

Technical and Bibliographic Notes / Notes techniques et bibliographiques

The Institute has attempted to obtain the best original copy available for filming. Features of this copy which may be bibliographically unique, which may alter any of the images in the reproduction, or which may significantly change the usual method of filming, are checked below.

L'Institut a microfilmé le meilleur exemplaire qu'il lui a été possible de se procurer. Les détails de cet exemplaire qui sont peut-être uniques du point de vue bibliographique, qui peuvent modifier une image reproduite, ou qui peuvent exiger une modification dans la méthode normale de filmage sont indiqués ci-dessous.

Coloured covers/
Couverture de couleur

Coloured pages/
Pages de couleur

Covers damaged/
Couverture endommagée

Pages damaged/
Pages endommagées

Covers restored and/or laminated/
Couverture restaurée et/ou pelliculée

Pages restored and/or laminated/
Pages restaurées et/ou pelliculées

Cover title missing/
Le titre de couverture manque

Pages discoloured, stained or foxed/
Pages décolorées, tachetées ou piquées

Coloured maps/
Cartes géographiques en couleur

Pages detached/
Pages détachées

Coloured ink (i.e. other than blue or black)/
Encre de couleur (i.e. autre que bleue ou noire)

Showthrough/
Transparence

Coloured plates and/or illustrations/
Planches et/ou illustrations en couleur

Quality of print varies/
Qualité inégale de l'impression

Bound with other material/
Relié avec d'autres documents

Continuous pagination/
Pagination continue

Tight binding may cause shadows or distortion along interior margin/
La reliure serrée peut causer de l'ombre ou de la distorsion le long de la marge intérieure

Includes index(es)/
Comprend un (des) index

Blank leaves added during restoration may appear within the text. Whenever possible, these have been omitted from filming/
Il se peut que certaines pages blanches ajoutées lors d'une restauration apparaissent dans le texte, mais, lorsque cela était possible, ces pages n'ont pas été filmées.

Title on header taken from:/
Le titre de l'en-tête provient:

Title page of issue/
Page de titre de la livraison

Caption of issue/
Titre de départ de la livraison

Masthead/
Générique (périodiques) de la livraison

Additional comments:/
Commentaires supplémentaires:

This item is filmed at the reduction ratio checked below/
Ce document est filmé au taux de réduction indiqué ci-dessous.

10X	12X	14X	16X	18X	20X	22X	24X	26X	28X	30X	32X
								✓			

The Canadian Patent Office

RECORD

Vol. XIX.—No. 1.

JANUARY, 1891.

{ Price in Canada \$2.50 per An.
United States - \$2.50 "

INVENTIONS PATENTED.

NOTE.—Patents are granted for 15 years. The term of years for which the fee has been paid, is given after the date of the patent.

No. 35,682. Chain for Halters. (*Chaîne de licou.*)

Oneida Community, Kenwood, New York, (assignees of Harry Eugene Kelley, Niagara Falls, New York.) U.S.A., 3rd January, 1891; 5 years.

Claim.—1st. A halter chain, provided at its ends with suitable fastenings, and a slide or ring arranged loosely upon the chain between said fastenings, whereby the ring may slide upon the chain to form a larger or smaller noose, substantially as set forth. 2nd. A halter chain, provided at its ends with suitable fastenings, and a slide arranged upon the chain between said fastenings, and provided with a ring or opening which is smaller than said fastenings through which the chain passes, and with a larger opening or loop to which the end fastenings of the chain may be attached, substantially as set forth. 3rd. A slide for a halter chain, provided with two openings, and a cross bar arranged between said openings, and provided with a slot connecting the openings, substantially as set forth. 4th. A halter chain, provided at its ends with suitable fastenings, and a slide or ring arranged loosely upon the chain between said fastenings, and provided with spurs which embed themselves in the post or other object upon tightening the chain upon the same, substantially as set forth. 5th. A halter chain, provided at its ends with suitable fastenings, and a slide or ring arranged loosely upon the chain between said fastenings, and provided with spurs bent alternately in opposite directions, substantially as set forth.

No. 35,683. Plug for Blasting.

(*Bouchon pour trous de pétard [mines].*)

Julius Hopkins Halsey and Charles Paul Ricker, both of Corsicana, Texas, U. S. A., 3rd January, 1891; 5 years.

Claim.—1st. A hollow blasting-plug divided longitudinally into two sections and one section having a disk-head coextensive with the external caliber of the plug, substantially as described. 2nd. A hollow blasting-plug divided longitudinally in two sections, having their adjoining edges rabbeted together, and one section provided with a disk-head coextensive with the external caliber of the plug, substantially as described. 3rd. A hollow blasting-plug divided longitudinally into independent sections, each having external transverse ridges or ribs, and one section provided with a disk-head coextensive with the external caliber of the plug, substantially as described. 4th. A hollow blasting-plug divided longitudinally into two sections of unequal length, the short one having a perforated diaphragm at one extremity, and the other having a perforated disk-head overlying said diaphragm and coextensive with the external caliber of the plug, substantially as described. 5th. A hollow blasting-plug having a vent and divided longitudinally into independent sections, one of which is provided with an internal brace-rib, substantially as described. 6th. A hollow blasting-plug divided longitudinally into two independent sections, and one having an internal brace rib and a disk-head coextensive with the external caliber of the plug, substantially as described. 7th. A hollow blasting-plug having a vent and divided longitudinally into two independent sections, each having a series of transverse beveled ribs or ridges extending in a circle round the same, and the ends of which vanish in the body of the section adjacent to the longitudinal dividing-line, substantially as described.

No. 35,684. Shuttle for Sewing Machines.

(*Navette pour machines à coudre.*)

Samuel Burgee Fuller, Watertown, Wisconsin, (assignee of Lee Alexander Miller, Portage, Wisconsin.) U. S. A., 3rd January, 1891; 5 years.

Claim.—1st. A sewing machine shuttle shell, having solid sides,

and a slot in its upper surface intermediate between the ends thereof, a tension spring secured to said shell, and having a free end yielding vertically within said slot, a superimposed shuttle spring, and a threading slit formed wholly in the top surface of said shell, and extending from the rear edge thereof forward to a point about midway of the length of the said tension spring. 2nd. In a sewing machine shuttle, having a threading slit and a slot in its upper surface communicating with the threading slit, a tension spring having a right angled slot communicating with said first named slot, and a raised inner free end yielding within said slot, and a superimposed shuttle spring normally resting on said raised portion of the tension spring, and secured to the shuttle at each end. 3rd. In a sewing machine shuttle, the combination, with the shell having a slot in its upper surface, and a depression or recess at one end, next and in line with said slot and of less length than the latter, and a tension spring having one end in said recess, and the other end yielding within said slot and extending the full length thereof, of a superimposed shuttle spring secured at one end of said shell, and a screw passing through both springs at the other end of said shell, and into said recess, whereby when said screw is loosened, the free end of the tension spring will drop away from the shuttle spring, by gravity, and when said screw is tightened, said free end of the tension spring will automatically rise and press against the under side of said shuttle spring, and the latter spring be simultaneously compressed down against the tension spring. 4th. In a sewing machine shuttle, the combination, with a solid sided shell having a longitudinal slot in its upper surface, a threading slit extending from the rear end of the upper surface of said shell to a point about midway of said slot, and a tension spring movably located in said slot, and having a right angled slot communicating transversely with the end of the said threading slit in the shell, and thence continuing rearward in the direction of the length of the said tension spring, whereby the shuttle may be threaded directly from the rear end with one direct pull of the thread towards the point of the shuttle. 5th. In a sewing machine shuttle, the combination with a solid sided shell having a longitudinal slot in its upper surface, a threading slit extending from the rear end of the upper surface of said shell to a point about midway of said slot, a tension spring movably located in said slot and having a right angled slot communicating transversely with the end of the said threading slit in the shell, and thence continuing rearward in the direction of the length of the said tension spring, and a shuttle spring secured at each end only to the upper surface of the shell, and normally in contact with the free end of the tension spring, whereby the said shuttle may be threaded directly from the rear end with one direct pull of the thread towards the point of the shuttle, and any foreign substance between the two springs simultaneously removed thereby.

No. 35,685. Wood Working Machine.

(*Machine à travailler le bois.*)

J. W. Carver, Auburn, Me., U. S., J. S. Bent, Boston, Mass., U. S., and H. F. Hawkes, Swampscott, Mass., U. S., 3rd January, 1891; 5 years.

Claim.—1st. A wood working machine, having two rotary cutter heads and two longitudinally movable shafts on which said cutter heads are mounted, a non-rotary clamp, a longitudinally movable shaft therefor, an opposing normally stationary clamp, a non-rotary shaft therefor which is normally stationary and an adjusting screw for said shaft, whereby the position of said stationary clamp may be varied to adjust the clamps for different thicknesses of work, substantially as shown and described. 2nd. In a wood working machine, the combination, with cutting mechanism, of a frame for supporting and guiding the wood, said frame being adjustably secured to the frame of the machine and being adjustable towards and from the cutting mechanism, whereby the wood-supporting frame may be adjusted towards and from said cutting mechanism to adapt the machine for different classes of work, substantially as shown and described. 3rd. In a wood working machine, the combination of duplicate clamping and cutting mechanism arranged to act simultaneously on both sides of the wood, with supporting and feeding mechanism consisting of a horizontal frame for holding the wood in position, and a horizontally reciprocating feed-dog, whereby the wood is securely held while the disk is being cut and is then fed forward to bring a new portion of the wood into position between the

No. 35,690. Washing Machine.*(Machine à blanchir.)*

Marvin Antony Caldwell, North East, Pennsylvania, U.S.A., 3rd January, 1891; 5 years.

Claim.—1st. In a washing machine, the combination, substantially as described, of a vertically yielding perforated rubbing plate D, and a chamber back, of and closed by said plate, and into which the latter sinks when it yields to pressure. 2nd. In a washing machine, the combination, substantially as described, of a chamber formed of the frame A and the back B, curved, as described, and the perforated yielding rubbing plate closing the top of said chamber. 3rd. In a washing machine, the combination of a chamber formed by the frame A and back B, the perforated or yielding rubbing plate closing the top of said chamber, and a spring secured to the loose end of the yielding plate and to the frame. 4th. In a clothes washing machine, the combination with the yielding perforated rubbing plate D, of the frame A, the chamber below said plate, of the packing strips C along the under side of the edges of said plate. 5th. In a washing machine, the combination of a yielding perforated rubbing plate, a chamber below said rubbing plate and closed by the latter, and a vertically yielding rubbing device arranged to act upon said plate, reciprocally. 6th. In a clothes washing machine, the combination with the yielding perforated rubbing plate D, and a chamber back of said plate which is covered thereby, of the pivoted yielding frame F, carrying a rubbing device at its free end in position to act upon and depress said plate, when the said frame is vibrated.

No. 69 Compound Wound Alternating Current Dynamo. *(Dynamo à courant alternatif composé et enroulé.)*

Herman Lemp, Lynn, Massachusetts, U.S.A., 3rd January, 1891; 15 years.

Claim.—1st. In a dynamo electric machine, the combination, with the field magnet coil, fed by an armature coil in circuit with the work, of a separate exciting source feeding the same field magnet coil in multiple with the said armature coil. 2nd. The combination of a transformer, whose primary is in the uncommutated portion, of the circuit of the armature of a dynamo, a field magnet coil in a locally-commutated portion of said circuit and in series with the primary, and an exciter armature coil operated in a field excited by its own currents, and also connected to the field-magnet coil, as and for the purpose described. 3rd. The combination, with a transformer for supplying large volume electric currents, of a dynamo machine, having a work circuit armature coil in series with the primary of the transformer, and a separate exciter connected in multiple with the first to the field magnet exciting circuit, as and for the purpose described. 4th. The combination, with a dynamo machine having an armature coil and field magnet coil in series with variable work, of a separate exciting coil feeding the field in multiple with the first armature coil, as and for the purpose described. 5th. The combination, with a dynamo machine, having a field coil in series with an armature coil and commutator, of a transformer, having its primary in a portion of said circuit where the current is uncommutated, and a separate armature coil supplying commutated current in multiple with the first-named armature coil to the field coil or circuit. 6th. The combination, in a dynamo machine, of a main circuit armature coil in series with the work and field magnet coil, and an exciter source or coil independent thereof, feeding the main coil in multiple with the first. 7th. In a dynamo electric machine, the combination with a work circuit coil, of an exciter coil, a commutator between the same and the field coil, a collector ring between a terminal of the exciter coil and the commutator, and a variable resistance between the collector brush for said ring and the commutator. 8th. The combination, with the exciter coil and the work circuit coil, of two collector rings in the circuit of the exciter coil, a variable resistance in the connection of the collector brushes therefor, two collector rings in the circuit for the work coil, brushes bearing on the same and including the work in circuit between them, and a commutator in the circuit of both coils, and between the same and the field magnet. 9th. In a dynamo electric machine, the combination, with the work circuit coil connected to the work through a suitable collecting ring, of an exciting armature coil connected to a separate collecting ring, and a variable reactive coil in the connection from the brush of said ring to the circuit of the first-named coil, as and for the purpose described. 10th. In a dynamo electric machine, the combination, with two revolving armature coils, of a field-magnet coil, and a commutator to which one terminal of each armature coil is connected, collector rings to which the opposite terminals of the coils are connected, and a third ring connected to the opposite side of the commutator, as and for the purpose described.

No. 35,692. Water Heating Attachment for Ranges. *(Calorifère à eau pour poêles de cuisine.)*

Henry Charles Steinhoff, Union, New Jersey, U.S.A., 3rd January, 1891; 5 years.

Claim.—1st. In a water-heating attachment to ranges, the combination, with the range hot-product chamber divided into independent flues communicating with the fire-pot, of auxiliary water pipes extending along one of said flues, a bonnet communicating by its independent passages or chambers with the separate hot product flues of the range and also with a common exit flue, and a damper at the bonnet adapted to direct the fire pot products to the exit flue either along the flue traversed by the water pipes or along the other flues of the range, substantially as described. 2nd. In a water-heating attachment to ranges, the combination with the range hot-product chamber divided into independent flues communicating with the fire-pot or auxiliary water pipes traversing the fire-pot to be heated thereby, and extended along one of the hot product flues, a bonnet communicating by its independent passages or chambers

with the separate hot product flues of the range, and also with a common exit flue, and a damper at the bonnet adapted to direct the fire-pot products to the exit-flue either along the flue traversed by the water pipes or along the other flues of the range, substantially as described. 3rd. In a water heating attachment to ranges, the combination, with the range hot-product chamber divided into independent flues, communicating with the fire pot, and a partitioned bonnet communicating by its independent passages or chambers with the separate hot product flues of the range and also with a common exit flue, of water pipes extended along one of said hot-product flues, and also into one passage or chamber of the bonnet, and a damper at the bonnet adapted to direct the fire-pot products to the exit flue, either along the flue and bonnet chamber traversed by the water pipes or through the other flues of the range and bonnet, substantially as described. 4th. In a water heating attachment to ranges, the combination, with the range hot-product chamber divided into independent flues communicating with the fire-pot, and a partitioned bonnet communicating by its independent passages or chambers with the separate hot-product flues of the range and also with a common exit flue, of water pipes traversing the fire-pot to be heated thereby and extended along one of the range hot product flues, and also into and along one passage or chamber of the bonnet, and a damper in the bonnet adapted to direct the fire pot products to the exit flue along either the flue and bonnet chamber traversed by the water pipes or through the other flues of the range, substantially as described. 5th. In a water heating attachment to ranges, the combination, with the main fire-pot having a ledge or shoulder formed preferably by its fire brick or refractory lining, of an auxiliary water heating pipe or coil set back of said ledge, and a bodily removable guard placed upon said ledge and shielding the pipe or coil from direct heat of the fire-pot, substantially as described. 6th. In a water heating attachment to ranges, the combination, with the main fire-pot having a ledge or shoulder formed preferably by its fire brick or refractory lining, and a hot product flue communicating with the fire-pot, of a water heating pipe or coil set back of said ledge and extending along said hot product flue, and a bodily removable guard adapted in part to said ledge and in part to the mouth of the hot product flue to shield the water heating pipes next the fire-pot and in the flue from the fire-pot products, substantially as described. 7th. In a water-heating attachment to ranges, the combination, with a range having a hot-product chamber divided into independent flues communicating with the fire-pot, of auxiliary water-heating pipes or coils traversing the side of the fire-pot next the direct hot-product flue and also extending along said flues, substantially as specified, said range fire-pot also provided with a water-back and pipe connections which are independent of the auxiliary water heating pipes or coils and their connections, substantially as described.

No. 35,693. Apparatus for Burning Hydro-Carbon. *(Foyer à hydrocarbures.)*

James Herbert Bullard, Springfield, Massachusetts, U.S.A., 3rd January, 1891; 5 years.

Claim.—1st. In an apparatus for burning hydro-carbon, the combination and arrangement of instrumentalities, as follows: a series of hydro-carbon burners, having oil and air-passages therethrough, a closed tank to be partially filled with oil constituting the oil supply located at a distance from and below said burners, an air-pump or compressor and a pipe leading from said air-pump to the air-space above the oil in said tank, a pipe leading from said oil-tank below the top of the oil therein upwardly to said burner, and a pipe leading from the air-space in said tank to the burner for supplying air under pressure to said burner, substantially as described. 2nd. In a hydro-carbon burner, a coupling body having therein an air-passage terminating in a pipe extension, open at its forward end, and a chamber separated from said passage for receiving oil therein, and having an opening therethrough, which is extended in the forwardly continued tube F, which terminates in proximity to the nozzle of said pipe extension, an axial spindle movably supported in the rear of said coupling body and adapted to open and close the ingress opening to said tube F, for the purpose set forth. 3rd. In a hydro-carbon burner, a coupling body having therein an air-passage terminating in a pipe extension formed with an opening in its forward end, and a chamber separated from said air passage for receiving oil therein, and having an opening therethrough, a tube movable through said opening and forwardly continued in a tubular extension movable therewith, and having its forward end open and in proximity to the nozzle of said pipe, said tube being provided with one or more perforations through the portion thereof, which is within said chamber, and having internally thereof and in advance of said valve perforations, a valve seat, an axial spindle supported in said tube at the rear of said valve-seat and capable of an independent longitudinal movement in said tube, whereby its forward end may open and close the valve seat, substantially as and for the purpose described.

No. 35,694. Hydro-Carbon Burner.*(Foyer à hydrocarbures.)*

Harrison Newell Davis, Armourdale, Kansas, U.S.A., 3rd January, 1891; 5 years.

Claim.—1st. In a hydro-carbon burner, the combination with a pan or water receptacle A, provided with an interior and separate chamber B, of the water-supply pipes E and D provided respectively with a funnel and valve J, substantially as described. 2nd. In a hydro-carbon burner, the combination of a separate chamber B located in the side of a water receptacle or pan A, and provided with the perforations, as shown, with an oil reservoir K, by means of suitably arranged conducting pipes, controlled by a valve L, substantially as and for the purpose set forth. 3rd. In a hydro-carbon burner, the combination with a water receptacle A, of a burner P having the annular chambers O, Q, and R formed by the annular walls S, T, U and V, through the medium of the short vertical feed pipes M, substantially as described. 4th. In a hydro-carbon burner, the pan or burner P, having the annular chambers O, Q and R, the annular walls S, T, U and V enclosing said chambers, the communi-

cating or overflow notches *t* and *u* in walls *T* and *U*, the enlarged central air chamber *W* and the series of air chambers *o*, *g*, *r* enclosed by the annular walls *o'*, *q'* and *r'*, substantially as and for the purpose set forth.

No. 35,695. Centre Board for Vessels.

(*Semelle de vaisseau.*)

James H. McPartland, Houlton, Maine, U.S.A., 3rd January, 1891; 5 years.

Claim.—1st. The combination with the sectional flanged casing *D* adapted to be applied to a vessel, as described, and a vertical guiding and supporting tube rising from the cap of said casing, of a centre board provided with a vertically and axially adjustable jointed rod, substantially as and for the purposes described. 2nd. The combination with a centre board casing and its guiding tube, of a vertically and axially adjustable centre board, the vertical shouldered rod to which this board is rigidly secured, and the two sections *H*, *J* jointed as described.

No. 35,696. Artificial Marble.

(*Marbre factice.*)

Richard Guelton, Hoboken, New Jersey, U.S.A., 3rd January, 1891; 5 years.

Claim.—1st. The process of manufacturing imitation marble in any desired form or color, by first laying upon a suitable supporting surface lines and figures in thin colored cement to represent the veins and markings of the marble, next laying thereon a suitable backing of suitably colored and shaded plastic cement, next removing by an application of dry cement all superfluous moisture from the thin slab or layer thus produced, then, after removing the dry plastic cement, and finally, after allowing the whole to harden, removing the set and hardened piece of cement from the supporting surface, and stoning and polishing its colored face, all substantially in manner as described. 2nd. The within described process of applying artificial marble to ceilings, walls, or curved surfaces by producing upon a facing sheet of paper, cloth, or other suitable flexible or textile material, a thin layer of plastic cement, colored and shaded in manner as set forth in imitation of marble, and after removing the superfluous moisture therefrom transferring said layer of cement supported by the underlying flexible sheet to the surface, to be removed with the cement face against said surface, and finally recoving the facing sheet, all substantially in the manner and for the purpose herein set forth.

No. 35,697. Speed Indicator for Vehicles.

(*Indicateur de vitesse pour voitures.*)

Fred Newton Scofield, Phoenix, Arizona, U.S.A., 3rd January, 1891; 5 years.

Claim.—1st. In a horse-timer, the combination with the friction wheel, its shaft, and the flexible shaft of the time-indicating hand, substantially as described. 2nd. In a horse-timer, the combination with the friction wheel and its shaft, and the time indicating hand of the concomitant speed indicating hand, the flexible shaft connected with the shaft of the friction wheel, and means for effecting a stoppage of the two hands at one and the same time, substantially as shown and described. 3rd. In a horse-timer, the combination with the shaft *e*, the plate or disk *G* and the shaft *J*, of the combination with the arm *k* to engage with and disengage the plate *G* and shaft *J* having substantially as shown and described. 4th. The combination with the shaft *e*, having hand *E*, the hub *p*, the plate *G* and shaft *J*, of the spring *I*, having forked, and bearing on said hub and the shaft *K*, having an arm *k*, substantially as and for the purpose described. 5th. The combination with the balance wheel and the shaft *K*, of the brake spring *N* and the curved rod *M* adapted to operate together to stop the balance wheel and turn the shaft *K*, substantially as described.

No. 35,698. Label Case for Medicine Bottles and Jars.

(*Etui d'etiquette pour bouteilles et jarres de médecine.*)

Oliver E. Given, Stuart, Iowa, U.S.A., 3rd January, 1891; 5 years.

Claim.—A label case adapted to be fixed to the outside convex surface of a jar or bottle, so that the cover will slide at right angles to the jar comprising a case, having a concave back, a spring fixed to the inside of the back to press cards outward and away from the bottle, and a sliding cover fitted to the open front of the case to slide at right angles to the bottle, and provided with an opening to allow the finger of a person to come in contact with the gummed surface of a label under the cover, substantially as shown and described.

No. 35,699. Machine for Preparing Drive Chains for Shipment.

(*Machine à préparer les chaînes sans fin pour chargement.*)

James Douglas Storie, of Oshawa, Ontario, Canada, 3rd January, 1891; 5 years.

Claim.—1st. In a machine for preparing drive chains for shipment, the combination with a table, of a support for a coil of chain from which the same can be unwound, scale indicators for measuring lengths of chain, a rotating key, with means for operating same, and a yielding pressure, whereby such lengths of chain can be compactly wound into coils. 2nd. In a machine for preparing drive chains for shipment, the combination with a table, of a spindle, suitably supported, on which a coil of chain can be placed and ro-

tated, one or more pins projecting from said table at a distance from such spindle, and means for indicating the point of detachment of portions of the chain from its coil for the purpose described. 3rd. In a machine for preparing drive chains for shipment, the combination with a table, of a horizontal spindle suitably supported, so as to extend at a convenient height across same, one or more pins projecting from such table at a distance from such spindle, and one or more scale divisions marked on the surface of the table, between said pins and a point beneath the spindle for the purposes described. 4th. The combination with table *A*, spindle *T* and its support, of pins *t*, *l*, as shown and described. 5th. In a machine for preparing drive chains for shipment, the combination with a table, of a key or spindle to which the end link is connected and upon which the chain is wound, and means for operating such key, of a yielding roller or shoe bearing against the coil and imparting friction thereto, for the purposes set forth. 6th. In a machine for preparing drive chains for shipment, the combination with a table, of a key or spindle for winding the chain into a coil, means for operating such key, a yielding roller or shoe bearing against such coil and imparting friction thereto, and means for regulating the extent of such frictional pressure, all as and for the purposes set forth. 7th. In a machine for preparing drive chains for shipment, the combination with table *A*, provided with slots *u* and with means for winding the chain, of slide *U*, roller *X* carried thereby, whipple-trees *U'*, spring *U''*, and means for adjusting said slide and roller with relation to the device for winding the chain, as and for the purposes set forth. 8th. In a machine for preparing drive chains for shipment, the combination with a table on which the chain rests edge upward, of a key or spindle projecting above the surface of such table and to which the end link is connected and upon which the chain is wound, such key or spindle being adapted to be withdrawn from the coil and leave the latter intact upon the table, and means for operating such key. 9th. In a machine for preparing drive chains for shipment, the combination with table *A* on which the chain rests edge upward, and suitable bearings, of a vertical plunger, a head piece *J* adapted to be carried by same, a spring arranged beneath and exerting a pressure on such plunger, a sleeve encircling both the plunger and the spring, means for connecting said plunger with said sleeve, means for rotating said sleeve, and means for depressing said plunger, as and for the purpose set forth.

No. 35,700. Apparatus for Treating Drive Chains.

(*Appareil pour préparer les chaînes sans fin.*)

James Douglas Storie, Oshawa, Ontario, Canada, 3rd January, 1891; 5 years.

Claim.—1st. The winding key or spindle, having a slit or recess for retaining the end link of a chain to be wound thereon, and sides configured to suit the shape of the centre of the coil. 2nd. The combination with a table and a key or spindle adapted to act as the core of a chain wound thereon, of a yielding roller or shoe bearing against the coil and imparting friction thereto as the coil is being wound, while issuing from mechanism for measuring the test strain of such chain, and means for effecting such yielding pressure. 3rd. In a machine for treating drive chains, the combination with a table, of a series of friction rollers mounted vertically thereon, and having their spindles passing through said table, whereby the chain may pass between said rollers edge upwards, for the purpose described. 4th. In a machine for treating drive chains, the combination with means for retaining the chain until the limit of test strain has been put on, of a series of rollers through which the chain is threaded, one or more of which is adapted to yield with the strain, and means in connection therewith for releasing the chain from the retaining devices. 5th. In a machine for treating drive chains, the combination with a table on which the chain rests edge upwards, and pulling mechanism, of a series of friction rollers mounted vertically thereon, and having their spindles passing through said table, a lever pivoted to and slides adjustable in such table, to which lever and slides such spindles are alternately connected for the purposes described. 6th. In a machine for treating drive chains, the combination with a table on which the chain rests edge upwards, and with mechanism for determining the test strain, of a device for winding the chain into a coil during its issuance from such testing mechanism, different portions of such chain being at the same time respectively tested and wound. 7th. The combination with a pair of shoes adapted to grip the chain until the limit of strain has been put on, of one or more series of rollers through which the chain is threaded and adapted to limber the same, and devices for applying a regulated test strain to said chain, while the operation of limbering is proceeding. 8th. The combination with a series of rollers through which the chain is threaded for limbering the same, of devices for applying a regulated test strain, and a key or spindle upon which the chain is wound, as it comes direct from such limbering and testing devices, substantially as described. 9th. In a machine for treating drive-chains, the combination, with a device for retaining the chain at one time, and offering a yielding resistance or friction thereto at another, and with means for effecting a pull on the chain of two graduated weighted scale beams and two levers adapted to operate together in such manner that the movement of one lever actuates the other, so that the chain is released from the retaining device and a specified test strain put thereupon. 10th. In a machine for treating drive chains, the combination with a device for retaining the chain at one time and offering a yielding resistance or friction thereto at another, and with means for effecting a pull on the chain of a series of rollers adapted to assist such device in offering a yielding resistance to the chain. 11th. The combination, with the table *A* and the sprocket wheel *G*, of the adjustable guide plate *G'* acting to prevent chain adhering to such wheel beyond a desired distance, and means for securing said plate in position, as shown and described. 12th. In a testing machine, the combination with pulling mechanisms, of the double-ended scale beam *O*, with weights attached to both ends, and means for bearing the weight at one end, while allowing its drop or gravity to act upon the end of the beam, as and for the purposes set forth. 13th. In a testing machine, having pulling mechanism, the combination with a table and scale

beam O, with weights attached to both ends of sheave O³, hung from table, and a cord passing over said sheave and serving to attach one of said weights to said beam, as shown and described. 14th. In a machine for treating drive chains, friction rollers mounted vertically on a table, and having two grooved peripheral recesses at their lower ends, for the purpose set forth. 15th. The combination with table A and scale beam O, suitably pivoted, and having weights connected with each end of lever E, chain N and sheave N¹, as and for the purpose set forth. 16th. The combination with table A, lever E, and means for operating same, of lever K having sliding weight side b¹ and k¹, as and for the purpose set forth. 17th. In a machine for treating drive chains, the combination with a suitable support, and means for offering a yielding resistance to the passage of the chain, of a double-armed scale beam, with one arm graduated and carrying a sliding weight to secure pressure and the other adapted to exert such pressure.

No. 35,701. Tower for Electric Lights.

(*Tour pour lumières électriques.*)

David Maxwell, Detroit, Michigan, U. S. A., 3rd January, 1891; 5 years.

Claim.—1st. In a trussed tower a central tube or column supported upon a tripod, said tripod consisting of tubular legs, said legs at their upper ends united to said central column, substantially as described. 2nd. In a trussed tower, a central tube or column supported upon a tripod, consisting of legs, and having in combination therewith a plate a, a cap a¹, rings a², and plate a³, uniting said legs to said column, substantially as described. 3rd. In a triangular tower, the combination with a central tube or column of perpendicular bars D, connected with said column by struts and braces, and a supporting tripod, substantially as described. 4th. In a triangular tower, the combination with a central tube or column of perpendicular bars D, struts and braces uniting said bars to the central column, a supporting tripod united to said column, a head casting located upon said column, said perpendicular bars spread at their base and united with said head casting at the top, substantially as described. 5th. In a tower, a central tube or column supported upon a tripod consisting of legs, connecting devices uniting the legs with the column, perpendicular bars D, united with said column by struts and braces, and braces run from the lower struts to the said connecting devices, substantially as described. 6th. In a trussed tower, a central column supported upon a tripod, an angle plate engaging the feet of the tripod and an anchoring plate engaged with said angle plate, substantially as described. 7th. In a trussed tower, a central column, a supporting tripod, connecting devices uniting said tripod with said column, the central column provided with bushing to support the connecting devices, substantially as described. 8th. In a trussed tower a central column, a supporting tripod, connecting devices uniting the tripod and column, and bolts or rods uniting said connecting devices, substantially as described. 9th. In a tower, the combination of the central column supporting tripod perpendicular bars D, struts uniting said bars to said column, collars uniting the struts to the column, and braces D¹, D², connecting the outer ends of said struts with the collars, substantially as described. 10th. In a tower, the combination of the central column, perpendicular bars united to the column by struts and braces, a supporting tripod and a platform at the top of the tripod, substantially as described. 11th. In a tower, the combination with a central column of perpendicular bars D, horizontal struts, and angular braces uniting said bars to said column, and horizontal braces uniting the outer extremities of the struts, substantially as described. 12th. In a trussed tower, a central tube or column provided with a weight located therein, a cable to operate said weight, a head casting I, and lower casting A³, engaged with said column, and pulleys journaled in said castings over which said cable is engaged, substantially as described. 13th. In a trussed tower, a central tube or column provided with a weight located therein, a head casting I, and lower casting A³, engaged with said column, pulleys journaled in said castings, a cable engaged with said weights and over said pulleys, said weight provided with a stern N², and said lower casting with an orifice to receive said stem, substantially as described. 14th. In a trussed tower, a central tube or column provided with a weight, a cable connected with the extremities of the weight and extended outside said column, a casing P⁴, to protect said cable, and a device to support said casing, substantially as described. 15th. In a tower, a central tube or column, provided with a weight, lamp-supporting arms engaged upon said column, lamp-supporting cables connected with independent lamps, engaged upon said arms and with said weight, and an operating cable connected with said weight the construction being such that the movement of the weight will raise and lower the individual lamps, substantially as described. 16th. In a tower, a central tube or column, provided with a weight, lamp-supporting arms engaged upon said column, lamp-supporting cables connected with independent lamps engaged upon said arms and with said weights, and guide cables to steady the lamps, substantially as described. 17th. In a tower, a central tube provided with a head casting, lamp-supporting arms engaged upon said casting, a weight located within the central tube, lamp-supporting cables engaged with said arms and weight, substantially as described. 18th. In a tower, a central tube provided with a weight, a head casting engaged upon said tube, said tube recessed on its periphery and provided with encircling bands P¹, and lamp-supporting arms engaged with said bands, substantially as described. 19th. In a tower, a central tube provided with a head casting and an interior weight, lamp-supporting arms engaged upon said casting, pulleys journaled in said casting and upon said arm, and lamp-supporting cables engaged over said pulleys and connected with said weight, substantially as described. 20th. In a tower, a central tube provided with a weight and lamp-supporting arms, a cable connecting independent lamps with said weight and guide cables to steady the lamp, said arms provided with casings q², sleeved upon said cables, substantially as described. 21st. In a tower, a central tube provided with a weight and with lamp-supporting arms, a cable engaged upon, said arms connecting independent lamps with the weight, guide cables to steady the lamps, said cables provided

with a turn-buckle and spring, substantially as described. 22nd. In a tower, a central tube provided with a weight and with lamp-supporting arms, a cable engaged upon said arms, connecting independent lamps with said weights, guide cables to steady the lamp, casings depending from said arms to embrace the upper ends of said guide cables, the lamp frame constructed to receive said casings, substantially as and in the manner described. 23rd. The combination of a lamp frame, a cable connecting the lamp frame with the weight, devices to steady the lamp frame when drawn up to the supporting arms, said lamp frame perforated as at q¹, to engage the steadying device, substantially as described. 24th. In an electric tower, the combination with a lamp supporting arm of an insulated connecting pin R¹, engaged therewith, substantially as and for the purposes described. 25th. In an electric tower, the combination with a lamp supporting arm, of arms R, supporting insulated pins R¹, substantially as described. 26th. In an electric tower, the combination with a lamp supporting arm, of a pin, a casing for said pin insulated therefrom, and a line wire connected with said pin, substantially as described. 27th. In a tower, a central tube, having in combination therewith a head casting, a lamp supporting arm engaged therewith, a lamp supporting cable engaged upon said arm, pulleys journaled upon said arm and in said casing to receive said cable, and a protecting covering for said cable and pulleys, substantially as described. 28th. In a tower, the combination with a central tube, provided with a head casting of perpendicular rods having a trussed engagement upon the central tube, a recessed plate engaged upon said casting, said perpendicular rods engaged at their upper ends with said plate and casting, substantially as described. 29th. In a tower, the combination with an arm of a lamp supported thereon, said lamp and arm provided with circuit closing devices, and means to lower and raise the lamp, the circuit being open when the lamp is lowered, and closed when raised into position, substantially as described. 30th. In a tower, the combination with an arm of a lamp supported thereon, said arm and lamp provided the one with a connecting pin, and the other with a spring to close the circuit when the lamp is raised into position, substantially as described. 31st. In a tower, the combination of a central tube, a supporting tripod, a cap a¹, uniting the upper ends of the legs of the tripod to the central tube, and a hub W, engaged with said cap and having a screw threaded engagement with said tube, substantially as described.

No. 35,702. Brake for Cars. (*Frein de chars.*)

John Paul Clancy, Scottsdale, Pennsylvania, U. S. A., 3rd January, 1891; 5 years.

Claim.—1st. In an automatic brake mechanism for railroad cars, the combination of the brake bars suspended by suitable hangers, the levers extending from said brake bars, a lever pivoted horizontally centrally under the car frame, rods connecting the ends of said lever with the levers extending from the brake bars and suitable connections between the ends of the horizontal lever and push bars mounted to slide longitudinally under the draw-head at the ends of the car frame, substantially as and for the purpose set forth. 2nd. In a car brake, the combination of the car frame, the vertical plates secured under the main sills of the same, the push bars mounted to slide longitudinally in slots in the said plates, braces connecting the lower ends of the latter with the centre sills of the car, and having boxes or bearings at their upper ends, the bifurcated levers mounted in said boxes or bearings and connected pivotally at their lower ends with the said push bars and suitable connection between the upward extending arms of said levers and the brake mechanism, substantially as and for the purpose set forth. 3rd. In a car brake, the combination with the car frame of the longitudinally sliding push bars at the ends of the frame, the brake mechanism, levers connected with and actuated by the push bars, a lever connected with and actuating the brake mechanism, connecting rods connected directly with the brake lever, and chains connecting each connecting rod with one of the levers actuated by the push bars at different distances from the fulcrums of said levers, substantially as set forth. 4th. In a car brake, the combination of the push bars the bifurcated levers connected with and actuated by said push bars, the chains attached to the forked arms of said levers at different distances from their fulcrums, the rods connected with said chains, the horizontal lever connected with said rods and the brake mechanism connected with and actuated by said horizontal lever, substantially as set forth. 5th. In a car brake, the combination of the brake bars mounted in suitable hangers, the link rods connecting said brake bars with a lever pivoted horizontally under the car frame the longitudinally sliding push bars at the ends of the car frame and the rods and links forming connections between the bifurcated levers actuated by said push bars and the horizontal brake operating lever substantially as set forth. 6th. In a car brake, the combination of the brake bars, a lever mounted horizontally under the car frame, link rods connecting the ends of said lever with the brake bars, the horizontal sliding push bars arranged under the ends of the car, the bifurcated levers connected with said push bars, the link rods each having its ends connected by two separate chains with the upward extending arms of the bifurcated levers at different distances from the fulcrums of said levers and the chains having interposed springs connecting the said link rods with the ends of the horizontal brake operating lever, substantially as set forth. 7th. In a car brake, the combination with the brake actuating push bars mounted to slide horizontally under the end sills of the car frame, and provided with pulleys at their rear ends, of chains attached to the under sides of the end sills, passing over the pulleys at the rear ends of the push bars over suitable guide pulleys upward through perforations in the end sills and attached to operating levers by means of which the said push bars may be thrown in an outward or forward direction, substantially as set forth. 8th. In a car brake, the combination of the brake bars mounted in suitable hangers, link rods connecting the said brake bars with the ends of a lever mounted horizontally under the car frame, the horizontally sliding push bars mounted under the ends of the car frame, the bifurcated levers connected with said push bars, link rods and chains connecting the said levers, the chains having interposed springs connecting the link

rod with the horizontal brake operating lever, and mechanism for throwing the said brake actuating push bars in an outward or forward direction, substantially as and for the purpose set forth. 9th. In a car brake, the combination of the brake bars suspended in suitable hangers under the car frames, the horizontal levers mounted under the car frames, the link rods connecting the ends of the said levers with the brake bars, the horizontally sliding push bars arranged under the ends of the car frames, the bifurcated levers connected with said push bars, the rods and chains connecting the said bifurcated levers, the chains having interposed springs connecting the connecting rods with the brake actuating levers, the springs attached to said levers to automatically release the brakes, the longitudinally sliding push bars arranged under the engine tender of the train and mechanism for throwing the said push bars in an outward direction, substantially as herein described, and for the purpose set forth. 10th. In a car brake, the combination of the brake mechanism arranged under the tender, the longitudinally sliding push bar and steam actuated mechanism for simultaneously setting the brakes on the tender, and throwing the push bar in an outward or forward direction, substantially as and for the purpose set forth. 11th. In a car brake, the combination with a push bar arranged to slide longitudinally under the tender, of a longitudinally adjustable extension bar mounted upon the said push bar and mechanism for throwing the latter in an outward and forward direction against the tension of a retracting spring, substantially as set forth. 12th. In a car brake, the combination of the brake mechanism arranged under the cars, the longitudinally sliding push bars connected with said brake mechanism to actuate the latter, mechanism whereby the rear push bar shall be moved outwardly a greater distance than the inward movement of the front push bar, a push bar mounted under the engine tender and mechanism for throwing the latter push bar in an outward or forward direction against the tension of a retracting spring, substantially as and for the purpose set forth.

No. 35,703. Fastening for Lamp and Lantern Burners. (*Attache de bec de lampe et de lanterne.*)

Dominion Tubular Lamp Company, Syracuse, New York, U. S. A., (assignees of Clovis Lapierre, Montreal, Quebec, Canada,) 3rd January, 1891; 5 years.

Claim.—1st. The combination with the base or oil pot having a burner socket and an air chamber surrounding said socket, of a burner seated in said socket and spring catches arranged within said air chamber and holding the burner in its socket, substantially as set forth. 2nd. The combination with the base or oil pot having a burner socket, a burner seated in said socket and provided with a surrounding gallery and spring catches secured in said base or oil pot and engaging with the burner gallery whereby the burner is locked in the socket, substantially as set forth.

No. 35,704. Amalgamator. (*Moulin à amalgamer.*)

Milton T. Van Derveer, Amsterdam, New York, U. S. A., 3rd January, 1891; 5 years.

Claim.—1st. In an amalgamating machine, the combination of the casing filled with mercury and having a feed-hopper and delivery chamber with revoluble screw-conveyor submerged in the mercury and having a mouth to receive the pulp from the hopper and a mercury delivery tube P, below the chamber, and the mechanism for operating said screw, substantially as specified. 2nd. The combination of the casing having an upstanding feed-hopper and delivery chamber at its opposite ends, and a tubular body with a tubular screw conveyor mounted in the tubular body having a series of internal blades secured to the outer wall thereof and the mechanism for operating said conveyor, substantially as described. 3rd. The combination of the casing having a feed-hopper and delivery chamber at opposite ends and the revoluble screw-conveyor therein adapted to receive and carry the pulp from the hopper to the delivery-chamber through the body of amalgamating fluid with the agitator in the delivery-chamber composed of conical perforated disks, constructed and arranged, substantially as set forth. 4th. The combination of the casing having a feed-hopper and delivery-chamber with the agitator mounted in said chamber, and composed of the spider and conical disks perforated near their center and having corrugated edges, all substantially as specified. 5th. The combination of a casing having a tubular body and a feed-hopper and delivery-chamber at opposite ends thereof with the shaft D, the tubular screw-conveyor mounted thereon having an internal series of transverse blades and a receiving-mouth n, adapted to rise above the level of mercury in the feed-hopper, the agitator in said chamber and the mechanism, substantially as described, for imparting motion to the screw and agitator, substantially as set forth. 6th. The combination of the casing having an inclined tubular body and a feed-hopper and delivery-chamber at opposite ends thereof with an inclined archimedean screw-conveyor for the pulp mounted on an inclined shaft in the tubular body of the casing and mechanism for operating the same, substantially as set forth. 7th. The combination of a casing A, having an inclined tubular body with the inclined tubular screw-conveyor N, submerged in mercury, and the blades O, in said conveyor and the shaft and gearing for operating said conveyor, all substantially as specified. 8th. The combination of the casing constructed, substantially as described, and the tubular screw-conveyor therein, mounted on a central shaft and having a series of internal blades O, and mouth n, and the shaft and gearing for operating said conveyor with the oscillating agitator I, composed of spider K, and perforated disks J, J, L, all substantially as and for the purpose described.

No. 35,705. Brake for Vehicles.

(*Frein de voiture.*)

Thomas Sydney Smith, Henry Copperthite, George Henry Prindle and Philip Gray Russell, all of Washington, District of Columbia, U.S.A., 3rd January, 1891; 5 years.

Claim.—1st. In combination with a piece, having the stem for supporting the brake-block, provided with a lug, the brake-block having the two ears with openings through which the supporting stem passes, situated on opposite sides of the stem-lug, substantially as and for the purpose shown. 2nd. In combination with the brake block supporting stem, provided with a lug, the brake-block having the two ears with openings to receive the supporting stem, and the stop between the ears to engage the lug on the stem to limit the swing of the block around the latter, substantially as and for the purpose set forth. 3rd. In combination with the supporting stem, having the lug, a brake-block having the ears provided with stem-receiving openings with offsets, and the lug-engaging stop between such ears, out of line with the offsets from the stem-receiving openings, substantially as and for the purpose described. 4th. In combination with a suitable head, provided with a stem having a lug, the brake-block provided with the two ears on its back, each having a stem-receiving opening with an offset, and a stop between the ears to engage the stem-lug when the block has been turned to bring the offsets in the ear-openings, and the lug on the stem diametrically opposite each other, substantially as and for the purpose specified. 5th. In combination with the brake-block supporting stem, having a lug on its under side, the brake-block having the two ears on its back, provided with the stem-receiving openings and offsets from such openings, and with a stop to engage the lug on the under side of the stem, such stop and the offset from the openings in the ears being out of line with each other, substantially as and for the purpose shown. 6th. A brake-block, having on its back the two ears, with openings for the reception of a supporting stem and offsets from such openings, and a stop projection between the two ears, out of line with the offsets, substantially as and for the purpose set forth. 7th. In combination with a head adapted to be attached to a brake bar or lever, and having a stem provided with a lug projecting from the stem periphery between its two ends, a brake-block having the two ears adapted to engage the stem on opposite sides of the lug thereon, each provided with a stem-receiving opening with an offset or notch to admit the passage of the stem-lug, as the block is slid longitudinally upon the stem, and the stop on the block between the ears out of line with the offsets or notches adapted to be engaged by the lug on the stem, substantially as and for the purpose described. 8th. In a brake, in combination with the brake-shoe, the piece upon which the shoe is supported having a socket to receive the end of a brake bar or lever, and adapted to be turned axially on the latter, and means for fastening the bar or lever end in the socket, substantially as and for the purpose specified. 9th. In a brake, in combination with the brake-shoe, the piece upon which the shoe is supported having a socket to receive the end of a brake-bar or lever and adapted to be rotated on the latter, and a set-screw on the piece to engage the bar or lever, substantially as and for the purpose shown. 10th. In a brake, in combination with the brake-shoe, the piece upon which the brake-shoe is hung, having a lug to engage a bearing or stop on the shoe, so as to limit the swing of the latter, and a socket adapted to receive the end of a brake bar or lever, and the set-screw to engage such end and fix it in the socket, substantially as and for the purpose described. 11th. In a brake, in combination with a brake-shoe, the piece having a stem upon which the shoe is pivoted, a lug engaging a bearing or stop on the shoe, so as to limit downward swing of the latter on the stem, and a socket to receive the end of a brake-lever or bar, adapted to be rotated about such end, and a set screw to engage the latter and fix the piece thereto, substantially as and for the purpose specified. 12th. In a brake, in combination with the brake-shoe, having the ears on its back provided with openings and a bearing or stop, the attaching piece having a stem engaging the ear-openings, and a portion provided with a cylindrical socket to receive the end of a brake bar or lever, the set-screw on such portion to engage the bar or lever, and a lug on the stem engaging the bearing or stop on the shoe, substantially as and for the purpose shown. 13th. In a brake, in combination with a brake-shoe having ears on its back, provided with openings and a stop or bearing between such ears, the attaching piece having a stem engaging the ear-openings, a lug on the stem between the ears, a shoulder adapted to receive one of the shoe-ears, between it and the stem-lug, and a portion provided with a socket to receive the end of a brake-bar or lever, and the set-screw on such socket portion of the piece, substantially as and for the purpose set forth.

No. 35,706. Handle for Burial Caskets.

(*Poignée de cercueil.*)

The Detroit Casket Company, assignee of William H. Blackford, all of Detroit, Michigan, U.S.A., 3rd January, 1891; 5 years.

Claim.—1st. In a casket handle, provided with a handle bar, the combination of an ear covered with a fabric, and a flexible connection uniting the ear with said handle bar, substantially as described. 2nd. A casket handle, consisting of a metal ear covered with fabric, and a flexible loop covered with fabric to receive the handle bar, substantially as set forth. 3rd. A casket handle, consisting of a covered handle bar, a covered ear, and a flexible strap connecting the ear to the handle bar, substantially as set forth. 4th. A casket handle, consisting of an ear covered with fabric, and provided at its lower end with an elongated slot, a loop constructed of a flexible band, doubled and engaged with said ear through said slot, and a handle bar extending lengthwise of the casket and passed through said loop, said ear extending forward above said slot, substantially as described. 5th. A casket handle, consisting of an ear provided with open sockets c, c', an elongated slot at its lower end and covered with fabric, having in combination therewith a loop constructed of a flat flexible band, doubled and united at its extremities and passed through said slot, a pin engaged in said loop and in said sockets, and a handle bar extending lengthwise of the casket and passed through said loop, substantially as set forth.

No. 35,707. Caster. (*Roulette de meuble.*)

Hubert R. Ives, Montreal, Quebec, Canada, assignee of Albert Benjamin Diss, Brooklyn, New York, U.S.A., 3rd January, 1891; 5 years.

Claim.—1st. The combination in a caster of a sheet metal horn frame, a washer and a pintle having a collar above the washer, a pintle passing through the washer and through the horn frame and being riveted up, substantially as set forth. 2nd. The combination with the roller horn frame and pintle of the sheet metal socket, having an opening through which the pintle passes, there being a head upon the upper end of the pintle for connecting the pintle with the sheet metal socket, substantially as set forth. 3rd. The sheet metal socket for a caster pintle, formed with the penetrating points 10 to enter the wood, and with the portions 8 to support the pintle near the upper end, substantially as set forth. 4th. The combination with the caster wheel horn frame and pintle of a sheet metal socket, having a plate 6, with a central bush 11, made by bending up the sheet metal of the plate, as set forth. 5th. The combination with the roller horn frame and pintle, of a sheet metal socket having a central plate 6, penetrating points 10, folded connections 11 between the plate 6 and the cylindrical portion 7 and the half circle portions 8 receiving between them the pintle near the upper end, and substantially as set forth.

No 35,708. Machine for Covering Wire.

(*Machin à couvrir le fil de fer.*)

Edison General Electric Company, New York, State of New York, U.S.A., assignees of William A. Phillips, Brooklyn, New York, U.S.A. 3rd January, 1891; 5 years.

Claim.—1st. In a thread-winder for covering wire, the combination of a central spindle, means adapted to revolve a supply-bobbin around said spindle, and a guide for said supply bobbin in its revolution around said spindle, additional to and independent of the revolving means, substantially as set forth. 2nd. In a thread-winder for covering wire, the combination of a central spindle, means adapted to revolve a supply bobbin around said spindle, and a ring guide for said supply bobbin in its revolution around said spindle, substantially as set forth. 3rd. In a thread-winder for covering wire, the combination of a central spindle, means adapted to revolve a supply bobbin around said spindle, and a guide for said supply-bobbin in its revolution around said spindle, free to rotate, the axis of said bobbin being in contact with said guide, substantially as set forth. 4th. In a thread-winder for covering wire, the combination of a central spindle, a carrier adapted to carry each end of a supply-bobbin, said carrier being rotated by said central spindle, and a guide ring loosely supported on each of said carriers, the axis of said bobbin being in contact with the inner periphery of said guide ring, substantially as set forth. 5th. In a thread-winder for covering wire, the combination of a central spindle, arms carried by said spindle adapted to carry a supply-bobbin, a guide ring loosely supported on each of said arms, the axis of the bobbin in contact with said arms, and the inner periphery of said rings, and means on one of said arms for retaining said axis in contact with said ring, substantially as set forth. 6th. In a thread-winder for covering wire, the combination of a central spindle, means adapted to revolve a supply-bobbin around said spindle, a guide-ring for said bobbin in its revolution around said spindle free to rotate, and means for centering said guide ring with relation to said spindle, substantially as set forth. 7th. In a thread-winder for covering wire, the combination of a central spindle, means adapted to revolve a supply-bobbin around said spindle, an independent guide for said supply-bobbin in its revolution around said spindle, an arm and a counter-weight carried by said arm, located diametrically opposite said bobbin, and revolving with it around said central spindle, substantially as set forth. 8th. In a thread-winder for covering wire, the combination of a central spindle, means adapted to revolve a supply-bobbin around said spindle, an independent guide for said supply-bobbin in its revolution around said spindle, and a counter-weight for each end of the supply-bobbin, revolving with said bobbin, substantially as set forth. 9th. In a thread-winding machine, the combination of a central spindle, means adapted to revolve a supply-bobbin around said spindle, a guide-ring for each end of the spindle, of the supply-bobbin, a supporting arm for each guide-ring rotating with said central spindle, a bearing for each end of the spindle, of the supply-bobbin being formed by the supporting arm and the inner periphery of the guide-ring, substantially as set forth. 10th. In a thread-winding machine, the combination of a central spindle, means adapted to revolve a supply-bobbin around said spindle, a guide-ring for the upper end of the spindle of said supply-bobbin, an arm for supporting said guide-ring, means for centering the same, and means for preventing the same from leaving its supporting-arm, substantially as set forth. 11th. In a thread-winder for covering wire, the combination of a central spindle, a supply-bobbin and counter-weight carriers for said bobbin, and counter-weight arranged about said spindle diametrically opposite to each other, a guide ring free to rotate for said supply-bobbin, said ring being centered by the axis of the supply-bobbin at one point, and the counter-weight at a point diametrically opposite, substantially as set forth. 12th. In a thread winder for covering wire, the combination of a central spindle, a supply-bobbin, a counter-weight for each end of the supply-bobbin, carriers for said bobbin and counter-weights, each of said counter-weights being situated diametrically opposite one end of the bobbin, and a guide-ring for each end of the supply-bobbin free to rotate said rings being centered by the axis of the supply-bobbin at one point, and the counter-weight at a point diametrically opposite, substantially as set forth. 13th. In a thread-winder for covering wire, the combination of a central spindle, a supply-bobbin and counter-weight arranged about said spindle, diametrically opposite each other, carriers for said supply-bobbin and counter-weight, and a guide-ring for said supply-bobbin, free to be rotated by the axis of the bobbin, said counter-weight comprising a roller in contact with said ring and free to be rotated by it, substantially as set forth.

No. 35,709. Screw Shank and Ferrule.

(*Fût à vis et ferrule.*)

John Pymm, Saint George, Utah, U.S.A., 7th January, 1891; 5 years.

Claim.—In an implement, the combination of a handle having a tapering recess, a ferrule secured to said handle and projecting

therefrom, a threaded ring inside said projecting portion and fitting against the end of the handle, a threaded shank engaging said ring, and also the tapering recess of the handle, and a re-enforcing ring surrounding the projecting end of the ferrule, forming with it a double shoulder, against which the head of the shank abuts, substantially as described.

No. 35,710. Means for Operating Fire Proof Shutters or Doors. (*Moyen de fermer les portes et contre-vents à l'épreuve du feu.*)

Gustave Andreen, Omaha, Nebraska, U.S.A., 7th January, 1891; 5 years.

Claim.—1st. The combination, with a supporting rail and with a door or shutter mounted to slide thereon, of a striker-plate projecting from said door or shutter in position to receive the impact of the hose stream, whereby the door or shutter may be shifted, substantially as described. 2nd. The combination, with a sliding door or shutter, of a pocket projecting from the door or shutter in position to receive the impact of the hose stream, said pocket having a front plate to better confine the water, substantially as described. 3rd. The combination, with a sliding door or shutter, of a striker-plate, a top plate and a front plate adapted to form a pocket to receive the impact of the hose-stream, substantially as described. 4th. The combination, with a door or shutter of a striker-plate, extending approximately from top to bottom of the door or shutter, and serving both to stiffen the door or shutter against warping, said striker-plate projecting in position to receive the impact of the hose stream, substantially as described. 5th. The combination, with a door or shutter of a striker plate, and a top-plate extending approximately from side to side of the door or shutter and serving to stiffen the door or shutter against warping, said top-plate and said striker-plate serving to form a pocket or cavity, against which a hose-stream may be directed to shift the door or shutter, substantially as described.

No. 35,711. Car Coupler. (*Attelage de chars.*)

Perry Brown, Sharonville, Ohio, U.S.A., 7th January, 1891; 5 years.

Claim.—1st. The combination in a coupling, of a swinging pivoted clutch and a pivotal pin therefor, having a part thereof of different shape from its pivotal portion, to secure the clutch in the locked position, substantially as described. 2nd. The combination in a twin jaw coupling, of a clutch, a pivotal pin therefor, constructed to secure the clutch in a locked position and means as the arm J, for raising the pin to unlock the clutch, substantially as described. 3rd. The combination in a twin jaw coupling, of a clutch, a pivotal locking pin therefor, an arm J, connected to the pin, a shaft J', carrying said arm and the handles J', connected to the shaft, substantially as described. 4th. The combination in a coupling, of a clutch having projecting hubs g, and a pair of ears provided with recesses opening sideways to admit the hubs and a pivotal pin as I, passing through the ears and the clutch to retain said clutch in the recesses, substantially as described. 5th. The combination, with a coupling, having the lug C, of the recessed casting F, and spring D, substantially as described. 6th. A twin jaw coupling having the ears H, H, disconnected at their outer ends and a horn B', in combination with a single armed clutch having one end pivoted in the ears, and constructed and arranged to swing outward clear of the face of the coupling, and provided with a recess within said end to receive a locking device, substantially as and for the purpose specified. 7th. A twin jaw coupling having ears H, disconnected at their outer ends and a horn B', opposite said ears, in combination with a clutch having a rounded hinged end, a recess for locking the same contained within the curve of said end, and a locking device fitting in said recess, substantially as described, and for the purpose set forth.

No. 35,712. Mechanism for Feeding Paper.

(*Appareil pour fournir le papier aux presses à imprimer, etc.*)

Edward Dummer, Newton, Massachusetts, U.S.A., 7th January, 1891; 5 years.

Claim.—1st. In a machine for feeding paper, the combination of a shaft b, two disks c, and d, adjustable thereon, and a finger F, pivoted between said disks, substantially as specified. 2nd. The combination of a shaft b, two disks c, and d, thereon, a finger F, pivoted to said disks and devices as the set-screws p, and q, for gaging the distance through which the finger may swing, substantially as set forth. 3rd. In a paper-feeding machine, a finger F, pivoted to a cylinder and adjustable in a direction transverse to its shaft or pivot pins, said finger being provided with an exterior friction-surface, substantially as and for the purpose set forth. 4th. In combination, with a finger F, and carrier therefor, means as the toothed wheel f, and toothed cylinder g, for imparting a varying movement to said carrier, said finger being provided with an exterior friction-surface, substantially as specified. 5th. In combination, with a cylinder E, carrying a finger F, a table D, for supporting a bank of paper in such relation to the cylinder that the finger will come in contact with the edge face of the sheet, substantially as and for the purpose specified. 6th. The combination, with a cylinder carrying a finger F, and a roller G, to co-operate with said cylinder as a gripper of a table D, for supporting a bank of paper in such relation to the cylinder that the finger will engage with the edge face of the sheet, substantially as set forth. 7th. The combination, of a cylinder carrying a finger F, a roller G, to co-act with said cylinder as a gripper, a roller H, tapes or bands e, extending around said rollers, and a table D, located under the roller G, and said tapes or bands, substantially as and for the purpose set forth. 8th. In combination, with a support for a bank of paper, a finger, and carrier therefor, whereby the finger is caused to touch the edge face of the sheet, and carry the edge of the sheet, substantially as specified. 9th. In combination, with a pivoted table D, for supporting a bank of paper, a finger and

carrier therefor, whereby the inclination of the bank is changed and the finger is caused to touch the edge face of each sheet, and carry and bend the sheet, substantially as specified. 10th. In combination, with a finger and carrier therefor, a table so located as to present an edge face of a sheet to said finger, said table being provided with a raised portion or block O, to form or maintain a bend or curve in the bank of paper, substantially as specified. 11th. The combination, with a finger and carrier therefor, of a table so located as to present an edge face of a sheet to said finger, said table being provided with a raised portion or block O, for supporting a curved bank, and with a bracket or gage L, substantially as and for the purposes specified. 12th. The combination, of a cylinder E, bearing a finger F, pivoted table D, for supporting and moving the bank, a chain or rope m, a shaft h, bearing a drum i, on which said chain or rope winds, and a worm k, and gear j, substantially as described. 13th. In a paper-feeding machine, a table D, provided with a raised part to support the bank of paper at or near the end, and with a bracket L, whereby the bank is maintained in a bent or curved form, the upper sheet prevented from sliding under the action of a finger pressing against its edge face, and so that an edge of each sheet projects or extends beyond the corresponding edge of the adjacent sheet, substantially as set forth. 14th. In a paper-feeding machine, a movable instrument herein called a finger, in combination with a support or table for a bank of paper located with reference to said instrument so as to present an edge of a sheet of said bank to the same, substantially as and for the purpose set forth. 15th. In combination, with an instrument herein called a finger, a support located with reference to said instrument so as to present the edge face of a sheet of paper to the same, said instrument being movable, whereby it will engage with said edge face and adjustable whereby the pressure on said edge face may be gaged, substantially as set forth. 16th. In combination, with an instrument herein called a finger, a support located with reference to said instrument so as to present the edge face of a sheet of paper to the same, said instrument being automatically adjustable (in position) with reference to said edge face, and movable transversely with reference to the edge of said sheet, whereby it will touch said edge face and carry and bend the sheet, substantially as specified. 17th. In combination, with an instrument herein called a finger, a support located with reference to said instrument so as to present an edge face of a sheet to the same, said instrument being movable, its movement being variable, whereby it will engage with said edge face and while in contact therewith have a comparatively slow motion, substantially as set forth.

No. 35,713. Panel for Burial Caskets.

(*Panneau de cercueil.*)

John Danford Ripsom, Thorold, Ontario, Canada, 7th January, 1891; 5 years.

Claim.—1st. In combination, the casket, the lid C, and a shrine panel plate b, of about the size of the head opening, and adapted to support various articles, said plate being embedded in the lid and held in horizontal position whether slid out or in by its edge engaging with the lid above it, substantially as described. 2nd. In combination, the casket, the lid C, having a grooved under side, the shrine panel arranged in the groove and in engagement with the lid above it, whereby it is sustained in horizontal position when slid out, and means for limiting the movement of the panel consisting of the stops E, projecting horizontally outward from the rear of the panel, and the stops f, projecting horizontally inward from the edge of the groove, substantially as described. 3rd. In combination, the casket, the lid, a shrine panel consisting of the two plates hinged together, the said lid having a groove under it to admit both of the hinged plates, the plate b, being adapted to receive and hold articles, and held in a horizontal position whether out or in by its edges engaging the groove, and the plate a, being adapted to rest on a projection h, when swung down. 4th. In combination, the casket, the lid, the head panel A, and the foot panel B, sliding beneath the lid, the said panel A, having extensions on its rear edge, and the panel B, having notches to receive said extensions, substantially as described. 5th. In combination, the casket, the lid, the channel extending beneath the lid from end to end, the shrine panel A, at the head sliding in said groove, the shrine panel B, at the foot flush with the shrine panel A, and also sliding in said groove, the inner edges of said panels shutting against each other when they are closed, substantially as described. 6th. In combination, the casket, and lid, the shrine panel consisting of the two parts a, and b, hinged together, the cloth covering therefor, and the elastic straps I, connecting the edges of the cover, substantially as described. 7th. The sunken head shrine panel A, sliding outwardly in the grooves H, through the slot u, and provided with catch F, to engage with the stop f, in combination with the sunken foot shrine panel provided with catches G, to engage with the stops g, and sliding outwardly in the same groove through the slot j, the two panels being exactly flush, and when closed are designed to abut against each other, substantially as and for the purpose set forth.

No. 35,714. Burner for Gas and Hydro-Carbons.

(*Foyer à gaz et à hydrocarbures.*)

George Roberts, Montreal, Quebec, and John Hally, Toronto, Ontario, both of Canada, 7th January, 1891; 5 years.

Claim.—1st. The combination, in a burner for gas, gasoline, or hydro-carbon vapour, of the casing a, having damper or dampers e', and openings e', section or sections i, perforated diaphragm c, with a casing f, having corresponding sections h, each provided with a pipe o, having perforations r, and each provided with openings l, downward extending ridges m, having perforations n, the whole constructed and arranged, substantially as shown and described. 2nd. The combination, in a burner for gas, gasoline, or hydro-carbon vapour, of the casing a, having damper or dampers e', and openings e', section or sections i, perforated diaphragm c, with a casing f, having corresponding sections h, each provided with a pipe o, having

perforations r, and each provided with opening l, downward extending ridges m, having perforations n, with a branch pipe o, having adjustable opening t, for the admission of air, the whole constructed and arranged to operate, substantially as shown and described for the purposes set forth.

No. 35,715. Governor for Air Pumps.

(*Régulateur pour pompes à air.*)

Craven Robert Ord, West Toronto Junction, Ontario, Canada, 8th January, 1891; 5 years.

Claim.—1st. In an air pump governor, the combination, with a passage way provided with a partition having a port therein and a cylinder opening into the outlet, of a main valve fitted to slide freely, but not steam tight, in the said cylinder, and adapted to close the said port, the portion of the valve which closes the port being of less cross sectional area than the part fitting in the cylinder, a spring acting on said valve to retain a greater pressure on the inlet than on the outlet side, and an auxiliary valve operated by air pressure and controlling the admission of steam to the first named valve, substantially as described. 2nd. In an air pump governor, the combination, with a passage way provided with a partition having a port therein, and a cylinder opening into the outlet and communicating through ports with the inlet, of a main valve fitted to slide freely, but not steam tight, in the cylinder, and having its lower end which closes the port of less cross sectional area than the part fitting in the cylinder, a spring acting upon the upper end of the valve, and an auxiliary valve for closing the ports leading to the said cylinder, said auxiliary valve being operated by air pressure, substantially as herein shown and described. 3rd. In an air pump governor, the combination, with a passage way divided by a partition having a port therein, a cylinder above the port and opening into the outlet side of the passage way, and a second cylinder of less diameter than the first named cylinder and communicating therewith, and with the inlet of the passage way, of a spring pressed valve in the first named cylinder, and adapted to close the port of the passage way, an auxiliary valve in the second named cylinder and adapted to establish and close communication between the inlet of the passage way and the cylinder containing the spring pressed valve through the cylinder, of the auxiliary valve, and a diaphragm adapted to be acted upon by air pressure to operate the auxiliary valve, substantially as herein shown and described. 4th. In an air pump regulator, the combination, with the spring pressed stem O, provided with the diaphragm P, adapted to be acted upon by air pressure, of a passage way divided by a partition having a port therein, the cylinder G, above the port and opening into the outlet of the passage way, the spring pressed valve F, in the cylinder, the cylinder J, above the cylinder G, and connected by port a, with the inlet of the passage way, and provided with a valve seat, the cylinder L, connected by port b, with the cylinder G, and the auxiliary valve K, provided with the stem K', having the reduced portion K', and adapted to be engaged by the lower end of the stem O, substantially as herein shown and described.

No. 35,716. Machine for Dyeing, Bleaching and Treating Yarn in Compact Form.

(*Machine pour teindre, blanchir et traiter le fil de caré en forme compacte.*)

August Graemiger, Cheetham, Manchester, and William Thomas Whitehead, Rodcliffe, both of England, 8th January, 1891; 5 years.

Claim.—1st. In machines for dyeing, bleaching, and otherwise treating yarn in cop or other compact form, a rotary cop carrier consisting of two discs b, b', formed respectively with four groups of cop tube holes or nipples e', e'', e''', e'', in combination with a stationary central carrier body c, hermetically fitted between the carrier discs b, b', and formed with a preliminary liquor or air exhaustion chamber h, primary liquor extraction chamber h', saturation and impregnation chambers h², and h³, and liquor extraction chamber h⁴, respectively adapted to subject each circular row of cops on the cop carrier b, b', being rotated to air exhaustion, and after each intermittent rotation thereof, simultaneously two cop groups to primary liquor extraction four groups to saturation and impregnation and two groups to liquor extraction, substantially as set forth. 2nd. The combination, with the preliminary air exhaustion chamber h, having ports n, and the automatically operated vacuum valve n', of an air and liquor separator in which the air charged with liquor strikes against a perforated division plate q², which causes the air to ascend, and the liquor to descend into the cylinder or casing o, furnished with an air valve o', and liquor valve o'', operated at suitable intervals by the rotary cop carrier b, b', whereby the liquor is returned into the tank a, free of air, substantially as and for the purpose set forth. 3rd. The clutch lever r, furnished with a projection r', operating the vacuum valve n', in combination with the lever arm t, actuated at suitable intervals by the rotary cop carrier b, b', and adapted to engage the clutch lever r, and thereby automatically close the vacuum valve n', and effect the intermittent rotation of the cop carrier b, b', all substantially as set forth. 4th. The rotary cop carrier b, b', furnished with cams p, in combination with a liquor charging vessel u, furnished with a two way tap n³, operated at suitable intervals by the rotary cop carrier b, b' and adapted to alternately receive and supply a given quantity of liquor to the tank a, substantially as and for the purpose set forth. 5th. In a machine for dyeing, bleaching, and otherwise treating yarn in cop or other compact form with cylindrical cop carrier, the cop carrier b, b' formed with cop tube hole or nipple rows e', all round its periphery and with a separate cavity w, for each row, in combination with a carrier body c, employed stationary on the axis d, hermetically against the end of the cop carrier b, b', which on being rotated successively brings the mouth of the cavities w, in communication with segmental chambers h², h³, h⁴, formed in the face of carrier body c, respectively adapted to subject the cop rows e', to preliminary or air exhaustion saturation, and impregnation liquor extraction, and substitution, substantially as and for the purpose set forth.

No. 35,717. Pulsating Current Motor.*(Moteur pour courant à pulsation.)*

Charles Joseph Van Depoele, Lynn, Massachusetts, U.S.A., 8th January, 1891; 5 years.

Claim.—1st. An electro-dynamic motor, or, having two circuits separately connected to the source of current, one circuit being connected at an intermediate point to the other, and separate means for directing current of constant polarity through one circuit, and of alternating polarity through the other. 2nd. An electro dynamic motor, having two circuits, one including the field magnet coils and the other including the coils of the armature, and means for placing one of the said circuits in shunt relation alternately with either half of the other circuit. 3rd. The combination, with an electric motor, having two circuits, one arranged to receive continuous currents and the other currents of alternating polarity, of a generator supplying both pulsatory and continuous currents, and circuit connections between the generator and motor, whereby currents of one polarity are supplied to one of the motor circuits, and currents of alternating polarity to the other of said circuits. 4th. The combination with an electro dynamic motor, having armature and field magnet circuits, a generator of the continuous current type, having stationary commutator brushes and circuit connections therefrom to one of the circuits of the motor, and a movable commutator brush rotated about the commutator, and circuit connections from the movable brush to the other of the motor circuits, whereby continuous currents are supplied to one motor circuit and alternating currents to the other. 5th. The combination, with an electro-dynamic motor, having two circuits thereon, one supplied with currents of continuous polarity, and the other with currents of alternating polarity, and means for preventing oscillation of the armature or rotating member of the motor at starting. 6th. The combination, with an electro-dynamic motor, having two circuits, one supplied with continuous current and the other with currents of alternating polarity, of means for preventing the backward movement of the armature at starting. 7th. The combination, with an electro-dynamic motor, having two circuits, one supplied with current of continuous polarity, and the other with currents of alternating polarity, whereby said motor is adapted to rotate in either direction, of a clutch mechanism adapted to engage the armature shaft to prevent rotation in one direction, whereby action of the reverse phase is prevented, and the armature free to move in the desired direction only. 8th. An electro-dynamic motor system, comprising a combined source of continuous and pulsating currents, two circuits upon the motor, one including the field magnets and the other the armature, and connections, whereby the current is divided and caused to flow always in the same direction in one circuit, and alternately in opposite directions in the other circuit. 9th. An electro-dynamic motor, having two circuits arranged to be operated by the flow of currents of continuous direction in one circuit, and of alternating direction in the other, and means for connecting the second circuit in shunt relation, first with one side and then with the other side of the said continuous current circuit. 10th. An electro-dynamic motor, having two circuits arranged to be operated by the flow of currents of continuous direction in one and of currents of alternating direction in the other, closed connections between the continuous circuit and the positive, and negative supply conductors, and connections to one terminal of the second circuit located midway of the continuous current circuit, means for placing the other terminal of said second circuit in circuit with first one, and then the other half of the continuous current circuit.

No. 35,718. Method of Expanding Hoops or Tires. *(Système d'expansion de cercles ou bandages.)*

Mark Wesley Dewey, Syracuse, New York, U.S.A., 8th January, 1891; 5 years.

Claim.—1st. As a preliminary step in the process of setting hoops or tires, the within-described method of expanding said hoops or tires, consisting in suitably connecting the same between electric terminals, and then subjecting the hoop or tire to the heating effect of an electric current, as set forth. 2nd. The method of heating hoops or tires, consisting in bringing in contact therewith at points diametrically opposite each other, the terminals of a low-resistance supply-conductor, and passing an electric current of large volume through said conductor and hoop or tire, substantially as set forth. 3rd. The method of expanding a hoop or tire preparatory to setting the same, consisting in circulating uniformly or substantially uniformly, within the entire circumference thereof, of an electric current of large volume, as set forth.

No. 35,719. Drier for Bricks.*(Sécherie à briques.)*

Phineas Arnold, Canal Dover, Ohio, U.S.A., 8th January, 1891; 5 years.

Claim.—1st. The combination, with a chamber provided with a floor having openings therein, and an off take flue leading from said chamber, of air-ducts arranged beneath the floor and connected with the off-take flue, the said air-ducts having perforations formed therein, heating coils supported between the air-ducts and the floor, ceiling flues having openings in their sides and deflectors arranged between the said flues adjacent to the side openings therein, substantially as and for the purpose specified. 2nd. The combination, with a structure, containing a series of independent chambers, a main air duct extending from side to side of the structure branch, air-ducts having perforations therein, and leading from the main duct within each chamber, and having connection with the off-take flues in the structure, each of the chambers being provided with a perforated floor above the lower section of the branch air-ducts, of a main steam inlet and outlet pipe, independent supply and exhaust pipes carried from the main steam inlet and outlet pipes to each of the several

chambers, coils arranged independently within each of the chambers beneath the floor, and having connection with the branch steam supply and exhaust pipes located therein, ceiling flues in each chamber, open at their forward ends and having communication with the air-duct, and of take-flues at their rear-ends, the said flues being provided with openings in their sides, and deflectors arranged between the flues adjacent to the openings therein, substantially as shown and described and for the purpose specified. 3rd. In a tunnel drier, ceiling-flues, consisting of a central flue or channel, and an outer flue or channel at each side, which flues extend from the rear of the plate and terminate at a point approximating the forward end, the said flues being provided with openings in their inner walls, angled deflectors connecting the forward walls of the flues, and similar deflectors arranged between the flues, near the openings therein, substantially as shown and described.

No. 35,720. Artificial Bait for Fish.*(Appât artificiel.)*

Ernest F. Pflueger, Akron, Ohio, U.S.A., 8th January, 1891; 5 years.

Claim.—1st. The combination, with a trolling-hook, of an elastic or flexible shield or protector arranged in front of the hook and extending laterally beyond the point thereof to protect the same, and prevent fouling or catching on objects in the water, substantially as shown and described. 2nd. The combination of a trolling spoon, having hooks attached thereto, of an elastic or flexible shield or protector arranged in front of the spoon and hooks, and extending laterally beyond the points of the latter, as and for the purpose set forth. 3rd. The trolling device, herein shown and described, the same consisting of a hollow elastic shield B, and one or more hooks having their stems secured within the shield, the latter projecting laterally beyond the points of the hooks, as and for the purpose described. 4th. The trolling device, herein shown and described, the same consisting of a hollow elastic or flexible shield B, one or more hooks having their stems secured within the shield, the latter projecting laterally beyond the points of the hooks to protect the same, and feathers also secured within the shield and projecting therefrom around the stems of the hooks, substantially as shown and described.

No. 35,721. Pick. *(Pic.)*

Kenneth John Morrison and Michael MacLellan, both of Stellarton, Nova Scotia, Canada, 8th January, 1891; 5 years.

Claim.—1st. The method of making and securing the points C, C, in the body of the pick A, A, substantially as and for the purpose hereinbefore set forth. 2nd. The slots e, e, through body of pick A, A, substantially as and for the purpose hereinbefore set forth. 3rd. The flats f, on taper ends of points C, C, substantially as and for the purpose hereinbefore set forth. 4th. The pins X, on points C, C, substantially as and for the purpose hereinbefore set forth. 5th. The holes O, O, from slots e, e, to eye b, substantially as and for the purpose hereinbefore set forth.

No. 35,722. Method of Coating Exposed Wooden Structures. *(Composition pour couvrir le bois et le préserver des insectes, etc.)*

George Phillips, Key West, Florida, U.S.A., 8th January, 1891; 5 years.

Claim.—1st. A covering for piles, timbers and wooden surfaces generally, the covering consisting of asphaltum, having its exterior surface hardened by combination with lime, and either with or without the interposed fabric, all substantially as described. 2nd. The method of covering wood surfaces, consisting in first applying asphalt to the wood, and then applying to the surface of the asphaltum coating pulverized lime, and either with or without the interposed fabric, all substantially as described.

No. 35,723. Holder and Fastener for Sashes.*(Arrête croisée.)*

George Hopkins Spring, Lemars, Iowa, U.S.A., 9th January, 1891; 5 years.

Claim.—1st. A sash fastener to be attached to a sash in its casement, composed of a wedge, suspended at its narrow end and normally held from contact with the casement, whereby the sash can be moved up or down freely in its casement, said wedge being susceptible of lateral motion, whereby it can be brought in contact with the casement to hold the sash in the required position, and a stop for the wedge to bind against when fastening the sash, substantially as set forth. 2nd. The combination, with the pendent wedge, of the pendent locking brace adapted to engage with and limited in its inward movement by the said wedge, and adapted to be turned up against the window stop or casement, substantially as described. 3rd. A sash fastener and holder, comprising a metal holding case attached to a sash in its casement, near one of its side casings, having its top and sides open, and having an oblong wedging key suspended within it, so that its upper narrow end projects upwardly between a stop, and the side casing or window stop near it to press the wedging key against the side casing or window stop, when the sash is lowering, and having within it, on the opposite side from the wedging key a pendent pivoted locking brace, which can be turned above its pivot to touch bracingly against the near window stop, and a metal attachment thereon to lock the sash when down, to shield these fastening and locking parts from sight, and to strengthen and hold them in good working relation with each other, substantially as set forth and for the purposes described. 4th. A pendent oblong wedging device, adapted to fasten a sash up, and a pendent locking brace adapted to lock a sash down, attached to the side style of a sash in its casement, near each other, having an anti-friction roller

between their upper ends to aid in the sash fastening service, each by gravity inclining inwardly below the roller, in combination with intervening means to limit this tendency, so as to keep each in its required position for ready service, to fasten the sash when raised, and to lock the sash when down, substantially as set forth and for the purposes mentioned. 5th. An oblong reversible locking brace, perforated at one end and attached by a stationary pin or rivet to the side stile of a sash in its casement, so as to hang pendently upon it, having a short pin projecting from its lower part toward the body of the sash, as a point of pressure by which to move it against a pendent oblong wedging key, between it and the casing, to effect wedging support of the raised sash, being adapted also to be turned upwardly above its pivot, so as to lean at the limit of its upward turning circuit against the nearest casing of the sash as formed to receive it, so as to brace against it or a metal attachment thereto to lock the sash securely when down, substantially as set forth and for the purposes indicated.

No. 35,724. Pouch for Tobacco.

(*Sac à tabac.*)

William James Cussen, Richmond, Virginia, U.S.A., 9th January, 1891; 5 years.

Claim.—1st. The combination, with a tobacco bag, of a flap secured to the mouth at one side, and a fastening device secured to said flap, the flap serving as a seal to the original package, and in connection with the fastening device to secure the bag while in use, substantially as specified. 2nd. A bag for tobacco or other material, having a flap near the edge on one side, the said flap containing a concealed string, which may be drawn out and tied around the bag to secure it, substantially as described. 3rd. A tobacco bag, having a series of eyelets along its opposite side, and an interior lining covering the said eyelets, as and for the purpose described. 4th. The combination, with a pouch, having formed in one of its sides a vertical tube or hem, of a string secured to the bag and passed through the said tube and around the bag, as and for the purpose described.

No. 35,725. Manufacture of Pepsin and of Peptonized Foods. (*Manufacture de pepsine et d'aliments peptinés.*)

Vicente Marcano, Caracas, Republic of Venezuela, America, 9th January, 1891; 5 years.

Claim.—1st. The herein described ferment, consisting of the juice of the plant of the bromeliaceae family, partially freed from water and inert existences. 2nd. The herein described process of making peptones, consisting in digesting albumen or an albumenoid by the organic ferment of the juice of a plant of the bromeliaceae family. 3rd. As a new article of manufacture, a food product, consisting of albumen or an albumenoid digested in the organic ferment of the juice of a plant of the bromeliaceae family. 4th. The process herein described of making pure peptones, which consist in subjecting meat to the action of organic vegetable ferments, contained in the juice of a plant of the bromeliaceae family, until peptonization takes place, then dissolving the peptonized meat thus obtained in water, and filtering it, so as to obtain pure peptones, substantially as set forth. 5th. The herein described peptonized meat, being free from foreign admixtures, such as salt, starch, and the like, containing all the digestible constituents and fibrinous parts of the meat, and obtained by treating meat with the juice of a plant of the family of bromeliaceae, and drying the same, substantially as set forth. 6th. The process herein described of making peptonized meat, which consists in subjecting meat to the action of the organic vegetable ferments, contained in the juice expressed from the plants belonging to the family of bromeliaceae, until peptonization takes place, then evaporating and drying the thus obtained liquid peptonized meat, and finally grinding it into powder, substantially as set forth.

No. 35,726. Cutter for Bands and Feeder.

(*Coupe-hart et alimentateur.*)

William H. Alston, Adrian, Illinois, U.S.A., 9th January, 1891; 5 years.

Claim.—1st. The combination, with the inclined table 13, of the beater arranged above said table and provided with the projecting plates 16, of the reciprocating bar 32, brackets arranged below said table, and the knives 36, secured upon said bar and projecting through said table beneath said beater, substantially as described. 2nd. The combination, with the inclined table 13, of the brackets 28, arranged beneath said table, a reciprocating bar arranged upon said brackets and provided with knives 36, projecting through an opening in said table, the rotating beater arranged above said table and over said knives, and consisting of the shaft 14, provided with the frame 15, the projecting plates 16, and the curved plates 17, arranged between said plates 16, substantially as described. 3rd. The combination, with the oppositely inclined tables provided with the knives, of the inclined table 35, located between said tables, the links 37, supporting the lower end of said table, a crank-shaft supporting the upper end of said table, and the transverse bars 55, arranged upon the tops of said table and provided with the series of inclined teeth 56, substantially as described. 4th. The combination, with the inclined tables 13, of the rack 67, pivoted above said tables and arranged to cover said tables, and the cords 69, secured to said racks for the purpose specified.

No. 35,727. Sleeping Car. (*Char dortoir.*)

James B. Davenport, Hartford, Connecticut, U. S. A., 9th January, 1891; 5 years.

Claim.—1st. The combination, in a railway sleeping car, of an adjustable covering or curtain E, with the rod R, and the side of the

car L, over and across the space b, above the upper berth, substantially as set forth. 2nd. The combination, in a railway sleeping car, of two or more adjustable coverings or curtains E, to each upper berth with the rod R, and the side of the car L, over and across the space b, above the upper berth, substantially as set forth.

No. 35,728. Low Water Alarm.

(*Indicteur d'eau à sifflet.*)

William Hardwick, Erie, Pennsylvania, U.S.A., 9th January, 1891; 5 years.

Claim.—In a low water alarm for steam boilers, the combination with the pipes C, and D, and cross arm E, which is firmly fixed to the pipe C, and loosely embraces the pipe D, of the lever G, mounted on said cross arm and having its long arm in contact with a stem of a whistle F, and its short arm in contact with the pipe D, and being provided with an adjusting screw o, substantially as and for the purpose set forth.

No. 35,729. Mechanical Movement.

(*Transmission du mouvement.*)

James Hayton, Salt Lake City, Utah, U.S.A., 9th January, 1891; 5 years.

Claim.—1st. A mechanical movement, comprising a frame fitted to slide and provided with two parallel racks having their teeth facing each other, segmental gear wheel having its teeth extending to somewhat less than one-half of the circumference of the wheel, the teeth being adapted to mesh alternately into the said racks, and a shaft mounted to turn in suitable bearings and carrying the said segmental gear wheel, substantially as shown and described. 2nd. In a mechanical movement, the combination, with parallel guide ways, of a frame fitted to slide in the said guide ways and provided with two parallel racks having their teeth facing each other, a segmental gear wheel having its teeth extending to somewhat less than one half of the circumference of the wheel, the teeth being adapted to mesh alternately into the said racks, and a shaft mounted to turn in suitable bearings and carrying the said segmental gear wheel, substantially as shown and described.

No. 35,730. Process of Preparing Fish.

(*Procédé pour préparer le poisson.*)

James Ogle Morrison, Westport, Nova Scotia, Canada, 9th January, 1891; 5 years.

Claim.—The process of cleaning, boning, and salting fish, as and by the ingredients in the preparations times, and intervals set forth, and described.

No. 35,731. Automatic Locking Device for Vehicle Wheels. (*Arrêt de sûreté pour roues de voiture.*)

William Higford Graham and George Rodney McDonald, both of 26 Lambs Conduit, Middlesex, England, 9th January, 1891; 5 years.

Claim.—1st. In perambulators and other similar wheeled vehicles, a wheel locking device comprising a clutch box in which are two sliding pawls for engaging with lobes or teeth forming part of or connected to the wheel centre, and operated from the driving handle in such manner that when the said handle is depressed the clutch box is elevated and the sliding pawls disengaged from the lobe wheel, thus leaving the vehicle wheels free to rotate, but when the hands are removed from the driving handle the sliding pawls engage with one lobe of the said lobe wheel, and thereby effectually lock the said vehicle wheels, substantially as described. 2nd. An automatic wheel locking device applicable to perambulators and other similar wheeled vehicles, constructed, arranged, and operating, substantially as described with reference to the drawings.

No. 35,732. Car Coupler. (*Attelage de chars.*)

George A. Sanders and Samuel J. Willett, (assignees of Nelson Newman), all of Springfield, Illinois, U. S. A., 9th January, 1891; 5 years.

Claim.—1st. The combination of the spring-pressed pivoted drawhooks, the pivoted flattened arms or keys k^2 , arranged against the neck of one drawhook, and adapted to lie between the same and the head of the companion drawhook, the thickness of the said flattened arms or keys being less than that of the shoulders of the drawhooks for the purpose set forth, substantially as described. 2nd. The combination of the spring-pressed pivoted drawhooks, the pivoted flattened arms or keys k^2 , arranged between the neck of one hook and the head of its engaging companion, and the crank arms attached to the said flattened arms or keys, whereby the latter may be turned, for the purpose set forth, substantially as described. 3rd. The combination, in a car coupling, of the pivoted engaging drawhooks, the pivoted flattened arms or keys k^2 , arranged between them and having the crank arm, and the slide bar mounted on the end of the car and connected to the said crank arm, substantially as described. 4th. The combination, in a car coupling, of the pivoted engaging drawhooks, the pivoted flattened arms or keys k^2 , arranged between them and having the crank arm provided with the pin k^4 , and the slide bar set forth, substantially as described. 5th. In a car coupling, the pivoted drawhooks, the spring, the shaft having the arm or key to disengage the drawhook, and provided further with the crank arm, the slide bar connected to the crank arm, and the lever connected to the slide bar, all in combination, substantially as described. 6th. In a car coupling, the combination of the sills, the cross plates connecting them, the drawhooks arranged between the sills,

and having the pivots in the cross plates, the spring bearing against one side of the drawhook arm, and the shaft having the flattened wings or arms bearing against the same side of the drawhooks, substantially as described.

No. 35,733. Holder for Bolts. (*Arrête-écrou.*)

Frank A. Loyet, James O'Connell, (assignees of Charles L. Edwards), all of Collinsville, Illinois, U.S.A., 9th January, 1891; 5 years.

Claim.—A bolt-holder, comprising the lever having one end chisel pointed to engage the head of a bolt, and provided with a series of teeth, the guard having its ends secured at the ends of the series of teeth, the hook provided at one end with an eye and having at the other end a head, and the link confined to the lever by the guard, and secured in the eye of the hook, and provided at one end with a beveled edge to engage the teeth of the lever, substantially as described.

No. 35,734. Apparatus for Preventing the Incrustation of Steam Boilers. (*Appareil pour empêcher les incrustations dans les chaudières à vapeur.*)

Henry Clay Nye and Emil Laas, both of Syracuse, New York, U.S.A., 9th January, 1891; 5 years.

Claim.—1st. The improved preventive of incrustation of steam boilers, consisting of one or more pans situated in the upper part of the boiler, and the feed water pipe having its discharge end in one end of said pan or pans as set forth. 2nd. The combination, with a steam boiler, of two or more pans disposed successively end to end lengthwise of the boiler in the upper part thereof, and inclined toward one end, the feed water pipe having its discharge end in the elevated end of said pans, and a blow-off pipe connected to the lower end of said pans, substantially as described and shown. 3rd. The combination, with a steam boiler, of the pans P, P', situated in the upper part of the boiler and arranged end to end, and communicating with each other at their junction, the overflow shelf b, in one of said pans, the feed water pipe a, having its discharge end in one end of said pans, and the blow-off pipe a', connected to the opposite end of the pans, substantially as described and shown.

No. 35,735. Seat for Cars. (*Siège de chars.*)

Arthur M. Richards, Bloomington, Illinois, U.S.A., 10th January, 1891; 5 years.

Claim.—1st. The combination, of a seat back, having an opening therein, to which is adapted a rotatable panel, fixed pivots projecting from the sides of said seat back opening through the sides of the panel-frame and projecting within said panel-frame, a flat spring securing said pivot and extending parallel to the panel-faces and within said panel-frame, and fastenings for the ends of said springs secured within said panel-frames, whereby both faces of said panel are left unobserved, substantially as described. 2nd. The combination, of a seat back, having an opening therein, to which is adapted a rotatable panel, fixed pivot projecting from the sides of said panel frame and projecting within said panel-frame, a flat spring secured to said pivot and extending parallel to the panel-faces and within said panel-frame, and corner-braces with said panel-frame having recesses for the ends of said spring, whereby the latter is secured to said panel, substantially as described.

No. 35,736. Snow Shoe for Sleigh Runners. (*Raquette pour patin de traîneau.*)

John Robertson Campbell, Clyde, Minnesota, U.S.A., 10th January, 1891; 5 years.

Claim.—1st. The combination, with a sleigh-runner, its narrow bearing-shoe, and the bolts confining said shoe to the runner, of an independent wide metallic plate interposed as a snow-shoe between the runner and its bearing-shoe to extend the length thereof, and have elongated apertures formed longitudinally therein to register with the bolt-holes in the runner, substantially in the manner and for the purpose herein set forth. 2nd. The combination, with a sleigh-runner and its narrow bearing-shoe, of an independent wide metallic plate interposed as a snow-shoe between the runner and its bearing-shoe bolts, confining the bearing-shoe and interposed snow-shoe jointly to the runner, and lateral brackets secured to the runner to bear upon and re-enforce the top of the snow-shoe, substantially in the manner and for the purpose herein set forth.

No. 35,737. Filter for Water. (*Filtre.*)

George Harvey, Toronto, Ontario, Canada, 10th January, 1891; 5 years.

Claim.—1st. In a water filter, the combination of a reservoir a fitted with an inlet pipe b, filters composed of porous stone and a compressed carbonized substance, the upper reservoir a', fitted with an outlet pipe connected to a tap, the glass float d, the valve e, valve-stem f, having an enlarged head f', the guide-collar e', the carbonized filter g, placed between the top d of the reservoir and the perforated bottom g, of the ice-chamber E, and the said ice-chamber, substantially as and for the purpose set forth. 2nd. In a water filter, the combination of a water chamber a fitted with an inlet pipe porous stone filter b, and upper reservoir a', fitted with an outlet pipe connected to a suitable tap, substantially as and for the purpose set forth. 3rd. In a water filter, the combination of the reservoir a, the porous stone filters, and a compressed carbonized filter c, placed between said stone filters and an upper reservoir a' provided with an outlet connected to a suitable tap, substantially as and

for the purpose set forth. 4th. In a water filter, the combination of a lower reservoir a, fitted with an inlet or in-take pipe porous stone filter, compressed carbonized filter c, a second porous stone filter b, an upper reservoir a', provided with an outlet connected to a tap, and air-hole e, substantially as and for the purpose set forth. 5th. In a water filter, the combination of a lower reservoir a fitted with an inlet pipe, a porous stone filter b, compressed carbonized filter c, a second porous stone filter b, an upper reservoir a', provided with an outlet connected to a tap, and air-hole e, fitted with a valve e', substantially as and for the purpose set forth. 6th. In a water filter, the combination of a lower reservoir a, fitted with an inlet pipe, a porous stone filter b, compressed carbonized filter c, a second porous stone filter b, an upper reservoir a', provided with an outlet connected to a tap, a float d' and an air-hole e fitted with a valve e', substantially as and for the purpose set forth. 7th. A water filter, fitted with a tap D, consisting of a water chamber d, in which is located a valve L and valve-seat m, a plunger l, passing through a washer l', and connected at one end to the valve L, and at the other to an end block l'', and operated by a lever O, substantially as and for the purpose set forth. 8th. A water filter fitted with a tap D, consisting of a water chamber d', in which is located a valve L, a valve seat m, a plunger l connected to the valve L, and operated by a lever O, pivoted to the frame of the tap, substantially as and for the purpose set forth. 9th. In a water filter, the combination of a lower reservoir a, a porous stone filter b, a compressed carbonized filter c, a second porous stone filter b', an upper reservoir a', fitted with a port b'', a water pipe c', connecting the port b'' to the water chamber d', of the tap D, with the tap D, consisting of a water chamber d'', in which is located a valve L, and a valve seat m, a plunger l passing through a washer l', and connected at one end to the valve L, and at the other to an end block l'', and operated by a valve O, substantially as and for the purpose set forth.

No. 35,738. Harvester Binder. (*Moissonneuse-lieuse.*)

Frederick Duncan Mercer and John Smith Mercer, both of Alliston, Ontario, Canada, 12th January, 1891; 5 years.

Claim.—1st. The combination, with a series of rake-heads connected together by endless chains or bands of sprocket wheels journalled on the inside of the side boards and above the back of the elevating table of a grain binder, substantially as and for the purpose specified. 2nd. In a harvester, the combination, with a series of rake-heads connected together by endless chains or bands, of sprocket wheels journalled on the inside of the side-boards and above the back of the elevator, combined with a shield extending across the elevator and underlying the lower sprocket-wheel, substantially as and for the purpose specified. 3rd. In a harvester, a series of rake-heads pivoted in and connected together by endless chains carried by sprocket wheels located at the top and bottom of the elevator, in combination with a guide-way extending from the lower sprocket wheel to a point opposite the centre of the top sprocket wheel, and the two spindles extending from the end of the rake head, one forward relatively to the motion of the chain, and the other to the rear of the axis of the rake-head, the rear spindle being swivelled in the chain, and the forward spindle being free, substantially as and for the purpose specified. 4th. In a harvester, a series of rake-heads connected by an endless chain or band, each rake-head having a series of rake-teeth fixed to it, and a cross-head formed on one of its ends with two spindles, extending from the said cross-head, one of the said spindles being free and placed forward of the axis of the rake head relatively to the motion of the chain, and the other being swivelled to the chain, a guide-way formed on the inside of the side boards and above the back of the elevator, said spindles travelling on the guide-ways, substantially as and for the purpose specified. 5th. In a harvester, a series of rake-heads connected together at each end by an endless chain or band carried by sprocket-wheels located at the top and bottom, above the back of the elevator, in combination with a curved guide or shield extending across the elevator and underlying the lower sprocket-wheel, and a plate extending across the grain-table at the base of the elevator in front of said shield, substantially as and for the purpose specified. 6th. In a harvester, the combination of the sprocket-wheels and endless chains, the rake-heads carrying teeth and having cross-heads at one end formed with spindles, one of said spindles being swivelled in the chain and the other free, said cross-head being formed with a tail on the side adjacent to the swivelled spindle, a lug or block against which said tail is adapted to contact to throw the free spindle forward, the guide-ways for said spindle, and the curved guide for guiding the spindles around the lower sprocket-wheels, substantially as described. 7th. In a harvester, the combination of the endless chains, and rake-heads, having cross-heads at one end formed with spindles, one of said spindles being swivelled in the chain, and the other free, the cross-heads being formed with a tail on the side adjacent to the swivelled spindle, with the lug or block adapted to be struck by said tail for throwing the free spindle forward, and the guideways for said spindles, substantially as described. 8th. In a harvester, the combination, with a series of rake-heads connected together by endless chains or bands, of sprocket-wheels journalled on the inside of the side-boards and above the back of the elevator, and a curved guide underlying the lower sprocket-wheel, substantially as and for the purpose specified.

No. 35,739. Extractor for Faucets. (*Extracteur de robinet.*)

Robert Douglass Black, Constantia, New York, U.S.A., 12th January, 1891; 5 years.

Claim.—1st. The combination, with the handle and a fulcral foot pivotally connected thereto, of a concave jaw pivotally mounted upon the inner end of the lever, and another jaw mounted upon draw bars pivotally connected to the lever. 2nd. The combination, with the handle and a fulcral foot pivotally connected thereto, of a concave jaw pivotally mounted upon the inner end of the lever, and another jaw adjustably mounted upon draw-bars pivotally connected

to the lever. 3rd. The combination, with the handle and a fulcral foot pivotally connected thereto, of a concave jaw pivotally mounted upon the inner end of the lever, and another jaw adjustably mounted upon draw-bars pivotally connected to the lever outside of the fulcral bearing thereof.

No. 35,740. Magnetic Separator.

(*Séparateur magnétique.*)

Thomas Alva Edison, Llewellyn Park, New Jersey, U.S.A., 12th January, 1891; 5 years.

Claim.—1st. In a magnetic separator, the combination of a hopper having a flat bottom and an opening therein, with a magnet below said hopper for altering the trajectory of magnetic material falling therefrom, substantially as set forth. 2nd. In a magnetic separator, the combination of a hopper having vertical sides, and a flat bottom with an opening therein, with a magnet below said hopper for altering the trajectory of magnetic material falling therefrom, substantially as set forth. 3rd. In a magnetic separator, the combination of a hopper having a flat bottom and a row of small holes therein, with a magnet below said hopper for altering the trajectory of magnetic material falling therefrom, substantially as set forth. 4th. In a magnetic separator, the combination of a hopper having a thin metal bottom plate with an opening therein, with a magnet below said hopper for altering the trajectory of magnetic material falling therefrom, substantially as set forth. 5th. In a magnetic separator, the combination of a hopper having a thin metal bottom plate with a row of small holes therein, with a magnet below said hopper for altering the trajectory of magnetic material falling therefrom, substantially as set forth. 6th. In a magnetic separator, the combination, with a hopper having a flat bottom with an opening in it and means for vibrating it, of a magnet below said hopper for altering the trajectory of magnetic material falling therefrom, substantially as set forth. 7th. In a magnetic separator, the combination, with a hopper having a flat bottom with a row of small holes in it, and means for vibrating it, of a magnet below said hopper for altering the trajectory of magnetic material falling therefrom, substantially as set forth. 8th. In a magnetic separator, the combination, with the hopper, and the magnet for altering the trajectory of the magnetic material, of means for producing an air current acting upon the falling material, substantially as set forth. 9th. In a magnetic separator, the combination, with the hopper and the magnet for altering the trajectory of the magnetic material, of means for directing an air current against the falling material, substantially as set forth. 10th. In a magnetic separator, the combination, with the hopper, and the magnet for altering the trajectory of the magnetic material, of the inclined partition and the air pipe for directing a current of air against the falling material, substantially as set forth. 11th. In a magnetic separator, the combination of the hopper having an opening through which the material falls into a wide thin stream, the magnet below the same for altering the trajectory of the magnetic material, and the air pipe placed parallel with the falling stream, whereby the air current is directed against the full width of the stream, substantially as set forth. 12th. In a magnetic separator, the combination, with the hopper, of the open end or bar magnet below said hopper for altering the trajectory of the magnetic material, substantially as set forth.

No. 35,741. Vulcanized Plastic Compound.

(*Composition plastique vulcanisée.*)

William Kiel, Butler, New Jersey, U.S.A., 12th January, 1891, 5 years.

Claim.—1st. The herein described process of manufacturing vulcanized plastic rubber compounds, consisting in mixing together sulphur and rubber, the sulphur being in the proportion of not less than about eighty per cent. of the rubber, by weight, and vulcanizing the compound with an initial temperature of not less than about 300° Fah., and for the periods of time set forth, substantially as described. 2nd. The herein described process of manufacturing vulcanized plastic rubber compounds, consisting in mixing together sulphur, rubber, and oil, the sulphur being in the proportion of not less than about eighty per cent. of the rubber by weight, and vulcanizing the compound with an initial temperature of not less than about 300° Fah., and for the periods of time set forth, substantially as described.

No. 35,742. Process of Manufacturing Vulcanized Plastic Compounds.

(*Fabrication de composition plastique vulcanisée.*)

William Kiel, Butler, New Jersey, U. S. A., 12th January, 1891; 5 years.

Claim.—1st. The herein described hard vulcanized plastic compound, consisting of crude rubber, sulphur and mineral oil, the sulphur being in the proportion of not less than approximately eighty per cent. of the rubber by weight, united by vulcanization, substantially as described. 2nd. The herein described hard vulcanized plastic compound, consisting of crude rubber, sulphur and kerosene, the sulphur being in the proportion of not less than approximately eighty per cent. of the rubber, by weight, united by vulcanization, substantially as described.

No. 35,743. Vise. (*Étau.*)

George S. Buok, Goodwill, Dakota, U. S. A., 12th January, 1891; 5 years.

Claim.—The combination of the two jaws A, B, the screw rod which passes horizontally through them, the board G, a nut secured to the board and through which the screw passes, two bent rods N

secured to the board G, and connected together by a box or bearing O, and a rigid support F, which slides freely back and forth upon the smooth portion of the screw-threaded rod D, and which has its lower end secured to the lower end of the outer jaw A, substantially as shown.

No. 35,744. Roll for Reworking Steel Rails.

(*Cylindre pour refaire les rails d'acier.*)

Henry Harris and John B. Brobst, both of Reading, Pennsylvania, U.S.A., 13th January, 1891; 5 years.

Claim.—The rolls herein described for splitting and forming billets from railroad rails, having the three grooves a, b, and c, as shown, whereby the head and base are severed from the web, and the three portions simultaneously rolled into billets of oval section at one pass, substantially as set forth.

No. 35,745. Process of Reworking Steel Rails. (*Procédé pour refaire les rails d'acier.*)

Henry Harris and John B. Brobst, both of Reading, Pennsylvania, U.S.A., 13th January, 1891; 5 years.

Claim.—The herein described process of heating and decarbonizing steel rails or bars for reworking, which consists in subjecting the same to the heat of a furnace, while covered by a heat-conducting medium, substantially as described, containing ingredients, as set forth, adapted to decarbonize and soften said rails or bars while being simultaneously heated, substantially as set forth.

No. 35,746. Revolving Hook Machine.

(*Crochet tournant pour machines à coudre.*)

Anthony Miller, Huntingburg, and John T. Corn, Jasper, both of Indiana, U. S. A., 13th January, 1891; 5 years.

Claim.—The combination, with the stitch-forming mechanism, of a rotary hook machine, of a supporting slide ring and means for locking the same in any adjusted position, and a bobbin cover, the former provided with two projections upon its inner engaging surface separated a suitable distance, and the latter provided with a single projection upon its outer engaging surface vibrating between and alternately engaging the two upon the slide ring, whereby the cover is allowed only a limited rotary movement, substantially as shown and described.

No. 35,747. Road Cart. (*Désobligeante.*)

James Henry Lewis and Charles Gardiner Hampton, both of Detroit, Michigan, U.S.A., 13th January, 1891; 5 years.

Claim.—1st. In a road cart, a seat mounted on oscillating supports, and held in position by check springs, substantially as described. 2nd. In a road cart, the combination of the seat mounted on oscillating supports to have a free play in the longitudinal direction of the cart of check springs applied thereto, to counter-act the oscillations, and of seat bars supported independently of the seat and holding such check springs in position, substantially as described. 3rd. In a road cart, the combination of a supporting frame pivotally mounted upon a seat supporting spring, and carrying the seat free to oscillate in the longitudinal direction of the cart, of check springs on opposite sides of the seat and engaging with the oscillating supports to check their motion, substantially as described. 4th. In a road cart, the combination of a seat pivotally supported upon the spring free to oscillate in the longitudinal direction of the cart, of springs applied to said seat to check its oscillations and adjusting devices for said springs, substantially as described. 5th. In a road cart, the combination with the seat and the seat supporting spring, of the supports G, interposed between and pivotally supported upon said spring, the check springs which hold said supports in position, the independent seat bars to which said check springs are secured, and the supporting frame under the rear end of said seat bars, substantially as described. 6th. In a road cart, the combination of the seat supporting springs, the oscillating seat supports pivotally supported thereon, the check springs which hold it in position the independent seat bars to which said springs are secured, and the circular bearings between such seat and seat bars, substantially as described. 7th. In a road cart, the combination, with the springs, of the U-shaped seat support G, the seat bars, hinged at their forward ends, the standards b, pivotally supporting the rear end of the seat bars, of the segmental circular faces K, and L, and the check springs f, sleeved upon the rod e, substantially as described. 8th. In a road cart, the combination, with the seat pivotally supported upon the springs, of the foot rest secured only to the seat, substantially as described.

No. 35,748. Combined Gauge and Syphon.

(*Indicateur et siphon combinés.*)

Wilfrid Emile Michel Robitaille, Quebec, Frank Gouin and Edgard Whiteford, Montreal, all of the Province of Quebec, Canada, 13th January, 1891; 5 years.

Claim.—1st. A combined gauge for measuring the height of liquid in barrels and the like, and syphon, consisting of a graduated transparent tube connected at its lower end to a flexible tube, the said transparent having its upper end open, substantially as and for the purposes set forth. 2nd. A combined gauge for measuring the height of liquids in barrels, and the like, and syphon consisting of a transparent tube securely held and protected in a body, and means for attaching the said body to a barrel or cask, the said tube being graduated by a scale engraved upon it or stamped or painted on the

body, and having its upper end open and its lower end connected to a flexible tube, substantially as and for the purpose set forth. 3rd. The combination, with the graduated transparent tube A, of the body B, having a groove *b*, the blocks C, and D, the said block D, having spikes *d*, the flexible ring E, and flexible tube F, having a flaring mouth *f*, substantially as and for the purposes set forth. 4th. The combination, with the tube A, of the flexible tube F, having a flaring mouth *f*, substantially as set forth.

No. 35,749. Art of Cleaning the Faces of Grind-Stones. (*Art de nettoyer les surfaces des meules.*)

The Berlin Mills Company, and Edwin J. Bonett, all of Berlin, New Hampshire, U.S.A., 13th January, 1891; 5 years.

Claim.—The method of cleansing grindstones, which consists in discharging a blast of steam directly against the working face of the grinder.

No. 35,750. Gas Burner for Heating Stoves, Furnaces, Boilers, etc. (*Bec à gaz pour poêles, fournaisses, chaudières, etc.*)

Michael Joseph O'Reilly, Buffalo, New York, U.S.A., 14th January, 1891; 5 years.

Claim.—1st. The combination, of the mixing tube C, provided with gas openings *d*, *d'*, at the upper end, having the concave disks E, E', adjustable thereon, forming the burners and the air and gas chamber B, adjusted on the lower end of tube C, by screwing thereon, and provided near the bottom with a screw threaded gas receiving pipe A', having the adjustable disks G, thereon, all substantially as and for the purpose specified. 2nd. The combination, of the mixing tubes C, provided with gas openings *d*, *d'*, at the upper end, and having the concave disks E, E', adjustable thereon, forming the burners, the air and gas receiving chamber B, adjusted on the lower end of tube C, by screwing thereon, said chamber provided with the adjustable disk G, at the bottom, the central oblong gas burner H, H', in connection with the central mixing tube C, and chamber B', and the flat links D, D', setting on top of plate H, and adjusted thereon, by the projection, *h*, and nut *i*, all substantially as and for the purpose specified.

No. 35,751. Car Coupler. (*Attelage de chars.*)

John Peters, Township of Bathurst, Ontario, Canada, 14th January, 1891; 5 years.

Claim.—1st. A car coupler made up of a draw-bar head having reciprocating jaws, such as hereinbefore shown and described, and a link having a spear shaped head, substantially as and for the purposes set forth. 2nd. In a car coupler, the combination, with the head A, having the steady pin E, the jaws or members C, C, of the chain D, the spring *e*, and the chain *f*, as set forth. 3rd. In a car coupler, the combination, of the draw-bar head A, and its appurtenances, of the link B, having the head *b*, the web *g*, and the recesses *d*, *d'*, as set forth. 4th. In a car coupler, the combination, of an ordinary link with the head *b*, the web *g*, and the recesses *d*, *d'*, substantially as set forth.

No. 35,752. Tail Piece for Banjos, etc.

(*Cordier de banjo, etc.*)

Rudolph Charles Bookser, Buffalo, New York, U.S.A., 14th January, 1891; 5 years.

Claim.—A tail piece for stringed instruments, having a raised transverse rib, provided with longitudinal slits opening through the top of the rib, and each having at its lower rear end an enlarged recess in which the knot is concealed, and which is connected with the contracted portion of the slit in front of the recess by a shoulder against which the knot rests, substantially as set forth.

No. 35,753. Tenderer for Meat.

(*Pilon à viande.*)

David L. Graves, Louisville, Kentucky, U.S.A., 14th January, 1891; 5 years.

Claim.—1st. The combination, of the body portion 5, having a downward flange 6, and ears 7, the notched blades 9, with packing-bars 10, interposed secured between said flange, and ears by means of binding-screws 8, and a handle for the body portion, substantially as described. 2nd. The combination, of the body portion 5, shaped for holding a series of blades, and provided with a rearward projection 12, a series of blades with packing-bars interposed secured in the body by means of binding-screws, a series of springs of curved form joined as one at their rear ends, and connected with the said rearward projection by means of a binding-screw 13, and resting near their forward ends upon the said packing-bars, their ends projecting forward of the blades, and a handle for the device, substantially as described.

No. 35,754. Cutter for Thread. (*Coupe-fil.*)

James Napoleon Dodge, Springfield, Massachusetts, U.S.A., 14th January, 1891; 5 years.

Claim.—1st. As an improved article of manufacture, a thread-cutter capable of complete insertion within the hole in a spool, and also of partial withdrawal therefrom, constructed of a single piece of elastic metal and having side parts for impinging against the walls of the opening in a spool, and a knife extending from the upper end

of one of said side parts toward the upper end of the other, and of such size as to pass within said opening in the spool. 2nd. As an improved article of manufacture, a thread-cutter capable of complete insertion within the hole in a spool, and also of partial withdrawal therefrom, constructed of a single piece of elastic metal, and having a knife at its upper end, a vertical part extending downward from one side thereof, a bottom part, and a part extending upward in an outwardly-inclined direction from one end of said bottom toward the free end of said knife, said bottom part and knife being of a size to be capable of passing within the hole in a spool. 3rd. As an improved article of manufacture, the herein described thread-cutter capable of complete insertion within the hole in a spool, and also of partial withdrawal therefrom, made of a single piece of spring metal and comprising the curved knife D, vertical part *a*, curved bottom part *b*, upwardly-extending outwardly-inclined part *c*, inwardly-extending curved part *d*, and part *e*, inclining downward toward said part *c*, all substantially as shown and described.

No. 35,755. Collar. (*Collet.*)

Léaude Bernard, St. Hyacinthe, Province of Quebec, Canada, 14th January, 1891; 5 years.

Résumé.—Un nouvel article de manufacture, un collet en cellulose, pour garçons, ayant la bande du tour du cou B, munie d'une feute C, *a'*, *a''*, en arrière, avec attache D, *a³*, *a⁴*, *a⁵*, *a⁶*, *a⁷*, *b¹*, *b²*, et deux paires de trous, *d¹*, *d²*, *d³*, *d⁴*, et dans lesquels sont introduits des cordons ou rubans d'attache, *d³*, *d⁴*, *d⁵*, *d⁶*, le tout, tel que ci-dessus décrit, et pour les fins sus-mentionnées.

No. 35,756. Incubator. (*Incubateur.*)

P. Fidèle Lacroix, St. Michel, Province of Quebec, Canada, 14th January, 1891; 5 years.

Résumé.—1o. La combinaison des réservoirs E, E, E, E, et des tiroirs L, L tel que décrits pour les fins mentionnées. 2o. La combinaison des réservoirs inférieurs E, E, avec la nourrice M, M, tels que décrits pour les fins sus-mentionnées.

No. 35,757. Hitching Device.

(*Appareil pour attacher les chevaux.*)

Andrew H. Wilson, South Vineland, New Jersey, U.S.A., 14th January, 1891; 5 years.

Claim.—1st. The herein described hitching device, consisting of a driving rein, a hitching ring upon the same, and a catch upon the rein, said hitching ring being normally detached from and independent of the catch, and loosely mounted and adapted to slide upon the rein, substantially as specified. 2nd. A hitching device composed of a driving rein R, a loose ring M, upon the same, a catch C, secured to the outer face of said rein in rear of said ring, and having a recess *c*, a longitudinal tongue T, within said catch, a spring A, connecting the tongue normally forward across said recess, and a strap A, connecting the rear end of said tongue with the rein in rear of the catch, the whole adapted to operate substantially as described. 3rd. The combination, with the rein R, secured to the bit, the loose ring M, upon said rein, and the strap A, secured to the rein, looped and buckled to itself at B, with the semi-cylindrical catch C, secured to the outer face of the rein forward of said strap, and provided with a forwardly inclined recess *c*, and a beveled front end F, said catch having a longitudinal opening through its body with a shoulder H, at its rear end, of the tongue T, reciprocating in said opening and provided with the shoulder *t*, a ring *a*, at the rear end of the tongue loosely embracing the loop in the strap A, and a coiled spring S, surrounding the body of the tongue between said two shoulders, all substantially as described.

No. 35,758. Disinfecting Device.

(*Appareil à désinfecter.*)

William Samuel Gubelmann, Buffalo, New York, U.S.A., 14th January, 1891; 5 years.

Claim.—1st. In a disinfecter, the combination, with a supporting board or plate having a horizontal band or ring, and a U-shaped bracket arranged below said ring, of an inverted disinfectant bottle arranged with its upper portion in said ring, and supported with its shoulder upon said U-shaped bracket, and an open pan supported upon said plate or board underneath the bottle and surrounding the mouth thereof, substantially as set forth. 2nd. In a disinfecter, the combination, with a supporting board or plate having a horizontal band or ring, and a U-shaped bracket arranged below said ring, of an inverted disinfectant bottle arranged with its upper portion in said ring and supported with its shoulder upon said U-shaped bracket, an open pan supported upon said plate or board underneath the bottle and surrounding the mouth thereof, and an evaporating wick immersed in said pan, substantially as set forth. 3rd. In a disinfecter, the combination, with a supporting board or plate having a horizontal band or ring, and a U-shaped bracket arranged below said ring, of an inverted disinfectant bottle arranged with its upper portion in said ring and supported with its shoulder upon said U-shaped bracket, a wedge whereby the bottle is clamped in said ring and an open pan supported upon said board and into which the mouth of the bottle projects, substantially as set forth. 4th. In a disinfecter, the combination, with a supporting board or plate having a horizontal band or ring, and a U-shaped bracket arranged below said ring, of an inverted disinfectant bottle arranged with its upper portion in said ring and supported with its shoulder upon said U-shaped bracket, an open pan supported upon said plate or board underneath the bottle, and surrounding the mouth thereof, and a movable perforated guard or cage enclosing the parts of the disinfecter, substantially as set forth. 5th. The combination, with the supporting plate or board and the pan or receptacle supported there-

on, of an inverted disinfectant holder or bottle attached to the supporting plate above said pan and having its mouth arranged in the pan, and a wick or absorbent covering enveloping the neck of the holder, substantially as set forth.

No. 35,759. Velocipede. (*Velocipède.*)

Henry Mayerhoff, Ottawa, Ontario, Canada, 14th January, 1891; 5 years.

Claim.—1st. The combination, with the horizontal frame 1, of the parallel rock shafts 7, 8, geared together, and each having an arm or crank 9, a two-throw crank shaft 10, and parallel wheel shaft 2 geared together, rods 11 connecting the parallel rock shafts 7, 8, to the double crank shaft 10, and a chair or seat 14, connected to rock one of said shafts and impart motion to the other shafts by a rocking motion of the driver seated in the chair to propel the velocipede, as set forth. 2nd. The combination, with the frame 1, of the steering wheel 5, journaled in a spindle 4, having arms 17, a shaft or bar 20, carrying pedals 19, rods 18, connecting said arms and pedals, and springs 21 to react the pedals after depression, whereby the velocipede is steered by the feet of the driver, as set forth. 3rd. The combination with the double crank shaft 10, having cog wheels 12, 24, and the wheel shaft 2, of the sleeve 22, having cog-wheels 13 and 23, spring 25, spiral cams 27 and rod 28, for obtaining a fast and slow speed by change of gearing, as set forth. 4th. The combination, with the chair, rocker or bar, having a locking projection 33, of a cutting-off and connecting the rocking motion of the chair for the running gear, as set forth. 5th. The combination with the propelling gear operated by the rocking motion of the driver of pedals, and steering wheel 19, 5, to operate, as set forth. 6th. A velocipede having runners attached to the main frame, driving wheels provided with sprockets and propelled by the rocking motion of the driver, and a steering wheel having a skate or shoe directed by pedals, as set forth.

No. 35,760. Wax Pad for Waxing Flat Irons.

(*Bourrelet à cire pour fers à repasser.*)

Anna R. Sherwood, Mount Vernon, Ohio, U. S. A., 14th January, 1891; 5 years.

Claim.—As an improved article of manufacture, a wax pad for said irons, consisting of a block or body, either solid or built up in layers composed of straw board, paper, wood pulp, or equivalent material, provided on its upper surface with a series of wax containing cups or receptacles, substantially as described.

No. 35,761. Binder for Grain.

(*Lieuse à grain.*)

Duncan Black, Dunwich, Ontario, Canada, 14th January, 1891; 5 years.

Claim.—1st. In a grain binder, grooved roller B and cleats D, substantially as and for the purpose hereinbefore set forth. 2nd. In a grain binding machine, in combination with roller B, wheels E, E, and chains F, substantially as and for the purpose hereinbefore set forth.

No. 35,762. Shedder for Horses.

(*Peigne pour chevaux.*)

Henry Goddard Thomas, Portland, Maine, U.S.A., 14th January, 1891; 5 years.

Claim.—A horse cleaner, consisting of a single blade of sheet metal having a series of fine teeth adapted to penetrate into the hair only of the horse, said teeth being formed with sharp edges or corners, in combination with a handle B placed on the edge opposite to the teeth, the parts being constructed, arranged and proportioned as described.

No. 35,763. Hank for Ships.

(*Anneau pour voiles d'étai.*)

Alfred Conover, Absecon, New Jersey, U.S.A., 14th January, 1891; 5 years.

Claim.—1st. The hank, comprising the larger ring, entirely free from abrupt or angular projections or breaks, and having two parts hinged at their extremities to allow their opposite ends to be separated by turning the parts on the hinge-pivot, said pivot being located at one side of that part of the hank that normally bears upon the stay, and a connected lesser ring provided with brackets having a pin for the sail-grommet and a fastening device, substantially as set forth. 2nd. The hank, comprising rings formed of two parts, hinged at their extremities by a pivot arranged longitudinally to the larger ring, said pivot having a bearing on each side of that part of the ring which normally rests upon the stay, said ring being free from angular or other abrupt projections or breaks, and the lesser ring provided with brackets, having a pin for the sail-grommet and a fastening screw, substantially as set forth.

No. 35,764. Gate. (*Barrière.*)

Charles M. Clark, Canandaigua, New York, U.S.A., 14th January, 1891; 5 years.

Claim.—1st. The combination of the gate, having its bars and rails pivotally connected and provided with recesses, the adjustable brace having one end pivoted to the gate and the other end arranged to engage the said recesses, the tube or bar 17, engaging the brace

and having its lower end pivotally connected to the gate, and the slide arranged upon the gate and sliding along one of the horizontal rails of the same, and engaging the upper end of the tube or bar, and provided with a set screw or equivalent means for securing the slide substantially as described. 2nd. The combination of the gate having its bars and rails pivotally connected, the adjustable brace having one end pivoted to the gate and the other end engaging said recesses, the tube or bar having its lower end pivotally connected to the gate and engaging the brace between its ends, and means for securing the upper end of the tube or bar at various points along the gate, substantially as described. 3rd. The combination of the gate, having its rails and bars pivotally connected, the tube or bar 17, having its lower end secured to the bottom of the gate, the slide arranged on one of the horizontal rails of the gate and engaging the upper end of the tube or bar 17, the adjustable brace arranged to engage the gate and connected with the tube or bar, and the sliding latch provided with a clamp to engage the tube or bar, and the sliding latch as described. 4th. The combination of the gate, having its bars and rails pivotally connected, the swivelled hook 18, arranged at the bottom of the gate, the tube having its lower end receiving the hook 18, and the adjustable slide arranged on one of the horizontal rails of the gate, and having a perforated swivelled stud to receive the tube, and provided with a set screw, substantially as described. 5th. The combination of the gate, having its bars and rails pivotally connected, the tube or bar having its lower end secured to the gate and engaging the upper end of the tube or bar, and the sliding latch provided with a clamp comprising the stationary section, having a recess to receive the tube or bar, and the pivoted section having a hooked end to engage the tube or bar, and retain the same in the recess of the stationary section, substantially as described. 6th. The combination of the gate, having its bars and rails pivotally connected, the swivelled hook 18, arranged at the bottom of the gate, the tube having its lower end receiving the hook, the slide arranged on one of the horizontal rails of the gate and comprising the rectangular casting provided with a laterally extending perforated stud, the shouldered block 23, and the set screw arranged to engage the block, substantially as described.

No. 35,765. Chest for Flour.

(*Boîte à farine.*)

Leroy Ritchie, Fair Haven, Minnesota, U.S.A., 15th January, 1891; 5 years.

Claim.—In a flour chest, the combination, with the casing closed on all sides except a rectangular hole in its face, and a strip across the upper edge of said hole, of a bin comprising a front fitting said hole, a strip across the upper edge of said front, and a semicircular bottom and a curved back secured to said front, an upper pivot pin depending from said casing strip and passing loosely through a hole in said front strip, and a lower pivot screwing upwardly through the bottom of the casing and engaging a socket in the bottom of the bin, all substantially as and for the purpose set forth.

No. 35,766. Circuit for Electric Railways.

(*Circuit pour chemins de fer électriques.*)

Frank Weidener Sabold, Albany, New York, U.S.A., 15th January, 1891; 5 years.

Claim.—In an electric railway, comprising an overhead conductor or trolley-wire, a motor-car, provided with electrical conductors by which the electric current is carried to the motor and thence into the track rails, a series of electric conductors fixed in the ground in proximity to the track rails, and connected to the latter by means of electric conductors, whereby a constantly-varying length of the electric circuit is automatically effected, substantially as specified.

No. 35,767. Leather Axle Washer.

(*Rondelle de cuir pour essieux.*)

Timothy Gingras, Buffalo, New York, U.S.A., 15th January, 1891; 5 years.

Claim.—1st. As an improved article of manufacture, a leather washer blank, consisting of a strip having serrations, as described, said strip being formed into an annulus, as and for the purpose stated. 2nd. A leather washer, formed with lubricant retaining spaces therein, substantially as described. 3rd. A leather axle washer, provided with lubricant retaining spaces in its edge, as and for the purpose set forth. 4th. A leather washer, provided with serrations in its edges, forming lubricant retaining spaces, as described. 5th. A leather washer, provided with serrations in one of its edges to form lubricant retaining spaces, as set forth. 6th. A leather washer, having serrations in its edges and recesses in its body to form lubricant retaining spaces, as set forth. 7th. A leather axle washer, having serrations in one of its edges and apertures in its body to form lubricant retaining spaces, as and for the object stated.

No. 35,768. Fastening for Horse Shoes.

(*Moyens d'assujettir les fers à cheval.*)

Edward Taber Covell, New Bedford, Massachusetts, U. S. A., 15th January, 1891; 5 years.

Claim.—1st. A fastening for a horse shoe, comprising a wire or band connected with the heel end of the shoe at each side thereof, extending upward therefrom and engaged with the sides of the hoof above the shoe, and extended down from said points of engagement with the hoof, and strained into connection with the toe end of the shoe, whereby the shoe is drawn tightly up against the bottom of the hoof, substantially as described. 2nd. The combination, with a horse shoe, provided with a fulcrum piece at its fore end, of a fastening wire engaged with the said horse shoe at the rear end, substantially as described.

for supporting the said wire upon the sides of the hoof, and a straining lever engaged with the said wire and with the fulcrum piece at the fore end of the shoe, substantially as and for the purpose described. 3rd. The combination of the band adapted to be connected with a horse shoe at the heel and the ends, with seats for engaging the said band which make frictional connection with the sides of the hoof, substantially as described. 4th. The combination, with a horse shoe, of a fastening band connected with the heel end of the shoe at each side thereof, extending upward therefrom, and engaged with the sides of the hoof above the shoe, and extended down from said points of engagement with the hoof toward the shoe at the front thereof, combined with a straining lever having its fulcrum on the shoe, and being engaged with the said band for tightening the same in engagement with the shoe and hoof, substantially as described.

No. 35,769. Pipe Coupling.

(*Joint de tuyau.*)

Enoch Lawson, San Francisco, California, U.S.A., 15th January, 1891; 5 years.

Claim.—1st. In a pipe coupling, substantially as described, the combination of the interior sleeve or union B, tapered upon its exterior, and interiorly threaded to engage the threads of the pipe-sections, the interiorly tapered outer sleeve adapted to be placed upon the sleeve B, the packing rings placed upon the pipes within the outer sleeve and against the ends of the inner sleeve, the flanges or disks also placed upon the sections of pipe and bearing against the packing rings and ends of the inner sleeve, and bolts connecting said flanges and adapted to draw them together, substantially as described for the purposes set forth. 2nd. In a pipe coupling, the combination, with two sections of pipe, of the sleeve or union interiorly threaded to engage the threaded ends thereof, and tapered upon its exterior, the interiorly tapered outer sleeve adapted to be placed upon the inner union, the packing rings interposed within the outer sleeve and bearing against the ends of the interior sleeve, and means for exerting a pressure upon the ends of the sleeve, for the purpose set forth, substantially as described.

No. 35,770. Wheel. (*Roue.*)

Alexander Craig Mather, Montreal, Quebec, Canada, 15th January, 1891; 5 years.

Claim.—1st. The combination, in a wheel, of the hubs *b*, *b'*, having flanges *c*, provided with eyes *l*, and grooves *f*, sleeve *g*, adapted to be held in place by the said hubs, and adapted to hold the said hubs apart, spokes *d*, and rim *m*, the whole substantially as described. 2nd. The combination, in a wheel, of the hubs adapted to the axle, a rim, spokes attached to the hubs and rim, and adapted to be tightened by setting the hubs apart, with a sleeve *g*, adapted to retain the hubs apart and form an oil chamber, the whole, substantially as described. 3rd. The combination, in a wheel, of the hubs *b*, *b'*, adapted to an axle and arranged to be held apart by the sleeve *g*, having plug *i*, with said sleeve, with spokes *d*, and rim *m*, the whole substantially as described. 4th. The combination, in a wheel, of the hubs *b*, *b'*, adapted to the axle with spokes *d*, individually attached thereto, and to the rim *m*, with rim *m*, and sleeve *g*, adapted to hold the hubs apart and impart to the spokes the required tension, the whole, substantially as described.

No. 35,771. Desk and Seat for Schools.

(*Pupitre-siège d'école.*)

Robert B. Hunter, Enterprise, Kansas, U.S.A., 15th January 1891; 5 years.

Claim.—1st. The combination of the castings having sockets formed therein, and slots communicating with said sockets, the pawls pivoted in and extending through the slots, said slots and the seat and desk frames having shanks extending into said sockets and provided with teeth or ratchets to engage the pivoted pawls, substantially as set forth. 2nd. The combination of the vertically-adjustable seat-frame having the back *O*, provided with flanges *a*, and grooved lugs *Y*, with the independently vertical adjustable desk-frame having notched flanges *W*, and rabbets *b*, said grooved lugs *Y*, being adapted to engage and slide upon the notched flanges *W*, and thereby hold the parts together adjustably, substantially as set forth.

No. 35,772. Device for Liberating Animals.

(*Appareil pour détacher les animaux.*)

William Smith, Caloma, Iowa, U.S.A., 15th January, 1891; 5 years.

Claim.—1st. In a stable, the combination, with a manger, of a ring or the like to which an animal is to be secured, catch mechanism for fastening the said ring removably to the manger, and a rope or other medium extending from the catch-mechanism to a suitable location as the stable door, whereby the catch may be displaced and the ring and animal released from a distance, as described. 2nd. In a stable the combination, with the manger, of a ring or the like to which an animal is to be secured, catch-mechanism for fastening the said ring removably to the manger, and a rope or other medium connected with the catch-mechanism and ring, and extending therefrom to a suitable location as the stable door, whereby the catch may be displaced from a distance and the animal led from the stable, substantially as described. 3rd. The combination, with a manger, of a housing *A*, secured thereto, catch mechanism in the housing, a bolt provided with a ring and extending with its shank portion into the housing where it is engaged by the catch-mechanism, and a rope or other medium connected to the catch mechanism and extending therefrom to a suitable location, whereby the catch-mechanism may be displaced from a distance to release the bolt and ring from the housing, substantially as described. 4th. In a device for liberating

animals from a distance, the combination, of a housing secured in a stall, a bolt entering the said housing and carrying a pivotal dog, a hitching ring upon the bolt catch-mechanism in the housing normally engaging the said dog, and a rope or the like connected with the catch-mechanism and extending therefrom to a suitable location, whereby the catch mechanism may be released, substantially as and for the purpose set forth. 5th. In a device for liberating animals from a distance, the combination of the spring-latch, the screw-threaded sleeve provided with a dog, the hitching-ring, the plate applied to the front board of the manger, the operating-rope having attached to it a wire provided with a button for operating the latch, and the grooved guides or ways in which the operating-rope is placed, substantially as specified.

No. 35,773. Car Coupling. (*Attelage de chars.*)

Harlow F. Chapin, Brockport, New York, U.S.A., 15th January, 1891; 5 years.

Claim.—1st. In a car-coupling, the combination, with a draw-head provided with a vertical longitudinal opening and a flaring mouth, the rear of which has an inner upper double beveled face, of a hook pivoted in the draw head, and having a slotted connection with its operating shaft, the said hook having an outer face double beveled and provided with a rectangular recess *e'*, on the under side of the hook, and the uncoupling arm *d*, mounted on a rock shaft and engaging the recess *e'*, substantially as and for the purpose described. 2nd. In a car coupling, the combination, with a draw head provided with a vertical longitudinal opening, of a hook pivoted in the draw head and having a slotted connection with its operating shaft, and provided with a rectangular recess *e'*, on the under side of the hook, and the uncoupling arm *d*, mounted on a rock shaft and engaging the recess *e'*, substantially as and for the purpose described.

No. 35,774. Reel for Harvesters.

(*Râteau de moissonneuse.*)

Charles Danfath Towne, Galesburg, Michigan, U.S.A., 15th January, 1891; 5 years.

Claim.—The combination, of a grain platform, the crank shaft having bearing-supports on said platform, said shaft being provided with cranks thrown out in opposite directions, oscillating arms pivoted to said cranks, and provided at their forward ends with right angled extensions, and the oscillating fulcrum rods pivoted to the arms, substantially as set forth.

No. 35,775. Fastening for Shingles.

(*Agrafe pour bardeaux.*)

Abram Sherman, Pacific Junction, Iowa, U.S.A., 15th January, 1891; 5 years.

Claim.—1st. A shingle-fastener, constructed of a single piece and comprising the cap adapted to receive the corner of a shingle, and the anchor-plate to be secured beneath the adjacent shingle, substantially as described. 2nd. A shingle-fastener, constructed of a single piece of sheet metal and comprising the plates 2, and 3, arranged to engage the upper and lower faces of adjacent shingles, the web connecting the plates and arranged between the adjacent edges of the shingles, and gradually varying in width to conform to the thickness of the shingles, and the end piece 5, completing the cap and fitting against the lower edge of a shingle, substantially as described. 3rd. A shingle-fastener, constructed of a single piece of metal and composed of the two plates 2, and 3, lying in different planes and connected by an intermediate web 4, which is made gradually varying in width, for the purpose set forth.

No. 35,776. Washing Machine.

(*Machine à blanchir.*)

Charles Hammons, Sheldon, Illinois, U.S.A., 15th January, 1891; 5 years.

Claim.—1st. In a washing machine, the combination, with the suds box provided at opposite sides and upon its interior with bearings, of a cage consisting of a bottom and opposite end sections hinged together, said end sections having bearing lugs taking in the bearings aforesaid, a rubbing head mounted in the cage, and rods pivotally connecting said head with one of the end sections, substantially as specified. 2nd. In a washing machine, the combination, with the suds box provided at each side with a series of rubbing strips and at the ends of the series with vertical standards having bearings, of a cage comprising a bottom and opposite end sections hinged together, said end sections having bearings removably mounted in the bearing standards, rods connecting pivotally said end sections, a bearing bracket depending from the rods, a rubbing head pivoted in the brackets, and rods connecting one of said sections with the rubbing head below its bearings, substantially as specified. 3rd. In a washing machine, the combination, with a suds box and a cage comprising a bottom and opposite end sections hinged to the bottom, of a rubbing head pivoted within the cage, and means for swinging said cage, and for rocking the rubbing head in directions opposite to the simultaneous movements of the end sections of the cage, substantially as specified. 4th. In a washing machine, the combination, with a suds box and a cage mounted for movement therein and consisting of opposite end and a central bottom section hinged to the lower ends of the end sections, of a rubbing head mounted for rocking in said cage and having oppositely inclined lower faces, and means for rocking the cage and the head, substantially as specified. 5th. In a washing machine, the combination, with the suds box, of the cage removably supported for movement therein and comprising a bottom and opposite end sections hinged to the bottom, connecting bars pivotally connecting the upper ends of the end sections and having depending bearing hangers,

and a rubbing head removably mounted in said bearing hangers, substantially as specified. 6th. In a washing machine, the combination, with the suds box and the opposite pairs of bearing standards, of the cage comprising a bottom and opposite end sections, said sections having opposite side strips and transverse rubbing strips grooved upon their inner faces and arranged a slight distance apart, bearing lugs extending from the side strips of the end sections and taking in the bearing standards of the suds box, bars pivotally connecting the side strips of the end sections and provided with depending hangers having irregular slots terminating in bearings, a rubbing head comprising a series of longitudinal shafts arranged parallel to each other, connected by a transverse bar having removable bearings in the slots, and connected upon their under sides with a series of rubbing strips, brackets secured to the side strips of one of the end sections, and a transverse shaft journaled in the brackets and beyond said brackets, having its ends bent and pivotally connected to the strips of the head below their bearings in the cage, substantially as specified. 7th. In a washing machine, the combination, with the suds box having bearings, of a cage composed of a central bottom and opposite end sections, one of which is extended to form operating handles, hinges connecting the end sections with the bottom section, a rubbing head pivotally mounted between the end sections, and rods leading from the extended end section and pivotally connected to the rubbing head below its bearing, substantially as specified.

No. 35,777. Machine for Gummung, Sharpening and Setting Circular Saws. (*Machine à affûter et évider les scies rondes.*)

Joseph Edward Whelan, (assignee of Thomas O'Dacre and Charles Cruikshanks), all of Pembroke, Ontario, Canada, 15th January, 1891; 5 years.

Claim.—1st. A machine for sharpening circular saws, consisting of a base supporting a swinging arm pivotally, and having a slotted curved end for carrying an adjustable bracket, and a post for holding up the saw blade while being operated upon, an arm pivoted at one end to said base and slotted to receive a saw arbor and setting attachment, a bracket adjustably supported upon the curved slotted end of the base and carrying an adjustable screw stop, and having a lever pivoted to it and connected to the said arm by the spring, a lever carrying an adjustable cam and a spring post, said lever pivoted to said bracket, a cam held on the pivot centre of said lever and adjustably secured to said lever, a draw rod held adjustably in the spring post, and an arbor consisting of a stud secured to the swing arm and holding a socket cone washer and hand nut, substantially as set forth. 2nd. The combination of a slotted arm B, stud F, held thereon, socket F¹, cone F¹¹, washer F¹¹¹, and nut F⁴, all upon said stud, a bracket G, adjustably bolted to said arm, and having a foot g, anvil bed g¹¹, and overhanging top g¹¹¹, anvil face G¹, secured to the anvil bed, and lever H, pivoted in the top g¹¹¹, substantially as set forth. 3rd. The combination of a slotted arm B, stud F, held to said arm by a nut f, and having a screw shank f¹, with groove f¹¹, a socket F¹, cone F¹¹, feathered washer F¹¹¹, and hand nut F⁴, all upon said stud, substantially as set forth. 4th. The combination of a sector-shaped base A, having a slotted end a¹, post a², and holding a pivot A¹, at the apex a, a slotted arm B, journaled upon said pivot and carrying a saw arbor, the bracket C, adjustably secured to the slotted end a¹, and having guide lug c, and lug c¹, and neck c¹¹, and supporting a lever pivotally, a screw stop C¹, in the lug c¹, and the spring C¹¹, connecting the arm B, and bracket C, by the neck c¹¹, substantially as set forth. 5th. The combination of the frame A, having the slotted end a¹, and supporting an arm pivotally, the arm B, pivoted to said frame, the bracket C, supported on the slotted frame end a¹, and connected to the arm B, by a spring, the spring C¹¹, connecting the bracket C, and arm B, the lever D, having lug d, and hub d¹, and pivotally connected to the bracket C, by the stud D¹, the screw E, passing through the lugs d, flat footed nut E¹, upon the screw having notch e¹, and cam E¹¹, pivoted upon the stud D¹, and having lug e¹¹, engaging notch e¹, substantially as set forth. 6th. The combination of the lever D, having hub d¹, post D¹¹, pivoted in said hub, spring d¹¹, coiled upon said post and having one end secured to said hub, the hooked rod D¹¹¹, adjustably secured in the head of said post, substantially as set forth.

No. 35,778. Marker for Billiards

(*Compteur pour billards.*)

George Charles Bateman and Richard Sheppard, both of Halifax, Nova Scotia, Canada, 15th January, 1891; 5 years.

Claim.—1st. The combination, in a billiard marker, with the revolving dials, one indicating units and the other tens, having teeth on their peripheries, and means for operating the said dials, of the projection c², on one of the teeth of the unit dial, adapted to engage and move the tens dial one tenth of a revolution, every revolution of the said unit dial, substantially as and for the purpose set forth. 2nd. The combination, in a billiard marker, with a casing and cover in which are journaled two revolving dials, one registering units, and one tens, having teeth on their peripheries operated by spring actuated dogs held by spring actuated levers, of the levers D, D², projecting through the rim of the said casing fulcrumed on pins d, and having shoulders d², adapted to abut against and operate the said spring actuated levers and shoulders d², substantially as set forth. 3rd. The combination, in a billiard marker, with the casing A, rim a, having apertures a¹, a², and a³, a⁴, over A³, glazed apertures B, B, toothed dials C, C², each having a series of digits on their front surfaces, and means for revolving the said dials of the projection c², on one of the teeth of the dial C, the indentations c¹, c², on two adjoining teeth of the dial C², adapted to be engaged and held by the dog F², and pawl G², the semi-cylindrical casing A³, the toothed discs H, H², each having a portion h, cut away formed on the axles of the said dials C, C², levers J, J², having segmental racks adapted to engage the said discs H, H², the spring slides K, K², en-

gaging and operating the said levers, the hook J³, on the lever J, adapted to be engaged by the spring catch M, the spring catch M, sliding in the semi-cylindrical casing A³, and the said slides K, K², projecting through the open ends of the said casing A³, substantially as and for the purpose set forth. 4th. The combination, in a billiard marker, with the revolving dials journaled in a suitable casing, one having digits representing units, and the other having digits representing the tens on their front surfaces, and means for revolving the said dials one unit at a time, of toothed discs formed on the axles of the said dials operated by segmental racks on levers suitably operated, the said levers and discs being adapted to revolve the said dials from registering any number to register zero, substantially as set forth.

No. 35,779. Cuspidor. (*Crachoir.*)

The Hartford Sanitary Manufacturing Company, (assignees of Daniel Henry Murphy), all of Hartford, Connecticut, U. S. A., 15th January, 1891; 5 years.

Claim.—1st. A cuspidor, formed of thin material, consisting of a base, and an inclined shield with flexible joints, part of which shield is permanently attached to the upper edge of the base, and part temporarily attached to the upper edge of the base, substantially as specified. 2nd. A cuspidor, formed of thin material, consisting of a base provided on two sides of the upper edge with flaps b, and on the opposite sides with folds d, and an inclined shield with flexible seams f, permanently attached to the flaps b, and provided with tongues e, which by contact with the folds d, temporarily connect the two free sides of the shield with the base, substantially as specified.

No. 35,780. Door for Freight Cars.

(*Porte de char à marchandises.*)

Hugh Yuill and Harry E. Gilpatrick, both of Cambridge, Massachusetts, (assignees of David Manuel, Hyde Park, Mass., U. S. A., 15th January, 1891; 5 years.

Claim.—1st. In a device of the character described, a horizontally arranged track secured to the car above the door-casing, said track being constructed in two sections, a chamber formed in the body of the car at the forward end of each section, said track projecting into said chambers, and a door suspended by carriages on said track, said carriages being so disposed that they will enter said chambers and force the door against the casing when closed, substantially as set forth. 2nd. In a device of the character described, the combination of a car provided with a beveled door-casing, a horizontal track disposed above said casing and constructed in sections, a chamber in the car-body at the forward end of each section, and a door provided with beveled edges and suspended from said track by pivoted carriages, which enter said chambers when the door is closed, substantially as and for the purpose specified. 3rd. In a device of the character described, the car A, having the beveled casing b, and socket 14, in combination with the sliding door B, having its edges beveled to fit said casing, and provided with the plate 85, having the arm 95, which enters said socket and forces the door against the casing when closed, substantially as specified. 4th. In a freight-car door, the bar 24, secured to said door and provided with the cam projection 34, in combination, with the bracket 54, secured to the car-body and provided with the roll 44, for engaging said projection and forcing the door against the casing, substantially as set forth. 5th. In a device of the character described, the car A, provided with the chambers D, F, casing b, and track C, in combination with the door B, suspended on said track by carriages H, K, and the hood R, disposed on the car above said track, substantially as specified. 6th. In a device of the character described, the car A, provided with the beveled casing b, and the chambers D, F, in combination with the track C, projecting into said chambers, the door B, suspended by carriages H, K, on said track and having its edges beveled to conform to said casing, and the hood h, on said track, all being arranged to operate, substantially as described. 7th. In a device of the character described, the combination of a car provided with a door-opening, and a single-rail horizontal track disposed in two sections above said door, a chamber in the car-body at the forward end of each track section, a door provided with hangers, and carriages mounted on said track by means of balls and rolls, said carriages being pivoted to said hangers and so disposed as to enter said chambers when the door is closed, substantially as specified. 8th. In a device of the character described, the combination of a car provided with a horizontal single-rail track disposed in two sections above the door-casing, a chamber in the car-body at the forward end of each track section into which said track projects, carriages comprising a chambered body in which two rolls bearing upon a ball are journaled, and a door provided with hangers in which said carriages are pivoted in position to enter said chambers when the door is closed, substantially as set forth. 9th. In a device of the character described, the carriages H, K, comprising the plates i, k, forming the chamber m, the rolls p, journaled therein, the ball r, projecting through the slot t, and the guide-wheels w, y, in combination with the car A, provided with the track C, and chambers D, F, and the door B, provided with the hangers L, M, to which said carriages are pivoted, substantially as specified. 10th. In a device of the character described, the door B, provided with the hanger L, and adjustable hanger M, having the grooves 45, in combination with the car A, provided with the track C, and chambers D, F, and the carriages H, K, pivoted to said hangers and provided with the circular flanges 35, working in said grooves, substantially as and for the purpose specified. 11th. In a device of the character described, the combination of the car A, provided with the beveled door-casing, the track C, having the rail d, and projecting into chambers D, F, formed in said car, the door B, provided with hangers L, M, the carriages H, K, pivoted to said hangers and adapted to travel on said track by means of the balls r, the plate 85, having the arm 95, adapted to enter the socket 14, the bar 24, provided with the cam projection 34, for engaging the roll 44, the lever P, pivoted to said door and having the hook 33, and the latch 43, for engaging said hook, all being arranged to operate, substantially as set forth.

No. 35,781. Die for Rolling Screw Threads.*(Coussinet pour fileter les vis.)*

The American Screw Company, (assignees of Charles D. Rogers), all of Providence, Rhode Island, U. S. A., 15th January, 1891; 15 years.

Claim.—A die for rolling screws by expanding the metal axially to form threads, provided with ribs and grooves, the acute angle of which, with the line of movement of the die, diminishes continually or by sections towards the finishing end of the die to correspond with the increasing diameter of the threads of the screw.

No. 35,782. Rolled Wood Screws.*(Vis à bois cylindrées.)*

The American Screw Company, (assignees of Charles D. Rogers), all of Providence, Rhode Island, U. S. A., 15th January, 1891; 15 years.

Claim.—1st. A screw, with the threads of the cylindrical portion extended on to the conical surface of the point, but reduced in diameter to correspond with the diameter of such surface, and terminating in a cutting edge before the extreme point is reached. 2nd. A wood screw having the threads of the cylindrical portion extended on to the surface of the point portion, but reduced in diameter to correspond with the diameter of such surface, and terminating in a cutting edge, and having an unthreaded spur-shaped entering portion *p'*, substantially as hereinbefore described.

No. 35,783. Die for Making Rolled Wood Screws.*(Coussinet pour faire les vis à bois cylindrées.)*

The American Screw Company, (assignees of Charles D. Rogers), all of Providence, Rhode Island, U. S. A., 15th January, 1891; 15 years.

Claim.—A die for raising the threads of a screw radially from a screw-blank by rolling, having at the entering end narrow or thin ribs to enter the metal to the required depth, but increasing in width to the opposite end with the intervening grooves of the same depth or slightly greater at the entering end than the depth of the groove in the blank, but increasing in depth to the opposite end to correspond with the increasing height to which the metal is raised as the rolling progresses.

No. 35,784. Die for Making Screw Bolts.*(Coussinet pour faire les boulons taraudés.)*

The American Screw Company, (assignees of Charles D. Rogers), all of Providence, Rhode Island, U. S. A., 15th January, 1891; 15 years.

Claim.—1st. The herein described die for making bolts, provided with transverse ribs and grooves over a portion of its surface, to produce longitudinal ribs and grooves, or flutings over a portion of the body of the blank, combined with ribs and grooves on another portion of the die, and nearly at right angles to the said transverse ribs to form screw-threads on the lower or entering end of the blank. 2nd. A bolt having its shank provided at its entering end with spiral ribs and grooves arranged to form a screw, and the portion between the screw and the head provided with longitudinal ribs and grooves, or flutings, substantially as described.

No. 35,785. Die for Rolling Wood Screws.*(Coussinet pour fileter les vis à bois.)*

The American Screw Company, (assignees of Charles D. Rogers), all of Providence, Rhode Island, U. S. A., 15th January, 1891; 15 years.

Claim.—Dies for rolling screws, provided with ribs for forming the grooves of the screws, the upper or working faces of which are formed of a series of rectangular sections increasing in width from the initial end of the die to the finishing end.

No. 35,786. Rolled Wood Screws.*(Vis à bois cylindrées.)*

The American Screw Company, (assignees of Charles D. Rogers), all of Providence, Rhode Island, U. S. A., 15th January, 1891; 15 years.

Claim.—1st. A rolled wood screw, having its point portion provided with a raised thread having the angle of its sides constantly increasing from its intersection with the main thread to its termination at or near the end of the screw. 2nd. A rolled wood screw having its point portion provided with a raised thread, the angle of the sides of which is constantly varying, and having an unthreaded entering portion *c*, substantially as hereinbefore described and set forth.

No. 35,787. Medicine for Dyspepsia.*(Médecine pour la dyspepsie.)*

Alexander Logan, North Sydney, Nova Scotia, Canada, 15th January, 1891; 5 years.

Claim.—A medical compound, composed of water subnitrate bismuth, saccharated pepsin, magnesia, alba carbonate, epsom salts, Jamaica ginger, and bicarbonate sodium, mixed together in the proportions herein stated.

No. 35,788. Coupling for Thills.*(Armon de limonière.)*

Frederick Hurst, Toronto, Ontario, Canada, 15th January, 1891; 5 years.

Claim.—1st. A thill iron *C*, having a semi-cylindrical T-shaped head *D*, formed on it, a groove *b*, being made in the said head *D*, to fit on to a rib *a*, formed in the socket *A*, in which the T-shaped head *D* is placed, in combination with a semi-cylindrical key *E*, having a groove *b*, corresponding with the groove in the T-shaped head *D*, substantially as and for the purpose specified. 2nd. A thill iron having a semi-cylindrical T-shaped head *D*, formed on it, a groove *b*, being made in the said head *D*, to fit on to the rib *a*, formed in the socket *A*, in which the T-shaped head *D* is placed, in combination with the semi-cylindrical key *E*, having a groove *b*, corresponding with the groove in the head *D*, and a longitudinal rib *f*, to fit into the longitudinal groove *d*, made in the head *D*, substantially as and for the purpose specified.

No. 35,789. Steam Boiler.*(Chaudière à vapeur.)*

David George McClelland, Manitoba, Canada, 16th January, 1891; 5 years.

Claim.—A baffle plate located or placed, as set forth, in a fire box, of a steam boiler, consisting of an iron case for heating water or generating steam, and connected to the boiler at each end of said baffle plate by water pipes, which water pipes hold said baffle plate in position, and also allow a free circulation of the water through said pipes and baffle plate, substantially as and for the purpose hereinbefore set forth.

No. 35,790. Covering for Freight Cars.*(Couverture pour chars à marchandises.)*

William Warren Green, Chicago, Illinois, U. S. A., 16th January, 1891; 5 years.

Claim.—1st. A covering composed of corrugated metal plates, covered at the joints with battens having grooves in their under surfaces filled with a packing, substantially as described. 2nd. A covering composed of metal plates having upturned edges, battens grooved to receive the said edges, and packing interposed between the battens and the plates, substantially as described. 3rd. A covering composed of metal plates having upturned edges, battens grooved to receive said edges, and packing in the grooves and about the upturned edges, substantially as described. 4th. A covering composed of corrugated metal plates having upturned edges, battens grooved to receive said edges, and packing in the grooves and about the upturned edges, substantially as described. 5th. A covering composed of corrugated metal plates, extending between the side posts and from the bottom of the car to the ridge having upturned edges along the sides, and the ridge end battens having grooves to receive the edges, and packing closely filling said grooves, substantially as described.

No. 35,791. Burner for Liquid Fuel.*(Brûleur des combustibles liquides.)*

Wesley Howell, Brantford, Ontario, Canada, 16th January, 1891; 5 years.

Claim.—The combination of the retort *A*, the tanks *B*, *C*, and connecting supply or feed pipes *D*, and *E*, provided with valves *F*, and *G*, the tube *H*, the perforated pipe burner *K*, below the retort, and the pan or dish *P*, below the said burner, as and for the purpose set forth.

No. 35,792. Can.*(Bidon.)*

Alvin Franklin Ahlum, Nashville, Tennessee, U.S.A., 16th January, 1891; 5 years.

Claim.—1st. The combination, with the can jacket and bail, of a staple driven between the can and jacket into and through the jacket and clinched on the outer side, and projecting above said jacket, forming ears to receive the bail and soldered to said can, substantially as and for the purposes set forth. 2nd. A shipping-can having a curved or round top, formed with a depression on each of the opposite sides of the discharge-opening, curved plates fitting said depressions and forming vents, and nozzle secured in the opening by the flange and bead.

No. 35,793. Sieve.*(Sis.)*

Alvin Franklin Ahlum, Nashville, Tennessee, U.S.A., 16th January, 1891; 5 years.

Claim.—1st. The improved sieve, combining with the body, having the outward recess *g*, formed by corrugating the said body, a wire cloth and a transverse supporting wire *m*, extending beneath said cloth and at its opposite ends through perforations in said body, the said end being bent to lie in said recess, concealed from sight, substantially as set forth. 2nd. The improved sieve, combining with the corrugated body, having an inward and outward recess, as described, a wire cloth and its peripheral supporting wire, and a transverse supporting wire, the said transverse and peripheral wires being locked within the closed recesses, substantially as set forth. 3rd. The improved sieve, herein described, having a perforated body with the inward recess *f*, a cloth having a peripheral wire *i* arranged in said recess, and a transverse wire having its ends bent to extend through the perforations in said body across the inner side of said peripheral wire, to tie or lock the same in place, substantially as set forth.

No. 35,794. Valve for Pumps.*(Soupape de pompe.)*

Edward Marshal Provonsil, Clarenceville, Quebec, Canada, 16th January, 1891; 5 years.

Claim.—1st. The improved pump valve, composed of a disk of leather or other analogous material, having a single incision with the ends thereof approaching each other, and with an integral portion between said ends, said incision being oblique to the plane of the disk and forming a bevelled bearing on the edges of the flap-section of the disk, and a correspondingly bevelled seat for said flap on the edges of the surrounding section of the disk, substantially as described and shown. 2nd. The combination of the disk *d*, having the single segmental incision *e*, oblique to the plane of the disk, and the rigid support *t* under said disk, and extending from the edge of the incision to the outer edge of the disk, substantially as described and shown.

No. 35,795. Re-Sawing Machine. (Sci.)

George Washington Mason, Eau Claire, Wisconsin, U. S. A., 16th January, 1891; 5 years.

Claim.—1st. The combination of a rigid board support, a band saw, means for adjusting the same in a vertical direction, and also in horizontal and inclined positions, and means for operating the band saw, substantially as described. 2nd. In a band saw, the vertically adjustable carrier B, having nuts *b²*, *b³*, key-way *b¹*, support A intermediate the ends of the beams, and having tubular guide *a¹*, and spline *a²*, and the lever frame beams D, D', having bearings *d*, *d¹*, substantially as described. 3rd. In a band sawing machine, the described vertically adjustable support A, B, a band saw, lever frame beams D, D', carrying the saw, the tilting swivel screws H, and means for operating the band saw, substantially as described. 4th. A band saw supporting lever frame beams D, D', in combination with the fulcrum shaft C, fixed bearing *d*, the adjustable spring bearing *d¹* and means for operating the band saw, substantially as described. 5th. In a re-sawing machine, the saw, means for operating the same and supporting lever frame beams D, D', having plane testing surfaces *d²*, substantially as described. 6th. The combination of the band saw, means for operating the same, the adjustable lever frame beams D, D', fulcrum shaft C and the longitudinally adjustable band saw guides, substantially as described. 7th. The combination, with a planing machine, of the re-sawing machine, comprising a band saw, means for operating the same, connected horizontal frame beams, and a central vertically adjustable support, substantially as described. 8th. The combination with a planing machine, of the re-sawing machine, comprising a band saw, means for operating the same, and means for adjusting the same inclinately with respect to the table of the planing machine, substantially as described. 9th. The combination, with a planing machine, of a re-sawing machine, comprising a band-saw, means for operating the same, and means for adjusting the same both vertically and inclinately with respect to the table of the planing machine, substantially as described.

No. 35,796. Writing Fluid and Process of Applying It. (Encre à marquer et procédé pour l'appliquer.)

David Sewall Oliphant, Toronto, Ontario, Canada, 16th January, 1891; 5 years.

Claim.—1st. A writing fluid, composed of chloride of aniline, water mucilage and glycerine, prepared in substantially the following proportions: three drachms and thirty-six grains of chloride of aniline, five drachms of water, three drachms and thirty-six grains of mucilage, and one drachm and forty-eight minims or drops of glycerine. 2nd. A mordant composed of bi-chromate of potash, mucilage and water, prepared in substantially the following proportions: eighty grains of bi-chromate of potash, one ounce of heavy mucilage and three ounces of pure water. 3rd. The written described process for marking textile fabrics, which consists in first applying to the surface of the fabric a mordant, composed of bi-chromate of potash, heavy mucilage and water, and when the surface so prepared is dry, writing upon it with ink, composed of chloride of aniline, water, mucilage and glycerine, substantially as specified.

No. 35,797. Composite Board.*(Planche de matière composée.)*

William Warren Green, Chicago, Illinois, U. S. A., 16th January, 1891; 5 years.

Claim.—1st. A corrugated metal sheet, containing a solid filling, within the corrugations thereof, in combination with a backing of fibrous material fastened thereto, as and for the purpose stated. 2nd. The above described composite board, composed of the corrugated metal sheet B, the filling C, the backing D, the metal sheet being turned over and pressed down upon the backing, as shown, at *b¹*, as and for the purpose stated.

No. 35,798. Hitcher for Horses. (Enrénore.)

Henry Jacob Baxter, Emerald, Wisconsin, U. S. A., 16th January, 1891; 5 years.

Claim.—1st. The combination, with the plate having converging jaws, of the wedge-block adapted to be inserted between the said jaws and clamp, a rope, strap, or cord between its sides and the opposing sides of the said jaws. 2nd. The combination, with the plate having converging jaws and having retaining lugs at the upper edge, of the said jaws, of the wedge-block adapted to be inserted between the jaws, substantially as and for the purpose described. 3rd. The

combination, with the plate having converging jaws, of the wedge block to be inserted between the jaws and having a projection which extends beyond the rear end of the block and above the top edges of the jaws, substantially as described, for the purpose specified. 4th. The combination of the plate having converging jaws and retaining lugs at the upper edges of the said jaws, and the wedge-block having a rear extension, substantially as described. 5th. The combination, with the plate having converging jaws and having a slot between the jaws, of the wedge-block having a shank which extends through the said slot, and a pin passing through the said shank, substantially as set forth. 6th. The herein described fastener, composed of the plates A and A', which are disposed at right angles to one another, the plate A, having converging jaws and retaining lugs at the upper edges of the said jaws, and having slot *e*, and of the wedge-block having extension D and shank E, the latter extending through slot *e*, and held in place by pin F, which passes through the said shank.

No. 35,799. Lawn Mower.*(Fauçaise le pelouse.)*

Arthur Porter, Galena, Illinois, U. S. A., 16th January, 1891; 5 years.

Claim.—1st. The combination of the axle, the apron secured at its lower edge upon the finger bar, and the brackets having hooked ends hooking over said axle, their lower ends being secured to the under side of the apron, substantially as set forth. 2nd. The combination of the frames carrying an apron and the receptacle adapted to receive the cut grass from the cutter-bar, and the bail having its side limbs pivoted upon the main axle, and reaching forward and engaging lugs on said frame, said receptacle having lugs also engaging said side limbs of the bail, and said bail having a handle, substantially as set forth. 3rd. The combination of the axle C, the bracket S, having hooked ends hooking over said axle, the apron L, the finger-bar B, the cutter-bar F, operated by means of the lever E, the cam-edged driving wheel, and the receptacle, substantially as and for the purpose set forth. 4th. The combination of the axle C, the brackets S, having hooked ends attached to the axle, the apron L, the finger-bar B, the cutter-bar F, operated by means of the lever E, the driving wheel having a cam on its periphery, the receptacle at the rear of the axle, and the revolving rake in front of it, substantially as described.

No. 35,800. Feed Water Heater and Purifier. (Réchauffeur et épurateur de l'eau d'alimentation.)

Robert Learmonth, Buffalo, New York, U. S. A., 16th January, 1891; 5 years.

Claim.—1st. In a feed-water heating and purifying apparatus, a chamber having two or more sectional disks arranged at suitable distances apart in its upper portion, and over which the water successively passes, a vertical tube or passage with open ends extending below the water level bottom of said chamber and projecting above said disks, a water supply pipe opening into said vertical tube or passage and communicating with the boiler below the water-line, a pipe leading from the live steam of the boiler to the upper portion of said chamber, the lower portion of said chamber being divided into two compartments by a dividing wall or partition, and a suitable blow-off valve arranged at the base of the chamber for cleansing the same, the whole combined and operating, substantially as and for the purpose stated. 2nd. In a feed-water heating and purifying apparatus, a chamber, having two or more sectional disks arranged at suitable distances apart in its upper portion, a vertical tube having open ends centrally located within said chamber, a water supply pipe opening into said vertical tube and communicating with the boiler, said pipe having an automatic shut-off valve, a pipe leading from the live steam of the boiler to the upper portion of said chamber, having a valve for regulating the pressure of the steam passing through it, and a suitable blow-off valve arranged at the base of the chamber for cleansing the same, the whole combined and operating substantially as shown and described. 3rd. In a feed water heating and purifying apparatus, the combination of a chamber 1, having the water supply pipe 2, and the sectional disks 3, 4, 5, 6, 7, 8, the sediment accumulating chamber 9, divided by the wall or partition 27, the vertical tube or passage 10, a feed-supply pipe 11, within which is arranged the automatic shut-off valve 12, having the valve-plate 13 resting on the sleeve or collar 16, the valve-stem 14, integral with the said plate and passing loosely through the sleeves 16 and 18, the pipe or passage 20, having the valve 21, and leading from the live steam to the top of said chamber, a blow-off pipe 26 and valve 25, substantially as shown. 4th. In combination, with a feed-water heating and purifying apparatus, an automatic shut-off valve, having a valve-plate adapted to automatically close, as the pressure in the purifier is lower than that in the boiler, substantially as described.

No. 35,801. Combined Metallic Shank and Counter for Boots and Shoes. (Tige et contrefort métalliques pour chaussures.)

Orlando W. Easton, Chester, Arkansas, U. S. A., 16th January, 1891; 5 years.

Claim.—The combination with the shank A and plate B, the former having the outwardly-projecting perforated flanges D, D, the shank A, plate B and flanges D, D, constituting a plate and shank of cruciform construction, of the counter C, having the inwardly-projecting scalloped flange *c*, and inwardly-projecting adjustable flanges E, E, coinciding with the bars D and provided with the perforations *e, e, e*, all constructed out of one piece of metal, all arranged and operating substantially as described and for the purposes specified.

No. 35,802. Bar for Grates.*(Barreau de grille.)*

David Uzal Cory, Englewood, New Jersey, U.S.A., 16th January, 1891; 5 years.

Claim.—The combination of rotating grate-bars, with alternating stationary bars, the upper surface of the latter being arranged substantially on a level with the axes of the former.**No. 35,803. Metal Wheel. (Roue métallique.)**

William Erastus Williams, Chicago, Illinois, U.S.A., 16th January, 1891; 5 years.

Claim.—A metal wheel, composed essentially of a metal hub, a web of sheet metal brought to the required curvature by means of tapering corrugations therein, substantially as described and suitably fastened to said hub and a metal rim riveted to said web as and for the purpose stated.**No. 35,804. Slide Valve for Steam Engines.***(Tiroir pour machines à vapeur.)*

John Baird, New York, State of New York, U.S.A., 16th January, 1891; 5 years.

Claim.—1st. The combination, substantially as hereinbefore set forth, of a valve-face, a face-plate, a valve sliding between them, a valve-plate carried by the valve and a packing consisting of thin sheets of yellow metal, such as brass interposed between the valve and valve-plate. 2nd. The combination, substantially as hereinbefore set forth, of a steam cylinder, its inlet and exhaust ports, a valve-face, a face-plate, a skeleton-valve, sliding between the valve-face and face-plate, valve-plates corresponding with the steam ports and a series of thin yellow metal plates interposed between each valve-plate and the valve. 3rd. The combination, substantially as hereinbefore set forth, of a valve-face, a face-plate, a valve sliding between them, valve-plates, a series of thin sheets of yellow metal interposed between the valve and valve-plates, tapering keys movable endwise in bearings in the valve-chest and acting on the face-plate, and bearing screws also acting on the face-plate in opposition to the keys to adjust and hold the face-plate firmly in position. 4th. The combination, substantially as hereinbefore set forth, of a valve-face, a face-plate, a skeleton-valve sliding between them, valve-plates, thin sheets of yellow metal interposed between the valve and face-plate, a valve-spindle passing through the valve and traversing guides at each end thereof, and mechanism for adjusting the valve longitudinally on the spindle to secure its correct adjustment and operation.**No. 35,805. Harness. (Harnais.)**

Franklin M. Hall, Trumansburg, New York, U.S.A., 16th January 1891; 5 years.

Claim.—In combination with the surcingle 1, having two pulleys 3 and 4, and the pastern-strap 8, having a pulley 7, the pastern-strap 10, having the eye 9, and the rein 6, having one extremity attached directly to the said eye of the pastern-strap 10, passing around the pulleys 4, 7, and 3, and adapted to extend back between the rear legs of an animal, substantially as described.**No. 35,806. Fixture for Electric Lights.***(Monture de lampe électrique.)*

Fred. H. Aldrich, Cadillac, Michigan, U.S.A., 17th January, 1891; 5 years.

Claim.—1st. The combination of a vertical shaft, an electric light fixture at the lower end of said shaft, the conducting wires extending through the shaft and spring actuated mechanism for automatically winding the wires around the said shaft, substantially as set forth. 2nd. The combination of a vertical shaft, an electric light fixture at the lower end of said shaft, the conducting wires extending through the shaft, spring actuated mechanism for automatically winding the wires around said shaft and a spring actuated catch to arrest said winding mechanism at any desired point of adjustment, substantially as set forth. 3rd. The combination of a shell or casing, a shaft revoluble within the latter, a spring, means for winding and unwinding said spring by the revolution of the shaft within the casing or the latter around the shaft and the conducting wires comprising the return and flow wires wound upon the shaft within the casing, depending from the latter and directly supporting the lamp, substantially as set forth. 4th. The combination of a shell or casing, a shaft revoluble within the latter, a spring, means for winding and unwinding said spring by the revolution of the shaft within the casing or the latter around the shaft, a catch or stop mechanism to arrest motion at any desired adjustment and the conducting wires comprising the return and flow wires wound upon the shaft in the casing, depending from the latter and directly supporting the lamp, substantially as set forth. 5th. The combination of a shell or casing and an interiorly arranged shaft, revoluble with relation to each other, a spring arranged to be wound by the revolution of such shaft or casing and a train of gears arranged to transmit motion between said spring and the shaft and casing, substantially as set forth. 6th. The combination with the conducting wires joined in a single continuous flexible cord comprising the flow and return wires and directly supporting the lamp, of a shell through which the said conducting wires are guided a shaft within said shell and spring actuated mechanism for winding said conducting wires upon the shaft, substantially as set forth. 7th. The combination of a tubular shaft or stem, a tube partially surrounding and connected to the same, a sleeve journaled upon said tube, a spiral spring mounted in the space between the tubular shaft and the tube surrounding the same

and attached at its ends to the said tube and to the sleeve journaled thereon, a surrounding shell or casing revoluble with relation to the tubular shaft, means for transmitting motion between said shell or casing and the revoluble sleeve and the return and flow wires entering through the tubular shaft, connected to and wound upon the tube surrounding the latter and guided over suitable pulleys out through an opening in the lower end of the shell, substantially as set forth.

No. 35,807. Freight Car. (Char à marchandises.)

William Warren Green, Chicago, Illinois, U.S.A., 17th January, 1891; 5 years.

Claim.—1st. The combination of the sills A, composed of the wooden timbers a, and angle plates a', the stringers B, having the side plates b, the tie rods E, struts F, the end sills C, plates c, and angle pieces D, substantially as described. 2nd. The combination of the tie rods E, the struts F, the plates b, the timbers B, and filling H, substantially as described. 3rd. The combination of the sills A, the stringers B, the tie rods E, struts F, the washers G, and the truss rods L, substantially as described. 4th. The combination of the sills A, posts P, struts F, tie rods E, braces S, composed of the wooden portions a', and the metal plates a, substantially as described. 5th. The combination of the side sills A, the shoe-plates T, the braces S, the socket plates U, and the posts P, substantially as described. 6th. The combination of the sills A, the shoes T, and the braces S, secured at their upper ends to the posts P, substantially as described. 7th. The combination of the posts P, the socket plates U, and the braces S, secured at their lower ends to the sills A, substantially as described.**No. 35,808. Mechanical Power.***(Travail mécanique.)*

James H. Frey, Cincinnati, Ohio, U. S. A., 17th January, 1891; 5 years.

Claim.—1st. The two treadles D, and F, a pitman pivoted to the toe of the latter, an arm rigidly connected to the other treadle D, and adapted to pass beneath the treadle F, a bearing at its outer end turning on the fixed supporting shaft C, a rod D', projecting from said bearing, and a pitman pivoted to the free end of said rod, the whole constructed as and for the purpose set forth. 2nd. The two treadles D, and F, an arm rigidly connected to the treadle D, and adapted to pass beneath the treadle F, a bearing at its outer end turning on the fixed supporting shaft C, a rod D', projecting from said bearing, internally threaded sockets L, pivoted to the toe of the treadle F, and to the free end of the rod D', pitmen G, H, each having oppositely threaded ends, the lower ones of which are seated in said sockets and other internally threaded sockets screwed onto the upper ends of said pitmen, and adapted to be pivoted on the wrist pin K, the whole constructed substantially as and for the purpose set forth. 3rd. The two treadles D, F, a pitman G, pivoted to the treadles F, an arm D', rigidly connected to the treadle D, and passing beneath the treadle F, a rod D', attached to said arm D', and the pitman H, connected to said rod as set forth.**No. 35,809. Pulp Machine. (Machine à pulpe.)**

Charles Sears Bucklin, Keyport, Monmouth Co., New Jersey, U. S. A., 17th January, 1891; 5 years.

Claim.—1st. In a pulp machine, the curved ribs K, attached to the main frame and channeled or grooved as at k, in their upper surfaces and provided with the outer re-enforcing sieve I, in combination with the inner fine sieve G, and bows W', to which the said fine sieve is attached, said bows being adapted to fit in the channels of the curved ribs K, substantially as described. 2nd. In a pulp machine, the curved or semi-cylindrical outer re-enforcing sieve, and the end and side of the main frame, and the cross bars J, J, and curved ribs K, K', in combination with the inner curved or semi-cylindrical sieve, and the separate curved bows for holding the inner sieve, substantially as described. 3rd. The main frame provided with the permanent curved ribs K, each channeled at the upper edge, the supporting frame for the sieve, the hopper F, passages F', D', and the two curved and semi-cylindrical sieves held by the curved ribs, in combination with the rotary beater journaled in the end pieces of the main frame, substantially as described.**No. 35,810. Knob Eyelet for Carriage Top Curtains. (Oeillet de crochet de rideau pour soufflets de voiture.)**

Daniel Conboy, Toronto, Ontario, Canada, 17th January, 1891; 5 years.

Claim.—1st. A metal ring B, clamped on the curtain D, so as to surround the eyelet C, a metal finger A, formed integral with the said ring B, substantially as and for the purpose specified. 2nd. A metal ring B, provided with a finger A, and clamped on the curtain D, so as to surround the eyelet C, prongs a, extending from the finger A, and ring B, in combination with a clamping plate E, substantially as and for the purpose specified.**No. 35,811. Dies for Making Rolled Wood Screws. (Coussinet pour faire les vis à bois cylindriques.)**

The American Screw Company, (assignees of Charles D. Rogers,) all of Providence, Rhode Island, U. S. A., 17th January, 1891; 15 years.

Claim.—A die for forging the threads upon a screw by rolling, having at its entering end a plane surface only, provided with ribs to form the threads on the cylindrical portion of the blank, and to

wards the finishing end a surface inclined to the plane surface and corresponding to the surface of the point of the screw-blank provided with ribs which engage in succession with the metal to form the threads on the point.

No. 35,812. Dies for Making Rolled Wood Screws. (*Coussinet pour faire les vis à bois cylindriques.*)

The American Screw Company, (assignees of Charles D. Rogers,) all of Providence, Rhode Island, U. S. A., 17th January, 1891; 15 years.

Claim.—1st. A screw-blank having a conical point with a section between the base of the cone and the cylindrical portion of the blank forming the frustum of a cone less acute than the cone forming the point. 2nd. A die for threading screws by rolling provided with smooth beveled surfaces to act upon the conical portion of the blank, while its cylindrical portion is being threaded, and bring it to the proper size and shape before a thread is formed thereon by a grooved portion of the beveled surface at or towards the finishing end of the die.

No. 35,813. Measure for Tailors. (*Mesure de tailleur.*)

Richard Lewis and Charles William Dabney, both of Union City, Pennsylvania, U. S. A., 17th January, 1891; 5 years.

Claim.—1st. The combination with the vertical blade and its cross-arms of the pendulum pivoted to the upper part of the vertical blade and the reversible guard pivoted on the center line of the pendulum to the said vertical blade, substantially as and for the purpose set forth. 2nd. The combination, with the vertical blade and its cross-arms of the flexible blade arranged in line with the said vertical blade, the pins projecting from said cross-arms at a certain fixed distance from the edges of the said flexible blade farthest from them and a pendulum pivoted to the vertical blade, substantially as and for the purpose set forth. 3rd. The combination, with the vertical blade and its cross-arms provided with pins H, with the flexible blade arranged in line with the said vertical blade, the swinging arm provided with a projecting pin at its free end and having its other end pivoted to the blade centrally between the pins H, and the projections on the back of the blade for retaining the said swinging arm, substantially as and for the purpose set forth.

No. 35,814. Car Coupling. (*Attelage de chars.*)

George W. Kemp and Albert Hudson, both of Ottawa, Ontario, Canada, 17th January, 1891; 5 years.

Claim.—1st. A draw-head having an internal cavity C, enlarged from the throat rearwardly and upwardly, and a depression K, at the bottom, a gravitating ball G, within said cavity, and a lever or arm J, to lift said ball within the cavity in uncoupling, as set forth. 2nd. A draw-head having an internal cavity C, and a loose ball G, within said cavity, as and for the purpose set forth. 3rd. The combination, with the draw-head B, having a cavity C, enlarged from the link entrance, and a depression K, at the bottom of said cavity, of a loose gravitating ball G, within said cavity, a shaft H, journaled through the draw-head and below said cavity, and provided with a radial arm J, to rest in said depression, as and for the purposes set forth.

No. 35,815. Car Coupler. (*Attelage de chars.*)

Daniel Cooper and John Cornelius Cooper, both of Grand Rapids, Michigan, U. S. A., 17th January, 1891; 5 years.

Claim.—1st. In a car-coupling, a vertical-plane coupling-hook pivoted in the draw-bar and projecting with its hooked front end beyond the mouth of the draw-head, and with its rear end in rear of its pivot and a spring secured in the draw-bar and engaging with its free end into the rear end of the coupling-hook, substantially as described. 2nd. In a car-coupling, the coupling-hooks C, pivotally secured by the vertical pivot-pin D, in the draw-bar, and provided with the hook E, projecting beyond the draw-head, and the rear extension in rear of its pivot provided with the vertical slot G, and the spring F, secured in the rear end of the draw-bar and engaging with its free end into the slot G, of the coupling-hook, substantially as described. 3rd. In a car-coupling, the combination of the vertical plane coupling-hook pivoted in the draw-bar, the spring engaging with the rear end of said hook, the spreader pivotally secured in the draw-head, and the uncoupling lever engaging with the said coupling hook and spreader to simultaneously operate them in uncoupling, substantially as described. 4th. In a car coupling, the combination of a vertical plane, coupling hook C, pivoted in the draw-bar, the spring F, engaging with the rear end thereof, the spreader I, pivotally secured under the coupling-hook in the mouth of the draw-head and the uncoupling lever H, provided with the segmental gear H¹, engaging the rear end of the spreader and the rearwardly curved arm H², engaging with the rear end of the coupling-hook, substantially as described.

No. 35,816. Bolting Reel. (*Blutoir.*)

Dobson and Crawford Manufacturing Company, assignees of James Brodie Dobson, Cleveland, Ohio, U. S. A., 17th January, 1891; 5 years.

Claim.—1st. In a bolting reel, the combination, with a shaft, a reel surrounding the shaft and supported in bearings formed in the casing, and gearing connecting the reel and shaft, whereby they are rotated simultaneously, but at unequal rates of speed, of a feed-trough leading to the reel at one end, a discharge spout leading

therefrom at the opposite end, and brushes secured to the shaft and engaging the internal surface of the reel, said brushes having spiral trend or lead, substantially as set forth. 2nd. In a bolting reel, the combination, with casing having metal heads, bored to fit the respective reel heads, the edges of the casing head having internal circumferential grooves, of metal reel heads adapted respectively to operate in the heads of the casing, such reel-heads having peripheral tongues adapted to fit the grooves of the casing heads, substantially as set forth. 3rd. In a bolting reel, in combination, double-walled mutually-engaging metal casing heads and reel heads, substantially as indicated, the engaging edges of these heads being tongued and grooved for mutual engagement, substantially as set forth. 4th. In a bolting reel, the combination, with a casing, a reel mounted at its ends in bearings formed in the casing, and a rotary shaft supported in bearings formed in the reel-heads, of gearing connecting the shaft and reel, and brushes secured on the shaft and engaging the internal surface of the reel, substantially as set forth. 5th. In a bolting reel, the combination, with a casing, a reel mounted in bearings formed in said casing, and a shaft mounted in bearings in the reel-heads, of flexible brushes and flexible agitators secured on the shaft, substantially as set forth.

No. 35,817. Track Sanding Apparatus.

(*Appareil pour sabler les voies de chemin de fer.*)

Henry Lowell Leach, Jr, Keene, New Hampshire, and Henry Lowell Leach, Sr., Boston, Massachusetts, U. S. A., 17th January, 1891; 5 years.

Claim.—1st. In track sanding apparatus, the combination of a trap and a blast nozzle introduced into the trap, substantially as and for the purpose set forth. 2nd. In track sanding apparatus, a trap into which a blast nozzle is introduced, the trap having a removable part opposite the blast, substantially as and for the purpose set forth. 3rd. In track sanding apparatus, a trap divided into chambers, the wall between which has an opening and cover, substantially as and for the purpose set forth. 4th. A track sanding apparatus, formed with an interior partition forming connecting upper and lower chambers, an opening in the upper chamber, an opening in the other chamber and a blast nozzle at the bottom of the upper chamber, all substantially as and for the purpose set forth. 5th. In track sanding apparatus, the combination of a swinging cover α , with a piston 4 and cylinder 5, substantially as and for the purpose described.

No. 35,818. Clasp. (*Agrafe.*)

Henry H. Robertson, assignee of Henry Clay Anderson, both of Whitesbury, Texas, U. S. A., 17th January, 1891; 5 years.

Claim.—A clasp, comprising a base and a reversely bent or inclined retaining or clamping arm, formed of a single continuous wire, with an eye at one end thereof and a bend or enlargement at the other end thereof, the frame or base being substantially rectangular and the upward bent arm extending through the eye at one end of the base, and having the bend or enlargement at the other end arranged near or against the end bar at the opposite end of the frame.

No. 35,819. Drainer for Liquid Measures.

(*Egouttoir pour mesureurs de liquides.*)

The Pannitt Drainer Company, Petersburg, Virginia, U. S. A., 17th January, 1891; 5 years.

Claim.—An apparatus for draining liquid measures, consisting of a case or box having an orifice in its bottom wall, a depending discharge tube secured at such orifice and adapted to enter an opening in a barrel or similar receptacle, a removable drip pan supported by the bottom wall of the case or box and provided in its bottom with an attached strainer located in coincidence with the discharge tube, and rails located above the drip-pan for supporting the liquid measures, substantially as described.

No. 35,820. Head for Grooving and Dadoing. (*Guide de rabot à rainure.*)

Francis I. Matthews and Daniel J. Quinlean, Oakland, California, U. S. A., 19th January, 1891; 5 years.

Claim.—1st. In a dado or grooving head, the combination, with a head having smooth outer side faces, and a recess A, produced in its periphery, substantially as described, of a carrier block held to have lateral movement in the said recess, provided with a vertical adjustable spur and a vertical adjustable cutter, a clamping block contacting with one wall of the said recess A and the opposed face of the carrier block, and an adjusting screw passing through the head and through the carrier block, terminating essentially flush with the side faces of the head, substantially as and for the purpose specified. 2nd. In a dado or grooving head, the combination, with a head, having smooth outer side faces, and provided with a recess A, substantially as described, having one inclined and one straight wall and provided with a transverse, semi-circular recess in its straight wall of reduced diameter at its center, of a carrier block inserted in the said recess contiguous to the straight wall thereof, and provided with a transverse recess interiorly threaded and registering with the transverse recess in the straight wall of the main recess A, a spur adjustably secured upon one side face of the carrier block, an adjustable knife secured upon the front face of the said block, a clamping block contacting with the inclined wall of the main recess and the approaching face of the carrier block, and an adjusting screw having a reduced diameter at or near its center, capable of contact with the wall of the transverse recess in the main recess A and the interiorly-threaded-recess in the carrier block, all combined for operation, substantially as shown and described. 3rd. In a dado or grooving head, the combination, with a head, having smooth outer

side faces and provided with a recess A, substantially as described, having one inclined ribbed wall and one straight wall, and provided with a transverse, semi-circular recess in its straight wall, of reduced diameter at its centre, of a carrier block inserted in the said recess contiguous to the straight wall thereof, and provided with a transverse recess interiorly threaded and registering with the transverse recess in the straight wall of the main recess A, a spur wider at its top than at its bottom, adjustably secured upon one side face of the carrier block, a reversible, adjustable knife secured upon the front face of the said block, a clamping block grooved to engage with the ribbed wall of the main recess A, and the approaching face of the carrier block, and an adjusting screw having a reduced diameter at or near its center, capable of contact with the wall of the transverse recess in the main recess A, and the interiorly-threaded recess in the carrier block, the said screw being adapted to terminate at its extremities, essentially flush with the outer face of the head, and provided in said extremities with a socket capable of receiving a key wrench or equivalent tool, substantially as and for the purpose specified.

No. 35,821. Method of Manufacturing Articles from Celluloid. (*Mode de fabrication des articles de la cellulose.*)

Wentworth Richardson, Campbellford, Ontario, Canada, 19th January, 1891; 5 years.

Claim.—1st. As a new article of manufacture, a collar, cuff, or like article, made of rubberine and polished by scouring with pumice stone, and afterwards washing and drying the same, and then subjecting it to friction with glass, on which a small quantity of tallow has been rubbed, substantially as described. 2nd. The process of polishing celluloid collars, cuffs and other articles, consisting of, first, scouring the rough sheet, until smooth, with powdered pumice stone, then washing and drying it, then polishing the articles by rubbing them with plate glass, on the surface of which a small quantity of tallow has previously been rubbed, substantially as described.

No. 35,822. Improvements in Machinery for the Manufacture of Glass Bottles, and similar Hollow Glass Articles. (*Appareil pour la fabrication des bouteilles de verre, etc.*)

Claim.—1st. In machinery for the manufacture of glass bottles and similar hollow glass articles, an upright frame having centred in its upper part a tubular crank arm, capable of inversion, and having mounted in its lower part a treadle connected to a vertically sliding table, to which are jointed the two halves of a bottle mould, and a lever for opening and closing them. 2nd. In combination, with the crank arm, a T-piece and nozzle fitted to receive a divided neck mould and a tubular punch or plunger. 3rd. In combination, with the divided neck mould, a divided parison mould fitting thereon, and suitable tongs for opening and closing the neck and parison moulds. 4th. In combination with the neck mould, the divided finishing mould fitting thereto, the tubular punch or plunger, and the air valve or cock, and spring lever for regulating the blowing pressure.

No. 35,823. Eye for Lacing. (*Oeillet pour lacets.*)

Franklin S. McKenney, Detroit, Michigan, U.S.A., 19th January, 1891; 5 years.

Claim.—1st. As an article of manufacture, a loop eyelet constructed with arms adapted to embrace the material, one of said arms provided with a fastening for engaging said material, and the other arm provided with a seat for said fastening, substantially as set forth. 2nd. A glove, boot, or analogous article, provided with loop eyelets constructed with arms embracing the marginal edges of said article of apparel, one of said arms provided with fastening projections for engaging the apparel, and the other arm provided with seats for said fastening projections, the edges of the end portion of the loop being curved outward, substantially as set forth. 3rd. As an article of manufacture, a loop eyelet constructed with arms adapted to embrace the material, one of said arms provided with piercing prongs on opposite marginal edges, and the other arm provided with seats at its sides to be engaged by said piercing prongs, the edges of the end portion of the loop being curved outwardly, substantially as set forth. 4th. As an article of manufacture, a loop eyelet constructed with arms adapted to embrace the material, one of said arms provided with piercing prongs on its opposite marginal edges, and the other arm provided with marginal recesses on its opposite sides to be engaged by said piercing prongs, the edges of the end portion of the loop being curved outward, substantially as set forth.

No. 35,824. Fastening for Lacing Gloves, etc. (*Agrafe pour gants, etc.*)

Franklin S. McKenney, Detroit, Michigan, U.S.A., 19th January, 1891; 5 years.

Claim.—1st. A fastening for gloves and other articles, consisting of a base, provided with a tongue A², struck therefrom, and with base extensions a², a¹, said tongue and base extensions formed, the one with marginal shoulders Q and the other with adjacent corresponding marginal recesses, substantially as set forth. 2nd. A fastening for gloves and other articles, consisting of a base provided with a tongue A², struck therefrom, and with base extensions a², a¹, provided with straight marginal edges a², the said tongue separated at its edges by a diverging slit, substantially as set forth.

No. 35,825. Lacing for Gloves, etc. (*Lacets pour gants, etc.*)

Franklin S. McKenney, Detroit, Michigan, U. S. A., 19th January, 1891; 5 years.

Claim.—1st. As an article of manufacture, the herein described fastening, consisting of a piece of metal bent to form a loop, and overlapping and impinging arms, which are each provided with fastening means, the edges of the end portion of the loop being curved outward, substantially as set forth. 2nd. As an article of manufacture, the herein described fastening, consisting of a piece of metal bent to form a loop and arms extending in the same direction, one of said arms shorter than the other, and provided with prongs at each side of said loop respectively, the longer arm provided with one or more prongs, said fastening having a plane surface on the side opposite said prongs, substantially as set forth.

No. 35,826. Blank for Carriage Steps. (*Ebauche de marche-pied de voiture.*)

Samuel E. Brown, Cleveland, Ohio, U.S.A., 19th January, 1891; 5 years.

Claim.—The improved method of making carriage steps, which consists, first, in rolling a plate with a rib, second, in cutting the blanks from said plate, third, in bending the shank and forming the completed step, substantially in the manner and for the purpose set forth.

No. 35,827. Valve for Steam or Water. (*Souape à vapeur ou à eau.*)

Thomas Riley, Toronto, Ontario, Canada, 19th January, 1891; 5 years.

Claim.—1st. The removable seat in the valve on the permanent seat, as described. 2nd. The insertion of the washer, as described, between the seats, which prevents leakage. 3rd. The placing of the cushion on the spindle of the valve to close off the pressure, the cushion being supported by a permanent plate above the cushion. 4th. The recess above the permanent plate, between the plate and the thread, in which a washer is forced, which prevents leakage.

No. 35,828. Shelves for Supporting Cheese. (*Tablettes pour supporter le fromage.*)

Joseph J. Singley, El Dorado, Kansas, U.S.A., 19th January, 1891; 5 years.

Claim.—1st. The combination, with a reticulated shelf, of dust pan consisting of a frame suitably covered and provided at one side with upwardly-extending hooks, and at the other side with an upwardly-extending spring-catch, substantially as set forth. 2nd. The combination, with a reticulated cheese-shelf, of a dust pan adapted to be connected detachably to and suspended below said shelf, and having a forwardly-extending handle, whereby the parts may be lifted, substantially as set forth. 3rd. The combination of a reticulated cheese shelf, and a dust pan, consisting of a frame, having a transverse brace extended forwardly to form a handle, said frame being covered with cloth, or other suitable material, and provided with means for connecting it detachably to the under side of the reticulated shelf, substantially as set forth. 4th. The cheese-supporting shelf, consisting of a frame, having transverse braces and provided with a screen of wire netting secured to its upper side, in combination with a dust-pan secured detachably to its under side, and a suitable supporting rack, with which the shelf engages, substantially as and for the purpose set forth.

No. 35,829. Radiator for Oil Stoves. (*Calorifère pour poêles à huile.*)

Mary Ellen Smith, Schuyler, Nebraska, U.S.A., 19th January, 1891; 5 years.

Claim.—1st. The combination, with the perforated disk, provided with a right angularly-disposed depending flange, having a series of draft-openings, and the convex deflector surrounded by the flange and supported by legs depending from the disk, of the damper ring mounted for movement in the flange, and having openings adapted to be thrown into register with those of the flange, substantially as specified. 2nd. The combination, with the concave circular radiating disk, of the upwardly-disposed supporting legs, the perforated circular radiating disk, supported by the legs above the disk, the depending flange encircling the table, perforations formed in the flange, and a groove formed near the edge of the flange, and the circular damper ring mounted to revolve within the flange and having openings adapted to register with those of the flange, and thumb-lugs projecting outside of the flange, and an annular bead for riding in the groove, substantially as specified.

No. 35,830. Combined Cash Drawer and Register. (*Tiroir et registre à monnaie.*)

William Assheton, Baltimore, Maryland, U.S.A., 19th January, 1891; 5 years.

Claim.—1st. The improved cash box, having a partially glazed sight opening, a support for a strip of paper under said opening, such support including a gear wheel, a longitudinally movable rack bar meshing said gear wheel, a spring for actuating the said bar in one direction, the cash drawer, inter-engaging portions between the said drawer and rack bar, whereby the drawer may move and hold the rack bar against the stress of its spring, and a latch by which the drawer may be held closed, all substantially as and for the purposes set forth. 2nd. In an apparatus, substantially as described,

the combination of the frame or casing, the paper strip supporting rolls, one of which has a toothed wheel, the longitudinally sliding bar arranged to operate one of such rolls, a spring for actuating such bar in one direction, the drawer, inter-engaging portions on the drawer and bar, whereby the drawer, when closed, may serve to hold the bar back against the stress of its spring and a latch for the drawer, all substantially as and for the purposes set forth. 3rd. The combination in an apparatus, substantially as described, of the frame or casing, the paper supporting rolls, one of which has a gear wheel, the spring actuated rack bar adapted to mesh such wheel and having its toothed portion movable into and out of mesh with the toothed wheel, the drawer arranged to operate such rack bar, and the latch for such drawer, all substantially as set forth. 4th. In an apparatus, substantially as described, the combination of the frame or casing, the paper supporting rolls, one of which has a gear wheel, the rack bar arranged to mesh said wheel, the spring for actuating said rack bar in one direction, the drawer arranged to actuate the bar in the other direction, the gong, and connections between the hammer of the gong and the rack bar, substantially as set forth. 5th. In an apparatus, substantially as described, the combination of the paper supporting rolls, one of which has a gear wheel, the rack bar arranged to mesh said wheel and having an arm Q, a spring by which to actuate the rack bar forward, the cash drawer having a slot or recess U, the front wall V, of which is arranged to abut arm Q, and force the rack bar back when the drawer is closed, and the latch for securing the drawer closed, substantially as set forth. 6th. In an apparatus, substantially as described, the combination of the casing, the paper strip supporting rolls, one of which has a gear wheel, the rack bar arranged to mesh said wheel and having an arm or portion R, arranged at about right angles to its main portion and provided at its end with a latch arm, arranged for engagement with the cash drawer, the spring connecting with the rack bar at or near the upper end of the arm R, whereby the spring will actuate the bar longitudinally, and will at the same time operate to hold the rack bar in engagement with the toothed wheel, all substantially as and for the purpose set forth.

No. 35,831. Method of Finishing Boot and Shoe Heels, Edges, Shanks and Buttons. (*Mode de finir les talons, tranches et boutons de chaussure.*)

John F. Swain, assignee of William Winslow Crooker, Lynn, Massachusetts, U.S.A., 19th January, 1891; 5 years.

Claim.—1st. The improved method, hereinbefore described, of finishing parts of boots and shoes, the same consisting in applying wax to a moving heated yielding surface, and presenting the part to be finished to said surface, as set forth. 2nd. The improved method hereinbefore described, of finishing parts of boots and shoes, the same consisting in applying wax to a yielding facing, heating said facing to melt the wax, and presenting the part to be finished to said surface, as set forth. 3rd. The improved method, hereinbefore described, of finishing parts of boots and shoes, the same consisting in applying wax to a moving heated yielding surface, dyeing the surface of the part to be finished, and then presenting said dyed surface to the heated yielding waxed surface, as set forth. 4th. The combination of a movable chamber c, adapted to receive steam, a yielding bed b, in contact with said chamber, and a flexible facing a, supported by said bed, as set forth.

No. 35,832. Paper Flour Sack.

(*Sac à fleur de papier.*)

William A. Lorenz, Hartford, and Bartlett Arkell, Canajoharie, both of New York, U.S.A., 19th January, 1891; 5 years.

Claim.—As an improved article of manufacture, a paper flour sack, composed of the dark-colored, strong and durable manilla paper, usually employed in the manufacture of such sacks, but having its exterior or exposed surface whitened, as specified, and also embossed in imitation of a woven fabric, whereby the finished sack is caused to present the appearance of a white cotton cloth sack, and is also rendered stronger, less pervious to moisture and extremely pliable, all as hereinbefore set forth.

No. 35,833. Slide Valve. (*Tiroir.*)

The Ross Valve Company, assignees of William Ross, all of Troy, New York, U.S.A., 19th January, 1891; 5 years.

Claim.—1st. In a slide gate valve, the combination, with the inclosing case, a slide-gate, a gate-carrier, having a bearing-block engaging abutment, and a carrier stem projecting exteriorly of the case, of a seating plunger, a nest of bearing blocks interposed between such gate, and a resisting medium comprising two pairs of bearing blocks, one pair bearing upon the gate and the other pair upon the resisting medium, and a mobile block interposed between the pairs, substantially as described. 2nd. In a slide gate valve, the combination, with the inclosing case, a slide-gate, a gate-carrier, having a bearing-block engaging abutment, and a carrier stem projecting exteriorly of the case, of a seating plunger, provided with a laterally-yielding foot, a nest of bearing blocks interposed between such gate, and a resisting medium comprising two pairs of bearing blocks, one pair bearing upon the gate and the other pair upon the resisting medium, and a mobile block interposed between the pairs, substantially as described.

No. 35,834. Pliers, incers, etc.

(*Tenailles, pinces, etc.*)

William Alexander Bernard, New York, U.S.A., 20th January, 1891; 5 years.

Claim.—1st. The pliers, pincers, or similar tool, having levers of sheet metal cut out and stamped up into semi-circular or trough-

shaped handles, and having the flat portions 2 crossing each other and rivetted together at 3, to form double X-shaped levers between the handle and jaw portions of the tool, substantially as set forth. 2nd. The sheet metal lever handles A, B, having the flat portions 2 crossing each other and rivetted together at 3 to form double X levers, in combination with the parallel moving jaws D, E, and connecting pivots 9 and 10, substantially as set forth. 3rd. The combination with the lever handles, having flat crossing portions 2, forming double X levers, of the jaws D, E, the arm K and the punch and die, substantially as set forth. 4th. The pliers or pincers formed of sheet metal cut out and stamped up to shape, and having the flat portions 2 crossing each other and forming double X-shaped levers, and the sheet metal between the lever ends, forming the jaws 6, substantially as set forth.

No. 35,835. Machine for Converting Motion

(*Machine pour convertir le mouvement.*)

Byron Coburn, Cardwell, Virginia, U. S. A., 2th January, 1891; 5 years.

Claim.—1st. In a machine for converting and transmitting motion, the combination of a rectangular frame, the longitudinal guide-rods secured to the outer sides of the side beams of said frame, the longitudinally reciprocating frame, comprising the head blocks mounted upon the said guide rods and connected by a longitudinal connecting rod, means for imparting a longitudinally reciprocating motion to the said frame, and a pitman connecting one end of said frame with a crank upon a shaft having a balance wheel, substantially as set forth. 2nd. In a device for converting and transmitting motion, the combination of the frame, the longitudinal guide-rods secured to the sides of the same, the reciprocating frame composed of the head blocks mounted upon said guide rods and connected by a central longitudinal rod, a drum or wheel mounted upon a suitable shaft, and having a belt or band passing over guide pulleys and connected with the ends of the reciprocating frame, a lever having a segmental rack meshing with a spur wheel upon the central oscillating shaft, and a pitman connecting one end of the longitudinally-reciprocating frame with a crank upon the end of a shaft carrying a fly-wheel, substantially as and for the purpose set forth. 3rd. In a machine of the class described, the combination of the frame having the longitudinal guide rods, the head blocks mounted to reciprocate upon the said guide rods and connected by a central longitudinal rod, means for imparting a reciprocating motion to the frame thus formed, a bracket extending laterally from one of the reciprocating head blocks, and a pitman connecting said bracket with a crank upon a transverse shaft, carrying a fly wheel, substantially as herein set forth.

No. 35,836. Advertising Shade or Screen for Lamps. (*Abat jour ou réverbère de lampe pour annonces.*)

Robert Parker Wetmore, Galveston, Texas, U.S.A., 20th January, 1891; 5 years.

Claim.—1st. The combination, with a lamp, of a partially transparent shade or screen removably attached to the lamp and having advertising matter thereon, substantially as shown and described. 2nd. The combination, with a lamp, of a support removably attached to the lamp burner, and a partially transparent shade or screen removably attached to the support and having advertising matter thereon, substantially as shown and described.

No. 35,837. Check for Doors. (*Arrête-porte.*)

John Jacob Krom, St. Augustine, Florida, U.S.A., 20th January, 1891; 5 years.

Claim.—In a door-check, the combination of the base-plate A, carrying the casing B, and notched at a, with the bolt D, bent at right angles at its upper end and carrying catch E, said bolt being provided with projections d', and the spring e', for operating said catch E, substantially as described.

No. 35,838. Coupling for Pipes.

(*Joint de tuyau.*)

James Daniel Bagg, Springfield, Massachusetts, U.S.A., 20th January, 1891; 5 years.

Claim.—1st. The combination, with a car, of a coupling-bar and a supporting eye for and embracing the rear portion thereof, another support spring-sustained, and vertically movable, and a link connected thereto, adapted to have a transverse swinging movement thereon, and on which the said coupling-bar, by a forward portion thereof, is supported, all whereby the said coupling-bar may have a sliding movement endwise through the said eye, and link may have a swinging motion from said eye as a fulcrum, and may have a rising and falling and lateral swinging motion on and with the said link, and a spring applied in relation to said coupling-bar for forcing same forward, and a stop for limiting the forward movement, together with a suitable coupling-head at the extremity of the coupling-bar having a passage therethrough, substantially as described. 2nd. The combination, with the supporting yokes or clips a, a, of the car, of a bar or part as e, adapted by a portion thereof, to be connected with one of said yokes, a hanger from which said bar is supported and by which it is adjustably connected to the other car-clip or yoke, and a coupling head and bar therefor supported from said bar e, and adapted to have endwise sliding and vertical and horizontal swinging movements thereon, or relative thereto, substantially as described. 3rd. The combination, with the car and the bar e, of the hangers f, and g, from which said bar is supported, a support i, and the sustaining spring n, therefor, and the link or stirrup j, the supporting eye h, the coupling-bar D, provided with a coupling-head the spring u, the stop q, substantially as described. 4th. The com-

bination, with the car having the yokes or clips *a*, *a*, of the hangers *f*, and *g*, the latter having a slot and bolt connection with one of the clips as described, the bar *c*, by its one portion supported on the said hanger *f*, and by another portion having an adjustable connection with the said hanger *g*, the eye-support *h*, and the link-support *j*, and the spring-sustained support *i*, therefore, the coupling-head and bar therefor, sustained and movable on said eye and link supports, and the spring *x*, and stop, substantially as and for the purpose described. 5th. The combination, with the supporting bar or part as *e*, sustained on the under part of a car, of the link or stirrup and a spring sustained support therefor, the lower uniting member of said link being provided with a roller *o*, the eye support *h*, sustained on said bar *e*, a coupling-head and bar therefor, mounted in said eye, and link support, and having a spring and stop, and capable of the movements set forth, substantially as described. 6th. The combination, with the steam or air-pipe of a car, of a coupling-bar supported from and below the car and adapted to have an endwise spring-resisted movement, and horizontal and vertical swinging movements provided at its forward end with a coupling-head, with a passage therethrough which is in communication with said pipe having opposite sides thereof, plane and forwardly tapered and provided with a pair of separated oppositely disposed forwardly projecting and outwardly diverging extensions, the inner faces of which are plane and arranged at right angles to the said plane tapering sides of the head, which are at the rear thereof, the angle and distance between the said inner faces of said extensions reversely corresponding to the taper of said head, substantially as and for the purposes set forth. 7th. The combination, with a coupling-head having tapered sides and forward extensions, and a passage therethrough leading to the front end of the head proper, the latter at the junction therewith, of said extensions being formed with the recesses 24, the rubber packing consisting of the base-piece 22, having a flange-surrounded perforation, the confining plate 23, and keys therefor fitting in said recesses 24, substantially as and for the purpose described. 8th. The combination, with the coupling-head having tapered sides and forward extensions, and a passage therethrough leading to the front end of the head proper, the latter at the junction therewith, of said extensions being formed with the recesses 24, the rubber packing consisting of the base-piece 22, having a flange-surrounded perforation, the short collar 27, lying inside of and back from the forward end of said flange, the apertured plate 23, and confining keys, substantially as and for the purpose described. 9th. The combination, with the support as the bar *e*, secured under the car, of the screw-shanked ring-eye *h*, and nut *h*, the spring sustained support *i*, and the link *j*, the coupling-bar supported in the said ring-eye, and link provided with a coupling-head having a passage therethrough, leading to the forward end thereof, and provided with the drip-cock leading downwardly from said passage, and all, whereby on turning the said nut the coupling-bar and head may be downwardly inclined to ensure at will an emission of water accumulations at said cock. 10th. A coupling-head, with a passage therethrough, having opposite sides thereof, plane and forwardly tapered as 10, 10, and also having both in advance of and to the rear of said tapered faces, the flat rests 30, 30, and 32, 32, the rests of each pair thereof being parallel to each other and to the common longitudinal line of the head, and provided with a pair of separated oppositely disposed forwardly projecting and outwardly diverging extensions, the inner faces 13, 13, of which are arranged at right angles to the said plane tapering sides of the head, which are at the rear thereof, the angle and distance between the said diverging inner faces of the extensions reversely corresponding to the taper of said head, and said extensions forward and to the rear of said diverging faces, having the parallel flat rests 33, 33, and 34, 34, substantially as and for the purposes set forth.

No. 35,839. Snow Skate. (*Patin à neige.*)

Robert Walter Kydd, Longueuil, Quebec, Canada, 20th January, 1891; 5 years.

Claim.—1st. A snow-skate, composed of a runner, which bears on the snow, and a foot-block (with fastening devices) surmounting such runner capable of oscillation to accommodate the movement of the foot, and provided with means for effecting a grip on the snow at the end of a step, as set forth. 2nd. A snow-skate, composed of a runner, which bears on the snow, and a foot-block (with fastening devices) surmounting such runner, pivoted at its forward end to same and carrying at such end claw-like extensions, all as and for the purposes set forth. 3rd. In a snow-skate, the combination of the runner *A*, *A'*, foot-block *B*, *B'*, *B'*, (with fastening devices), claw-like extensions *C*, and pivot pin *E*, as set forth.

No. 35,840. Truck for Pianos.

(*Camions pour pianos.*)

Christian Henderson Martin, Sioux City, Iowa, U.S.A., 20th January, 1891; 5 years.

Claim.—1st. A piano truck mounted on wheels, journaled upon axles held in pivotal baits, and adjustable arms, said truck provided with an end or head firmly attached thereto, and provided at its upper end with castors, and having means for holding the arms controlling the front axle adjustably, substantially as set forth. 2nd. The carrier, consisting of a frame adapted to ride upon a truck, and the sills of which are handle-shaped at one end, said frame provided with castored legs secured pivotally on the outside of the sills thereof, and means for adjusting and holding the same in any desired position, and provided with means of attachment to a truck, substantially as set forth. 3rd. The combination of a body *A*, consisting of two thicknesses with spaces between them, the head *A'*, secured thereto by angle irons, and provided with castors, the angle irons *a'*, *a'*, connecting the body and head and having eyed upper ends for the insertion of a hand spike, the hand spike or handle *A''*, inserted in said eyes, the cushions *A'''*, provided on the inner surface of said head, the axles *B'*, having wheels *B*, journaled upon them, baits *C*, journaled in the body *A*, and holding said axles, arms *C'*, holding said axles and having their free ends pivoted to adjustable pieces,

the rod *C''*, passing through a slot in the body and holding upon its ends the arms controlling the rear axle, and provided with thumb-nut *c''*, the guide blocks *D'*, holding pivotally the ends of the arms controlling the front axle and sliding upon guide rods, the guide rods *D*, secured to the head and carrying slidably the guide blocks, the notched plates *E*, pivoted at their upper ends to said angle irons *a''*, the links *E'*, connecting said plates to bell crank levers, the bell crank levers *E''*, operating said plates by said links, the bell crank lever *E'''*, operating the bell crank levers *E''*, and the spring *E''*, operating the bell crank lever *E'''*, in one direction, substantially as set forth. 4th. The combination of the sills *G*, having one end shaped into handles, cross bars *G'*, connecting said sills, rods *G''*, holding said sills together and having legs pivoted upon their ends, the bolts *K*, pivotally attached to the cross bars, the legs *H*, and *H'*, pivoted upon the rods *G''*, outside the sills, castors *h*, secured to straps, the straps *h'*, secured to the lower ends of the legs and extending upwards and holding at their upper ends pivotally arms, the arms *I*, *I'*, pivoted to said straps and having their other ends adapted to be secured in position, being respectively hooked to slide in a guide, and attached to slides, the plate *J*, secured to the underside of the sills and forming a slot *j*, and notch *j'*, adapted to receive the hooked ends *i*, of the arms *I*, the guide blocks *J''*, pivoted to the arms *I*, and provided with the set screws *j''*, and adapted to slide on guide rods, and the guide rods *J'*, secured to the side of the sills and adapted to receive the guides *J''*, substantially as set forth. 5th. The combination of the body *A*, having slotted spaces, head *A'*, secured to said body and provided with cushions, and the padded and bucked crossing straps *O*, and *P*, respectively adapted to pass through one of the slotted spaces in the body and around the head *A'*, and secured around a piano, to be transported, substantially as set forth. 6th. The combination of the truck, consisting of the body *A*, and head *A'*, said body mounted upon wheels on axles adjustable to different heights and positions, and said body provided with a sunk slotted plate *M*, *m'*, and with pins *L*, on the edge of the forward part, the carrier consisting of the frame *G*, *G'*, *G''*, provided with pivotal legs, and means of adjusting and securing the same, the front cross bar provided with catch plates *L*, adapted to engage the pins *L*, and the rear cross bar with a hooked plate *M*, *m*, and slide *m''*, adapted to engage in the slot *m'*, of the plate *M*, substantially as set forth. 7th. The combination of the head *A'*, having angle iron *a''*, notched plates *E*, pivoted to the upper part of said angle iron links *E'*, connecting said plates to bell crank levers, the bell crank levers *E''*, having one end pivoted to said links, and the other to another bell crank lever, the bell crank lever *E'''*, connecting said bell crank levers and being pressed down by a spring, and the spring *E''*, pressing down said lever, substantially as set forth. 8th. The combination of the body *A*, having bail *C*, journaled near one end and holding the axle *B*, the axle *B'*, held in said bail, and the arms *C'*, the head *A'*, secured at the end of said body by angle irons, the angle irons *a''*, connecting said body and head, the guide rods *D*, secured to said head, and the guide blocks *D'*, sliding upon said rods and having one end of the arms *C'*, pivoted thereto, substantially as set forth. 9th. The combination of the body *A*, having a bail *C*, journaled near the rear end thereof, an axle *B'*, held in the ends of said bail, the arms *C'*, holding said axle and having their free ends pivoted upon a transverse rod, the rod *C''*, passing transversely through a slot in said body and having the arms *C'*, pivoted upon its ends and provided with a thumb-nut at one end, and the slotted *A'''*, sunk in the edges of said body through which said rod passes, substantially as set forth.

No. 3,841. Joint for Hinges. (*Joint de penture.*)

Frederick Hurst, Toronto, Ontario, Canada, 20th January, 1891; 5 years.

Claim.—1st. A hinge joint, consisting of a female part composed of a body *A*, and suitable means for fastening the same to the article to which it is to be secured, and aperture *C*, formed in the body *A*, large enough to receive the pin *E*, of the male part, and an opening *D*, entering into the said aperture, in combination with the male part, consisting of a body *A*, pin *E*, and the check *H*, the body being provided with suitable means for securing the same to the article to which it is to be fastened, substantially as and for the purpose set forth. 2nd. A hinge joint, consisting of the female part composed of a body *A*, and suitable means for fastening the same to the article to which it is to be fastened, and aperture *C*, formed in the body *A*, large enough to receive the pin *E*, of the male part, an opening *D*, entering into the said aperture, in combination with the male part, consisting of a body, a pin *E*, and the check *H*, the body being provided with suitable means for securing the same to the article to which it is to be fastened, the male and female parts being provided with stops *I*, and *I'*, respectively, substantially as and for the purpose set forth. 3rd. A hinge joint, consisting of a body having formed therein an aperture *C*, and an opening *D*, entering into the said aperture, in combination with the male portion composed of side bars *f*, and *f'*, cross bars *a*, and *a'*, and opening *G'*, substantially as and for the purpose set forth. 4th. A hinge joint, consisting of the female part provided with an aperture *C*, having an opening *D*, entering therein, and male part, consisting of a body provided with a pin *E*, and check *H*, substantially as and for the purpose set forth.

No. 35,842. Fastening for Burners for Lamps and Lanterns. (*Agrafe pour becs de lampe et lanterne.*)

Frederick Dietz, New York, State of New York, U.S.A., 20th January, 1891; 5 years.

Claim.—The combination, with the oil pot, of a burner socket secured with its lower edge to the oil pot, and provided in its upper edge, on diametrically opposite sides, with locking lips opening in opposite directions and formed integral with the socket, and a burner provided with a wick raiser shaft which engages under said locking lips, substantially as set forth.

No. 35,843. Lantern. (Fanal.)

Frederick Dietz, New York, State of New York, U.S.A., 20th January, 1891; 5 years.

Claim.—The combination, with the oil pot and the locking springs secured thereto, of an auxiliary bow spring secured at its middle to the oil pot and engaging with its free ends against the locking springs, substantially as set forth.

No. 35,844. Looping Attachment for Circular Knitting Machines. (Appareil à touffes pour machines à tricot circulaire.)

Richard Anthony Gage, Pawtucket, Rhode Island, U.S.A., 20th January, 1891; 5 years.

Claim.—1st. The combination, with the feed-wheel, yarn-guide and needles, of a circular knitting machine, of fingers or pins, and means, substantially as described, for sustaining and operating said fingers or pins, substantially as specified. 2nd. The combination, with the yarn-guide and the feed-wheel, of fingers or pins periodically entering given spaces in the said feed-wheel, and acting to depress therein the yarn from the yarn-guide, and means, substantially as described, for sustaining and operating the said fingers or pins, all as for the purposes set forth. 3rd. The combination of fingers B, pins p, cam e, cam d, and feed-wheel A, substantially as specified.

No. 35,845. Scissors and Shears.

(Ciseaux et cisailles.)

Julius Langenberg, Ohligs, Prussia, German Empire, 20th January, 1891; 5 years.

Claim.—1st. The method of automatically increasing the cutting efficiency of scissors or shears, by the application of pressure between the blades, upon the opposite side of the pivot to that of the cutting edges of the said scissors or shears, substantially as described. 2nd. In such scissors or shears, the application of pressure between the blades by the pin d, arranged on the part b of the scissors or shears, and protruding through the same to press on the other part c, the amount of such pressure being regulated by the spring e and the screw f, substantially as described.

No. 35,846. Harrow. (Herse.)

Charles La Dow, Albany, New York, U.S.A., 20th January, 1891; 5 years.

Claim.—1st. In a harrow, two or more concave S-shaped blades arranged on a spindle and clamped together between two discs, substantially as and for the purpose specified, in combination, with a draft frame. 2nd. In a harrow, two or more concave S-shaped blades arranged on a spindle and clamped together between two discs, the face of each disc being stepped, so that the blades shall be in contact with each other, and each blade in contact with the stepped face of a disc, substantially as and for the purpose specified, in combination with a draft frame. 3rd. In a harrow, a journal-box supporting the blade to the spindle, and having trunnions which fit into oval holes made in a forked projection, fixed to the frame of the machine, substantially as and for the purpose specified. 4th. In a harrow, a rotary gang of cutters, a drag-bar attached to said gang and having a curve on the upper edge of said bar, in combination with a bar extending over the said curve, substantially as and for the purpose specified.

No. 35,847. Electrical Exercising Machine.

(Machine électrique pour exercice musculaire.)

Joseph Brown Gardiner, Nyack, New York, U.S.A., 20th January, 1891; 5 years.

Claim.—1st. In combination, a magneto-electric mechanism, connections, whereby the current generated thereby is transmitted to the person of an operator, a shaft, a pulley rotating thereon, a pull connected to the said pulley, a spring connected to the shaft, and pulley connections from the pulley to operate the magneto-electric mechanism, and means whereby the shaft may be turned and held in adjusted position, and the tension of the spring thus varied to suit the strength of different individuals. 2nd. In combination, a magneto-electric mechanism, and means, whereby the current generated thereby is transmitted to the person of an operator, a shaft, a pulley, rotating thereon, a pull connected to the said pulley, a spring connected to the pulley, and shaft connections from the pulley to operate the magneto-electric mechanism, a nut or boss on the pulley, a spring pawl to engage the said nut or boss and thus hold the said shaft in adjusted position, and means whereby the shaft may be turned and the tension of the spring thus varied. 3rd. In combination, a magneto-electric mechanism, connections for conveying the current produced thereby to the person of an operator, two pulleys, two pulleys, two ratchet mechanisms on the shaft of the magneto-electric mechanism, and means whereby the said ratchet mechanisms are operated from the respective pulleys, and the current produced from the reciprocation of either pull. 4th. In combination, a magneto-electric mechanism, connections for conveying the current produced thereby to the person of an operator, two pulleys, two pulleys, two ratchet mechanisms on the shaft of the magneto-electric mechanism, and belts connecting the said pulleys to the respective ratchet mechanisms, whereby the current is produced from the reciprocation of either pull. 5th. In combination, a magneto-electric mechanism, connections for conveying the current thereby produced to the person of an operator, two shafts, two pulleys thereon, two springs connecting the said shafts and pulleys, means whereby the said shafts may be turned up and held in adjusted position, two pulls connected to the said pulleys, two ratchet devices on the shaft of

the magneto-electric mechanism, and two belts connecting the said pulleys to their respective ratchet-devices, whereby the current is produced from the reciprocation of either pull. 6th. In combination, a magneto-electric mechanism, connections for conveying the current thereby produced to the person of an operator, two shafts, two pulleys thereon, two springs connecting the said shafts, and pulleys, nuts or bosses on the said shafts, spring pawls adapted to engage the said nuts and hold them in adjusted position, and means whereby the said shaft may be turned up, as desired, two pulls connected to the said pulleys, two ratchet devices on the shaft of the magneto-electric mechanism, and two belts connecting the said pulleys to the said ratchet devices, whereby the current is produced from the reciprocation of either pull. 7th. In combination, a pull and a resisting spring therefor, a magneto-electric mechanism actuated by said pull, means, whereby the electric current is transmitted to the person of an operator, and a lever or device, whereby the current may be short-circuited, and the device used simply as an exercising apparatus. 8th. In combination in a magneto-electric apparatus, the rotating shaft carrying the armature, the stationary or field magnet, a lever or other device, which in one position is in contact with both the magnet and actuating shaft, and suitable connections whereby, when the lever or other device is in the position indicated, a short circuit through the shaft and magnet will be closed. 9th. In combination, in a magneto-electric apparatus, the rotating shaft carrying the armature, the stationary or field magnet, the keeper moving in contact with the magnet, whereby the force of the current may be varied by a magnetic short-circuiting, the said keeper in its extreme position being in contact with both magnet and shaft, and suitable connections, whereby in this position of the keeper an electric short circuit through the magnet and shaft will be closed. 10th. In a magneto-electric apparatus, the rotating shaft carrying the armature, the field magnet, suitable connections, combined with means whereby the magnet and shaft may be connected, so that an electric short-circuit through the shaft and magnet is closed. 11th. In combination in a magneto-electric mechanism, a series of contact breakers, and means whereby any contact breaker may be thrown into electric circuit, whereby the alternating current may be converted into a series of impulses of greater or less intensity. 12th. In a magneto-electric mechanism, in combination, the rotating shaft carrying the armature, a series of contact breakers carried thereby, and means whereby any of the contact breakers may be thrown into electric operation, so that the alternating current may be converted into a series of shocks or impulses of greater or less intensity. 13th. In a magneto-electric mechanism, in combination, the rotating shaft, a series of cams carried thereby, means for throwing any one of these cams into electric operation, and thereby converting the alternating current into a series of shocks or impulses of varying intensity, as desired. 14th. In a magneto-electric mechanism, in combination, the rotating shaft, a series of cams carried thereby, contact springs for each of the cams, and a switch, contact points, and connections, whereby any one of the cams may be thrown into electric operation, any the alternating current converted into a series of shocks or impulses of varying intensity. 15th. In a magneto-electric mechanism, in combination, the rotating shaft, a series of cams carried thereby, inclined at different angles to the armature contact springs for each of the cams, a switch and contact points, and connections, whereby any of the cams may be thrown into electric operation, and thereby the alternating current converted into a series or succession of impulses of varying intensity. 16th. In a magneto-electric machine, in combination, the rotating shaft carrying the armature, the field-magnet, the cams M, the springs M', the terminal J connected to the coils of the armature, the switch N connected thereto, and connections from the springs M', so that by moving the switch N, any one of the cams may be thrown into electric connection, and thus convert the alternating current into a series of impulses or shocks, or by breaking all connections with the cams M, the simple alternating current is obtained. 17th. In combination, two shafts, two pulleys, springs connecting the shafts and pulleys, two pulls, a magneto-electric mechanism connections for conveying the current to the person of the operator, and means whereby the magneto-electric mechanism is actuated from the pulleys upon the reciprocation of either pull. 18th. In combination, two shafts, two pulleys, two pulls, a magneto-electric mechanism connections for conveying the current of the person of the operator, and means whereby the magneto-electric mechanism is actuated from the pulleys upon the reciprocation of either pull. 19th. In combination, two pulls and means for imparting a resistance to the said pulls when operated, a magneto-electric mechanism, connections for conveying the current to the person of the operator, and belts or similar means whereby the magneto-electric mechanism is actuated upon the reciprocation of either pull. 20th. In combination, two pulls, and means for imparting a resistance to the said pulls when operated, a magneto-electric mechanism, connections for conveying the current to the person of the operator, ratchet mechanisms on the shaft of the magneto-electric mechanism, and belts or similar means whereby the magneto-electric mechanism is actuated upon the reciprocation of either pull. 21st. In combination, a pull, a resisting pulley, a magneto-electric mechanism, connections for conveying the current to the person of the operator, and a belt, or similar means, whereby the magneto-electric mechanism is actuated from the pulley upon the reciprocation of the pull.

No. 35,848. Griddle. (Gril.)

Augusta Jacoby, Langhorne, Pennsylvania, U.S.A., 21st January, 1890; 5 years.

Claim.—1st. A griddle for gas or gasoline stoves, consisting of a stationary ring or circular pan, apertured lugs and the movable section or pan having lugs coincident with said former lugs, and the wire passed through the apertures of said lugs, and the handle secured by said wire, substantially as set forth. 2nd. A griddle for gas or gasoline stoves, consisting of a rigid section, having a chambered ring or pan, a ring or skeleton frame, a connecting neck having apertured lugs, a movable section or chambered pan having apertured lugs, the wire passed through the coincident apertures of said lugs, and the handles held by said wire, substantially as set forth.

No. 35,849. Burner for Oil.*(Bruleur d'huile.)*

Charles Trench, Boston, Massachusetts, U.S.A., 21st January, 1891; 5 years.

Claim.—1st. The combination, with a wick-tube D, and means for raising and lowering the wick therein, of a perforated platform F, supported in a horizontal plane above and parallel with the top of the wick tube, and having a wick slot G, which conforms in size and shape to the passage in the wick-tube, and fits closely around the wick arranged to receive and support the wick laterally at such distance above the top of the wick-tube, and in such manner that the flame is thereby terminated at and caused to impinge upon the top of the platform, whereby both the wick and tube are prevented from becoming unduly heated, substantially as and for the purposes specified. 2nd. The combination of wick tube D, and means for raising and lowering the wick therein, with a deflector E, having a perforated platform F attached thereto, and constructed and arranged therein, so that when the deflector is serving its usual purpose upon the base of the burner, it will also support a platform F above the wick tube and in position to serve as the seat of the flame of the ignited wick, as and for the purposes specified. 3rd. The combination of the perforated platform F, having a wick passage G, formed with upturned edges H and arms I, having thereon clinching points J, with a cone or deflector E, the platform being so connected therewith that the two may be removed from and replaced upon the base of the burner as one piece, and so relatively arranged that when in place upon the base platform F will be supported above the top of the wick-tube, with its slot G, vertically coincident therewith, all substantially as and for the purposes specified.

No. 35,850. Chair. (Chaise.)

William Gavin Cross, Little Falls, New York, U.S.A., 21st January, 1891; 5 years.

Claim.—1st. The combination of inclining supporting standards a, having grooves a' on their inner faces, a chair seat D, having tongues d, locking bolts c, a pivoted lever e, links e' and a spring e'', substantially as and for the purpose set forth. 2nd. In a chair, the combination of supporting standards a, an adjustable seat D and a removable tray D', substantially as and for the purpose set forth. 3rd. In a chair, the combination of supporting standards a, having grooves a', a chair seat D, having a tongue d, lateral projections d', and a locking bolt c, levers e' and a link e'', substantially as and for the purpose specified.

No. 35,851. Case for Tickets. (Casier à billets.)

James Knox Deming, Detroit, Michigan, U.S.A., 21st January, 1891; 5 years.

Claim.—1st. The combination, with the casing A, of a detachable frame consisting of the vertical partitions B, and connecting walls C, having apertures H, and I, the overhanging inclined flanges D, and the spring actuated plates F, substantially as described. 2nd. The combination, with the casing A, the detachable frame consisting of the walls C, the partitions B, the overhanging inclined flanges D, the apertures H, and I, the plates F, having the pin a, and the grooves b, in which said pins engage, the pockets E, and the spring G, the parts arranged to operate, substantially as described.

No. 35,852. Buckle. (Boucle.)

Jonas Parker and Richard William Watts, Williamsport, Pennsylvania, U. S. A., 21st January, 1891; 5 years.

Claim.—1st. In a buckle, the combination, with a buckle frame having projecting keepers on its lower frame bar, and a locking bar between the same, of a pivoted hook having a locking recess in its shank adapted to engage the locking bar between said keepers, substantially as and for the purposes specified. 2nd. In a buckle, the combination, with a buckle frame having bed bars, of a slotted presser foot pivoted on the buckle frame, and a hook pivoted on the presser plate, said hook having its nose turned backward, substantially as and for the purposes specified. 3rd. In a buckle, the combination, with a buckle frame having a locking bar for engaging a recess in the shank of a pivoted hook, of a pivoted hook having its nose turned backward and provided with a recess in its shank to engage the locking bar of the frame, the swell caused by the recess in the hook shank projecting over the nose of the hook, substantially as and for the purpose specified. 4th. In a buckle, the combination, with a frame having raised bed bar of a slotted presser plate having a rib or flange on its under surface at the edge of the slot, substantially as and for the purpose specified. 5th. In a buckle, the combination, with a slotted presser plate, of a buckle frame having longitudinally folded sheet metal bed bars with raised faces, substantially as and for the purpose specified. 6th. In a buckle, the combination, with a buckle frame having a bed bar, a presser plate pivoted on the buckle frame, and provided with a slot or slots which fit down and over said bed bars, of a pivoted hook adapted to pass through and under the buckle frame, substantially as and for the purpose specified.

No. 35,853. Folding Door and Method of Hanging. (Porte à deux battants et mode de suspension.)

Donald Johnson, West Superior, Wisconsin, U. S. A., 21st January, 1891; 5 years.

Claim.—In a folding door, the combination of a series of sections hinged together, and one of them hung to the casing pins C, secured at the top and bottom of each section, except the one hung to the jamb, and the grooves B, b, adapted to receive said pins, substantially as set forth.

No. 35,854. Vapor Bath. (Bain à vapeur.)

Tamar G. Humphrey, Hill City, Kansas, U.S.A., 21st January, 1891; 5 years.

Claim.—1st. In a bathing apparatus of the class described, the combination, with an outer closed casing, of an inner bottomless casing having a movable top mounted for vertical movement therein, a drum shaft located at one side of the outer casing, a pawl and ratchet and crank for operating the same, and a series of ropes or chains connected at their outer ends to the drum shaft and over suitable guides and at their inner ends connected to the inner casing substantially as specified. 2nd. In a bathing apparatus of the class described, the combination, with an outer closed casing provided with a door and an inner vertically-adjustable bottomless casing provided with a door, of mechanism for raising and lowering and locking in position said inner casing, substantially as specified. 3rd. In a bathing apparatus of the class described, the combination, with an outer closed casing, of an inner bottomless casing provided at its lower edge with a flange having a packing forming a tight connection between the two casings, each of the casings being provided at one side with doors, and mechanism for adjusting said inner casing vertically within the outer casing, substantially as specified. 4th. In a bathing apparatus of the class described, the combination, with an outer casing provided with a sliding door, of an inner casing provided at its front with an opening, and a removable cover formed in sections and provided at its adjacent edges with semi-circular openings adapted to fit the neck of the patient, substantially as specified. 5th. In a bath apparatus, the combination, with an outer closed casing and an inner sliding bottomless casing, each of said casings being provided with doors, and a suitable packing between the two casings, of a pair of steam-pipes terminating in the outer casing below the inner casing, substantially as specified. 6th. In a bathing apparatus, the combination, with an outer casing having a removable cover, a door, and provided with a pair of bearing arms, and at its upper edge above the arms with recesses, of an inner casing mounted for sliding in the outer casing, provided with a door and with a surrounding packing, eyes located at the opposite sides and at the rear end of the inner casing, pulleys mounted in the recesses and at each side of the inner casing, ropes or chains mounted over the pulleys and connected at their inner ends to the eyes, a drum provided with a ratchet mounted for rotation in the arms and provided with a crank for operating the same, the cords at their outer ends being connected to the drum, and a gravity pawl pivoted to the casing and adapted to engage the ratchet, substantially as specified.

No. 35,855. Handle for Sad Irons, etc.*(Poignée pour fers à repasser.)*

Hubert Root Ives, Montreal, Quebec, Canada, 21st January, 1891; 5 years.

Claim.—1st. As a new article of manufacture, a handle for sad and smoothing irons, formed of a coiled wire spring bent down at its ends onto and around studs, or seats, on a bar, locked to and detachable from such iron. 2nd. A handle for sad and smoothing irons, composed of a bent coiled wire spring graduated in diameter, and having its ends fixed in place by screwing therein studs, or seats, attached to a bar locked to and detachable from such irons.

No. 35,856. Hand Fence Machine.*(Machine à clôture à bras.)*

Mathew Franklin Connett, Davenport, Iowa, U.S.A., 21st January, 1891; 5 years.

Claim.—1st. In a fence-machine, the combination, with the annular guide-frame, of a twister C, mounted to travel thereon, and provided with one or more bell-mouthed passages through it, for the wire to be twisted, substantially as and for the purpose set forth. 2nd. In a fence machine, the combination, with the annular guide-frame, of a twister C, mounted to travel thereon, and provided with one or more pairs of hollow conical projections, each said pair affording a passage flaring at both ends, for the wire to be twisted, substantially as and for the purpose set forth. 3rd. In a fence-machine, the combination, with the guide-ring A, having the supporting lugs q, of a twister C, in two parts bolted together, mounted to travel on the guide-ring, and having inwardly projecting segmental rims overlapping the edges of the outer surface of the guide-ring, and projections on their inner faces overlapping the edges of the inner surface of the guide-ring, lugs upon one of the said parts, extending against the other part, and one or more bell mouthed passages through the twister, for the wire to be twisted, substantially as and for the purpose set forth. 4th. In combination, the guide-ring A, operating bar B, tension devices D, and a twister C, comprising two parts C' and C'', embracing the edges of the guide-ring, and held in fixed relation with each other by intervening lugs and a bolt h, one or more bell-mouthed passages through the twister for the wire to be twisted, and a lip d, on one of the parts, substantially as and for the purpose set forth.

No. 35,857. Brake for Waggon.*(Frein de wagon.)*

Nathan A. Wheeler, Alpowa, State of Washington, U. S. A., 21st January, 1891; 5 years.

Claim.—1st. A wagon brake, consisting essentially of a disk fixed to an axle or shaft and suspended by toggles from a shaft mounted upon the girders of a wagon, a suitable brace attached to the axle of the disk and pivoted to the forward wagon axle, so as to hold said disk and axle in position, and a suitable rod connecting said toggles with a brake lever, so that the disk may thereby be forced down into contact with the ground, substantially as described. 2nd. A wagon brake, consisting essentially of a disk fixed to an axle and suspended by stirrups and cranks as shown, from a shaft mounted upon the wagon girders, a suitable brace attached to said disk axle

and pivoted to the front wagon axle to hold said disk axle in position, a brake lever mounted in brackets upon the wagon girders and extending upwardly at the side of the wagon body, a rod connecting a crank of the disk suspending shaft with a crank of the brake lever, whereby by actuating the brake lever, the disk may be moved vertically as shown, and a spring coiled upon the brake lever and attached to a girder and to a crank of the brake lever in such a manner that the disk and its axle will be thereby held normally in an elevated position, substantially as described. 3rd. In a wagon brake, the combination, with a frictional disk suspended beneath a wagon body and having means, as shown, for throwing it into contact with the ground, and with the axle or shaft to which said disk is fixed, of a brake shoe pivotally attached to the rear wagon axle and held in elevated position by a suitable spring, and a brake rod and chain connecting said brake shoe with the disk axle, so that when the disk revolves, the chain will be wound upon the disk axle and the brake shoe forced into contact with the ground, substantially as described. 4th. A wagon brake, consisting essentially of a frictional disk fixed to an axle and suspended beneath the wagon body, said disk having suitable connection with a brake lever so that it may be forced into contact with the ground, a brake shoe or drag pivotally connected by suitable rods with the rear wagon axle and provided with a spring to hold it in elevated position, and a connecting rod and chain connecting said brake shoe with the disk axle, so that when the chain is wound upon the disk axle the brake shoe will be forced down into contact with the ground, substantially as described. 5th. The combination, with the axle B, having the disk A, fixed thereto, and having means, as shown, for raising and lowering the same, of the brace F, pivoted to the front axle, as shown, and provided with a forked end having eyes *f* to engage the axle B, and hold the same in position, substantially as described. 6th. The combination, with the axle B, having means, as shown, for operating the same, of the disk A', having slots *s*, therein, and having the teeth *t*, fixed to said slots, substantially as described.

No. 35,858. Feed Regulator for Mills.

(*Régulateur pour l'alimentation des moulins.*)

William Gribben, Crosswell, Michigan, U.S.A., 21st January, 1891; 5 years.

Claim.—1st. In a feeder, the combination of the hopper provided at its lower end with the band 6, forming a semi-circular opening, the conical distributor, the inclined flanges 24, arranged on the conical distributor, and the inclined deflector arranged beneath the distributor and adapted to direct the material in a sheet, substantially as described. 2nd. In a feeder, the combination of the hopper, the band 6, the stationary conical distributor having lateral extensions 22, forming continuations of it, and provided with flanges 24, arranged along the extensions, and the inclined deflector secured to and connecting the extensions, at one side and depending below the extensions at the other side, substantially as described. 3rd. The combination of the hopper provided at its lower end with the collar, the conical distributor arranged at the bottom of the hopper and secured thereto, the band closing the back of the hopper and forming a semi-circular discharge opening, the sliding sleeve arranged upon the collar and adapted to vary the size of the discharge opening, the central vertical shaft, the screw arranged upon the shaft and capable of vertical movement, and being connected with and operating with the sliding sleeve, substantially as described. 4th. The combination of the hopper having an open bottom and provided with a collar, the conical distributor arranged concentric with the collar and secured thereto, the band closing the back of the hopper and forming a semi-circular discharge opening, the central vertical shaft, the sliding sleeve arranged upon the said collar, the screw vertically movable on the shaft, the cross bar arranged to be engaged by the screw and having its ends extending through the sides of the hopper, and the rods 18, connecting the cross bar and the sliding sleeve, substantially as described. 5th. In a feeder, the hopper, the band 6, the stationary conical distributor having its apex arranged within the bottom of the hopper, the series of rotary inclined fingers working flat against the exterior face of the apex of the conical distributor, the inclined flanges 24, at the sides of the distributor, and the deflector secured to the distributor, and extending below the same, as set forth. 6th. In a feeder, the combination of the hopper, the central rotary shaft, the inclined blades 15, loosely mounted on the shaft, so as to rise and fall by the increase or decrease of the material in the hopper, and the collar 4, connected with the blades and operated thereby, as set forth. 7th. In a feeder the combination of the hopper having a conical distributor 5, arranged in the mouth of the hopper, and the band 6, partially closing the space between the mouth of the hopper and the distributor, so as to provide a semi-circular feed opening; 7, the central rotary shaft, the inclined blades 15, loosely mounted on the shaft, so as to rise and fall by the increase or decrease of the material in the hopper, and the exterior collar 4, the exteriorly arranged rods 18, and the cross bar 19, resting above and operated by the blades, as set forth. 8th. The combination of the hopper provided at its lower end with the band 6, closing the back of the hopper and forming a semi-circular discharge opening, the conical distributor arranged at the bottom of the hopper and secured thereto, the sliding collar 4, arranged on the band 6, to vary the size of the discharge opening, and suitable means for controlling the sliding sleeve, substantially as described.

No. 35,859. Ball for Cricket.

(*Balle de jeu de paume.*)

Thomas Prest, Toronto, Ontario, Canada, 21st January, 1891; 5 years.

Claim.—1st. A ball, composed of scraps of cork, compressed into form by a pressure sufficiently powerful to force the cork into a solid mass, the said cork ball being enclosed in a leather cover C, substantially as and for the purpose specified. 2nd. A ball composed of scraps of cork, compressed into form by a pressure sufficiently powerful to force the cork into a solid mass, the said cork ball A, being covered with string B, and enclosed in a leather cover C, substantially as and for the purpose specified.

No. 35,860. Aerator for Milk.

(*Aérateur à lait.*)

George Noble, Tweed, Ontario, Canada, 21st January, 1891; 5 years.

Claim.—1st. The combination, with the frame A, clock train B, motor or drum C, and mutilated wheel 1, of the base E, post 3, rack-bar 2, rod 6, trip bar 11 and a pail 5, having a valve 9, opened by the trip bar, as set forth for showering the contents of the pail. 2nd. The combination, with the frame A, train B, and a motor or drum C, of the mutilated wheel 1, base E, post 3, rack-bar 2, rod 6, trip 11, and a revolving fan or speed governor, as set forth. 3rd. The combination, with the frame A, train B, motor or drum C, of the worm gear 16, shaft 19, fan 20, casing 21, and tube 22, for injection of a current of air, as set forth. 4th. The combination, with the fan 20, and fan case 21, of the chute 18, to in pour the milk, as set forth. 5th. The pail 5, provided with an inlet valve 9, and having a supplementary perforated rim 10, and air space 13, for carrying down and discharging air into the milk, as set forth.

No. 35,861. Knife. (*Couteau.*)

William Valentine Barclay, Oakland, Maine, U.S.A., 21st January, 1891; 5 years.

Claim.—1st. A blade, having a series of transverse through-and-through corrugations, and one of its edges bevelled or ground to a cutting edge, forming a series of serrations, substantially as specified. 2nd. A blade, having a series of transverse corrugations, extending through and through the blade, and to about its transverse centre, and one of its edges bevelled to form serrations or teeth, and having its back provided with one or more longitudinal stiffening corrugations, substantially as specified.

No. 35,862. Sectional Tubular Tunnel.

(*Tunnel à section tubulaire.*)

David Hobart, Madison, Maine, U.S.A., 21st January, 1891; 5 years.

Claim.—The combination, with the tubular sectional shell A, of the double flange B and packing C, surrounding one end of the said shell, and the opposite end provided with the external curved socket flange E, the internal heads D, and cross-beams H, H', provided with the ball I, and socket J, substantially as described, as and for the purposes set forth.

No. 35,863. Basket for Shipping Purposes.

(*Panier de sûreté.*)

Anthony Ion, Oakville, Ontario, 21st January, 1891; 5 years.

Claim.—1st. A basket, having projections formed to extend above the capacity line thereof, by the continuation of its sides, substantially as shown and described. 2nd. In a basket, the lid or cover formed of an outline frame-work, with or without netting or other fabric secured therein, substantially as shown and described. 3rd. The combination of the basket, having projections formed to extend above the capacity line thereof, by the means specified, with the lid or cover formed of an outline frame-work, with or without netting or other fabrics secured therein, substantially as shown and described.

No. 35,864. Pocket Book. (*Livret de poche.*)

Frederick Lieker, New York, State of New York, U.S.A., 21st January, 1891; 5 years.

Claim.—1st. The combination of a pocket book, having flap *a*¹ that folds over the open ends of the pockets, with a strap secured to the back of the pocket book and folding around the closed ends of the pockets, and with a clasp for securing the free end of the flap to the free end of the strap, substantially as specified. 2nd. The combination of a pocket book, having a slitted back *a*², and a flap *a*¹ that folds over the open ends of the pockets with a strap secured within the slitted back and folding around the closed ends of the pockets, and with a clasp for securing the free end of the flap to the free end of the strap, substantially as specified. 3rd. The combination of a pocket book, having a slitted back *a*² and a flap *a*¹, that folds over the open ends of the pockets with an elastic strap secured within the slitted back, a stop *e* on the strap and a clasp for securing the free end of the flap to the free end of the strap, substantially as specified.

No. 35,865. Cobbing Apparatus.

(*Appareil à broyer le minéral.*)

David Hislop Ferguson, Montreal, Quebec, Canada, 22nd January, 1891; 5 years.

Claim.—1st. In a mechanical cobbing apparatus for minerals, such as asbestos, the combination of a crusher, a disintegrator and a separator, as set forth. 2nd. In a mechanical cobbing apparatus for minerals, such as asbestos, the combination of a crusher and a separator, as shown and described. 3rd. In a mechanical cobbing apparatus for minerals, such as asbestos, the combination of a crusher and a disintegrator, as shown and described. 4th. In a mechanical cobbing apparatus for crushed minerals, such as asbestos, the combination, with a disintegrator, of partitions, and a series of inclined planes forming a chute having open spaces preceded by retarding surfaces at points in its length, as and for the purposes set forth. 5th. In a mechanical cobbing apparatus for minerals, such as asbestos, a separator, consisting of a series of inclined planes, forming a chute having open spaces preceded by retarding surfaces at points in its length, as and for the purpose set forth. 6th. In a mechanical cobbing apparatus for minerals, such as asbestos, a separator,

consisting of partitions and a series of planes separated by open spaces and forming a chute, one or more of which planes, and portions of same, are arranged at a diminished angle of inclination to the first, as and for the purpose set forth. 7th. In a mechanical cobbing apparatus for minerals, such as asbestos, a separator, consisting of partitions, and a series of inclined planes forming a chute having open spaces, preceded by retarding surfaces formed of wire gauze at points in its length, as and for the purpose set forth. 8th. In a mechanical cobbing apparatus for minerals, such as asbestos, a separator, consisting of the inclined planes D, D', and D², having retarding end portions d, d', and d², and partitions F, F', as shown and described.

No. 35,866. Combined Whip Socket and Rein-Holder. (*Porte-fouet et accroche guides combinés.*)

William Alexander Cowan, Township of Middleton, Ontario, Canada, 22nd January, 1891; 5 years.

Claim.—1st. The combination of the tongue B, and the socket A, with using of part of the socket for a portion of the rein-holder, substantially as and for the purpose hereinbefore set forth. 2nd. The combination, with the lugs E, E, on the tongue B, and the standard piece H, in the socket A, substantially as and for the purpose hereinbefore set forth.

No. 35,867. Electric Call Bell and Indicator (*Sonnette d'appelle et indicateur électriques.*)

William Cox, Toronto, Ontario, Canada, 22nd January, 1891; 5 years.

Claim.—1st. The combination of the push button lever U, the L-shaped lever T, pull-wire s, pull-lever I, the latch levers G, indicator drops B, hung on suitable spindles C, circuit lever K, circuit pin L, circuit closer N, conducting plate O, and wires P, Q and S, substantially as and for the purpose specified. 2nd. The circuit pin L, combined with the circuit-closer N, to which is attached a battery wire P, and the conducting plate O, to which is attached the wire Q, leading to one of the poles of the bell magnet, substantially as and for the purpose set forth. 3rd. The circuit pin L, suitably connected to the pull levers I, combined with circuit closer N, to which is attached a battery wire P, and the conducting plate O, to which is attached a wire Q, leading to one of the poles of the bell magnet R, substantially as and for the purpose set forth. 4th. The circuit pin L, suitably connected to a circuit lever K, combined with the circuit closer N, to which is attached a battery wire P and conducting plate O, to which is attached a wire Q, leading to one of the poles of the bell magnet R, substantially as and for the purpose set forth. 5th. The combination of the latch levers G, suitably pivoted on frame H, with the indicator drops B, arranged on a suitable spindle C, substantially as and for the purpose set forth. 6th. The combination of the latch levers G, suitably pivoted on a frame H, with the indicator drops B, arranged on a suitable spindle C, the circuit pin L, circuit closer N, conducting plate O and battery wire P, and bell magnet wire Q, substantially as and for the purpose set forth. 7th. The combination of latch levers G, suitably pivoted on frame H, with indicator drops B, arranged on a suitable spindle C, the circuit pin L, suitably connected to a circuit lever K, circuit closer N, conducting plate O, battery wire P and bell magnet wire Q, substantially as and for the purpose set forth. 8th. The combination of the latch levers G, suitably pivoted on a frame H, with the indicator drops B, pull levers I, circuit pin L, circuit closer N, connecting plate O, battery wire P and bell magnet wire Q, substantially as and for the purpose set forth. 9th. The combination of the latch levers G, indicator drops B, circuit lever E, circuit pin L, circuit closer N, conducting plate O, battery wire P and bell magnet wire Q, substantially as and for the purpose set forth. 10th. The combination of the indicator drops B, having side extensions b, spindles C, having lifting pins D, lugs d, coupling bar c, and lift rod F, substantially as and for the purpose set forth. 11th. The combination of the push button lever U, the L-shaped lever T, substantially as and for the purpose set forth.

No. 35,868. Hammer. (*Marteau.*)

Ambrose Louis DeVol, Binghampton, New York, U.S.A., 22nd January, 1891; 5 years.

Claim.—1st. A hammer, having the handle A, made hollow and provided with a slot a, the head B, having the driving end d and the peen end d', the latter having a groove d² in its rear side connecting with the slot a, said groove being covered by a slotted guide-plate, which extends around the extremity of the peen end of the hammer, as set forth. 2nd. The combination of a hollow handle, having the guide slot a, the head B, having the groove d², and the guide plate F having the hole f², the slot f', and the slot f, as set forth.

No. 35,869. Embryotome. (*Embryotome.*)

Stephen H. Swain, Decatur, Illinois, U.S.A., 22nd January, 1891; 5 years.

Claim.—1st. An embryotome, comprising shaft 1, holder 2, on an end of the shaft and having shoulder 5, the ledges 3, 3, and the holes 4, cutters 7, 7, having each a diverging edge 8, a hole 11, a shoulder 9 and a bevel portion 10, and screws 14, 14, that secure the cutters in the holder, as set forth. 2nd. In combination, with the embryotome, the shield comprising the plate, the lugs and the rod, as set forth.

No. 35,870. Guide for Sash Cords.

(*Guide-corde de croisée.*)

H. R. Ives & Co., Montreal, Quebec, Canada, assignee of Frederick W. Hoefler, Freeport, Illinois, U.S.A., 23rd January, 1891; 5 years.

Claim.—1st. In a sash-cord guide, the combination of two parts making up the shell, the meeting edges of said parts at one end of the shell being provided with over-lapping projections adapted to receive a locking pin for fastening together such meeting edges, substantially as and for the purpose set forth. 2nd. In a sash cord guide, the combination, with the parts A, formed with openings O, O', rod R and lip L, and the part A', provided with the tongues T, T', of the locking pin P, interposed between the tongue T' and the lip L, and preventing the separation of the meeting edges on which said tongue and lip are formed, substantially as and for the purpose set forth. 3rd. In a sash-cord guide, the combination of the side plates A, A' and the axle A', substantially as and for the purpose set forth.

No. 35,871. Wringer for Mops.

(*Essoreuse de torchon.*)

George D. Mussey, Samuel S. Babcock and Walter E. Campbell, all of Detroit, Michigan, U.S.A., 23rd January, 1891; 5 years.

Claim.—1st. In combination with the base, the swinging uprights pivoted to the base at their lower ends and carrying the rollers in their upper ends, the treadle-bail having the T-shaped heads, the brackets pivotally supporting the heads of the bail, the cross-arms pivoted to the heads of the bail and to the swinging uprights, as set forth, the spring bail F, attached to the base and having engagement with the uprights D', as and for the purposes specified. 2nd. In combination with the base, the uprights D, D', pivotally coupled thereto, the corrugated rollers journaled in the upper ends of said uprights, the brackets E, the treadle bail, pivoted to said brackets, said bail having the T-shaped heads and the loop f, the tread-block in said loop, the arms b, b, pivoted to the T-shaped heads and to the uprights D, D', as specified, and the spring-bail F, the whole operating in the manner and for the purposes specified.

No. 35,872. Mouth Opener for Animals.

(*Speculum.*)

James D. Halpenny and David Dickie, both of Pontiac, Michigan, U.S.A., 23rd January, 1891; 5 years.

Claim.—1st. The combination in a mouth opener for animals, of two bits having an adjustable relation the one to the other, substantially as set forth. 2nd. The combination in a mouth opener for animals, of two bits having a spring adjustment the one to the other, substantially as set forth. 3rd. In a mouth opener for animals, the combination, with a fastening device, of two bits, one of said bits provided with end bars, and the other bit having a movable engagement on said bars, substantially as set forth. 4th. The combination in a mouth opener for animals, of two bits having an adjustable relation the one to the other, and springs connecting said bits, substantially as set forth. 5th. In a mouth opener for animals, the combination, with a fastening device, of two bits, one provided with end bars and the other bit having a movable engagement on said bars, and set screws to hold said bits in any given adjustment, substantially as set forth. 6th. The combination in a mouth opener for animals, of two bits the one having an adjustable movement with relation to the other, and a strap engaged with one of said bits to engage over the nose of the animal, substantially as and for the purpose set forth.

No. 35,873. Detachable Sleigh Runner.

(*Patin mobile de traîneau.*)

The Gendron Manufacturing Company, Toronto, Ontario, Canada, (assignees of Joseph Alfred Gendron, of Toronto aforesaid), 23rd January, 1891; 5 years.

Claim.—1st. In a detachable sleigh runner, the combination, with the runner, of transverse journal boxes for the front and rear axles, and means for adjusting said boxes laterally in relation to each other, substantially as described. 2nd. In a detachable sleigh runner, the combination of the runner, having front and rear vertical extensions of transverse journal boxes upon said extensions, said bearings being attached at one side of their middle, and means for adjusting them in or out of line, substantially as described. 3rd. In a detachable sleigh runner, the combination, with the runner, of transverse boxes secured thereto, and consisting of a central securing portion, and a lateral bearing extending on either side of said securing portion, substantially as described. 4th. A detachable sleigh runner, comprising the runner portion, and adjustable transverse boxes, secured thereto, substantially as described. 5th. A detachable sleigh runner, comprising the runner portion a, the extensions b, c, the transverse boxes c, f, having securing portions at one side of the middle, and means for reversing them, substantially as described. 6th. In a detachable sleigh runner, the box f, having a horizontal adjustment to or from its companion e, substantially as described. 7th. As a new article of manufacture, a detachable sleigh runner composed of a single piece of round metal bent to form the runner portion a, extensions b, c, and transverse boxes e, f, substantially as described.

No. 35,874. Base Ball Game Puzzle.

(*Jeu de paume et de patience.*)

Marion Lucy Cole and Harold Edmund Sewell, both of Toronto, Ontario, Canada, 23rd January, 1891; 5 years.

Claim.—1st. In a base ball game puzzle, the combination of a plane having a base ball diamond, pegs inserted at the corners of the diamond, and in the other different positions on the field, and rings corresponding to the number of pegs, substantially as specified. 2nd. In a base ball game puzzle, the combination of a box having a transparent top, and a bottom having a base ball diamond marked or otherwise indicated on it, having the corners or bases and other

positions of the players marked by pegs which have rings corresponding in number, located within the box, substantially as and for the purpose specified. 3rd. In a base ball game puzzle, the combination of a box having a transparent top, and a bottom having a base ball diamond marked or otherwise indicated on it, having the corners or bases and other positions of the players marked by pegs which have rings corresponding in number located within the box, a ball being also provided, substantially as specified.

No. 35,875. Spring Clasp. (*Agrafe à ressort.*)

The Syracuse Speciality Manufacturing Company, (assignees of John Nase), all of Syracuse, New York, U. S. A., 23rd January, 1891; 5 years.

Claim.—1st. In a clasp, the tongue-supporting frame composed of two plates of sheet metal lying one upon the other, and rigidly united at their rear ends, one of said plates being formed with forwardly-extending arms, and with an opening between said arms and extending to the free ends thereof, and having apertures vertically through said arms, and the other plate formed with a similar central opening and forwardly-extending arms, terminating with vertically-projecting lips passing through the apertures in the arms of the first plate, in combination with the tongue having on its side edges flat lateral projections, extending between the arms of the two plates immediately back of the aforesaid lips, substantially as described and shown. 2nd. The combination of the plate A, formed of the rear cross-bar *a*, and forwardly-extending plain flat arms *d*, *d*, with a central opening between said arms and extending lengthwise thereof, and with notches *n*, *n*, in the inner edges of said arms, the plate A', lying upon the plate A, and formed of the rear cross-bar *a'*, the forwardly-extending arms *d'*, *d'*, with a recess between said arms lengthwise thereof, and with recesses *c*, *c*, and transverse-disposed vertical lips *d*, *d*, extending through the aforesaid notches, rivets uniting said plates at the rear cross-bars, and the tongue *t*, formed with lateral flat projections *l*, *l*, inserted into the aforesaid recesses, substantially as described and shown. 3rd. In a spring-clasp, the combination of a body-plate provided with right-angled slots, the tongue having its pintle rigid thereon, and formed with lugs projecting at right angles from the pintle and entering the aforesaid slots, and a plate secured to the body-plate and holding between them the aforesaid pintle, as set forth.

No. 35,876. Take-up for Mid Wires. (*Cric tendeur des fils.*)

Charles M. Kiler and George W. Kiler, both of Indiana, U. S. A., 23rd January, 1891; 5 years.

Claim.—1st. The spool *a*, constructed of metal in two pieces, and consisting of the spindle *a'*, having the annular head *a'*, formed upon it with the holes *a'*, therethrough, and having the central square opening formed axially through it from end to end, with the bisecting longitudinal slot *a'*, and the removable sleeve or collar *a'*, having openings or holes *a'*, to register with the holes in the head *a'*, and the fin or projection *a'*, to enter the slot in the spindle to prevent turning, and the pin *B*, extended through two registering holes in the collar and head to prevent the spool from turning back after the wire is wound thereon, substantially as and for the purposes set forth. 2nd. A winding-spool for wires of fences, consisting of the slotted spindle *a'*, and head *a'*, formed integral therewith, with the holes *a'*, therethrough, as shown, in combination with the perforated loose and removable collar *a'*, having the projecting fin *a'*, to enter the slot of the spindle, in combination with an incase geared mechanism, as set forth, to turn said spool and wind the fence-wire thereon, as and for the purpose described. 3rd. In a wire tightening device, the casing *c*, provided with the handle *c'*, and having an intermeshing pinion and worm journaled therein, with a square-ended shaft projected from the pinion beyond the casing, a device to turn the worm to revolve the pinion and shaft, in combination with the spool A, having the slotted spindle *a'*, to engage the fence-wire, and having the perforated head *a'*, and perforated collar *a'*, with the fin to enter the slot in the spindle, said spindle having a square axial opening to receive the square end of the pinion-shaft, and the pin *B*, to extend through the perforations in the head, and collar to prevent the unwinding of the wire on the spool after the same is drawn taut, all as and for the purpose set forth. 4th. In a wire tightener for fences, a bifurcated spool adapted to straddle the fence wire, which wire will be drawn taut by revolving the spool, thereby causing the wire to wind up on the spool when it will be held by a cross pin whose ends are engaged by suitable extensions from the spool, substantially as described.

No. 35,877. Gate. (*Barrière.*)

William L. Cromwell and John H. Cole, both of Roscommon, Michigan, U. S. A., 23rd January, 1891; 5 years.

Claim.—The within-described gate, consisting of the gate proper, the uprights between which the gate slides, having the bars *e*, and hinged to the gate-post A, and the spring-rod arranged on either side of the gate, the upper ends thereof pivoted to the top rail of said gate, and the lower ends pivoted to the uprights, all as and for the purposes set forth.

No. 35,878. Waggon. (*Wagon.*)

The Gendron Manufacturing Company, Toronto, Ontario, Canada, (assignees of Joseph Alfred Gendron, of Toronto aforesaid), 23rd January, 1891; 5 years.

Claim.—1st. In a toy wagon, the combination, with the platform, of a wire frame secured to the platform at the edges, across the back and on the two sides to at or near the middle, and a dash at the front, substantially as described. 2nd. In a toy wagon, the combination, with the platform, of a wire frame secured to the platform at

the edges across the back and two sides, at or near the middle, said frame consisting of U-shaped wires secured in eyes formed in standards, substantially as described. 3rd. In a toy wagon, the combination, with the platform, of a wire frame, arranged at edges across the back and two sides to at or near the middle, said frame consisting of U-shaped wires secured in eyes formed in standards, of means for securing said standards to the platform, and of a dash at the front of the platform, substantially as described.

No. 35,879. Tightener for Wire. (*Cric tendeur des fils.*)

Charles M. Kiler and George W. Kiler, both of Indiana, U. S. A., 23rd January, 1891; 5 years.

Claim.—1st. In a fence, the combination, with the post and fence-wire, of the two-part casing bolted to said post having the projected base A', and arm A', the shaft B', journaled in said base and arm, and having the square or angular portion B', the drum B, secured to or formed a part with said shaft, having the elongated slot S, therein, to receive the fence wire end, the toothed wheel C, secured to said shaft, and the worm D, journaled in arms M, of the casing, said worm meshing with the toothed wheel, substantially as and for the purpose set forth. 2nd. In a fence, the combination, with the tubular post, of a two-part casing having arms to embrace the post as shown, and having the slotted winding drum B, the shaft B', of which is journaled in the casing, a toothed wheel fixed to said shaft, and a worm D, meshing therewith, and having ends projected beyond said casing to be engaged by a wrench or key, substantially as and for the purposes described. 3rd. In a wire-tightener, the two-part casing A, the posts being riveted together, in combination with a slotted drum journaled in said casing with a toothed wheel secured thereto, and a worm to mesh with said toothed wheel and means to operate the drum, substantially as and for the purposes set forth.

No. 35,880. Manufacture of Steel or Iron. (*Fabrication de l'acier et du fer.*)

Phoenix Actien Gesellschaft für Bergbau und Huttenbetrieb, (assignees of August Spannagel), all of Laar, German Empire, 23rd January, 1891; 5 years.

Claim.—The improvement in the manufacture of steel or iron, consisting in the addition of non-metallic carbonaceous material to the fluid metal for the purpose of imparting the desired amount of carbon to the finished product, substantially as described.

No. 35,881. Holder for Lights. (*Porte-lumière.*)

The Meadville Vise Co., (assignees of James Osborn Barrett), all of Meadville, Pennsylvania, U. S. A., 23rd January, 1891; 5 years.

Claim.—1st. In a light-holder, the combination, with the burner, of an arm, of flexible and practically non-elastic or non-reacting material supporting said burner. 2nd. In a light-holder, the combination, with the burner of an arm, of hollow flexible and practically non-elastic or non-reacting material supporting said burner, and conveying the lighting agent to the same. 3rd. In a light-holder the combination, with the burner, of an arm, of flexible and practically non-elastic or non-reacting material supporting said burner, and a conduit or conductor for the lighting agent leading to said burner, and supported by said arm.

No. 35,882. Cut off for Steam Engines. (*Détente de machine à vapeur.*)

George Fussell Jr., Lockport, New York, U. S. A., 27th January, 1891; 5 years.

Claim.—1st. In a cut off, and in combination, with inlet and exhaust valves, two arms, each connected to a separate valve and means for locking said arms together to move simultaneously or independently, substantially as described. 2nd. In a cut off, and in combination with the inlet and exhaust valves, two arms locked together to move simultaneously and means for automatically unlocking said arms, substantially as described. 3rd. In a cut off, and in combination with inlet and exhaust valves, two arms locked together to move simultaneously and an adjustable unlocking device, substantially as described. 4th. In a cut off, and in combination with inlet and exhaust valves, two arms locked together to move simultaneously an adjustable unlocking device, and a spring for returning one of the arms to a perpendicular position when the arms are unlocked, substantially as described. 5th. In a cut off, and in combination with inlet and exhaust valves, two arms locked together to move simultaneously, an unlocking device, and a governor connected to said unlocking device, substantially as described. 6th. In a cut off, and in combination, with inlet and exhaust valves, two arms, a spring actuated dog in one locking it to the other, the pivoted segments for unlocking the same, and a connection with the governor for operating said segments, substantially as described. 7th. In a cut off, and in combination with inlet and exhaust valves, two arms, a spring actuated dog in one locking it to the other, the pivoted segments T, the rods U, the slides V, working in the standard 16, and operated by the ring W, sliding on said standard, substantially as described. 8th. The combination, with the reciprocating rod H, the arm I, connected thereto, the arm M, connected to the arm I, the valves F, G, connected to said arms, the dog I, the segments U, rods U, slides V, and ring W, operated by the motion of the governor or balls, substantially as described. 9th. The combination, with a cut off, of the steam chest B, having a central partition C, provided with triple ended passages therein, communicating with the cylinder, and the inlet and exhaust chambers with reciprocating valves, alternately opening and closing the inlet and exhaust ends of said passages, substantially as described.

No. 35,883. Electrical Switch.*(Commutateur électrique.)*

John Alexander Kennedy McGregor, city of New York, New York, U.S.A., 27th January, 1891; 5 years.

Claim.—1st. In an electrical switch, the combination, of two contact pieces, a slide carrying a bridge, and a wing and an inclined plane arranged in a line drawn parallel to the line of movement of said slide and through said wing, and the free end of the adjacent piece secured as described, so that when said slide is moved in one direction until a line drawn at right angles to its line of movement will pass through the contact piece, the wing, and the inclined plane said wing will be at one side of said piece and of the inclined plane, a portion of said plane will be between a portion of said wing and the contact piece, and all will be in contact, and when moved further the contact piece will engage the bridge, all substantially as set forth. 2nd. In an electrical switch, the combination of two contact pieces, a slide carrying a bridge, and a wing and an inclined plane arranged in a line drawn parallel to the line of movement of said slide, and through said wing, and the free end of the adjacent piece secured as described, so that when said slide is moved in one direction until a line drawn at right angles to its line of movement will pass through the contact piece, the wing, and the inclined plane, said wing will be at one side of said piece and of the inclined plane, a portion of said plane will be between said wing and the contact piece, and all will be in contact, but when moved in the opposite direction from its limit of motion until it reaches the position aforesaid said wing will be at the other side of said piece, all substantially as set forth. 3rd. In an electrical switch, the combination of two contact pieces a slide carrying a bridge and an inclined plane located in front of said bridge one end higher and the other lower than it, and lower than the normal position of the free end of the adjacent contact piece, which is itself normally lower than the plane of the bridge, substantially as set forth. 4th. In an electrical switch, the combination of two contact pieces, a slide carrying a bridge, and an inclined plane located in front of said bridge, one end higher and the other lower than it, and lower than the normal position of the free end of the adjacent contact piece, which is itself normally placed below said bridge, substantially as set forth. 5th. In an electrical switch, the combination of two contact pieces with space between their free ends, a slide with a body narrower than said space adapted to the space between said ends, inclined planes of greater dimensions than the space between the sides of the slide, and the adjacent ends of the contact pieces, and at one end higher and the other lower than said free ends, a bridge secured to said slide beyond said planes of greater length than the space between the free ends of said contact pieces and at a level higher than the normal position of said free ends, substantially as set forth.

No. 35,884. Mangle for Clothes. (Calandre.)

William Howell, Township of Onondaga, and Alexander Howell, Paris, Ontario, Canada, 27th January, 1891; 5 years.

Claim.—1st. The combination in a cloth mangle machine, the frame A, made of wood, the spindles L, L, forming the upper journal box for the upper roller D, and surrounded by the spiral springs K, K, the pressure bar C, in combination with the nut M, screw N, and cap B, substantially as and for the purpose hereinbefore set forth. 2nd. In a cloth mangle machine, the bracket box F, in combination with the shaft I, I, gear pinions G, G, and wheel H, and crank E, and brace P, substantially as shown and for the purpose hereinbefore set forth.

No. 35,885. Cleaner for Boiler Flues.*(Nettoyeur des carneaux des chaudières.)*

Gabriel Sayr Smith, Towanda, Pennsylvania, U.S.A., 27th January, 1891; 5 years.

Claim.—1st. A boiler-flue cleaner, comprising a slide or sleeve, a rod to carry a scraper or cleaner, said rod and sleeve being adjustable one upon the other, and means for securing said parts in their relative adjustment without removal of the cleaner from a flue, substantially as and for the purposes set forth. 2nd. A boiler-flue cleaner, comprising a slide or sleeve, a rod to carry a cleaner or scraper, said rod and sleeve being adjustable one upon the other, and a longitudinally-movable rod passing through said sleeve at an angle to and engaging said cleaner-rod, whereby the length of said cleaner-rod between its cleaner and said sleeve may be varied at will by movement of the rod engaging therewith, and locked in position by said rod, substantially as and for the purposes set forth.

No. 35,886. Knitting Machine.*(Machine à tricot circulaire.)*

Edward Elisha Kibourn, New Brunswick, New Jersey, U.S.A., 27th January, 1891; 5 years.

Claim.—1st. The combination, as before set forth, of the knitting-cylinder needles having ribs for the action of a needle-cam, and provided with shoulders in addition thereto, and a needle-holder. 2nd. The combination, substantially as before set forth, of the knitting-cylinder, the sectional needle-holder, and needle-holder cams by which a needle-holder section may be moved crosswise of the knitting-cylinder. 3rd. The combination, substantially as before set forth, of a knitting-cylinder, the sectional needle-holder, and the cam-ring by which all the sections of the sectional needle-holder may be moved simultaneously from and toward the knitting-cylinder. 4th. The combination, substantially as before set forth, of the knitting-cylinder, the sectional needle-holder, the cam-ring and the holding-spring. 5th. The combination, substantially as before set forth, of the cam for circular knitting with the driving-shaft for

circular work through the intervention of connecting mechanism including the disconnectible drivers, and two gear wheels of unequal diameters. 6th. The combination, substantially as before set forth, of the knitting-cylinder, two knitting-cams, the driving gear-wheels for said cams, and the clutch through which motion is transmitted from one of said driving gear-wheels to the other, with the capacity of disengagement. 7th. The combination, substantially as before set forth, of the knitting-cylinder, two knitting-cams, two concentric gear-wheels, the clutch, the cam-gear shaft, and the tubular bearing for one of said gear-wheels. 8th. The sectional picker-carrier, constructed substantially as before set forth, of two sections which are adjustably secured to each other. 9th. The combination, substantially as before set forth, of the knitting-cylinder, the picker-carrier and concentric V-formed bearings for said carrier, surrounding the knitting-cylinder. 10th. The combination, substantially as before set forth, of the knitting-cylinder, the picker-carrier, the picker, and the picker-cam, arranged upon a shaft independently of the knitting-cylinder, the said cam and picker being operatively connected. 11th. The combination, substantially as before set forth, of the picker-carrier, the picker having its body of dovetailed cross-section, and the set-screw by which the picker-body is held in place. 12th. The combination, substantially as before set forth, of the picker-carrier, the worm-segment, the screw and the cam-collars arranged upon a sleeve independently of the bearings of the screw-shaft. 13th. The combination, substantially as before set forth, of a picker-carrier, the worm-segment, the screw cam-collars arranged upon a sleeve independently of the bearings of the screw-shaft, and the adjusting-screws for said sleeve. 14th. The combination, substantially as before set forth, of the picker-carrier, the worm-segment, the screw, the cam-collars, and the adjusting-screw by which the bearing of the lug of the screw-shaft against one of said cam-collars may be adjusted. 15th. The combination, substantially as before set forth, of the knitting-cylinder, the picker-carrier, and the change-wheels arranged upon a shaft independently of the knitting-cylinder said change-wheels and picker being operatively connected. 16th. The combination, substantially as before set forth, of the change-wheels, the shifting-pinion, the shaft from which said shifting-pinion receives motion, the gear-wheels which intervene between said shifting-pinion and said shaft, and the differential adjusting-pin by which two of said intervening wheels are connected. 17th. The combination, substantially as before set forth, of the knitting-cylinder, the knitting-cam for reciprocating work, the picker-carriers, the picker, the driving-shaft for reciprocating work, and connecting mechanism including a clutch through the intervention of which the picker-carriers and pickers are combined with said shaft. 18th. The combination, substantially as before set forth, of the knitting-cylinder, of the knitting-cam cylinder for reciprocating work, the thread guide and ring, and the driving and stop lugs movable under friction on said guide and ring. 19th. The combination, substantially as before set forth, of the knitting-cylinder thread-guide driver, movable thread-guide stops, and stop-mover. 20th. The combination, substantially as before set forth, of knitting-cylinder, thread-guide, thread-guide driver, driver controlling cams, movable thread-guide stops, and stop-mover. 21st. The combination, substantially as before set forth, of the knitting-cam for reciprocating work, the thread-guide driver, the casing, the thread-guide ring resting thereon, and driving lug. 22nd. The combination, substantially as before set forth, of a cam operating during reciprocating work, the thread-guide driver, the thread-guide, and ring and driving lug, and movable thread-guide stops. 23rd. The combination, substantially as before set forth, of the knitting-cylinder, pull-hook, hook-stock, hook-heel, and hook-stop. 24th. The combination, substantially as before set forth, of the knitting-cylinder, pivotal pull-hook-weight, and clutch-lever operatively connected with said pull-hook. 25th. The combination, substantially as before set forth, of the knitting-cylinder, the pull-hook, narrowing and widening devices, hook-holder, hook-stock, and an automatic trip for said hook-holder. 26th. The combination, substantially as before set forth, of the knitting-cylinder, hook-partitions for holding down and casting off the work, narrowing and widening devices, a pull-hook and automatic devices for applying said hook to assist in casting off the work during widening. 27th. The combination, substantially as before set forth, of the knitting-cylinder, pull-hook, hook-holder, and holding-spring. 28th. The combination, substantially as before set forth, of the two driving-shafts, the belt-shippers, two shipper-rods constructed with hook-nibs, and a shipper-lever with which the hook-nib of each shipper-rod is fitted to engage. 29th. The combination, substantially as before set forth, of two driving-shafts, belt-shippers, two shipper-rods, each constructed with two hook-nibs, the shipper-lever, and the latches. 30th. The combination, substantially as before set forth, of the clutch, of the cam-gear shaft and the shifting-pin with the same change-lever, said change-lever being operatively connected with the clutch and shifting-pin whereby both may be moved by the same lever. 31st. The combination, substantially as before set forth, of the movable thread-guide stops, and the circular-knitting cam-clutch with the same change-lever, said change-lever being operatively connected with said stops and clutch. 32nd. The combination, substantially as before set forth, of the clutch, of the cam-gear shaft, the shifting-pin of the shipper-rods, the stop mover of the thread-guide stops, the circular-knitting cam-clutch, and the pull-hook with the same change-lever, said change-lever being operatively connected with said clutches, thread-guide stops, shifting-pin, and pull-hook. 33rd. A knitting-machine organized for circular and reciprocating work, having combined therewith a change-lever for shifting from one motion to the other, narrowing and widening devices including pickers, and a picker-guard adapted to engage a part operatively connected with said change-lever, and permitting its movement only when the pickers are in proper position, substantially as described. 34th. A knitting-machine organized for circular and reciprocating work, having combined therewith a change-lever for shifting from one motion to the other, narrowing and widening devices including pickers, belt-shipper, rods, a pin connected with said change-lever, controlling said rods, and a picker-guard adapted to engage a part connected with said change-lever, and permitting the shifting and belt-shipper only when the pickers are in proper position, substantially as described. 35th. The combination, here-

inbefore set forth, of the knitting-cylinder needles having nibs for action of the operating devices, and additional shouldered, needle-operating devices, and a needle-holder, whereby the needles are held against movement out of range of the moving devices. 36th. The combination, as hereinbefore set forth, of the knitting-cylinder needles, needle-operating devices, and a needle-stop, whereby the needles are given a rebound from their lowest position. 37th. The combination, as hereinbefore set forth, of the knitting-cylinder, shouldered needles, needle-operating devices, a needle-holder and a needle-stop, whereby the needles are held and given a rebound from their lowest position. 38th. The combination, substantially as before set forth, of the knitting-cylinder, pivoted pull-hook, hook-stock, and hook-holder. 39th. The combination, substantially as before set forth, of the knitting-cylinder, change-wheels, pull-hook, hook stock, hook-holder, and a trip-arm connected with said holder. 40th. The combination, substantially as before set forth, of the knitting-cylinder the change-wheels, pull-hook, hook-stock, hook-holder, trip-arm connected to said holder and the hook-holder spring. 41st. The combination, substantially as before set forth, of the knitting-cylinder, pull-hook, hook-stock, hook-guide, hook-spring, hook-heel, and hook-stop. 42nd. The combination, substantially as before set forth, of the pickers, their operative mechanism, picker-guard, guard-pin, and lever, and the change-lever operatively connected therewith. 43rd. The combination, substantially as before set forth, of the pickers, picker-guard, guard-pin, and lever shifting-pin, and the same change-lever operatively connected therewith. 44th. The combination, substantially as before set forth, of the stationary knitting-cylinder, the sliding nosing for said cylinder and the screw-ring, which holds said nosing. 45th. The combination, with the knitting-cylinder, of two cam-cylinders operating in connection therewith, two driving-shafts gearing intermediate one of said shafts, and the cam-cylinders for imparting a circular movement to the latter, reciprocating gearing operated from the other driving-shaft, and means for throwing said reciprocating gearing into operative connection, whereby one of the cam-cylinders may be reciprocated. 46th. The combination, substantially as before set forth, of the knitting-cylinder, two cam-cylinders for operating the needles thereof, a driving-shaft and gearing for operating the cam-cylinders from said shaft for circular work, said gearing having drivers with provision for lost motion or play to permit reciprocating movement to be given to one of the cam-cylinders, without reciprocating the driving-shaft. 47th. The combination, substantially as before set forth, of two driving-shafts which are operated successively, the two belt-shippers for the same, and a single shipping-lever, and means for putting the same into operative connection with either of said shippers when desired. 48th. The combination, substantially as before set forth, of two driving-shafts, two belt-shippers for the same, a single shipping-lever, and a shifting device by which but one of the two belt-shippers, at a time, is subjected to the control of the shipping-lever. 49th. The combination, as before set forth, of the knitting cylinder, a circular series of needles divided into two gangs, two cam-cylinders for operating the needles for circular work, one of said cam-cylinders operating one of said gangs of needles for reciprocating work, and the counting device which indicates the number of circular rows of stitches, which have been knitted. 50th. The combination, substantially as before set forth, of the knitting-cylinder, two cam-cylinders by which the needles thereof are operated for circular work, the counting devices which indicate the number of circular rows of stitches which have been knitted, the driving-shaft for circular work, the belt-shipper appertaining to said driving-shaft, and the belt-shipper latch of the driving-shaft for circular work. 51st. The combination, substantially as before set forth, of the picker and its carrier, a revolving shaft, and intermediate mechanism including the change-wheels, and segments through the intervention of which the carrier is caused to move in reverse directions, the latch of the belt-shipper appertaining to said shaft, and a stop through the intervention of which the said latch is disengaged. 52nd. The combination, substantially as before set forth, of the picker and its carrier, a driving-shaft gearing intermediate said shaft, and said carrier including the change-wheels and segments among its members, a belt-shipper for said shaft, and its connected latch and a stop moving with the change-wheels, and adapted to release said latch. 53rd. The combination, substantially as before set forth, of a needle-cylinder with two cam-cylinders, devices, whereby said cam-cylinders are given a common operative rotation for knitting circular work, and devices whereby one of said cam-cylinders is given a reciprocating movement independently of the other for operating the needles during the widening and narrowing of the work. 54th. The combination, substantially as before set forth, of the picker-carrier with the frame of the machine, by means of grooves which are concentric with the needle-cylinder, and which hold and guide the upper and lower edges of said picker-carrier. 55th. The combination, substantially as before set forth, of the picker, the needle-holder, and the carrier by means of which the first two are held and moved. 56th. The combination, of a driving-shaft, and a picker-carrier with intermediate gearing through the intervention of which the picker-carrier is operated from the driving-shaft, the members of said gearing being inseparable during operation. 57th. The combination, substantially as before set forth, of the knitting-cylinder, a cam-cylinder for operating the needles for reciprocating work, the picker for acting on the needles which are to be put out of operation with said cam-cylinder, the carrier for said picker, and the needle-holder by which the needles are held positively out of their operating positions. 58th. The combination, substantially as before set forth, of the knitting-cylinder, two cam-cylinders for operating the needles of the same for circular work, the picker for acting on the needles which are to be put out of or into operation with one of said cam-cylinders for reciprocating work, and the movable carrier for said picker. 59th. The combination, substantially as before set forth, of the circular series of needles, the picker, a cam operated independently of the needle-cam for moving the picker positively in both directions, the carrier and the worm-segment and screw, whereby said carrier is moved partially around the circular series of needles positively without the possibility of over movement by momentum. 60th. The combination, substantially as before set forth, of the knitting-cylinder, the two cam-cylinders for operating the needles thereof, for

circular work, the picker, and the carrier which operates, in combination with one of said cam-cylinders for reciprocating work. 61st. The combination, substantially as before set forth, of the circular series of needles, the cam-cylinder for operating the same for reciprocating work, the picker, the carrier, the worm-segment and screw, and the cams by which the said screw is moved endwise while being caused to turn. 62nd. The combination, substantially as before set forth, of the knitting-cylinder, two cam-cylinders for operating the needles thereof, for circular work, the picker, the carrier, the worm-segment and screw, and the cams by which said screw is caused to move endwise. 63rd. The combination, substantially as before set forth, of the circular series of needles, the cam-cylinder for operating the same for reciprocating work, the picker, the carrier, the change-wheels and segments, whereby the number of times the carrier is to be moved in opposite directions is determined, devices intermediate said change-wheels, and the carrier for moving the latter, and the driving-gearing engaging with said change-wheels and segments. 64th. The picker, substantially as described, having a lug for engaging the nibs of the fashioning-needles from the under side, and a lug for engaging such nibs on their upper side, said lugs being located upon the picker in different vertical planes, substantially as described. 65th. The combination, herein described, of a knitting-cylinder having a gang of needles for reciprocating work, a cam for operating said needles, a picker having two lugs in different horizontal and vertical planes, and an independently operated cam for actuating said picker. 66th. The combination, substantially as before set forth, with the frame of the machine, and a knitting-cylinder, said frame being provided with annular grooves outside of said cylinder of picker-carriers of segmental form mounted in said grooves. 67th. The combination, substantially as before set forth, of the knitting-cylinder having a gang of needles for reciprocating work, provided with nibs for engaging the operating cam, a portion of which are provided with supplemental nibs, a cam for operating said needles for circular and reciprocating work, pickers for engaging the supplemental nibs of said needles, and mechanisms operated independently of the needle-cam for operating said pickers positively in both directions. 68th. The combination, with a knitting-cylinder and needles of two pickers, two picker-carriers, and the worm-segments and screws for moving the carriers the movable parts of said pickers intersecting the planes of said segments and screws, substantially as described. 69th. The combination, substantially as before set forth, of a knitting cylinder, and a circular series of needles including a gang for reciprocating work, a portion of said reciprocating needles being provided with supplemental nibs, cams for operating said needles for circular or reciprocating work, pickers for engaging the supplemental nibs of the needles, and cams for operating said pickers having motion independent of the needle-operating cams. 70th. The combination, substantially as before set forth, of a knitting-cylinder having needles divided into gangs, one of said gangs being for reciprocating work, and a portion of said reciprocating gang being provided with supplemental nibs, pickers for engaging the supplemental nibs of said needles, a cam for operating the reciprocating gang for both reciprocating and circular work, a cam for operating the other gang for circular work, and a cam for operating said pickers positively in both directions. 71st. The combination, substantially as before set forth, of a knitting-cylinder having a gang of needles for reciprocating work, a cam for operating said needles, two pickers having each two lugs in different vertical and horizontal planes, two picker-carriers having alternate movement from needle to needle, and a cam for operating said pickers. 72nd. The combination, substantially as before set forth, of a needle-cylinder with needles all of which are in operation during circular work, and a part of which constitute a gang for reciprocating work, a thread-guide for reciprocating work, narrowing and widening devices including both means for throwing a portion of the reciprocating gang of needles out of operative position, and a stop for said thread-guide and screws for moving said narrowing and widening devices in proper relation to the needles during the narrowing and widening. 73rd. The combination, substantially as before set forth, of the knitting-cylinder, the cam which operates the gang of fashioning-needles for both circular work and reciprocating work, the cam which operates the other gang of needles for circular work, the gang of fashioning needles having their nibs arranged to be operated by the said first cam, the other gang of needles having their nibs arranged to be operated only by the second cam, and the hook partitions of the nosing by which the work is prevented from rising. 74th. The combination, substantially as before set forth, of the needle cylinder, the cam-cylinder for operating the needles for reciprocating work, the needles, the picker, the carrier, and the hook-partitions of the needle-cylinder, which not only hold down the work during narrowing but which press the stitches forward out of the way of the needles. 75th. The combination, as before set forth, of a needle-cylinder and cams for both circular and reciprocating work, with a gang of needles all of which are operated for circular work, but a portion of which are thrown out of operation for narrowing during reciprocating work, but which retain their stitches while out of operation, the said needle-cylinder being provided with stationary hook-partitions which not only hold down the work during narrowing, but press the stitches forward out of the way of the needles. 76th. The combination, with a needle-cylinder, of needles, a part of which are thrown out of operation for narrowing during reciprocating work but which retain their stitches while out of operation, and cams for operating the needles for circular and reciprocating work, the said needle-cylinder being provided with stationary hook-partitions between its needle-grooves, said partitions having inclines below the hooks to assist in casting off the stitches, and a part above said inclines and below the hooks for holding the stitches inward out of the way of the needles, substantially as described. 77th. The combination, substantially as before set forth, of a needle cylinder provided at the top with stationary hook-partitions between the needle-grooves, each of said hook-partitions having an outwardly-inclined point at its upper end, the extreme point extending outside of the needles and having all parts of its inner edge below the hook extending as far as or farther inwardly than the outer face of the body of the needle, a series of needles including narrowing-needles, needle-operating devices, and devices for narrowing and widening. 78th. The combination, substantially as be-

fore set forth, of two cam-cylinders, one of which only operates during circular work, the gang of fashioning-needles for both circular and reciprocating work having nibs arranged to be operated by the reciprocating cam for reciprocating work, the other gang of needles having nibs arranged to be operated by the first-named cam for circular work, and the hook-partition, whereby the work is prevented from rising. 79th. The combination, substantially as before set forth, of the needle-cylinder, the needles, the cam by which the needles are operated for reciprocating work, the picker, the picker carrier, the thread-guide which is operated for reciprocating work, and means for transferring said thread-guide from one side of said cam to the other side thereof, including a stop for said thread-guide moving in a determined relation with the picker-carrier. 80th. The combination, substantially as before set forth, of a knitting-cylinder the needles, two cam-cylinders one of which is in operation only during circular work, means for imparting motion to one cam-cylinder for reciprocating work, thread-supplying devices and means for operating said thread-supplying devices for circular and reciprocating work. 81st. The combination, substantially as before set forth, of the knitting-cylinder, the needles, a cam-cylinder which only works during circular work, a reciprocating cam-cylinder, thread-supplying devices for circular work, and for reciprocating work, and means for operating the thread-guide in connection with the reciprocating cam-cylinder. 82nd. The combination, substantially as before set forth, of a knitting-cylinder and its needles, two cam-cylinders, one of which only works during circular work, and thread-supplying devices, the thread-supplying devices for reciprocating work being moved from the reciprocating cam-cylinder. 83rd. The combination, substantially as before set forth, of a needle-cylinder and its needles, two cam-cylinders one of which only works during circular work, and thread-supplying devices, the thread-supplying devices for reciprocating work moving in unison with the reciprocating cam through the whole or part of its movement. 84th. The combination, substantially as before set forth, of the knitting-cylinder, the cam for reciprocating work, the thread-guide driver, the cams for controlling said driver, the levers controlling said cams having locking projections and the casing. 85th. The combination, substantially as before set forth, of the thread-guide, the driving lug connected therewith, the pivoted thread-guide driver, and the cams controlling the same.

No. 35,887. Scales. (*Balance.*)

John Milne, (assignee of Joseph Franklin Noyes and John Frederic Miller), all of Hamilton, Ontario, Canada, 28th January, 1891; 5 years.

Claim.—In a single pillar dormant warehouse scales, the combination and arrangement of the several parts, namely, in combination with the platform L, and the mechanism beneath the same with the steel yard H, cut off lever F, table D, single pillar E, connecting rod I, beam C, post K, and drop lever A, all operating substantially as and for the purpose set forth herein.

No. 35,888. Paper Bag. (*Sac de papier.*)

Kilgour Brothers, Toronto, Ontario, assignees of William Albert Lorenz, Hartford, Connecticut, U.S.A., 28th January, 1891; 5 years.

Claim.—1st. A paper bag, having a flat rectangular bottom, two inwardly inclined longitudinal folds in each of two opposite sides of the said bag, and an inwardly-inclined quadrangular fold A, and an outwardly-inclined fold B between the rectangular bottom and each of said sides, all substantially as described. 2nd. A paper bag having a flat rectangular bottom, and two inwardly-inclined longitudinal folds in each of two opposite sides of the said bag, and having the outer bends of the plies of paper which constitute those longitudinal folds, occupying two or more different vertical planes, all substantially as described.

No. 35,889. Pressure Gauge.

(*Manomètre métallique.*)

Empire Steam Gauge Company, assignees of Murdock McNeil, all of Boston, Massachusetts, U.S.A., 28th January, 1891; 5 years.

Claim.—1st. In a pressure gauge, the combination of the casing, the spring tube A therein, the spring *a* interposed between the casing and the tube, a holder or support for the outer end of said spring attached to the casing, a clamp attached to the tube, a nut or collar engaged with the inner end of the spring, and a hinge or joint connecting the collar with the clamp, as set forth. 2nd. In a pressure gauge, the combination of the casing, the tube A therein, the spring *a* interposed between the casing and the tube, the adjusting screw *e* engaged with the casing and supporting a nut which is engaged with the outer end of the spring *a*, the clamp *p* attached to the tube, the nut or collar *b* engaged with the inner end of the spring, and the hinge or joint connecting said collar *b* with the clamp *p*, as set forth.

No. 35,890. Brake for Railway Cars.

(*Frein de char.*)

Frank O'Neil, Toronto, Ontario, Canada, and William Henery, West Toronto Junction, 28th January, 1891; 5 years.

Claim.—1st. A pivot lever, connected at one end to the brake levers on the trucks by a rope, and its other end extending above the roof of the car, in combination with a notched plate fixed to the car, and a spring fixed to the lever arranged to hold the said lever in contact with the said notched plate, substantially as and for the purpose specified. 2nd. A pivot lever, connected at one end to the brake levers on the trucks by a rope, and its other end extending above the roof of the car, a notched plate being fixed to the car and a spring fixed to the lever arranged to hold the said lever in contact with the said notched plate, in combination with a rope or chain car-

ried over pulleys and extending to a point where it may be conveniently handled from the ground, substantially as and for the purpose specified. 3rd. A pivot lever, connected at one end to the brake levers on the trucks by a rope, and its other end extending above the roof of the car, a notched plate being fixed to the car and a spring fixed to the lever arranged to hold the said lever in contact with the said notched plate, in combination with a crank rod journalled on the end of the car below the lever, and provided with crank-handles by which the said crank-rod may be readily revolved from the ground, substantially as and for the purpose specified. 4th. A pivot lever, connected at one end to the brake levers on the trucks by a rope, and its other end extending above the roof of the car, a notched plate being fixed to the car and a spring fixed to the lever arranged to hold the said lever in contact with the said notched plate, in combination with a rope or chain carried over pulleys and extending to a point where it may be conveniently handled from the ground, and with a crank rod journalled on the end of the car below the lever and provided with crank handles, by which the said crank-rod may be readily revolved from the ground, substantially as and for the purpose specified. 5th. A lever, connected to the brake levers of the truck by a rope or chain, and pivoted in a pivot box adjustably supported in a horizontal bracket fixed to the end of the car, substantially as and for the purpose specified. 6th. A lever A, connected to the rope D, and pivoted at *a*, in the pivot box N, in combination with a bracket O, provided with an adjusting screw P, arranged to support and adjust the pivot-box N, substantially as and for the purpose specified. 7th. A rope B, connected to the brake lever J, and extending around the grooved roller H, on the brake lever L, and is carried thence around the grooved roller G, in combination with the pivoted lever A, connected to the rope B, and arranged to operate the brakes, substantially as and for the purpose specified.

No. 35,891. Sick Bed Appliance.

(*Appareil pour lits de malade.*)

Thomas Erlin Kaiser and Jonathan Wilkinson, both of Oshawa, Ontario, Canada, 28th January, 1891; 5 years.

Claim.—In an adjustable sick bed appliance, the combination, with the revolving axle D, having a ratchet wheel and pawl secured therewith, of double clutches provided with removable clutch jaws, and having fixed and movable parts at each end of said axle, substantially as and for the purposes hereinbefore set forth.

No. 35,892. Slot Machine.

(*Appareil actionné par une pièce de monnaie.*)

Anselm Garrett Hart, Detroit, Michigan, U.S.A., 29th January, 1891; 5 years.

Claim.—1st. An information slot machine, the same consisting of a ribbon upon which the data to be displayed is printed, means for causing said ribbon to traverse past an indicating orifice, a tilting frame provided with an obscuring shield adjacent to said orifice, and a coin hopper, said frame adapted to be tilted by the weight of the coin in the hopper, and means for dropping the coin from the hopper by the further movement of the ribbon, substantially as and for the purposes described. 2nd. An information slot machine, consisting of a ribbon, with means for traversing the same in front of an indicating orifice, said ribbon having the information to be displayed printed thereon, and a tilting frame provided with an obscuring shield and a coin hopper, said frame adapted to tilt and shift the shield by the weight of the coin in the hopper, said hopper provided with a springing bottom, adapted to be actuated by a moving part of the mechanism when the ribbon is shifted, and thereby dropping the coin, substantially as described. 3rd. An information slot machine, consisting of two rollers, upon which is wound a ribbon with the desired information printed thereon, and adapted to traverse past an indicating orifice and a gear wheel engaged with said rollers, and an exterior handle for actuating the same, and in connection therewith an obscuring shield and means for actuating the same by the weight of a coin in a coin hopper, and means for discharging the coin from the hopper by the operation of shifting the ribbon, substantially as described. 4th. In an information slot machine, the combination, with the ribbon B, wound upon two rollers, and means for winding upon the said ribbon, whereby the same is maintained taut, substantially as and for the purposes described. 5th. An information slot machine, consisting of a ribbon B, and means for actuating the same past an indicating orifice, said ribbon provided with dates corresponding with the consecutive days, and opposite each date the information desired to be exposed therewith, and in combination with said ribbon an obscuring shield adapted to obscure the information adjacent to the date, and a tilting frame to which said obscuring shield and a coin receiver is attached, said frame adapted to be tilted by the weight of the said coin, and means for discharging the coin from the hopper upon the farther movement of the ribbon, substantially as described.

No. 35,893. Process of Forming Ingots.

(*Procédé pour la formation des ingots.*)

William Russell Hinsdale, Newark, New Jersey, U.S.A., 29th January, 1891; 5 years.

Claim.—1st. The process of forming ingots, which consists, first, in forming the casting in an ingot mould, secondly, protecting the top of the casting from the atmosphere, by chilling the same, and, thirdly, reserving the casting, as and for the purpose set forth. 2nd. The process of forming ingots, which consists, first, in filling the ingot mould, secondly, in excluding the atmosphere from the mouth of the mold by a cap, and, thirdly, reversing the mold, as and for the purpose set forth. 3rd. The process of forming ingots, which consists first, in inserting a cup of heated material in the bottom of the mold, secondly, filling the mold, thirdly, reversing the mold, as and for the purpose set forth.

No. 35,894. Wire Fencing.*(Clôture en fil de fer.)*

George P. Richel, Hornellsville, New York, U.S.A., 29th January, 1891; 5 years.

Claim.—The wire fencing, herein described and shown, consisting of a pair of parallel strands, each composed of a series of strands continuously twisted together throughout their length, and the two zig-zagged wires, having their bends alternately in looped engagement with the wires of the opposite strands, and crossing each other between the said bends, substantially as described.

No. 35,895. Trunk. (Valise.)

George Owens, Albany, New York, U.S.A., 29th January, 1891; 5 years.

Claim.—1st. The trunk body A, furnished with the lid B, and provided interiorly at each end with the rods S^2, S^3 , sustained by the brackets T, T, with springs S^2, S^2 , and shelves S, S, with collars S^1, S^1 adjusted thereon, and having the hinged front C, combined with movable trays resting on said shelves, as hereinbefore set forth and described. 2nd. The trunk body A, furnished with the lid B, and provided interiorly at each end with the rods S^2, S^3 , sustained by the brackets T, T, with springs S^2, S^2 , and shelves S, S, with collars S^1, S^1 adjusted thereon, and having the hinged front C, combined with movable trays resting on said shelves, said trays being provided with rollers w, w, w , as hereinbefore set forth. 3rd. A lever P, having the foot p^1 , and pivoted, secured at each end of A on the inside, adjusted to bear upon an angle-iron p , fastened to each end of D on the outside, combined with the rods S^2, S^3 , sustained by the brackets T, T, the springs S^2, S^2 , the shelves S, S, having the collars S^1, S^1 adjusted thereon, and the movable trays E, E, resting on said shelves, as and for the purpose hereinbefore set forth and described. 4th. The combination, with the hinged front board C, of the jointed books R, R, arranged for holding the front board in place, when raised, as hereinbefore set forth and described.

No. 35,896. Check for Commodities Measured by Meters. (Mesure métrique.)

Thomas Ahearn, Ottawa, Ontario, Canada, 29th January, 1891; 5 years.

Claim.—1st. A system of taking and rendering account of commodities measured by index meters, consisting of taking a diagrammatic copy of the meter index, and presenting the same to the consumer, together with the diagrammatic representation of a state of the index at the previous accounting and computing the consumption by deducting the figures previously indicated from those indicated at last, substantially as set forth. 2nd. A system of taking and rendering account of commodities measured by index meters, consisting of a blank diagram representing the meter index without hands or pointers, inscribing said pointers on inspecting the meter, and of a bill blank containing two similar diagrams, and marking the same to represent the previous and present state of said index, substantially as set forth. 3rd. In a system of taking and rendering account of commodities measured by index meters, a note book containing blank diagrams representing the meter index without pointers, substantially as set forth. 4th. In a system of taking and rendering account of commodities measured by index meters, a bill blank containing a pair of diagrams, each representing the meter index without pointers substantially as set forth.

No. 35,897. Lock for Tubular Lantern Burners. (Agrafe pour becs de lanternes tubulaires.)

Charles Frederick Smith and George Lorenzo Flower, both of Belleville, Ontario, Canada, 29th January, 1891; 5 years.

Claim.—1st. In a tubular lantern, the locking together of the burner cone c, and the collar b, by one or more projections or pins in cone collar b, and one or more grooves or slots in cone c, substantially as and for the purpose hereinbefore set forth. 2nd. In a tubular lantern, the combination of the cone c, cone collar b, slots or grooves c, and pins or projections d, substantially as and for the purpose hereinbefore set forth.

No. 35,898. Compound Aluminum Plate.*(Plaque de composition d'aluminium.)*

Charles Henry Land, Detroit, Michigan, U.S.A., 29th January, 1891; 5 years.

Claim.—1st. A compound metallic plate, or otherwise shaped metallic body, consisting of aluminum, provided with a tinned surface, substantially as set forth. 2nd. The process herein set forth, of manufacturing a compound aluminum plate, or other aluminum body, provided with a tinned surface, consisting of burnished tin upon a surface of the aluminum at a desired temperature, substantially as set forth. 3rd. The process of attaching aluminum facings to various surfaces, consisting of turning a face of the aluminum in the manner described, and attaching the same to said surface, as herein set forth.

No. 35,899. Swivel Arm for Electric Lights.*(Bras à emillon pour lumière électrique.)*

James Kingdon, Hamilton, Ontario, Canada, 29th January, 1891; 5 years.

Claim.—1st. In a device for the purpose described, the projecting wrought-iron rigid frame-work, composed of the longitudinal bars B, having flanges B', braces D, latch G, bolt c, with its tube casing

c', and the upper and lower supports E, E and F, F, in combination with the electric light arm H, the upper and lower sides being in arc form, the ends welded together to form the jaws J, and to receive the weight K and the insulator supports m and n, substantially as and for the purpose hereinbefore set forth. 2nd. In a device for the purpose described, the combination of the longitudinal rigid frame-work for supporting the electric light arm H, and allowing the same to swivel therein, and the supports o and p secured to the perpendicular pole A, substantially as and for the purpose hereinbefore set forth.

No. 35,900. Trunk. (Valise.)

Frank Joseph Polica, Racine, Wisconsin, U.S.A., 29th January, 1891; 5 years.

Claim.—1st. The combination, with a trunk-body having a rear overhanging portion and sides shouldered to correspond and inclined downward to the front of the trunk, of a top hinged to said overhanging portion and provided with downwardly-inclined sides registering with the said inclined sides of the trunk-body, substantially as set forth. 2nd. The combination, in a trunk, of tray cleats having inclined and shouldered recesses, and a tray having inclined rear edge, substantially as described. 3rd. The combination, with the trunk having rear overhanging portion and top hinged thereto, of the tray having inclined rear edge, and the tray cleats having inclined shouldered recesses, substantially as described. 4th. The combination, with a trunk having a rear overhanging portion and a top hinged thereto, of tray-cleats secured to the inside of the trunk and provided with shouldered recesses, and a tray adapted to be supported therein, substantially as described. 5th. In a trunk, the combination, with the body made higher at the rear than at the front, and provided with sides having vertical rear shoulders and downwardly inclined top edges extending to the front of the trunk, of a top made shallow at the rear and deep in front, and having sides with inclined bottom edges registering with the inclined sides of the trunk-body, substantially as set forth. 6th. In a trunk, the combination, with the top of a valance formed from a casting made with two oblique angles on the same side, in the same plane, substantially as and for the purpose set forth. 7th. An improved attachment for trunks, etc., comprising an angular corner-iron having one of its arms formed with an off-set, and a companion angular iron having one of its arms provided with an extension adapted to enter beneath said off-set, substantially as and for the purpose set forth.

No. 35,901. Nut Lock. (Arrête-écrou.)

Julius C. Richardson, Auburn, New York, U.S.A., 29th January, 1891; 5 years.

Claim.—1st. The improvement in the process or method of making nuts herein described, the same consisting in bending the arms of a bar against each other forming threaded apertures therethrough, and then separating said arms, substantially as described. 2nd. The improvement in the process or method of making nuts herein described, the same consisting in bending the arms of a bar against each other, cold punching apertures therein which are afterwards threaded, and then separating the said arms so that the same form a V-shaped slot, substantially as described.

No. 35,902. Garment. (Vêtement.)

Elizabeth Lee, Little Falls, New York, U.S.A., 29th January, 1891; 5 years.

Claim.—1st. The combination of a bodice adapted to fit snugly to the form, a supporting-band thereon, at a distance below the waist-line, about equal to the distance from the natural waist-line to the upper line of the hips, fastening devices secured to said band to support a petticoat, and a skirt gathered and full at the top and also secured to said band, substantially as described. 2nd. The combination of a bodice adapted to fit snugly to the form, a supporting-band thereon, at a distance below the waist-line about equal to the distance from the natural waist-line to the upper line of the hips, fastening devices secured to said band to support a petticoat, a skirt full and gathered at the top, and also secured to said band supporting devices for other skirts attached to the outside of the bodice at a little below the waist-line, and an inverted hook secured to the front of the bodice to engage with the outer skirt and prevent the same from riding up, substantially as described. 3rd. The combination of a bodice adapted to fit snugly to the form, a supporting band sewed at its upper edge only to the inside of the bodice at a distance below the waist-line, about equal to the distance from the natural waist-line to the upper line of the hips, fastening devices secured to the inner side of said band to support a petticoat, fastening devices secured to the outside of said band, and a skirt gathered and full at the top and adapted to be supported by said last named fastening devices, substantially as described.

No. 35,903. Machine for Balling Twine.*(Machine pour emballer la ficelle.)*

Andrew Calvin Miller, Auburn, New York, U.S.A., 29th January, 1891; 5 years.

Claim.—1st. In a machine for balling cord, the travelling cord guide arm, in combination with and pivoted at one end to its actuating shaft, and at its outer end overhanging the shaft or mandrel on which the cord is wound, substantially for the purpose described. 2nd. In a machine for balling cord, the combination, with the cord guide actuating shaft and the travelling cord guide pivoted thereon, of rods or bails lying parallel with the path of and operated upon by said guide, supporting levers for said rods and reversing mechanism connected to said levers, for reversing the movement of the actuating shaft and guide, substantially as described. 3rd. The combina-

tion, with the cord guide and mechanism for giving a reciprocating movement thereto, of the transversely arranged rods or bails between which said guide moves and the mechanism for reversing the direction of movement of said guide connected with and operated from said bails, substantially as described. 4th. The combination, with the cord guide and its actuating mechanism, of transversely arranged rods or bails, supporting levers therefor, and reversing mechanism connected to said levers, substantially as and for the purpose described. 5th. The combination, with the cord guide and its actuating mechanism, of the bail or rod operated upon by the weight of said guide for reversing its direction of movement, and a stationary rest or support for upholding said guide at the inner end of its throw above said bail, and reversing mechanism connected with said bail, substantially as and for the purpose set forth. 6th. In a machine for winding or balling cord, the combination of the cord guide, and its actuating mechanism, a two armed lever having rods or bails arranged to be operated by said guide, and a clutch mechanism connected to said two armed lever to be operated for reversing the movement of the cord guide, substantially as described. 7th. The combination in a machine for balling cord, of a tapering mandrel, the disc or head on said mandrel having a projecting pin or spur, sliding pawl rods actuated by said pin the cord guide and its actuating mechanism, a lever actuated by the cord guide for lifting the pawls into engagement with said pin, and reversing mechanism connected to and operated by said pawls for reversing the direction of movement of the cord guide, substantially as described. 8th. The combination, with the screw threaded shaft and the cord guide operated thereby, of two driving wheels mounted loosely on said shaft and rotated continuously in opposite directions, the clutch feathered to and sliding on said shaft between said wheels, a shifting fork or lever for operating said clutch, the trip levers and bails operated by said cord guide, and connections between said levers and bails and the shifting levers, substantially as described, whereby the movements of the cord guide are made to operate the clutch and change the direction of movement of the cord guide, substantially as set forth. 9th. The combination, with the screw threaded shaft for operating the cord guide, of oppositely moving driving wheels, the sliding clutch member, the lever and devices for moving said clutch member and the springs operating substantially as described, to hold the said clutch in its adjusted position. 10th. The combination in a machine for balling cord, with a reciprocating cord guide and its actuating mechanism, of the bails, and trip levers and reversing mechanism connected with said bails and trip levers and acted upon thereby for reversing the movement of the guide, a pulley on said guide and a roller for guiding the cord, and the fixed rest and support for upholding the cord guide arm at the inner end of its movement, in beginning the ball or spool, substantially as described.

No. 35,904. Cutter for Plows.

(*Couteur de charrue.*)

Isaac Daniel Roy, Bono, Arkansas, U. S. A., 29th January, 1891; 5 years.

Claim.—The combination, with a beam standard and cutter, of the slotted screw-plates D, E, the bolts F, G, and the forked slotted slide plates H, I, the plates D, E, and bolts F, G, being provided with nuts, as for the purpose set forth.

No. 35,905. Chart for Drafting Garments.

(*Patron pour tracer les vêtements.*)

Henry Gorman Kennedy, Berlin, Ontario, Canada, 29th January, 1891; 5 years.

Claim.—1st. A chart for drafting garments, comprising a rectangular strip having extending from a point near its top edge, an oblique slit *e*, with a scale C, arranged upon one side thereof, the lower edge *a*, provided with an indicating point *i*, the right hand side *b*, with a scale A, and the upper edge with a scale B, the latter for locating the lower shoulder point, and the distance from A, to C, determining the width of the back at shoulder, substantially as and for the purpose set forth. 2nd. A chart for drafting garments, comprising a rectangular strip having series of oblique slits Q, *f*, and *e*, with scales or graduated marks G, F, and E, upon the left thereof,

for indicating the initial points for the seye, substantially as and for the purpose set forth. 3rd. A chart for drafting garments, comprising a rectangular strip having a scale *i*, upon its right hand side, and an oblique slit Q, extending from a point near its top edge, said slit having arranged upon the right hand bordering edge a scale J, given points upon the scales *i*, and J, determining the initial points for the upper shoulders, and gorge, substantially as and for the purpose set forth. 4th. A chart for drafting garments, comprising a rectangular strip having a series of oblique slits Q, *f*, and *e*, with scales of graduated marks G, F, and E, upon the left hand bordering edge for indicating the initial points of the seye, said chart also provided at its lower edge *a*, with a scale K, and upon its left hand edge with a scale L, said last mentioned scales determining the points for fitting the sleeve to the seye, substantially as and for the purpose set forth. 5th. A chart for drafting garments, comprising a rectangular strip having an oblique slit Q, with graduated marks upon the opposite bordering sides of said slit, and also having a series of similar slits *c*, *f*, and *e*, with graduated marks upon one bordering side, the lower edge *a*, of the outliner provided with a scale K, and indicating points 1 and 2, the right hand side or edge with a scale B, and the left hand edge with indicating points M, and D, and the scale L, substantially as and for the purpose set forth.

No. 35,906. Treatment of Spent Soap Lyes.

(*Traitement des lessives de savon.*)

James S. Kirk & Company, Chicago, Illinois, U. S. A., (assignees of Albert Domeier and Otto Christian Hagemann, both of London, England), 31st January, 1891; 5 years.

Claim.—1st. In the process of treating spent soap-lye for the purpose of obtaining glycerine and other products therefrom, the improvement which consists in first treating the lye with lime or other oxides to precipitate insoluble soaps, removing the precipitate thus formed, next neutralizing the lye with acid to precipitate albuminous bodies, then adding soluble metallic salts to decompose any remaining soapy matters, next adding metallic oxides to completely remove fatty bodies, then removing the precipitates, to completely concentrating the clear liquor, as set forth. 2nd. In the process of treating spent soap-lye for the purpose of obtaining glycerine and other products therefrom, the improvement which consists in first treating the lye with lime or other oxides to precipitate soaps, removing the precipitate thus formed, next neutralizing the lye with acid to precipitate albuminous bodies, then adding a mixture of metallic oxides and soluble metallic salts to completely remove soapy and fatty bodies, next removing the precipitates thus formed, and finally concentrating the clear liquor, as set forth. 3rd. In the process of treating spent soap-lye for the purpose of obtaining glycerine and other products therefrom, the improvement which consists in first neutralizing the lye with acid to precipitate albuminous bodies, then adding a mixture of metallic oxides and soluble metallic salts to completely precipitate the soapy and fatty bodies, next removing the precipitate thus formed, and finally concentrating the clear liquor, as set forth.

No. 35,907. Draw Head. (*Tampon d'attelage.*)

Taylor W. Heintzelman and Henry J. Small, both of Sacramento, California, U. S. A., 31st January, 1891; 5 years.

Claim.—1st. The combination, with a draw head, of a movable buffer connected to said draw head, and adapted to be moved either into position to project longitudinally beyond said draw head, or to be swung upwardly back of the face thereof, substantially as set forth. 2nd. The combination of a draw head recessed to receive a coupling link, and provided with vertical lugs or projections, a buffer pivotally supported upon said lugs, and a locking pin securing the buffer in either a horizontal or a vertical position, substantially as set forth.

*CERTIFICATES OF THE PAYMENT OF FEES FOR FURTHER TERMS HAVE BEEN ATTACHED TO
THE FOLLOWING PATENTS.*

2039. ANDREW DERROM, 2nd five years of No. 23,081, from the 5th day of January, 1891. Improvements in Composition Mastic for covering Roofs, Telegraph Wires and the like, 5th January, 1891.
2040. JOHN GOOD, 2nd five years of No. 23,113, from the 7th day of January, 1891. Improvement in Machines for Spreading and Drawing Hemp, Flax, and other Fibrous Material, 7th January, 1891.
2041. FRANK M. BLODGETT, 2nd five years of No. 23,240, from the 19th day of January, 1891. Improvements in Micro Audophones, 7th January, 1891.
2042. JOHN B. F. HERRESHOFF, GEORGE HENRY NICHOLS and WILLIAM H. NICHOLS, 2nd five years of No. 23,436, from the 16th day of February, 1891. Improvements on Sulphuric Acid Towers, 7th January, 1891.
2043. CHARLES ALLEN, 2nd five years of No. 23,104, from the 7th day of January, 1891. Self Holding Pulley Block, 7th January, 1891.
2044. JOSEPH DRADER, 2nd five years of No. 23,130, from the 11th day of January, 1891. Improvements in Double Action Hay Cars, 8th January, 1891.
2045. JULIA M. GAST and FREDERICK G. ATCHISON, 2nd five years of No. 23,345, from the 4th day of February, 1891. Improvements in Steam Pipe Coverings, 8th January, 1891.
2046. HENRY BRONK, 2nd five years of No. 23,116, from the 8th day of January, 1891. Improvements in Snow Scrapers, 8th January, 1891.
2047. JULES WEIRICH, 2nd five years of No. 23,301, from the 10th day of February, 1891. Improvements in the Treatment of Auriferous and Aurargentiferous Minerals, 12th January, 1891.
2048. STAHLSCHMIDT & CO., 2nd five years of No. 23,178, from the 14th day of January, 1891. Improvements in Combined School Desks and Seats, 12th January, 1891.
2049. ALEXANDER LAIDLAW, 2nd five years of No. 23,199, from the 15th day of January, 1891. Improvements in Grain Cleaning Machines, 13th January, 1891.
2050. ROBERT J. QUIGLEY, 2nd five years of No. 23,201, from the 15th day of January, 1891. Improvements in Watch Cases, 13th January, 1891.
2051. GUSTAVUS MICHAELIS and WILLIAM T. MAYER, 2nd five years of No. 23,215, from the 12th day of January, 1891. Improvement on the Manufacture of Chloroform and Acetic Acid or Purified Acetates, 13th January, 1891.
2052. JOHN D. EARDMAN and WILLIAM L. KNAPPENBERGER, 2nd five years of No. 23,151, from the 13th day of January, 1891. Improvements in Fire Escapes, 13th January, 1891.
2053. BEAUDRY EDGE SETTING AND HEEL BURNISHING MACHINE COMPANY, 2nd five years of No. 23,184, from the 14th day of January, 1891. Improvements in Machines for Burnishing the Soles of Boots and Shoes, 13th January, 1891.
2054. DAVID PLEWS, 3rd five years of No. 12,212, from the 15th day of January, 1891. Improvements on Wooden Pumps, 14th January, 1891.
2055. JOHN T. HARLAND, 2nd and 3rd five years of No. 31,199, from the 29th day of April, 1891. Improvements in Shipping Cans for Shipping and Handling Varnishes, Oils, and other Liquids, 15th January, 1891.
2056. CASE AND WILLARD THRESHER COMPANY, 2nd five years of No. 23,481, from the 23rd day of February, 1891. Improvements in Threshing Machines, 19th January, 1891.
2057. CHARLES W. MILLARD, 2nd five years of No. 23,246, from the 20th day of January, 1891. Combined Latch and Lock, 20th January, 1891.
2058. GENEVA ARMSTRONG, 2nd five years of No. 23,294, from the 1st day of February, 1891. Improvements on Adjustable Troughs for Feeding and Watering Live Stock on R. R. Cars, 20th January, 1891.
2059. REID P. SMALL and STEPHEN J. SMALL, 3rd five years of No. 12,270, from the 27th day of January, 1891. Improvements in Sugar Evaporators, 21st January, 1891.
2060. ROYAL ELECTRIC COMPANY, 3rd five years of No. 12,331, from the 8th day of February, 1891. Improvement on Armatures for Dynamo Electric Machines, 21st January, 1891.
2061. ROYAL ELECTRIC COMPANY, 3rd five years of No. 12,341, from the 10th day of February, 1891. Improvement on Automatic Adjusters for Commutator Brushes of Dynamo Electric Machines, 21st January, 1891.
2062. ROYAL ELECTRIC COMPANY, 3rd five years of No. 12,477, from the 24th day of February, 1891. Improvement on Regulators for Electric Lamps, 21st January, 1891.
2063. ROYAL ELECTRIC COMPANY, 2nd five years of No. 24,028, from the 10th day of May, 1891. Improvements in Electric Switches, 21st January, 1891.
2064. GEORGE McSHERRY, 2nd five years of No. 23,395, from the 11th day of February, 1891. Improvements in Two Furrow Plows, 21st January, 1891.
2065. FRANCIS L. NORTON, 2nd five years of No. 23,264, from the 25th day of January, 1891. Improvements in Life Ships and other Boats or Vessels, 23rd January, 1891.
2066. JOHN B. ARMSTRONG, 2nd five years of No. 23,400, from the 12th day of February, 1891. Improvements in Vehicle Springs, 24th January, 1891.
2067. JOSEPH T. DUNHAM, 2nd five years of No. 23,388, from the 8th day of February, 1891. Improvements in Envelopes, 25th January, 1891.
2068. WILLIAM FRIPP, 2nd five years of No. 23,246, from the 29th day of January, 1891. Improvements in Cooking Stoves, 28th January, 1891.
2069. BELL TELEPHONE COMPANY, 2nd and 3rd five years of No. 23,300, from the 1st day of February, 1891. Improvements in Electric Battery Telephones, 30th January, 1891.
2070. WILLIAM R. GARDNER, 2nd five years of No. 23,313, from the 2nd day of February, 1891. Improvements in Nail Holding Hammers, 31st January, 1891.
2071. GEORGE VALIANT, 2nd five years of No. 23,306, from the 16th day of October, 1893. Improvements in Boots, 31st January, 1891.
2072. GEORGE VALIANT, 2nd five years of No. 23,394, from the 5th day of February, 1891. Improvement in Boots, 31st January, 1891.
2073. RUDOLPH d'HEUREUSE, 3rd five years of No. 12,311, from the 1st day of February, 1891. Improvements in the Manufacture of Starch, Glucose, Maltose, etc., from Grain, 31st January, 1891.

JANUARY LIST OF TRADE MARKS.

Registered at the Department of Agriculture—Copyright and Trade Mark Branch.

3914. GEBRUDER BAUMANN, FIRMA JOH. BAUMANN'S WVE, of Amberg, Bavaria, Empire of Germany. Enamelled Tin Ware, 2nd January, 1891.
3915. REV. GABRIEL ALFRED GREZIER, Procurator of the Monastery of La Grande Chartreuse, near Voiron, Isère, France. Fermented Liquors and Spirits, namely, the Liqueur manufactured at La Grande Chartreuse, 3rd January, 1891.
3916. EDWARD LYNCH, of North Bay, Dist. of Nipissing, Ont. A Sign for a Hotel at said place, 5th January, 1891.
3717. THE COMPANY OF THE PURE MILKS, of Paris, France. Preparations of Milk, 7th January, 1891.
3718. WILLIAM JOSEPH COPP and CHARLES CARPENTER, of Hamilton, Ont. Saws, 8th January, 1891.
3719. THE BUSHNELL COMPANY, L'D., of Montreal, Que. Oils, 8th January, 1891.
3720. HOWARD W. WENTZELL and JOHN C. LARDER, of Halifax, and Dartmouth, respectively, N.S. Larder's British North American Liniment, 12th January, 1891.
3921. LOUIS OVIDE GROTHÉ, of Montreal, Que. Cigars, Cigarettes and Cut Tobaccos, 13th January, 1891.
- 3922 } JOHN DE KUYPER & SON, of Rotterdam, Kingdom of the Netherlands. Hollands
3923 } Geneva, 14th January, 1891.
3924. TASSÉ, WOOD & CO., of Montreal, Que. Cigars, 14th January, 1891.
3925. PURE GOLD MANUFACTURING CO., of Toronto, Ont. Blacking, 21st January, 1891.
3926. WILLIAM DAVID HOLDEN WYLIE, of Brockville, Ont. Liquid Shoe Dressing and other Chemical Mixtures, 23th January, 1891.
3927. HAMILTON POWDER CO., of Hamilton, Ont. Dynamite and like Explosives, 29th January, 1891.
3928. S. DAVIS & SONS, of Montreal, Que. Cigarettes, Cigars and Tobaccos, 30th January, 1891.
3929. ISRAEL ADAM, de Montreal, Que. Une Remède, 31 Janvier, 1891.

COPYRIGHTS.

Entered during the month of January at the Department of Agriculture—Copyright and
Trade Mark Branch.

5754. THE TROOPERS' MARCH, by Fred. W. Holland. The Anglo-Canadian Music Publishers' Association, L'd., London, England, 2nd January, 1891.
5755. QUEEN CHARITY and OTHER SERMONS, by Rev. J. Edgar Hill, Montreal, Que., 3rd January, 1891.
5756. SOUVENIR ALBUM OF CANADIAN STATESMEN. The News Printing Co., L'd., Toronto, Ont., 3rd January, 1891.
5757. SELECTIONS from "SESAME" and "LILIES," being portions of two lectures delivered by John Ruskin, LL.D. W. J. Gage & Co., Toronto, Ont., 8th January, 1891.
5758. ROYAL QUILT COMPETITION (advertisement). The Queen Publishing Co., Toronto, Ont., 8th January, 1891.
5759. MAILING LIST FOR THE GARDEN OF MANITOBA, PORTAGE LA PRAIRIE and Surrounding Districts. (pamphlet). Charles Samuel Birch Burley, Portage la Prairie, Man., 8th January, 1891.
5760. THE CANADIAN QUEEN. JANUARY NUMBER, 1891. The Queen Publishing Co., Toronto, Ont., 8th January, 1891.
5761. GITANA. (Spanisches Liedchen) by Franz Behr. }
5762. LAYS OF ALBION. Phantasy by W. S. Rockstro. }
- The Anglo-Canadian Music Publishers' Association, L'd., London, England, 8th January, 1891.
5763. LAYS OF CANADA AND OTHER POEMS, by Rev. Duncan Anderson, M.A., New Liverpool, Que., 9th January, 1891.
5764. A SECOND EXTRACT FROM THE TECHNICAL STUDIES FOR THE PIANO-FORTE, by Louis Plaidy, Breitkopf & Hartel, Leipzig, Germany, 10th January, 1891.
5765. MORNING THOUGHTS, by Rev. George Bruce, B.A., St. John, N.B., 12th January, 1891.
5766. THE CANADIAN MINING MANUAL, 1890-91, by B. T. A. Bell, Ottawa, Ont., 15th January, 1891.
5767. LA CIGALE LANCERS. }
5768. LA CIGALE VALSE. } Arranged by Charles Coote.
- The Anglo-Canadian Music Publishers' Association L'd., London, England, 16th January, 1891.
5769. THE PROTESTANTISM OF THE PRAYER BOOK, by the Rev. Dyson Hague, M.A. }
5770. THE LAW OF BILLS OF EXCHANGE AND PROMISSORY NOTES, }
being an Annotation of The Bills of Exchange }
Act, 1890, by Edward H. Smythe, LL.D. }
The J. E. Bryant Co., L'd., Toronto, Ont., 17th January, 1891. }
5771. DOMINION CITIES STREET POST BOXES AND CAB STAND GUIDE. Edward A. Barton, Longueuil, Que., 19th January, 1891.
5772. THE WESTERN WORLD. Vol 2. No. 11, January, 1891. Acton Burrows, Winnipeg, Man., 19th January, 1891.
5773. THE BROOKLET. Words by Alfred Tennyson. Music by Henry C. Grounds. J. L. Orme & Son, Ottawa, Ont., 19th January, 1891.
5774. EVANGEL OF SONG. J. H. Hathaway, Brantford, Ont., 20th January, 1891.
5775. THIRD GENERAL CONFERENCE OF THE METHODIST CHURCH, HELD IN ST. JAMES CHURCH, MONTREAL, SEPTEMBER, 1890. (Photograph.) Christopher Willis Coates, Montreal, Que., 20th January, 1891.
5776. GAGE'S STANDARD AND HIGH SCHOOL BOOK-KEEPING BLANKS. W. J. Gage & Co., Toronto, Ont., 21st January, 1891.
5777. ONLY WAITING, Sacred Part Song for Mixed Voices, by Emma Fraser Blackstock, Toronto, Ont., 21st January, 1891.
5778. THOMPSON'S CHURCH ENVELOPE FOR VOLUNTARY CONTRIBUTIONS }
TO SPECIAL FUNDS. }
5779. THOMPSON'S SUNDAY SCHOOL RECORD (forms). }
Frederick Somerville Thompson, St. John, N.B., 21st January, 1891. }
5780. ILLUSTRATED MONTREAL. THE METROPOLIS OF CANADA (book). John McConniff, Montreal, Que., 22nd January, 1891.

5781. THE MANUFACTURERS' ACCIDENT INSURANCE FORM. Francis Furniss Rolland, Montreal, Que., 24th January, 1891.
5782. MERCHANTS AND PROFESSIONAL MEN'S AGREEMENT AND NOTE BOOK, Douglas Alexander Thurston, Toronto, Ont., 24th January, 1891.
5783. YOLANDE WALTZ, by Walter A. Geddes. The Anglo-Canadian Music Publishers' Association L'd., London, England, 24th January, 1891.
5784. BELL TELEPHONE COMPANY OF CANADA, HAMILTON AND DUNDAS EXCHANGES, SUBSCRIBERS' DIRECTORY, ONTARIO DEPARTMENT, JANUARY, 1891. The Bell Telephone Company of Canada, Montreal, Que., 24th January, 1891.
5785. DAS KALTE HERZ, KALIF STORCH and DIE BURGSCHAFT, with English Notes, Glossary and Grammatical Appendix, by W. H. Van der Smissen, M.A. The Copp. Clark Co., L'd., Toronto, Ont., 26th January, 1891.
5786. A DIGEST OF THE NOVA SCOTIA REPORTS (by Fred. T. Congdon, LL.B., Barrister at-Law). In Common Law, Equity, Vice Admiralty and Election Courts. Carswell & Co., Toronto, Ont., 26th January, 1891.
5787. GLADSOME TIDINGS. Song. Words by Arthur Chapman. Music by Frederick Bevan. }
 5788. AH, WELL-A-DAY. Song. Words by F. E. Weatherly. Music by Mrs. Arthur Goodeve. }
 The Anglo-Canadian Music Publishers' Association, L'd., London, England, 26th January, 1891.
5789. ONTARIO PRACTICE REPORTS. Vol. XIII., by T. T. Rolph, Barrister-at-Law and Reporter to the Court. J. W. Smith, Q.C., Editor. The Law Society of Upper Canada, Toronto, Ont., 27th January, 1891.
5790. CANADA. Song and Chorus, by R. P. Joyce, Orpheus Series. Whaley, Royce & Co., Toronto, Ont., 28th January, 1891.
5791. BELL TELEPHONE COMPANY OF CANADA, WESTERN EXCHANGES, SUBSCRIBERS' DIRECTORY, ONTARIO DEPARTMENT, DECEMBER, 1890. The Bell Telephone Company of Canada, Montreal, Que., 29th January, 1891.
5792. QUEBEC FROM POINT LEVIS (Lithograph). John Henry Walsh, Sherbrooke, Que., 29th January, 1891.
5793. STRUCK BY LIGHTNING, by Rev. Epenetus Owen. Rev. Albert Sims, Otterville, Ont., 31st January, 1891.

THE

CANADIAN PATENT OFFICE RECORD

ILLUSTRATIONS.

Vol. XIX.

JANUARY, 1891.

No. 1.



35682 Kelley's Halter Chain.

Fig. 1.

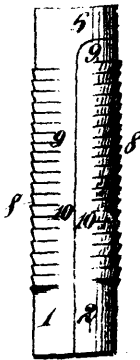

35683 Holsey's Blasting Plug.

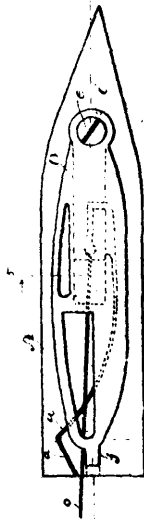

35684 Miller's Shuttle.

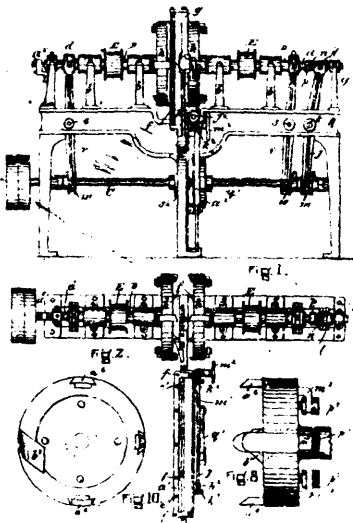

35685 Carver's Wood-Working Machine.

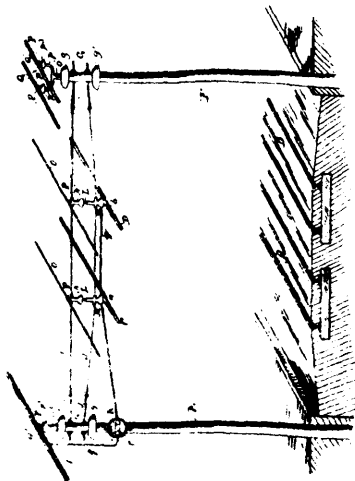

35686 Van Depoele's Structure for Supporting and Insulating Suspended Bare Conductors.

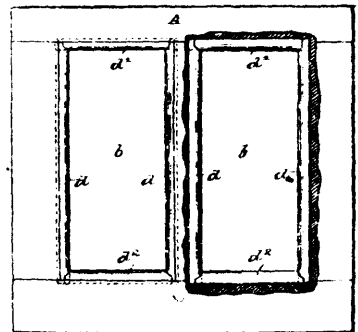

35688 Crosser's Window Sash.

Fig. 1

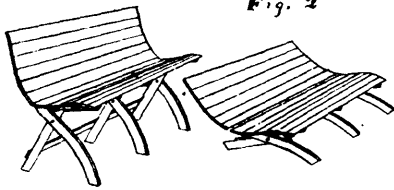

Fig. 2

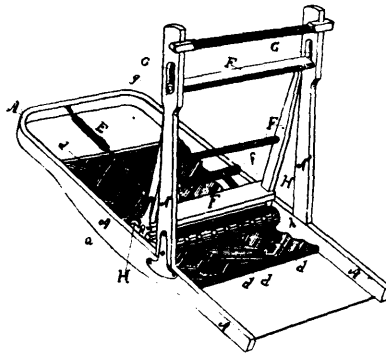

Fig. 1.

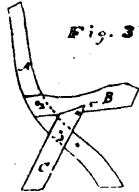
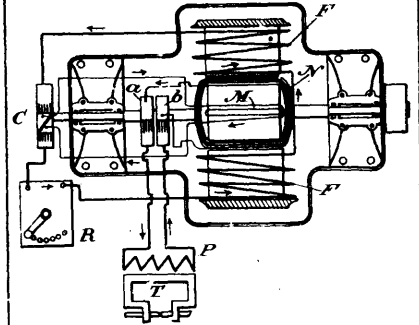

Fig. 3

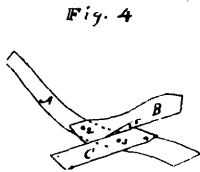
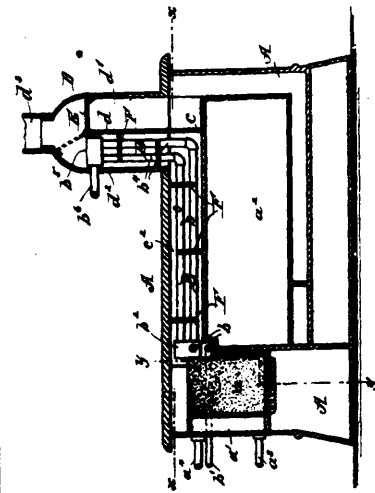

Fig. 4

35689 Gillis' Folding Chair.

35690 Caldwell's Washing Machine.

35691 Lemp's Compound Wound Alternate Current Dynamo.



35692 Steinhoff's Water Heating Attachment for Ranges.

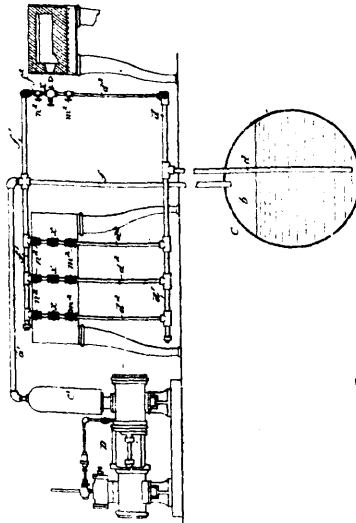

35693 Bullard's Apparatus for Burning Hydro Carbon.

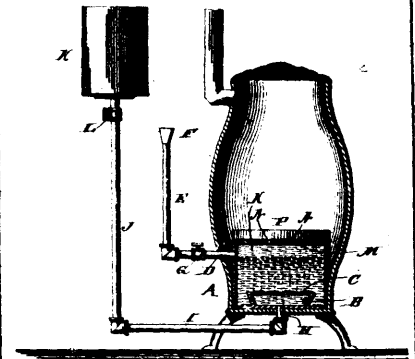

35694 Davis' Hydro-Carbon Burner.

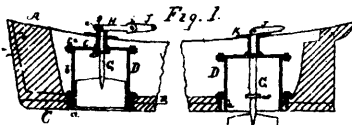
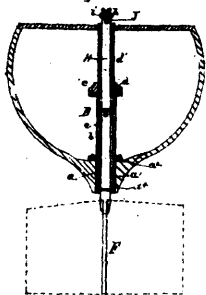
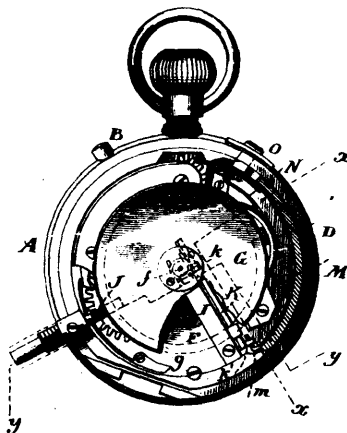

Fig. 2.



35695 McPartland's Centre Board for Vessels



35697 Scofield's Speed Indicator for Vehicles.

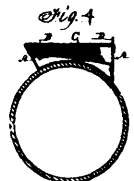
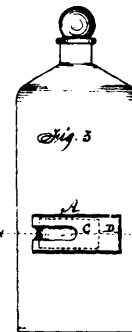
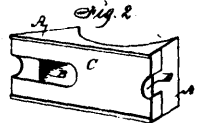
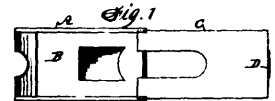

35698 Given's Druggists' Label Case and Attachment for Bottles and Jars.

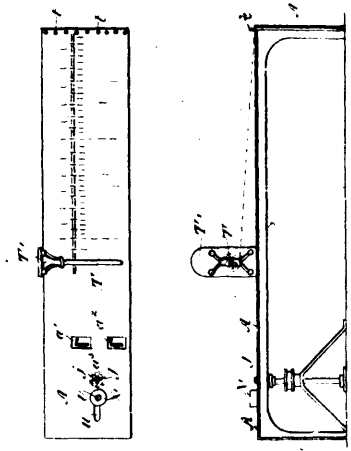

35699 Storie's Machine for Preparing Drive Chains for Shipment.

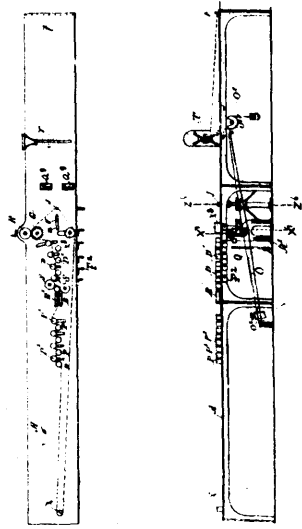

35700 Storie's Method of Treating Drive Chains.

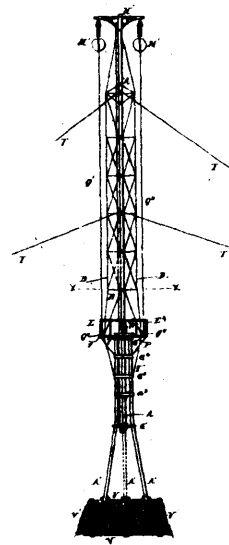

35701 Maxwell's Electric Light Tower.

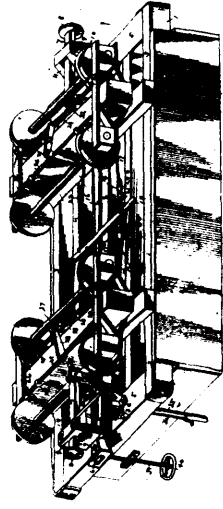

35702 Clancy's Car Brake.

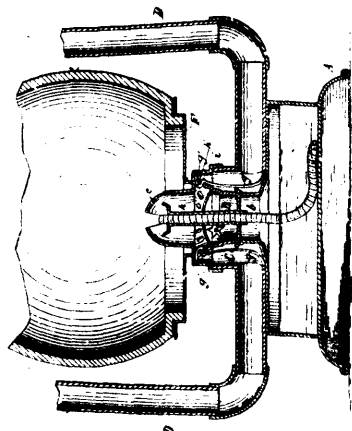

35703 Lapierre's Lamp Burner.

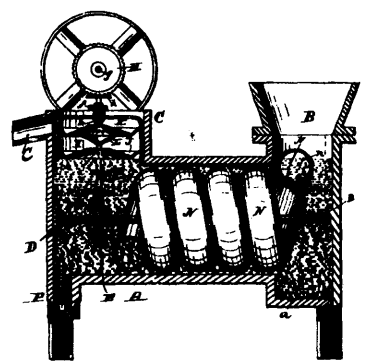

35704 Van Derveer's Amalgamator.

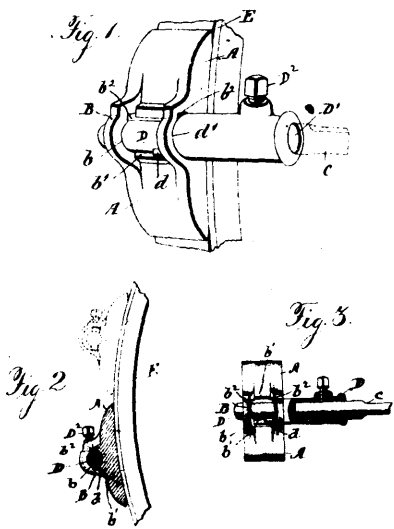

35705 Smith's Vehicle Brake.

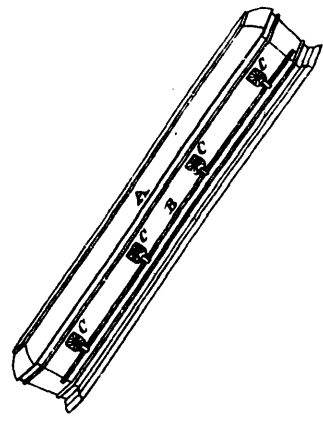

35706 Blackford's Casket Handle.

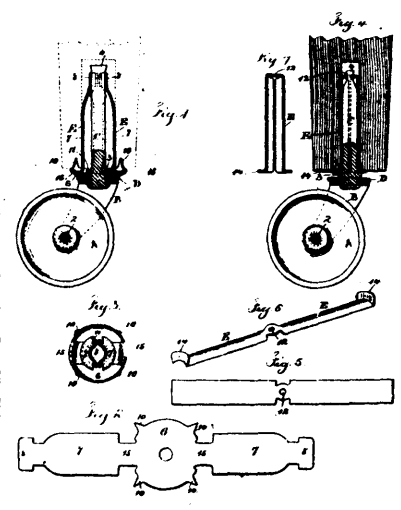

35707 Disc' Caster.

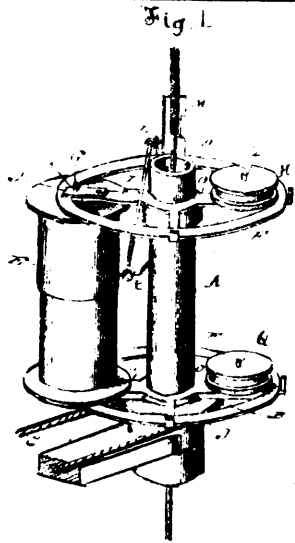

35708 Phillips' Machine for Covering Wire.

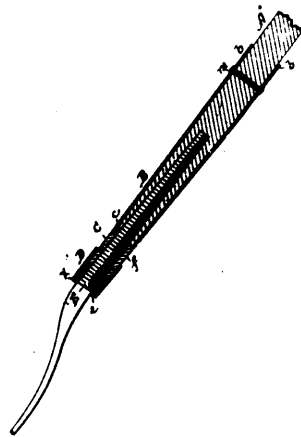

35709 Pymm's Screw Shank and Ferrule for Agricultural Implements.

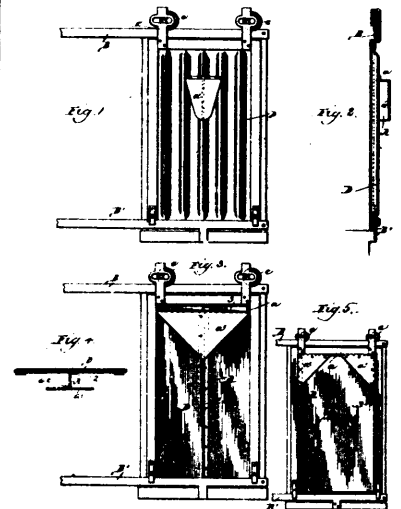

35710 Andreen's Means for Operating Fire-Proof Shutters and Doors.

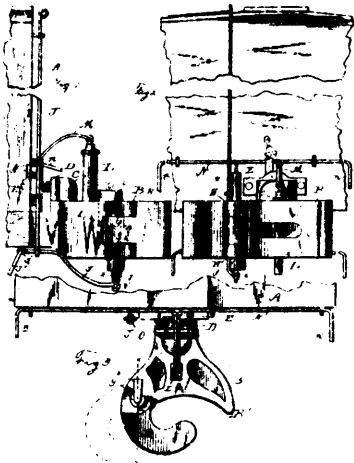

35711 Brown's Car-Coupling.

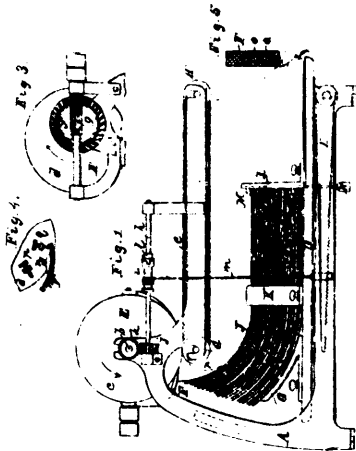

35712 Dummer's Paper Feeding Mechanism.

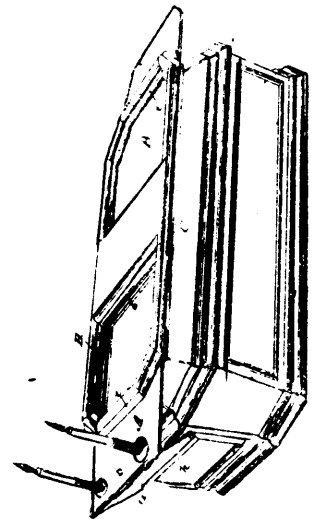

35713 Elpsom's Shrine Panel.

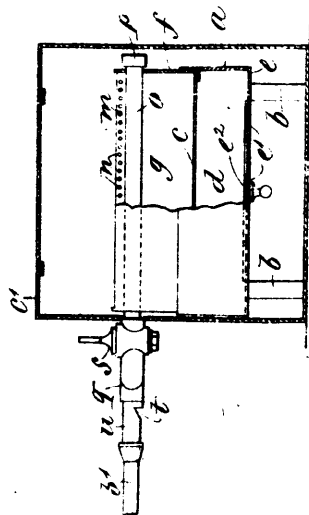

35714 Roberts' Gas and Hydro-Carbon Burner.

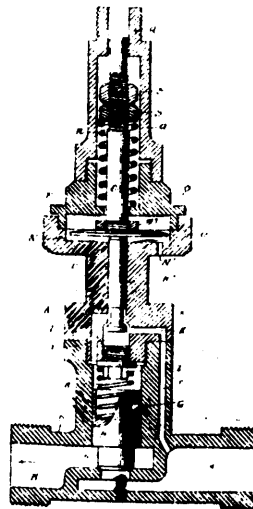

35715 Ord's Air Pump Governor.

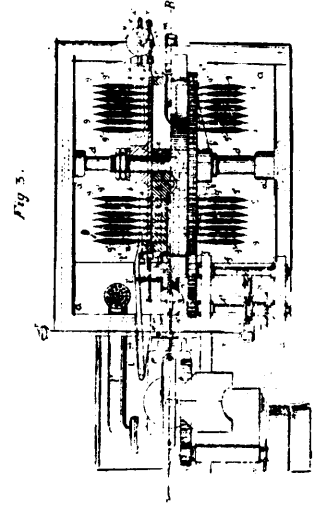

35716 Graemiger's Machine for Treating Yarn in Compact Form.

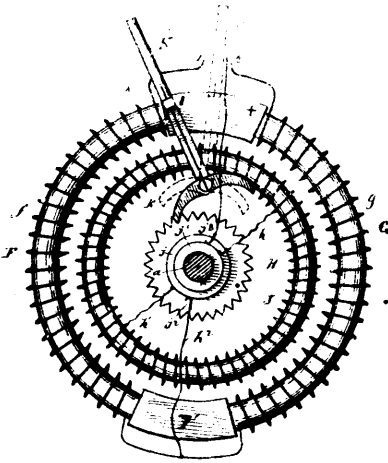

35717 Van Depoele's Pulsating Current Motor.

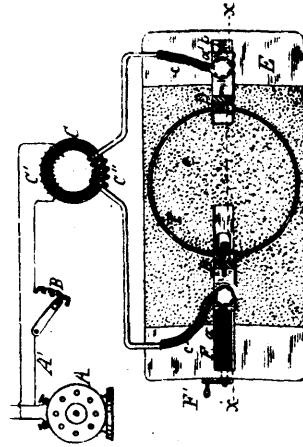

35718 Dewey's Method of Expanding Hoops and Tires.

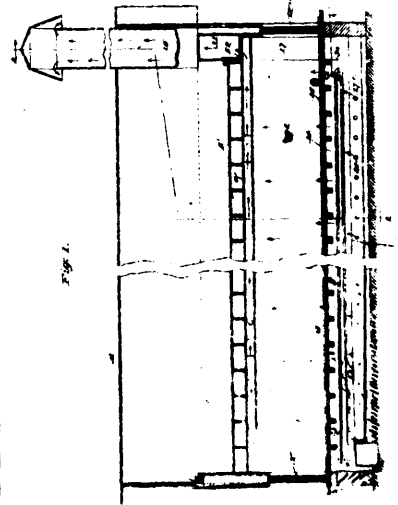

35719 Arnold's Brick Drier.

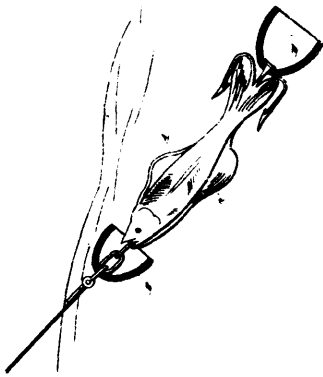

35720 Pfueger's Fish Bait.

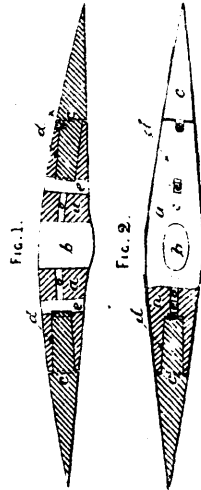

35721 Morrison and McLellan's Pick.

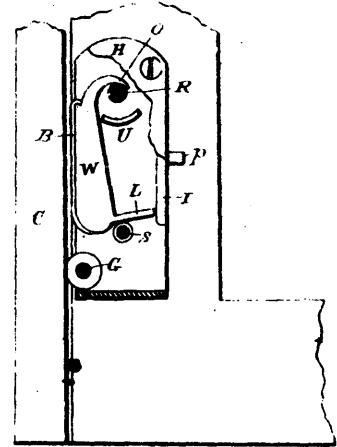

35723 Phillips' Sash Holder and Fastener.

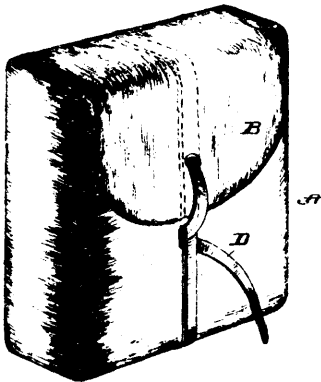

35724 Cussen's Tobacco Pouch.

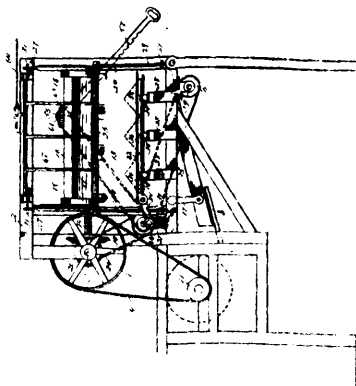

35725 Alston's Hand Cutter and Feeder.

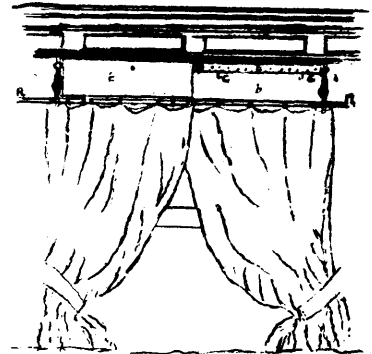

35727 Davenport's Sleeping Car.

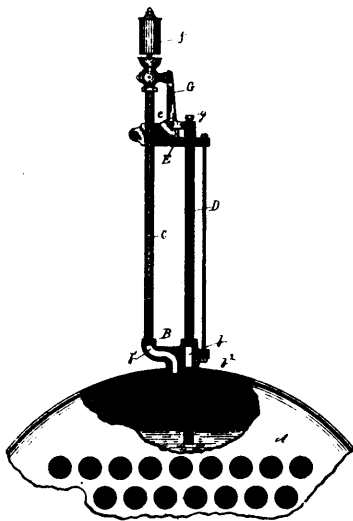

35728 Hardwick's Low Water Alarm.

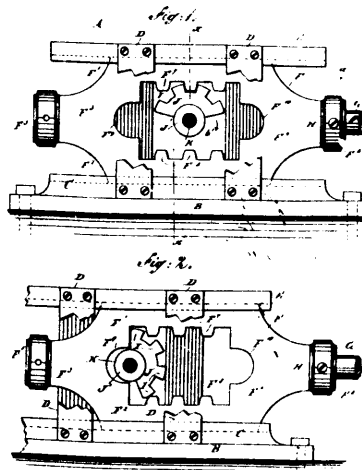

35729 Hayton's Mechanical Movement.

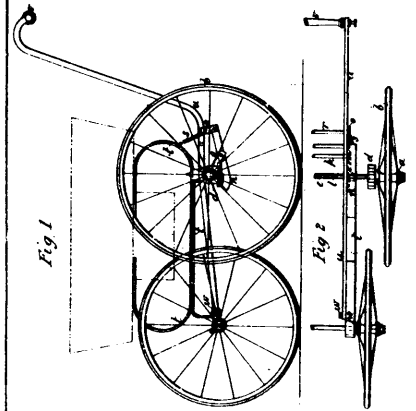

35731 Graham and McDonald's Automatic Wheel Locking Device.

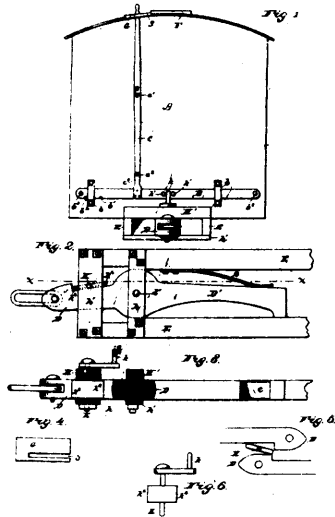

35732 Sanders and Willett's Car Coupling.

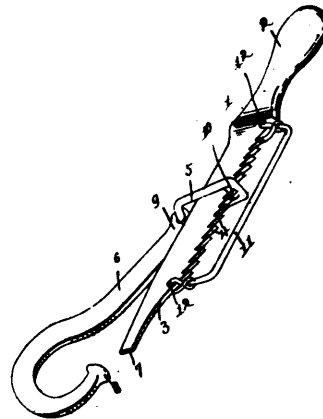

35733 Edwards' Bolt Holder.

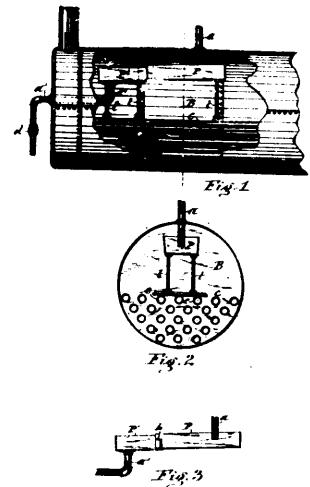

35734 Nye and Leass' Device for Preventing the Incrustation of Steam Boilers.

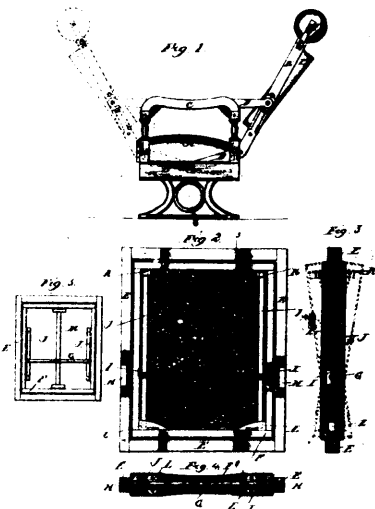

35735 Richards' Car Seat.

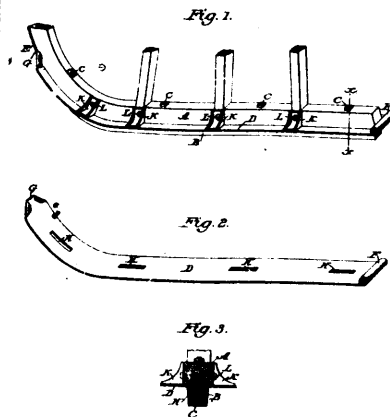

35736 Campbell's Snow Shoe for Sleigh Runner.

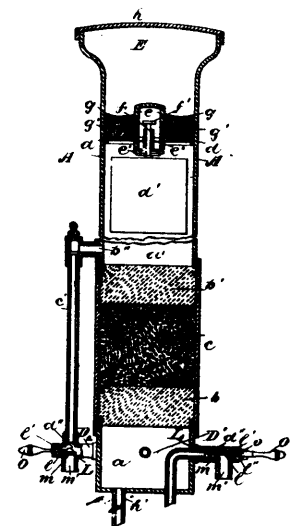

35737 Harvey's Water Filter.

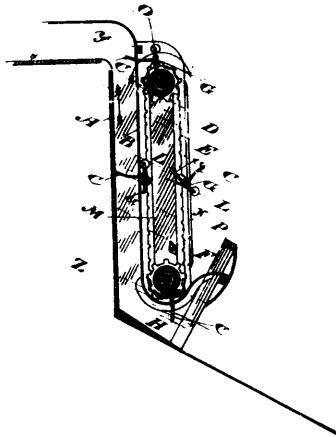

35738 Mercer's Harvester Binder.

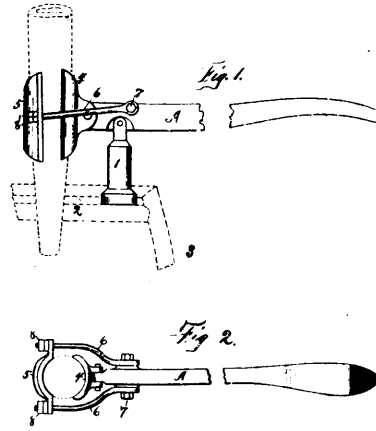

35739 Black's Faucet Extractor.

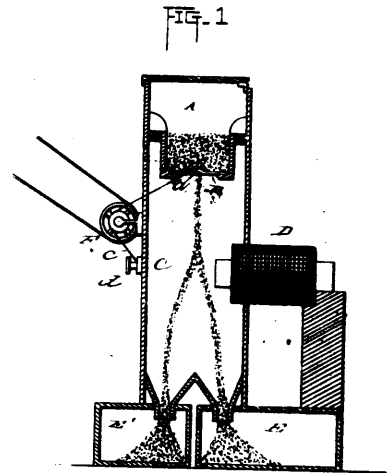

35740 Edison's Magnetic Separator.

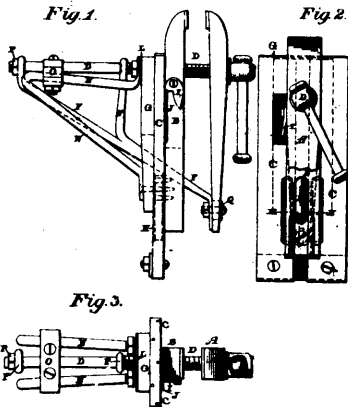

35743 Buck's Vise.

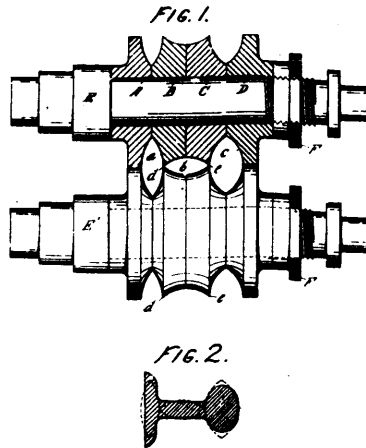

35744 Harris and Brobst's Rolls for Re-working Steel Rolls.

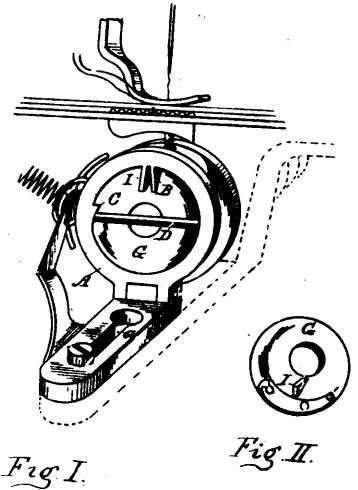

35746 Miller's Revolving Hook Machine.

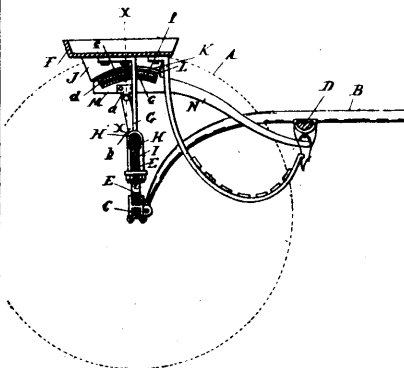

35747 Lewis' Road Cart.

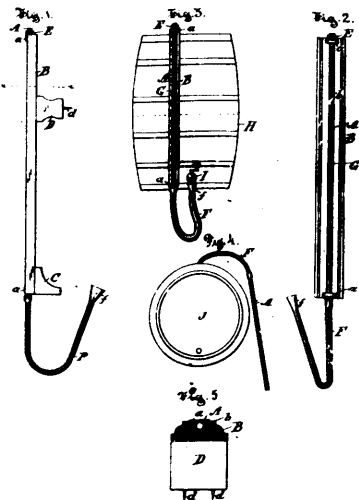

35748 Robitaille's Gauge and Syphon.

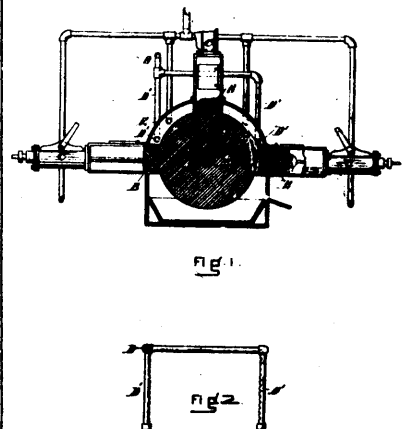

35749 Bonett's Art of Cleaning the Face of Grindstones.

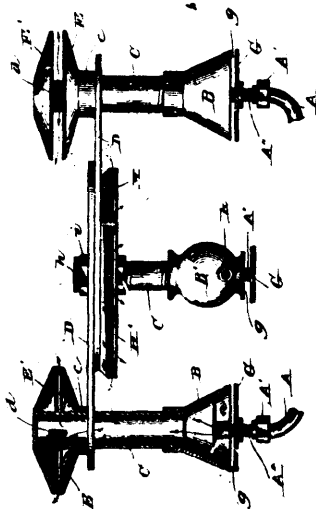

35750 O'Reilly's Gas Burner.

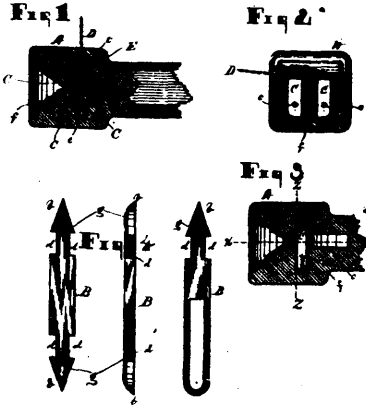

35751 Peters' Car Coupler.

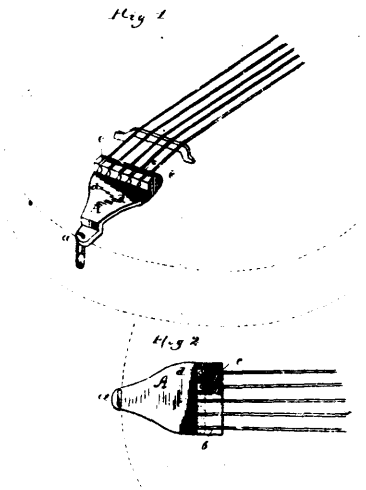

35752 Bookser's Tail Piece for Banjos, etc.

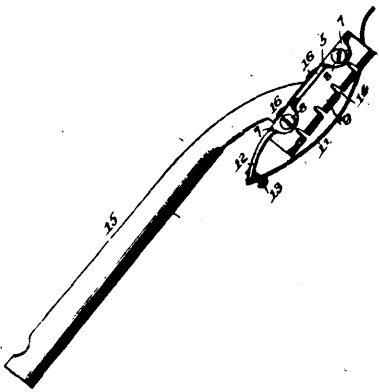

35753 Graves' Meat Tenderer.

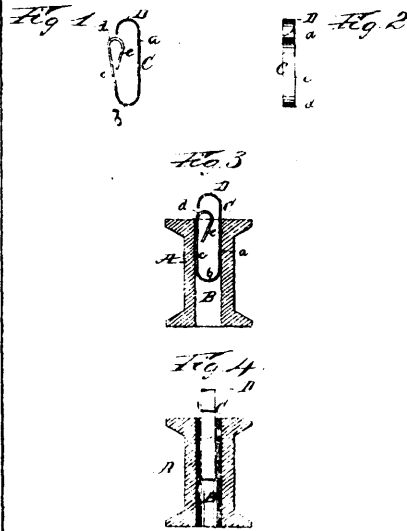

35754 Dodge's Thread Cutter.

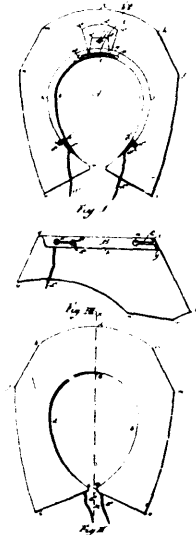

35755 Bernard's Collar.

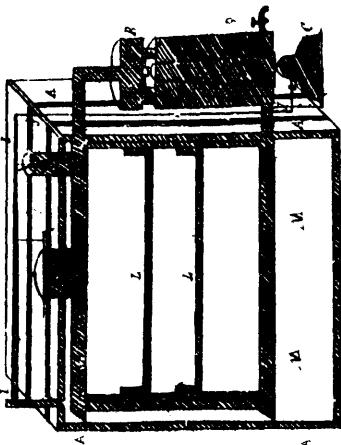

35756 Lacroix's Incubator.

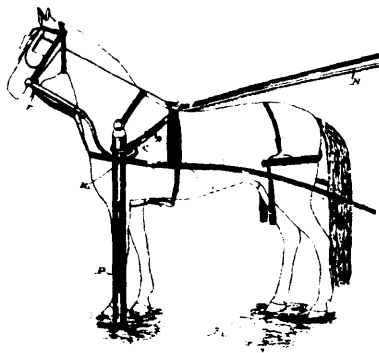

35757 Wilson's Hitching Device.

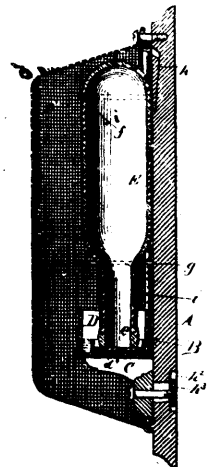

35758 Gubelmann's Disinfecting Device.

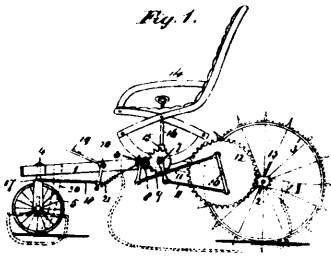
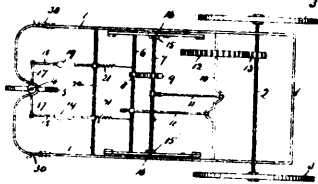

Fig. 1.



35750 Mayerhoff's Velocipede.

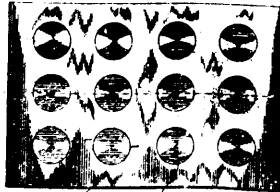

Fig. 1

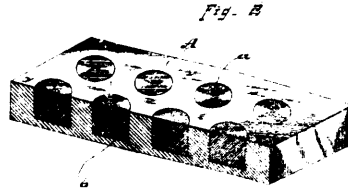
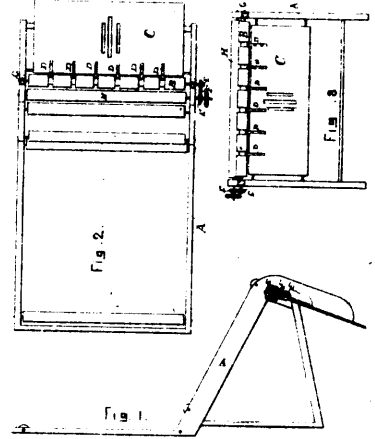

Fig. B

35760 Sherwood's Wax Pot



35761 Black's Binding Machine.

Fig. 1.

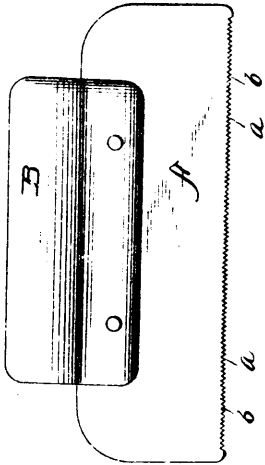

35762 Thomas' Horse Shedder.

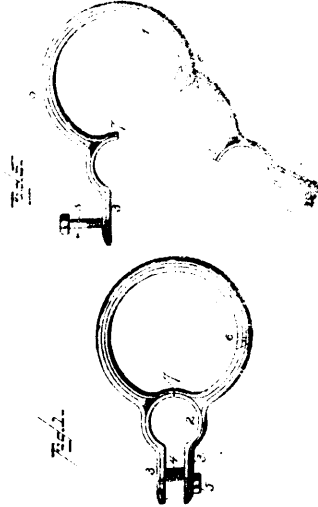

35763 Conover's Hank.

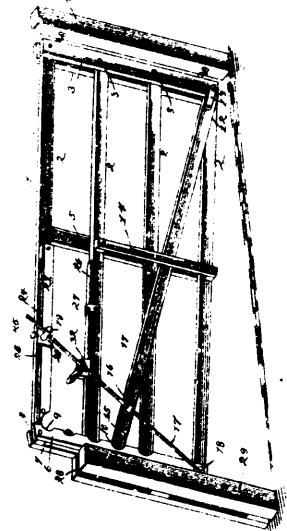

35764 Clark's Gate.

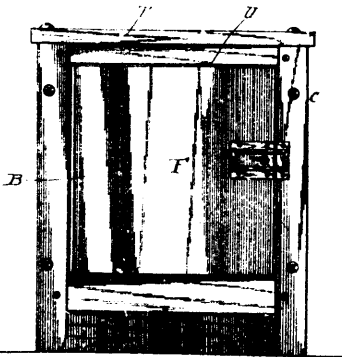

35765 Ritchie's Flour Chest.

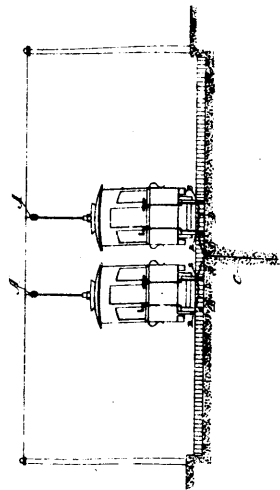

35766 Sabold's Circuit for Electric Railways.

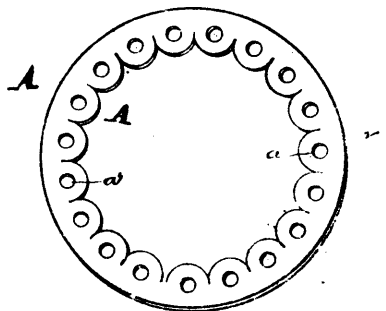

35767 Gingras' Leather Axle Washer.

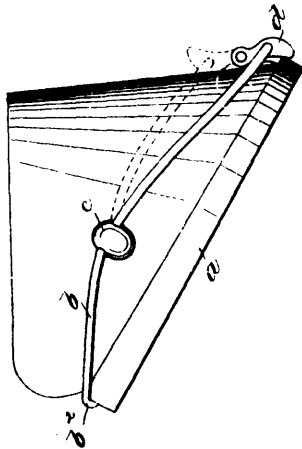

35768 Covell's Horse Shoe Fastener.

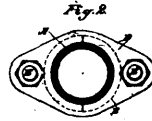
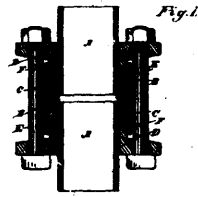

35769 Lawson's Pipe Coupling.

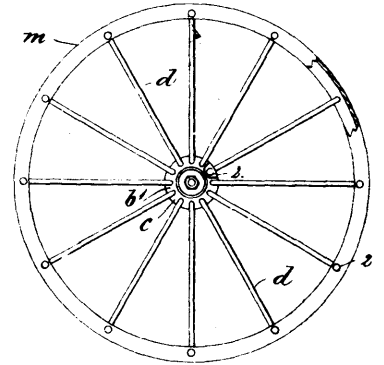

35770 Mather's Wheel.

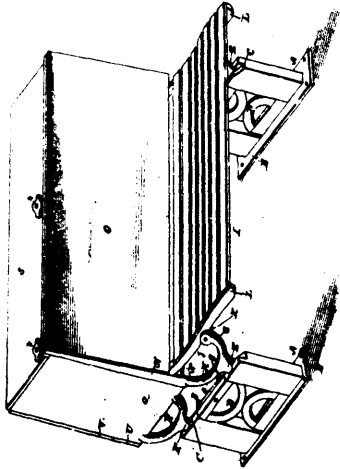

35771 Hunter's School Desk and Seat.

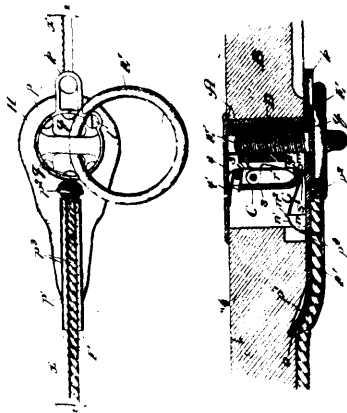

35772 Smith's Device for Liberating Animals.

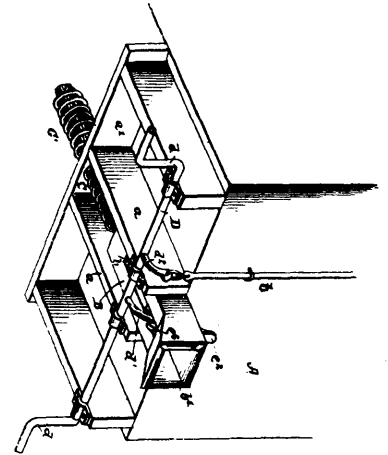

35773 Chapin's Car Coupling.

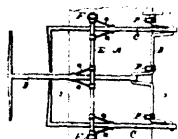

Fig 1

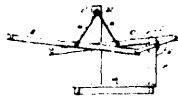

Fig 2

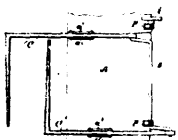
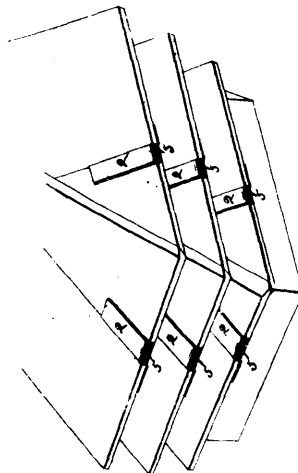

Fig 3

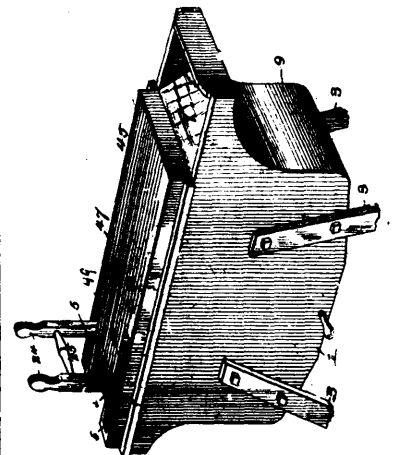

Fig 4

35774 Towne's Harvester Reel.



35775 Sherman's Fastening for Shingles.



35776 Hammons' Washing Machine.

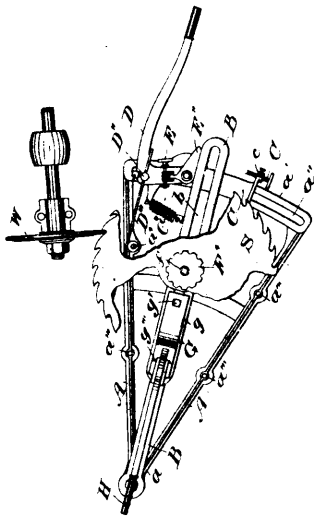

35777 O'Dacre's Machine for Gumming, Sharpening and Setting Circular Saws.

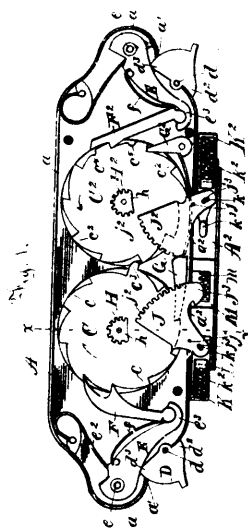

35778 Bateman's Billiard Marker.

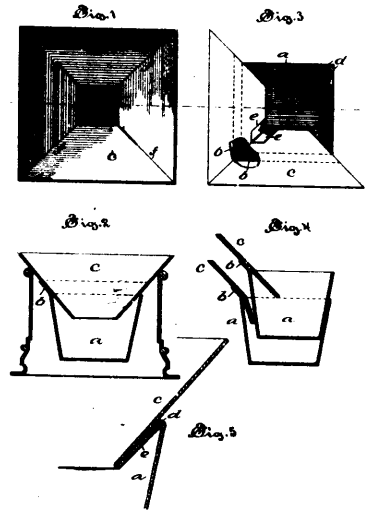

35779 Murphy's Cuspidor.

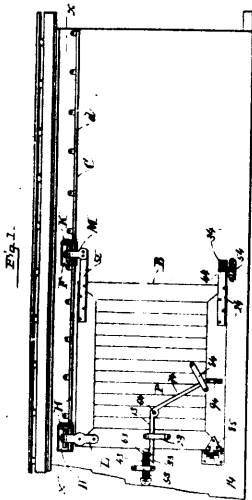

35780 Manuel, Yull and Gilpatrick's Freight Car Door.

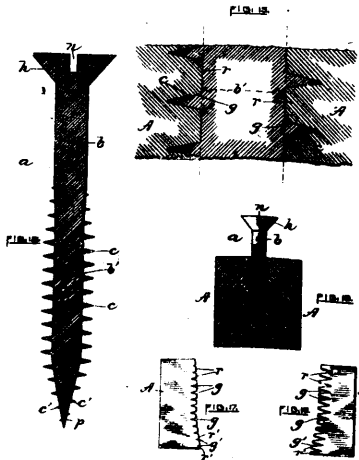

35781 Rogers' Die for Rollers Screw Threads.

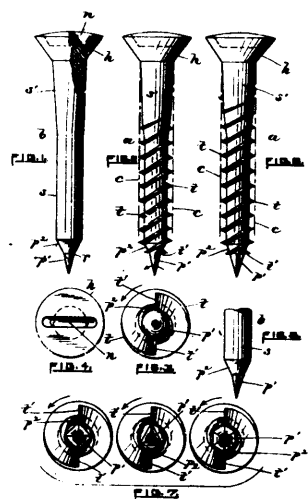

35782 Rogers' Rolled Wood Screw.

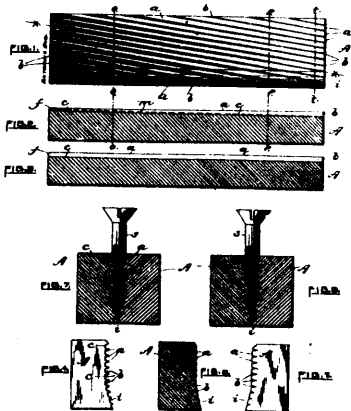

35783 Rogers' Die for Making Rolled Wood Screws.

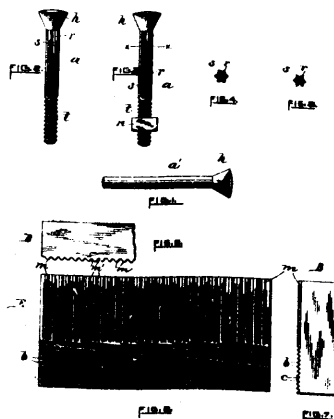

35784 Rogers' Die for Making Screw Bolts.

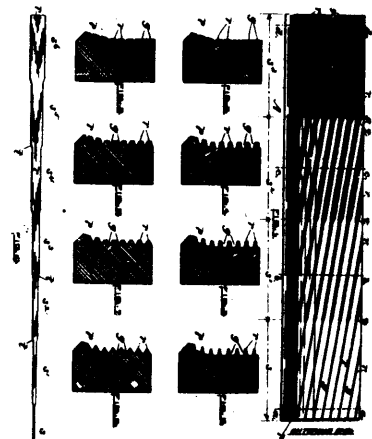

35785 Rogers' Die for Rolled Wood Screws.

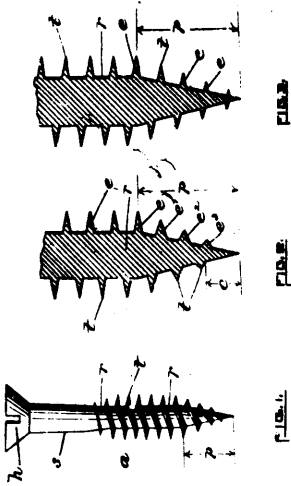

35786 Rogers' Rolled Wood Screw.

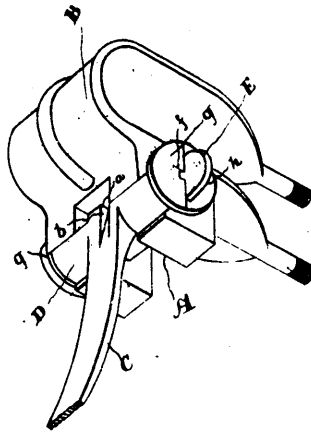

35788 Hurst's Thill Coupling.

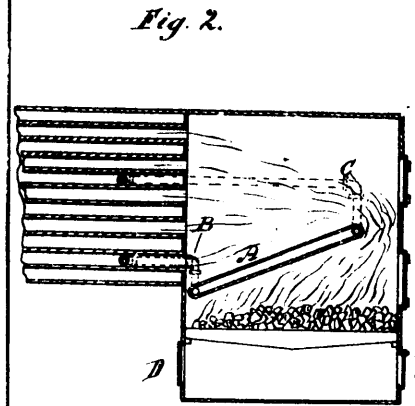

35789 McClelland's Steam Boiler.

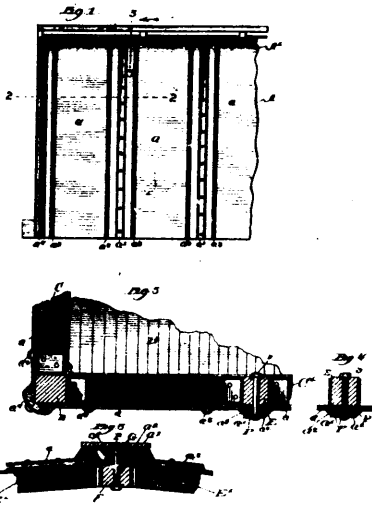

35790 Green's Freight Car Covering.

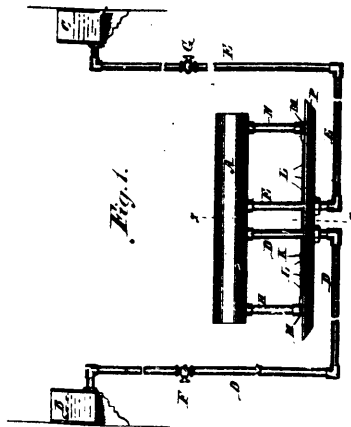

35791 Howell's Liquid Fuel Burner.

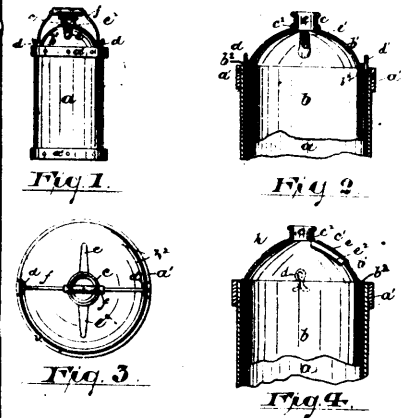

35792 Ahlum's Can.

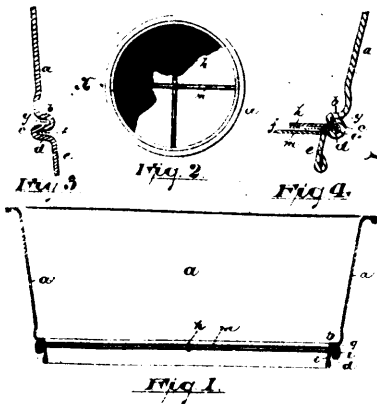

35793 Ahlum's Sieve.

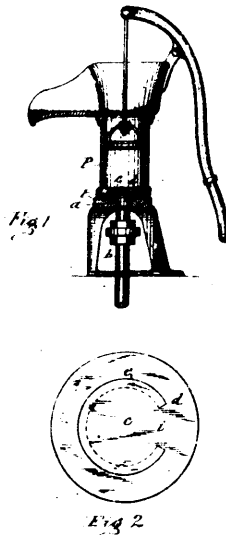

35794 Provonsin's Pump Valve.

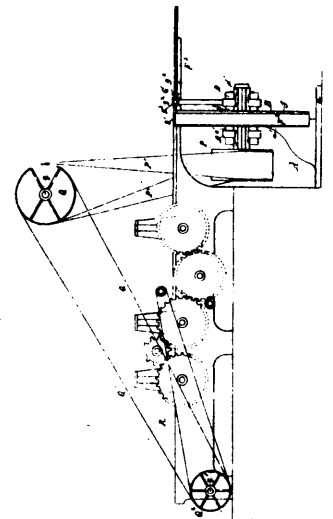

35795 Mason's Re-Sawing Machine.

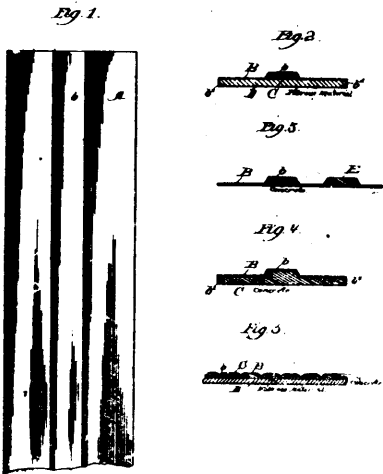

35797 Green's Composite Board.

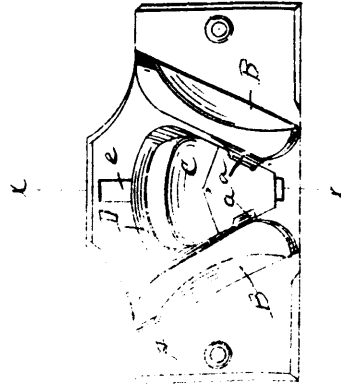

35798 Porter's Horse Hitcher.

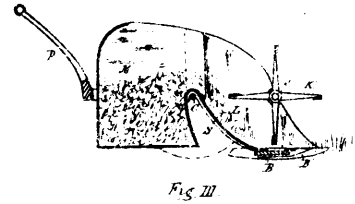
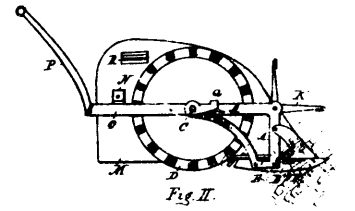

35799 Porter's Lawn Mower.

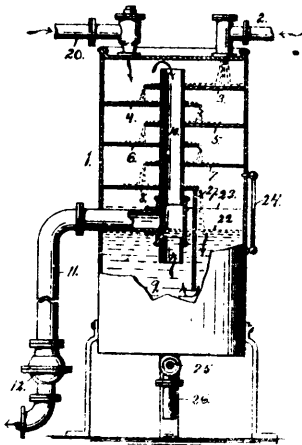

35800 Learmouth's Feed Water Heater and Purifier.

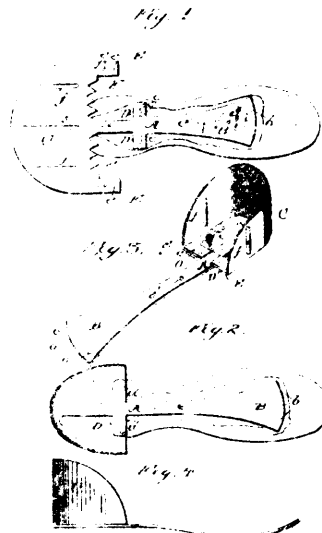

35801 Easton's Metallic Shank and Counter for Boots or Shoes.

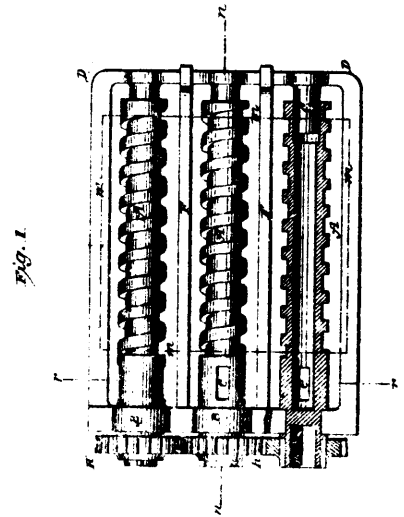

35802 Cory's Grate Bars.

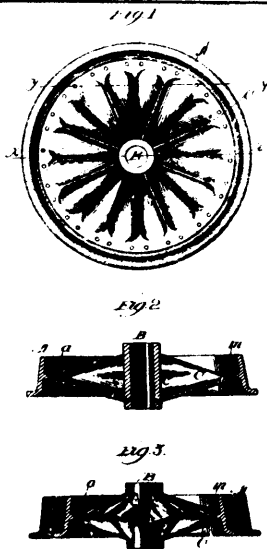

35803 Williams' Metal Wheel.

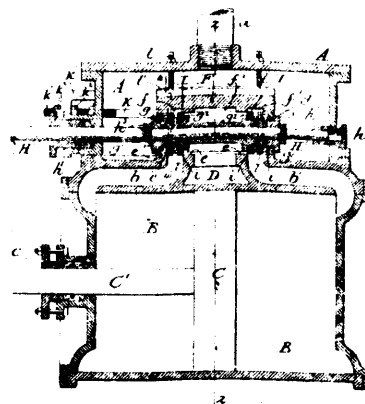

35804 Baird's Steam Engine Slide Valve.

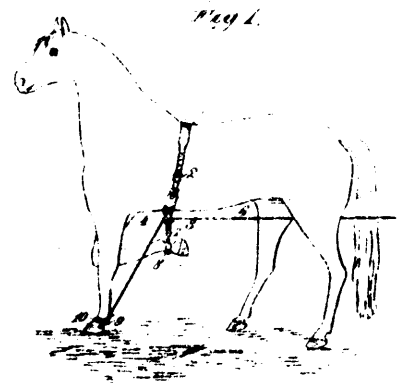

35805 Hall's Harness Attachment.

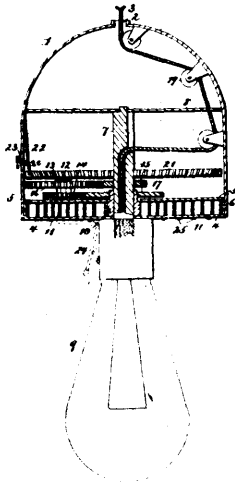

35806 Aldrich's Electric Light Fixture.

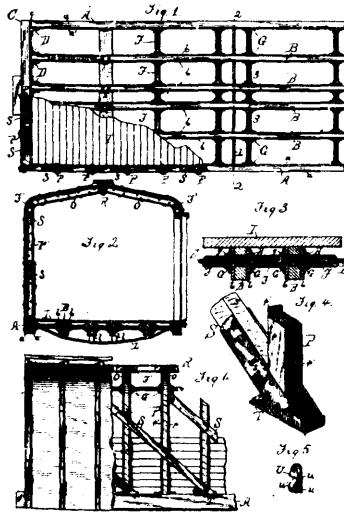

35807 Green's Freight Car.

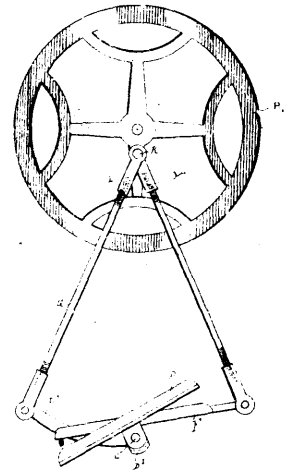

35808 Frey's Mechanical Power.

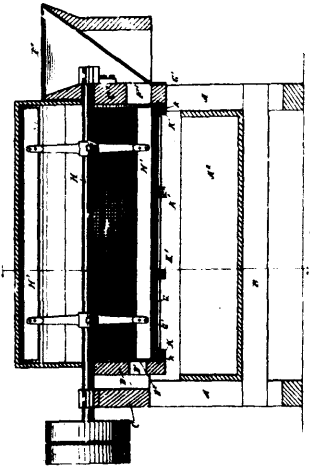

35809 Bucklin's Fruit and Vegetable Pulp Machine.

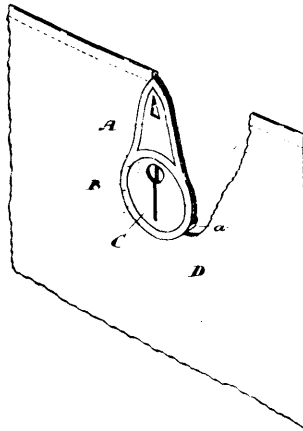

35810 Conboy's Knob Eyelet for Carriage Top Curtains.

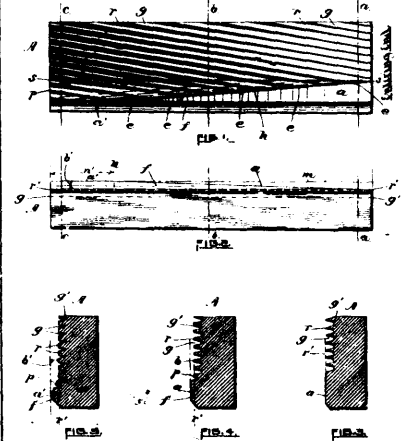

35811 Rogers' Die for Making Rolled Wood Screws.



35812 Rogers' Die for Making Rolled Wood Screws.

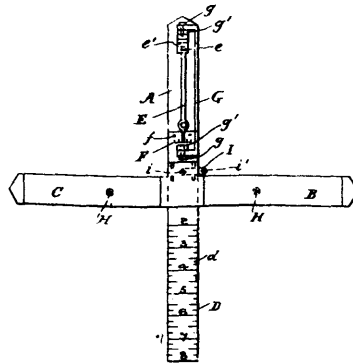

35813 Tailor and Dabney's Tailor's Measure.

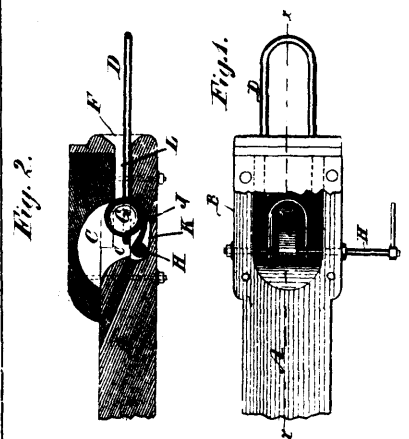

35814 Kemp's Car Coupling.

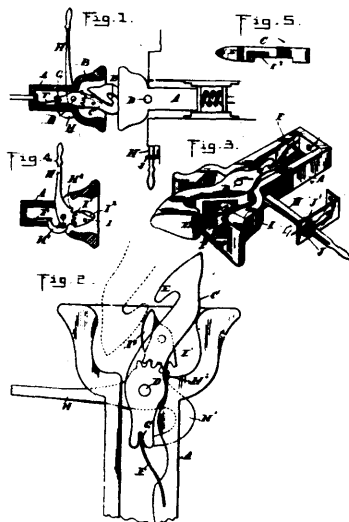

35815 Cooper's Car Coupler.

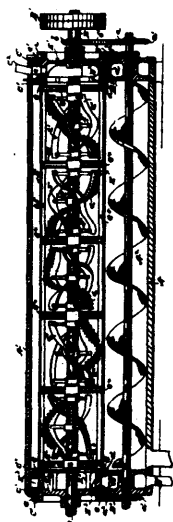

35816 Dobson's Bolting Reel.

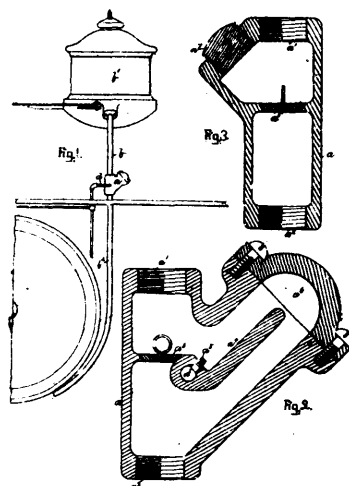

35817 Leach's Track Sanding Apparatus.

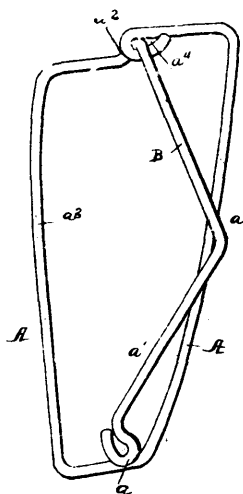

35818 Anderson's Clasp.

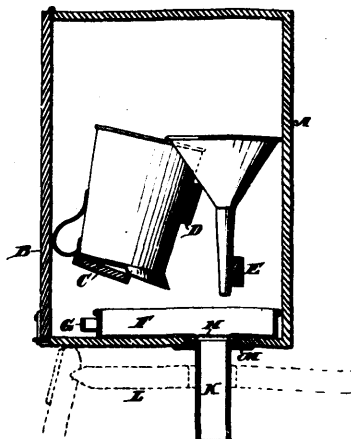

35819 Pannill's Drainer for Liquid Measures.

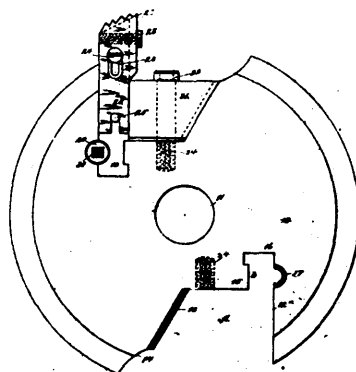

35820 Matthews and Quinlean's Adjustable Dado and Grooving Heads.

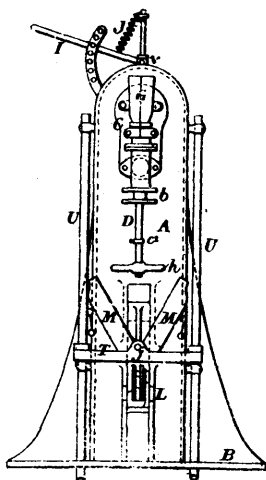

35822 Ashley's Machine for Manufacturing Glass Bottles, etc.

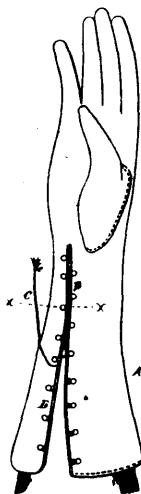

35823 McKenney's Lacing Eye.

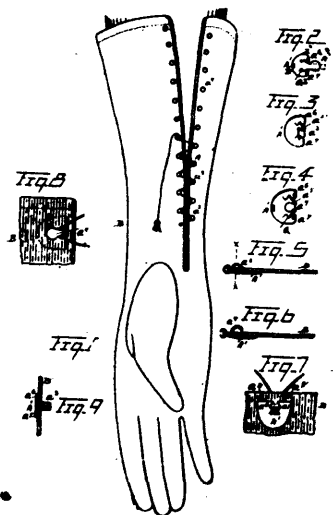

35824 McKenney's Fastening for Lacing Gloves, etc.

Fig. 1.

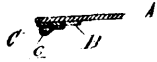

Fig. 2.



Fig. 3.



Fig. 4.

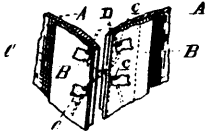

35825 McKenney's Lacing for Gloves and other Articles.



35826 Brown's Blanks for Carriage Steps.

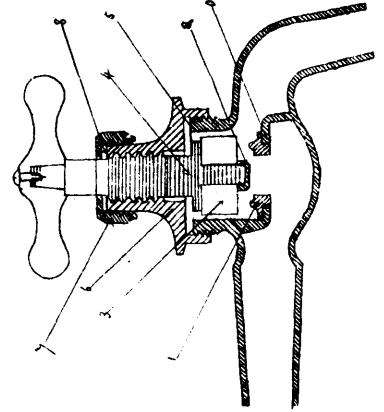

35827 Riley's Valve.

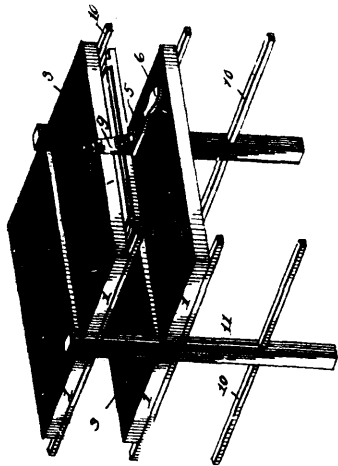

35828 Singly's Shelves for Supporting Cheese.

Fig. 1.

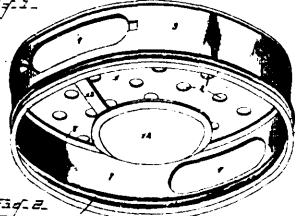

Fig. 2.

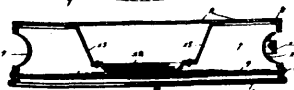
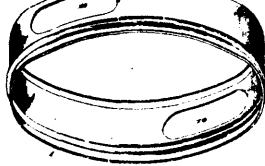
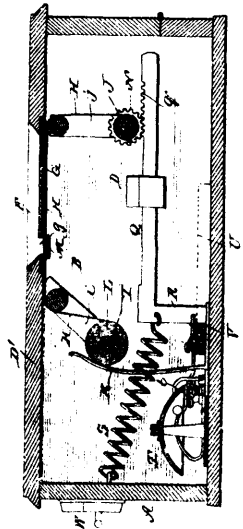

Fig. 3.



35829 Smith's Heat Radiator.

Fig. 4.



35830 Assheton's Cash Drawer and Register.

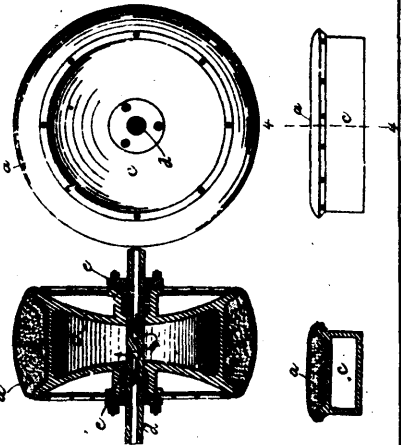

35831 Crooker's Method of Finishing Boots and Shoes.

Fig. 2

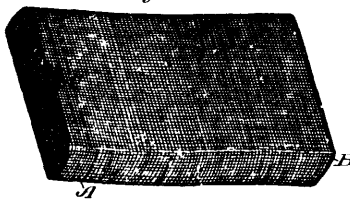
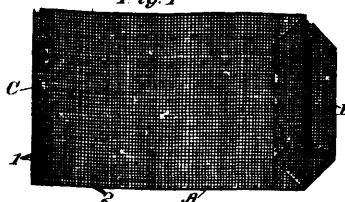
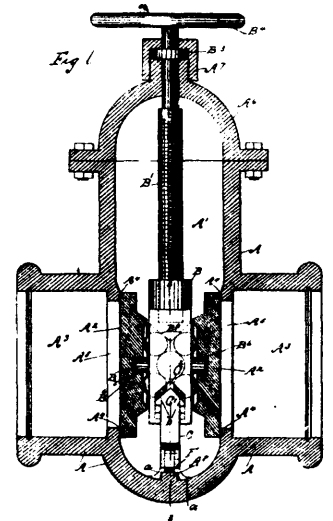

Fig. 1



35832 Lorenz's Paper Flour Sack

Fig. 1



35833 Ross' Slide Gate Valve.

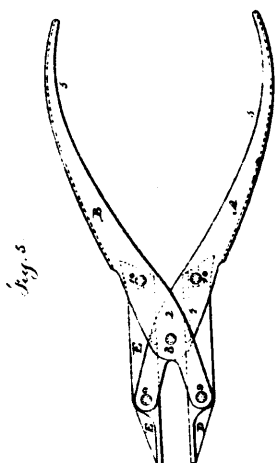

35834 Bernard's Pincers.

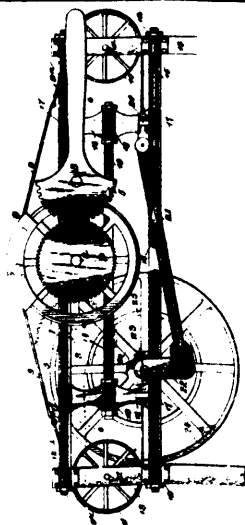

35835 Coburn's Machine for Converting Motion.

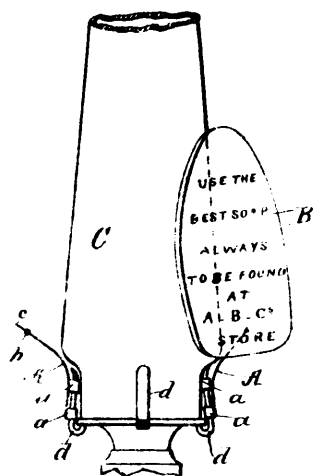

35836 Wetmore's Advertising Shade or Screen for Lamps.



35837 Krom's Door Check.

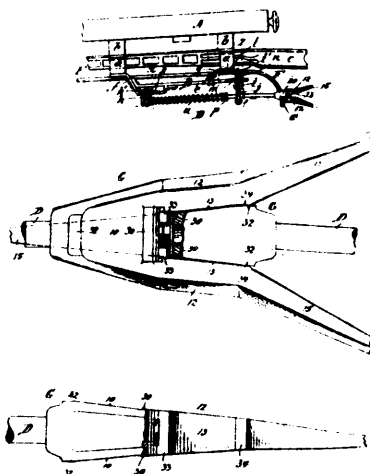

35838 Bagg's Coupling for the Steam and Air Pipes of Railway Cars.

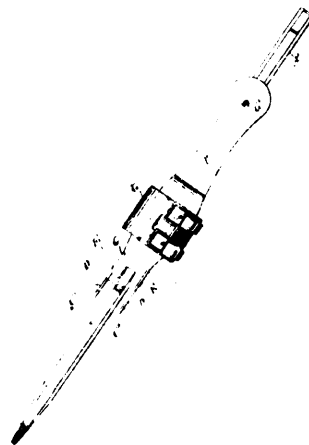

35839 Kyld's Snow Skate.

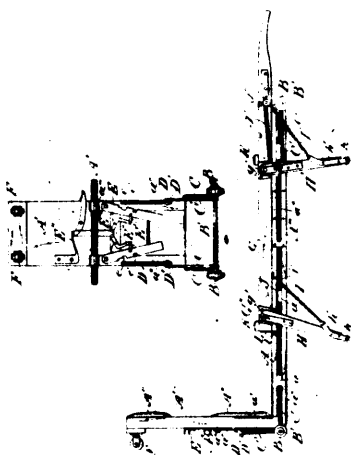

35840 Martin's Piano Truck

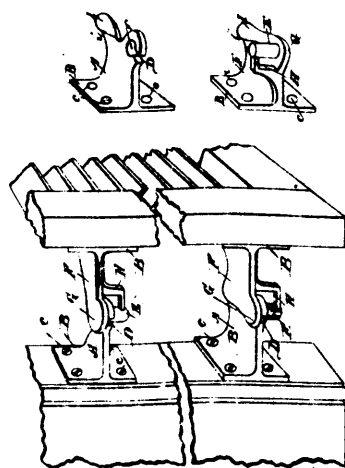

35841 Hurst's Hinge Joint.

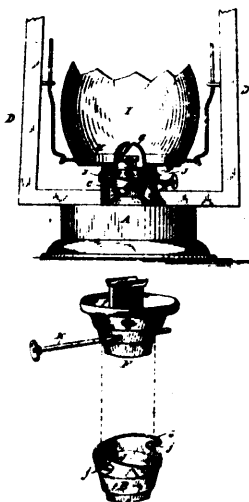

35842 Dietz's Burner Fastener for Lamps and Lanterns.

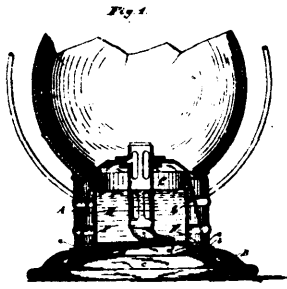

35843 Diets's Lantern.

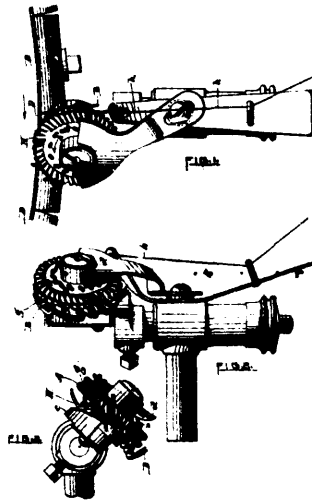

35844 Gage's Looping Attachment for Circular Knitting Machines.

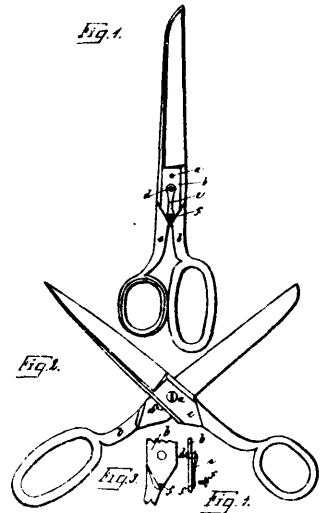

35845 Langenberg's Scissors.

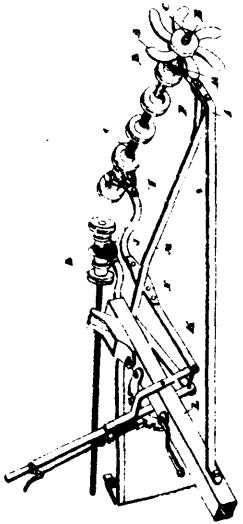

35846 LaDow's Harrow.

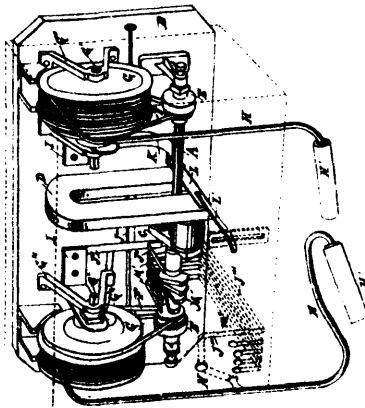

35847 Gardiner's Electrical Exercising Machine

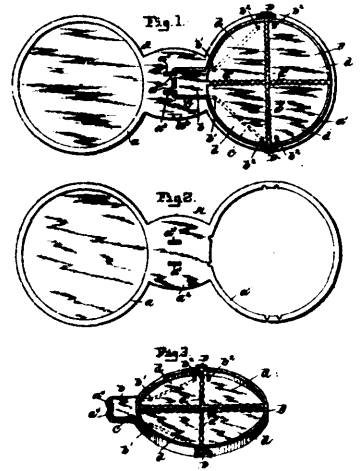

35848 Jacoby's Griddle.

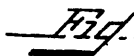
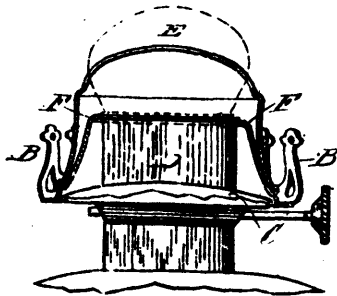

35849 Trench's Oil Burner.

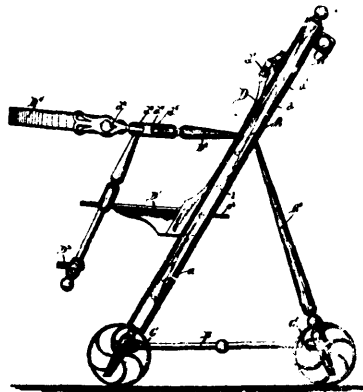

35850 Cross' Chair.

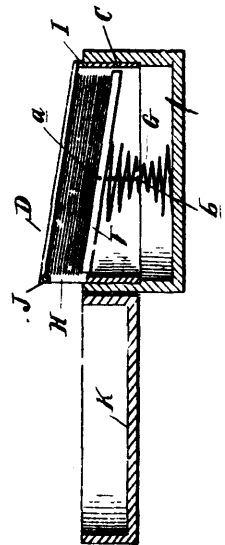

35851 Deming's Ticket Case.

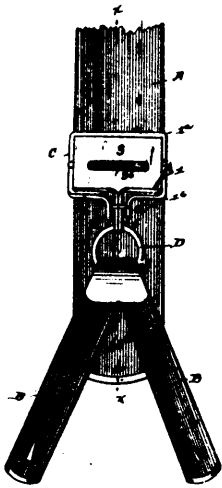

35852 Parker and Watts' Buckle.

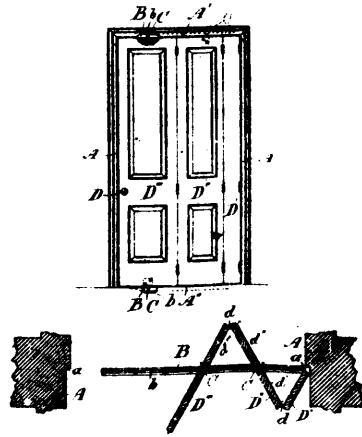

35853 Johnson's Folding Door.

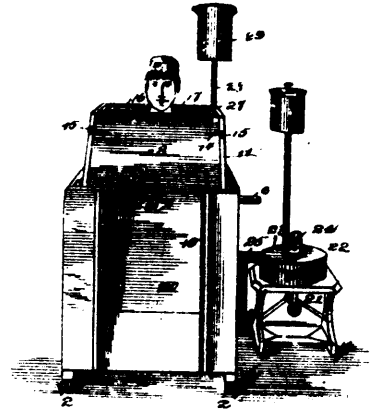

35854 Humphery's Vapor Bath.

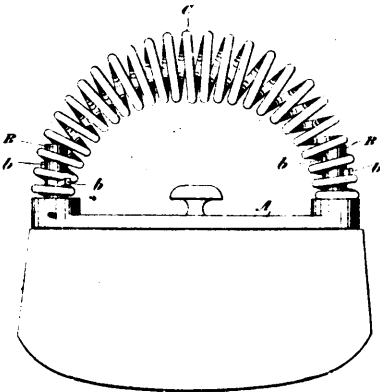

35855 Ives' Handle for Sad Irons.

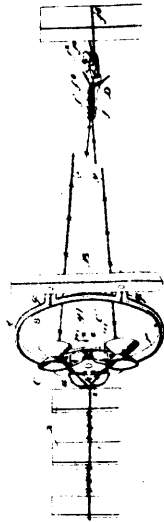

35856 Connett's Hand Fence Machine.

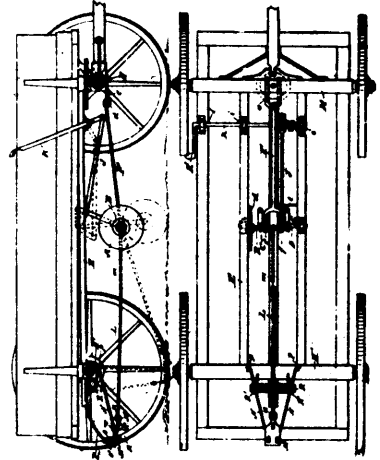

35857 Wheeler's Waggon Brake.

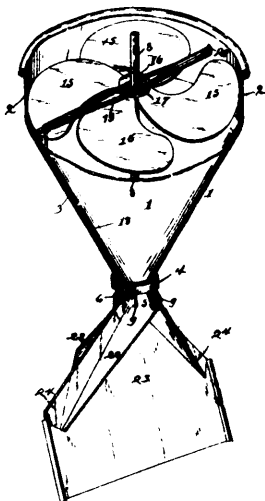

35858 Gribben's Feed Regulator for Mills.

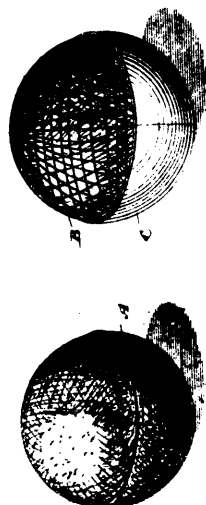

35859 Frest's Cricket Ball.

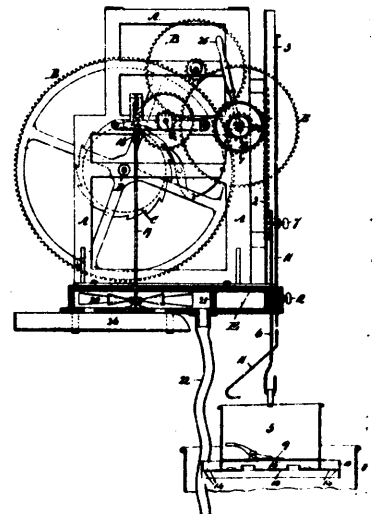

35860 Noble's Milk Aerator

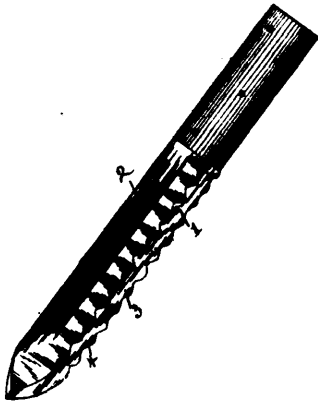

35861 Barclay's Knife.

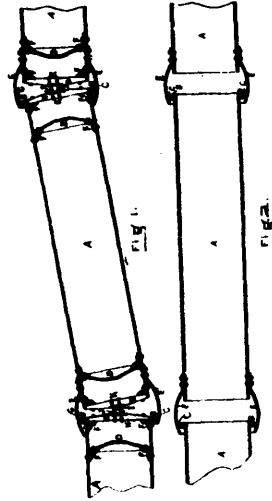

35862 Hobart's Sectional Tubular Tunnel.

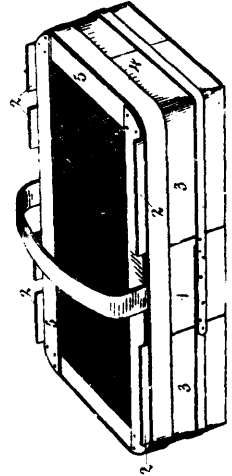

35363 Ion's Shipping Basket.

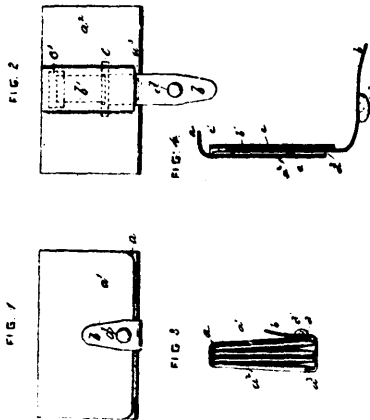

35864 Leher's Pocket Book.

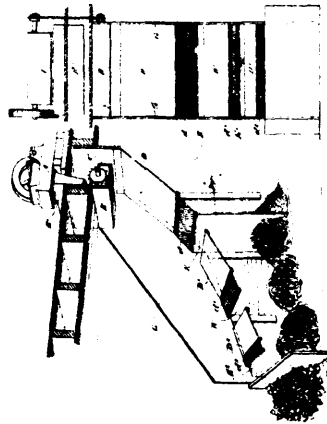

35865 Ferguson's Mechanical Cobbing Apparatus

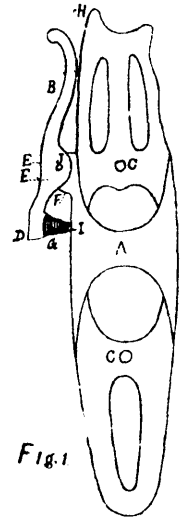

35866 Cowan's Whip Socket and Bein Holder

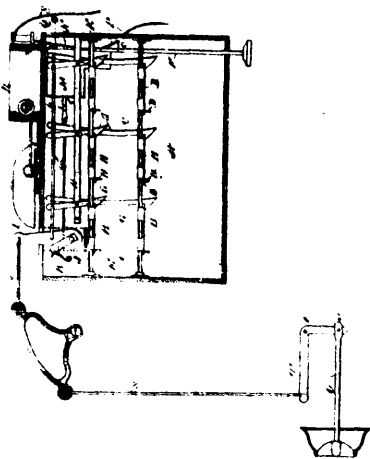

35867 Cox's Electric Call Bell and Indicator.

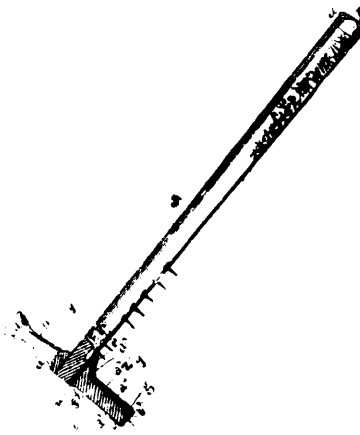

35868 De Vol's Hammer.

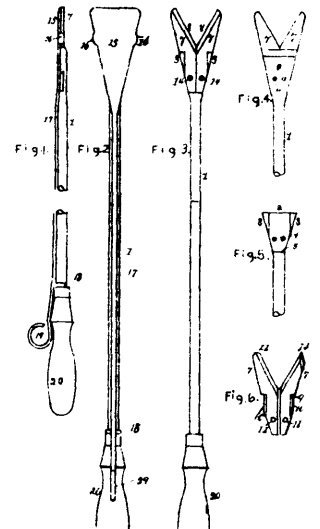

35869 Swain's Embryotome.

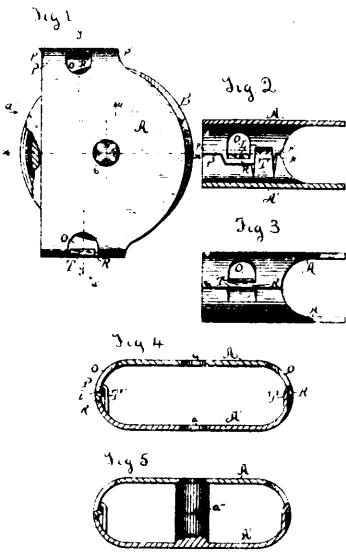

35870 Hoefler's Sash Cord Guide.

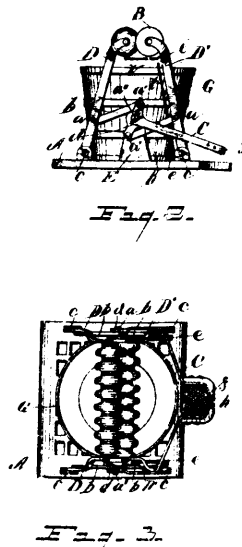

35871 Mussey's Mop Wringer.

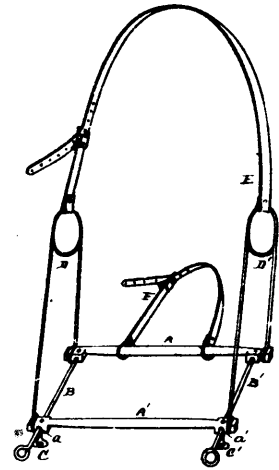

35872 Halfpenny's Mouth Opener for Animals.

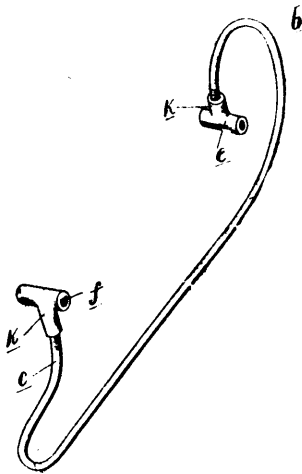

35873 Gendron's Detachable Sleigh Runner.

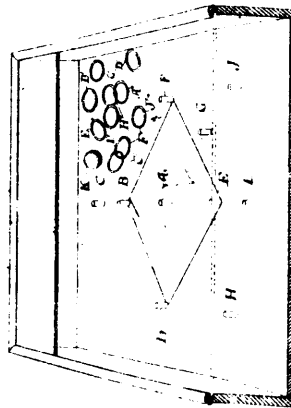

35874 Cole's Base Ball Game Puzzle.

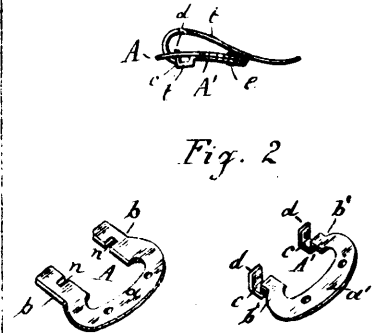
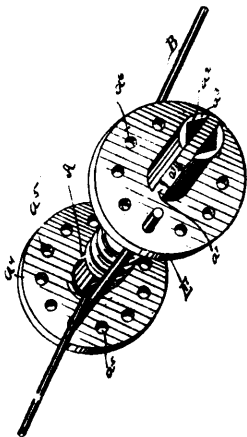
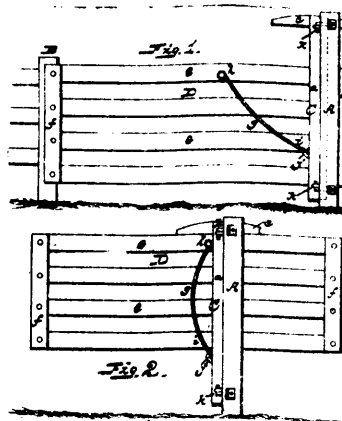

Fig. 4 Fig. 5

35875 Nase's Spring Clasp.



35876 Klier's Mid Wire Take-Up.



35877 Cromwell's Gate.

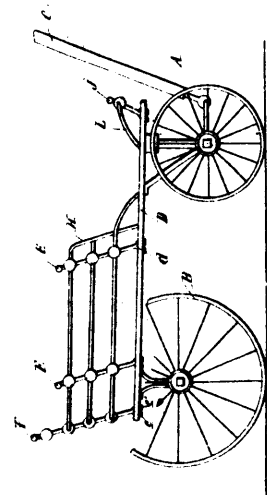

35878 Gendron's Waggon.

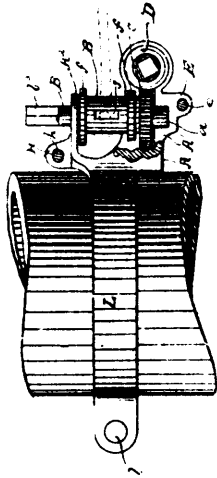

35874 Killer's Wire Tightener

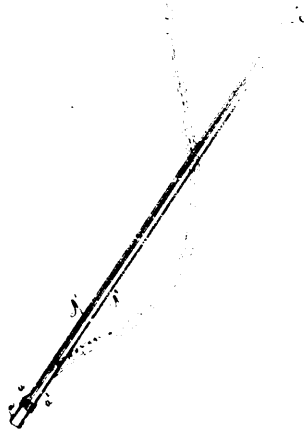

35881 Barrett's Light Holder.

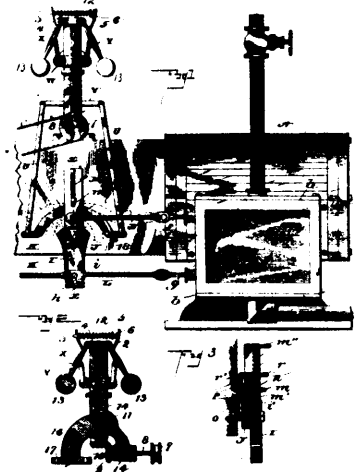

35882 Fussell's Cut-Off for Steam Engines.

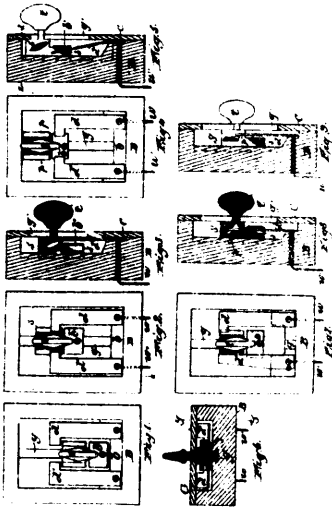

35883 McGregor's Electrical Switches.

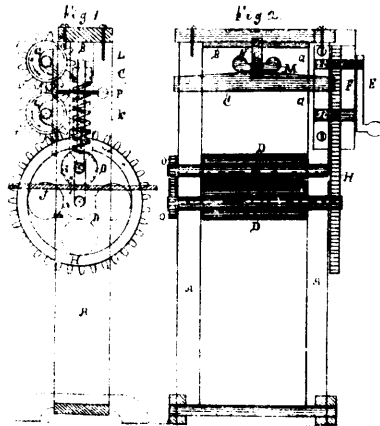

35884 Howell's Cloth Mangle.

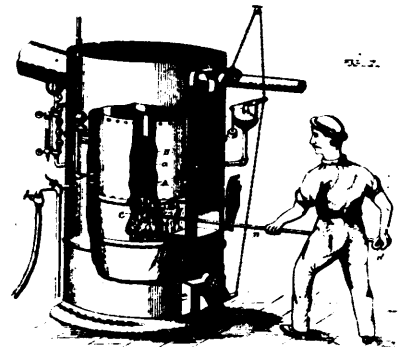

35885 Smith's Boiler Flue Cleaner.

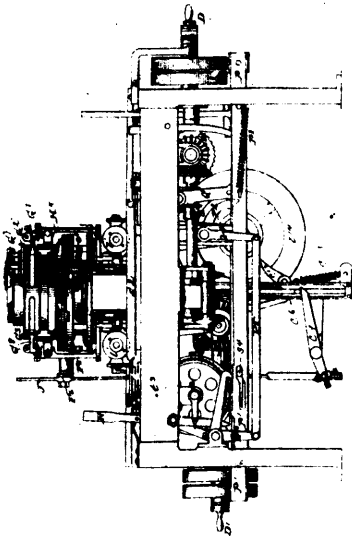

35886 Kilbourn's Circular Knitting Machine.

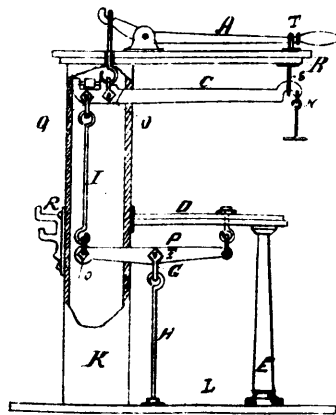
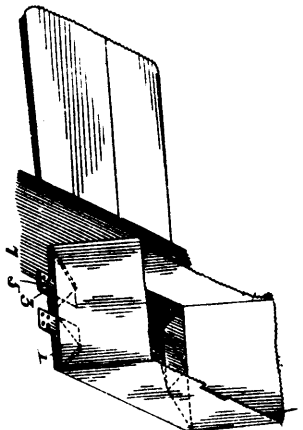
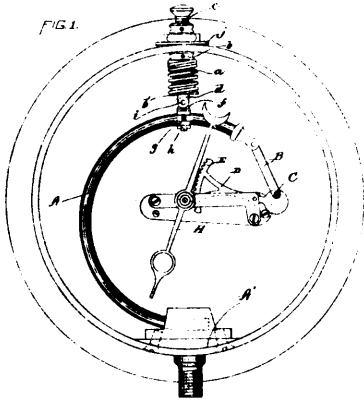

Fig. 1

35887 Noyes and Miller's Dormant Warehouse Scale.



35888 Lorenz's Paper Bag.



35889 McNeill's Pressure Gauge.

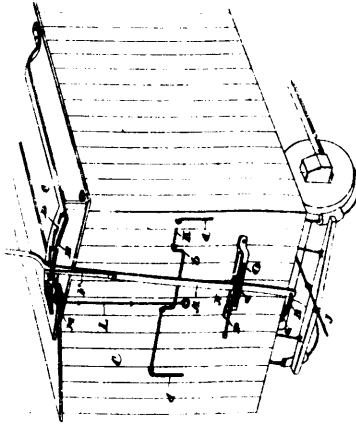

35890 Henry's Railroad Car Brake

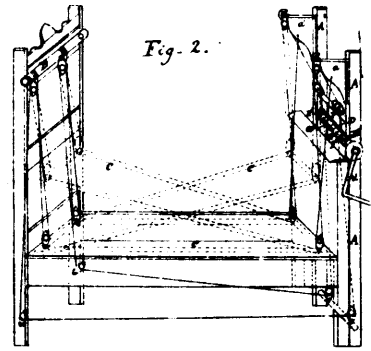

35891 Kaiser and Wilkinson's Adjustable Sick Bed Appliance.

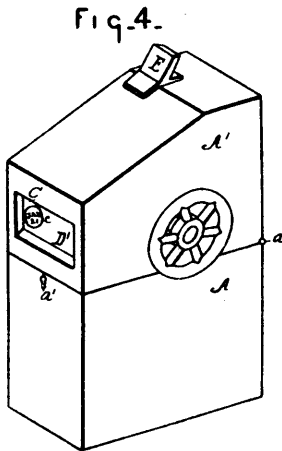

35892 Hart's Information Slot Machine.

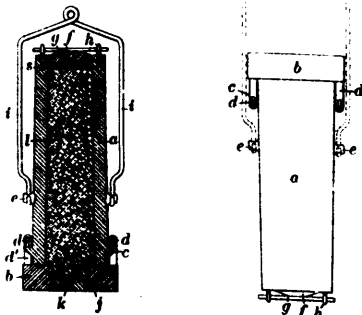

35893 Hinsdale's Process of Forming Irons

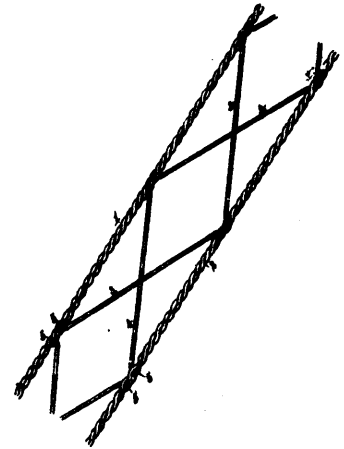

35894 Richel's Wire Fencing.

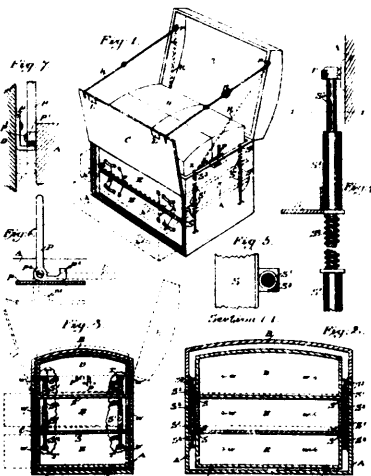

35895 Owens' Trunk.

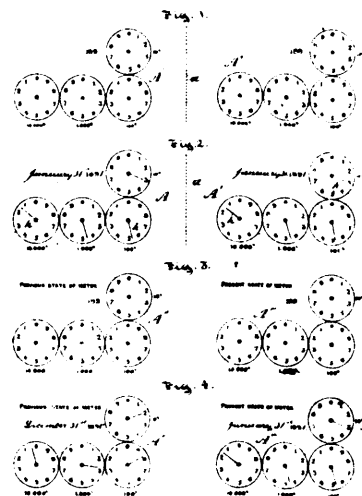

35896 Abern's System of Taking and Rendering Account of Commodities Measured by Meter.

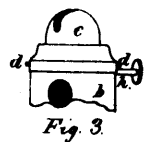
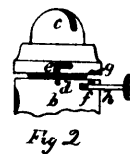
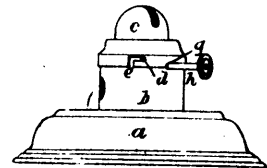

35897 Smith and Flower's Look for Tubular Lantern Burners.

Fig-1-

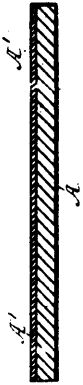
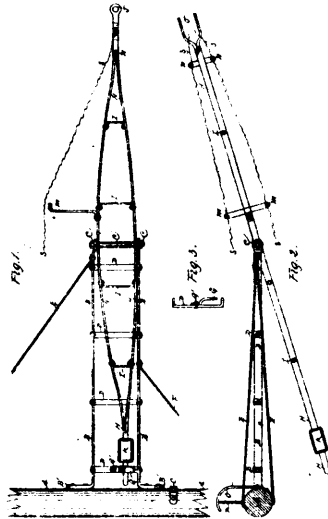

Fig-2--



35898 Land's Compound Aluminum Plate.



35899 Kingdon's Swivel Arm for Electric Lights.

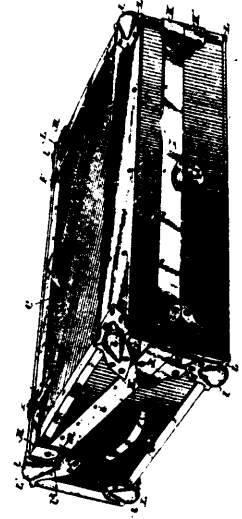

35900 Falca's Trunk.

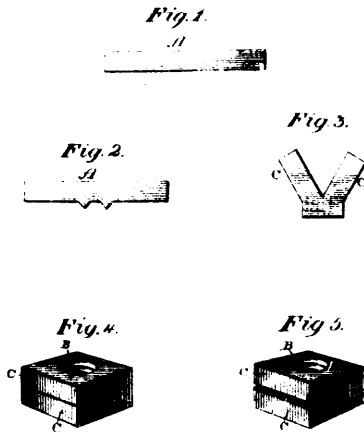

35901 Richardson's Method of Making Nut Locks.

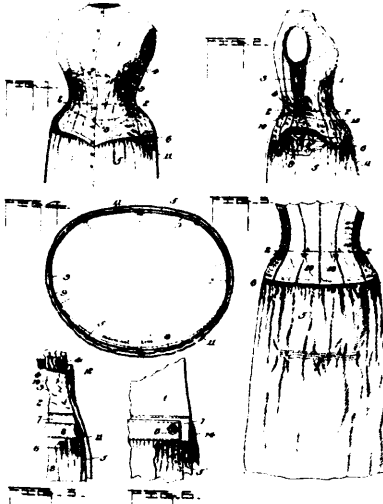

35902 Lee's Combination Garment.

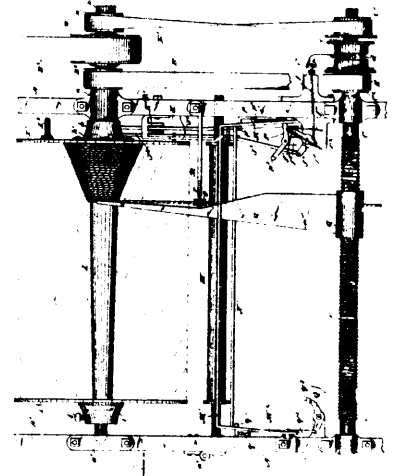

35903 Miller's Machine for Balling Twine

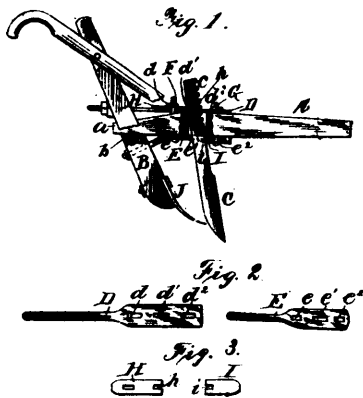

35904 Roy's Plough Cutter Mechanism.



35905 Kennedy's Chart for Drafting Garments

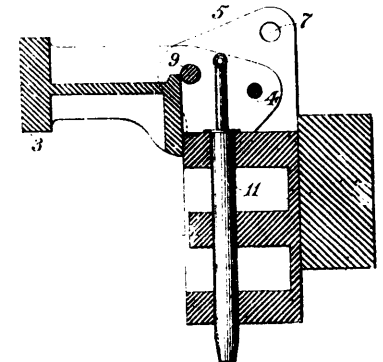

35907 Heintzelman and Small's Draw Head

INDEX OF INVENTIONS.

Adjustable sick bed appliance. Thomas Erlin Kaiser.	35,891	Cuspidor. Hartford Sanitary Manufacturing Com- pany.	35,779
Advertising shades or screens for lamps. Robert Parker Wetmore.	35,836	Cutter for bands and feeder. William H. Alston.	35,726
Aerator for milk. George Noble.	35,860	Cutter for thread. James Napoleon Dodge.	35,754
Alarm: see Low water.		Cut off for steam engines. George Fussell, Jr.	35,882
Aluminum plate. Manufacture of compound. Charles Henry Land.	35,898	Desk and seat for schools. Robert B. Hunter.	35,771
Amalgamators. Milton T. Van Derveer.	35,704	Device: see Disinfecting. Liberating animals.	
Apparatus: see Mechanical cobbing. Treating drive chains.		Die for making rolled wood screws. American Screw Company.	37,783. 35,811. 35,812
Artificial marbles. Richard Guelton.	35,696	Die for making screw bolts. American Screw Com- pany.	35,784
Attachment for harness. Franklin M. Hall.	35,805	Die for rolling screw threads. American Screw Com- pany.	35,781
Bag: see paper.		Die for rolling wood screws. American Screw Com- pany.	35,785
Bait for fish. Ernest F. Plueger.	35,720	Disinfecting device. William Samuel Gubelman.	35,758
Balls for cricket. Thomas Prest.	35,859	Detachable sleigh runners. Gendron Manufacturing Co.	35,873
Bar for grates. David Uzal Cory.	35,802	Door: see Folding.	
Base ball game puzzle. Marion L. Cole et al.	35,874	Door for freight cars. Hugh Yuill et al.	35,780
Basket for shipping. Anthony Ion.	35,863	Drainer for liquid measures. The Pannill Drainer Co.	35,819
Bath: see Vapor.		Draw head. Taylor W. Heintzelman et al.	35,907
Bell: see Electric call.		Drier for bricks. Plineas Arnold.	35,719
Binder for harvesters. Frederick Duncan Mercer et al.	35,738	Dynamo. Hermann Lemp.	35,691
Binding machine. Duncan Black.	35,761	Electric call bell and indicator. William Cox.	35,867
Blank for carriage steps. Samuel E. Brown.	35,826	Electrical exercising machine. Joseph Brown Gardiner.	35,847
Board: see Composite.		Electrical switch. John A. K. McGregor.	35,833
Boiler: see Steam.		Embryotome. Stephen H. Swalu.	35,669
Book: see Pocket.		Expanding: see Hoops or tires.	
Boots and shoes: see Finishing.		Extractor for faucets. Robert Douglass Black.	35,739
Bottles: see Glass.		Eye for lacing. Franklin S. McKenuey.	35,823
Brake for cars. John Paul Clancy.	35,702	Eyelets: see Knob.	
Brake for railroad cars. Frank O'Neil.	35,800	Faces: see Cleaning.	
Brake for vehicles. Thomas Sydney Smith.	35,705	Fastener: see Holder.	
Brake for wagons. Nathan A. Wheeler.	35,857	Fastener for burners of lamps or lanterns. Frederick Dietz.	35,842
Buckle. Jonas Parker et al.	35,852	Fastening for horse shoes. Edward Taber Covell.	35,768
Burner fastenings for lamps and lanterns. Dominion Tubular Lamp Company.	35,703	Fastening for lacing gloves, etc. Franklin S. Mc- Kenuey.	35,824
Burner for liquid fuel. Wesley Howell.	35,791	Fastening for shingles. Abram Sherman.	35,775
Burner for oil. Charles French.	35,849	Feed regulator for mills. William Gibben.	35,858
Can. Alvin Franklin Aulum.	35,792	Fencing: see Wire.	
Car: see Sleeping.		Ferrule: see Screw shank.	
Car coupler. Daniel Cooper et al.	35,815	Filter for water. George Harvey.	35,737
Car coupling. George A. Sanders et al.	35,732	Finishing boots and shoes. John F. Swain.	35,831
Car coupling. George W. Kemp et al.	35,814	Fixture for electric lights. Fred H. Aldrick.	35,806
Car coupling. Perry Brown.	35,711	Folding chair. Ronald Gillis.	35,689
Car for freight. William W. Green.	35,807	Folding door. Donald Jompson.	35,853
Car seat. Arthur M. Richards.	35,735	Food: see Pepsin.	
Carriage top curtains: see Knob eyelets.		Fruit and vegetable pulp machine. Charles S. Bucklin	35,809
Cart for roads. James Henry Lewis et al.	35,747	Garment. Elizabeth Lee.	35,902
Case for tickets. John Knox Deming.	35,851	Gas and hydrocarbon burner. George Roberts et al.	35,714
Cash drawer and register. William Assheton.	35,830	Gas burner for heating stoves, furnaces, boilers, etc. Michael Joseph O'Reilly.	35,750
Caster. Hubert R. Ives.	35,707	Gate. Charles M. Clark.	35,764
Celluloid collars and like articles. Manufacture of. Wentworth Richardson.	35,821	Gate. William L. Cromwell et al.	35,787
Centre board for vessels. James H. McPartland.	35,695	Gauge: see Pressure.	
Cereals. Preparation of. Frank Lanhoff.	35,687	Gauge and syphon. Wilfred E. M. Robitaille et al.	35,748
Chain for halters. Oneida Community.	35,682	Glass bottles, etc. Manufacture of. Howard M. Ashley.	35,822
Chair: see Folding.		Gloves: see Lacing.	
Chair. William Gavin Cross.	35,850	Governor for air pumps. Craven Robert Ord.	35,715
Chart for drafting garments. Henry Gorman Kennedy.	35,905	Griddle. Augusta Jacoby.	35,848
Check for doors. John Jacob Krom.	35,837	Guide for sash cords. H. R. Ives & Co.	35,870
Check for meters. Thomas Ahearn.	35,896	Gumming: see Circular saws.	
Chest for flour. Leroy Ritchie.	35,765	Haddock. Method of preparing boneless. James Ogle Morrison.	35,730
Circuit for electric railways. Frank Weidener Sabold.	35,766	Handle for burial caskets. The Detroit Casket Com- pany.	35,708
Circular saws. Machine for gumming, sharpening and setting. Joseph Edward Whelan.	35,777	Handle for sad irons, etc. Hubert Root Ives.	35,855
Clasp: see Spring.		Hank. Alfred Conover.	35,763
Clasp. Henry H. Robertson.	35,818	Hammer. Ambrose L. De Vol.	35,868
Cleaner for boiler flues. Gabriel Saye Smith.	35,885	Harrow. Charles La Dow.	35,846
Cleaning the faces of grind-stones. Art or process of. Edwin J. Bonett et al.	35,749	Head: see Draw head.	
Coating of exposed wooden structures. George Phillips.	35,722	Head for dadoing and grooving. Francis J. Matthews et al.	35,820
Collar. Leandre Bernard.	35,755	Heat radiators for oil stoves. Mary Ellen Smith.	35,829
Composite board. William W. Green.	35,797	Heater and purifier for feed water. Robert Lear- month.	35,800
Conductors. Structure for supporting and insulating bare. Charles Joseph Van Depoele.	35,686	Hitcher for horses. Henry Jacob Baxter.	35,798
Converting motion. Machine for. Byron Coburn.	35,835	Holder: see Rein.	
Counter: see Shank.		Holder and fastener for sashes. George Hopkins Spring.	35,723
Coupler for cars. John Peters.	35,751	Holder for bolts. Charles L. Edwards.	35,733
Coupling: see Car coupling.		Holder for lights. Meadville Vise Co.	35,881
Coupling for cars. Harlow F. Chaplin.	35,773	Hoops or tires. Method of expanding. Mark Wesley Dewey.	35,718
Coupling for pipes. Enoch Lawson.	35,769		
Coupling for thills. Frederick Hurst.	35,783		
Covering for freight cars. William W. Green.	35,790		

Hydrocarbon: see Gas.		
Hydrocarbon. Apparatus for burning. James Herbert Bullard.....	35,693	
Hydrocarbon burner. Harrison Newell Davis.....	35,694	
Incrustation: see Preventing.		
Incrustation of steam boilers. Device for preventing the. Henry Clay Nye et al.....	35,734	
Incubator. P. Fidele Lacroix.....	35,756	
Indicator: see Electric call bell. Speed.		
Ingots. Process of forming. William R. Hinsdale...	35,893	
Jar: see Label.		
Joint for hinges. Frederick Hurst.....	35,841	
Knife. William V. Barclay.....	35,861	
Knob eyelets for carriage top curtains. Daniel Conboy.....	35,810	
Label case for medicine bottles and jars. Oliver E. Given.....	35,698	
Lacings for gloves, etc. Franklin S. McKenney.....	35,825	
Lamp: see Shade or screen.		
Lantern. Frederick Dietz.....	35,843	
Liberating animals. Device for. William Smith.....	35,772	
Lock: see Nut.		
Locking device for wheels of small vehicles. William Higford Graham et al.....	35,731	
Locks for tubular lanterns. Charles F. Smith et al....	35,897	
Looping attachment for knitting machines. Richard Anthony Gage.....	35,844	
Low water alarm. William Hardwick.....	35,728	
Machine: see Binding machine. Preparing drive chains. Revolving hook. Slot. Wood working.		
Machine for circular knitting. Edward E. Kilbourn...	35,886	
Machine for covering wire. Edison General Electric Company.....	35,708	
Machine for hand fences. Matthew F. Connett Jr....	35,856	
Machine for resawing. George W. Mason.....	35,795	
Machine for washing. Charles Hammons.....	35,776	
Machine for washing. Marvin Antony Caldwell.....	35,690	
Manufacture of iron or steel. Phoenix Actlen Gesellschaft für Bergbau und Huttenbetrieb.....	35,880	
Mangle for clothes. William Howell et al.....	35,884	
Marble: see Artificial.		
Marker for billiards. George C. Bateman et al.....	35,778	
Measure for tailors. Richard Lewis et al.....	35,813	
Mechanical cobbling apparatus. David H. Ferguson...	35,865	
Mechanical movement. James Hayton.....	35,729	
Mechanical power. James H. Frey.....	35,808	
Mechanism: see Paper feeding.		
Medicine bottle: see Label.		
Medicine for the cure of dyspepsia. Alexander Logan.	35,787	
Mid wire take up. Charles M. Kiler et al.....	35,876	
Motor: see Pulsating current.		
Mouth opener for animals. James D. Halpenny et al.	35,872	
Movement: see Mechanical.		
Mower for lawns. Arthur Porter.....	35,799	
Nut lock. Julius C. Richardson.....	35,901	
Operating fire proof shutters or doors. Gustave Andreen.....	35,710	
Pad: see Wax.		
Paper bag. Kilgour Brothers.....	35,888	
Paper feeding mechanism. Edward Dummer.....	35,712	
Paper sacks for flour. William A. Lorenz et al.....	35,832	
Pepsin and peptonized food products. Vicente Marciano.....	35,725	
Pick. Kenneth John Morrison et al.....	35,721	
Pincers and similar tools. William A. Bernard.....	35,834	
Plate: see Aluminum.		
Plow cutter mechanism. Isaac Daniel Roy.....	35,904	
Plug for blasting. Julius Hopkins Holsey et al.....	35,683	
Pocket book. Frederick Lieker.....	35,864	
Pouch for tobacco. William James Cussen.....	35,724	
Power: see Mechanical.		
Preparing drive chains for shipment. Machine for. James Douglas Storie.....	35,699	
Pressure gauge. Empire Steam Gauge Co.....	35,889	
Pulp: see Fruit and vegetable.		
Pulsating current motor. Charles Joseph Van Depoelle.....	35,717	
Purifier: see Heater.		
Puzzle: see Base ball game.		
Quinlean. Daniel James et al. Head for dadoing and grooving.....	35,820	
Rails: see Reworking.		
Ranges: see Water heating.		
Reel for bolting. Dobson and Crawford Manufacturing Company.....	35,816	
Reel for harvesters. Charles Danforth Towne.....	35,774	
Register: see Cash drawer.		
Revolving hook machine. Anthony Miller et al.....	35,746	
Reworking steel rails. Art or process of. Henry Harris et al.....	35,745	
Rolled wood screw. American Screw Co'y.....	35,782	35,786
Rolls for reworking steel rails. Henry Harris et al...	35,744	
Runners: see Detachable sleigh.		
Sash for windows. David Crossen.....	35,688	
Scale for warehouses. John Milne.....	35,887	
Scissors and shears. Julius Langenberg.....	35,845	
Screw: see Bolt.		
Screw shank and ferrule for agricultural implements. John Pym.....	35,709	
Seat: see Desk and seat.		
Sectional tubular tunnel. David Hobart.....	35,862	
Separator. Thomas Alva Edison.....	35,740	
Setting: see Circular saws.		
Shank and counter for boots and shoes. Orlando W. Easton.....	35,801	
Sharpening: see Circular saws.		
Shears: see Scissors.		
Shedder for horses. Henry Goddard Thomas.....	35,762	
Shelves for supporting cheese. Joseph J. Singley.....	35,828	
Shrine panel for caskets. John Danford Ripson.....	35,713	
Shuttle for sewing machine. Samuel Burge Fuller...	35,684	
Sick bed appliance: see Adjustable.		
Sieve. Alvin Franklin Ahlum.....	35,793	
Skate for snow. Robert Walter Kydd.....	35,839	
Sleeping car. James B. Davenport.....	35,727	
Slide valve for steam engines. John Baird.....	35,804	
Slot machine. Ansaem G. Hart.....	35,892	
Snow shoe for sleigh runners. John Robertson Campbell.....	35,736	
Soap lyes. Method of treating spent. James S. Kirk & Company.....	35,906	
Socket: see Whip.		
Speed indicators for vehicles. Fred Newton Scofield.	35,697	
Spring clasp. Syracuse Specialty Manufacturing Company.....	35,875	
Steam and air pipes of railway cars. Coupling for the. James Daniel Bagg.....	35,838	
Steam boiler. David G. McClelland.....	35,789	
Strap for hitching horses. Andrew H. Wilson.....	35,757	
Switch: see Electrical.		
Swivel arm for electric lights. James Kingdon.....	35,899	
Syphon: see Gauge.		
Tail piece for banjos, etc. Rudolph Charles Bookser..	35,752	
Take-up: see Mid wire.		
Tenderer for meat. David L. Graves.....	35,753	
Textile fluids: see Writing fluid.		
Tightener for wire. Charles M. Kiler et al.....	35,879	
Tower for electric lighting. David Maxwell.....	35,701	
Track sanding apparatus. Henry Lowell Leach.....	35,817	
Treating drive chains. Apparatus for. James Douglas Storie.....	35,700	
Treating yarn in compact form. Machine for. August Graemiger et al.....	35,716	
Truck for pianos. Christian Henderson Martin.....	35,840	
Trunk. Frank Joseph Palca.....	35,900	
Trunk. George Owens.....	35,895	
Tunnel: see Sectional tubular.		
Twine. Machine for balling. Andrew Calvin Miller...	35,903	
Valve: see Slide.		
Valve for pumps. Edward M. Provonsil.....	35,794	
Valve for steam or water purposes. Thomas Riley...	35,827	
Valve for slide gates. Ross Valve Company.....	35,833	
Vapor bath. Tamar G. Humphrey.....	35,854	
V-hicle: see Speed indicator.		
Velocipede. Henry Mayerhoff.....	35,759	
Vessel: see Centre board.		
Vise. George S. Buck.....	35,743	
Vulcanized plastic compound. William Kiel.....	35,742	
Vulcanized plastic compound. Process of manufacturing. William Kiel.....	35,741	
Wagon. Geniron Manufacturing Co.....	35,878	
Washer for axles. Timothy Glogras.....	35,767	
Water heating attachments to ranges. Henry Charles Steinhoff.....	35,692	
Wax pad for flat irons. Anna R. Sherwood.....	35,760	
Wheel. Alexander Graig Mather.....	35,770	
Wheel of metal. William E. Williams.....	35,803	
Whip socket and rein holder. William A. Cowan.....	35,866	
Wire fencing. George P. Richel.....	35,894	
Wood: see Screw.		
Wood working machine. James Wakefield Carver et al	35,685	
Wringer for mops. George D. Mussey et al.....	35,871	
Writing fluid and process of applying it to textile fabrics. David S. Oilphant.....	35,796	
Yull, Hugh, et al. Door for freight cars.....	35,780	
Yarn: see Treating.		

INDEX OF PATENTEES.

Ahern, Thomas. Check for commodities measured by meters.....	35,896
Ahlum, Alvin Franklin. Can.....	35,792
Ahlum, Alvin Franklin. Sieve.....	35,793
Aldrich, Fred H. Fixtures for electric lights.....	35,806
Alston, William H. Band cutter and feeder.....	35,726
American Screw Company. Dies for making rolled wood screws.....	35,783 35,811 35,812
American Screw Company. Dies for making screw bolts.....	35,784
American Screw Company. Dies for rolling screw threads.....	35,781
American Screw Company. Dies for rolling wood screws.....	35,785
American Screw Company. Rolled wood screw.....	35,782
Andreen, Gustave. Method of Operating fire-proof shutters or doors.....	35,710
Arkell, Bartlett. Paper sack for flour.....	35,832
Arnold, Phineas. Drier for brick.....	35,719
Ashley, Howard M. Glass bottles, etc. Manufacture of.....	35,822
Assheton, William. Cash drawer and register.....	35,830
Badcock, Samuel S., et al. Wringer for mops.....	35,871
Bagg, James Daniel. Coupling for the steam and air pipes of railway cars.....	35,838
Baird, John. Slide valve for steam engines.....	35,804
Barclay, William V. Knife.....	35,861
Bateman, George C., et al. Marker for billiards.....	35,778
Baxter, Henry Jacob. Hitcher for horses.....	35,798
Bent, James Stuart, et al. Wood working machine..	35,685
Bernard, Leandre. Collar.....	35,755
Bernard, William A. Pincers and similar tools.....	35,834
Black, Duncan. Binding machine.....	35,761
Black, Robert Douglass. Extractor for faucets.....	35,739
Bonett, Edwin J., et al. Art or process of cleaning the faces of grind stones.....	35,749
Bookser, Rudolph Charles. Tail pieces for banjos, etc.....	35,752
Brobst, John B., et al. Art or process of revolving steel rails.....	35,745
Brobst, John B., et al. Rolls for reworking steel rails	35,744
Brown, Perry. Car couplings.....	35,711
Brown, Samuel E. Blank for carriage steps.....	35,826
Buck, George S. Vise.....	35,743
Bucklin, Charles S. Fruit and vegetable pulp machine.....	35,809
Bullard, James Herbert. Apparatus for burning hydrocarbon.....	35,693
Burlin Mills Company, et al. Art or process of cleaning the face of grind-stones.....	35,749
Caldwell, Marvin Antony. Machine for washing.....	35,690
Campbell, John Robertson. Snow shoes for sleigh runners.....	35,736
Campbell, Walter E., et al. Wringer for mops.....	35,871
Carver, James Wakefield, et al. Wood-working machine.....	35,685
Chapin, Harlow F. Car coupling.....	35,773
Clancy, John Paul. Car brakes.....	35,702
Clark, Charles M. Gate.....	35,764
Coburn, Byron. Machines for converting motion.....	35,835
Cole, John H., et al. Gate.....	35,877
Cole, Marion L., et al. Base ball game puzzle.....	35,874
Conboy, Daniel. Knob eyelets for carriage top curtains.....	35,810
Conover, Alfred. Hank.....	35,763
Connett, Matthew F., Jr. Machine for hand fences..	35,856
Cooper, Daniel and John Cornelius. Car coupler.....	35,815
Corn, John T., et al. Revolving hook machine.....	35,746
Cory, David Uzal. Bar for grates.....	35,802
Covell, Edward Taber. Fastening for horse shoes....	35,768
Cowan, William A. Whip socket and rein holder.....	35,866
Cox, William. Electric call bell and indicator.....	35,867
Cromwell, William L., et al. Gate.....	35,877
Cross, William Gavin. Chair.....	35,850
Crosser, David. Sash for windows.....	35,688
Cussen, William James. Pouch for tobacco.....	35,724
Dabney, Charles W., et al. Measure for tailors.....	35,813
Davenport, James B. Sleeping car.....	35,727
Davis, Harrison Newell. Hydro-carbon burners.....	35,694
Deming, John Knox. Case for tickets.....	35,851
De Vol, Ambrose L. Hammer.....	35,868
Dewey, Mark Wesley. Method of expanding hoops or tires.....	35,718

Dickie, David, et al. Mouth opener for animals.....	35,872
Dietz, Frederick. Fastener for burners of lamps and lanterns.....	35,842
Dietz, Frederick. Lantern.....	35,843
Dobson and Crawford Manufacturing Company. Reel for bolting.....	33,816
Dodge, James Napoleon. Cutter for thread.....	35,754
Dominion Tubular Lamp Company. Burner fastenings for lamps and lanterns.....	35,703
Dummer, Edward. Paper feeding mechanism.....	35,712
Easton, Orlando W. Shank and counter for boots and shoes.....	35,801
Edison General Electric Company. Machine for covering wire.....	35,708
Edison, Thomas Alva. Separator.....	35,740
Edwards, Charles L. Holder for bolts.....	35,733
Empire Steam Gauge Co. Pressure gauge.....	35,889
Ferguson, David H. Mechanical cobbling apparatus...	35,865
Flower, George L., et al. Lock for tubular lanterns...	35,897
Frey, James H. Mechanical powers.....	35,808
Fuller, Samuel Burge. Shuttle for sewing machines..	35,684
Fussell, George, Jr. Cut-off for steam engines.....	35,882
Gage, Richard Anthony. Looping attachment for knitting machines.....	35,844
Gardiner, Joseph Brown. Electrical exercising machine.....	35,847
Gendron Manufacturing Co. Detachable sleigh runners.....	35,873
Gendron Manufacturing Co. Waggon.....	35,878
Gibben, William. Feed regulator for mills.....	35,858
Gillis, Ranald. Folding chair.....	35,689
Gilpatrick, Harry E., et al. Door for freight cars.....	35,780
Gringras, Timothy. Washer for axles.....	35,767
Given, Olivier E. Label case for medicine bottles and jars.....	35,698
Gouin, Frank, et al. Gauge and syphon.....	35,748
Graemiger, August, et al. Machine for treating yarn in compact form.....	35,716
Graham, William Higford et al. Locking device for wheels of small vehicles.....	35,731
Graves, David L. Tenderer for meat.....	35,753
Green, William W. Car for freight.....	35,807
Green, William W. Composite board.....	35,797
Green, William W. Covering for freight cars.....	35,790
Gubelman, William Samuel. Disinfecting device.....	35,758
Guelton, Richard. Artificial marbles.....	35,696
Hall, Franklin M. Attachments for harness.....	35,805
Hally, John, et al. Gas and hydro-carbon burner.....	35,714
Halpenny, James D., et al. Mouth opener for animals.....	35,872
Hammons, Charles. Machine for washing.....	35,776
Hampton, Charles Gardiner, et al. Cart for roads....	35,747
Hardwick, William. Low water alarm.....	35,728
Harris, Henry, et al. Rolls for reworking steel rails..	35,744
Harris, Henry, et al. Art or process of reworking steel rails.....	35,745
Hart, Ansalem G. Slot machine.....	35,892
Hartford Sanitary Manufacturing Company. Cuspidor.....	35,779
Harvey, George. Filter for water.....	35,737
Hawkes, Harrison Fillmore, et al. Wood working machine.....	35,685
Hayton, James. Mechanical movement.....	35,729
Heintzelman, Taylor W., et al. Draw-head.....	35,907
Hinsdale, William R. Process of forming ingots.....	35,893
Hobart David. Sectional tubular tunnel.....	35,862
Holsey, Julius Hopkins, et al. Plug for blasting.....	35,683
Howell, Alexander, et al. Mangle for clothes.....	35,884
Howell, Wesley. Burner for liquid fuel.....	35,791
Howell, William et al. Mangle for clothes.....	35,884
Hudson, Albert, et al. Car coupling.....	35,814
Humphrey, Tamar. Vapor bath.....	35,854
Hurst, Frederick. Coupling for thills.....	35,788
Hurst, Frederick. Joint for hinges.....	35,841
Hunter, Robert B. Desk and seat for schools.....	35,771
Ion, Anthony. Basket for shipping.....	35,863
Ives, Hubert R. Caster.....	35,707
Ives, Hubert Root. Handle for sad irons, etc.....	35,855
Ives & Co. (H. R.) Guide for sash cords.....	35,870
Jacoby Augusta. Griddle.....	35,848
Johnson, Donald. Folding door.....	35,853
Kaiser, Thomas Erlin. Adjustable sick bed appliance.	35,891
Kemp, George W., et al. Car coupling.....	35,814
Kennedy, Henry Gorman. Chart for drafting garments.....	35,905
Kiel, William. Process of manufacturing vulcanized plastic compound.....	35,741
Kiel, William. Vulcanized plastic compound.....	35,742

Kilbourn, Edward E. Machine for circular knitting.....	35,886	Parker, Jonas, et al. Buckle.....	35,852
Kiler, Charles M., et al. Mid wire take up.....	35,876	Peters, John. Coupler for cars.....	35,751
Kiler, Charles M., et al. Tightener for wire.....	35,879	Phillips, George. Coating of exposed wooden structures.....	35,722
Kiler, George W., et al. Mid wire take up.....	35,876	Phoenix Actien Gesellschaft fur Bergbau und Huttenbetrieb. Manufacture of iron or steel.....	35,880
Kiler, George W., et al. Tightener for wire.....	35,879	Plueger, Ernest F. Bait for fish.....	35,720
Kilgour Brothers. Paper bag.....	35,888	Porter, Arthur. Mower for lawns.....	35,799
Kingdon, James. Swivel arm for electric lights.....	35,899	Prest, Thomas. Balls for cricket.....	35,859
Kirk (James S.) and Company. Method of treating spent soap lyes.....	35,906	Provonsil, Edward M. Valve for pumps.....	35,794
Krom, John Jacob. Check for doors.....	35,837	Pymm, John. Screw shank and ferrule for agricultural implements.....	35,709
Kydd, Robert Walter. Skate for snow.....	35,839	Richards, Arthur M. Seat for cars.....	35,785
Laass, Emil, et al. Device for preventing the incrustation of steam boilers.....	35,734	Richardson, Julius C. Nut lock.....	35,901
Lacroix, P. Fidele. Incubator.....	35,758	Richardson, Wentworth. Manufacture of celluloid collars and like articles.....	35,821
Lanhoff, Frank. Preparation of cereals.....	35,687	Richel, George P. Wire fencing.....	35,894
Leach, Henry Lowell. Track sanding apparatus.....	35,817	Ricker, Charles Paul, et al. Plug for blasting.....	35,683
Learmouth, Robert. Heater and purifier for feed water.....	35,800	Riley, Thomas. Valve for steam or water purposes or uses.....	35,827
Lemp, Herman. Dynamo.....	35,691	Ritchie, Leroy. Chest for flour.....	35,765
Lewis, James Henry, et al. Cart for roads.....	35,747	Ripson, John Hanford. Shrine panel for caskets.....	35,713
Logan, Alexander. Medicine for the cure of dyspepsia.....	35,787	Roberts, George, et al. Gas and hydro-carbon burners.....	35,714
La Dow, Charles. Narrow.....	35,846	Robertson, Henry H. Clasp.....	35,818
Land, Charles Henry. Manufacture of compound aluminum plates.....	35,898	Robitaille, Wilfred, E. M., et al. Gauges and syphons.....	35,718
Langenberg, Julius. Scissors and shears.....	35,845	Ross Valve Company. Valve for slide gates.....	35,833
Lawson, Enoch. Coupling for pipes.....	35,769	Roy, Isaac Daniel. Plow cutter mechanism.....	35,904
Lee, Elizabeth. Garment.....	35,902	Sabod, Frank Weidener. Circuit for electric railways.....	35,766
Lewis, Richard, et al. Measure for tailors.....	35,813	Sanders, George A., et al. Car coupling.....	35,732
Licker, Frederick. Pocket book.....	35,834	Scotford, Fred. Newton. Speed indicator for vehicles.....	35,697
Lorenz, William A., et al. Paper sack for flour.....	35,832	Swell, Harold E., et al. Base ball game puzzle.....	35,874
MacLeilan, Michael, et al. Pick.....	35,721	Shepard, Richard, et al. Marker for billiards.....	35,778
McClelland, David G. Steam boiler.....	35,789	Sherman, Abram. Fastening for shingles.....	35,775
McDonald, George Rodney, et al. Locking device for wheels of small vehicles.....	35,731	Sherwood, Anna R. Wax pad for flat irons.....	35,760
McGregor, John A. K. Electrical switch.....	35,883	Singley, Joseph J. Shelves for supporting cheese.....	35,828
McKenney, Franklin S. Eye for lacing.....	35,823	Small, Henry J., et al. Draw head.....	35,907
McKenney, Franklin S. Fastening for lacing gloves, etc.....	35,824	Smith, Gabriel Saye. Cleaner for boiler flues.....	35,885
McKenney, Franklin S. Lacings for gloves.....	35,825	Smith, Charles F., et al. Lock for tubular lanterns.....	35,897
McPartland, James H. Centre board for vessels.....	35,695	Smith, Mary Ellen. Heat radiators for oil stoves.....	35,829
Marcano, Vicente. Pepsin and peptonized food products.....	35,725	Smith, Thomas Sydney. Brake for vehicles.....	35,705
Martin, Christian Henderson. Truck for pianos.....	35,840	Smita, William. Device for liberating animals.....	35,772
Mason, George W. Machine for resawing.....	35,795	Spring, George Hopkins. Sash holder and fastener.....	35,723
Mather, Alexander Graig. Wheel.....	35,770	Steinhoff, Henry Charles. Water heating attachment for ranges.....	35,692
Matthews, Francis J., et al. Head for dadoing and grooving.....	35,820	Storie, James Douglas. Apparatus for treating drive chains.....	35,700
Maxwell, David. Tower for electric lighting.....	35,701	Storie, James Douglas. Machine for preparing drive chains for shipment.....	35,699
Mayerhoff, Henry. Velocipede.....	35,759	Swain, John F. Finishing boots and shoes.....	35,831
Meadville Vise Co. Holder for lights.....	35,881	Swain, Stephen H. Embryotome.....	35,869
Mercer, Frederick Duncan, et al. Binder for harvesters.....	35,738	Syracuse Specialty Manufacturing Company. Spring clasp.....	35,875
Mercer, John Smith, et al. Binders for harvesters.....	35,738	The Detroit Casket Company. Handle for burial caskets.....	35,706
Mfler, Andrew Calvin. Machine for balling twine.....	35,903	Thomas, Henry Goddard. Shedder for horses.....	35,762
Miller, Anthony, et al. Revolving hook machine.....	35,746	Towne, Charles Dantorth. Harvester reel.....	35,774
Milne, John. Dormant scale for warehouses.....	35,887	Trench, Charles. Burner for oil.....	35,849
Morrison, James Ogle. Method of preparing boneless haddock.....	35,730	Van Depoele, Charles Joseph. Pulsating current motor.....	35,717
Morrison, Kenneth John, et al. Pick.....	35,721	Van Depoele, Charles Joseph. Structure for supporting and insulating suspended bare conductors.....	35,686
Mussey, George D., et al. Wringer for mops.....	35,871	Van Derveer, Milton T. Amalgamator.....	35,704
Noble, George. Aerator for milk.....	35,860	Watts, Richard William, et al. Buckle.....	35,852
Nye, Henry Clay, et al. Device for preventing the incrustation of steam boilers.....	35,734	Wetmore, Robert P. Advertising shades or screens for lamps.....	35,836
Olliphant, David S. Writing fluid and process of applying it to textile fabrics.....	35,796	Wheeler, Nathan A. Brake for waggons.....	35,857
O'Neil, Frank. Brake for railroad cars.....	35,890	Whelan, Joseph Edward. Machine for gumming, sharpening and setting circular saws.....	35,777
Oneida Community. Halter chain.....	35,682	Whiteford, Edgard et al. Gauge and siphon.....	35,748
Ord, Craven Robert. Air pump governor.....	35,715	Whitehead, William Thomas et al. Machine for treating yarn in compact form.....	35,716
O'Reilly, Michael Joseph. Gas burner for heating stoves, furnaces, boilers, etc.....	35,750	Willett, Samuel J., et al. Car coupling.....	35,732
Owens, George. Trunk.....	35,895	Williams, William E. Metal wheel.....	35,803
Palica, Frank Joseph. Trunk.....	35,900	Wilson, Andrew H. Strap for hitching horses.....	35,757
Pannill Drainer Co. Drainer for liquid measures.....	35,819		