

Rs
5
6 11
C 14
1117.1

The Canadian Chresherman and Farmer

CANADA'S FARM MACHINERY MAGAZINE
WINNEPEG CANADA

Robert Bell 65
Magneto



December 1912

E.H. Heath COMPANY Publishers
"OUR TENTH YEAR"



Christmas
Greetings
from the
John Deere Plow Co
Limited

To all their friends, present and prospective, who can be reached by this message. As the old year closes, they recall the pleasant associations of many years of business intercourse, and trust that the New Year will be one of unexampled prosperity. We live by giving and receiving; we have received our share of the country's substance, and we have given of our own quality, value and service; we believe the deal has been one of mutual satisfaction; we are grateful for all that has gone, and will continue our simple policy of

John Deere Quality and Service



JOHN DEERE IMPLEMENTS

THE MARKET IS WAITING For Prime Condition Stock

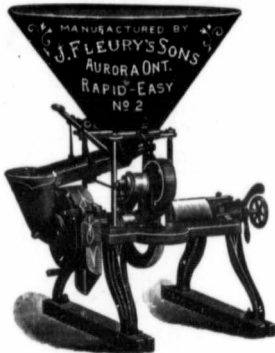

FLEURY "RAPID-EASY" No. 2

This machine is unsurpassed, not only for its great capacity and the uniformly excellent work it does, but for its structural superiority, the ease with which it is operated, and its lasting qualities. The feed trough is long and broad giving feeding and screening capacity equal to the rapid work of the grinder. 10 inch feed—also in 12 and 13 inch sizes. Baggers for this or any Fleury Grinder can be furnished.

Top prices are reached through the character and condition of the feed. Twenty per cent of grain fed whole to the stock is wasted. It is not masticated and is therefore never assimilated. It misses the "grinders," but a

Fleury Feed Grinder

will crush it to a fine meal, pulverizing at same time all the weed-seeds, so that your stock will have a perfect diet and your land will be infinitely cleaner.



"GOOD LUCK" POWER with GRINDER ATTACHMENT

THE "GOOD LUCK" HORSE POWER AND GRINDER

is a feed-mill and horse-power combined. You can have it with grinder attachment (as shown in cut) or without it. As a simple horse-power machine, it can be adapted to an endless variety of purposes. As illustrated, it is all ready to grind feed. By removing the hopper and grinder head, it can be used to operate Straw Cutters, Wood Saws, the "Rapid-Easy" grinder or any machine requiring the power service of two or four horses. In structural details and finish the machine is perfect

Why Burn Your Straw?

Said a well-known stock-man in sight of a blazing straw pile: "THERE'S SOME FELLOW CREMATING HIS DOLLARS!" That pile might just as easily be turned into crisp new dollars if cut with a

FLEURY STRAW CUTTER

and fed in its place to your animals.

We have a Fleury Straw Cutter to suit every possible requirement, from the small 8 inch feed Hand Lever Cutter to the large Ensilage machine with 14 inch feed, steel carrier feed table and elevating pipe cutting and elevating from seven to 15 tons of corn per hour. These cutters are all in stock and they can be operated by Hand Belt or Rod Power.



FLEURY STRAW CUTTER No. 2

JOHN DEERE PLOW COMPANY LIMITED, WINNIPEG

Regina Calgary Saskatoon Edmonton Lethbridge

JOHN DEERE IMPLEMENTS

THE DAIN SELF-FEED PULL-POWER HAY PRESS

**GIVES ENORMOUSLY INCREASED CAPACITY
SAVES MANY DOLLARS IN TIME AND LABOR**

Marvellous results are obtained by this great Hay Packer at an infinite saving in time, in manual labor and in horse flesh. There isn't a wasted movement in it and the Compound Leverage makes the draft hardly perceptible to the horses. There are **ONLY SIX WORKING PARTS** and there is **NO DELICATE MECHANISM**. It is the most powerful and yet the very lightest of draft presses.

*Saves
One Man
in the
Operating
Crew*

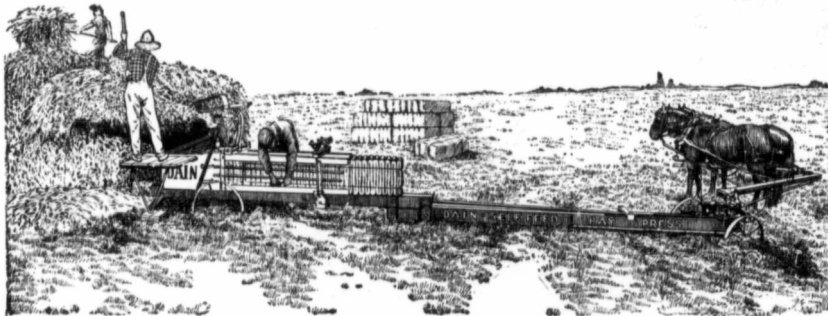

*Makes
a Perfect
Pack
with Half
the Pull*

AN UNWIELDY OUTFIT NEVER PAYS

Horses and men were never designed for galley slaves. A fair and square labor task is a necessity to man and beast, but needless drudgery will "break the heart of a camel." In this great labor-saving implement, a steel draw-bar of much smaller size is used instead of the old, heavy, awkward pitman employed on push presses for operating the plunger.

WHAT THE DAIN SELF-FEED PULL-POWER MEANS

**A DOUBLE ADVANTAGE TO THE TEAM — NO HIGH OBSTRUCTION FOR THE HORSES TO
STEP OVER AND BREAK THEIR PACE — SELF-FEEDER SUPERSEDES HAND LABOR
IN CARRYING HAY FROM HOPPER INTO PRESSING CHAMBER**

If you have any hay-crop to handle, make it a point to see a John Deere Agent at once or write us direct for complete details of this Automatic Self-Feed Hay Press.

**GET QUALITY AND SERVICE
JOHN DEERE DEALERS GIVE BOTH**

JOHN DEERE PLOW COMPANY LIMITED, WINNIPEG

Regina

Calgary

Saskatoon

Edmonton

Lethbridge

JOHN DEERE IMPLEMENTS

A CUTTER OF PRESSED STEEL!

THE LATEST NOVELTY IN CARRIAGE BUILDING

STRUCTURE: Fine Pressed Steel Side Panels, Backs and Dashes, Steel Fore Doors, Gears of selected, thoroughly seasoned Hickory.

ADVANTAGES: There can be no checking, warping, splitting or opening up of panels as in the case of the best wood body built. After many seasons of excessive moisture, followed by excessive heat, the **BROCKVILLE STEEL CUTTEL** will be found as whole and as firm as when it left the factory.

BROCKVILLE CUTTERS

have always represented the highest point obtainable in

QUALITY AND VALUE

This entirely new departure is to provide a Cutter that is required to do anything and everything in the worst of weather, and come through it all without a scar.

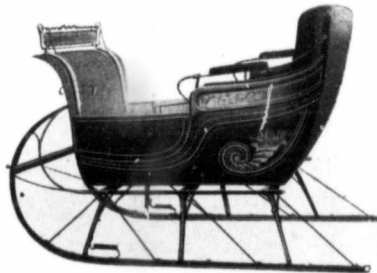

BROCKVILLE CUTTERS

are universally recognised as the leading models in

STYLE AND COMFORT

The New Steel Body with its patented fore door device is as fine and elegant as the finest wood body made, and the moulding is a raised part of the panel itself.

THE "REINDEER" SLEIGH

THE STRENGTH AND DURABILITY OF QUALITY DISTINGUISHES THIS SURE-FOOTED ROADSTER FROM ANY OTHER SLEIGH SOLD TODAY

JOHN DEERE No. 28—In all sizes, with Steel Cast Shoes



BOLSTERS are equipped with iron stakes, fastened with bolts and rivets to prevent bolster ends from slipping.

ROLLER RODS for tongue and reach are full length.

BOLSTER PLATES are unusually large and made of steel.

START PINS are $\frac{3}{8}$ inch. Plates riveted to outside of runners prevent start pins from slipping.

RUNNERS are one of its strongest features. Front inside ends are plated to save wear of tongue, reach roller and rod holes.

EASY ON THE HORSES

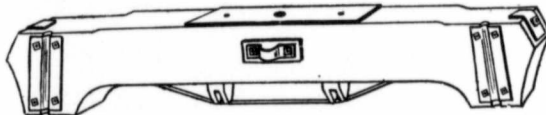

STEADY ON THE TRACK

Get Quality and Service
John Deere Dealers Give Both

JOHN DEERE PLOW COMPANY LIMITED, WINNIPEG

Regina

Calgary

Saskatoon

Edmonton

Lethbridge

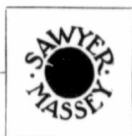

We Thank You

for giving us, this year, the largest business in our history.

It is gratifying to find that genuine service in your interest pays **us** as well as **you**.

We shall continue to give that kind of service, expecting to hold your confidence and your patronage only by striving to deserve them.

We wish you and yours a very merry Christmas, and a prosperous, happy and successful Nineteen Thirteen.

Sawyer-Massey Co.

LIMITED

MANUFACTURERS OF CANADIAN POWER FARMING MACHINERY

Western Branches: Regina, Sask.; Winnipeg, Man.

Factories: Hamilton, Ont.



Vol. XVII.

WINNIPEG, CANADA, DECEMBER, 1912.

No. 12.

EIGHTY YEARS YOUNG

THAT "A merry heart doeth good like a medicine" is not only the affirmation of King Solomon, but it has been the experience of human flesh all down the ages. A long lease of the merry heart is not in the gift of men, but in keeping the soul young and the heart attuned to the voice of God, there is no alchemy in Heaven or out of it equal to fresh air and an easy conscience.

Men and women who spend much of their time in the open, who live all the time close to Nature, have a chance that the cooped-up millions of the cities cannot hope to realize. The submerged town-dweller has not the means to understand "country life." He has his conception of "a good time," but the patriarch (whether we find him buried in the city or sunning his silvery locks on the prairie) will never hesitate when he is questioned as to what it is more than all else that has kept him hale in body and mind and still regarded as a "Youngster of Eighty."

Ian MacLaren has, in his inimitable way, given a remarkable picture of this — all the more significant because it is scarcely exaggerated — in his description of the "Young Chaps" of Drumtochty.

Sandy Stewart "napped" stones on the road in his shirt-sleeves, wet or fair, summer and winter, till he was persuaded to retire from active duty at eighty-five, and he spent ten more years in regretting his hastiness and criticising his successor. The ordinary course of life, with fine air and contented minds, was to do a full share of work till seventy,

then to look after "orra" (odd) jobs well into the eighties, and gradually to "slip awa" when within sight of ninety.



Bringing in a New Year
The Best of Friends and Still Young

Persons above ninety were understood to be acquitting themselves with credit, and assuming airs of authority, brushing aside the opinions of seventy as im-

the end of last century. And when Hillocks' brother so far forgot himself as to "slip awa" at sixty, that worthy man was scandalized and offered labored explanations at the "beerial."

Scotland seems to have created a record in breeding "Youngsters of Eighty" and even very young people who have clung to this life with pleasure and tenacity through many more than eighty cycles of twelve calendar months. It seems to be in the blood of country-bred Scotch folk to live long—whether they spend their days in the "Land of Brown Heath and Shaggy Wood" or are found transplanted in some foreign soil on which they can, at least, be sure of an abundance of "fresh air and caller water."

Speaking of remarkable cases of longevity, reminds us that few readers of this magazine are likely to know of that extraordinary linking of the memory of three generations, spoken of by the Rev. Thos. Guthrie in his Autobiography, and reaching back from the middle of the nineteenth century to the battlefield of Flodden fought in 1513. These are the facts as related by Dr. Guthrie:

Dr. Alison, the celebrated physician and contemporary of Guthrie's was hardly less celebrated as a philanthropist than the eminent "Apostle of Ragged Schools" himself. Alison, dying in 1859, told Dr. Guthrie that he had spoken to a man who had spoken to a man who had been at Flodden Field. There was thus, so to speak, but one

man between him and an event that occurred more than three hundred years before. What seems incredible in these days is thus explained:

When a mere child, Dr. Alison had been put into the arms of a man in Aberdeenshire, who lived to the remarkable age of a hundred and thirty; and this old Highland patriarch had once met with Jenkins—who survived till he was a hundred and sixty-nine years old and had when a boy been compelled to carry arrows to the English archers who fought the field of Flodden.

Another and scarcely less extraordinary case is authenticated, also by Dr. Guthrie on the authority of Lord Ardmillan who, to the integrity of a Judge and the graces of a Christian gentleman, added a knack for story-telling, that made his society quite a delightful experience. Mr. F. Dundas, M.P., a friend of his, having heard, when on a visit to Shetland, of a very old man who lived on the mainland determined to see him.

On approaching his cottage, he saw an aged but hale-looking man at work in a field close by, and not doubting but that this was the person he was in search of, he made up to him, but had no sooner begun to moralise on topics suitable to old age and the close of life, than the person he addressed turned round on him to say, "It'll be my feyther ye've come to see; there he is sitting at the cheek o' the door." And there, on walking up to the house, he saw a grey-haired venerable patriarch, sitting on a stone by the door.

On going up to him and introducing himself as a traveller who had come far out of his way to see one who had seen so many years, he was much surprised when this old man, pointing his staff to the door, said: "It'll be my feyther ye've come to see; he's in the house, there." He entered, and there in one who with bleared eyes and furrowed brow, cowered over a peat fire, while he stretched out his palsied hands to catch its warmth, and over whose shoulders, bent under the weight of years, fell a few spare silver locks, he saw the very picture of a great old age.

He was sure he had now got hold of the veritable man. Raising his voice, for he found the aged patriarch almost as deaf as a door-post, he let him know the purpose of his visit. But what was his astonishment when this withered form by the "chimney neuk," pointing to the door of an inner room, said, "Oh, it'll be

my feyther ye've come to see: he's ben there," and an old woman who sat by the fire added: "Surely, sir, you'll not go till you've seen The Lucky Dad?" And "ben there" to be sure, lying in a "box-bed," he found the father of the other three generations, alive indeed, but more like a dried



Their Life's Work—Among the Flowers in the Sunshine.
The Tuberose Harvest of Grasse, France

mummy than a living intelligent being.

These are, of course, extreme cases. They are interesting but hardly stimulate a desire to hang on to this life until the flesh and faculties have become shrivelled up to the similitude of a living mummy. Yet those men (if we may take the all but universal testimony of long livers) had a keen relish for life in every waking hour of their existence. Every day was well worth living and it brought its own new and sometimes surprising experiences.

Most men, it has been said, are born with a great deal of curiosity and very poor eye-sight. These old warriors, how-

always maintained the curiosity and interest of young minds in all the wonderful things around them, they knew it was a human impossibility to know all about everything, and so one condition of their many years of happiness was the elimination of worry and discontentment.

They were contented with the lot the Almighty has assigned them, but this did not blow out the flame of an intelligent ambition to know more than they did about things they didn't quite comprehend. They were not hermits or bivalves, living most of the time in darkness, but kept their faces towards the sun all the time. They had an open mind and sought for more knowledge and still more enlightenment on mysterious phenomena. They lived closed to Nature and instinctively if not unconsciously obeyed Nature's Commandments. Hence their lives of sunshine, and if a shadow did creep in at an odd time, it only served to relieve the monotony and make them more grateful and glad in the sunshine.

What an immense book could be written about "Youngsters of Eighty!" One feature common to every biography it contained would probably be that **no wild oats were sown**. It isn't merely the ruling of wise men that it is not necessary to sow wild oats in youth, but it is established beyond peradventure in the most successful lives we know of that they never sowed "wild oats." We know there is a section of our race who readily condone the follies of youth and brush away these days of indulgence and dissipation with the "comforting" theory that a youth must sow his wild oats before he can really know the world.

What man with the spunk of fatherhood in him will subscribe to the belief that it is conditional to his boy's success that he should taste ever so little of any one of the common vices? No one will dare to equivocate in answering this question. A clean life, lots of "hill air" and plenty of occupation seems to have been the only "medicine chest" these old worthies knew of.

As one instance of many thousands, take the wonderful life of Mr. Gladstone. He was the most effective optimist of his time, never for one day "rusting" but yielding himself naturally to ideas of his age and trusting to their impulse as if they carried with them nothing but good. And he never knew of any harvest of "wild oats." He was, withal, one of those sunny fellows whose advancing years never driven into that stage where "old age" becomes a burden to itself and a perpetual



A Young Scotch Lassie of Eighty Packing Fleeces in the Hill Air.

ever, were also endowed with a big heritage of contentment and a common-sense philosophy that seemed to remind them as constantly of their limitations as it did of their wonderful possibilities. They didn't worry about things they had no means of knowing about. While they

nuisance to every body who has to reckon with it.

We respect and reverence old age, but not in spring chicken or that played out type of "old times" that refuses to accept rest and release, to hand over without jealousy and without fretting the heavier labors to young men; that is **unwilling to substitute counsel for control**. When ambition ceases to torment, when men are willing to with-draw themselves from the crowded thoroughfares of life, the young will rally round them with veneration and with love.

The point of it all is that "old age" is not represented by years. Some men are old at twenty, others are as young at eighty as the children we delight to watch at their gambols in the school playground. A man's anatomy or any part of it is not his "life". His life is the fabric he weaves from his thoughts. Happiness and Heaven are one and the same thing and we have not to wait upon any "hereafter" to know what it means. While we fail to realize this, we are **missing Heaven**.

Happiness is an **attitude of the mind** and the purest example of it on earth is probably that of an infant responding to some outburst of the great mother-love, say in a new toy at Christmas. The **simple life** is the sublime secret, and anything else is not "life." By this we do not mean that carefully classified set of rules for the "simple life" prescribed by certain odd people of our day who clothe themselves in something like gunny sacks and do penance bare headed in the rain; who take exactly twenty-five bites to every mouthful of food and measure out their diet in tea-cups!

Mortals of this type whose life is one long-drawn period of anxious abnegation are very much in a class with those of the other extreme who wear out long before their time under a bewildering burden of miscellaneous "truck." John Burroughs tells of a friend of his who once declared that if he outlived his wife, he would put upon her tomb stone: "Died of Things"—killed by the multitude of her possessions.

None of these young people of eighty are ever the sport of poverty, and on the other hand you will never find them groaning under responsibilities of what the world calls their "wealth." Poverty and wealth are greatly misunderstood—always have been. The peace of contentment "passeth understanding" to those demented creatures whose vitality is being rapidly

cremated by the fever of human restlessness. The greatest of all a man's possessions in his individuality, and happy is the man who knows himself, who sticks by "himself" and is never a wretched reflex of some one else. Imagine one of those happy fellows rejoicing in their own simple way in the cabin of their "wind-jammer" being told that the Admiral of the Fleet was the only fellow whose lot was **worth living**. The

"Homely joys and destiny obscure" of these brave lads of Neptune represent a wealth of human satisfaction that the Lord High Admiral would often give his entire "wealth" to possess.

Take another phase of life in which the sanguinity of youth continues to hold its own and in which the red fluid refuses to stagnate to the accompaniment of grey hairs. Look into the perennial sunshine of that face of Thomas Guthrie. He was one of Scotland's most powerful preachers in his day, but his mighty gifts in the pulpit were as nothing to the leavening

life and there is not much of it I would like to change if I could live it over again. I have shared the common lot and have found it good enough for me. Unlucky is the man who is born with great expectations and who finds nothing in life quite up to his mark. One of the best things

a man can bring into the world with him is **natural humility of spirit**, and about the next best thing is an appreciative soul—a loving and susceptible heart. If he is going to be a reformer and stir up things, he needs some other qualities; but if he is going to get the most out of life in a worthy way, if he is going to enjoy the grand spectacle of the world from first to last, then he needs his life pitched in a low key and well attuned to common universal

things. The strained, the loud, extravagant, the frenzied—how lucky are we to escape them, and to be born with dispositions that will cause us to flee from them."

To the same strain Epictetus once addressed himself to a certain magnificent orator on his way to Rome, and who called upon the Stoic to learn something of his philosophy. Epictetus received his visitor coolly, not believing in his sincerity. "You will only criticise my style," said he; "not really wishing to learn principles." "Well, but," said the orator, "If I attend to that sort of thing, I shall be a mere pauper like you, with no plate, no equipage nor land." "I don't want such things," replied Epictetus: "and, besides, you are poorer than I am after all. Patron or no patron, what care I? You do care. I am richer than you. I don't care what Caesar thinks of me. I flatter no one. You have silver vessels but earthenware reasons, principles, appetites. My mind to me a kingdom is, and it furnishes me with abundant occupation in lieu of your restless idleness. All your possessions seem small to you; mine seem great to me. Your desire is insatiate—mine is satisfied."

According to Robert Louis Stevenson: "To earn a little and to spend a little; to make upon the whole a family happier for his presence; to renounce when that shall be necessary and not to be embittered; to keep a few friends but these without capitulation; above all, on the same grim condition to keep friends with himself"—is a modest and need never be an impossible task for any man.



Rev. Dr. Thomas Guthrie
One of the Youngest "Old Boys" of His Day



Cronies Ever—Let the Wind Blow as it Will
"A Storm in a Tea Cup"

influence of his crowded life among the thousands of destitute children he befriended and to whom he was all of "father" they ever knew, and the "bairns" kept him young.

"Old" John Burroughs wrote to one of the magazines lately: "I have had a happy

FOR a full six weeks before Christmas the children have been shouting appeals for toys up the chimney, in the fond hope that Santa Claus may be prematurely loitering round the chimney pots. Mysterious confidences have gone up through that sooty channel, with curly heads down on the hearth—the right side of the guard—and big saucer eyes watching the sparks leap gallantly up the black aperture, down which will come tumbling on the day of days, a torrent of bicycles, horses, dolls' houses, chocolate boxes and Teddy bears—all the things, and more, that the little hearts have longed for all the weary waiting time.

For month's Christmas has appeared on the children's horizon like a star, first a mere pin point, but increasing steadily in magnitude as the grey days grew shorter and shorter, till at last it fills the world with a glorious burst of radiance on Christmas morning. Every year Christmas preparations seem to start earlier and every year the festival grows more widespread and popular; and those who shake their heads over it, and say the religious aspect is overshadowed by the secular, will at least admit that the spirit of good-will to all men and charity to the poor, grows stronger with each Christmas, and that after all, is the religion taught by the Babe in the Manger.

Little purses are very limp and empty on Christmas Eve, for everyone must be remembered, from grand-papa to the baby, and small brains, like bigger ones, have been very much worried over the Christmas shopping.

Oh, the Christmas shopping—the waiting three deep at the counter, and the being invariably overlooked because your head hardly comes above it! Oh, the crushing, bustling, irritable grown-ups, who crowd and push, and seem to think that importance and superiority go by size only!

Still, little discomforts of this sort are all in the good cause of Christmas, and naturally traffic becomes congested when everybody carries a sheaf of brown paper parcels, not forgetting the youngsters; in fact the rule seems to be—the smaller the child, the larger the parcel.

Those who are not old enough to go shopping are never too young, however, to give the pudding a stir, to sieze that dreadfully sticky-handled spoon and push it a little way through the brown delicious jorum in the big puncheon on the kitchen

THE CHILDREN'S SEASON



"I believe I hear him!"

table. Then there are the silver charms to be dropped in and stirred round—the mascots that will bring love and wealth, or vice versa, to possessors of fortunate slices. So enthusiastic, in fact, do the little ones grow over this part of the pudding-making that they have been known, on the sly, to push in a little possession of their own—tiny china



The Sceptical Boy Scouts are looking into this "Santa Claus" Business

animals, for the most part, which, when the pudding is eaten, bid fair to make dentists of their adult victims busy.

But there are other things to be done besides making or marring the pudding. There is the doyley to be worked for

Mummy, under Nurse's supervision, and the paper-plaited mat for Daddy. Both cost some tears, but

both, a trifle "shop soiled" and grimy, are eventually presented and received with great pride and enthusiasm on Christmas morning. What a relief it is, too, when the secret is out at last, and the reason of all that hole-and-corner hiding-away business can be confessed, though there is something sensationally fascinating about the December whisperings, the closed-door consultations, and, to small prying noses and peering eyes, the dark corners bulging with parcels, not to be investigated till Christmas.

Yes, it's a long, lovely, magical time for children, full of mystery, which comes to a head on Christmas Eve. Can any child be expected to go to sleep in an ordinary manner on that most extraordinary night, when the very air is charged with stealthy expectancy and Santa Claus may arrive at any moment?

Santa Claus! Was ever so burly a saint so deservedly loved by such a host of undersized disciples? Was ever a miracle so whole-heartedly swallowed, as his ample form gliding down a very constricted chimney and filling stockings with gay colored gifts, unblemished by a

vestage of soot? Of course there are some sceptics—the Boy Scouts for example. It is a little too much, naturally, to imagine for one instant that this, the newest of new ideas, should be taken in by the oldest of old superstitions. Why, if the members of a local "patrol" should actually come across the scarlet-robed and hooded figure on his rounds, they would track his spoor across the snow, and, in all probability, hand him over to the authorities and charge him with having stolen his sack full of tools from Eatons or Hudson's Bay.

But the child, of any age between two and six, and sometimes later, never connect the fairy toys in the stockings with their doubles sold over the counter in every toyshop; and how valiantly they try to keep the dustman away on Christmas Eve, and even creep barefoot to the landing in order to interrupt Santa Claus if he should come that way. But that is, of course, before they have been to school, for it is at school that the first seeds

of scepticism are usually sown.

If children find it hard to go to sleep on Christmas Eve, they find it equally as hard to stop asleep on Christmas morning; and one of the greatest pleasures of the grown-ups' Christmas is to stand and

watch the "crib inhabitant" wake as the day of enchantment is beginning to dawn. The little form tosses and squirms among the tumbled bed-clothes. Suddenly it sits erect as memory returns. The wide eyes—blue, brown, or hazel—light on the bu'gy stocking hanging on the crib rail and the toys that have brimmed over the bed. The dream has come true! It is Christmas morning! Santa Claus has really been! And with joyous cries of gratified desire, the child tears down the stocking and pulls out the toys with a frantic enthusiasm.

But in some fortunate, or unfortunate, cases the early morning gifts of Santa Claus are only a drop in the ocean of toys, that rises round the little one—generally an only child—as the day progresses. There are presents by post, presents brought by hand from neighbors, presents from guests in the house, all to be unwrapped and attended to, till literally bored to tears, the bewildered recipient pushes the growing heap of parcels petulantly aside, and tries wearily and with jaded appetite to play with one or two among the score already unwrapped, and exclaims with piteous entreaty as nurse brings in another handful of envelopes; "Oh, don't bring me any more cards!" And the moral addressed to parents and guardians, when such an event threatens, is this—keep back the overplus for a rainy day, or pass them on to the less highly favored.

"Just enough, and not too much" is a good adage for all times, but particularly appropriate for Christmas. There are so many good things to eat, to taste each of which is a special duty of the season, that the knowledge that immoderation has been indulged in does not arrive home till too late. Think of the glamour that hangs about every course of the Christmas dinner, the noble bird and all its stodgy "trimmings," the holly-crowned pudding, and the insidious superstition that promises happy months to the struggling eater of mince-pies.

The day, however, brings its own antidote, for there is no doubt that Christmas games are particularly helpful to both youthful and adult digestions, and the children are perhaps kinder than they mean to be when they insist on the grown-ups "playing too," in spite of their evident desire for more passive pleasures.

But who can say "No" on Christmas Day? So the bachelor-uncle crawls round the room with a well-fed child taking horse exercise on the small of his back—a

performance which would bring on an attack of lumbago at a less genial season—and the elderly maiden-aunt forgets to be acid, even when the joke turns against herself.

Then comes a sudden interruption as a mysterious voice from the passage calls



All Ready for Santa and Having a Last Peep at the Snow-flakes.

the children to breakfast, which room by the way has been locked since morning. It is open now, and there on the table stands the Christmas tree, that symmetrically-shaped, dwarf-fir radiant with colored candles, sparkling with silver festoons and rainbow balls, with an eloquent burden of toys, weighing down each bough, and there, on the topmost twig, stands a fairy doll, in glittering gauze and flounces, a wand in her hand and a star in her golden hair.

All the world over, the Christmas-tree is the crowning glory of the children's Christmas, from the dream-vision of the woodcutter's little daughter in the heart of the winter forest, to the mighty fir that rears its toy-laden branches to the roof of the supper-rooms at our big restaurants



Love at Work While Innocence Sleeps

on the "children's night." There is nothing in life that will ever occasion greater or purer delight than the memories of the Christmas tree, and all agree that it is worth the worry and turmoil of the whole year to see the kiddies deal with their stockings at Christmas.

It is often said: "Ah, it's no Christmas without children!" And, as a matter of fact, in many homes, there would be no Christmas without the children, who earn the wherewithal to provide the season's cheer. In these times of pantomimes and fairy plays the salaries of the small

nummers not only keep the home together all the year round, but buy the turkey and the plum-pudding, the snap dragon and the Christmas-tree for the rest of the family. Those who oppose the employment of juveniles on the stage, may have some right on their side, but there is no doubt that the children, not realizing the

fact that they are the little breadwinners, revel in the brightness, artificial though it may be, shed across their lives when their pantomime time comes round. It may be hard work, and stage managers may occasionally lose their "wool" over the difficulties of keeping their *corps de ballet* together, but, on the whole, the relations between the youngsters and their histrionic instructors are cordial, not to say affectionate, and the children are undoubtedly protected and cared for, and thoroughly enjoy themselves.

So here is Christmas upon us again, kinder, bigger, jollier then ever; and ignoring the croakers who say the festive season is not what it used to be, we turn to the millions of delighted and excited little ones, whose one regret is that Christmas comes only once a year, though, for the sake of Daddy's pocket, not to mention their own digestions, it's really just as well it doesn't come twice.

It is a happy circumstance that Christmas falls at the end of the Year. People seem to take on a jaded air—to find a sort of "played-out" feeling take possession of them as the holiday season approaches. They pass through a long and tiresome twelve months, and the "flesh" begins to rebel.

The spirit also cries out for a breathing space just at this time, and it seems as if the same kind Providence that decreed the weekly Sabbath had also planned this little breathing space at the end of the year.

Let us take advantage of it to cast our thoughts back on what has gone—what we have failed and succeeded in since we had our last Christmas rest. This will be found a very profitable occupation if rightly used. It may be compared to a yearly "stock-taking" of our inmost selves in which we can see the figures of our "profit and loss account" and find the way to better balance sheet at next reckoning.



"Everything Begins and Ends with the Soil"

DEC., 1912

The CANADIAN THRESHERMAN & FARMER

CANADA'S LEADING AGRICULTURAL MAGAZINE

PUBLISHED MONTHLY BY

E. H. HEATH COMPANY, Limited, WINNIPEG, CANADA

E. H. HEATH, PRESIDENT

E. W. HAMILTON, MANAGING DIRECTOR

F. C. BRAY, TREASURER

J. D. DUTHIE, EDITOR

MEMBERS WESTERN CANADA PRESS ASSOCIATION)

AUTHORIZED BY THE POSTMASTER GENERAL, OTTAWA, CANADA, FOR TRANSMISSION AS SECOND CLASS MATTER

SUBSCRIPTION RATES

Postage prepaid,
Canada and Great
Britain,
\$1.00 Per Year.

Postage prepaid,
United States and
Foreign Countries,
\$2.00 Per Year.

Failing to receive paper, you should notify the office at once, when mistakes, if any, will be corrected immediately.

All Subscriptions must be paid for in advance and are positively discontinued at date of expiration unless renewed.

Advertising copy in order to secure good position should be in our hands not later than the 15th of the month preceding date of issue.

Advertising rates furnished on application

ON PARTY LINES

CURSED WITH PARTY-ISM!" That was the expression of one who is entitled to be heard—an eminent "foreigner" in the sense that he was not a Canadian citizen—who saw us on his way home to Europe the other day. He has many thousands of invested capital in this great "Occidental Star" and came to have a look round, just to satisfy himself as to the validity of his securities, and also to advise his friends who might also or might not follow his example. He said: "It is a marvellous piece of God's earth, but its vitals are cursed and clogged with extreme party-ism."

THAT HE IS RIGHT, no one who has lived one month in close touch with the ordinary daily doings of any city or hamlet in the Dominion can doubt for a moment. It is a fact that cannot be hidden. The man in the street knows it; every boy at school sees it oozing out in his home circle when some neighbor visits his father, and no one is more alive to it than the Politician himself. It is a horrible excrescence upon the body of one of the fairest national structures that ever came into life and that has a destiny to fulfil. It has got to be dried up or some effective surgery will have to be applied one of these days.

THE PARTY IDEA may be all right. There is no reason why it shouldn't. In his green and callow state of adolescence, the writer of these observations was taught to believe that there was only one "party" that could be entrusted with the government of the people and the handling of international relations, and that was the party to which his father belonged. The other party might be allowed to live, but it consisted of a very stupid race of men. The next-door neighbor was a fairly representative unit of this party. He might be a very decent honest man. In fact he (the writer) might come to regard him as "stupid" but he was never allowed to breathe one word of suspicion as to the neighbor's integrity.

THE NEXT-DOOR NEIGHBOR, in those days, might be a useless "old wife" but he certainly was no crook. If he suffered in person or estate—politics went to the four winds of heaven and the neighborly spirit rose to the occasion against all odds. He had views on certain features of national economy that had all the ear marks of rottenness, but he was given the fullest credit for his sincerity in professing these "views." They were the honest convictions of his heart, established according to the light of knowledge and capacity for sound judgment the Almighty had given him.

BUT THAT WAS IN DAYS GONE BY, else—where and under other conditions than the mad race for riches we are running in these days in this last lap of Western "progress." Here, in Canada, the position is the sad, heart-breaking, humiliating spectacle of a company of men living practically under one roof, under what might be the very finest social relations in the gift of civilization, split up and lashed into deadly feud over

the most wretched bone of contention that ever invaded domestic concord.

SO UTTERLY RIDICULOUS is the position that no sane, single minded person will have the patience to "account" for it, far less to attempt to defend or apologise for it. Under ordinary conditions, when there is no electioneering excitement, the state of affairs is woeful, but when it comes to voting a man into a seat in the legislature, it does seem as if all hell had been let loose into the hearts of the people. This is no exaggeration or mere matter of opinion. It is a fact that is "gibbeted for ever upon the imperishable rock of history," let the future kill the memory of it when and how it will.

A RESPONSIBLE DOMINION OFFICIAL some years ago assured the writer when he first set his foot on Canadian soil that he would find many things to encourage him in the new country and some features that would probably astound him. Among the latter was the fact that most things "from church courts to wedding compacts" were run on politics. Experience gained from actual observation and contact, from Atlantic to Pacific, has positively and almost literally confirmed that prophesy.

HOW LONG IS THIS TO CONTINUE? When will our country begin to work its way by the light of its conscience instead of taking its cue from and slavishly following the lead of certain political factions? Is not a man's greatest birth-right his individuality? How does he conduct the affairs of his home life? Does he "run the family" at the bidding of some boss? Does some high functionary prescribe the policy which he will pursue in guiding those children whose destiny has been placed in his keeping? In such a case if his judgment said "no" and his boss thundered "yes", would his love for the children or his "loyalty to the party" turn the scale?

OUR YELLOW PARTY JOURNALS are responsible for much of this deplorable phase of our "civilization," that is to say, if the press really does mould public opinion. The party Journals—all of them—in this country are conducted on their political side with a rancour that was scarcely excelled by Jean Paul Marat in his "Peoples' Friend" of the "Reign of Terror." When did any one see a measure brought in by one party that ever received a word of ingenuous support in the columns of an ostensible organ of the opposite party?

IS IT NOT POSSIBLE that we can all hold our individual opinions and believe in the single-mindedness of that man who differs from us? Cannot intellectual differences be really respected and live side by side in the bonds of perfect harmony? When the next or at most the following generation reads of our political squabbles (particularly as they are painted in the recent issues of our jaundiced press) how foolish will we not look to them. Resolution for the New Year: LET US REFORM AND BECOME MEN.

OUR GUARANTEE

No advertisement is allowed in our columns until we are satisfied that the advertiser is absolutely reliable and that any subscriber can safely do business with him. If any subscriber is defrauded E. H. Heath Co., Ltd., will make good the loss resulting therefrom, if the event takes place within 30 days of date advertisement appeared, and complaint be made to us in writing with proofs, not later than ten days after its occurring, and provided, also, the subscriber in writing to the advertiser, stated that his advertisement was seen in "THE CANADIAN THRESHERMAN AND FARMER." Be careful when writing an advertiser to say that you saw the advertisement in "THE CANADIAN THRESHERMAN AND FARMER."

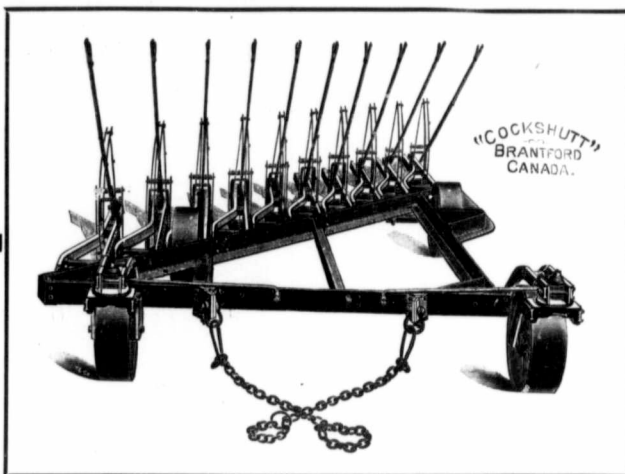

All Soils Are Alike To The Cockshutt

GIVE DUE HEED TO A REPUTATION WELL EARNED AND BUY A

Cockshutt Engine Gang

All soils are alike to them! It is the BEST Engine Gang in the world, although YOU may not know that ALL THE WORLD KNOWS IT! For Farmers EVERYWHERE have learned as well as MAN ever CAN learn that the COCKSHUTT ENGINE GANG answers the requirements under any and all conditions: Built for tough going and rough land. It will stand all you can give it without striking up costly intimacy with the repair man, without breaking down at a time when you need it most.

Comes out victorious in every practical test; whether your land is hilly, stony or level, whether you break sod or stubble, the COCKSHUTT Engine Gang is the plow for YOU.

There is, however, only ONE way by which you can definitely establish for yourself the worth and value of an Engine Gang BEFORE YOU BUY IT, and that is: The behavior of the Plow in the hands of a great many owners over a period of years. Judged by this standard—and, we repeat, no other is available—the COCKSHUTT ENGINE GANG commends itself to your attention in a way that will not brook refusal.

To set forth in detail all the advantages of the Cockshutt Engine Gang over other makes would require another page, but the features which are bound to decide you are discussed in an interesting booklet. It contains the testimonials of prominent farmers who have been made independent of soil conditions by the perfect performance of the Cockshutt.

WRITE FOR THIS BOOKLET TODAY. SEE THE DEALER.

Cockshutt Plow Company, Limited

BRANCHES: Winnipeg Regina Calgary Saskatoon DISTRIBUTING WAREHOUSES: Red Deer Lethbridge Edmonton Brandon Portage la Prairie

Establishing a Farm Home

By a Student of the Manitoba Agricultural College.

THE prairie provinces or Manitoba, Saskatchewan and Alberta are rapidly being transformed from a virgin expanse into profitable farms with comfortable homes. These farms are variable in extent and equipment and are largely owned and operated by private individuals. The enhanced value of Western lands is making it more difficult for a man of limited means to become possessed of a farm of his own. But even yet by careful management one may start with quite a limited capital and in a few years' time be on a sound financial basis and in a fair way to become independent. It is because of this fact that many men are induced to adopt agriculture as a means of livelihood. Although it involves a great deal of manual labor, farm life has many admirers and it seems to be characteristic of the human race to prefer to be ones own "Boss" even under the pressure of rigorous work.

Among the thousands of settlers that are yearly coming to the West to build up homes, we find that the majority are men of experience from other farming localities. Many bringing with them a full equipment of farm necessities, together with bank accounts of great or less extent. Among the wide range of men that are coming in there is a variety of ideals of "A farm." On account of the difference of opinion in this regard and because of the difference of financial standing of the men who are taking up this work there will be a great number of possible ideals worked out. Some men attempt mixed farming in its broadest sense, others prefer dairying and grain growing, still others beef cattle and grain and so on—working in their favorite line of live stock with grain production as the essential source of their dividends. Others prefer to grow small grains only and force their farms in this direction, adopting what is termed extensive rather than intensive farming. This no doubt is the most paying proposition for the beginner, but it is a system that will eventually impoverish the soil to such an extent as to render it of little value in grain production unless some attempt is made to maintain the soil fertility. With this end in view I maintain that the farmer who is

just starting in business is justified in expending his energies in producing the largest amount of grain and at the same time gradually working into some line of stock. By the end of about three years, however, he should have sufficient of his particular line of stock to use up all coarse grains and as much of the rough feeds as possible. In this way he will be able to maintain humus in the soil by manuring and by so doing it will be possible for the future generations to continue growing profitable crops.

The three prairie provinces present almost ideal conditions, in some locality or other, to suit the fancy of the most exacting individual in whatever line he wishes to follow. The intending settler, then, must decide on what class of farming he wishes to follow and then make an effort to obtain a locality suitable to his requirements. For the purpose of this essay the land chosen is situated in Northern Saskatchewan four miles from a newly constructed line of railway. It is clear, level, open prairie with nothing particular to prevent him from breaking every foot of the half section. During the summer of 1910 this land was purchased from the Canadian Pacific Railway Land Company at \$15.00 per acre, the first payment only having been made. The settler whom we presume to direct in his farming operations for the first three years, obtains it from the former purchaser by paying him the amount of the first payment which was \$719 together with \$240 to cover the enhanced value of the land at \$1.00 per acre and the twenty acres of land which he had broken, at \$4.00 per acre. On the company's ten year payment plan he has only the interest to pay the second year which is \$244 followed by nine yearly payments of \$600 each, which includes the interest for each year.

The incoming settler is a young married man who has previously been following farming in an adjoining district. He brings with him practically a complete set of farm machinery consisting of two wagons, one twenty-two disc drill, one light foot binder, one gang plow with breaker bottoms, one 16 x 16 disc harrow, one

UNION BANK OF CANADA

Established 1865



Head Office - Winnipeg

Paid-up Capital..... \$5,000,000
Reserve and Undivided Profits..... 5,175,000
Total Assets, over..... \$10,175,000

HON. PRESIDENT J. SHARPLES

PRESIDENT JOHN GALT

VICE-PRESIDENTS:
W. PRICE R. T. RILEY

DIRECTORS:

W. R. ALLAN S. HAAS
S. BARKER, M.P. F. E. KENASTON
M. BULL G. P. REID
Lieut-Col. J. CARSON H. THOMSON
E. L. DREWRY W. SHAW
E. E. A. DU VERNET, K.C.

G. H. BALFOUR, General Manager.

H. B. SHAW, Assistant General Manager.

F. W. S. CRISP, Superintendent of Branches and Chief Inspector.
London, England, Branch—No. 51 Threadneedle Street, E.C.

Head Office, Winnipeg.

Special Attention given to Farmers' Business

Grain Drafts Negotiated.

Interest Allowed on Deposits.

Branches and Agencies West of Great Lakes:

Manitoba—Bridle, Birnie, Boissevain, Brandon, Carberry, Carleton Place, Carroll, Clearwater, Crystal City, Cypress River, Dauphin, Deloraine, Glenboro, Hamiota, Hartney, Holland, Killarney, Manitoba, Melita, Minnedosa, Minto, Morden, Neepawa, Newdale, Nings, Rapid City, Roblin, Russell, Shoal Lake, Souris, Strathearn, Virden, Waskada, Wawanesa, Wellwood, Winnipeg.

Saskatchewan—Adanac, Almasak, Arcoia, Asquith, Assiniboia, Bounty, Buchanan, Cabri, Canon, Carlyle, Craik, Cupar, Cut Knife, Esterhazy, Eyebrow, Fillmore, Gravelbourg, Gull Lake, Herbert, Humboldt, Indian Head, Jansen, Kerrobert, Kindersley, Landis, Lang, Langan, Lemberg, Lumden, Luseland, Macklin, Maple Creek, Maryfield, Milestone, Moose Jaw, Moosomin, Netherhill, Neudorf, Ogema, Outlook, Oshawa, Pense, Perdue, Plenty, Prince Albert, Qu'Appelle, Regina, Rocanville, Rosetown, Saskatoon, Seaport, Scott, Simpson, Sinitaluta, Southey, Strassburg, Swift Current, Teasler, Theodore, Toga, Tompkins, Vanguard, Viceroy, Wapella, Wawota, Watrous, Webb, Weyburn, Wilkie, Windhorst, Wolseley, Yorkton, Zeelandia.

Alberta—Airdrie, Alix, Barons, Bashaw, Bassano, Bellevue, Blackie, Blairmore, Bowden, Bow Island, Brooks, Calgary, Carbon, Cardston, Carstairs, Claresholm, Cochrane, Consort, Cowley, Didsbury, Edmonton, Fort Saskatchewan, Grande Prairie, Grassy Lake, High River, Hillcrest, Innisfail, Irvine, Lacombe, Langdon, Lethbridge, Macleod, Medicine Hat, Okotoks, Passburg, Pincher Creek, Seven Persons, Strathmore, Swainwell, Three Hills, Wainwright.

British Columbia—Enderby, Hazelton, Nanaimo, New Hazelton, Prince Rupert, Telkwa, Vancouver, Vernon, Victoria, New Westminster.

This Bank, having over 290 branches in Canada, extending from Halifax to Prince Rupert, offers excellent facilities for the transaction of every description of banking business. It has correspondents in all cities of importance throughout Canada, the United States, the Continent of Europe, and the British Colonies.

Collections made in all parts of the Dominion, and returns promptly remitted at lowest rates of exchange.

Winnipeg Branch, D. M. NEEVE, Manager. F. J. BOULTON, Asst. Manager.



WILD OAT SEPARATOR

We positively guarantee our Separator to remove EVERY KERNEL of Wild or Tame Oats from your SEED WHEAT and NO WHEAT LOST with the oats.

Made in Three Sizes:

6-Shoe Power Separator
3-Shoe Hand Separator
1-Shoe Elevator Wheat Tester

Perfect Separation of OATS from BARLEY or RYE for Seed.

WM. H. EMERSON & SONS
DETROIT, MICH. AND WINDSOR, ONT.

Write for Circular fully explaining this wonderful Separator

A Fine Home and a Great Investment

The finest natural conditions of soil, climate and location in Canada for fruit-growing with an ideal home life are to be found in the Similkameen Valley, British Columbia.

Fruit and vegetables mature here two weeks earlier than any other district in Canada. With a low altitude of a thousand feet, and being sheltered among the lofty mountains, it enjoys a mild and genial climate the year round.

All varieties of apples, peaches, plums and cherries yield abundant crops. The district is particularly adapted to the growing of tomatoes, water-melons, peaches, apricots, etc.

The Victoria, Vancouver Eastern Railway now under construction will place this Valley many miles nearer Vancouver than any other high class semi-arid fruit growing district in British Columbia.

We have irrigated several thousand acres and have subdivided it into five and ten acre blocks which we are offering at very reasonable prices.

Write for our book on the Similkameen Valley.

SIMILKAMEEN FRUIT LAND COMPANY LIMITED

P.O. Box 2997 505 McArthur Block, Winnipeg, Man.

mower, one rake, two set of sleighs, one buggy and one cutter, together with a set of blacksmith and carpenter tools. This machinery is all in good repair having been used only from one to three years and for which he charges his stock account \$650. He also has eight horses and harness valued at \$1,900, together with household effects valued at \$500. Besides this he has a bank account of \$4,000. He arrives at the scene of action about the last week in March. By the help of a man, whom he hires for the summer at \$30 per month, he transfers his car of effects out to the farm in a few days. They then haul lumber for a shack and for the shell of the barn. By the help of a carpenter at \$3.00 per day they build the shack, which is 12 x 16 and is to serve the purpose of a house until a larger one is built by contract, and also the shell of the barn, which is planned with the intention of extending it later. The completed building is to be 36 ft. x 86 ft. For the present he only puts up the shell of one-half of it which is 36 ft. x 40 ft. This work is sufficiently well along to be used when it is time to commence seeding. The barn is set on temporary blocks with the intention of putting a stone foundation under later. The back wall being only a temporary one has no foundation and in it is made a wide door so that any space not occupied by the stock can be used for storing implements. A temporary poultry pen is also built in the barn connecting with an outside door on the side of the barn.

He arranges with a neighbor for the purchase of a small stack of hay. Fifteen loads at \$5.00 per load, also for five hundred bushels of oats at 30 cents per bushel. From the same man he obtains eighteen bushels of good clean red fife wheat for seed at one dollar per bushel. He puts ten out of the twenty acres that were broken the previous summer, into wheat and the remaining ten together with fifteen of spring breaking are sown to oats. His idea of sowing the ten acres of wheat is to get seed for the following year. This work together with the digging and cribbing of a four foot round well, twenty-four feet deep takes until the 15th of May when it is full time to commence breaking. For this work six horses are used on the gang plough. Before going to the field he breaks, the garden, house, yard and location for the wind break. This is all plowed shallow with the intention of back-setting it in the fall. He then commences breaking in field No. II and by the middle of July it and the remainder of No. I is completed making one hundred

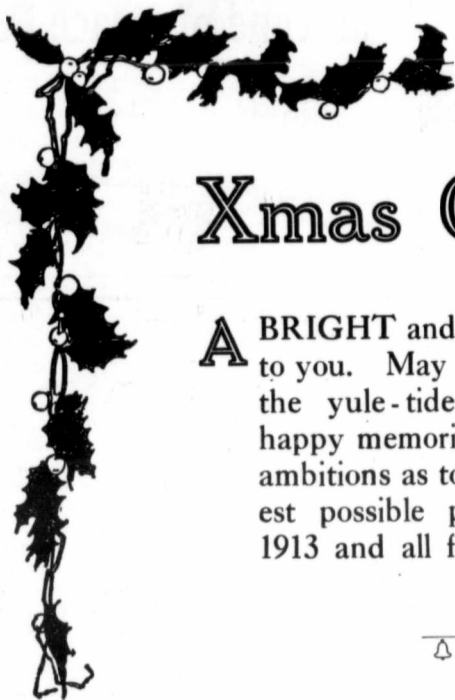

Heartiest Xmas Greetings

A BRIGHT and cheery Christmas to you. May the glimmer from the yule-tide log reflect only happy memories and create such ambitions as to assure the greatest possible prosperity during 1913 and all future years.



Massey-Harris Co., Limited

- | | | |
|-------------------|------------------|-----------------------|
| Grain Binders | Corn Binders | Reapers |
| Mowers | Rakes | Tedders & Hay Loaders |
| Manure Spreaders | Drills | Corn Cultivators |
| Field Cultivators | Feed Cutters | Disc Harrows |
| Drag Harrows | Cream Separators | Walking Plows |
| Horse Gang Plows | Engine Gangs | Sulky Plows |
| Disc Plows | Scufflers | Packers |
| Rollers | Wheelbarrows | Wagons |
| Sleighs | Lorries | Dump Carts |
| | Gasoline Engines | |

Use Massey-Harris Implements and be
HAPPY and PROSPEROUS

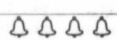

Massey-Harris Co., Limited

Branch Offices:

- | | | | |
|----------|-----------|----------|--------|
| Winnipeg | Saskatoon | Edmonton | Regina |
| Yorkton | | Calgary | |





Our Disc and Seeder Hitch will haul any number of Discs, or Discs and Seeders, or both, required. Keep them always in place, without piling up and never break down. It is light and adds no load to your engine. Furthermore the price is reasonable. To own one is cheaper than not. Let us tell you all about it, and the Famous Caswell Belt Guide. Ask for our catalog. It was printed for you. Write us today, now, while you think of it. A postal card will do. Address:

Caswell Mfg. Co. - - Cherokee, Iowa

In Time of Peace Prepare for War

A splendid principle! Applied to your business it means: Plan now for your next spring and summer rush. You cannot plan wisely without our Catalog of **POWER FARMING EQUIPMENT** because it shows the most complete and up-to-date line of **Disc and Seeder Hitches, Binder Hitches, Engine Wagons, Soil Packers, Belt Guides, etc.,** ever placed upon the market.

If you **FARM WITH POWER**, our machinery will absolutely save you more time, labor and money than any other part of your outfit of equal cost. It will pay for itself in a single season. You actually lose money without it.



You saw this advertisement in this magazine. Don't forget to say so when writing.

and five acres of breaking. While this work is being done by the man the "Boss" is kept busy putting a little garden, fencing the farmstead, scraping out house cellar, hauling stones for the cellar which is supplied by the contractor also hauling lumber for the house.

The house which is to be 28 x 30 with stone foundation and the remainder frame is let by contract at \$1,000 which covers material and all work except hauling the material. Any one who is acquainted with farm life knows the necessity there is for a good roomy house, but on account of the cost it is not always possible to build full size at first. Very often a small house is built at first and later as necessity demands additions are built on at different times until a very unsatisfactory, unsightly affair is the result. Realizing that every farm house should have a good cellar and that a fair sized square house gives greatest amount of room for the cost he lets his contract accordingly, but instead of going to the expense of a complete house on this scale he has it built only one story which is finished complete as far as the cellar and walls and rooms are concerned. Only a plain temporary roof, however, is put on and for this purpose sheeting and medium weight roofing paper are used on a rather flat pitched roof. It is his intention to put on another story in about four years time, when this temporary roof will be easily removed. The ceiling inside is sheeted and finished with metallic ceiling, as it will stand the subsequent jar when the top part is being put on. The outside is covered with shiplap sheeting, two layers of tar paper and then good siding and the inside is sealed then stripped and lath and plastered. The plan consists of parlor, hall and stairway and bedroom on the front half and on the back half corresponding to this is a dining room with double sliding doors connecting it with the front room and then a kitchen and pantry on the other quarter with cellar stairs out of the pantry underneath the other stairs in the centre of the house. The contract

includes all painting inside and out, all of which must be finished by September 1.

It is impossible to tell to a day the amount of time required to do different sections of farm work and we consider for the purpose of this essay it is sufficient to trace approximately the work done from one season to another rather than to account for the time day by day because of the possible variation in climatic conditions. For instance one year we may have a very early spring while the following spring it may be a month later. Also the crop returns can only be estimated as yields vary and so do the prices.

As soon as the breaking is finished the six horse team is put to work discing the breaking until about July 20, when it is time to put up hay. He obtains a permit for about eighty loads of prairie hay on an adjoining school section. This work keeps them both busy until harvest commences which is about August 20. During any wet weather in haying or harvest the team is put on the disc while the farmer is employed at carpentry work around the barn. The work of cutting his small crop is only the matter of a few days and on account of having such a small crop he stacks it after it has stood in the stook for a couple of weeks. During the remainder of the time until freeze up the disc or drag harrows are kept going on the breaking getting it in first class shape for sowing in the following spring and his own time is well spent putting things in shape around the yard and buildings. The threshing is done by a large machine at 7c for wheat and 5c per bus. for oats. The outfit has a boarding car. The crop returns are three hundred bushels of wheat and one thousand of oats. This work is finished before his man leaves on the first of November. During the winter the farmer spends his time doing chores, hauling, cutting and piling twenty-four loads of wood, twelve each of dry and green. The remainder of the time is spent in hauling hay, cleaning seed grain and odd jobs about the place.

Second Year

When spring opens up about April the first everything is ready for the summer's work. He has again hired a man for the summer at thirty dollars per month. During wheat seeding one team is kept on the drill steady, while the other is on the drag harrow giving the land a single stroke both before and after the drill. All the land that was in crop the previous year is spring plowed and sown to oats. After seeding they take a week to plant potatoes and put in some garden. Also, two rows of trees are planted in the wind break with young poplar from a natural bluff near by. Previous to this he had sent in an order for trees, for the next spring's planting, to the Forestry farm at Indian Head. There are one hundred and forty acres to break this summer and as the six horse team and gang are only able to break about one hundred acres it is necessary for him either to hire forty acres broken, or buy another horse and a hand plow and do it himself which he decides to do. He buys the extra horse with the intention of selling him again in the fall. In this way he saves about \$100 on the breaking. This part of the summer's work is finished about July 12, when both teams are used in discing which necessitates the buying of another set of discs at \$45. By working at it in wet weather the breaking has all received a double stroke before harvest commences. About the same amount of hay is put up under similar conditions this year as the previous one. By working until seven in the field during cutting this work only takes about two weeks. This year the threshing is done out of the shock by the same machine as the previous year only at eight and ten cents per bushel for wheat and oats respectively. The wheat is put into three portable steel bins in the field and three hundred of it is put in a bin in the work shop, while the oats are put in bins in the stable. The returns from the land this year are three thousand of wheat and fourteen hundred of oats. As soon as the threshing is finished the discs are started again giving

the breaking a double stroke "cross ways" followed by a double stroke with the drag harrows each way. This is followed by hauling out the grain which takes most of the time until the end of the year. The remainder of the winter is used in hauling and cutting wood, etc.

Third Year

The spring of the third year, 1913, finds him ready for action waiting for the break up. This year he hires a man for the year at thirty per month. This enables him to get a good man and also makes it possible to retain him for a number of years providing everything is satisfactory. The wheat all being on breaking is soon in, after which the oat land is plowed and sown. This consists of forty acres of field No. II. The remainder of this field is disced as soon as possible to give any surface weed seeds a chance to germinate and also by breaking the surface moisture is conserved. The manure that has accumulated on the farm up to this time is spread on this land after which it is plowed and twenty-five of it sown to Barley. By the use of a grass seeder attachment this land is seeded with brome at fourteen lbs. per acre. The remaining five acres are planted with fodder corn. The breaking which is the heavy part of the work in starting on a new place was finished the year before leaving him more time during the third summer to make preparation for handling some cattle. After seeding and until June 15th his man and himself are occupied planting potatoes and garden stuff, fixing up the lawn by setting out some perennial borders, specimen trees and laying some cement walk from the house to the front gate. The house yard is also fenced with woven wire and iron gates on good cedar posts. A temporary fence is also put around the pasture as indicated in the plan. The trees obtained from the Experimental farm are planted in the wind break together with two rows more of small poplar making fine rows. The remaining three rows are to be planted the following spring

Continued on page 66

EMERSON SERVICE

How a Great Modern Institution Centralizes the Products of Ten Large Plants in One Selling Organization and Distributes Through Retail Implement Dealers the Largest Line of Farm Machinery in the World

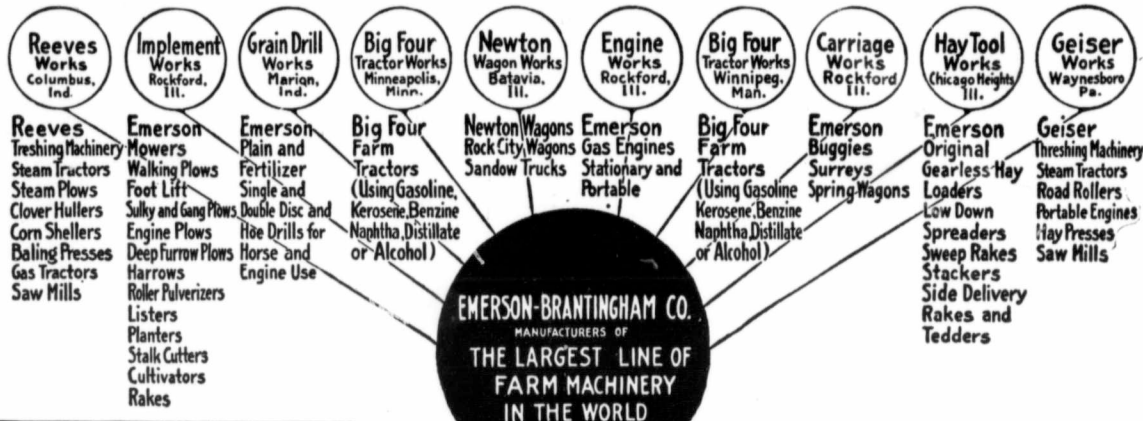

NOW the FARMER
can have the **EMERSON**
name and reputation behind
every implement he buys.

The **EMERSON Service**
and guarantee can now be
obtained on every imple-
ment the farmer uses.

**EMERSON-BRANTINGHAM
IMPLEMENT COMPANY
ROCKFORD, ILL.
DISTRIBUTERS**

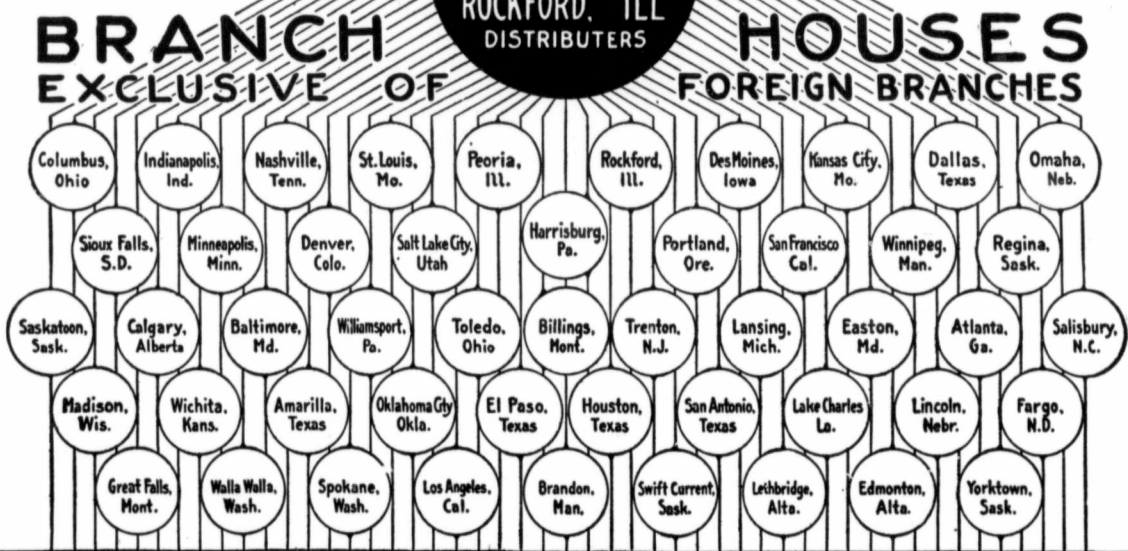

Sold by 12,000 Retail Implement Dealers to
Over Eight Million Farmers

We Want to Send Catalogs and Information to Every Farmer

Mail This Coupon
TODAY!

EMERSON-BRANTINGHAM IMPLEMENT CO., 156 Princess St., Winnipeg, Man.
Please send free catalogs on _____
Name _____
Address _____

GASOLINE TRACTION ENGINES

A DEPARTMENT FOR THE USER

We want every owner of a gas tractor in Western Canada to give us his experience. The owners of gas tractors to-day are in a sense pioneers. They are working out the data and compiling a record of work done that both manufacturer and farmer alike the world over are watching with intense interest. Don't keep what you know under your hat, but let us have a story of your gas tractor work. We will reward every such story with a copy of "Plain Gas Engine Sense," one of the best handbooks we know of on the gasoline engine. Don't neglect this matter but let us have your experience at once.—(Editor.)

Likes It.

I am certainly pleased to give you what experience I have had in the line of traction plowing.

My engine is an International 20 horse power, and my plows are the John Deere four bottom plow. I employ simply a boy on the plow and operate the engine myself.

I use two gallons of gasoline per hour, or 20 gallons for ten hours work, and about the same for breaking. We turn one acre per hour easily, at an average cost of \$1.20 per acre. I use about 1½ barrels of water on an average per day.

Regarding plowing being harder on my engine than threshing, I can see very little difference on my engine with the strain in either case. However, the condition of the grain and condition of the earth has a slight effect on it.

I have had no experience with hitches.

Now my general experience with the outfit is very satisfactory. I find I could not begin to do its work for twice the money, or do it as well with horses. My engine has never given me any trouble. I have worked with it when 10 or 15 degrees below zero, and it starts as readily as at any other time of the year.

Hoping that these few facts may be of some use to intending purchasers, and help you in your own work, I remain,

Yours respectfully,

C. Caron.

Mutrie, Sask.



Bad Oil Causes Trouble.

I might say I just got my engine before threshing commenced. I did some threshing and then I plowed about 130 acres.

I cannot give a very bright account of my work, as I was entirely green at it. My engine is a Hart-Parr gasoline engine. My batteries were weak at first, and I did not get very good satisfaction.

I could not get a very early start in the mornings as the ground was frozen so hard. Then I had some oil which was anything but good. However,

having had some experience during the past season, I will be in a position to do anything the coming season, and will be able to make a better report another year:

I do not intend to do any other work than threshing and plowing this year.

Yours truly,

Wm. Miller.

Elstow, Sask.



Uses Disc Plows.

We have a 45 brake horse power or 25 traction horse power Hart-Parr gasoline engine. Our plows are Cockshutt, and we pull 5 or 6 bottoms, according to the condition of the soil. They are

Likes Gasoline.

In regard to your inquiry, relating to my experience in traction plowing, will say, in the spring of 1911, I purchased a Big 4-30 gasoline traction engine, manufactured by the Gas Traction Co. of Minneapolis. I have used the same for plowing during the past season, pulling a six furrow P & O engine gang, which the engine handled with the greatest ease. In fact, I could have pulled two more plows. The land is very heavy clay gumbo. People plowing with horses have been using from five to six horses on a 14-inch plow, so you may understand what kind of land it is. I

In regards to cost of plowing with gasoline, will say it took about 2½ gallons of gasoline per acre, which cost me 21 cents per gallon in my own tank from the storage warehouse. It cost me in the neighborhood of \$1.00 per acre for breaking and about 80 cents per acre for summer-fallowing. In summer-fallowing I used a 14 disc Emerson plow, which cut 10 feet wide, of which the engine hauled quite easily, though in some places it was almost prairie.

The engine is a 30 horse normal and 60 break test, and in plowing in very hot weather we used about three pails of water every two days for cooling. The tank holds about a barrel and a half of water.

I employ two men to run the outfit. I have done some threshing the past fall, driving a 36 x 60 Winneschiek separator, though I could as easily drive a 40 inch separator if I had it, as the engine handled it very easy in the wet tough grain that we had the past fall, and give a very steady power.

In my opinion a four cylinder engine is way superior to a single or double cylinder engine for threshing or plowing, as I have had several years experience, having operated a two cylinder engine, which I found to give very unsteady power and found it was very wasteful in oil. I have not had any experience in pulling seeders or disc harrows yet, but intend to try the same the coming spring.

My hitch consists of a 40-foot draw bar on two wide wheels placed about six feet in from each end with draw rods from end of bar about 15 feet long, coming together on a casting, which hitches to the engine with two shorter rods, connecting on the same casting. I consider this a good hitch, as the length of bar gives plenty of spacing, it could also be trust with rods to keep it from sagging if necessary. The bar consists of heavy three cornered channel iron, and is supported by heavy cast iron brackets, to which the wheels are attached. I think this is about the simplest and most durable hitch I know of.

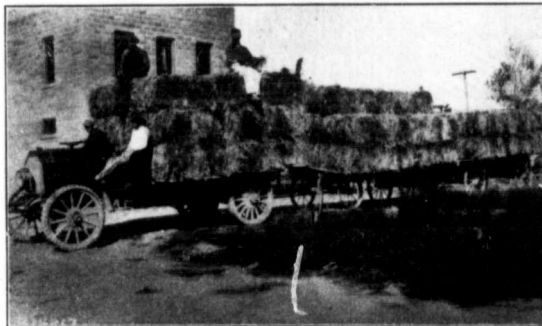

The Avery Farm Tractor Doing a Real Hauling Stunt

14-inch bottoms. We have also Emerson disc plows, and we pull fourteen with ten inches each.

In the summer time we have on an average of six men working for us and in the fall about 14. We have at present 24 head of work horses.

We use gasoline to start up and then turn on to coal oil. It takes about 70 gallons for a 12 hours run, and just about the same of water.

I consider it a great deal harder to plow than to thresh.

We broke over 1,200 acres and summerfallowed 480 acres, and we estimated the cost \$2.25 per acre. That is for everything.

We just use our engine for plowing and threshing, and have never used it for drilling or harrowing, for I think it pays us to keep it plowing.

Yours truly,

Regina, Sask. G. C. Moore.

am highly pleased with the engine, have found it very easy to operate, and also it is a splendid engine for plowing in wet weathers, as the big wheels will take it through places that a small wheeled engine couldn't go through. In fact, I have travelled with this engine on the road when it was so wet that they could not travel with loaded wagons. I have also one of the Gas Traction self-steering devices, which I will say is a great invention. I can start it on the end of a mile furrow and it will steer the engine to the other end without me touching the steering wheel, and in my opinion it will be a long time before they get anything that will beat this for steering an engine. I would not be without one for any money, and would not buy an engine without one, as I consider it a great help in steering.

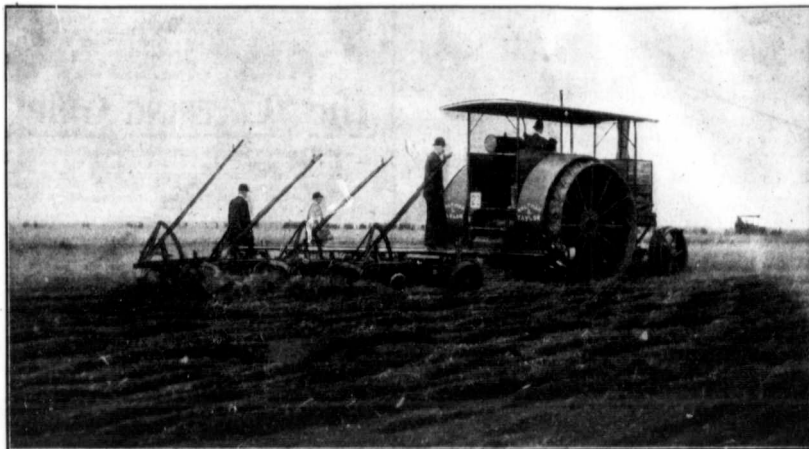

To Our Friends

The Farm Power Users of the World

The Well Known Season's Greeting—"A Merry Christmas and a Happy and Prosperous New Year"—is extended to all of our friends, many of whom favored us with orders for the **Famous Aultman-Taylor 30-60 Gas Tractor**. Throughout the entire season of 1912, the demand for the **Aultman-Taylor "30"** has taxed our factory to its utmost capacity.

With increased facilities for 1913, we will be in a position to better serve our customers than ever before, but our policy will remain unchanged—not how many, but how well can we build? Every **Aultman-Taylor "30"** will be given that same careful and thorough inspection throughout its construction which insures to the purchaser that high standard of excellence characteristic of all **Aultman Taylor machinery**.

Here's the reason for this overwhelming demand: The **Aultman-Taylor "30"** is not a cheaply and hurriedly built tractor—not built to meet a certain price—not a stationary gasoline engine converted into a so-called tractor, but an especially built farm tractor, designed for maximum service, built of the very best materials obtainable and by men whose life's work has been entirely devoted to the designing and building of high-grade farm power machinery.

The man who buys an **Aultman-Taylor "30"** is assured **maximum power at minimum cost**, combined with **reliability, durability and adaptability**. The remarkable performance of this tractor on the field, as well as in every official test in which it has participated, proves conclusively that it is the **most economical, most convenient and most reliable tractor ever placed on the market**.

50 Years of Experience Back of This Tractor

For nearly a half century the **Aultman & Taylor Machinery Company** has been building reliable farm power machinery. It's a great thing to know that the **Aultman-Taylor "30"** is backed and guaranteed by the **Aultman & Taylor Machinery Company**, whose name is a household word in every farming community—whose reputation for building High Grade Machinery and dealing fairly with customers is well known wherever farm power machinery is used.

Write us today for descriptive literature and during the long winter evenings learn more about this superior tractor, or call at our nearest branch and look it over. **Do it now.**

The Aultman & Taylor Machinery Co.

MANSFIELD, OHIO

BRANCHES: Minneapolis, Minn., U.S.A. Calgary, Alta. Regina, Sask., Canada

Gasoline outfits are used extensively in my neighborhood. I have not a picture of my outfit at present, but will send you one later on.

Will say that the Big 4-30 is a splendid plowing and threshing engine, and can highly recommend it to anyone wishing to purchase an engine, as this is all I can think of at present, so I will close my letter. I remain,

Yours truly,

W. H. Cathcart.

Drinkwater, Sask.

P.S.—I have been a subscriber to your paper for a number of years, and like it very much. I would not be without it. It is a great help to farmers.



The Best Way to Plow.

I received a letter from you some time ago, asking for my experience on plowing. I have had a little experience in plowing, and would say that it is the best way to plow land, but only when it is dry, as I don't believe in plowing when it is wet, with an engine.

I use a 30-h.p. Rumely Oil Pull, and it is a dandy, because I can pull 13 plows in stubble and 10 in sod, and I can pull 13 in timothy sod.

I use a Cockshutt plow with 10 bottoms, and when plowing stubble I hitch a gang on behind. I can plow 40 acres in stubble land per day with two men.

I think plowing is harder on the engine than threshing. It cost me about \$1.50 per acre to plow four inches deep. My engine is too heavy for that purpose, and I think it better not to go on the plowing with the engine, as the horses are better for seeding.

Steam and oil tractors are about the same number down here.

Yours truly,

W. J. Kerr.

Otterburne, Man.



One Man All That Is Needed

My engine is a 30-60 Rumely Oil Pull, and I use an 8-bottom John Deere engine gang. It makes a good outfit for breaking and backsetting, but in stubble I can pull more plows.

Last fall, when plowing away from home, we used another engine gang, a 10-bottom one, and when we started to plow at home again, we used our own 8-bottom engine gang, and put an ordinary horse gang behind, so that we had ten plows. Two men can handle the outfit very nicely.

I also bought a steering device, which helps out in steering the engine.

Las fall, at threshing time, when men were scarce, my engineer sometimes plowed all alone. About all the horses we need is just sufficient to haul a tank of oil and a tank of water about once a week. We use engine kerosene for fuel, which we get out of the storage tank at Sperling, for 11¼c. per gallon, but we have to start the engine on gasoline. A barrel of gasoline, of course, lasts us a long time when used only for this purpose.

I didn't do any threshing with my engine, but some of the other engines of the same type, threshing in this neighborhood, got along very nicely.

In breaking we used from 3 1-5 to 3½ gallons of fuel oil to the acre. Last spring I did some seeding and harrowing with the engine, for which we used a little over three-fourths of a gallon to the acre. We pulled three drills and harrows, enough to cover the same strip that the drill cut, making a strip 32 feet wide, which was a light load for the engine.

Yours truly,

H. W. Palas.

Sperling, Man.



Believes Fall Plowing Best

Your articles on traction plowing and your experience letters, I must say, are very interesting to me, and so I will try and do my best to tell you what I know about it.

My brother and I bought a 20-h.p. International Gasoline Tractor four years ago. The first two years we only used it for threshing and chopping, but two years ago we got a 5-bottom 14-inch Cockshutt engine gang. We have had very good success with this, and did a nice lot of work while it kept dry, but as soon as it got wet we had to quit.

The fall of the year is the best time for engine plowing. We used about 15 to 20 gallons per ten hours work while plowing, and plowed about one acre per hour. Two men were all that were required to operate the outfit. We used about 1½ barrels of water per day.

We consider that plowing is a lot harder on the engine than threshing. The load while plowing is always constant, while in threshing it is more or less varied. We have not tried any other machinery behind our engine, so can give you no experience along that line.

We usually take out enough water and gasoline in the morning to do us all day.

Our chief drawback here is the small slews and bluffs, which, of course, make short furrows. The engine, however, is far ahead of

THE TOP NOTCH OF EFFICIENCY AND STRENGTH

Lays its own steel track—model of skill and common sense construction, after the best traction principles. The "Creeping Grip" works in loose or soft ground without excessive pressure. Sure and dependable anywhere. Works easily on land too soft for a "heavy wheeler," or in late fall plowing when the "heavy wheeler" clogs or slips, or in the spring during thaw, or over bad hollows or ridges. The "Creeping Grip" hangs on with its traction shoe like a "dog to a root" and pulls its load with it.

The "CREEPING GRIP" TRACTOR

60-45 h.p.—All working parts easily accessible. Auto type steering device—one lever control—three speeds forward, one reverse—dust-proof transmission—roller bearings—non-clogging continuous steel track, and every feature fully proven in actual use. A "Creeping Grip" is a steady, powerful and universally useful tractor, giving maximum power at the draw bar or belt pulley.

DEALERS: Here is the opportunity of a lifetime. The "Creeping Grip" is the best tractor of all, sells at a fair price, and will bring you a reputation because every one sold will sell others. The features, efficiency and construction of the "Creeping Grip" Tractor give you the most convincing arguments in the world for selling to those who want, and ought to have, high-grade tractor service.

Send today for Catalog and Terms

WESTERN
IMPLEMENT
AND MOTOR
COMPANY

Department G

Davenport
Iowa

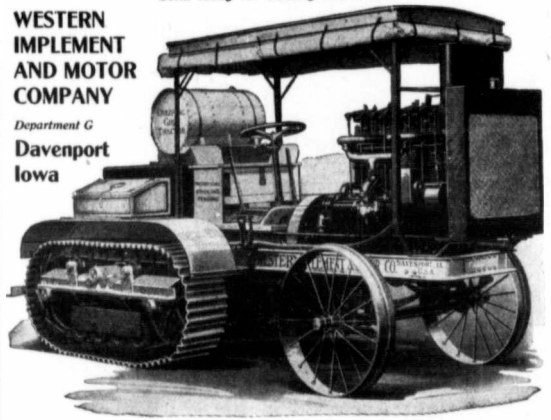

You saw this advertisement in this magazine. Don't forget to say so when writing.

What Do You Demand Of The Tractor You Buy?

You expect that tractor you intend buying, to increase your profits by decreasing the cost of producing your crops.

Consider this: It is the motor in the tractor that must make good these expectations. You can buy a tractor that will deliver every bit of the real efficiency your farm work demands—and that is any tractor equipped with the **Waukesha Long Stroke Tractor Motor.**

The Waukesha Long Stroke Tractor Motor is strictly a tractor motor. It is the strongest motor in the world—and its strength means an almost entire elimination of repair expense.

The Waukesha Crankshaft has a tensile strength of 140,000 lbs. to the square inch. The Bearings have 3 times the wearing qualities of the best in general use. The Piston Pins outwear the bronze bushings—it's the other way 'round in other motors. All these metals are our own exclusive features—you can't get this strength in any other tractor motor made. The Waukesha stands the pounding of the heaviest work you can impose on it.

It burns only 1 pint of kerosene per hour per horse-power—only ¼ of a pint of gasoline. That fuel economy is equalled by no other motor.

There are several tractor manufacturers using the Waukesha. They are putting a perfect motor in their tractors just to give you the efficiency they promise. Write us for a list of these manufacturers. Tell us the size of your farm. We'll be glad to help you select just the right size tractor to suit your requirements, and we'll tell you all about the Waukesha Motor. Write us that letter tonight.

Waukesha Motor Co.

Second St., Waukesha, Wis.

We don't make Tractors, but just efficient Tractor Motors. [3]

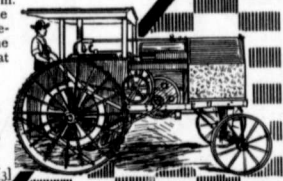

horses, for you can get in as many hours' work as you like. The engine handles the five plows quite easily, and when it comes to threshing, we have all the power that is required.

Yours truly,
Birtle, Man. John Young.

A Good Start

With regard to my experience with a traction engine, will say that it is rather limited, as I have only had mine working for about two months last fall.

We plowed 175 acres and threshed 35 days. The plowing that we did was just when we were waiting to repair a separator, and, therefore, there was not much notice taken of how much was plowed per day or how much gasoline was used.

My engine is a Minneapolis Big Four-thirty, and my plows were Cockshutt engine gang, consisting of six 14-inch bottoms.

I used about 40 gallons of gasoline per day, and about two pails of water during the same time. I am convinced that plowing is harder on the engine than threshing.

It cost me about \$1.10 per acre, as near as I can estimate, to plow.

I have not had any experience with pulling drills, discs or harrows as yet.

Oil tractors are more extensively used here than steam.

I expect that by next winter I will have something more definite to present to you, as I expect to do all my seeding, plowing and harvesting with my engine. I have not had any experience with engine hitches.

Yours truly,
Rosetown, Sask. Jas. Machan.

Saving \$1500 in One Season

For the last season I have been working a 25-h.p. gas traction engine, and the amount of work done speaks for itself.

Last spring I seeded, packed and harrowed 500 acres, and of this plowed 150 acres. I summer-fallowed 250 acres seven inches deep. I packed and harrowed it four times, and cultivated most of it with the disc. In harvest, I cut the 500 acres and fall plowed considerably, and threshed all of the crop.

This work was done for \$450 worth of gasoline and with the assistance of four horses. I had only two men till harvest, but, of course, in harvest and threshing I had more.

I believe it cost me \$1,500 less to farm this last season with gas power than it would have cost me by using horses.

Sincerely yours,
C. S. Touchburn.
Alexander, Man.

FLOUR CITY TRACTORS



Let "Proven Service"—not "Price" Govern Your Tractor Purchase

NOW THAT POWER FARMING has become general, the chief question that arises before prospective purchasers is—which is the **BEST** tractor to buy? It is not a question of buying a tractor for the least money, but one that is **designed and constructed** on lines that have been proven to be best adapted for **general farm work**.

The "**FLOUR CITY**" was the first gasoline tractor in the field, consequently was not guided by the experience of others. It was not built upon theory, but from a practical standpoint. Its try-out and development was in our own field where it was subjected to all the varied conditions incident to general farm work. It passed through the experimental stages long before others appeared. That we "**made good**" is best attested by the fact that the "**FLOUR CITY**" carried off the Gold Medals four years in succession in the Winnipeg contests in both gasoline and kerosene classes.

The "**FLOUR CITY**" is not built with a view of underselling the other fellow. Our policy is to build the **best** regardless of cost. We manufacture only one line, and concentrated efforts in one direction has placed the "**FLOUR CITY**" in a class by itself, and today it is recognized as the **highest development** of a gasoline-kerosene tractor.

We make no claims the "**FLOUR CITY**" cannot fulfill. Its success is due to **merit alone, and its record is open to the world.**

If interested send for Catalog 828 44th Avenue North



KINNARD-HAINES CO. MINNEAPOLIS-MINN.

Any Man Who Will Can Do It

I am simply a gasoline plow man, and have no experience whatever with threshing, but can give you a bit of experience which extends over two seasons. My engine is an I.H.C. 20-h.p. With this I pull five Cockshutt, and working 14 horses I can plow 15 acres.

My gasoline cost me 22 3/4c. per gallon. I used about 27 or 28 gallons plowing the above, also two barrels of water.

I consider that a gasoline outfit is cheaper than steam. I work my outfit myself, in this way doing away with a plow man. From what I can see, I should

consider that plowing is harder on the engine than threshing, on account of the dust getting into the gearing. Taking into consideration the cost of fuel, wages for myself, other oils for lubricating, hauling gasoline and water, depreciation of machine and sundry repairs and batteries, it cost me as near as I can estimate \$1.50 per acre. Stubble plowing, is of course, not so hard on the engine as breaking.

I have had no experience with hitches, as I have only plowed. I must say in conclusion, that any man with a few grains of common sense and a little stick-to-itiveness, can run a gasoline

engine, as it is so very simple. I can safely say that I have experienced no difficulty with my machine that I could not rectify myself.

Yours truly,
H. A. Porteous.
Oakville, Man.

A college professor, noted for strict discipline, entered the classroom one day and noticed a girl student sitting with her feet in the aisle, and chewing gum. "Mary," exclaimed the indignant professor, "take that gum out of your mouth, and put your feet in."

I H C Kerosene - Gasoline Tractors

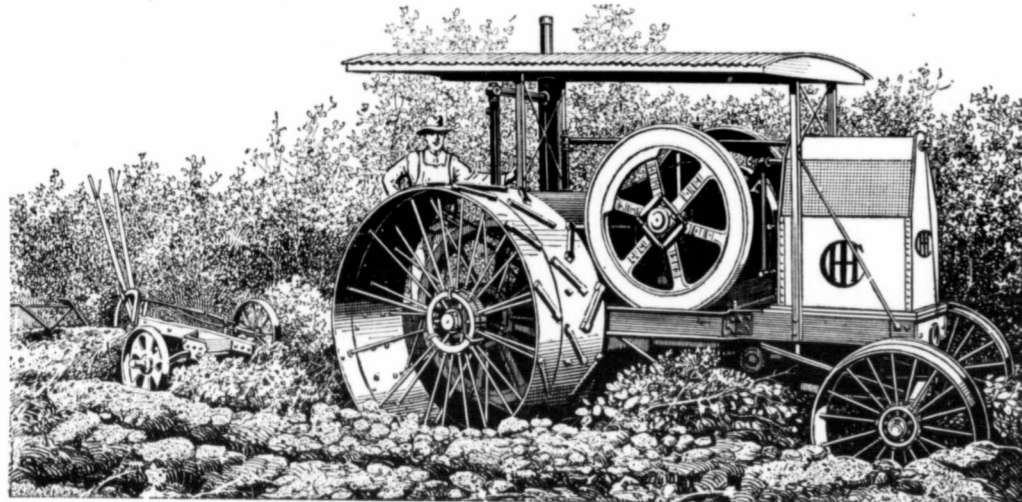

MOST POWERFUL

Machines Do Hardest Work

All the hardest farm work, the work that used to wear out horses and make farmers old before their time, can now be done by machines. Plowing, harrowing, disking, seeding, harvesting, threshing, pumping sawing, grinding—all the ordinary "hard work" operations of farm life are made easy by the use of reliable, dependable IHC tractors and engines.

Investigate I H C Tractors

Your interests demand a thorough investigation of this farm power question. You want your work finished on time. You want it well done. You want to make it as easy as possible for yourself. Take a week—or a month if necessary, this winter, to investigate IHC Kerosene-Gasoline Tractors. Then decide to which size and style you will turn over your spring plowing and the rest of the hard work.

MOST ECONOMICAL

An I H C Tractor's General Usefulness

Changes in farming methods usually result in unexpected benefits to farmers. When you buy a tractor or engine you expect it to save you all the harvest work but you will undoubtedly find a great deal of new work—work that you never before thought of—for your new engine to do. The engine itself will suggest many profitable uses that you never thought of until you had the power.

The Tractor a Hard Worker

When your IHC tractor or engine is installed on the farm, and you have become accustomed to it, it will not spend many idle days. You can work it as hard as you please and as long as you please. All it asks is plenty of fuel and oil and the right kind of care. Give it proper treatment and an IHC tractor will far outwork the best horses.

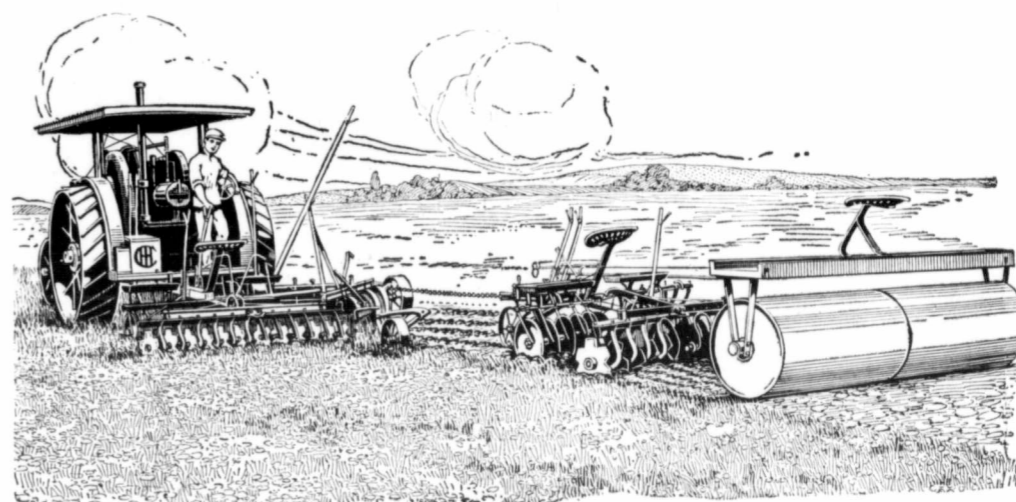

MOST DEPENDABLE

Cost of Operating a Tractor

Since a tractor is purchased to do the work of horses, cost comparisons must be made on that basis. Individual comparisons with horses are deceptive and seldom do justice to either horse or tractor. It is only by taking the average of a large number of cases that any valuable data can be obtained. In 500 cases taken during 1912 it was shown that the cost of farming with an IHC tractor is little more than one-third the cost of doing the same work with horses. The tests included all the ordinary farm work for which tractors are adapted. Plowing, for instance, averages \$1.25 per acre with horses and 45 cents per acre with the tractor.

Dependability of I H C Tractors

Being ready for work whenever called upon is a valuable characteristic of IHC engines and tractors. The machines are so simple, and yet so strong, that there is little likelihood of trouble of any kind. IHC engines start readily, run smoothly, develop plenty of power, and generally finish on time the work they are set to do. IHC tractors, properly handled, make splendid records. One tractor in North Dakota was used every day for 204 days and during that time had four weeks of day and night service, 24 hours a day.

Why I H C Tractors are Best

A farmer or thresherman cannot afford to take chances with power. His work must be done on time and in season. Therefore he should buy an IHC tractor. Is overtime demanded?—the IHC tractor is always ready. Is the load a heavy one?—the IHC has plenty of reserve power. Is the work dusty and dirty?—the IHC has no exposed bearings or rapidly moving parts to be injured. It carries its own daily supply of fuel. It may be set close to a stack without reference to the direction of the wind, without danger of fire, and with all these advantages, it has done, is doing, and will do more work, in less time, at lower cost, and will last longer than any other tractor you can buy. These are statements of fact, backed by records made in actual use both in contest fields and on real farms.

Investigate tractor farming. Learn how you can profitably use an IHC tractor. Get all the facts from the IHC local agent. He will point out the many IHC tractor features and advantages in design, materials and construction. He will tell you about the complete IHC line, which includes gasoline and kerosene tractors, 12, 15, 20, 25 and 45-H.P., in several styles, and horizontal and vertical general purpose engines, stationary or mounted on skids or trucks, air-cooled or water-cooled, 1 to 50-H.P. See him or write the nearest branch house for catalogue.

MOST USEFUL

Branches:

International Harvester Company of America

- Ottawa, Ont.
- Brandon, Man.
- Quebec, Que.
- Calgary, Alta.
- Edmonton, Alta.
- Regina, Sask.
- Hamilton, Ont.
- St. John, N. B.
- Lethbridge, Alta.
- Saskatoon, Sask.
- London, Ont.
- Weyburn, Sask.
- Montreal, Que.
- North Battleford, Sask.
- Winnipeg, Man.
- Yorkton, Sask.

Course in Gas Engineering

CONDUCTED BY D. O. BARRETT

This course consists of a series of practical talks on the theory and practice of the gas, gasoline and oil engine. They will be simple, illustrated when necessary, and of such a nature that the gas engine owner may easily adapt them to his daily engine work.

Lesson XXIV Ignition

IN lesson XXI we took up the subject of Ignition from the battery standpoint, and showed the various connections for the

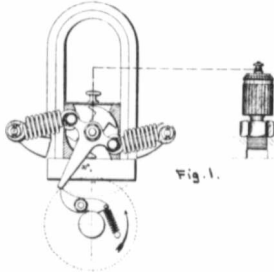
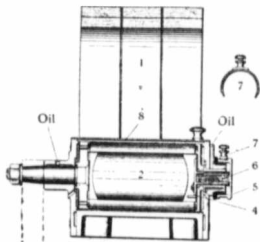

Fig. 1.

most common systems. Mention was also made of magnetos, and we wish now to show one or two types of some of the latest forms of magneto ignition which are rapidly replacing those using of this form of ignition apparatus batteries.

One of the oldest manufacturers is the Bosch Company. They as well as several other firms make rotary magnetos suitable for high speed automobile engines, but the types shown here are suitable only for the slower running

Longitudinal Section of the Magneto.



Description of Parts.

- 1 Steel magnet.
- 2 Armature.
- 3 Brass cover with stud for the terminal conducting spring 6.
- 4 Balance springs.
- 5 Insulated brass plate with hole for the connection of the winding.
- 6 Brass cover with stud for the terminal conducting spring 6.
- 7 Spring steel with connection terminal.
- 8 Dial cover.
- 9 Eccentric bolts for the springs.

Fig. 2.

stationary engines, such as we have been discussing previously in these lessons.

In Fig. 1 is shown the Bosch type K-23. The armature of this magneto has only an oscillating motion through an arc of about 30 degrees out of normal. To the armature is fastened a long projecting arm, with two attached springs for holding in its normal position. This arm is pushed out of normal by means of a cam on the rotating half time shaft of the engine. As shown, this cam is arranged with a spring connection

so that in case of a backfire, or if the engine is turned backward, this will simply slip by the magneto arm without causing rotation in that direction. With this type of magneto the time of ignition is fixed, that is, it always occurs at the same point in the stroke of the piston as far as the magneto itself is concerned. The only method of changing the point of ignition is by mechanical means that is, by changing the time at which the arm on the magneto shaft shall slip its driving cam. This may be done in several ways, the details of which are not shown here.

A section through the magneto is shown in Fig. 2; the armature 2 carries a single winding in which the current is induced when

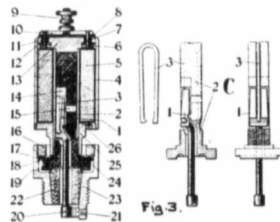

Fig. 3.

the armature is rapidly moved, due to the action of the springs at the time the arm is slipped off the cam. The spark of course occurs at this moment. The current is taken from the armature through the brass spring 6 to the brass cover 5. This spring allows for the oscillating movement of the armature and does away with brushes or moving contacts of any kind. A spring 7 carrying the connection terminal slips over the brass cover and may be turned completely around to any position desired.

As shown in Fig. 1 the current is taken directly from the magneto to the magnetic spark plug, a section of which is shown in Fig. 3. This plug has a magnetic coil, 5, which operates the interrupter lever which makes contact at the

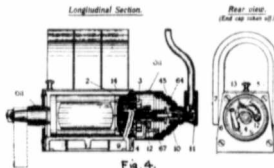
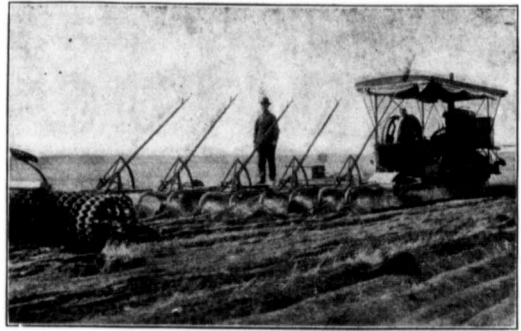

Fig. 4.

lower end with 21; when this contact is broken at these points a spark occurs between them the same as in the ordinary make-and-break mechanically-operated ig-



Holt Caterpillar Tractor

The all-purpose farming and freighting tractor. Most practical because it works on wet ground and won't mire down. The long bearing surface of the caterpillar track on the ground does it. The CATERPILLAR is compact, with a low center of gravity; it is simple and accessible. You know what this means in the field. If you wish more information, your name on the coupon will bring it.

Canadian Holt Co. Ltd.
609 Eighth Avenue, West
Calgary, Alberta

Name _____ Address _____
Please send me Caterpillar Catalogue.
C.T. & F. 12-5-12

You saw this advertisement in this magazine. Don't forget to say so when writing.

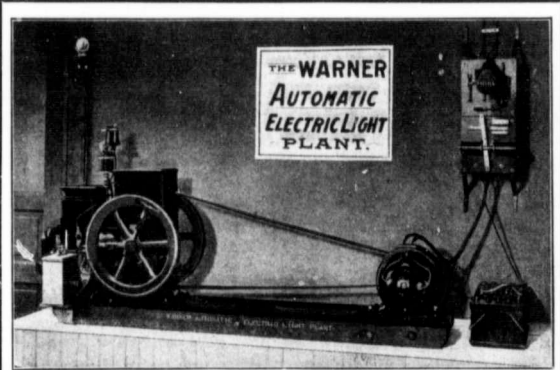

You Can Now Have Electric Light in Your Own Home

Each plant is complete with Special Self Contained Gasoline Engine, Special Automatic Electric Dynamo, Storage Battery, Automatic Switch-board, and all necessary instruments. Each plant is entirely automatic, the engine starting and stopping itself whenever necessary. The only attention required is to fill with gasoline and oil, and whenever this becomes necessary an electric bell rings and keeps on ringing until the fuel is placed in the tanks. No electrical experience is necessary. These are the **only** plants made that are **absolutely automatic** and "fool proof." The gasoline engine will also burn kerosene in case of emergency. The cost of operation is almost nothing. Each plant comes completely mounted on suitable timbers, and requires no expert to set it up. They take up a very small space in basement, and are almost noiseless. There is no danger from the electrical current, in fact, the pressure is so low and harmless that two wires may be placed in the mouth without danger.

PRICE LIST

Plant No. 50. -This is our smallest plant. It will run continuously seventy-five 8 c.p. lamps; or fifty 12 c.p. lamps; or thirty-seven 16 c.p. lamps. Cost of operation about 1 1/2c. per hour. Weight, 750 lbs. Price, \$450.00 complete F.O.B. Winnipeg. Terms, 25% with order, balance C.O.D.

We have several larger sizes of plants. Pieces on request.

WESTERN MOTOR COMPANY, 52 1/2 Princess St., WINNIPEG, MAN.

You saw this advertisement in this magazine. Don't forget to say so when writing.

When You Buy a Tractor Buy a Medal-Winner!

The "IDEAL" Tractor took silver medal at the Winnipeg Trials last summer, beating every entry in its class for design and construction. In the life of a tractor, design and construction play a great part, much the same as the constitution of an individual governs the length and productiveness of his life.

The "IDEAL" Tractor has two opposed cylinders placed horizontally upon cast bed pieces. Pistons are operated by a two-throw crank shaft, placed in heavy bearings between the two cylinders. This gives perfect balance and ensures the greatest power at lowest cost.

The engine is governed on the throttling principle, and is fitted with jump-spark ignition. We use the vibrating Bosch system of ignition, which is positive in action, no batteries being required, and works irrespective of weather conditions.

All levers are within easy reach of the operator. Drive wheels are made on our improved 1912 pattern, adopted after many tests. Our water pattern ground locks, prove best for heavy sticky soil.

The "IDEAL'S" steering device is similar to that in automobiles. Front wheels are attached to axle, permitting short, sharp turns. Our steering device overcomes all "walking" of the front wheels, and enables the operator to run perfectly straight when plowing. This feature is fully protected by patents.

The Cooling System is of the automobile type. It gives perfect results with only a slight evaporation of water. Water jackets of cylinders are so constructed that only a small percentage of water is heated at each explosion.

There are many other points about the "IDEAL" Tractor that make it best for Western use. Let us send you our catalogue, which describes it fully, and gives letters from users, telling of their experience.



Gold, Shapley & Muir Co. Ltd.,

MANUFACTURERS OF "IDEAL" Gasoline Tractors, "IDEAL" Hopper-Cooled Gasoline Engines, "Maple Leaf" Grain Grinders, Windmills and Pumps of every description, Wood Sawing Outfits, etc., etc.

Brantford

WINNIPEG

Calgary

You saw this advertisement in this magazine. Don't forget to say so when writing.

niter. This plug is entirely self-contained and its advantage lies in its simplicity, as there is practically nothing to get out of order and it may readily be screwed in to any opening of the proper size at any point in the combustion chamber. This makes it very handy in replacing other systems which for any reason have been discarded.

Fig. 4 shows a Bosch high tension magneto of practically the same outward appearance, and operated in precisely the same manner as the low tension magneto just described. With this magneto it is only necessary to run a cable from the magneto directly to the spark plug, thus doing away with coils and other apparatus.

Around the armature are two windings, the primary, of heavy wire; and the secondary, of fine wire. One end of the primary winding is grounded to the armature core, the other running to the insulated bolt 2 which makes connections with the contact block 3 in the end of which is the platinum tipped screw 5, these all being insulated from the body of the magneto. The platinum tipped screw 13 is fastened to the hinged lever 7, the two platinum points being caused to separate at the proper moment in the movement of the armature by the

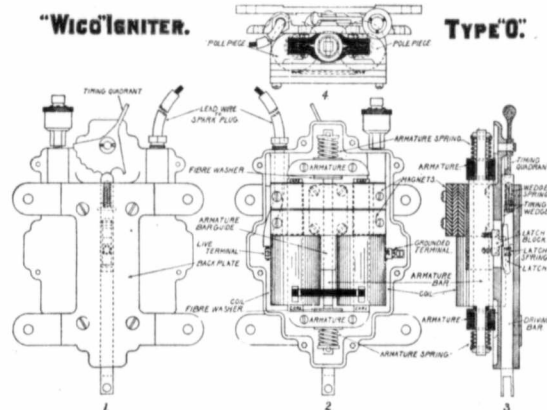

Fig. 5.

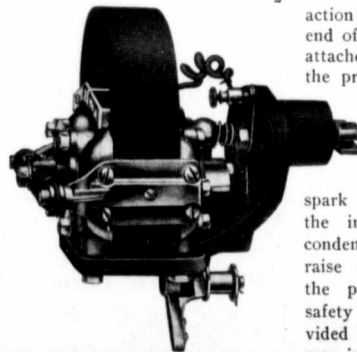

Fig. 6

action of the cam 12. The one end of the secondary winding is attached to the grounded end of the primary winding forming a continuation of the same. The other end leads to the collecting ring 9 and so to the cable and thence to the spark plug. In parallel with the interrupter points is the condenser 8, which serves to raise the voltage at the time the points are separated. A safety spark gap is also provided across which the current may jump should the outside cir-

cuit in any way be broken, this preventing excessive voltage which might cause damage to the windings of the armature. When the interrupter points are separated by the action of the cam the primary and secondary windings are in series, and a high voltage current is induced which causes a spark at the plug. A special form of plug is used by which it is claimed a very wide spark or ribbon flame is obtained which will ignite very weak mixtures.

Fig. 5 represents the Wico Igniter, the operation of which is somewhat similar to that of the Bosch machine just described. In this there are two coils with high tension windings connected in series. One end of this winding is connected to the metal case, the other end to the cable leading to the spark plug. For a two cylinder machine the grounded end is attached to the cable leading to the spark plug of the second cylinder.

In the back of the case is a square driving bar having a reciprocating movement and carrying a tool steel latch which engages a tool steel latch block attached to a bar carrying at each end an armature. Across the ends of the coils are Tungsten steel magnets fastened to cast iron pole pieces. The armatures consist of

Continued on page 64b

Questions and Answers For Gas Engine Operators

This is a department for gas engine operators similar to that which we have so successfully carried on for the past few years for those interested in steam. We invite your questions and will give them our best attention. Just tell us your troubles or ask us about any point upon which you desire information. We have secured the services of a competent expert who can handle gas engine queries intelligently and to the complete satisfaction of all concerned.

Q. E.H. Is it possible to take an automatic or side exhaust on a gasoline engine that only has a mechanical or valve exhaust? How may it be done? and how large should the side exhaust be for a 7½ horse power engine?

A. Yes, it is possible to make a side or auxiliary exhaust by putting a port into the side of the cylinder so that the piston will uncover the port when it has reached the last fifth of its power stroke is completed. If the entire length of the cylinder is water jacketed then it is necessary to drill through both jacket and cylinder wall or thread or tap out both and run a good threaded plug clear through both, then drill out the plug to the proper size for the exhaust port. Proper caution may be used in dressing down the underend of this plug so that it will be of the same circle segment as the cylinder so that no high point or roughness may remain to give trouble while the piston passes over it.

The speed of the engine generally determines the size of the exhaust. A clear diameter of one and one-fourth inches would probably serve your 7½ h.p. in connection with the mechanical exhaust already on the engine.

Q. B.F. I have a vertical engine, which I like very much and think I will get another one. Some say to get a horizontal, that they are better. I thought the vertical best as the stroke is up and down, and will wear the same on each and all sides. The firing is downward, the cylinder dust-proof, takes up less room and the cast base doesn't have to be as heavy as most of the horizontal engines are. Which is the best engine to buy vertical or horizontal? Some say the vertical cannot be oiled properly. Now if your oil is kept clean I would think the splash system with oil cup in cylinder would be the best. Which engine is best to buy, either large or small? I had thought I would get another vertical, having had one for two years. Does an engine need a carbureter and does an engine need an extra firing jacket; that is to get the best results?

A. Both horizontal and vertical single cylinder engine in small sizes are giving good satisfaction

and results. We would not presume to advise you in favor of either type.

Since you have had a vertical for two years and are well pleased with it we think you are fully able to judge for yourself which type to buy, whether vertical or horizontal. If you have gotten good service out of your vertical and are contemplating another of the small size type we see no reason why you should consider a horizontal just because some one is urging you to do so.

A single cylinder vertical is usually not considered so desirable in the larger sizes even by the manufacturers who manufacture the small vertical, because they drop the vertical idea when they reach 6 and 8 h.p. sizes. The oiling of the piston from an oil cup is a more simple proposition in the horizontal than in the vertical type.

Any kind of a gasoline mixture may be and is by many considered a carbureter. Taking this view of it every gasoline engine is fitted with a carbureter, but not necessarily the type usually used on an automobile engine.

No, and engine does not need an extra firing chamber. The compression space serves as the firing chamber proper.

Q. D.B. Please tell me why spark plugs have such a hollow between the steel plug and the porcelain. I think spark plugs having a smooth bottom would save time in cleaning and would be harder to short circuit. Please tell me also is such plugs can be had, also what material could be used in a cylinder as an insulator on a spark plug that could be threaded and drilled and where such could be found.

A. The space referred to between the steel and porcelain on spark plug is intended to hinder and prevent short circuit from coating or bridging of burnt carbon. Go to your garage men or dealers and ask them to show you their supply or variety of spark plugs and you may find something to meet your views, or they may be able to procure it for you. Porcelain, mica, glass and certain kinds of lava are used for insulating purposes. Mica properly glued and packed is probably more susceptible of true thread-

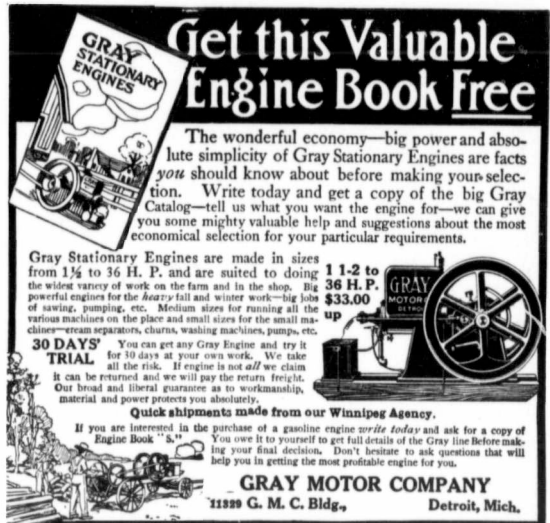

Get this Valuable Engine Book Free

The wonderful economy—big power and absolute simplicity of Gray Stationary Engines are facts you should know about before making your selection. Write today and get a copy of the big Gray Catalog—tell us what you want the engine for—we can give you some mighty valuable help and suggestions about the most economical selection for your particular requirements.

Gray Stationary Engines are made in sizes from 1½ to 36 H. P. and are suited to doing the widest variety of work on the farm and in the shop. Big powerful engines for the heavy fall and winter work—big jobs of sawing, pumping, etc. Medium sizes for running all the various machines on the place and small sizes for the small machines—cream separators, churns, washing machines, pumps, etc.

30 DAYS TRIAL You can get any Gray Engine and try it for 30 days at your own work. We take all the risk. If engine is not all we claim it can be returned and we will pay the return freight. Our broad and liberal guarantee as to workmanship, material and power protects you absolutely.

Quick shipments made from our Winnipeg Agency.

If you are interested in the purchase of a gasoline engine write today and ask for a copy of Engine Book "S." You owe it to yourself to get full details of the Gray line before making your final decision. Don't hesitate to ask questions that will help you in getting the most profitable engine for you.

GRAY MOTOR COMPANY
1129 G. M. C. Bldg., Detroit, Mich.

You saw this advertisement in this magazine. Don't forget to say so when writing.

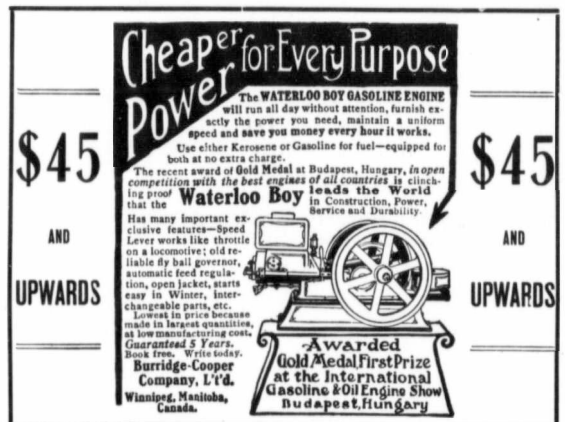

Cheaper Power for Every Purpose

The WATERLOO BOY GASOLINE ENGINE will run all day without attention, furnish exactly the power you need, maintain a uniform speed and save you money every hour it works.

Use either Kerosene or Gasoline for fuel—equipped for both at no extra charge.

The recent award of Gold Medal at Budapest, Hungary, in open competition with the best engines of all countries is clinching proof that the Waterloo Boy leads the World in Construction, Power, Service and Durability.

Has many important exclusive features—Speed Lever works like throttle on a locomotive; old reliable fly ball governor, automatic feed regulation, open jacket, starts easy in Winter, interchangeable parts, etc.

Lowest in price because made in largest quantities, at low manufacturing cost.

Guaranteed 5 Years. Stock item. Write today.

Burridge-Cooper Company, Ltd., Winnipeg, Manitoba, Canada.

Awarded Gold Medal First Prize at the International Gasoline & Oil Engine Show Budapest, Hungary

\$45 UPWARDS AND **\$45 UPWARDS**

You saw this advertisement in this magazine. Don't forget to say so when writing.

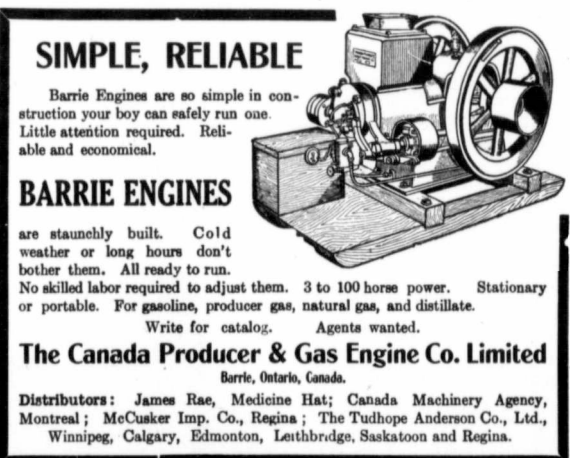

SIMPLE, RELIABLE

Barrie Engines are so simple in construction your boy can safely run one. Little attention required. Reliable and economical.

BARRIE ENGINES

are staunchly built. Cold weather or long hours don't bother them. All ready to run. No skilled labor required to adjust them. 3 to 100 horse power. Stationary or portable. For gasoline, producer gas, natural gas, and distillate.

Write for catalog. Agents wanted.

The Canada Producer & Gas Engine Co. Limited

Barrie, Ontario, Canada.

Distributors: James Rae, Medicine Hat; Canada Machinery Agency, Montreal; McCusker Imp. Co., Regina; The Tudhope Anderson Co., Ltd., Winnipeg, Calgary, Edmonton, Lethbridge, Saskatoon and Regina.

You saw this advertisement in this magazine. Don't forget to say so when writing.

Patronize Those Who Patronize This Magazine

The Moody Threshing Machine For Individual Farmers

If your crop is not threshed, buy a Moody machine for your individual use. Our machines have done good work this year threshing all kinds of grain. We have a limited number on hand at Edmonton, Red Deer, Calgary, Swift Current, Saskatoon and Winnipeg.

It will pay you to own your own machine and do your work when you wish it done. An eight horse power gasoline engine will operate a Moody Threshing Machine successfully. Write for price, terms and prompt delivery to

The Matthew Moody & Sons Co.

P.O. BOX 2083

WINNIPEG, MANITOBA, CANADA

You saw this advertisement in this magazine. Don't forget to say so when writing.

ing than either of the other materials. Electrical supply houses can supply these materials.

Q. O.O.H. I have a gasoline tractor that I built myself, and it is giving good satisfaction except the cooling system. I made one of the open type, with the screen cooling system. The objection to it is that it evaporates a lot of water in a day. I have intended to build one of the closed type out of common one inch pipes and make a coil about two feet in diameter like a close laid coil spring, and put a fan like a fanning mill inside of the coil. I would appreciate it very much if you can give me an idea of about how many feet of one-inch pipe would be necessary for cooling, and about how many gallons of water should be circulated through in a minute. Double opposed type of motor, 2 cylinder, 4 cycle, 7 in. stroke, 7 in. bore, speed 550 per minute normal, 25 brake h.p.

A. One rule to get the radiating surface in square inches required for a given engine is to multiply the cylinder diameter in inches by the stroke in inches, this by the number of cylinders and then by a constant of 200. Your example stands as follows: $7 \times 7 \times 2 \times 200 = 19,600$ square

inches. The outside diameter of one-inch pipe is about $1\frac{1}{4}$ inches. The circumference is $1\frac{1}{4} \times 3.1416 = 3.93$ inches. 3.93×12 , the number of inches in one foot—47.16 square inches of radiating surface in 1 foot of one-inch pipe, 19,600 or practically 20,000 square inches

required for your engine divided by 47.16—425 feet, length of one-inch pipe in your coil. Have your coil wound with half good vigorous fan and a lively circulating pump that will throw the contents of say a 60 gallon tank through the coil every 10 minutes.

DON'T LET YOUR ENGINE IDLE

because weather's cold. Don't waste time and strength pulling round a balky engine either. My device easily starts any engine that can be turned over, in coldest weather. Make it yourself, costs but few cents, no expensive, dangerous chemicals—gasoline only. Drawings and full particulars, one dollar. Money back if it won't work. Send dollar bill in envelope today. It will save you many dollars first month.
Addison Johnston, Box B. Stettler

Manitoba Engines Have Set Up a QUALITY Standard!

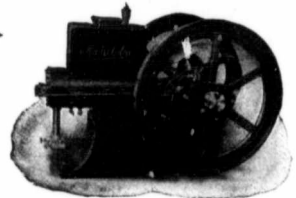

The maker of cheap engines bids for trade on a price basis only. The better class of engines sell mainly on **QUALITY** and **SERVICE**. They are bought by the thinking man, who sees far enough ahead to spend a few more dollars at the start, in order to get back many more dollars in service and freedom from repairs.

Among higher class engines, the MANITOBA has set a standard for quality, performance and durability. Read the story of what goes into MANITOBA Engines, how it is put in, and how it pays both buyer and seller. Read what to look for and what to avoid when purchasing an engine. Our booklet tells much about gasoline engines generally. Free on receipt of your name and address.

WE MANUFACTURE Gasoline Engines, 1 1/2 to 25 h.p. Wood and Iron Pumps, Pumping and Power Windmills, 3 to 14 feet. Grain Grinders, 6 to 12 inch Wood Saws, all sizes

MANITOBA ENGINES LIMITED

(Formerly The Manitoba Windmill and Pump Co., Limited)
BRANDON, MAN. CALGARY, ALTA.

You saw this advertisement in this magazine. Don't forget to say so when writing.

EVERY farmer nowadays, doubtless, has read of the conveniences acquired by the use of electric power, but it is probable that in the majority of instances he has not applied the matter personally to his own case nor considered the practicability of using electricity on his farm. Likely as not, if he is attracted by a glowing article on this theme, he will think, "That is all very well for city folks, but out here in the country I can't have such conveniences." The purpose of

Electric Power on the Farm
BY ADOLPH SHANE

lamp is about like daylight, which is not true of the carbon lamp. This makes an excellent light for seeing things in their natural colors. The external appearance of the two styles of lamps is much the same, and unless one watches

from the source of illumination is concerned? Moreover, electric lighting has the advantage of being instantly at one's command. The mere snapping of a conveniently located switch produces the light or puts it out. In fact, several switches at different points may control the same light, so that on entering the house for an instance, one may light his way up stairs, and after ascending, put out the lights behind him without any groping or stumbling about in the dark.

Electric light in the barn is more than a convenience. It is real economy, especially during the winter months, when the sun rises late and sets early. On a winter day the farmer may spend

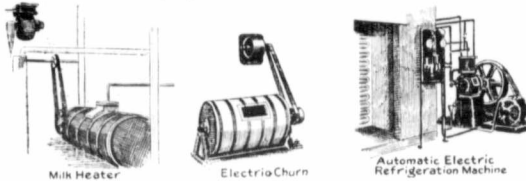

this article is to reassure everyone living in the country that electric power may be made available anywhere so long as gasoline and coal oil are available.

There are several methods of procuring this power. One may, if he is so fortunate as to be located near a transmission line, purchase what he needs from a power company. Or, if there is a stream on his farm, this may be harnessed to furnish him sufficient electric power for his purposes. But most farmers are not in position to get power in either of these two ways, so recourse must be had to a gasoline engine for driving the electric generator. The steam engine is neither so convenient nor as economical as the gasoline engine for generating electric power for use on the average farm. There are many such private plants now in operation which have proven highly successful.

It is pertinent at this point to discuss some of the conveniences and economies produced by the utilization of this mysterious form of energy.

The application of electricity to lighting is the earliest and one of the most important phases of the subject. We have had electric lighting on a commercial basis for a generation or more, but the most rapid advances in this field have been made in the last few years. The advent of the tungsten incandescent lamp has produced a very cheap and beautiful form of electric illumination in the home. The lamp consumes but one-third the power of the older carbon lamp for the same amount of light. In other words, by substituting the new lamp for the older type, the lighting bill is cut down to two-thirds if the amount of light used remains the same. Besides this, the quality of light produced by the tungsten

the speed of the meter in the house, it is difficult to believe that this economy is really a fact.

How does this apply to the farmer? Let us see. The amount

of electric current needed for lighting being only one-third as great with the latest form of lamp over the old, it follows that the power plant for lighting a home

need only be a third as great, so that unless power is utilized for other purposes, the cost of equipment is greatly reduced. More will be said later about the little power plant.

It is generally conceded that electric lighting is the safest and most convenient of any form known. Consider what this means to those living in homes with little or no fire protection. The barn can be safely and efficiently illuminated. Mr. Farmer, do you catch the significance of this last statement? Do you always feel it perfectly safe to take your lantern with you into the hay mow or other parts of the barn, containing inflammable material? Have you ever considered the desirability of so lighting your barn as to feel perfectly secure in so far as the possibility of fire

several hours in the barn, morning and evening, when artificial light is necessary. He cannot work fast with poor light. Now, with electric lights, if he has cor-

rectly placed switches he may light his way to any part of the barn, switching off those lights no longer needed, and with good illumination accomplish more in

a given time than he could by the dim light of a lantern. In other words, his earning capacity is increased. This may seem like a small matter, but several such small savings of time may result in a definite reduction in the expense of farm operations. The farmer himself may have time to

do some of the things he has heretofore hired done.

To digress a moment—it may be stated that the industrial world today is carefully studying ways of increasing the efficiency of the workmen in the shops, in order to reduce the cost of production of the articles manufactured. Not the least in importance of these methods is the giving of better and more scientific illumination to the night workers. The results have amply proved the value of these efforts. The farmer, no less than the manufacturer, desires to produce his wares as cheaply as possible. If certain machinery should help him do this, he would have small claim to any business sense if he did not acquire such labor-saving aids. If he has one tool which works only half as fast as a later model, there is but one thing to do—buy the later model. The writer has heard of instances where hundreds of thousands of dollars worth of electric power machinery, only a few years old were junked to give way to better types. Why, you ask? Because it was found that it cost so much to operate the older machinery as compared with the new, that it paid to replace the former with the latter. This point of view should at all times be kept in mind and it applies to the saving of the energy of the housewife as well as to the man on the farm.

The electric washing machine is one of the notable labor saving devices for the home. Nearly every woman who has one feels it is not only a convenience but an absolute necessity. The machine is similar to the usual types of hand operated washers with wringers attached, excepting that a small electric motor, which scarcely takes more power than an ordinary electric lamp, does the work. A small lever connects with either the machine or the wringer and the latter may be reversed at will. A good machine may be purchased for fifty or fifty-five dollars. With this useful device the drudgery of washing is done away with and the house wife has

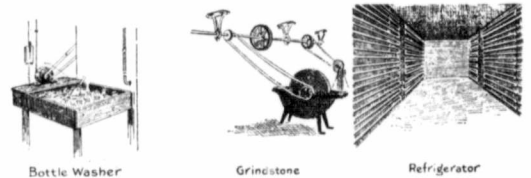
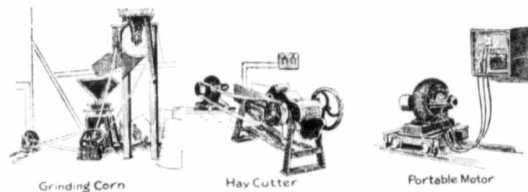
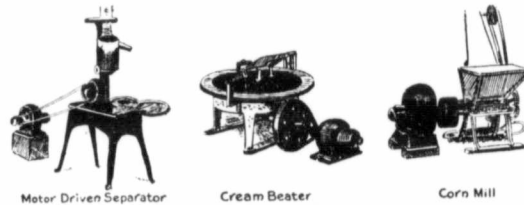

more time for other duties. That is, her efficiency is increased.

The electric flat-iron, no less than the washing-machine, is a boon in the home. The rather prevalent notion that its operation is expensive is scarcely true, because, though the heat may be

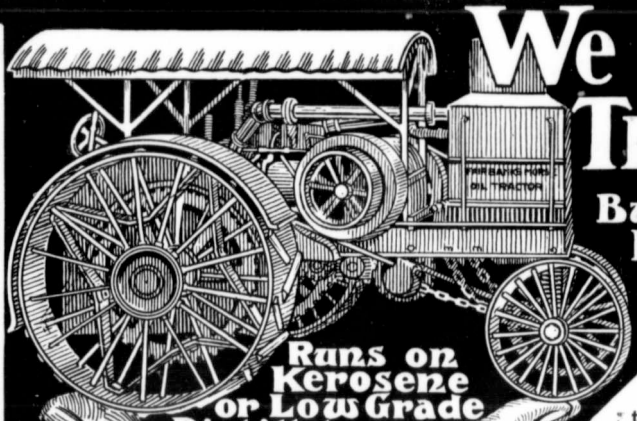

We offer a Tractor

Built to Last

The First Operation of the Year!

Runs on Kerosene or Low Grade Distillate or Gasoline

SPRING PLOWING—the first step toward the harvest of 1913. Get off to a good start with a FAIRBANKS-MORSE Oil Tractor. We build with a full knowledge of the exacting work required of them—hard rough work and years of it.

To sow early—you must plow early. Early plowing is best done with a FAIRBANKS-MORSE Oil Tractor. It develops full rated power and more, on cheap fuel oils. Has a surplus of power for emergencies. Two speeds forward and one reverse, all controlled by a single lever.

Points That Count In Service

- HIGH EFFICIENCY** both in belt and Traction Work.
- WELL BALANCED ENGINE.** No racking of frame. No heavy strains on gears, shafts or bearings.
- ALL PARTS ACCESSIBLE**, yet fully protected from dust and dirt.
- SHEET STEEL RADIATOR** with centrifugal pump—cools effectively with little water.
- FORCE FEED LUBRICATION**—a strong, long-life feature.
- ADJUSTABLE SPOKES** in drive wheels.
- GUARANTEED.** Workmanship, materials, and power-delivering ability.

FAIRBANKS-MORSE OIL TRACTOR

35 years Engine building experience behind this Tractor.

Our nearest office will promptly send catalogue upon request. It gives full description of both the 15-30 and the 30-60 Tractors, also letters from users telling of their experience. We invite and will gladly answer any questions you may wish to put.

FAIRBANKS-MORSE OIL TRACTOR SCHOOL open to Fairbanks-Morse Engine owners, operators, prospective buyers and anyone interested in oil engines. Short and complete course, including lectures and practical work, commencing latter part of January, closing the end of February. Schools at Winnipeg, Regina, Saskatoon and Calgary. For full information write any of the offices mentioned, using coupon below.

WE MANUFACTURE

- Fairbanks-Morse Oil Tractors, 15-30 and 30-60 H.P.
- Gasoline Engines, all Types, Portable and Stationary, 1 to 500 H.P.
- Binder Engines, adapted to all makes of Binders.
- Marine Engines, 2 and 4 Cycle, 1 to 6 Cylinders.
- Hand and Power Pump; for every purpose.
- Truck and Pitless Wagon Scales.

THE CANADIAN FAIRBANKS-MORSE CO. LTD.

- | | | |
|----------|-----------|----------|
| WINNIPEG | SASKATOON | CALGARY |
| Montreal | St. John | Ottawa |
| | Vancouver | Victoria |
| | | Toronto |

Made in 3 sizes

Send this **COUPON** to our nearest office.

THE CANADIAN FAIRBANKS-MORSE CO. Limited
Mail free Catalogue of your

State on what subject

NAME

ADDRESS

"CASE" The MARK of PROSPERITY for GENERATIONS

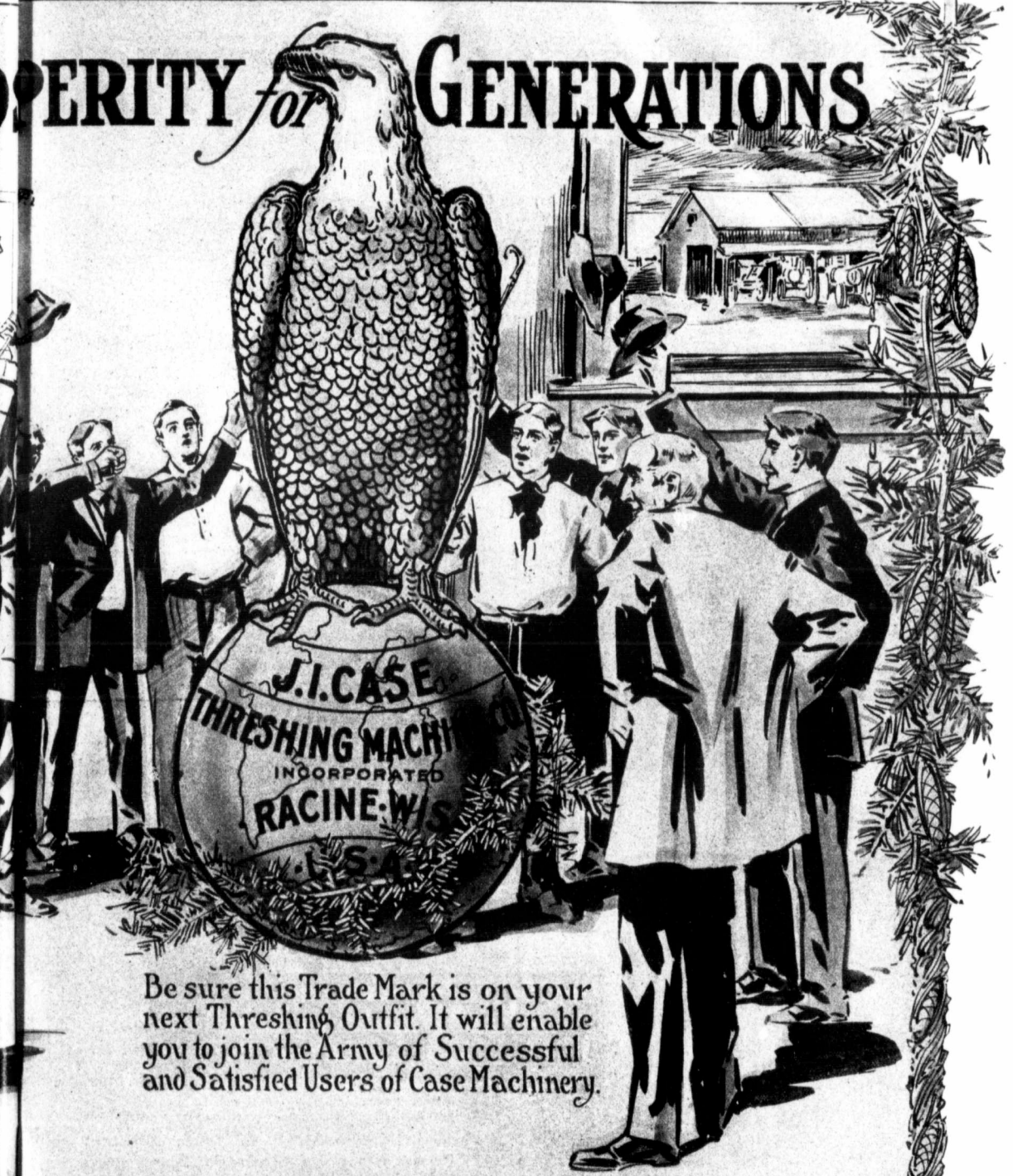
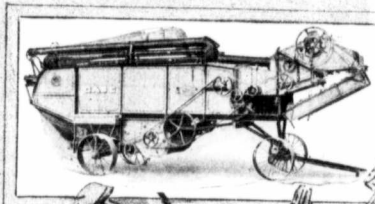
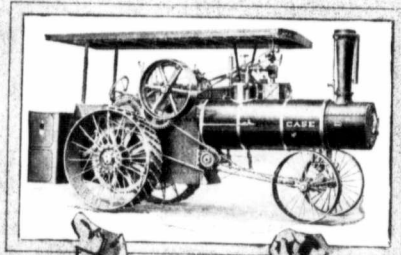

The 1913 CASE THRESHING MACHINE CATALOG
OPENS the DOOR to NEW OPPORTUNITIES for ALL.
Send Your Address, We Will Mail You One.

Be sure this Trade Mark is on your
next Threshing Outfit. It will enable
you to join the Army of Successful
and Satisfied Users of Case Machinery.

J. I. CASE THRESHING MACHINE COMPANY

INCORPORATED

RACINE, WISCONSIN, U.S.A.

CANADIAN BRANCHES, TORONTO, WINNIPEG, SASKATOON, REGINA & CALGARY

Concrete Corner and Gate Posts

Methods of Making One-Piece Post with Braces

NOTHING gives more trouble and injures the appearance of property so greatly as sagging gates and fences caused by rotten gate and corner-posts. Property owners are rapidly getting rid of this nuisance by making such posts of concrete.

The concrete post shown below is a home-made article according to the owner's plan. It has been in service five years and is easily

nailed to the three sets of 2 x 4-inch cleats as shown in the drawing. Holes are bored in the cleats so that the 5/8-inch bolts 18 inches long, running across the forms from cleat to cleat, will rest against the 2 x 4-inch boards and hold the box-like form in shape. One-inch triangular-shaped strips tacked in the corners of the form will bevel the sharp edges and produce a neater appearing post.



good for ninety-five more. The post and braces were molded in position and as one piece. The post proper is 10 inches square and the braces 6 inches. They extend 3 1/2 feet into the ground and end in a bulb of concrete.

Forms for Post and Braces

For the post mold proper, two-inch lumber makes a stiff form. Cut two boards 2x10-inch and two

Each form for the braces consists of two side pieces, 1 x 6 inches, and one bottom piece, 1 x 8 inches, all 10 feet long. Nail the pieces together in the form of a trough six inches deep. To make the bevel joint with the post form, lay off 3 1/2 inches on the lower edge of the side pieces at one end and saw off the trough

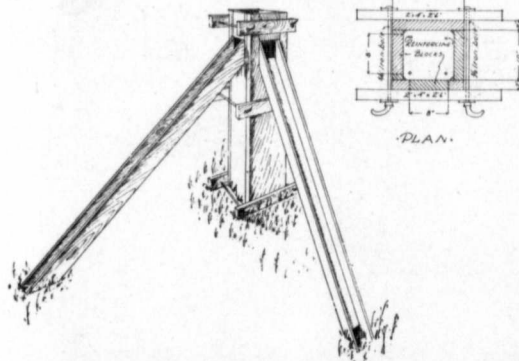

2 x 14-inch, all 7 feet 6 inches long. (For the 2 x 10, a 2 x 4 and a 2 x 6-inch piece may be substituted; likewise for the 2 x 14-inch, a 2 x 6 and a 2 x 8-inch may be used.) The 2 x 10-inch pieces are

to the bevel. In the side pieces of the post mold, 8 inches from the top, cut an opening extending downward 7 inches deep and 8 inches wide to receive the molds for the braces.

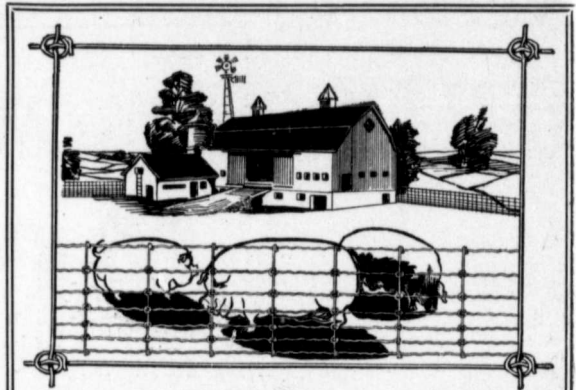

"GREAT WEST" WIRE FENCING

is manufactured from the heaviest and best hard drawn Bessemer Spring Steel Wire, heavily galvanized and guaranteed to be full gauge. Our aim is to supply something of extraordinary strength, and we are making our fences of good strong wire throughout. This enables you to save half your posts and the cost of setting the same.

For every dollar spent on "Great West" Wire Fencing you will get a dollar's value, and be more than paid by results.

LET US PROVE IT

Send for our Illustrated Catalogue and the name of your nearest dealer

GREAT WEST WIRE FENCE CO., Limited - WINNIPEG

Calgary Office: Care Reynolds & Jackson, P.O. Box 2063.
Edmonton Office: Care Race, Hunt & Giddy, cor. 5th and Columbia Ave.

The Monarch Peninsular Steel Range

Ensures Every Housekeeper a Merry Xmas

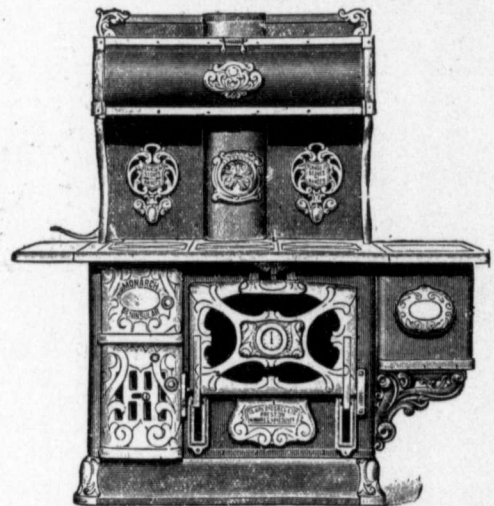

The discriminating housewife demands a **MONARCH PENINSULAR RANGE**. Experience has taught her that most satisfactory results in cooking can only be obtained by using a reliable range.

The **MONARCH PENINSULAR** is as near "range perfect" as expert mechanics and specially trained workmen can make it.

The **MONARCH PENINSULAR** embodies, among many others, such features as

THE REVERSIBLE RE-ENCASED RESERVOIR, BRACED OVEN DOOR, DROP CLOSET DOOR AND IS PURE ASBESTOS LINED

If this range is not on view at your hardware store, send direct to us for Illustrated Booklet.

CLARE & BROCKEST, LTD.

May St., Winnipeg, Canada

You saw this advertisement in this magazine. Don't forget to say so when writing.



GILSON ENGINE

"GOES LIKE SIXTY"

Always ready for work. Perfectly adapted for operating all farm machinery from the pump to the biggest Thresher. Improved cooling, governing and sparking devices. Up to date. All sizes. Write for catalogue. Gilson Mfg. Co. Ltd., 11 York St., Guelph, Can. FOUNDED 1860

Mixing the Concrete and Molding the Post

With the forms ready and all of the material on hand, dig the hole $3\frac{1}{2}$ feet deep for the post proper. At distances of 9 feet 6 inches from the centre of the finished post dig another hole $3\frac{1}{2}$ feet deep for the concrete bulb in which the brace will end. One foot above bottom of this hole, open a trench 8 inches wide sloping upward towards the corner post to a point within 7 feet of the center of it.

Mix the concrete, 1 bag Portland cement to 2 cubic feet of sand to 4 cubic feet of crushed rock, or 1 bag of cement to 4 cubic feet of good pit gravel. Make the concrete mushy wet and fill the holes to the depth of 1 foot. Set the mold for the post in position and slide the troughs for the braces into the openings, with the upper ends even with the inside of the post form. Fasten them securely and chink the cracks with old rags. Brace all forms firmly. Down the post form, two inches from each corner, set a $\frac{1}{2}$ -inch rod 10 feet long with the upper ends bent backward. Fill the post form with concrete to the openings of the braces. Place one inch of concrete in the troughs for the braces and lay upon it, one inch from each side, two $\frac{1}{2}$ -inch rods with their upper ends extending into the post mold. Put in 4 inches more of concrete, place two more rods in a similar manner and then another inch of concrete. Work rapidly and without delay finish filling the post form with concrete. After the concrete has stiffened, bevel the top edges of the post and the upper edges of the brace with a trowel.

For each post with two braces, there will be required 4 bags of Portland cement, 8 cubic feet of sand, 16 cubic feet of crushed rock (or 4 bags of cement and 16 cubic feet of bank-run gravel), and 12 pieces of $\frac{3}{8}$ -inch rods 10 feet long. These materials will cost about \$2.50.

Curing the Post and Stringing the Fencing

See that the post is fenced off so that animals cannot disturb it before the concrete has acquired its strength. After 7 days the forms may be carefully removed. Do not use the post until it is 30 days old. Many persons make corner-posts in the fall, before freezing weather, and do not place the fencing on them until the next spring. The wire fencing may be pulled around the post, as shown, or ratchet fasteners may be attached by making holes through the post by means of small gas-pipe set through holes in the form or by means of greased rods turned frequently while the cement is setting.

When You Buy MARQUIS You Want Marquis

You don't want some Marquis mixed with something else. And since it is hard to know whether seed wheat is pure as to the variety, you have to rely somewhat upon the seller. You should know whether he knows what he is selling, and whether he would sell you inferior seed if he knew it to be poor.

We have a big crop of Marquis grading No. 1 Northern. It is free from other kinds of grain and noxious impurities, and is pure to within a fraction of one per cent. We know its quality because all the Marquis we are selling was grown from seed produced on our own farms in 1911. And because we know our seeds are right we say without hesitation that if you are not satisfied with them you may return them at our expense and your money will be refunded.

We Have a Special Offer

Send us a post card and we will tell you about it. Do not delay in sending us your name; you can remit for the seed during January.

Have You a Satisfactory Fanning Mill?

After testing various kinds of grain cleaning machinery we selected for our own use machines which we believe are unequalled for quality and quantity of work performed. Knowing that they would do for you what they are doing for us we secured agency rights for Western Canada. Our experience is at your service.

We await your inquiry for Catalogues, Seed Samples and Prices

THE MOONEY SEED CO., LIMITED

"Seedsmen to Men who Care"

Willoughby, Building

Saskatoon, Sask.

THOUGHTS ON AGRICULTURAL EDUCATION

BY DR. EDWARD A. RUMELY



Dr. Edward A. Rumely

MANKIND has come into possession of new tools. The Steam Engine has attracted all productive activities from the home and centered them in vast factories. It has built up cities. Rapid and cheap transportation has enabled the still further centralization of productive effort into larger units. Engine power is so much cheaper and more effective that men throughout the civilized world have assembled near it so they may use it in all their work and as part of the daily routine of living. A still further increase of human power came as we learned that ten men working together are vastly more efficient than ten individuals working singly. When a thousand men are united for a common purpose, their power has increased almost in geometrical ratio.

Today, in consequence, we are attacking problems of such magnitude that before them single individuals would be powerless. The corporation is the institution created within the last century to focus the endeavor of large numbers to a common end. Corporations have grown in size from decade to decade until they have become national and international in their scope, dealing successfully with problems that would have appalled our forbears of only a generation ago.

With this growth to greater and greater size, the corporation became a factory of such importance to the life of each citizen that the feeling spread among the

This article is a portion of an address delivered some time ago by Dr. Edward A. Rumely. While written for and delivered before an American audience, it contains a great deal of advice along certain lines of Educational development with which Canada must deal in the future. It requires careful reading but the reading of the last sentence is well worth the time and effort. Editor).

people of all countries that the State, representing the people as a whole, must step in to define the principles, limit the scope, regulate, and prevent the abuse of the power that has been acquired by such corporate groups. This new function of regulating corporations has given the public officials in charge of our government an authority and influence reaching intimately into our business activities.

viction that the political organization, in this case our United States Government, is the most stable and permanent thing in human affairs. To the Panama Canal every American can point with pride as one of the monumental results of our governmental activity.

It is true that after this effort the efficiency of our officials and of the public organization at Washington sank back to lower

No private corporation operated for profit could afford to cultivate forests on a national scale and for national aims and with due regard to such matters as influence on water supply, with no prospect of returns for sixty or seventy years. The distribution of mail, and building of public roads have fallen wholly within the sphere of the government's work. Everybody recognizes that such a gigantic task as the digging of the Panama Canal could not have been entrusted to a private corporation. In spite of the fact that some of the best and most efficient schools are privately managed and privately owned, we all recognize that the education of our children is of such fundamental importance that this function must be assumed mainly by the City, State and National governing bodies responsible to all the people.

From year to year the field of activity that lies beyond the scope of the private corporation broadens; new tasks arise which to be handled effectively must be assumed by our public institutions. It is only necessary for us to be cautious in this matter and not to develop too fast. We must hold as a principle that whatever can be handled by the individual must be left to the individual, that no function that can be effectively discharged by individual men should be taken over by the corporation.

The corporation binding a larger number of men together into group effort has permanence beyond the life of any one man and can best deal with a great variety of problems, as is evidenced by the thousands of corporations operating within our midst. Everything that can be done by the corporation should be left for it to do, and the City, State and National Government should assume only such functions as can not adequately be discharged by private corporate effort. Starting with this view-point, the important thing to realize is that some broadening of governmental activity is inevitable. My teacher of political economy used to say: "The State exists to protect life and property, and for defence against foreign enemies," but we young men can no longer believe that this is the whole truth. The machines and tools, the railroads and commerce, the vast bodies of knowledge organized in the sciences, the fund of power in



Grain Judging Team, Manitoba Agricultural College, 1912. Names left to right: T. J. Harrison, B.S.A., W. Betts, A. T. Webster, J. L. Brown, Instructor.

The application of scientific knowledge and the use of larger tools have made possible, and public welfare demands, some undertakings that exceed even the powers of our modern corporations. Think for a moment of the Panama Canal, where the very rocks which have stood as a barrier through all time are being severed to make a channel for ships and commerce, for thought and closer intercourse among the peoples. A corporation had undertaken and failed at the work. Our National Government rose to the need, used all the powers that inhere in our modern political organization, and gave the necessary credit to carry on the work. It is interesting in this connection to recall that the low interest rate and favorable market for the bonds was due to the deep con-

levels. In the meantime, however, a demonstration has been made of what can be achieved by a government under disinterested and effective leadership.

We are finding that there are many other activities that can best be carried on if delegated to the government. No corporation, for example, could be safely entrusted with the unlimited powers and the many-sided control of individual lives necessary to the most successful operation of industrial, accident, sickness and old-age insurance; for as soon as such a system is developed, the instruction of all medical schools must be modified accordingly, health conditions in cities and industries changed by legislation, safety devices enforced in factories and upon farm machinery by the police power of the State.

"The Great Minneapolis Line"

Yuletide Greetings—A Prosperous New Year

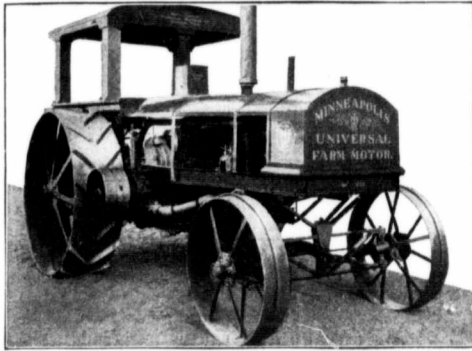

Minneapolis Universal, 2-Cylinder opposed, 20 h.p.
"The Machine that will keep the boy on the farm"

To Our Friends

The
Canadian Threshermen
and Farmers

Gas Tractors for every
purpose — Built Right
— Sold Right — Run
Right

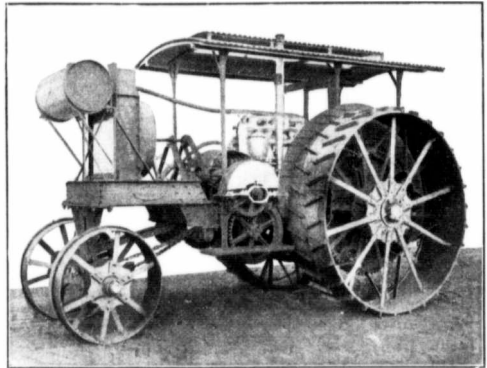

Minneapolis 4-Cylinder (vertical) 25 h.p.
Guaranteed not to balk, and eats only when at work

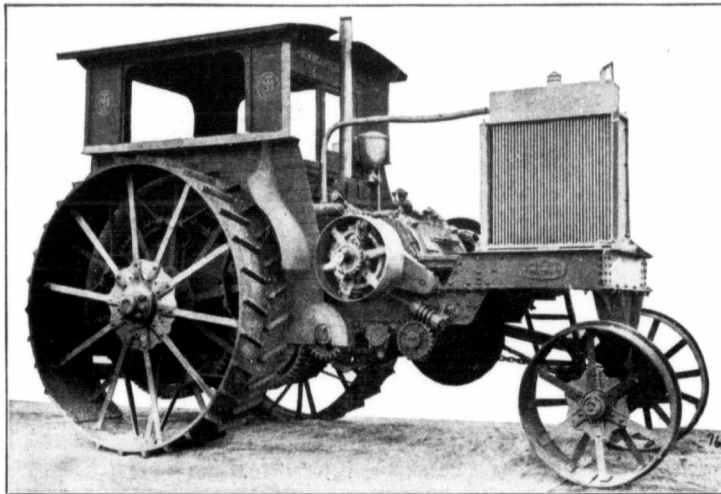

Minneapolis 4-Cylinder (horizontal) 40 h.p.
THE CENTER OF ATTRACTION

Minneapolis Farm Motor—20, 25 or 40 Horse Power

Modern
Invincible
Nicely finished
No part slighted
Economical
Accessible
Powerful
Only finest materials
Lubrication positive
Ideal in design
Send us your order for a

Steel gearing
Unobstructed view
Perfect alignment
Efficient
Radiation perfect
Ignition—dual system
Operates easily
Reliable
Immense crank shaft
Two speeds forward
You will be pleased

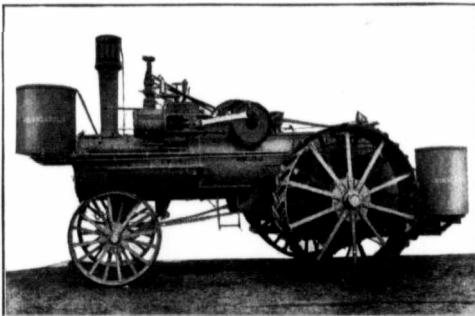

Minneapolis Standard Separator
The Standard by which others are gauged

1913

Calendar and Catalog
are yours
for the asking

Better write for them
today. You might
forget it tomorrow

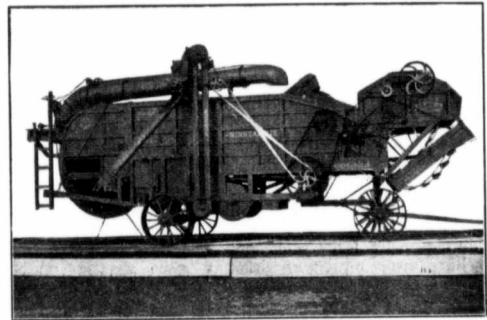

Minneapolis Single Cylinder Steam Engine mounted on special
Canadian High Pressure Boiler. Extra heavy gearing throughout

The Minneapolis Threshing Machine Co.

West Minneapolis (Hopkins P.O.) Minnesota, U.S.A.

General Office for Western Canada at Regina

Distributing Points: Winnipeg, Calgary, Edmonton

medicine and hygiene that the last generation created and left as a heritage to us, have made necessary a broadening of state functions. In consequence, public activities—what the State, in the broadest sense of that word, meaning the political group, does and how it is managed—in short, politics from year to year are becoming more important to each individual citizen.

Agricultural education is but a part of a larger demand of our time. Our cities are calling for skilled workers and better training for industrial effort. Every boy and girl is to be fitted by the school for the vocational effort of real life. The acute need for this at present is due to the fact that we have entered a new economic period of our country's development.

When the United States was founded, four generations ago, our forefathers, scattered along the Atlantic seaboard, were but a few millions in number. To their west lay a whole virgin continent, richer in soil fertility, timber, ore, and other national resources than any land the white man had ever found. With energy and shrewd intelligence, they took possession and exploited these stores in a gigantic way. The fur-bearing animals were killed. The timber was cut and sawed into lumber for use at home and sale into export markets, with mills that could handle a million feet a day, operated by the labor of a few men. Improved methods of mining by machinery enabled a few men to handle vast masses of ore and metal. Faster and faster the prairies were broken and seeded to wheat, partly because wheat can be easily transported, but mainly because in the value of wheat there is not merely the labor of producing it, but also a content of valuable soil salts in which we have been selling the fertility of our virgin prairies in European markets.

In 1830 the work of growing a bushel of wheat on the farm required hours of human time. Today, due to the introduction of improved machinery, a bushel of wheat contains only 10 minutes of labor value. In other words, the unit of soil salts, worth over 20 cents in each bushel, sufficed to furnish employment for three hours; while today the wheat-selling farmer must part with that amount of his soil capital to sell ten minutes of his labor—a development of 1800 per cent in the wrong direction.

At first there was but a limited population and a vast land to be mastered and worked. To take its treasures with the least amount of labor became the aim of our people. Everybody's thoughts centered upon labor-

saving devices, with the result that more mechanical inventions and machines to economize labor were put forth in the United States than all the rest of the world. From our midst the typewriter and self-binder started on their unending march.

The first or colonial period of our history is now at an end. We are a hundred millions in number. Our open west is gone. The country is occupied. Our population is spread until cities have touched the Pacific. Already our timber is half cut, and we have calculated that within another generation at the present rate of consumption the last of our

the demand for conservation of our natural wealth is becoming more and more insistent. We have been made to realize that every child born brings a mouth that must be fed, a body that must be sheltered and clothed, but no increase in natural wealth. We must still learn that every child does bring two hands, which can work, and which, when highly trained and backed by scientific knowledge, can create untold values. Stated otherwise, we must care for our increasing population, not by increased exploitation of our natural stores, but by providing abundant work for skilled labor.

work for one man. If the workman had the skill of a German cabinet maker and artistic training, he might produce articles worth several thousand dollars, and find in the lumber from that single tree profitable employment upon which he could support his family for from one to three years. And, finally, if he had the highest artistic ability and the skill of an Italian wood carver, he might produce objects with an art value ranging into many thousands of dollars, upon the return from which he could live his whole life.

The whole range of values in this series, from the \$7.00 worth of cord wood to the \$7000.00 art object, depends upon the degree of refinement extended to identically the same raw material through quantity and quality of labor employed upon it.

The ideal of selling labor instead of natural wealth is binding upon the farm. We do not need better agricultural education, to increase the wheat crop from 13 to 30 bushels per acre merely for the sake of increasing our total yield of cereals. I doubt with our present population whether it would be a good thing to increase the yield of wheat from 13 to an average of 30 bushels per acre for the sake of growing seventeen hundred million bushels annually instead of seven, for that would simply hasten the day of soil exhaustion. Our aim should be rather to get the same amount of cereals from a smaller acreage, so as to leave more land free for other varied crops. The ideal of selling labor values is binding for agriculture exactly as for manufacturing industries. The more highly refined the farm product, the more labor and intelligence it contains, the greater its value in dry substances per pound and the smaller the drain it entails upon the soil of the farm from which it came. Instead of cattle at 8 cents per pound, and he will get for each pound of soil salts forty times as much return. In butter, eggs, cheese and fruits he sells his personal labor rather than his soil values.

Of course we want to increase our acre yield to the highest profitable limit, so that we can grow our national quota on the smallest area, thereby releasing acreage for other crops, through which, with much less drain on our soil fertility, the farmer can market large values arising from labor, a larger capital investment, and intelligent management.

The degree to which the farmer is successful in reaching this ideal of selling his labor measures the approach to a balanced state of agriculture that will leave each acre of land at the end of the year as fertile as at the beginning.



TWO FAITHFUL GUARDIANS OF THE LONE HILLSIDE

forests will be gone. We are mining our iron, our copper, our lead and other metals more rapidly than any other country in the world. The pioneer farmers who worked the soils of the South with tobacco and of the East with wheat, can no longer move off to the West, when, having exhausted the fertility of our lands, they find farming no longer profitable. The hundred thousand vigorous Americans who went last year to Canada with energy, capital and American tools are a concrete evidence that we have reached the end of the course which we have been travelling. The whole country has been startled by the warning of far-sighted men, and now

We began by cutting the maple tree into a cord of wood, worth from three to seven dollars, and each tree furnished material for one day's work. This same tree, if sawed into lumber, is worth twenty dollars and would furnish employment for three or four days for one man. If quarter-sawed, and more carefully treated, it might be worth forty dollars and would furnish employment for more skilled and better paid workers and for a period of from 10 to 12 days. And this same lumber, in a furniture factory would produce furniture worth from \$100 to \$500 and would furnish employment directly and indirectly equal to from six months' to one year's

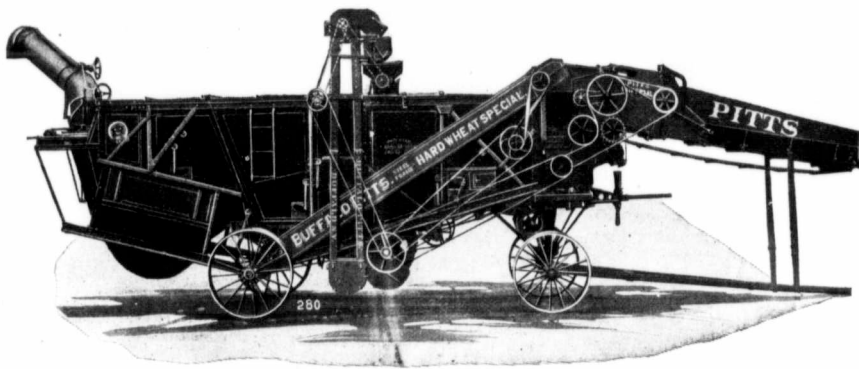

Buffalo Pitts Thresher Line

Now Sold by Agents of the

International Harvester Company of America

Beginning at once, Branch Houses and Local Agents of the International Harvester Company of America will sell the Buffalo Pitts line of threshers and attachments.

Farmers and threshermen who now own Buffalo Pitts machines will be able to secure parts and service from IHC local dealers. A special point will be made of taking care of present owners of Buffalo Pitts machines.

The Buffalo Pitts line is widely and favorably known. Since they placed it on the market in 1837 the manufacturers have constantly maintained the high standard of quality which seventy-five years ago established their reputation. Buffalo Pitts threshers separate with equal facility, rice, headed wheat, flax, and all grains grown in the States and Canada. A Buffalo Pitts thresher and an I H C tractor make an ideal outfit for large and small farms.

The sales organization of the International Harvester Company of America, with representatives in every agricultural community, is an ideal selling medium for these threshers.

See the I H C local agent or write for catalogues and full information.



CANADIAN BRANCH HOUSES

International Harvester Company of America, Inc.

At Brandon, Calgary, Edmonton, Hamilton, Lethbridge, London, Montreal, North Battleford, Ottawa, Quebec, Regina, Saskatoon, St. John, Weyburn, Winnipeg, Yorkton.



You saw this advertisement in this magazine. Don't forget to say so when writing.

We must cease looking upon our land as an object which has us as transient masters. Instead, the passing years must teach us to love our soil as the European owner does the few acres that he has inherited from his father and in which lie all the past traditions of his family. In the soil we must see our great and permanent possession that is to be preserved, built up and made more fruitful for our children in coming years. If we accept as a national ideal the demand that we live by the labor power of our people we must quickly become a nation of skilled workers in the city and upon the farm, for crude and unskilled effort will not support us in our present standard of living. It is comparatively a simple thing to farm by machinery for wheat on the virgin prairie; but to carry on intensive agriculture in accordance with scientific principles under a system of crop rotation, using a great equipment of tools, with large stocks of well bred cattle, growing a great variety of plants and fruits, supplying from year to year the needed fertilizer to the soil, requires special skill and much technical knowledge.

The routine of tradition will no longer suffice. The sciences of chemistry and physics, acquaintance with botany and some of the other elemental laws of plant life, mechanical skill in handling tools and machinery are a necessary part of the equipment for successful farming. The knowledge that underlies this is of recent development, but is not yet a common possession of the farmers of this country; hence, not knowing himself, the father cannot impart adequate training to his son.

The modern demand that the school shall broaden its function and take over industrial and agricultural education to fit its pupils for vocational work in life is not accidental or sporadic. The broadening of its function is part of the great sweep of development—another step in a process of the great evolution itself that began with the earliest human history. Originally the family or clan, based upon the ties of kinship, was the highest social group in and through which men could work. Everyone outside of the clan was a stranger and an enemy, and each family was self-sufficing. In the old Testament we find the story of such primitive conditions. Abraham was father and grandfather to his people. He was the ruler, with powers of life and death. He was the priest who worshipped and offered sacrifices; he allotted the tasks, ordered the work and owned the property. If his people needed bread he provided it, and for water he found the well. When the tribal war was to be declared, he com-

manded. One by one these functions were taken. First the city crystallised a political organization that began to protect life and property. Authority over the person of the citizen passed from the father or head of the clan to the larger group. It was one of the later Roman emperors who announced that thereafter a law that on that day forth the authority to kill would be vested in the state, and that no father must thereafter kill his son or daughter or wife, but must turn over to the state for proper punishment when they had committed wrong. In other words he announced that the time had come when the person can be better protected by the state institution organized outside of the family. In the early days, the father performed all worship at the family hearth-fire. But soon religious feeling found a higher expression in prophets and great religious leaders, who called their disciples to follow them and gradually organized institutions that took over religious worship and the propagation of religious doctrine in a separate institution. Until a hundred years ago, the production of food still centered largely in the family. The advent of the steam engine and the introduction of new tools and machinery called for a broader group than was possible within the family circle. Corporations were organized to control factories.

In a similar way the family was no longer able to transmit successfully the body of knowledge that had been accumulated. Public schools were erected as a great innovation. The parents who under former conditions were responsible for the training of their children, were called upon to send them out of the home into the public school, and back of this demand of the state for control over the education of the child from the sixth year on we have placed the truant officer of today.

As it was found that the family was no longer adequate to furnish proper training, one subject after another has been added to the school course. Domestic science or home making itself is one of the latest of the additions to the curriculum. When vocational training in all its aspects, to fit directly for the broad work of life, shall have been completely included in the curriculum, it will be one step more in the long development towards social integration from the family to the larger unit. It will give us the benefit of the specialist who will be devoted to his particular line of activity with freedom to accumulate the broad special knowledge that has been in process of growth through all the centuries

and will continue long after his time.

Our discussion in America of the aims of better agricultural education so far has turned too much upon knowledge alone. We have assumed that it was simply a body of new information for the benefit of the farmers. But much more is needed. Many of the most valuable experiences we are unable to formulate in words, especially when they arise from our muscle sense. Skill of hand and a sort of sixth sense or quick intuition for practical work comes only of experience. Work with the hands leading to vocational training must become part of our school course for reasons altogether different from those originally enumerated.

Every child, merely as a human being, has values within its life so sacred that we may not use it as a means to an end. The fact that there is a dearth of skilled labor and that our factories need skilled workers, or that our farms must be more efficiently managed if they are to furnish the nation a permanent food supply, would not be a satisfactory ground for our taking control of our public schools, and turning them to such utilitarian ends. The school has its first duty to develop the powers and best possibilities of each child entrusted to its care so that it may grow to the richest possible life. It must give bread culture. Every child should be helped to understand the great truths that were accumulated for our generation as its heritage from the past. It should receive a working knowledge of reading, writing, spelling and numbers that will enable it to reach out and climb into any field of thought to which its interests may lead, and in addition our schools should give to all children feeling for the highest social and religious aspiration.

For the sake of this culture, work must be made part of the school course. We have still to learn that the hand is our primary sense organ. Man differs from the animals and is superior to them not because of his better eyes, or a sharper ear, or a keener sense of smell than they. He is superior to them mainly because the two foremembers of his body, that in the animals are either the wings or the fore-feet, have been freed from the burden of merely supporting or moving his weight. In the fore-members that thus became free, the thumb moved opposite the fingers and made the hand able to take hold of things and through the hand the human species grew in both a spiritual and intellectual grasp of the world. The club and the stone, which at first were only weapons, gradually shaped themselves into

tools, and while plying these tools against the material world, a knowledge of the properties was gained that has made man able to master them. Step by step this knowledge of physical properties was accumulated, organized, until finally it was hand acquired, finally formulated into words and written into the books. Through this hand knowledge has come our marvelous understanding and control of the physical world that has enabled us to build our machines, our railroads, our cities.

I look at a piece of wood. I see its color and its shape, but neither would tell me how that wood could be used for this table, chair, or in a building, as structural material. As a boy with a jack-knife, whittling a pine stick, I first learned the properties of pine wood; then by sawing boards and driving nails into them, as I made a box or a boat, I added to my experience further knowledge of the properties of wood.

We look at a piece of iron, and see its color and its shape. We can hear its ring if struck by a hard object, but we must file it and hammer it, fuse it and weld it, we must work with it with our hands, if we wish to know its properties, and know its resistance, strength, elasticity and the other characteristics that make it useful in machine and bridges and tools.

The experience of Henry Ford, our master builder of automobiles who has carried the art of quantity manufacture to a point of perfection unequalled probably in the United States or for that matter anywhere in the world, is interesting in this connection. This year Mr. Ford has built \$80,000 cars—or every third car manufactured for the American market. The aim that he is realizing is to produce two years hence every second car manufactured in the entire world. Exports from his plant have increased ten fold, and of the 200,000 cars projected for the next season a very large number will go into foreign markets. For the Ford car is already at home in South America, South Africa, China as well as in every European country. The export power of this factory is based upon the refinement of the manufacturing process and the use of heat-treated and alloy metals, by which qualities are imparted which make a pound of metal do the work of three pounds, thereby making possible the Ford as the lightest of all power-driven vehicles.

To be Concluded Next Month



Habit is a cable. We weave a thread of it every day, and at last we cannot break it.—Horace Mann.

P & O

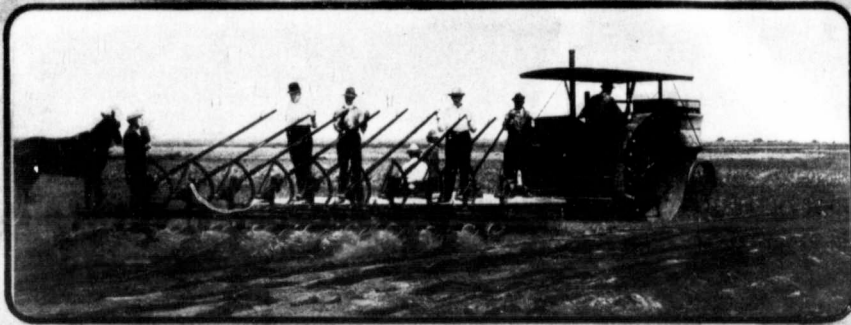

MOGUL ENGINE GANG PLOWS

Some Special Features

A full sized level platform covers the entire frame, with no openings through which the operator may trip or fall. It is made of heavy lumber, and fits on the steel frame in such a manner that it can be readily removed when necessary to get at the frame or wheels for adjustment.

The Levers are made of steel and are very long, giving great lifting power, and as each bottom has its own lever, it can be independently operated. An entirely new feature and one that cannot be found on any other plow in the Bunching of the Levers, which shortens the distance which the operator must travel in working them, and therefore lessens the time required to get the bottoms into or out of the ground. At the same time the levers are adjustable and can be set parallel or at any angle to suit the operator.

Stops on the ratchets regulate the depth of the plowing, and make it impossible for one bottom to go deeper than the others, unless the operator should desire it.

Each bottom has its own gauge wheel which follows the contour of the ground and maintains an even depth, whether the ground is rough or otherwise.

The Pin Break is a most important feature. When plowing in stumpy or stony ground, where there would be danger of damaging the bottoms or breaking the beams, the bolt through the beam and standards is removed and a wooden pin inserted in the holes through upward projections of the standards in such a way as to bear down on the beams, and when an obstruction is encountered, the pin breaks and allows the bottom to trip back just as a cultivator shovel does when equipped with wooden break pine.

A Spacing Block between the beams keeps them in perfect alignment, and prevents any side swing or lost motion.

The Beams have every adjustment for giving perfect draft to the bottom, and have cone couplings between beams and frame by means of which lost motion can be taken up from time to time and absolutely perfect alignment can be secured with but little work.

Each bottom is equipped with a 16-inch rolling coupler having extra heavy shanks. These couplers are self-castering which is another exclusive feature not found on any other plow. Because of these couplers and the position of the gauge wheel, backsetting can be easily accomplished with the Mogul.

The plow has a **chain hitch** which works on swivels, and adjustments on all sizes of plows are made by raising or lowering the clevis brackets, which are provided with a series of holes.

The end clevis is merely a link, drawn together at the lower end, and the chain can be quickly shortened or lengthened by catching it in this link. The hitch can be regulated for any size of traction engine and chains can be hitched straight or crossed, as desired.

P. & O. Mogul Engine Plows are made in five sizes, with five, six, eight, ten, and twelve bottoms. The twelve-furrow plow can be reduced to eleven or ten furrows by removing either one or two bottoms. The ten, eight, six and five-furrow plows can be reduced one or two bottoms by the same process.

If you are interested in engine plowing we will be glad to send you a beautiful De Luxe pamphlet, describing our MOGUL. A card addressed to the Advertising Department, Parlin & Orendorff Co., Canton, Illinois, U.S.A. will bring it.

International Harvester Co. of America (Inc.), Sales Agents for Canada

OPPORTUNITY FOR MANITOBA'S FARM BOYS

THE prosperity of a Country depends, not on the abundance of its revenues, nor on the strength of its fortifications, nor on the beauty of its public buildings; but it consists in the number of its cultivated citizens, in its men of education, enlightenment and character; here are to

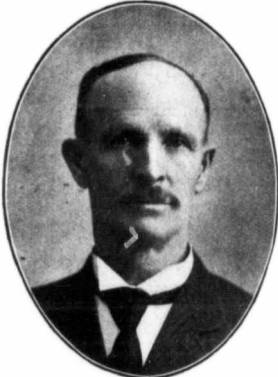

S. A. Bedford, Deputy Minister of Agriculture be found its true interest, its chief strength, its real power."

These are the words of Martin Luther. Luther was a strong man, a man of extraordinary instincts, who had a remarkable faculty for sizing up things and a perfect genius for winnowing the flim flam and chaff out of anything, from old dust-clogged, worm-eaten clocks to the prescriptions of a time-encrusted religion.

And he said exactly the right thing when he spoke of a country's real worth as consisting of its men of education, enlightenment and character. If he had, metaphorically, to cram his views down the throats of his contemporaries, everybody agrees with him now, and the people of Manitoba have nailed Luther's flag to their mast-head.

The new Agricultural College now fast approaching completion on the banks of the Red River at St. Vital is an impressive evidence of how seriously they are taking things in this way. The old home of intelligent and intensive agriculture, which it is intended to replace, was never an institution to be treated lightly. Only about seven years old, it long since became too circumscribed for the needs of the case, and so the idea of erecting a pile of buildings and providing equipment in quantity and quality that would do justice to the insatiable craving for knowledge and scientific training has been materialized in this magnificent group of buildings.

The mere bricks and mortar give a wonderful idea of Western progress. These power houses, residence buildings, lecture halls, laboratories, etc., were not designed and fashioned on the fine architectural plan which has been followed merely for the fun of the thing. Some five millions of the peoples' money will be expended on the scheme but not a single ratepayer will be found even in the ranks of those red republicans who are "agin' the government" all the time (whatever party color that government may wear) who will grudge one dollar of it.

This is the body, so to speak, of the institution which we see on a fine summer's afternoon in its unique setting of utility and beauty, but after all it is the Soul of the Concern with which we are exercised. But stately buildings

really makes the hole and it is the men behind this great educational institution who have already secured and will continue, while they live, to command the confidence of those who will come to them for education and enlightenment; to have their characters ennobled and their capabilities directed to some real purpose in life.

Principal Black has been with the "show" since its inception and will continue to be the Chief of the College faculty. He came with the new paint, so to speak, on the original building and before the College Campus received its first "shave." And he is still there, looking and probably feeling no older than when he first assumed the responsibilities of his position. His career has been one of conspicuous success from an

hobby of it and you can't help getting interested in it." That denotes in a brief sentence the essential quality of the teacher—the man who casts a glamour around his theme that makes it go by its own steam, as distinguished from the old dry-as-dust pedantic "domminee" that Carlyle whips with cords of steel.

Mr. Black is loyally supported by a staff of specialists in their own line who are, in every case, the best men to be had for their respective departments. In making these appointments the final decision rests with the Honorable George Lawrence, Minister of Agriculture for the Province, and since Mr. Lawrence took up his portfolio, this, and indeed every interest in the College, has been meted out with no gingerly hand.

When the personality of Mr. Lawrence crops up in any public function or private capacity, somehow or other the political atmosphere usually associated with "a member of the Government" fails to be appreciated. He is one of Manitoba's solid farmers who have an intellect, a judgment and an experience that is not circumscribed by the cultivation of the prairie. He not only "made good" on his own acres, but it is a matter of common knowledge that he has, in his own unostentatious neighborly fashion, helped more than probably his memory could count

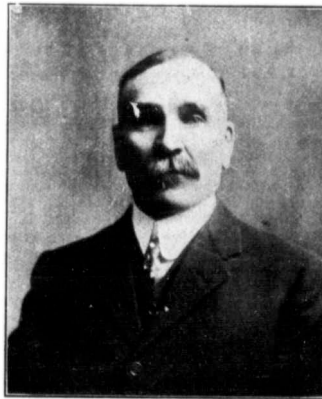

Hon. George Lawrence, Minister of Agriculture

and luxurious appointments don't make a thing of life. The "Soul" of the great idea is the "men of education, enlightenment and character," who will have the destiny of the College in their keeping and all eyes are on them at this moment, rather than on the workshops in which they and the hundreds of their young students will spend their days and nights in solving every old and fresh problem of the principles and practice of intensive agriculture.

Beautiful buildings, fine scenery and pleasant social relations are not sufficient to draw many hundreds of hard-headed sons of the farm from their Manitoba homes. "Institutions" never captivated and held the interest of a single creature any more than a twelve-inch gun will spontaneously pierce an armour-plated enemy with its projectile. It is "the man behind the gun" all the time who

educational as well as from the executive point of view.

It has already been the subject of numerous magazine and newspaper articles but the farming community, not only of Manitoba but of a far wider portion of the Dominion, can tell better than any fulsome newspaper account what it owes to his tact, push and principle no less than to his scholarly attainments in moulding the future of its sons. Nothing great was ever done without enthusiasm, a few score of writers have told us. The constitutional enthusiasm of Principal Black in the most prosaic details of his work has kept him as fresh to it as when, for the first time, his curiosity looked out on the wonders of "life growth and fructification."

An old student once said to the writer: "He (Mr. Black) handles his subjects as if he made a real



Professor W. J. Black, Principal of Manitoba Agricultural College

on the way to fortune in farming (if he cared to exercise his memory in this way).

Mr. Lawrence is also an enthusiast in his job and, with the whole atmosphere of his "den" charged with the spirit of the West, there is already strongly in evidence the prospect of a brighter day for "The College" such as it has

Continued on page 85

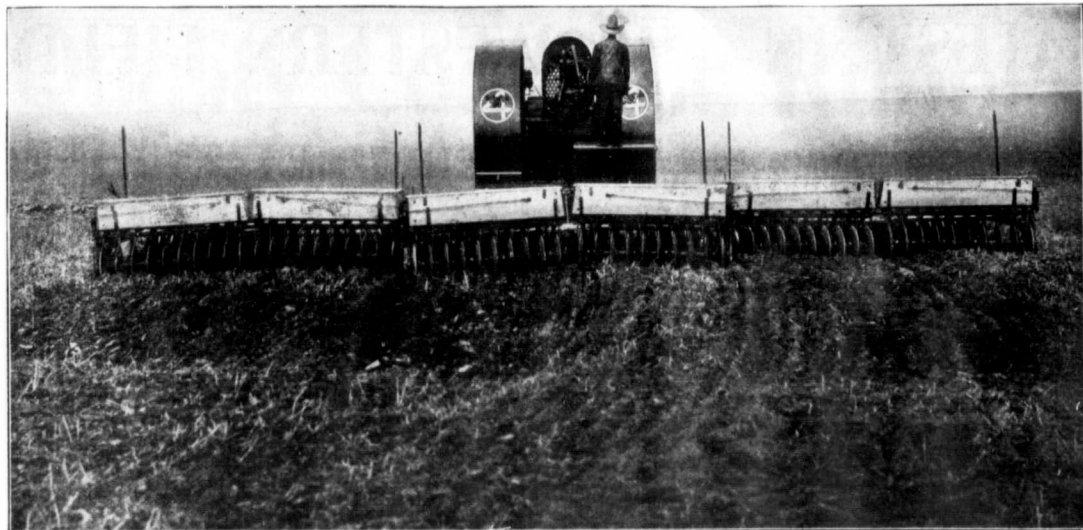

A Great Combination

The Big Four "30," three 10-foot Emerson No. 60 Engine Disc Harrows—and one man to run both. A perfect seed bed thirty feet wide and twenty miles long can be doubled-disked in one day with this outfit, which does the work of at least thirty-two horses and eight men. No wonder up-to-date farmers everywhere are putting their seed beds in perfect condition for spring with this work-saving and result-producing combination.

The Big Four "30's" remarkable efficiency, economy, durability and adaptability are due in large measure to the fact that it was designed from the ground up especially as a farm tractor and was not adapted from a stationary gasoline engine. The Emerson No. 60 Engine Disc Harrow's unequalled record of efficiency in the field has been due to the same cause. It was designed especially for tractor use only, not adapted from the ordinary horse harrow. Both the Big Four "30" and the Emerson Engine Disc Harrow are the work of specialists who have spent years in practical work and experimenting with tractors and tractor implements. Working together they represent the maximum of efficiency and the minimum of labor and expense.

The Emerson Engine Disc Harrow is strong, durable and easily managed. The front section is set so the discs throw out while the rear section discs throw in, thus the 40 16-inch

discs thoroughly pulverize the soil — preparing a perfect seed bed with one operation. Setting all the discs straight makes a good sub-surface packer.

The disc blades are one-third heavier than those on a horse disc harrow, and the disc spools are twice as heavy, with wide flanges to reinforce the discs. Axles are one inch square instead of $\frac{3}{4}$ inch as used on horse discs, and there are four bearings on each gang in place of three on the horse discs. The levers are heavier than on the horse discs and are worked on the outside end of the gangs, giving the operator more leverage than in the center lever construction. The draw bar is fastened to the frame with a clevis around the end of the bar, and the front gangs are connected with the draw bar at both outside and inside ends. The platform is divided in the center, and fastened with six U bolts so the discs can conform to their work properly. The levers are so arranged that the rear section can be set at a greater or lesser angle than the front section. At the same time the operator of one lever changes the angle of both front and rear sections on one side.

Rock, sod or sacks of sand or dirt may be piled on the weight pan between the front and rear sections, where there is room for a ton of sod.

The New Emerson Force Feed Seeder

is used on the rear section for sowing all kinds of small grains. By a graduated adjusting device a certain number of bushels of seed per acre are insured and every grain is planted at an even depth and thoroughly covered.

The seed spout extends from the seed box downward in front of the axle, thence down on the back side of the disc blade, in such a manner that trash cannot clog, nor stones or stumps injure the spout. Each disc blade cuts an oval bottom furrow about an inch or an inch and a half in width. In this furrow the seed spout deposits the seed. It is not all piled up, one seed on top of another, as is so frequently the case with a shoe drill, but the seed as it falls in this furrow scatters itself over the bottom of the furrow to the extent of about one and one-half inches in width. Then the next disc covers this seed at a uniform depth with the earth that it has taken to make the seed bed for the seed from the neighboring seed spout.

On the forward side of each spout is an opening or shutter device which may be turned by loosening a thumb nut, and the seed scattered broadcast in front of the discs instead of being drilled.

By attaching an ordinary tooth harrow behind this machine, the required dust mulch is made, and the field left in fine shape for the harvester; or where it is better practice to pack the seed bed, the common home-made plank made of three oak planks 2 inches thick, 12 inches wide, and 8 or 10 feet long, an edge of one lapped on top and nailed fast to the edge of the other, drawn behind the disc harrow, will crush all clods, pack the soil and leave a little fine mulch on top, or, if desired, both the plank and the tooth harrow could be used.

This machine is also made 8 feet wide, with 32 16-inch disc blades.

Sold by Implement Dealers Everywhere, and Branch Houses at Leading Trade Centres

EMERSON-BRANTINGHAM COMPANY

Manufacturers of the Largest and Most Complete Line of Farm Machinery in the World. 156 Princess St., Winnipeg, Man.
TUDHOPE, ANDERSON & COMPANY LIMITED, Sales Agents: Winnipeg Regina Calgary

School of Gas Tractioning opens Nov. 11 at Minneapolis. Write Big Four Tractor Works, Minneapolis, Minn. for particulars.

LATEST IN THE WESTERN FIELD

Thirty-eight years on the Canadian Market "Decker" Engines and Separators are not untried novelties.

Engines in the following sizes:—

18 h.p., 20 h.p., 22 h.p. and 25 h.p.

Plow Engines a Specialty

Heavy Gearing suited for heavy work. Most perfect Valve Gear in use. Easy steamers.

Decker Separators

in the following sizes:—

24-46, 28-50, 32-54 and 36-60.

There is no Separator better adapted to Gas Power, being easily driven, convenient to handle and perfect in separation. All sizes have large Cylinder and heavy shafting.

Decker Wind Stackers

Decker Feeders and Baggers

Threshers Supplies

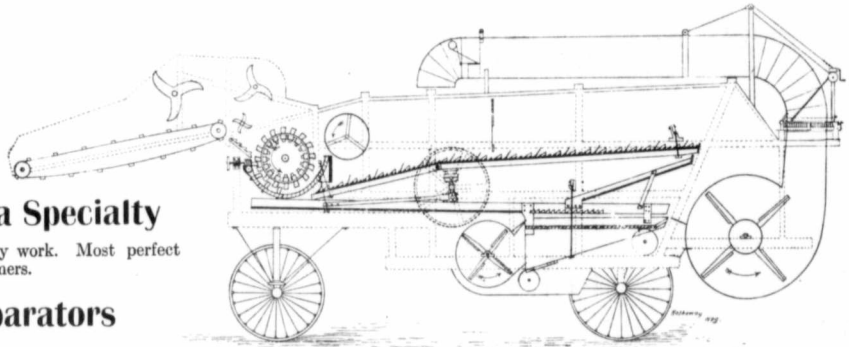

THE MACDONALD THRESHER CO. Limited

Write for Catalogue.

Head Office and Factory, Stratford, Ontario, Canada.

Box 1296 Winnipeg, Man.

THE rise and progress of the Canadian Consolidated Rubber Co., Ltd., is a splendid portion of the Dominion's industrial life, but there are features about it which are interesting, not only to cold-blooded men of business, but which also fascinate the popular mind to a point that is seldom reached by more imposing spectacles.

In association with the Canadian Rubber Company of Montreal, it has a record of steadily increasing success which stretches over half-a-century, and in point of fact it is the oldest and now the largest industry of its kind in Canada.

In 1854 the parent factory was probably considered a wonderful institution although it only covered a superficial area of less than an ordinary town lot. Now the great rubber house owns and operates five gigantic factories (the largest of which is at Montreal) covering many acres of valuable city property.

Sales branch houses are located at every strategic distributing point in Canada from Halifax to Victoria. Winnipeg is the Western central depot of the "Consolidated" and the occasion of this reference to its affairs is to announce the near completion of magnificent new warehouse premises in that city as well as at Saskatoon and Edmonton.

The year which is about to close presents at all of these a record of bricks and mortar, of sky-scrapers and steel structures that beggars description; and in common with so many of their neighbors, this company has been compelled to find a way or make one to much greater facilities for handling the ever-increasing volume of Western trade.

These are impressive signs of the times. They do more than "point a moral and adorn a tale." The Canadian Consolidated Rubber Company have a slogan that is made up of something like "Quality and Value," and the happy circumstances in which they now find themselves points conclusively to the fact that they must have been living up to their war-cry, and also to the fact that the natural expansion of commerce in Western Canada is a very real thing

The Wonderful Record of a Canadian Rubber Industry

and not an inflated expression of "things hoped for."

Men of the West do not buy rubber goods unless they actually and urgently need them, and they do not continue year after year to buy them from a source of supply that is not eminently and uniformly satisfactory.

That is the story of the Canadian Consolidated Rubber Company in a nutshell. The new warehouses referred to are these splendid structures that cannot be set out in cold type or described in "dimensions." The new Winnipeg building will be used entirely for warehouse and shipping purposes, and will cost in the neighborhood of \$50,000.

The premises at 89 Princess Street are being fitted entirely as city offices and show rooms and also to accommodate a certain amount of stock to serve the local trade. The shipping for Western points and the general wholesale distribution outside of Winnipeg will, however, be conducted almost entirely from the new warehouse.

The Company's new premises at Saskatoon and Edmonton consist in both cases of substantial and imposing six-story warehouses, basement and office building.

At Regina it recently moved into a more commodious building while work will be commenced almost immediately upon the erection of another large ware-

house in Calgary. Lastly the rapidly growing requirements of the motor tire business which the company conducts, have called for the erection of a new factory in the East, where the tires of the Morgan and Wright type will be produced.

This is a healthy and most gratifying story, as it is an exact statement of the multitude of departments this company handles, it requires no effort of the imagination to understand why it finds its own difficulty in simply keeping step in the march of Western progress.

The Company manufacture all kinds of mechanical Rubber Goods, Druggists' Sundries, Waterproof Garments, Fire Hose and Fire Dept's. Supplies, also all kinds of Moulded Rubber Goods, Rubber and Felt Footwear, Automobile, Truck and Carriage Tires and indeed rubber utensils and accessories for every purpose to which rubber-textile products can be employed.

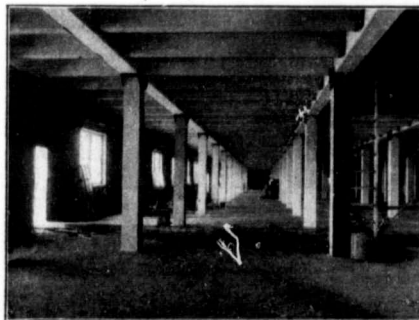

A Section of the Ground Floor of New Warehouse of Canadian Consolidated Rubber Co., Winnipeg.

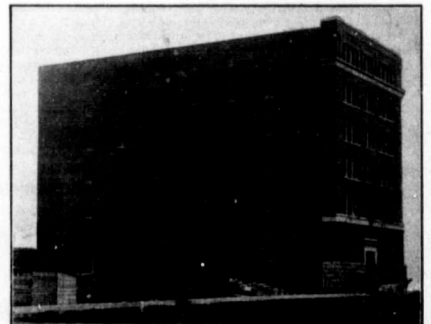

New Warehouse of Canadian Consolidated Rubber Co., Saskatoon.

Quality Counts in Rubber

AND WINS AGAINST ALL ODDS OF PRICE PREJUDICE OR PUFF

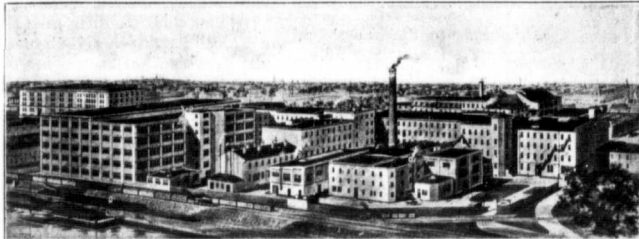

Our Mammoth Factory at Montreal

First and Largest Factory

Manufacturing General

RUBBER GOODS

in the Dominion of Canada

Our Products

- Rubber Footwear:** "Jacques Cartier" Brand
 "Merchants" Brand
 "Maple Leaf" Brand
 "Granby" Brand
 "Anchor" Brand
- Felt Footwear:** "Berlin" Brand
 "Elmira" Brand
 "Kimmell" Brand



Where "Berlin" Felts are Made

CANADIAN CONSOLIDATED RUBBER CO., LIMITED

Manufacturers of the Celebrated

"Para" "Lumber King" "Star" and Other Brands

of Belting for Threshing Outfits and all kinds of Mill Work



Factories of the "Maple Leaf" Rubber Footwear

Everything in Rubber

from the largest piece of rubber belting or hose to the smallest of moulded or cut specialities.

Quality and Value Has Built Our Business in Canada

Completely Equipped Branch Houses at

Calgary Edmonton Regina Saskatoon
Vancouver and Victoria

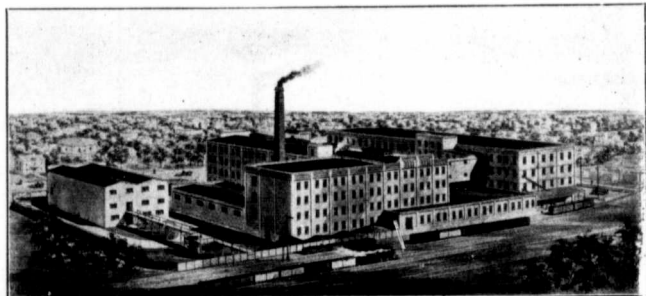

"Merchants" Factory

Central Depot for Western Canada, 89 Princess St., Winnipeg

You saw this advertisement in this magazine. Don't forget to say so when writing.

THE transmission of rotary motion from one shaft to another by means of pulleys coupled together by flexible bands called "belts" has long been a popular means of power transmission. Electricity undoubtedly is more economical and desirable for factory purposes and where heavy power is required, but many instances are known where it would not be at all practical.

Belts for power transmission are made of different materials, such as leather, rubber, canvas and metal chain belt. All are made in widths to suit the re-

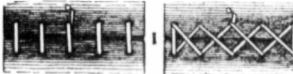

quirements of the user. Of these, leather is undoubtedly the most commonly used. It also has been longer used for this purpose.

The use of this material for belting, in fact, for all general purposes, goes back so far that no date can be set that would be anywhere near correct. Since hides of different animals always have been available, their use, of

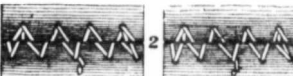

course, has been varied. Rubber and canvas belting are comparatively new in comparison with leather.

As years went on, its usefulness became more and more apparent, and the demand for the same has increased. This brought about new and better ways of curing and tanning the hides, treating them to prolong their

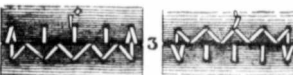

life and make them more adaptable for power transmission purposes. The demand has led the belt manufacturers to produce belts of almost any size, capable of transmitting power for all general purposes, from light, round leather belts as on sewing machines, to 60-in. belts for large power houses, transmitting thousands of horse-power.

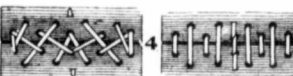

These same belts are often made in the same factories, by the same process, under the direction of the same men, and made with equal care, so that they will be the best possible for their respective needs.

In the process of belt manufacturing, many things are to be considered. To the uninitiated, leather is "leather," and nothing

The Why and How of a Belt

more. To those who constantly work this material, no doubt much difference is apparent. Even to those of us who have use for it for driving purposes, as in belts, we can frequently tell a good piece from a poor one. Leather belt manufacturers select the hides from which the belt is to be made, with much care. Even the kind of animal from which the hide is taken is of no small consideration. These large belts for heavy transmission purposes necessarily should be of a better grade than the smaller belts.

The tanning process of the hides no doubt has much to do with the life of leather belting and to this end, no small amount of attention is given by the manufacturers. The more modern leather belt manufacturers have their own tanneries, therefore, the entire process comes under the careful supervision of the management.

Only a portion of the entire hide is available for leather belting. Those parts that were on the under side of the steer, the "belly" as it is termed, the shoulder and neck are not adaptable for good leather belting. Those parts are soft and spongy, and the difference in the grain also makes them undesirable. The middle portion of the hide, the center only is used, and about 50 inches is an average length. About 48 inches in width are available, so that with this size carefully selected, well tanned and built up into a belt, the best possible grade and the longest lasting belt is obtained.

Belts are very frequently made up in layers. That is, each hide forms one layer, and they are put up and glued together to form heavier kinds, and each layer is called a "ply," as, for instance, a two-ply belt, or a three-ply belt, and so on, indicating the thickness and strength of the belt. To construct these belts of more than one-ply to work as though it were a single belt, requires the experience acquired only by years of study and experimenting to attain a belt that will work under the most severe strains and transmit the power that it was intended for, with a maximum efficiency and last the longest. In these large, heavy belts is where the work of selecting the hides, tanning the same and the entire process of manufacture, reflect only credit to the manufacturers, and with this in view, no small

amount of care has been used to make their product the best possible.

Which side of the belt should be run on the face of the pulley? This has long been a question amongst inquirers, and many good reasons are given for each as the case may be. In later years, it seems that the majority have agreed that the hair side, or grain side is better. By that is meant that the belt will transmit more nearly its maximum power with the least slippage, and the life of the belt will be prolonged.

The hair, or grain side, being harder and tougher, makes it more desirable for running next to the pulley. The flesh side being more flexible, bends and "gives" more in turning around pulleys, particularly when of small diameter, since this side must necessarily stretch a trifle in going round the pulley, for the outside diameter is a little greater.

When putting the belt on the pulleys preparatory to running, see that the belt runs in the direction so that the pulley face runs with the laps of the belt and not against them. Many manufacturers have an arrow stamped into the leather to indicate the direction in which the belt should run.

Nearly all new belts will stretch a little after having been used a short time. Manufacturers, nevertheless, have stretched the leather before manufacturing the same into a belt. After a new belt has been run a day or two doing its required work, it will lengthen and get loose. This should be taken up from time to time. Where tightners are used, this can easily be accomplished, otherwise, a piece should be cut from the belt. Frequently it is difficult to tell exactly how much needs to be removed to make the belt of proper tension to work correctly. Care should, of course, be exercised not to cut out too much, as this will cause an unnecessarily heavy strain on the belt, besides it will transmit this strain to the bearings and may cause a hot-box. If enough is not cut from the belt, the operation of cutting and lacing will have to be repeated. Therefore some judgment must be used in determining how much to cut out to have the belt done properly and do its work.

After the belt has been shortened a few times, it will have reached its maximum length, and

with good care will never again need shortening, or, if it does, the intervals will be few and far between. A good oak tanned leather belt (if properly run and cared for) should, it is estimated last thirty years for indoor work.

When used out of doors, subjected to the heat and cold and dampness, even rain, they deteriorate very rapidly. Yet we not uncommonly find farmers who have had belts on their thrasher machines for fifteen and eighteen years. This is, of course, not because of the outside work, or the dirt and dust of threshing, but in

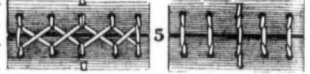

spite of the same, and we can readily conclude that these farmers understand how to properly care for the belting.

Slipping belts on pulleys is frequently the source of much trouble, particularly on agricultural machines at work out of doors. It is sometimes also very hard to locate this trouble. We often find a threshing machine at work in the field, not doing its

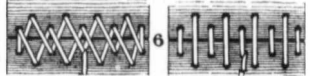

work properly; perhaps not cleaning well; perhaps not shaking or agitating the straw properly, or the material doesn't move rapidly enough on the chaffer and conveyor, and it is very often the fault of a lack of proper speed of these parts. Therefore it is well to see that the belts are not so loose that slippage occurs. Besides giving trouble to the operators by

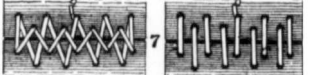

the poor work of the machinery, this slipping causes a large amount of friction and rapidly ruins the belt. On agricultural machinery, the pulley face is not machined to a smooth surface, and this rough surface acts like a fine rasp and wears the leather.

A belt that is too small and narrow to do its work properly will slip very much. Frequently we

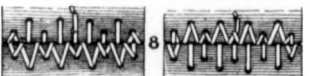

find a three inch belt on a machine where a wider face would have interfered with other parts of the machine, and this belt doing the work that a four inch belt should. This will no doubt slip very much and give a lot of trouble. Whenever a belt is required to transmit more power than is usually required for that size, slippage will

DESMOND MATCHLESS



MODEL "U" INJECTOR

THE ONE INJECTOR THAT MEETS ALL CONDITIONS. The New Desmond Model "U" is made with a two-piece body with the parts connected by a Union nut. When loosened, connections can be turned in any direction desired. When the connections are made, the nut is tightened and the injector is ready for work. It will fit any space, can be fixed in any position or adapted to any special condition and connected with either side of the boiler. The piping and valves can be arranged to suit your requirements—not merely to fit the injector. All tubes screw into the body and cannot fall out or get damaged when cap is removed. Neither can they get out of alignment. The New Desmond Model "U" is flexible. One of them will meet every conceivable demand that can be made on an injector. It starts low at from 20 to 25 lbs. It works high to 175 lbs.

Special High Pressure Injectors working up to 235 lbs. can be furnished when desired.

Lifts water 25 ft.; handles water at 130 deg. and delivers it to the boiler at almost 212 deg. Absolutely automatic, it will not "buck" or "break" under any circumstances. The Drip Cock of the Model "U" permits draining the Injector and piping in freezing weather, and makes a convenient place for drawing hot water when in operation.

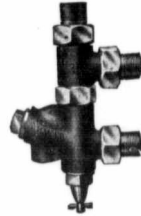
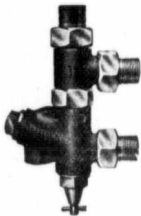

Every injector is rigidly tested before leaving the factory and is sent out with an unqualified guarantee to work perfectly under all conditions

If your dealer cannot supply you—write us direct and give us his name. We will see that you are supplied.

DESMOND STEPHAN MFG. CO.
URBANA, Ohio

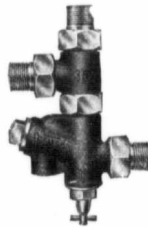

CRANE & ORDWAY CO. LTD.
SALES AGENTS FOR CANADA
WINNIPEG, Canada

You saw this advertisement in this magazine. Don't forget to say so when writing.

be the result and trouble will follow.

Pulleys of too small diameter also will cause the belt to slip, as they do not have compact surface enough to grip the belt properly. Oil and grease, as well as moisture, if the belt is run in the rain or on a very damp day, will cause the belt to slip very much. A slipping belt rarely travels in the center of the pulley. It will be seen running from one side to the other alternately, and if the slippage is too great, the belt will run to the edge of the pulley and slip off.

By covering an iron pulley with leather, some of the trouble due to slippage will be overcome. This will give the belt a better grip on the pulley face. All pulleys of small diameter running quite rapidly should be covered with leather as it will add very much to the amount of power that the belt can transmit, besides prolonging the life of the belt by reducing the wear caused by slippage to the minimum.

The care of leather belting is an item not to be overlooked by those who have machinery driven by belts. The need of much care is even more apparent on those machines that work out of doors and on the farms as do huskers, hullers, shellers and threshers. Being out of doors, they are sub-

jected to the changes of the weather. Perhaps one day it may be very dry and sultry, while on the next day it might be wet and raining. These changes necessarily effect the leather very much. On those machines that work in doors, where the temperature is always the same, and where they receive the best of care, they last much longer. Therefore no small amount of care should be required to keep all the belts in the best possible condition to transmit all the power that was intended with least possible amount of slippage and wear of the belt.

Belt manufacturers are now furnishing what they call "waterproof belts." These are made to better serve on out-door machinery since they will stand moisture much better than belts not treated. Since treatment of a leather belt is a means of filling the pores of the leather with some waterproof substance. After the pores are full no moisture can get in through the pores, consequently the amount of dampness and moisture in the air has no material effect on the leather. We not uncommonly find leather belts that have been treated with this waterproofing running in places where an untreated belt would not run and transmit at all.

Belts treated this way are preferable on all agricultural mach-

Stickney and Chapman Gasoline Engines

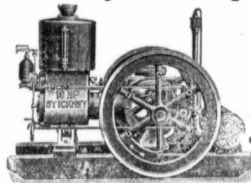

are marvels of power, ease of operation and economy—a boy can run them. They last longer with a minimum of repairs than any other made. The 2 H.P. Chapman is recognized everywhere as the best engine for pumping water. Simplicity, staunch construction and wonderful economy have made the 1 1/2 to 20 H.P. STICKNEY ENGINE the most widely used for grinding grain, sawing wood and ANY general farm work a good engine can be expected to do.

Get a STICKNEY or a CHAPMAN and your engine troubles become merely a memory, for they are as right and accurate as a lifetime of effort can make them. Write for Catalogue TODAY.

TORONTO GRAIN GRINDERS
CANADIAN WOOD and POLE SAWS
AYLMER PITLESS SCALES
EACH IN THEIR CLASS THE BEST THAT MONEY CAN PRODUCE



Ontario Wind Engine and Pump Co. Ltd.
TORONTO—CALGARY—MONTREAL
WINNIPEG

ines. Waterproofing does not in any way lessen the strength, durability, or driving power of the belt, but on the contrary will have a tendency to increase them.

Many different kinds of dressings are made and used on leather belts to keep them in good condition. Any leather belt necessarily will need some care and attention to keep it in good condition. Being an animal product,

and having had life, it was originally quite oily. Time and constant use cause this oil to evaporate and dissipate, therefore something needs to be put on the leather to keep it in good condition.

When a leather belt is pliable and soft, when it is "mellow," then it will be in good shape to do its work best. When dirty, dusty and dry, it soon begins to crack and in a short time will tear at the

edges, the rents gradually working in farther till it tears apart. This same thing is also very noticeable in harnesses for horses. Unless a good dressing is frequently applied, the leather becomes so hard and harsh that it cracks easily and breaks.

Mineral oils such as kerosene or engine cylinder oil are very injurious to leather and should never be used as a dressing, and should always be kept from the surface of the belt. Animal oils, such as lard, tallow and neat's-foot oil or vegetable oils, as olive or castor oils, are good for leather belts. Of all these, neat's-foot oil is perhaps most preferable as a dressing and a preservative. It will tend to keep the leather soft, pliable, mellow and in good condition to do its work in the best possible manner.

It is a good plan to wash a leather belt once in a while with soap and water. This will remove all the dust and dirt from the surface and the pores of the leather, after which the dressing should be applied. A dressing put on a belt when it is gritty and dirty does not have an opportunity to get into the pores and into the center of the leather.

There are many different belt dressings on the market that may be purchased either in stick form, or as a paste. The former is perhaps preferable for agricultural machinery since it can easily be handled and applied.

Beef-tallow and neat's-foot oil both make good dressings for belts. The latter has particular advantages, for besides preserving the leather, it adds to the friction and helps transmission. It enters the pores of the leather when rubbed in well and doesn't tend to solidify as does tallow. To properly apply the beef tallow, it should be heated a little, then applied. Either of these dressings soak into the leather and dry quite rapidly. For those belts that are run in damp and moist places, or out of doors very much, the tallow can be mixed with a small amount of beeswax, which will tend to make the belt impervious to moisture and dampness, and yet have flexibility and be mellow from the tallow.

It is not uncommon to find rosin put on the surface of belts to make them transmit more power or prevent slippage. When it becomes necessary to resort to this means to get enough friction to transmit the power required, it is high time to look for trouble somewhere. Something is tight or binding, and the trouble should be located. It may be that the belt is too small and being overworked, so that rosin is being applied to overcome the difficulty without finding and remedying the cause thereof. On all standard

Water Scarcity Booms Business for Well Drillers

Enormous increase in immigration, scarcity of pure water and alarming spread of TYPHOID FEVER are booming the well-drilling business. Entire populations demand pure well water.

Well drillers are making from \$25.00 to \$50.00 a day clear profit the year around. Magnificent money-making possibilities for live men everywhere who want to work—men who have a reasonable amount of money to invest in machinery—men who can grasp the exceptional opportunity for engaging in this business NOW—a business VITAL to the country's prosperity and growth.

Immigration Compels Immediate Action!

Hundreds of thousands of families are settling throughout Canada, and every homestead requires a pure supply of fresh water. Creeks, lakes, ponds and shallow wells, now contaminated in every locality, are being condemned by health authorities. And the drilled well is the people's only alternative. Today, there is ten times more drilling to be done than men to do it. Enter this profitable field, simplify the work with

Armstrong Well-Drilling Machinery

Built for Service Since 1867—Cuts the Cost—Trebles the Profits

Armstrong Well-Drilling Machinery affords you the quickest and easiest way to turn the Canadian water scarcity into profits. It does more work at less expense than any other drilling machinery in existence.



By actual test Armstrong machines average 92 feet per day in solid rock, using 6 1/2 gallons of fuel on work where other machines average only 65 feet on 11 gallons. Armstrong gives 46 per cent more efficiency at 32 per cent less fuel.

For nearly half a century Armstrong Machinery has been noted for its unequalled durability; also for its simplicity of construction and operation. Our patented Internal Compensating Band Wheel Clutch—which does away with lost motion—is one of the greatest improvements ever made in well-drilling designs. This clutch and our improved friction hoists do away with all attachments, balance wheels, cast brakes, cams, bumpers, treadle beams, bumper axles, eccentric rollers, chains, springs, sprockets and ratchets. Produces ideal elliptic drilling motion with absolute minimum friction. Eliminates expensive repairs and delays. Only one gear and pinion. We make gasoline and steam cutting and combination outfits—a machine for any depth, every formation. Outfits furnished with power or without. We furnish famous Armstrong Special Dynamic Drilling Engine with patented speed-controlling lever of drilling end of machine. Changes instantly and absolutely controls speed of engine. Sent direct to manufacturers and tanners. Confer with us on any technical question, you fully. A branch now in Saskatoon to take care of our Dominion trade. Write for BIG 184-PAGE ILLUSTRATED CATALOG—The book fully explains well drilling and shows how Armstrong Machinery simplifies it. Tells how our men have jumped in and made big successes with little or no experience. If you are interested in well drilling write for this book. Sent free on receipt of 2c to cover postage. **ARMSTRONG MFG. CO., 611 Second Avenue, Saskatoon, Sask., Home Office and Factory, Waterloo, Iowa**



Why Well Drilling Beats Threshing

An Armstrong Well-Drilling Outfit costs from one-half to one-third that of a threshing outfit, can be operated every day in the year, and pays from two to three times the profit. Proving wonderfully attractive to three-hundred farmers, railroad men—to all seeking steady work and a profitable business of their own. Complete outfits furnished with or without power. (16)

You saw this advertisement in this magazine. Don't forget to say so when writing.

agricultural machines that have belt driven parts, the belts, are, no doubt of proper size to transmit the right amount of power, and when it seems as though an application of rosin was needed, it is certain that some other cause of the trouble can be located. It may be the belt is too small and be overworked, so that rosin is being applied to overcome the difficulty without finding and remedying the cause thereof. On all standard agricultural machines that have belt driven paths, the belts are no doubt, of proper size to transmit the right amount of power, and when it seems as though an application of rosin is needed, it is certain that some other cause of the trouble can be located. Rosin is not a good medium to put on any belt, and it tends to ruin good leather rapidly. Anyhow the pulling power and friction of a belt by the application of rosin is not permanent. It sticks to the surface and in a short while the slippage will increase instead of decrease, due to the dust and dirt which will cover the rosin on the pulleys and belt.

Rubber belting, while not so commonly used as leather, has many qualities to recommend it for general use. For outdoor work and in slightly moist places, it gives excellent service. It is made up of several layers of canvas held together by being vulcanized with rubber, which is pressed into the meshes of the cloth, binding them solidly and firmly together. The outer surface is given an extra heavy covering of rubber, which besides making the belt stronger and prolonging its life gives it a good wearing surface and a good grip on the pulley on which it runs. Rubber belting is usually found of uniform thickness throughout its entire surface, due

to the care used in its manufacture. It also has very great strength.

When placing a rubber belt on a machine, see that the seam is on the outside and away from the pulleys. This seam can easily be seen, as it is a small strip of rubber usually in the center of the belt and running along its entire length.

Oil and grease of any kind should be kept from a surface of rubber belting as these will ruin rubber more rapidly than anything else. Should any accidentally get onto the belt, it is well to remove it directly by a liberal application of soap and water. Boiled linseed oil can be used as a dressing for a rubber belt when needed, but ordinarily no dressing whatever is needed, and when rosin, or anything of a sticky nature is used to prevent slipping, it will ruin the rubber belt very rapidly, because, as the belt travels around the pulleys small particles of rubber will tear from the belt and in time entirely destroy the rubber surface. A rubber belt to be at its best should have a clean, smooth surface, in which condition it will give entire satisfaction to the user.

Excessive heat tends to destroy rubber very fast, therefore when storing rubber belts from one season to another, a dark cellar is the best place. Here it will be out of the light and heat, the sun and moisture, which will tend to preserve and keep the belt in good condition.

Of late, canvas stitched belting has largely come into use for driving purposes. In many instances it has displaced leather. It has the advantage of being made endless, that is, it has no joints or seams that can open. Therefore for hard usage and

Raw Furs and Beef Hides

Join with the thousands of shippers and send your raw furs and cattle hides to us. We always pay top prices, save middlemen's profits as we sell direct to manufacturers and tanners. Write for our new price list, just issued, mailed free, postpaid, to any address. Our reference is any bank in the country. Address all shipments and correspondence direct to Dept. N.

Northwest Hide & Fur Co.

278 Rupert Ave. WINNIPEG

Mention this magazine when writing advertisers.

THIS BOOK FOR YOUR NAME

and address. Written by practical farmers—packed full of information to make your profits bigger—all about the

ACME PULVERIZING HARBOR

cloud crusher and pulverizer. Prepares best seed bed. Cuts through in under soil—compacts it—leaves no lumps or voids between furrows. Cuts, crushes, levels, turns and smooths at one operation. Get our Book—NOW.

Duane H. Nash, Inc. 318 Division Ave., Millington, N.J.

John Deere Plow Co. (Ltd.) Calgary, Alta Regina, Sask. Winnipeg, Man.

Mention this magazine when writing advertisers.

NO MORE WET OR COLD FEET!!

Try a Pair of our famous (Health Brand) **FELT-LINED CLOGS** as illustration, on leather tops, wooden soles, lined feet. Men's or Women.

ONLY \$1.60

Express prepaid to your home, on receipt of money order or cash (no checks)

Higher 3 buckles . . . \$ 2.25
High legged Wellingtons \$2.75 & 3.25
Childrens Lace 7's to 2's . . . 1.25

CANADIAN FELT-LINED CLOG CO.,
Dept. K, 363 Spadina Ave., Toronto, Canada

Mention this magazine when writing advertisers.

The Winnipeg Rubber Co.

Extends a Message of **Good Cheer** and **Heart-Felt Appreciation** to its many Customers.



During the year that is just closing we have given our every effort to the production of a line of **THRESHER BELTING** that is second to none. We have spared neither time, labor nor expense in the manufacture of



LION BRAND

Rubber Belts

AND



MAPLE LEAF

Endless Thresher Belts

We Solicit Your Patronage For 1913

We have laid our plans carefully and we are prepared to give you the maximum in quality and service. You, as a Thresherman, are the connecting link between crop production and crop realization. We as belt makers furnish you with the connecting link that makes this possible. Our interests are mutual. Let us work together during the coming year for bigger and better results. Our part is to build Thresher Belts, your part is to insist on getting either **LION** or **MAPLE LEAF** brands.



Winnipeg Rubber Co., Limited

NOT IN ANY TRUST OR COMBINE

WINNIPEG

CALGARY

You saw this advertisement in this magazine. Don't forget to say so when writing.

ers
PHOID
water.
reshing
Outfit costs
of a thresh-
day in the
ree times
attractive
ad man-to
profitable
outfits for
(14)
engine. Ben-
also protects
ical question-
ing and shows
th little or no
cover postage
aterloo, Iowa

S
es
shippers
d cattle
pay top
as we
ers and
rice list,
d, to any
bank in
shipments
Dept. N.
r Co.

g advertisers.
R NAME
arm-
akko
best
oids
ols, turns and
ook—NOW
ision Ave.,
Calgary, Alta
peg, Man.

FEET!!
alth Brand)
D CLOGS
leather tops,
lined felt,
n.
ONLY \$1.60
express pre-
aid to your
ome, on re-
of money
der of cash
to checks)
\$ 2.25
75 & 3.25
1.25
CLOG CO.,
nto, Canada
g advertisers.

severe service it give excellent results. For main drive belts with threshing rigs in widths of six, seven, and eight inches, and lengths of eighty, one hundred, and one hundred and fifty feet, they seem to be the most commonly used, and give better satisfaction than belts of any other material. They are not easily effected by heat, or moisture, and besides, they will stand hard surface and heavy strains,

These belts are nearly all made of about thirty-two ounce cotton duck which is very carefully and uniformly woven, then folded in layers or plies, depending on the power to transmit, after which they are reinforced with a stitching to further increase their strength. These stitches are put in the belt about four per inch of width and run lengthwise of the belt and are made of a very heavy strong twine.

Care should be used to have these belts run on the center of the pulleys so they will not run on anything at the edge. Being folded in plies, if the edge is worn through, they soon become frayed and look badly besides they are somewhat weakened. Running as they do about a half mile a minute it doesn't take long to ruin the edges if they rub very much.

These canvas stitched belts really require dressing if properly cared for. The manufacturers, however, furnish a dressing which tends to make them waterproof. A coat of good thin paint will do no harm and in many cases will preserve them.



Electric Power on the Farm

Continued from page 28

expensive there is no waste, all the heat going into the iron and nowhere else. On the other hand, if a coal range is used to heat the iron, most of the heat energy of the coal goes up the chimney; most of what is left heats up the mass of the range, dissipating it self in the kitchen, causing a sweltering atmosphere (in summer) in which to work; and finally a little, a very little, of the coal heat enters the flat-iron. Here we have cheap heat used very wastefully so that in the final analysis it is expensive heat. Aside from the consideration of a cooler kitchen, the fact that the iron stays hot all the while it is used saves many steps and pauses. A good iron may be purchased for five dollars. The writer has an electric iron in his home which has been used continuously for over four years. During this time it has ironed all the family washing and is still in service.

Perhaps no device should claim a higher place in the home than the vacuum cleaner, whose merits, though well recognized in the

cities, are probably less familiar to those living in the country. It cleans everything by suction. Carpets, rugs, walls, curtains, shelves, clothes, hats, etc., may be cleaned in a short time without raising dust and without any wear and tear on the articles. It is a fact that carpets and rugs last longer and look better if cleaned in this manner, for a broom or sweeper is bound to wear the surfaces in time. The power required to drive the vacuum cleaner is very little yet it accomplishes much. Instead of having spring or fall house-cleaning, the possessor of one of these contrivances may have thorough cleanings every week, or oftener, with the expenditure of less time and energy than the good use of a broom would require.

There are many other electric devices for domestic use that might be mentioned. The electric fan is a comfort in hot weather. The electric toaster, stove and electric waffle-iron are so neat in appearance and clean to operate that either utensil may be placed on the dining table at a meal and toast, hot cakes, or waffles, served right off the griddle.

So much for the home. But what about electrifying the farm? Unless the farm is very large, requiring a variety of high powered machines frequently operated, the writer does not think it advisable to plan on a large and expensive power plant; because excepting for a few days in the year at the time of harvesting, it would be operated inefficiently, due to light load. But the small machines, such as the cream separator, churn, tilting table saw, corn-sheller, feed grinder, root cutter, corn crib elevator, pump, etc., can be very conveniently operated by electricity. The problem of ice is a very serious one for those living in the country. There are now small ice plants on the market of very moderate cost, suitable for placing in the basement of a house. A half horsepower motor will operate some of these very satisfactorily. Such a machine will make enough ice to last a week when operated one or two days during this period.

There is no piece of machinery more reliable, more fool proof, more sanitary, or easier of control, than the electric motor. Merely closing a switch and operating a handle brings the motor up to full speed in a very few seconds. Opening the switch stops it. It runs very quietly with practically no attention; it is very light in weight for its power and so is portable. In fact, the motor may be fastened to the floor, ceiling joists, or wall, with equal facility; or it may be placed on a truck for portability.

It is not to be understood that

Protect Your Face This Winter



Here is an article that will enable you to face even an arctic temperature in a blizzard.

The Dysthe Face Protector

keeps the face and ears snug, protects the eyes, and enables you to see clearly in any storm. Made of flannel with double pyralin goggles that never freeze; fits any face.

Thousands in use by Doctors, Ministers, Liverymen & railway employees, farmers and others called upon to travel in all weather. Dr. F. Moore, of Clarkburg, Oat., says, "It would have been practically impossible for me to have kept up my work this winter without the protection afforded by your device. Several times it was worth more than the cost for a single trip."

Price, \$1.00. Postage Free. Send for Booklet C. T.

M. DYSTHE

302 Toronto Street

Winnipeg, Man.

You saw this advertisement in this magazine. Don't forget to say so when writing.

WE WANT TURKEYS NOW



PACKING TURKEYS FOR LAING BROS. FROM NORTH SASKATCHEWAN

Will pay cash or handle on commission. Best results assured in either case. Write us today what you have to offer.

LAING BROS., 307 Elgin Ave.,

WINNIPEG

You saw this advertisement in this magazine. Don't forget to say so when writing.

Farmers! Grain Merchants! Etc.

WHY pay exorbitant prices for your flour, bran and shorts when you can mill your own wheat? Send for particulars of

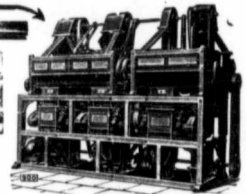

The Best Self-Contained Flour Mill in the World

It produces 300 pounds of fine flour per hour in three distinct qualities. It can be erected in any shed or barn. It is the best English make, the best material and best workmanship only used in manufacture.

The British-Canadian Agricultural Tractors Limited
SASKATOON, SASK. and CALGARY, ALTA.

You saw this advertisement in this magazine. Don't forget to say so when writing.

SPECIAL OFFER

We Have a Few Big Snaps in - Flour City Tractors

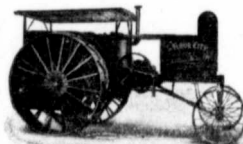

for early Spring delivery. Get next to our Bargain List AT ONCE. Write TODAY for our special proposition.

Ontario Wind Engine and Pump Company Limited

TORONTO CALGARY MONTREAL
WINNIPEG

You saw this advertisement in this magazine. Don't forget to say so when writing.

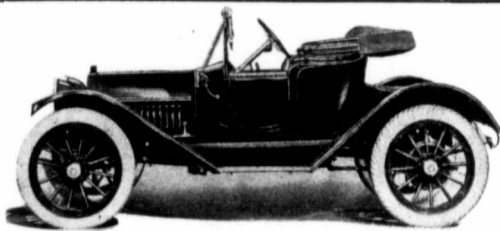

McLaughlin-Buick "30"—\$1750, Winnipeg

Model 31 Touring Car—5-passenger; 32 h.p.; 108-in. wheel base; 35 x 4-in. tires, non-skid on rear; demountable rims; fully equipped top; wind shield; speedometer; nickel trim; self-starter; dynamo electric lighted throughout; f.o.b. Winnipeg, \$1900.

Model 30 New Model Roadster—32 h.p.; 108-in. wheel base; 35 x 4-in. tires, non-skid on rear; demountable rims; fully equipped top; wind shield; speedometer; nickel trim; self-starter; dynamo electric lighted throughout; f.o.b. Winnipeg, \$17.60.

Complete specifications are given in our latest catalogs. Write for one and order early so that you may not be disappointed.

Live Dealers Wanted in Unoccupied Territory

McLaughlin Carriage Company, Limited
WINNIPEG, MANITOBA

TWO OF OUR 1913 LEADERS

These are Canadian built automobiles of the best construction and design in the mechanical world. A car guaranteed by the makers and endorsed by the Canadian motorist from coast to coast. There are more "McLaughlin-Buick" cars in use than the combined product of many manufacturers, and in 1912 the out-put of the McLaughlin-Buick factories of former years was doubled in the one year—a tribute to their sterling value that no other manufacturer has ever attained.

THE McLAUGHLIN-BUICK LINE

Contains a car that will suit every one in price, style, adaptability and durability.

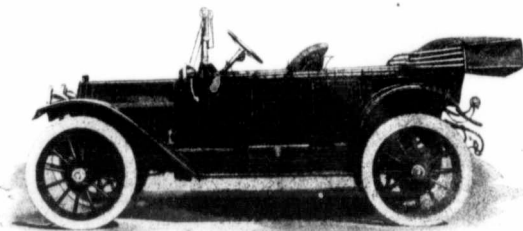

Model 31—Five Passenger Touring Car—\$1900, Winnipeg

You saw this advertisement in this magazine. Don't forget to say so when writing.

many electric motors are required to do the work about the farm. One or two are often sufficient—one large enough to operate the heaviest machine planned for as well as some of less power, and a small motor to run light machinery, such as repair tools, cream separator, pump, etc. A thorough study of the conditions existing on each particular farm is the only way to determine the degree to which electrification may be advantageously carried. Most likely the first thought will prove the desirability of a small plant for lighting. A logical extension of this thought will consider increasing the size of the plant to give capacity for the operation of motors. Good judgment should be used, however, in deciding how far to carry these improvements.

Now, as to the power plant. This consists of a gasoline engine, an electric generator, a storage battery, and a switchboard to control the electric power. The size of the generator is determined by the greatest amount of power that it is expected to furnish at one time. The engine should have capacity enough to run the generator satisfactorily at full load. The chances are that if the plant is intended for house operation only, a two horse-power engine and a one kilowatt generator is all that will be required. When the generator is also required to furnish power for motors about the farm, the capacity of the plant should be increased accordingly. Even with the two horse-power outfit all the electric devices mentioned in this article for domestic use may be operated without trouble. The storage battery furnishes the power at night when the generator is not running. It is charged by the generator during the day

to replace the energy utilized at night. It goes without saying that the heavier the load the more economically is the plant run. Hence, it is desirable to have enough apparatus requiring electric current in operation at one time to give the generator a fairly heavy load. The generator, of course, may furnish the power for the lights directly in lieu of the storage battery, but this would necessitate running the plant at inconvenient times, such as at night. The use of the storage battery avoids this.

A word of caution is suggested by the writer to intending purchasers of small lighting or power machinery. Do not necessarily buy the least expensive outfit, unless it checks out to meet your needs. It may also prove the least satisfactory in operation. A larger unit necessarily costs more than a small one. This fact should be taken into consideration. If the plant is intended for lighting only, the purchaser should not be satisfied with the statement that the generator is a 15-light or that it is a 20-light machine. He should know, in addition, the power of the lights referred to. A generator that will properly light fifteen or twenty small lamps may not do the same for larger lamps. Strictly speaking, the guaranteed capacity of the generator should not be given by the number of "lights" capacity but by the number of watts capacity. This puts all machines on the same basis. The watt is simply the electrical unit of power. If this is somewhat confusing, the selling agent should be asked, "How many 25-watt (20 candle power) lamps will the generator operate satisfactorily?" It happens that this size of lamp is the

most used in private dwellings, though smaller sizes may be used in the basement, halls, and porches.

Before the final payment is made on an outfit it is a good plan to test the plant to see that it meets with the guarantee. The generator should be loaded up to capacity after the installation is completed. There should be no trouble in maintaining this full load indefinitely, if both the engine and generator are properly rated. The engine speed should not slow down and the generator should not spark to any extent nor should it heat up unduly after running several hours under this load. To avoid any possible controversies on these points, however, it is best to consider only the machinery of manufacturers of reputation. There are a number of establishments of good standing which cater especially to farming communities. Their products have stood the test of time and there is less danger of the purchaser getting "stung" when dealing with them or their authorized agents.

Nothing has yet been said about the wiring of the premises. This is a very important consideration from the viewpoint of safety and reliability in operation. A poorly wired house may be a real fire risk though one may rest secure from this danger in a correctly wired home.

The question of cost of electrification is, of course, important, yet it is difficult to make any definite statements on this point because of the many variables which enter into the installation on different farms. Where the purpose is to light the house only, and assuming the house of average size with (say) eight

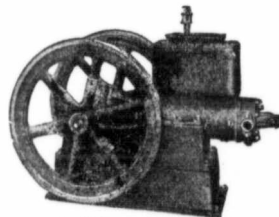

GILSON Hopper-cooled, 4 to 24-H.P.

**Cheap Power
Plenty Power**
For Every Need on the Farm
THE
Gilson Engine

grinds 1000 bushels of Grain at a cost of \$2.50.

Just 1/2 cent per bushel. The test was recently made by Prof. DAY of Guelph Agricultural College, and the Gilson Engines, in competition with other much advertised power engines, outclassed every thing in the contest.

Connecting Rod, Gears, Piston, Piston Rings, Crank Shaft and every vital detail subject to strain and wear are of a strength and quality not found on other engines.

THE PRICE WILL ASTOUND YOU
—It is the greatest value and gives the finest service of any power machine made to-day.

Write for complete details.

E. ELLWOOD: Manager
Renfrew Machinery Co. Ltd.
Enderston Block Winnipeg

Mention this magazine when writing advertisers

rooms, the total installation including plant, wiring, fixtures, lamps, labor, etc., may be obtained at a cost of about \$400 or \$500. This will probably secure as complete a wiring and as good illumination as is found in similar homes in cities. The barn may be furnished with electric light at a small additional cost which centers mainly in the additional wire,



YES

Our dealers sold more "Barth" Jacks this year than in any year since we started building Jacks in 1892—twenty years ago. That should be good news to you who have one of our Jacks. And still better news to you who have made up your mind to buy one of our Jacks. The "Barth" Jack is a good Jack. We know it is because we make it. You know it is if you own one.

Ask your dealer for the Jack. Ask us for a catalogue.

BARTH MFG. CO.
158 L St. Milwaukee, Wis.

Mention this magazine when writing advertisers



Where You Entertain Your Guests

Home is not for its inmates alone, but even if it were, it should be as attractive and artistic as possible. Therefore the decorating of the Dining Room should receive the careful and serious consideration of the home-maker.

SILKSTONE FLAT WALL COLOURS

"Smooth as Silk—Hard as Stone"

Enables the home-maker to produce artistic and permanent effects never before possible. It is the new finish for plaster and metal walls and ceilings. Fine for refinishing burlap. Silkstone is durable and sanitary—is not affected by steam or moisture—may be thoroughly cleaned with warm water and pure Castile soap. Suitable for every wall in the house—takes the place of wall paper and kalsomine. Sixteen beautiful colours and white.

Sold by leading dealers. Write today for free book of "Suggestions"—for paint users.



Mention this magazine when writing advertisers

fixtures, and labor. Satisfactory barn illumination need be nothing like as bright as in the house, since the chief purpose here is to find one's way about. If it is desired, in addition to the lighting, to operate one or two motors, the larger not exceeding six horsepower in capacity, the cost may reach as high as \$1,200 by the time the system is ready to be operated. A good vacuum cleaner may be purchased for about \$100; a small fan motor for \$10 or \$12. The cost of operating the plant, including gasoline for fuel, will probably be such as to make the cost of electric lighting no greater than it is in the city.

Much might be added with profit to the above in discussing this important phase in the development of modern living, but only a mere outline can be offered in a limited space. The writer hopes, however, that he has said enough to arouse interest among those to whom this article is especially directed.

Gas Engines and Fires.

Gas, gasoline and oil engines are safer than any other form of engine including steam, as all the fire is inside the gas engine cylinder and there is no bare flame, sparks, danger of boiler explosion, or fire risk of any nature.

Of course the fuel tank should be located underground and be equipped with suitable pump; but this is only necessary with large engines where a considerable quantity of the gasoline or other fuel is stored at the time.

We have all read of the fool who looked for the leak in the gasoline barrel with a match, and his sad end should be remembered by those who hunt for leaks with a lantern, in the gasoline piping around an engine at night.

On engines having battery ignition there is the possibility that a loose connection outside the engine will produce a spark and ignite any loose gasoline that may be around, but with engines having the more modern slow speed engine timed built-in magneto even this condition is practically impossible.

With the batteries it is possible by tapping the wire on the engine frame, at any point, to produce a spark, whether the engine is running or not, and this has resulted in fires. With the magneto, the spark can only be produced while the engine is in motion, and only between the igniter points inside the cylinder, as the snapping of the igniter must coincide with the position of the magneto armature. This makes it impossible for any one to take the igniter out and by snapping it in front of the hole in the cylinder causing explosions.

**DO NOT BUY A SEPARATOR, A SHREDDER,
A HULLER OR A HUSKER WITHOUT A**

Rockwood Paper Pulley

They are furnished free with new machines if you insist

They Pull Stronger

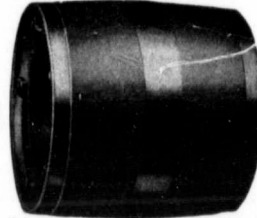

They Wear Longer

**NO COVERING TO WEAR AND COME LOOSE
NO BOLT HEADS OR RIVETS TO CUT THE BELT**

If you have had trouble with covered pulley it will pay you to investigate. Made in all sizes for all makes of machines

WRITE FOR CIRCULAR

The Rockwood Mfg. Co.

1928 English Avenue

INDIANAPOLIS, INDIANA

WHAT GIFT SHALL YOU BUY

for your family this Xmas-time?

Why not, this year, a gift that really means something? Why not Life Insurance?

For a REAL gift—a lasting memento—affection made tangible—what could be more appropriate than a Life Policy?

So—this Xmas-time—take Life Insurance, and thus make safe provision for XMASSES TO COME. You make yourself a sterling gift at the same time. In choosing—choose the best. Choose as over 40,000 others have chosen—the Policies that cost least—that return highest profits—that include everything good Life Insurance implies. That is to say—choose the Policies of

THE GREAT-WEST LIFE ASSURANCE COMPANY
Head Office - Winnipeg

Your request for rates involves no obligation. When writing ask for a 1913 Calendar—one of the famous "Animal" series—copyrighted by The Great-West Life.

The Comet Magneto Holds First Place

In the minds of hundreds of the leading Gasoline Engine builders, jobbers and dealers.

THE COMET
30 Days Free Trial



BECAUSE of neatness of mechanical design, simplicity of construction, and GREAT ELECTRICAL EFFICIENCY.

IT PAYS TO BUY THE BEST

Henricks Novelty Co.
1205 St. Paul St.
INDIANAPOLIS - IND.

The
**Red River Special
Line**

The Red River Special Thresher

The one thresher which uses the only correct principle in separating grain. IT BEATS IT OUT! It has the Big Cylinder, the Man Behind the Gun, the Uplifting Shakers which BEAT the straw, the Adjustable Slatted Chaffer, and a mill which always cleans the grain.

It Saves the Farmer's Thresh Bill

The Nichols-Shepard Steam Tractor

Double or Single Cylinder. Properly Designed. All Castings either steel or semi-steel. A Maximum of Power. The Greatest of Wearing-life. Link Reverse. Main Shaft running in oil. Strong Gearing. Rocker Grates. Steel Frame Platform Support and Draw Bar. The Strongest Boiler built. Easy Steamer.

The Oil-Gas Tractor

Two sizes. Draw Bar pull, 22 Horse and also 35 Horse. Two Cylinders. Throttling Governor. The Strongest Oil Burning Tractors built. Will burn Gasoline, Kerosene or Distillate. No idle-running gears when working in a belt.

Seel Frame Horse Powers

Unequaled in Strength or Wearing-life.

Universal Self Feeders

No Slugging. No Litter. No other Self Feeder compares with it.

Gearless Wind Stackers

The First Successful Wind Stacker. The Only Wind Stacker that gives the Operator no trouble.

A full line of Extras and Threshermen's Supplies. WRITE US.

NICHOLS & SHEPARD COMPANY
BATTLE CREEK, MICH.

BRANCHES: CALGARY, ALTA.; REGINA, SASK.; WINNIPEG, MAN.

PRACTICAL TALKS TO THRESHERMEN

CONDUCTED BY PROFESSOR P. S. ROSE

Talk No.
LXIV

THIS course of lessons was started over 3 years ago, and has continued to the present time. Only one or two issues in that time have appeared without one of these lessons.

We started our first with a discussion of the steam traction engine, then added a few lessons on business management, after which we undertook the discussion of threshers.

During the time which has elapsed, we have witnessed the development of the gas tractor and it seems fitting that this great prime mover be made the subject of the succeeding lessons. It is of interest to threshermen and to farmers alike.

It seems destined to become more and more important as a tool in agriculture as time goes by and we feel that the time has now come to present the fundamental principles of the gas engine and the gas tractor in particular, to our readers.

The subject will be presented in the simplest and plainest manner of which we are capable. While there must be a certain amount of theoretical discussion it will be made easy so that the average non-technical man will have no trouble in understanding everything. Heavy mathematical theory will not be presented.

In order that our readers may know what to expect we are publishing herewith an outline of the course. This outline will be followed quite closely and when the course is completed it will give every reader who follows it to the end a very full and complete idea of the construction, theory and operation of all the different tractors on the market.

Outline of Gas Tractor Lessons

Introduction

Rise and development of the tractor. Its place in agriculture. Kinds of work to which it is adapted. Reasons for its popularity. The present status of the gas tractor business. Social and economic problems arising through use of the gas tractor.

Fundamental Principles

Heat and mechanical energy. The simple steam engine. Elements of a gas engine; gas engine cycles. Four cycle engine described; explanation of principle of two cycle engine; other cycles.

Fuels and Combustion

Petroleum and its products; products of distillation, kerosene, gasoline; distillate; physical and chemical properties of fuels.

Combustion a chemical process; composition of air; chemistry of combustion; heat; relation between heat and work; heating value of fuels; graphic representation of work; the laws of gases; absolute pressures; absolute temperature; compression; explosion; expansion; cylinder pressure; cylinder temperatures; heat losses in the cylinder.

Types of Tractors

Discussion of single cylinder, twin cylinder opposed, four cylinder vertical, and other cylinder arrangements.

methods of cooling; methods of starting.

Cooling of Cylinder

Amount of heat to be carried away; water necessary in tank coolers; in spray coolers; arrangement and design of closed radiators; the effect of fan; the use of oil for cylinder cooling.

Lubrication

Oiling devices classified; oil cups; oil pumps; arrangement of oiling system; amount of oil required; kind of oil needed for different parts of machine; classi-

Ignition

General principles governing ignition and combustion; propagation of the flame cap; types of ignition devices; dry cell batteries; wet cell batteries; wiring diagrams; dynamos; magnetos; igniter blocks for make and break ignition; coils and spark plugs; ignition troubles; order of firing in various multiple cylinder engine.

Governors and Governing

Possible means of governing a gas engine; methods in general use; details of various gas engine governors.

Tractor Frames

Types of frames; the box frame; the trussed frame; stresses in frame work analyzed; materials used; distribution of material; the countershaft; gears; trains; discussion of the pitch of gears; the bevel gear drive; the all spur gear drive; chain drive; the differential gear; distribution of weight.

Vibration, Wheels, Etc.

Causes of engine vibration; methods employed to prevent vibration; effect of vibration on durability of engine; size of drive wheels; weight per inch of surface; general design of wheels; drive wheel lugs.

Field and Road Work

General directions for handling a gas tractor; chart for finding trouble; general repair work; tractor engine hitches; electric lighting equipment.

Description of Different Tractors

General description with details of various tractors.

Reports of Tests

Analysis of reports of tests in this country and abroad and reports from operators in the field.

Some Economic Problems

Discussion of some of the economic problems arising through the widespread use of gas tractor in agriculture; such effect upon size of farms; influence toward greater co-operation among farmers; the tenant problem and the tractor, etc.

Gas Engine Theory

Discussion of results of experiments on various types of gas engines.



Each man can learn something from his neighbor; at least he can learn this—to have patience with his neighbor, to live and let live.—Charles Kingsley.



Judges Doing a Bit of Hard Thinking at the Plowing Test

Light weight vs. heavy weight tractors; tractors for special purposes; three wheeled tractors; four wheeled tractors; distribution of weight; general arrangement.

The Motor

Details of construction; the cylinder; cylinder head; cylinder jacket; engine frame; piston; piston rings; connecting rod; crankshaft; connecting rod bearings; crank shaft bearings; inlet valve; exhaust valve; valve lifts; valve cams and cam shaft; valve timing; time of ignition; exhaust pipe and disposition of exhausts; degrees of compression for different fuels; effect of compression on efficiency; effect of increased altitude on engine power; changes necessary to affect altitude; volumetric efficiency;

the physical and chemical properties of oils; tests of oils.

Horse power and other power terms defined; how power is measured; forms of Prony brakes; traction dynamometers; draw bar horse power; indicated horse power; cost of producing a horse power; results of tractor performances.

Carburetors and Carburetion

General principles of carburetion; types of carburetors; gasoline carburetors; kerosene carburetors; use of water in carburetor; heating the fuel; heating the air; specific heat of air; heat of vaporation of gasoline or kerosene; carburetor adjustments; difficulties incident to changes in quality of fuel.

REEVES

CANADIAN
BRANCH:

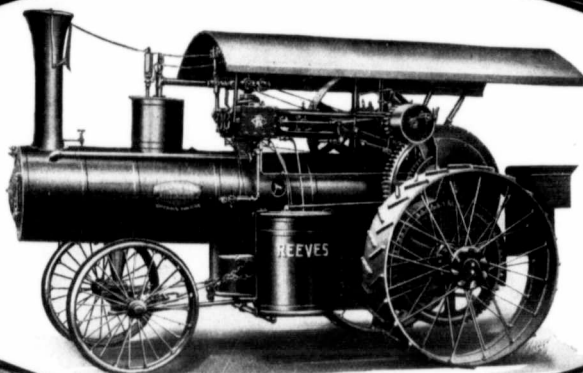

REGINA,
SASK.

Durability and Good Working Qualities in a Threshing Outfit Assure Profit to the Owner

Profit is what appeals to the buyer of threshing machinery, and when the qualities necessary to the greatest profit can be found in one machine, that is the one you should buy, even though, as is likely to be the case, the price is larger than on other machines. The following letter is right to the point and tells the experience of an operator of Reeves machinery:

Fullerton, N. D., May 29, 1911.

Reeves & Co., Columbus, Ind.

Dear Sirs:—Have you on hand lower pan for 40x60 separator No. 1052 bought in 1900? If you have, let me know and send price. This is the first repairs I have had to buy in eleven falls. I run this separator six falls in Illinois and five falls in Dakota, and it is still in first-class shape excepting this pan, and today, with a new pan, I will put it up along side any new separator and do a better job. I also am using most of the belts that came with it.

Respectfully,

Myron McKeague, Fullerton, North Dakota.

R. F. D. No. 2, Box 25.

The Reeves Double Cylinder Engine and the Reeves Compound Separator make an outfit that will prove profitable to you, satisfactory to your patrons, and with reasonable care, will last a life time.

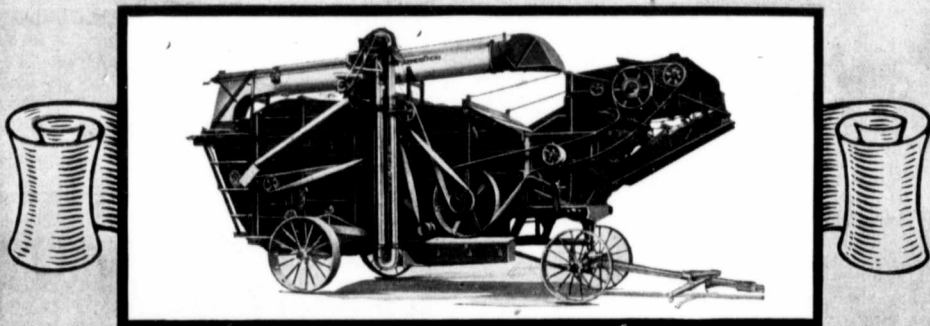

Our catalogs are free — ask for them

Emerson-Brantingham Implement Company

ROCKFORD, ILLINOIS, U.S.A. The Largest Line of Farm Machinery in the World

Tudhope, Anderson Co., Canadian Sales Agents, Winnipeg

REEVES

The Thresherman's Question Drawer

ANSWERS TO CORRESPONDENTS

Q. B. B. Which traction engine is more powerful on the road, the one having a high drive wheel or the one with a low one, both engines having a speed of 225 revolutions per minute; travelling the same speed on the road, this being obtained by different sizes of gearing? Both engines being of equal horse-power.

A. Theoretically they will be the same. The engine having the larger drive wheels may have the advantage on a bad road, such as sand or soft ground, for more surface of the wheel will be in contact with the road, and when the wheel sinks into the soft ground, a greater number of cleats will be in contact which will give the engine a better footing; but on hard roads there will be very little difference in the efficiency and no difference in the power the cylinder exerts on the traction wheels.

Q. L. C. W. 1. Do you consider the single cylinder engine as good for plowing as the double?

2. Does the single cylinder run as steadily in plowing as the double?

3. Suppose the double would last a good many years longer, both of the same horse-power, etc.?

4. How many plows would a 10 x 12 engine running at 375 revolutions per minute pull in rather light soil, and do it easily from daylight till dark?

5. How many would a double engine pull with 10 x 12 cylinder at 375 revolutions per minute, level ground?

6. How much oil would each take in a day's run of twelve hours running time?

7. Which do you consider the best engine to buy, steam, gas or oil? We have plenty of good water here, coal is \$7.50 per ton, gasoline 15c. per gallon, coal oil 7c. per gallon.

8. Which engine of the two, gasoline or steam, will give the best power and lasting qualities? What is the average life of a plow engine with good care?

A. 1. We doubt if it makes very much difference whether a motor has one or a number of cylinders, so far as the matter of pulling plows is concerned. The

only trouble is if you have a single cylinder engine you can not have more than about 20-h.p., which is only sufficient to haul three or four plows. If you want to handle more plows you must have a two or a four cylinder engine.

2. The steadiness of running depends, not upon the number of cylinders, but upon the weight of the fly wheel and general design of the machine. There are many single cylinder engines which run with very slight variations in speed.

3. The length of service which may be obtained from a tractor is, in our opinion, not measured by the number of cylinders.

4 and 5. A 10 x 12 two cylinder engine at 375 revolutions per minute ought to handle from eight to ten 14-inch plows in light soil.

6. The amount of fuel required is slightly variable, but amounts to about 6½ or 7 gallons for each 14-inch plow per day.

7 and 8. The cost of coal at the price you mention will be a little greater than the cost of oil. You will also require the services of a man and team to haul water and fuel. The other running expenses will be fully as high, if not higher, than for the gasoline or oil engines. Where water is good it does not make very much difference which is decided upon, as it does where the water is alkaline. Both engines will last about the same length of time if properly handled and cared for. We think it requires a little higher skill to handle gas tractors successfully than steam tractors. The average life of the steam tractor is between six and seven years. The gas tractor will not last any longer.

R. Y. Which is the most economical on a large boiler and engine (high pressure) while doing work that 60 lbs. could easily do, to carry about 100 lbs. or keep her up to the point of blow-off at 160 lbs.? What I'm getting at is in regard to fuel and water.

A. The high pressure with the larger engine is always the best. The valve gear of the engine can then be hooked up thereby working the steam to a higher degree of expansion and then using less steam.

For Farming Purposes Hillcrest Steam Coal Is the Most Economical

Because "Hillcrest" "the best coal in the Rocky Mountains," contains less slate, rock and other foreign substances. It will plow more land per ton than any other Coal.

Order some now and try it
HILLCREST COLLIERIES, LTD.
Hillcrest, Alta.

You saw this advertisement in this magazine. Don't forget to say so when writing.

WRITE TO The Garlock Packing Co. 117 Market St. E., Winnipeg.

For catalog and prices on canvas, leather and rubber belts, water and steam hose, babbitt metals, etc., and Genuine Garlock Packings.

The Garlock Packing Co.

TORONTO

HAMILTON

MONTREAL

You saw this advertisement in this magazine. Don't forget to say so when writing.

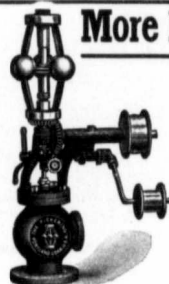

More Power From Same Engine

Why do two engines identical in build show difference in power? You just notice the governors and see what make is on engine that is doing best work.

PICKERING
"THE GOVERNOR WITHOUT JOINTS"

We fit every build of engine and give our guarantee.

Patent Ball Ranger Speed Changer Supplied on all Genuine Pickering Governors. Will increase speed 50% or more. **PICKERING**

The Pickering Governor Co.

PORTLAND

CONN., U.S.A.



You saw this advertisement in this magazine. Don't forget to say so when writing.

Why Don't
Guaranteed



YOU Use
Belt?

Sawyer Canvas Thresher Belts

Are guaranteed to be free from defects. They are always pliable and are both waterproof and weather-proof For full information write for Booklet L.

SAWYER BELTING CO., Cleveland, Ohio

You saw this advertisement in this magazine. Don't forget to say so when writing.

Q. G.A. What size of exhaust nozzle would I use for straw burner 10 x 10 cylinder, about 220 revolutions and what size of nozzle for coal the same size of cylinder and same number of revolutions?

A. The size of the opening in an exhaust nozzle is very important. It does not need to be far from the right size to do poor work. You can find the correct size by writing to the makers of the engine.



Q. L.W. How far will the piston of an 8 1/2 x 10 engine travel on the first 6 inches of the crank? Connecting rod six times length of crank, and will the piston travel the same distance from both ends of the cylinder?

A. On an engine with 10 inch stroke and with connecting rod 30 inches long, the first six inches of the travel of the crank pin (measured on the path of the crank pin), will move the piston at cylinder head end 3 5/8 inches, and at the crank end of the cylinder 2 7/8 inches. This difference is due to the angularity of the connecting rod.



Q. C.W.W. What causes the breaking of the wrist-pin on threshing machine engines? My instance is a 13 h.p. engine running a 36 inch cylinder and a 56 rear with blower. Last year was the engine's fourth year. When we had threshed about 15,000 bushels it broke the wrist-pin and knocked out the cylinder heads. Had it fixed and threshed about 10,000 bushels when it did the same thing again. Some say bad water caused it, others say the wrist-pin was not in line with the cylinder.

A. Very likely your engine is a little light for the work you are doing. A 36 x 56-inch separator with blower is all a 16 or 18 h.p. engine can take care of when in the hands of some threshermen. However, a 13 h.p. engine will run a 36 inch machine, but it should not be fed very fast. Some engines are built strong enough to be run beyond their rated capacity. The suggestion that bad water caused the break will hardly stand. There may have been water in the cylinder at the time of the breaking of the pin, caused by foaming of the boiler, and due to bad water, but a crank-pin should be of sufficient strength to stand a certain amount of water shocking. The suggestion that the pin may be out of line with the cylinder is hardly the reason. The writer's opinion is that the work is too severe for the pin, and the steel becomes fatigued, or as some people say crystallized, and in this weakened condition is broken.

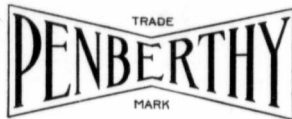

"The Safeguard will Guard Your Safety."

This mechanically correct gage assures absolute safety and protection against the dangers which result when the glass is broken in an ordinary gage.

The upper seat is designed to leak for purposes solely of sureness of operating at the proper time. Only dry steam escapes and in small quantity, hurting no one. The leak equalizes the pressure in the glass and the boiler pressure, and the Balls Cannot Stay Seated Unless Glass is Broken. This fact is positive and any gage not made to leak on the upper arm is unsafe. The lower seat is made absolutely tight and when glass breaks the ball seats instantly and Not a Drop of Water and No Steam Escape to injure anyone.

It operates on any pressure from two pounds up, is tested to 300 pounds, is very simple and strong, and is self-cleaning by the action of the blow-off vibrating the balls.

You need the "Safeguard" in your boiler room—try it.

Manufactured by
Penberthy Injector Co., Ltd.
WINDSOR, ONT.

Safeguard

Automatic Water Gage

Mechanically Correct

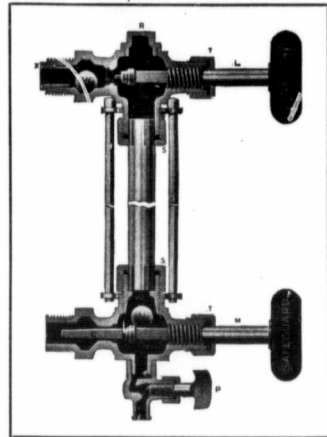

This Automatic Water Gage is made with Special 1/4-inch drip connection for the conditions of Western Canada and has been accepted by the Government of Alberta under Register No. 441, and in Saskatchewan under Register No. 2170.

PRICES

1/4-inch and 3/8-inch sizes, \$3.00 net. 1/2-inch size, \$3.50 net.

You saw this advertisement in this magazine. Don't forget to say so when writing.

Q. R.T. How do you get the angle of 90 degrees on crank when setting eccentric?

A. Eccentrics are not set by degrees on the crank. They are usually set by the valve when crank is on center, or in some cases, by other parts of the valve gear.



Q. L.A. When a double engine does not start at all points of the stroke what is the trouble?

A. The maximum cut-off on a double engine should be later in the stroke than that of a single engine. The object of having a later cut-off is not so much to get power as to be able to start a heavy load at any position of the cranks. The cranks being set at 90 degrees one would naturally think that a valve gear set at a little over one-half cut-off would start the cranks at any point; and it would, if the load were not too great. When the maximum cut-off is, say, five-eighths of the stroke (the one crank on dead center and the other at one-half of its stroke—the latter only having to move a short distance till the steam is cut off) this brings the one which was on the center in position to move; but it being so near the dead point and now alone in the work, it has a poor chance to start a heavy load. Hence the

advantage of having a late cut-off, for it is clear that if one piston follows its crank with steam to the point of, say, three-fourths of the stroke, the other piston and crank is so far on its travel that it can take the load alone till the former one gets off dead center again and can help itself. Thus not only is the engine ready to start at any position, but by having a late cut-off it can start a heavy load at any position of the cranks; for when one cylinder is in cut-off the other is at its best.



Q. J.D. My engine is considerably out of balance. I realize that the counterbalance is not heavy enough to balance the engine, and it knocks so much that it shakes the stack off the stack base. I tried to balance the engine by putting a weight in the flywheel, but this only changed the rock from an end to a side rock. Can you suggest any plan by which I can balance the engine. I could do it by having a larger crank disc made, but don't want to go to that expense. Can you give me a rule to find the amount of counter-weight it requires?

A. Rule for horizontal engine counterbalance; Add together the weight of the crank-pin, connecting rod complete, crosshead complete, and the piston complete.

Multiply this by three and the length of the crank and divide by four and the radius of the center of gravity of the counterweight. This will give you the counterbalance weight.

Since you simply want to add to the weight already of the engine, instead of making a new crank disc you could make a band of one-half inch thick, and the width of the crank disc and allow it to be loose enough to put lead between the band and the crank disc. The band can be made adjustable by making ears on the ends and a bolt through the ears to draw it tight to the disc and thereby hold the lead in place. The lead can be made in pieces the width of the crank disc and different amounts can be tried till the right amount is arrived at. The cavity for the lead should be crescent shape, allowing the band to rest on the disc at the crank-pin, and the bulk of the lead at the opposite side. After the correct amount is arrived at, the circumference of the band can be decided on and it can be welded up solid, thus doing away with the bolt. The band then can be put on the disc, having the pin upward and the ring resting on the disc, thus leaving the crescent-shaped cavity below. The lead can then be melted and poured in the bottom

and then caked in tightly. The band should not be a true circle, but fit close to the disc over half around it on the pin side. and then leaving the lead in a bulk at the opposite side of the pin. There should be provisions made to prevent the whole thing from slipping around the disc. This can be done by putting a pin or screw through the band into the disc.



Q. W.B.B. Can a boiler blown off at night and refilled, injure the flues after working hard all day? What is the best method of keeping a boiler clean during threshing season?

A. As a general rule a boiler should be cleaned out once a week, but in some sections once a day would not be too often. The boiler can be blown out at a low pressure, say 20 to 30 lbs. The hand hole plates should be taken off and a scraper used wherever it is possible. It should also be washed out with water. If mud or sediment is allowed to collect in the boiler the sheets are apt to be burned out, as the water cannot get to the sheets.



Q. J.J.H. One of experience knows well that after turning water out of boiler that a small quantity of water always remains in the boiler. Can such water damage boiler by freezing?

2. Is mud in boiler injurious to the plates?

3. Is there danger of the water gauge glass blowing out when the engine is under steam and standing idle?

4. Is it injurious to glass to shut the water out when going to dinner or for any other purpose?

5. Will glass become hot and break?

6. Is lead a good alloy for filling any plug?

A. If water is left in a water bottom there must be enough to fill the space between the two sheets to do any damage to the boiler as it cannot force the sheets otherwise.

2. It is not specially injurious, if it does not get up to the fire line.

3. The glass is as likely to break while boiler is under pressure with the engine idle as with it running.

4. It is not injurious to the water glass to shut the water out at times, but it will surely injure its value as a gauge and that is what it is there for. Better not shut it off unless absolutely necessary, and turn it on again as soon as the necessity for closing it is past. It is not necessary to shut it off when going to dinner.

5. The expansion and contraction, owing to heat, is no doubt

the cause of glass gauges breaking at times.

6. Tin is better than lead as it melts at a lower temperature.



Q. J.H.T. Why is it that a return flue boiler takes less coal for the same amount of work than a straight flue boiler?

2. Why is it a straight flue boiler or engine has more power than a return flue engine while pulling up a steep grade?

I have seen 12 to 16 h.p. engines pull their load up hills, where the large 20, 22 and 25 h.p. return flue engines could not pull. When it comes to the hard pulls their piston stops. They seem to be powerless, like a gasoline engine when overloaded.

A. It is a fact that some return flue boilers are more economical on fuel than some straight flue boilers and some straight flue boilers are more economical than some return flue boilers. It all depends on the construction and condition of the boiler. In making comparison between two boilers the heating surface should be considered rather than the nominal horse power of the boiler. There is another condition that may be misleading in such a case; if the engine on one boiler is more wasteful than the other, that boiler will take more coal to do the work. However, the boiler with the wasteful engine will take more water and the trouble can be located by observing the amount of water used.

2. The boiler with the strongest engine and the best arranged gearing will pull the load up a steep hill the easiest. The writer is inclined to think the straight flue boiler engines are underrated, or the return flue boiler engines are overrated. It may be that neither kind are properly rated to the common standard of nominal horse power. The pulling qualities depend on the size of the cylinder, boiler pressure, revolutions of engine and speed of engine on road. The latter is governed by ratio of the revolutions of the crank shaft to the circumference of the traction wheels. A small engine with gearing arranged so that with a certain number of revolutions of the crank shaft, it will travel slower on the road than a larger engine with the same number of revolutions of the crank shaft, and gearing arranged so, that the speed on the road is faster, the smaller engine may pull more than the larger engine; but it will take a longer time to do the work due to the slow travel.



Q. R.K. The slide plates in firebox of a boiler are slightly bagged (one-fourth inch) between staybolts where the same are set

The Only Attachment

For a Traction Engine that increases its power, or saves a corresponding amount of fuel and water is manufactured by

The Gould Balance Valve Company
KELLOGG, IOWA

Send for Catalog.

Agents Wanted for 1913

You saw this advertisement in this magazine. Don't forget to say so when writing.

Sawyer-Massey Co.

NOT IN A COMBINE!

You saw this advertisement in this magazine. Don't forget to say so when writing.

20,000 Thresherman Have EXTRA Money This Christmas

These are the users of The Gandy Thresher Belts who accomplished a saving by getting the biggest dollar value for every dollar investment in thresher belts.



The Gandy Thresher Belt is an economical investment. Its initial cost is reasonable, and the belt will give you the best of results wherever employed, and last longer than any of the so-called "just as good but cheaper belts."

The Gandy Thresher Belt

has been on the market for over 30 years. It is constructed of a special weave of heavy duck made in our own factory.

A full stock of all lengths, widths and plies is carried, enabling us to fill orders on day received and to ship in fulfillment thoroughly seasoned belts.

It may be that the thresher belt used during the past season gave you trouble, or did not give you as much service as you expected. Why don't you find out if you, too, cannot save money on your belts by getting the Gandy Thresher Belt in 1913, the standard thresher belt—the best belt we know how to make.

We will gladly send you booklet, samples and prices. Simply sign and return the attached coupon. Do it now — it will pay you.

Gandy Belting Co.

733 W. Pratt Street
Baltimore, Md.

New York Office:—88-90 Route St.



THE HART LINE

Peoria
Perfection
and
Glendale
Weighers
Loaders
and
Baggers

Big Free
Catalog

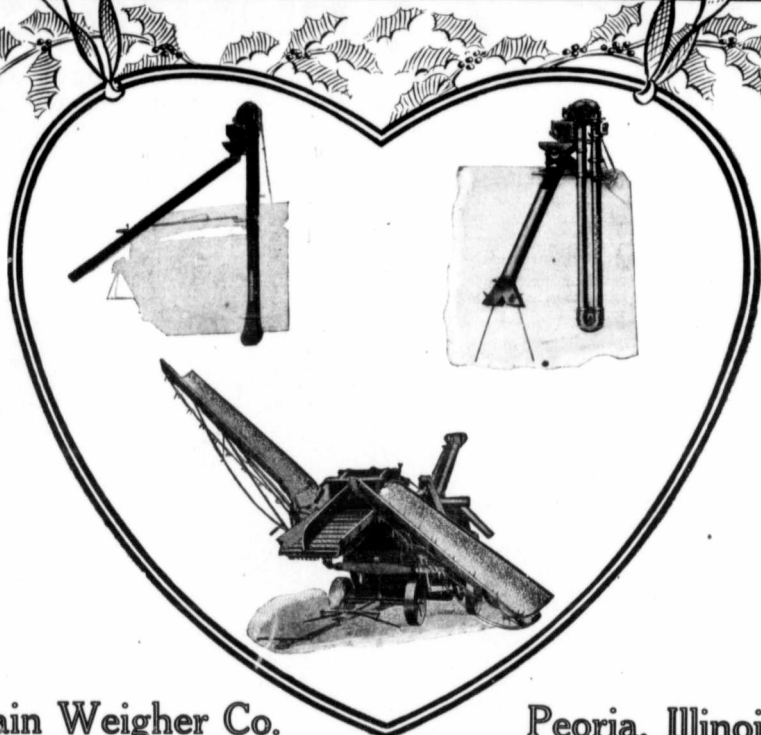

Hart-
Brown
Wing
Carriers
Hart
Universal
Thresher
Racks

Big Free
Catalog

Hart Grain Weigher Co.

Peoria, Illinois, U.S.A.

You saw this advertisement in this magazine. Don't forget to say so when writing.

more than the regular distance apart, owing to slanting seams in the plate. The stay bolts leaked slightly, but were easily tightened with a hammer. Boiler was steamed up later to normal pressure, 150 lbs., and appeared to be all right. As the plates are covered on the outside by the axle brackets, making it unhandy to put in extra stay bolts would you consider it safe to run the boiler at normal (150 lbs.) without putting in extra stay bolts?

A. The firebox of boiler was likely strained while running with a pressure which was higher than the working pressure of the boiler. The boiler should stand (150 lbs.) pressure, if it was built for that pressure, even if the sheet is slightly sprung by mis-use in the past.

Q. B.B. How was the standard for h.p. rating established?

A. The first application of the steam engine as a substitute for horses was in hoisting coal from mines. James Watt found the best English draft horse would raise a weight of 150 lbs. walking at a pace of two and one-half miles per hour, or 220 feet per

minute; hence 150 x 220—33,000, or the same things, 33,000 lbs. raised one foot per minute. This duty is the recognized English standard of the indicated horse power (h.p.) as applied to steam engines, and recognized by all engine builders in the United States. It follows that an engine having a piston of 10 square inches area, working with a mean effective pressure (m.e.p.) of 15 lbs. (10 x 15—150) would be equal in strength to that of a horse raising 150 lbs., and a piston speed of 220 feet per minute (10 x 15 x 220—33,000) is the equivalent of the work done by the horse. Or in modern traction engines practice, a piston having one and one-half square inches area, working with a m.e.p. of 55 lbs. and a piston speed of 400 per minute (1.5 x 55 x 400—33,000) would also be equivalent to the work done by the horse.

Q. N.V.E. A young man says that he set the valve on a traction engine with link reverse and when the engine was on center and the valve had one-eighth inch lead with reverse lever in last notch, and when

moved up to center notch it had one-fourth-inch, and he says the valve was set right. What is your opinion? Engine has the same lead at both ends on either center, but when the lever was brought to the center notch it increased the lead one-eighth inch.

2. Can the lead be changed on a single eccentric reverse after it leaves the factory? If so, please explain.

A. The link has a radius equal to the length of the eccentric rod, but since the center of the eccentrics are not with the center of the crank shaft the link does not run exactly true with the shaft, so that every link changes the lead of the valve somewhat at the different points. For an ordinary size engine this lead is too much. One half of this amount would be sufficient.

2. The lead can be changed on a single eccentric valve gear by changing the length of the valve.

Q. W.J.T. How can safety plug which appears to be limed in be taken out without injuring crown sheet?

A. In taking out the safety plug you are more apt to injure the plug than the crown sheet. If the plug will stand screwing out no harm will be done, but if the plug is so tight that it will twist it off a little hammering round the plug may loosen it up. Care should be taken not to hammer too near the stay bolts as they may be loosened and made leaky.

How They Started.

A certain boy, for being a truant and runaway, was put in a reformatory. A grown-up friend of his visited him there.

"Well, Jack," said the grown up friend, "how are you getting on here in this institution?"

The lad smiled a smile singularly bitter for one so young.

"Oh, I am getting on fine, sir," he remarked. "They are going, they say to make an honest man of me."

"And how are they going to make an honest man of you, Jack, my boy?"

"Well, sir, they've started by putting me in the shoe shop. I stuff pasteboard into oak leather soles."

A Merry Christmas and A Prosperous New Year

We wish a merry time at this season of good will and rejoicing to you--threshermen, and you--farmers, who have helped the Rumely organization on to bigger things. 1912 has been our banner year. The men in our organization away from La Porte have helped to make it such are recognized in this announcement. They have done nobly. We deeply appreciate their loyal co-operation.

We wish to all a happy and prosperous New Year. May it heap greater wealth on each of you. May your crops be heavier, you farmers, and the threshing season one to please you threshermen. And to you--dealers, salesmen, and men of the branches out in the Rumely field of salesmanship, may success and kindly co-operation between yourselves and the threshermen and farmers continue so that 1913 may be a still greater banner year.

HISTORY

The history of the Rumely company reads like a romance where everything goes on smoothly and everyone is glad. From the birth of the business with Meinrad Rumely, a German immigrant, in his little blacksmith shop at La Porte, until the close of 1912, there has been ever present the spirit of optimism, progressiveness and vigor, which means bigger and better things.

The first Rumely separator was manufactured in 1856. Meinrad Rumely, with the help of John Hanna, (still in the employ of the company) fashioned the parts, and in that year three separators were built. There was merit in the Rumely machine, clumsy and crude though it was. Three years later Meinrad Rumely felt like a happy monarch when he carried away the silver medal at the United States Fair in Chicago, winning over thirteen other grain threshing machine competitors. That was the first public Rumely triumph; there have been many since.

In the old days of separator threshing, Meinrad Rumely's outfits were recognized as dependable. The machines were as sturdy and strong as the pioneer who constructed them. The threshing public learned to trust threshing outfits which bore the name, "Rumely."

With the coming of the first steam engine, old eyes grew wonder wide, and young eyes saw visions. Larger acreages of tilled land were planned--larger wheat fields were cultivated--larger harvests were realized--more threshing was done. Progress moved westward and Rumely machinery helped the cause.

Meinrad Rumely died and was gathered to his fathers after realizing the fruits of his labors. His sons and grandsons continued in the work. They are worthy successors of a worthy sire. They have all been schooled in manufacturing. They know the making of Rumely machinery from start to finish, just as Meinrad Rumely did. The new men in the organization have dreamed dreams and are still dreaming, for themselves, for the good of their country, and for the welfare of their fellowmen.

While men in the west were operating the steam engine, men in the east were studying fuel problems and the problems of deeper and better cultivation. They saw that coal and wood were scarce and growing scarcer every year. Progress was not to stop with the steam engine. They became interested in an internal combustion engine, realizing, however, that they could not depend upon gasoline, the scarcest and most expensive of liquid fuels, as a dependable product.

In New York City at that time a veteran engineer and inventor was planning an internal combustion engine for submarine boats, operating on kerosene and distillate. The Rumely company learned of him and he was brought to La Porte. Then began the planning of a kerosene burning engine. Shortly there was introduced in the threshing world a new tractor. It was called "Oil Pull" because of its great pulling power. It operated successfully on the cheapest known fuel--crude kerosene. With it came new visions of even greater achievements to the men in the Rumely organization.



The Rumely Organization

We are erecting buildings, adding shop tools, developing new machinery for the farmer's use, extending our sales organization, building branch houses in places where before the RUMELY trademark was unknown. But all these buildings, all this machinery, is not the essential thing. Back of it there is a group of men who are working together in creating an organization.

An Organization! Think what that means in the human body. Millions of separate cells, each contributing its own particular part to the work of the others, to carry out the one will. Does the hand hesitate, or the foot halt in its task? The heart beats, the eye sees, the voice speaks. Each does its own work in perfect harmony with all the other members of the body. By caring for the others, and the whole, each is cared for itself. The story of life upon the globe is nothing but the irresistible growth of a more perfect organization, ranging from the simple-celled amoeba to the perfection of the human body.

Our company will grow as we make it perfect. There isn't a man in our business who will ever be useless or superfluous if he does well the task allotted to him. And further, as long as we all work together, harmoniously, and render American farmers real service by offering them honest goods in an honest way, the world will need the RUMELY organization. As long as other men heed the RUMELY COMPANY there will be increasing opportunity for its entire force.

Rumely Prize-Winning Machinery

Steam	Gasoline	Kerosene
Steam	Gasoline	Kerosene
Steam	Gasoline	Kerosene
Automatic Balers	Corn Huskers	Cream Separators
Grain Separators	Wind Stackers	Grain Graders
Weighers	Feed Mills	Grain Feeders
Baggers	Rice Separators	Husker & Redders
Gang Plows	Oil Tanks	Saw Mills
Engine Guides	Water Tanks	Diaphragm Pumps
Contractor's Hoists	Corn Shellers	Pulverizers
	Soil Packers	

GROWTH

We took on new growth with the "OilPull" tractor. Realizing that threshing outfits and other machines could not be manufactured fast enough in La Porte to supply the demand which the new tractor created, we bought the interests, assets and good will of the Advance Thresher Company, of Battle Creek, Michigan, and the Gaar-Scott Company, of Richmond, Indiana. Thus the well known threshing machinery of these two great companies became a part of our output.

The latest additions to our line are the ToeHold Cultivating Tractor--good for the large or small farmer, the orchardist and the vineyard man, and the GasPull tractor; both of which operate on gasoline. These tractors are making a sensation in the tractor world.

The "OilPull" tractor was a success from the start. This giant of power and its cheap cost of operation was placed at once in a class alone. The "OilPull" tractor won medal after medal in public contests wherever it appeared, and last July at Winnipeg carried off the sweepstakes, winning for itself the title, "The most economical plowing and threshing tractor in the world." In La Porte at the present time "OilPull" tractors are manufactured in a million dollar plant. Here night and day the busy hum and whir of the factory may be heard. Here hundreds of "OilPull" tractors are built.

The way our company has progressed in the past year is marvelous. Two men carried on the work in 1856. In 1912, only 59 years later, more than 5000 men and women are earning their bread in our organization. Five large factories in five large manufacturing cities are Rumely Power-Farming Machinery producers. In addition there has been added: Rumely-Olds stationary engines, Rumely-Adams stationary engines, Rumely-Adams corn huskers, Rumely cream separators, Rumely-Watts corn shellers and OilTurn stationary and portable engines.

For years we have served the public well, and the public has placed its confidence in us. That confidence shall strengthen. Our faith in the farmers and threshermen, and their faith in us continues, and our faith in the Rumely men who are doing their best in the field, shall likewise continue. Service is the keynote of success, and service shall be given in its fullest sense by each of us. It will be better for the coming year than it ever yet has been. Our repairs department will be in better condition to take care of the calls from the field. Our offices will be better equipped to do all necessary work pertaining to their line. Our factories are prepared, as well as money and brains can make them, to carry on larger capacity work.

We have an information bureau, where our friends may receive free information on power farming subjects. We have men especially fitted for expert work. We manufacture machinery for every day in the year. Wherever power-farming is needed we trust we shall hear from the man who wants it, as we believe we can serve him to the very best advantage.

Branches of our company are located in practically all the large cities of the United States and Canada. Dealers are everywhere where power-farming is known. We invite you to call at our branches. If this is not convenient, make your request known to us for any catalog in which you are interested. We shall be glad, indeed, to become better acquainted. We can help you and you can help us. Let's get together and make 1913 the best year, both for you and for our organization, that we have ever known.



RUMELY - LA PORTE





Canada Must Improve Her Live Stock Production

WHAT is to be done in order to build up the meat industry of Canada? There will be little use for abattoirs if the farmers do not raise animals for slaughter therein, and the question is now not so much how can we export our surplus meat, but rather how can we import enough meat to feed ourselves.

Canada, like other growing countries, is already facing a shortage in meat supply. The population is rapidly increasing, whereas the supply of cattle, sheep and hogs is decreasing rapidly. In several provinces the actual number of cattle, sheep and hogs is less than five years ago. The breaking up of the ranch and range country in the west into small farms has made serious inroads into the supply of mutton from that territory, and has practically cut off the supply of thin young cattle which formerly were shipped to Ontario to be finished over.

Grain farmers of the Western provinces are being urged by experimental farm workers, farmers' institutes, livestock and farm papers to diversify their farming not only for safety as to returns, but as an insurance against the time when fertility will be so depleted that yields of grain will be no longer profitable.

Live stock is a safeguard, not only for the farmer, but would be a big factor in helping solve the car shortage problem which is so acute every fall. Grain farmers all want to market their grain at the same time and get the money. Sheep and steers can be marketed every day in the year, provide a safe revenue, and distribute the traffic for the transportation companies. There is at present a market in Canada for all live stock produce and for all kinds of smoked meats, lard, ham and bacon, so that the market is here with good prices. As the population increases this market will grow.

One of the greatest drawbacks against more live stock in the

West is the fact that the Canadian banks are not allowed to accept live stock as collateral for loans, whereas in the United States an enormous and profitable cattle loan business is done by large cattle loaning companies who get behind the beginner in the live stock business and carry him until the returns come in from his investment.

It is generally supposed that the extremely low temperatures which prevail during the winter in the West are absolutely prohibitive of the successful and economical handling of live stock. As a matter of fact, much of the best beef sold in Calgary, Edmonton and Winnipeg this spring was fed out in the open air last winter with no shelter, except a few buildings, and here and there some haystacks or very cheap sheds. Northwest winters are no harder on live stock than the winters of Ontario.

Although the Province of Alberta is unusually well equipped for producing cheaply mutton of the finest quality, large quantities of frozen sheep and lambs are each winter brought in from Australia and New Zealand, in addition to the large number of live sheep and lambs driven across the border from Montana and Wyoming.

One thing our farmers and stock raisers should learn is that the home market is the best. The cattle embargo has combined with other causes to make shipping cattle to Liverpool unprofitable. Indeed, several firms, formerly large exporters of cattle, have practically ceased their shipment to England.

Again, the Canadian market is better than the American market, for the Canadian farmer and rancher will almost uniformly get a better price net at Edmonton, Calgary or Winnipeg than he will at Chicago. No more delusive argument was put forward by the advocates of reciprocity than the argument that the Canadian cattle raiser would be benefited by freer access to the American market.

Some Western Canadian stockmen have been led by Chicago market reports and rumors of an acute shortage of finished cattle in the United States to ship their

The Money is Made

by the Business Farmer

The "Business" farmer is distinguished from "the crowd" by his ability to spot a good thing in a mixed mob either of men, machinery or merchandise. He will not experiment with "any old" implement but will get the best that is made—even if its initial cost is a little more. He knows that the very first result will pay the difference and the final reckoning will be

Big Money and Still Earning.

THE "MAGNET"



among cream separators is just the difference between easy money, easy labor, and something else that is "bristling with trouble, delay and waste." Again and again the strength, solidity and uniformly excellent work of the "Magnet" has been proved on the farm and in record-breaking International Contests. Its square gear as distinguished from the ordinary "wobbling worm" is the admiration of every practical man who sees it. Let us send you details of forty facts about the "Magnet" that sets it far ahead of any other separator in use to-day.

Our Slogan is "TO SATISFY"—and we will do it at all costs.

We will prove every point we claim for the superiority of the "Magnet" on your farm—at our expense.

The Petrie Mfg. Co., Ltd.

Head Office and Factory: HAMILTON, ONT.
Winnipeg, Calgary, Regina, Vancouver, Montreal, St. John, N.B.
Edmonton, Alta.

You saw this advertisement in this magazine. Don't forget to say so when writing.

THE GREGG MALLEABLE KNEE SLEIGH

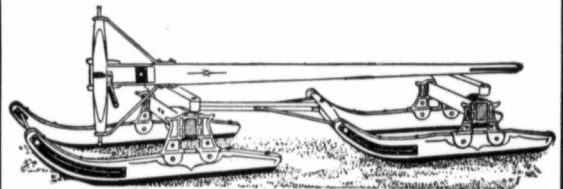

Made from A1 stock, in an up-to-date factory, by men who have had years of experience in this kind of work. Result—A Sleigh that cannot be duplicated in material, workmanship or appearance. Recognized—by those who have gained their knowledge by experience—to be the strongest, easiest running sleigh made.

Has many distinctive features not found in other sleighs. Ask your dealer or write to us. We will tell you about them.

GREGG MFG. CO. LTD., WINNIPEG, MAN.

You saw this advertisement in this magazine. Don't forget to say so when writing.

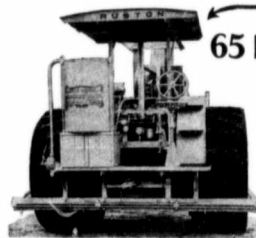

65 b.h.p. Ruston Proctor Oil Tractor

If you want a tractor that will last—this is the one.

THIS TRACTOR has all the latest improvements and is the result of many years of testing by that well known English firm: Ruston Proctor & Co. Ltd. of

Lincoln, England. One of these tractors can be seen demonstrating at our Saskatoon Depot.

Agents: **The British-Canadian Agricultural Tractors Ltd.**

Ontario Avenue, Saskatoon, Sask. And at Alberta Investment Bldgs. Calgary, Alta.

You saw this advertisement in this magazine. Don't forget to say so when writing.

finished cattle to the Chicago market. In the case of the first large shipments of cattle made from Alberta to Chicago this fall the market was unusually favorable and entirely abnormal. Cattle for that week touched the highest prices ever known in Chicago stock yards, so that the Alberta cattle being carried along with the current, sold for a few cents a hundred more than they would have brought on the same date at Winnipeg. The success of this shipment led numerous other ranchmen in the West to take a chance on the Chicago market, with the result that in every case, so far as known, the net prices received at Chicago were less than the prices the stock would have netted at Calgary, Edmonton or Winnipeg. Western Canadian prices for beef, mutton and pork are regulated by supply and demand. With the West each year importing larger quantities of meats from Eastern Canada, the United States, Australia and New Zealand, it is obvious that prices for finished products in the West must be at least on a parity with prices for those products in other countries from which they are exported.

This general subject will be found discussed at great length in the last annual report issued by Dr. J. G. Rutherford, as veterinary general of the Dominion Government, which was extensively quoted from and commented upon at the time by "The World." The general subject of the languishing meat industry of Canada was the subject of a lengthy debate in the house of commons about a year ago, and it is a fair surmise that the present government intends in some way to encourage the industry. Unfortunately, the cold climate of Western Canada and the natural desire of the new settler to get a quick return from his land and to pay for his farm as quickly as possible militates against the industry. In the end, however, the farmer who raises some live stock and who feeds his frosted grain will come out ahead, and unquestionably the country as a whole will be greatly benefitted by more mixed farming in Eastern and Western Canada alike. Indeed, the situation is becoming so grave as to demand the earnest and early attention of the Dominion and provincial governments. Nothing, perhaps, will accomplish so much as a campaign of publicity and education, which will convince the Western farmer that he will benefit himself and his land by raising live stock. And in this connection it is to be hoped that the government, when revising the Bank Act, will permit loans to be made to the farmer upon the

products of his farm, including both grain and live stock. The lesson cannot be too strongly impressed upon the farmers of the northwest that the growth and prosperity of the live stock and meat business of the country depends upon an ample and steady supply of live stock being furnished to the packers and butchers scattered over the country. Without ample supplies and raw material these people cannot operate economically, so that it is greatly to the benefit and profit of the farmers to keep a steady supply moving forward in order that the home market may be maintained and developed and the best prices established for the live stock grown within the provinces.

A learned man is an idler who kills time with study. Beware of his false knowledge; it is more dangerous than ignorance.—G. Bernard Shaw.

Cash in on Your Misfortunes!

Best Service at lowest possible cost.



THE CENTRAL CANADA INSURANCE COMPANY
BRANDON-CANADA

INSURANCE AGENCIES LIMITED
General Agents
Jos. Cornoll
General Manager

THE SASKATCHEWAN INSURANCE COMPANY
SASKATCHEWAN

THE ALBERTA-CANADIAN INSURANCE COMPANY
EDMONTON-CANADA

We write policies of insurance covering practically every form of misfortune incident to farming. Whether it be a disastrous fire, the destruction of your entire crop by hail, or losses among your live stock through accidents or disease, you are quickly reimbursed, **provided you are insured.**

A policy with us means a prompt "cashing in on your misfortunes." We issue policies of

Fire Insurance Live Stock Insurance Hail Insurance

free from harassing conditions, always giving policy-holders the best service at the lowest possible cost. Our strong organization covers Western Canada. We issue the most up-to-date policies in all classes of insurance, incorporating new features of advantage to our policy-holders from time to time.

Our clients stay with us year by year—undoubted proof of the fairness of our methods and rates.

For information write any of the Companies or

Insurance Agencies, Limited

GENERAL AGENTS

BRANDON WINNIPEG REGINA
SASKATOON EDMONTON CALGARY

Or consult any one of our 1,200 Local Agents.

You saw this advertisement in this magazine. Don't forget to say so when writing.

Some Horse Pointers

By A. S. Alexander, M.D.C.

THERE is, perhaps, no wound of the horse so much dreaded, or so poorly treated, as that which is commonly called "thistilo," or correctly "fistula of the withers."

In the first place it may be stated that the writer has seen no less than seventeen brood mares in one field all suffering from fistulous withers at the same time, and all of them owing the trouble to a biting stallion. This suggests that a man should always ask a stallioner if the horse is a biter before allowing the mare to be served. Another common cause is having the stable door too low, or the ceiling too low, so that the withers may be bruised.

By fistula we mean a large abscess which, not being opened in time or given proper drainage,

forms "pipes" or sinuses in which pus burrows to all parts of the neck, and causes the bones of the withers to become involved. The fistula then becomes characterized by a large swelling upon both sides of the withers, and this tumor contains one or more small discharging orifices from which pus exudes and runs down over the sound skin, causing excoriation.

At first pus is not present. There is a large, very sore swelling, and unless treatment be prompt and proper this will become a pus abscess. When such a lump is noticed, the horse should be at once retired from work and the enlargement covered with blankets wrung out of hot water. At the same time the feed should be cut down to bran mashes and hay, and a physic ball may be given if the animal is fat. After keeping up the hot compresses for some hours, sponge the parts with a solution of one ounce of sugar

of lead and two ounces of tincture of opium in a quart of water, and finally saturate a mass of cotton batting with this solution and lay it upon the swelling, retaining it in place by means of a roller bandage, which will require some ingenuity to apply properly. Keep this wet for hours with the solution, and in some cases, at least, if taken in time and before the serum has had a chance to form in large quantities, the fistula will be aborted.

Often it is too late to give this treatment when the enlargement is discovered, and in such instances treatment consists in applying a blister. A favorite application among farmers is mandrake root boiled down to a salve in lard. The common May-apple of the woods is the root referred to. The salve acts as an absorbent, and sometimes drives away the swelling, or at least brings it "to a head." Another effective blister is one drachm each of pulverized cantharides and biniodide of mercury mixed well with one ounce of lard and rubbed in for fifteen minutes after removing the hair from the enlargement.

When the swelling becomes soft, indicating the presence of pus, it must be opened freely, and this should be done with a perfectly clean knife and in such a manner as to give free drainage to the pus and serum. Make the opening large and low down, and then wash out the cavity with a warm 5 per cent. solution of coal-tar disinfectant. Insert the finger and with it determine whether pipes have formed, and open any that may be found so as to secure proper drainage. After all has been done, pack the cavity full of oakum saturated in a mixture of one part of turpentine and three parts of raw linseed-oil. Repeat this treatment daily, and have lard smeared upon the skin below the orifice of the wound to prevent unnecessary excoriation of sound skin. Inject full strength tincture of iodine twice a week.

As soon as the wound is filling up nicely, blister the enlargement with either of the blisters mentioned here and repeat in two weeks. Always allow the blister to remain in place for forty-eight hours; then wash off and apply lard daily. If the pipes refuse to cease discharging, open them more fully and inject two or three times a week a solution of two ounces of chloride of zinc in a pint of water; then go on treating as before. The modern veterinarian also gives hypodermic injections of polyvalent or autogenic bacterin in obstinate cases of fistula.



Poverty is the precursor of revolution.—Lord Brassey.

Flax
By Manley Champin, Asst. Agronomist
South Dakota Experimental Station

If you saw a friend drowning you would make an effort to save him, would you not? Or if you saw him about to step over the brink of a precipice to fatal disaster, you would try to warn him, wouldn't you? Lest I be put in the class with the man in the funny paper, the asker of foolish questions, let me hasten to explain.

As you would try to save a friend, so should a state and the citizens thereof attempt to save an industry that threatens to step over the border line into Canada. While we are worrying about the loss of population to Canada, we may as well lose a wink or two of sleep in the interest of an industry that we are in danger of losing bodily. The industry referred to is that of growing flax, the beautiful, blue flowered, brown podded, oily seeded, high priced flax.

The Center of Production

The center of production of this crop was once Massachusetts; then it moved westward to Pennsylvania, where there were more linseed oil mills than in any state. From thence it passed to Ohio, to Indiana, to Illinois, to Iowa and Minnesota—until today the center of the flax production is in North Dakota and is rapidly advancing toward Montana and the Canadian line.

The reasons for this ever westward movement are not difficult to discern. Flax is subject to two diseases which in turn have made it subject to many superstitions. The diseases are "wilt" and "canker." The superstitions are that it takes out more fertility from the ground than any other crop, that it ruins the land for the succeeding crops for two or three years and that it is only possible to grow flax on new plowing or land that has been broken but a short time.

The growing of flax usually infests the soil with one of its diseases so that it cannot be grown profitably on the same land again for five or six, or even ten years. In Belgium and the flax-producing countries of Europe, they do not expect to grow flax in succession, but grow it in a long rotation varying from eight to twenty years. The rotation followed is usually potatoes or some root crop for three or four years and then some tame grass for three or four years. When the tame grass is plowed up, flax is grown on the sod the first year after plowing. By this method the flax is grown successfully on a portion of the farm every year, and the output

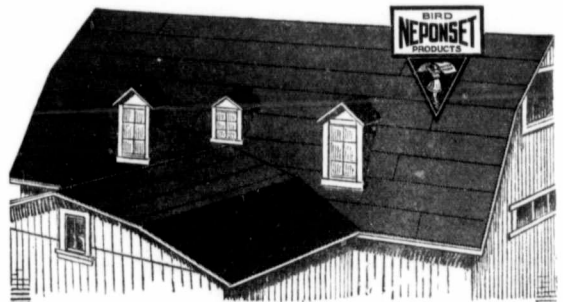

Don't Experiment with Roofing

It pays to buy good roofing just as it pays to buy good machinery and to keep good stock. Good roofing has good records behind it, not claims.

NEPONSET PARDIO ROOFING

has excelled the records of best shingles. A warehouse built in 1898 was torn down last summer with its NEPONSET Paroid Roof still in good shape. NEPONSET Paroid has outworn tin and metal time and again. It is bought by Governments, by Railway Systems—by farmers, because it has proved itself the most economical roofing. Buy NEPONSET Paroid next time.

Blue Print Barn Plans—FREE

Canadian farm plans are the finest in the world, and these plans are designed especially for your needs. Send today for...

NEPONSET Roofings are made in Canada

F. W. BIRD & SON, (Incorporated) 438 Heintzman Bldg., Hamilton, Ont. Winnipeg St. John, N. B. Vancouver, B. C.

NEPONSET Prostate Roofing makes a handsome red or green roof for houses.



How To Save That Lame Horse

MACK'S \$1000 SPAVIN REMEDY IS GUARANTEED

to quickly and permanently relieve the very worst case of Bone or Bog Spavin Ringbone, Knee, Lacerated and Ruptured Tendons, Sweeney and all other forms of lameness affecting a horse. It is a shame to let your poor dumb horse suffer any longer when this marvelous preparation will put him squarely on his feet. It is a powerful remedy that goes right to the heart of the trouble and quickly restores natural conditions in the bones, muscles and tendons—cures the lameness in just a few days to a week and the animal may be worked as usual. Contains nothing that can injure the horse and heals without leaving scar, blemish or loss of hair. We positively guarantee every bottle of Mack's \$1000 Spavin Remedy; if it fails, you get back every cent you paid for it as stated in our \$1000 Warranty Bond. Write us today and get our free diagnosis. It isn't let anyone "blister" or "fire" because such methods are positively cruel, inhuman, extremely painful, always leaves a big scar and seldom do any good. Use Mack's \$1000 Spavin Remedy to remove the lameness quickly and without a bit of pain. See illustration of horse below and read paragraph "Free Diagnosis Coupon."

Relieves Cases Formerly Considered Incurable

No matter how long your horse has been lame, or what the nature of his lameness, you can absolutely rely upon Mack's \$1000 Spavin Remedy. We know of many cases where horse owners have paid out big fees and had valuable animals tortured with "drugs," "whiskering" and other good-for-nothing methods and as a last resort tried Mack's \$1000 Spavin Remedy, and were amazed at the painless, positive, quick and permanent cure. It does not leave any scar, blemish or loss of hair—absolutely no matter how long the animal has been lame. Safe to use on any horse, old or young. It's the surest remedy money can buy, and it's the only spavin remedy in the world that is absolutely guaranteed by a

\$1,000 Warranty Bond

Write for a sample of this bond and other valuable information about lame horses. Mailed free upon request.

Your Druggist Will Obtain Mack's \$1,000 Spavin Remedy For You—

If you ask him. Price \$2.50 per bottle. If he refuses, remit \$2.50 to us and we will see that your order is filled without delay.

No matter where, when or from whom you buy Mack's \$1000 Spavin Remedy the price is the same. Every bottle is absolutely guaranteed, and is accompanied by our \$1000 Warranty Bond, which insures you that your money will be refunded if the remedy fails to do all we claim for it, as stated in our guaranty.

Do not accept a substitute, for there is no other remedy like Mack's \$1000 Spavin Remedy—nothing so powerful and sure to cure. It stands supreme as the only in all forms of lameness.

McKALLOR DRUG COMPANY Binghamton, N. Y.

FREE DIAGNOSIS COUPON



On picture of horse mark with an X where swelling or lameness occurs, then clip out coupon and mail to us with a letter telling what caused the lameness, how long horse has been lame, how it affects the animal's work, age of horse, etc. We will tell you just what the lameness is, and how to relieve it quickly. Absolutely no charge. Write today.

Free Book "Horse Sense" Send us the Free Diagnosis Coupon, get absolutely free a copy of our book "Horse Sense." Describes and illustrates diseases of horses, limbs, shows correct names for every part of horse and tells valuable facts every horse owner should know.

Lyman & Sons, Distributors to Drug Trade.

BLATCHFORD'S CALF MEAL

The complete milk substitute, raises calves without milk, prevents searling, insures early maturity, raises food calves at the cost of one. Send for free booklet, how to raise calves cheaply and successfully without milk.

STEELE BRIGGS' SEED COMPANY, WINNIPEG, Man.

You saw this advertisement in this magazine. Don't forget to say so when writing.

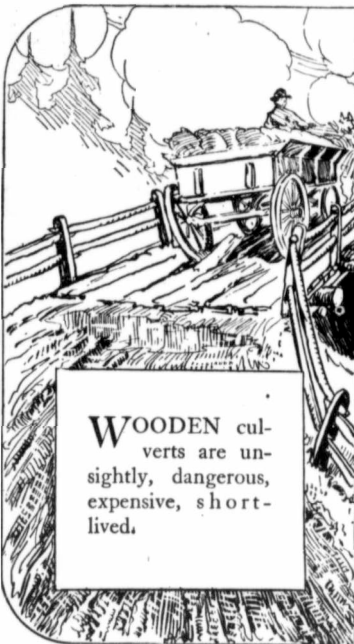

WOODEN culverts are unsightly, dangerous, expensive, short-lived.

Which kind of a culvert does your waggon cross?

DOES the road you use pass over rickety, dangerous wooden culverts, that are constantly in need of repairs and often washed away entirely? Or is it carried safely across the low places by modern, everlasting culverts? Build your

CULVERTS OF CONCRETE

which not only cannot be washed away, but actually grow stronger with age and use.

Every farmer owes it to himself to insist that the money he pays for road-taxes be spent to the best advantage. As a ratepayer, he is entitled to the best roads that can be made with that money. When culverts are washed out, and the road rendered impassable, he not only suffers inconvenience but may also be caused financial loss by inability to get necessary supplies in time for spring ploughing. And at best, with wooden culverts, part of the money that should be used to make better roads must be spent every year for repairs.

Insist upon Concrete Culverts

It will pay you and everybody else in your county.

Canada Cement Company Limited
601-580 Herald Building, Montreal

LET us send you a copy of our free book, "What the Farmer Can Do With Concrete."



IF you want to know more about Concrete Culverts, write our Information Department.

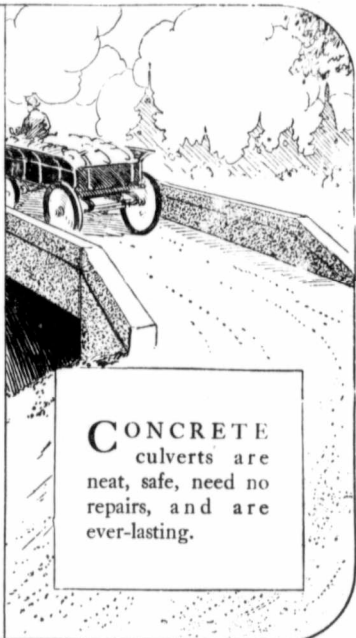

CONCRETE culverts are neat, safe, need no repairs, and are ever-lasting.

You saw this advertisement in this magazine. Don't forget to say so when writing.

of these countries is quite regular and varies only slightly. It is probable that the reason for the belief that flax "kills the land" is due to the fact that it cannot be grown successfully very many times on the same land without intervening crops, on account of the disease infections rather than the removal of fertility. A good crop of flax should be considered twelve to fifteen bushels per acre, worth from \$20 to \$30 per acre. The actual plant food removed in such a crop would be less than that removed in a wheat crop of the same value. The effect on the

moisture of the soil would be much the same with flax as with wheat as far as can be ascertained from the present stage of experimentation.

Grow Flax in Proper Rotation

The solution then of the problem of not losing this profitable industry to our neighbors on the north as soon as all the new land is broken up in Dakota and Montana, lies in crop rotation.

One of the problems which the substations of the Agronomy Department is engaged in solving, is that of determining a profitable rotation of the crops adapted to

South Dakota conditions, in which flax can be grown.

The rotation on trial at Highmore is alfalfa four or eight years, flax one year, corn one year, Canadian peas for green manure, one year and potatoes one year. The flax is grown on the potato ground, double disced and harrowed in the spring. This gives a comparatively clean seed bed for the flax and eliminates the danger from Russian thistles as the potatoes are cultivated and kept clean the year before. At the end of four or eight years the alfalfa is plowed up and a new

field is reseeded on land that had grown a crop of potatoes the year before.

At the Eureka substation, flax is grown in rotation with alfalfa seven years; flax one year, corn one year, wheat one year, peas for green manure one year, sorghum one year, oats one year and potatoes one year. As in the rotation at Highmore, the flax follows the potato crop without plowing, there being eight years between each flax crop on the same land, thus enabling the land to rid itself naturally of the infection which the flax may leave in it. At the

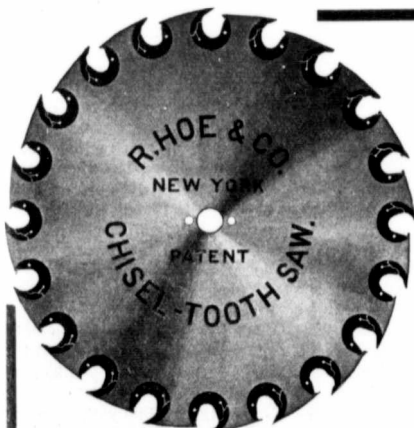

HOE & CO. CHISEL TOOTH SAWS

Portable Saw Mills

SINGLE AND DOUBLE EDGERS
LUMBER TRIMMERS

LIVE ROLLS
and
TRANSFERS

KICKERS
LOADERS
and
NIGGERS

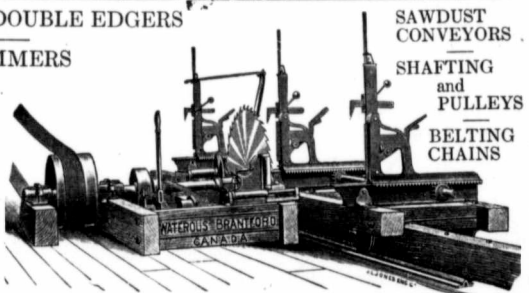

SAWDUST
CONVEYORS
SHAFTING
and
PULLEYS
BELTING
CHAINS

Write for Prices

Waterous Engine Works Co. Ltd. Winnipeg Manitoba

You saw this advertisement in this magazine. Don't forget to say so when writing.

IMPROVED NEW SUPERIOR

THE KING OF

Wild Oat Separators

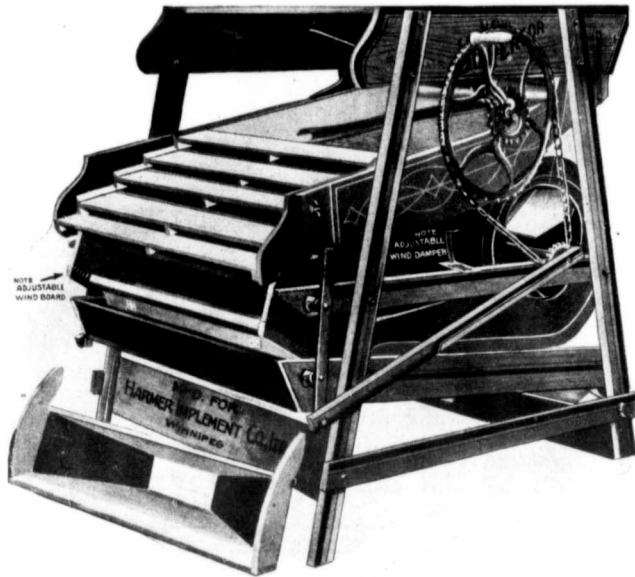

MADE IN THREE SIZES, 24, 32, 42in. wide, with or without Bagger.
We can furnish power attachment to operate with gasoline engine if desired.

Because of its positive separation with our patented open and blank space sieves causing the oats to lie flat and not up on end.

Patented **Adjustable Wind Boards** so that blast is always under control. Can blow out as much or as little as you like, making it a perfect oat cleaner and grader.

The lower shoe is fitted with a cleaning rack that is adjustable, never touching the sieve, but just close enough to knock out any grain that gets stuck when going over the sieve. It is movable, working back and forth about two inches in opposite directions to the shoe. By this improvement the capacity is increased about 25 per cent.

It is strong and well built and bolted, not nailed together.

Our machine is built to clean any kind of grain and do perfect work. What the New Superior can't do, no other can. Exceptionally easy to operate.

LIVE AGENTS WANTED

Write at once for our large descriptive catalogue of **OWEN'S Smut Machines** and **NEW SUPERIOR Fanning Mills**.

The Harmer Implement Company, Ltd.

182 PRINCESS ST.

WINNIPEG

You saw this advertisement in this magazine. Don't forget to say so when writing.

Eureka substitution there is also an experiment to determine which is more profitable to grow, a crop of flax on new land and follow it with a crop of wheat, or to leave the new land fallow and to grow a crop of wheat the second year.

It seems then the only possibility of saving the flax-growing industry to the North-West territories lies in the very careful attention to systematic crop rotations and the use of flax as one of the crops in carefully planned rotation. That it is a profitable crop is without question since the price usually rules high and the yield when properly handled is sufficient to make total results per acre very satisfactory.

Keep the Boys on the Farm
By Prof. Thomas Shaw

VERY much is being said in the press and out of it as to how boys can be best kept on the farm. Various methods are proposed, all of which, of course, seem excellent to those who make them.

Among these methods the following are prominent: Exact less work from the boys than is now required of them; make home more attractive to them; conduct farming so that it will be more

profitable to the farmer; give the boys more time for outing and more expense money. Much of this is vain reason and false philosophy.

It is not work that drives the average boy away from the farm, providing the work is within reason, and generally it is. It is the work that the boy does on the farm that helps to make him self-reliant. If he were not required to work at all, he would unquestionably be more anxious to get away than he is now. Boys brought up on the farm in childhood are fond of work. One of the chief dangers is that they are over-anxious to work beyond their strength.

It is not true that all farm homes are unattractive. It is true that many of them are less attractive externally than they ought to be, but external attractiveness is not the only kind of attractiveness. It is not the most important kind of attractiveness. The attractiveness within resulting from the love of parents, goes much farther to make home attractive to the farm boy than any external influence. The fact cannot be gainsaid that farm parents love their children as much as others. If there is any difference, they love them more. The farm boy's home is attractive where parental hearts within beat sym-

pathetically, and in nearly all instances they do.

It is not true that the small profits of the farmer make the boy of the farm discontented with his lot, but it is true that the big profits of the successful business man make the boy discontented with his lot. It is true that it leads to idleness, for he feels that he will not of necessity have to work, and this too often results in his being of no use to his generation.

Nor does it follow that boys leave the farm because they do not have time for outings and do not have expense money. Amusement and pleasure are not confined to locality in childhood. The farm boy can find it with rod or gun on his own farm and in many, many ways. He should of course have some money that he may call his own, but is it not true that too much money has wrecked the future of ten times more boys than too little of the same commodity? If none of these have led the boys away from the farm, what has done it?

What has done it? Why, the parents, and they have done it unwittingly. They are forever talking disparagingly about the toilsomeness of their own calling. They are forever drawing comparisons that sound unfavorable to farming with reference to other callings. It is a sort of chronic

habit that has possessed them. Fancy a mother saying to her boy, "You must have a profession. You are too bright a boy to be a farmer." Fancy a father saying to his boy in a moment of weariness, "Well, I hope your life work will not be so hard as mine has been."

Such talk within the home does more, in the judgment of the writer, to take both boys and girls away from the farm than all other influences combined.



Thoroughly Capable

"Urgent" was written on her card, and the attractive young lady was shown into the consulting-room of Sir Chopham Fyne, head of the famous surgical hospital in Splintshire.

"And what is the matter with you?" said the great man.

"I wish," she answered, "to become a nurse in this institution."

The surgeon tapped a thoughtful tooth with his lancet. "First, one question. Have you had any previous experience?"

She dazzled him with a reassuring smile.

"Experience!" she cried. "I should just think so. Two of my brothers play football, another has tried to cross the Channel in an aeroplane of his own make, mother is a Suffragette, and father keeps a motor-car!"

Gas Engine Igniters

The contact points between which the electric spark is produced which ignites the charge in the engine cylinder is often called the "igniter."

Formerly batteries, together with a coil, were used for producing the necessary current for operating the igniter. The nature of the battery current was such that the contact points soon corroded, causing the engine to miss fire and run badly. To eliminate this trouble small belt-driven dynamos were tried, but due to the use of belts and speed governors necessary with such devices trouble resulted.

Modern engines have a slow speed engine timed magneto built into them, which eliminates all batteries, switches, wiring troubles and corroded contact points.

To those having battery equipped engines the following will be of interest.

See that no more cells of battery are used than the maker specifies. Adding batteries will not do any good and may do a great deal of harm.

See that the igniter points are clean and bright, and are true and have no points or rough spots on them. See that the oil supply is correct, and avoid a surplus of oil if you would avoid dirty contacts.

Remember that a heavy deposit of soot on the igniter will prevent it from working. Keep soot and carbon scraped off.

Have all connections clean and bright and firm. A loose wire will often cause trouble.

Batteries should be kept in a cool place. Don't put them in a box alongside of the engine where they can get hot.

As a general rule, on engines having battery ignition, the igniter should be examined once a week or oftener.

Fool-Proof Gas Engines

In the early days of the gas engine industry the gas engine was regarded as very complicated, dangerous and uncertain.

As a matter of fact, the modern gas engine is the simplest known form of prime mover, is much less complicated than a steam engine, and is easily understood and cared for by the average man.

Most of the complications in older types of gas engines were in the ignition, that is, the batteries, coils, switch and igniter necessary for making the spark in the engine cylinder at the right instant to ignite the charge.

These battery outfits were more or less uncertain, and their unreliability was blamed on the engine as a whole.

All this complication and uncertainty has been eliminated in the modern gas engine by the use of a slow speed engine timed alternating current magneto of the built-in type which is a small machine geared directly to the engine, thereby forming a part of same. This machine generates

electricity by mechanical action, so that the engine makes its own electricity as long as it runs, there being no batteries to replace or other parts requiring attention or renewal.

The perfection of the magneto made possible the simple gas engine, and placed same within the reach of the farmer, who can now use the engine, especially the small portable type, for such a wide range of purposes that no

farm can afford to be without one.

From the various makes of magnetos on the market with which an engine may be equipped, it is well to select one that has a visible method of timing, so that the magneto timing can be checked and the user can ascertain if the spark is being produced at the right time by simply looking at the magneto. This is a feature of great importance.

This man uses a BT Manure Carrier instead of a wheelbarrow. He saves half the work and time of cleaning his barn, saves all the Manure, prevents disease among his stock and increases his profits in a score of other ways.



There is no reason why you should not own a BT Manure Carrier. We have the figures to prove that it will save its cost with a twelve months' use. Other men are making that saving. Why not you? Read the facts.

DON'T BE A SLAVE TO THE WHEELBARROW! Clean Your Barn the Easy BT Way

The slow, hard, dirty, disagreeable work of cleaning the barn should now be a thing of the past. It is no more necessary to wheel the manure out than it is to waste the manure entirely. The BT Manure Carrier makes the work play—even for a boy. The big, 14-bushel tub lowers close to the floor. It is easily and quickly filled, with liquid as well as solid manure. It is easily raised—and an easy push runs the carrier out and away from the barn. Then it dumps its load directly into the spreader, wagon, shed, or on a pile—all without any heavy work on your part.

THE BT MANURE CARRIERS

You need one—if you want to have a Modern Dairy Barn. You need one if you want to Save Work and Time. You need one if you want to Help Prevent Tuberculosis and other diseases among your cows. And we can prove that you need one—if you want to increase your profits.

Cuts Barn Work in Two Get the Two BT Books FREE

Send for Our New Fine Free Book and Read the Facts

Read of the value and superiority of the BT Manure Carrier. Know why it is the choice of men who investigate thoroughly. Read about the famous BT Truck, the Hanger, the Friction Brake, the Hoist, the Latch and Latch Tip and all the other BT advantages. It will pay you well to

MAIL COUPON NOW!

Get your BT Carrier now and put it up while work is slack. Be ready for the early cold snap. Let the BT save your time so you can do other rush work. Our five-year guarantee protects you. Write us today. Our book gives you complete instructions for erecting your outfit.

If interested in Stalls, Stanchions, Bull Pens, Calf Pens, Cow Pens, etc., ask for our Stall Book, too. Either or both are free. Mail Coupon now. Address:

Beatty Bros.

LIMITED 304 Pacific Ave. Brandon

BEATTY BROS., LTD. 304 Pacific Ave. Brandon, Man.

Please send me the books I have checked: () Manure and Feed Carriers. () Stalls and Stanchions, including Bull Pens and Calf Pens.

I have.....Cows (how many) I intend to put in a Manure Carrier about.....and will need about.....feet of track.

Province..... Town..... Name.....

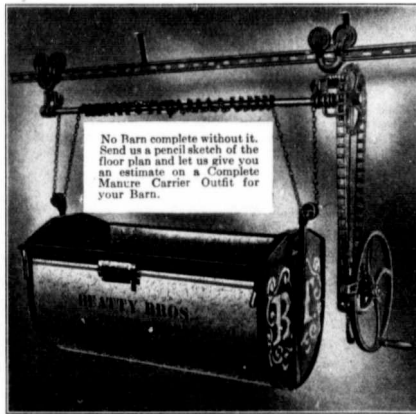

No Barn complete without it. Send us a pencil sketch of the floor plan and let us give you an estimate on a Complete Manure Carrier Outfit for your Barn.

Farmer Up-to-Date - Farmer Good Intention

Their Farms adjoin. Both of these Farmers live in your neighborhood. You know them and they know you. Are you one of them? If so, we sincerely hope you are the right 'one.

DECEMBER
1912

FARMER UP-TO-DATE

Charles : Well, well! I don't remember a year that slipped so quickly along as this one has done. Seems to me that it was only last month we were getting our bits of things ready to send at Christmas and here we are with less than four weeks off another Christmas day. I suppose the reason is we've been so busy all the while anyhow, I haven't had time to weary, and in looking back over the farm I can't see very much that we've missed that we might have done. The long open fall is the best I can remember, and if we have anything like the same luck in the spring, I should say things look blooming for a good start after all we've put in. But it's no use any man talking about things getting behind. I haven't lived your length of years, father, but I can see with half an eye that if we are going to do big things, we must have "big things" to do it with. We should never have gone ahead as we've done if we hadn't spent what we did on Machinery.—

Father : You're quite right, Charlie. You can cultivate a decent sized garden patch with a one-horse plow and an ox to haul it, but if you've got acres to take care of, the land wants more "tickling" than horse flesh can give it. We'll never be able to get along without our faithful friends in the stable but they were never intended to do the same work in the same time that steel and steam can accomplish. I was driving through a big farm near Winnipeg about the time that wet season started there this year and had a chat with the man who was managing it. Poor fellow, he was heart broken at the prospect in front of him. His boss (who evidently knew more about real estate diplomacy than intensive farming) had set him up against an impossible task. There was a full section and a half and a few teams to do the entire job except that he had counted on hiring a Gas Tractor from a neighbor, but the neighbor had his hands full with his own troubles and the Tractor couldn't be spared.

Mother : I don't suppose you men folk mean to take credit for all the "work" that has been done this year. There are things that don't appear, but if they have been quietly busy, they have to get their little bit of back-patting, too. Oh, I'm not complaining and you needn't twist your mouths into a smile; but just look at those dishes on that dresser and the pots and pans in the scullery. They haven't much to say for themselves, and they have nothing to "show" but their own black and white faces, but I can tell you they have had a busy time, too, this year—especially when you chaps brought around that hungry crowd at harvest time. But I'm just as "cockie" as you are, and as far ahead too, in my own little way. For all that, I'm not tired of it yet, but I want to take a rest in a little bit of excitement at Christmas. I haven't done much for our Home Economics friends except take an odd cake and some eggs to the meetings, so I am going to invite the whole bunch here on the day after Christmas.] Any objections? —Carried.

John's weekly letter : I took a trip out to that new Agricultural College at St. Vital last Saturday afternoon. It certainly will be a great institution, and if fine equipment and a tip-top educational staff will encourage men to come to anything of the kind, I can't see that there's a loop-hole left in providing for this fine show. It could scarcely have been located at a better point in so far as environment is concerned. But of course the great thing is what will be done inside. Not many of us need to move away from home to find comfortable quarters and fine scenery. The Old College (of so many pleasant memories to me) was never to be found fault with. On the other hand I say that in nearly every case, from the Principal downwards, they have been lucky in getting a bunch of men who know their book but best of all they are enthusiasts. They are not crammers but have a happy knack of inciting fellows to dig out information and they do it in such a way that any serious chap cannot fail to take an interest in his schooling.

FARMER GOOD INTENTION

Father : My goodness. Here's the last lap of another year and we're in a worse plight than when we started. I'd give a lot to be able to put the clock back six months, but that's a dream so we'll give it up. My affairs on this unfortunate place are certainly on the bum. I wonder how it is I don't ever seem to make any headway. God knows I struggle as hard as any man but it seems to me just like an old time horse-power threshing outfit—travelling in a circle all the time with this difference that my tread-mill never seems to grind anything. We began late with everything in the spring and we wind up in the dray with not a hope of making up time so far as I can see. Even the train crews seem to be in league to humbug us. Not a car to be had except through the most barefaced bit of blackmailing that was ever perpetrated by crooks upon honest people. This country is rotten, sure. What with party politics and graft and—

Charles : And ourselves, father, to complete your sentence. But I wish you wouldn't introduce so much of the "we" into your complaints. While you've been sitting there I have been running my mind back a few months and upon my word I don't see an awful lot I've got to blame myself for in so far as the farm work is concerned. I'm ready to take my medicine with any man but not unless it is "coming to" me. Frankly let me tell you that I have been working now for some years with a pair of chain fetters around my feet. I've raised my little pipe in protest more than once and you know what weight it has carried. I've advised you, and I've threatened, and I know I've lost my temper on more than one memorable occasion. But I've stuck to you in spite of the fact that you still think I'm just "the boy" and the additional fact that I have scarcely a dollar's worth of property I can call my own. All that I have earned or might have made elsewhere is sunk in this muskeg of a proposition. But there's an end to it, I hope, within sight.—

Mother : I'm sorry to hear you speaking in that way, Charlie, but I can't blame you. And I'm neither going to blame or support your father. I've no doubt had something to do as well, with our unfortunate circumstances. But we've a little time left us yet before this old year passes away. Let us sit down quietly and reason together. I do believe that what the minister quoted last Sunday was quite right. "The evil we sustain we carry about with us and we are never real sufferers except by our own fault." I am perfectly satisfied that we have had as good land and as good an opportunity as any of our neighbors. The weakness is within ourselves. As we have made our lot so far, it is possible, if perhaps not quite so easy to re-make it. There's no good to be done by merely lamenting. Let us face the situation with one solid determination—to get on our feet and to clear ourselves of every encumbrance. This is a life of give and take. I'm prepared to give my bit, and father, you'll have to give up your bit, too.

Biggs, the Implement man, sends in his fine new calendar for 1913 with the following note enclosed—scribbled on a bill-head:—

"Dear Good-Intent:

"That note of yours for \$350 is still taking its long rest. Even if there's "nothing doing," this fact will not keep me from wishing you and all your folks the Season's Compliments and Good Cheer. If I can't help you I will not hinder you from trying to help yourself. Get up, man, and get the dust out of your eyes!

"Biggs"

"I think it is the only machine I ever bought that will pay for itself in twenty days."

J. E. BERGEY
Rosser, Man.

"We figure our loader saves us \$30 a day in help and board. It also saves us a lot in handling the grain."

FAIRBAIRN BROS.
Clavet, Sask.

STOOK LOADING

"When TIME was never in the mart
And MEN were cheap as apples."



The Ghost
of a
Back
Number

"Are You
Ready for
Another
One, Jim?"

YET this is practically how it was done by thousands of farmers in Wester Canada in 1912 — who would like to be reckoned as "business men"—who are in the game to make money! Philanthropists, they are, who have given employment to a mob of harvest hands at the rate of from \$20 to \$30 a day over what it would have cost them had the job been done with a

STEWART SHEAF LOADER



THE STEWART SHEAF LOADER is now as well known in Western Canada as the Self-Binder and every farmer who has used it values it as a labor-saving, money-making implement at no less than the binder. As the Commissioner for Immigration says: "It shares equally with that machine as being indispensable to every successful and progressive farmer." If you would save a big margin on the purchase price and be sure of delivery in time for the next crop

Communicate With Us At Once

Stewart Sheaf Loader Co. Ltd.
804 Loan and Trust Building
WINNIPEG

"It gathers up everything, whether loose or tied, and one loader will supply the biggest outfit made with plenty of sheaves."

ROBT. A. ROBINSON
South Regina, Sask.

"The Stewart Sheaf Loader does all you claim for it. Saves \$33 a day in wages alone, not counting horses' feed and board for men."

G. W. STEWART
Sedley, Sask.

Course in Gas Engineering

Continued from page 25

a number of laminations or sheets of soft iron which are loosely mounted and held by springs on either end of the armature bar. When the driving bar is moved into the case the latch is caused to slip off the block by a wedge. However this has carried the armature bar and the upper armature away from the cores. When the latch slips off the block the upper armature is carried forcibly down by means of its spring and the bar then strikes the lower armature knocking it just as forcibly away from the opposite end of the core. The combined results of this action is to produce a current of high tension in the windings of the coil and which causes a single spark at the plug points. The timing wedge is operated by a quadrant which contains several notches varying the position of the wedge and consequently the time at which the latch separates from the block. Thus the spark may be timed over a wide interval, or the wedge may be moved sufficiently far so that the armature bar does not slip off and thus no spark is produced. The later spark positions are produced by longer movements of the armature and thus produce a heavier spark which is more suitable for starting purposes. The movement of the driving bar is 5-16 of an inch and may be produced by a cam or eccentric. This magneto is entirely enclosed so that it is unaffected by weather conditions.

Fig. 6 shows a low tension oscillating magneto which is attached directly to the ordinary make-and-break igniter. The oscillating movement of the armature is accomplished by means of the rod which formerly operated the igniter and the separating of the igniter point is mechanically accomplished by the oscillating movement of the armature. This system is practically equivalent to the one first described except that a mechanical make-and-break is used.

On practically all the engines manufactured in the old country a Bosch magneto of the low tension type is connected to the mechanical make-and-break in a manner somewhat similar to this, producing practically the same combination. This is one of the most satisfactory and simple systems, and the current being of low tension it is not difficult to insulate.

With the development of these different types of magnetos the battery systems are being gradually replaced and in the next few years we may look forward to their elimination, probably the only reason for their not being universally adopted at present being their first cost.

Nearly Half a Century an Implement Man

It is with keen regret that we mention the loss of an old-timer to Western Canada's implement business. The implement salesman of today has things pretty much cut and dried for him. He travels in a Pullman, he stops, generally, at a good first-class hotel, and in a large number of cases the automobile is the vehicle that conveys him to his country prospect.

These things were not even dreamed of 42 years ago when John MacVicar started out to sell his first farm implement in Manitoba. These were the days of the pioneer. Traips really ran nowhere. Hotels were a real luxury. In fact it was a case of "stay where night overtook you and sleep in your own blanket." It took a real salesman in those days to sell goods—a man



Mr. John MacVicar

who thoroughly understood human nature. Such a man was John MacVicar. He came to know the farmer and the farmer knew him. His word was as good as his name. To know him was to know a friend. For the past 16 years Mr. MacVicar has acted as travelling salesman for the Sawyer-Massey Co., but owing to extensive private interests in Victoria he has retired from the Sawyer-Massey service and henceforth the island will claim him as a resident. Upon his retirement, the office, field and warehouse staff of the Sawyer-Massey Co. presented him with a beautiful solid gold watch, locket and chain as a testimony of 16 years of pleasant associations.

It is a credit to any Company that one man should remain in its employ for so long a period and not a little credit is also due the man.



WILL NOT FREEZE

WILL NOT BOIL

Guaranteed to do no injury to the cooling system. Absolutely prevents the freezing of radiators.

Gas Tractors and Automobiles

can be used during the coldest weather.

One filling lasts a whole season. Freezing point 49° below zero F. by actual tests. The cooling properties are of the best for its boiling point is higher than that of water. Boils at 239° F. by actual tests. Is a watery solution saturated with chemicals that will not injure in the least any part of the cooling system and does not affect the rubber hose connections. Unlike Alcoholic Mixtures, Alaska Radiator Fluid is always uniform in strength, for its essential elements never evaporate.

Price f.o.b. Winnipeg

BULK.....75c.
IN 44 GAL. STEEL DRUMS.....84c.

We stock Alaska Radiator Fluid at four Western points at Winnipeg price plus car-load rate of freight

We agree to allow \$3.00 for the steel drums when returned.

Continental Oil Co., Limited

WINNIPEG - MANITOBA

Branch Offices: Regina Saskatoon Lethbridge Calgary

You saw this advertisement in this magazine. Don't forget to say so when writing.

This Oil Pump Will Outwear the Engine

The simple construction of the Madison Kipp Model 10 Oil Pump makes it at once the most reliable and the most durable pump that can be placed on an engine. Its strong, rugged design and few working parts are alone a guarantee of its effectiveness and durability but it has other features that stamp it as the PERFECT LUBRICATOR.



The MADISON-KIPP

is the pioneer line in automatic lubrication—the pump illustrated has reached its high state of perfection through years of patient labor.

The Madison-Kipp will pump without adjustment, the extremely thick oil of winter and the thin oil of summer and force the oil against any pressure required.

The Madison-Kipp pump positively will not freeze. It works equally well at 20 deg. below zero and 90 above zero. No valves, no springs or stuffing boxes to wear out.

The Madison-Kipp is more durable, economical and constant than any other device on the market. They easily pay for themselves in one season in oil saved.

Model 10-In any number of feeds from one to ten.

Seriously; don't you think it would pay you to investigate the Madison-Kipp Line? Write for complete literature and DO IT TO-DAY.

THE MAYTAG CO., LIMITED

Sole Agents for Western Canada. WINNIPEG, Man.

Manufactured by the MADISON-KIPP LUBRICATOR CO., Madison, Wis.

You saw this advertisement in this magazine. Don't forget to say so when writing.

30 H. P. Bell Rear Mount Traction Engine

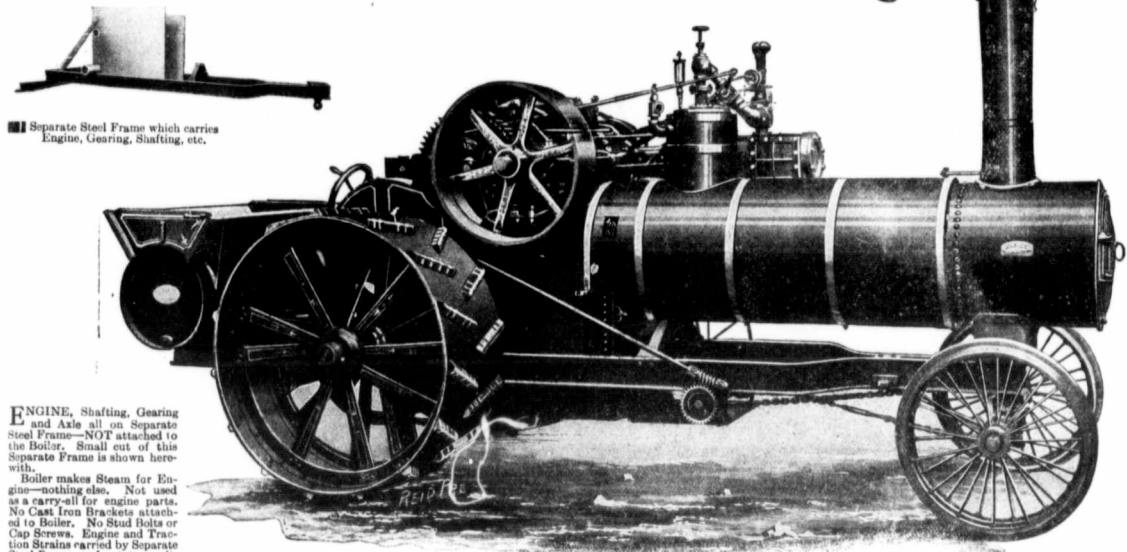

Separate Steel Frame which carries Engine, Gearing, Shafting, etc.

ENGINE, Shafting, Gearing and Axle all on Separate steel Frame—NOT attached to the Boiler. Small cut of this Separate Frame is shown herewith. Boiler makes Steam for Engine—nothing else. Not used as a carry-all for engine parts. No Cast Iron Brackets attached to Boiler. No Stud Bolts or Cap Screws. Engine and Traction Strains carried by Separate Steel Frame, and not transmitted through Boiler to the Drivers.

ALL OPEN HEARTED CAST STEEL GEARING, cannot be broken. Large diameter, wide faced Drivers. Large capacity Water Tanks and Fuel Box. SPECIALLY designed for plowing and no other engine made will stand up to its work like this one. Investigate before you buy an engine for plowing or threshing. Send for specifications and full particulars.

Our full line of IMPERIAL MACHINERY for Plowing, Hauling and Threshing is worth enquiring about. Write to-day

The Robt. Bell Engine & Thresher Co. Ltd., Seaforth, Ont.; Winnipeg, Man.

You saw this advertisement in this magazine. Don't forget to say so when writing.

Old Friends Always Come Back to Canada

A great many readers will welcome the fact that the Minneapolis Threshing Machine Company have again decided to open up in Canada. The Minneapolis line has always been popular with the



Mr. T. H. Runey

Canadian farmer and thresherman, and it was due largely to the insistent demand for their goods that the company again decided to share their output with the Canadian wheat grower.

The Company is now located at 405 Darke Block, Regina. How-

ever, a full half block of trackage ground has been purchased at the corner of Sixth Avenue and Osler Street, and the trackage has been laid for the warehouse and office building, 100 x 250. This will be of practical construction, and will be completed before March 1st. A full line of gas plow engines, steam plow engines, plowing outfits, grain separators and attachments, will be carried in stock as well as a full and complete line of repairs. Arrangements have also been made for the handling of goods at Calgary, and also at Winnipeg. It is also the intention of the Company, to establish branches at several other distributing centres in the Canadian West, in order to take care of the trade.

The business of the Minneapolis Threshing Machine Company in Canada will be under the supervision of Mr. T. H. Runey. Mr. Runey has been with the Minneapolis Threshing Machine Company over twenty years, and for the past eighteen years has been manager at Fargo, N.D.

The Minneapolis Threshing Machine Company has enjoyed a most enviable reputation on the other side of the line. Being practically pioneers in the business, they have carried it successfully through the various stages,

and have in every case kept pace with the changing demands of the thresherman. Their line today is indicative of the truth of the above statement. They build several sizes of gas tractors and a full and complete line of steam tractors, and a separator for every purpose and of almost every practical size for the thresherman.

We wish Mr. Runey and his Company every success.



Opportunity for Manitoba's Farm Boys

Continued from page 40

never known even in all the splendid record that stands to its credit. In this connection it is very satisfactory to reflect that we have now Mr. Lawrence's first lieutenant in the person of Professor S. A. Bedford, who for many years "watched his stocking" at the Brandon Experimental Farm and subsequently was Professor of Agronomy at the College until he was called upstairs to Kennedy Street.

Without belittling in the least any predecessor or his work, it is safe to say that no provincial appointment was ever made in Manitoba that gave such general and complete satisfaction as when Mr. Bedford was asked to under-

take the duties of Deputy Minister of Agriculture. Like his old colleague Mr. Black, Mr. Bedford's career and services to the country are the subject of common knowledge.

These men have souls above cheap applause. They are not politicians or platform mouth organs. They are what, without invidiousness, might be called just common day laborers in one of the finest educational propagandas the Almighty ever set before men. "Bouquets" have never been meat and drink to them as they are to so many of those flimsy fellows who are never so much at home as when they are chaired by the crowd or have been glorified in print. They leave no dearer desire than to be left alone at their life's work. We might find a crowd of men who would do otherwise than these men do, but would they do better?



If you suspect a woman do not marry her; if you marry her, do not suspect her.—Warwick Price.



While you have a future do not live too much in contemplation of your past; unless you are content to walk backward the mirror is a poor guide.

Establishing a Farm Home

Continued from page 16

with material obtained from the nursery. There is also to be a hedge planted along the north fence of the house yard and also on the north and east of the garden. About the 15th of June the six horse team starts plowing the summer fallow, harrowing each night the land plowed during the day. The one team has practically steady work on the summer-fallow until haying. During this time the farmer himself is hauling stone for the barn foundation, also hauling material for the shell of the remaining half of the barn which is to be used for a loose shed for a bunch of feeding cattle he intends to buy during the latter part of the summer and which are to be fed over winter and sold about the end of May the following year. He figures on buying about fifty head and then in the spring he will select ten of the best heifers to keep to start a herd of his own. He also puts up a fence around the remainder of the farm consisting of willow post a rod apart and two strands of barbed wire. It is his intention to add more strands of smooth wire from time to time together with upright wires every three feet, put on with patent stay fasteners. This fence when completed will be hog and sheep

proof, horse high and the two strands of barbed wire will prevent the stock from stretching the fence by rubbing. It is his intention to put in the cross fences the following spring. This year by the use of a haystacker which costs him \$75 he is able to put up one hundred and fifty load in the usual haying season. The extra amount of hay is to feed the cattle from the middle of March until the grass comes, previous to that time they are fed on oat and barley straw inside and wheat straw outside. About the first of December he commences feeding crushed oats in troughs outside at the rate of five lbs. per head and increases this gradually until about fourteen lbs. is reached per day at the end of the feeding period. The cutting and threshing of the grain involves more time this year than in the previous year but is completed without any draw backs happening. The wheat is put in the three portable bins in the field and the remainder in bins in the cattle part of the barn and is hauled out before it is needed for the stock. The oats are put upstairs in the barn. After the threshing help is paid back field No. IV is fall plowed for wheat, the following year giving him seventy acres of summer-fallow and seventy of fall plowing of wheat in 1914 when he

commences the crop rotation as indicated on the accompanying plan. His crop returns for 1913 are wheat, four thousand, oats, two thousand, barley, seven hundred and fifty bushels. During the fall and until freeze up he is employed buying, feeding cattle through the country. He also makes arrangements with the butcher in town to take any young cattle he gets that are not in condition for butchering. In these ways he obtains the fifty head without much trouble.

My purpose in this three years plan has been to work out a natural development in all parts. There is a tendency for a man who has sufficient capital to go in for having everything done the first year, but I maintain even if he has the capital it is not a paying plan to adopt, because when having buildings put up by contract he has to pay big money for all work done. He is quite able to do the carpentry work of all the outbuildings himself and in this way he can earn as much or more money than he would if he were working on the land all the time. Live stock is a necessary adjunct to any farm but while he is engaged breaking up his farm he wants little or no extra work in the way of looking after stock. However, there is not sufficient work on a half

section to keep two men busy on the land while at the same time there is rather too much for one, so by doing his own building and having some stock to look after he can have a man doing all the work on the land except in the busy season during spring and fall when he can help in the field himself. By this arrangement he avoids the necessity of having to get help for harvest when hands are scarce and wages are high. As he gets his buildings in shape he can go in for stock a little more extensively and gradually work into pure-bred stuff. Also if he feels disposed he might have time to look after a bunch of poultry and when he gets a satisfactory granary he can go in for growing registered seed grain which will sell at a profitable figure. In fact gradually working into a system of intensive farming which is the only system that will maintain the standard of agricultural production.

**The Thoughtless Response.**

"The baby likes to play with my hair."

"But you don't trust him with it when you are out, do you?" inquired her caller. And thus a coolness arose between two women who had been lifelong friends.

THE STOVER GASOLINE ENGINE

Stationary, Portable and Traction Engines always in stock

Don't Buy A Stover

unless you want the Best Engine on the Market, an Engine that is dependable and will deliver the power with the least consumption of fuel. We have Engines for every purpose at prices before unheard of.

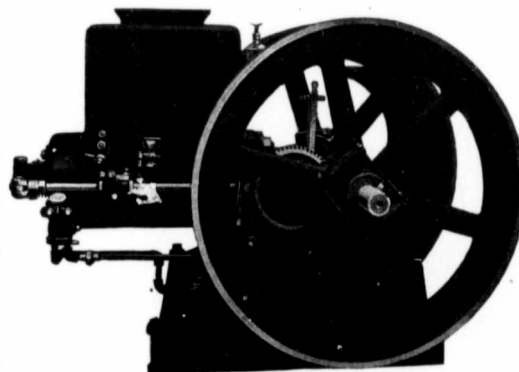

Do You Use

Dry Cells, Crusher Plates, Harness, Oils, Plow Shares, Bag Holders, Scales, Buggies, Harrows, Threshers, Supplies, Belting, Cultivators, Plows, Grain Crushers, Pole Saws, etc. ? Write us for prices—they read like a romance.

OUR FULL LINE includes: Fuller & Johnson repairs; repairs for the Wilkinson Plow Line; Shares for all kinds of plows at reasonable prices, wholesale and retail. Engines for pumping, churning, crushing, grain cleaning, sawing, threshing, and running washing machines.

We handle every known Farm Requisite

Write for our Special Catalogue. When you come to Brandon visit our Mammoth Warerooms and have your mail sent to our care.

CANADIAN STOVER GASOLINE ENGINE CO. Ltd.

EIGHTH AND PACIFIC AVENUE, BRANDON

The Original Farmers Company

Agents for Minneapolis line of Threshing Machinery.

COUPON

Canadian Stover Gasoline Engine Co., Brandon: Please send me Catalogue of your Engines and Sundries, as advertised in the "Canadian Thresherman and Farmer."

Name.....
Post Office.....

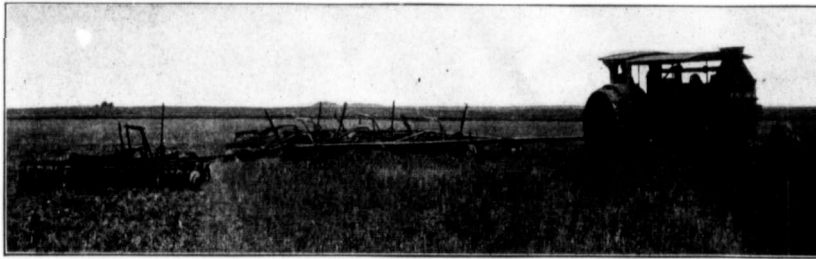

The Hansmann Disc-Drill Hitch

This Hitch is shown in the picture pulling five double action disc harrows. It is perfect in construction; can be adjusted for three or five discs or drills of any make or size; and will stand up under the pulling power of any traction engine.

With The Hansmann Disc-Drill Hitch, turning at the ends of the field is done in as small a circle as the engine can make, each implement keeping its path and not coming into contact with the other.

The Hansmann Line:—

- HANSMANN DISC-DRILL HITCH
- HANSMANN PLOW ENGINE GUIDE
- HANSMANN SEPARATOR-GRADER STEERING POLE
- HANSMANN BINDER HITCH.

These devices have passed the experimental stage and every "Traction Farmer" should have them in his equipment.

If your dealer can not supply you, write the home office,

THE HANSMANN MANUFACTURING COMPANY

Long Prairie, Minnesota

You saw this advertisement in this magazine. Don't forget to say so when writing.

The Robert Bell Engine Works

WE present herewith a bird's-eye view of The Robert Bell Engine & Thresher Co.'s Plant, Seaforth, Ont., where the Bell engines and Imperial separators are built. This company has been manufacturing bell engines for fifteen years and Imperial separators and Ruth feeders for eight years. During this time a large number of these engines and separators have been sold through the Western provinces, Ontario and British Columbia, and each year are becoming more popular with the users. The plant has recently been very much enlarged and equipped with the most modern facilities for handling the increase of business.

Up to the present time this company has confined itself to the manufacture of portable engines from 14-40 h.p., traction engines from 16-30 h.p., and separators from 28 inches upwards. This year, however, the company following out the modern tendency towards an all-steel construction, have brought out a new type, rear mount traction engine, designed specially for plow

ing and hauling purposes. This Company has enjoyed a prosperous trade in Western Canada largely so because of the fact that they have always kept pace with the requirements of the West.

"How is the new filing system? Success?" asked the agent of the merchant to whom he had sold a "system" a few days before. "Great!" said the merchant.

"Good!" said the agent, rubbing his hands. "And how is business?"

"Business?" echoed the merchant. "Oh, we have stopped business to attend to the filing system."

The following epistle was sent by an angry tenant to his landlord:

"Dear Sir:
"I want them sellar steps fixed right off. My wife fel down last nite and broke her dam neck. Please send plumbber and figs our bath tub it will soon be time now for us to use him agen and oblige.
"Yours trule,
"_____."

A little girl who lived opposite a large orphan asylum in our city had a small guest visiting her, who asked in wonder:

"What's that big building over there, Ruthie?"

"Why, that," said Ruthie, "is where the orphans live—lots and lots of 'em, little boys and little girls—an' Mr. and Mrs. Orphan are both dead!"

"Your husband says he leads a dog's life," said one woman.

"Yes, it's very similar," answered the other. "He comes in with muddy feet, makes himself comfortable by the fire, and waits to be fed."

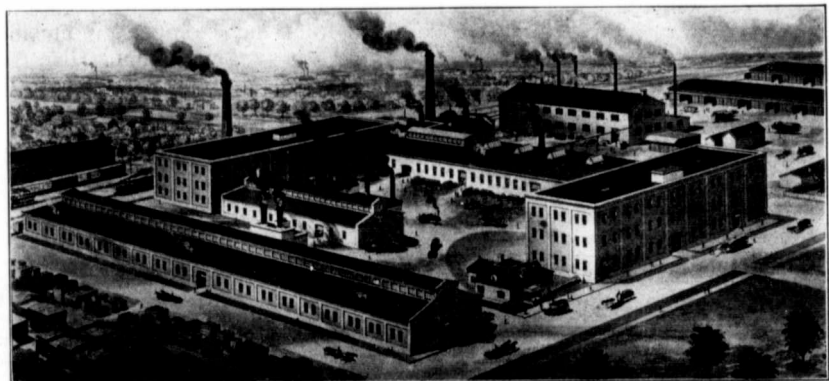

Plant of the Robt. Bell Engine and Thresher Co., Seaforth, Ont.

n busy on same time h for one, ilding and k after he l the work the busy and fall field him- ment he having to hen hands are high. s in shape little more ally work Also if he have time of poultry itisfactory r growing vchich will e. In fact a system ich is the maintain tural pro-

sponse. play with

him with do you?" nd thus a two wo- lifelong

E

Plates, hares, ggies, plies, Plows, Saws, -they

prices,

ngine Cat- Sun- ana-



You Will See This Large Double Page Scene in the New 1913 Avery Separator Catalog

It's time to begin thinking about the machinery you want to get next year.

These long nights of the winter months are just the time when you should carefully read about and compare the points in the different makes of machines.

Now's the time to drop a line for the new 1913 Avery Catalogs so that you will get the ones you want just as soon as they are delivered from the printer.

This year we are printing the following list of catalogs:

- Avery Steam Traction Engines*
- Avery Gas and Oil Tractors*
- Avery "Yellow-Fellow" Separators*
- Avery "Self-lift" Engine Gang Plows*
- Avery Gasoline Motor Trucks*

You will want to know all about what the Avery Company is building in the line of the machines you want. The Avery Line always has New Improvements and Superior Features.

Use the coupon here and write for the New 1913 Avery Catalogs you want.

EVERY COMPANY 675 Iowa St., Peoria, Ill.

Haug Bros. & Nellercoe Co. Ltd., Winnipeg, Regina, Calgary
Western Canadian Distributors

Avery Company, 675 Iowa St., Peoria, Ill.
Please mail me as soon as ready for delivery, your 1913 catalogs checked below:

- Avery Steam Traction Engines.
- Avery Gas and Oil Tractors.
- Avery "Yellow-Fellow" Separators.
- Avery "Self-lift" Engine Gang Plows.
- Avery Gasoline Farm Trucks.

Are you in the market?..... If so, when?.....

What for?.....

Name..... Town..... R.F.D.....

State..... Date.....

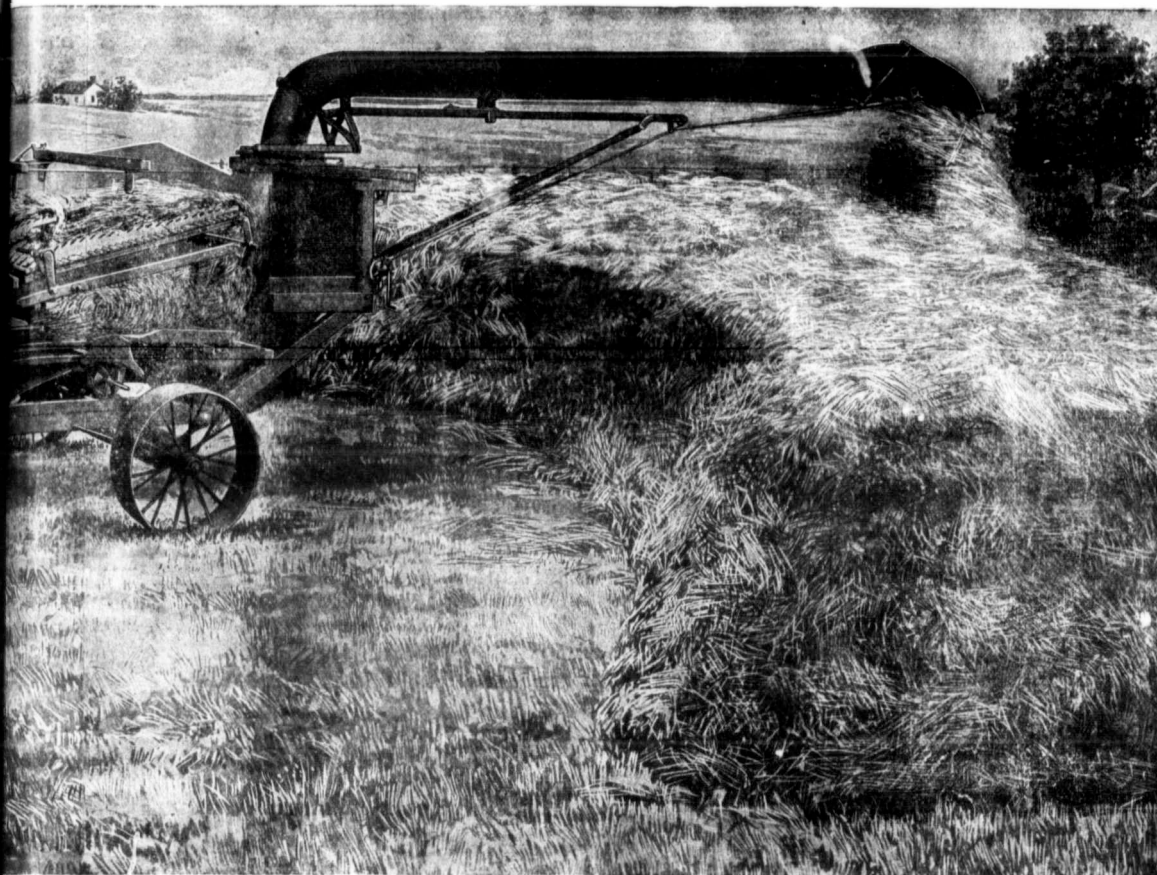

You Get an Up-to-Date Design When You Get an Avery

These are some of the many Superior Features of Design you will find discussed in the New Avery catalogs. We can only list them here. Write for our catalogs and learn all the facts about Avery Design.

Avery Double Undermounted Steam Engines

The only Undermounted Traction engines built. Like a railroad locomotive. Boiler independent of traction parts. No boiler strains. Straight line pull from cylinders to load. Working parts low down where they can be easily reached from the ground for oiling or adjusting. One man can put main belt on alone and stand on the ground while doing it. Locomotive throttle inside dome saves condensation of steam. Automatic fire door—a wonderful improvement—operated by foot, leaving both hands free. Gould balanced valves reducing loss of power by friction to the minimum. Positive screw shaft guide—the finest guide ever put on any engine. These and the many other improved features in Avery engines are worth your careful study.

Avery "Yellow-Fellow" Threshers

The separators with the famous Jumbo Took Steel Teeth that are so good they're guaranteed for life against breakage. No choke feeder with positive governor for carrier as well as feeding parts. Long grate surface with adjustable grate at the rear of the cylinder. Wonderful I.X.L. grain-saving separating device. No-cross-blast fan. Gearless wind stacker driven by straight open belt direct from cylinder shaft. Double cone pulley-belt guide—the best belt guide made. Paper center cylinder pulley. These are only a few of the "Yellow-Fellow's" fine points—no other separator has anywhere near as many.

Avery Gas and Oil Tractors

The lightest weight tractors built, considering their power and strength of construction. They don't pack the ground or waste fuel moving useless dead weight. Also the simplest tractors of all—least gears of any, no intermediate gear for traveling ahead, no cooling fan, no water pump, no fuel pump, only one clutch. Have strong, simple double opposed motors. Economical in fuel consumption and burn either gasoline or kerosene. It's wonderful how many improved features these tractors have.

Avery "Self-lift" Engine Gang Plows

They are beyond comparison with any hand lever plows built. No plowman required—saves his wages and board. Saves all the hard backbreaking work of lifting and lowering plows by hand levers. Saves time at the ends. Also built with fine adjustments to do first class plowing. You simply cannot afford to fail to investigate this plow if you want an engine gang.

Avery Gasoline Motor Trucks

The only combination gasoline farm wagons and general farm power machines. Do hauling, field work and belt work. Haul cheaper and quicker than horses.

This list of some of the improved features in the design of Avery machinery certainly means that the Avery line is worthy of your most careful investigation.

Write for catalogs you want. Don't delay. Get your name in for one of the first new 1913 books off the press.

England and Germany

BY REV. JAMES L. GORDON, D.D.
Pastor Central Congregational Church, Winnipeg, Man.

Sail on, O Ship of State!
SAIL on, Sail on, O Ship of State!
Sail on, O Nation strong and Great!
Humanity, with all its fears,
With all the hopes of future years,
Is hanging breathless on thy fate!
We know what master laid thy keel,
What workmen wrought thy ribs of steel,
Who made each mast, and sail, and rope,
What anvils rang, what hammers beat,
In what a forge and what a heat
Were shaped the anchors of thy hope!
Fear not each sudden sound and shock,
'Tis but the wave and not the rock,
'Tis but the flapping of the sail,
And not a rent made by the gale!
In spite of rock and tempest's roar,
In spite of false lights on the shore,
Sail on, nor fear to breast the sea!
Our hearts, our hopes, our fears,
Our tears,
Our faith triumphant o'er our fears,
Are all with thee—are all with thee!

War clouds hang heavy today.
Great men are pleading for peace
while great nations are preparing
for war. Every shock of exploding
artillery on land and every
manifestation of naval ingenuity
on the sea sends a thrill of alarm
through the world. We have read
predictions of a coming Armageddon
and we fear their sudden fulfillment.

The universal verdict of civilized
humanity has been against
war. "That man," said General
Dudley, "is most anxious for
peace who has had the longest
experience in war."

Victor Hugo declared his conviction
in these words: "Peace is the
virtue of war and war is the crime
of civilization."

Ulysses Simpson Grant, weary,
sick and tired of the tramp of
armies and the noise of battle,
exclaimed: "Let us have peace."

The Duke of Wellington asserted
that, to avoid war, even one
month of war, he would gladly
lay down his life.

George Washington, anticipating
the growing sentiment for
peace which is characteristic of

modern times, wrote, "My first
wish is to see the plague of war
banished from mankind."

General Sherman, that grim old
veteran, congested the common-
sense of humanity in one pregnant
sentence when he said: "War
is hell."

The brains and scholarships of
the world have also declared
against war. "War always de-
vours the best," says David Starr
Jordan. Noble John Clifford ex-
claimed: "War is barbarism—
wild, ferocious, murderous bar-
barism," and John Ruskin, that
prophet of God and friend of the
poor, expressed the matter in a
plain and pointed fashion when
he quietly remarked: "If the rav-
ages of war, instead of unroofing
the home of the peasant, should
break the china on your own
drawing-room table, no war in
civilized countries would last a
week. You would pronounce an
immediate anathema on the
heresy of war."

And yet we witness, on every
hand, the strange paradox—
Christian nations stand armed to
the teeth while heathen nations,
so-called, have scarcely learned
the art of war.

Huge standing armies and enor-
mous navies mark the confines of
our so-called, Christian civiliza-
tion. The standing armies and
floating navies of the world cost
five million dollars a day. The
standing armies of Europe com-
pose a force of six million men.

Some time ago, there appeared
on the Thames river eight miles
of fighting ships—three hundred
and forty ships of war—while in
the city of London there existed,
at the very moment this mobiliza-
tion of naval strength was in
progress, a multitude of 800,000
people who never know what it is
to have enough to eat.

The world's annual expendi-
ture for war, in times of peace, is
£ 500,000,000—in Canadian coin—
two billion and a half dollars. A
Dreadnought costs ten million
dollars to build and one million a
year to keep, and it is out of date
and behind the times in ten years.

The army and navy of Great
Britain cost \$350,000,000 a year.
The military and naval expendi-
ture of Germany is \$250,000,000
for the same period, while the
United States spends annually for
army, navy and pensions the
appalling sum of \$470,000,000—a
financial burden heavy enough to

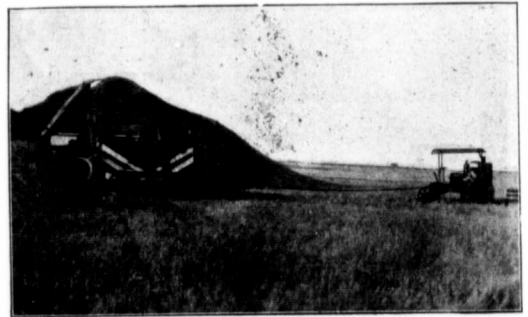

The Three Speed "General Purpose" Farm Tractor

One of our Model F. 15 B.H.P. tractors had no difficulty whatever in handling the above separator at Kindersley this fall. Mr. Seager Wheeler (the winner of the world's wheat prize) is also using one of our engines to run his separator and for plowing.

The following is a testimonial from one of our customers:

"Dear Sirs:—
Re Model F. Tractor.
"This tractor which you supplied me with a few months ago has been hauling two 12-inch plows right along in breaking on the low speed. I have done over five acres per day with it. I am not using quite forty-five gallons of gasoline in three days and am using nearly one gallon of lubricating oil per day.

"I seeded and harrowed thirty-five acres per day during seeding time. I am hauling three hundred bushels of oats (and could haul four hundred without any trouble) on second speed; the haul is one and a half miles. I can make seven trips per day getting two cents per bushel; this haul is 10,200 lbs. without the waggon. This makes a total of \$42.00 per day earned, less two men's wages and board at three dollars per day each, gasoline \$3.80 per day and lubricating oil seventy-five cents per day. This leaves a total of \$31.45 for my own wages, wear and tear of tractor and profits. I do not use batteries for this tractor, but always start up on magneto."

The British-Canadian Agricultural Tractors, Ltd.

Ontario Avenue, Saskatoon, Sask. And at Alberta Investment Buildings, Calgary, Alta.

WATSON'S POLE SAWS Lead the Market

Money can't buy a better saw. We make them with heavy steel shafts and boxes, solid by wheel and three pulleys. Frame is strongly braced, rigid and sits firmly and evenly on the ground.

WATSON'S Cordwood saws are designed especially for the purpose. Equipped with ratchet pulley and regularly finished with 26-inch saw.

WE SELL
Channel Steel Harrows Lawn Goods
Boss Wood Harrows Turnip Seed Sowers
Steel Boss Harrows Warehouse Trucks
Harrow Carts Double Trees and
Pulverizers Neck Yokes
Pole and Cordwood Horse Powers
Saws Straw Cutters
Wheel Harrows
Root Pulpers
Grain Grinders
Heider Reapers
and Janesville
Plows

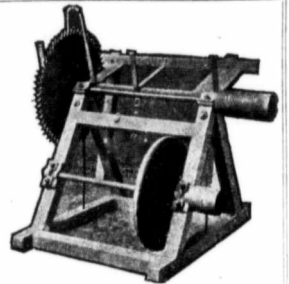

John Watson Mfg. Co.
Winnipeg, Canada



HAVE YOU A HIDE

or skin to be tanned for a Coat, Robe, Gauntlets or Rug?

Send it to us and we will make it as soft as a glove. No acid used in our tanning, only the purest and best bark and mineral extracts. We have been tanning hides for robes and coats for sixteen years in Western Canada, and with only the best results. Ask your neighbor.

Send for our Raw Fur and Hide Report
We pay the highest prices

BRANDON TANNERY

BRANDON

Successors to Carruthers & Co.

MAN.

Waterloo Lion Brand

of Farm Machinery has never yet been surpassed by anything in Agricultural Engineering for Quality, Durability, Efficiency and Value. Plowing and Threshing Engines ranging from 14 to 30 H. P. are unsurpassed by anything of their size. Wind Stackers, Feeders, Baggers and Drive belts a specialty.

Waterloo Separators, 28-42 to 36-56

Are the Greatest Grain Savers in the Market

THE "CHAMPION" Made in three sizes, 28-42, 33-52, 36-56 Write for CATALOGUE OF COMPLETE LINE

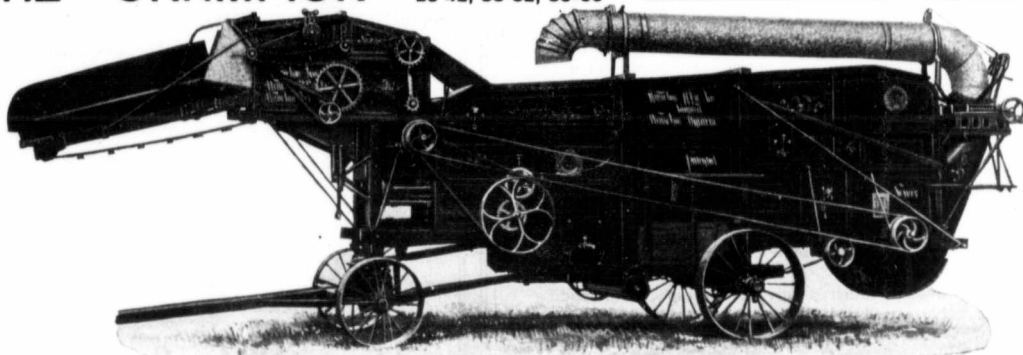

The WATERLOO MANUFACTURING CO. Ltd., PORTAGE LA PRAIRIE

You saw this advertisement in this magazine. Don't forget to say so when writing.

make the richest nation on earth reel and stagger.

Andrew Carnegie asks: "Why should all the nations arm when peace is in the interests of all?" He adds: "The nations of the world spend half of all their revenues in preparations for war and nobody wants to fight!"

Years pass without war and yet men suffer from fear of war. Germany's fear of France, England's fear of Germany, Japan's fear of Russia, the United States' fear of Japan, the world's fear of itself. The great international disease is FEAR.

The relationship between Germany and England has been "strained" for ten years. Ever since the Boer War these two nations have had uncertain sensations when thinking the one of the other.

England and Germany are great nations. They lead Europe in Religion, Science and Liberty. Both are protestant, both progressive, both aggressive, both ambitious, and both are feared and watched.

Imagine, if you can, one year of war between Great Britain and Germany. Let these two begin to fight and we stand at Armageddon.

Germany, the land of Goethe, Luther and Bismark. Germany the land of the Reformation. Ger-

many the land of universities. Germany the Fatherland. Germany leads the world in intellectual keenness, commercial enterprise and social legislation. Germany has become, during the last forty years, one of the greatest nations in the world. Her population of sixty-six millions is increasing at the rate of a million a year.

Few countries are more densely populated than Germany. There are 291 persons to every square mile. If Germany cannot find room for her growing population she must lose through immigration. There are in the United States, alone, five million German-born and German-speaking citizens.

Germany presents two facts—military consciousness and industrial progress. Germany has become "a nation of shopkeepers," to use a phrase which Napoleon applied to England. In 1880 Great Britain produced twice as much steel as Germany. In 1896 Germany produced twice as much steel as Great Britain. Germany has a genius for commerce and industry.

But fix in your mind one fact, namely, Great Britain by shrewd diplomacy has welded a ring of iron around the German Empire and Germany wants to get out of that ring. Germany, occupying a

A Prize Food for Prize Stock

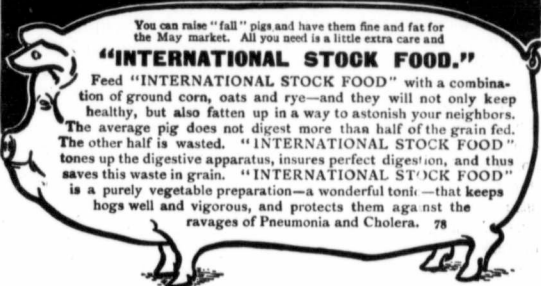

Make a nice profit on your "fall" pigs by feeding "INTERNATIONAL STOCK FOOD." Get a pail to-day from your dealer.

INTERNATIONAL STOCK FOOD CO., LIMITED TORONTO

You saw this advertisement in this magazine. Don't forget to say so when writing.

SPECIAL OFFER

We Have a Few Big Snaps in - Flour City Tractors



for early Spring delivery. Get next to our Bargain List AT ONCE. Write TODAY for our special proposition.

Ontario Wind Engine and Pump Company Limited
TORONTO CALGARY MONTREAL WINNIPEG

You saw this advertisement in this magazine. Don't forget to say so when writing.

Remember to renew your Subscription

position in Central Europe, is a prisoner; and she imagines that England is the sheriff, warden and jailor. Hedged in by land and sea (take a look at the map) Germany finds herself checkmated and hindered on every side.

Germany must sit by while England possesses Africa, while Russia descends on Persia and Mongolia, while Italy helps herself to a piece of Tripoli, while France annexes a choice bit of Morocco, and while the United States wields a directing hand in the destinies of Cuba and the Phillipine Islands.

The average German believes that Great Britain has, during the past ten years, made all possible use of her skilled diplomacy to deny to Germany and Austria any opportunity for colonial development and imperial expansion. The commercial competitors and political opponents of Germany, are allied with Great Britain. Great Britain is in alliance with France, Russia and Japan, and is contemplating a closer relationship with the United States.

England is not loved by other nations. She is rather feared and her motives questioned with suspicion. The late William T. Stead was bold enough to say: "Great Britain has a reputation for never doing anything except for selfish purpose." The nations of Europe are as suspicious of England as England is suspicious of Germany, and Germany finds herself ever and always under the shadow of the British Empire.

Great Britain is in possession of "the gates of her enemies": Malta is British, the Seuz Canal is British; the great trading centres like Shanghai and Canton are under British influence. All the coaling stations are British. India belongs to Great Britain, France is her neighbor, Japan her friend, Russia her ally and the United States her daughter by blood and inheritance.

But, mark you, Germany is not to be ignored, neglected or overlooked. Since the days of Bismarck the war god has been enthroned in Germany. The aristocracy of Germany is a military aristocracy. The war with France in 1870 made Germany a warlike people. The German Emperor is the advocate of the "mailed fist," albeit he has stood for peace for four decades. The German hero is a soldier. Germany is a "nation in arms." Germany has a standing army of 600,000 men and an available army of six million men.

The German navy is now stronger than any other two navies in the world, not including that of Great Britain. The Emperor of Germany could call into the field in three weeks, an army of two million men. History has

never witnessed such a concentration of military strength or such an exhibition of warlike discipline. The German navy in the North Sea has simply to indulge in a few hours steaming in order to enter the Thames River. Perhaps that is the reason why the British "tugs of war" are to be found, of late, in the North Sea rather than in the English Channel, as in the days of yore. Is Germany getting ready to fight?

England has two great fears—the cutting off of her food supply and the invasion of a foreign foe. England's food supply would be exhausted in seven weeks.

Is Germany preparing for war?—I answer—Germany can never have and hold her place in a world programme without a great navy. Germany has as much right to build a fleet as France has a right to erect a line of fortifications between herself and her traditional enemy. If I were a German who believed in an International programme for Germany, I would stand for an efficient army and a respect-commanding navy.

Well then, is Great Britain justified in increasing her naval strength so that she may hold her marginal superiority of sixty per cent and retain her sovereign position as mistress of the seas? Before I answer that question let me indulge in a few remarks of a general character.

First: There is great need for the development of a spirit of international generosity and a national disposition to let every country, young and old, have fair play, and the same universal chance of success.

Second: The greatest game in the world is the game of international diplomacy. We need a new type of diplomacy. A diplomacy which is through whispering in a corner. A diplomacy which takes the people into its confidence. England has passed through many a crisis and never knew it until long after the crisis had passed. Twenty men control and direct the world's bank account, and forty other men are personally responsible for the diplomacy of the world.

The next great question for democracy to settle, is, "Who shall govern?" The "boss" or the ballot box? The political machine or the people who created it? The man of wealth or the commonwealth? The ecclesiastical politician or the true hearted citizen? The international schemer, who shakes the dice box of diplomacy, or the statesman, clear visioned and spirit crowned who stands for the people and speaks for God?

Third: War is a commercialized evil. The people who are always the most anxious for war are the



BIRKS'

Bracelet Watches

This is the very latest, most convenient and most fashionable mode of "wearing the time." **Everybody's doing it**, and we have specially provided ourselves with an immense stock for Christmas, which includes every possible and approved design introduced into this really sensible idea.

Inexpensive, reliable Time-keepers with the Birks' Guarantee in Every Case

LADY'S Sizes in Silver Case with fine Leather Strap, from.....	\$5.00 up
With Silver Expansion Bracelet.....	\$25.00
Solid Gold Case With Strap, from.....	\$35.00 up
With Solid Gold Expansion Bracelet, from.....	\$50.00 up
GENTLEMAN'S Size in Silver Case with fine Leather Strap.....	\$12.00 and \$16.00
In Solid Gold Case.....	\$35.00 and \$40.00

NOTE—Our splendid new catalogue contains accurate reproductions of all of our representative Watches and the various items of our magnificent stock of Jewellery, etc.
FREE COPY TO ANY ADDRESS

Henry Birks & Sons

JEWELLERS and SILVERSMITHS LIMITED

Winnipeg

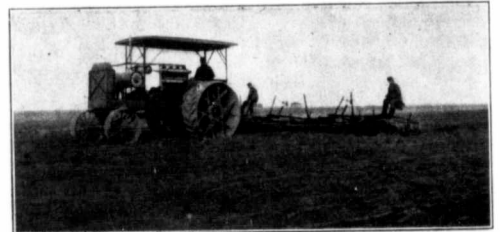

Definition of a Sawyer-Massey Tractor

A gasoline tractor for money-making farming. A tractor that has the pull of twenty-two horses, the durability of steel, the continuous power of a waterfall, and the smooth running qualities of an automobile; together with the flexibility of power, and ease of control and operation of a well-broken team.

SEND FOR FREE CATALOGUE

Sawyer-Massey Co. Limited

Manufacturers of Canadian Power Farming Machinery
Western Branches: Regina, Sask., Winnipeg, Man.
Factories: Hamilton, Ont.

people who profit the most by it. The most dangerous evil in a Christian civilization is a commercialized evil. Because it is profitable, it persists. The commercialized evils are, the liquor traffic, the social evil, the low-class theatrical, the gambling dive and war. They all persist because they are profitable. Were Judas alive today he would be a saint compared with the man who would send a bullet crashing through the sacred flesh of a youth for whose existence a mother has passed through the crucifying agony of child birth, in order that he might be able to declare a larger dividend on the stock of some bomb producing concern. Let us speak plainly. The hour demands it.

Fourth: The peace of the world is pivoted on the character and quality of the daily newspapers of the world. The "yellow" press produces a jaundiced eye in the face of human thought. There are certain newspapers the world over, which are engaged in the business of creating fear and fear is the enemy of peace and the mother of war. The war between Spain and the United States, over Cuba, was precipitated very largely by the "yellow" press. How well we remember the hour when "Remember The Maine" was printed on the title page of every American newspaper in characters as lurid as hell and as black as midnight. Does anybody know today, to a point of absolute certainty, whether the "Maine" was blown up or blown out?

Fifth: Before the nations disarm there must be brought into existence an Imperial Parliament of the Nations and in association therewith an Imperial Court of Final Appeal—the supreme court of the world. First a parliament for the world. Second a judgment seat for the nations—"and before Him shall be gathered all nations." The prophesy is a prediction and a guarantee of an imperative need. Who shall write an anthem for the world? Who shall weave a flag for the race? Who shall create a parliament for the nations? Who shall institute a court of appeal for all humanity?

Great Britain, the United States, Japan, France, and Germany could create, organize and control a world parliament. The combined naval and military strength of these nations could police the world and silence every barbarous gun and spike every unholy bayonet.

Sixth: The rise and progress of modern socialism indicates that humanity is beginning to indulge in thoughts which are planetary in their proportions and to speak in terms which are universal in their application. The Socialistic tide is increasing the world over.

THE CANADIAN LIGHTNING ARRESTOR AND ELECTRIC COMPANY

LIGHTNING!

has destroyed millions of dollars worth of property in Western Canada this year—and it has not been a bad year of Electrical Storms.

At a very trifling cost we will absolutely protect you. No building that has been made lightning-proof by our 99% pure copper cable has ever been damaged by electricity. We will positively refund amount of all damage caused by lightning to any building and its contents which has been installed with our system. We have been ten years in business and we have yet to meet our first claim because **it is impossible for lightning to injure a building equipped with the Townsley System.** You are not safe one day the year through while your buildings are unprotected.

*Write us at once for full particulars.
Agents wanted in Western Canada.*

Canadian Lightning Arrester & Electric Company Limited
(O. W. Townsley, Manager)

**OFFICES & FACTORY
199 MAIN ST.,
WINNIPEG · MANITOBA
CANADA**

**GUAR-
ANTEED**

**PRO-
TECTION**

99%

PURE

COPPER.

You saw this advertisement in this magazine. Don't forget to say so when writing.

Both Out-Throw and In-Throw

This illustrates the correct Harrow for Spring's work. It is a double action Disk, both Out and In-Throw, working the ground twice with the one operation. The Bissell In-Throw Harrow in the rear worked at a sharp angle leaves the surface of the ground pulverized like a "mulch" so it will hold the moisture. The central position of the seat is convenient from which to adjust both Harrows. 6 horses will handle this double action nicely. There is no neck weight and it works complete without a Fore Truck or other make-shift. For Engine Power connect up 4, 6 or 8 of these Harrows in a group.

For further particulars write Dept. L.

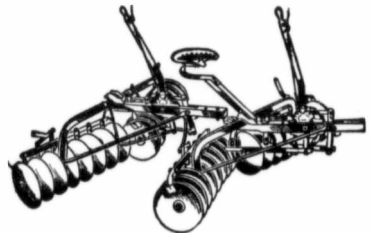

The "Bissell" Double Action Disk

Manufactured Exclusively by T. E. BISSELL CO. LTD., Elora, Ont. Write to any of the John Deere Plow Co's Branch Houses

You saw this advertisement in this magazine. Don't forget to say so when writing.

Berlin has gone "red." The very district in which the Emperor of Germany and the Crown Prince reside has sent a Socialist to represent them in the Reichstag and even in certain Roman Catholic districts in Germany there are Socialistic gains. Socialism is democracy in its spiritual essence brotherhood in its practical application and Christianity in operation at the cross-roads of the world.

Socialism, in some form, must win in the end. National emblems must some day be used for higher purposes than simply to hide blood stains on legislative walls.

The flag of Calvary is dearer to me than any earthly standard which floats over a mere section of humanity. My parents were born in Great Britain—I first saw the light in yonder Republic. I am now an adopted child of the Dominion of Canada. I would surrender my interest in the greatest flag which enriches the atmosphere of the world for an ensign which represented the best thought of God for the progress of the whole race. If this be treason make the most of it.

Should Great Britain disarm or increase her naval strength? This is the question uppermost in your

minds this morning and in my concluding remarks I will address myself to that question.

The naval supremacy of Great Britain is so vital that it does not admit of discussion. I will give you seven vital reasons for a statement so positive and dogmatic.

(1) England is a small island on the border of a great sea—alone, isolated, lonely and separated. The capital of a race. The home of an empire. The centre of a commercial system. The birth place of parliamentary institutions. The focal spot for humanitarian interests which encircle the world in their sym-

pathetic embrace. Oh, lonely sea-girt isle! Wrapt in the mists and memories of a thousand years! Cradle spot of a giant civilization! Thou art dear to us! Thou art dear to us all. May destiny guard thee! England encircled by the silver glory of the restless sea! May heaven protect thee!

(2) Great Britain has many colonies, great and small, scattered over the face of the whole earth. Her flag floats over islands and continents and protects a family of nations and a sisterhood of separated states whose extent and prodigious proportions have scarce been equalled in the history of man. To all these there has been granted, by the kind hand of destiny, a common origin, a consanguinity of birth, a diadem of Christian institutions, blood bought and precious, the rare heritage of a universal form of speech and a galaxy of enthroned ideals acknowledged by the sons of men as the best prophesy of an emancipated race. Shall this empire be broken on the wheel of time? Shall these legislative units be torn from the constellation of history? Shall Greater Britain cease to be? Shall the flag which has survived a thousand battlefields be robbed of its starry splendors and float over the dismembered fragments of the greatest empire known to history? Does any other imperial ensign mean more of freedom for a struggling humanity or liberty for an aspiring world? Oh flag! May the breezes of heaven bless thee and night's silent glory and the day's fiery splendor be thine.

(3) Great Britain is very close to Europe and threatened by every combination of European states. She holds her own in the presence of interests which are varied, contrary and ever presenting new aggregations of strength. Near by the Homeland lies spread the map of past history. Here sits envy enthroned. Here prejudice watches with a jealous eye. Here memory slumbering, sleeps not. Here national antipathy breathes a hatred unknown beneath the skies of a new world. Here bigotry marches with intolerance and inspired by a strange oriental suspicion awaits the hour of darkness to strike a fell blow. Shall England disarm in the presence of warring camps or become less vigilant in the hour when the noise of armed hosts can be discerned like the ominous sound of distant thunder? Great Britain must be strong upon the seas and swathed in might wherever her standards are planted.

(4) England, during the ages, has fought with almost every nation on the continent of Europe. The Anglo-Saxon is the most aggressive child of time. Quick

to move, hard to remove, urgent in business, fervent in spirit, deep in invention, resourceful in difficulty, keen in making a bargain and not easily discouraged. The Britisher has crowded in where others have been crowded out. Edged in where others have been forced over the edge. He has held on when others were compelled to let go, and profited by every mistake which he has ever been foolish enough to make. He has learned all that his enemies had to teach him and has matched him one better. Such a competitor is never popular. England is not beloved by the nations.

(5) Germany has a navy almost equal to that of Great Britain if United with any other power. Herein lies the menace of the German policy. Great Britain having a world empire must keep her hand on the affairs of the world. Her position is an inheritance. It was bestowed upon her by the discerning hand of destiny. She finds herself, unwittingly, in possession of marvelous stretches of virgin soil sufficient to sustain a population of a thousand million people. These shall yet be given to her. Great Britain is a world empire with a world policy and a world programme. And she must sustain herself in the position in which she finds herself. Any other policy would mean imperial suicide.

(6) **Great Britain must have a navy and the best navy which the world can produce, because she guards and protects the strongholds of the greatest civilization of history.** Great Britain has a world programme in operation. Great Britain stands for free trade, an open door, and free intercourse among the nations of the earth. Every other nation is national in its policy and seeks to build some kind of a high wall to shut something in or to shut somebody out.

The British Empire is not perfect, but the British Empire stands for righteous government, for personal liberty, for intellectual progress, and for religious toleration for one-fourth of the human race. Bismarck was right when he said: "If England were to lose Shakespeare and Milton and all her literary heroes, that which she has accomplished for India would be sufficient to establish, for ever, her merit to fame in the world of culture."

Great Britain must be strong upon the seas. Let the "Five Nations" of which Kipling sings be prepared by silent guns and peaceful battalions to compel the nations of the earth to bow at the altar of Reason, Law and Order. To do this Britain must be strong. The greatest empire of history exists not for itself. The downfall of the British Empire would

involve immense disasters to mankind. We close with the words of one of our great poets:

"For dearly must we prize thee
We who find in thee a bulwark
for the cause of men."

Spelling Is Doubtful but No Uncertainty about the Sense

Our friends the Stewart Sheaf Loader Co. send us a letter from one of their correspondents which we reproduce exactly as it is written. Some hypercritical educationalists might take exception to the spelling, but what after all is there in orthography if the meaning is without the shadow of a doubt? Even the "experts" differ as to the correct spelling of a thousand and one words in daily use but it requires no weight of authority or expert opinion to satisfy any one that a man means FULL even if he spells it with two Os and one L.

"The Stewart Sheaf Loader Co
Winnipeg Man

Dear Sirs

I have used your Loader for the past two years which has worked satisfactory and it is a great saving of Men Grain Horses Time and Board and it keeps the mecheen fool all the time and Picks up all loos straw which pitchers would not do and for Loading Flax it can't be bet and I don't think I could do with out it now as we have So Little of a crue around us This remains Yours B.B."

Foolish Father

A doctor who cured by suggestion met the son of one of his friends.

"How is your father?"

"He is pretty ill, doctor."

"Absurb! Tell him for me he is an imaginary invalid. There is nothing the matter with him. He simply imagines he is ill."

A few days later doctor and son met again.

"And your father?"

"Doctor, he now imagines he is dead."

Cause of Death: Unknown

First Bystander—What an impressive funeral! Even the family doctor is in the procession.

Second Bystander—Yes, that's the first time I ever saw the cause following the effect.

Whose Witness?

When Rufus Choate was United States District-Attorney, three sailors were before his court

for the robbery from their ship of a bag of specie, and one of them turned State's evidence as follows:

"Well, sir, arter feelin' round a bit, they ses to me, ses they: 'Come on Jack, an' jine us. It's dead easy, an' it'll make us all rich; so as if we get ketched we can hire Choate, an' he'll clear us if they find the money in our boots.'"

One could never forget the semi-comic expression on that naturally grave face, as Choate, amid suppressed laughter, in which both court and jury had to join, busied himself with the papers upon his table, and, turning to the defending council, with as much dignity as the situation permitted, said: "He's your witness."

Our Friend—The Dog

First Sportsman—I tell you that's the greatest retriever in the world. I shot the tail off a rabbit once, and he retrieved the tail in perfect form.

Second Sportsman — That's mere child's play. If I stop hunting, to flirt with a pretty peasant girl, my dog retrieves the compliments I have paid her and takes them to my wife.—Le Rire.

In the Wash-House

An English lawyer was cross-examining the plaintiff in a breach of promise case.

"Was the defendant's air, when he promised to marry you, perfectly serious, or one of jocularity?" he inquired.

"If you please, sir," was the reply, "it was all ruffled with 'im a-runnin' 'is 'ands through it."

"You misapprehend my meaning," said the lawyer. "Was the promise made in utter sincerity?"

"No sir, an' no place like it. It was made in the wash-'ouse an' me a-wringin' the clothes," replied the plaintiff.

Calamity is the occasion of virtue, and a spur to a great mind. The apprehension of a wound startles a man when he first bears arms; but an old soldier bleeds boldly, because he knows that a man may lose blood and yet live. Seneca.

WILD OATS

Stop sowing wild oats. While you continue to sow them you cannot expect to get rid of them. We can supply you with a machine which will take out every kernel of wild oats from your wheat. We handle the best line of hand and power cleaning machinery in Western Canada. Write us for a catalogue and prices and state what class of mill you require.

The Mooney Seed Co, Limited
Saskatoon, Sask.

LET US SHOW YOU HOW EASILY YOU AND YOUR NEIGHBORS CAN HAVE A TELEPHONE SYSTEM OF YOUR OWN

YOU—you and your neighbors—would have a telephone system for your own community, if you only realized how easily you yourselves could construct it and get it going. If you knew, in detail, how you and the people around you could form, own and control a local, self-maintaining company, for your own use and convenience, you would have such a system. There would be a telephone system in your community to-day if you knew how easily you and your neighbors could build every foot of the line and install every instrument yourselves—and especially if you realized that you do not need very much capital to do it either. Now, there is no reason why you should not know all these facts; for we stand ready to give you, for the mere asking, every bit of this information, provided only that you are sufficiently interested in the subject to write and ask us for it.



The Northern Electric is the instrument on the wall of nine out of every ten telephone users in Canada.

We Will Explain All About Rural Company Organization

YOU do not need experience to organize a telephone company in your own community, when you have our book. It tells you exactly what you have to do and how to do it. All you need to do is to follow the instructions that the book gives and then get out and interest your neighbors. Whether you want to organize a mutual or a stock company, the book will tell you how.

You And Just Your Own Friends Can Build Every Foot Of Line

BUILDING your own line keeps down construction costs. With the help we give you, you do not need to employ expert linemen. The book explains the last word in line construction and contains, in this one chapter alone, thirty-seven diagrams and illustrations, showing how to make every kind of connection necessary, how to route the line, how to put the fittings on the poles, how to guy the poles, how to place the insulators and string the wires—in fact, how to handle every detail as well as an expert lineman can. On request, we will also tell you of your provincial regulations, what your government requires and what it will do to help you.

The Cost To Operate Your Own Line is Low

YOU can readily understand that when you and your friends have the entire management in your own hands, you can regulate the cost of running the line. In the book we explain just exactly what is necessary and you can take your pencil and figure out how little it will cost you to have a telephone on the wall in your own house.

Let Us Explain To You How To Interest Your Neighbors

THE first step in getting started, is to enthuse your neighbors and get them all in with you. When you have read "How to Build Rural Telephone Lines," you will have a mass of information at your finger ends that will enable you to place positive, definite facts before your friends, to enthuse them with the idea of a self-maintaining, community-owned system and to make everybody around you anxious to help. All it needs to get a telephone system started, is for some one progressive man to start the ball rolling. With the information that we will place at your command, you can get everything organized in short order.

There Will Be A Telephone System In Your Locality — Get Posted

SOONER or later someone is going to start a telephone system in your community, just as systems are being started every day in farming centres throughout the Dominion. When this subject comes up, you will want the full particulars before you. Now is the time for you to post yourself. The book tells you everything and, if you are interested, we will be glad to send it to you free. Do you care to sign the coupon and send it to us now?

We Send This Book **FREE** But Only On Request

HOW to Build Rural Telephone Lines," is an illustrated, cloth bound book of one hundred pages, full of a carefully indexed mass of information on rural telephones. This book tells everything; with it before you, you can organize your own company and construct your own line. It tells you absolutely everything you need to know, step by step, as you go along. There is no other book in existence that deals so thoroughly with every vital, essential fact. Remember, this book has cost a lot of money and careful study to prepare. We really ought to charge for it. However, we send it free on request—but ONLY on request. To get it you have to send us the coupon and thus signify that you are really interested. The book is too valuable to distribute haphazard.

Send Us The Coupon Now



The Northern Electric and Manufacturing Company Limited

Gentlemen: Please send me FREE, one copy of your 100 page, bound and illustrated book on "How to Build Rural Telephone Lines." 236

Name.....
 Post Office.....
 Province.....



Montreal

THE Northern Electric AND MANUFACTURING CO. LIMITED.

Manufacturer and supplier of all apparatus and equipment used in the construction, operation and maintenance of Telephone, Fire Alarm and Electric Railway Plants. Address our nearest house
 236 Toronto Winnipeg Regina Calgary Vancouver



With the big wheat growing countries of the Northern Hemisphere marketing their wheat with such feverish haste, there could be but one logical result and new low levels for some years past have been reached. The November movement from Canada, the United States and Russia was everywhere a record one. Fine open weather permitted the threshing of most of our huge crop, and enabled the railways to make phenomenal records. Likewise it helped the Winter wheat crop, so that the American Government Crop Estimate of the Winter crop as at December 1st gives a crop condition of 93.2 against a ten year average of 89.8. To all the foregoing "bearish" conditions must be added the fact that the Argentine crop has promised unusually well. Thus the European buyers have drawn from many sources and have been beset with offers, rather than having to come keenly after our wheat as in the past three years.

But the time of the year when crop prices are usually lowest is at hand. The United States had up to December 1st exported about 60,000,000 bushels, which is about four-fifths of the excess their farmers had shipped to that date over last year's marketings up to that time.

Canadian inspections to December 1st are very large, namely:

Wheat60,943,900 bushels
Oats17,615,500 bushels
Barley 5,640,000 bushels
Flax 5,110,000 bushels

The extension of the season of navigation has meant much to

Western Canada. Good premiums for higher grades have been maintained to date, and boats will likely load to clear down to the 12th inst.

Farmers who possibly can, should withhold marketing for a time, as the time seems at hand for the long pull for higher prices. Damage to the Winter wheat crop in the United States of America or to the Argentine crop is almost a certainty. Tough or off grade grain however, should be shipped and sold in the next two months.

It might be noted that the Lake and Ocean Shipping Companies, profiting by the big demand for space, are easily obtaining carrying charges double those of other years: thus the cost of our grain to the European consumer is little less than it was a year ago, while our producers have to take 12 to 15 cents less. All a very good argument for nationalizing Common Carriers.

OATS

With the increase in the United States of 1,000,000,000 bushels of oats, barley and corn, over the crop of 1911, can we wonder at such low prices across the line, resulting in our oats having to find a market only in Eastern Canada? It seems advisable to market only the off grades at these prices till the market digests its tremendous load.

BARLEY

So far, this has been the most profitable crop of the year, and our barley though weather-stained is of a good weight and type. It

FARMERS! SHIP YOUR GRAIN TO THE CANADIAN ELEVATOR CO. LTD. GRAIN COMMISSION MERCHANTS, WINNIPEG

It is as much our business to give satisfaction as to secure grain shipments. We watch the grading of each car and allow liberal advances on all bills of lading.

SHIP YOUR GRAIN TO US!

Take advantage of our experience. We never sacrifice grain that farmers ship us. We know HOW and WHEN to sell on bulges, and we avoid selling on declines. Our business has been built up on our motto:

"GOOD RETURNS TO FARMERS"

We have been established for twenty-eight years—don't you believe our experience could be made valuable to YOU?

Established since 1884 **McBEAN BROS.**
Grain Exchange, Winnipeg, Man.

Reference: Bank of Hamilton, Winnipeg, Man.

Consign your Grain to a firm that will look after your interests: call for re-inspection when necessary — obtain highest market prices, and make prompt returns:

Central Grain Company Limited
COMMISSION MERCHANTS
707 Grain Exchange Winnipeg, Man.
Car Tracing and Claim Department in connection. Send us samples of your Grain, we will look after the grading and advise you promptly. The permanent success of our business depends on our customers' continued satisfaction.
Paid-up Capital: \$150,000
References: Any Bank or Commercial Agency



You'll Feel as Happy as This Man Does—

If you ship your grain to US!

HERE'S WHAT HE SAYS:
"Dear Sirs,
I recommended you to and told what you had done for me in regard to my car of wheat. He is shipping you a car today. I have spoken to several more about here, and they are going to ship to you as well.
Yours truly....."

WE RECEIVED THE ABOVE CAR THE NEXT DAY. LATER, THE SAME SHIPPER WRITES:

"Dear Sirs,
Another car of wheat en route for you to-night through my influence.
Yours truly....."

Thirty Years Experience

Selling Grain means **TOP PRICE** to YOU!
We advance liberally and remit immediately
Grain is sold.

GIBBS' COMMISSION CO.

(Successors to GIBBS & ROBINSON)
GRAIN COMMISSION MERCHANTS
LICENSED WINNIPEG BONDED
Members Winnipeg Grain and Produce Exchange, New York Produce Exchange, Montreal Board of Trade, Calgary Grain Exchange.

Farmers!
Ship Your Grain Direct
We are prepared to handle all kinds of grain in carloads direct from farmer to Eastern markets. Farmers may draw on us for high percentage of value, bill of lading attached. No delay in final returns. Reference: Sterling Bank of Canada. Full particulars furnished promptly.
Canada Grain Co. Ltd., Toronto

Donald Morrison & Co.
ESTABLISHED 1904
GRAIN COMMISSION
711 T Grain Exchange WINNIPEG
WE handle Wheat, Oats, Flax and Barley on commission, obtaining best possible grades and prices. Our work is prompt, accurate and reliable. Let us handle YOUR shipments this season. Daily or weekly market letter on application.
REFERENCES: Bank of Toronto, Northern Crown Bank and Commercial Agencies.

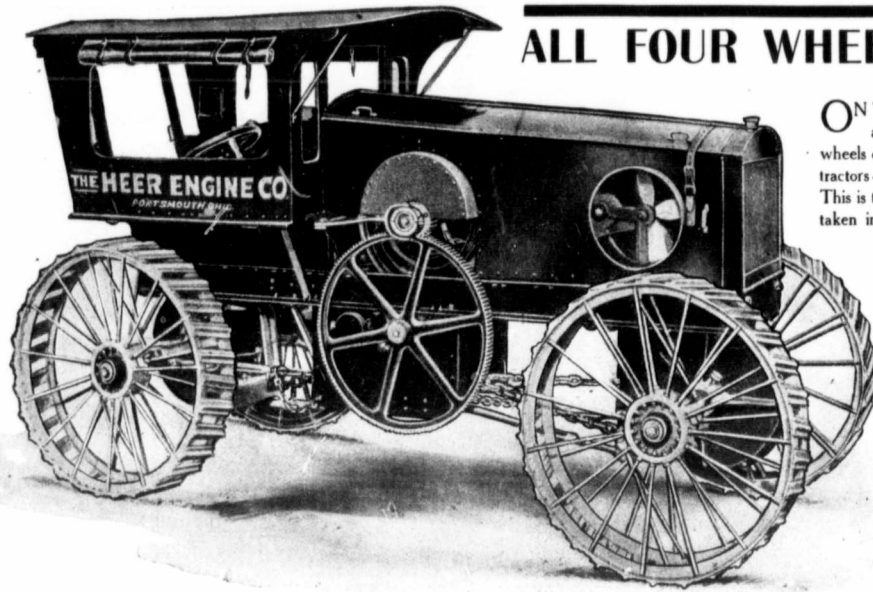

ALL FOUR WHEELS PULL

ON THE HEER TRACTOR all four wheels pull—not two wheels or three wheels as on ordinary tractors—but **All Four Wheels**. This is the farthest step that has been taken in tractor improvement.

If you have plowing, disking, seeding, heavy hauling, road work or threshing to do it will pay you to get acquainted with this most improved type of tractor.

The Heer Four-Wheel Drive

Special Advantages of this Tractor:

NEVER STICK IN A MUD HOLE—Even if three wheels of this tractor are in the mire, the fourth wheel will pull the tractor out. The ordinary type of tractor would be helpless in such a position and would only get itself into more trouble with every effort to get out. The Heer is the **ONLY** tractor that can be successfully used during wet weather.

LESS WEIGHT—The Heer is only about one-half as heavy as the ordinary tractor. This, and the fact that the wheels are of open construction, prevents the tractor from packing the soil and enables it to go over soft ground where an ordinary tractor would mire.

MORE POWER AT THE DRAW-BAR—This tractor delivers 80% of its engine power at the draw-bar—other tractors rarely deliver more than 50%. A 25-H.P. Heer Engine on the Four-Wheel Drive will pull **MORE** than the

ordinary drive tractors can, using a 40-H.P. engine. That is one of the reasons why the expense for fuel is so low.

STEEL CUT GEARS—There are no cast iron gears on this tractor, every gear is steel cut.

LESS REPAIRS—The use of the Four Wheel Drive relieves the tractor of the twists and strains that cause breakage and high repair bills. Engine and frame are set on heavy springs, which absorb the shocks and jars that cause engine troubles and make adjustments necessary on other Tractors.

Before buying a tractor, send for our Catalogue and full information about the Heer. You will be glad that you did when you see the tractor.

Made in three sizes, 20, 30 and 40 Brake Horse Power, or 16, 20 and 32 Tractive Power.

CANADIAN HEER ENGINE CO., LTD.

R. McLENNAN, Manager

808 McArthur Bldg., WINNIPEG

You saw this advertisement in this magazine. Don't forget to say so when writing.

will hardly hold steady or do slightly better. High grade barley will find a good seed demand next month.

FLAX

With so much flax yet to thresh in the country North and West of the Missouri River, meaning likely delay till spring in marketing, receipts of flax across the Line have been phenomenal, but must surely let up soon. A considerable percentage of our own flax will remain in shock till spring. The Oil Companies in the East, alert to the congestion, are simply buying our flax at their own prices. Farmers wherever possible should hold back flax until late summer if necessary.

With prices of oil still held firm, this flax is much too low.

Looking at the whole situation, all grains are so low that the consumptive demand is very broad, and if our farmers who can well afford to do so, will refrain from marketing for a few months what they can well carry over, the market will gradually attain once more to reasonable values.



Frank H. Hitchcock, the post-master-general, tells this story concerning one of the rural coqs in the post-office machine:

"That the rural post-office is still the bureau of general information, in the South no less than in the North and the middle West, was recently evidenced by a conversation precipitated by an old dorky, who approached the post-master of an Alabama village and said:

"Any letters fo' me?" 'No.'

"Any postal cards?" 'No.'

"Is my paper come?" 'No.'

"Got any almanacs?" 'No.'

"Say, does you know anybody that wants to buy a live alligator?"

Grain Markets Are Too Low

for you to produce grain with any profit. Assuredly you need the very best services you can employ in marketing your grain. You owe it to yourself to ship it and get the last possible eighth out of it. We firmly believe that grain loaded in the country this month will find a good upturn in the market on arrival at Terminals about the New Year and afterwards.

You cannot do better than get our bids on barley before shipping. We can pay you good premiums for special shipment.

Our long experience, efficient selling, and good service have built up already a big patronage. Send us a trial shipment and see for yourself. Wire or phone for net track bids.



Blackburn & Mills

(A. M. Blackburn)

(D. K. Mills)

531 Grain Exchange

Winnipeg, Man.

TELEPHONE MAIN 46

Licensed

Reference: The Royal Bank of Canada.

Bonded

ABSORBINE

will reduce inflamed, swollen Joints, Bruises, Soft Bunches, Cure Boils, Fistula or any unhealthy sore quickly; pleasant to use; does not blister under ointment or remove the hair, and you can work the horse. 42 per bottle at dealers or delivered. Horse Bunk 7 D free.

ABSORBINE, JR. for manking, \$1.00 per bottle. Reduces Varicose Veins, Varicocele, Hydrocele, Gout, Wens, Strains, Bruises, stops Pain and Inflammation.

W. F. YOUNG, P.D.F., 112 Mansmouth St., Springfield, Mass.
LYMAN, BONS & CO., Montreal, Canadian Agents.

It is spelled **A-B-S-O-R-B-I-N-E** and Manufactured only by **W. F. Young, P.D.F., 112 Lyman's Building, Montreal, P.Q.** It is furnished by Martin Bros. & Wynne Co., Winnipeg, National Drug and Chemical Co., Winnipeg and Calgary, Henderson Bros. Co., Ltd., Vancouver.

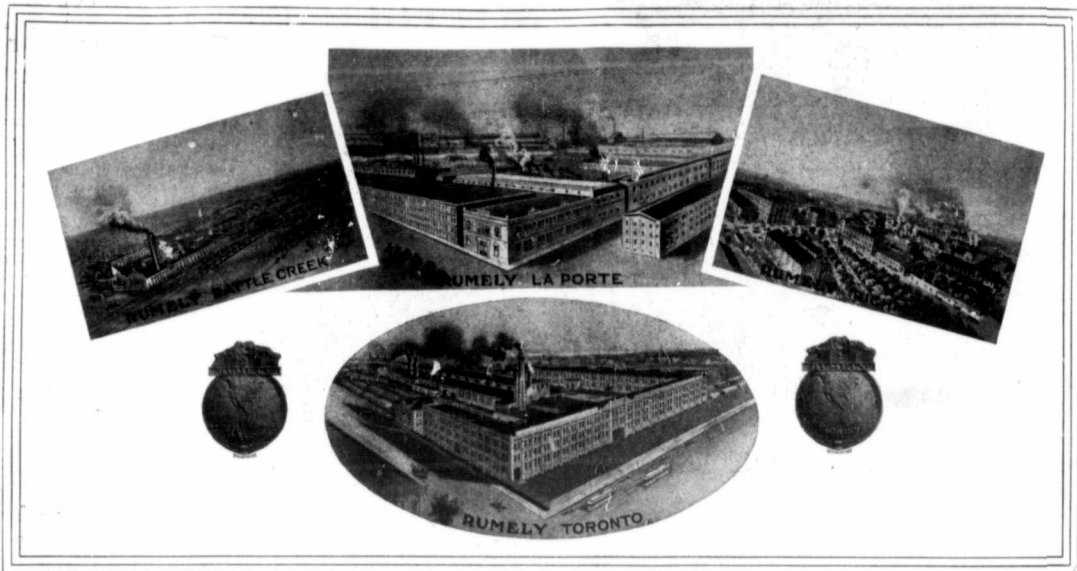

The Growth of an Honest Business

From a Blacksmith Shop in 1857 to Four Big Factories in Four Large Manufacturing Cities in 1912—M. Rumely Company takes its place among the Leaders in Power Farm Machinery Manufacture

MEINRAD Rumely never dreamed how vast his business would grow when, in his little blacksmith shop in 1857, he began to build his first grain separator. He would have opened his eyes wide, could he have seen the twenty-five acres in buildings now located in La Porte and the big yards covering many more acres which are needed for testing grounds and for storage purposes. The two-million dollar OilPull plant in itself would have caused him wonder. This wonder would have increased, could he have known that the small business he managed at the start would, in a little more than a half century, include four big factories in four large manufacturing cities.

M. Rumely Company, which now controls the Advance plant at Battle Creek, Michigan; the Gaar-Scott plant at Richmond, Indiana; the Northwest plant at Stillwater, Minnesota; and the Canadian Rumely Co., Ltd., at Toronto; comprises one of the liveliest groups of manufacturing farm implements known to the industrial world.

Meinrad Rumely, when he built, built his foundation upon a rock, and the first grain separator, clumsy and crude though it was, was built of as good material and in as honest a way as its maker knew how to construct it. This is the foundation upon which the Rumely reputation stands. The business grew because of its solid foundation. The name "Rumely" on a machine soon meant quality—and the fame of Rumely machines spread rapidly.

About six years ago, M. Rumely Company was capitalized at a half million dollars. At the beginning of 1912 this capital was increased to \$22,000,000 when the interests of the Gaar-Scott Company at Richmond, and the Advance Thresher Company at Battle Creek, were taken over.

There were good reasons for this action: The great demand for OilPull tractors brought with it an additional demand for grain separators and other power-driven farm implements. M. Rumely Company had not the room nor the men to build these machines; the city of La Porte with a population of about 12,000 people, was not big enough to care for the number of employees necessary to carry on the work, so the other companies were interviewed and they sold to M. Rumely Company their plants, machinery and assets. They were big companies turning out vast numbers of machines of world-wide reputation. For instance the Advance plant at Battle Creek turns out from 800 to 1,000 grain separators and from 600 to 800 steam engines per year. The Gaar-Scott plant

at Richmond, Indiana, turns out products totaling in daily sales value more than \$7,000.00.

The Rumely Companies now control the manufacture of what is perhaps the largest aggregation of threshing machines, clover hullers, tractors, stationary engines, gang plows, hay balers, corn shellers and other power-farming machinery in the country. The Rumely interests employ in their factories, offices and on the road, an army of considerably more than 5,000 people.

M. Rumely Company is strictly a manufacturing concern. There is a selling organization separate from it known as Rumely Products Company, Incorporated, which takes care of the selling end of the business. So great is the demand for Rumely machinery that in almost every state in the United States, and in almost every province in Canada, there are one or more branches of this company. During the past summer alone new branches have been established at Estevan, Saskatchewan; San Francisco, California; Harrisburg, Pennsylvania; Edmonton, Alberta; Yorkton, Saskatchewan; Brandon, Manitoba; Sioux Falls, S. D.; Minot, N. D.; Pocatello, Idaho; and Houston, Texas.

At the present time there are fifty more men working in the factory at Richmond than were ever employed by that factory at one time in its history. At Stillwater, the Northwest plant has about 500 employees on its pay roll—many more than were there a year ago.

There are 375 people in the Rumely offices at La Porte. Twenty years ago there were but six; six years ago there were but seventeen; a year ago 150 men and women were able to carry on the work. Today in one department, where a year ago seven people handled the business, there are now fifty-five employed. Outside, in the factories at La Porte there has also been considerable growth. In the OilPull plant, a year ago, there were 1148 people on the pay roll; in the steam plant, 476. Today in the OilPull plant there are 1223, 617 are working in the old plant, while 502 are employed in the foundry. Five years ago all outside work was done by about 225 people.

The Rumely organization continues to expand. New lines, new buildings and new employees are constantly being added. The demand for its products increases even faster. Back of it all the motto of Meinrad Rumely stands—quality, honesty and the desire to serve the public best. Coupled to this, is good will, energy, ambition and a kindly feeling in the hearts of all Rumely employees. That is why the business is growing fast, and will continue to grow as the years progress.

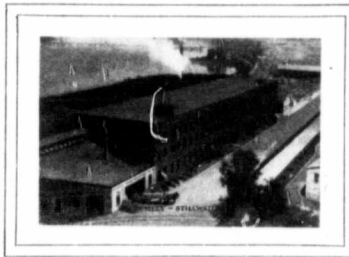

Your Choice of These Premiums Free!

With Either NEW or Renewal Subscriptions. Premiums That are Useful and Not Cheap Junk. Get In Your 1913 Renewal Now so as Not to Miss a Single Issue. Your Subscription Will Be Extended from Date of Expiration.

Mrs. Beeton's Cookery Book

Ladies!

To reach a man's heart through his stomach, you really should have one of Mrs. Beeton's Cookery Books illustrated here. The new edition contains over 400 pages with over 30 full page illustrations and is nicely bound in cloth.

No doubt most of our readers are familiar with this book. Sent, postpaid, with one-year subscription.

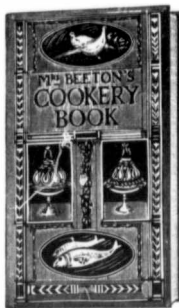

Handy Atlas of the World

Most complete and accurate popular Atlas of the World ever published. Contains beautifully clear and full maps of every part of the world—statistics of areas of different countries and states; languages, religious sects, river systems, timber supply, cities and towns of all countries with latest (1911) census of population, historical data and a mass of information such as is rarely found in the most extensive publications. Sent, postpaid, with one-year subscription.

This is really a marvel of an atlas, and alone worth ten times the price of a year's subscription.

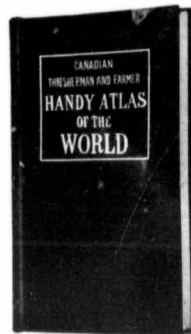

A Young Harness Shop "Awl-U-Want"

A convenient, handy Sewing Awl for mending harness, shoes and all leather work. Sent, postpaid, with one-year subscription.



Your Choice of Any of the Following Books FREE with Your Subscription, Either New or Renewal

All Bound in Cloth



All Bound in Cloth

Best Quality Zig-Zag Varnished Four-Foot Rule



Sent, postpaid, with one-year subscription.

Fine Quality Combination Pliers

Sent, postpaid, with one-year subscription.



This Pipe for a Good Smoke



Isn't it a Peach? Made from very fine clear briar and fitted with a black vulcanite mouthpiece. The bowl and mouthpiece are well proportioned and highly polished. The pipe smokes very easily and the bowl is of sufficient thickness to always keep cool. Sent, postpaid, with one-year subscription.

Irish Wit and Humor
Tricks with Coins
Ropp's Commercial Calculator
Harris' Complete Songster
Card Tricks and How To Do Them
Gleason's Horse Training Made Easy
Comic Recitations and Readings

Conundrums and Riddles
How to Tell Fortunes by Cards
A. B. C. Guide to Music
Dutch Dialect and German Monologues
How to Make \$500 Yearly Profit with 12 Hens
Hodgson's Modern House-building
Comic Recitations and Readings

Specially Fine Quality Steel Pocket Scissors



Sent, postpaid, with one-year subscription.

CLUBBING OFFERS

No Premium Allowed with Clubbing Offers. Both Papers Can Be Sent to One Address or Each to a Separate Address.

The Western Home Monthly—one year.....	\$1.00
The Canadian Thresherman & Farmer—one year.....	1.00
OUR PRICE—BOTH FOR	\$1.25
The Weekly Free Press—one year.....	\$1.00
The Canadian Thresherman & Farmer—one year.....	1.00
OUR PRICE—BOTH FOR	\$1.25
The Weekly Telegram—one year.....	\$1.00
The Canadian Thresherman & Farmer—one year.....	1.00
OUR PRICE—BOTH FOR	\$1.50
The Weekly Tribune—one year.....	\$1.00
The Canadian Thresherman & Farmer—one year.....	1.00
OUR PRICE—BOTH FOR	\$1.25
The Family Herald & Weekly Star—one year.....	\$1.00
The Canadian Thresherman & Farmer—one year.....	1.00
OUR PRICE—BOTH FOR	\$1.25

To those who have never seen our Premium Specialties, we wish to say that in every case they are of a particularly high character and quality, and in not a single case have we ever had a complaint, but are constantly receiving letters of appreciation.

E. H. Heath Co. Ltd., Winnipeg

Pin a dollar bill to this coupon, and if you are not more than satisfied back goes your dollar

E. H. Heath Co. Ltd.

Gentlemen:

Enclosed please find \$.....for which send me "The Canadian Thresherman & Farmer" for one year and.....
.....(Premium or paper wanted)

Name.....

Town.....Province.....

P. O. Box.....

Be sure to write Name and Address plainly.

An Advertisement by the Department of Natural Resources, Canadian Pacific Railway

IN DISPOSING of the large acreage of farm lands which it still holds, the Canadian Pacific Railway is legally hampered by no restrictions whatever. If it so desired the Company could sell this land to any one—to those whose former environment or standards of living would make them absolutely undesirable citizens of Western Canada; to those who could never be progressive citizens of the Empire. But the officials of the Canadian Pacific realize that they owe a duty to the people already resident in the Canadian West and to those who shall come after them. The management has decided that these lands must and shall be peopled with men, women and children who will develop them—not only this, but with people who possess morals and ideals of the same high level as those of the great Angle-Saxon race.

As far as is possible, the speculative element will be eliminated in the sale of this land. The Canadian Pacific desires to sell land to those who will reside upon and cultivate it. These instructions have been given to the immense sales force of the Company in Canada, Great Britain, the United States and Europe. **The Canadian Pacific Railway would rather withdraw from sale every acre of this land than to sell it to those who do not intend to make it produce and add to the prosperity of the Nation.** The Department of Natural Resources is not a land selling but a colonization organization in every sense of the word.

The above is a declaration of principles on the part of the Department of Natural Resources, Canadian Pacific Railway.

A few of the policies which the Company has in force to attract the best class of immigration to Canada, are outlined below:—

LONG TERMS FOR PAYMENT—All lands held by the Company are sold on ten-year terms of payment, interest at the low rate of six per cent. per annum. For actual settlers the second and all subsequent payments on the land are set forward one year. **Never yet has the Company foreclosed on a farmer making any sort of an effort to get on his feet.**

IMPROVED FARMS PROJECT—Realizing that the best class of agriculturist in Great Britain and Ireland is in no sense a pioneer, the Company improves farms in Western Canada, placing them in such condition that the new arrival can take up residence and immediately start farming. These are sold at the price of raw land plus actual cost of improvements; the whole is payable in ten years, interest at six per cent. per annum.

LOAN TO SETTLERS POLICY—This policy is designed especially for the benefit of the renting farmer in the United States. This class contains some of the best farmers on the continent, who on account of the high rents they are paying, would never be able to have a place of their own. All have some cash and the necessary farm implements and live stock. The Canadian Pacific Railway makes them the following proposition:—If you are a married man and a practical farmer, if you can get together sufficient cash to make a first payment on a piece of C.P.R. land and get your family, implements, household goods and live stock to that land, we will make a loan to the extent of \$2,000 for building you a house and barn, drilling a well, fencing the land and making other improvements, at six per cent. interest payable in ten years.

The Canadian Pacific Railway Company does not for a moment propose to let its help to the settler stop when that settler is placed on the land. Through many channels, but especially through the Agricultural and Animal Husbandry Branches, aid and advice is gratuitously extended Western Canadian farmers.

In its campaign for the advancement of agriculture the Company takes as a fundamental principle, that none save a diversified or so-called "mixed" system of farming will bring the Canadian Prairies to their highest and most economical production. Every effort is being made to turn the Western farmer from the one-crop "soil mining" system to methods involving the growing on every farm, of fodders, grains, vegetables, roots and live stock. A number of the policies in force in this campaign are outlined below; true, some of these are at present

confined to limited areas, but they are the forerunners of greater development plans that will eventually cover the entire West.

DEMONSTRATION FARMS—In addition to several supply farms which are also used for purposes of demonstration, The Canadian Pacific has this year established twenty-five new demonstration farms—five in Manitoba, ten in Saskatchewan and ten in Alberta—for the sole design of proving that there is a greater cash return from a farm operated under mixed farming methods than from one operated on the one-crop system. Absolutely correct accounts of all expenditures and receipts will be kept and will, when the farms have been in operation one year, be open for inspection. The managers of these farms are at all times willing and anxious to extend gratuitous information to all who desire it.

AGRICULTURAL COMPETITIONS—This year the Canadian Pacific has under way competitions with prize lists that total nearly five thousand dollars in cash. This money is furnished by the C.P.R. exclusively; the competitions cover a large field and are for tree planting, various agricultural contests and steer feeding. But this is just a start. Contemplated contests will cover the entire Canadian West.

MIXED FARMING DEMONSTRATION TRAINS—In the Prairie Provinces the Company, in conjunction with the provincial Departments of Agriculture, runs agricultural demonstration trains which stop at practically all stations, and instruction is given the farmers of the district in better methods of agriculture. The best agricultural experts obtainable are on the trains.

EGG CIRCLES—In the Irrigation Block, the Company has established egg circles, taking all eggs sent in by the farmers and paying cash for them. The price given is in excess of that offered by other purchasers.

PURCHASE OF CREAM—In order to encourage dairying and kindred operations, the Company, at several of its farms, has installed creameries. They take all milk sent in by farmers in the district, paying therefor the highest cash price and turning back the skim milk for feeding purposes.

DISTRIBUTION OF LIVE STOCK—This fall, as a start in wider operations of the same sort, cattle, hogs and sheep have been supplied, in certain districts to farmers having a quantity of feed but lacking money for the purchase of live stock. Many a farmer will thus be able to realize a fine profit on low grade grain that otherwise would have to be disposed of at a low price.

The Company supplies these animals at actual cost, making mutually satisfactory terms for payment. As an aid in this work, receiving stations are being constructed at various points.

BULLS FOR SERVICE—High grade bulls will be placed at various points, in charge of some progressive farmer. The only charge for service will be the negligible one of fifty cents which will go to the caretaker to remunerate him for his work.

CO-OPERATIVE CIRCLES—The Company will interest itself in the formation of circles among farmers for the co-operative breeding, care, feeding and marketing of live stock.

MARKET PRICES AND FREIGHT RATES—The Company contemplates the employment of an expert who will concern himself with live stock prices on the various markets, giving advice to farmers regarding shipments, etc.

ADVICE AND INSTRUCTION—A careful selected corps of inspectors is being gotten together whose duty it will be to visit farmers and advise them in their agricultural operations. These will be trained, practical men, specialists in their particular lines. In addition, articles and pamphlets of instruction will be issued, treating subjects of interest to every farmer of Western Canada.

DEPARTMENT OF NATURAL RESOURCES,
CANADIAN PACIFIC RAILWAY,
CALGARY, ALBERTA

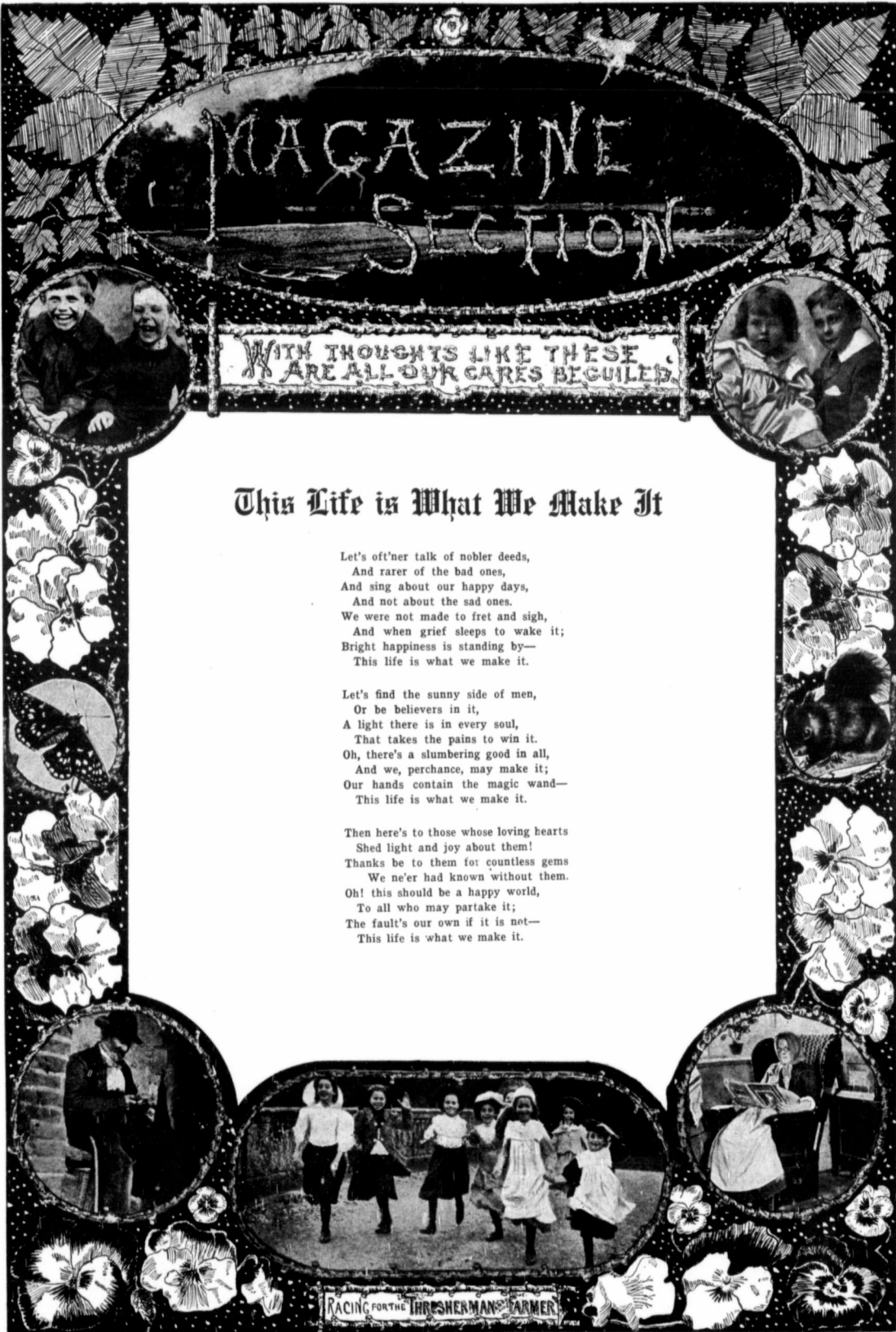

MAGAZINE SECTION

WITH THOUGHTS LIKE THESE
 ARE ALL OUR CARES BEGUILLED.

This Life is What We Make It

Let's oft'ner talk of nobler deeds,
 And rarer of the bad ones,
 And sing about our happy days,
 And not about the sad ones.
 We were not made to fret and sigh,
 And when grief sleeps to wake it;
 Bright happiness is standing by—
 This life is what we make it.

Let's find the sunny side of men,
 Or be believers in it,
 A light there is in every soul,
 That takes the pains to win it.
 Oh, there's a slumbering good in all,
 And we, perchance, may make it;
 Our hands contain the magic wand—
 This life is what we make it.

Then here's to those whose loving hearts
 Shed light and joy about them!
 Thanks be to them for countless gems
 We ne'er had known without them.
 Oh! this should be a happy world,
 To all who may partake it;
 The fault's our own if it is not—
 This life is what we make it.



RACING FOR THE THRESHERMAN & FARMER

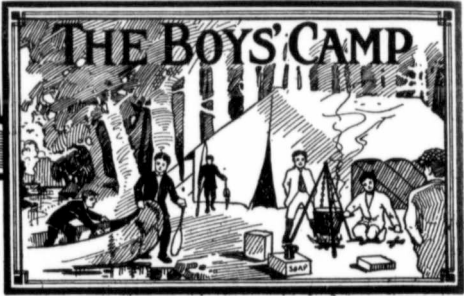

Girls' Cozy Corner

THE BETHLEHEM STAR

By Eugene C. Dolson
 When midnight wrapt Judea's plain,
 Night of the Christ Child's birth,
 From Heaven there came an angel train
 To hail Him King of Earth.
 And shepherds heard the angels sing;
 And wise men from afar
 Across the lands their tribute bring,
 Led by a shining Star.
 Since then the years have come and gone;
 The world has risen from night;
 While, over all, shines on and on
 That Bethlehem Star of Light.

WHEN SANTA CLAUS COMES

A good time is coming; I wish it were here -
 The very best time in the whole of the year;
 I'm counting each day, on my fingers and thumbs,
 The weeks that must pass before Santa Claus comes.
 Good-by for awhile, then, to lessons and school;
 We can laugh, talk, and sing, without
 "breaking the rule;"
 No troublesome spelling, nor writing, nor sums;
 There's nothing but play-time when Santa Claus comes.

I suppose I shall have a new dolly, of course, -
 My last one was killed by a fall from her horse;
 And for Harry and Jack there'll be trumpets and drums,
 To deafen us all with, when Santa Claus comes.

I'll hang up my stockings to hold what he brings;
 I hope he will fill it with lots of nice things!
 He must know how dearly I love sugar plums;
 I'd like a big box full when Santa Claus comes.

Then when the first snow-flakes begin to come down,
 And the wind whistles sharp, and the branches are brown,
 I'll not mind the cold, though my fingers it numbs;
 For it brings the time nearer when Santa Claus comes.

Elizabeth Sill.

WHERE THE TOYS COME FROM
 Nuremberg Leads and the Towns of Central France Are Next.

(From the Boston Herald.)
 Many of the toys with which children now amuse themselves originate in Nuremberg, an old German city situated northwest of Munich, famed the world over as a center of the great toy industry of Germany. Furth, a near-by city, is also devoted to the extensive manufacture of toys. Out of over 200 factories in Nuremberg and Furth 150 are devoted

exclusively to the manufacture of metal toys, the only hand work being the painting on the little figures, which is done by women and children.

There are about 20 of these factories, whose entire output is tiny churches, altars and other religious toys, and as many others where dolls' houses are made complete from cellar to garret, also racing stables, farms and grocery stores and meat markets, equipped with all the contrivances of an up-to-date shop.

On a little island in the heart of old Nuremberg is the Troedel market, where is located the factory of the famous tin soldiers which have brought fame to Nuremberg and fortune to the inventor. Here soldiers from nearly every land are to be had in their respective uniforms and high boots, some mounted on chargers and some afoot. These vast armies have an educational value, as they are made to represent famous battles and campaigns.

are quiet too much to make an interesting club. Just send a little drawing or poems, something to extend the club. I am 14 years and don't go to school. I would like to correspond with any girls of my age. I enjoy reading the girls' Cozy Corner page but girls, we have to try to make a big club so we can go over the P. C. Club who extends every day. I wish the editor would write a letter to have the girls send more drawing or poems. We are going to thresh now. My father got a threshing machine (Advance) and it is very interesting to watch the men working. Winter or skating time will be here pretty soon. I am anxious what nice fun I will have then. Now as my letter is getting long I close with a riddle. As I was passing the London bridge I saw a boat with men in and not one of them were single. Why? Answer next month. Well cousins I wish

Francis, Sask.

Dear Cousin Doris—This is my first letter to your charming club. My father takes the Canadian Thresherman and likes it very much. I like to read the letters in the girls' Cozy Corner. I am ten years old. I like to cook. Here is a recipe for ginger cookies. 1 cup sugar, 1 cup butter or lard, 1 cup molasses, 1 cup hot water, 2 heaping teaspoons of ginger, 1 heaping teaspoonful of soda, flour enough to roll out. I go to school. My studies are reading, writing, arithmetic, drawing and geography. Hope to see my letter in print. I remain yours truly, -Lola Phillips.

Russell, Man.

Dear Cousin Doris—This is my first letter to the Girls' Cozy Corner and I hope to see my letter in print. I have a niece called Doris. She is three years old. My father has taken the Canadian Thresherman and Farmer for some time and I enjoyed reading the letters very much. I am twelve years old. My birthday is on the twenty-second of September. I have two brothers and two sisters. Well I guess I will close and leave room for some other members. How is Cousin Doris and her little girl? I remain, your cousin, -Heather M. Rea.

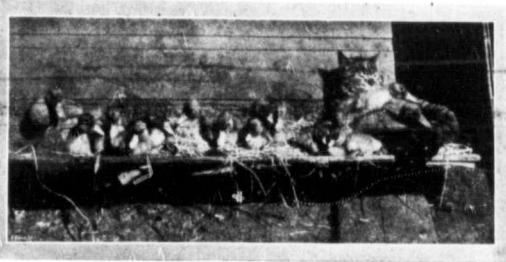

"The Greatest of All is the Mother Love." Cat Nursing a Brood of Ducklings.

I could exchange cards with you. I am your new cousin, -Flora Corbin.



SEND 1 DOLLAR
 Receive by return mail post paid Two pretty Fall and Winter Dresses for little girls age 1 to 10. Material is soft warm goods for winter wear in checks and stripes in various pretty colorings made just as pictured. Add 10c for postage. Order at once.
Standard Garment Co.
 17 Standard Building, London, Ont.



BOYS AND GIRLS, OWN A CANDY STORE OF YOUR OWN.
 This elegant store is the greatest money making and pleasure providing outfit ever offered and you can start in to-day selling the finest candies to all your friends.
 Each of these wonderful stores contains a complete stock of fine Chocolates, Bonbons, Butter Scotch, Licorons, Candy Balls, Kisses, etc., all in lovely glass jars and metal candy cases, the same as in any big candy store.
 We also provide a fine counter with drawers for stock, the magnificent set of candy scales you see above, complete with weights and platforms, a fine set of bright metal scoops to serve the candy with, a stock of Bonbon boxes, candy bags and in fact every necessity of the candy store business.
 Then besides all this wonderful stock of candies and store fittings, WE GIVE YOU THIS ELEGANT CASH REGISTER AS AN EXTRA PRESENT.
 It is an exact model of the big cash registers costing \$100 each and rings up every sale made. It is complete with bank book and keyboard is a wonderful present in itself.
 Boys and girls, get this candy store and you will be the envy of all your friends. We will give it to you complete with the elegant cash register and all, if you will sell among your friends, only 30 bottles of our delightful Royal Japanese Perfumes at only 10c. each. They come in six lovely odors—White Rose, Carnation, Lily of the Valley, Heliotrope, Wood Violet and Jockey Club, put up in fine large bottles with beautiful gold floral labels. Everybody wants this lovely perfume at only 10c. a bottle. It sells like hot cakes.
 Send and get the perfume to-day. We trust you with it. When sold, return our in any, only \$3.00, and the complete candy store as well as the cash register and all, will be sent to you ABSOLUTELY FREE. This is a wonderful offer to bright boys and girls. Be the first in your neighborhood to get this wonderful store. Address:
NATIONAL PRODUCTS, LIMITED
 Dept. G. 437 TORONTO, CANADA.

Girls' Letters

Oterburne, Man. .
 Dear Cousins—Hello, girls, how are you getting along? Just get a move on, you

Canadian Boys' Camp

MOTHER'S FACE.

Three little boys talked together,
One sunny summer day,
And I leaned out of the window
To hear what they had to say!

'The prettiest thing I ever saw,'
One of the little boys said,
'Was a bird in grandpa's garden,
All black and white and red.'

'The prettiest thing I ever saw,'
Said the second little lad,
'Was a pony at the show—
I wanted him awful bad.'

'I think,' said the third little fellow,
With a grave and gentle grace,
'That the prettiest thing in all the world
Is just my mother's face.'

'God bless us every one' prayed Tiny
Tim,
Crippled and dwarfed of body yet so tall
Of soul we tiptoe earth to look on him
High towering over all.
He loved the loveless world nor dreamed,
indeed,
That it at best could give to him the
white
But pitying glances when his only need
Was but a cheery smile.
And thus he prayed, "God bless us every
one!"
Infolding all the creeds within the span
Of his child heart, and so, desiring none,
Was nearer saint than man.
James Whitcomb Riley.

A CHRIS-MUS STORY: BAD CHARLEY

By Margaret G. Hayes

There's was one 'n' two 'tittle chil'run,
A 'tittle girl an' boy—
The 'tittle girl was tur'ble good
She was her muvver's joy;
The 'tittle boy was orful bad—
He'd even—TELL A LIE!
An' tease his sister, till she cried,
An' steal the cake an' pie.
His muvver and his nursey maid
'Ey warned him all those days
'At Santy Claws was comin' soon,
He'd better "Mend his ways,"
But he'd jus' mock, an' say "Don't care,"
An' fur the puss eat down the stair!

Good Betsy dressed her dollies dear,
'Cause now—it's Chriss-mus Eve;
She knowed 'at Santy'd see 'em here
An' she was kind he'd b'lieve;
But naughty Charley didn't care
An' wouldn't leave nurse brush his hair;
He kicked an' 'fused to take his baf—
When Betsy said her p'ayers, he'd laff.
'I got no use for pious stuff,"
Bad Charley said; "I'm good enuff!"
Their socks was hanged up side by side
'Front of 'the chimney broad and wide.
Good 'tittle Betsy said "Good night!"
When Nursey-dear put out the light,
But naughty Charley jumped in bed
Wif'out no p'ayers nor nuffin said.

Soon it was Chriss-mus mornin' dark,
Bad Charley woked up—"Lis-sen—Hark
While Betsy sleeps I'll steal her toys."
Oh, wasn't he the worst o' boys
But Santy's fairies was about,
Betsy woked too, an' tumbled out.
"Merry Chriss-mus, Muvver-dear,
Come quick, and see what we have here!"
Hal bad Charley's sorry now,
Santy Klaws does sure know how
To punish boys what's bad all year
An' re-ward chil'run kind an' dear.
Good 'tittle Betsy's hanged-up sock
Was bustin' full—jus' full as "chock"
Wif' dollies, candy horns an' sich—
Bad Charley's sock held
ONE BIG SWITCH.

HANGING UP A JAR INSTEAD OF A STOCKING

No little Mexican boy or girl ever
thinks of hanging up a stocking. They
have something far more interesting.
Three or four days before Christmas,

WILL THERE BE A "COLUMBIA" IN YOUR HOME THIS CHRISTMAS?

The Latest Columbia Hornless Graphophone \$26 \$45 VALUE FOR

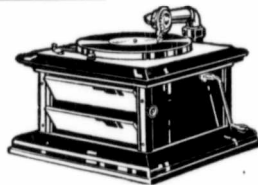

* Here is the newest musical instrument in the field—a hornless Columbia Graphophone—offer- ed at \$26 to those who want the latest improvement in Graphophones, and yet who believe \$26 is enough to pay. We will supply on very easy terms if desired. Write for full particulars, or call and see the machine.

No "hornless talking machine" of any make so far offered at anything like this price, has the Columbia features of the continuous tone- chamber, the improved Columbia reproducer, the Columbia tapered tone-arm, the tone-control shutters, the faultless and noiseless Columbia motor, nor the musical tone-quality that these Columbia features unite to produce.

The Columbia hornless Graphophone "Eclipse" is 15 1/2 in. square, beautifully quartered oak; plays any disc record—all the recorded voices of the world's great artists without exception at your command. Certainly price need no longer deprive you of the endless enjoyment that only a Columbia can bring. The "Eclipse" can be supplied in Mahogany Cabinet at \$32.50.

We have other Columbia models at all prices from \$20 to \$650. Complete illustrated list sent free on application. Old machines of any make taken in exchange.

The ECLIPSE-- Oak \$26, Mahogany \$32.50 EASY PAYMENTS IF DESIRED

COLUMBIA RECORDS

Longest Life Perfect Reproduction

Absolutely the best, perfect reproduction, longest wear, will play on any make of disc machine. Insist on having them, 30,000 records always in stock. Double side records, two different selections, 85 cents. Specially imported English, Irish, Scotch records. Your old favorite sets. Complete lists free.

No. 67.

THE BEST IS THE COLUMBIA

You could hear Caruso, Bonel, Nordica, Tetrazzini, Nielsen, Melba, in Grand Opera; Harry Lauder, Collics and Harlan, Ada Jones, in comic selections; Kubelik, Miesha Elman, Scharwenka, Hoffman, in instrumental pieces, and many other artists on the Columbia Graphophone. You get the finest reproductions, the living voice of the artist. We will supply the "Eclipse" or any Columbia Graphophone, for cash or to very easy terms of payment. Send for full particulars. CUT OUT THIS COUPON AND MAIL TO US.

WINNIPEG PIANO CO. 295 PORTAGE AVE. WINNIPEG.

WINNIPEG PIANO CO., 295 Portage Ave., Winnipeg, Man. Please send me your new illustrated Ma- chine Catalog and inter- esting history of the Graphophone.

I assume no obligation and all you send is to be mailed free.

Name _____ Street _____ City _____ Prov _____

You saw this advertisement in this magazine. Don't forget to say so when writing.

WATCHES WITH FOBS

FREE

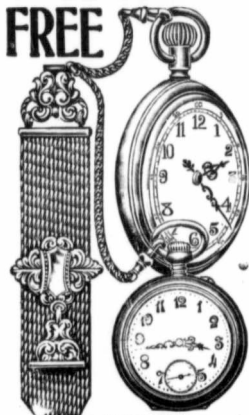

This unprecedented offer is now open to every Boy and Girl, every Lady and Gentleman, to take advantage of promptly. We will give you absolutely free your choice, or both, of these handsome and accurate Watches with Fob attached. The Gentleman's Watch is the latest thin model, stem wind and stem set, with a genuine Swiss Precision Movement, Solid Silver Nickel Case, highly polished, fancy Dial with ornate hands, protected by a heavy bevelled French Crystal. The Lady's size is also the newest thin model, stem wind and stem set, with a genuine quality Swiss Precision Movement as in the man's size, highly polished, Solid Silver Nickel Case, beautifully ornamented Dial with fancy, Gold hands, and clear French Crystal. The beautiful Fob is the newest design, Solid Rolled Gold Plate throughout, fancy Mesh Pattern with Safety Chain attachment. The Suspension Clasp, Ornament, and Pendant Square, are all handsomely engraved. We give you your choice of either of these Watches with Fob attached for selling only 24 of our fast-selling, size 16x20, Multi-color Olograph Pictures. All of our Pictures are reproductions of Famous Paintings, the originals of which cost hundreds of dollars. They are all suitable for framing, and well worthy of a place on the walls of any home. These Pictures sell in Art stores at 50 cents each, so that at our wholesale price of 15 cents each you can sell the whole lot in an hour. To assist you to make your sales quickly, we will your customer to receive an extra present from us absolutely free. Order right now. We will send the Pictures by return mail Postpaid. When sold return us our money, \$5.50, and your choice of either of these beautiful Watches with Fob attached complete, will be sent to you at once Postpaid. Address: COLONIAL ART CO. Desk PE 6 TORONTO, ONT.

50 cents each, so that at our wholesale price of 15 cents each you can sell the whole lot in an hour. To assist you to make your sales quickly, we will your customer to receive an extra present from us absolutely free. Order right now. We will send the Pictures by return mail Postpaid. When sold return us our money, \$5.50, and your choice of either of these beautiful Watches with Fob attached complete, will be sent to you at once Postpaid. Address: COLONIAL ART CO. Desk PE 6 TORONTO, ONT.

You saw this advertisement in this magazine. Don't forget to say so when writing.

He leads the procession to a tiny cave, built perhaps about the patio fountain. Here the images are laid to rest, and the doors closed.

On Christmas morning the doors are thrown open again, and the children see the image of the Christ Child in His mother's arms. Sometimes the children are roused at early dawn to watch the procession of the wise men on their camels.

In the old days it was no uncommon thing for these camels to be almost as tall as the men who drew them along on wheels. But usually the images are small enough to be carried in the arms of the marchers. No Mexican child would exchange such a play for a mere bulging stocking on Christmas morning. Santa Claus is unknown. To him the only Christmas figure is El Nino—the Christ Child.



Womans' Department

Conducted by PEARL RICHMOND HAMILTON

A HOUSEHOLD FORUM FOR THE DISCUSSION OF EVERYTHING THAT PERTAINS TO THE HOME



The Impossible

O, I wish I were an artist, inspiration in my brush,
And I wish I had the rose-tint of a Southern morning's blush,
For my color, and the redness of the sunset for my red,
And for blue the sky's own blueness as it arches overhead,
And the yellow of the sunshine to spread daringly and bold
On my canvas, till my picture would be yellower than gold;
Then, with all my colors waiting, with my canvas stretched and clean,
I'd fill in the grandest picture that the world had ever seen.

I would take the sweetest blueness I could pilfer from the skies,
And would mix it full of sunshine for a laughing pair of eyes.
I would snatch the pink of morning from the highest mountain peaks,
With two daring little dimples, and would fashion it for cheeks;
And would take the brightest scarlet that the sunset's arrows tips,
And would mix a laugh in with it and would form a pair of lips,
And would take the softest yellow that the sun has ever spread,
And would twist it into ringlets for a little baby's head.

Then the world should see a baby sitting happy on the floor,
With a little bunch of playthings scattered just inside the door,
And above it a young mother with the lovelight in her eyes,
And—but what's the use of dreaming! never on the seas or skies
Has there ever been the brightness that could limn the mother-look,
One might almost paint the music of the singing, tinkling brook,
One might almost paint the sweetness of the mocking bird's glad song,
But the mother-look—no color in the world could hold it long!

I am glad I am no artist with the blueness of the sky,
With a tube of every color, I would try and try and try
For the thing most worth the painting, till my spirit should grow faint,
Till I sat all gray and wrinkled 'midst my twisted tubes of paint,
Trying, trying, trying, trying, for the look that only lies,
When her baby looks up smiling, in a youthful mother's eyes.
Better be one of the common, plodding herd who toil for gain
Than a genius, striving ever for what no man might attain.

Judd Mortimer Lewis.

Christmas Acres

By Pearl Richmond Hamilton

"I tell you I will not give it to you!" shouted Jack's father, following this exclamation with a cruel oath.

May Smith halted on the stairway as she heard the bitter words bellowed out

from the kitchen. Many a time May placed her hands over her heart to ease the pain caused by her father's oaths hurled at different members of the family. This time Jack was asking for three dollars to buy Christmas presents for his mother and sister.

If Jack had asked for one dollar he would have had to go through the same ordeal.

May had ceased to ask for any money long ago, for the usual cyclonic thunder of words that followed such a request had crushed her completely.

Mother wiped her eyes on the corner of her checked apron and went on peeling potatoes.

May opened the door, and her reddened eyes spoke more emphatically than words that her sympathy for Jack reached to the depths of her breast.

She shook the dust cloth, hung it on a nail on the wall back of the pantry door, and went over to Jack.

"Jack, dear," she pleaded, "will you let me give you five dollars from my school money? I'd so love to give it."



Still in the Heart of an Empire's Love
Queen Alexandra and Her Little Grandson, Prince Olaf

Christmas day was two weeks ahead and preparations in this family were sadly and heavily postponed.

"Some day I'll buy you each a nice present," mother soothingly promised.

Mother had promised this for the past ten years.

Jack's father warmed his calloused hands over the red hot stove, buttoned his stiff short coat, slammed the kitchen door, and walked down to the gate, uttering an oath at every breath.

The door closed on a purgatory of heavy hearts.

"Not on your tin-type!" exclaimed Jack. "Do you suppose I'll take your money you have earned teaching school? That kind of business robs a fellow of his manhood."

May choked down a lump in her throat. "And what's more, sis, I don't want you to give me a present this Christmas. It makes me feel like a pauper."

Jack rocked back and forth on two legs of the straight wooden chair and pushed his hat down over his forehead.

"It's no Christmas in this house; I wish it would not come; I dread the day, and it's getting worse every year.

"I work here every day, and when I ask for a cent, father makes me feel like a beggar.

"There's Tom Jackson has an allowance, and it makes a fellow feel like doing his level best when he can have a little money of his own.

"As it is, I don't care whether I work or not. I never get any thanks for it."

Jack looked at the stooped shoulders of his mother. It was through consideration for her that he had not left home long ago.

Her personality had been so crushed by the domineering power of her tyrannical husband, that the horizon of her life circled the boundary of their farm.

May was the life of the home. With her school money she had papered the house, bought the carpets, in fact had furnished it throughout.

The stamp of feet outside the door and a jovial conversation of good fellowship announced the coming of a neighbor with father.

As the door opened, mother greeted the friend with a smile and Jack offered a chair.

"I tell you, Smith, your home is the place for a man to enjoy himself. It's the coziest place I know, and the guest rubbed his cold fingers as he leaned over the stove to thaw the icicles that fringed his dark mustache.

At this remark, Jack's father's eyes filled with satisfaction.

The payment of praise—the interest on the efforts of the sacrifices of his family he always accepted compoundly, with swollen paternal pride.

"Jennie get us a little lunch," the husband requested in his company-tone of voice.

Mrs. Smith meekly responded.

Jack's father was a king of hospitality. Throughout the entire neighborhood he was known as everybody's friend. In his family circle he scarcely spoke, and when he was at the table the meals were eaten in silence, for everyone was awed in his presence.

"May, show your certificate to Brown."

May went upstairs prompt in obedience. "May—May—May," she repeated to herself. "Father never addresses me only in the presence of a stranger."

May opened the drawer of her dresser and reached for the be-ribboned roll of legalized standings. She brushed a tear away, hurried down the stairs and handed the certificate to Mr. Brown, who sat toasting his feet in the oven.

May's father waited for Brown's approval, which he very generously gave.

The room rang with good cheer, and Brown envied this home of hearty hospitality.

The dinner over, the two men pulled on their overcoats, and in the height of good nature expressed the usual good-byes.

Mr. Brown drove out of the barn-yard gate, and the open heart of Jack's father closed up like a clam shell.

Jack Smith gazed at his mother forgetful of everything else.

"I'm sorry, mother, for you. You've slaved for twenty years, and your heart is a continual hades of aches. I know it, and I believe I could help you more if I were to leave home and buy you a few comforts."

"May has clothed you for the last three years, and it's up to me now."

"No, no, boy, I need you near me, else I would break underneath this load. I cannot understand father."

"He buys more land every year and we're always in debt. We're land paupers. I feel sometimes that the insane asylum would be a rest."

LET MOONEY DO IT

MOONEY'S WINNIPEG

MOONEY'S

PERFECTION CREAM SODAS

ALSO IN TIN BOXES

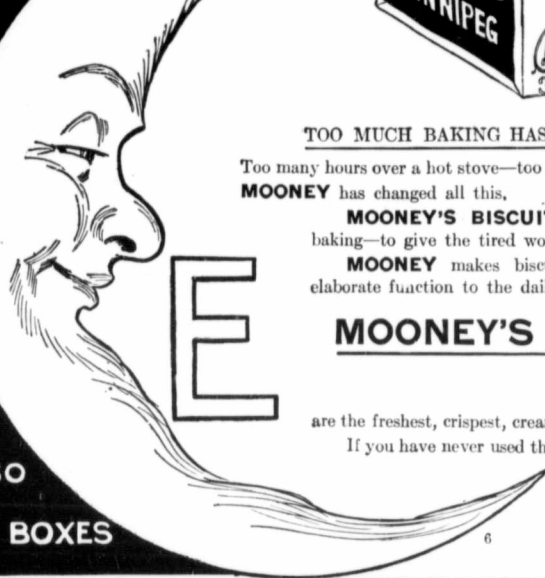

TOO MUCH BAKING HAS KILLED MANY A WOMAN

Too many hours over a hot stove—too few for rest and recreation, MOONEY has changed all this.

MOONEY'S BISCUITS are made especially to replace home baking—to give the tired woman a chance.

MOONEY makes biscuits for every time and place, from the elaborate function to the daily meal.

MOONEY'S PERFECTION SODA BISCUITS

are the freshest, crispest, creamiest, biscuits ever made.

If you have never used them you have a delightful treat in store.

They sell in dainty packages or tin boxes—in either case free from every adulteration

"LET MOONEY DO IT"

You saw this advertisement in this magazine. Don't forget to say so when writing.

The saddest time of the whole year is Christmas!" cried May, "taking the dishes to the cupboard.

"Yes!" responded Jack, excited, alive, alert in every fibre. "It's got to stop this megaphoning prosperity and pleasure in the ears of the neighbourhood and pleading poverty in the ears of home. I'm going to expose father!"

"My boy never do that!" the mother pleaded, half-frightened at the threat.

The father then opened the door, and stood white, tense and mad with rage. He had heard the last threat of Jack.

"Got out—I tell you get out!" he shouted as if he were speaking to a dog. May went on upstairs and Jack followed.

Only the weak trembling mother remained to cringe and dodge the rain of oaths that fell on her head like hail from a destructive storm cloud.

In the attic Jack and May pulled out two old weather-beaten trunks. Their contents emptied out on the floor presented a feast for a bonfire. Some worn out baby shoes that mother could not throw away, a few old dresses and some battered toys—not many—all indicated happier days.

At the very bottom May found a red fringed Christmas card that her father had given her on her fifth Christmas—before the miserly Demon of dollars had clutched at his heart strings.

Now all about these two young people were acres of land. To them they were regarded as acres of aches.

The two bumped the trunks down to the "spare bedroom" and began to pack them with their keepsakes and clothes.

"Say, Sis, we must be careful lest father and mother see these trunks."

"They seldom come upstairs, Jack, and anyway they never come into this room," and the two went on packing.

"Well, anyway, I don't feel sure about that. Let us move them into the closet," and the two pushed the trunks out of sight.

"Now it would never do to leave until after Christmas for mother's sake," insisted Jack.

"Say, did I tell you what I am buying for father?" questioned May as she smoothed down the blue and white rag rug.

"For father?" exclaimed Jack. "Yes, you know his old coat is not warm enough, and I've planned to buy him a new fur coat with my school money. He might expose himself and—well you know

father is our father anyway. I can't help it. I'm going to buy him one. He will never get it himself."

Just at this moment Jack did not care if his father would freeze. He felt that he had a good start in that direction if the body begins to freeze at the heart.

Slowly the days passed until the night before Christmas, when the two young people drove to town in company with the neighborhood young people.

Meanwhile father sat near the coal oil lamp reading the good wishes of a Christmas editorial page, when his eyes seemed to fix themselves on a particular paragraph:

"Dear Lord, Kind Lord! Gracious Lord, I pray Thou wilt look on all I love Tenderly to-day! Weed their hearts of weariness; Scatter every care Down a wake of angel wings Winnowing the air."

Mr. Smith read and re-read the message, and as the bells of the merry sleigh load jingled loudly and then softly into silence, the words of the Christmas thought stood out in bold relief, and the paper seemed to fade into a haze.

Then side by side in big black letters the oaths of the yesterdays boldly faced him.

From one to the other he turned in mingled confusion.

"Dear Lord, kind Lord! Gracious Lord, I pray Thou wilt look on all I love Tenderly to-day! Weed their hearts of weariness; Scatter every care—"

Then a terrible crash! The sleigh load

had been hit by a train. His boy Jack—and—the girl, too, are killed. He goes to call their mother, but she cannot be awakened. She, too, has been put to death by an awful Something.

He tries to move, but is fixed to his chair while visions of his past life crowd into a living moving picture panorama, and always he towers above his trembling dead ones as a fearful gloating giant.

Every heart lies open before him, and he re-lives his trials burned by red scorching needles of flame

—all—all transcribing what he has said.

Suddenly a voice startles him.

He opens his eyes to see "Mother" filling the stove with coal.

"You've been asleep, father, I thought you might take cold, so I am making some fire."

"Guess I have, mother, guess I have," and he rubbed his eyes to make sure that he was awake.

Then to Mrs. Smith's surprise he went upstairs.

Soon the call "Mother" roused her to trembling excitement, and she hurried up to see what was wanted.

There the father leaning over two trunks, was taking out one by one a

garment, a trinket, a picture and a needle case.

"They're going to leave us, wife," he said in a new strange tone. "and—and—well I don't blame them."

Then he and the wife sat on the foot of the bed and had the first soul-to-soul talk that had taken place between them since their honeymoon.

What they said was too sacred to relate here.

But a great barrier had been broken, and

they both came downstairs with that indescribable expression that comes from hearts that have been touched by the influence of the Christ-child.

"A tablet, mother, a tablet." Mr. Smith sat down near the table and rubbed his forehead as he reached for the pen and ink.

He tore three pages from the tablet.

On each he wrote at the top the quotation:

"Dear Lord, kind Lord! Gracious Lord, I pray Thou wilt look on all I love Tenderly to-day! Weed their hearts of weariness; Scatter every care—"

Dear Ones: I have had a vision of Christmas, and from this Christmas Day, charity begins at home. Each one shall be given an allowance according to the salary each can earn outside of the home. And mother—well, she shall be an equal partner of mine. God bless you all, and children unpack your trunks. You're needed at home.

Merry Christmas—not only for a day, but for many years. Lovingly, Father."

The next morning this note from father lay on each plate.

May came down first and placed a big package at her father's plate.

As each read the note, father opened his package, and the warm fur coat with May's greetings overpowered him, he broke down.

And in the Smith house, the acres of aches were transformed into Christmas acres.

Nellie L. McClung

"To-day is the To-morrow that you worried about Yesterday—and it did not happen."

It is an honor to be invited to the home of a famous woman, and I had that honor not long ago when I visited Nellie L. McClung. While taking off my coat I noticed on her dresser the quotation I have used in the beginning of this little bit of information about one of Canada's most talented and most popular of authors.



Ms. Nellie L. McClung

The above quotation is suggestive of her character, for Nellie L. McClung has a disposition full of hopes and harmonies.

If the face is the tablet whereon is written the inner life, surely Mrs. McClung's reveals a character of great strength and rare beauty, for her expression had been formed by habits of harmonious mental and spiritual progress. She has been before the public eye a great deal during the past four years and she wins her way into the heart of everyone.

I know of no other woman who is more popular with her family, her friends, her audiences and her readers than is Nellie L. McClung.

She has a dignity that immediately commands respect and admiration, and she is so gracious that she is approachable. A gentle and kindly heart ever ready to act helpfully is a test of womanly strength, and Mrs. McClung is remarkable for just this kind of power. As a stranger I have watched her public life; then my admiration led me to study her as an acquaintance; and lately I have had the privilege of knowing her in her own community and even in her home circle. My admiration of her has increased since I know how completely and beautifully she lives the part of friend, sister, wife and mother. She does little things in a great way.

As a mother she is ideal. Every little bruise, every little trouble that her children bring to her, she cures with a few words of sympathy and a soothing pat, and her five children adore her. It is something to be able to have the confidence of three healthy growing boys and a pretty girl of thirteen. The youngest, a bright beautiful babe of ten months, is the pet of the house.

Minds in the McClung home are active and alert, for there seems to be a continuous game of matching wits.

Mrs. McClung is a wife and mother first of all—she is the idol of her husband and children, and she appreciates that love and admiration as only an ideal wife and mother can. A great part of Mrs. McClung's success is due to her husband for he himself is a clever man and makes it possible for her to carry out her ambitions. Another characteristic of Mrs. McClung's popularity is her quick grasp of situations, with the ability to put herself in another's place—she loves humanity. She has the art of bringing out the best in every one she meets and always sees the good. She has a big mind and a big heart and consequently sees things in a big way.

A little incident that took place a few months ago at her summer home illustrates this characteristic in her. During the early part of the season she said to me: "I want to invite my acquaintances here to a garden party before I return to the city." From her remarks I judged that perhaps twelve would have the honor of being entertained, but the next time I saw her she remarked: "I have invited forty women. I really could not draw the line, because I like them all." And every woman at that resort was invited.

Though Mrs. McClung is a famous woman now, to her former friends she is "Nellie." Her popularity has not created in her one bit of affectation. She is sweetly natural. One woman who knew her before she began to write said to me: "With all her success and fame she is to us 'The same Nellie.'" What a splendid compliment! But that is the secret of her charm.

Some of Mrs. McClung's short expressions have become household words.

An idea of her popularity is evident by the universal applause that follows the mention of her name in audiences all over Canada. Not long ago I mentioned her name in the course of an address before a large company of young men and young women, and so great was the applause at the mention of her name that I stopped for a moment. Mrs. McClung is a philanthropic woman, and gives of her talent freely to help any worthy cause.

She wastes no time. When she is waiting for a car or an appointment, she reads a little book or article, for she always has tucked away in her muff or pocket book something that is worth while. She says that talent is the product of making use of waste moments.

I have written this as I know her, for if I were to ask for a bit of biography, she would exclaim in a surprised manner: "Why, there is nothing worth mentioning!" She does not realize how much she is admired by the Canadian people for her talent and personality. Nellie L. McClung has a future and a great one, because she

has absorbed the spirit of her environment. Her home has been in Manitoba since childhood, and she has felt all the phases of pioneer life. In the gallery of her mind are stored pictures of Manitoba life—the real genuine kind that are worth knowing about. She is writing these stories in a sincere pleasing style. In her new book, "The Black Creek Stopping Place," there is a great deal of philosophy and splendid originality. A vein of fine clean wit and humour convinces the reader that her latest book is from the pen of an artist. The delineation of characters is so artfully handled that they are living people, and the pictures of the unpacking of a trunk, a lonely evening on the prairie, a Manitoba life, and electioneering in the country, are so vivid that they remain with the reader. Best of all, the book is inspiring, and the reader leaves it with a broader and better love for humanity. There is a universal vein, and Nellie L. McClung has touched that vein in her new book. It is not surprising that the book is having an enormous sale.

Mothers' Corner

MADONNAS

Madonnas hallow every home;
O'er every roof where babies are
Shines high and pure a guiding star;
And mother hearts do always hear
Divinest music ringing clear
And peace and love, good will on earth,
Are born with every baby's birth."

Dear Mothers,—I love this corner, and I feel that my readers love it. I cannot express in words how much the lovely messages from women who read this corner have helped me. To every woman who reads this I send a message of love and goodwill. Sometimes I feel that you who are on the lonely prairie or live in the quiet town think it is easy for me to preach the message of sunshine. I know our women in isolated places are lonely, and I often wish I might drop in to every lonely home and leave a smile and an encouraging word. In a club of young women which I conduct was a girl who was always ready to repeat a beautiful quotation. She learned a new one every week. Since then she became the wife of a homesteader, and has been happy even though she had before lived in the city. "They are never alone who are accompanied with beautiful thoughts."

Touching hearts is the secret of all true Christmas giving. Then scatter smiles as you begin the Christmas year.

MY KITCHEN CREED

Every month I give in this department hints on the care of children. Since this is the Christmas month, I am going to fill the department this month with thoughts from great minds. They will help you in the care of your children. When I am in my kitchen I am living with great minds, for I have a border of helpful quotations around the kitchen wall. When little vexations might occur I have no room in my mind to entertain annoying thoughts. I cannot give you all of them, but I shall copy some of the quotations that are tucked above my sink, for I like to study my favorites when I am washing dishes.

LIFE'S MIRROR

"There are loyal hearts, there are spirits brave,

There are souls that are pure and true;
Then give to the world the best you have,
And the best will come back to you.

Give love and love till your heart will flow,
A strength in your utmost need;
Have faith and a score of hearts will show
Their faith in your word and deed.

For life is a mirror of king and slave.

"Tis just what you are and do;
Then give to the world the best you have
And the best will come back to you."

THE WORLD'S NEED

So many gods, so many creeds,
So many paths that wind and wind;
When just the art of being kind
Is all this sad world needs."

"Would you have your friend live a better life?

CHRISTMAS AND NEW YEAR OFFERINGS

THE FOLLOWING small selection of the very latest Styles and highest quality of Furs, Fur Garments and Ladies' Wear is taken from the largest and most varied stock of real quality goods we have ever carried; probably the most representative stock of Fashionable Goods in Canada today.

THE TIME is now very brief but there is still the opportunity to obtain one of our splendidly illustrated Catalogues, and have your order delivered in good time. Anything from Fairweather's is good for all time and for any occasion, and our value is unexcelled by any house handling quality materials.

Write as soon as ever you have seen this announcement

WAISTS

In plain and fancy silks, Roman striped crepe de chine, macramé lace, etc., \$6.50 to \$45.

GLOVES

Kid, \$1 to \$2; silk lined, \$2; long kid, \$2.50 to \$5; wool and fur lined, \$2.50 to \$8.

HANDKERCHIEFS

Irish Linen, 25c to \$1.50; real lace, \$1.50 up.

DRESSING GOWNS

Flannelette, plain and fancy eider-down and silks and satins in floral and conventional designs, \$3.75 to \$18.50.

HOSIERY

Cashmere, plain and embroidered hse, 50c to \$1.50; silk hosiery, \$1 to \$4.75.

HANDBAGS

Velvet, tapestry and leather in newest shapes, \$3.75 to \$22.50.

FURS

Ladies' Hudson Seal Coats

\$150 to \$400

Ladies' Persian Lamb Coats

\$175 to \$550

Ladies' Muskrat Coats

\$75 to \$275

Ladies' Fur Lined Coats

\$45 to \$175

Ladies' Russian Pony Coats

\$75 to \$175

Ermine Sets

\$100 to \$350

CHILDREN'S FURS

Children's White Coney and Ice-

land Lamb Coats, \$10 to \$20

Children's Muskrat Coats

\$25 to \$40

Children's White Fur Sets

\$3.50 to \$15

Children's Grey Lamb Sets

\$10 to \$20

Black Fox Sets

\$75 to \$200

Persian Lamb Sets

\$25 to \$125

Pointed Fox Sets

\$100 to \$250

Alaska Sable Sets

\$30 to \$200

Mink Sets

\$50 to \$600

Persian Lamb Crown Sets

Special, \$12.50

MEN'S FURS

Men's Beaver Coats, plucked and unplucked, \$250 to \$450

Men's Fur Lined Coats

\$50 to \$375

Men's Chamouis Lined Coats

\$45 to \$100

Men's Raccoon Coats

\$57.50 to \$300

Send for our
Great New Illustrated Catalogue
Free to any address

Fairweather's
& CO. LIMITED

297-9 Portage Ave.

Winnipeg



You saw this advertisement in this magazine. Don't forget to say so when writing.

YOUR FAMILY WOULD APPRECIATE THIS HANDSOME DINING ROOM SUITE

At the price, it's the best ever offered. The most attractive of the newest dining room furniture creations. Order from this ad. or ask for Wingold Catalog, showing a large assortment of new high grade furniture, priced 25 to 50% lower than retailers are compelled to charge. It will pay you to get our catalog and compare quality and prices.



\$133.00

For Complete Set

The entire suite is made of selected quartered oak, finished golden. Built by expert cabinet-makers—perfectly and extremely high grade. Shipping weight of entire suite, 750 lbs.

If you prefer, will substitute any set of diners shown on page 6 of our catalog and adjust price accordingly.

THE LARGE BUFFET is a colonial design of finest select quarter sawed oak with cross band veneer, finished golden. Base is 52 inches wide and 22 inches deep, fitted with 2 small oval and one large straight drawer and spacious 2-door cabinet below. The top contains a French plate beveled mirror, size 42 x 14 inches.

PRICE OF BUFFET No. 619 **\$39.75**

PRICE OF CHINA CLOSET No. 618 **\$33.50**

PRICE OF 6 FT. EXTENSION TABLE No. 615 **\$33.75**

PRICE OF CHAIRS, SET No. 619 **\$34.00**

PRICE OF COMPLETE SUITE No. 615 **\$133.00**

CHINA CLOSET is also colonial in design and matches buffet exactly. Is 63 inches high 40 1/2 inches wide. It is fitted with double strength glass door and ends and has sufficient shelves to accommodate large quantity of dishes.

EXTENSION TABLE—It is made of select solid oak, in golden finish, has large round top, measuring 48 inches in diameter and extends 6 feet. The pedestal is extra large, 10 inches in diameter, full quartered oak.

THE CHAIRS are high grade, very strongly built of mission design of solid oak, finished to match the rest of the suite.

Wingold Stove Company Limited, Winnipeg, Canada—181-183 1/2 Bannatyne Ave.

Picture only that better life in your thoughts of him, and never by word or look emphasize the opposite." "Then away with longing and ho! for labor! And ho! for love Each one for his neighbor, 1 For a life of labor and study and love Is the life that fits for the joy above."

HOSPITALITY

"I never crossed your thresh'old with a grief But that I went without it; Never came heart-hungry but you fed me, eased the blame, And gave the sorrow solace and relief. I never left you but I took away The love that drew me to your side again, Through the wide door that never could remain.

Quite closed between us for a little day." "The best things are the nearest: breath in your nostrils, light in your eyes, flowers at your feet, duties at your hand, the path of God just before you."

A PRAYER

"These are the gifts I ask of Thee, Spirit serene:— Strength for the daily task; Courage to face the road; Good cheer to help me bear the traveler's load;

And for the hours of rest that come between An inward joy in all things heard and seen."

"Just being happy Is a fine thing to do; I'd rather than the blue; Sit and sunny musing Largely in the choosing, And just being happy I'd brave work and true."

"Any little word of ours can make one life the brighter; Any little song of ours can make one heart the lighter; Can help us speak that little word, And make our bit of singing, A lonely vale, and set the



The Puddings, Cakes & Pastries of the Yuletide bespeak the praises of **ROYAL HOUSEHOLD FLOUR**

You saw this advertisement in this magazine. Don't forget to say so when writing.

"Do not pray for easy lives! Pray to be stronger. Do not pray for tasks equal to your powers. Pray for powers equal to your tasks. The doing of your work shall be no miracle, but you shall be a miracle. Every day you shall wonder at yourself, at the richness of life which has come in you by the grace of God." "A garden is a lovesome thing,

Got wot! rose plot, Fringed foo, feru'd grot— The veriest school Of peace; and yet a fool Contends that God is not—

Not God! in gardens! when the eve is cool? Nay, but I have a sign; 'Tis very sure God walks in mine."

"Loving words will cost but little, Journeying up the hill of life; But they make the weak and weary Stronger, braver for the strife. Do you count them only trifles What to earth are sun and rain? Never was a kind word wasted; Never was one said in vain."

"If you and I, just you and I Should laugh instead of worry; If we should grow, just you and I— Kinder and sweeter hearted, Perhaps in some near by and by A good time might be started. Then what a happy world 'twould be For you and me, For you and me."

"The gift is to the giver and comes back most to him; the theft is to the thief and comes back most to him; the song is to the singer and comes back most to them; the

love is to the lover and comes back most to him; and no one can see or understand any goodness or greatness except what is in himself, or the reflection of what is in himself."

And so I might go on copying the quotations around my kitchen wall. They are tacked on the wall on a level with my eyes, and I can read them with no effort. They bring into my life Christmas love the entire year and fill me with hopes and harmonies.

That these may bring every one of my readers real Christmas joy, hope, light and happiness, is the sincere wish of,
P. R. H.

Christmas Ideas

TEA-COZY

An inexpensive and easily made gift is a silk teapot-holder. Cut a paper pattern shaped like a butterfly that measures seven inches from wing to wing. From this pattern cut two pieces of silk, and between the silk place two layers of cotton. Turn in the edges of the silk, bast carefully round the edges and catch-stitch them together with silk of a contrasting shade. To make a holder, ray fancy silk can be used, but the likeness to a butterfly is obtained when the outside is made of shaded brown silk, with a lining of orange or yellow, and when the catch-stitch is done with black.

HANGER

It is not always best to sew hangers or loops to thin dresses or white skirts, and as a substitute, the ribbon-hangers are useful. A ribbon-hanger is made of a loop of ribbon, about five inches long, having at one end a safety-pin securely sewed, and at the other end a small bone ring that is about an inch in diameter. A small bow of the ribbon is sewed over the safety-pin. The pin is fastened into the garment to be hung up. A set of these hangers, having different sizes of pins, would make an acceptable gift.

PIN-HOLDER

It is sometimes desirable to have a case for a paper of pins that can be hung neat at hand. To make a case of ribbon, the material should be eight inches wide and fourteen inches long. Pleat the ribbon slightly on the ends, and finish with rosettes and a long loop.

PIN CUSHION

An attractive pin cushion can be made from twin dolls covered with silk. Wind the dolls with cotton, and from silk cut a strip that is a little longer than the doll. Sew this strip together, and turn down the edges at the top and bottom. Gather the edges, and cover the doll. Draw the gatherings round the neck and feet. Attach the dolls at the side, and hang with a long loop of narrow ribbon.

BUTTON BAG

A durable button bag is easily made, and is always an acceptable and useful article. From wide cream-colored cross-stitch canvas, cut a strip fourteen inches long and five inches wide. Fold this in the middle and with green mercerized cotton work the cross-stitch border about three-quarters of an inch from the middle. When this is worked, fold the canvas and stitch up both sides, and overcast the seam to keep it from raveling. At the top turn down and stitch an inch-wide hem. On the outside of the bag, where the stitching of the hem comes, sew on eight quarter-inch brass rings. Through these rings run two pieces of narrow green ribbon, starting with one piece at each side of the bag. Fasten the ribbons with a knot. This ribbon will close the bag and provide a loop to hang it.

To make this bag, figured material can be used. Cut to the same dimensions and omit the cross-stitch decoration. A cretonne laundry bag that opens easily may be made in the same way if all the dimensions are multiplied by two.

A HOLIDAY SUGGESTION

Instead of sending one large gift to a girl friend at college, I tried a different plan last Christmas. I bought a pair of lisle stockings, rolled one up in holly paper and put it in the toe of the other stocking. The rest of the stocking I filled with inexpensive trifles—a home-made hand-

kerchief, a silver coin-holder, a dainty jabot, a pocket calendar, a tiny box of salted nuts and some peppermint sticks. I wrapped each article separately in holiday guise.

HAIRPIN HOLDER

A convenient hairpin holder can be made from crocheted Shetland floss, attached to a doll's head. Chain-stitch the skein of floss, and hang to the head in loops about seven inches long. Run ribbons through the holes in the neck, and finish with a bow. Tie a loop of narrow ribbon to the back of the head.

HANDKERCHIEF CASE

A ribbon handkerchief case can be easily made from two-thirds of a yard of ribbon four and one-half inches wide. Cut this in the middle, and hem the four ends with a quarter-inch hem; place one piece of ribbon across the middle of the other; to give a little firmness, place a square of thin cardboard between the pieces of ribbon where they cross, and stitch round the square. Fold the four ends over the square, fastening on top with "hook and" loop. Ball-and-socket fasteners like those used on gloves can be put on at a glove store. This case will hold a dozen handkerchiefs. Finish this case with a little bow of narrow ribbon on top. For a case for gentlemen's handkerchiefs, take one yard of six-inch ribbon, and make up in the same way.

LIVING PLANTS FOR GIFTS

No gift so well expresses the Christmas spirit as a living plant, and these are well worth considering before you complete your Christmas gifts. Use the same good judgment and taste in selecting a plant that you would in choosing any other present. Consider the room in which it is likely to be kept and get something suitable. As to the plants which are best adapted to Christmas giving, the range is wide. A handsome fern, azalea, primrose, begonia and poinsettia are all suitable, and would be highly appreciated.

FOR THE OLD FOLKS AND INVALIDS

And have you remembered the invalids and older folk? Those who are confined to house or room or bed, and are dependent on the people around them for the cheer the season brings. Think of the many little gifts that would be appreciated far more than big or expensive ones.

GIFTS TO CHEER THEM

Dainty breakfast caps with ribbons; wee ferns growing in pretty pots, for the breakfast tray; crochet and knitting bags or baskets; tiny tinkling bells for summoning people; a cane perhaps, or an easel book-stand on which to place the book too heavy for weak or tired hands to hold.



BROUGHT IN PA'S PRAYERS

Once upon a time, sickness came to the family of a poorly paid pastor of a rural church. It was winter, and the pastor was in financial straits. A number of his flock decided to meet at his house and offer prayers for the speedy recovery of the sick ones, and for material blessings upon the pastor's family. While one of the deacons was offering a fervent prayer for blessings upon the pastor's household, there was a loud knock at the door. When the door was opened, a stout farmer boy was seen, wrapped comfortably.

"What do you want, boy?" asked one of the elders.

"I've brought pa's prayers," replied the boy.

"Brought pa's prayers? What do you mean?"

"Yep, brought pa's prayers; and they're out in the wagon. Just help me and we'll get 'em in."

Investigation disclosed the fact that "pa's prayers" consisted of potatoes, flour, bacon, corn-meal, turnips, apples, warm clothing and a lot of jellies for the sick ones. The prayer meeting was adjourned in short order.—Missionary.



Two friends who had not seen each other in years, met unexpectedly as neighbors in a suburban town.

"Hello, Mason! Who are you working for now?" asked Taylor, over the garden fence.

"Same people," came the reply. "A wife and five children."

Extra Value Muskrat Coat and Muff

These are but two of the incomparable values from the fall and winter catalogue of the

National Skirt, Suit and Millinery Company, Limited, Toronto

The only mail order house in Canada making garments to special measurements

No. 772. Lady's Automobile Muskrat Coat, 50 inches long, made slightly semi-fitting front and back with deep storm collar and wide lapels, or deep shawl collar, as desired. Closed with three large buttons and loops. Made of first quality Canadian Muskrat skins cut diamond shape and perfectly matched. Deep cuffs and satin lined throughout. A handsome stylish coat that will keep you warm in the severest weather. **\$72.50**

No. 774. Beautiful Muskrat Muff made of the same fine grade of skins as coat No. 772. Pillow style, handsomely striped and lined with best quality satin. **\$10.00**

We guarantee you satisfaction. If when you receive it you are not satisfied, return the garment to us and we will refund your money. We also pre-pay express on every order. We invite you to compare our prices with those of our competitors; only by doing so will you appreciate the wonderful values we offer. Send for a free copy of our catalogue. When ordering kindly mention this journal.

AFTER ALL THERE IS NO BETTER TEST

Of An Article Than Popularity. Ask Your Friends What They Think Of

Then buy a packet, and if it does not please you your grocer has authority to refund your money.

Throw Away

your old burners and put the Wonder Burner on in their place.

Wonder Burner

Gives a 100 candle-power light for 1 cent per hour.

Fits any ordinary lamp. A pure white light, easy to read or sew by and easy on the eyes.

\$3.00

Delivered complete with Mantle and Chimney

RELIABLE AGENTS WANTED in unrepresented localities A GOOD PROPOSITION

Western Lighting Agency

293 Carlton St. WINNIPEG

Home Economics

Report of Lethbridge Dry Farming Congress

Written by Mrs. McCharles, President of Manitoba Home Economics Society

I am sure our readers will be very interested in this excellent report (our president.) The Manitou Home Economics Society won first prize in the exhibits at the Lethbridge Dry Farming Congress. Mrs. McCharles won first prize in the best display of flowerwork.

WOMAN'S WORK TO BROADEN HER OWN SPHERE IN LIFE
By Rev. L. H. Bailew, Cornell University

It takes two persons, a man and a woman, to make a family, so the efficiency of the home depends on the co-operation of both, and for that there must be equal educational opportunities. The educational work should be on divergent lines, but the opportunity for education should be equal.

Good farming means permanent occupation of the land, and consequently a family on the farm. Women have not yet found their recognized place in education in the public schools of to-day.

In re-directing rural civilization there are two things needed - improved farming and improved home making, for they are the two underlying factors in rural civilization, and in the re-direction of farm life the woman has an equal responsibility. The man who is to re-direct farm life is not a public speaker, but she who keeps the house, and she must be able to extend her influence to the affairs of the community and never lose her domesticity.

Her development depends on her opportunity for education, and as yet there has been no education in the public schools for women, altho' the introduction of the study of home economics has been a step toward this.

Must Educate

As it is necessary to educate men in the demands of their daily work, so it is necessary to educate the women. Any occupation that is worth while, is worth putting in the schools. Everything should be taught somewhere. The day of training women in domestic accomplishments is past. Accomplishments we must have, but they should come as a result of other lines.

Country women must be trained to escape the small range of conversation, which narrows the horizon of life. She must take means to broaden her own sphere, not adopt man's sphere, and must be master of her own problem before she can solve other problems.

There should be more attention paid to the artistic side of the farm architecture, women must eliminate the crude and raw, and the residence must express the ideals of the woman. There should be a rest room on the farm, as well as an office for the farmer, and also a rest room in town for the farm woman. The emancipated woman must have half a day a week to devote to herself or the interests of the community. If the woman is away from her home for a day, "She neglects her job." This is not so. All persons should get away and get a perspective of their work.

I don't know but you ought to make a bargain with your husband that when the farm gets one piece of machinery the home gets another.

Rural civilization is the backbone of society. Woman should make her home her "evening spot."

Man does not follow the plow to-day the same as he followed it 50 years ago. He has an intellectual interest in it. Woman must have similar intellectual resources at her house.

Our education expresses a lack of initiative. Don't eliminate the old subjects, but introduce the new. Schools and educational systems should recognize this.

OUR DAILY BREAD

By Miss Ravenhill, Vancouver, B. C.
Why do we need daily food? To grow, to repair, to do efficient work. Every thing we do wears away a particle of body hence the need for food. Energy is dependent on food. We tire easily when hungry. Fat serves as a reservoir of



THE PLAYER PIANO

A Christmas Present to the Entire Family



Your daughters can pursue their regular practice on the key-board;

Your little ones can learn to distinguish and love the best in music from hearing it often repeated by means of music rolls;

Your sons can get far more pleasure from evenings spent at home, with "two-steps," "college songs," light opera hits, etc.;

Your wife can renew her acquaintance with pieces she "used to play";

And You can find relief from business worries in the absorbing occupation of yourself personally producing music.

By our "Factory-To-Home" selling plan, and through our Seventeen Western Branch Stores, we are in position to, and do effect a substantial saving to our customers on their purchase of a Piano or Player-Piano.

A number of exceptional bargains and special low payment terms during the holidays.

Fine Used Upright Pianos from \$150 Up



Mason & Risch, Limited

Factory Branch:- 272 Portage Ave., Winnipeg

energy. The body requires a great deal of water. I should say about three pints a day—not tea or anything else.

Never give bananas to children between meals, as they require a long time to digest, and every part of the body works and rests alternately. Children under seven years of age should not be given bananas unless baked.

Nuts are very valuable taken with meals. The intelligent nutrition of the individual is at once an art, a science, a trade and a service.

ECONOMY FUNCTION OF HOME MAKING WOMEN

By Miss Barry of Tallman College, Washington

Miss Barry spoke of the home making woman as a great earner, and in order to enable her to do her best, her work must be done in co-operation with man. Altho' woman has always carried a large share of the world's work, yet she has not been in a sense dependant. In our factory system it is recognized that labor adds value to raw material. Production is anything that increases the value of any article. The woman in the home works same as factory girl. She takes the raw material and converts it into food. The home-making woman is an earner, and she earns no small share of the family income. To-day she would know children and the sick should be fed, therefore the necessity of education to fit woman for that greatest profession on earth—motherhood.

They would know more of sanitary science now and should apply it.

If there is a gasoline engine on the farm, have it do the heaviest part of the work of the home it is just as good to use women as men. If you have not a gasoline engine, then harness the wind, put your wits to work and use the power you have. Woman should give her best power to labor-saving devices. How foolish to use fifty dollars' worth of time embroidering on five cents worth of material.

HOME CANNED FRUITS, VEGETABLES AND MEATS

Mrs. Norman, Mirror Lake, B.C.

It is interesting to look into the scientific side of canning. To keep perishable foods many chemicals are used that seriously interfere with digestion. Investigation shows that bacteria causes food to spoil. Mrs. Norman demonstrated canning elctric and celery. It was intensely interesting, and gave good results. She uses glass jars entirely, and recommends those with a wide mouth and straight discs.

Mrs. Norman claims that old fowl canned in this way is more tender than if cooked in the open.

FARMERS' SONS

Mr. N. L. Clark, Leamington, Ontario.

I have spoken to 150,000 young men in the last twelve months. I know them better in their farm clothes than their Sunday ones. There are 14,000,000 young men on the American continent. We have 1,000,000 young men in Canada, who could build a rail-road from the Atlantic to the Pacific in eight or ten days, and enough girls to bake the biscuits for these boys while they built the road. Mr. Clark told a story of a young couple who were married. After a time the wife went to her old home. In conversation with her mother, she told her that she and Jack had had a quarrel and he repined a biscuit at her. Her mother replied "Never mind, Mary, he might have killed you."

One day I was out walking and I saw a boy hoeing potatoes and I asked him how much he got for the job. He replied, "I get nothing for hoeing the potatoes, but I do if I don't hoe them."

A mother sent her boy outside to get a bush or a switch to punish him with, but told him he was not to take any that were of any use. When he returned he said, "I could not find a bush I should not touch, but here's a stone you may throw at me."

Another mother punished her boy for what she considered his wrong-doing. After a time she saw him writing on a piece of paper, which he threw in a hole. First chance she got she took it out and read: "Dear Devil come and get Mamma."

A mother came to me one day and said, "Mr. Clark, I've had such a heartbreak lately that I am almost distracted."

"Oh, let me hear your story."

"My daughter went to a country district to teach. I went with her and saw that she got a good boarding place.

Things went all right for a year or two. She always came home for holidays, but never told me she intended to get married."

"Did you ever speak to her about marriage," I asked?

"Oh, no, I could not."

"Well you ought to. Fathers and mothers ought to say all they know they should to their children. Is there any thing in a boy or girl's life that parents cannot talk about?"

Well to end my story, this mother was troubled because her daughter was going to marry a farmer's son, instead of a professional man. That's the kind of woman some boys have to call mother-in-law. The only sad thing about that is it's a wonder he did not kill her, and then there would not be much dead, for there was not much alive. Farmer's sons sometimes marry girls unworthy of their love.

Mr. Clark told another story of a bank boy he met. He saw at once that he used cigarettes. He was black under the eyes and his fingers colored. He talked to the boy for a time, then, in conversation with the boy's father, he told him he hoped to see the boy a preacher yet. The father replied, "He may go to Hell first, and they go because they are sent."

Do you know as much about the boys and girls as you do about many other things in your own home? If not, I pity you. Why are we not giving more time and thought to our boys and girls. Some of us will not wake up till those things strike us fair in the face. It must be done quickly for we must die and they take our place. Say it quickly. Money ought to be used to make men, and not men to make money.

Mr. Putnam, Ontario

Mr. Putnam thought one of the main objects of our Home Economic Societies should be to reach the isolated woman or home and make her life brighter. He spoke of the glare of the city, with its amusements and entertainments, as drawing the young people from the farm home. He thinks women can do anything they try to do. He thinks our Societies could better conditions in our public schools. Appoint a committee to visit on trustees. Canada's greatest asset is not her mines, her forests or her wheat fields, but her children. No woman in any station of life ought to eat the bread of idleness. If the boys are educated to earn money, the girls ought to be taught to spend it wisely. With the loss of the fire-place, being the decline of the home. Herbert Spencer regrets the need of education for motherhood and fatherhood.

PAPER GIVEN AT WOMEN'S CONGRESS, LETHBRIDGE, ALTA.

Mrs. Howe, Wisconsin. Sketch of a trip she had to the Old Land to visit some of the best dairies there. I never felt so proud in my life that I lived on a farm as I did when visiting some of the large dairies. If you want to find real intelligence go to your farm women.

I would strongly recommend to any one on a farm to have one good pure bred cow—How Duncan Marshall told us of a banquet that he attended in honor of a man who milked a cow, a Jersey. She produced 1030 lbs. of butter in a year.

Mrs. Howe told us when she started to farm, she knew very little about cattle and would only peek through the fence at them—"not on the other side for my life." When anyone came to look at her herd and would enquire which was her best cow, she would have to call Albert, the hired man, to find out. She had two cows and a heifer to begin with, now she has a herd of 78. She has a number of "Gold Medals" won by her herd. She invited us to come to some foreign dairies with her. Why could not we do as well?

She told us of travel'ing in Scotland and noticing a beautiful herd of cattle she remarked to her friends that she believed that they were in County Ayr as she had read of the beautiful herds they had there. When they arrived in Glasgow she inquired and found out it was in County Ayr, Fairfield Mountain where she saw the fine herd so she decided to go and visit there. She was directed to the home. When she reached the gate and saw the beautiful gravel walk and flowers growing by the house it came over her "that she was a foreigner in a strange land and wondered what reception she would receive."

There was a knocker on the door, which she made use of. A sweet faced girl came to the door and opened it.



862

Bon-Ton

THESE VALUES CANNOT BE DUPLICATED

The Bon-Ton specialize in women's, girls' and children's clothing exclusively and handle nothing outside of these. They are, therefore, in a better position to cater to the needs of women, girls and children both as to styles, and materials, and give better values than houses which carry all lines and purchase everything on the same basis.

It is safe to say that the two following values taken at random from the new Bon-Ton 1912 Autumn and Winter Catalogue cannot be duplicated, quality for quality, and price for price, anywhere in Canada. So confident are we of this, that if on receipt, the articles are not entirely satisfactory return them and get your money back and we will pay shipping charges.



8136

862—This is a good quality, warm, Nap'cloth Coat with a reversible back. It is 52 inches long and can be worn open or closed at neck. The colours are Navy blue, with lighter reverse also bronze with brown reverse. The same coat may be had in reversible cloth, oxford or light grey back, green with fawn or brown with drab. Price prepaid **\$13.95** Write to your address

8136—Here is a good quality reversible girl's coat with lining of self material. May be had in oxford grey with light grey, green with drab and brown with drab. It can also be had in Chinchilla Cloth or ratine of the navy blue shade with light blue reversible or in bronze with brown, sizes 6 to 12 years. **\$7.99** Write to your address

Write to-day for copy of the Catalogue if you have not already received one. D-12

THE BON-TON CO., 77 St. Joseph Street, QUEBEC.

You saw this advertisement in this magazine. Don't forget to say so when writing.

MAGIC BAKING POWDER

MADE IN CANADA CONTAINS NO ALUM CONFORMS TO THE HIGH STANDARD OF GILLETT'S GOODS.

THE WHOLEST. LIGHTST. MAGIC BAKING POWDER NEW STYLE LABEL

You saw this advertisement in this magazine. Don't forget to say so when writing.

FREE

Handsome doll and carriage and set of real China dishes for dolly and you

Free

Send us your name and address at once and agree to sell only 25 bottles of our delicious, fast selling, essential perfume at only 10 cents per bottle. They come in six delicious odors—rose, carnation, lilj of the valley, hellebore, violet and lilac. Tur perfume are so good and sweet and so handsomely put up that they sell like lightning. You will have no trouble at all to dispose of only 25 bottles. When sold, send us the money, only \$2.50, and we will promptly ship you the doll, carriage and the beautiful tea set, exactly as represented. Don't delay, we are giving handsome extra presents for promptness. Address:

THE ROSE PERFUME CO., Dept 423, TORONTO, ONTARIO

You saw this advertisement in this magazine. Don't forget to say so when writing.



8136
D-12
UEBEC.
A writing



writing
id set
you
and home
and raw
and sweet
st. You
only half
the into
age you
set of
and a five
y deor-
you will
n have
s, fast
-poss,
sweet,
ly, we
RIO
ng.

Howe said "You'll pardon me but come to look at your cattle." "Come and see Father and Mother," she said—"Papa and Mamma—I've been in places where they did not want me to go. Father and Mother. The Mother brought in and looked sweet and kind and as young as the daughter. I asked to her about her lovely home. She told me she had five sons and five daughters helping to make home comfortable. She inquired if I would like to go to the dairy. Just what I did want but I did not like to ask. It was a neat building with roses growing over its sides. Everything was polished, clean and bright. I knew it was a lady's hand that tended that dairy. She asked me if I would like to see the "cow byres." I told her I'd be delighted to see them. She asked Father to take me. As we went near I began to lift up my dress but it did not need to. There was a cement floor in all the stable and it was "as clean as a new pin." I remarked to him that I heard he owned the best row in Scotland. He said "do you mean Nillie?" I said yes but I did not hear her name." He said "we will go out to the field to see her." When we got out a short distance I called "Nillie" twice. All at once she began to come to us. Here she came with all the dignity of a queen. He wanted to her many good features. I asked "how many pounds of milk a day does she give?"

"About 54."

"How much butter fat?"

"About 4 per cent. We don't force Nillie for the last drop as we send her back to Norway and America." He did not kill the goose with the golden egg. She was looking to the future.

Mrs. Howe told us of getting permission from the late king Edward to visit the dairies of the late Queen Victoria, the Victoria the Good. In the Queen's barn I saw 50 Royal bred Jersey's and 50 and 50 Short Horns. Then we went to the dairies. Frognore where the Queen and the Royal Consort are at rest. The Queen preferred the farm. Just to think that I should stand in the Queen's dairy, visited in the 21st year of the Queen's reign. Inside there were two busts, of Victoria and the Royal Consort. Flowers were growing on all sides. There were large marble tables, with basins of blue tiled with milk and cream. The walls were in tiling, the trimming around the ceiling was medallions, of the Queen's children set at regular intervals. "You get a separator," he first words I said to the Queen's dairy. Although I thought had quite a speech to get off as soon as got in.

"No, the skim milk is given to the poor and a little cream will do no harm." If anyone thinks farm work low they should talk to the Queen's dairy.

P.S. Before leaving for Lethbridge Mrs. Howe shipped two car loads of cattle to the Japanese Government.

not tell Mrs. McNamara about this suggestion.) At any rate I am going to ask her for some recipes for this department. I am sure our readers will be thankful for them.

I am indebted to Mrs. McTavish and Mrs. George Armstrong for the splendid hospitality extended me in their home, the memory of which will long remain a pleasure. When a stranger has the opportunity to visit such homes as this, she feels that this kind of home-life is the saving power of Canada. Where we find good literature, music and inspiring conversation, as we witness in the McTavish in such homes have a solid foundation in character building, and are a power for good in their community. This kind of home building is practical patriotism.

I felt honored to be entertained in the home of Mrs. McCharles, who is the president of the Manitoba Home Economics Society. Mrs. McCharles is the mother of two sons and a daughter and is a practical successful woman in everything she undertakes. The Home Economics Society is fortunate in having as president a woman of Mrs. McCharles' executive ability. She has lately returned from the Lethbridge Congress of Women and is full of enthusiasm and inspiration for the club she represents. As the problem of Alberta and Saskatchewan wives who are too far from medical help concerns me very seriously, I sought the advice of Dr. McCharles knowing that he is familiar with conditions in the country, and I feel that his suggestions will help our readers in isolated places.

Mrs. Rowe, the secretary, is a very active worker and I heard on every side great praise for her work and splendid ability. She is a very influential woman in the society and the Manitou women appreciate her. She won the first prize at the Lethbridge Congress for the best and largest display of fancy work.

The hall where the November meeting was held was crowded with women and girls and their interest and cordiality was an inspiration to the visitor.

I might add that since coming to the city after the Manitou meeting, Mrs. Nellie L. McClung, our brilliant and famous Canadian author, entertained one afternoon in honor of Mrs. McNamara who was spending a week with her. Mrs. McClung invited as guests all the women who formerly lived in Manitou but are now living in Winnipeg and her guests numbered between thirty and forty women; the writer asked another guest what most impressed her as she looked about at the faces of the guests. This was the answer: "They are faces that suggest great strength of character." Indeed our talented author is indebted to a splendid environment, for Nellie L. McClung is sincerely patriotic when she mentions Manitou.—P. R. H.

BENITO
Canadian Farmer and Thresherman,
Winnipeg, Man.

The first regular meeting of the Benito Home Economic Society was held on Thursday, Oct. 17th. Interesting papers on home comforts and conveniences were given by the President, Mrs. Smith and 1st Vice President, Mrs. J. T. Douglas, followed by a discussion led by Mrs. Fawcett. It was decided to get up a sale of work in the near future to raise money for the purpose of street lights.

The following resolution was passed unanimously:

Resolved—That this meeting of the Benito Home Economic Society pass a hearty vote of thanks to Mrs. E. C. Salisbury, Winnipeg, in appreciation of her personal assistance in the organization of the Society.

The Society is in a very satisfactory condition and bids fair to become an important element in the life of our village.—M. Hunt, Sec. Treas.

SWAN LAKE
Home Economics

The October meeting of the Swan Lake H. E. was held on Saturday, 26th inst., and in spite of it being the busy season there was quite a large attendance.

After the ordinary business, the Handbooks sent by Mrs. Charlton-Salisbury were distributed and the members were asked to glance through them, page 11 being specially pointed out for their perusal. After some discussion it was pointed out that the holding of the annual meeting during the first week in December would clash with the November session, with the possible result that many

The Dingwall Jewellery Catalogue for 1913!

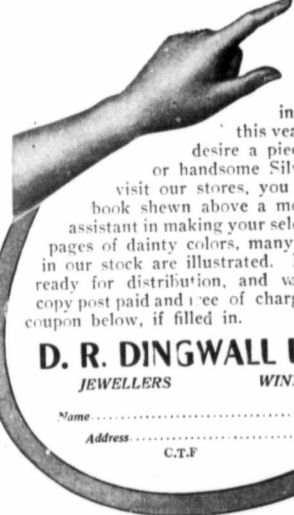

When you are choosing your Christmas gifts this year you will undoubtedly desire a piece of pretty Jewellery or handsome Silverware. If unable to visit our stores, you will find the beautiful book shown above a most pleasing and helpful assistant in making your selections. For in its 128 pages of dainty colors, many of the finest articles in our stock are illustrated. It will very soon be ready for distribution, and we will send you a copy post paid and free of charge, upon receiving coupon below, if filled in.

D. R. DINGWALL Limited

JEWELLERS WINNIPEG

Name

Address

C.T.F.



PLEASURABLE EVENINGS

will do more towards keeping your young people home than anything else you can devise. Don't have them discontented with a musicless home. Put in a

KARN OR MORRIS PIANO

and brighten life for your children. We warrant every instrument for an unlimited period, because they are made to stand Western climatic changes. We sell these famous pianos for cash or on terms, at lowest prices possible. Catalogue on request.

KARN-MORRIS PIANO & ORGAN CO. LTD.

337 Portage Ave., Winnipeg

Upright, Grand and Player Pianos, Reed and Pipe Organs

E. J. MERRELL, Manager

\$50 DISCOUNT on any new piano purchased during the month of December.

You saw this advertisement in this magazine. Don't forget to get so when writing.

NATIONAL BRAND

FREE! FINE CHEST OF TOOLS

BOYS—Here is the very thing you need—A fine outfit of real carpenter's tools, containing 11 (eleven) high grade pieces just as illustrated, everything complete for setting up a carpenter shop, and making anything in carpentering and building you could desire. **THESE ARE NOT TOYS**, but good, well made, substantial English steel tools, which you will be proud to own.

SEND NO MONEY. This magnificent set will be given to you absolutely free, if you will sell only thirty big handsome bottles of Royal Jansene Perfumes, at only 10 cents each. Six different delicious odors—Rose, Lily of the Valley, Wood Violet, Lilac, Heliotrope and Jockey Club. We send you a fine silent salesman show card to help you sell them quickly. No one could resist such lovely perfumes at only 10 cents each. It sells like hot cakes. Returns our money, only \$3.00, when it is sold, and this lovely set of tools is yours. Write for the perfume to day. We'll send you the tools. Address:

NATIONAL PRODUCTS, LIMITED
Dept. T. Toronto, Ont.

members would be unable to attend both, so it was decided to advance the November meeting by one week while the President promised to write to Mrs. Salisbury with the view of holding the Annual meeting a little later.

The President then spoke of the Dry Farming Congress at Lethbridge and again voiced her regret that Swan Lake had not been able to contribute and mentioned the pride all members must feel in hearing that Manitoba had been awarded the first prize over all the Women's Societies in the world.

Mrs. Blair gave a most interesting paper on "Bread." She began by pointing out that good bread was an absolute necessity in every house and was far more important than cakes, pastries, etc., and then explained that good bread making was not in the least difficult provided the bread maker had the four necessary ingredients:—good flour, good yeast, salt and water for plain bread, shortening and sugar for richer bread and potatoes or potato water to make the bread moist for keeping. The sponge must be kept warm and should be of uniform consistency without lumps; it requires 3 kneadings, the first to work in all the flour it will hold and the second and third to thoroughly distribute all the gas from the yeast. Bread should be baked 1 1/2 hours; insufficient baking makes poor bread.

The paper was so interesting that Mrs. Blair was given a hearty round of applause on its conclusion.

Mrs. W. H. Couch also gave her method of making bread, by request. She attributed her great success in making bread to the fact that she made the yeast some 3 or 4 days before it was required, keeping it meanwhile in a cool place. This had the merit of allowing the yeast to work thoroughly and facilitate matters, it being only necessary when baking to take the quantity wanted to set the sponge which meant that a big batch of bread could be set and baked in about 5 hours.

Mrs. Moffatt's remarks on butter making were also much appreciated in spite of the fact that she spoke without notes. She emphasized the special need for cleanliness—clean cows, clean stables and clean milkers, also a clean building in which to keep the milk that it might not get tainted. The best way to make good keeping butter was to pasteurize the cream by putting it into a pail and the pail into a pan of boiling water on the stove until the cream reaches 120 or 150 degrees; butter made from such cream will keep sweet for months. The streaks often noticed in butter are caused by the salt not being properly mixed in and to obviate that the salt should first be well worked in and then the whole left for 3 hours to allow the salt to dissolve.

The November meeting will be held on Saturday, 23rd and the subject on the programme is "Christmas Gifts" by all the members.

After singing the National Anthem, lunch was served and the meeting dispersed.

RECIPES

Mrs. W. H. Couch.—Preparation of Yeast.

Take 1 cup flour, moisten with a little warm water, add 1 qt. boiling potato water. Let stand till cool, then add 1 yeast cake, stir briskly. Keep in a glass or glazed earthenware jar. 1 qt. liquid, including yeast, is sufficient for 3 ordinary sized loaves. 3 heaping measures of flour to 1 scant measure of liquid including yeast, will in general be found a good proportion. Will keep 3 or 4 days.

Before leaving Swan Lake, Mrs. Dodds of Fort William kindly gave us her recipe for making 5 hour bread.

Mrs. W. J. Dodds.—5 hour bread. For a baking of 8 loaves take 6 pints potato water, 1 cup mashed potatoes, 1 tablespoon each of salt and sugar, 1 1/2 yeast cakes soaked in lukewarm water. Strain all ingredients and let stand all night in warm place, covered with a warm cloth. Make sponge in morning adding 1 tablespoonful lard; it will rise in about 1 hour; mix down soft and put back in crock 2 or 3 times. Set loaves and bake.

DELORAINÉ

The October meeting of the Delorainé Home Economic Society was held on Saturday Oct. 5th in the basement of the Presbyterian church. The different methods of cooking meats were discussed. Two papers were given on this subject one by Miss Kimes the other by Miss Dutton, in both were given many helpful suggestions.

Mrs. H. Dymond entertained the Society by giving a humorous reading, after which refreshments were served by Mrs. W. A. Johnston and Mrs. Alec Sutherland.

The November meeting was held in the same place. The ladies of our Society feel deeply indebted to Dr. Montgomery for the lengthy and instructive paper he gave us on Tuberculosis. The Dr. had spared neither time nor trouble in preparing this paper, and I am sure we shall all try to remember and profit by the hints thrown out by the Dr.

Miss Hay then favored us with a solo, which was much appreciated by all, after which Mrs. Dr. Thornton and Mrs. W. J. Thomas served light refreshments.

Our Society sent a collection of pickles, fruits and needle work to Lethbridge, (valued at \$125.00). We now feel proud that our small contribution should have been a part of the Manitoba collection which carried off a first prize.

Secretary to the Thresherman.

Some Delicious Christmas Cakes

By Mrs. Oliver Bell Bunce in Mothers' Magazine

Oatmeal Fruit Bars

3 cups of uncooked oatmeal, 4 cups of whole wheat flour, 1 cup of sugar, 1 cup of seeded raisins, 1 teaspoonful of baking soda, 1 1/2 teaspoonfuls of salt, 1 cup of melted butter.

Mix all ingredients well together and add cold water to make a stiff dough. Roll out as thin as possible and cut in long bars. Then lay on greased baking tins and bake in hot oven.

PLUM PUDDING

Beat five eggs very light and add to them a cup of sweet milk; stir in gradually one cup of dried bread crumbs, one pound of flour, three-quarters of a pound of sugar, and a pound each of beef suet, chopped very fine, cleaned currants and seeded raisins. Mix well and add one cup of molasses, and another half cup of milk, also a heaping teaspoonful of salt, one of cassia and a grated nutmeg. Dissolve a teaspoonful of soda in a little hot water and stir it into the molasses. Boil in molds for five hours.

PATTERN DEPARTMENT

Any of these patterns supplied by the Pattern Department of the E. H. Heath Co., for 10c, or stamps. Please order by number and state the month in which pattern appeared.



ATTRACTIVE GARMENTS FOR ALL OCCASIONS

7464—Semi-Princesse Dress for Misses and Small Women, 16 and 18 years. 4 1/2 yds. 36 in. wide, with 1 1/4 yds. of lace to finish as shown in front view, for 16 year size.

7601—Semi-Princesse Dress in Tunic Effect, for Misses and Small Women, 16 and 18 years.

With long or elbow sleeves. 3 1/2 yds. 36 in. wide, with 1 1/4 yds. 27 in. wide for panels and lower portion of skirt, 1 1/2 yds. of lace for sleeve frills, for 16 year size.

7364—Blouse with Vestee, 34 to 42 bust. With three-quarter sleeves and cuffs or plain elbow sleeves.

1 1/2 yds 36 in wide, with 1/2 yd. 18 in. wide for yoke and collar, 3/4 yd. 21 for vestee and 9 yds. of banding, for medium size.

7563—Two-piece Skirt with Side Panels and V-Shape, 22 to 30 waist.

With high or natural waist line. 2 1/2 yds. 36 in. wide, with 1 1/4 yds. any width for panels, for medium size.

7342—Girl's Dress, 4 to 8 years.

583 and 417 Embroidery Patterns. 2 1/2 yds. 36 in. wide, with 3/4 yd. 27 for the trimming, for 6 year size.

7595—Child's Pointed Yoke Dress, 1, 2 and 4 years.

2 yds. of material 36 in. wide, with 3/4 yds. of insertion, 1 yd. of edging to make as shown, for 2 year size.

The above patterns will be mailed to any address by the Fashion Department of this paper, on receipt of ten cents for each.



SLEEPING GARMENTS

7629—Girl's Sacque Night Gown, 10 to 16 years.

4 yds. 36 in. wide, for 12 year size. 7080—Square Yoke Night Gown for Misses and Small Women, 14, 16 and 18 years.

5 1/2 yds. of material 36 in. wide, 1 1/2 yds. of edging to trim as shown, for 16 year size.

7611—Square Yoke Night Gown, 34 to 46 bust.

With square or high neck, elbow, three-quarter or long sleeves. 5 yds. 36 in. wide, 2 yds. of banding, 3 yds. of edging, for medium size.

7233—Child's Pajamas, 2 to 6 years.

2 1/2 yds. 36 in. wide, for 4 year size.

6323—Boy's Pajamas, 6 to 14 years.

4 1/2 yds. 36 in. wide, for 10 year size.

The above patterns will be mailed to any address by the Fashion Department of this paper, on receipt of ten cents for each.

FASHION MODELS

7588—Shirt Waist or Blouse, 34 to 40 bust.

With or without rolled-over cuffs. 2 1/4 yds. 36 in. wide, with 3/4 yd. 27 for collar and rolled-over cuffs, for medium size.

7578—Fancy Waist, 36 to 46 bust.

2 1/2 yds. 36 in. wide, with 3/4 yd. 27 in. wide for collar and revers, 3/4 yd. 18 in. wide for chemisette, 3 yds. lace for frills, for medium size.

7340—Semi-Princesse Gown, 34 to 42 bust.

5 1/2 yds. 36 in. wide, with 1 yd. 27 in. wide for trimming, for medium size.

7682—Six-Gored Plaited Skirt, 22 to 30 waist.

With high or natural waist line.

6 1/2 yds. of material 36 in. wide, for medium size.

SLEEPING BEAUTY DOLL FREE

This lovely doll dressed in a beautiful costume of satin trimmed with lace, has large hat trimmed with straw edge and lace trimming, has jointed body and sleeping eyes. Given free for selling only \$3.00 worth of finest glazed, embossed Christmas and New Year post cards at 6 for 10 cents. Our cards sell in no time, and they are the best obtainable. Write now for cards, and when sold, send us the money, and we will send the doll by return.



THE STERLING PREMIUM CO.
Dept. 106, Ashdown Block, Winnipeg, Canada.

Mention this magazine when writing advertisements.

I Will Develop Any Woman's Bust.

I Will Tell Any Woman Absolutely Free of Charge How To Do It Positively and Safely. Many women believe that the bust cannot be developed, but I have brought back to its former vigorous condition.

Thousands of women have vainly used massage, electricity, pump instruments, ointments, general tonics, constitutional treatments, exercises and other methods without results. Any Woman May Now Develop Her Bust. I will explain to any woman the plain truth in regard to bust development, the reason for failure and the way to success. The Mdme. Du Barrie Positive French Method is different from anything else ever brought before American women. By this method, any lady—youthful, middle aged or elderly—may develop her bust from 2 to 8 inches in 30 days, and see definite results in 3 to 5 days, no matter what the cause of the lack of development. It is based on scientific facts absolutely. This method has been used in Europe with success, and has been accepted as the most positive method known. To any woman who will send a 2c stamp to pay postage, I will send complete illustrated booklet of information, sealed in plain envelope. Address Mdme. Du Barrie, Suite 3481 Pontiac Bldg., Chicago.

Mention this magazine when writing advertisements.

Watches and Diamonds on Credit

Write today for OUR BEST...
LARGE CATALOGUE...
WALTHAM WATCHES...
BIBB GORE RAILROAD WATCHES...
JEWELRY...
Selling and Fining...
Gold Watch Jewellers

A Square Deal

All Sold on Our Easy Credit Terms
and submitted under our ABSOLUTE GUARANTEE TO BE EXACTLY AS REPRESENTED.
Square Deal Miller, Pres. HILLER-BROWER COMPANY, 46 Bloor St. W., Toronto, Ontario. The Original Watch and Jewelry Credit House of Canada.

A Square Deal

Mention this magazine when writing advertisements.

SWEET TONED VIOLIN FREE



This high-grade Cremon Violin, full size, made of Rosewood with deep edges. We guarantee the violin to be of the best make. Given free for selling \$5.00 worth of finest glazed embossed and colored Christmas and New Year post cards at 6 for 10 cents. We have a fine range of post cards, and every card is a red hot seller. Write now for cards and when sold send us the money and we will send you the violin by return. Don't miss the splendid offer.

THE STERLING PREMIUM CO.
Dept. 106, Ashdown Block, Winnipeg, Canada.

Mention this magazine when writing advertisements.

The Best Present of All

This Style
Guaranteed

For

10 Years

\$185

Cash

F.O.B.

WINNIPEG

Louis Style

\$185.00



DETAILED DESCRIPTION OF THE DONALDA CABINET GRAND PIANO

THE Frame of the Donalda Piano is made of selected hardwood carefully built to withstand the immense strain to which it is subjected. The **Pin Block** is "built up" of several layers of the finest rock maple to give strength to this important part. The **Sound Board** of beautiful spruce is the best that money can obtain and this great feature is one of the reasons for the rich and powerful "Donalda Tone." The **Metal Plate** is heavy and adds support to the whole piano (the Donalda has a great reputation for staying in tune). The **Action** is of the illimitable repeating type and one of the finest we have ever seen. The **Gold Hammer Rail** is a distinctive feature of the action and a sign of the highest grade. The **Hammers** are scientifically constructed of fine felt and of a size (13 pounds to the set) ample for all purposes. The **Hammers** are almost sure to have small hammers and therefore we call particular attention to the hammers used in the Donalda. The **Pedals and Pedal Action** are the finest obtainable and fully up to the high grade demanded by us.

All Donalda cases are double cross-band veneered, both inside and out, thus preventing warping or cracking and assuring at all times a beautiful even action and tone. We use only the finest of mahogany and quarter cut oak veneers and our finish which is hand rubbed cannot be excelled anywhere. Our Colonial Design is furnished in both mahogany and Early English oak and the Louis in mahogany only. Size of the Donalda Piano:—height 4 ft. 8½ in., width 5 ft. 4½ in., depth 2 ft. 3½ in., with 7½ octaves.

It is with pride that we present to our thousands of friends and customers the Donalda Piano, as shown on this page and in colors on the back of our catalogue. We have here an instrument fully worthy of the great esteem in which it is held and backed to the limit by our unqualified ten year guarantee.

The Donalda is of generous size, and in every detail of material and workmanship is a thoroughly high grade piano, well worth double our price if sold in the ordinary way. Our selling plan eliminates expense and you receive it at actual cost to manufacturer with our one small percentage of profit added.

Price of Colonial style, \$180.00

Price of Louis style, \$185.00

HUDSON'S BAY CO. Mail Order Department WINNIPEG

DOLL FREE
IUM CO.
t, Winni
ting advert
ny
oman's
Bust.
I Will Tell
Any Woman
Absolutely
Free of
Charge
How To Do
It Positively
And Safely.
Many women
believe that
the bust can-
not be devel-
oped or
brought back
to its former
vigorous con-
dition.
vainly used
ointments, oint-
ments, and
treatments
with out re-
sults.
p Her Bust
plans truly in-
crease the
Mme. Du
is a differ-
ent American
ady—young,
long her bust
and see definite
that the ex-
perience is
based on
Europe with
at most possi-
ble an who will
ill send com-
mission, sealed in
31 Pontiac
g advertisers
aments
dit We trust
UR BEAUTIFUL
OF THE
WOMAN'S
A large line of
BUSTS IN
THE PRINCE
and for sale
able to order
and made
of the best
materials.
square feet
FREE
olin, full
ep edges.
f the best
.00 worth
colored
cards at
range of
red hot
nd when
will send
n't miss
CO.
nnipeg,
Advertisers.

Special Winter Pants

Order a pair for Winter wear. Made in England from finest quality material. Seams overlapped and strongly sewn out in latest style with seven distinct features of merit. Extra high back, watch pocket, rule pocket, two hip and two front pockets, and back strap. Besides being good for extraordinary wear, moleskin is of such close texture that the keenest wind fails to penetrate. Colors: black, brown, grey. Every pair guaranteed for six months—Delivered free \$3. Waist sizes: 32, 34, 36, 38, 40, 42, 44. Be sure to mention size required.

Scottish Wholesale Specialty Co.
134-136 Princess St., Winnipeg



\$3 DELIVERED FREE

Ladies, Gentlemen's and Children's Clothing,

also furs, positively made to measure. Fully illustrated catalogue free. Prices absolutely below any house in Canada. Medium priced goods, quality and fit are our strong points. We will give 15% discount to all new customers on their first order.

Metropolitan Mngf. Co. Limited.
Toronto, Ont.

FRUIT GROWING
IN
SUNNY BRITISH COLUMBIA

There are instances of \$500 to \$800 gross profit per acre. (B.C. Government Report No. 10.)

Comfortable and healthy climate, outdoor life, beautiful scenery, plentiful sport. Land offered by the International Securities Company is three miles from town, and is suitable for growing apples, pears, plums, cherries, apricots, strawberries, raspberries, currants, gooseberries, vegetables and cereals. Railways, roads, telephones, telegraph, school, pure water, free timber.

PRICES—Five acres cost from \$250 to \$400.

TERMS—\$25 to \$40 down, and \$12.50 to \$20 monthly, without interest.

Cut out this coupon now.

Please forward full information of your orchard tracts in East Kootenay, B.C.

Name

Address

The International Securities Company, Limited
Somerset Building
Winnipeg - Canada

Mention this magazine when writing advertisers

7687—Tunic Skirt for Misses and Small Women, 16 and 18 years. 2 1/2 yds. of material 36 in. wide for foundation skirt, 4 yds. 36 for tunic and flounce, for 16 year size.



The above patterns will be mailed to any address by the Fashion Department of this paper, on receipt of ten cents for each.



PRETTY AFTERNOON MODELS

7216—Fancy Blouse, 34 to 42 bust. 2 yds. 36 in. wide with 1/2 yd. of silk 21 in. wide for fancy collar, cuffs and piping, 1 yd. of all-over lace 18 for chemisette and under sleeves, for medium size.

7488—Blouse for Misses and Small Women, 16 and 18 years. 1 1/2 yds. 36 in. wide, 1 1/4 yds. of braid, 2 yds. of cord for lacings, for 16 year size.

7538—Semi-Princesse Dress, for Misses and Small Women, 16 and 18 years. 4 yds. 36 in. wide, with 7 1/4 yds. of banding, 5 1/2 yds. lace, 3 1/2 inches wide to trim as shown, 1 1/2 yds. 18 in. wide for yoke and under sleeves, for 16 year size.

7494—Five-Gored Skirt, 22 to 32 waist. With high or natural waist line. 3 1/2 yds. 36 in. wide when material has figure or nap, 4 1/2 yds. 27 when material has neither figure nor nap, for medium size.

7477—Four-Piece Envelope Skirt, 22 to 30 waist. 5 yds. of material 36 in. wide for plain skirt when material has figure or nap 4 1/2 yds. 36 when material has neither figure nor nap, 1 yd. for plaited portions, for medium size.

The above patterns will be mailed to any address by the Fashion Department of this paper, on receipt of ten cents for each.

YOU WANT A COPY



And every man or woman who is interested in fine Furs and latest Fur Fashions.

A Post Card will bring you our 1912-13 Art Catalog of McKay Furs.

We use only selected Skins, purchased direct from the Trappers, made up in our clean, sanitary Fur Factory, under the personal supervision of Mr. McKay, ensuring you value and satisfaction in every way.

For more than half a century, the House of McKay has been Trading, Dealing and Making Furs, and our positive Guarantee of Fit, Style and Quality, goes with every piece of Fur bearing the McKay TRADE MARK.

Now is the time to make your selection before the rush begins.

Write today

While you think of it.

Illustration shows McKay Model Coon Coat, made from selected, full furred skins, lined with best quality of quilted Farmers' Sati Leather Shields, etc., full skirted, lots of room **\$75.00 up**

Other good serviceable Winter Coats, with Fur Collars **\$14.00 up**

Just write Mr. McKay, about what you want and price you want to pay. He will personally see you get satisfaction. You don't need to send one cent. Make your selection from the Catalog. We will send it to your Express Office, prepaid, for free examination.

JOHN MCKAY, THE FUR HOUSE
KINGSTON, ONTARIO

You saw this advertisement in this magazine. Don't forget to say so when writing.

Have you Renewed Your Subscription ?

Best for all Purposes



PURITY FLOUR makes more bread and better bread, but its superiority is just as evident when you use it for pies, cakes, buns, cookies and pastry of all kinds.

THE OVEN TEST is all we ask, and a 7-lb. trial sack will give you a dozen reasons for using **PURITY FLOUR** always.

FOR SALE BY BEST DEALERS EVERYWHERE

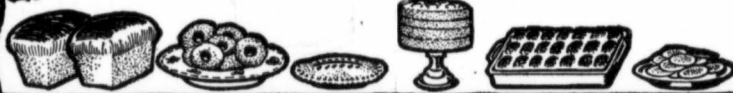

PURITY FLOUR

More bread and better bread

156
If you saw this advertisement in this magazine, don't forget to say so when writing.

WHEN George Stephen was cradled under a very modest roof in Dufftown, Banffshire, nearly eighty years ago, the most daring prophet would scarcely have predicted that he would end his days a peer of the realm, and a veritable king among the world's millionaires. His parents were poor enough in all conscience; his forbears, for many a generation back, had found life a rather hard struggle for bread and for a roof to keep the rain out, and the infant George might thank his lucky stars if at his zenith he had a few acres to farm or a small shop to call him master.

But the same might have been said of George's cousin, Donald Smith, then a boy of nine, who, though none dreamt anything so absurd, was also to blossom into a baron and a multi-millionaire; of Andrew Carnegie, who opened his eyes, seventeen years later, in a Dunfermline cottage, and of many another little Scot who has startled the world in later life by his swift climb to rank or riches.

"Dowered with Brains."

That George Stephen had been dowered with brains was abundantly clear from his earliest days. It was little schooling that fell to his share; but what little there was, he mastered at a rate which startled his teacher. Everybody in Dufftown recognized that George was a "smart lad;" but there were plenty of other smart lads in Dufftown, and there was no reason why he should do better than the others.

But George, young as he was, had different views. When, in his spare time, he was herding the minister's cattle, or fishing,

From Herd Boy to Millionaire

The Story of Lord Mount Stephen

a barefooted laddie, with his big cousin Donald, he began, so he says, to dream dreams of what he would do some day out in the big world. Donald meant to cross the seas to seek fortune, and some day when he was big enough, he would follow him, and then—Foolish dreams, maybe, for a cottar's lad to indulge in; but it is from such boyish visions as these that many of the greatest careers in the world have crystallized.

It soon became clear to his parents that George would never settle down to the humdrum life of the country side. Almost before he had reached his teens he was restless to be off. Donald had gone to distant Labrador to begin his laborious climb to riches and a peerage; and although George could not follow so far in his cousin's footsteps, neither could he stay to vegetate in Dufftown. And so, in the early thirties, he was packed off to Aberdeen, which loomed as large and mysterious almost as London, to the natives of Dufftown, to take his place behind a draper's counter. It was a poor start, to be sure, on the long journey to wealth and fame which he had set himself to accomplish; but at least it was a step in the direction of his desires.

Goes to London.

But Aberdeen by no means satisfied the lad's ambition. It

was no doubt an honorable ambition to become one of Aberdeen's leading citizens—this was well within his reach—but George Stephen had set his heart on a much more splendid

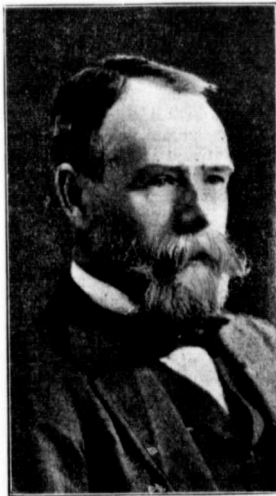

Lord Mount Stephen

goal, and after four years of hard work in the "granite city" he made up his mind to fare forth into the great world. There was a vacancy in the well-known wholesale and shipping-house of Pawson, of St. Paul's Churchyard, London; and it was

a proud day for George Stephen when he got it and secured a footing in the world's metropolis.

Then followed a few years of excellent business training, in which the canny young Scotsman completed his commercial education, winning golden opinions alike from his employers and his fellow servants. If he had been content to stay in London he might some day, it is true, have ridden in his gilded coach as Lord Mayor—a Scottish Whittington; but the call of the West was never out of his ears. Canada was the golden land of his dreams; there was scope there for the most boundless ambition, and Donald's letters, with their tale of hardship and slow but sure triumph, kept the fire of his unrest alive. What Donald could do he could do; they wanted men out there, and he was now a man, pining for difficulties to conquer and a career to carve out for himself.

In Canada.

And thus it came to pass that George shook the dust of London off his feet and turned his face to the West, as Donald had done a dozen years earlier, though it was not, like Donald, to the icy waters of Labrador that he went. He had another cousin out in Canada, one William Stephen, who kept a small dry goods store, and George was willing to act as his cousin's assistant for a time while he looked round him to find a more promising road to riches. For three years he worked early and late, and in that time so extended the business that William was glad to offer him a partnership, and thus the ex-herd boy placed his foot on the first rung of the ladder of fortune. A few years

later William died, and George now found himself sole proprietor of a business which had grown to huge proportions. He was a man of substance, and one of Montreal's most thriving and honored citizens.

With capital to spare he next started a cloth factory, and soon found so much gold in his new enterprise that he decided to leave shop-keeping to others and to give all his mind and energies to the manufacture of the raw material, with results that surprised even himself. His fortune grew by leaps and bounds; he was the "warmest" man in all Montreal, and as he walked through the streets boys would point him out to one another as Mr. Stephen, the rich manufacturer, who was once just as poor a lad as they were. The ball of fortune was now, indeed, at the feet of the cottar's boy, who was already far on the way to joining the ranks of the millionaires. So rich and so respected was he that, when the Bank of Montreal wanted a governor there were no two opinions as to who was most fitted for the honorable and responsible post. It was offered to Mr. Stephen, who in his fiftieth year, was promoted to the most enviable office in Canada, and without a single person to dispute his fitness or to grudge him his good fortune.

By this time "Cousin Donald" had already reached the governorship of the Hudson Bay Company, of which he had been the humblest servant, and was a member of the Canadian House of Commons. It was now a close race between the two Banffshire lads, the goal of which, though even they little suspected it, was to be the House of Lords at Westminster.

The C. P. R.

This was the time when the air was full of vast schemes for binding together all the North American colonies into one united Dominion, and the greatest of all these unifying schemes was the construction of a railway which should run from sea to sea, an artery of steel through which the life-blood of commerce should flow from one end of the Dominion to the other. It was a daring project—"Utopian," "impossible,"—many of the shrewdest men in America called it—but they didn't count on George Stephen and Donald, Smith. Over both men the project exercised an irresistible fascination. It was the kind of colossal, almost superhuman, task which called for precisely the indomitable energy and courage they possessed, and into it they flung themselves heart and soul.

There is nothing in human history grander than this struggle

against the arrayed forces of Nature and financial opposition which resulted in the Canadian Pacific Railway, the story of which is too long to tell here. It must suffice to say that grit triumphed; the Rockies were subdued and fettered with steel, torrents and mountain gorges were bridged, and the Atlantic was linked with the Pacific for all time. Rich as George Stephen was before he embarked on this great enterprise, his fortune was now increased many fold. He was made the first president of the railway which owed so much to his tireless and clever brain and to his unquenchable pluck; and when, in 1886, Queen Victoria made him a Baronet there was none to say that he had not well earned the honor. A more enduring monument of his work, however, is the huge mountain which raises its crest to the skies above the terrific gorge of the Rocky mountains, and which through the ages will be known as "Mount Stephen" in honor of this great Scotsman.

Elevated to the Peerage.

George Stephen, Baronet and millionaire, known and honored wherever the British flag flies, might well have considered that he had now reached his goal—a goal so far removed from his lowly Banffshire start—but greater honors still were to fall to his lot unsuspected. When, in 1891, Lord Salisbury was looking out for men of distinction to recommend to his Sovereign for the honor of a peerage, one of the first his eyes fell on was Sir George Stephen, who had rendered the Empire such splendid service, and as a Baron he was summoned to Westminster to place his ripe experience at the service of the State, happily choosing for his title the name of the mountain which in another continent will tell his fame to countless generations still unborn. Six years later "Cousin Donald" Smith was sitting in his Peer's robes by his side in the House of Lords.

Many men have amassed wealth as great as this son of Scotland, but few have dedicated it so generously to noble uses. The list of his benefactions would fill a column, and only the chief of them can be recorded here. Part of the debt he owes to Canada (which is small compared with Canada's debt to him) he has repaid by endowing the Victoria Hospital at Montreal with the princely gift of \$500,000. Into King Edward's Hospital Fund he has literally poured his gold until he has enriched it to the extent of \$150,000 a year for ever. Among his relatives he has distributed \$2,500,000, on the principle that "they may as well en-

Lend Variety to the Daily Menu

And add to the enjoyment of home cooking by using

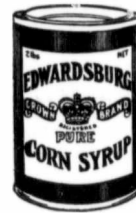

Crown Brand Corn Syrup

The purest and most delicious table syrup obtainable.

Crown Brand—clear as strained honey—gives a delightful flavor to dumplings, puddings, pastry, etc., and is especially desirable for serving with Buckwheat and Griddle Cakes, Cookies and Biscuits.

It is a most nourishing food—splendid for children, because it is so easily digested.

Next Time Try Crown Brand—Your Grocer Has It

THE EDWARDSBURG STARCH CO.
LIMITED
MONTREAL—CARDINAL—TORONTO—BRANTFORD—VANCOUVER

You saw this advertisement in this magazine. Don't forget to say so when writing.



FREE This 150 Piece Complete Scholar's Outfit FREE

BOYS AND GIRLS, NEVER BEFORE IN CANADA HAS SUCH A GRAND PREMIUM BEEN OFFERED AND SO EASY TO GET.

READ WHAT THIS GRAND SCHOLAR'S OUTFIT CONTAINS.

1 large leather bound school bag, 1 dozen fine quality H. B. pencils, 6 steel tip pen holders, 1 dozen 292 pennibs, 60 sheets of writing paper, 1 dozen envelopes to match, 1 box of 15 water color paints with brushes and pots, 10 beautiful drawing crayons of different colors, 1 fine quality steel blade penknife, 1 large hard wood slide top pencil box, 1 complete printing outfit containing type, ink, tweezers and stamping pad, 1 twelve inch ruler, 1 large memorandum book, 1 complete dater good for five years, 1 large rubber eraser, 1 steel blade pencil sharpener, and last but not least, 1 Swiss warbler for imitating birds and animals.

Think of this scholar's complete outfit is FREE. We are determined to sell a million packages of Marvel Bluing this year and are sparing no expense to reach this mark.

Marvel Bluing is a great improvement on the old style of bluing and goes twice as far. Everybody buys it because it is so good and a present is given away with every package.

We will give you one of these grand scholar's outfits if you will agree to sell ONLY 25 PACKAGES OF MARVEL BLUING AT ONLY 10¢ PER PACKAGE. Any boy or girl can sell 25 packages easy. No trouble at all.

We send you the Marvel Bluing free and trust you with it until sold. Simply send us your name and address to-day. Every girl and boy should win one of these grand scholar's outfits.

Try. If you can't sell the Marvel Bluing send it back to us.

Address to-day THE MARVEL BLUING CO., Dept. B. 138 Toronto, Ont.

EVERY BOY AND GIRLS ALWAYS PLEASUED WITH OUR PREMIUMS

You saw this advertisement in this magazine. Don't forget to say so when writing.

Family Group Photos a Speciality

AT

STEELE & CO., LTD.

MAIN ST. AND BANNATYNE AVE.

WINNIPEG

You saw this advertisement in this magazine. Don't forget to say so when writing.

joy some of my money while I am alive as when I am dead"—a precept which other millionaires might adopt with advantage—to their relatives. Nor has he forgotten the land to which he owes his birth, for to the Royal Infirmary, Aberdeen, of which he was a patient in his 'prentice days, sixty years and more ago, he has made several magnificent gifts, including sums of \$135,000, \$125,000, and securities yielding \$50,000 a year.

Though he is now nearing his eighty-second birthday Lord Mount Stephen carries his burden of years lightly. His beard and hair are white with the snows of time, but his eyes still sparkle with the zest of life, and his heart is as young as when, a barefooted lad, he fished the Banffshire streams and dreamed dreams which have been more than realized. If he has a trouble at all it is that he has no son to wear the honors and enjoy the riches he has won, but in the devotion of his adopted daughter, Lady Northcote, he finds much compensation for the knowledge that he will be the last, as he is the first, Baron of his line.



COUNSELS from the Classics

There is not less wit nor invention in applying rightly a thought one finds in a book than in being the first author of that thought.—*Boyle*.

ECONOMY is a Great Revenue.—*Cicero*.

TOO Great Haste Leads to Error.—*Moliere*.

LABOR, Bestowed on Trifles, is Silly.—*Martial*.

LET a Man Do the Work He Knows Best.—*Cicero*.

STUBBORN Labor Conquers Everything.—*Virgil*.

DESPATCH is the Soul of Business.—*Earl of Chesterfield*.

HE Who Considers too Much Will Perform Little.—*Schiller*.

WE Accomplish more by PRUDENCE Than by Force.—*Tacitus*.

THERE Can Be no Profit if the Outlay Exceeds It.—*Plautus*.

IT is Better to WEAR Out Than to RUST Out.—*Bishop of Cumberland*

ALL Historic Nobility Rests on Possession and Use of Land.—*Emerson*.

NOTHING Great was Ever Achieved Without Enthusiasm.—*Emerson*.

THE Principal Part of Everything is the BEGINNING.—*Roman Law Maxim*.

THAT Which is Everybody's Business is NOBODY'S Business.—*Isaak Walton*.

HONORS Come by Diligence; Riches Spring from ECONOMY.—*John Francis Davis*.



Seam-in-front stockings would seem absurd! Then why any seam?

You have kept on wearing stockings with a seam up the back—shapeless, uncomfortable things! because you probably didn't realize the perfection reached by Pen-Angle Seamless Full-Fashioned Hosiery. These are hose without the sign of a seam—look for the sign of the trademark. As they are being knit they are shaped lastingly to the curves of the foot and leg. They fit—they wear better—and the utter absence of any seam at all makes them ever so much more comfortable. No difference in cost—but much in quality, in economy and in comfort when you buy

Pen-Angle Full-Fashioned Seamless Hosiery

Next time you go shopping ask for the hosiery with the trademark that insures you foot-ease.

65

Made by **Penmans Limited** Paris, Canada



Makers of **Underwear Sweaters and Hosiery**

You saw this advertisement in this magazine. Don't forget to say so when writing.

JOKES

His Terrible Fear

The Sunday-school teacher had explained very carefully how Eve was created out of one of Adam's ribs and made the wife of Adam. Little Bobby was deeply impressed with the story, and when he went home he related it to his parents. The next day, after running around a good deal, a pain developed in his side, and when his mother found him he was lying on the bed, sobbing bitterly. "Why, what's the matter with my little boy?" she asked. "Oh, dear," was the response, "I'm getting a wife."



A Job for an Expert

A gang of navvies were employed on a railway contract

removing earth with wheel barrows. While proceeding with his work one of the navvies noticed that the wheel of his barrow was squealing terribly, and to put a stop to the noise he turned the barrow over, and was in the act of greasing it when the ganger noticed him and shouted out: "Halloa, O'Brien! Halloa, sir! What the deuce are you doing?" "I'm greasing my barrow, sir." "Who told you to do that?" "Sure, no one, sir, I took it upon myself." "Well, don't let me catch you at it again. What do you know about machinery?"



A parson, seeing a lazy man standing idly at the street corner, approached him and said: "Don't you know, my dear sir, that it is positively sinful to stand about wasting your time in this manner?"

The man replied—"Yes, I know it is, parson, and I'm going to stop it just as soon as I find a suitable place to sit down."



"What a stiff family those new rich people are?" "Yes; you see, they made their money in starch."



The wife of a literary man, it is said, once undertook to raise a brood of chickens. They turned out badly. She told a neighboring farmer's wife that they seemed to be doing all right at first, but in the course of a few days they all died in the coop.

"What did you feed them?" asked the farmer's wife. "Feed them?" exclaimed the author's helpmate. "I didn't feed them. I thought a healthy young pullet like that ought to have milk enough for her chicks!"

The Household Carpenter

Or How the Handy Man May Take His Part in "Home Economics."

IF Mrs. Harbottle suffers from one thing more acutely than most others, it is a general disinclination to recognize my extraordinary genius. Only the other day she discovered a lack of shelving accommodation, and was on the point of sending out for a carpenter.

"My good woman," I said, "why this needless expense? Why have the place turned upside down for a week, sawdust in the



When I grabbed at the saucepan-shelf overhead to steady myself, it came down with a shower of fourteen pots.

soup, shavings mingling with the breakfast bacon, and chisels and spirit levels getting under the cook's feet? Why, when you have a man on the premises who will do the work in a couple of hours, and not even perspire?"

"Is this a new riddle, Richard," she asked, "or have you got that strange feeling in the head again? Aren't you feeling well?"

"Show me the spot where these shelves are to be put, Mrs. Harbottle," I said briskly. "A little job like this can be done between drinks." Within half an hour I was at work with a ball of string.

"Hang on to that end, Mrs. Harbottle," I said smartly. "We'll soon get this worked out. Cook, you fetch me a stool to stand on, and call in the chore boy to take the sizes!"

Now, with a little help it doesn't take me long to set about a thing; but the people who lend a hand generally manage to make a muddle of the business. The stool wobbled at the critical moment, and when I grabbed at the saucepan-shelf overhead to steady myself, it came down on top of me with a shower of fourteen pots of assorted sizes.

"I thought you do something!" said Miriam sharply.

That's the way a man gets treated when he is trying to beautify the home and save money. They daren't talk like that to an outside workman. I dismissed the lot of them, measured up the wall myself without any aid, and went down for the lumber and tools.

The lumber merchant wasn't able to guage the amount I required, as he didn't know the number of shelves; and, as I couldn't tell him, not knowing myself, we had to make a guess at it. He sold me enough to build a small aeroplane hangar, and sent it home on a trolley.

The hardware merchant had a better idea.

"Haven't got a saw, I suppose?" "I've got an old one."

"Old ones are no good for that kind of work; better have a new one. Then you'll want a couple of planes for smoothing off the ends, and chisels—say, four sizes—and a hammer and nails, and a mallet. You'll want a lot of brackets, 'oo, and a spirit level, and a gimlet and a Bradawl. Shelves look nice stained; so we'd better say a gallon jar of walnut."

—I left it all to him, and by the time the articles were deposited at home I reckon he must have pretty well cleared the store. But I soon got to work. In half an hour you couldn't see the kitchen floor for shavings, and the cook was sublimely mixing a treacle-pudding in a thick atmosphere of sawdust.

Like a true workman, you pause in your labor to take a bit of lunch, but the meat always drops out of the sand vich mustard side down on the sawdust. And you never know what's happened to the mutton-fat you grease the saw with, until you empty the beer-jug, and find it at the bottom.

The way to put a shelf up is to smack a bracket hold on the wall, stick a nail in it, and smite hard with a hammer. My first attempt in this direction would have been a howling success if the hammer-head hadn't come off, and nearly brained the cook in its mad flight. At the second go I made a mis-hit by about a foot, and put a thumb out of action. The third go was nearer, but a trifle hard. My trusty nail went clean through into the waterpipe behind, and I had to pause for a couple of hours and save the basement from being flooded.

Here's [the doubt dispeller! The Vanadium built Ford is backed by a financial responsibility unmatched in the automobile manufacturing world—a responsibility that the car itself has built and must maintain. And it is your best guarantee.

Every third car is a Ford. Nearly 180,000 have been sold and delivered. New prices—runabout \$675—touring car \$750—delivery car \$775—town car \$1000—with all equipment, f.o.b. Walkerville, Ont. Get particulars from Ford Motor Company of Canada, Limited, Walkerville, Ont., Canada.

You saw this advertisement in this magazine. Don't forget to say so when writing.

FREE Extra Present

FREE! THESE SIX MAGNIFICENT PRESENTS (10 Pieces) FREE!

GIRLS!—THIS IS THE MOST WONDERFUL COMBINATION OF MAGNIFICENT PREMIUMS THAT HAS EVER BEEN OFFERED IN CANADA. JUST READ WHAT WE GIVE YOU, AND SO EASY TO GET.

SIX BIG PRESENTS—10 PIECES.
 THIS MAGNIFICENT GO-CART is made of solid steel, richly enameled in beautiful Royal Blue or Foxcock Green. It can fold up like a real baby carriage, and is positively the grandest carriage you could get. THE HANDSOME DOLL IS NEARLY HALF-A-YARD TALL, a perfect Eurasian beauty, dressed in complete frock to shoes in the latest style. She has lovely curly hair, peary teeth, sleeping eyes, and can move her hands, legs or feet, or sit down like a real baby. Then we give you the LOVELY LITTLE FRENCH "EUC" BAKING ROLL, and the handsome M. ALL-METAL D.C. & B. BED you have ever seen, complete with canopy top, mattress, back, bedspread, and all. Next comes the MAGNIFICENT SOLID GOLD SHELL RING, set with three sparkling jewels and an elegant 2 PIECE FAIRY KITCHEN set, a delightful toy for every girl. Last but not least, every girl who wins these six magnificent premiums can also receive an extra present of the exquisite sterling silver chateau watch.

A LIFETIME. We want to introduce at once, our new delicious Royal Japanese Perfumes, and are so lovely and delicious that you will use them all the first time you show them. Return our money only \$2.00, after you sell the perfumes, and we will immediately send you, all carefully packed, the Handsome Doll, Baking Tin-Cut, Baby Doll, Doll Bed, Gold Shell Ring and Fairy Kitchen Set, exactly as represented, and every girl who wins these 6 magnificent gifts by selling only \$2.00 worth of perfume can also win the exquisite sterling silver Ladies' Watch without selling any more goods. Write at once, to arrange to stand payment of all charges right to your door. Address:

THIS IS THE OPPORTUNITY OF NATIONAL PRODUCTS LIMITED Dept. K 434 TORONTO, ONT. 21

You saw this advertisement in this magazine. Don't forget to say so when writing.

Mackenzie, Brown, Thom & McMorran
Mackenzie, Brown, MacDonald & Bastedo
 Barristers, Solicitors, &c.
 Regina, Saskatchewan, Canada

Norman MacKenzie, K.C. T. Sydney McMorran Hon. George W. Brown
 Douglas J. Thom Frank L. Bastedo Hector V. MacDonald
 General Solicitors in Canada for the National Thresher Manufacturers' Association of America
 General Solicitors in Canada for the American Collectors' Association,
 General Solicitors in Saskatchewan for Fifteen Canadian and American Thresher and Implement Companies.

You saw this advertisement in this magazine. Don't forget to say so when writing.

"You seem to be getting on!" cooed Mrs. Harbottle, looking in. "Famously, my dear!" I chirped. "When I have hung out this suit to dry, and patched up the wall, I shall be well on the way towards getting a nail in. If all goes well, I shall have up one of the brackets tonight."

My wife is never unduly enthusiastic. She said something about making the place a dust-hole, and banged the door to show her approval.

Some men would be put off by little things like that, but they don't upset me. The thing that does upset me is for the cook to borrow one of my chisels, use it for poking the fire, and put it back in the box without notifying me of the temperature.

Anyhow, I began to get the first shelf into shape after a couple of days' work. A couple of brackets were up, and all I had to do to complete the tout ensemble of the thing, as it were, was to put the shelf on. There was a slight hitch at first, owing to my cutting it about a foot too short, and having to stick a bit on. This made no difference, except the artistic beauty of the thing was somewhat impaired. Jimson said he couldn't tell if it was a shelf or the framework of a staircase; but, then, he is notoriously jealous of my technical skill.

"I'll be bound, old friend," I said, in quite a friendly spirit, "that you couldn't put up a shelf like that if you were to try."

"You're right, Harbottle," he answered; "I couldn't. I'm thankful to say that I haven't come down to inflicting monstrosities of that kind on a suffering public. For a first-class botcher, you just about take the diploma. Chuck over that saw, and I'll show you how a proper carpenter would put up a shelf!"

Jimson has a special working method of his own. He doesn't put a board on a chair, and cut through on one side of it. He puts it on two chairs, and saws between them. When he is nearly through the board splits, and he goes down with it, and rips his trousers with the saw, and messes his hair up with sawdust, and uses farmyard language. When he'd spoilt about fourteen lengths of deal he got the shelf the right length.

"There you are!" he said. "Now what do you say?"

I didn't venture to say anything. I simply stood by with a chisel in one pocket, a pair of pliers in another, a tape measure around my neck, a saw between my teeth, and the tool-chest in my arms, ready to lend first-aid. We were now about to get to work in earnest.

"Fetch in the cook to hold the nail," said A. J. "We'll have this

job done in about two shakes of a lamb's tail."

This was a mere figure of speech. The more people Jimson has to help him the longer he takes, and he can only work in the middle of a crowd. The cook came in to hold the nails, and the chore boy stood by to hand up the hammer. Then he fetched a couple of boys on their way home from school to keep the shelf in position, and stopped a coal-man on his round to hold the steps.

Having mounted on the top, like a general surveying the operations, he hitched up the board, and smacked it on the supports.

"A bit more to the left!" he ordered. "Too much; more to the right! That's about it!" Harbottle, step back and see if it's even."

It was even. Jimson gave a smile of triumph.

"I'll just see if it bears," he said, "then I'll fix it."

He ought to have known better than to do what he did. We don't want selves strong enough to hold citizens weighing about 250 lbs. apiece. He put his whole weight on it, and the supports care out with a rip. The shelf shot down with him on it, capsizeing the two boys; the steps collapsed on the top of the coal-man, and the cook sat down in the tool-box, distributing five pounds of tempenny nails in her descent. I was the only person

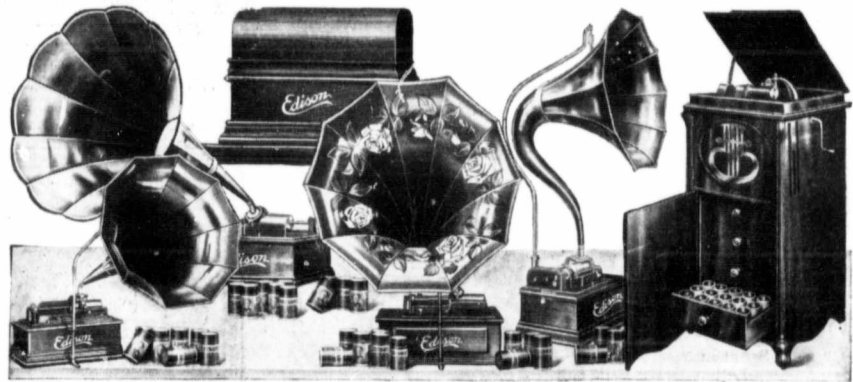

Wonderful NEW Edison Shipped FREE



Mr. Edison's Pet and Hobby

He realizes the wonderful value of his phonograph as a cement of home ties and as a maker of happy homes. And for this reason he worked for years striving to produce the most perfect phonograph. At last he has produced this new model, and his friends have induced him to take the first vacation he has had in over a quarter of a century. Just think of it: over twenty-five years of unremitting work on many new inventions—then his pet hobby perfected—then a vacation.

Write today for our New Edison Catalog that tells you all about the wonderful new model Edison with Mr. Edison's new model R Reproducer and the new parlor grand equipment. With this catalog we also send full explanation of our free shipment offer.

The Offer We will send you the new model Edison Phonograph and your choice of over a thousand records on an absolutely free loan. We want you to have all the waltzes, two steps, vaudeville, minstrels, grand operas, also the sacred music, etc., etc., by the world's greatest artists. Entertain your family and your friends. Give plays and concerts right in your own parlor. Hear the songs, solos, duets, and quartettes, the pealing organ, the brass bands, the symphony orchestras, the choirs of Europe's greatest cathedrals, the piano and violin concerts, virtuoso—all these we want you to hear free as reproduced on the new Edison. Then, when you are through with the outfit you may send it back to us.

Mr. Edison Says

"I want to see a phonograph in Every Home."

Read this remarkable free shipment offer on the first lot of the new style Edison Phonographs—these new Phonographs to be shipped free on this special offer now.

The Reason

Why should we make such an ultra-liberal offer? Why should we go to all this expense and trouble just so you can have all of these free concerts? Well, we'll tell you. We are tremendously proud of this magnificent new instrument. When you get it in your town we know everybody will say that nothing like it has ever been heard—so wonderful, so grand, so beautiful, such a king of entertainers—so we are pretty sure that at least some one, if not you, then somebody else, will want to buy one of these new style Edisons (especially as they are being offered now at the most astounding rock-bottom price and on easy terms as low as \$2.00 a month.) But even if nobody buys there is no obligation and we'll be just as glad anyway that we sent you our free loan; for that is our way of advertising quickly everywhere the wonderful superiority of the New Edison. But don't delay sending the coupon today.

Why should we make such an ultra-liberal offer? Why should we go to all this expense and trouble just so you can have all of these free concerts? Well, we'll tell you. We are tremendously proud of this magnificent new instrument. When you get it in your town we know everybody will say that nothing like it has ever been heard—so wonderful, so grand, so beautiful, such a king of entertainers—so we are pretty sure that at least some one, if not you, then somebody else, will want to buy one of these new style Edisons (especially as they are being offered now at the most astounding rock-bottom price and on easy terms as low as \$2.00 a month.) But even if nobody buys there is no obligation and we'll be just as glad anyway that we sent you our free loan; for that is our way of advertising quickly everywhere the wonderful superiority of the New Edison. But don't delay sending the coupon today.

FREE Our New Edison Catalog

Write today for our New Edison catalog and learn all about the wonderful New Edison. Learn how thousands of people are entertaining their friends by giving Edison concerts—learn how the boys and girls are kept at home and all the family made happy by the wonderful Edison. No obligations whatsoever in asking for this MAGNIFICENTLY ILLUSTRATED catalog, so send the free coupon now—today.

Babson Bros. Edison Phonograph Dist., Dept. 7709
365 Portage Ave., Winnipeg, Man.
U.S. Office, Edison Bldg., Chicago.

FREE Coupon

BABSON BROS.
Edison Phonograph Distributor
355 Portage Ave., Winnipeg, Man.
Dept. 7709
Dear Sir: Please send me your New Edison Catalog and full particulars of your free loan offer on the first lot of the new model Edison Phonographs.

Name.....
Address.....

undisturbed, and I came in for the blame.

We got the supports up again in a fresh place, and rearranged the shelf, with the help of an extra man Jimson called in from outside.

"Now, don't get upsetting my work this time!" he growled. "I'll manage the scientific part; all you others have to do is to obey orders! Now, then: Boys to the shelf! Hammer, Bob! Nails.

There was such an electric dash on the part of everybody, that Jimson got hustled in the scrimmage. The hammer caught him in the ribs, and he turned round quickly, and bumped his nose on the shelf edge.

"Clear the whole blessed lot out, Harbottle!" he raved. "Leave me alone to it! I'll do the job myself in half the time!"

It was a do, too! The wall looked like a football ground after an International match on a muddy day, and the shelves were about a foot higher on one side than on the other. And it took the cook, with the help of the gardener, two hours to clear up afterwards. Jimson, wouldn't wait to be thanked, but modestly withdrew, and went home to his supper. And Mrs. Harbottle came in, and gave me the credit for the job.

"Well," she said sorrowfully, "it's exactly what I might have expected of you, Richard! If you'd only let a practical man like Mr. Jimson do it!"

One of these times, when I've got a few weeks to spare, I'll pull the shelves down and put up some good ones myself.



FREE TO YOU. The best premiums and biggest values ever offered. Gold and Silver Watches, Gem set Rings and Brooches, Laughing, producing MOVING PICTURE MACHINES, finely-decorated TEA SETS, SILVERWARE, ACCORDIONS, LOVELY DRESSED DOLLS and many other beautiful premiums given FREE for selling our high-class GOLD EMBOSSED PICTURE POST CARDS at 6 for 10c. Our cards are the very latest designs in FLORAL, BIRTHDAY, HOLIDAY, VIEWS, COMICS, &c., in artistic colors and of such superior quality that you will have no trouble selling them.

JUST SHOW THEM AND TAKE IN THE MONEY. You can win any of these splendid premiums by selling \$2.00 worth and upwards, and if you will write to-day you can also win one of the EXTRA PREMIUMS we are giving to those who are prompt. Send us your name and address, plainly written, and we will forward you a package of cards and our big premium list. We get a great many repeat orders from our customers. Why? BECAUSE OUR PREMIUMS ARE THE BEST. COBALT GOLD PEN CO., Dept. 194 Toronto, Ont.

You saw this advertisement in this magazine. Don't forget to say so when writing.

Colonel Crockett's
Co-operative Christmas

Spent in New York City—As Told by Himself in
Letters to His Wife on the Ranch in Texas.

By RUPERT HUGHES

The Best Christmas Story Written Since Dickens Let All-the-World-and-His-Wife
into the Heart of Scrooge

New York N. Y.,
Dec. 26, 1903.

Friend Wife:

The miserabest night I ever spent in all my born days — the solitariest, with no seconds—was sure this identical Christmas night in New York city. And I've been some lonesome, too, in my time.

There was people aplenty. But I didn't know one goldarned galoot. I had plenty of money, but nobody to spend it on — except tiptakers. I was stopping at this big hotel with lugsury spread over everything thicker than sorghum on corn pone. But lonely — why, honey, I was so lonely that, as I walked along the streets, I felt as if I'd like to break into some of the homes and compel 'em at the point of my gun to let me set in and dine with 'em.

I felt like asking one of the bellboys to take me home and get his ma give me a slice of goose and let her talk to me about her folks.

There was some four million people in a space about the size of our ranch. There was theaters to go to—but who wants to go to the theater on Christmas?—it's like going to church on the Fourth of July. There were dime muzhums, penny vaudevilles, dance-halls.

There was a big dinner for newsboys. The Salvation Army and the Volunteers gave feeds to

the poor. But I couldn't qualify. I wasn't poor. I had no home, no friends, no nothing.

The streets got deserted and deserted. A few other wretches was marooned like me in the hotel corridors. We looked at each other like sneak-thieves patrolling the same street. Waiters glanced at us pitiful as much as to say, "If it wasn't for shrimps like you, I'd be home with my kids."

The worst of it was, I knew there were thousands of people in town in just my fix. Perhaps some of them were old friends of mine that I'd have been tickled to death to foregather with; or, leastways, people from my State. Texas is a big place, but we'd have been brothers and sisters—or at least cousins once removed—for Christmas's sake.

But they were scattered around at the St. Regis or the Mills Hotel, the Martha Washington or somewhere, while I was at the Waldorf-hyphen-Astoria.

It was like the two men that Dickens—I believe it was Dickens — tells about: Somebody gives A a concertina, but he can't play on it; winter coming on and no overcoat; he can't wear the concertina any more than he can toodle it. A few blocks away is a fellow, Mr. B. He can play a concertina something grand, but he hasn't got one and his fingers itch. He spends all his ready money on a brand-new overcoat,



For the Modern Baby Bunting

Daddy doesn't go out to hunt for rabbit skins. He is less romantic, but more practical. He buys a

PERFECTION SMOKELESS OIL HEATER

and all during the cold Fall and Winter months his house is kept warm and cozy for his wife and babies.

A Perfection Oil Heater is almost indispensable when there are children in the home. Every home has uses for it.

Made with nickel trimmings, plain steel or enameled, turquoise-blue drums. Ornamental. Inexpensive. Lasts for years. Easily moved from room to room. At dealers everywhere.

THE IMPERIAL OIL COMPANY, Limited
WINNIPEG MONTREAL TORONTO ST. JOHN HALIFAX

You saw this advertisement in this magazine. Don't forget to say so when writing.

Let us BRIGHTEN up this Christmas for you FREE OF CHARGE!

Do not spoil your Christmas this year by burning common coal oil. The coupon below is good for one quart of

NATIONAL LIGHT COAL OIL

Fill it in and make your Christmas brighter—your family happier. Costs you nothing but a postage stamp—DO IT NOW.

Canadian Oil Companies Limited
Winnipeg, Man.

My Name is.....

P.O. Address.....

My Dealer's Name is.....

Beautiful Large Size Solid Nickel Plated Parlor Lamp

GIVEN AWAY ABSOLUTELY FREE

We are offering our New Brand Kerosene oil which we claim to be the Best Grade of oil made yet. In refining this oil we use a double process, which takes out all bad odors. This oil will give a clear white light and last longer.

In order to advertise this oil, and get the people of the northwest using our oil, we are going to give away 2000 of our new style, large size Nickel Plated Parlor Lamp that stands 24 inches high and has a large White Dome Glass Shade. This lamp gives 100 candle power light and is a Beautiful lamp for any home and cannot be bought at any store for less than \$6.00.

Our Offer

Send us an order for one Barrel of our famous Silver White Kerosene Oil, that holds 42 Imperial gallons or 52 American gallons at 27 1/2 c. a gallon. We will send you Free one of our Parlor Lamps as mentioned above, and if you are not well pleased with this oil and lamp we will make no charges for what oil you have used and will refunded your money cheerfully. We make shipments prompt and pack lamp so it cannot get broken. We will give away only 2000 of these lamps, so fill out coupon below and send us your order at once. Address all orders to

Empire Oil Co.
Winnipeg, Manitoba.

Enclosed find \$11.55 Please send me one barrel of your Kerosene oil, with which I am to receive one of your Parlor Lamps Free with the understanding that if I am not satisfied, my money will be returned.

Name _____

Town _____

Empire Oil Co.

Winnipeg

BOX 2196

Manitoba

WE PAY YOU \$1.50 FOR BARREL WHEN EMPTY

You saw this advertisement in this magazine. Don't forget to say so when writing.

and just then his aunt sends him another one. He thinks he'll just swap one of them overcoats for a concertina. So he advertises in an exchange column. About the same time, A advertises that he'll trade one house-broken concertina for a nice overcoat. But does either A or B ever see B's or A's advertisements? Not on your beautiful daguerreotype.

That was the way with us all in New York. The town was full of lonesome strangers, and we went moping round, stumbling over each other and not daring to speak.

They call us "transients" here. It's like a private soldier that's killed in a battle; he's only a "casualty." So you poor, homeless dogs in New York are only transients. Why, do you know, I was that lonely I could have stood out in the square like a lonely old cow out in the rain, and just moored for somebody to take me in.

I'd have telegraphed for you and the children to come to town, but Texas is so far away, and you'd have got here too late, and you couldn't come anyway, being sick, as you wrote me, and one of the kids having malarial. How is his blessed self today? I hope you're feeling better. Telegraph if you ain't, and I'll take the first train home.

Well, last night I ate a horrible mockery of a Christmas dinner in a deserted restaurant, and it gave me heartburn (in addition to heartache) and a whole brood-stable of nightmares. I went to bed early, and stayed awake late.

I tried Philosophy — the next station beyond Despair. I said to myself, "You old fool, why in the name of all that's sensible should you feel so excited about one day more than another?" I wasn't so lonely the day before Christmas, I ain't so lonely today, but then I was like a small boy with the mumps and the earache on the Fourth of July. The firecracker will pop just as lively another day, but—well, the universe was simply thrown all out of gear, like it must have been when Joshua held up the moon—or was it the sun?

You remember reading me once about—I reckon it was Mr. Aldritch's pleasing idea of the last man on earth; everybody killed off by a pestilence or something, and him setting there by his lonely little lonesome; an' what would he have done if he had heard his doorbell ring? Well, I reckon he'd have done what I'd have done if I'd met a friend—given one wild whoop, wrapped his arms round his neck, kissed him on both cheeks, and died with a faint gurgle of joy.

Finally, I swore that if I ever foresaw myself being coralled again in a strange city on Christmas, I'd put on a sandwich board or something and march up and down the streets with a sign like this:

I'm lonely!

I'm homesick for a real Christmas!

There must be others.

Let's get together!

Meet me at the Fountain in Union Square!

We'll hang our stockings on the trees.

Perhaps some snow will fall in 'em.

Come one—Come all!

Both great and small!

I bet such a board would stir up a procession of exiles a mile long. And we'd get together and have a good crying match on each other's shoulders, while the band played Old Lang's Sign.

But it's over now. I've lived through the game of Christmas solitaire in a big city, and I feel as relieved as a man just getting out of a dentist's office. He's minus a few molars, and aches considerable, but he's full of a pleasing emptiness.

But let me say right here, and put it in black and white: If I'm ever dragged away from home on Christmas, I'll take laughing-gas enough for a day and two

nights, or I'll take some violent steps to get company, if I have to hire a cayuse and a lariat and rustle Broadway, rounding up a herd of other unbranded stray cattle.

Well, this is a long letter for me, and I will close. Love and kisses to the sweet little kids and to the best wife a fellow ever had.

Your loving

Austin.

P.S.—I pulled off the deal all right. The syndicate buys the mine. I get \$500,000 in cash and \$500,000 in stock, and I start for home in three days. We'll hang up our stockings on New Year's Day.

[The Fates accepted Colonel Crockett's challenge, and, by an irresistible syndication of events, forced him to be alone in New York again the very next Christmas. After a series of masterly strokes, he had felt rich enough in his two millions to spend a year abroad with his family. A cablegram called him to America early in December, to a directors' meeting. Expecting to return at once, he had left his family in Italy. A legal complication kept him postponing his trip from day to day; and finally an important hearing, in which he was a valued witness, was postponed by the referee—or deferee—till after the holidays. The Colonel saw him-

self confronted with another Christmas far away from any of his people. The first two days he spent in violent profanity, and in declining invitations which he received from business acquaintances to share their homes. Then he set out to make the occasion memorable. Once more we may leave the account to him.]

New York, Dec. 28, 1904.
Friend Wife:

Well, I've been and went and gone and done it! And golly, but it was fun—barring wishing you and the little ones had 'a' been here, too. Next year we'll arrange it so, for I'm going to do it again. You remember Artemus Ward's man who "had been dead three weeks and liked it." Well, that's me. This camping out in New York is getting to be a habit. I'm send you a bundle of newspaper clippings as big as a stovepipe—all about yours truly.

As soon as I saw that circumstances had organized a pool to corner me and my Christmases, I spent a couple of days sending rain-making language. Then I settled down to work like a bronco does to harness after kicking off the dashboard and snapping a couple of traces.

"If I've got to be alone this Christmas," I says to myself, "I'll make it the gol-darnedest crowdedest solitude ever heard of this side of the River."

I looked for the biggest place in town under one roof. Madison Square Garden was it. You remember it. We was there to the Horse-Show—so-called. You recollect, I reckon, that the Garden holds a right smart lot of people. At a political meeting once they got 14,000 people into it, and there was still room for Grover Cleveland to stand and make a speech.

Well, feeling kind o' flush and reckless-like, I decided to go and see the manager, or janitor, or whatever he is. And go I went. I says to him: "Could I rent your cute little shack for one evening—Christmas Eve?"

"Certainly, sir," he says. "There happens to be nothing doing this Christmas Eve."

"How much would it set me back?" I says very polite.

"Only one thousand plunks," says he.

"But, my dear Gaston," I says with a low bow, "I don't want to buy your little Noah's Ark for the baby. I only want to borrow it for one evening."

"One thou. is our bargain-counter limit," he says. "I couldn't make it less for the poor old Czar of Rooshy."

I kind o' hesitated, remembering the time when a thousand dollars would have kept me comfortable for about three years.

SMASHING

Free Trial OFFER

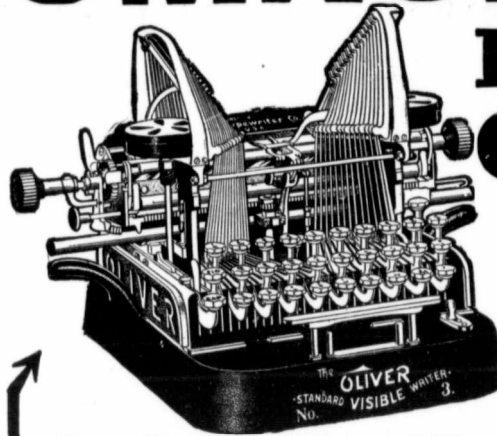

This is positively the most astounding—the most amazing offer ever made in the history of the typewriter business. Dealers everywhere baffled by our wonderful offer!

Genuine Oliver No. 3
The King of Typewriters!
Send no money with coupon

\$250 and You Keep This Machine

If you know typewriters you know the Oliver—if you do not, just ask any typewriter operator about the Standard Oliver No. 3. Then you will realize what a simply tremendous opportunity this is to get the world's greatest typewriter on our amazing Free Trial Offer. No matter what your business is or even if you are not in business at all—you need an up-to-date typewriter. Helps your standing in the business and professional world—saves time and money. Don't write long hand another day when you can get this superb Standard Oliver No. 3, the king of typewriters on our astounding free trial offer.

Here is Our Free Trial Offer

We will ship to you for an absolutely free trial a genuine Standard Oliver Typewriter No. 3. Send us no money—no, not a cent! We want you to use this superb machine in your own home and office absolutely free. Write your business letters with it—send out your bills typewritten and see how much better your collections are—let your family learn to use it—all on our free offer—and then, if you are not convinced that the Oliver will pay for itself over and over again, just tell us that you don't want it and return the machine to us at our expense. If after the free trial you decide that you do want it, send us only \$2.50 and you keep the machine, paying the balance in small monthly payments. But send for the full particulars of this great free trial offer today. Let us tell you all about it.

Send the Coupon Today

Don't fail to fill out the coupon and send it to us now. Remember that this is a limited offer—already our force is working day and night to meet the tremendous demands. Get in your application at once. Send the coupon today for our illustrated catalog, application blank and full particulars of this startling Free Trial Offer. It will pay you to investigate this startling offer and use this superb machine in your own home or office absolutely free. You will be under no obligations—so send the coupon now while the offer lasts.

Canadian Typewriter Syndicate, 355 Portage Ave. Dept. 7709, Winnipeg, Canada. Gentlemen:—This is no order for anything, but you may send me free and postpaid your Typewriter Book, Free Trial Application Blank and full particulars of your Free Trial Offer.

Canadian Typewriter Syndicate
355 Portage Avenue Dept. 7709 Winnipeg, Canada

Name _____ Address _____

You saw this advertisement in this magazine. Don't forget to say so when writing.

It's hard to get over the habit of counting your change. Then Mr. Janitor, seeing me kind o' groggy, says, a little less polite:

"If that's more than you care to pay for a single room you can get a cot for five cents on the Bowery; for a quarter you can get a whole suite."

That riled me. I flashed a wad of bills on him that made his eyes look like two automobile lamps. He could see it wasn't Confederate money, either. Then I shifted my cigar to detract at-

tention while I swallowed my Adam's apple, and I says:

"I was only hesitating, my boy, because I wondered if your nice young Garden would be big enough. You haven't got a couple more to rent at the same price?"

He wilted and caved in like a box of ice cream does just before you get home with it. Then he began to bow lower, and we cut for a new deal.

He says what might I be wanting to use the Garden for?

"Oh, I won't bulge the walls or strain the floor," I says. "I only want it for a Christmas tree. I am going to invite my friends to a little party."

"Whew, but you must be popular!" he says. "Who the dickens are you? Brother Teddy, or Mother Eddy?"

"I'm Colonel D. Austin Crockett, of Waco," I says as meek as I could.

"Pleased to meet you, Colonel," he says. "What you running

Trappers Names

are valuable to us. Your name in our possession will be just as valuable to you. We pay the highest prices for furs. Ship them to us.



Mention this magazine when writing advertisers

Gas, Automobile and Traction Engineering



Regular Winter Quarter commences November 26. No vacation during holidays, except Christmas and New Year's Days. Special Winter Term for short course students begins Jan. 6, 1913.

Each course may be finished in three months.

Highland Park College

In three months than in that many years as an apprentice. Students work in the machine shops, traction engine house and auto garage.



Mention this magazine when writing advertisers

Hunters and Trappers

Save your fine Specimens! Every trophy you kill is worth money to you.

Mount Birds and Animals

also heads, fish, and to tan hides, make rugs, robes, etc.

Special for Canadian Students

For a short time we are making a special reduced price to Canadian students. Act promptly. Write today.

Mention this magazine when writing advertisers

Send your Raw FURS to John Hallam

Sixty Thousand trappers now send us their Raw Furs. Why not you? We pay highest prices and express charges.

FREE Our "Up to the minute" Fur questions and the last Edition of HALLAM'S TRAPPERS GUIDE.

Mention this magazine when writing advertisers

for?—District Attorney? Or are you starting a new Mutual Benefit Life Assassination?"

"Neither," I says; "I'm a stranger in New York."

"But these friends of yours?" he gasped. "Is all Waco coming up here on an excursion?"

"Mr. Prosecutor," I says, "if you'll stop cross-examining a minute, and let me tell how it all happened, it will save right smart of time. I am a stranger here to about four million people. They are strangers to me. We ought to know each other. So I'm going to give a little Madison Square Garden warming and invite 'em in."

"What are you going to sell 'em—prize poultry, or physical culture?"

"I've nothing to sell. I'm just going to entertain 'em."

"Well, I've heard of Southern hospitality," he says, "but this beats me. How much you going to charge a head?"

"Nothing. Everything is to be free. Admission included."

"Not on your dear old Lost Cause!" he exclaims. "Leastways not in our little doll's house. Not for ten thousand dollars! Why, man, do you realize that if you offered these New York, Brooklyn, Bronx, Hackensack and Hoboken folks a free show, more'n two thousand women would get trampled to death? Did you ever see a bargain-counter crowd on Twenty-third Street? Well, that's only for a chance to get something they don't want at a fishbait price. But if you offered them a free, 'take-one' chance—holy gee-whizz!—I can just see it now! The Garden ain't half big enough in the first place. There's enough Take-On-ers in these parts to fill the old Coliseum. And they'd make the wild animals look like a cage of white rabbits."

Well, the upshot of it was, he persuaded me to charge an admission; so we set it at \$1.00 a head "on the hoof." I wrote out a card and sent it to all the papers to print at advertising rates. It cost right smart, but looked neat:

To Every Stranger in New York and His Lady.

If you are not otherwise engaged on Christmas Eve, the honor of your presence at Madison Square Garden is requested by

David Austin Crockett, Colonel Fifth Texas Cavalry, C. S. A.

Music, Dancing, Refreshments, Souvenirs. For the purpose of keeping out the undesirable element a charge of \$1.00 will be made.

I knew that them magic words, "Refreshments and Souvenirs," would hit 'em hard. In order to

Household Expenses

If the head of your home were removed—would the comfortable daily routine go on as before?

Life Insurance will answer the question.

Over 34,000 persons have found the best reasons for entrusting their Insurance to

The Great West Life Assurance Co.

Head Office: WINNIPEG.

Lowest rates—highest profits. Over \$79,000,000 now in force

You saw this advertisement in this magazine. Don't forget to say so when writing

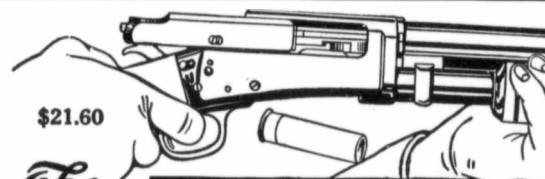

\$21.60

The Marlin Repeating Shotgun

12 or 16 GAUGE

Made famous by its dependability. The solid top and side ejection keep gases and powder away from your eyes; help quick, effective repeat shots.

The mechanism is strong, simple, wear-resisting. The double extractors pull any shell instantly; two special safety devices prevent accidental discharge while action is unlocked, and an automatic recoil block makes bang fires harmless.

Send three stamps postage today for our 136 page catalog describing the full Marlin line.

The Marlin Firearms Co. 100 Willow Street New Haven, Conn.

You saw this advertisement in this magazine. Don't forget to say so when writing.

THE lifetime of daily service a Waltham watch gives, combined with its grace and beauty, makes it the ideal holiday gift.

WALTHAM Colonial Series

A Waltham Colonial of the Riverside grade is especially recommended for professional, business and social purposes. It is as thin as it is safe to make a reliable watch. The absolute reliability of Riverside movements has been proved in thousands of instances by a full generation of service. Riverside is made in various sizes for ladies and gentlemen. Write for Descriptive Booklet.

"It's Time You Owned a Waltham"

WALTHAM WATCH COMPANY Montreal, Canada

You saw this advertisement in this magazine. Don't forget to say so when writing.

CHALLENGE GOLLARS

Save you money

Stop all laundry troubles. "Challenge" Collars can be cleaned with a rub from a wet cloth—smart and dressy always. The correct dull finish and texture of the best linen.

If your dealer hasn't "Challenge" Brand write us enclosing money, 25c. for collars, 50c. per pair for cuffs. We will supply you. Send for new style book.

THE ARLINGTON CO. OF CANADA Limited 54-64 Fraser Ave., Toronto, Can. 2142

You saw this advertisement in this magazine. Don't forget to say so when writing.

**If You Have a Motor Car
Jaeger Motor Coats and
Usters will Interest You**

**They are Very Comfortable!
Very Stylish! Well Made!
Durable!**

A Jaeger Double Fleece Coat gives greater warmth and does not induce perspiration like a leather or fur coat.

See them at the Jaeger Stores in their attractive variety.

Dr. JAEGER SANITARY WOOLEN SYSTEM Co.

364 Portage Avenue, Winnipeg, Man.
316 St. Catherine St., West, Montreal
231 Yonge Street, Toronto, Ont.
And from JAEGER Agents throughout the Dominion

Mention this magazine when writing advertisers.

TACKS

WE ARE MANUFACTURERS OF ALL KIND OF
Guaranteed Tacks and Small Cut Nails

ALSO MAKE A SPECIAL FEATURE OF
Brass Plating and Electro Tinning.

Write for Quotations to
Dominion Tack and Nail Co.,
Limited,
GALT, ONTARIO

Mention this magazine when writing advertisers



**SYNOPSIS OF CANADIAN NORTH-
WEST LAND REGULATIONS**

Any person who is the sole head of a family or any male over 18 years old, may homestead a quarter-section of available Dominion land in Manitoba, Saskatchewan or Alberta. The applicant must appear in person at the Dominion Lands Agency or Sub-Agency for the district. Entry by proxy may be made at any agency, on certain conditions, by father, mother, son, daughter, brother or sister of intending homesteader.

Duties—Six month's residence upon and cultivation of the land in each of three years. A homesteader may live within nine miles of his homestead on a farm of at least 80 acres solely owned and occupied by him or by his father, mother, son, daughter, brother or sister.

In certain districts a homesteader in good standing may pre-empt a quarter-section alongside his homestead. Price \$3.00 per acre. Duties—Must reside six months in each of six years from date of homestead entry (including the time required to earn homestead patent) and cultivate fifty acres extra.

A homesteader who has exhausted his homestead right and cannot obtain a pre-emption may enter for a purchased homestead in certain districts. Price \$3.00 per acre. Duties—Must reside six months in each of three years, cultivate fifty acres and erect a house worth \$300.00.

W. W. COREY,
Deputy of the Minister of the Interior
N.B.—Unauthorized publication of this advertisement will not be paid for.



WELL DRILLING

**GUS PECH
FOUNDRY AND
MANUFACTURING
COMPANY**

Manufacturers of the
Celebrated

**MONITOR WELL
AUGERS AND
DRILLS**

Write for prices
and Illustrated
Catalogue.

124 MARSH, IOWA
U.S.A.

Branch House:
REGINA, SASK.

Mention this magazine when writing advertisers

whet the public interest, I asked the papers where I advertised to give the thing some editorial or other reference. But they were very cold and said the best they could do was to send their dramatic critics to criticize the show afterward. A lot of good that would do me! So I took more space in advertising.

In a day or two I was visited at the hotel by one of the most imperudent young fellow I ever met up with. He sent up a card, "James J. James, Publicity Expert." I said to show him in, and he sort of oozed through the door — he was that oily. He looked about to see if we was alone, then winked slow and important, and says:

"What's your game, Colonel? It looks pretty slick, but I can't quite make it out. It's a new bunco, all right, but slick as it looks, it ain't quite so slick as it ought to be."

"Look here, you cub," I roared, "if you imply that I have any evil motives in this, I'll shoot you so full of holes you'll look like a mosquito net!"

He wasn't a bit scared, and said in a kind of foreign-sounding:

"Forget it, Colonel! Cut it out! Back to the alfalfa with your Buffalo Bill vocabulary! If you are really on the level, you don't need to prove it with artillery. But it makes no diff. to me about that. My business is producing fame, not merit. Once more I ask, what's your lay?"

I overcame a desire to kick him through the ceiling, and told him I proposed to entertain the strangers in New York.

"Strangers in New York?—Why, that means everybody! There's been only one man born in New York since the war, and he's kept in alcohol at a dime museum. Your idea is really to give old New York a Christmas party, eh? Very pretty, indeed! But if you insist on exploding money all over the place, I don't see why you shouldn't get a run for it. Besides, I need a bit of it myself. What you want is a press agent. You're starting all wrong. People in New York can't understand or believe anything except through the language of the press agent. You take one on your staff, and in three days you'll be so famous that, if a child in a kindergarten is asked who is the Queen of Holland, it will answer: 'Colonel Crockett, of Waco.'"

Well, he poured out the most remarkable string of talk I ever heard, and before I knew it he had made me promise to trust my soul and my scheme to him; to be surprised at nothing that might appear in the papers, and to refer all reporters to him. The next morning I found my name



FREE-MAGNIFICENT PHONOGRAPH-FREE

Here is the most stupendous offer ever made by any reliable firm. We will give away, absolutely free a cost 1.000 of these magnificent imported phonographs, complete with your choice of thousands of the newest and most popular records.

This is the Chance of a Lifetime.

Grasp It Now.

This magnificent phonograph will talk, sing songs, play orchestra or band music, tell funny stories and in fact **DO EVERYTHING YOU WOULD EXPECT OF A \$50.00 MACHINE.** You want a phonograph for your home, but don't throw away your money by paying \$25.00 to \$50.00 to get one, when you can get this magnificent instrument absolutely free for just a few minutes easy work.

Now all we ask you to do, is just send us your name and address to-day, and let us send you by return of mail, all charges paid, just one of our famous Gold Dollar Concentrated Flavoring Extracts to sell for us among your friends as only 25c. each. These wonder flavors are the greatest improvement on ordinary extracts ever achieved. Handsomely put up in collapsible tubes, all the best flavors—Vanilla, Lemon, Orange, Raspberry, Strawberry, Almond and 20 others. Four drops of Gold Dollar Flavor equals a teaspoonful of ordinary extracts.

Every tube is guaranteed to equal five regular 25c. bottles of regular flavorings. Every homesteader you show them to wants to buy three or four tubes of the different flavors we send, and every lady who buys a trial tube can receive free from us, a magnificent edition of a new cook book, worth 50c. You cannot fail to sell them all in a few minutes. Our agents sell thousands of tubes daily.

SEND NO MONEY. We trust you with the extracts supplied. As soon as our money (only \$4.00) is returned to us, you will receive the magnificent phonograph, all complete with record, absolutely free.

IT'S A WONDERFUL MACHINE. We are spending thousands of dollars to introduce these famous extracts into every household, and when we say we will give you this grand phonograph, we will do so. Address to-day

**NATIONAL PRODUCTS, LTD.
DEPT. P. 435 TORONTO, ONT.**

You saw this advertisement in this magazine. Don't forget to say so when writing.

**SILVER MEDALIST
IN EXPERT
TAXIDERMY**



Phone: Main 5185
Send for Price Lists

John Ambrose
173 Fort St. - Winnipeg

Buyer of Elk Tusks, Raw Furs and Game Heads

You saw this advertisement in this magazine. Don't forget to say so when writing.

**AUSTIN
Well Digging and
Prospecting Machinery**

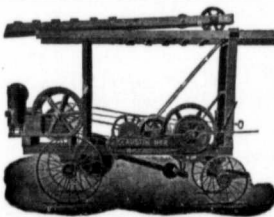

Rock Drilling, Hydraulic Jetting, or Hydraulic Rotary Machines to drill any depth in any formation. Operated by steam or gasoline engines, or horse power.

Write for Illustrated Catalogue No. 15.
**AUSTIN MANUFACTURING COMPANY,
CHICAGO.**

Canadian Sales Agents—**BURRILL COOPER CO., LTD., Winnipeg**

You saw this advertisement in this magazine. Don't forget to say so when writing.



THE GOLDEN RULE

"The best for you
is the best for us."

Sawyer-Massey Co. Limited

You saw this advertisement in this magazine. Don't forget to say so when writing.

One Half Bottle Earned Him \$50

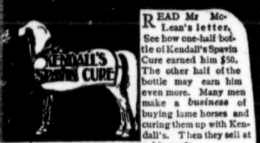

READ Mr. McLean's letter. See how one-half bottle of Kendall's Spavin Cure earned him \$50. The other half of the bottle may earn him even more. Many men make a business of buying lame horses and curing them up with Kendall's. Then they sell at a big profit.

How about your horses? Why not get a bottle of

Kendall's Spavin Cure

and be ready to cure cases of Curb, Spavin, Splint, Ringbone, Bony Growth or lameness from bruises or other causes? Thousands of other Farmers are following it—have been doing it for over 25 years. It's the only safe, remedy you can depend on. Get a bottle at once and see how much it will save or make for you. At drug-gists \$1 a bottle, 6 for \$5. Ask your druggist for Kendall's "Treatise on the Horse," or write to DR. J. KENDALL COMPANY, Esauburg Falls, Vermont.

Post Wad, Nova Scotia
Gentlemen: "I, J. J. I, bought a mare that I gave up on account of a lump on her hock. I tried you Kendall's Spavin Cure and a half bottle removed the lump. I bought another bottle and cured her. Very truly yours, LAURENCE McLEAN."

Mention this magazine when writing advertisers

GRAND TRUNK RAILWAY SYSTEM

THE Double Track Route

TO Detroit, London, Hamilton, Toronto, Montreal and New York via Niagara Falls

Smooth road-bed, polite employees, unequalled dining-car service, and latest standard equipment

AGENTS, COOK'S TOURS AND ALL STEAMSHIP LINES

Rates, reservations and all particulars at Ticket Office

Phone Main 7098 260 Portage WWINNIPEG

Mention this magazine when writing advertisers.

CHEW MAPLE SUGAR TOBACCO

MILD, SWEET, MELLOW AND JUICY
Manufactured by
ROCK CITY TOBACCO CO.
Quebec Winnipeg

Mention this magazine when writing advertisers

Erickson Leg

Does not chafe, over-heat or draw and of stump.
Sold as Easy Term.
The largest limb factory in the world.
R. H. Erickson Artificial Limb Co.,
Baltimore Ave., St. Louis, Mo. Send for catalog.

Mention this magazine when writing advertisers

on the front page of every journal, with my picture in most of them. It seems I had held at bay two hundred angry Italians who were trying to mob a Chinese laundryman. The evening papers said that I had stopped a runaway coach-and-four on Fifth Avenue, that morning, by lassoing the leader. On the coach were Mrs. Aster, Mrs. Fitch, Reggie Banderbuilt, George Gould, Harry Leer and a passel of other "Among those presents." That night I went to a music-hall — according to the next morning's papers — and broke up the show by throwing a pocketful of solitaires to the chorus girls. The next day three burglars got into my room: I held them up in a corner, took away their masks, spanked them and gave them each a hundred-dollar bill to help them to avoid temptation. That afternoon the three big life-insurance companies asked me to be president. And so on — you can read for yourself in the clippings — only for Heaven's sake don't believe any of it. In every article was a neat allusion to my Christmas party.

I wanted to kill James J. James, and I scoured the town for him, but he dodged me. He kept his word, though. For the last few days I've been the most talked-of man in town. Looks like I'd been the only man in New York.

And now to tell about my little party. For two days a regiment of men was working in the Garden under my direction—and at my expense. It was like paying the war appropriation of Russia. But it was worth it.

At 6 o'clock Christmas Eve the crowd began to line up at the Garden doors. At 6.30 a platoon of police arrived. At 6.40 the line reached twice around the Garden. At 6.45 they sent for more police. At 7.15 every street was solid with people. They called out the police reserves and clubbed about four hundred innocent by-standers insensible. At 7.45 the fire department was called and played the hose on the crowd.

This thinned 'em off a bit on the outskirts. Then the ambulances give out and the fainting women was carried home in express wagons and wheelbarrows. The subway was the only line that could run cars.

At 8.30 the doors opened. You should of seen the rush. The Galveston flood wasn't in it. At 8.45 the Garden was so full they closed the doors. That sent some of the outside crowd home.

The Garden was a beautiful sight. One the tower outside, in big electric letters, there was a sign, "Merry Christmas to you and yours."

LAMP FOR FARM HOME

THE

HOME

SAVE YOUR EYES

and read, sew or do your indoor work of any kind in absolute comfort by using one of our

Table or Hanging Lamps

An entirely new lighting system for domestic purposes, for stores, offices, schools halls, etc. Gives a powerful white, steady yet mellow light of approximately 300 candle power. One cent is the cost of four hours light. Odorless, smokeless and no wicks to trim.

Perfect combustion, lowest gas consumption, absolutely shadowless, highest candle power—will not blacken the mantle. Better than gas or electricity and infinitely superior to kerosene. Easy to light and while burning may be carried from room to room in horizontal or in any position in perfect safety. May be rolled on the floor without effecting it in any way. It is supported on cork cushions so as not to mar the most delicately finished furniture.

Most Simple, Safe and Economical light ever Built. Send for one; if after lighting and testing you don't find it the finest light you ever saw, return to us and your money will be refunded. If we have no agent in your district, Secure The Agency at once. You will make many friends and a good margin of profit by selling "ACORN" LAMPS.

ACORN BRASS MANUFACTURING COMPANY, 275 FORT STREET, WINNIPEG.

You saw this advertisement in this magazine. Don't forget to say so when writing.

A crackerjack of a Christmas present

Big Ben

REMEMBER when you were a kid?—the presents that were all *shiny* and bright and that *worked*?—weren't they the ones that you were proudest of?

Something for your room—something you could use all year—something like *big people* had in their rooms. Didn't sensible presents appeal to you best when you were a kid? Think back a bit and see.

Then think of Big Ben for those boys and girls.—Toys, of course, should never be displaced. It wouldn't be Christmas without them, but mix in *useful* things—things that develop *pride* and make little people feel responsible. Give them presents to *live up to* and to *live up with*. Don't make the mistake of thinking they don't feel the *compliment*.—Let one of the first things that greets your little boy and girl Christmas morning be that triple nickel-plated, handsome, pleasant-looking, serviceable and inspiring clock-alarm—BIG BEN.

Just watch if they don't say, "Isn't that a crackerjack! Why! is that for me to use myself?"—Then see how proudly they carry Big Ben upstairs "to see how he looks in my room."—Just put yourself in that boy's or girl's place.

Big Ben is a crackerjack-of-a Christmas-present to give to anyone. The fact is, he is two presents in one, a dandy alarm to wake up with, a dandy clock to tell time all day by. And he's as good to look at as he's pleasing to hear.

He stands seven inches tall, slender, handsome, massive, with a big, frank, honest face and big, strong, clean-cut hands you can see at a glance in the *dim morning light* without even having to get out of bed.

He's got an inner vest of steel that insures him for life; large comby keys that almost wind themselves, and a deep, jolly ring that calls just when you want and either way you want, *five straight minutes or every other half minute for ten minutes*, unless you flag him off.

Big Ben is sold by 18,000 watch-makers. If you can't find him at your jeweler's, a money order mailed to his designers, Westclox, La Salle, Illinois, will send him when and wherever you say, attractively boxed and express charges paid.

\$3.00

At Canadian Dealers.

REGISTERED TRADE MARK

JOSEPH RODGERS & SONS, Limited

SHEFFIELD, ENG.

Avoid imitations of our CUTLERY by Seeing that This EXACT MARK is on Each Blade.

SOLE AGENTS FOR CANADA

JAMES HUTTON & CO., MONTREAL

3

Leading Brands

Sold everywhere throughout
Western Canada

DREWRY'S

Refined

Ale

(Registered)

Extra Stout

AND

Redwood

Lager

These well known malt
beverages are brewed from
barley malt and hops only.
Always uniform in quality and
flavor.

Mention this magazine when writing advertisers.

WE WANT AGENTS

Everywhere in Western Canada

for

C O W. L. Brand Ranch & Farm
Remedies. (Preparations made from
refined Coal-Tar and blended with
suitable emollient oil).

Liberal Commissions

Full particulars, prices etc., on application.

The Carbon Oil Works, Limited

WINNIPEG - CANADA

Write to Dept. "T" Remedies.

Mention this magazine when writing advertisers.

**Dealers Increase
Your Sales!**

Take a Look at the
Strite Governor Pulley

It's the original and the
only thing for driving cream
separators with gasoline en-
gines. Once tried, always
used. TRY ONE. More in use
than all others combined.
Costs no more than imita-
tions. Also, ask about our
friction clutch pulleys.

STRITE GOVERNOR PULLEY CO., 310 S. 3RD ST., MINNEAPOLIS

Mention this magazine when writing advertisers.

PATENTS TRADE MARKS
AND DESIGNS

Write for booklet, circulars, terms, etc.

FETHERSTONHAUGH & CO.

FRED. B. FETHERSTONHAUGH, K. C. M. E.
GERALD S. ROXBURGH, B. A. Sc.

Portage Avenue, WINNIPEG.
209-10 Bank of Nova Scotia

Mention this magazine when writing advertisers.

Komon-Sense

130 Egg Incubator

Write for Free Book

\$7.50

KOMON-SENSE INCUBATOR CO.
Box 75, Racine, Wis.

Mention this magazine when writing advertisers.

Inside it was decorated with holly leaves and berries—tons of it. At one end was built a big house with a chimney and an old-fashioned fireplace. The roof of the house was covered with snow (cotton), and the sky back of it was full of electric stars that twinkled something beautiful. And there was a moon that looked like the real thing.

There was four bands in the balconies and a chorus of angels with real wings and electric halo. They sang Peace on Earth, Good Will to Men, written for the occasion by Mr. de Koven.

By and by all the bands bust out gorgeous, and then Santy Claus appeared in a sleigh drawn by six real live stuffed reindeers. He run along the sky on unseen grooves and drove up to the roof of the house, and slid down the chimney with a pack of presents. He filled all the stockings with candy cornycopies and toys, and a lot of attendants passed 'em out to the children. You should of heard them squeal with joy—poor little tots living in hotels and apartment places where Santy Claus would of had to come up the steam radiator or the gas-log pipe to get in. Well, my Santy Claus had to make sixteen trips to satisfy the children.

The Garden was divided into sections, one for every State and Territory, with its own shield in electric lights and colors. There was a native of every State in charge, and every State had its own big Christmas tree, and reception-room and refreshments. Some of the people I noticed seemed to of been born in several States at once, they way they passed from one booth to another fillin' up their pockets and stummicks. I reckon they paid for it the next day in doctors' bills.

But there was nary a sign of rowdyism. That dollar admission was a regular sieve for straining out the toughs. Then there were policemen everywhere, and every other man nearly was a plain-clothes man or a detective. Besides, after sober consideration, and on advice from the Gardeners, I cut out all drinks, except soft stuff. So there were no jags, except what some people brought with them from their Christmas dinners and loaded 'plum puddings.

And then, of course, that peculiar something we get into us at Christmas time filled everybody with a sort of loving fellowship and a hankering to hug their neighbors and divvy up their fund like a Mutual Life-Insurance Company prospectus says it's going to do some day.

In the centre of the hall there was a big sign in electric letters: Everybody is Hereby Introduced to Everybody Else — for
Tonight Only

WINCHESTER

W  W

THE NEW WINCHESTER

MODEL 1912 20 GAUGE TAKE-DOWN

Hammerless Repeating Shotgun

The lightest, strongest and handsomest repeating shotgun made. It weighs only 5 3/4 pounds, yet, all metal parts being made throughout of Nickel Steel, it has wonderful strength. In grace of outline and refinement of detail and finish, it is unapproached by repeating guns of other makes. It is exceedingly simple to load, unload and take down, and shoots with the strength and accuracy for which Winchester guns are noted.

Ask your dealer to show you one, or send to Winchester Repeating Arms Co., New Haven, Conn., for handsome, illustrated circular describing it

A 20 GAUGE GUN FROM BUTT TO MUZZLE.

You saw this advertisement in this magazine. Don't forget to say so when writing.

WHEN YOU BUILD



When you build, first consider well your plans. We will send, prepaid and duty free, to Canadian customers, **two** famous Hodgson cloth-bound books showing Bungalows, Cottage and House Plans, each containing over 225 pages and more than 300 designs, including floor plans, upon receipt of \$1.

The regular price of these books is \$1 each. Every design is by a licensed Architect; Mr. Fred. T. Hodgson being a resident of Canada and member of the Canadian Architects, F.A.I.C. Many of the houses are the last word in architectural beauty. Adapted to every purse and every taste. Every design a typical modern home, with approximate cost to build given. Complete

Blue Prints and Specifications

for these cheap and moderate-priced homes may also be obtained from us at about \$5 per set, and from which any carpenter can build. If made to your order, an architect would charge from \$50 to \$75 for any one of them, and it would be no better. If you purchase a set of our plans, we will rebate the \$1 you paid for the books. To any prospective builder this offer is easily worth **ten times** the cost. Address:

FREDERICK J. DRAKE & CO.

Architectural Department

1325A Michigan Ave. Chicago, Ill.

You saw this advertisement in this magazine. Don't forget to say so when writing.

Wall Plaster

Patent Hardwall Plasters (the "Empire" Brands) manufactured from Gypsum will give results not to be obtained by any other plastering material or so called plaster substitutes.

Plaster Board—the fireproof plaster lath and sound deadner

THE MANITOBA GYPSUM COMPANY, LIMITED

WINNIPEG, MAN.

You saw this advertisement in this magazine. Don't forget to say so when writing.

Well Drilling Machines

Over 70 sizes and either deep or shallow wells in any kind of soil on wheels or on gins or horse styles for drilling or rock. Mounted on sills. With engines Strong, simple, durable. Any mechanic can operate them. Send for catalog.

WILLIAMS BROS.,
ITHACA, N. Y.

Mention this magazine when writing advertisers

Imperial Bank

OF CANADA
Established 1875

Capital Subscribed..... \$ 6,460,000
Capital Paid Up..... 6,460,000
Reserve Fund..... 6,460,000
Total Assets..... 70,000,000

BRANCHES IN WESTERN CANADA

Province of Manitoba
Brandon Portage la Prairie Winnipeg
Province of Saskatchewan
Balgonie Broadview North Battleford
Rosthern Fort Qu'Appelle Prince Albert
Saskatoon Moose Jaw Regina
Wilkie Hague Weyward

Province of Alberta

Athabaska Landing Edmonton Strathcona
Banff Lethbridge Wetaskiwin
Calgary Red Deer Rediff
Rocky Mountain Hts. Medicine Hat Millet

SAVINGS DEPARTMENTS AT ALL BRANCHES

Interest allowed at Current Rates
Drafts and Letters of Credit issued available in all parts of the world.

Winnipeg Branch
N. G. LESLIE, Manager.

Mention this magazine when writing advertisers

INVENTIONS

Thoroughly Protected in all Countries

EGERTON R. CASE

F. M. Chart, Inst. P. A. London.

Specialist in procuring Canadian and Foreign Patents

Dept. H., Temple Bldg., TORONTO

BOOKLET AND DRAWING SHEET ON APPLICATION

Mention this magazine when writing advertisers

MYERS' PUMPS
Double-acting, Lift, Tank and Spray
MYERS' HAY TOOLS
Sole Leaders, Etc.
of all kinds. Write for Descriptive Circular and Price.
Myers Stayon Flexible Door Hangers
with steel roller bearings, easy to push and to pull, cannot be thrown off the track—keep in season—write for descriptive circular and price. Exclusive agency given to right party who buy in quantity.
P. E. MYERS & SONS, Antwerp, Ohio.

Mention this magazine when writing advertisers

THE ORIGINAL PECH Boring Machine
THE OLD RELIABLE
Improved Up-to-date Drilling Machines
Easiest to operate
Bores Faster
Most Durable
DESCRIPTIVE CATALOGUE FREE
Cherokee Mig. Co., Dept. A. Cherokee, Iowa.
Mention this magazine when writing advertisers

ERZINGER'S No. 2 CUT PLUG
Leads them all. It's the Best Dollar Tobacco sold anywhere.
JOHN ERZINGER
McIntyre Bldg. - 293 Portage Ave.
Phone 69 Phone 2677
Mention this magazine when writing advertisers

At every State booth you'd see people gathering and recognizing old friends or introducing themselves to new ones.

At the Texas booth there was a big, immense crowd. A lot of 'em turned out to be old friends of ours; school friends of yours, ranch friends of mine, people I had worked for, people who had worked me—or for me. A lot of them sent their love and a Merry Christmas to you I remember especially— [Here we omit a list of names somewhat lacking in universal interest.]

I had advertised that people who wanted to give each other Christmas presents could have them hung on the State trees. My attendants gave them checks for their gifts and there wasn't many mix-ups. Old Miss Samantha Clay got a box of cigars meant for Judge Randolph, and he got a pair of silver-buckle garters meant for her. But most of them come out right, and several of them was so surprised at getting presents in New York that they bust out crying. Major Calhoun's whiskers was soaking wet with tears when he got a bottle of old Bourbon from Judge Payton.

Rich folks who had been poor men met charter-members of the "I'm on to your origin" association. But the Christmas spirit made them forget to be snobs. You'd hear millionaires telling plain people how they used to play Hallow'en jokes, how they scraped up to buy their mothers' little Christmas gifts — what ridiculous things they used to get and give.

All evening as fast as anybody went out they'd let somebody else in. Along about eleven o'clock a lot of the people began to go home. Then a new crowd come in. People who had taken their children home and put them to bed would come back for more fun. Others, who had spent the evening dining, began to dribble in.

All the actor people and singers came. It was good to see them. Some of them told me what a godsend such a thing was to them, homeless by profession. A lot of them brought their wives and babies. One father was playing Romeo in Newark, his wife was playing Little Eva in Harlem, and their daughter was playing Camille on Broadway. You should of seen them rejoicing round the Kansas tree!

About midnight the big refreshment hall was opened and opened and everybody that could squeeze in set down to long tables where I had supper served. I had some of the best after-dinner speakers in town come in, and you should of heard some of the funny stories — it would of brought back dear old childhood



There Is No String To This Pipe

It is absolutely FREE to subscribers who take advantage of this offer

The Weekly Free Press and Prairie Farmer Winnipeg The Canadian Thresherman and Farmer

Both including Pipe for the nominal sum of **\$1.25**

The lowest price at which these two papers will be offered this year is \$1.25. It makes no difference whether you take the pipe or not, the price is the same. While the supply of these pipes lasts they will be given away free to all who subscribe. Better get your order in early and be sure of a good smoke.

1911.

Weekly Free Press and Prairie Farmer.

Winnipeg, Man.

Find enclosed \$1.25, for which send the "Weekly Free Press and Prairie Farmer" one year, and the "Canadian Thresherman and Farmer" one year, together with pipe, to the following address:

Name _____

Town _____

Province _____ P.O. Box _____

Alex. Naismith, Pres. Wm. Paterson, Vice-Pres. C. D. Kerr, Treasurer

The WAWANESA MUTUAL INSURANCE COMPANY

HEAD OFFICE: WAWANESA, MAN.
A. F. KEMPTON, Secretary-Manager

Amount of Insurance in Force Dec. 31st, 1911	\$31,243,598 00
Assets over Liabilities	522,944.15

THE NUMBER OF FARMERS INSURED 21,543
The Largest Farmers Mutual Fire Insurance Company in Canada. Agents wanted in unrepresented districts

The Occidental Fire Insurance Co.

Head Office: WAWANESA, MAN.

A. NAISMITH, President R. M. MATHESON, Vice-President
A. F. KEMPTON, Sec. and Mgr. C. D. KERR, Treasurer

Subscribed Capital \$500,000.00
Security to Policy-holders 640,817.29

Full Deposit with Dominion Government
Agents wanted in unrepresented districts

National Trust Company, Ltd.

TORONTO, WINNIPEG, EDMONTON, MONTREAL, REGINA, SASKATOON
Capital and Reserve, \$2,800,000.00

The strain and worry of managing Estates will all be borne for you by this Company.

A PRIVATE Executor may die or become incapable of acting before the completion of the Trust. A Trust Company is PERMANENT and will survive the longest Trusts.

This Company's financial strength and expert staff ensure responsible and capable administration.

We act as Trustee, Executor, Administrator, Guardian, Liquidator, Assignee, Financial Agent

SAFE DEPOSIT VAULTS SAVINGS DEPARTMENT MONEY TO LOAN
ARTHUR STUART, Manager, Winnipeg Branch, 323-325 Main St.

FIRE INSURANCE

The Liverpool-Manitoba Assurance Co.

All Policies Guaranteed by
THE LIVERPOOL AND LONDON AND GLOBE INSURANCE COMPANY, LTD.

Northwest Branch - WINNIPEG, Canada
Agents wanted in unrepresented districts. S. N. RICHARDS, Local Manager

You saw this advertisement in this magazine. Don't forget to say so when writing.

THE BEST LINIMENT

OR PAIN KILLER FOR THE HUMAN BODY

**Gombault's
Caustic Balsam**
IT HAS NO EQUAL

For — It is powerful
for soothing and
healing, and for all
the Sore, Swelling,
Inflammation, Burns,
Scalds, Bruises,
Corns and
Blisters.
CAUSTIC BALSAM has
no equal as
a Liniment.

A
Perfectly Safe
and
Reliable Remedy
for
Sore Throat
Chest Cold
Backache
Neuralgia
Sprains
Strains
Lumbago
Diphtheria
Sore Lungs
Rheumatism
and
all Stiff Joints

We would say to all
who buy it that it does
not contain a particle
of poisonous substance
and therefore no harm
can result from its ex-
ternal use. Persistent,
thorough use will cure
every old or chronic
ailment and it can be
used on any case that
requires an outward
application with
perfect safety.

REMOVES THE SORENESS—STRENGTHENS MUSCLES

Corchill, Tex.—"One bottle Caustic Balsam did
my rheumatism more good than \$100.00 paid in
doctor's bills."
Price \$1.50 per bottle. Sold by druggists, or sent
by an express prepaid. Write for booklet B.
The LAWRENCE-WILLIAMS COMPANY, Toronto, Can.

Mention this magazine when writing advertisers

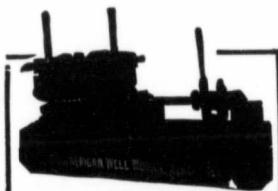

\$1500 to \$5000 Per Year

have been made by hundreds of people
operating the "American" Drill-
ing Machines. 40 years' experience,
50 regular styles and sizes and the
output of the world's largest manu-
facturers of this kind of machinery
make

**"AMERICAN"
MACHINES STANDARD**

Made in types for every kind
of earth and rock drilling or
mineral prospecting, equip-
ped with any power, or oper-
ated with your traction en-
gine. Our new 196
page Catalog Free.

**THE AMERICAN
WELL WORKS**



Mention this magazine when writing advertisers

MAKE YOUR OWN TILE

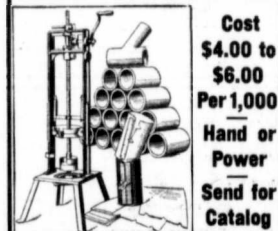

Cost
**\$4.00 to
\$6.00
Per 1,000**
Hand or
Power
Send for
Catalog

FARMERS' CEMENT TILE MACHINE CO.
WALKERVILLE, ONT.

Mention this magazine when writing advertisers

memories. Mayor McClellan gave us all a welcome, and then there was Chauncey Depew, of course, and Simeon Ford, and Augustus Thomas, and Wilton Lackaye, and Job Hedges, and Lemuel Ely Quigg, and General Horace Porter, and a passel of others.

They all made the most surprising allusions to your poor old husband. They called me Daddy and sang about me being a jolly good fellow. And one of them christened me "Santy Crockett." Why, my ears burned so hot I near set my collar on fire! It sure was worth all I spent, and I had a terrible time to keep from blubbering. I must of swallowed about four hundred and eleven Adam's apples.

Finally they called on me for a speech. I just kind of gibbered—I don't know what. The papers say I said: "Merry Christmas, my children! This old world sure is some comfortable, after all. The only trouble is that the right people can't seem to get together at the right time often enough. But this here Christmas supper tastes to me terrible much like More. I'm going to try it again. And I hereby invite you all that ain't in any better place or any better world to meet me here a year from tonight. And so God bless you all, and—God bless everybody!"

Then after a lot of song-singing and hand-wringing we all went home, tears in every eye and smiles on every mouth. The remnants of food and toys made more than the twelve baskets full of Scripture. I sent them round to the Hospitals and Orphan Asylums. I've engaged the Garden again for next Christmas and paid a deposit down. It ain't the extravagance it looks, either, for while the expenses was high—twelve thousand-odd dollars—they took in at the door nearly eighteen thousand dollars. I sent the profit to the Salvation Army and the Volunteers, and now I'm being prayed for and halleluoyied for everywhere there's a brass drum. But I'd do it again if it cost me twenty thousand. It's worth that and more to have your heart nearly break wide open with joy and fellowship.

It was broad daylight when I got to bed, all wore out with happiness. I cuddled up, like I was a little boy once more in the days when I used to get up Christmas morning cold and early and look at my presents and then crawl back under the covers again with a double armful of toys to keep warm and sleep some more. If only you and the chicks had 'a' been there! Next time you shall be.

Your loving
Austin.

EASTERN EXCURSIONS

26th ANNUAL SERIES

December 1st to 31st, inclusive

VIA THE

CANADIAN PACIFIC RAILWAY

RETURN LIMIT THREE MONTHS

Extension of return limit on payment of \$5.00 for each 15 days. Stopover allowed at any point east of Fort William.

Return Fares from and to a few of the principal points :

TO	Toronto Hamilton Sarnia Windsor	Montreal Ottawa Belleville Kingston	S. John, N.B. St. Stephen St. Andrews Moncton	HALIFAX
Brandon	42.70	47.70	62.20	66.15
Calgary	59.90	64.90	79.40	83.35
Edmonton	59.90	64.90	79.40	83.35
Fort William	40.00	45.00	59.50	63.45
Lethbridge	59.35	64.35	78.85	82.80
Medicine Hat	56.25	61.25	75.75	79.70
Moose Jaw	48.45	53.45	67.95	71.90
Port Arthur	40.00	45.00	59.50	63.45
Regina	47.15	52.15	66.65	70.60
Saskatoon	49.60	54.60	69.10	73.05
Swift Current	51.75	56.75	71.25	75.20
Weyburn	46.40	51.40	65.90	69.85
WINNIPEG	40.00	45.00	59.50	63.45
Yorkton	45.60	50.60	65.10	69.05

Corresponding excursion fares from all stations, Port Arthur to Calgary, Alta, and Midland, B.C., to all stations east of Port Arthur in

Ontario, Quebec, and the Maritime Provinces

Through standard and tourist sleeping cars and dining cars to Toronto and Montreal.

3 Through Express Trains Daily 3

The "Imperial Limited" to Montreal and Toronto
The "Eastern Express" to Montreal
The "Toronto Express" to Toronto

For booklet of information and full particulars as to fares, train service, tickets and sleeping car reservations apply to nearest Canadian Pacific Railway ticket agent or write to :

- C. B. FOSTER District Passenger Agent WINNIPEG
- J. A. McDONALD District Passenger Agent BRANDON
- J. E. PROCTOR District Passenger Agent REGINA
- R. G. McNEILLIE District Passenger Agent CALGARY

You saw this advertisement in this magazine. Don't forget to say so when writing.



Conducted for the benefit of Dealers, Threshermen and Farmers who have anything to sell or exchange. Three cents a word for each insertion.

MACHINE SHOPS. Practical machinist position, manager or otherwise. County Expert gasoline engine, automobiles. Business experience. Place where business could be taken over or partnership arranged later would suit. Address 1209 Alexander Ave., Winnipeg.

POSITION WANTED.—Spring till winter driving gasoline engine, Rumely preferred. Experience electricity and gasoline plowing on prairie. Good character, abstainer, work long hours if necessary. Reply, stating wages offered. Engineer, care Canadian Thresherman.

WANTED.—Position as Engineer on a steam traction outfit. Fully experienced. Can furnish references. Address J. E. Peatch, Clava, Man.

SALEMEN WANTED.—Threshermen or engineers to sell oils, greases, belts, packing, lacing, paints, etc. First class opportunity for first class men. O. L. Doty, Cleveland, Ohio.

SALEMEN.—are drawing two to six hundred dollars per month. Traveling with their own teams. Selling our Lubricating Oils, Grease, Paint and Specialties, direct to the consuming public. Now is the time to take orders for immediate and spring delivery. Inland Oil Works Company, Winnipeg, Canada.

FOR SALE.—45 H.P. 2-cylinder gasoline engine and 8-furrow gang plow. Used one season; good reasons for selling. E. Schroeder, Hanley, Sask.

FOR SALE.—A Cuddy steering device for a 20 H. P. International gasoline engine. Device only used two days. Terms: \$70 f.o.b. purchaser's shipping point. S. Melville Webb, Sunny Isle, Sask.

WANTED.—Live salesmen in every good town and district in Western Canada to sell our Hardy Tested Nursery Stock. Highest commissions paid. Exclusive territory. Equipment free. Canada's greatest Nurseries. Stone & Wellington, Toronto.

FOR SALE.—Cock of the North engine, 22 H. P. This engine is in perfect order and nearly new. Apply to E. Rear, Keyes, Man.

FARMS WANTED. We have direct buyers. Don't pay commissions. Write describing property, naming lowest price. We help buyers locate desirable property free. American Investment Association, 15 Palace Bldg., Minneapolis, Minn.

DO YOU WANT city houses or lots for your farm, or lots in other districts for your present home site? We have the best equipped and the most efficient exchange department in the city. We can get you property anywhere in the Dominion for what you have and can effect an exchange for you within a few days time. Thorstad, Reed & Liholm, 443 Main St., Winnipeg.

WANTED.—Strictly high class gas tractor salesman for Minnesota, Nebraska, North and South Dakota, Montana and Western Canada. Permanent and attractive proposition to live salesman that can make good. Address c/o Canadian Thresherman, Winnipeg, Man.

MARQUIS WHEAT.—Won the world's championship again this year. It was grown from seed supplied by me. Get some of the big, strong stuff that has proved its superiority. Make sure of it now. Money back guarantee. Sample and special price on request. Harris McFayden, I am Seed Export, Winnipeg, Man.

STEAM PLOWMEN.—Look! Good section of All steam plow land on C.N.R., Saskatoon-Regina Line in Twp. 23, R. 26. Level—free from scrub or stone. Clear title. Only \$16 per acre, \$4 cash, balance in 1, 2 and 3 years. This is exceptional. For further particulars, write S. O. Cromie, 12 Bank of Hamilton, Winnipeg.

FOR SALE

We have on hand at present a very full line of rebuilt and second-hand Engines and Separators which we are offering at attractive prices. Write us fully what you are thinking of buying, when we shall be pleased to tell you what we have and quote prices. All our rebuilt goods are sold under same guarantee as new ones and of course are carefully re-painted and look exactly like new. If you write us at once we are sure to have the size you almost want.

We also have a thoroughly Rebuilt 25 H. P. Saw Mill Engine. Can hardly be distinguished from new goods. Will be sold at a bargain.

SAWYER-MASSEY COMPANY LIMITED
Winnipeg, Man.

BUYERS, ATTENTION!
THE GEORGE WHITE & SONS COMPANY,
LIMITED, BRANDON, MAN.

- ENGINES**
- 2—25 H.P. White tractions thoroughly rebuilt and in good shape. Each \$ 160.00
 - Second Hand
 - 1—16 H.P. American Advance traction \$ 700.00
 - 1—18 H.P. Minnesota traction..... \$ 600.00
 - 1—20 H.P. Braden Cornish, Portable \$400.00
 - 1—20 H.P. White traction..... \$1200.00
- SEPARATORS—Second Hand**
- 1—Aultman & Taylor, 25x50, all attachments..... \$ 400.00
 - 1—40x62 Waterloo separator, all attachments..... \$ 400.00
 - 1—36x60 Goddison separator, all attachments..... \$ 300.00
 - 1—36x60 American Abell, all attachments..... \$ 325.00
 - 1—36x56 Felshie separator, all attachments..... \$ 300.00
 - 1—32x56 Great West separator, all attachments..... \$ 200.00
 - 1—36x56 Great West separator, all attachments..... \$ 200.00
 - 2—White Challenge separators, thoroughly rebuilt, all attachments. Each \$ 90.00
- Write us re new goods—We have the best.

HOW TO START YOUR GAS ENGINE in the coldest weather, first clip. No hot water, (save time.) **Formula 50c.**
P.S. For your information—This Formula is a liquid, very high explosive, will evaporate in coldest weather. I use it myself at all times in cold weather.
J. W. BARRON, 2112 Louise, Brandon

BARGAINS

- 1—32 H.P. Port Huron engine, rebuilt and in first class shape.
 - 1—American-Abell 20 H.P. engine, rebuilt.
 - 1—Minnesota Separator 44x72, rebuilt. With all connections.
 - 1—32x54 Avery Separator complete, just rebuilt.
 - 1—36x60 Avery Separator to be rebuilt complete.
 - 2—Avery 30 H.P. double undermounted engines.
 - 1—30 H.P. Northwest engine, not rebuilt, cheap.
 - 1—J. I. Case steel, 42x50 separator complete with all attachments.
 - 1—42x70 Avery separator, will be rebuilt in time for next fall's work.
- If you are interested in second hand goods please write and let us know what you want as we are making deals almost every day, and feel sure that we can fit you out with almost anything you want, either in new or second hand goods.
HAYG BROS. & NELLEMOE CO. Ltd.
WINNIPEG.

GASOLINE TRACTOR FOR SALE.—I have a first class 30 H. P. Gasoline Tractor for sale. This tractor is manufactured by Kinnard-Haines, Minneapolis, whose Gas Tractors have carried off more Diplomas and first class prizes at Agricultural Fairs than any other Tractor sold in Western Canada. Having disposed of my farm, I will sell this Tractor right. Buy now, so as to have use of it for threshing season. Write for particulars. Address W. D. Weedy, Brandon, Manitoba.

FOR SALE

- 15 Horse Case Simple Portable Engine..... 20540
 - 15 Horse Case Simple Portable Engine..... 15833
 - 15 Horse Compound Portable Engine..... 13426
 - 18 Horse Simple Traction Waterloo..... 323
 - 18 Horse Portable Sawyer-Massey..... 8290
 - 20 Horse Portable Sawyer-Massey..... 1419
 - 20 Horse Simple Traction Sawyer-Massey..... 1116
 - 20 Horse Compound Traction Engine, Case 7636
 - 20 Horse Simple Traction Engine, Case..... 17721
 - 20 Horse Simple Traction Engine, Case..... 16912
 - 32 Horse Simple Traction Engine, Case..... 15619
- J. I. CASE THRESHING MACHINE COMPANY, Winnipeg, Canada.**

FOR SALE.—One 65 horse power Marshall gasoline tractor, thoroughly overhauled and in first-class condition. G.S.C., Box 3079, Winnipeg.

WANTED — SALESMEN AND SALESWOMEN.—Hundreds of good positions now open paying from \$1,000.00 to \$5,000.00 a year. No former experience required to get one of them. We will teach you to be a high grade Traveling Salesman or Saleswoman by mail in eight weeks and assist you to secure a good position where you can earn good wages while you are learning Practical Salesmanship. Write today for full particulars and testimonials from hundreds of men and women we have recently placed in good positions; also list of good positions open. Address Dept. K, NATIONAL SALESMEN'S TRAINING ASSOCIATION, 806 Kent Building, Toronto, Ont.

Mention this magazine when writing advertisements.



MODEL F. TRACTOR
(15 b. h. p.)

pulling three 12-inch plows six to eight inches deep on Mr. Seager Wheeler's farm at Rosthern. (Mr. Seager Wheeler won the world's prize for wheat.) This "General Purpose" Farm Motor has three speeds.

The British-Canadian Agricultural Tractors
LIMITED
ONTARIO AVE., SASKATOON, SASK.
AND AT ALBERTA INVESTMENT BUILDINGS, CALGARY, ALTA.

You saw this advertisement in this magazine. Don't forget to say so when writing.

Safety from Punctures and Skidding

COST NOTHING TO USERS OF WOODWORTH TREADS

Woodworth Treads by protecting the tires from outside injury and wear prolong their life enough to pay more than the cost of the treads so that users obtain protection from punctures and skidding not only without ultimate cost but so as to actually save money.

Woodworth Treads are made of chrome leather treated by a secret process which makes it absolutely water-proof and prevents dirt from getting in to the pores to cause hardening or rotting.

Woodworth Treads are held on the tires by coil Springs which keep them always perfectly adjusted. They cannot get loose to chafe or injure the tires.

If you wish to have an anti-skid always on your tires so that you can pull out of slippery places and need not be afraid of skidding accidents: if you wish to feel safe from puncture and reduce your expense for tires, order a set of Woodworth Treads.

Woodworth Treads are sold by John Millen & Son, Ltd., and the Russell Motor Car Co., at all their branches and by first-class dealers everywhere.

Send us for catalog and free booklet on the care of Tires.

LEATHER TIRE GOODS CO., Niagara Falls, Ontario

You saw this advertisement in this magazine. Don't forget to say so when writing.

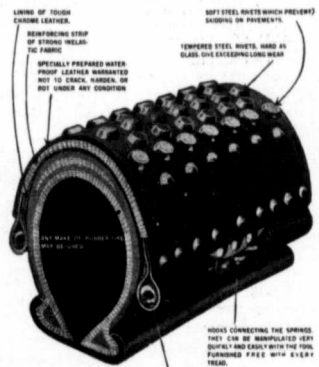



10

Reasons Why You Should Buy a Hart-Parr Oil Tractor

Now that you have decided to sell most of your horses and put the money into a general purpose farm tractor, be sure you buy the *right* one. If you are a shrewd buyer who can't be misled by a lot of unsupported claims—if you insist on getting *full value* for every dollar you invest in a tractor—your choice will surely be the "old reliable" Hart-Parr Oil Tractor.

Thousands of other wise farmers have made this same choice and the tractor has earned and saved money for them ever since. But first of all, they did just what you should do. They carefully investigated Hart-Parr construction. Then they compared it with that of other tractors. And here are just a few of the many superior features they found:

- 1. Efficient Design** Gigantic power, great strength and absolute reliability, all combined in the Hart-Parr in simple form, with complications entirely eliminated.
- 2. Fewer Working Parts** Several hundred less parts, by actual count, than are found in any other tractor of equal power.
- 3. Long Life Bearings** at every point where heavy traction effort comes. These are unseen when the tractor is assembled, but hard field work soon shows the absence of them in other tractors and then repair bills begin to soar skyward.
- 4. Ground Joints** The kind that are heat and moisture proof. In direct contrast to the troublesome, inefficient packed joints used by many tractor builders.
- 5. Enclosed Construction** All working parts of motor enclosed. No chance for dust or dirt to enter and cur these vital parts.
- 6. Accessibility** Every part at your finger tips. No need to tear down the whole engine to get at any part of it. A time and money saving feature when making adjustments or repairs.
- 7. Surest Fuel Feed** A carburetor especially designed for tractor work. Feeds just the right quantity of fuel, at just the right time, no matter at what angle the tractor is tilted.
- 8. Automatic Lubrication** Keeps all parts freely oiled. No need for operator to worry about parts running dry.
- 9. Uses Cheapest Fuel** Operates successfully on kerosene or distillate at all loads and produces full power with any of these fuels.
- 10. Oil Cooled** This feature insures you a frost proof engine. No danger of a freeze-up, even in below zero weather. On cold days, when a water-cooled tractor stands idle, you've got to drain the cooler or risk serious damage. No such fuss or trouble with the original *oil-cooled* Hart-Parr.

And Last But Not Least

These thousands of farmers found, too, that Hart-Parr Oil Tractors are a big success in the hands of their owners. And they also learned that Hart-Parr Service really serves. A Service that sends an expert to show you how to get the most benefits from your purchase. A Service that lays repairs down at your station in record time.

But You Must Get Our Catalog

and other literature to learn of many other advantages that you get when you buy a Hart-Parr Oil Tractor. Write today for this fistful of good stuff.

HART-PARR COMPANY

26 Main St. - Portage la Prairie, Man.
53 West 23rd St. - Saskatoon, Sask.
1612 8th Ave. - Regina, Sask.

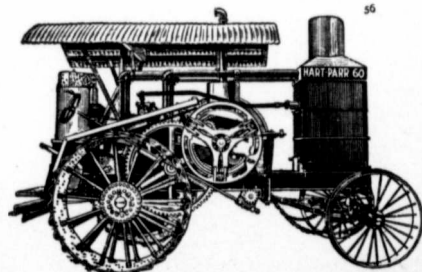

THE CHAPIN CO.
321 8th Ave. West, Calgary, Alta.

Y
it.
MINERY, SELF
PACKERS AND
ENTS.
50
50
26
3
62
ny Thresher
Guide..... 50
50
9
35-68
211
35
58-67
20
(Ask any
40
41
42
35
(Ask any
(Ask any
47
35
35
51
38
59
56
53
53
FLIES.
Ask Any
8
11
17
17
23
24
Co.
in West
Thresher
35
17
35
y Thresh-
se Goods
Lubbers
64
HOES.
y Team
15
15
15
ka..... 55
ca..... 28
39
30
10-64
15
30
17
27
55
n..... 19
60
25
30
64-69
17
36
17
17
Truck
30
30
36
agon..... 38
10
30
36
MINERY.
0
6
43
8
48
PUMPS
4
43
27-7
44
Mills
241
35
34
33
33
43
49

CASE CAR for CHRISTMAS



The Ideal Expression of the Holiday Spirit

No gift expresses the Sentiment of the Season quite so well as the beautiful Case Automobile—because no gift combines so many qualities of Practical Usefulness.

Men can give them to their Wives—their Sons—their Daughters. Wives can give them to their Husbands. Sons and Daughters can give them to the Old Folks—always with the assurance that they will prove a Source of Keen Enjoyment and much Pleasure to those who receive them. Or give one to yourself.

You can't go wrong in buying a Case Automobile. For Seventy Years it has been the Case Policy to maintain every day in the year and in every transaction, the Spirit of Honesty, Good Will and Fair Dealing. It is this Christmas Spirit of Business expressed in Scientific Design, Honest Manufacture and Reliable Salesmanship that has enabled us to grow as we have. Our growth again finds expression in the 1913 Case 40 and the Case 30. Our reputation is staked on these cars. They are thoroughly representative of all Case Products and of Case Policy. Does not your Business Judgment tell you that we can not afford to lose your Good Will or sacrifice the Reputation gained by Seventy Years Honest Dealing, by putting the name "Case" on an unworthy car? The Case Cars for the careful investors combine all the elements of utility and beauty.

Do not miss this opportunity to make Someone happy with a Case Automobile—the most perfect Embodiment of the Christmas Spirit.

Eight Models to select from—two to seven passenger. Write for a Catalog at once or call and see them at the nearest Case Agency.

The J. I. Case Threshing Machine Co.
(Incorporated) Racine, Wisconsin

CANADIAN BRANCHES, TORONTO, WINNIPEG, SASKATOON, REGINA & CALGARY