

**CIHM  
Microfiche  
Series  
(Monographs)**

**ICMH  
Collection de  
microfiches  
(monographies)**



**Canadian Institute for Historical Microreproductions / Institut canadien de microreproductions historiques**

**© 1994**

Technical and Bibliographic Notes / Notes techniques bibliographiques

The Institute has attempted to obtain the best original copy available for filming. Features of this copy which may be bibliographically unique, which may alter any of the images in the reproduction, or which may significantly change the usual method of filming, are checked below.

L'Institut a microfilmé le meilleur exemplaire qu'il lui a été possible de se procurer. Les détails de cet exemplaire qui sont peut-être uniques du point de vue bibliographique, qui peuvent modifier une image reproduite, ou qui peuvent exiger une modification dans la méthode normale de filmage sont indiqués ci-dessous.

Coloured covers/  
Couverture de couleur

Coloured pages/  
Pages de couleur

Covers damaged/  
Couverture endommagée

Pages damaged/  
Pages endommagées

Covers restored and/or laminated/  
Couverture restaurée et/ou pelliculée

Pages restored and/or laminated/  
Pages restaurées et/ou pelliculées

Cover title missing/  
Le titre de couverture manque

Pages discoloured, stained or foxed/  
Pages décolorées, tachetées ou piquées

Coloured maps/  
Cartes géographiques en couleur

Pages detached/  
Pages détachées

Coloured ink (i.e. other than blue or black)/  
Encre de couleur (i.e. autre que bleue ou noire)

Showthrough/  
Transparence

Coloured plates and/or illustrations/  
Planches et/ou illustrations en couleur

Quality of print varies/  
Qualité inégale de l'impression

Bound with other material/  
Relié avec d'autres documents

Continuous pagination/  
Pagination continue

Tight binding may cause shadows or distortion along interior margin/  
La reliure serrée peut causer de l'ombre ou de la distorsion le long de la marge intérieure

Includes index(es)/  
Comprend un (des) index

Title on header taken from:  
Le titre de l'en-tête provient:

Blank leaves added during restoration may appear within the text. Whenever possible, these have been omitted from filming/  
Il se peut que certaines pages blanches ajoutées lors d'une restauration apparaissent dans le texte, mais, lorsque cela était possible, ces pages n'ont pas été filmées.

Title page of issue/  
Page de titre de la livraison

Caption of issue/  
Titre de départ de la livraison

Masthead/  
Générique (périodiques) de la livraison

Additional comments:  
Commentaires supplémentaires:

Pagination is as follows: p. 363-401, [8].

This item is filmed at the reduction ratio checked below/  
Ce document est filmé au taux de réduction indiqué ci-dessous.

10X	12X	14X	16X	18X	20X	22X	24X	26X	28X	30X	32X
<input type="checkbox"/>	<input type="checkbox"/>	<input type="checkbox"/>	<input type="checkbox"/>	<input type="checkbox"/>	<input type="checkbox"/>	<input type="checkbox"/>	<input type="checkbox"/>	<input checked="" type="checkbox"/>	<input type="checkbox"/>	<input type="checkbox"/>	<input type="checkbox"/>

The copy filmed here has been reproduced thanks to the generosity of:

Library,  
Geological Survey of Canada

The images appearing here are the best quality possible considering the condition and legibility of the original copy and in keeping with the filming contract specifications.

Original copies in printed paper covers are filmed beginning with the front cover and ending on the last page with a printed or illustrated impression, or the back cover when appropriate. All other original copies are filmed beginning on the first page with a printed or illustrated impression, and ending on the last page with a printed or illustrated impression.

The last recorded frame on each microfiche shall contain the symbol  $\rightarrow$  (meaning "CONTINUED"), or the symbol  $\nabla$  (meaning "END"), whichever applies.

Maps, plates, charts, etc., may be filmed at different reduction ratios. Those too large to be entirely included in one exposure are filmed beginning in the upper left hand corner, left to right and top to bottom, as many frames as required. The following diagrams illustrate the method:

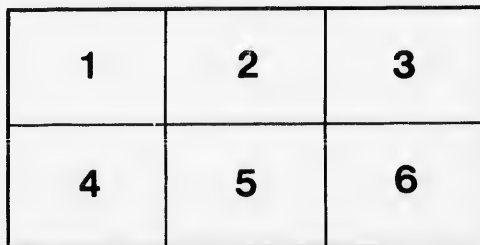
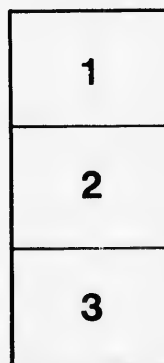

L'exemplaire filmé fut reproduit grâce à la générosité de:

Bibliothèque,  
Commission Géologique du Canada

Les images suivantes ont été reproduites avec le plus grand soin, compte tenu de la condition et de la netteté de l'exemplaire filmé, et en conformité avec les conditions du contrat de filmage.

Les exemplaires originaux dont la couverture en papier est imprimée sont filmés en commençant par le premier plat et en terminant soit par la dernière page qui comporte une empreinte d'impression ou d'illustration, soit par le second plat, selon le cas. Tous les autres exemplaires originaux sont filmés en commençant par la première page qui comporte une empreinte d'impression ou d'illustration et en terminant par la dernière page qui comporte une telle empreinte.

Un des symboles suivants apparaîtra sur la dernière image de chaque microfiche, selon le cas: le symbole  $\rightarrow$  signifie "A SUIVRE", le symbole  $\nabla$  signifie "FIN".

Les cartes, planches, tableaux, etc., peuvent être filmés à des taux de réduction différents. Lorsque le document est trop grand pour être reproduit en un seul cliché, il est filmé à partir de l'angle supérieur gauche, de gauche à droite, et de haut en bas, en prenant le nombre d'images nécessaire. Les diagrammes suivants illustrent la méthode.

# MICROCOPY RESOLUTION TEST CHART

(ANSI and ISO TEST CHART No. 2)



4.5



5.0



3.6

4.0



4.5

5.0

5.6

6.3

7.1

8.0

9.0

10



APPLIED IMAGE Inc

1653 East Main Street  
Rochester, New York 14609 USA  
(716) 492-0300 - Phone  
(716) 286-5989 - Fax

*By* FRA  
Mo  
the  
Pr

I.  
II.  
III.

IV.

V.

VI.

THAT roc  
earth's cr  
was reco  
accurate  
in more r  
been fold  
from one  
the mann  
VOL. C.



XI. *An Experimental Investigation into the Flow of Marble.*

By FRANK DAWSON ADAMS, M.Sc., Ph.D., F.G.S., *Logan Professor of Geology in McGill University*, and JOHN THOMAS NICOLSON, D.Sc., M.Inst.C.E., *Head of the Engineering Department, Manchester Municipal Technical School (formerly Professor of Mechanical Engineering in McGill University).*

*Communicated by Professor CALLENDAR, F.R.S.*

Received June 12,—Read June 21, 1900.

[PLATES 22-25.]

CONTENTS.

	Page
I. Introduction . . . . .	363
II. Conditions to be reproduced in Experimental Work . . . . .	369
III. Deformation of Carrara Marble . . . . .	370
A. Methods employed . . . . .	370
B. Deformation of the Dry Rock at Ordinary Temperatures . . . . .	373
C. Deformation of the Dry Rock at 300° C. and at 400° C. . . . .	376
D. Deformation of the Rock at 300° C. in the presence of Water . . . . .	382
IV. Comparison of the Structures produced in Carrara Marble by Artificial Deformation with those produced by Deformation in the case of Metals . . . . .	386
V. Comparison of the Structures produced in Carrara Marble by Artificial Deformation with those observed in the Limestones and Marbles of highly contorted portions of the Earth's Crust . . . . .	387
VI. Summary of Results . . . . .	398

I. INTRODUCTION.

THAT rocks under the conditions to which they are subjected in many parts of the earth's crust become bent and twisted in the most complicated manner is a fact which was recognised by the earliest geologists, and it needs but a glance at any of the accurate sections of contorted regions of the earth's crust which have been prepared in more recent years to show not only that in many cases even the hardest rocks have been folded, but that there has often been a marked transfer or "flow" of material from one place to another in the folds. While, however, these facts are undisputed, the manner in which this contortion, with its concomitant flowing, has taken place is a

matter concerning which there has been much discussion and a wide divergence of opinion. Some authorities—among whom HEIM,\* whose work in Alpine geology must command the admiration of all, may be mentioned—have held that while, in the upper portions of the earth's crust, rocks, when submitted to pressure, will break, giving rise to faults and overthrusts, the same rocks in the deeper portions of the earth's crust are unable to break up in this way, owing to the great weight of the superincumbent strata. The lines of fracture become smaller and greatly increase in number, the various minerals constituting the rock thus breaking down into grains, which, however, move around and past one another, the adjacent grains always remaining within the sphere of cohesion. The structure becomes cataclastic; the rock mass, acting as plastic bodies do, and flowing in the direction of least resistance, maintains its coherence while altering its shape. HEIM believes that there is a further stage in the process which he thus describes:—

“Wird die umformende Kraft endlich so gross dass sie anstatt an ein, paar tausend Stellen die Festigkeit durch Bruch aufheben zu können, dieselbe in jedem einzelnen Punkte überwindet, so wird das Spaltennetz unendlich fein und das Gesteinskorn zur Kleinheit eines Moleküles reducirt, d. b. die mechanische Bewegungseinheit ist nicht mehr ein Gesteinsbrocken sondern unendlich klein so dass die Bewegung eine continuirliche Umformung ohne Bruch wird.”

Now, according to SPRING,† the property known as regelation is really due to a power which fragments of bodies have of uniting if brought within the range of the molecular forces, a property which, although possessed in a marked manner by ice, is also, as he has experimentally demonstrated, exhibited by many other bodies, and would probably be displayed by all if the required conditions could be attained. The “flow of rocks” would therefore, according to this view, be a manifestation of regelation on an enormous scale.

Other writers on this subject have maintained that rocks are absolutely destitute of plasticity in any proper sense of the term. Thus MALLET‡ based his theory on the supposition that in the earth's crust rocks under pressure are shattered. PFAFF§ has held that in the depths of the earth great pressure alone will tend rather to prevent molecular movement and thus keep the rocks rigid. Those holding such views attribute the deformation of rocks either to crushing with subsequent recementation of the fragments by mineral matter deposited from percolating waters as the movements proceed or after they are completed,|| or to a continuous process of

\* ‘Der Mechanismus der Gebirgsbildung,’ p. 31; see also VAN HISE, C. R., ‘Metamorphism of Rocks and Rock Flowage,’ ‘Bull. Geol. Soc. of America,’ vol. 9, 1898.

† ‘Recherches sur la propriété que possèdent les corps de se souder sous l'action de la pression.’ ‘Revue Universelle des Mines,’ 1880.

‡ ‘Philosophical Transactions,’ vol. 163, 1874.

§ ‘Der Mechanismus der Gebirgsbildung,’ pp. 19–21.

|| STAPFF, ‘Zur Mechanik der Schichtenfaltungen,’ ‘Neues Jahrbuch für Mineralogie,’ 1879, p. 792; REYER, ‘Theoretische Geologie,’ p. 443.

solutio  
water  
great  
mover  
whole  
contor  
deform  
very in  
by MA  
their c  
their  
empha  
at the  
in mos  
of thes  
been pe  
howeve  
some tv  
in chie  
deforma  
obtain  
as to th  
From  
taken a  
by fold  
FORCHE

\* ‘Rep  
Arsenal, 2  
same serie

† ‘Unt

‡ ‘Zu

‘Der Glär

§ ‘On

1815.

|| ‘Etud

¶ ‘Urs

\*\* ‘EX

†† ‘TH

‡‡ ‘Ve

1868.

§§ ‘Üb

Dissertatio

||| ‘Thir

solution and redeposition of the minerals which make up the rock. The percolating waters, it is held, tend to dissolve material at those points where the pressure is greatest, and to redeposit it where the pressure is wholly or partially relieved; the movements thus being accompanied by a more or less complete recrystallisation of the whole rock. Moisture would thus be a necessary factor in all rock folding or contortion, and recrystallisation the essential feature of the phenomenon. The deformation of a body of dry rock would be impossible. The opinion that water is a very important, if not an absolutely essential, factor in the folding of rocks was held by MACCULLOCH, DE LA BECHE, and a number of the earlier geologists; who based their opinions on the fact that rocks are often much softer while they still contain their quarry water than after they are thoroughly dry, a fact which has been emphasised by tests of the relative strength of wet and dry rocks recently carried out at the arsenal at Watertown, Mass.\* It is a matter of great difficulty, and, in fact, in most cases it is quite impossible to decide with certainty upon the relative merits of these conflicting views from a study of the deformed rocks themselves. Had this been possible, the controversy would long since have been brought to a close. HEIM, however, in his great work on the 'Mechanism of Mountain Making,'† published some twenty years since, refers to the very valuable results which might be looked for in elucidation of these questions from carefully conducted experiments upon the deformation of rocks under conditions as nearly as possible approximating those which obtain in the deeper parts of our earth's crust. He expresses grave doubts, however, as to the possibility of reproducing the conditions in question.‡

From the time of Sir JAMES HALL§ experimental investigations have been undertaken at intervals, aiming more particularly at the reproduction of the forms exhibited by folded strata. Those by DAUBRÉE,|| REYER,¶ CADELL,\*\* FAVRE,†† OBERMEYER,‡‡ FORCHEIMER,§§ and BAILEY WILLIS||| may be especially mentioned. In these experi-

\* 'Report of the Tests of Metals and other Materials for Industrial Purposes made at Watertown Arsenal, Mass., during 1894,' Washington, Government Printing Office, 1895. Also subsequent Report of same series for 1895.

† 'Untersuchungen über den Mechanismus der Gebirgsbildung,' vol. 2, pp. 4, 84.

‡ 'Zum Mechanismus der Gebirgsbildungen,' 'Zeit. d. deutsch. Geol. Gesell.,' 1880. See also BALTZER, 'Der Glärnsch,' p. 52.

§ "On the Vertical Position and Convolution of Certain Strata." 'Trans. Roy. Soc. Edin.,' vol. 7, 1815.

|| 'Etudes Synthétiques de Géologie Expérimentale,' Paris, 1879.

¶ 'Ursachen der Deformationen und der Gebirgsbildung,' Leipzig, 1892.

\*\* "Experimental Researches in Mountain Building," 'Trans. Roy. Soc. Edin.,' vol. 35, 1888.

†† "The Formation of Mountains," 'Nature,' December 5, 1878.

‡‡ "Versuche über das Ausfluss plastischen Thones," 'Sitz. der Wiener Akad. Math.-Natur. Class.,' 58, 1868.

§§ "Über Sanddruck und Bewegungs-Erscheinungen im Inneren trocknen Sandes," 'Inaugural Dissertation der Eberhard-Carls-Universität in Tübingen,' Aachen, 1883.

||| 'Thirteenth Annual Report U.S. Geological Survey.'

le divergence of  
Alpine geology  
at while, in the  
ure, will break,  
portions of the  
t weight of the  
atly increase in  
own into grains,  
grains always  
lastic; the rock  
east resistance,  
that there is a

n, paar tausend  
edem einzelnen  
esteinskorn zur  
inheit ist nicht  
Bewegung eine

really due to a  
e range of the  
mer by ice, is  
er bodies, and  
ttained. The  
nifestation of

ly destitute of  
heory on the  
PFAFF§ has  
er to prevent  
g such views  
ecementation  
aters as the  
s process of  
phism of Rocks

le la pression."

' 1879, p. 792;



ments comparatively low pressures, and materials, such as paper, wax, clay, &c.—much less resistant than the rocks themselves—were employed, so that while they have thrown much light upon the dynamics of mountain making, they have left the aspects of the subject referred to above, and especially dealt with in the present paper, untouched. In another series of interesting investigations, specimens of the rocks themselves have been submitted to the action of direct pressure or heat, the conditions being otherwise those which obtain at the earth's surface. HOBKINSON,\* for instance, showed that if thin ribs of stone, 7 feet long and 1 inch thick, properly supported at the extremities, are submitted to transverse strain they undergo a permanent deformation, no matter how small the strain to which they are subjected may be. He does not, however, state what stone he employed. MIALLE,† in more elaborate experiments of a similar character, measured the amount of permanent deformation produced in thin slabs of gypsum and limestone. He found that a more marked deformation without rupture could be obtained if these rocks were embedded in pitch before being submitted to the action of pressure. He could not, however, succeed in permanently deforming slates or sandstones to any noticeable extent. In the tests made at the Watertown Arsenal,‡ by employing greater pressure, a slight though permanent "set" was given not only to marble but to sandstone, and the same effect was produced by the simple application of heat without pressure. REYER§ has stated, as the result of experimental study, that while it is possible to slowly deform gypsum by the aid of low pressures continuously applied, the action is greatly accelerated if the material be kept moist.

A few other investigations, among which those of GÜMBEL and KICK are especially worthy of mention, bear more directly upon the question at issue. These have been designed with the object of reproducing, at least in some of their features, the conditions existing at great depths in the earth's crust, and in this way bringing about such rock deformation as there results. GÜMBEL subjected little cylinders of orthoclase, quartz, Iceland spar and alabaster, enclosed in steel collars, and having an area of 1 centim. in cross section, and a height of between half a centim. and 1 centim., to pressures varying from 22,000 to 25,000 atmospheres in a powerful testing machine. The cylinders of orthoclase and quartz crushed to an incoherent powder. The cylinder of calcite, on the other hand, retained its coherence. It became perfectly opaque, and while still retaining its cleavage, is stated to have had a conchoidal fracture induced in it by the pressure. The cleavage faces showed their usual lustre,

\* 'Athenæum,' 1853, p. 1165: "Report of the 23rd Meeting of the British Association for the Advancement of Science."

† "Experiments on the Contortion of Mountain Limestone," 'Geological Magazine,' November, 1869; and a subsequent paper in the 'Popular Science Review.'

‡ *Loc. cit.* See also MELLARD READE'S 'Origin of Mountain Ranges,' pp. 16 and 21.

§ 'Theoretische Geologie,' p. 444.

|| "Das Verhalten der Schichtgesteine in gehobenen Lagen," 'Sitzungsber. d. königl. Bayer. Akad. d. Wiss.,' Math. Phys. Classe, 1880, 4, 596-623.

and t  
obser  
collu  
the p  
condi  
The r  
sider  
the s  
concl  
foldin  
harde  
the n  
the cr  
ROSE  
quartz  
experi  
witho  
observ  
prop  
pressu

Som  
enclos  
except  
small l  
filled w  
atmosph  
the lin  
limesto  
spheres  
flow in  
surface  
pressur

KICK  
the onl  
closely  
result o  
piston,

\* 'Neu

† 'Der

‡ 'Die

Deutscher

and the surfaces of fracture also had a vitreous lustre. The calcite, however, was observed to have been forced into little depressions and cracks which existed in the collar, but in such cases the calcite occupying the depressions and cracks, as well as the portions of the cylinder adjacent to them, was reduced to a finely pulverulent condition, and did not show the cleavage possessed by other portions of the mass. The alabaster deformed itself in a similar manner under pressure. GÜMBEL considered that these experiments proved an entire absence of plasticity on the part of the several minerals in question, except possibly in the case of the alabaster, and concluded from their results, fortified by extended observations in the field, that the folding of the older crystalline rocks had taken place before they had become hardened. He also believed that in cases where a folded rock shows distinctly under the microscope that it has been crushed, its coherence is due to a recementation of the crushed mass by subsequent infiltration of mineral matter. It was shown by ROSENBERG,<sup>\*</sup> however, in reviewing GÜMBEL's work, that while in the case of the quartz and orthoclase the minerals had undoubtedly been crushed to powder; in the experiment with the calcite column it was by no means proved that deformation without rupture, or "flow," would not equally well account for the phenomenon observed. Unfortunately, no examination of the microscopical characters and optical properties of the several minerals, before and after they had been submitted to pressure, was made.

Somewhat similar experiments on limestone were carried out by PFAFF.<sup>†</sup> He enclosed a small column of lithographic limestone from Solenhöfen in a steel block, except at the top where a piston of the same metal came down upon it. A very small hole was drilled through the side of the block to the limestone, and this was filled with wax. The marble was then submitted to a pressure amounting to 9970 atmospheres, which was continued for seven weeks. The wax was not displaced, and the limestone suffered no alteration. In another experiment, a specimen of the same limestone, having a polished surface, was submitted to a pressure of 21,800 atmospheres, delivered by means of a small ring-shaped steel die. The limestone did not flow into the centre of the ring, and only a slight depression was left on the polished surface of the rock. From these experiments PFAFF drew the conclusion that pressure alone is incapable of inducing any plasticity in limestone.

KICK,<sup>‡</sup> in his experiments on deformation, made use of many different materials the only rock investigated being marble. One of his experiments reproduces very closely the conditions in the first of PFAFF's experiments just described; but the result obtained was entirely different. A stout casting was bored out to receive a piston, the hole being closed at the lower end. In the bottom of the hole a steel die,

\* 'Neues Jahrbuch für Mineralogie,' 1882, 1, 222.

† 'Der Mechanismus der Gebirgsbildung,' pp. 16-19.

‡ "Die Principien der mechanischen Technologie und die Festigkeitslehre," 'Zeit. des Vereines Deutscher Ingenieure,' Bd. 36, p. 919 (1892).

having some device standing out from its surface, was placed face upwards. On this was laid a circular disc of marble. Oil was then poured in to fill up all vacant spaces. The piston was then inserted, and by it pressure was brought to bear upon the marble, which pressure was gradually increased to 13,000 atmospheres. The oil, which could escape only through the very narrow space between the piston and the casting, served to maintain a considerable pressure on all parts of the apparatus and the marble to which it had access, while the raised portions of the die coming in contact with the marble were pressed against it with great force. It was found that a well-marked, although not very perfect, reproduction of the device upon the die was impressed upon the marble. He also placed a small marble sphere in a stout copper box, filling the space between the marble and the sides of the box with alum or sulphur, poured in while molten. A heavy cover was then placed upon the box, and the whole was squeezed down to a fraction of its former height by means of a powerful press. After compression the alum or sulphur was dissolved away, setting free the enclosed marble, which was found to have been considerably flattened in a direction at right angles to the pressure.\* In another experiment he enclosed a marble cylinder in an iron tube, and having filled the intervening space with water, bent the whole transversely by the application of a high pressure. When the tube was sawn open, the marble was found to have acted "like a plastic body," without having "altered its original characters."† In connection with these experiments, however, it must be mentioned that the marble, as will be seen later, could not have preserved its original character in all respects, although it retained its coherence, and REYER in referring to the experiment says that the marble was crushed, and "nur mässig zementirt."‡ It is doubtful in the case of the deformed spheres of the first-mentioned experiment in how far the deformation obtained is traceable to plastic flow. Three of these deformed spheres were presented by Professor KICK to the University of Zürich, and are preserved in the Geological Museum of the University. Two of them, each about 2 centims. in diameter, certainly show a decided flattening, such as might be produced by plastic flow; but the third, which is considerably larger, and is so flattened that the length of the smallest diameter is about two-thirds that of the greatest, shows in its surface a series of fine cracks crossing obliquely, as if the rock had undergone some sort of complicated shearing, and where cracked across in one place the interior is seen to present a shelly structure, resembling in appearance the successive coats of an onion.

DAUBRÉE§ also obtained some very interesting results bearing on this subject, in

\* "Die Principien der mechanischen Technologie und die Festigkeitslehre," Zeit. des Vereines Deutscher Ingenieure, Bd. 36, p. 919, 1892.

† "Das Gesetz der proportionalen Widerstande," p. 76.

‡ "Theoretische Geologie," p. 444.

§ "Recherches expérimentales sur le rôle possible des gaz à hautes températures," Bull. de la Société Géologique de France, 3e série, tome 19, p. 310.

carry  
Litt  
2 cen  
by m  
small  
the r  
the e  
wire  
The e  
its tra  
to hav  
The e  
perfor  
The  
is belie  
the ro  
presen  
enses r  
these  
temper  
duratio  
charact  
deform  
be dete

It is  
conditio  
folding

With re  
produce  
rearrang  
the mass  
them, as  
"Plas

VOL. C

carrying out his experiments on the perforation of rocks by means of explosives. Little cylinders of marble, granite, and other rocks, having a diameter of about 2 centims., were cut in two vertically, the two halves tightly bound together again by means of wire, and inserted firmly in a tube connected with a chamber in which small charges of dynamite were exploded. The escaping gas completely perforated the rock along the line of contact of the two half cylinders. Under the influence of the explosive force the marble cylinders apparently became somewhat plastic, the wire binding them often leaving slight depressions on the surface when removed. The cylinder was also found to be somewhat shorter and stouter, the marble had lost its translucency and had become opaque. Under the microscope, he says, it was seen to have been crushed to powder, and then squeezed together again into a solid mass. The cylinders also had a concentric structure induced in them around the central perforation.

The several experimental investigations hitherto made on the flow of rocks (and it is believed that the summary given above outlines all the experimental work in which the rocks themselves were employed, the results of which have appeared up to the present time), while very interesting and instructive, are inconclusive and in certain cases apparently mutually contradictory. Neither has account been taken in any of these investigations of the rapidity with which the pressure was applied, of the temperature of the rock during compression, nor, except in a very few cases, of the duration of the pressure. Nor have we in any case an accurate description of the character of the rock before and after the experiment, or of the strength of the deformed rock, so that the actual nature of the effect produced by the pressure can be determined.

## II. CONDITIONS TO BE REPRODUCED IN EXPERIMENTAL WORK.

It is generally agreed that three chief factors contribute to bringing about the conditions to which rocks are subjected in the deeper parts of the earth's crust, where folding with concomitant flowing is most marked. These are:—

1. Great pressure.
2. High temperature.
3. Percolating waters.

With regard to the first factor it must be noted, that mere cubic compression will not produce movements of the nature of flowing, although it may produce molecular rearrangement in the rock. A differential pressure is necessary to give movement to the mass. HEIM\* has stated the conditions of movement, so far as pressure affects them, as follows:—

“Plastische Umformung geschieht also nur, wenn allseitig ein Druck wirkt, der

\* ‘Untersuchung über den Mechanismus der Gebirgsbildung,’ Band II., s. 91.

jedenfalls grösser als die Festigkeit, aber auf verschiedenen Seiten nicht gleich gross but it v  
 ist, so dass Ausweichen seitlich zum Maximaldruck stattfinden kann. Ist das the req  
 vorhandene Druckminimum kleiner als die Festigkeit, so tritt Zerbrecben und damit difficult  
 Ausquetschen, 'Umformung mit Bruch,' ein." In rock movement resulting from iron we  
 these several factors the additional factor of time may play an important part, thin str  
 Whether all these factors, or only certain of them, are actually necessary for the as it wa  
 production of rock deformation is unknown, but can probably be determined by leaving  
 experiment. For by experiment the action of each may be studied separately, as thick, a  
 well as in combination with the others.

In experimental work, therefore, the first condition to be reproduced is that of a  
 differential pressure which, even in the direction of its minimum value, exceeds the  
 elastic limit of the rock under investigation. The action of this pressure should then  
 be studied when combined with heat, and then with heat in the presence of moisture.  
 Finally, the effect of time or rapidity of motion should be investigated.

### III. DEFORMATION OF CARRARA MARBLE.

#### A. *Methods employed.*

In the present paper\* a first contribution to such a study is presented, pure  
 Carrara marble being the rock selected. At the outset the endeavour was made to  
 submit this rock to the first of the three conditions above mentioned only—that is, to  
 bring to bear upon it great pressure from all sides, a pressure, however, which should  
 not be equally great in every direction, but which, while always exceeding the elastic  
 limit of the rock, should be greater in one direction than in others, thus tending not  
 merely to bring about cubic compression but to determine a flow of the material in  
 one direction. For this purpose it was sought to enclose the marble in some material  
 having a much higher elastic limit than the rock itself, and possessing at the same  
 time a very considerable ductility, so that it would move without rupture when the  
 pressure became sufficiently high. Under such conditions it was believed the marble  
 could not break in the ordinary way, even when submitted to a pressure far above  
 that which under ordinary conditions would be required to crush it, for it would be  
 enclosed on all sides by a stronger substance, and the pressure being increased it would  
 remain intact until the elastic limit of the enclosing material had been exceeded, when  
 it would commence to move, acting as water or any other enclosed fluid might.

As it was proposed to extend the investigation eventually to granites, and possibly  
 other rocks, a long series of experiments was made on various alloys in the endeavour  
 to obtain a material which possessed a sufficiently high elastic limit combined with  
 the necessary ductility to fulfil the requirements as enclosing material in all cases;

\* A preliminary notice of these experiments was read before Section C of the British Association for  
 the Advancement of Science, at the Toronto Meeting in 1897, an abstract of which appears in the 'Pro-  
 ceedings' of the Association for that year.

en nicht gleich gross but it was found that none possessed a sufficiently high elastic limit combined with  
 len kann. Ist das the required ductility, except certain aluminium bronzes, which however it was  
 erbrechen und damit difficult to obtain with constant composition and properties. Heavy tubes of wrought  
 ment resulting from iron were then made on the plan adopted in the construction of ordnance by rolling a  
 an important part, thin strip of Low Moor iron around a bar of soft iron and welding the strip to the bar  
 y necessary for the as it was rolled around it. The core of soft iron composing the bar was then bored out,  
 be determined by leaving a tube of welded Low Moor iron, the sides being about a quarter of an inch  
 udied separately, as thick, and so constructed that the fibres of the iron ran around the tube instead  
 of being parallel to its length. These were found to answer the requirements  
 duced is that of a admirably. The following procedure was then adopted: Columns of the marble,  
 value, exceeds the 0·81 inch, or in some cases 1 inch, in diameter and 1·53 inch in length, were  
 pressure should then accurately turned and polished, by Messrs. VOIGT and HOCHGESANG, of Göttingen.  
 presence of moisture. The tube was then very accurately fitted around the marble. This was accomplished  
 ted. by giving a very slight taper to both the column and the interior of the tube, and so  
 arranging it that the marble would only pass about half way into the tube when cold.  
 The tube was then expanded by heating, so as to allow the marble to pass completely  
 into it and leave about 1·25 inch of the tube free at either end. On allowing the  
 tube to cool a perfect contact between the iron and marble was obtained, and it was  
 no longer possible to withdraw the latter. This perfect fit was considered indispens-  
 able in order to prevent the limestone crumbling when pressure was applied, as it  
 would have done had it not been supported at every point. In some experiments  
 the tube was subsequently tur- 1 down, so as to be somewhat thinner immediately  
 around the marble. Into either end of the tube containing the column an accurately  
 fitting steel plug was then inserted, and by means of these the pressure was applied.  
 The high pressure required was obtained from the city water mains by using a double  
 hydraulic "intensifier"; the whole arrangement being shown in the accompanying  
 photograph (Plate 22, fig. 1).

is presented, pure  
 our was made to  
 d only—that is, to  
 ver, which should  
 ceeding the elastic  
 thus tending not  
 of the material in  
 e in some material  
 ssing at the same  
 rapture when the  
 lieved the marble  
 pressure far above  
 t, for it would be  
 creased it would  
 a exceeded, when  
 id might.  
 tes, and possibly  
 in the endeavour  
 t combined with  
 ial in all cases;  
 ish Association for  
 appears in the 'Pro-

A cylinder containing a moveable piston, whose upper portion is cast of square  
 shape so as to form a press plate, has another press plate mounted opposite to it by  
 means of four strong steel columns. The small cylinder containing the marble with  
 the two steel plugs is set up between the two press plates, the plugs being kept in  
 axial alignment with each other by having their enlarged ends fitted into cylindrical  
 holes bored in a small but massive casting (A), which acts as a guide to them when  
 under pressure. The sliding piston in the large cylinder is 20 inches in diameter,  
 and is kept tight by cup leather packing. The strong copper vessel (B) has its upper  
 half filled with a heavy oil, and thence is led the only pressure connection to the  
 cylinder (C), to which oil, but no water, is admitted, in order that corrosion and  
 undue leakage may be averted. For moderate pressures the city mains are con-  
 nected directly to the lower half of the copper vessel, but for high pressures to the  
 larger end of the small intensifier (D), and a pipe then leads from the upper end of  
 the same to the lower end of the copper vessel. In either case the pressure is kept

steady for weeks at a time when necessary by means of a small spring relief valve (*a*) the square with an adjusting screw, so that the water from the mains is allowed to overflow at was sy any desired pressure, which thus cannot be exceeded. A recording gauge (*b*) attached This di to cylinder (C) registers the history of the experiment throughout its course. The the pre allowance to be made for the friction of the 20-inch diameter cup leather was care- fully determined, so that a close estimate of the pressure to which the rock is sub- jected can be formed. This was done by observing the amounts of compression of a specimen of hard steel due to various loads applied by a Buckton testing machine, and then inferring the loads to which it was afterwards subjected in the actual press- Eight tures, t fully determined, so that a close estimate of the pressure to which the rock is sub- jected can be formed. This was done by observing the amounts of compression of a specimen of hard steel due to various loads applied by a Buckton testing machine, and then inferring the loads to which it was afterwards subjected in the actual press- Eigh tures, t fully determined, so that a close estimate of the pressure to which the rock is sub- jected can be formed. This was done by observing the amounts of compression of a specimen of hard steel due to various loads applied by a Buckton testing machine, and then inferring the loads to which it was afterwards subjected in the actual press- sequen tures, t fully determined, so that a close estimate of the pressure to which the rock is sub- jected can be formed. This was done by observing the amounts of compression of a specimen of hard steel due to various loads applied by a Buckton testing machine, and then inferring the loads to which it was afterwards subjected in the actual press- rapidly. The pre way the deforma sooner t fully determined, so that a close estimate of the pressure to which the rock is sub- jected can be formed. This was done by observing the amounts of compression of a specimen of hard steel due to various loads applied by a Buckton testing machine, and then inferring the loads to which it was afterwards subjected in the actual press- Plate sure ha experim occupie After safety, t slit thro two line firm an severed cal aids however through them, an having b case the detached blow on released of the m to the c marks or Fig. 2 shown in which it The de

$$P = \frac{311p - 400}{a} \quad (a \text{ being in sq. inches}).$$

We may tabulate the values of *P* for the three sizes of rock cylinder employed, viz., 1 inch, 0·8 inch, and 0·4 inch diameter, corresponding to various values of *p*, from 50 lbs. to 300 lbs. per square inch in the cylinder (C). (The latter was the greatest pressure allowable in the 20-inch cast-iron cylinder as designed.)

<i>p</i> .	Rock 1 inch dia.		Rock ·8 inch dia.		Rock ·4 inch dia.	
	<i>P</i> , lbs./sq. in.	atm.	lbs./sq. in.	atm.	lbs./sq. in.	atm.
50	19,500	1330	31,300	2130	125,300	8530
100	39,500	2680	63,400	4320	253,500	17,200
200	79,500	5400	127,600	8700	510,300	34,700
300	119,500	8150	191,800	13,050	767,100	52,100

It having been ascertained that columns of the Carrara marble, 1 inch in diameter and 1·585 inch high, crushed at a pressure of from 11,430 to 12,026 lbs. to the square inch when free from any lateral support, the column enclosed in its wrought-iron tube in the manner above described was placed in the machine and pressure applied gradually, the exterior diameter of the tube being accurately measured at frequent intervals. No effect was noticeable until a pressure upon the marble, varying of course with the thickness of the enclosing tube, but ordinarily about 18,000 lbs. to

SON

spring relief valve (a) allowed to overflow at its course. The cup leather was carefully which the rock is subjected to compression of a testing machine, in the actual pressure were measured by 1/8th of an inch; and successive loadings tely stretching and way the cup leather independent of the to about 400 lbs. the pressure per

the square inch, was reached, when the tube was found to slowly bulge. This bulge was symmetrical and confined to that portion of the tube surrounding the marble. This distension was allowed to increase until the tube showed signs of rupture, when the pressure was removed and the experiment concluded.

*B. Deformation of the Dry Rock at Ordinary Temperatures.*

Eight experiments were made in this manner on the dry rock at ordinary temperatures, the rate at which the pressure was applied differing in different cases, the consequent deformation in some cases being very slow and in others taking place more rapidly, the time occupied by the experiment being from 10 minutes to 64 days. The pressure was regularly increased so soon as the movement ceased, and in this way the rate of motion was kept as nearly constant as possible. The final amount of deformation was not in all cases equal, as some of the tubes showed signs of rupture sooner than others, thus requiring the experiment to be brought to a close.

Plate 23, fig. 1, shows one of the tubes enclosing a marble column before the pressure has been applied, and beside it the same column after the completion of the experiment. The deformation in this case was carried out very slowly, the time occupied by the experiment being 64 days.

After the bulging of the tube had been carried as far as possible, consistent with safety, the tube was removed from the press, the plugs taken out, and the tube was slit through longitudinally by means of a narrow cutter in a milling machine along two lines opposite one another. The marble within, however, was found to be still firm and compact and to hold the respective sides of the tube, now completely severed from one another, so firmly together that it was impossible without mechanical aids to tear them apart. By means of a steel wedge, driven in between them, however, they could be separated, but only at the cost of splitting the marble through longitudinally. Columns so split, with the portions of the tube adhering to them, are shown in Plate 23, figs. 3 and 4, the marble column in the former case having been reduced to one-half of its original height in 4 hours, while in the latter case the deformation occupied 17 days. The marble was in one or two instances detached from the tube without breaking it further, by striking the latter a smart blow on the back with a hammer, but usually it adhered so firmly that it could be released from the tube only by spreading the latter in a vice. The exterior surface of the marble where it had been in contact with the tube was smooth and conformed to the curve of the bulging iron, its surface reproducing perfectly all the fine tool marks on the latter.

Fig. 2 of Plate 23 shows the deformed marble, freed in this way from the tube shown in fig. 1 of the same plate, and beside it a marble column of the dimensions which it originally possessed, for purposes of comparison.

The deformed marble is uniform and compact, and seems to break with equal ease

cylinder employed, various values of  $p$ , the latter was the (med.)

h dia.
atm.
8530
17,200
34,700
52,100

inch in diameter os. to the square wrought-iron tube pressure applied red at frequent ble, varying of t 18,000 lbs. to



in all directions. It differs somewhat in appearance from the original rock in possessing a dead white colour, somewhat like chalk, the glistening cleavage surfaces of the calcite being no longer visible, and the difference being well brought out in certain cases owing to the fact that a certain portion of the original marble often remains unaltered and unaffected by the pressure. This, when present, has the form of two cones of obtuse angle, whose bases are the original ends of the column resting against the faces of the steel plugs, while the apices extend into the mass of the deformed marble and point toward one another. These cones, or rather parabolas of rotation, are developed, as is well known, in all cases where cubes of rock, Portland cement, or cast iron are crushed in a testing machine in the ordinary manner. In the present experiments they seldom constituted any large proportion of the whole mass, and in some cases are absent or but faintly indicated, but there is always in immediate contact with the ends of the steel plugs a thin cake at least of marble possessing the characters of the original rock.

In order to ascertain the strength of the deformed rock as compared with the original marble, and also whether, in the case of the former, the rate of deformation influenced the strength, three of the half columns, obtained by splitting the deformed columns as above described and freeing them from the collar, were selected and tested in compression by means of an Emery testing machine. The results are presented in the following table, the measurements being given in inches:—

	Original height.	Original diameter.	Greatest diameter after deformation.	Time of deformation.	Crushing load for deformed marble, lbs. per square inch.
Experiment A ...	1.594	1.000	1.407	64 days	5350
" O ...	1.594	1.000	1.203	1½ hours	4000
" P ...	1.505	1.000	1.388	10 minutes	2776

As already mentioned, columns of the marble of the original dimensions, namely, 1.5 inch high and 1 inch in diameter, were found to have a crushing strength of between 11,430 and 12,026 lbs. per square inch. These figures show, that, making all due allowance for the difference in shape of the specimens tested, the marble, after deformation, while in some cases still possessing considerable strength, is much weaker than the original rock. They also tend to show that when the deformation is carried on slowly the resulting rock is stronger than when the deformation is rapid. The specimens of the deformed rock when tested, in all cases crushed in exactly the same manner as the columns of the original marble, namely, with the development of two cones whose bases are the end faces of the columns, and whose apices point toward one another, with the appearance, when the limit of strength is reached, of a series of inward curving cracks running from top to bottom of the specimen along which strips of the rock split away from the cones in question. These cones while in

original rock in possession of the deformed rock possibly influenced in their position to some extent by the cones  
 average surfaces of the produced in deforming the rock, do not result from them, since, as above mentioned,  
 brought out in certain they are always observed in the case of the original marble as well.  
 marble often remains. Thin sections of the deformed column passing vertically through the unaltered cone  
 has the form of two and the deformed portion of the rock were readily made, and when examined under  
 column resting against the microscope clearly showed the nature of the movement which had taken place.  
 mass of the deformed The deformed portion of the rock can be distinguished at once by its turbid appear-  
 parabolas of rotation, ance, differing in a marked manner from the clear transparent mosaic of the unaltered  
 Portland cement, or cone. In those cases where the deformation has been rapid, as in Experiment P of  
 ner. In the present the above list, an anastomosing and complicated meshwork of curved and branching  
 whole mass, and in lines, which are especially turbid in appearance, are seen running through the rock.  
 s in immediate con- These, when magnified 500 diameters, are resolved into strings or bands of very small  
 nible possessing the calcite granules. They mark lines along which shearing has taken place. The calcite  
 compared with the individuals along these lines have broken down, and the fragments so produced have  
 rate of deformation moved over and past one another and remained as a compact mass after the movement  
 ritting the deformed ceased. In these lines of granulated material are enclosed great numbers of irregular  
 were selected and fragments and shreds of calcite crystals, bent and twisted, which have been carried  
 The results are pre- along in the moving granulated mass as the shearing progressed. The structure is  
 sents:— therefore cataclastic, and is identical with that seen in the felspars and many  
 gneisses. A microphotograph of a thin section of the deformed marble showing this  
 structure is seen in Plate 25, fig. 1. It is taken in ordinary light, and magnified  
 70 diameters. The original column in this case had a diameter of 1.067 inch, which  
 was increased by the pressure to 1.356 inch along the line of greatest bulging. The  
 deformation was carried out in 7 hours. The dark areas are the granulated portions  
 of the rock in which the fragments of calcite individuals, often distinctly twinned,  
 are seen to be embedded.

Crushing load for deformed marble, lbs. per square inch.

5350
4000
2776

Dimensions, namely, the strength of the marble, after deformation is rapid. in exactly the development of these apices point is reached, of a specimen along cones while in

Between these lines of granulated material the marble shows movements of another sort. Most of the calcite individuals in these portions can be seen to have been squeezed against one another, and in many cases a distinct flattening of the grains has resulted with marked strain shadows, indicating that they have been bent or twisted. They show, moreover, a finely fibrous structure in most cases, which, when highly magnified, is seen to be due to an extremely minute polysynthetic twinning. The chalky aspect of the deformed rock is chiefly due to the destruction by this repeated twinning of the continuity of the cleavage surfaces of the calcite individuals, thus making the reflecting surfaces much smaller.

By this twinning the calcite individuals are enabled under the pressure to alter their shape somewhat, while the flattening of the grains is evidently due to movements along the gliding planes of the crystals. This, however, will be referred to again.

In these parts, therefore, the rock presents a continuous mosaic of somewhat flattened grains. A microphotograph of a portion of the rock showing this structure

is seen in Plate 25, fig. 2. It was taken in ordinary light, and magnified 50 diameters. Every stage can be traced, however, from the mosaic of twinned and somewhat flattened grains to the areas of perfectly granulated material. Minute lines of granulated calcite first appear along directions of intense twisting in the mosaic, then these become more numerous, and finally the complete breaking down of the mosaic into finely granulated material, filled with twisted remnants of the calcite grains, can be seen. The question of time does not seem to play any important part in the character of the deformation. The structure of the marble deformed in 64 days is essentially the same in character as that which was deformed to the same extent in 10 minutes. In both cases the lines of cataclastic structure and the intervening areas composed of flattened grains are found. It seems probable, however, from a study of the thin sections, that very rapid deformation tends to render the former structure more pronounced and more abundant, and as the granulated calcite is apparently the weakest portion of the mass, in this way to make the rock which is rapidly deformed weaker, as it is shown to be by the tests. The fact that the twinning and other structures above described are not developed in the cones proves that they are not produced by statical pressure or cubic compression, but that they are developed only when actual movement takes place in the mass.

In one experiment, of which a photograph is given in Plate 23, fig. 6, under the pressure of the two pistons, the marble was deformed as above described, causing the enclosing tube to bulge in a marked manner, and the pressure being continued, the enclosed marble tore the wrought-iron tube apart, developing a ragged rent across the fibres of the iron in a vertical direction, and commenced to fall out of the rent in the form of a fine white powder. On removing the pressure and milling open the tube, the remaining marble was found to be still firm and compact, except in the vicinity of the rent, where it was pulverulent.

### *c. Deformation of the Dry Rock at 300° C. and at 400° C.*

It was next sought to determine experimentally in what respect the second factor, namely, heat, would influence the result. A column of the same Carrara marble and of the same dimensions as those used in the former experiments was enclosed in a wrought-iron tube of the same construction as before. This, which is marked (A) in the accompanying figure (fig. 1), is surrounded by a cast-iron jacket (B), which is bored to receive it. The casting is so arranged that hot gases circulate in an annular channel (D) within it and outside of the wrought-iron cylinder (A), so that the marble is kept at a high temperature while the pressure is applied. The casting is as massive as possible so as to equalise the temperature of the interior and enable that of the enclosed rock to be inferred by a Callendar's platinum resistance thermometer (C), which is inserted at the side of the shell in the air space (E). The hot gases are excluded from this space by the wall (F); and the heat flows into the cylinder and

rock r  
is well  
tempe  
300° C

variation  
for 124 da  
and at as  
are given

VOL. CX

rock rather by the ends that across the badly-conducting air space (E). The whole is well lagged with asbestos. The heat is supplied by means of a Bunsen flame. The temperature, which was observed thrice daily, was maintained as nearly as possible at 300° C., and was within a few degrees of this most of the time, the extreme limits of

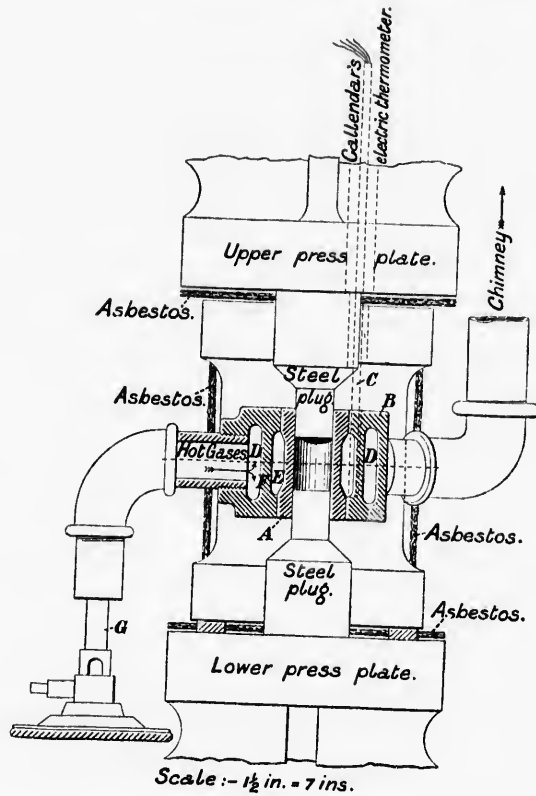

Fig. 1.

variation being 270° C. and 352° C. The marble was maintained at this temperature for 124 days, or four months, and was during this time deformed as slowly as possible and at as nearly as possible a constant rate. The dimensions of the column in inches are given in the following table :—

## Experiment K.

Height before deformation.	Height after deformation.	Diameter before deformation.	Diameter after deformation.	Time of deformation.	Crushing load after deformation in lbs. per sq. inch.
1.53	1.355	1.002	1.110	124 days	10,652

The column was thus shortened by .175 inch, or 11.4 per cent.

On removing the pistons and slitting the tube open the marble within was found to be so hard and compact that it was necessary to insert a steel wedge between the two halves of tube and drive it in by means of a hammer in order to split the marble so that the adhering portions of the tube might be removed. The rock broke with a clear, even fracture along a vertical plane passing through the centre.

Cones were not visible in this marble, the whole column (although not in so marked a manner as in the former experiments) presenting the dead white appearance characteristic of the deformed marble, although the ends of the column in contact with the plugs were a trifle less chalky in aspect than the rest of the rock. This difference was, however, by no means well marked, and little glistening cleavage faces could be seen throughout the whole mass of rock. One of the half-columns obtained by splitting the deformed marble was freed from the tube which still adhered firmly to it, in the usual manner. It separated as a single solid mass, which was quite smooth on the surface but stained with spots of a deep-brown colour where it had been in contact with the hot iron. The polish had, however, disappeared owing to the movements which had taken place over the surface, except on the ends and along a narrow zone at either end of the column where the lustre was still retained. The half-column was, of course, distinctly bulged. A photograph of bulged column, together with one of original size, is seen in Plate 23, fig. 5.

In order to determine the strength of this limestone after deformation, the half-column was then placed in an Emery testing machine and tested in compression. The pressure was gradually increased without developing any signs of distress until a load of 4200 lbs. had been reached when it suddenly crushed to fragments. Rude half-cones appeared to have sheared in at either end, which, however, were not coincident with the traces of cones of the original marble and strips split off the sides longitudinally, precisely as in the case of the columns of the original marble when tested in a similar manner. Columns of the original marble, in all respects identical with those employed in the experiment, as has already been mentioned, crushed at a pressure of between 11,430 and 12,025 lbs. per square inch. The crushing load of the marble of the deformed half-column is equivalent to 10,652 lbs. per square inch. Although therefore the two cannot be compared with absolute exactness, owing to their difference in shape, and to the fact that but a single test of the deformed marble was

made.  
nearly  
c. the  
that t  
of the  
trace  
shows  
this fil  
—the  
mate se  
end to  
place.  
are now  
as long  
adjacen  
(fig. 3).

distance  
(fig. 4);  
in one di  
cases is  
lines par

Cleavag  
grains, ev  
is no grea  
visible wa

ON

Crushing load after deformation in lbs. per sq. inch.
10,652

within was found to be between the two split the marble so rock broke with a re. h not in so marked white appearance column in contact of the rock. This being cleavage faces of columns obtained still adhered firmly s, which was quite colour where it had appeared owing to the ends and along ll retained. The f bulged column,

made, it is clear that the deformed marble, if not quite as strong, is at least very nearly as strong as the original rock. Twenty thin sections were cut from a portion c. the other half-column and examined under the microscope. The sections show that the deformed rock possesses a more or less distinct foliation except at the ends of the column, where practically no motion had taken place. Here scarcely any trace of foliation is visible. Cataclastic structure is absent, but almost every grain shows an exceedingly fine fibrous structure. When examined under a high power this fibrous structure resolves itself into an extremely narrow polysynthetic twinning—the whole grain consisting of slightly sinuous twin lamellae, extinguishing in alternate sets. Each individual is usually twinned throughout, the lamellae passing from end to end, although a single lamella often varies somewhat in width from place to place. The calcite grains which in the original rock are practically equidimensional, are now often distinctly flattened (fig. 2), some of them being three or even four times as long as they are wide. Some grains can be seen to have been bent around others adjacent to them, the twin lamellae and the extinction curving with the twisted grain (fig. 3). In other twisted individuals the twin lamellae only extend in to a certain



Fig. 2.

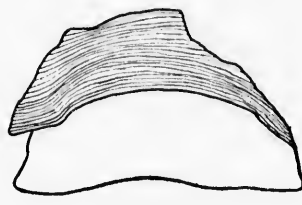

Fig. 3.

distance from the margin of the grain, leaving a clear untwinned portion in the centre (fig. 4); and other crystals again show not only the fibrous structure due to twinning in one direction, but broader lamellae crossing this obliquely. As the twinning in all cases is probably parallel to  $-\frac{1}{2}R$ —this is due to the appearance of a set of twin lines parallel to a second face of the rhombohedron (fig. 5).



Fig. 4.



Fig. 5.

Cleavage is not developed by the crushing, for it is not seen in the majority of grains, even where they are most deformed. The proportion of grains which show it is no greater in the deformed than in the original limestone. What cleavage is visible was probably developed during the grinding of the section, as it is seen in

places in sections of all marbles. There has been no breaking—the rock has not been crushed in the ordinary sense of the term. The movement has been brought about partly by twinning but chiefly by a deformation of the grains due to a slipping on their gliding planes. The structure is essentially that presented by those portions of the marble lying between the lines of granulated calcite in the case of the marble deformed at the ordinary temperature. In the accompanying plates, microphotographs of the marble before and after deformation at 300° C. are shown.

Plate 24, fig. 1, shows the appearance of a thin section of the original Carrara marble in ordinary light, magnified 50 diameters. The individuals are approximately equidimensional, and only three or four show twinning.

Plate 24, fig. 2, is the marble after having been slowly deformed at a temperature of 300° C., photographed between crossed nicols in polarised light and magnified 50 diameters. The individual grains can be seen to be distinctly flattened in a horizontal direction, giving a certain foliation to the rock. The fibrous appearance above referred to, as due to polysynthetic twinning, is also seen.

Plate 24, fig. 4, is a microphotograph of a few grains of calcite, the thinnest edge of another section of the same, taken between crossed nicols in polarised light and magnified 150 diameters. The polysynthetic twinning is well seen. Two sets of lamellæ cross and two of the bands represented in fig. 5 of the text are seen on the left. The lamellæ curve somewhat and vary more or less in width from place to place.

In the case of ice crystals a rise in temperature develops a greater ease of movement along their gliding planes, and this experiment seemed to show that the same is true of calcite. The individual grains are more plastic and accommodate themselves to the deforming forces by flowing around each other more readily rather than by breaking. The rock is therefore much stronger than when deformed at the ordinary temperature, the lines of cataclastic structure being apparently lines of weakness. As, however, the deformation in this experiment was carried on with extreme slowness, it was impossible to determine in how far this latter factor had influenced the result. Another trial was accordingly made in which the deformation was carried out quickly and at the same time at a much higher temperature. The amount of deformation induced in the marble was nearly the same as in the last case. The height of the column before compression was 1.552 inch, and after compression 1.352 inch; that is to say, the column was shortened by 12.9 per cent. The time occupied in the deformation, however, was only 8¼ hours, and the rock was maintained at a temperature of about 400° C.; the extremes of variation of the temperature during the experiment being 380° C. to 415° C. The temperature measurements were made by means of a special modification of the Le Chatelier pyrometer, calibrated by H. M. TORY, M.A., of McGill University. On slitting the tube in the usual manner and inserting the wedge to split the marble, the latter was found to offer more resistance than in any of the former experiments, and was finally pulled out of the separated

halves  
was tr  
imposs  
hot col  
zone of  
disasso  
with m  
examin  
but the  
in some  
polysyn  
lamellæ  
which p  
The ind  
shapes,  
different  
grains h  
along g  
undoubt

Apart  
viduals,  
grains, as  
one insta

two other  
precisely t

halves of the tube without splitting in two as in all other cases; but unfortunately it was traversed by a few slight cracks developed in the process which rendered it impossible to test its strength. The surface where it had been in contact with the hot collar was brown in colour and maintained its polish, except around the central zone of maximum bulging, where the lustre had disappeared. There had been no disassociation of the calcium carbonate, as fragments of the powdered marble tested with moist turmeric paper gave no trace of an alkaline reaction. When sliced and examined under the microscope, the rock showed no trace of cataclastic structure, but the grains were seen to be distinctly flattened, giving to the rock a foliation which in some places was very pronounced. The calcite individuals showed the very narrow polysynthetic twinning producing the fibrous appearance before described. The twin lamellae are in some cases twisted, the twisting being accompanied by strain shadows, which phenomenon, however, in this rock is neither very common nor very striking. The individuals are seen in many cases to have been squeezed into very irregular shapes, and in some cases to have been forced into wedge-shaped forms (fig. 6), quite different from those of the regular mosaic of the original rock. The individual grains have to all appearance acted as plastic bodies. A very pronounced movement along gliding planes, coinciding in direction with the course of twin lamellae, is undoubted.

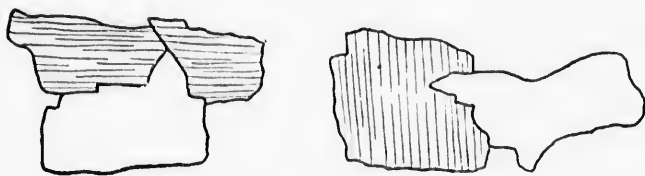

Fig. 6.

Apart from the evidence of this presented by the form of the calcite individuals, direct evidence can be seen in many cases in the step-like outline of the grains, as shown in fig. 6, the steps coinciding in direction with the twin lamellae. In one instance, shown in fig. 7, a lamella was seen to have moved inward between



Fig. 7.

two other very narrow lamellae on either side. This is of especial interest, as it is precisely this movement of individual lamellae of measurable width over one another



that gives rise to the phenomenon of the "flow" of metals as described in Section IV. Calcite, however, is apparently much more prone to twin during this deformation than metals are, although the greater difficulty of recognising twinning in metals—the latter being opaque—may have led to the frequency of this phenomenon in their case being underestimated.

The character of the movement in the case of quick deformation at a high temperature shows therefore that calcite has freer movement in its gliding planes at a high temperature and breaks less readily than when cold. A microphotograph of a section of this deformed marble (400° C.), taken in ordinary light and magnified 70 diameters, is seen in Plate 24, fig. 3. The evenness of movement and freedom from all fracturing or cataclastic action is well seen. The flattening of the grains is also distinctly shown and is especially noticeable if it be compared with the section of the original marble beside it, forming fig. 1 of the same Plate.

#### d. *Deformation of the Rock at 300° C. in the presence of Water.*

It was next sought to introduce the third factor above mentioned as possibly having an influence on rock deformation, namely, moisture.

For this purpose a modification of the apparatus employed in the experiments just described was used. A drawing of this is given in fig. 8. A hole was bored through the cast-iron jacket (B), as well as through the end of the wrought-iron cylinder (A) which contained the marble, so as to reach the surface of the steel piston at H, just above its contact with the marble column. Through this hole a stout copper pipe (K) was passed and having been screwed into A was brazed. Water was then forced through this tube by means of a hydraulic accumulator, similar in construction to that marked D in fig. 1 of Plate 22, while at the same time the required temperature was obtained by means of a gas flame as before. Even under the great hydraulic pressure employed, the water passed so slowly that the temperature could be easily maintained at 300° C.; the water making its way between the side of the steel piston and the tube (A) to the marble and passing through the latter and out of the lower steel piston by the hole (N) drilled through it. In order to prevent the water entering at H from passing upwards along the piston instead of downward into the marble and thus escaping, a heavy brass cap (P) was screwed on the end of the ring (Q), which in its turn was screwed into the jacket (B). The cap was turned with a projecting ring on its lower surface, while the upper surface of Q was slightly hollowed. In the space (M) thus intervening between the two, a ring of lead was placed, which, on screwing down the cap (P), was forced to occupy the whole space and to make a perfectly water-tight joint around the piston. This arrangement was repeated in the case of the lower steel piston.

The Callendar thermometer was inserted at C as before. In this way a column of

the Cur-  
temperat  
460 lbs. t

uniform a  
following a

Height before  
deformation

1.513

The color  
On cutting

the Carrara marble, enclosed in its iron tube, was slowly deformed while at a temperature of 300° C., but in the presence of water vapour under a pressure of 460 lbs. to the square inch. The deformation was carried on very slowly and at as

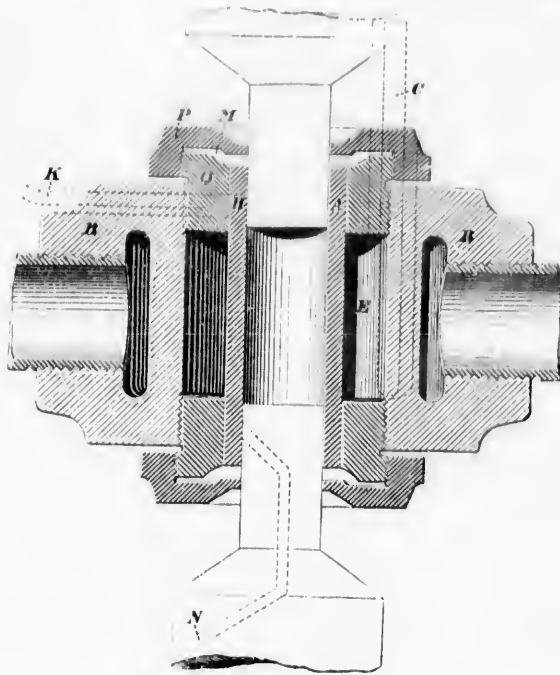

Fig. 8.

uniform a rate as possible for a period of 54 days, or nearly 2 months. The following are the dimensions of the column stated in inches:—

Experiment L.

Height before deformation.	Height after deformation.	Diameter before deformation.	Greatest diameter after deformation.	Time of deformation.	Crushing load after deformation.
1.513	1.127	.813	1.0205	54 days	Stronger than the original rock

The column was thus shortened by .386 of an inch, equivalent to 25.51 per cent. On cutting through the tube the deformed marble was found, as in former experi-

ments, to be so hard that a steel wedge had to be employed to split it. The ends of the column were found to be nearly black in colour from the deposition upon them of a thin ferruginous coating, derived apparently from the inner surface of the iron accumulator by means of which the water had been forced through the rock, as a similar deposit was found lining the tubes conveying the water both to and from the marble. This deposit, which is probably identical with that above referred to as coating the surface of the marble, was found upon examination to be composed of oxide of iron, a few little flakes of copper, carbonate of lime, and some material insoluble in acids, probably derived from the evaporation of the water on entering the heated portion of the apparatus.

In the thin ferruginous coating on the end of the column, and thus immediately beneath the face of the piston, a few minute flecks of metallic copper were also visible, showing that a little copper had been dissolved from the copper pipe carrying the water from the accumulator and redeposited on the surface of the marble. This coating although less pronounced was also visible around the sides of the column where it was in contact with the heated iron tube enclosing it. It penetrates into the marble for a short distance at one or two spots at the top and bottom of the column, but is not seen elsewhere in the inner part of the marble.

On splitting open the marble column, cones could be seen within it at either end but they were not very sharply defined. The deformed portion of the marble, that is to say, the portion of the column not included in the cones, presented the same dead white or chalk-like appearance noted in former experiments. One of the halves of the deformed limestone column after being freed from the iron tube was tested in compression in an Emery testing machine. The pressure was raised gradually without developing any signs of distress in the marble until a load of 3090 lbs. had been reached, when a minute crack developed. The pressure was then gradually increased to 3240 lbs., when the column suddenly crushed. In breaking down it split from top to bottom, like a perfectly homogeneous body, and without reference to the above-mentioned cones. Two columns of the same marble employed in the experiment and of the same dimensions as the original column, when similarly tested, broke suddenly by shearing, under loads of 4870 lbs. and 5760 lbs. respectively. These figures, however, cannot be used for the purpose of comparing the strength of the limestone before and after compression, as in the experiment at present under consideration, the bulge given to the marble was so considerable that with material of equal strength the new form would certainly be considerably stronger than a half-column of the original dimensions. In order to make a direct comparison, however, a fragment of the original marble was cut into the form of a bulged half-column of the same dimensions as that produced in the present case by compression. This when tested in compression suddenly sheared to pieces when the pressure rose to 3050 lbs.

While, therefore, the averages of a number of trials would be required to establish the exact relative strength of the original marble and the marble after deformation

the r  
weak  
A l  
verse  
referr  
from  
follow  
micro  
very n  
has be  
through  
This g  
be due  
polysy  
of the  
individ  
than tw  
distinct  
calcite g  
wide.  
while t  
to the f  
shadows  
other.  
1050 dia  
sets whi  
and .000  
Where  
under th  
which la  
There are  
stained p  
The pro  
It is just  
amounts o  
to mainta  
visible.

to split it. The ends of  
deposition upon them of  
er surface of the iron  
through the rock, as a  
both to and from the  
above referred to as  
on to be composed of  
e, and some material  
water on entering the

and thus immediately  
allic copper were also  
e copper pipe carrying  
e of the marble. This  
e sides of the column  
c. It penetrates into  
p and bottom of the  
e.

thin it at either end  
of the marble, that is  
ented the same dead  
One of the halves of  
n tube was tested in  
aised gradually with  
of 3090 lbs. had been  
n gradually increased  
own it split from top  
erence to the above

the experiment and  
sted, broke suddenly.  
These figures, how  
th of the limestone  
er consideration, the  
l of equal strength  
half-column of the  
ever, a fragment of  
column of the same  
visible.

This when tested  
to 3050 lbs.  
quired to establish  
e after deformation.

the results of the test just described show that the marble after deformation is not weaker, but actually somewhat stronger than the original rock.

A large number of thin sections of the deformed rock (some radial and some transverse) were prepared and examined. The rock shows the continuous mosaic before referred to with the exception of a little turbid line or band in each section, starting from the periphery of the top of the cylinder, and curving down toward the middle, following approximately the curve of the surface of one of the cones. Under the microscope this is seen to owe its appearance to the presence of a number of fine and very narrow reticulating lines, which appear to be lines of motion along which there has been a very minute granulation of the marble. Between these, and elsewhere throughout the column, there are no signs of granulation or cataclastic structure. This granulated material is so trivial in amount, that the deformation may be said to be due exclusively to movements on the gliding planes of the calcite, accompanied by polysynthetic twinning. It is thus identical in character with that seen in the case of the marble when deformed while dry, either at 300° C. or 400° C. The calcite individuals in the original rock are approximately equidimensional (none are more than twice as long in one direction as in the other), but in the deformed rock a very distinct foliation is often seen in the thin sections, owing to the flattening of the calcite grains, many individuals being three or even four times as long as they are wide. Some few of these flattened grains show strain shadows but no twinning, while the grains in their immediate vicinity show well-defined twinning, giving rise to the fibrous appearance before described. In some cases a grain will show strain shadows at one end, which will pass into a very narrow polysynthetic twinning at the other. The twin lamellae in many grains are so narrow that even when magnified 1050 diameters, they are not very clearly resolved. The individual lamellae in several sets which were measured, were found to have an average width of between .0005 and .0006 of a millim., and some were even narrower.

Where the iron stain has penetrated into the substance of the rock, it appears under the microscope as little lines of ferruginous material between the calcite grains, which latter are twinned and flattened in every way like those above described. There are no signs of solution and redeposition of calcium carbonate even in this iron-stained portion of the rock.

The presence of water, therefore, did not influence the character of the deformation. It is just possible, however, that there may have been a deposition of infinitesimal amounts of calcium carbonate along very minute cracks or fissures, thus contributing to maintain the strength of the rock. No signs of such deposition, however, are visible.

IV. COMPARISON OF THE STRUCTURES PRODUCED IN CARRARA MARBLE BY ARTIFICIAL DEFORMATION WITH THOSE PRODUCED BY DEFORMATION IN THE CASE OF METALS.

MÜGGE,\* whose researches in the movements set up by pressure in ice, and in various minerals and artificially prepared salts, are so extensive and so well known, in a paper read on January 14, 1899, presents the results of his investigations into the effect of pressure on metals and the nature of the movements resulting from it; and, in two papers read on March 16 and May 18 respectively of the same year, EWING and ROSENHAIN† describe a series of investigations carried out by them on the same subject, and which cover practically the same ground and yield the same results. It is pointed out that all simple metals when examined under the microscope, are seen to be allotriomorphic aggregates of metallic crystals, the structure being precisely that of a block of marble.

When the metal is deformed by compression or tension, the effect being identical in both cases, the movement is found to be due to the distortion of each grain by slipping along gliding planes, with or without the accompaniment of twinning. This was observed in gold, silver, platinum, tin, copper, lead, cadmium, bismuth, antimony, nickel, iron, steel, and various alloys. It is in fact in this way that metals move or "flow" when submitted to pressure or impact.

Polysynthetic twinning was found to accompany the movement on gliding planes, in the case of most of the metals enumerated above, both phenomena often presenting themselves in the same grain.

MÜGGE shows that in the case of soft iron, gliding can take place along six planes, and that twinning is probably also developed by pressure. EWING and ROSENHAIN, in their first paper, give three photographs of the same surface of soft iron showing the results of progressive deformation of the constituent crystalline grains under pressure, which photographs could not be distinguished from those of thin sections of the marble described in the present paper at corresponding stages of deformation. In the case of a specimen of Swedish iron, strained by a pull, the width of the lamellæ between the lines of slip was found to average 1/400 of a millim.

MESSRS. EWING and ROSENHAIN sum up the results of their experiments in the following words:—

"These experiments throw what appears to us new light on the character of plastic strain in metals and other irregular crystalline aggregates. Plasticity is due to slip on the part of the crystals along cleavage or gliding surfaces. Each crystalline grain is deformed by numerous internal slips occurring at intervals

\* "Ueber neue Structurflächen an den Krystallen der gediegenen Metalle," *Nachricht. der k. Gesell. der Wissen. zu Göttingen*; Math.-phys. Klasse. 1899. Heft 1.

† "Experiments in Micro-metallurgy: Effects of Strain (Preliminary Notice)," *Roy. Soc. Proc.*, vol. 65; "The Crystalline Structure of Metals," Bakerian Lecture, *Roy. Soc. Proc.*, vol. 65.

through  
possibil  
itself  
discon  
of the  
of slip  
easily  
"W  
occurs  
another  
the por  
involves  
is an ag  
deformed  
Plasticit  
position.  
itself, an  
By a c  
in the pr  
between  
movement  
the move  
in a vice.

V. COMP  
FIG  
MA

While th  
made the s  
paratively  
marbles. T  
limestones  
PFAFF,\* in  
widely sepa  
rocks, repres  
not mention  
that in only  
species of fo

\* "Einiges t  
der Wissen. zu

throughout its mass. In general these slips no doubt occur in three planes or possibly more, and the combination of the three allows the grain to accommodate itself to its envelope of neighbouring grains as the strain proceeds. The action is discontinuous; it is not a homogeneous shear but a series of finite slips, the portion of the crystal between one slip and the next behaving like a rigid solid. The process of slipping is one which takes time, and in this respect the aggregate effect is not easily distinguishable from the deformation of a viscous liquid.

"We infer from the experiments that 'flow' or non-elastic deformation in metals occurs through slip within each crystalline grain of portions of the crystal on one another along surfaces of cleavage or gliding surfaces. There is no need to suppose the portions which slip to be other than perfectly elastic. The slip when it occurs involves the expenditure of work in an irreversible manner. It is because the metal is an aggregate of irregular crystals that it is plastic as a whole, and is able to be deformed in any manner as a result of the slips occurring in individual crystals. Plasticity requires that each portion should be able to change its shape and its position. Each crystalline grain changes its shape through slips occurring within itself, and its position through slips occurring in other grains."

By a comparison of these results in the deformation of metals with those presented in the present paper in the deformation of marble, it will be seen that the agreement between the two is so close that the term "flow" is just as correctly applicable to the movement of heated marble in compression, under the conditions described, as it is of the movement which takes place in gold when a button of that metal is squeezed flat in a vice, or in iron when a billet is passed between a pair of rolls.

#### V. COMPARISON OF THE STRUCTURES PRODUCED IN CARRARA MARBLE BY ARTIFICIAL DEFORMATION WITH THOSE OBSERVED IN THE LIMESTONES AND MARBLES OF HIGHLY CONTORTED PORTIONS OF THE EARTH'S CRUST.

While the microscopic structure of the silicated rocks of the earth's crust has been made the subject of most exhaustive researches during the past half-century, comparatively little attention has been paid to the minute structure of limestones and marbles. The papers which have appeared on this subject deal chiefly with unaltered limestones, and there is but little mention made of structures resulting from pressure. PEAFF,\* in his somewhat extended study of limestones and dolomites from many widely separated localities, in which he examined some 700 thin sections of these rocks, representing, however, chiefly unaltered strata of Mesozoic or Neozoic age, does not mention a single instance in which cataclastic structure was observed, and states that in only two instances was a flattening of the calcite grains seen, producing a species of foliation in the rock. Both of these were from the Alps, one of them a

\* "Einiges über Kalksteine und Dolomite," *Sitzber. der Math.-phys. Classe der K. BAYER. Akad. der Wissen. zu München*, 1882. Heft 4, p. 566.

specimen of the well-known Loehseitenkalk from some locality not specified, and the other from the Fläischerberg, near Ragatz.

VOCG,\* in his recent studies on marble, mentions cataclastic structure only in the marbles from a few localities along the contact zone in Velfjorden, where it was produced by dynamic action on the already altered limestones of the contact zone. He states that this structure often makes the marbles of this district so brittle that they are unfit for use, but mentions no case in which any foliation in the marble is produced by the flattening of the calcite individuals.

Cataclastic structure has been noted in a few instances in marbles from other parts of Europe, but it would seem to be very uncommon. The development of a foliation through the mechanical flattening of the calcite grains by dynamic action is, with the exception of the cases mentioned by PEAFF, so far as we are aware, unrecorded. HEIM refers to this structure in certain Swiss limestones, but regards the grains as broken fragments.

Twinning in the calcite of marbles is common, and has frequently been described. PEAFF states that it is rare except in the primitive limestones ("Urkalken"), where it is always present. ZIRKEL† states that, as a rule, the greater proportion of the calcite individuals in marbles are untwinned, but that when present twinning is for the most part undoubtedly due to pressure and has a "Gleitflächencharakter."

As, therefore, but very few dynamically altered limestones or marbles have been made the subject of a microscopical study sufficiently detailed to enable a comparison to be instituted between their structures and those seen in the artificially deformed limestones described in the present paper, a series of 42 limestones and marbles from highly folded or metamorphosed districts were selected and studied for the purpose of instituting such a comparison. The following is a list of the limestones and marbles selected, with the localities from which they were derived. The list is divided into three parts—the first comprising the rocks in which the effects of the movements, due to dynamic action, are distinctly visible, and either closely resemble or are identical with those seen in the artificially deformed marbles; the second embraces several mesozoic limestones from intensely folded portions of the Alps, whose structure is of doubtful origin; while the third includes those rocks in which evidence of movement under pressure is doubtful or absent. Of the 42, as will be seen, 15 exhibit the structures seen in the artificially deformed marbles described in this paper.

*Limestones and Marbles showing the Structures of the Artificially Deformed Marbles.*

1. Marble. Troviken, Norway.
2.     "     Tyrol, Austria.

\* "Der Marmor in Bezug auf seine Geologie, Structur und seine mechanischen Eigenschaften," *Zeit. für prakt. Geol.*, Jan. und Feb., 1898.

† *Lehrbuch der Petrographie*, Bd. 3, p. 447.

3. Marble. Andermatt, Switzerland.
4. " Schaftelen, "
5. Limestone. Bützistöckli, Switzerland.
6. " Flims, "
7. " Griesbach, Germany.
8. Marble. Carrara, Italy.
9. " Lot 12, Range V., Township of Burleigh, Canada.
10. " Lot 11, Range IV., Township of Burleigh, Canada.
11. " Lot 38, Range VIII., Township of Austruther, Canada.
12. " Lot 29, Range XI., Township of Cardiff, Canada.
13. Limestone. Lot 28, Range XI., Township of Monmouth, Canada.
14. " Lot 27, Range XIV., Township of Monmouth, Canada.
15. Marble. Lachute, Province of Quebec, Canada.

*Mesozoic Limestones from the Alps whose Structure is of Doubtful Origin.*

16. Limestone. Längis Grat, Switzerland.
17. " Lochseite, "
18. " Saasberg, "
19. " Färnigen, "
20. " Meienthal, "
21. " Haslithal, "

*Limestones and Marbles not showing any distinct Pressure Structures.*

22. Marble. Pentelicus, Greece.
23. " Hymettos, "
24. " Segelför, Norway.
25. " Leifset, "
26. " Kvandal, "
27. " Saxenvig, "
28. " Langesundfjord, Norway.
29. Limestone. Asker, Norway.
30. Marble. Carassiner Thal, Switzerland.
31. " Ascona, Switzerland.
32. " Lot 30, Range IX., Township of Metlauen, Canada.
33. " Lot 8, Range IX., Township of Monmouth, Canada.
34. " Lot 9, Range XXIII., Township of Cardiff, Canada.
35. Dolomite. Lot 16, Range VI., Township of Cardiff, Canada.
36. " Lot 15, Range XI., Township of Wollaston, Canada.
37. Marble. Lot 15, Range XIII., Township of Galway, Canada.
38. " Lot 13, Range XIV., Township of Lutterworth, Canada.



39. Marble. Lot 14, Range III, Township of Lake, Canada.  
 40. Limestone. Lot 1, Range I, Township of Lake, Canada.  
 41. " Lot 16, Range XII, Township of Wollaston, Canada.  
 42. Marble. Lot 12, Range V., Township of Burleigh, Canada.

*Limestones and Marbles showing the Structures of the Artificially Deformed Marbles.*

1. *Marble. Troviken, Norway.*—This is a beautiful white marble from the contact zone in the Velfjorden. It is cited by Voer as an example of a marble showing cataclastic structure, and is figured in his paper on marble before referred to. It is composed of large irregular-shaped individuals or fragments of calcite, embedded in a mass of smaller grains. In the hard specimens the cleavage surfaces of the large individuals can often be observed to be bent or curved in a striking manner. Under the microscope the large grains are seen to be in the act of breaking down into smaller grains. Almost every grain is twinned, and the great majority show strain shadows, which are often very marked. The structure is cataclastic, the smaller grains having been derived from the breaking down of larger ones, some of which survive in part as the remnants. There has not, however, been that rolling out and flattening of the grains seen in No. 13. The rock is stated by Voer to owe its coarsely crystalline character to contact metamorphism, and its secondary cataclastic structure to subsequent dynamic action.

2. *Marble. Tyrol, Austria.*—A medium grained white saccharoidal marble of Liassic age, the precise locality of which it has been impossible to ascertain. The rock has undergone incipient deformation, and under the microscope presents an appearance similar to that seen in those artificially deformed marbles where the motion is due to twinning and gliding. The individuals of calcite with scarcely a single exception are twinned, often showing a double set of twin lines crossing one another. Many of the grains are bent or twisted along certain lines marked by deep strain shadows. The individual grains are approximately uniform in size and usually come together along smooth sweeping lines.

3. *Marble. Alte Kirke, Andermatt, Switzerland.*—This well-known marble, believed to be of Jurassic age, and which has, according to HEIM, been reduced to one-tenth of its original thickness by the enormous pressure to which it has been subjected during the folding of the Alps, is distinctly foliated, consisting of rude bands of larger and smaller grains of calcite. The foliation is chiefly due to the flattening of the calcite grains. Almost every grain is twinned and many show strain shadows. The sections also show little streaks or areas of much more finely crystalline calcite, containing a good deal of dark colouring matter, apparently a carbonaceous pigment. These are quite different in structure from the rest of the rock, and evidently represent the last remains of the original fine-grain limestone, from

the al  
 sericit  
 probab  
 graine  
 twinni  
 moven  
 that of  
 thin se  
 Nicols  
 of the  
 the fie  
 4. M  
 Upper  
 of Scha  
 Alps an  
 ing of a  
 of large  
 action.  
 parallel  
 perfect  
 twin lin  
 accompa  
 disappea  
 the mas  
 flattened  
 irregular  
 angles to  
 strain sha  
 this rock  
 the break  
 planes, is  
 marble.  
 intense, ti  
 rock. Th  
 5. Lim  
 (Malm) fr  
 fold. As  
 pressure to  
 structure,  
 be so ext  
 sufficient t

the alteration of which the marble was produced. There are a few little strings of sericite between the calcite grains at intervals. While the movements in this rock probably took place chiefly before or during its recrystallisation from the finer grained limestone, the flattened character of the grains, accompanied as they are by twinning and strain shadows, indicate that there have been very considerable movements in the rock since its recrystallisation. The structure closely resembles that of the Carrara marble artificially deformed at 400° C. A microphotograph of a thin section of this rock is shown in Plate 22, fig. 2. It is taken between crossed Nicols in polarised light, and is magnified 70 diameters. A part of one of the areas of the finely crystalline aggregate above mentioned is seen at the margin of the field.

4. *Marble. Near Schafstelen, Switzerland.*—This occurrence, believed to be Upper Jurassic (Malm) in age, is crossed by the Susten Road near the village of Schafstelen. Like that at Andermatt, it has been caught up in the folding of the Alps and the rock has been greatly compressed. It is a pure white marble, consisting of a very fine-grained alabaster-like base, in which there are numerous remnants of large twisted calcite individuals which are almost entirely destroyed by cataclastic action. These have an irregular elongated form, with their longer axes generally parallel to one another. Under the microscope the rock is seen to possess a most perfect cataclastic structure. The large calcite remnants are traversed by narrow twin lines and show most pronounced twisting, with strain shadows and other accompanying pressure phenomena. Many of them are seen to be in the act of disappearing by being resolved into a mass of smaller grains like those making up the mass of the rock. The smaller grains, produced in the way described, are flattened in one plane, having the form of little disks or cakes of somewhat irregular outline, as can be seen by examining sections cut parallel with and at right angles to the foliation of the rock. They do not show twinning, but frequently show strain shadows. The fine-grained portion of the rock somewhat resembles No. 5. In this rock both cataclastic action and the flattening of the small grains resulting from the breaking down of the large ones, by what must be a movement on their gliding planes, is plainly seen; both of which are structures exhibited by artificially deformed marble. Although the deformation of the calcite in this case is undoubted and intense, the twinning lines are not nearly so numerous as in the artificially deformed rock. The conditions here have evidently been less favourable to twinning.

5. *Limestone. Bütistöckli, Switzerland.*—A limestone of Upper Jurassic age (Malm) from the Canton of Glarus and forming a portion of the Glarner Double Fold. As shown by HEIM, it has been greatly squeezed and rolled out by the pressure to which it has been subjected. It is greyish-blue in colour, has a slabby structure, and shows no signs of recrystallisation. Under the microscope it is seen to be so extremely fine in grain that an enlargement of 500 diameters is barely sufficient to resolve it. In structure it closely resembles the finely granulated calcite

in the little shear zones of the artificially deformed marble. There are, however, a few rather coarser-grained streaks in the section, and these are composed of calcite grains which show marked twinning, and which are being broken down by granulation into minute grains like those composing the mass of the rock. These latter are seen under a very high power to be distinctly flattened, while the pigment still remains as minute black dots scattered throughout the mass. The somewhat coarser-grained streaks evidently result from the rolling out of little veins of calcite formed in the rock during the earlier stages of its deformation, as shown by the fact that they cut obliquely across the foliation of the rock in many cases. They consequently are free from pigment, but have been greatly crushed by later movements, and now consist of small calcite fragments in a finely granulated groundmass, presenting a typical cataclastic structure. These fragments have precisely the same "fibrous" structure as that seen in the calcite of artificially deformed marbles. The fact that these later veins have not been recrystallised would seem to indicate that the finer grained groundmass of the rock is still intact in this respect, and that the flattening of the minute calcite grains has probably been produced by the pressure to which the rock has been subjected, as it is in the case of the Carrara marble in the experiments described in this paper.

6. *Limestone. Flims, Switzerland.*—A very fine-grained bluish Upper Jurassic limestone, showing structures similar to those described in No. 5.

7. *Limestone. Griesbach, Erzgebirge, Germany*—A light grey granular limestone or marble, rather fine in grain, with an indistinct banded appearance caused by the alternation of lighter and darker streaks or bands. Under the microscope the rock shows what is to all appearances a well-marked cataclastic structure. There are larger grains of irregular elongated form, with their longer axes lying in the same direction, and between them smaller grains which look as if they had been torn from the larger ones. Almost every grain, large or small, is highly twinned, often showing two sets of two lamellæ crossing one another. The twinning is usually in very narrow polysynthetic bands, often so narrow that the grains have a fibrous appearance, exactly like that in the artificially deformed limestones. Strain shadows are also common, but usually the grains are so highly twinned that the strain seems to have been relieved in this way. The larger grains are often as much as seven times as long as they are wide and are ragged in outline. The whole appearance of the rock indicates movement under great compression. The structures are exactly those seen in the deformed Carrara marble. The cataclastic structure, however, as in Nos. 10 and 11, has a more coarse-grained development than that produced artificially. The original rock was composed of larger individuals, and the granulated material is not so finely triturated. The other structure, which consists of the deformation and flattening of the component individuals of the rock by twinning and movement on their gliding planes, is exactly like that seen in the Carrara marble when deformed at 300° C. or 400° C. In thin sections the finer-grained portions of this

Griesbach  
marble  
this rock  
polarised  
of quartz

8. *Marble*  
pressure  
figured  
tion were  
in the gl  
calcite g  
proportio  
appearan  
produced  
As in the  
rock has  
this speci

Nos. 9  
The first  
Ontario, I  
point abo

9. *Marble*  
from the s  
from the  
point to g  
of the lim  
some cases  
diameter.  
free from  
foliation, a  
more or les  
parallel to  
Under the  
are twinned  
seen to be  
margins.  
between cr  
small grain  
seen, and th  
as that in v  
grains of q  
marked gra

VOL. CXXV

Griesbach limestone cannot be distinguished under the microscope from the Carrara marble deformed at 400° C., the structures being identical. A microphotograph of this rock is shown on Plate 22, fig. 3. It was taken between crossed Nicols in polarised light and is magnified 70 diameters. The rock also contains a few grains of quartz and muscovite which usually show marked strain shadows.

8. *Marble. Carrara, Italy.*—Carrara marble is usually free from any evidence of pressure or deformation, its normal character being that of the marble described and figured in the former part of this paper, and upon which the experiments in deformation were carried out. In this specimen, however, there is a suggestion of parallelism in the glistening cleavage surfaces of the broken rock, and under the microscope the calcite grains show a distinct tendency to assume a flattened form. A very large proportion of the grains are twinned, and strain shadows are seen in some cases. The appearance of the sections indicates that the flattening of the grains has been produced by movements along gliding planes under the influence of dynamic action. As in the case of No. 15, pressure acting subsequent to the recrystallisation of the rock has probably set up movements in certain parts of the mass, from one of which this specimen has been derived.

Nos. 9 to 15 are from the Grenville series, of the Laurentian system, of Canada. The first six are from the counties of Peterborough and Hastings, in the province of Ontario, in the district to the north of the lake of that name, and the last is from a point about 40 miles west of Montreal, in the province of Quebec.

9. *Marble. Lot 12, Range V., Township of Burleigh, Ontario.*—This marble comes from the same great limestone belt as Nos. 10 and 11, although several miles distant from the locality from which the latter was obtained. The stratigraphical relations point to great movements along this line, a fact which is borne out by the structure of the limestones themselves. The limestone at this locality is coarsely crystalline, in some cases becoming very coarse, the constituent grains being as much as an inch in diameter. As in the case of the Carrara deposits, it is for the most part massive and free from any foliation, but along certain lines or bands it presents a very marked foliation, and cataclastic structure is distinctly seen in hand specimens, large and more or less lenticular and much twisted calcite remnants lying with their longer axes parallel to one another in a fine-grained base derived from their partial destruction. Under the microscope the evidence of this action is most striking. The large remnants are twinned and curved, showing marked strain shadows, and can in many cases be seen to be in the act of breaking down into smaller grains, especially about their margins. A microphotograph of the rock is shown in Plate 25 fig. 3. It is taken between crossed Nicols in polarised light, and is magnified 41 diameters. In the small grains constituting the base twinning and strain shadows are also frequently seen, and there is presented a distinct tendency to flattening in the same direction as that in which the longer axes of the large remnants lie. A number of twisted grains of quartz, showing very marked strain shadows, and in some cases even a marked granulation, are also present in the rock.

10 *Marble.* Lot 11, Range IV., Township of Burleigh, Ontario.—This is identical with No. 9, except that the base is very much finer in grain. The larger remnants are so highly twinned that they often present the fibrous appearance before referred to. They lie scattered about in the fine-grained base, and wedge-shaped tongues of the finer-grained material can often be observed penetrating them. The structure is identical with that seen in the Carrara marble when deformed at ordinary temperatures, that is, with a marked development of cataclastic structures rather than of movement on gliding planes. The whole in the case of the natural marble, however, is on a larger scale; the original rock was more coarsely crystalline, and the resulting product was not so finely granulated.

11. *Marble.* Lot 38, Range VIII., Township of Anstruther, Ontario.—Practically identical with 10 in every respect. A microphotograph of a thin section of a highly granulated portion of this rock is shown on Plate 25, fig. 4. It is photographed between crossed Nicols in polarised light and is magnified 70 diameters.

12. *Marble.* Lot 29, Range XI., Township of Cardiff, Ontario.—A very fine-grained marble, through which are distributed occasional large twisted calcite remnants, which indicate that the rock in its present form has resulted from the granulation of a coarsely crystalline marble. The rock bears a very strong resemblance to No. 4, but the granulation is more advanced and the calcite remnants less numerous. The granulated portion of the rock is also identical with that of No. 10; in fact, No. 10, if more completely granulated, would be identical in character with this rock.

13. *Limestone.* Lot 28, Range XI., Township of Monmouth, Ontario.—At two places in this township (Nos. 13 and 14) the coarsely crystalline white limestone of the Laurentian contains somewhat irregular-shaped streaks or bands which are bluish-black in colour and very fine in grain. These are portions of the original limestone in a comparatively unaltered condition. In these bluish-black portions the calcite grains are very small, and have the dark carbonaceous colouring matter distributed all through their substance. An enlargement of 500 diameters is required for their study. With this power the rock is seen to be perfectly crystalline, the minute calcite individuals being fitted together along boundaries which are smooth or in some cases slightly crenulated. The grains are usually distinctly flattened, but this is not seen in all cases. Some of them are twinned, and many of them show strain shadows. The white marble with which this blue limestone is associated consists of a much more coarsely grained aggregate of calcite grains. These show the most marked evidence of motion, being very much twisted and flattened in the direction of the foliation of the rock, with twinning and very pronounced strain shadows. The carbonaceous pigment has been destroyed. Distributed in the usual more or less rounded forms through both the blue and the white varieties, but especially abundant in the latter, are grains of several other minerals—plagioclase, pyroxene, biotite, &c.—the results of metamorphic action. These generally show the effects of pressure, often in a striking manner.

The st  
deformat  
original  
with the  
subjected  
while affe

14. *Li*  
in charac

15. *Ma*  
structure.  
flakes, wh  
cataclastic  
grained r  
shadows, i  
the phen  
visible. T  
deformatio  
cataclastic  
calcite gra

*Mesc*

The Jura  
Alps, and v  
certain line  
contorted, i  
have becom  
(No. 3) and  
these limest  
(No. 5) and  
former, as h  
deformation  
doubtedly be  
evidence of t  
To the latter  
is in all cas  
described ab  
"Umformun  
angles to the  
however, this  
about by pre

The structure of this rock is due in part to cataclastic action, but chiefly to the deformation of the calcite grains by motion on their gliding planes. Evidently the original blue limestone was recrystallised throughout the greater part of its mass with the development of numerous secondary minerals, and the whole was then subjected to dynamic action, which resulted in the movements described, which, while affecting both rocks, are most noticeable in the coarser-grained marble.

14. *Limestone. Lot 27, Range XIV., Township of Monmouth, Ontario.*—Identical in character with No. 13.

15. *Marble. Lachute, Province of Quebec.*—This rock has a very distinct foliated structure, the plane of foliation being emphasised by the presence of little graphite flakes, which have the appearance of being smeared along it. The rock has a marked cataclastic structure, and has clearly been derived from the squeezing of a coarse-grained marble. The deformation of the calcite grains, accompanied by strain shadows, is very marked in all but the smallest grains, which would probably show the phenomenon also if their surfaces were sufficiently large to render the shadows visible. Twinning is also common, although many grains which show a marked deformation are free from all traces of it. While, therefore, the structure is cataclastic, it is combined with a most marked development of deformation of the calcite grains by movement along their gliding planes.

*Mesozoic Limestones from the Alps whose Structure is of Doubtful Origin.*

The Jurassic limestones which have been caught up in the mighty foldings of the Alps, and which are found not only in the flanks of the mountain system but along certain lines in the deep synclinals of the chain, although extremely compressed and contorted, in many cases show but little signs of alteration, while elsewhere they have become converted into coarsely crystalline marbles. The marbles of Andernatt (No. 3) and of Schaftelen (No. 4) are believed to be of Mesozoic age, and to represent these limestones in their highly altered condition; while the limestones of Bützistöckli (No. 5) and Flins (No. 6) represent the rocks in a comparatively unaltered state. The former, as has been shown, present certain structures which are clearly attributable to deformation under pressure, but in some of the mesozoic limestones which have undoubtedly been extremely plicated and subjected to enormous internal movements, the evidence of these movements in the minute structure of the rock is by no means striking. To the latter class belongs the rocks of this division, Nos. 16 to 21. Their structure is in all cases essentially the same, and they are closely related to Nos. 5 and 6 described above. This structure is that which is the most important element in HEIM'S "Umformung ohne Bruch." The individual grains of calcite are flattened at right angles to the pressure, and in the direction of the movement of the rock. Whether, however, this flattening, inducing what HEIM terms "microclivage," has been brought about by pressure, the flattened grains flowing on their gliding planes and moving over

one another and thus always adapting their shape to the space to be occupied, or whether the structure is in part due to recrystallisation, is not perfectly certain. HUBER holds the former view, and believes that microclivage and fluidal structure are essentially the same. "Es gibt in der That," he writes, "keine Grenze und keinen wirklichen mechanischen Unterschied zwischen beiden."\* If this be the true explanation of the structure, these rocks are closely related to those of the class just described. We intend in a subsequent series of experiments, making use of fine-grained limestones, to endeavour to reproduce this structure also by artificial compression, and thus, if possible, to determine its origin.

16. *Limestone. Längis Grat, Switzerland.*—A fine-grained grey limestone from the Längis Grat, which rises above the Furka Road, opposite the Rhone Glacier, and which is believed to be a continuation of the same limestone as that which further east appears as the Andernatt marble (No. 3). It breaks up into long thin chip-like fragments, and where it disintegrates in damp places falls into a mass of needle-like calcite grains. It is indistinctly streaked in very narrow lines in lighter and darker shades. With the exception of a little carbonaceous matter and a few mica plates it consists altogether of calcite. In some places it holds belemnites. It has a very distinct foliated structure, due to the calcite grains being all flattened in one direction. The mass of the rock is made up of very small grains, but there are at intervals lines of similarly flattened grains of larger size. As shown by the study of longitudinal and transverse sections, the grains have the shape of short laths of irregular outline, resembling very closely in form the little leaves of quartz seen in certain gneisses, and are frequently as much as six times as long as they are wide. The larger grains are frequently twinned, but the smaller grains rarely show this structure. Strain shadows are not seen. It seems doubtful whether this structure is attributable to recrystallisation in the case of such a fine-grained limestone which still retains its organic pigment. It is not cataclastic, but may be due to the flattening of the calcite grains by gliding, under the influence of the great pressure to which the rock has been subjected.

17. *Limestone. Lochseite, Switzerland.*—The Malm limestone which is such a striking element in the succession in the Glarner Double Fold, and which derives its local name from Lochseite, near Schwanden, presents the same flattening of the constituent calcite grains as described in No. 16. The rock from Lochseite itself is very impure and extremely fine in grain, so that the structure is not well seen, but the elongation or flattening of the minute calcite grains composing the rock was observed in a number of slides of the Lochseiten-Kalk from various localities, which are preserved in the collections of the Geological Department of the University of Zürich.

18. *Limestone. Saasberg, Switzerland.*—The rock from the Saasberg, near the Bützistöckli, shows this structure excellently.

\* 'Untersuchungen über den Mechanismus der Gebirgsbildung,' Bd. 2, p. 56.

19. *Limestone. Farnip, Switzerland.*—A syenitic limestone at Farnip, Switzerland, in that some cases white calcite grains, like those of darker untwinned calcite. There are some of the origin is identical with the same structure. 20. *Limestone. Helm's 'E', Switzerland.*—A calcite limestone folded in various directions, thus forming a characteristic rock because of becoming flattened in various directions, the grain. The calcite grain.

*Limestone.*

The limestone described above is under pressure. The recrystallisation described by Huber is certain of the mosaic is produced.

\* 'Geology.'

19. *Limestone. Färnigen, Switzerland.*—Near the eastern end of the Susten Pass a synclinal of Mesozoic rocks is pinched in by the folding of the Alps. Among these at Färnigen is a very fine-grained, slabby, blue limestone, which is of especial interest in that it contains numerous belemnites, which have been greatly elongated and in some cases torn apart. The rock shows no signs of recrystallisation, except that white calcite has been deposited between the fragments of the broken belemnites. Under the microscope it is seen to be composed of very minute elongated calcite grains, like those above described. There are also dotted all through the rock, groups of darker coloured grains of a rhombohedral carbonate, probably dolomite. These are untwinned and apparently uncrushed. The foliation of the rock, due to the flattening of the calcite grains, curves around them as it does around the garnets in a schist. There are also lines of more coarsely crystalline calcite, as described in No. 5, whose origin is identical in both cases.

20. *Limestone. Meienthal, Switzerland.*—Other specimens in the Zürich collection labelled simply "Meienthal," but probably also from near Färnigen, show exactly the same structure as described in No. 19. The little elongated calcite grains not having an identical orientation extinguish between crossed Nicols in different positions.

21. *Limestone. Haslithal, Switzerland.*—This rock, which is a typical example of HEIM'S 'Bruchlose gefaltete Malm Kalk,' shows the same flattening of the minute calcite individuals composing it. The little calcite veins referred to in No. 5 are here folded in with the rock and are more coarsely crystalline. Their presence shows that the rock was at first brittle and became shattered under the pressure, the fissures thus formed becoming filled and giving rise to calcite veins more coarsely crystalline in character than the rest of the rock. With the continuance of the pressure the rock became plastic and the veins were folded, the calcite grains composing them becoming flattened like those constituting the mass of the rock. The plane of the flattening or foliation of the grains cuts across the veins quite irrespective of their course, the position of the latter being marked by their lighter colour and coarser grain. The motion evidently took place in connection with the flattening of the calcite grains, and possibly, as above noted, by their movements over each other.

#### *Limestones and Marbles not showing any Distinct Pressure Structures.*

The limestones and marbles of this class (Nos. 22 to 42) do not here merit individual description. They do not present any undoubted evidence of movement under pressure. Their structure is that of a mosaic, apparently resulting in each case from the recrystallisation of a previously existing finer-grained limestone. This process, as described by LEPSIUS\* in the Attic marbles, consists of the enlargement or growth of certain of the constituent grains at the expense of others until finally a coarse-grained mosaic is produced. Traces of this are seen in several of these rocks. Twinning is

\* 'Geologie von Attika; ein Beitrag zur Lehre vom Metamorphismus der Gesteine,' p. 186.



often present, but there has been no distinct alteration in the shape of the grains by pressure. The individual grains are, in some cases, very irregular in shape and often come together along more or less crenulated lines, and in No. 24 the peculiar intergrowth of separate calcite individuals described by Voegt\* was observed. The structure of the limestones and marbles of this class is in fact quite different from those included in the first list, although they might readily give rise to such rocks as these, were they subjected to dynamic action under the required conditions.

It will thus have been seen that the deformed limestones and marbles met with in nature, present in many cases at least precisely the structures developed in marble by artificial deformation. Among these are to be especially noted, in the first place, cataclastic structure; and, in the second place, the twisting, elongation, and flattening of the component calcite individuals either with or without the concomitant development of twinning and strain shadows, these latter phenomena being almost invariably seen in the larger individuals but less frequently observed in the very small grains, apparently on account of the very smallness of their surface. When a large, highly twinned and strained calcite individual is observed breaking down into a mass of smaller grains, it can be distinctly seen that each individual grain resulting from this granulation is so small that it is, in the great majority of cases, derived from a single twin lamella, and its surface is so limited that the strain shadow upon it would be scarcely noticeable.

While, therefore, recrystallisation undoubtedly plays an important, and in many cases probably a chief, part in the great movements which are observed to have taken place in the limestones of contorted districts, this process is by no means the only one by which such movements are brought about. Many limestones under pressure in the earth's crust *flow* precisely as metals do by deformation of the compressed grains and without the intervention of water or any other solvent.

## VI. SUMMARY OF RESULTS.

1. By submitting limestone or marble to differential pressures exceeding the elastic limit of the rock and under the conditions described in this paper, permanent deformation can be produced.
2. This deformation, when carried out at ordinary temperatures, is due in part to a cataclastic structure and in part to twinning and gliding movements in the individual crystals composing the rock.
3. Both of these structures are seen in contorted limestones and marbles in nature.
4. When the deformation is carried out at 300° C., or, better, at 400° C., the cataclastic structure is not developed, and the whole movement is due to changes in the shape of the component calcite crystals, by twinning and gliding.
5. This latter movement is identical with that produced in metals by squeezing or

\* *Loc. cit.*, p. 13.

6. The  
7. The  
8. In  
9. It is

Fig. 1. The  
d  
a  
d

Fig. 2. The  
g  
t  
ag  
fr  
re  
P

Fig. 3. This  
Th  
lar  
me  
an  
als  
art  
bet

Fig. 1. On t  
rea  
mar  
nat

- hammering, a movement which in metals as a general rule, as in marble, is facilitated by increase of temperature
6. There is therefore a flow of marble just as there is a flow of metals under suitable conditions of pressure.
  7. The movement is also identical with that seen in glacial ice, although in the latter case the movement may not be entirely of this character.
  8. In these experiments the presence of water was not observed to exert any influence.
  9. It is believed, from the results of other experiments now being carried out but not yet completed, that similar movements can, to a certain extent at least, be induced in granite and other harder crystalline rocks, and that several structures developed in these rocks in nature in highly contorted regions can thus be reproduced.

EXPLANATION OF PLATES.

PLATE 22.

- Fig. 1. The machine used in the investigation. A marble column is in process of deformation. The experiment is being carried out in the absence of moisture and at the ordinary temperature. The small boiler on the extreme right does not belong to this machine.
- Fig. 2. Thin section of the marble from Alte Kirke, Andermatt, Switzerland. The grains are slightly flattened in a horizontal direction, and are repeatedly twinned in almost every case. On the right there is a fine-grained aggregate which represents a remnant of the original fine-grained limestone, from the recrystallisation of which the marble was derived. The structure resembles that of Carrara marble artificially deformed at 300° or 400° C. Photographed between crossed Nicols.  $\times 70$  diameters.
- Fig. 3. Thin section of the limestone or marble from Griesbach, in the Erzgebirge. The smaller grains have probably been derived from the breaking down of larger individuals, a portion of one of which is seen. All the grains show most pronounced polysynthetic twinning, two sets of lamellæ crossing one another being visible in most individuals. Movement on gliding planes is also pronounced, the structure being identical with that produced by the artificial deformation of Carrara marble at 300° C. or 400° C. Photographed between crossed Nicols.  $\times 70$  diameters.

PLATE 23.

- Fig. 1. On the left the iron tube enclosing the marble of Experiment A is shown ready to be placed in the machine. On the right the same, after the marble had been slowly deformed during a period of 64 days. 13/14 of natural size.

- Fig. 2. The deformed marble of Experiment A freed from the enclosing iron tube, and beside it a marble column of the dimensions which it originally possessed. 14/13 of natural size.
- Fig. 3. Tube containing the deformed marble, milled open, and the marble split in two as described. The marble column in this case was reduced to one-half its original height in 4 hours. Natural size.
- Fig. 4. Another experiment similar to that shown in fig. 3; the deformation, however, is less marked. The experiment in this case occupied 17 days. The cones were quite distinct in the original. 10/11 of natural size.
- Fig. 5. Column of marble (Experiment K) deformed at 300° C. The experiment occupied 124 days. Beside it is a column of the original dimensions. Natural size (very nearly).
- Fig. 6. In this case the pressure on the marble was continued so long and the deformation carried so far that the moving marble within tore the iron tube apart, as shown. This tube when opened is shown in fig. 3.

## PLATE 24.

- Fig. 1. Microphotograph of the Carrara marble used in the experiments. The rock as found in nature. The individual grains have very nearly the same diameter in every direction, although differing somewhat in size among themselves. Twinning is seen only in two or three grains, and in these is represented by a few broad lamellæ. Photographed in ordinary light.  $\times 50$  diameters.
- Fig. 2. A microphotograph of the Carrara marble after having been slowly deformed during 124 days at a temperature of 300° C. The individual grains can be seen to be distinctly flattened in a horizontal direction, giving a certain foliation to the rock, and to possess the fibrous appearance referred to in the text as due to polysynthetic twinning. Photographed between crossed Nicols in polarised light.  $\times 50$  diameters.
- Fig. 3. Microphotograph of the Carrara marble deformed at 400° C. A uniform mosaic of somewhat flattened grains, free from all fracturing or cataclastic action. Photographed in ordinary light.  $\times 70$  diameters.
- Fig. 4. Microphotograph of a few grains of the calcite on the thinnest edge of a section of the deformed marble shown in fig. 2. The polysynthetic twinning is well seen. Two sets of twin lamellæ cross one another in the large grain, curving somewhat, and varying more or less in width from place to place. Photographed between crossed Nicols in polarised light.  $\times 150$  diameters.

Fig. 1.

Fig. 2.

Fig. 3.

Fig. 4.

VOL. CX

PLATE 25.

- Fig. 1. Microphotograph of a thin section of the Carrara marble (shown in Plate 24, fig. 1) deformed at the ordinary temperature in 7 hours. The dark areas are the granulated portions of the rock. Irregularly shaped fragments of calcite individuals, often distinctly twinned, are seen scattered through it. Photographed in ordinary light.  $\times 70$  diameters.
- Fig. 2. Microphotograph of a thin section of the same marble between the lines of granulated material. It presents a continuous mosaic of flattened grains. Photographed in ordinary light.  $\times 50$  diameters.
- Fig. 3. Microphotograph of a thin section of the Laurentian marble from Lot 12, Range V., of the township of Burleigh, Ontario. Presents a cataclastic structure identical with that shown by the deformed marble of fig. 1 of this Plate, but on a larger scale. The original rock was much more coarsely crystalline, and the granulation has not been so minute. The twisting and twinning of the large remnants in process of granulation is well seen. Photographed between crossed Nicols in polarised light.  $\times 47$  diameters.
- Fig. 4. Microphotograph of a thin section of the Laurentian marble from Lot 38, Range VIII., of the township of Anstruther, Ontario. The rock is identical in character with that shown in fig. 3, but the section represents a more thoroughly granulated portion. The structure is identical with that seen in the artificially deformed marble of fig. 1, but the granulation is not quite so minute. Photographed between crossed Nicols in polarised light  $\times 70$  diameters.

*Adams*



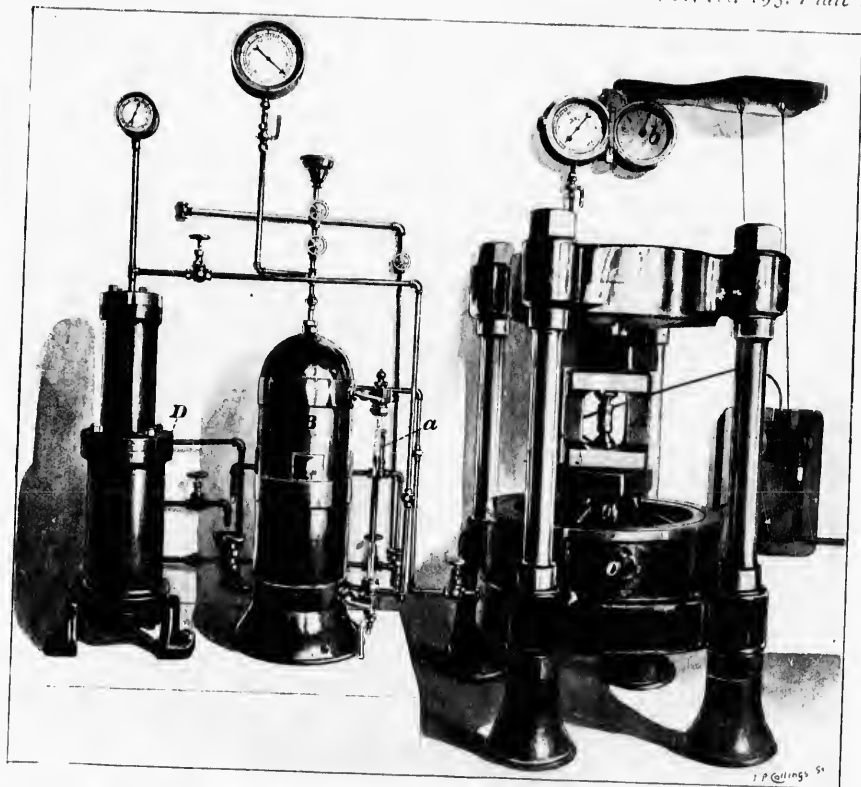

Fig. 1.



Fig. 2.



Fig. 3.





Fig. 1.



Fig. 1.



Fig. 2.



Fig. 3.

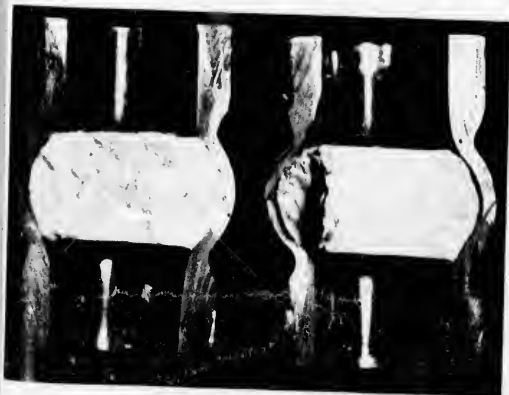

Fig. 3.



Fig. 6.





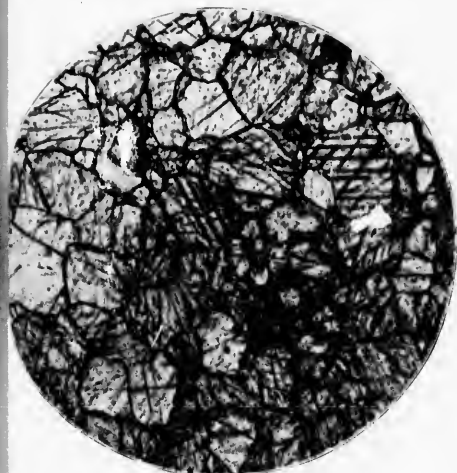

Fig. 1.

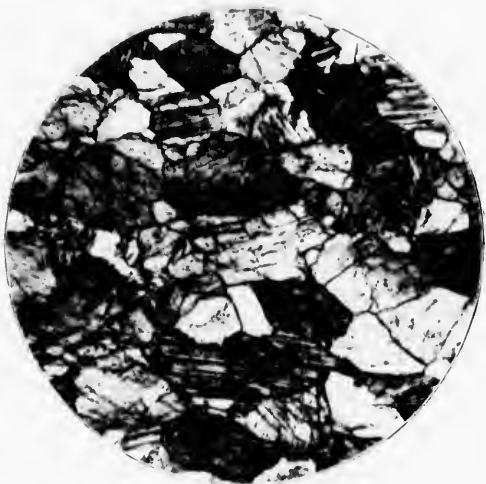

Fig. 3.



Fig. 2.



Fig. 4.

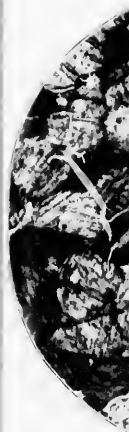



Fig. 1.



Fig. 3.



Fig. 2.



Fig. 4.

