

Technical and Bibliographic Notes / Notes techniques et bibliographiques

The Institute has attempted to obtain the best original copy available for filming. Features of this copy which may be bibliographically unique, which may alter any of the images in the reproduction, or which may significantly change the usual method of filming, are checked below.

L'Institut a microfilmé le meilleur exemplaire qu'il lui a été possible de se procurer. Les détails de cet exemplaire qui sont peut-être uniques du point de vue bibliographique, qui peuvent modifier une image reproduite, ou qui peuvent exiger une modification dans la méthode normale de filmage sont indiqués ci-dessous.

Coloured covers/  
Couverture de couleur

Covers damaged/  
Couverture endommagée

Covers restored and/or laminated/  
Couverture restaurée et/ou pelliculée

Cover title missing/  
Le titre de couverture manque

Coloured maps/  
Cartes géographiques en couleur

Coloured ink (i.e. other than blue or black)/  
Encre de couleur (i.e. autre que bleue ou noire)

Coloured plates and/or illustrations/  
Planches et/ou illustrations en couleur

Bound with other material/  
Relié avec d'autres documents

Tight binding may cause shadows or distortion along interior margin/  
La reliure serrée peut causer de l'ombre ou de la distorsion le long de la marge intérieure

Blank leaves added during restoration may appear within the text. Whenever possible, these have been omitted from filming/  
Il se peut que certaines pages blanches ajoutées lors d'une restauration apparaissent dans le texte, mais, lorsque cela était possible, ces pages n'ont pas été filmées.

Additional comments:/  
Commentaires supplémentaires:

Coloured pages/  
Pages de couleur

Pages damaged/  
Pages endommagées

Pages restored and/or laminated/  
Pages restaurées et/ou pelliculées

Pages discoloured, stained or foxed/  
Pages décolorées, tachetées ou piquées

Pages detached/  
Pages détachées

Showthrough/  
Transparence

Quality of print varies/  
Qualité inégale de l'impression

Continuous pagination/  
Pagination continue

Includes index(es)/  
Comprend un (des) index

Title on header taken from:/  
Le titre de l'en-tête provient:

Title page of issue/  
Page de titre de la livraison

Caption of issue/  
Titre de départ de la livraison

Masthead/  
Générique (périodiques) de la livraison

This item is filmed at the reduction ratio checked below/  
Ce document est filmé au taux de réduction indiqué ci-dessous.

10X	14X	18X	22X	26X	30X
<input type="checkbox"/>	<input type="checkbox"/>	<input type="checkbox"/>	<input type="checkbox"/>	<input checked="" type="checkbox"/>	<input type="checkbox"/>
12X	16X	20X	24X	28X	32X

**ROYAL OIL CO.,** TORONTO  
...and...  
MONTREAL

CYLINDER  
DYNAMO  
ENGINE.....

**OILS**

**ANADIAN MANUFACTURER**  
AND INDUSTRIAL WORLD.  
DEVOTED TO THE MANUFACTURING INTEREST OF THE DOMINION.

Vol. 87.

TORONTO, AUGUST 5, 1898.

No. 3.

THE INVOICE

**Tag Envelope**

Should be used on all Express Parcels. The saving in postage pays for the Envelope ten times over.

Manufactured by

**The Barber & Ellis Co., Limited.**

Nos. 43, 45, 47, 49 BAY STREET, TORONTO.

Write for Samples.

**ANILINE LIZARINES**  
DOMINION DYEWOOD & CHEMICAL CO.  
TORONTO.  
PRODUCTS OF  
The Farbenfabriken vorm. F. Bayer & Co.  
DOMINION DYEWOOD & CHEMICAL CO.  
SOLE AGENTS FOR CANADA TORONTO.

CHARLES F. CLARK, Prop. JARED CHITTENDEN, Treas.  
ESTABLISHED 1849.

**THE BRADSTREET MERCANTILE AGENCY**

THE BRADSTREET COMPANY, Proprietors.

348 & 348 Broadway, NEW YORK.

Offices in the principal cities of the United States, Canada, the European Continent, Australia, and in London, England.

The Bradstreet Company is the oldest, and financially the strongest organization of its kind—working in one interest and under one management—with wider ramifications, with more capital invested in the business, and it expends more money every year for the collection and dissemination of information than any similar institution in the world.

TORONTO OFFICES:

McKinnon Bldg., Cor. Jordan & Melinda Sts.  
THOS. C. IRVING, Superintendent.

**J. G. McLAREN BELTING CO.**  
OAK EXTRA TANNED  
1856  
THE J. G. McLAREN BELTING CO. MANUFACTURERS  
MONTREAL TORONTO

ALSO MANUFACTURERS OF  
**CARD CLOTHING**  
SET IN IMPORTED OAK LEATHER BACKING,  
LOOM REEDS, ETC.  
AND  
**GENERAL MILL SUPPLIES.**

**THISTLE BRAND**  
FRICITION SURFACE RUBBER BELTING  
MONTREAL TORONTO

**Fensom's**  
ELECTRIC HYDRAULIC STEAM HAND-POWER  
All made of the best material and finest workmanship.  
**Elevators**  
The Fensom Elevator Works...  
10, 51, 53 Duke Street, Toronto, Ont.

**RUBBER GOODS OF ALL KINDS.**  
THE GUTHRIE PERCHA & RUBBER MFG CO.  
TRADE MARK  
TORONTO  
61 and 63 FRONT ST. WEST, TORONTO.

THE.....  
**Walkerville Malleable Iron Co., (Limited)**  
Manufacturers of...  
**REFINED AIR FURNACE**  
**Malleable Castings**  
ALSO LIGHT GREY-IRON CASTINGS.  
WALKERVILLE, ONTARIO.

**RIDOUT & MAYBEE**  
Foreign managers of the...  
CHARTERED INSTITUTE OF PATENT AGENTS, ENGLAND

SOLICITORS of and EXPERTS in  
PAMPHLET ON PATENTS SENT FREE  
103 Bay Street, Toronto

**Patents**

HAMILTON FACINGS LIMITED Foundry Facings, Ceylon Plumbago, Core Compound and Foundry Supplies  
 HAMILTON, ONT.

REGD. TRADE MARK  
 A. D. SANDERSON & CO.  
 MACHINISTS TAPS  
 SEND FOR CATALOGUE.

# The Royal Electric Co'y

MONTREAL, QUE.

Western Office.... TORONTO, ONT.

## S.K.C. Two-Phase Alternators

Incandescent Light, Arc Light and Power from same Dynamo and Circuit.

**Highest Efficiency**

**Best Regulation**

**Slow Speed**

**Least Attention**

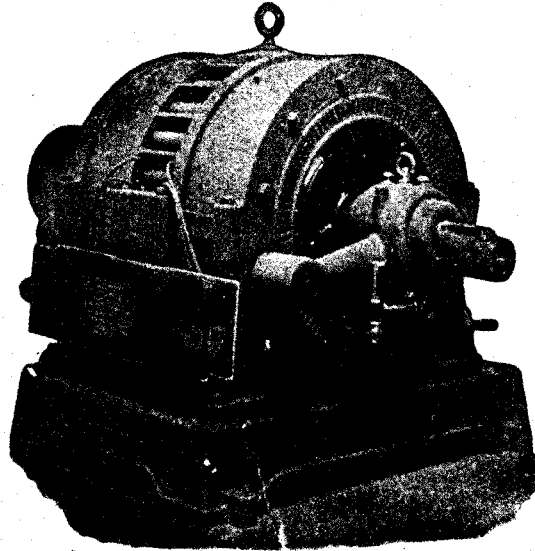

**No Collector**

**No Moving Wire**

**No Exposed Parts**

**No Compounding**

S.K.C. 50 Kilowatt Two-Phase Generator

DIAMOND BRAND

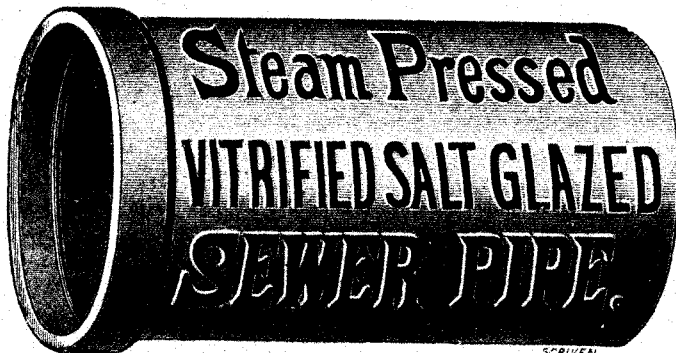

Manufactured by... **The HAMILTON AND TORONTO SEWER PIPE CO.**  
HAMILTON, ONTARIO.

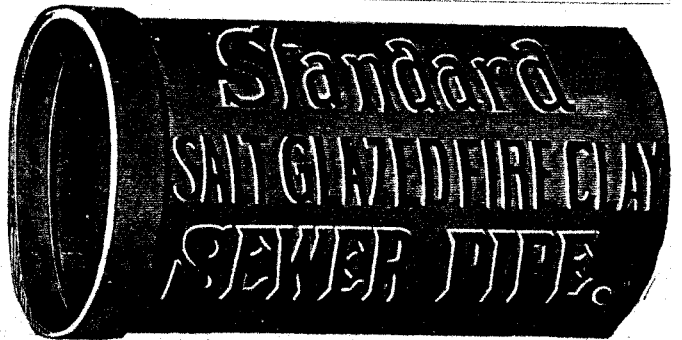

**THE STANDARD DRAIN PIPE COMPANY, ST. JOHN'S, P.Q.**

Manufacturers of Salt Glazed Vitrified Sewer Pipes, Double Strength Railway Culvert Pipes, Inverts, Vents, and all kinds of Fire Clay Goods.

The Standard Drain Pipe Co. of St. John's, P.Q., Ltd. **W. C. TROTTER**  
President.

REGISTERED..... BRAND

**The Sampson Brand** IS A HIGH GRADE OF

**Portland Cement.**

..UNIFORM.. ..FINELY GROUND.. ..RELIABLE..

Quality equal to the best English and German Brands.  
Manufactured by the

**Owen Sound Portland Cement Co., LIMITED**  
SHALLOW LAKE, - ONTARIO.

The City of Toronto have contracted with us to supply our Sampson Brand Portland Cement for the requirements of the whole City for 1897 and 1898.

For Prices and further information address the Manager at Works,  
Shallow Lake, Ont., or

**JOHN LUCAS, 377 Spadina Ave., Toronto, Ont.**  
Correspondence Solicited.

### FIRE PROTECTION.

INDICATOR VALVES. CHECK VALVES.

INDICATOR POSTS.

FIRE HYDRANTS. CAST IRON PIPE.

For the modern equipment of your Mill with Automatic "Sprinkling System," write us.

\*We manufacture a full line of these goods.

**ST. LAWRENCE FOUNDRY CO.**

OF TORONTO (Limited),

TORONTO, - CANADA.

# THE PLANSIFTER

## This Machine Leads; Others try to Follow!

The floor space required is so little that sufficient room can be spared in the smallest mills.

Its form of construction is such that

It is the most convenient to

- Special
- Get it
- Examine flour stocks
- Examine separations.
- Examine sieves. ) Without
- Repair sieves, ( removing spout.
- Easily Balance.

### ABSOLUTELY NO SCOURING ACTION.

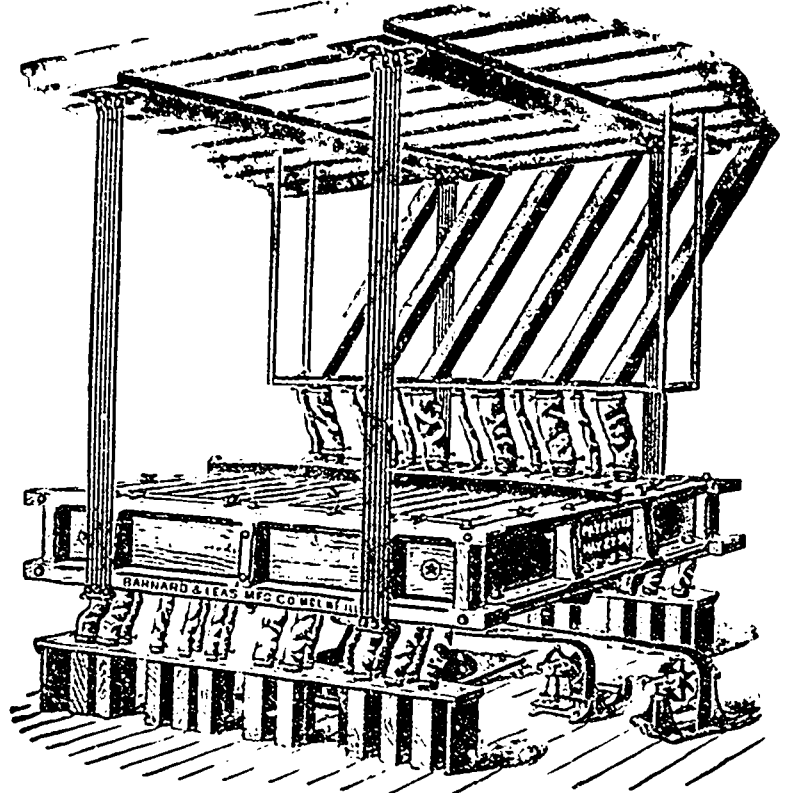

### Some Advantages are:

Saves spouting, saves elevators, saves conveyors, saves millwrighting.

Displaces 6 to 10 ordinary rolls.

All parts are easy of access without leaving the floor.

(No step ladders required).

All passages for stocks are straight, large, ample, will not choke, and communicate directly from sieves to outside.

There are no joints at edges of sieves for stock to leak through.

Every separation and flour stock is taken independently from the machine, and can be examined before mixing with other stocks.

Each section of machine handles one reduction and can be independently regulated to produce the exact result desired.

Its bolting and results are completely under the control of the miller while running.

The Plansifter is perfectly balanced, so that it imparts no vibration to mill building.

Requires no bracing whatever.

Impurities all floating to the surface, are carried off and never again mixed with pure stock.

The Plansifter will be placed on trial on its merits, and the miller himself left to be the judge as to its performing all that is claimed. If not perfectly satisfactory machine need not be kept.

THE PLANSIFTER MILL has plenty of light, air and room, with easy access to every stock.

THE PLANSIFTER produces results far superior to any other machine or system.

POWER SAVED - The saving in power alone in steam mills will soon pay the cost of a PLANSIFTER.

THE PLANSIFTER makes pure, white, evenly granulated flour, free from specks, without using fine numbers of cloth.

It Saves Space

It Saves Power

It Saves Cloth

Makes Better Separations

Makes Purer Stock

Makes Better Flour

Makes Better Clean-up

Makes Closer Finish

Makes Larger Yield

Makes Milling Easier

No Vibration

No Noise

No Dust

Easily Controlled

Insures Uniform

High Grade

Increases Capacity

Must Come into

General Use

Big Mills Cannot Afford to do Without them, and they do Charming Work in the Smallest Mills.

SOLE LICENSEES AND MANUFACTURERS FOR CANADA

# WM. & J. C. CREEY, 2 Church St., TORONTO

THE . . . .

# CANADIAN .. MANUFACTURER ..

TORONTO, CANADA.

The Official Organ of the  
Canadian Manufacturers' Association

Which Represents all the Important Manufacturing  
Industries of the Dominion.

## EXPORTERS FROM CANADA

Desiring information regarding the best facilities for shipment  
abroad, with whom Correspondence may be had, and to  
whom Consignments may be made, should  
correspond with

The Canadian Manufacturer  
TORONTO, CANADA.

No Charge Made for Giving Information.

## The Perfection Dust Collector.

The Only Machine  
with a Perfect Au-  
tomatic Cloth  
Cleaning Device

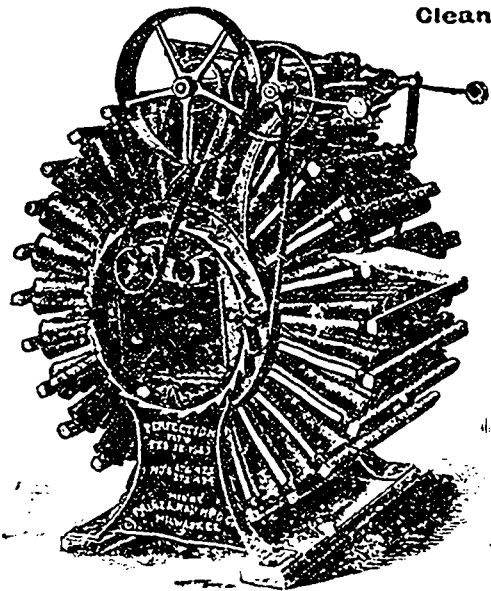

Patented

We guaran-  
tee it to col-  
lect absolu-  
tely all the  
Dust, and  
discharge  
the air free  
and clean

We guar-  
antee it  
will not  
make any  
backpres-  
sure  
against  
the Fan

WM. & J. G. GREEY, 2 Church St.,  
TORONTO, ONT.

SOLE LICENSEES FOR CANADA.

## CANADA IRON FURNACE CO., LIMITED

Montreal, Radnor and Three Rivers

Manufacturers of the well-known

### "C.I.F." Three Rivers Charcoal Pig Iron

Suitable for Car Wheels, Cylinders and Fine Castings,  
where the utmost strength is required.

UNSURPASSED IN STRENGTH BY SWEDISH, RUSSIAN  
OR AMERICAN CHARCOAL IRON.

Offices: Canada Life Insurance Bldg., Montreal.

## CANADA CHEMICAL MANUFACTURING CO.

— MANUFACTURERS OF —

Sulphuric, Nitric, and Muriatic Acids—Commercial and  
Chemically Pure.

Mixed Acids for Explosives.

Liquid Ammonia, Glauber Salts, Copperas, Muriate Tin,  
Tin Crystals, Acetic Acid, Nitrate Iron, Bisulphite  
Soda, Acid Phosphate for Baking Powders  
and General Chemicals, Fertilizers, etc.

LONDON, - ONTARIO.

## MONTREAL PIPE FOUNDRY CO... (Limited)

SUCCESSORS TO

DRUMMOND-McCALL PIPE FOUNDRY CO.  
(Limited)

Manufacturers of

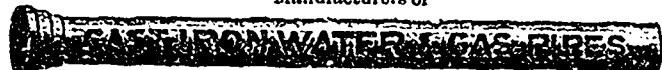

"Specials," Hydrants, Valves, Etc.

Offices: - - - Canada Life Building,  
MONTREAL

REDDAWAY'S PATENT

BREAKING STRAIN 6 IN. CAMEL HAIR BELT—14,181 lbs.  
6 IN. DOUBLE OAK LEATHER—7,522

W.A. FLEMING  
SOLE AGENT FOR CANADA  
57 ST. FRAS. XAVIER ST. (24 FRONTS) VICTORIA CHAMBERS  
MONTREAL (TORONTO) OTTAWA



**WINN &  
HOLLAND,**  
MONTREAL,  
SOLE  
AGENTS FOR CANADA.

### BRUNNER MOND & CO.'S

Pure Alkali,  
Bleaching Powder,  
Caustic Soda, <sup>ALL</sup> STRENGTHS.  
Bicarbonate of Soda,  
Concentrated Sal Soda,  
Soda Crystals.

## Wm. J. MATHESON & CO., LIMITED

NEW YORK

BOSTON

PHILADELPHIA

PROVIDENCE

CHARLOTTE, N.C.

MONTREAL, CANADA

# DYE . . . STUFFS

## The Polson Iron Works, TORONTO CANADA.

THE BEST EQUIPPED BOILER AND ENGINE WORKS IN CANADA.

We Manufacture—

### STEEL BOILERS

The BROWN AUTOMATIC ENGINE, MARINE ENGINES (SINGLE, COMPOUND AND TRIPLE), Hoisting and Mining Engines

STEEL STEAM VESSELS OF EVERY DESCRIPTION.

STEAM YACHTS AND LAUNCHES.

GET OUR PRICES BEFORE ORDERING.

ESPLANADE EAST, Foot of Sherbourne St., - - Toronto, Canada

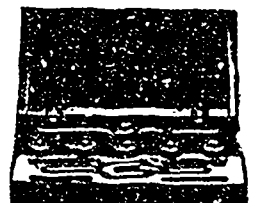
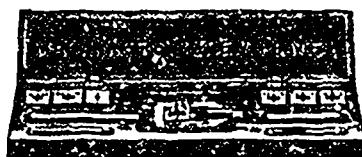

Bicycle Screw Plates, Reece Screw Plates, Derby Screw Plates, Blacksmiths' Stocks and Dies,  
Blacksmiths' Improved Screw Plates, Hand Taps, Machine Taps, Pipe Taps,  
every kind of Taps and Dies are manufactured by

**BUTTERFIELD & CO., Rock Island, P.Q.**

# ALBERT MANUFACTURING CO.

Manufacturers of the well-known

"HAMMER BRAND"

## Calcined PLASTER

—AND—

### Patent Rock Wall Plaster

HILLSBOROUGH, N.B., CANADA.

#### GET THE BEST

And at Same Time the CHEAPEST HEARLE'S ANTI-SCALE POWDER The unequalled Boiler Purge. Send for Circulars with Testimonials. C. C. HEARLE, 023 LaGauchetiere St., Montreal, P. Q.

#### WM. BARBER & BROS.

Georgetown, Ont.

Manufacturers of Book and Fine Papers.

#### THE TORONTO PAPER MFG. CO., Cornwall, Ont.,

Manufacturers of Engine Sized Superfine Papers, White and Tinted Book Papers, Blue and Cream Laid and Wave Foolscaps, Account, Envelope and Lithographic Papers, etc.

#### KEMP MFG. CO. TORONTO.

### Galvanizing

DONE FOR THE TRADE.

GET OUR PRICES.

#### WELLAND VALE MANUFACTURING CO. Limited, ST. CATHARINES ONT.

Manufacturers of....

Axes, Edge Tools, Saws, Farming Implements and Bicycles.

#### F. W. Hore's Sons, HAMILTON, ONT.

Manufacturers of

Wheels, Wheel Materials, Shafts, etc.

#### W. H. Storey & Son, ACTON, ONT.,

Manufacturers of FINE GLOVES AND MITTS In every variety and style. Moccasins.

**CANADIAN OFFICE & SCHOOL FURNITURE CO. LIMITED**  
 PRESTON ONT.  
 FINE BANK OFFICE, COURT HOUSE & DRUG STORE FITTINGS.  
 OFFICE, SCHOOL, CHURCH & LODGE FURNITURE.  
 SEND FOR CATALOGUE

## THOUSANDS IN USE.

### THE WEBSTER FEED-WATER HEATER AND PURIFIER.

#### Points of Advantage.

- 1—All back pressure from engines dispensed with.
- 2—Simple in construction and most durable.
- 3—All condensation from heating coils, machines, etc., can be returned to the Webster Heater.
- 4—The only heater in the market that the condensation from coils, etc., can be returned to.
- 5—Guaranteed temperature of feed water from 208 to 212 degrees, utilizing the waste exhaust steam.
- 6—We have Webster Heaters in operation for eight years that have never cost one cent for repairs.



116 PAGE CATALOGUE MAILED ON APPLICATION.

DARLING BROS., Queen and Ottawa Sts., MONTREAL

FRANK DARLING, Agent, NELSON, B.C.

J. HERBERT LARMONTH, C.A. Sc., Agent, CENTRAL CHAMBERS, OTTAWA, ONT.

## The Packard Electric Co., Limited.

MAKERS OF

# Lamps and Transformers

Sole Agents for SCHEEFFER RECORDING WATT METERS ST. CATHARINES, ONT.

## Mumford's Improved Boiler.

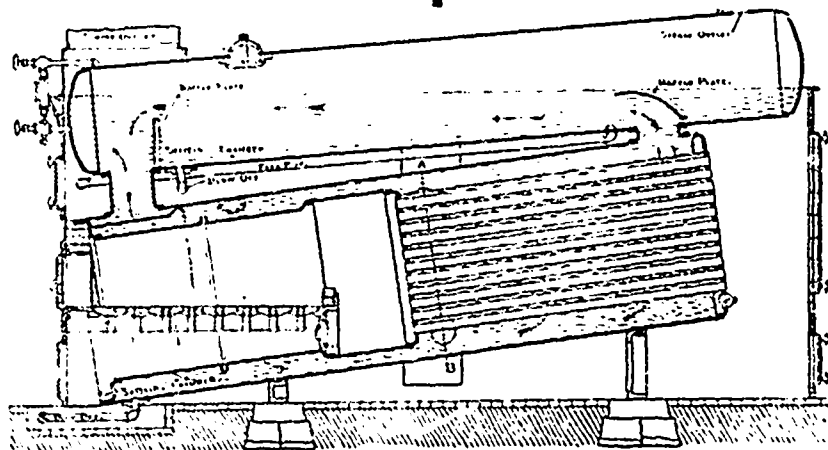

LARGE HEATING SURFACE.

Adapted to Forced Draft... INCREASING HORSEPOWER WITHOUT FOAMING OR PRIMING.

Specially arranged for using Bad Water—with little or no scale formation.

## ROBB ENGINEERING CO., LIMITED, AMHERST, N.S.

Wm. McKay, Traveller. - Seaforth, Ont.]

# DO YOU REQUIRE Rubber Belting?

IF SO, BUY THE BRANDS MADE BY

## The CANADIAN RUBBER COMPANY of MONTREAL

CAPITAL \$2,000,000.

**Manufacturers of all Kinds of Rubber Goods**

**ONTARIO BRANCH—Cor. Front and Yonge Streets, TORONTO.**

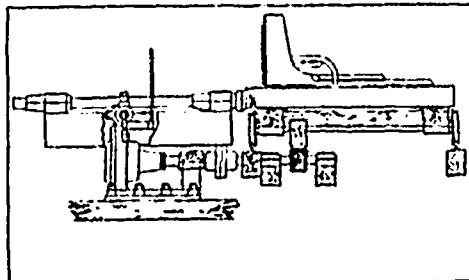
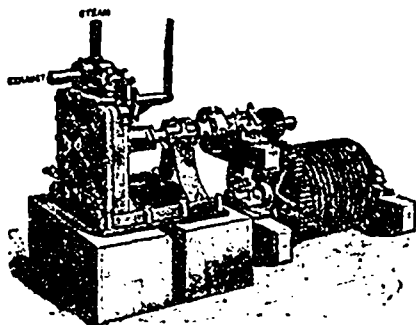

### THE DAKE STEAM FEED

EMBODIES THE FOLLOWING  
ADVANTAGES :

- Simplicity of Construction.
- Small Space Occupied.
- Economical Use of Steam.

Easy Adaptation to either New Mills or those now in use.  
Positive and Easy Control. Cheapness.

The movement of the engine in either direction is under the absolute control of the sawyer, thus accommodating the speed of the feed to the size of the logs.

Mill men, who have used other makes of Steam Feeds, comment favorably on the economical use of steam of our Feed over others.

Write for Catalogue and full particulars.

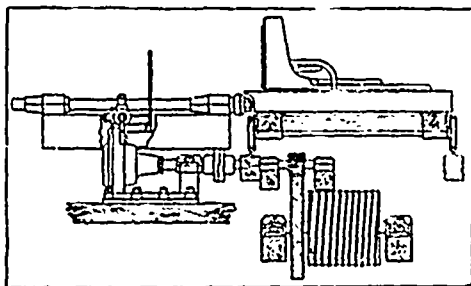

**THE JENCKES MACHINE CO.,**  
SHERBROOKE, QUE.

Succeeding the Phelps Machine Co., Eastman, Que.

### The KAY Electrical Manufacturing Co.

HAMILTON, ONT.

Begs to announce that in future it will conduct its business under the name of

## The T. & H. Electric Co.

HAMILTON, ONT.,  
255-257 James St.

Phone 938.

TORONTO, ONT.,  
Phone 1214. 58 Adelaide St. W.

### The WEBBER Patent Straitway Valve

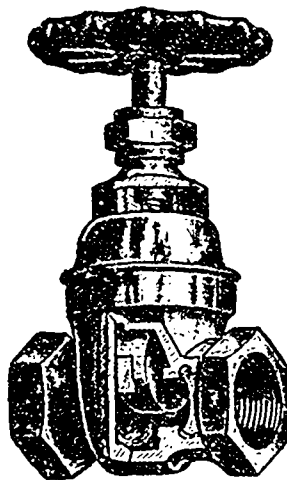

FOR.....  
Steam,  
Water  
or  
Gas...

EVERY  
VALVE  
TESTED.

The Kopp Engine Co., (Limited),  
WALKERVILLE, ONT.

Sole Manufacturers for Canada. Send for  
Price List.

### TORONTO ELECTRIC MOTOR CO.

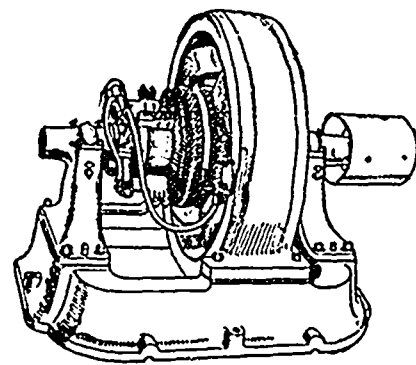

From 8 to 100 K. W.

103 105, 107, 109 Adelaide Street West, Toronto  
or to

P. E. T. PRINGLE,  
216 St. James Street, Montreal.



# DOMINION BRIDGE CO., Limited,



MONTREAL AND  
LACHINE LOCKS, P.Q.

Steel Bridges for Railways and Highways,  
Steel Piers and Trestles, Steel Water Towers and Tanks,  
Steel Roofs, Girders, Beams, Columns for Buildings.

A large Stock of ROLLED STEEL BEAMS, JOISTS, GIRDERS, CHANNELS, ANGLES, TEES, Z BARS and PLATES

Tables, giving Sizes and Strength of Rolled Beams on application.

**ALWAYS ON HAND**

IN LENGTHS TO  
THIRTY-FIVE FEET.

Post Office Address,  
MONTREAL.

**GEORGE E. EVANS,**

Agent, 38 Canada Life Building,  
TORONTO, ONT.

# THE NOVA SCOTIA STEEL CO., LIMITED

MANUFACTURERS OF

## BRIGHT COMPRESSED STEEL SHAFTING

FROM 1/2 TO 5 INCHES IN DIAMETER. GUARANTEED STRAIGHT AND TRUE TO WITHIN 1/32 OF AN INCH.

Spring, Reeled Machinery, Tire, Toe Caulk, Sleigh Shoe, Angles, Special Sections  
and all Merchant Bar Steel. Sheet Steel up to 48 Inches wide.

## RAILWAY AND ELECTRIC RAILWAY CAR AXLES

## FISH PLATES, SPIKES AND TRACK BOLTS

Tee Rails, 12, 18, 24 and 28 lbs. per yard

## HEAVY FORGINGS a SPECIALTY.

### "FERRONA" PIG IRON, For Foundry Use.

Works--NEW GLASGOW, N.S., and FERRONA, N.S.

Head Office--NEW GLASGOW, NOVA SCOTIA

# GALT Machine Knife Works

PETER HAY,



GALT, ONT.

Manufacturers of Every  
Description of..

## KNIVES, For Wood-Working, Paper Cutting and Leather- Splitting Machines

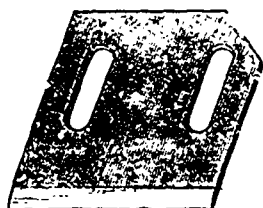

BARK  
KNIVES  
PULP  
KNIVES  
RAQ  
KNIVES  
Etc., Etc.



Shear Blades  
Saw Knives,  
Paper Knives,  
Etc., Etc.



Quality Guaranteed. Special Knives Made to Order. Send for Price List

# The Goldie & McCulloch Co., (Limited) GALT, - - - ONT.

MANUFACTURERS OF

## STEAM ENGINES, BOILERS, WATER WHEELS

Flouring and Saw Mill Machinery, Wood Working Machinery, Wool Machinery.  
Fire and Burglar Proof Safes, Vault Doors. Wood Rim Split Pulleys,  
Friction Pulleys, Friction Clutch, Couplings, etc.

**"Dumfries Foundry," - - Galt, Ontario, Canada.**

## THE Defiance Machine Works,

DEFIANCE, OHIO, U.S.A.

Established 1850

INVENTORS AND BUILDERS OF UP-TO-DATE  
NINETEENTH CENTURY

### AUTOMATIC Wood-Working Machinery

For Making

WAGON AND CARRIAGE WHEELS, HUBS, SPOKES, RIMS,  
FELLOES, SHAFTS, POLES, NECK-YOKES, SINGLE-  
TREES, BARREL HOOPS, Etc., Etc.

Send for 300-Page Catalogue—FREE  
GENERAL CANADIAN AGENTS

ESTATE OF T. T. COLEMAN

SEAFORTH, ONTARIO, CANADA

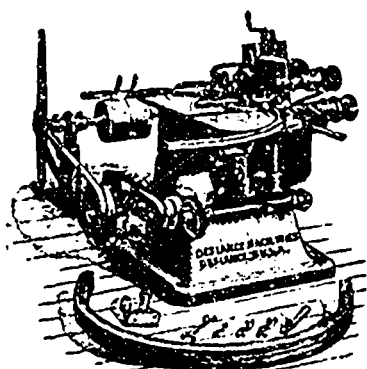

RIM PLANING MACHINE.

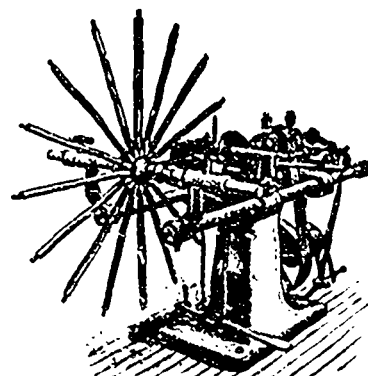

WHEEL TENONING MACHINE

# JOHN BERTRAM & SONS,

DUNDAS, - - - ONTARIO.

We have a number of

## Second-Hand Tools

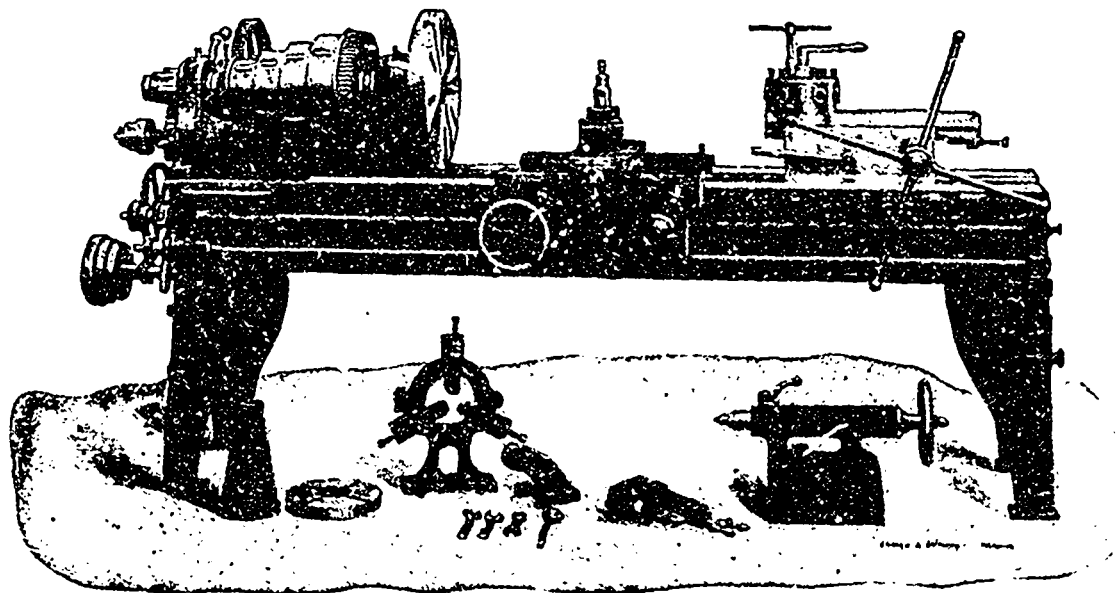

ENGINE LATHE WITH TURRET ATTACHMENT.

Which being in  
Good Order are  
offered at

**Very  
Low  
Prices**

To clear out,  
Stock quickly

★

PLEASE  
WRITE IF  
INTERESTED

★

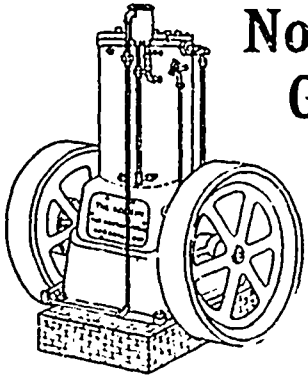

**Northey  
Gas and  
Gasoline  
Engine**

OUR BOOKLET TELLS  
ALL ABOUT IT.  
WRITE FOR IT.

"BUILT FOR HARD WORK."

Steam and Power



# Pumps

"FOR ALL DUTIES"

ALL KINDS FOR ALL PURPOSES.

Estimates and Plans Furnished.      Correspondence Invited.

**Northey Mfg. Co., Limited,** 1000 King St. W.  
Toronto.

## MICA BOILER AND STEAM PIPE COVERING.

THE CHEAPEST IN THE MARKET. DURABLE, FLEXIBLE, AND A MAGNIFICENT NON-CONDUCTOR OF HEAT.

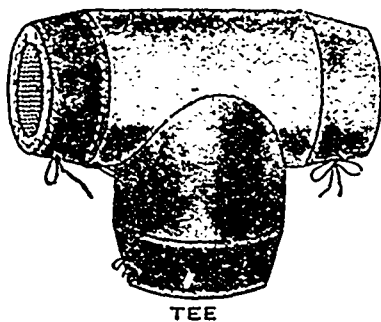

TEE

Made in Sections to fit all sizes of Pipes, and can be removed and replaced as often as desired.

Adjustable Mica Coverings for all kinds of fittings.

Mica Covering cannot be affected by vibration, and will not shift or sag.

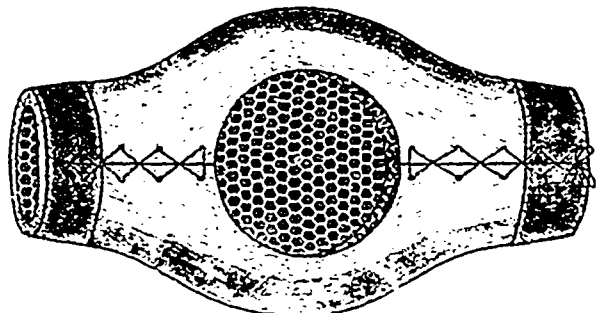

GLOBE VALVE.

Write for reports of trials, testimonials, etc., to

**THE MICA BOILER COVERING COMPANY, Limited**  
9 JORDAN STREET, TORONTO.

### FETHERSTONHAUGH & CO.

PATENT BARRISTERS AND SOLICITORS

ELECTRICAL AND MECHANICAL EXPERTS AND DRAUGHTSMEN

Head Office: Canadian Bank of Commerce Bldg., Toronto, Ont.

**Patents** Procured in Canada and all Foreign Countries.

Offices in Montreal, Que., Ottawa, Ont., and Washington, D.C.

## Upton Midget Enclosed Arc.

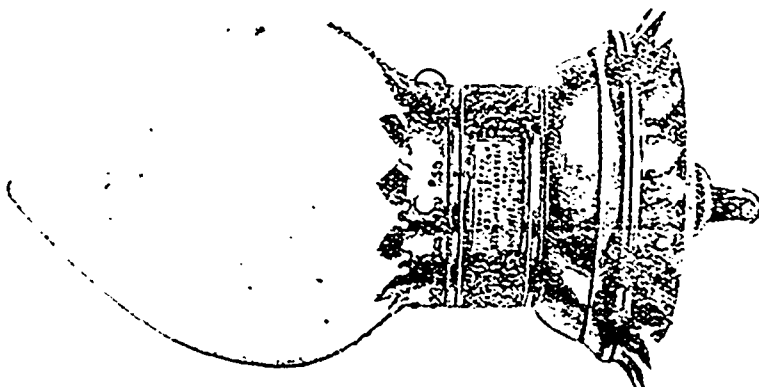

THIS LAMP BURNS 150 to 200 HOURS WITH ONE SET OF CARBONS. SIMPLE, RELIABLE AND EFFECTIVE.

600 to 800 C.P. WITH 5 AMPERES AT 100 VOLT ALTERNATING OR STRAIGHT.

Write for Full Particulars.

### JOHN FORMAN

ELECTRICAL SUPPLIES,

HARDTMUTH CARBONS.

644 CRAIG STREET, - MONTREAL.



ESTABLISHED IN 1880.

PUBLISHED ON THE FIRST AND THIRD FRIDAYS OF EACH MONTH

*Official Organ of the Canadian Manufacturers' Association.*

Subscription, \$1.00 per year.

ADVERTISING RATES:

\$12.00 Per Column inch per year; Thirty inches to Page.

**The Canadian Manufacturer Publishing Co., Limited.***McKinnon Building, Cor. Melinda and Jordan Sts., Toronto.*

J. J. CASSIDY, . . . . . Editor.  
 J. C. GARDNER, . . . . . Business Manager.

C. A. G. BROWNE, 145 Fleet St., London, E.C., Eng., Sole Agent  
 in Great Britain.

**THE NATIONAL POLICY.**

That the National Policy is doing its good work in Canada is evidenced in every issue of *THE CANADIAN MANUFACTURER*, for in its department "Captains of Industry" is constantly recorded the events that prove this assertion. A large proportion of the pages of this journal are required to keep our readers advised of the new enterprises being started, the tall chimneys being built, the investment of capital and the additional avenues opened for labor in this happy and prosperous country. It was feared that when the Conservative party went out of power and the Liberal party came in, the National Policy was to be abandoned, and quick and long strides were to be taken in the direction of free trade. Happily for the manufacturers and for the whole country, whatever may have been the promises or the intention of the leaders of the Liberal party before their advent to power, the forebodings that threatened changes would be made have not been realized, and from present appearances, will not be. Our manufacturers never were the slaves of any party, nor will they ever be. Believers as they are in a policy of tariff protection to the industries in which they have invested their wealth, they have always adhered to the party that promised and gave them that protection. Owing to circumstances over which they had no control whatever, they find that the party that had given them protection went out of power, and that another party is now in power. They find, too, that notwithstanding the fears that beset them that the change boded evil for them, they find that the party now in power, with a perspicacity that does them infinite credit, are not at all disposed to abandon the National Policy, but to uphold it in all its integrity; and this knowledge has resulted in the confidence in the Government that impels them to renewed exertions. This feeling of confidence is the thing that is causing the erection of high factory chimneys in all directions. In our opinion the National Policy is more firmly established in Canada than ever before. Of course the Conservative party, now in the cold shades of Opposition, could never hope to regain power should they reject the means by which they first obtained control of the government, and the

Liberal party, now in power, have adopted in its entirety the principles of the National Policy, which, they find, are so entirely essential to the prosperity of Canada. The manufacturers of Canada undoubtedly hold the balance of power as between the existing parties, and they will undoubtedly exercise that power in favor of the National Policy.

**A QUEER IDEA.**

The Hamilton Spectator, according to its own showing, is possessed of a queer idea. It seems that the Secretary of the Ottawa Central Fair invited the general manager of the Montreal Cotton Company's Mills at Valleyfield, Que., to make an exhibit of the company's products at the forthcoming Ottawa Fair, which Mr. Louis Simpson, the manager, declined as follows:—

DEAR SIR:—For the first time in our history we exhibited our goods last year in Montreal. The exhibition cost us somewhere between \$500 and \$1,000. We were so disgusted at the treatment which we received, that we determined never to exhibit again. We had at that exhibition what was probably the best exhibit of cotton goods ever shown in Canada, and there was not a newspaper that would even give us a notice, unless we were prepared to pay for the same as an advertisement. Our exhibit in Montreal did not return us one cent for all our outlay, and I personally do not feel justified in seeking to in any way alter the decision we then came to last year, namely, not to exhibit at any of the exhibitions held in Canada until such times as the Canadian press are willing to do justice to the exhibits shown without demanding payment, irrespective of the intrinsic value of the exhibit.

This, the Spectator says, is queer doctrine, and proceeds to lecture Mr. Simpson because he will not allow himself to be bled by the local newspapers who decline to tell of the attractions to be seen at their fairs unless at the usual rate, we suppose, of so much per line. The Spectator says:—

There is nothing extraordinary about this man. He is one of a large class who imagines that it is the duty of newspapers to build up their businesses for them without asking for money in return for their services. It would be interesting to be told by one of these men how they think newspapers manage to live. The newspaper business is precisely like the cotton business. The Valleyfield Cotton Mills Company has goods to sell, and makes its living by selling these goods. The newspapers have advertising space to sell and make their living by selling that space. If a newspaper proprietor were to go to the Valleyfield cotton man and say, "Give me cotton to the value of \$500 or \$1,000 to help my business along," the cotton man would put down the newspaper man as being either a lunatic or the cheekiest beggar he ever encountered. And that is precisely what the Valleyfield man is asking the newspapers to do for him—to give him \$500 or \$1,000 worth of their goods to help his business along.

In our opinion the Spectator views the matter from the wrong standpoint. Mr. Simpson did not ask the Montreal newspapers to build up any business for his company. He had invested a large amount of money in preparing his exhibit and in attending upon it at the Montreal Fair, and this was done quite as much to boom and benefit the fair as his own business. His outlay was intended to add to the attractiveness of the fair and to thereby benefit Montreal. Judging from the methods observed at the Toronto Fair, the Montreal papers gave full and lengthy particulars of the attractions at their show such as prize cattle, speeding in the horse ring, cat concerts, dog shows, the general appearance of things, etc., but manufacturers who had expended large sums of money in preparing

and exhibiting valuable machines and machinery, and gave much valuable time in attending to explain the construction and operation of it, found themselves entirely ignored by these newspaper narrators of current events unless they would allow themselves to be blackmailed to any amount that might be demanded. No doubt newspapers can only hope to live by selling their space to advertisers, but do they sell their space when filling their columns with accounts of dog fights, rows, scandals, etc.? If they wish to tell of the attractions of a show in which their city and country are interested, do they confine their accounts to only those features of it that pay for the space? It would seem that this is the ethics of the Spectator and of the Montreal and Toronto papers also.

And this is how the Spectator would encourage exhibitions. Hear it:—

And now, having given the Valleyfield people a little bit of a lecture, this great family journal will proceed to give them a good, sound business pointer: If, instead of wasting a thousand dollars in sending an exhibit of goods to the Montreal Fair, they had spent that much in advertising in the papers of that city, they would have been very much better off in the end.

We might have expected such an expression of sentiment from the Mail and Empire, but not from a self-proclaimed "great family journal," such as the Spectator. We do not believe that any manufacturer would act in his best interest to give even a dollar's worth of advertising, at fair time or at any other time, to a newspaper that would proclaim such a sentiment, and the newspaper that views the matter in that light is no friend to the fair or to the city in which it is held. But manufacturers will observe that in any description of the forthcoming Toronto Exhibition that may be given in some of our great family journals, published daily, their names nor exhibits will be mentioned unless paid for at about fifteen cents per line.

#### JUG-HANDLED PREFERENTIAL TRADE.

We have been asked from several quarters to refer to a publication, in the English language, which is being scattered broadcast in our Colonies in the interest of German trade. In its editorial pages it gloats over the prospective decline of British commerce, and dances a kind of carminole on the prostrate remains of British industry. It is not surprising that with the aid of bounties, nominal railway rates on State railways, fraudulent trade marks, subsidized shipping, excessive hours of labor in factories and workshops, and a protected home market, German exports should be experiencing a spurt. What we are surprised at is that the English language should be misused by German manufacturers to give rancorous and violent expression to this fact in English speaking countries. It seems to us a policy admirably devised to further the movement for preferential tariffs on British goods in British Colonies, by which the unfair conditions under which our manufacturers have now to compete will be equalized. Our present generous policy is bringing us abuse instead of thanks. At the same time, the action of our competitors should stimulate manufacturers in this country to increased enterprise, and to make their goods still more widely known.—British Trade Journal.

This is decidedly cool and refreshing. Our contemporary is surprised, not so much at the fact that Germany should encourage its manufacturing industries by the aid of bounties, low railway charges, subsidized shipping, a protected home market, etc., as that German manufacturers should use the English language in scattering their literature in British

Colonies. Our contemporary thinks that this misbehavior on the part of the Germans is calculated to further the movement for a preferential tariff on British goods in British Colonies, by which the unfair conditions under which British manufacturers have now to compete will be equalized.

It does not seem to occur to our British friends that the present arrangement is as one-sided as the handle on a jug. According to the representations of the German manufacturers their British competitors are losing ground even in British Colonies by the inferiority of their goods and the higher prices charged for them; and the British manufacturers smile pleasantly and talk about the advantages to the Colonies of Imperial federation, which sentiment they want to see encouraged by the Colonies by the imposition of preferential duties. They do not seem to comprehend that it would be but fair and equitable that if British goods are to have preferential treatment in Colonial markets, Colonial goods should have similar favors shown in the British market. In the case of Canada, British goods have a tariff preference of 25 per cent. over German goods, but why should this be while in the British market no preference whatever is shown to Canadian over German goods.

Our contemporary remarks that the present free trade policy of Great Britain is bringing abuse instead of thanks. What else could it expect. Under free trade in Britain and protection in Germany the industries of the former are being rapidly broken down by the latter, the remedy for which, the British manufacturer thinks, lies in Canada voluntarily relinquishing its trade with Germany, from whence the cheaper goods may be had, and paying the greater price for British goods. But it is a one-sided arrangement which will be found to be very irksome to this country.

#### YANKEE PUSH vs. BRITISH CONSERVATISM.

The other day, in the course of an interview with a representative of one of our principal engineering firms, who supply mining machinery to all parts of the world, we elicited some interesting facts as to the competition of United States machines. Our informant did not think it essential that in order to secure the British North American market there should be any preferential duties, although he would welcome such an arrangement as strengthening the ties between the mother country and the Colonies. The use of United States mining machinery in South Africa and other mining districts, he attributed solely to the fact that United States experts have been employed in developing those districts. There is nothing whatever in the machinery itself which should lead a mining company to prefer that from America as against that from this country. In every case English machinery is far superior in design and more durable in construction, and considerably less expensive. When, however, American engineers are consulted, they make it a rule to order machinery from the States, often regardless of cost, and to the great loss of the shareholders. Perhaps, twenty years ago there might have been an excuse for employing American engineers, but there is none whatever now, as there are scores of Englishmen with varied experience of mining, gathered in all parts of the world, who are open to engagements in British North America or any other part of the globe. Their employment would be to the best interests of the shareholders, as well as an advantage to the engineering trades of this country.—British Trade Journal

It is very remarkable that British manufacturers do not size up the situation with more accuracy than is indicated in

the above. The one quoted by our contemporary seems to be strangely oblivious to the value of the great boon conferred upon him by the preference the Canadian tariff shows to him in granting a rebate of 25 per cent. of the duties imposed on his imports while no such preference is shown to his American competitor. He seems to lose sight of the fact that this tariff preference in his favor would amount to a very handsome profit on his sales if he made any. If the British manufacturer of mining machinery would study the trade returns of this country he would discover that his American competitor, whose products have to pay the higher duties, is capturing the cream of the Canadian trade.

Another mistake the British manufacturer makes is in supposing that in the South African trade there is nothing whatever between British and the American mining machinery that would lead to the preference of the latter to the former, or that English machinery is superior in design, more durable in construction and considerably less expensive than American machinery. No doubt when American engineers are consulted as to the machinery to be used in mining in South Africa, or anywhere else, all other circumstances being equal, they would naturally give the preference to American machinery, but it is ridiculous to suppose that if British machinery possesses the advantages claimed for it, it would not be purchased in preference to any other.

And it is remarkable too, that this British manufacturer should admit that American engineers twenty years ago were superior in any particular regarding their business, and that until now British engineers were their inferiors. It may be that there are scores of competent British engineers open to engagements in Canada, but the reason that their American competitors obtain the positions is that they seek them. It seems to be a case of Yankee push versus British conservatism in which the Yankee usually wins.

#### THE WAY TO DO A THING IS TO—DO IT.

Anent the question of the establishment of a municipal electric plant in Toronto for commercial purposes, while the matter was under consideration a few days ago before the City Council, it was stated that Mr. James Milne, an electrical expert of high standing, had prepared a report on the information gathered from the users of power in the city with regard to the amount of electric power which would probably be required in Toronto should the city establish an electric plant for commercial purposes. Mr. Milne says that nearly everyone has exaggerated the horse-power in actual use. In seventeen of these plants the aggregate is 3,248 horse-power, whereas according to the daily average load, and allowing a fair margin on the safe side, this would not exceed 1,550 horse-power. Mr. Milne concludes, from the information received, that only 1,000 horse-power might be supplied by electric power or gas as cheaply as at present, but that it would be useless to try to persuade manufacturers to adopt electricity for the other 6,000 horse power used in the city.

His reasons for this conclusion are:—first, that they have steam plants already installed, and are satisfied with them; second, a large percentage of them use refuse for fuel; third, for heating, drying, etc., boilers must be kept; fourth, the larger firms would have to keep their steam plants as auxiliary in cases of breakdown of lines, generators, etc.; fifth,

having the steam plant on hand, an expenditure of capital would have to be made for the installation of electric motors with no apparent return for the same; sixth, with steam power they are entirely independent of any outside source, which some consider is worth the difference, whatever it might be; seventh, there must be a material difference in the cost before any radical change can be made, and in many of the larger plants the power (although large) bears such a small percentage of the cost of the finished goods or the output that little or no hope can be held out for such places changing to electric power.

In breweries, laundries, and dye works, where large quantities of water are boiled by steam, electricity could not be adopted. The ratio of heating water by electricity to that of steam is 1 to 15, or it would take fifteen times more power to heat a given quantity by electricity than by steam, which puts it entirely out of the question.

In the matter of hydraulic power, it would pay every elevator-owner whose water bill is \$15 a month and upwards to change to electric at the present rates charged by the Toronto Electric Light Company.

In conclusion, Mr. Milne reiterates his opinion that over and above the power already supplied by the electric companies, not more than 1,200 horse-power would be used in the city, and that for a large percentage of this amount the gas stands on an equal footing.

Toronto is not nor has it ever been a manufacturing centre as compared with Montreal or even Hamilton, nor will it ever be until different methods are adopted looking to that end. Several thousand horse-power of the Lachine Rapids has already been converted into electrical energy for industrial and manufacturing purposes in Montreal, and it is said that even that large power is to be increased; and the same may be said of Hamilton where the transmission of power by means similar to that of Montreal will soon be in operation.

The way to do a thing is to—do it.

#### THE TORONTO FAIR.

The forthcoming exhibition to be held in Toronto from August 29th to September 10th, promises to equal any of its predecessors in attractiveness. Always in accordance with the times the energetic management have arranged this year for illustrations of the blowing up of the Maine, for a representation of the siege of Santiago, and for an exhibit of war-like weapons and relics of the campaign in Cuba. The Ontario Agricultural College and Experimental Farms are coming out strong this year. The former will have two exhibits, one of honey and bees, under Mr. C. F. Holtermann, apiarist, lecturer at the College, and the other of cereals, which will be in charge of Professor Zavitz, who, like Mr. Holtermann, will deliver explanatory addresses. Mr. Woolverton, of the experimental fruit farms at Grimsby, will have a large variety of both fresh and bottled fruits on view. Port Arthur will make a special exhibit of the mineral and other resources of that district. Displays that will interest Canadian manufacturers and merchants will be a special exhibit made by fifteen English firms, and another exhibit made by a number of French firms. These collections will include fancy goods, all kinds of provisions, dairy implements, perfumes, hardware, etc., etc. As regards other features at the fair the greatest

activity is being shown. Upwards of \$30,000 is to be given this year in premiums for live stock and for dairy products, entries for which are coming in rapidly and close on Saturday, August 6th. Railway agents both in the United States and in the Dominion agree that the travel to Canada's great exhibition this year will be on a bigger scale than ever, thanks in a measure to the trend of opinion in the two countries towards Anglo-Saxon unity.

#### EDITORIAL NOTES.

**NOTICE.**—A general meeting of the Canadian Manufacturers' Association will be held in the Board Room on the grounds during the time of Toronto's Great Industrial Fair, which opens on August 29th instant. The meeting has been called for 2.30 o'clock in the afternoon of Tuesday, Sept. 6th, and it is hoped that every member of the association, and all manufacturers who may be in attendance at the Fair, will be present, as matters of much interest to them will be presented and discussed.

As usual upon all such occasions, the Canadian Manufacturers' Association will keep open house in what is known as the Press Building upon the grounds during the continuance of the forthcoming Toronto Industrial Exhibition, for the convenience of members of the association and their friends and of manufacturers generally.

The Dominion Government has been furnished with a list of some fifty commercial organizations in the United States that have taken action by resolution favoring the establishment of reciprocal commercial relations between the United States and Canada. This is one of the subjects that will come up for consideration at the Quebec conference. There are a great many other organizations which, besides the fifty mentioned, have taken similar action, but which have taken no means to put themselves on record. It is reported that the sentiment in the United States is growing in favor of some reciprocity arrangement with Canada. The fifty resolutions which have been received by the Government are exactly of the same tenor as that passed by the Boston Chamber of Commerce, which was the first organization to take hold of the matter. The resolution purport to voice the sentiments of the business community for better and freer trade relations which would increase, to a very large degree, trade between the two countries.

A few days ago 125 tons of binder twine were shipped from the Penitentiary at Kingston, where it was made, for points in Manitoba, followed by fifty tons for points in Ontario, the expectation being that by July 1st the whole of the year's output of 550 tons would have been disposed of. Until recently the binder twine industry, operated by free labor, was a large and valuable one in Ontario, but both the Dominion and Ontario Governments determined to crush it out of existence by manufacturing the article by prison labor. And thus it is that free men, women, boys and girls are deprived of employment and left to suffer to the end that slaves in prisons may be kept employed. Why not employ the convicts in making good roads throughout the country?

Travellers on the New York, New Haven and Hartford Railroad, as they pass through Jamaica Plain, near Boston, Mass., now look out on the large manufacturing establishment of the B. F. Sturtevant Company, and wonder at the disappearance of the tall boiler chimney, which previously stood as an evidence of so much invested capital. It had, however, outlived its usefulness, and its value was measured only by the possible utilization of its bricks, for a substitute had been installed in the shape of a Sturtevant fan for providing the draft. The invisible products of combustion are now discharged through a small stack extending such a short distance above the boiler house roof as to be hardly noticeable. Thus does the new and efficient method push out that which is old and wasteful. No longer is a manufacturing plant to be identified by the existence of a tall chimney, for the time is at hand when the progressive engineer will seek for a more convenient and efficient substitute. The boiler plant is of about 300 horse-power, and is effectually served by a fan having a wheel 54 inches in diameter, driven by a direct connected upright engine whose speed is so regulated that it increases as the steam pressure falls, and thus maintains practically constant steam pressure. A mixture of half and half Cumberland coal and yard screenings is used with absolute smokelessness, and in a recent test the Orsat apparatus gave no evidence of the presence of any carbonic oxide in the gases. An efficiency of 11.05 pounds of water evaporated into dry steam per pound of combustible was shown at a combustion rate of 16.45 pounds per square foot of grate. With the plant of sufficient size to warrant the introduction of an economizer, the otherwise wasted heat of the gases (although their temperature is only about 450 degrees) could be readily utilized.

The Mail and Empire says we begin on our second instalment of free trade to-day. It is a singularly good proof of the absurdity of Tory fears of freer trade relations that at no time since the inauguration of the N. P. has there been more factory building in progress in Toronto than at the present time, when we are "entering on our second instalment of free trade." A moderate estimate is that new factory buildings erected or to be erected in Toronto this season will afford room for 3,000 additional work-people.—Toronto Globe.

The mistake of the Mail and Empire consists in imagining that when the present Government came into power there would be an abandonment of the National Policy. It ignores the fact that that policy is as much in evidence now, with some exceptions, as ever it was. The mistake of the Globe consists in suppressing that fact. We are pleased to observe, however, that the Globe of to-day is a stauncher and more reliable friend of the National Policy than the Mail and Empire ever was.

The Ontario Department of Agriculture has received inquiries from Germany regarding the addresses of reliable firms exporting evaporated apples and other fruit. One essential of the German market is the drying of such fruit on wooden and not on zinc trays, as the detection of zinc by official analysis would prevent importation. This inquiry, due to information given by the Canadian Curator of the Imperial Institute, may open up a profitable line of export business.

The Customs Department has issued a circular reminding appraisers and collectors that medicinal preparations, wine in

bottles, chewing gum, perfumery and cosmetics, are subject to a war revenue tax when purchased in the United States, and that the tax must be considered part of the value of such goods when shipped to Canada.

The Dominion postal note system will be inaugurated in a few days, Mr. G. S. Everett, superintendent of the money order branch of the Post-office Department, having perfected arrangements therefor. The notes will consist of sixteen denominations, ranging from twenty cents to five dollars. The Government's commission will range from one cent up to forty cents, being at the rate of two cents on notes up to \$2.50 and three cents on the \$5 notes. These postal notes will be issued by postmasters throughout the country, and bear the date stamp of the office of issue. They must be cashed within three months of the date of their issue.

The Sewer Committee of the City Council of Hamilton, Ont., have decided to grant the request of the Bricklayers' and Masons' Unions to employ only union men in the construction of sewers in that city. A contractor who has been paying wages to his employes according to the union scale, but who does not employ union labor, will probably be forced to surrender his contract. Perhaps an injunction from a court of competent jurisdiction might be effectual in setting aside the hasty and ill-advised action of the committee.

Mr. James M. Swank, General Manager of the American Iron and Steel Association, has just published the fourteenth edition of the Directory to the Iron and Steel Works of the United States, Canada and Mexico, in which many new and valuable features have been introduced, while all the old features have been retained. It embraces 396 printed pages, sixty two pages more than the edition of 1896, the increased size being due to the enlarged description of many of the iron and steel plants heretofore described in the Directory, to the erection in the last two years of similar new plants, and to the addition of many lists of consumers that have not appeared in previous editions. The body of the volume has been corrected to April, 1898, but a supplementary chapter brings down all information to June. Speaking of the industry in Canada and Mexico, Mr. Swank says:—"We have revised the lists of blast furnaces, rolling mills, and steel works in Canada and Mexico which were first given in the Directory for 1892. Canada now has eight completed blast furnaces and one building, seventeen rolling mills, and one open-hearth steel plant, while Mexico has twenty-one completed blast furnaces and two building, seven rolling mills, and two partly completed open-hearth steel plants, of which one will certainly be built. The new furnace that is being built in Canada is at Deseronto, Ontario. We scarcely need add that all the completed iron and steel enterprises in Mexico are small."

The Newfoundland transinsular railway was completed, and the first through train across the country left St. John's, the eastern terminus, June 29th, arriving at Port aux Basques, the western terminus, covering the distance of 548 miles in twenty-four hours. At Port aux Basques the fast ferry steamer Bruce, with a speed of seventeen knots, takes passengers aboard for Sydney, C.B., landing them there in six hours, and connecting with the railway systems of Canada and the United States. This service gives Newfoundland a tri-weekly connection with the American continent.

Hawaii has come in. We have in them a rich chain of mid Pacific volcanic islands, with an area of 6,587 square miles and a population of about 100,000. And the islands are in number the lucky American thirteen, the same as the number of States with which we began our career as a nation. A great trade can be developed with these islands and they give us a station all important to our commerce with Eastern Asia and the islands of the Pacific, destined to expand constantly and rapidly in the future. Especially important to us also in connection with the Philippines and other islands we shall take from Spain. There isn't a drawback about Hawaii, all the bugaboos that have been created to the contrary notwithstanding, and our people should give, as the future will show they ought to give, hearty welcome to our new possessions. -New York Financial News.

This is what the London Free Press (Conservative), said the other day:—

It is curious to note that a fall in the price of sugar comes at the beginning of the fruit-preserving season. A late Montreal dispatch states that "the local market for all grades of granulated has ruled weaker, and refiners have made a further reduction in prices of 1-16c. per pound. Standard granulated is now quoted at 4½c.; Canadian German at 4 3-16c., and Austrian at 4½c.

And the Grit Chatham Banner, remembering how the Grit press used to lie about the price of sugar during the earlier years of the N.P., is very nearly astonished out of its boots, and shouts:—

Great guns, such a statement coming from a Conservative paper and a Liberal Government in power.

The Banner perhaps forgets that the Laurier Government made one of its most notable "steps toward free trade" by adding to the Conservative duty on sugar. And, in spite of the croaking of the fool free trade press, the increased protection has resulted in cheaper sugar. Hurrah for the N.P. ! —Hamilton Spectator.

All those who are fond of bright, entertaining fiction for mid-summer reading will find the August Ladies' Home Journal entirely to their taste. As usual, the August issue of the Journal is largely given up to short stories, there being nine in the one number, and all by well-known writers. These include a story by Julian Hawthorne; a tale by Clara Morris, and a humorous adventure by John Kendrick Bangs. There is genuine humor in Robert J. Burdette's "Tongueless Liars," and fresh interest in "Summer Piazza Stories." By the Curtis Publishing Company, Philadelphia.

Outing for August, in text and illustration, is up to the high standard of this popular magazine of amateur sport and pastime. The number opens with a very useful article on "How to Get Out of Trouble in Golf," by Willie Tucker, illustrated by fine photographs by T. C. Turner, showing the best methods when in difficulties. Other notable features include "The Yarn of the Yampa," a transatlantic cruise, by E. L. H. McGinnis; "A Bit of Sea-fishing," by Ed. W. Sandys; "To the Catskills Awheel," by A. H. Golfrey; "Camping in Comfort," by H. A. Hill; "The Sporting Clubs of the Adirondacks," by S. A. Miller, and "A Summer with Tennis Experts," by J. P. Parot. The editorial and record departments are interesting and up to date.

Of special interest in connection with the Hebrew and other ancient monarchies, which the Sunday Schools of Christendom are about to study, are two important articles in the Methodist Magazine for August: "The Lost Empires of the East," by the Editor, and "Babylon and Nineveh," by R. E. Sanderson, F.A.S. The never failing interest in the story of "Mary, Queen of Scots and Queen of Hearts," is revived by a brilliant article by Miss E. Sanderson, with numerous illustrations and quaint extracts from documents by Queen Mary and her contemporaries. The editor protests strongly against the present war, and all war, in an article entitled "The More Excellent Way." Toronto: William Briggs



# CANADIAN MANUFACTURERS' ASSOCIATION.

President :

**J. F. ELLIS.**

First Vice-President :

**JAMES KENDRY, M.P.**

Second Vice President :

**P. W. ELLIS.**

Treasurer :

**GEORGE BOOTH.**

Chairman Executive Committee :

**R. W. ELLIOT.**

Chairman Tariff Committee :

**W. K. McNAUGHT.**

*The Executive Committee meet on the Second Tuesday of each month.*

OFFICES

**McKinnon Building,**

**TORONTO.**

**Tel. 1274.**

**J. J. CASSIDEY, - SECRETARY.**

**THE OBJECTS OF THIS ASSOCIATION ARE :**

To secure by all legitimate means the aid of both Public Opinion and Governmental Policy in favor of the development of home industry and the promotion of Canadian manufacturing enterprises.

To enable those in all branches of manufacturing enterprises to act in concert, as a united body, whenever action in behalf of any particular industry, or of the whole body, is necessary.

To maintain Canada for Canadians.

Any person directly interested in any Canadian manufacturing industry is eligible for membership.

**CANADIAN INDUSTRIAL LEAGUE.**

President, . . . . . **JAS. KENDRY, M.P.**

**WOOLEN MANUFACTURERS' ASSOCIATION,**

President, . . . . . **BENNETT ROSSAMOND, M.P.**

**KNIT GOODS MANUFACTURERS' ASSOCIATION,**

President, . . . . . **JOHN PENMAN.**

**CARPET MANUFACTURERS' ASSOCIATION,**

President, . . . . . **J. P. MURRAY.**

**CLOVE MANUFACTURERS' ASSOCIATION,**

President, . . . . . **A. R. CLARK.**

REPRESENTATIVES TO

**TORONTO INDUSTRIAL EXHIBITION ASSOCIATION.**

**R. W. ELLIOT. GEORGE BOOTH.**

**W. K. McNAUGHT. A. E. KEMP.**

**J. J. CASSIDEY.**

## WHAT THE ASSOCIATION ADVOCATES.

The following resolutions were passed at the Twenty-Third Annual Meeting of the Canadian Manufacturers' Association held in Toronto, April 12, 1898.

### THE NATIONAL POLICY.

Whereas, from its geographical position and commercial environments the prosperity of the Dominion of Canada depends largely upon the maintenance of a fiscal policy which will foster our agricultural, mining, commercial and industrial enterprises, and which will make the interests of Canadians paramount to those of foreigners, by preventing this from being made a slaughter market for the surplus products of foreign countries; and

Whereas, the observance of such policy gives confidence and stability to capital and enables our artisans to obtain wages far in excess of those which prevail in European countries, and which keeps them in the country by the payment of wages which enable them to live in comfort; and which provides a home market for many lines of agricultural products, which cannot be exported; a policy which also attracts foreign capital and inaugurates industries by inducing those who desire to participate in the benefits of our market to manufacture their products here; a policy which encourages and develops inter-provincial trade, and produces amongst the people a feeling of security, of national pride, and commercial and industrial independence, highly conducive to the welfare of the whole people, without which we can never attain to the name of national prosperity; and

Whereas, the revival of the mining industry in this country has given an impetus, not only to agricultural, but to many other industrial enterprises, as nearly everything used or consumed in the mining regions has to be brought from outside sources;

Therefore, be it resolved, that this Association desire to again place itself upon record, that in its opinion the prosperity of this country imperatively demands the continuance of a fixed and definite policy of protection, from the general principle of which there shall be no deviation, in order that our agricultural, mining, commercial and other industrial enterprises may participate in its general prosperity.

### PREFERENTIAL TRADE.

While heartily commending the Dominion Government for their desire to confine the scope of the Preferential Tariff exclusively to the Mother Country and the British Colonies, this Association is strongly of the opinion: -

1. That our Preferential Tariff should not be extended to any colony, unless such colony accords to us a tariff preference in their market, equivalent to the discrimination allowed by us in its favor.

2. Where our minimum Preferential Tariff is applied, the minimum rate of duty thereunder should be high enough to protect existing Canadian industries from the competition of countries having lower priced labor, cheaper raw materials and capital, and whose long established industries give them great advantages over those of Canada.

3. That although the minimum Preferential Tariff has already been extended to Great Britain without any corresponding preference to Canada, we would strongly impress upon the Dominion Government the necessity of obtaining reciprocal concessions from the Mother Country as speedily as possible.

## CANADA'S COMMERCIAL AGENTS.

Following is the correct official list of Canada's Commercial Agents in Great Britain, British Possessions and foreign countries.

- J. S. Lurko**, Sydney, N.S.W., agent for Australasia.
- G. Eustaco Burko**, Kingston, Jamaica, agent for Jamaica.
- Robert Bryson**, St. John, Antigua, agent for Antigua, Montserrat and Dominica.
- S. L. Horsford**, St. Kitts, agent for St. Kitts, Nevis and Virgin Islands.
- Edgar Tripp**, Port of Spain, Trinidad, agent for Trinidad and Tobago.
- C. E. Sontum**, Christiania, Norway, agent for Sweden and Denmark.
- D. M. Rennio**, Buenos Ayres, Argentine Republic, agent for Argentine Republic and Uruguay.

In addition to their other duties, the undermentioned will answer inquiries relative to trade matters, and their services are available in furthering the interests of Canadian traders.

- J. G. Colmer**, 17 Victoria Street, London, S.W., England.
- Thomas Moffat**, 16 Church Street; Cape Town, South Africa.
- G. H. Mitchell**, 15 Water Street, Liverpool, England.
- H. M. Murray**, 10 St. Enoch Square, Glasgow, Scotland.
- Harrison Watson**, Curator Imperial Institute, London, England.

## A LAUDABLE UNDERTAKING.

The Executive Committee of the Canadian Manufacturers' Association have determined to begin the publication of a monthly bulletin, to be sent to members of the Association and others, which will contain the latest and most reliable information regarding the possibilities of the export trade of Canadian manufactures. This information will be obtained from the Dominion Department of Trade and Commerce, from the publications issued by the British Government, and by the United States Department of State and the Treasury Department. A list of the names of the commercial agents of Canada is kept standing in its appropriate place in THE CANADIAN MANUFACTURER. The duties of these agents, like the consular agents of both Great Britain and the United States, are to obtain all possible reliable information at and near the places whence they are stationed throughout the world, and without delay transmit it to the Dominion Government. These Canadian reports are published quarterly, sometimes oftener, in the form of blue books that are supplied

free to members of Parliament, newspapers and some others, but not for general distribution. These reports may be had on application to the Queen's Printer at Ottawa for a small consideration, or by application through members of Parliament. This is, we believe, similar to the practice obtaining regarding the blue books published by the British Government. Such publications, issued by the United States Government, are more easily obtainable to manufacturers and others in that country.

One obstacle that has always been in the paths of our Canadian manufacturers has been the lack of authentic and concrete information regarding the possibilities of foreign trade, and it is the object of the Canadian Manufacturers' Association, through the publication of the Bulletin alluded to, to collate all the current information obtained through the source named, and sent to the members of the Association and other manufacturers in the manner indicated.

It is expected that the first number of the Commercial Bulletin of the Canadian Manufacturers' Association will make its appearance sometime during the present month of August.

## CANADA'S MESSAGE.

One of the objects of the Canadian Manufacturers' Association is to keep in touch with all similar organizations, and from the standpoint of closer trade relations with the Mother Country that it has always maintained, particularly with those of Great Britain. There are many in Canada who have more than a very faint idea of the extent of the feeling prevalent in Great Britain in favor of what is there called Fair Trade, in contradistinction to what is known as Free Trade; and that there are a large number of leagues, societies and associations there whose aim is to cultivate and educate public sentiment up to the point where the fiscal policy of the country will be changed to the extent that will give encouragement to the agricultural classes by the imposition of duties upon certain food products imported from abroad, a very decided preference being shown such articles the products of British colonies and possessions. The Canadian Manufacturers' Association, we are pleased to state, is in affiliation with at least a score of these British Fair Trade leagues, and to Mr. John W. Hall, the secretary of one of these—the Warminster Home Trade and Labor Defense League, Warminster, Wiltshire, England, the secretary, on a recent occasion wrote in part as follows:—

"DEAR SIR,—At a recent meeting of the Executive Committee of the Canadian Manufacturers' Association I was instructed to communicate with you with a view to bringing about a closer relationship between your League and our Association. It is the desire of this Association to be in touch and correspondence with all similar organizations, not only in Canada but in Great Britain also; and I will esteem it a favor, which we will be glad to reciprocate, if you would send to this Association any printed reports of the doings of your League. I am sending you a copy of THE CANADIAN MANUFACTURER which contains the resolutions re The National Policy and Reciprocal Tariffs, passed at the annual meeting of our Association, held on April 12th last. These resolutions express very fully the sentiments of our Association in the matters referred to."

The reception of this communication was not only kind but enthusiastic, an account of which is published in the Wiltshire Chronicle. At a meeting of the League, at which Mr. Hall presided, other business having been disposed of, the Chairman, on rising, said it was his privilege to propose the next resolution, which he thought from its importance should come from the chair, and he would introduce it to their consideration by calling it, "Canada's Message to Warminster"—little Warminster—and it was not the first time their little town, through this League, had been talked of and its literature copied and printed abroad. He had referred to the objects of their League as Imperial, which they were as well as economic, for he was convinced that if Great Britain would remain great she must consult Greater Britain; and the intimation had come from Canada, Britain's eldest born and most important colony, that she wished to work with us in the effort to attain this Imperial policy. They had heard it was in the air of an Anglo-Saxon alliance which should withstand the world—a crown of glory and coping stone of the race, and a pledge for the progress, civilization, and, perhaps Christianity of the world. They were aware the Anglo-Saxons were the only people who had voluntarily freed their slaves. The British public subscribed twenty millions for this purpose in 1835, and the American nearly four hundred millions in 1866. The race seems destined to dominate the world for the good of humanity, a survival of the fittest, because a survival of the best, and, to paraphrase Campbell.—

"Hope would bid the world farowell  
And freedom shriek when Anglo-Saxons fell."

Besides it was the only race with a genius for colonizing and populating the waste places of the earth. But for Great Britain to remain great there was one first necessity. She must bind the colonies to herself by stronger ties even than love and loyalty, at least ties more lasting—the ties of mutual interest. It may be true that "sentiment sways more minds

than minds admit," but the sway is not permanent. Britons leave the old country and carry memories with them, and are loyal, but they die out in the course of nature, and the sentiment is weaker in their children. New ties and interests displace old memories, and in the third generation the sentiment is often absent altogether. What, then, is the abiding interest that shall make and keep the colonies loyal, the only solid foundation on which a permanent superstructure can be built. It is federation on a trade basis of preferential tariffs in favor of the colonies, they on their part giving a preferential tariff in favor of the old country; and this will last as long as human interests last. As an earnest of the bona fides of the Canadians they have already reduced their duties twenty five per cent. in our favor, which I take to have been the quid pro quo for the remuneration of those abominable treaties designed, one would think, for the express purpose of throttling the loyalty of the colonies. They are going next month, thank Heaven! as an instalment, at any rate of returning reason on the part of Great Britain. Now Canada is offering to shake hands with us across the Atlantic in commercial friendship; but we cannot return the grip, as we should do, because of the cancer of the thing called Free Trade. It blocks the way to any real reciprocity. We must away with it. Why cumbereth it the ground? It must go. We dare not refuse to return the friendly grip; posterity will reckon with us if we do. The very first step to real federation is moving the monster Free Trade out of the way. The unclean thing is on our own doorstep. Unclean because unfair to ourselves as well as our brothers across the ocean. We have a world wide Empire, and we are proud of it. It is a high honor, but it entails a condition that the colonies shall not lose by it, and they are losing now, because we can give them no preference over the alien commercials, although the colonies offer, and Canada has already given us, preferential treatment. The child has a right to demand from the parents an advantage over the stranger, or of what value is the heritage? We fear it has already been proved damnable to some of our own flesh and blood. To make a distinction in their favor, as we now charge nobody anything for using our markets, we must charge the foreigner something; and this can only be done by wiping from the statute book the free import system—a disgrace from the first to our intelligence as a thinking people. He would now read them the letter from the manufacturers of Canada, and then move a resolution, and invite their remarks thereon.

The letter alluded to was then read, and the following resolution proposed by the chairman:—"That this meeting is of opinion that the advances made by the Canadian Manufacturers' Association should be cordially reciprocated by the Fair Trade and Home Labor Defence League of Warminster, and that the secretary be hereby instructed to send to the secretary of the above Association, all literature and reports bearing on the question of Fair Trade, and to afford him all the information in the power of the Warminster branch to acquire, the fourth point and object of the latter being federation of the Empire under a custom union, giving and receiving a differential and preferential tariff to and from our colonies." This was carried unanimously with acclamation.

It is very evident that the spirit of protection, and of Imperial Federation is actively at work in Great Britain.

## THE SOUTH AFRICAN EXHIBITION

Mr. W. G. Parmelee, Deputy Minister of Trade and Commerce, has sent the Canadian Manufacturers' Association a circular having reference to the South African Industrial and Arts Exhibition that is to be held at Grahamstown, South Africa, from December 15, 1898, to January 21, 1899. In the circular it is stated that it is expected that arrangements can be made for the free transportation from Canada to Cape Town of such exhibits, and you will notice that it is stated in the prospectus that exhibits from abroad will be brought from

any part of the colony in bond, carried free to the exhibition grounds, and will not be subject to duty unless sold.

It will be noted that parties wishing to exhibit are requested to make application for space, etc., as early as possible, and as for mode of transportation from Canada to the Cape, due notice will be given in sufficient time to admit of the goods being forwarded to such Canadian ports as may be decided upon, from which they will either be sent by vessel direct or via Great Britain, as circumstances may hereafter seem to require.

The Minister takes the opportunity of calling to the attention of any who may be interested in the matter to the opening that exists in South Africa for nearly all varieties of Canadian products and manufactures. The South African colonies are not manufacturers, and nearly all of their manufactured goods are imported, and Canada can share in the trade if our producers and exporters will make a little exertion with that end in view.

A few figures are appended to Mr. Parmelee's circular showing the rapid increase in the value of the imports into the country during the past five years, as well as a short list of articles, with values of imports during the year 1896 into the Cape, and the year 1897 into Natal, of such articles as might be supplied in considerable quantities from Canada.

It is hoped, says Mr. Parmelee, that the opportunity offered for the introduction and exhibit of Canadian products and manufactures will be taken advantage of and result in the opening up of an important trade. Should it be found practicable to despatch a vessel direct from a Canadian port, due notice thereof will be given in ample time.

The department has made arrangements for space for permanent exhibit and storage accommodation of Canadian products at Cape Town through Mr. Thomas Moffat, 16 Church street, Cape Town, South Africa, with whom parties can correspond with reference thereto.

## IMPORTS—CAPE OF GOOD HOPE.

1892.....	\$45,582,127
1893.....	56,161,270
1894.....	52,304,207
1895.....	92,928,416
1896.....	91,354,005

## IMPORTS—NATAL.

1893.....	\$12,080,176
1894.....	10,897,270
1895.....	12,017,275
1896.....	26,464,262
1897.....	29,120,133

Statement of values of the following articles imported into the Cape of Good Hope in the year, 1896:—

Articles.	Value.
Agricultural Implements .....	\$496,682
do Machinery.....	259,569
Books, Printed .....	612,587
Butter, including Margarine ..	743,821
Coal, Coke and Patent Fuel ..	1,257,960
Confectionery, Jams, Preserves ..	535,718
Corn, Grain and Flour —	
Wheat.....	2,358,907
Maize .....	725,114
Flour, Wheaten .....	243,416
Cotton Manufactures .....	5,895,772
Drugs and Chemicals.....	1,910,856
Dynamite, Blasting Powder, etc ..	2,621,036
Furniture.....	2,063,934
Hardware, Cutlery and Ironmongery ..	5,066,609
Instruments, Musical.....	434,827
Leather, and Manufactures of.....	3,197,390
Machinery, not Agricultural ..	8,078,608
Saddlery and Harness.....	534,321
Soap.....	531,021
Whiskey.....	762,217
Stationery.....	1,641,059
Sugar, Refined, or Candy.....	243,168

## Tobacco:—

Manufactured (Exclusive of Cigarettes and Snuff).....	227,205
Cigars .....	546,079
Wood, Deals .....	1,049,706
Wood, Manufactured.....	1,280,313

Statement of values of the following articles imported into Natal in the year, 1897:—

Articles.	Value.
Apothecaries wares, Drugs and Chemicals..	\$591,334
Cabinet and Upholstery ware.....	742,371
Cotton, Manufactures.....	209,841
do Blankets and Sheets .....	158,259
Flour, Meal, Bran and Pollard .....	847,861
Ironmongery, Hardware and Cutlery .....	1,996,604
Leather, Manufactures of.....	1,582,757
Machinery and Railway Plant.....	2,216,888
Spirits, Brandy, Gin, Rum and Whiskey ..	470,543
Stationery.....	310,284
Wood and Timber .....	1,506,107

## CAN CANADIAN MANUFACTURERS COMPETE?

The British and South Africa Export Gazette, published monthly in London, is, as its name indicates, devoted to the interests of exporters, principally British, to the South African market. In each issue it gives a list of impending contracts and tenders relating to South African business, somewhat after the style observed in THE CANADIAN MANUFACTURER under the department of "Captains of Industry." Without attempting to cover the ground as our contemporary does, we select a few of the items as they appeared in a recent number, directing the attention of Canadian manufacturers to them, and enquire if it is not possible for some of them to compete in this large and rich field of industrial enterprise.

We quote from the Export Gazette as follows:—

**Acetylene Gas Apparatus.**—An order for twenty-seven acetylene gas machines, of capacities ranging from twenty-five to 200 lights each, has been placed by the Cape Government with Messrs. Exley & Co., Huddersfield.

**Air Compressors.**—The compressor plant supplied to the Anterior gold mine, Rhodesia, was manufactured by Messrs. Fraser & Chalmers, Erith.

A new 40-drill compressor has been ordered for the Consolidated Main Reef gold mine.

Orders for a compressor plant to supplement the present installation will be placed at an early date by the Lancaster West Gold Mining Co.

**Belting.**—Large consignments of cotton belting, in fulfilment of orders received, have, we hear, been forwarded to Johannesburg by the Gandy Belt Manufacturing Co., Limited, Manchester.

**Boilers.**—Three water-tube boilers have been supplied to the Great Eastern Collieries by Messrs. Babcock & Wilcox.

The order for two ten h.p. boilers placed by the Anterior gold mine, Rhodesia, with Messrs. Robey & Co., Limited, Lincoln, has been completed.

Six Babcock & Wilcox 106 h.p. boilers have been erected at the Consolidated Main Reef gold mine in place of four Ruston & Proctor boilers previously used.

**Dairy Appliances.**—In the event of the realization of the scheme to start a co-operative creamery at Somerset, Cape Colony, orders for the latest steam driven plant, including mechanical churns, workers, and moulders, besides a powerful refrigerator, will be placed.

**Electrical Plant.**—A shipment of electrical material and machinery, valued at £3,000, has been consigned to Port Elizabeth by a New York firm.

The electrical installation supplied to the Angelo and Driefontein mines is a three-phase plant, including engines of 450 h.p., and was manufactured by Messrs. Brown, Boveri & Co., Switzerland.

The Town Council of Kingwilliamstown are considering a scheme for the electric lighting of the borough.

The Queenstown (Cape Colony) Municipality has also an electric light scheme under consideration.

The Durban Town Council have recently ordered two additional miles of cable and a condenser.

Engines.—An order for a twin Corliss steam engine, with cylinders twenty inches by forty-eight inches stroke, has been placed by the Durban Roodepoort Deep Co.

The main engine at the Village Main Reef is 500 h.p. Corliss tandem compound, and there is also an auxiliary 500 h.p. engine manufactured by Williams & Robinson, Limited, Rugby.

Fire Extinguishing Appliances, etc.—The Durban Town Council have decided to give out orders for additional fire-extinguishing appliances.

Flour-milling Machinery.—An order has been received by Messrs. William R. Dell & Son, London, E.C., for a Plansifting machine from Central African clients.

Orders for centrifugal dressing machines and accessory wheat cleaning machinery have lately been received from South African clients by Messrs. Henry Simon, Limited, Manchester.

Furniture.—A sum of £6,700 is set apart in the Natal estimates for the year ending June, 1899, for expenditure on new furniture.

Hydraulic Machinery.—The delivery has, we learn, been made of a water wheel manufactured by the Pelton Water Wheel Co., San Francisco, for driving the reduction plant of the Glynn's Lydenburg gold mine.

An extension of the hydraulic system in Durban Harbor is provided for in the Government estimates for the year ending June, 1899, to the amount of £25,000.

Lifts.—Electrical lifts for the new premises of Messrs. Thorne, Stuttaford & Co., Johannesburg, are on order with Messrs. R. Waygood & Co., Limited, London, S.E.

Mining Machinery.—An order for sixteen sets of diamond-washing machinery has been booked by Messrs. Whitmore & Binyon from Kimberley clients. Most of this kind of machinery at Kimberley is of this firm's manufacture.

Among the additions to the equipment of the Durban Roodepoort deep gold mine just forwarded is a "Comet" crusher, and a crusher manufactured by Messrs. Blake & Marsden, Leeds.

An electric elevator, manufactured by Messrs. Easton, Anderson & Goolden, has been supplied to the Luipaardsvlei gold mine.

A steel cyanide plant with a capacity of 6,000 tons, is on order for the Sheba gold mine.

A "Whiting" hoist is on order for the Durban Roodepoort deep gold mine, and orders for two others for a neighboring mine have been placed.

Piping, etc.—Tenders for the supply of piping were recently called for in connection with the waterworks service of Standerton, South African Republic.

A new water-pipe service will be immediately required for Port Elizabeth at a cost of £75,000.

Considerable orders for piping, etc., will shortly be placed by the Wynberg Town Council Cape Colony, for the new drainage scheme, which is to cost £60,000.

Orders for pipes to convey water to the Angelo-Driefontein reduction plant have been given out.

Orders are about being placed by the Durban Town Council for the supply of twelve inch and fifteen inch iron pipes for the water service extension.

Pumping Machinery.—The pumping plant of the Great Eastern Collieries, Transvaal, includes a twelve inch cylinder, six and one-half inches double ram pump, manufactured by Messrs. J. Cameron, Manchester.

The present air compressor pumping plant, which was manufactured by Messrs. J. Cameron for the Langlaagte Deep gold mine, is shortly to be replaced by an electrical pumping installation manufactured by Messrs. Riedler & Co.

An order for a steam pump to augment the condensing plant for the lighting department of the Johannesburg Town Council has been given out.

Two twenty inch by twenty-four inch three-throw pumps, each with a capacity of 80,000 gallons per hour, being part of the pumping plant of the Angelo Driefontein, have been erected, and two 9½ by twelve inch vertical three-throw pumps are on order, the makers in both cases being Messrs. Hayward, Tyler & Howards, Luton.

The Worthington Pumping Engine Co., Manchester, have booked an order for a compound auxiliary—air or steam—pump for the Geldenhuis Estate gold mine.

Railway Material.—Orders for the material for a short line of railway for the Contats Collieries, Cape Colony, will shortly be placed.

Two thousand five hundred steel rails were recently landed at East London for the Orange Free State railways.

Railway material to the extent of 3,300 tons has been delivered at Beira for the Umtali-Salisbury extension.

Refuse Destructor.—The East London Town Council have just placed orders through their London agents for the iron-work of a refuse destructor, the cost for the complete work being estimated at £4,500.

Stamp Batteries.—The order for a reduction plant for the Aurora West United gold mine will be immediately given out.

Additions to the present 280 stamp mill of the Siamer and Jack gold mine are under consideration.

An addition of ten stamps to the existing seventy head mill of the Paarl Central gold mine is contemplated.

An additional forty stamps to the present sixty stamp equipment of the Durban Roodepoort Deep gold mine are to be ordered.

The remaining ten of the twenty stamps under order for Glynn's Lydenburg gold mine are being supplied by Messrs. Fraser & Chalmers, Limited.

Telephone Material.—A telephone installation has been ordered for Bulawayo.

The Natal Government estimates for the year ending June, 1899, make provision for additional telephone plant to the extent of £4,900.

Tenders for Oil.—Sealed tenders are invited by the Cape Government Railways for the supply of 20,000 Imperial gallons of castor oil, tenders to be addressed to the Controller and Auditor-General, Capetown, marked "Tender for Castor Oil," and forwarded before or up to noon of July 14th.

Traction Engines.—Two traction engines and eight trucks were recently shipped to Uganda by Messrs. John Fowler & Co., Leeds.

Wire Rope.—The Robinson Deep gold mine has been supplied with a hoisting rope manufactured by Messrs. John A. Roebling, Sons & Co., Trenton, New York.

The ordering of material for an aerial tramway and accessories for wharf work at an estimated cost of £14,000 is under consideration by the East London Harbor Board.

Wood-Working Machinery.—Part of the large wood-working plant on order for Messrs. Wesche & McLellan, East London, has been delivered.

A consignment of sawing machinery was recently forwarded to the Gwaai Station, Rhodesia, by an Oldham firm.

#### EUROPEAN MARKET FOR AMERICAN SHOES.

In reply to the widely circulated statement that there is little demand in Europe for neat and light footwear the United States Consul-General at Frankfort-on-the-Main, Germany, says, in a recent report:—

"Only the grossest ignorance can obscure the fact that in the Germany of to-day a large and rapidly growing percentage of the people, especially in all the cities and larger towns, are educated and progressive in all that relates to dress and the comforts and refinements of living. They appreciate, understand, and are perfectly able and willing to purchase, at reasonable cost, what is best and most becoming, and they have no serious prejudice against an imported article which is superior to that of home manufacture. For more than a

century France has been the arbiter in matters of taste, and her exports of high-priced goods, in which style and beauty form an important element of market value, have made that country rich and prosperous. In one branch of manufacture—that of factory-made footwear—the United States has now taken the lead, and the only question is whether our manufacturers will show sufficient skill and enterprise as merchants to reap the harvest that they have sown."

It is recommended that a wholesale depot be established by several firms representing different lines of shoes and that the concern be made a purchasing centre for the retail houses in the region which can be induced to handle the American product. The report contains the information that one of the greatest drawbacks to the introduction of American shoes is the lack of such wholesale facilities. The German retail dealers are unwilling to keep on hand large stocks of American shoes, and when purchases have to be made directly from America the time required for filling an order is so long that the German customers can not wait for the stock of American goods to be replenished, although many persons prefer the American to the native footwear.

"The merits of the American factory-made shoes," the report concludes, "will render them popular and saleable wherever they are offered at fair prices. A few can be sold even at high prices to the better class of purchasers, but the export trade to Germany can never become the important traffic that it ought to be until our manufacturers appreciate and learn the real wants of this market and meet them by the same energetic, intelligent means that the Germans employ so effectively in mastering and developing a foreign trade."

As Canadian-made shoes are almost identical with the article made in the United States, both as to style, quality and price, there is no reason why Canadian shoe manufacturers should not enjoy a liberal portion of this German trade.

#### IMPORTANT INFORMATION FOR IMPORTERS.

In the memorandum of information and instructions respecting the British preferential tariff which has just come into force the attention of exporters is drawn to the fact that the customs laws of Canada provide severe penalties for the making of false invoices and certificates by which the customs revenue may be defrauded. In such cases the goods are liable to forfeiture, and the exporter making such fraudulent invoice or certificate, as well as the importer using them, are subject to heavy pecuniary penalties in addition to the forfeiture of the goods. Exporters are, therefore, advised and cautioned to use every care in furnishing true and correct invoices and certificates for goods shipped to Canada. Unless the regulations governing the preference are complied with in every respect imports otherwise entitled to it will be subject to the general tariff rates of duty. Every invoice of goods imported into Canada shall be certified as correct by the person, firm or corporation selling or consigning the goods, and shall truly show the actual value of the goods in the currency of the country whence the goods have been exported directly to Canada, and the quantity and description of such goods, and the marks and numbers on the packages, in such a manner as to indicate truly the quantities and values of the articles comprised in each exportation package, all of which packages shall be legibly marked and numbered on the outside when of such a character as to enable such marks and numbers to be placed thereon. If invoices are made out at lower prices for goods exported directly to Canada than the fair market value at the same time and place for such goods when sold for home consumption in the country whence so exported, in all such cases the invoices are also to show clearly such fair market value for the goods described therein.

Exporters will note particularly that a separate invoice must be furnished for goods entitled to entry under the preferential tariff, and that the certificates required must be written, printed or stamped on the invoice, and also that the preferential tariff does not apply to any of the following articles:—Wines, malt liquors, spirits, spirituous liquors,

liquid medicines and articles containing alcohol, tobacco, cigars and cigarettes. Exporters are required to mark distinctly in writing on all invoices of sugars exported to Canada that the sugars described therein are either raw or refined, in every case whether for entry under the preferential tariff or under the general tariff. In the case of the entry of refined sugars under the preferential tariff, in addition to the certificate of growth, produce or manufacture on the invoice, there shall be attached to the invoice a certificate of the refiner of the sugar as to its growth and refining before entry under the preferential tariff. The certificate will be waived in the case of postal packages, not exceeding \$25 in value, when for entry under the British preferential tariff, if the contents of the packages are not merchandise for sale, provided that such packages shall have endorsed on them a certificate which shall be signed in the presence of the postal officer of the country whence the package is shipped direct to Canada.

We are informed by Canadian advices that the doings of The Warminster Fair Trade and Home Labor Defence League are watched with great interest in Canada, and the Manufacturers' Association of Toronto have requested to be kept posted up with the speeches and letters on the subject, emanating from the Warminster Fair Traders. This Canadian society formed to promote a closer commercial federation with the mother country realises that no such federation can take place until the free import system—free to friend and foe alike—in Britain to those who will not give a preference to British goods equally with the Canadian, who will, is unjust and impolitic, and is a bar to any differential and preferential treatment required by Canada as an equivalent for the preference tariff given to British goods. This has been the consistent contention of the Warminster Fair Traders from the first—that the ground must be first cleared of the present system, before any permanent consolidation of the mother country with her children, the Colonies, can possibly take place.—Wiltshire, England, Chronicle.

## ECONOMICAL ROOF PROTECTION

That is Reliable and Durable.  
Isn't that what you want?  
Then use the Popular

EASTLAKE

STEEL

SHINGLES

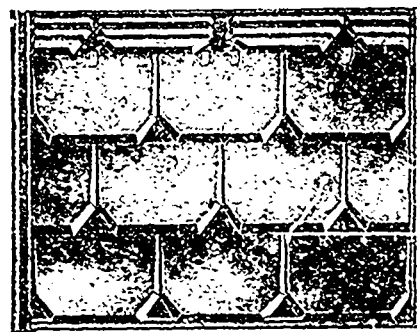

They're Fire, Rust, and Lightning Proof.  
The only Shingles made with our Patent Cleat and Water Gutter.  
Easily and quickly applied.  
Galvanized or Painted.  
The kind that gives absolute satisfaction.

BETTER WRITE FOR OUR CATALOGUE.

**METALLIC ROOFING COMPANY, Limited**  
1181 KING STREET WEST, TORONTO.

## NEW ZEALAND TRADE.

We are in receipt of the following letter that explains itself:

Sydney, N.S.W., June 30, 1898.

To the Editor of THE CANADIAN MANUFACTURER.

Sir,—Mr. Yerex, of the Yerex & Jones Company, of Wellington, N.Z., will leave for Canada in a few days. Mr. Yerex is a Canadian who has been in business in New Zealand for some years. The firm has been very successful in introducing specialties and some staple lines for the United States, but now propose to take up Canadian goods, and Mr. Yerex is going over to see what can be done in them. The firm is a keen, pushing one, and have active agencies in nearly all the leading centres of the Islands, and should prove effective agents for Canadian manufacturers.

J. S. LARKE.

As will be seen by their business card in page 25, the firm, of which Mr. Yerex is senior member, announce that Mr. Yerex is expected to arrive in Canada on August 11th, and will be in Toronto a few days later, and while in this country would like to make arrangements to represent any Canadian business concerns who wish to have their goods introduced in New Zealand. Any communications for Mr. Yerex up to October 1st will reach him by being addressed to him, care CANADIAN MANUFACTURER, Toronto.

Hon. William Patterson, Minister of Customs, has written to T. H. MacPherson, M.P., replying to the request of the Heinz Pickle Company, of Hamilton, transmitted through Mayor Colquhoun, of that place, for the free importation of empty packages from the United States for use in salting vegetables grown in Canada. The request has been refused, as the law makes no provision for the free admission of packages imported under such conditions.

The Dominion Weights and Measures Act, Section 16, which was assented to June 13, 1898, is as under:—

In contracts for the sale and delivery of any of the under-mentioned articles, the bushel shall be determined by weighing, unless a bushel by measure is specially agreed upon—the weight equivalent to a bushel being as follows:—

Wheat, sixty pounds;  
Lime, eighty pounds;  
Indian corn, fifty-six pounds;  
Rye, fifty-six pounds;  
Peas, sixty pounds;  
Barley, forty-eight pounds;  
Malt, thirty-six pounds;  
Oats, thirty-four pounds;  
Beans, sixty pounds;  
Clover seed, sixty pounds;  
Timothy seed, forty eight pounds;  
Buckwheat, forty-eight pounds;  
Flax seed, fifty six pounds;  
Hemp seed, forty-four pounds;  
Blue grass seed, fourteen pounds;  
Castor beans, forty pounds;  
Potatoes, turnips, carrots, parsnips and beets, sixty pounds;  
Onions, fifty pounds;  
Bituminous coal, seventy pounds.

"2. In the Province of Quebec when potatoes are sold or offered for sale by the bag, the bag shall contain at least eighty pounds.

"3. Every person who violates any provision of this section shall be liable, for a first offence, to a penalty not exceeding twenty-five dollars, and for each subsequent offence, to a penalty not exceeding fifty dollars."

# E. A. WALLBERG, C.E.,

Bell Telephone Building, - MONTREAL, QUE.

HEAD CANADIAN OFFICE FOR

## KINGSLEY WATER TUBE BOILERS

Manufactured in Montreal,  
Ottawa and Toronto.

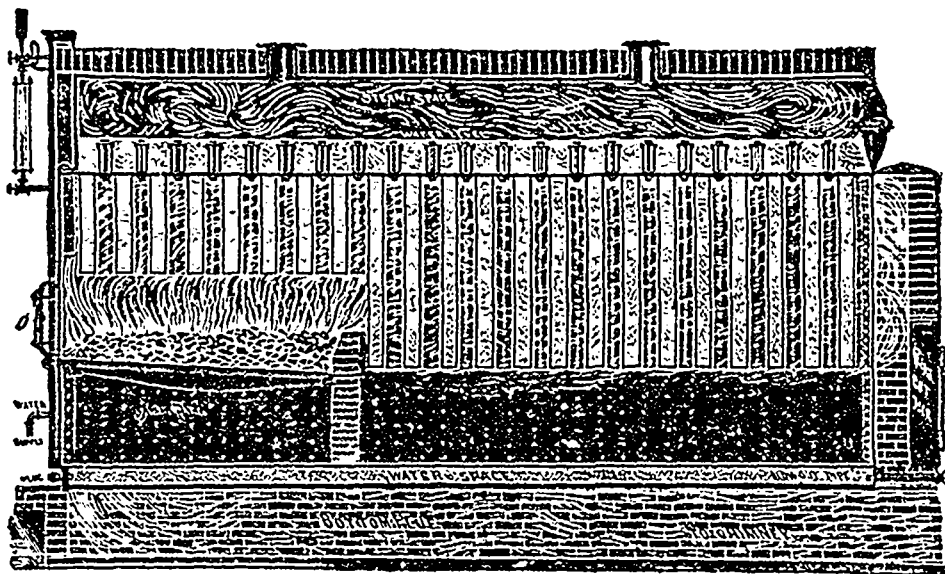

*For Steam, Power  
and Hot Water  
Installations...*

*The Most Economical Boiler,  
and the Cheapest, when  
based on Evaporat-  
ing Capacity.*

Can be installed in any Basement,  
requiring only 6½ feet in height.

**GUARANTEED:** A Saving in Fuel of 30 per cent. over Return Tubular Boilers.  
A Saving in Fuel of 50 per cent. over any Cast Iron Heater.

...Catalogue Free.

## CAPTAINS OF INDUSTRY.

The following items of information, which are classified under the title "Captains of Industry," relate to matters that are of special interest to every advertiser in these pages, and to every concern in Canada interested in any manufacturing industry whatever, this interest extending to supply houses also.

If a new manufacturing enterprise of any kind is being started, or an electric lighting plant instituted, or an electric railroad, or a telephone, or a telegraph line is being constructed; or a saw mill, a woolen, cotton, or knitting mill; or if any industrial establishment has been destroyed by fire with a probability of its being rebuilt, our friends should understand that possibly there may be something in the event for them. Do you catch on to the idea?

The starting of any such concern means a demand for some sort of machines, machinery, or supplies, such as steam engines and boilers, shafting, pulleys, bolting, lubricants, machinery supplies, wood or iron working machinery, ventilating and drying apparatus; pumps, valves, packing, dynamos, motors, wire, arc and incandescent lamps, and an infinite variety of electrical supplies, chemicals, acids, alkalies, etc. It is well worth the while of every reader of the Canadian Manufacturer to closely inspect all items under the head of Captains of Industry.

The Lachine, Que., council has adopted a by-law granting a bonus of \$15,000 to George Barrington & Sons, trunk manufacturers, Montreal, Que., to establish a factory there.

A new Methodist church will be erected at Jeannotte's Creek, Ont.

Plans are being prepared for an addition to Conboy's carriage factory, Toronto.

The ratepayers of Fort William, Ont., will vote on a by-law to authorize a loan of \$40,000 for the construction of a system of waterworks.

Chas. Riordan, Morritton, Ont., will erect a pulp and paper mill at Hawesbury, Que., to cost about \$200,000.

The boiler in the saw-mill of Charles Betts, Sycamore Siding, near Ridgeway, Ont., exploded July 15th, completely destroying the mill.

The Brantford Electric Light Co., Brantford, Ont., will purchase at once the necessary plant for the extension of the works.

The town council of Southampton, Ont., has granted a loan of \$10,000 to the Knechtel Furniture Co., to enable them to enlarge their factory.

The Prescott, Ont., town council will submit a by law to raise \$100,000 for the construction of a water works and sewerage system.

George McEwan, Hensall, Ont., will establish a plant for the manufacture of linseed oil. Robert Bell, jr., of that town is building the machinery.

John Ryan, woollen mill, St. Boniface, Man., has opened a branch at Rapid City, Man.

A clothing manufacturing company will shortly be started in connection with the T. Lindsay Co., Ottawa, having a capital stock of \$100,000.

The town council of Magog, Que., have passed a resolution to borrow \$10,000 for the purpose of further improving its electric light system.

The tender of Messrs. A. Rousseau & Co., Montreal, has been adopted at \$23,000 to build the new iron bridge over the river St. Charles, Que.

Tenders for Shanghai, China, Electric light plant are being asked by F. S. Blackall of the firm of Blackall & Baldwin, 29 Cortland street, New York, for two 100 k.w. alternators direct coupled to horizontal medium speed engines; switchboard and instruments, water-tube boiler. Mr. F. S. Blackall has conditions and specifications. August 10, 1898, is latest date for tenders to be handed in.

The Lake of the Woods Brewing Co., Rat Portage, Ont., have been incorporated.

David Richard's saw mill at Campbellton, N.B., was destroyed by fire a few days ago, loss about \$19,000.

The G.T.R. will shortly erect a 100 x 50 feet building on car shop property, London, Ont. Mr. Mills of Hamilton has the contract.

The Non-Magnetic Asbestos mill, Avoca, Que., which has been shut down for some months, will start up again in a few days.

The Furniture Manufacturers' Exporting Company of Ontario, have removed their head office from Toronto to Berlin, Ont.

An iron bridge is to be erected at Arnprior, Ont., to replace the old white bridge.

The Williams-Hurlburt Co., Collingwood, Ont., has increased its capital stock from \$11,000 to \$25,000.

The Peoples' Telephone Co., St. Thomas, Ont., has been incorporated with a capital stock of \$60,000, to construct and operate telephone lines.

Charles Smith's foundry, Durham, Ont., was destroyed by fire July 12th, loss about \$2,500.

W. H. Kelly's lumber mill at Buckingham, Ont., was destroyed by fire July 9th. Loss about \$5,000.

The tin factory of W. A. McDonald, Montreal, Que., was gutted by fire July 16th, loss about \$15,000.

The bleaching house in connection with Telfer Bros. woollen mills at Collingwood, Ont., was damaged by fire July 15th to the extent of about \$500.

A note from Messrs. Ker & Harcourt, Walkerton, Ont., manufacturers of spools, bobbins, etc., informs us that they are now building a new factory at Parry Sound, Ont., which they expect to occupy in about a month. All the machinery in the Walkerton factory will be removed to Parry Sound, to which considerable new machinery will be added. Messrs. Ker & Harcourt have been subscribers to THE CANADIAN MANUFACTURER ever since its establishment in 1880.

The Police Commissioners of Hamilton, Ont., will recommend the City Council to put up a modern police headquarters, to embrace detectives, officers, Police Court, etc.

W. H. Croker, Orillia, Ont., has completed plans for a four-storey building 100 x 50 feet to be used as a warehouse for the Thudhope Carriage Co.

A meeting of the Westmount Library Committee, Montreal, has been held to consider the tenders for the public library and other buildings shortly to be erected. The structure is to be built of pressed brick, and carved and moulded Ohio buff sandstone dressings. The plan provides three reading rooms, librarian's office, catalogue room, toilet room, large attic floor, and look-out tower.

The Halifax Herald says that Nova Scotia is well in the van in the wood pulp industry, and notes that the mills there are prosperous. Canadian pulp, it says, has been sold in England at 75 3/8 a ton, when Scandinavian pulp commanded only 44 6s.

## INGERSOLL-SERGEANT Rock Drills

FOR MINES, TUNNELS AND QUARRIES

## PISTON INLET Air Compressors

STRAIGHT LINE  
JUPLEX and  
COMPOUND.

FOR ALL DUTIES.

... COMPLETE MINE EQUIPMENT ...

JAMES COOPER MANUF'G CO., Limited, - 299 St. James St., Montreal.

Other Offices - - - ROSSLAND, B.C. RAT PORTAGE, ONT. HALIFAX, N.S.

The Montreal Cotton Co., are erecting new buildings in Valleyfield, Que. The brick smoke stack is to be 165 feet high.

It is said that the common looms in the Bourno Mills, at Fall River, Mass., will soon be replaced by 1,300 Northrop-Draper looms. These looms have a magazine head by which the shuttle is supplied with thread automatically, and the continuous stoppages for threading the shuttle are avoided. The importance of this movement lies in the fact that it entails an expenditure of at least \$100,000 and marks the adoption in Fall River of the loom which has been used very successfully in the South and in some places in New England. Weavers can operate twice as many looms of the new kind as they can of the old ones. It is said that if this experiment proves successful other mills in Fall River will adopt these looms also. It has heretofore been shown in these pages that an extensive factory is being built at Valleyfield, Que., for the manufacture of these Northrop-Draper looms. It is being rapidly pushed to completion, the expectation being that it will be in operation within a few weeks.

The recent growth of the British Columbia Iron Works is very noteworthy. Besides building steamboats and steam engines, with which their hands are full, it is making arrangements to make all kinds of mining machinery, hydraulic motors, air compressors, stamp mills, pumps and hoisting machinery. Seven steamers for the Yukon or Stikine trade, have been built at these

works, and it has equipped with engines and boilers four other steamers. There is now building in its premises a gold-dredger, for working on the Fraser River gold sands, also a guano plant for utilizing the offal from salmon canneries below Westminster.

Mention was recently made in these pages of the fact that Mr. V. L. Emerson, an American, was in connection with Mr. W. C. Edwards of Ottawa, about starting a plant in or near that city for the manufacture of calcium carbide from sawdust. A retort is being erected in the W. C. Edwards Company's yards in New Edinburgh, and within a few weeks the machinery will be in place. The gas is generated in a large retort into which sawdust and limestone have been placed, and then subjected to great electrical force, which fuses the mass. Intense heat is applied for some time, and calcium carbide is then produced. The gas is then separated from the carbide and can be used for illuminating or heating purposes.

Plans are being prepared for the new factory of the Brockville Packing and Provision Co., Brockville, Ont.

Roger Bros., will erect another elevator in connection with their flour mill at McGregor, Man.

The Grand Trunk Railway Co. will provide extensive terminal facilities at both Sarnia, Ont., and Port Huron, Mich., and architects are now engaged in figuring the cost of roundhouses and machine shops for these places, the estimated cost of which will be \$70,000 each.

Arrangements have been completed with the Detroit Bridge Company for the rebuilding of the bridges on the line between Montreal and Richmond, Que. The bridge over the Richelieu River at St. Hilare has been completed, and the building of the remaining five or six will be proceeded with at once.

The Barrie, Ont. Town Council passed a by-law to be submitted to property owners, permitting the issuing of debentures to raise \$35,000 to be used in purchasing a new and thoroughly modern electric plant for arc and incandescent lighting, and also for power service to be operated by the corporation.

A new electric railway company is being formed to run their cars over the T. H. & B. tracks to Waterford, Ont., making that road both steam and electric, and from Waterford to Port Dover, Ont., an electric line will be built. The new road will be known as the Brantford and Port Dover electric line.

The Montreal Glove Mfg. Co., Montreal, are applying for incorporation with a capital stock of \$20,000.

The Pearsall Co's basket factory, Kingsville, Ont., was destroyed by fire July 22nd.

Two large summer hotels at Georgeville, Que., were destroyed by fire July 15th. Loss about \$30,000.

The Waterloo ratopayers have sanctioned the by-law granting a bonus of \$12,000 to the Galt and Preston Electric Railway for the extension of its road.

THE CANADIAN RAND DRILL CO. have moved their General Sales Office, controlling Canadian Territory, to 18 Victoria Square, Montreal, in order to facilitate their business, which has been rapidly increasing during the last two years. They have established an office at 88 York St., Toronto, one in Halifax, one in Rat Portage in charge of Mr. George J. Rees, and one in Rossland in charge of Mr. Mendenhall. They are as usual manufacturing largely along the lines of duplex construction which they have advocated from the first. A duplex compressor costs a little more in the first place than a straight line machine, but the difference in economy of the two offsets the difference in price. Their Toronto office has lately contracted with the Canadian Copper Co., the largest nickle producers of Canada, for a very large mining plant. The Canadian Gold Fields of Marmora, they have also just equipped with a large Corliss Compressor.

Through the Halifax office the Intercolonial Coal Mining Co., of Westville, are also installing one of their high class machines for pumping. Duplex construction permits of an economical arrangement of cylinders in proper ratio to the steam pressure at hand, and to the air pressure required.

The Rat Portage office last year installed from start to finish a large plant at the Sultana mine, a large plant at the Foley mine, and also a large plant at the Mikado. They are now putting in machinery at the Cameron Islands mine, and also a large plant for the Boulder Gold Mining Co., which is controlled by Mr. Leclair and other American capitalists.

The Rossland branch has rather the advantage of the others in that it has a large warehouse at its back and is able to fill orders from stock. They have lately contracted with the Knob Hill mine for a large power plant and two mining plants, the object being for the second mining plant being supplied with power from the one Compressor located at Knob Hill.

# Sulphur

ROCK  
ROLL  
FLOUR  
GROUND

English Recovered  
- Sicilian -

Etc,

The Anglo-Sicilian Sulphur Co.,  
Limited.

Arthur P. Tippet & Co.,

CANADIAN AGENTS,

30 St. Francois-Xavier Street,  
MONTREAL.



**B. GREENING WIRE CO.**  
(LIMITED)  
WIRE MANUFACTURERS  
& METAL PERFORATORS  
**HAMILTON  
& MONTREAL.**



Wire Screens for Every Class of Material.  
Perforated Metal of Steel, Copper, Brass, Zinc for all purposes.  
Special Attention given to Minor's Requirements.



The Electric Construction Co., of London, Ont., has lately shipped three eight h.p. motors to British Columbia to run elevators, also one 150 k.w. generator, one 15 h.p. multipolar type motor, and 150 light multipolar generator to Winnipeg, Man., and three motors to Halifax, N.S.

The Toronto Carpet Mfg. Co. are putting in an eight h.p. motor, bought of the Electric Construction Co., London, to run some of their special machines.

Large quantities of molding sand are being shipped from Hamilton, Ont., to Montreal.

Tenders will shortly be invited for the construction of a cottage hospital in connection with the Upper Canada College, Toronto.

The Electric Storage Battery Co., Drexel Building, Philadelphia, Pa., have sent us an illustrated circular having reference to the application of storage batteries to lighting and power stations, particularly the installation of their chloride accumulators in the plant of the Claremont Electric Light Co. at Claremont, N.H.

The revolving bottom steamboat recently patented by Mr. H. M. Welch, of Cowasville, Que., is constructed with improved ball bearing propelling mechanism, which allows the boat to be run either on land or water, thus making it adaptable for navigating shallow streams. This boat was designed for use in the Klondike region, it being expected to run with equal ease on land and water.

The Royal Electric Co., has installed a 15 h.p. Stanley Induction Motor for the Montreal Water and Power Co., which is to be used for pumping purposes.

The Napanea Water and Electric Light Co., have gone into the incandescent lighting business, and are now serving light from their new "S.K.C." plant recently installed by the Royal Electric Co.

The Toronto Carpet Mfg. Co., Toronto, have secured a large plot of land on King street west, at the corner of Fraser avenue, upon which they are about erecting what will undoubtedly be the largest and best equipped carpet mill in Canada. The main building will front 52 feet on King street, extending 205 feet along Fraser avenue, four stories high, in the rear of which, beyond an intervening wagon way, will be another building 100 feet long by 70 feet wide, two stories high. An office and show-room building 65 x 40, two stories high will face on King street. All these buildings will be of brick, constructed in the most approved and substantial manner, and will contain all the looms and other machinery now contained in the several factories occupied by this concern at and near the south end of Sherbourne street, this city.



## WATER WHEELS

For Heads of 3 Feet to 2000 Feet.

ADAPTED TO MILLING AND ALL POWER PURPOSES.

Recent tests at Holyoke enable us to guarantee:

The Largest Power ever obtained from a wheel of the same diameter. The highest speed ever obtained for the same power. The highest mean efficiency ever obtained when running from half to full gate. We guarantee also: 1 runner of the greatest possible strength. 1 gate unequalled in quickness and ease of opening and closing.

Write for pamphlet, stating your Head.

JAMES LEFFEL & CO., Springfield, Ohio, U.S.A.

THE TORONTO PATENT AGENCY, (LIMITED) . . .

Head Office, 79, 80, 81 Confederation Life Building.  
CAPITAL, \$25,000.00.

Patents obtained. Patents sold on commission. Provincial rights sold. Most actual sales. Best results. Quickest work. Honest Treatment. Oldest company. Reliable references. All patent business promptly attended to. Valuation and prospects of any patent furnished on application.

## Pipe and Boiler Coverings, Engine Packings,

LUBRICATING OILS, GREASES, AND BOILER COMPOUND, COTTON WASTE, ETC.

EUREKA MINERAL WOOL and ASBESTOS CO., 136 Bay Street, - Toronto.

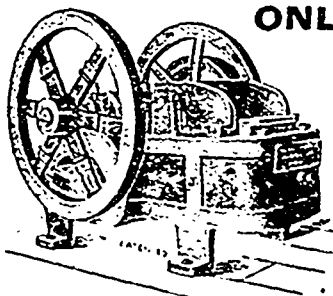

ROLL JAW CRUSHER.

ONLY

# FINE CRUSHER

BREAKS LARGE, or when set close  
Reduces to GRAVEL and SAND.

FOR ORES.

STURTEVANT MILL CO., BOSTON, MASS.

## THE Crocker Patent Turbine



Small Crocker Wheel Plant at the works of the Boston Rubber Co., St. Jerome, Que.

This Wheel is to be found in representative plants in nearly all parts of the Dominion. It possesses among its leading features

LARGE POWER FOR THE DIAMETER. SUPERIOR STRENGTH AND DURABILITY.  
GREAT EFFICIENCY AT ALL DEGREES OF GATE OPENING.

\* Designs prepared for complete plants and the best development of power possible under the peculiar circumstances of head, etc., in any locality.

CIRCULARS AND PRICES ON APPLICATION.

The JENCKES MACHINE CO.,

28 LANSDOWNE STREET  
SHERBROOKE, QUE.

Mr. R. L. Murchison, advocate, and Mr. Taylor, inventor of the Taylor hydraulic air compressor for the transmission of power by compressed air, have returned from a most successful trip to England. In London the two gentlemen spent much of their time exhibiting a model of the wonderful air compressor, which certainly bids fair to out-rival both steam and electricity in its own field. The English and Australian financiers who have paid attention to it, while the two Montrealers were in London, have announced their intention of putting an immense amount of money into it just as soon as the official test of the efficient working of the compressor at Magog is made. A special commission was appointed by these gentlemen in England, to come out here, at large cost and make the test. This will be done in a very few weeks, and if successful, will mean that the inventor and the shareholders of the Canadian company will make a handsome profit. The test is to be made within the next thirty days.—Montreal Herald.

The Gutta Percha and Rubber Mfg. Co. of Toronto are sending out a circular in which they say:—We very much regret to be obliged to announce a further advance of ten per cent. in the price of all mechanical rubber goods, such advance to take place this date. As was the case with the first advance, we are the last to advance prices. The mechanical rubber companies all over the world took action several weeks sooner. The same is true in this instance, and we trust, will be appreciated by the trade. The reason for this advance is as heretofore explained, namely, the steady and unprecedented advances in cost of crude rubber. There is no prospect of lower prices, and all the indications point to even further advances in the future.

The Westinghouse Machine Co., and the Westinghouse Electric and Mfg. Co., Pittsburg, Penn., favored us with an invitation to be present at their works in East Pittsburg on Saturday last to inspect the new and interesting exhibit there made of engines and electrical machines which were then ready for immediate shipment to foreign markets. It is quite evident that these concerns are in the swim of the export trade in manufactures now being so rapidly developed in the United States.

The Eureka Woolen Mfg. Co. of Eureka, N.S., will increase their capital stock from \$30,000 to \$40,000.

**Canadian Goods for New Zealand**  
**To CANADIAN MANUFACTURERS**

Our Mr. YEREX—a Canadian—but for the last 10 years a resident of New Zealand, will arrive at Vancouver by the "Aorangi" on August 11th, and will proceed eastward, touching at the leading towns en route. He leaves the same port again by the same steamer on November 17th, and while in Canada would like to make arrangements to represent any firm or firms who wish to have their goods introduced to the New Zealand public.

We have had 8 years experience in importing American Manufactures, and we think we understand the New Zealand market.

REFERENCES—The Union Bank of Australia, Limited, Wellington; J. S. Larke, Esq., Agent for the Government of Canada, Sydney, N.S.W.

**The YEREX & JONES CO.**

HEAD OFFICE—Wellington, New Zealand.  
BRANCHES—Dunedin, Christchurch, Wanganui and Napier, New Zealand.  
Agencies throughout the Colony.  
Address at once GEO. M. YEREX, care of THE CANADIAN MANUFACTURER, Toronto, up till October 1st

The Sherbrooke Gas and Water Co., has closed a contract with the Royal Electric Co., for two 240 k.w. "S.K.C." generators. This is the fifth order that has been placed with the Royal Electric Co., for "S.K.C." machinery by the Sherbrooke Water and Gas Co., within the last two years.

A new iron foundry is being erected by Messrs. Bruce, Stewart & Co., of Charlottetown, P.E.I., 78 x 27 feet with an annex 25 x 24 feet. In these buildings will be installed two cupolas and all the latest appliances of modern foundry practice.

A. C. NEFF, Chartered Accountant. JAMES WOOD, Late Sec. The T. Eaton Co., Ltd.  
**NEFF & WOOD**  
PUBLIC ACCOUNTANTS, AUDITORS, ASSIGNEES, ETC.  
Room 500 McKinnon Bldg., Toronto

**GEORGE WHITE-FRASER.**

Member Can. Soc. C.E. Member Am. Inst. Elec. Eng.  
**CONSULTING and Electrical Engineer.**  
**CONSTRUCTING** Railways, Lighting, Power Transmissions, Factory Plants, Reports, Specifications, Tests.  
18 Imperial Loan Building, TORONTO.

**H. F. STRICKLAND,**  
Electrical Contractor.

77 ADELAIDE ST. E., TORONTO.  
Telephone 1838.

SPECIALTY: Electric Wiring, by skilled men. All work done according to latest methods, at lowest possible prices. Complete Isolated Plants.

To WOOLEN CLOTH Manufacturers and Wool Dealers.

**SYKES, HOLT & CO.**

Wool Brokers, SYDNEY, N.S.W.

We undertake the buying of Washed and Greasy Wools in all the Australian markets on the lowest terms.

Orders executed strictly to instructions. Samples and all information will be forwarded on application.

BANKERS: The Union Bank of Australia, Limited, Sydney.

REFERENCES: J. S. Larke, Esq., Agent Govt. of Canada in Australia.

**ROBT. A. ROSS, E.E.,**

Consultant to Canadian Pacific Ry., and Boiler Inspection Co.

**CONSULTING ENGINEER.**

Specifications, plans, advice upon Steam and Electric Plants, Power transmission and distribution. Special machines designed.

17 St. John Street, MONTREAL.

**SPORTSMEN**

NOTE

**The ABBEY IMPROVED CHILLED SHOT**

NEWCASTLE-ON-TYNE, ENGLAND.

It is made by a New Process, and is highly spoken of by Sporting Papers and Sportsmen. Kills at greater distance than Soft Shot.

Send to your Gunmaker for Samples

**JOHN J. GARTSHORE,**

19 Front St. West, Toronto.

RAILWAY, TRAMWAY, and

**Contractors' Supplies**

METALS and SCRAP IRON Bought and Sold.

**ALBERT BELL ENGINE WORKS**

DUNNVILLE, ONT. Makers of YACHT ENGINES, 1 H.P. to 50 H.P. Safety Water Tube BOILERS PROPELLER WHEELS Stationary Engines and Boilers

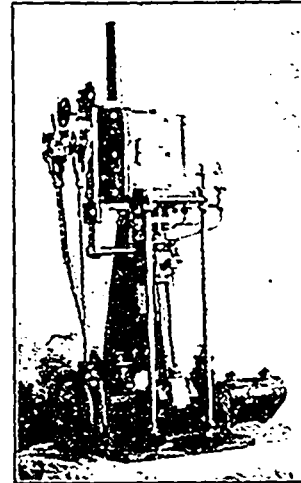

WRITE FOR CIRCULARS

Fleming & Chapin, **TAPES** Twisted and Plain. 229-231 Church St., PHILADELPHIA. In Rolls or on Spool.

**CARBONIZER** A neutral substance, harmless to animal fibre or tissue, while it destroys burrs, etc., as efficiently as acid. It leaves the wool in fine condition. Manufactured by the Merrimac Chemical Co., 13 PEARL ST. BOSTON.

**BOILERS.**

YOU WANT THEM. WE MAKE THEM

WRITE FOR PRICES

**BANNERMAN & FINDLATER,** Boiler Makers, OTTAWA, ONT.

**WANTED**

Mechanics, Engineers and Firemen to enclose 20 cents in stamps for Working Model of Valve for Steam Engines.

Address: H. F. LOWE, M.E.,

Patent Solicitor, Confederation Life Bldg., Toronto, Canada.

**PATENT FOR SALE.**

Canadian Patent No. 33178, relating to apparatus for rapidly discharging cargo from vessels, whereby the necessity of shoveling grain, coal, etc., in small quantities is avoided.

Apply to

**JOHN W. GLAHOLM,** Nanaimo, B.C.

**J. ALEX. CULVERWELL,** Electrical and Mechanical

**BROKER,**

Special Agent Royal Victoria Ins., 5 King Street West, - - TORONTO.

The work on the extension of the cotton mills at Magog, Que., is progressing rapidly.

The pulp mill at Sturgeon Falls, Ont., has been purchased by an English syndicate, to which a bonus is to be granted on conditions that must first be approved by the rate-payers of the town. It is expected the mill will be in operation by the first of October.

The ratepayers of Thorold, Ont., will be asked to sanction a loan of \$7,000 to extend the electric light plant.

Messrs. John Bertram & Sons, Dundas, Ont., have asked the Dundas Town Council for a grant of \$12,000 in view of the expense entailed in increasing the capacity of their tool works.

The Department of Railways and Canals has completed arrangements with Mr. A. M. Pearson, of Colborne, Ont., for the use of the Cleveland locomotive cylinder, a Canadian invention, which it is claimed will develop great speed. If entirely satisfactory all the locomotives of the Government system will be fitted with this cylinder.

The Cataract Power Co., Hamilton, Ont., is making fairly good progress in finishing its line between Decew's Falls and Hamilton. All the poles have been erected, and the heavy wiring has been completed to Stoney Creek.

The M. Langmuir Mfg Co., Toronto, will build an addition to their present factory, 150 x 96 feet, and also erect a new office.

The shingle mill of Mr. W. Cayouette, Ste Moise, Que., was destroyed by fire July 20th.

The Local Electric Co., Wallaceburg, Ont., will install an incandescent lighting plant.

The Waterous Engine Works Co., Brantford, Ont., have supplied the Shuswap Milling Co., of Kamloops, B.C., a new boiler for their saw mill.

David Spiers has purchased the Cherry Bros.' Mills at Galt, Ont.

Galt, Ont., will build a new fire hall.

The cargo trade of the saw mills of British Columbia amounted in 1897 to 68,000,000 feet, valued at \$608,989. Of this amount the United States received about 250,000 feet. Australia bought nearly one-third of the total exported, Europe about one-fourth, China one-eighth. Of the sixty-four cargoes twenty-seven went from Vancouver, and seventeen from Chemainus.

The Clinton street Congregational Church, Toronto, will erect a new church to accommodate 700 persons.

The Hamilton Engine Packing Co., Hamilton, Ont., will build an addition to their premises.

Robert Bell, jr., proprietor of the Hensall Engine and Machine Works, Hensall, Ont., is one of the active and energetic men of Canada who is quick to see the opportunities and possibilities of the country, and equally quick to turn them to his advantage. Hensall is not a large town, but in 1892 Mr. Bell engaged in the saw mill business there, in which his mechanical experience was of invaluable service to him to doing his own repairs; and this quickly led to his doing other work, so that in a couple of years he found himself the proprietor of a small but well equipped machine shop. A year later his business had increased to such an extent that he added to his premises a new brick machine shop and iron foundry, and since then other and more important additions have been made, both in building and machinery, until now these works are first-class in all respects. Mr. Bell is making a specialty of an automatic engine more fully described in another page, and is doing much other work. Among his recent deliveries are six engine lathes to Toronto, one lath cutting and one clapboard cutting machine to St. John, Newfoundland, and a saw mill outfit to the Arrow Head Lumber Co., Arrow Head, B.C.

The Mather Joint Stock Farmers Elevator Co., Mather Siding, Man., has been incorporated.

The Electric Cloth Cutting Co., Toronto, has been incorporated with a capital stock of \$40,000.

## ROOFS FOR THE BARN.

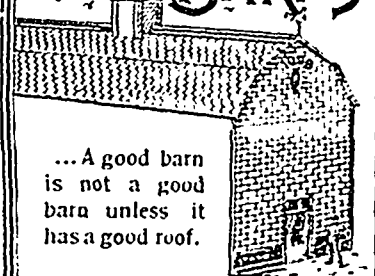

... A good barn is not a good barn unless it has a good roof.

We would therefore press on you the importance of enquiring into the durability of our Steel Shingles before deciding on the covering of your barn.

We guarantee all our steel products to be water, wind, and storm proof and to last a lifetime.

**We will give you**

the benefit of our 32 years' experience in roofing, our illustrated catalogues, and up-to-date information on these goods on receipt of a post card.

**The Pedlar Metal Roofing Co.**  
OSHAWA, ONT.

## MALCOLM MILLS CO.

Manufacturers of  
Fancy Twist Yarns, in Worstad, Silk Cotton, etc. Polished Threads.  
Silk Noils Yarns.  
Metal Threads and Tinsels.  
MILLS Frankford, Pa  
OFFICE 229 Chestnut Street, Philadelphia

## PROGRESSIVE MANUFACTURERS

USE THE  
**BLACKWELL UP-TO-DATE VARNISHES**  
For Finishing Pianos, Carriages, and Railway Coaches.  
**BLACKWELL & CO., TORONTO.**

## Dominion Oil Cloth Co.

Manufacturers of...  
**OIL-CLOTHS** of Every Description  
---  
*Floor Oil-Cloth, Table Oil-Cloth,  
Carriage Oil-Cloth,  
Enamelled Oil-Cloth,  
Stair Oil-Cloth, etc.*  
---  
Office and Works  
Cor. St. Catharino and Parthenals Sts.,  
MONTREAL, Que.

## Felts for Pulp Mills

Felts are woven endless, without a splice. Our Felts will last longer and make dryer Pulp. All up-to-date mills use our Felts. New mills, when in need, write for samples and prices.

**HAMELIN & AYERS, Lachute Mills, P.Q.**

## ELECTRIC REPAIR & CONTRACTING CO.

GEO. E. MATTHEWS, Manager. 621 LaGauchetière St., MONTREAL. TEL. 2177.

**COMPLETE ELECTRIC PLANTS INSTALLED.**

**ELECTRIC APPARATUS OF ALL KINDS REPAIRED ON THE SHORTEST NOTICE.**

Armatures Rewound for all Systems. Commutators Re-filled.  
Write us, our Prices are reasonable and work good.



**The Diamond  
Machine & Tool Co.**  
TORONTO, ONT.  
Manufacturers of  
**Machine Screws**  
OF EVERY DESCRIPTION.

SEND FOR  
CATALOGUE  
and  
PRICE LIST.

# ..THE NEW "BELL" AUTOMATIC ENGINE..

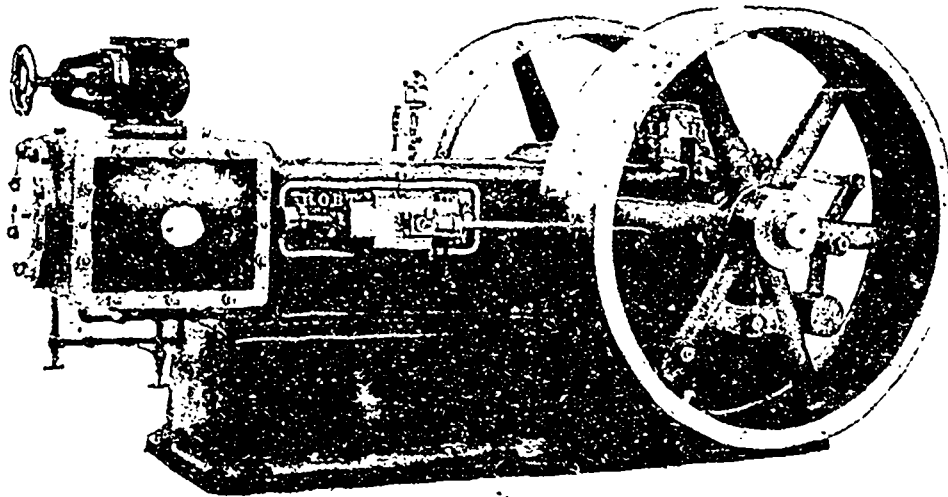

For Electric Lighting,  
Electric Railways,  
Manufactories,  
Mills.

Unsurpassed for  
Economy,  
Perfect Balance,  
Absolute Regulation,  
Smooth Running.

SEND FOR CATALOGUE

Manufactured only by

**ROBT. BELL, Jr.**  
HENSALL Engine and Machine Works,  
HENSALL, ONT., CANADA



# Emery

WRITE FOR LATEST CATALOGUES AND SAMPLES TO

CLOTH AND PAPER.  
GLASS & FLINT PAPER.

"Atlas Brand"

"FLORA" Knife Polish  
in 3d. Gal. & 1 Tin.

Ground, Washed & Flour

WHEELS of highest  
quality for general  
& special purposes.

Grinding Machinery.



THE LONDON EMERY WORKS CO., 10/12 VINE ST., CLERKENWELL, LONDON, E.C.  
... AGENTS WANTED ...

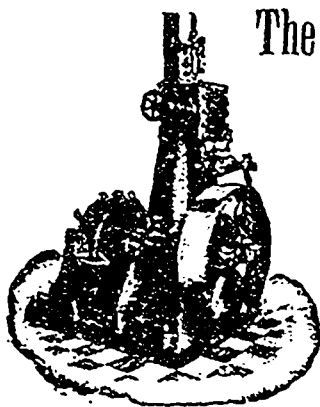

## The Whitelaw-Shepherd

### ...ENGINE...

SIMPLICITY, COMPACTNESS,  
PERFECT REGULATION,  
ECONOMY,  
AUTOMATIC LUBRICATION.

For Electric Lighting Mills, Factories,  
and other purposes where Economy,  
close regulation and enduring service  
is required.

Manufactured  
by...

**R. WHITELAW, Woodstock, Ont.**

## The ELECTRICAL CONSTRUCTION CO.

OF LONDON (Limited).

### MULTIPOLAR MOTORS and DYNAMOS

AND

DIRECT CONNECTED PLANTS FOR  
ISOLATED LIGHTING.

Repair Work a Specialty.

HEAD OFFICE AND FACTORY:

**No. 90 YORK STREET, LONDON, CANADA.**

760 Main Street, WINNIPEG.

42 York Street. TORONTO.

## Westinghouse

### Alternating Current Generators

are used in  
Theory as the

Standard of Comparison,

and in Practice by those

Requiring the Best.

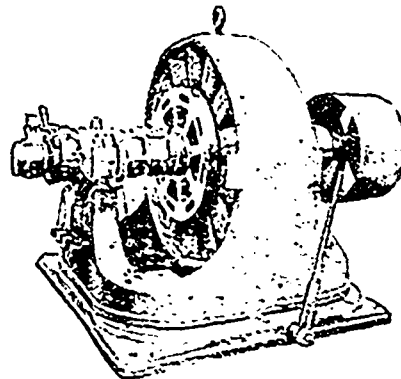

Westinghouse Two-Phase Belted Generator.

Electric & Mfg. Co.,  
Pittsburg, Pa.

In 1897,

We sold more H P Capacity in  
Polyphase Generators than all  
our competitors combined.

New York, Atlanta, Austin, Boston, Buffalo,  
Chicago, Cincinnati, Philadelphia, St. Louis, San  
Francisco, Syracuse, Tacoma, Denver, Mountain  
Electric Co. Canada, Ahearn & Soper, Ottawa,  
Mexico, G. & O. Bramif & Co. City of Mexico.  
Westinghouse Electric Co., Limited, 32 Victoria  
Street, London.

The Royal Electric Co., has secured an order from the corporation of Joliette, Que., for a 120 k.w. "S.K.C." Generator with full complement of transformers, etc.

The development of electrolytic processes for the production of refined copper has proceeded very rapidly during the past three years, and at the present time a very large proportion of all the refined copper is thus produced. The Westinghouse Electric and Manufacturing Company have installed a very large amount of apparatus for this class of service. One of the principal installations is at the refinery of the Anaconda Copper Company, Anaconda, Montana, where ten generators of 270 to 300 kilowatts capacity

have been installed. Another very large installation is that of the Boston and Montana Consolidated Copper and Silver Mining Company, Great Falls, Montana, where two 810 k.w. Westinghouse engine type generators are in service. The latest comer in this field is the Raritan Copper Works, of Perth Amboy, New Jersey, who are about to erect the largest copper refinery in the east. They have contracted with the Westinghouse Electric and Manufacturing Company for three 600 k.w., 150 volt engine type generators, 150 r.p.m., with a nine section switchboard for electrolytic service, and the operation of two 75 k.w. 220 volt, engine type generators, which will be used

for lighting and power service. The installation will be the most complete of its kind in the world.

One of the largest and best equipped power buildings in the United States is the Manufacturers' Building, in Providence, R.I. This building has accommodation for upwards of sixty manufacturing concerns, being particularly well equipped with conveniences for the production of jewelry, specialties, etc. The Manufacturers' Building Company have just purchased a 250 k.w. 500 volt Westinghouse Electric and Mfg. Co.'s engine type generator, 100 r.p.m., to be driven by an Armington & Sims Corliss engine. This generator will supply power for the operation of motors in the various manufacturing departments of the building. The engineering features of this establishment are under the direction of Lewis & Clavin, consulting engineers, whose wide reputation for engineering installations of the highest order is borne out by their selection in this instance.

John Philip, Grand Valley, Ont., has secured a franchise from the corporation of Arthur for the supply of electric light in that town. He will generate the current at Grand Valley from his "S.K.C." plant, and with the aid of step-up transformers transmit it to Arthur, a distance of sixteen miles. Mr. Philip will illuminate the streets of Arthur with alternating current arc lamps. The order for the complete work has been placed with the Royal Electric Co.

The Ontario Crown Lands timber agent at Rat Portage states that the lumbering business in that section of the province is very prosperous, so much so that some of the camps have kept at work all summer. The district is not affected by the depression in the lumber business in the east as their market is in Manitoba and the territories. Very few mining explorers are out in the woods, but many properties are being actively developed. The settlement of the fisheries dispute will result in the establishment of a large industry. Besides the fish a large quantity of caviare is prepared in the district for export. The new Rainy River railroad, too, will make accessible many large bodies of water where the fishing can be pursued. The railroad is now under construction. Forty miles of it have been completed at the Manitoba end and the line

## ECO MAGNETO WATCHMAN'S ELECTRIC CLOCK.

Without Batteries.

Write for descriptive circular to

### Eco Magneto Clock Co.,

Room 71, 620 Atlantic Avenue,  
BOSTON, MASS.

MONTREAL ELECTRIC CO.,

1898 Notre Dame Street,  
(Balmoral Hotel Block).

Agents for Province of Quebec.

John Starr, Son & Co. (Limited),  
HALIFAX, N.S.,

Agents for the Maritime Provinces.

## Jones & Moore Electric Company

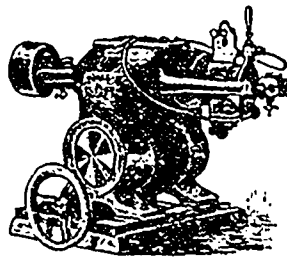

### ELECTRIC LIGHT

AND

### POWER PLANTS

#### Multipolar Machines

25 to 100 K. W.

16-Light Arc Plant for sale cheap. Good as New.

22 Adelaide Street West, - Toronto.

ESTABLISHED 1823.

Telegrams: "WILSONS, CORNHOLME." -A.B.C. Code Used.

# WILSON BROS. BOBBIN CO.

(LIMITED)

CORNHOLME MILLS, TODMORDEN, ENGLAND.

## BOBBIN AND SHUTTLE MANUFACTURERS.

THIRTY PRIZE MEDALS AWARDED.

HIGH-CLASS WORKMANSHIP. SEVENTY YEARS' REPUTATION.

LARGEST BOBBIN MAKERS IN THE WORLD—(Over 1,200 Workmen).

ADDRESSES:

### CORNHOLME MILLS, TODMORDEN, ENG.

BRANCH ESTABLISHMENT:

ATLAS BOBBIN WORKS, GARSTON, LIVERPOOL.

OFFICE AND SHOWROOMS:

14 MARKET PLACE, MANCHESTER

Advertise in the Canadian Manufacturer.

## Engineers' Supplies

OF ALL DESCRIPTIONS

### THE HEINTZ STEAM SAVER

Will increase your productive power  
and decrease your fuel account.

Write us for Booklet C.

'Twill interest you.

The **JAMES MORRISON**  
**BRASS MFG. CO. Limited.**  
TORONTO.

west of Port Arthur is being located with a view to letting contracts.

Messrs. Miller Bros. & Toms, Montreal, have placed an order with the Royal Electric Co., for two 40 h.p. direct current motors. These machines will be direct connected to two Quimby Screw Pumps, and will be used for the operation of elevators, etc.

Some weeks ago, it will be remembered, the City Council of St. John, N.B., awarded a contract for a large quantity of water pipe to a concern at Scottsdale, Pa. The price was a low one and many persons were at a loss to know how the iron could be manufactured and the duty paid and the other expenses covered in the price. If we remember rightly, the figure was in the vicinity of \$21.50 per ton delivered at St. John. Nor does the fact that the Londonderry Iron Works have just agreed to manufacture, under a sub-contract, 1,000 tons of twelve and twenty-four inch pipes help us to any explanation of the matter, unless it be that the Pennsylvania firm has been able to make a low enough rate with our local works to cover the difference of freight and duty between. At all events every person is glad to learn that the Acadia Co. have secured the order, only it seems a trifle strange that our own foundry should receive from an American source an order for goods to be used here in the provinces. — Maritime Merchant.

The Toronto Cotton Batting Co., Toronto, has been incorporated with a capital stock of \$10,000, to manufacture cotton batting, etc.

"Dye Stuffs" is the name of a brochure published monthly by Messrs. W. J. Matheson & Co., New York, devoted to the interests of dyers and colorists. Following is the table of contents of the last received number just to hand:— The dyeing of shoddy, the application of the diamine colors in wool and union dyeing, printed greens, new discharge for cotton plushes dyed with diamine colors, hints for the garment dyer, the month's new colors: Oxy-diamine black A T pat., oxy-diamine orange G, oxy-diamine orange R. The month's sample cards. Diamine colors on mercerized cotton lining, dyeing on straw plait, diamine deep blue B and R, pat., diamine red ten B pat., anthracene acid colors, lanafuchsine S B and S G interwoven with white, excelsior lake scarlet J N and J J N.

Mr. Charles Macwood, who for some considerable time has been chief clerk in the London, Ont., shops of the Grand Trunk Railway, has severed his connection with that concern and accepted a position as commercial traveller for Messrs. Scarfe & Co., manufacturers of varnishes, etc., Brantford.

The pipe shop of the Londonderry Iron Company is progressing well, with the twenty-four in. pipe for the city of St. John. The

inspection is very satisfactory, and very few pipes have been rejected by the inspector, Mr. Harris Allan, of St. John. Mr. Allan makes a careful and exact inspector, yet the company express themselves as being very well satisfied with the courteous and fair treatment received at his hands. The company expect to obtain a further portion of the St. John contract from the National Foundry and Pipe Works of Scottsdale, Pa. Mr. Meissner has recently obtained for his company the contract for all the water works extensions for the towns of New Glasgow and Digby. This includes the pipes, hydrants, valves, specials, etc.—Truro News.

Mr. Charles Riordon, who owns a large paper mill at Merriton, Ont., has about completed arrangements with the town of Hawkesbury, Que., to build a \$200,000 pulp and paper mill in that municipality, promising that he will not begin with less than 100 hands. The town gives several valuable concessions, such as freedom from taxation, a large area of land, etc., and work will be begun immediately. Mr. Riordon has purchased extensive timber limits in the vicinity.

The Bertram Engine Works Co., Toronto, have been awarded the contract by the Richelieu and Ontario Navigation Co., to build another steamer in all respects similar to the Toronto, which was launched by them a few days ago. She is to be ready for next year's service.

THE - - - -

# WM. HAMILTON MANUFACTURING CO., Limited

MANUFACTURERS OF

## THE "RELIANCE"

### Mining, Milling

AND

### Smelting Machinery

FOR THE DOMINION OF CANADA

(Under License from The E. P. ALLIS CO., Milwaukee, Wis.)

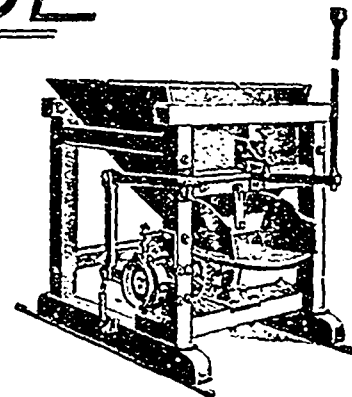
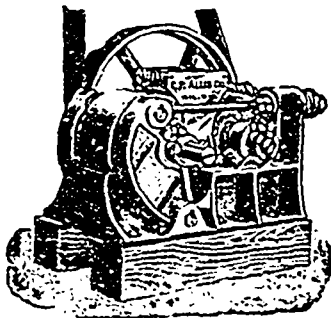

Crushers, Rolls, Jigs, Concentrators, Screens, Stamps, Pumps, Compressors, Hoists, Boilers, Engines, Water Wheels, Etc.

Branch Office . . . .  
VANCOUVER, B.C.

 PETERBOROUGH, ONT.

**FAIRBANKS STANDARD SCALES.**

The Fairbanks Co., Montreal, have sent us their illustrated descriptive price list of Fairbanks Standard Scales manufactured by them. The index includes the general descriptive names of more than 150 different styles of scales, which includes more than 4,000 different sizes and patterns. Of course it would be necessary to reproduce nearly the whole contents of the entire catalogue to mention even very briefly the different machines enumerated, and any intending purchaser could readily obtain a catalogue from the company on application.

An idea may be had, however, of the variety of uses for which these scales are made when we mention that the company furnish several patterns of scales up to sixty feet long for weighing hot rolls and other shapes of rolled steel as they are produced in the mill, and hot metal scales fitted with platforms of fire brick, with capacity from ten to fifty tons, all the way through every requirement of business to the delicate scale equipped with knife-edged beam and agate bearings, used by druggists in weighing very minute particles where the greatest nicety and precision is absolutely essential.

The company, speaking through their catalogue, regarding their special standard scales, say:

There is a constantly increasing demand for special modifications of scales to accomplish new and unusual purposes, or to fit into difficult or contracted situations.

If purchasers desire a scale to fit a particular place, we should be pleased to compare our plans with his, and we at all times offer all possible assistance to our patrons.

Our experience and facilities, combined with a careful study of the most hopeless case, will often reveal to us a method of accomplishing what others have regarded as impossible.

Out of our immense stock of patterns we can usually construct whatever is desired, yet we would urge all intending customers to carefully examine our list with a view to using regular goods wherever possible.

We have given special attention to weighing machinery for rolling mills and for those who handle iron and steel in large quantities.

We are informed that the Fairbanks Company intend making a fine display of their Standard Scales at the forthcoming Toronto Industrial Exhibition, which will no doubt attract much attention.

For further particulars regarding these scales apply to the Fairbanks Company, 749 Craig Street, Montreal.

**CHEMICAL COMPOUND COMPANY**

**CORRECTLY COMPILED CHEMICAL COMPOUNDS**

**CIVILITY CAREFULNESS COMPLETENESS CONTINUITY**

**DO YOU KNOW**

That you are paying for Boiler Compound all the time whether you use it or not?

**IF YOU DO NOT BUY**

You will pay your coal dealer more than its cost in the extra Coal you burn.

**Zinkolene Saves Money**

**THE CHEMICAL COMPOUND CO., 311 Temple Building, Toronto.**

**THE BELL AUTOMATIC ENGINE.**

In page 27 of this issue is an illustration of a new automatic steam engine manufactured by Robert Bell, Jr., at his Hensall Engine and Machine Works, Hensall, Ont. This engine is specially adapted for electric lighting and power purposes, and is now being put to such use in quite a number of electric and manufacturing establishments in Canada.

The engine is described as being massive

**THE OTTAWA PORCELAIN AND CARBON CO., Limited, OTTAWA, ONT. . . .**

MANUFACTURERS OF

**CARBON POINTS** for all kinds of Arc Lamps, including Cored and Solid Carbon for Incandescent Circuits.

..... ALSO.....

**M**OTOR BRUSHES and Specialties in Carbon for Telegraph, Telephone and Electric Light Supplies.

**P**ORCELAIN INSULATORS, Cleats, Door Knobs, and all kinds of Pressed Porcelain for Electrical and Hardware Lines.

ALL GOODS GUARANTEED TO GIVE SATISFACTION.

**A Saving.**

The first cost is not the test of an actual saving. The truly Economical Manufacturer knows this to be true. For instance, the cheap, trappy Pulley, by its inferior working qualities, is a source of loss to the user the moment it is put in operation, and this loss continues all the time the Pulley is working. You do not get the full or proper results from your power plant. Higher price, though, is not always a sign of better quality, for instance—you may or may not have to pay more for

**"THE REEVES" PATENT WOOD SPLIT PULLEY**

but in either case you are getting the best value on the market. Because with THE REEVES the saving is continual, in Power, in Time, in Shafting, in Belting, and last but not least, and as a result of all the other savings, a saving in Money.

CAN YOU AFFORD TO BE WITHOUT "THE REEVES"? Is the best too good for you? WRITE TO-DAY FOR OUR CATALOGUE AND GET OUR PRICES.

Also COLUMBUS, IND.

- REEVES PULLEY CO., Toronto, Ont.

in appearance, economical in the use of steam, smooth running, and easy of regulation and operation. The bed is very heavy, has large bored slides, and large bearings for crank shaft. The cylinder being bolted to the bed, is capable of withstanding great strain and severe pressure. The crank shaft is either of cast steel or forged from the best quality solid bar. The cross-head is very strong and heavy, having a steel wrist pin which can be quickly and easily removed for renewal when necessary. The slides are heavy brass shoes with long and wide bearing, and can be adjusted to take up wear until they are worn out. The connecting rod is of best quality cast steel with solid straps and heavy bronze boxes at each end, adjustable by means of wedge and screw. The piston is a hollow casting made as long as possible so as to afford a long bearing surface in the cylinder, and there are grooves in it in which are spring packing rings. The governor is of a new design, is very sensitive and operates the valves according to the load in a most satisfactory manner. The valve also is of a new design, embodying all the essential features

of thoroughly up-to-date requirement. It works between the face of the cylinder or steam chest and a pressure plate which is held in place by the pressure of the steam, but prevented from pressing on the valve by distance pieces at both top and bottom. The stuffing boxes of both piston and valve rod are equipped with brass linings, and are of the easiest possible adjustment.

Any further information regarding this engine can be had on application to Mr. Robert Bell, Jr., Hensall, Ont.

**MECHANICAL DRAFT.**

The chimney has so long stood as one of the evidences of the existence of a manufacturing plant that it surprises one to look out on a vast area of buildings evidently devoted to manufacturing purposes and not see the tall shaft of brick, pointing heavenward and usually capped with a cloud of smoke. The chimneyless establishment of the B. F. Sturtevant Company at Jamaica Plain, Mass., however, serves to awake such surprise, for it is equipped with a mechanical draft plant, and the otherwise use-

less chimney has just been torn down for the sake of the bricks it contained.

When the tracks of the New York, New Haven and Hartford Railway were recently elevated it became necessary to make extensive changes in the arrangement of these works, which are adjacent. Among other alterations the location of the boiler plant was changed to a point so far distant from the chimney which had produced the draft, that its further use was precluded. This condition proved, however, a most excellent opportunity for the introduction of mechanical draft, in the success of which this company has been deeply interested. Accordingly a Sturtevant fan was installed on top of the boilers and the gases were drawn through it and discharged through a short stack, extending but a few feet above the top of the boiler house. The arrangement is simple, economical and convenient. Above all, it forcibly illustrates the adaptability of this method.

One of the incidentals of economy, independent of the lessened first cost of the mechanical draft apparatus, has been the gain in floor area on the floors through which

**GEO. REID & CO.,**  
Dealers in  
**Textile Machinery and Supplies,**  
TORONTO, ONT.,  
Have bought and are offering for sale at great Bargains the entire machinery of the Campbellford Woolen Mill (which they are now taking out), also  
A 4-Set Mill (Running). A 2-Set Mill (Running), and Three 1-Set Mills (Running).  
Write at once for Prices and particulars.

ADVERTISE IN THE CANADIAN MANUFACTURER.

... ORDER ...



**“Capitol”**  
THIS IS THE STANDARD GRADE **CYLINDER**  
**“Renown” “Atlantic”**  
ENGINE RED OIL  
NO BETTER OILS MADE  
**THE QUEEN CITY OIL CO., LIMITED**  
SAMUEL ROGERS, PRESIDENT  
TORONTO, Canada

**BELTING**  
**E L T I N G**  
Leather Belting,  
Lancashire Hair,  
English  
Card Clothing,  
**D. K. McLAREN**  
Head Office and Factory -  
VICTORIA SQUARE, - MONTREAL  
Stock Depots - Ottawa, Galt.  
**O A K**  
**E N U I N E**

WESTERN TRADE:—  
Our Mr. R. M. W. McLaren, in charge of Galt Branch, will be pleased to give quotations as well as receive orders.

**STORAGE BATTERIES**  
THE LIGHTEST. THE STRONGEST. THE BEST.  
If you use Electricity we Batteries Repaired and Recharged can save you Money. at Reasonable Rates.  
**The Croftan Storage Battery Co.**  
W. M. H. NELLES. CANADIAN BRANCH. REIN WADSWORTH.  
22 Sheppard Street, Toronto, Ont.  
DO YOU USE  
**CORRUGATED SHUTTLES**  
FOR WEAVING FROM COP?  
WE MAKE THEM. Write for Prices and Samples.  
**JOHN HOPE & CO.,** LACHUTE SHUTTLE and BOBBIN WORKS,  
LACHUTE, QUE.

**THOMPSON & CO.,** Manufacturers of  
**BOBBINS and SPOOLS**  
FROM SELECTED STOCK.  
Correspondence Solicited ..... Orders Promptly Filled..... • **SHERBROOKE, P. Q.**



the chimney passed. The fan occupies no valuable space, being located on top of the boilers, and no expensive foundations were required.

Although the present stack does not extend above the level of the surrounding buildings, nevertheless no inconvenience has resulted therefrom. In fact, smoke is scarcely ever visible, and then only for an instant, the positive and ample supply of air resulting from the operation of the fan serving to promote perfect combustion. By means of a special automatic device the speed of the fan is exactly regulated to the requirements of the fire and the steam pressure is maintained absolutely constant.

With the modern advances in steam engineering practice, the economy of steam generation is receiving more of the attention which was previously accorded to grates. Efficiency in its utilization is imperative and mechanical draft is turned to as one of the important factors in decreasing the wastes usually incidental to the production of steam. The intensity of draft produced by a fan and its entire independence of the temperature of the escaping gases makes possible the utilization of much of the heat which is otherwise wasted, and which must be incidental to the operation of a chimney in which the draft is directly dependent upon the temperature of the gases. Progressive engineers are now substituting the fan for the chimney, whose days as the unquestioned means of draft production are already numbered, and the future will present many views like that here shown, in which the chimney is no more.

The Colwell Candy Co., St. John, N.B., are building a factory and warehouse.

#### THE ROYAL ELECTRIC.

The Royal Electric Company's fourteenth annual meeting was held in Montreal, July 19th. The reports presented were considered to be satisfactory. The gross revenue was shown to have been \$955,826; expenditure, \$636,057; interest and fixed charges, \$42,609; net profit, \$277,160. Four quarterly dividends have been declared, of two per cent. each, equalling \$120,000. Ninety thousand dollars was charged to profit and loss for reduction of assets in patents; \$25,000 for depreciation of plant, and \$31,992 for other reasons.

It was shown that the company last year made eighteen and one-half per cent. on invested capital, as compared with sixteen and one-half per cent. the preceding year. A dividend of eight per cent. has been paid yearly since 1891. The company now employs six hundred hands, and its wage bill exceeds a thousand dollars a day. There was expended in material last year \$400,000. Business in new customers has increased fourteen per cent., and for lights, sixteen per cent. The addition of a new plant has resulted in an economy of coal consumption of 5,300 tons of coal; as compared with the figures of two years ago.

The old board of directors were re-elected, namely:—The Hon. J. R. Thibault, president; Messrs. D. Morrice, vice-president; F. L. Beique, Allan R. Macdonell, H. S. Holt, J. A. L. Strathy, A. Burnet, Edwin Hanson, Robert Cowans, and W. H. Brown, general manager.

In his address the president mentioned that the company employs 600 hands and its wage bill exceeds one thousand dollars a day. In material last year \$400,000 was expended.

The volume of business exceeded one million dollars increase. In business in new customers and for lights the increases were fourteen and sixteen per cent. respectively. The addition of new plant has resulted in an economy of coal consumption of 5,300 tons of coal as compared with the figures for two years ago.

The increase in incandescent lights connected during the year was 7,736, or nearly as many as during the two years ending May 31, 1897. Some of the additions in arc lights are for street lighting in the town of Maisonneuve, with which municipality a contract was made in November, 1897, to continue for a period of ten years. A number of contracts for lights and motors have been entered into for periods of five years or more.

The alternating current motor service has increased steadily, and promises to grow rapidly, customers being satisfied with the power and the motors, and having demonstrated by experience the advantages of electric current motive power. A contract has been entered into with the Dominion Cotton Mills Company, Limited, for the use of electric current for motive power to the extent of at least 1,500 horse-power for the operation of the machinery in their mills in this city for a period of twenty years. The contract carries the privilege of increasing the amount of power to be used up to 3,000 horse-power. It may, reasonably, be anticipated that other large manufacturers will soon take measures to obtain the advantages of electric power.

The work of completing the building and hydraulic works at Chambly is approaching completion. Orders now on hand for electrical apparatus amounts to \$300,000. Among the contracts secured during the year

# FAIRBANKS STANDARD SCALES

LOOKS  
FAMILIAR  
EH?

It's a Sentinel, and the Picket Line extends around the world, showing the universal use of Fairbanks Hay, Coal and Wagon Scales.

If it looks **old and weather-beaten** it shows that the scale has been used for years and is still doing business at the old stand.

If it is **new and fresh** it shows that another wise man has picked out a good thing. Quality—same as ever—you know. Prices lower.

Write to-day and let us know the size and capacity of the scale you need.

## THE FAIRBANKS COMPANY

749 Craig Street,

MONTREAL.

was one for transmitting current thirty-three miles—the longest distance, and at 22,500 volts, the highest voltage hitherto undertaken in Canada.

**MANUFACTURING INDUSTRIES IN TORONTO.**

The Toronto Globe has been taking an inventory of the improvements now being made in different manufacturing industries in this city with the following results. It says:

This season's factory extension in Toronto will cost not less than \$300,000.

The extensions of existing establishments and erection of new factories will give employment to not less than 2,130 additional employees. The increase of the principal industries will be

Allan Manufacturing Co	800
Massey-Harris Co.	350
Bertram Engine & Shipbuilding Co.	300
Canadian Oil Clothing Co.	100
Park, Blackwell Co.	100
Davies Packing Co.	50
Firstbrook Box Co.	75
Otto Higel Co.	30
Eckardt Casket Co.	25
Many smaller extensions	300

Total . . . . . 2,130

That the manufacturers of the city are in a flourishing condition, and that in the majority of cases the men in control of them are enterprising and progressive, is abundantly indicated by the amount of extension and improvement now going forward, and which will be suspended only with the close of the building season. The output and visible evidence of this improvement and prosperity will, of course, be manifested to the least observant in the brick and mortar piles, more or less imposing, within which the various industries are housed; but those accustomed to reflect will give consideration to what each of these new structures involves in increased employment to citizens, in larger output of goods and general benefit to the community, and they will perhaps be led to believe that the period of depression is finally past and gone, and an area of plenty has succeeded.

The aggregate cost of the factory and workshop building already under way or contracted for, and which will be completed this season, falls very little short of \$300,-

000, and it is more than probable that this amount will be largely increased before the year is over. The largest proportion of this outlay will be upon additions to established industries, which are extending their territories in answer to the popular demand for the articles they manufacture, but here and there a new institution is a proof that the facilities of Toronto as a manufacturing centre have impressed themselves on the world at large, and lends strength to the assertion

that a generous policy on the part of the civic authorities would draw hither many industries which are looking for a location in Ontario.

Of the manufacturers which are increasing their capabilities for production the following are making the most extensive improvements: -

The Massey-Harris Company, which will expend about \$250,000 on their works here and in Brantford. Of this amount the

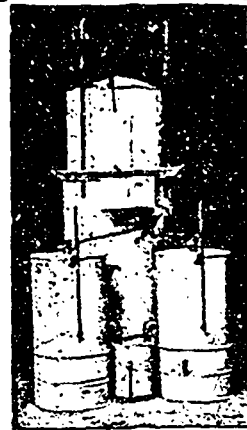

**The "SAFETY" ACETYLENE GAS MACHINE**

THE MOST SIMPLE AND THE SAFEST MACHINE MADE.

It does what other machines cannot do. It generates Gas Cool. It washes and purifies the Gas twice. Automatically removes the Ash from the Carbide. Leaves the Ash perfectly dry and thoroughly exhausted.

**EVERY MACHINE GUARANTEED.**

Manufactured by . . .

**THE SAFETY LIGHT & HEAT CO., Dundas, Ont.**

Proprietors and Sole Manufacturers for the Dominion of the celebrated **CLIFF-WARDLAW GENERATORS.**

**HAMILTON COTTON CO.**

HAMILTON, ONTARIO.

**YARN MANUFACTURERS, DYERS, AND BLEACHERS,**

Warp Yarns of all descriptions, in Skein, Chain or on Beams. Hosiery Yarns in Single or Double; in Cop, Skein or Cone. Yarns of all kinds for Manufacturers' use.

**Twines, Lampwicks, Webbing, Etc.**

Dyeing of all colors, including **GENUINE FAST BLACK.**

ALEX. GARTSHORE, President. J. G. ALLAN, Sec.-Treas. JAS. THOMSON, Vice-Pres. and Gen. Mng'r.

**THE GARTSHORE-THOMSON PIPE & FOUNDRY CO.**

Limited



3 in. to 60 in. diameter.

**For Water, Gas, Culverts and Sewers**

Special Castings and all kinds of **FLEXIBLE AND FLANGE PIPE.**  
**WATER WORKS SUPPLIES HAMILTON, ONT.**

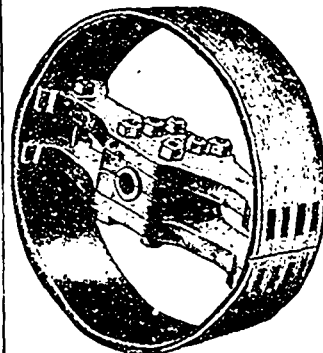

**BENT WOOD SPLIT PULLEYS, RIM... (REID'S PATENT).**

The Strongest, Lightest and Best Belt Surface in the World

No Glue, no Nails in Rim like Segment Rim Pulleys, to be affected by Steam, Dampness or Moist Temperature.

**EVERY PULLEY GUARANTEED.**

**The Reid Bros. Manufacturing Co., of Toronto, 257 King St. West, Toronto.**

**Splendid . . .**

**Water Power**

AND

**SPECIAL INDUCEMENTS**

TO

**MANUFACTURERS**

TO LOCATE ON

**The ST. MAURICE RIVER, Province of Quebec.**

THE SHAWINIGAN WATER AND POWER COMPANY is prepared to treat with parties desiring to lease large units of power.

For information, address the Company.

1724 Notre Dame St., Montreal.

# The London Machine Tool Co., LONDON, ONT.

MANUFACTURERS OF GENERAL MACHINERY...

Having recently sold our patterns and plant to the A. R. Williams Co., of Toronto, retaining only such machines as are useful in our business, we beg to say that we are rapidly putting in New Machinery, from new and improved designs, and are now in a position to receive orders for all Standard Tools for Metal Working in all branches. It will be our aim, by personal supervision of the product of works, with expert men of large experience at the head of each department, to turn out nothing but first-class work at moderate prices. And as we intend to deal directly with the manufacturers, they will be enabled to get their machinery at first cost.

As we shall not be able to personally visit each manufacturer, it is for this purpose that we publish this advertisement. This is our agent who is going about to solicit a share of your patronage. We are thankful for the patronage extended to us in the past, and hope that we may secure an extension of the favor for the future.

All correspondence relating to the following Tools will be promptly answered, viz:

LATHES - Engine, Gap, Break, Turret, Fox, Spinning, Etc.	SHAPING MACHINES Whitworth, O. & E., Rack Driven, Etc.
PLANERS - Standard, Crank, Plato, Etc.	HAMMERS Steam, Sandage Drop, Stiles Drop.
DRILLS - Standard, Sensitive, Multiple, Radial, Etc.	BULL-DOZERS for all purposes.
MILLING MACHINES Lincoln, Plain, Universal, Etc.	PUNCHES AND SHEARS for Plato, Angles, Channels, Gauges, Etc.

And we would call special attention to our **Wiring, Riveting, Etc.** We shall also esteem it a pleasure to give quotations on Special and General Machinery in our line.

**PRESSES for Cutting, Stamping, Drawing**  
it a pleasure to give quotations on Special and  
**LONDON MACHINE TOOL CO.**

## JOHN J. KELLER & CO.

104 and 106 MURRAY ST.  
NEW YORK

220 Church St., Philadelphia.  
135 Pearl Street, Boston.

**Aniline Colors,  
Dyewood Extracts,  
Sumac and  
Nutmeg Extracts.**

**FAST COLORS for Wool Dyeing.**  
One Dip Cotton Colors, Novelties  
and Specialties for Calico  
Printing.

MANUFACTURED BY  
**JOHN R. GEIGY & CO.**  
BASLE, SWITZERLAND

**LIGHT YOUR  
FACTORY WITH**

# LUXFER PRISMS

The latest device for

**LIGHTING**

dark rooms and  
offices

**By Daylight**

For catalogue  
and estimates  
write to

**Luxfer Prism  
Co'y, Limited.**

58 Yonge Street, - **TORONTO.**

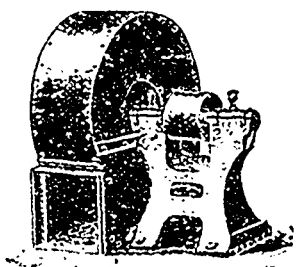

## Ventilating Steel-Plate Fans, Blowers and Exhausters.

**WE** have on hand Fans of the Best American Makes, ranging from 15 inch to 72 inch. Also Second-hand Coil Heaters, with Fans to suit, from 1,000 feet to 5,000 feet of inch pipe capacity.

THE ABOVE ARE FOR SALE CHEAP.

Write for Prices and Send for Catalogue.

**McEachren Heating and  
Ventilating Co., GALT, ONT.**

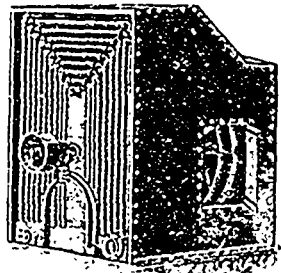

greater portion will be laid out in the Toronto institution.

The Allen Manufacturing Company, the addition to whose premises will consist of a building 160 x 100 feet, and eventually give employment to 800 more employees. A permit for this building was issued yesterday. It will cost \$30,000.

Park, Blackwell & Company, whose new pork-packing establishment and improvements will entail an outlay of about \$60,000.

The Wm. Davies Packing Co., which will expend in the neighborhood of \$60,000.

Firstbrook Bros., who will expend from \$25,000 to \$30,000 in building additions and plant.

The Canadian Oil Clothing Co., a new industry in the city, whose premises are approaching completion, and will cost from \$15,000 to \$20,000.

The Otto Higel Co., piano actions, which will expend from \$10,000 to \$12,000 on a building now in course of erection.

The Eckardt Casket Co., the addition to whose factory will entail an outlay of from \$25,000 to \$30,000.

By the improvement to the establishment of the Eckardt Casket Company, twenty-five additional hands will be given employment, and about \$4,000 a year in wages will be divided among them.

There are in addition to these larger amounts, a considerable number of smaller ones, averaging about \$3,500, and aggregating upwards of \$50,000.

When the Allen Manufacturing Company have finally completed their improvements and are running full blast, they will probably employ 1,200 hands. In their present building, which is 100 feet square, they employ in the manufacture of white goods, etc., 410 persons, chiefly women, and the wages check last Saturday for the factory hands, which did not include 100 employees in the offices, amounted to \$2,600. An increase in the hands to three times the present number will mean a large addition to the amount of wages paid. As soon as the new building is completed the employees will be increased to 900 or 1,000, and it will be gradually enlarged until it is hoped ultimately to employ 2,000 persons. It is the intention of the company to begin the manufacture of new lines of goods allied to those at present produced.

The full capacity of Park, Blackwell & Co's pork-packing business when their extensions have been completed will be 1,000 hogs a day, and this will involve an increase of their staff of workers by three times the number it is at present. They have now thirty-five hands in their factory. Their new building will cost about \$40,000, and the plant about \$20,000.

The addition to the Wm. Davies & Co. establishment will involve a considerable increased production and the employment of about fifty additional hands, which will mean from \$15,000 to \$20,000 more yearly paid out in wages. They have now a staff of 300 people.

The value of the increased output which Firstbrook Bros. expect from the addition to their factory will be from \$100,000 to \$150,000. From 50 to 100 more hands will find work, and the wages will be increased by about \$500 a week. Their new building will be 63 x 136 feet, and consist of three storeys and a basement.

The Canadian Oil Clothing Company, whose factory is being erected on the corner of Jefferson avenue and King streets, just west of the subway, will give employment to about 100 men. Their building will consist of two storeys and a basement. The com-

THE ...  
**A. R. WILLIAMS MACHINERY CO.**

(limited)

Head Office, - - SOHO MACHINE WORKS, TORONTO.

Manufacturers of and Dealers in  
**High-Class Iron Tools,**  
**Wood-working Machinery,**  
**Engines, Boilers,**  
**Motors, Water Wheels,**  
**General Machinery**  
**and Supplies**

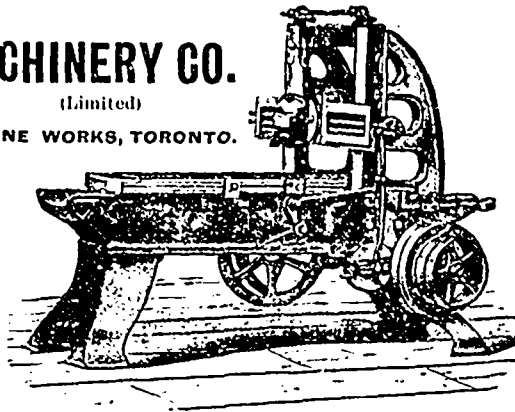

**The Pulsometer**  
**STEAM PUMP**

OFTEN IMITATED BUT  
NEVER EQUALED ...

...  
The handiest sim-  
plest and most efficient  
steam pump for gene-  
ral Mining, Quarrying  
and Contractors' pur-  
poses.

...  
Muddy or Gritty Liquids  
Handled without  
wear.

...  
Descriptive Catalogue  
with prices, furnis-  
hed on application.

...  
**PULSOMETER**  
Steam Pump Co.  
New York, U.S.A.

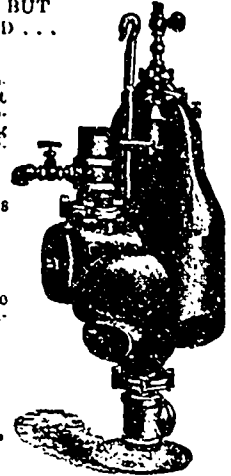

**A. R. Williams Machinery Co.**

Toronto and Montreal,  
Selling Agent for Canada.

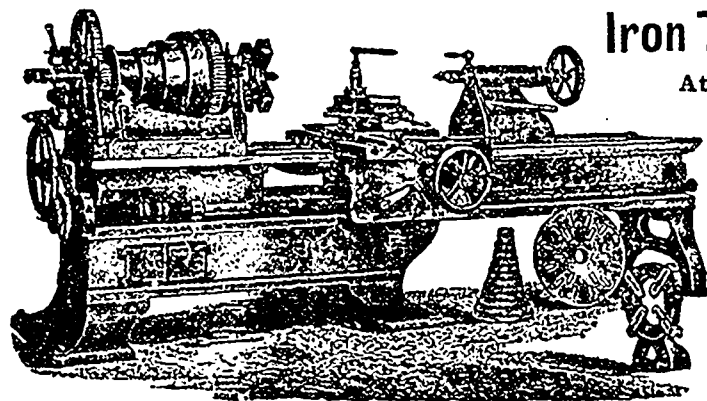

**Iron Tool Works**

At London.

BRANCHES

193 Colborne St.,  
BRANTFORD

345 and 347  
St. James St.,  
MONTREAL

Send for Circulars,  
Referring  
to this Advt.

**The Sturtevant**  
**IMPROVED PORTABLE FORGES**

TWENTY-FIVE SIZES AND STYLES

HAND POWER  
AND  
BELT POWER  
**Hand Blowers**  
FOR FORGE:

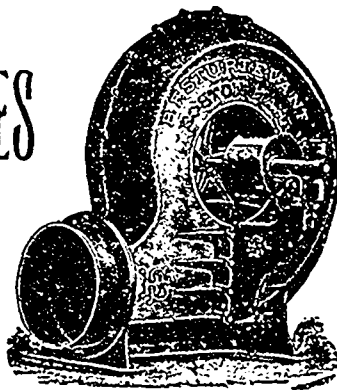

**The Sturtevant**  
**STEAM : FANS**

For BOILER FIRES

FORCED OR INDUCED DRAUGHT

MANUFACTURED BY

**B. F. STURTEVANT CO.**  
Boston, Mass., U.S.A.

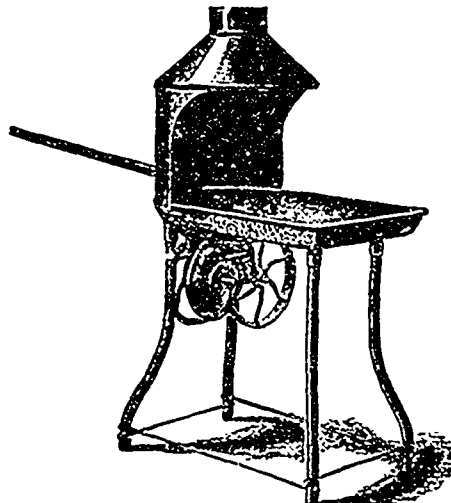

**The STURTEVANT**  
Blowers  
and Exhausting  
**FANS**

Known as the Monogram Pattern,  
For Blowing Boilers and Fires, Ex-  
hausting Dust and Gases.

SEND FOR CATALOGUES

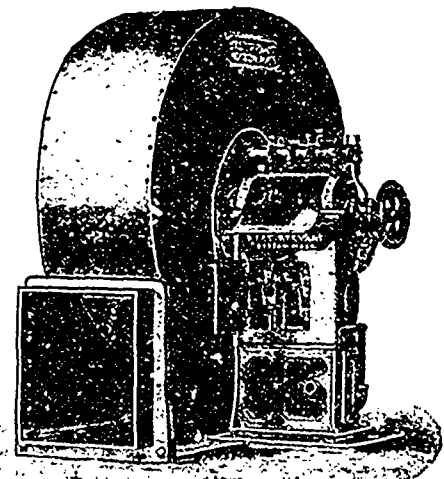

**A. R. WILLIAMS MACHINERY CO.,** General Canadian Agents, Toronto, Brantford, Montreal.

FOR  
**SALE OR TO LEASE**

For term of years,

**LARGE**

**FACTORY PREMISES**

AT KING ST. SUBWAY, TORONTO.

Ground Floor Area, 36,000 feet.

Railway sidings and other City facilities.

LIBERAL TERMS.

LAND SECURITY COMPANY,

41 Victoria St., Toronto.

**ADVERTISEMENTS RECEIVED FOR ALL PAPERS.**

*C. G. Browne,*

*Advertising Agent.*

145 Fleet Street  
LONDON EC Eng.

R. C. Jamieson.

A. T. Higginson.

**R. C. JAMIESON & CO.**

Manufacturers of

**Varnishes and Japans.**

Importers of Oils, Paints, Colors, Turpentine,  
Methylated Spirits, Shellacs, Rosins,  
Glues, Gold Leaf, Bronze, etc.

OFFICE—13 ST. JOHN STREET.

FACTORY AND WAREHOUSE—23 to 29 ST.  
THOMAS STREET.

MONTREAL.

**Sun Lighting Machine.**

ACETYLENE GAS.

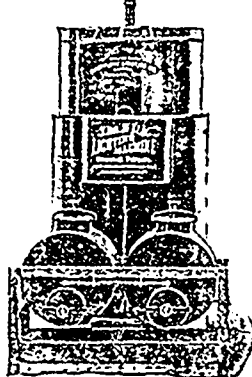

*The Acme of Perfection in Lighting.*

At the Minimum of Cost.

Suitable for any place where Artificial Light is required. Dwellings, Stores, Churches, Factories, Hotels, Street Lighting, etc.

Write for Catalogue.

THE  
**Acetylene Lighting Co.**

(LIMITED).

LONDON, ONTARIO.

pany now have works at Hamilton and Port Hope.

Bickell & Wickett will add two storeys to their tannery on Cypress street, and will do more business in buying and finishing goods.

Peuchen & Co. will add two additional storeys to their acid factory at a cost of \$2,000, which will give increased employment.

The James Robertson Co., Limited, are also adding to their factory to the amount of \$2,000.

Perhaps the greatest increase of employment of late by any one industry is in the case of the shipbuilding industry. The additions to the Bertram yards this season consist only of a two-storey machine shop, and a one-storey shed, costing \$3,000, but this small item covers a great deal. The yards are exceedingly busy on rush orders, and between 600 and 700 men, mostly skilled and highly paid mechanics, are employed, where last season not half so many were at work. Passenger steamers, grain barges and general trading steamers are being built, and the rush will continue for the balance of the season. Mr. George Bertram, in the course of conversation, said that he had no longer doubt as to the permanency of the shipbuilding business.

Speaking of the improvements being made by the Massey-Harris Co., the Globe, mentioning the fact of a visit of the Mayor and City Council to their works, says: "The visitors were conducted through the works

by Mr. W. E. H. Massey, the president of the company, Mr. James K. Osborne and Mr. Lyman M. Jones. Every department was glanced at, from basement to roof, and the massive character of the whole impressed the spectators, as it could not fail to do. Mr. Massey stated that the extensive additions which were being made to the works were called for by the large increase in the old country and European trade, to which continent they were this year shipping 10,000 machines. From the roof of the main factory an excellent bird's-eye view was obtained of the whole works, and a comprehensive idea of what further improvements are intended. The ground which the works now cover to the south of King street contain between seven and eight acres, but their floor space is six or seven times greater than that.

The Massey-Harris Company now employ over 1,000 men, and are paying out over \$2,000 a day in wages. The extensive additions which are to be made will increase the capacity of the works by fifty per cent., and of course correspondingly increase the number of hands and the amount of wages paid.

**BALDWIN-WESTINGHOUSE ELECTRIC MINE LOCOMOTIVE.**

THE CANADIAN MANUFACTURER is in receipt of a very handsome brochure describing and illustrating a new type of mine locomotive manufactured by the Baldwin Locomotive Works, of Philadelphia, and the Westinghouse Electric and Manufacturing Company, of Pittsburgh. The locomotive frame consists of heavy cast-iron side and end pieces, securely bolted together and kept square by machined joints and accurately fitted shoulders. The frame is placed outside of the wheels, thus allowing all possible space between the wheel hubs to admit the greatest practicable width of motor. This is an important feature, and obtains maximum power on narrow track gauges and also permits ready accessibility to the journal boxes. The top of the locomotive is made of heavy planks, with hinged trap doors. The journal boxes have bronze bearings, with oil cellars for sponging, as in steam locomotive practice. The brake

**TORONTO MACHINE SCREW CO.**

Manufacturers of



**Hexagon AND Square Head Cap Screws.**

Steel and Iron Set Screws.

Hanger and Plumber Bolts, Studs, etc.

Send for Price List and Discounts.



109 1/2 Adelaide St. W., - TORONTO.

THE  
**NIAGARA FALLS ACETYLENE GAS APPARATUS**

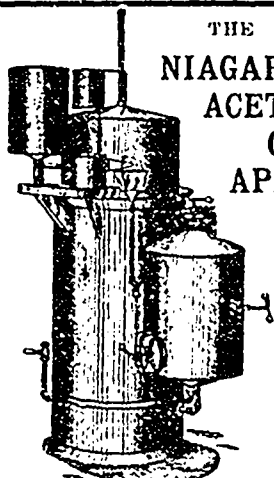

Patented in Canada, United States and Great Britain.

This is the only machine perfectly automatic in its action, requiring little or no attention. Machines made in 10 Sizes costing \$15 and upwards.

**Acetylene Gas the Coming Light.**

CHEAPER THAN ELECTRIC LIGHT  
COAL GAS OR COAL OIL

For Private Dwellings, Business Houses  
Churches, Public Halls and Offices.

For particulars write to the

**NIAGARA FALLS ACETYLENE GAS MACHINE CO.**  
NIAGARA FALLS, ONT. LIMITED.



**REMINGTON**

FIRST and BEST

**1,600 REMINGTON'S** used by U. S. Government  
Departments at Washington.

Endorsed and used by Dominion and Provincial Governments.

**EDISON MIMEOGRAPH**

The Only Thoroughly Satisfactory  
Means of Reduplicating.

**"MACEY" Card Index System**

AND OTHER

Labor-Saving Office Devices.

Full information and prices on application.

**CHAS. E. ARCHBALD,**

45 Adelaide St. E., TORONTO.

apparatus is simple and powerful. The operating platform is placed at one end, and is compactly and conveniently arranged, so that the motorman has all levers within reach without leaving the seat.

The entire machine, including the electrical apparatus, is supported on the journal boxes by helical springs, which prevent destructive pounding on the track and relieve the apparatus from shock. The locomotive is driven by two spring supported motors, one geared to each axle by single reduction gearing, running in oil lubrication in tight cases. These motors are especially designed for mining service, and are of the four-pole, steel-clad, enclosed railway type. The ar-

mature is of the iron-clad type, the coils being held in slots below the surface and secure from displacement, as in the most approved railway practice.

The controller is of the latest rheostatic type with magnetic blow-out to prevent arcing at the contacts. It is provided with six speed changes and is operated by handles for starting and reversing. The rheostat or diverter is non-combustible, very compactly set up, and has large carrying capacity. The trolley pole is of special design, is reversible, and can be placed in a socket on either side of the frame, automatically adjusting itself to the varying heights of the trolley wire. The current connections are made by in-

sulated cable. The locomotive is provided with all requisite electrical fittings, such as fuses, lightning arrester, main switch, and two electric headlights.

All sizes of the Baldwin-Westinghouse mine locomotive are designed to run at a standard speed of eight miles per hour when developing their full load tractive effort. With light trains the speed may be increased. Those locomotives are made in seven sizes from 20 to 150 horse-power each and weighing from 7,000 to 34,000 pounds. The minimum track gauge varies from 24 inches to 56 inches. On a level track the full load drawbar pull varies from 900 pounds to 6,500 pounds.

## 70 MANUFACTURERS . . .

Bar Iron, Steel, Boiler Plate,  
Rivets, Tube Expanders,  
Hammers, Metallic Letters  
and  
Figures for Patterns.

### RICE LEWIS & SON

(LIMITED)

COR. KING AND VICTORIA STREETS, TORONTO.

ADVERTISE IN THE CANADIAN MANUFACTURER.

SEND FOR RATES.

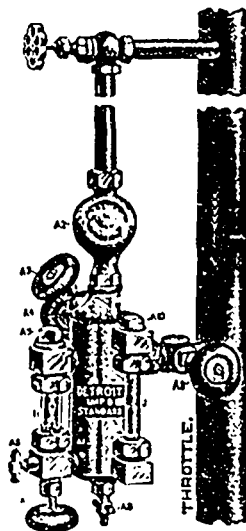

## THE BEST JUDGES OF ENGINES

THOSE WHO BUILD HIGH-GRADE ONES.  
ALL USE

### The Detroit Sight-Feed Lubricators

This is equally true of Canadian as of American engine builders. They know that the valve friction must be overcome if their engines are to work at their best. They know from experience that the Detroit Lubricators do this, and where so much is at stake they want only the best. It should be the same with all engine owners. The saving on Lubricators effect will pay for themselves very soon.

Send for Catalogue and Prices.

Detroit Lubricator Co.,  
DETROIT, MICH.

# RETURN OF PROSPERITY

The Wise Will Take Advantage of it.

## MANUFACTURERS

Who would increase their output—  
Retain their present customers—  
and secure new ones, will  
not fail to exhibit at . . .



CANADA'S GREAT  
**INDUSTRIAL EXPOSITION**  
TORONTO  
AUGUST 29th to SEPTEMBER 10, 1898.

GREAT  
DEMAND  
FOR SPACE

Applications should  
be made at once.

Entries Close August 6th.

For Prize Lists, Entry Forms and all Information  
address the Manager.

JOHN J. WITHROW, President.

H. J. HILL, Manager, Toronto.

The Attendance of Visitors this Year will be Greater than ever.

**THE WELAND POWER COMPANY.**

Mr. Henry Symons, Q.C., of Toronto, has just returned from England, where he had estimates prepared for the construction of the proposed works of the Welland Power and Supply Canal Company. This project involves the construction of a canal from the Welland River to the brow of the Mountain at Thorold, a distance of eight miles; the construction at Thorold of a power house, and from Thorold to Lake Ontario, a raceway by which to carry water into the lake. In addition to these different works, estimates were obtained for the construction of a transmission line from Thorold to Toronto by way of Burlington Beach. The estimates obtained by Mr. Symons were prepared by Dr. Hopkinson, F.R.S., one of the leading electricians of Great Britain; Sir Douglas Fox, Edmund Wragge, late of Toronto, and Mr. W. C. Unwin.

The estimate for the machinery to generate 100,000 horse-power is £125,000; for transmission line to Toronto at a voltage of 10,000 and delivery of 50,000 horse-power, £801,600; for excavation and other work connected with the undertaking, £1,525,062. The total estimate therefore amounts to £2,452,162, or roughly speaking, \$12,000,000. If the amount to be delivered in Toronto is reduced to 20,000 horse-power, the project would cost \$1,000,000 less. Messrs. S. Pearson & Son, contractors, state that if the contract could be secured from the cities of Toronto and Hamilton for a considerable quantity of power, for a definite term, there would be little difficulty in raising money for the project by bonds and shares in Great Britain, and that they themselves would be prepared to undertake the work, taking as part of their payment these securities. Mr. Symons intends laying the matter before the Mayor and City Council of Toronto before long to see if he cannot make a conditional contract for the supply of 5,000 or 10,000 horse-power.

The Montmorency Power Co., of Quebec, has made an addition to their plant by the installation of another 600 k.w. "S.K.C." Generator, which was purchased from the Royal Electric Co.

The Ossekeag Stamping Company, started at Hampton, N.B., in January last, is already an extensive concern, employing sixty hands, and it is expected to shortly increase the number to between one hundred and one hundred and twenty-five. The factory has a capacity of manufacturing \$200,000 worth of goods a year, and if the present good business continues, the ten machines, which are

at present running night and day manufacturing grey ware, white ware, blue and white ware, in pans, preserving kettles of all kinds, seamless pails, sauce pans, tea and coffee pots, pudding dishes, bowls of all kinds, boilers, trays, moulds, spoons, jars, ladles, pitchers, measures, skimmers, scoops, mugs and cups, plates, roasting pans, sinks, toilet sets, and numberless other articles. Their machinery is the best that can be procured, and their manufacturing is all done on the latest principles known. Their enamelling and galvanizing is in every way equal to the best work turned out by foreign concerns. Everything required for the successful operation of a tin and stamping factory is present, and the results are highly satisfactory to the enterprise. The company makes all its own dies for stamping and is thoroughly independent of outside assistance. It has already acquired a fine reputation and is rapidly forging ahead as the best equipped factory in Canada. Already the Upper Canadian houses are beginning to feel its existence. In winter the company has advantages over its western neighbors, as all its material is shipped from England to the port of St. John and can be landed in Hampton at a much smaller cost than Upper Canadian firms can procure it. Three travellers are constantly engaged soliciting orders, with such good results that the factory can hardly supply the demand. The company that built and is operating these works is composed entirely of provincialists, and the enterprising manager is Mr. J. E. Whittaker, of St. John.—Maritime Merchant.



**Canoes for Alaska and Gold Regions**

This cut is one of our 19 foot No. 69x Canoes, and shows carrying capacity. Write for our catalogue and discounts. Peterborough Canoe Co., Limited, Peterborough



For IRON FENCING, BANK and OFFICE RAILINGS and all kinds of IRONWORK

Address:

Toronto Fence & Ornamental Iron Works  
73 Adelaide St. West, Toronto.



Canada Elevator Works, Queen and Peter Sts., Patent Safety Hydraulic, Hand and Power ELEVATORS. Telephone connection.

**BROWN & CO.**

Manufacturers of Square and Hexagon

**HOT PRESSED NUTS.**

PARIS, - ONT.



**THE PARIS ELECTRO-PLATING CO.**

Manufacturers of

Stove Trimmings, Organ and Piano Trimmings, also all kinds of Brass and Nickel Plating Done  
Paris Station, - - Ontario

**FIRSTBROOK BROS.**

Dovetail and Packing Boxes

Top-Pins, Slide Blocks and Cross Arms. Wood Printers, Etc.

Cigar Boxes. Shipping Cases.

TORONTO, - - ONTARIO  
Write for Prices.

**Smith Wool-Stock Co., Toronto.**

Makers of WOOL STOCK, SHODDIES, Etc. All lines of Graded Woolen Regs. Carbonizing and Neutralizing. Buyers of Wool Pickings. All lines of Hard and Soft Waste.

Advertise in the Canadian Manufacturer.



**Mills,  
Factories,  
Warehouses**

Are best protected against fire by being equipped with

**Eddy's Indurated Fibreware  
FIRE PAILS**

We are the only manufacturers in Canada of this celebrated ware.

**The E. B. EDDY CO., Limited.**  
Hull, Montreal, Toronto

**The Wellington Mills, LONDON, ENGLAND**

**GENUINE EMERY**

Oakey's Flexible Twilled Emery Cloth.  
Oakey's Flint Paper and Glass Paper.  
Oakey's Emery Paper, Black Lead, Etc.  
Prize Medal and Highest Award Philadelphia, 1876, for Superiority of Quality, Skilful Manufacture, Sharpness, Durability, and Uniformity of Grain.

Manufacturers....

**JOHN OAKEY & SONS, Ltd.,** Wellington Mills, Westminster Bridge Road, London, Eng.

Inquiries should be addressed to

**JOHN FORMAN, 650 CRAIG ST., MONTREAL.**

**A. KLIPSTEIN & CO.**

122 PEARL STREET, NEW YORK.

**Anilines, Dyestuffs and Chemicals.**

DELIVERY MADE AT NEW YORK, MONTREAL OR HAMILTON.

**WRIGHT & DALLYN,**

AGENTS,

HAMILTON, ONTARIO.

**Ford, Ruthven & Co.,**

26 PITT STREET, SYDNEY,  
AUSTRALIA.

**WOOL BUYERS on Commission**

Letters of Credit must accompany orders.

Bankers:—Bank of Australasia, Sydney.

**GEO. PATTINSON & CO.**

PRESTON, - ONTARIO.

Manufacturers of

FINE AND MEDIUM **TWEEDS**

**Guelph Woolen Mill Co.,**

QUELPH, ONT. LIMITED,

Manufacturers of

Underwear, Hosiery, Wheeling,  
Fingering and Worsted Yarns,  
Eiderdown Flannel, Etc.

Selling Agents—Donald Fraser, Montreal.  
E. H. Walsh & Co., Toronto.

**PENMAN MANUFACTURING CO.**

PARIS, ONT. LIMITED,

Manufacturers of

Hosiery, Shirts, Drawers,  
Glove Linings and Yarns.

Selling Agents—D. Morrice, Sons & Co.,  
Montreal and Toronto.

**ROSAMOND WOOLEN CO.**

ALMONTE, ONT.,

Fine Tweeds, Cassimeres,  
and Fancy Worsted  
Suitings and Trouserings.

**JOHN HALLAM**  
TORONTO.

WHOLESALE DEALER IN

DOMESTIC and FOREIGN **WOOLS**

Sumac, Japonica, etc.

Reproductions Made for Eight  
Cents per Square Inch.



Half Tones Made Direct from  
Photos.

**It Leads Them All.**

THE OLDEST,  
THE LARGEST,  
THE SAFEST,  
THE CHEAPEST,

CANADIAN LIFE INSURANCE COMPANY IS

**THE CANADA LIFE ASSURANCE COMPANY.**

CAPITAL AND FUNDS OVER \$13,000,000.

Write for  
Prospectus.

A. G. RAMSAY,  
PRESIDENT.

GEO. A. & E. W. COX,  
Managers for Toronto  
and Eastern Ontario.

**PHENIX ASSURANCE COMPANY,**

OF LONDON, ENGLAND.

ESTABLISHED 1782.

AGENCY ESTABLISHED IN CANADA, 1804.

**PATERSON & SON,** GENERAL AGENTS FOR THE  
DOMINION,

35 St. Francois Xavier Street, MONTREAL.

**LEWIS MOFFATT & CO., Agent at Toronto.**

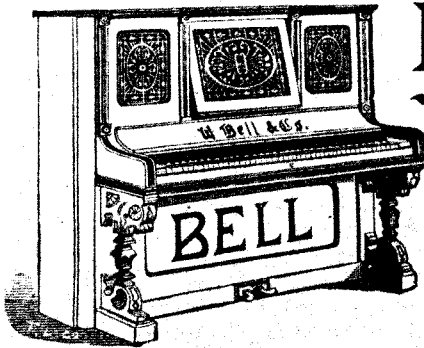

**BELL**

HIGH-CLASS

INSTRUMENTS

USED AND RECOMMENDED  
BY

LEADING MUSICIANS.

Send for Catalogue.

**THE BELL ORGAN AND PIANO CO**

(LIMITED)

QUELPH, - ONTARIO.

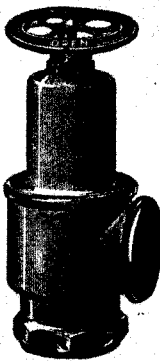

**CROSBY STEAM GAGE AND VALVE CO.**

Sole Proprietors and Manufacturers of

Crosby Pop Safety Valves, for all kinds of Boilers, Water Relief Valves including the Underwriter, which is fully approved by the Associated Factory Mutual Insurance Companies; Crosby Steam Engine Indicators, with Sargent's Electrical Attachment; Crosby Improved Steam Gages, Recording Gages and Patent Gage Testers. Original Single Bell Chime Whistles.

BRANDEN PATENT PUMP VALVES

CLARK'S LINEN FIRE HOSE AND ADJUSTABLE COUPLINGS

All Kinds of Pressure and Vacuum Gages used in the Various Arts

Gold Medal Paris Exposition, 1889

Ten Highest Awards Columbian Exposition, 1893

Main Office and Works.....

BOSTON, MASS., U.S.A.

Underwriter

Branch Offices at New York, Chicago, and London, Eng.

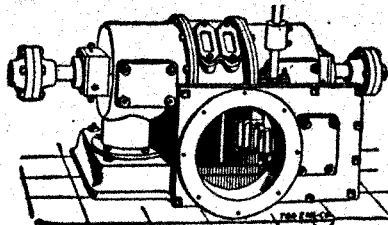

Horizontal Type.

**"LITTLE GIANT" TURBINE**

.... FOR ALL PURPOSES....

HORIZONTAL AND VERTICAL  
BUILT IN 44 SIZES.

We guarantee a higher percentage of power from water used than any other wheel on the market.

Water Wheel Governors, Machine Dressed Gearing, Pulleys, Shafting and Bearings.  
Catalogue and Gear List mailed on application. Correspondence Solicited.

**J. C. WILSON & CO., - - GLENORA, ONT.**



# LANGWELL'S BABBITT, MONTREAL.

AN EXCELLENT ANTI-FRICTION METAL.

G. LANGWELL & SON, MONTREAL

The DOMINION FOUNDRY SUPPLY CO.  
22-24 St. George Street, MONTREAL.

## BELLHOUSE, DILLON & CO.

SOLE AGENTS FOR THE UNITED STATES AND CANADA.

The West Indies Chemical Works LIMITED, JAMAICA.

MAKERS OF THE FINEST QUALITY OF

### EXTRACTS OF LOGWOOD.

28 Colborne St., TORONTO.  
30 St. Francois Xavier St., MONTREAL.  
20 Cedar St., NEW YORK.



## The Ontario Malleable Iron Co.

(Limited)

....Manufacturers of....

**MALLEABLE IRON** . . . . . Castings to Order for all kinds of

**AGRICULTURAL IMPLEMENTS**

....AND....

Miscellaneous Purposes . . . . .

OSHAWA, - - ONT.

FOUNDRY FACINGS and SUPPLIES,  
CRUCIBLES, PLUMBAGO, Etc.

FOR LIGHT and HEAVY WORK.

# MOULDING SANDS

Albany and South Amboy



Manufacturers of

### FINE VARNISHES

Japans—Asphalts—Shellacs

## Maple Leaf Brand Coach Varnishes

# J. H. FARR & CO.

## Armature Insulating Compound

Insulating Compound for Weather-Proof Wire, Tube Compound, Mica Paste, etc., etc.

8 to 10 MORSE STREET  
TORONTO



## THE CANADA SWITCH & SPRING CO., LIMITED.

Manufacturers of  
.....SPECIALTIES FOR.....

*Steam and Electric Railways,*

SPRINGS, STEEL CASTINGS,  
FROGS, FORGINGS,  
TRUCKS FOR ELECTRIC RAILWAYS, ETC.

*INTERLOCKING SWITCH and SIGNAL PLANTS,*

(Under patents of Messrs. Saxby & Farmer Limited, of London, Eng.)

CANAL BANK, POINT ST. CHARLES,  
MONTREAL.

## BRISTOL'S PATENT STEEL BELT LACING

—ONE HUNDRED SIZES—

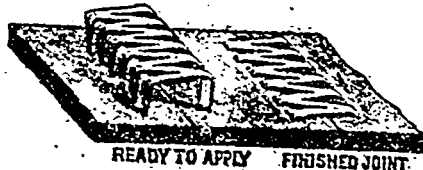

READY TO APPLY FINISHED JOINT

*Greatest Strength with Least Material*

EASILY APPLIED and LOW IN PRICE

*Saves Time, Saves Belts, Saves Money*

SAMPLES SENT FREE

000

THE **BRISTOL CO.**  
WATERBURY, CONN.

## SMITH'S FALLS

### Malleable Iron Works

00000

*CAPACITY 2,000 TONS.*

00000

## WILLIAM H. FROST

PROPRIETOR,

SMITH'S FALLS,

ONTARIO, CANADA.

# CARRIER, LAINE & CO.

LEVIS, P.Q.

ENGINEERS, FOUNDERS, MACHINISTS,  
BOILER MAKERS AND  
GENERAL CONTRACTORS

Montreal Branch....  
147 St. James St.  
Quebec Branch