

**CIHM
Microfiche
Series
(Monographs)**

**ICMH
Collection de
microfiches
(monographies)**



Canadian Institute for Historical Microreproductions / Institut canadien de microreproductions historiques

© 1997

Technical and Bibliographic Notes / Notes techniques et bibliographiques

The Institute has attempted to obtain the best original copy available for filming. Features of this copy which may be bibliographically unique, which may alter any of the images in the reproduction, or which may significantly change the usual method of filming are checked below.

- Coloured covers / Couverture de couleur
- Covers damaged / Couverture endommagée
- Covers restored and/or laminated / Couverture restaurée et/ou pelliculée
- Cover title missing / Le titre de couverture manque
- Coloured maps / Cartes géographiques en couleur
- Coloured ink (i.e. other than blue or black) / Encre de couleur (i.e. autre que bleue ou noire)
- Coloured plates and/or illustrations / Planches et/ou illustrations en couleur
- Bound with other material / Relié avec d'autres documents
- Only edition available / Seule édition disponible
- Tight binding may cause shadows or distortion along interior margin / La reliure serrée peut causer de l'ombre ou de la distorsion le long de la marge intérieure.
- Blank leaves added during restorations may appear within the text. Whenever possible, these have been omitted from filming / Il se peut que certaines pages blanches ajoutées lors d'une restauration apparaissent dans le texte, mais, lorsque cela était possible, ces pages n'ont pas été filmées.
- Additional comments / Commentaires supplémentaires:

L'Institut a microfilmé le meilleur exemplaire qu'il lui a été possible de se procurer. Les détails de cet exemplaire qui sont peut-être uniques du point de vue bibliographique, qui peuvent modifier une image reproduite, ou qui peuvent exiger une modification dans la méthode normale de filmage sont indiqués ci-dessous.

- Coloured pages / Pages de couleur
- Pages damaged / Pages endommagées
- Pages restored and/or laminated / Pages restaurées et/ou pelliculées
- Pages discoloured, stained or foxed / Pages décolorées, tachetées ou piquées
- Pages detached / Pages détachées
- Showthrough / Transparence
- Quality of print varies / Qualité inégale de l'impression
- Includes supplementary material / Comprend du matériel supplémentaire
- Pages wholly or partially obscured by errata slips, tissues, etc., have been refilmed to ensure the best possible image / Les pages totalement ou partiellement obscurcies par un feuillet d'errata, une pelure, etc., ont été filmées à nouveau de façon à obtenir la meilleure image possible.
- Opposing pages with varying colouration or discolourations are filmed twice to ensure the best possible image / Les pages s'opposant ayant des colorations variables ou des décolorations sont filmées deux fois afin d'obtenir la meilleure image possible.

This item is filmed at the reduction ratio checked below /
Ce document est filmé au taux de réduction indiqué ci-dessous.

10x		14x		18x		22x		26x		30x	
<input type="checkbox"/>	<input type="checkbox"/>	<input type="checkbox"/>	<input type="checkbox"/>	<input type="checkbox"/>	<input type="checkbox"/>	<input type="checkbox"/>	<input type="checkbox"/>	<input checked="" type="checkbox"/>	<input type="checkbox"/>	<input type="checkbox"/>	<input type="checkbox"/>
12x		16x		20x		24x		28x		32x	

The copy filmed here has been reproduced thanks to the generosity of:

National Library of Canada

The images appearing here are the best quality possible considering the condition and legibility of the original copy and in keeping with the filming contract specifications.

Original copies in printed paper covers are filmed beginning with the front cover and ending on the last page with a printed or illustrated impression, or the back cover when appropriate. All other original copies are filmed beginning on the first page with a printed or illustrated impression, and ending on the last page with a printed or illustrated impression.

The last recorded frame on each microfiche sheet contains the symbol \rightarrow (meaning "CONTINUED"), or the symbol ∇ (meaning "END"), whichever applies.

Maps, plates, charts, etc., may be filmed at different reduction ratios. Those too large to be entirely included in one exposure are filmed beginning in the upper left hand corner, left to right and top to bottom, as many frames as required. The following diagrams illustrate the method:

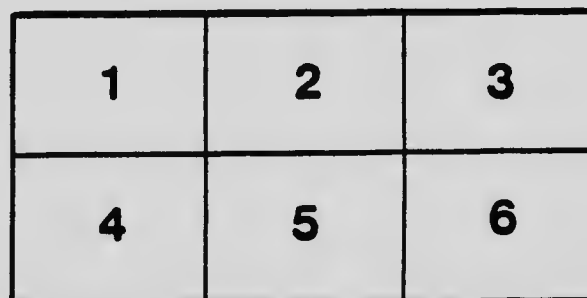
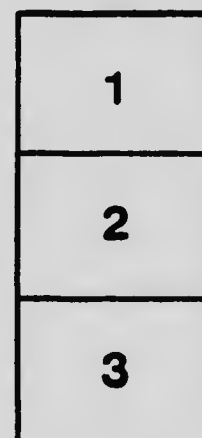

L'exemplaire filmé fut reproduit grâce à la générosité de:

Bibliothèque nationale du Canada

Les images suivantes ont été reproduites avec le plus grand soin, compte tenu de la condition et de la netteté de l'exemplaire filmé, et en conformité avec les conditions du contrat de filage.

Les exemplaires originaux dont la couverture en papier est imprimée sont filmés en commençant par le premier plat et en terminant soit par la dernière page qui comporte une empreinte d'impression ou d'illustration, soit par le second plat, selon le cas. Tous les autres exemplaires originaux sont filmés en commençant par la première page qui comporte une empreinte d'impression ou d'illustration et en terminant par la dernière page qui comporte une telle empreinte.

Un des symboles suivants apparaît sur la dernière image de chaque microfiche, selon le cas: le symbole \rightarrow signifie "À SUIVRE", le symbole ∇ signifie "FIN".

Les cartes, planches, tableaux, etc., peuvent être filmés à des taux de réduction différents. Lorsque le document est trop grand pour être reproduit en un seul cliché, il est filmé à partir de l'angle supérieur gauche, de gauche à droite, et de haut en bas, en prenant le nombre d'images nécessaire. Les diagrammes suivants illustrent la méthode.

MICROCOPY RESOLUTION TEST CHART

(ANSI and ISO TEST CHART No. 2)

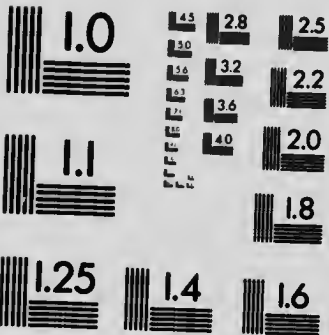

APPLIED IMAGE Inc

1653 East Main Street
Rochester, New York 14609 USA
(716) 482 - 0300 - Phone
(716) 288 - 5989 - Fax



M32-511

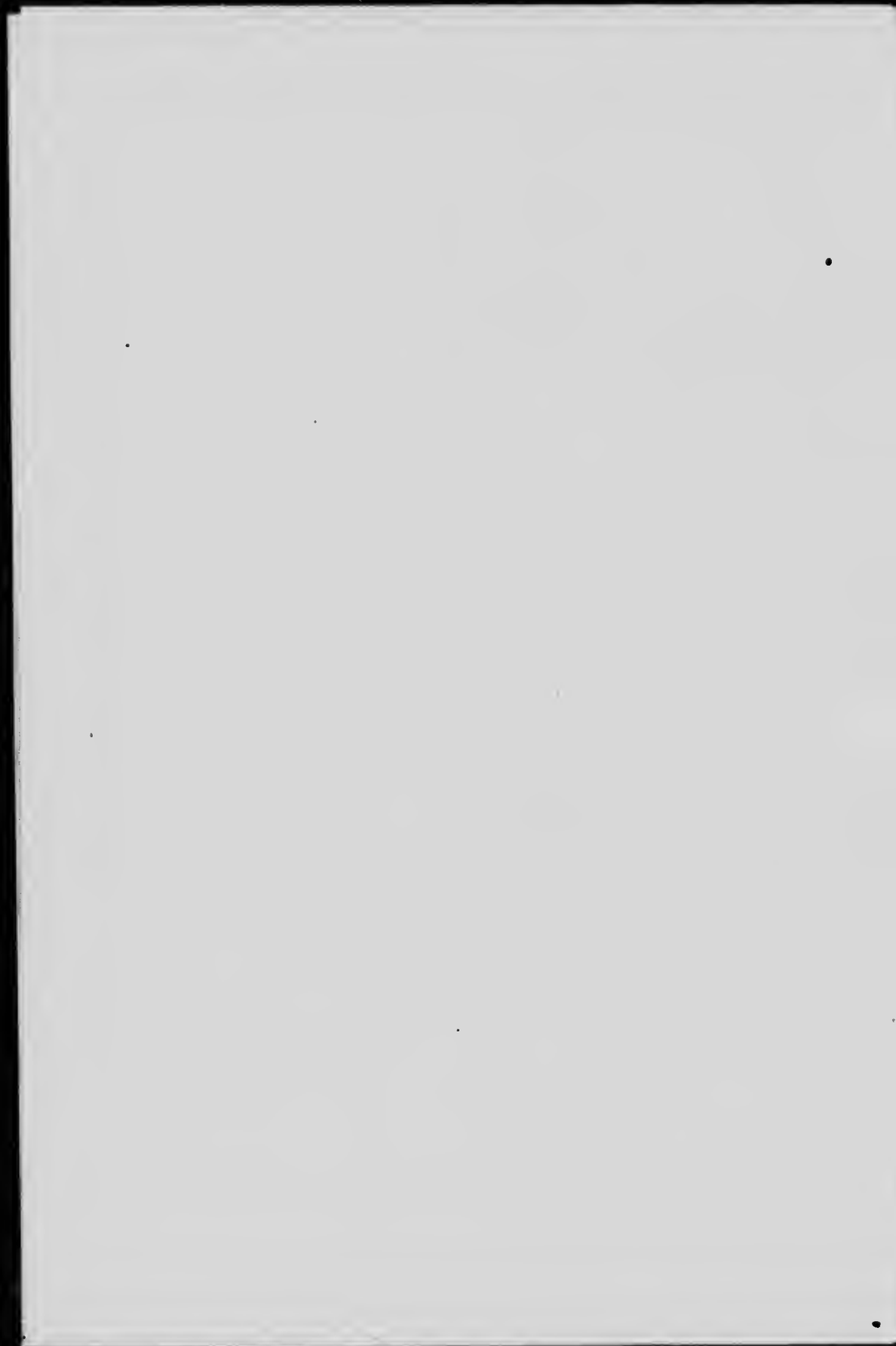





CANADA
DEPARTMENT OF MINES
HON. MARTIN BURRELL, MINISTER; R. G. McCONNELL, DEPUTY MINISTER.

MINES BRANCH
EUGENE HAANEL, PH.D., DIRECTOR.

GRAPHITE

BY
Hugh S. Spence, M.E.



OTTAWA
THOMAS MULVEY
PRINTER TO THE KING'S MOST EXCELLENT MAJESTY
1920

No. 511

67945-1



LETTER OF TRANSMITTAL.

DR. EUGENE HAANEL,
Director, Mines Branch,
Department of Mines,
Ottawa.

SIR,—I beg to submit, herewith, my report on the graphite industry in Canada, together with details relating to the occurrence, distribution, refining, and uses of graphite.

I have the honour to be, Sir,

Your obedient servant,

(Signed) **Hugh S. Spence.**

OTTAWA, May 20, 1919.

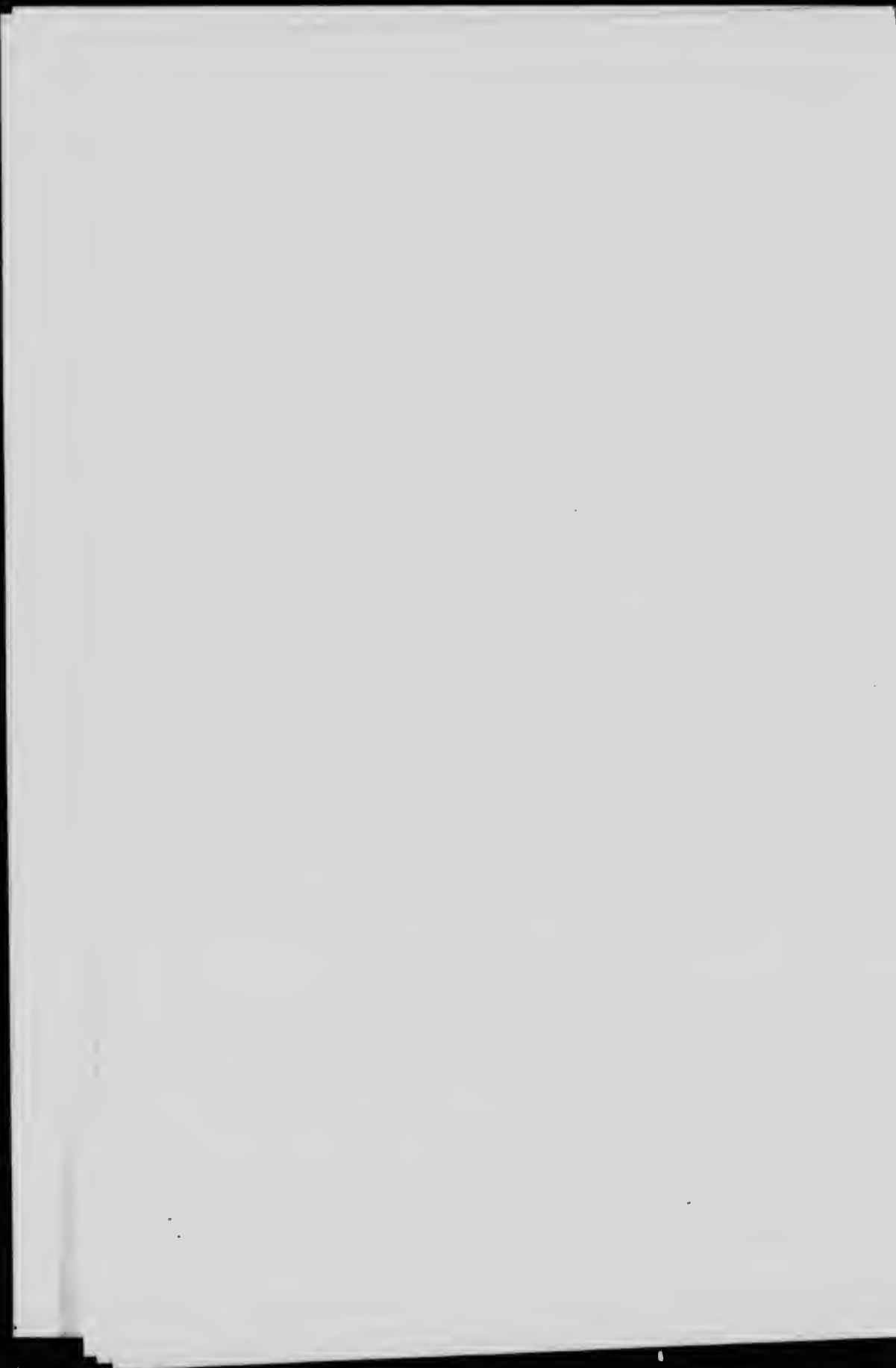

CONTENTS.

	PAGE.
Introductory	1
CHAPTER I.	
History of Graphite and description of its chemical and physical properties	3
History.....	3
Chemical and physical properties.....	4
CHAPTER II.	
Mode of occurrence and origin of Graphite	9
CHAPTER III.	
Composition and economic importance of Graphite ores	13
CHAPTER IV.	
Graphite in Canada	18
General.....	18
Types of deposits.....	19
Mining methods.....	21
Graphite mines and occurrences.....	22
Province of British Columbia.....	22
Province of New Brunswick.....	22
Province of Nova Scotia.....	24
Province of Ontario.....	25
Frontenac county.....	26
Township of Bedford.....	26
Haliburton county.....	26
Township of Cardiff.....	26
Township of Monmouth.....	27
Lanark county.....	28
Township of North Burgess.....	28
Township of North Elmsley.....	29
Renfrew county.....	35
Township of Brougham.....	35
Township of Lyndoch.....	39
Additional Graphite localities in Ontario.....	39
Lake of the Woods. (Carbonaceous schists).....	41
Province of Quebec.....	42
Argenteuil county.....	44
Township of Grenville.....	44
Township of Wentworth.....	46
Labelle county.....	46
Township of Amherst.....	46
Township of Buckingham.....	48
Township of Lochaber.....	58
Hull county.....	58
Township of Low.....	58
Maniwaki Indian Reserve.....	60
Additional Graphite localities in Quebec.....	60
Baffin island.....	61
CHAPTER V.	
Concentrating and refining of Graphite	63
Plumbago.....	63
Amorphous Graphite.....	63
Flake Graphite.....	64

	PAGE
Concentration by dry methods.....	67
Pneumatic jigs.....	68
Air classifiers.....	73
Rolls and screens.....	78
Electrostatic machines.....	80
Concentration by wet methods.....	80
Buddles.....	83
Mechanical washers.....	83
Log washers.....	84
Rake washers.....	85
Wet tables.....	86
Flotation.....	86
Frothing oil flotation.....	90
Callow system.....	98
Minerals Separation system.....	99
Simplex system.....	100
K. and K. system.....	101
Surface tension or film flotation.....	108
Miscellaneous.....	110
Refining of Graphite concentrates.....	111
Summary.....	112
Chemical refining of Graphite.....	112
CHAPTER VI.	
Artificial Graphite.....	114
CHAPTER VII.	
Uses of Graphite.....	119
Crucibles.....	119
Clays for crucibles.....	125
Manufacture of crucibles.....	131
Other Graphite refractory products.....	144
Pencils.....	149
Foundry facings.....	150
Dry batteries.....	150
Electrotyping Graphite.....	151
Graphite brushes.....	154
Graphite electrodes.....	155
Graphite for lubricating.....	158
Graphite paints.....	159
Stove polish.....	159
Boiler Graphite.....	160
Graphite for powder glazing and shot polishing.....	160
Subsidiary uses.....	160
CHAPTER VIII.	
The Canadian Graphite Industry.....	162
Production, exports, imports, etc.....	162
Domestic consumption of Graphite.....	167
General review of the industry.....	167
Review of market conditions 1914-1918.....	170
CHAPTER IX.	
Sources of the world's Graphite supply.....	174
Austria.....	174
Ceylon.....	175
Chosen (Korea).....	177
Germany.....	177
Italy.....	178
Madagascar.....	178
Mexico.....	180
South Africa.....	180

	PAGE
Spain.....	180
United States.....	181
Alabama.....	181
New York.....	182
Pennsylvania.....	183
Crystalline Graphite or Plumbago.....	183
Alaska.....	183
Montana.....	183
Flake Graphite.....	184
California and Texas.....	184
Amorphous Graphite.....	184
Colorado.....	184
Michigan.....	184
Nevada.....	184
Rhode Island.....	184
Miscellaneous Localities.....	184
World's production of Graphite.....	185
Artificial Graphite.....	187

CHAPTER X.

Determination of the carbon content of Graphite and Graphite ores....	188
Combustion method.....	189
Fusion method.....	191
Absorption method.....	191
Re-carbonating method.....	191
Further notes on analytical methods.....	192
Appendix.....	195
Bibliography of Canadian Graphite.....	195
Index.....	197

ILLUSTRATIONS.

Photographs.

Plate I. Canadian flake graphite ore.....	End.
II. Foliated plumbago.....	"
III. Fibrous or columnar plumbago.....	"
IV. Radiated, lamellar crystals of graphite.....	"
V. Foliated plumbago.....	"
VI. Mill of National Graphite Company, Munford, Ont.....	"
VII. Mill of Tonkin-Dupont Graphite Company, Wilberforce, Ont..	"
VIII. Method of working graphitic limestone ore-body, township of Monteaule, Ont.....	"
IX. Mill on Timmins property, township of North Burgess, Ont...	"
X. Open cut at workings of Globe Graphite Mining and Refining Company, township of North Elmsley, Ont.....	"
XI. 100-foot level at mine of Globe Graphite Mining and Refining Company, township of North Elmsley, Ont.....	"
XII. Needle-flake graphite ore, township of North Elmsley, Ont....	"
XIII. Mill of Globe Graphite Mining and Refining Company, Port Elmsley, Ont.....	"
XIV. Mill and part of surface plant of Black Donald Graphite Company, township of Brougham, Ont.....	"
XV. North end of east or hanging wall stope, Black Donald mine, township of Brougham, Ont.....	"
XVI. Main pit at Miller or Keystone mine, township of Grenville, Que.....	"
XVII. Mill of Graphite, Ltd., township of Amherst, Que.....	"
XVIII. Folded structure in gneiss, township of Buckingham, Que....	"
XIX. Mill of New Quebec Graphite Company, Buckingham, Que....	"
XX. Mill and workings of Bell Graphite Company, township of Buckingham, Que.....	"
XXI. Large sized graphite flakes from township of Buckingham, Que	"
XXII. Mill of Plumbago Syndicate, township of Buckingham, Que...	"

Plate XXIII.	Mill of Buckingham Graphite Company, township of Buckingham, Que.	End.
XXIV.	Pegmatite intruded into gneiss, Walker mine, township of Buckingham, Que.	"
XXV.	Mill of Consolidated Graphite Mining and Milling Company, township of Buckingham, Que.	"
XXVI.	Foliated plumbago from Lake harbour, Baffin island.	"
XXVII.	Sectional view of Raymond High-Side mill and separator.	"
XXVIII.	Type of kiln used for drying graphite ore.	"
XXIX.	Krom pneumatic jig.	"
XXX.	Hooper pneumatic concentrator.	"
XXXI.	Type of rolls used in Canadian mills.	"
XXXII.	Installation of King Bee rolls at a mill in the Buckingham district, Que.	"
XXXIII.	Sutton, Steele and Steele di-electric separator.	"
XXXIV.	Details of Sutton, Steele and Steele di-electric separator.	"
XXXV.	Section of mill showing Krupp-Ferraris tables, slime tables and hydraulic classifiers, New Quebec Graphite Company, Buckingham, Que.	"
XXXVI.	Callow pneumatic flotation cells in operation.	"
XXXVII.	Seck polishing rolls for finishing flake graphite.	"
XXXVIII.	Machine for mixing crucible bodies: back view.	"
XXXIX.	Machine for mixing crucible bodies: front view.	"
XL.	Pull-down and jigger used in making crucibles.	"
XL I.	Pull-down and jigger used in making crucibles.	"
XLII.	Crucibles as removed from moulds.	"
XLIII.	Types of crucibles used in melting non-ferrous metals.	"
XLIV.	Types of crucibles used in tilting furnaces.	"
XLV.	Defects developed in crucibles by improper usage.	"
XLVI.	Type of crucible used in melting steel.	"
XLVII.	Bottom-pour crucible.	"
XLVIII.	Brazing crucibles for dip-brazing.	"
XLIX.	Type of retort used in the smelting of gold, silver, zinc, etc.	"
L.	Funnel or extension tops for increasing the capacity of crucibles, and pyrometer shields.	"
LI.	Types of graphite stoppers and nozzles for steel-pouring ladles.	"
LII.	Types of phosphorizers used in the manufacture of phosphor bronze.	"
LIII.	Types of stirrers, skimmers, and dippers.	"
LIV.	Types of graphite commutator brushes.	"
LV.	Types of Nigrum oilless bushings.	"
LVI.	Types of Bound Brook oilless bushings.	"

Drawings.

	PAGE
Fig. 1. Surface plan at mine of Globe Graphite Mining and Refining Company, township of North Elmsley, Ont.	30
2. Diagram of ore-body at mine of Globe Graphite Mining and Refining Company, township of North Elmsley, Ont.	31
3. Sections through workings at mine of Globe Graphite Mining and Refining Company, township of North Elmsley, Ont.	33
4. Plan of workings, Black Donald Graphite Company, township of Brougham, Ont.	38
4a. Profile of workings, Black Donald Graphite Company, township of Brougham, Ont.	38
5. Surface plan of graphite showings, township of Lyndoch, Ont.	40
6. Plan and section of graphite deposit, township of Wentworth, Que.	47
7. Geologic relationships at Dominion mine, township of Buckingham, Que.	51
8. Plan of workings at Walker mine, township of Buckingham, Que.	56
9. Sketch of occurrence of plumbago, Lake harbour, Baffin island.	61
10. Installation showing Raymond mill for grinding graphite.	65
11. Section through Hooper pneumatic concentrator.	68
12. Section through Krom pneumatic jig.	69
13. Sutton, Steele and Steele three section jig.	70
14. Flow sheet of Sutton, Steele and Steele dry concentration installation.	71

	PAGE
Fig. 15. Result of test made on Alabama graphite ore by Sutton, Steele and Steele dry process.....	72
16. Section through type of air classifier used in Alabama mills.....	73
17. Flow sheet of dry concentration system employing rolls.....	76
18. Flow sheet of dry concentration system by means of a combination of rolls and tables.....	76
19. Flow sheet of dry concentrating and finishing plant for flake graphite....	77
20. Section through Huff electrostatic separator.....	80
21. Flow sheet showing mill system using buddles as installed in a New York mill.....	81
22. Flow sheet of combined wet and dry concentrating system as installed in an Ontario mill.....	82
23. Flow sheet of mill employing log washer concentration, Byers, Pennsylvania.....	83
24. Flow sheet of wet concentration system using rake washers in a Pennsylvania mill.....	84
25. Ferraris type of wet table.....	85
26. James type of wet table.....	86
27. Flow sheet of wet concentration system using Ferraris tables as installed in a Quebec mill.....	87
28. Flow sheet showing Callow pneumatic flotation system as installed in an Alabama graphite mill.....	91
29. Flow sheet of mill using Callow pneumatic flotation concentration.....	92
30. Flow sheet of Minerals Separation oil flotation system as installed in an Alabama mill.....	99
31. Flow sheet showing Simplex oil flotation system as installed in an Alabama graphite mill.....	100
32. Section through Simplex washer.....	100
33. Section through original Munro washer.....	101
34. Section through New Munro washer.....	102
35. Section through Colmer washer.....	103
36. Flow sheet of surface tension concentration installation using Munro washers in an Alabama mill.....	104
37. Flow sheet of surface tension concentration installation using Munro washers in an Alabama mill.....	105
38. Flow sheet of surface tension flotation installation using Colmer washers in an Alabama mill.....	107
39. Section through electric furnace for the production of artificial graphite..	116
40. Section through electric furnace arranged for graphitizing carbon electrodes of rectangular section.....	117
41. Section through electric furnace arranged for graphitizing round carbon electrodes.....	117
42. Type of automatic graphite cylinder lubricator.....	155
43. Diagram showing production of graphite in principal countries in 1907-1917.....	185

Maps.

No. 513. Graphite occurrences in Bedford, Loughborough, Burgess and Elmsley townships, Ont.....	26
514. Graphite occurrences in Monmouth, Cardiff, Monteagle and Dungannon townships, Ont.....	26
515. Graphite occurrences in Brougham and Blithfield townships, Ont.....	36
516. Graphite occurrences in Grenville and Wentworth townships, Que.....	44
517. Graphite occurrences in Amherst township, Que.....	46
518. Graphite occurrences in Buckingham and Lochaber townships, Que.....	48

GRAPHITE.

INTRODUCTORY.

Graphite occurs somewhat plentifully in certain belts in the crystalline limestones and gneisses of the Archæan (Grenville) series of eastern Canada, the mineral being found both in the disseminated flake and vein (plumbago) form. Deposits of the latter type are known, and have been worked in a small way, on the south shore of Baffin island. Amorphous graphite, also, is common in the slates of Nova Scotia and New Brunswick, and there was formerly an important output of this class of material from workings near St. John, N.B.

Unfortunately, the veins of plumbago (the most valuable form of graphite, and greatly in demand for crucible manufacture) are narrow, and their exploitation is unlikely ever to prove a profitable undertaking. Small amounts of plumbago have, from time to time, been taken from shallow workings on such veins, but the total quantity thus obtained is insignificant.

The commercial flake ores are represented both by crystalline limestone, ranging in graphite content up to about 8 per cent, and gneiss, which sometimes contains as much as 30 per cent of graphite. The average run-of-mine in the case of the latter type of ore is, however, only 10 to 15 per cent graphite. Both classes of ore commonly grade insensibly into barren country rock.

While mining and milling of Canadian flake ores commenced as far back as 1866, the industry has never assumed any large proportions. This is due, largely, to the failure that has for years attended efforts to evolve an efficient and economical concentrating process for these ores. A great variety of methods have been tried, but none can be said to have proved conspicuously successful. The result has been that few operators have continued work for any length of time; and of the dozen or so mills that have been erected within the last twenty years, not more than two or three have been on the list of active producers at any one time. In the last two or three years, however, considerable experimentation has been carried out on graphite ores with the frothing oil flotation method of concentration, and the results achieved have shown that this method offers probably the cheapest and most efficient means of extracting graphite from its ores that has yet been devised. A number of American mills have adopted one or other of the various systems of oil flotation, with highly satisfactory results, and, at the time of writing, the process is being tried out in one Canadian mill and is under consideration by others. Since the better grades of Canadian flake ores average 10 to 15 per cent graphite as against 3 to 6 per cent in American ores, profits per ton of ore treated would be proportionately greater. It is to be hoped that oil flotation may prove the means of placing the flake graphite industry in this country on a more satisfactory basis than heretofore.

The question of graphite supplies for the crucible trade, which at the time of the outbreak of the war was estimated to consume probably 75 per cent of the world's output of graphite, became of urgent importance

to American metallurgical industries in 1915. Owing to the embargo placed upon exports of Ceylon plumbago and Madagascar flake by the British and French Governments, respectively, American crucible manufacturers were faced by a serious shortage of graphite, and a great expansion in the American—more particularly the Alabama—flake graphite industry took place. Between 1916 and 1918, more than forty new graphite mills sprang up in this State, a great variety of concentrating methods being employed in the different plants.

With the object of securing the latest data on milling methods, details of manufacture of graphite products and the requirements of the trade, as well as information regarding the graphite situation generally, the writer in 1918-19 visited the principal mines and mills in Alabama, New York, and Pennsylvania, and also a number of plants in the United States, manufacturing crucibles, pencils, stove polish, foundry facings, paints, commutator brushes, artificial graphite, etc. The principal graphite importers and brokers in New York were interviewed; Government departments in Washington were visited; methods in assay and analytical laboratories were studied; and a number of other authorities on graphite and the graphite industry were conferred with.

The writer desires to express his appreciation of the universal courtesy shown him in the course of the above-mentioned investigation, also his grateful acknowledgment for the information so freely afforded him by individuals and managements, who, by their cordial co-operation, have assisted so materially in the preparation of this report.¹

¹NOTE.—This report is intended to take the place of Report No. 18, Graphite: Its Properties, Occurrence, Refining and Uses, by F. Cirkel, published by the Mines Branch in 1907, and which is now out of print.

CHAPTER I.

HISTORY OF GRAPHITE, AND DESCRIPTION OF ITS CHEMICAL AND PHYSICAL PROPERTIES.

HISTORY.

Graphite¹ was known in very early times, though its use was probably limited to decorative purposes, in the same way as red earthy hematite: both minerals have been found in prehistoric burial places in Europe, and urns and pottery coloured by graphite are also recorded from ancient graves.

Graphite first came into general use, however, many centuries later, and it is first mentioned in the Middle Ages as a substance for use in drawing. It was regarded as somewhat of a mineral curiosity, and was doubtless often confused with other minerals, such as molybdenite, as well as with artificial products designed for drawing or writing. Despite the fact that graphite has been known for so long, its true nature and identity were not recognized until the end of the 18th century. The generally accepted idea was that graphite contained lead, and the names "black lead" and "plumbago" were applied to it on this assumption. There is little doubt that there was much confusion among the early chemists and mineralogists over the identity of the mineral in question, and various substances were investigated and described under the same name.

Possibly the first specific reference to pencils is that contained in a treatise on painting, written by Cennini, of Florence, about the year 1400. Cennini describes a pencil composed of two parts of lead and one part of tin, and the "lead" has been commonly supposed to have been graphite; this, however, would appear to be decidedly doubtful.

Agricola (1495-1550), describes refractory crucibles made of graphite, and it would seem that such crucibles were in general use by the alchemists in their attempts to transform the base metals into gold.

Conrad Gesner (1565), in his treatise on the nature of minerals and rocks, makes mention of a writing pencil composed of "English antimony", by which was probably meant the soft graphite obtained from the famous mines at Borrowdale, in Cumberland. These mines were opened in 1554, and for over three centuries furnished a superlative grade of pencil graphite.

Heinrich Pott (1692-1777), a German chemist, showed that "plumbago" contained no lead; but there is some doubt whether he actually experimented with graphite or with molybdenite, because, like his fellow chemist Quist, he did not distinguish in his writings between the two minerals.

It was Karl Wilhelm Scheele (1742-1786) who first made a thorough investigation of both graphite and molybdenite, and finally showed in

¹ From the Greek "graphein", to write. Other names for the mineral are plumbago, black lead, kishi, potelot, crayon noir, carbo mineralis. "Plumbago" and "black lead" are names that still are applied to graphite by the trade, though each has a slightly different significance. While the name "graphite" is commonly used for the crystalline flake mineral, "plumbago" is applied to the massive, vein material, such as obtained from Ceylon; while "black lead" is often employed for the amorphous material that enters largely into stove polish, lead pencils, etc. These different terms are merely a matter of usage and convenience to distinguish the three slightly different forms of the same substance.

what respects they differed. Scheele demonstrated the carbon content of graphite by igniting it in a current of oxygen, and also dissolved molybdenite with nitric acid, obtaining molybdic oxide.

The name "graphite" was first given to the mineral by the mineralogist Werner in 1789.

CHEMICAL AND PHYSICAL PROPERTIES.

The element carbon exists in three allotropic forms, two of which, graphite and diamond, are found in nature as minerals. Graphite, however, differs to such a degree from diamond and amorphous carbon (charcoal), both in its outward characteristics, such as form, colour, hardness, etc., as well as in many of its properties, that Brodie considered it to be a distinct element, which he termed "graphon".

The three forms of carbon, charcoal, graphite, and diamond, may be readily distinguished by chemical and physical tests. The specific gravity of charcoal is 1.3 to 1.9; of graphite, 2.1 to 2.3, and of diamond 3.5. Chemically, a ready means of differentiating between the three forms is to treat with potassium chlorate and concentrated nitric acid in the proportion of one part of the substance to be tested, three parts of potassium chlorate and sufficient acid to render the mass liquid. The mixture is then heated on a water bath for several days, when the diamond is found to be entirely unaffected. The graphite is converted into golden-yellow flakes of graphitic acid and the amorphous carbon is altered to a brown substance soluble in water². Many so-called graphites, when treated in this way, are shown to be charcoal, natural coke, or even coal or carbonaceous shale. Coal or carbonaceous shale may be detected by the amount of volatile matter present, while all of the enumerated adulterants are conspicuous by reason of their low ignition temperatures, as compared with graphite. A further means of distinguishing between graphite and coke or retort carbon is to note their behaviour when fused with sodium sulphite: graphite does not reduce this salt, whereas coke and retort carbon react very actively with it.

Natural graphite seldom occurs in well formed crystals (e.g. in certain crystalline limestones), but is usually found in laminated or more or less fluky aggregates disseminated in schistose rocks. It also occurs in veins, in which case the mineral usually exhibits either a foliated or fibrous structure. Earthy, amorphous graphite, commonly occurs in bedded deposits, and is then considered to be the result of the metamorphism of coal or carbonaceous material.

Graphite, as it usually occurs, is a black, lustrous mineral generally held to crystallize in the hexagonal system, with rhombohedral symmetry. Some authorities, however, claim it to be monoclinic. The crystals have tabular form, are six-sided, and the faces are commonly striated. On account of the softness of the mineral, the faces are seldom very distinct. Very perfect crystals are found in the crystalline limestone of Pargas, in Finland, but the best specimens have been obtained from meteorites.

¹ See Donath, E., *Der Graphit*, Leipzig, 1904, and Haenig, A., *Der Graphit*, Wien, 1910.

² Donath (*Der Graphit*, p. 3) considers it not absolutely certain that chemically pure amorphous carbon yields a red-brown solution when treated as described, but suggests that the coloration may be due to impurities in the material.

The formula $C_2H_6O_4$ has been proposed by Berthelot for graphitic acid prepared from natural graphite. It is insoluble in all solvents, and its yellow, mica-like scales alter upon drying to a brown mass.

Twinned crystals or crystals in parallel intergrowth have been recorded by W. Luzzi.

When well crystallized, the flakes have a black to steel-grey, metallic lustre, while the amorphous variety is matte, black and earthy. The streak is black and lustrous, the hardness 1, and the specific gravity 2.1 to 2.3. The mineral is easily sectile, and is flexible but not elastic. Owing to its softness, it marks other substances very easily and is greasy to the touch. It is a good conductor of heat and electricity. The flakes have a perfect basal cleavage and are opaque, even in the thinnest scales. Its temperature of fusibility is unknown, but is probably above 3000°C. It is combustible in the presence of oxygen at between 620°C and 670°C, but is not altered by heating in a vessel free of air.

Chemically, graphite is pure carbon, and it is thus identical in composition with charcoal and the diamond. Impurities are almost always present in natural graphite, and usually consist of included foreign mineral substance, such as clay, oxide of iron, calcite, quartz and mica. A small amount of hydroxyl, also, is not infrequently to be found in natural graphites.

Graphite is very resistant to weathering influences, and perfectly bright flakes of the mineral are commonly to be found in the surface soil formed by the disintegration of graphite-bearing rocks.

With reference to the specific gravity of graphite, Donath gives the following list of determinations on samples from a number of localities:—

Ceylon (1).....	2.257
Borrowdale.....	2.286
Oberer Jenisei.....	2.275
Upernivik.....	2.298
Arendal.....	2.321
Tieonderoga.....	2.17
Ceylon (2).....	2.246
Blast furnace graphite.....	2.30

The specific heat of graphite is 0.2019, and Weber has found it to vary for different temperatures as follows:—

At -50°C	0.1138
+61°C	0.1990
+977°C	0.4670.

That of diamond for approximately the same temperatures was found to be:—

At -50°C	0.0635
+58°C	0.1532
+1000°C	0.4589.

The above values for graphite were determined on pure Ceylon graphite containing only 0.38 per cent ash.

At the lower temperatures, the specific heat of diamond is thus seen to vary considerably from that of graphite and amorphous carbon, both of the latter being approximately the same. As the temperature rises, however, the values for all three modifications become more nearly equal, and at 1000°C they are practically identical.

The calorific values for different forms of carbon have been determined as follows:—

Graphite.....per gram.	7779.45 Cal.
Diamond.....	7770.00 "
Blast furnace graphite.....	7762.30 "

Graphite is highly resistant to attack by most chemical reagents. Fusion with alkaline carbonates produces carbon monoxide, which puffs through the molten material and ignites as fast as formed, the graphite being consumed in reducing the carbonate. Pure molten caustic alkali, at a low red heat, does not attack graphite appreciably, but separates it from its mineral associates and leaves the graphite in a free and purified condition. Pure graphite is not altered by heating in a stream of dry chlorine gas, nor is it affected by hydrochloric or hydrofluoric acids.

High grade graphite is only slowly attacked by molten potassium nitrate at a low red heat. Certain metallic oxides upon the surface of molten metal or alloys at very high temperatures have a tendency to oxidize or burn out graphite, and the same holds for strongly oxidizing slags which have high melting points. For this reason, graphite crucibles used in steel work rarely average more than six or seven heats, while those employed in melting brass give as many as twenty to twenty-five heats.

Graphite may be completely oxidized by a mixture of chromic and sulphuric acids. It may also be converted to carbon dioxide in a combustion furnace. A far simpler method, however, and the one usually followed in making a determination of the carbon content of a graphite sample, is to heat the graphite in a platinum crucible over the full heat of a Bunsen burner, while admitting a stream of oxygen.

In the assay of graphite, the samples should always be graded according to the apparent carbon content; low grade material, such as a graphite ore, requiring different treatment to a sample of refined graphite. The chief impurities in the refined graphite of commerce, are moisture, sulphur (in the form of pyrites), calcite, quartz, and mica. Sulphur is undesirable in graphite for crucibles used in melting silver or high grade alloys, and for this reason pyrites should be eliminated as far as possible in the milling as the combined iron gives rise to red spots on annealing.

It is common practice to term certain finely divided graphites "amorphous", in contradistinction to the coarser, flake or crystalline variety. The term "amorphous" graphite is really a misnomer, since all graphite is crystalline carbon, and, as shown above, is distinct from amorphous carbon, which does not yield graphitic acid on treating with potassium chlorate and nitric acid. So called "amorphous" graphite is really crystalline graphite whose particles are so small as to be indistinguishable to the eye, and which consequently has a dull or earthy appearance. Under the microscope, these earthy graphites are seen to be made up of very finely-crystalline material, and are, thus, cryptocrystalline.

Certain graphites, however, as, for instance, the Bohemian, which is an earthy so called "amorphous" variety, yield graphitic acid in the nature of a yellow powder, while that obtained from Ceylon plumbago is in the form of lamellar crystals. On decomposing by heat, the powdery graphitic acid yields a material resembling lampblack, while that obtained from the crystalline acid is lighter in colour and does not appear to be in such a fine state of division. It would appear, therefore, that there may be some difference in the molecular structure of certain of the "amorphous" and "crystalline" graphites, but the subject has not been sufficiently investigated to enable any definite distinction to be drawn between the two types. On the other hand, the loose application of the term "amorphous" to many finely crystalline graphites as, for example, that from the Black Donald mine, in Ontario, is decidedly erroneous.

It was formerly suggested that several varieties of graphite existed, the distinction between them being based on their different behaviour when treated with chemicals. For instance, certain graphites, when moistened with fuming nitric acid and then heated, swell up and assume vermiform shapes, having a circumference of $\frac{1}{4}$ " to $\frac{1}{2}$ " and a length sometimes of several inches. These forms have a steel grey colour and metallic lustre, and are bent and twisted in regular curves: their regular structure imparts to them a very characteristic appearance, and the volume of such so called "graphite worms" is often a hundred or more times greater than that of the original graphite from which they were formed. It is supposed that the cause of this phenomenon is the capillary structure of the flakes, which permits them to absorb the acid readily. On heating, the gas generated from the acid exfoliates the graphite. The graphites that yield such forms are, therefore, not believed to be essentially distinct from those that show no such reaction. The former were originally classed by Luzzi, who investigated many graphites along these lines, as true "graphites", while the latter he termed "graphitites". The name "graphitoid", also, has been applied to a black, earthy pigment containing nitrogen and water, which burns in the Bunsen flame, and which even under the highest power of the microscope exhibits no crystalline structure.

Weinschenk, who made an investigation of many graphites, disputes the existence of any such distinct modifications of natural graphite, and regards the different behaviour of the graphites from various localities as due usually to their structure. The above distinctions are seldom made nowadays, and the matter of these differences of behaviour under certain conditions possesses only academic and little technical importance. The nitric acid treatment has, however, been employed as a means of cleaning natural graphite and obtaining a product of exceptional purity and in a very fine state of division.

When finely powdered graphite is heated with a mixture of one part of nitric and four parts of strong sulphuric acid, or when a mixture of fourteen parts of graphite and one part of potassium chlorate is warmed with seventy-eight parts of strong sulphuric acid, the graphite assumes a purple tint, but on washing regains its original colour. It is, however, no longer graphite, but contains in addition oxygen, hydrogen, and sulphuric acid. When this is heated to redness it swells up with a copious evolution of gas and then falls to an extremely fine powder of pure graphite, which has a specific gravity of 2.25—(so called "Brodie's graphite").

The above process has been employed for the purpose of purifying natural graphite. With this object it is first ground fine and the powder well washed in troughs to remove as much of the earthy gangue as possible. The concentrates are then treated as described above and the resulting material passed on to the surface of water, when the graphite floats off and the impurities sink. Flake graphite is more readily purified by this process than the powdery forms. The latter may be similarly treated, however, if a small amount of sodium fluoride be added to the mixture as soon as the evolution of chlorine trioxide gas has ceased; by this means, the silica is removed as silicon tetrafluoride.

Artificial graphite, the product of the electric furnace, does not possess the property of swelling up when treated with nitric acid, but that separating out from fluid metals, by reason either of simply the high temperature or on account of chemical reaction, possesses it very markedly.

Artificial graphite may be either amorphous or crystalline. Its specific gravity ranges from 2 to 2.25, and its temperature of combustion in oxygen is in the neighbourhood of 660°C. The resistance to oxidation of artificial graphite produced in the electric furnace is proportional to the temperature at which it was formed.

Ceylon graphite, which is more or less readily oxidized, may be made more refractory by subjecting it to great heat.

For fuller details regarding the chemical, physical, and other properties of graphite, the reader is referred to pages 1 to 29 of Donath's work already cited, and to pages 6 to 19 of Haenig's monograph. Much of this information is of scientific rather than technical importance and, as such, has not been included in the present report.

CHAPTER II.

MODE OF OCCURRENCE AND ORIGIN OF GRAPHITE.

The natural graphites are usually divided into three classes, according to the character of the mineral. These divisions comprise disseminated flake, crystalline (plumbago), and amorphous. As pointed out elsewhere (p. 6), what is sometimes termed "amorphous" graphite is in reality extremely finely-divided flake graphite, and the term "amorphous" should not, strictly, be applied to any graphite, since all "graphites" are in their physical characteristics essentially distinct from amorphous carbon. As used, however, the term "amorphous" is applied to those graphites which exhibit no semblance of crystalline structure, being so finely divided as to be more or less earthy in character, and which for this reason cannot be utilized for many of the purposes to which the flake or crystalline varieties are adapted. The distinction between "flake" and "crystalline" graphite (both are essentially crystalline in character) lies in the mode of occurrence of the two varieties and the consequent difference in form assumed by them. Flake graphite, as the name indicates, is the earthy or lamellar form of the mineral, commonly found disseminated in metamorphic rocks, such as crystalline limestones, gneisses and schists. In such cases, each flake is a separate individual and has crystallized as such in the rock. Crystalline graphite, on the other hand, is the graphite found either in the form of more or less well-defined veins or as pocketly accumulations along the intrusive contacts of pegmatites (usually) with limestones, schists, etc. Both types of occurrence are fundamentally similar, in that they represent fissure or fracture-filling by graphite, the shape only of the ore-body being different and the amount of foreign mineral substance in the form of in-crystallized, contact-metamorphic minerals being greater in the latter case than in the former. The graphite of such deposits is of two types, foliated or bladed and columnar (fibrous). (See Plates II and III). Vein graphite generally requires no other preparation for the market than is involved in a hand-cobbing process, followed possibly by screening. By these means, a product running 90 per cent graphitic carbon may readily be secured.

Amorphous graphite is commonly found in the form of minute particles more or less uniformly distributed in feebly metamorphic rocks, such as slates and shales, or in beds consisting practically entirely of graphite. The latter represent usually metamorphosed coal seams, and carry as high as 80-85 per cent graphitic carbon, while the former, being altered carbonaceous sediments, commonly range from 25 to 60 per cent. The graphite content of such amorphous deposits is dependent on the amount of carbon originally present in the sediments, and there is no evidence of any enrichment being caused by the intrusive rocks that have been the metamorphosing agencies in some cases. Certain amorphous graphite deposits have undoubtedly been formed by the agency of igneous intrusives, while others are probably the result of dynamic metamorphism.

Most, if not all of the world's deposits of flake and crystalline graphite occur in rocks of Pre-Cambrian or early Palæozoic age. Crystalline limestones, gneiss (often calcareous and associated with limestones)

and schists are the more usual types of rock in which the economic deposits of flake graphite occur, and in many cases the series has been intruded extensively by rocks of pegmatitic or granitic character. The vein graphites are found in rocks of similar character to the above, but the rock enclosing them is not necessarily graphitic; in fact, in the majority of cases, the wall rock of such veins carries little or no graphite, and the deposits thus assume the character of true lodes. Graphite veins seldom attain an important width, however, anything over 10-12 inches being exceptional, and the majority measuring considerably less than this.

It is convenient to class with the vein graphites those pockety bodies of crystalline graphite sometimes met with in the Pre-Cambrian gneiss-limestone series of Quebec and New York State.¹ Such bodies are far less common than the true vein type, and are characterized by their irregular form and the abundance of foreign mineral substance intergrown with the graphite. The most common of such minerals are scapolite, idocrase, pyroxene, calcite and sphene, and their association with the graphite is so close as to render milling of a large proportion of the ore necessary. In the case of the vein graphites, on the contrary, the amount of such associated mineral substance is generally small, and most of the graphite can be brought to a state of sufficient purity by hand-cobbing. The genetic relation of these pockety graphite bodies to the associated rocks has not been definitely decided, but they appear to have been formed along the contact of certain types of intrusive rocks with crystalline limestone or calcareous gneiss. The graphite of this type of deposit is of similar character to the foliated graphite of the veins, and where free from accessory minerals is of an equal degree of purity. Fibrous or columnar graphite is not commonly present in such deposits, but may occur in small veins or off-shoots traversing the rocks in immediate proximity to them. There can be no doubt that both the above types of deposits are of epigenetic character and owe their origin to the igneous rocks with which they are associated. The graphite has probably been deposited by some sort of pneumatolytic action connected with the intrusion of these rocks, either on pre-existent fractures or on fissures caused by the fracturing of the invaded rock by the intrusive.

Various theories have been advanced for the source of the graphite of such deposits. Weinschenk, who has made an exhaustive study of graphite deposits, favours the view that cyanogen compounds accompanied the intrusions and suffered a reduction to graphitic carbon. An alternative theory regards carbon dioxide or monoxide gases as the substance reduced. In both cases, the source of the graphite is sought in the igneous rocks with which the deposits are associated. A third hypothesis suggests that graphite was formed at the expense of the invaded limestones, calcium carbonate being dissolved to form lime silicates and the liberated carbon dioxide reduced to graphite in the presence of hydrogen. The latter view calls for the presence of limestones in the more or less immediate vicinity of the graphite bodies, and it is noteworthy that this condition is observed in almost all instances where the geological relations of such crystalline graphite deposits have been studied in detail. In cases where the presence of limestones is not conspicuous, such rocks may yet be found to occur in depth.

In place of limestone, other carbonate rocks, such as dolomite or magnesite, may conceivably have yielded the carbon dioxide. The Mun-

¹ See G. S. Bastin, *Mineral Resources of the United States, Part II, 1913, p. 210.*

glinup flake graphite deposits, Western Australia¹, are associated with magnesite, and those of Eyre's peninsula, South Australia², with magnesite and limonite.

The necessary carbonate of lime may, also, have been furnished by the gneisses or schists; that they were originally more or less calcareous is evidenced by the frequent presence in them of garnet and other lime silicates.

The theory that the graphite of such deposits has been formed at the expense of carbonate rocks is supported by the fact that the intrusives (usually pegmatitic in character) do not carry graphite as a component mineral. Graphite is often found in them in local aggregates of flake in the immediate contact zone, and also sometimes within the intrusive mass proper. Such graphite may, however, very possibly have been derived from limestone that has undergone solution by the igneous rock.

In the case of the Canadian deposits, the ore-bodies are directly associated with intrusive rocks of a pegmatitic character. These, while usually of dike form, may also occur as bosses or laccolithic masses: the region has suffered so much deformation that their true form is often obscure. The graphite bodies appear to be associated in particular with rock of a gabbro or anorthositic type, or with modified forms of such rocks. Pegmatites of more acid character are abundantly developed throughout the region, but no graphite ore-bodies are associated with them. The fact that the graphite deposits are confined to those pegmatites carrying lime- or lime-soda-feldspar may have significance.

Graphite is often developed along joint planes and fractures in the pegmatites, and in some cases appears to be disseminated through a large part of the mass of such intrusives.

The graphite veins often show clearly that the crystallization of the graphite has proceeded simultaneously from both walls, the comb structure being quite distinct. In some cases, one-half the vein consists of foliated graphite and the other of fibrous graphite.

As to the source of the carbon of the disseminated flake graphite bodies, considerable difference of opinion exists, and not all deposits of this type are considered to have a common origin. According to the generally held theories, such graphites may be of either organic or inorganic origin, and are considered to have been formed in one or other of the following ways:—

1. Through the alteration of organic, carbonaceous matter present as an original constituent of sediments. The graphitization of the carbonaceous matter may have been achieved by contact, dynamo or regional metamorphism of the containing rocks. In such case, the graphite may be found in the position originally occupied by the carbon, or the latter may, conceivably, have migrated and under favourable conditions become concentrated and crystallized out as graphite. Such a mode of origin would thus conform to that of the amorphous graphites, the latter, however, having suffered a less intense degree of metamorphism. That this theory may be the correct one in the case of many deposits is supported by the fact that cases are known where carbonaceous slates have had their amorphous carbon converted to graphite in the immediate vicinity of intrusive contacts, the transition from graphite to amorphous carbon with increasing distance from the contact zone being distinctly traceable³.

¹Bull. No. 76, Geol. Surv., West. Australia, 1917, p. 9.

²Min. Review, No. 27, Dept. Mines, South Australia, 1918, p. 52.

³See Stutzer, Die Nicht-Erze, p. 78.

2. Through the impregnation by pneumatolytic action of the country rock (limestones or calcareous schists, gneisses, etc.) bordering intrusive contacts. Such a mode of origin is analogous to that suggested for the contact-metamorphic bodies of crystalline graphite. In this case, however, it would be necessary to assume certain peculiar conditions of composition or structure in the invaded rock, tending to make it permeable to solutions of gases, with consequent precipitation of the graphite in flake form within the mass of the rock, rather than as solid bodies of graphite.

3. Through the destruction of calcium carbonate originally present in the rocks invaded by pegmatites, the lime going to form various silicates and the graphite being deposited more or less in situ by reduction of the carbon dioxide liberated.

In the case of 2 and 3 the graphite may, possibly, also have been formed at the expense of calcium-magnesium carbonate, the intruded rocks often being dolomitic rather than purely calcareous.

Both these theories, however, seem difficult to apply in the case of the graphitic crystalline limestones, in which graphite flakes often occur more or less uniformly distributed for considerable distances from intrusive contacts. It would be reasonable to expect a far larger concentration of graphite in the immediate contact zone than is actually found to be the case in many such deposits.

For a more detailed discussion of the theories of the origin of graphite the reader is referred to the extensive literature on the subject. Many of the more important treatises and articles are listed in the bibliography given as an appendix to the chapter on graphite in Mineral Resources of the United States for 1914, Part II, pp. 167-174.

A supplementary bibliography containing articles, etc., on graphite that have appeared since the publication of the above report is appended to the chapter on graphite in Mineral Resources of the United States, 1917, Part II, pp. 117-119.

Two further reports dealing with graphite that have recently been published are:—

Alling, H. L., The Adirondack Graphite Deposits, New York State Museum Bulletin No. 199, 1918.

Dub, G. D., Preparation of Crucible Graphite, U.S. Bureau of Mines, War Minerals Investigations Series, No. 3, December, 1918.

Articles and reports dealing particularly with Canadian graphite are listed on pp. 195-6 of this report.

CHAPTER III.

COMPOSITION AND ECONOMIC IMPORTANCE OF GRAPHITE ORES.

Practically all natural graphites, whether amorphous, crystalline, or flake, contain a certain amount of impurities in the shape of admixed mineral substance, the proportion of such impurities being commonly greatest in the flake ores. Many of the latter are really crystalline schists, in which the graphite has been developed subsequent to the formation of the rock proper. In these ores, the usual impurities are mica, calcite, quartz, feldspar, sulphide of iron (pyrites and pyrrhotite) and various silicates of lime, magnesia and alumina; in short, the typical, commoner metamorphic minerals. Where pronounced weathering of such ores has taken place, many of the above minerals are not to be recognized in their original form, having been converted into clayey material. In such case, a considerable enrichment in graphite has doubtless often resulted, due to the leaching out of the more soluble mineral constituents.

In the case of the fresh, unaltered flake ores of the above type, such, for example, as those of the Canadian deposits, the common range of graphite content is from 10 to 30 per cent. The soft, decomposed ore of the Passau district, in Bavaria, on the other hand, commonly runs from 30 to 50 per cent graphite. It is of gneissic type, somewhat resembling that of the Grenville series in Canada, but has suffered an intense degree of decomposition, the feldspar being mostly kaolinized.

The crystalline graphites, such as that from Ceylon, are the purest of all natural graphites. They occur in vein form, and the amount of included foreign mineral substance is usually small, so that hand picking of the ore commonly suffices to prepare them for the market. Calcite and quartz are the principal impurities in such graphites, and the carbon content of the crude ore is from 60 to 70 per cent. By hand picking and cobbing, the impurities in many of such ores can be readily eliminated and a product running well over 90 per cent secured, while selected material may run over 99 per cent carbon. In the case of the columnar or fibrous ores, quartz sometimes forms a thin film or crust between the fibres, and is then more difficult to remove by hand.

The amorphous graphites, in many cases, are the result of the metamorphism of coal seams, whose carbon content has been converted into the graphitic form. The purity of such graphites naturally is dependent on that of the original coal. Some are of high grade, as, for example, the Sonora (Mexico) graphite, which averages 86 per cent graphitic carbon, while those derived from coals high in ash are of correspondingly poorer quality.

The low grade, amorphous graphite found near Providence, Rhode Island, occurs in the zones of more intensive metamorphism (apparently dynamic) of the coal, and appears to have been formed principally in the neighbourhood of anticlinal folds. The occurrence is a peculiar one, in that the beds at one point yield graphite, while not far away they have been worked for fuel.

Amorphous graphite is also found finely disseminated in slates and shales. Such graphitic slates are, as a rule, relatively low in carbon,

and in most cases it is not practicable to refine the graphite, the ore being hand picked and ground up for use in paints, foundry facings, etc.

With regard to the potential economic importance of graphite ores of the various types, it is difficult to generalize, since it is not merely the carbon content alone of a graphite that determines its value. Its physical form, relative refractoriness, and, in the case of flake graphites, the size of the flake, all are of paramount importance. The crystalline graphites (plumbago) and the flake form command the highest price. Crystalline graphite occurs in the form of veins, which are usually narrow and both difficult and expensive to work. Practically the whole of the world's supply of such graphite is derived from Ceylon, where cheap native labour renders possible the exploitation of the deposits. The cost of working such ore-bodies with white labour would almost certainly prove prohibitive, without a very material increase in the selling price. Such an increase would, however, react to the advantage of flake graphite, since it would probably result in the more extended use of the latter in crucible work, for which, as shown by recent investigations, this form of graphite may be employed without any serious disadvantage.

While occurrences of crystalline graphite, approximately similar to that of the Ceylon deposits, are not uncommon in the Buckingham district, in Quebec, the narrowness and impersistence of the veins have prevented their exploitation, and there does not appear to be any likelihood that such deposits can ever be worked profitably.

The governing factors in the case of disseminated flake ores are chiefly size of flake and a satisfactory milling and refining process to free the flake from the gangue and eliminate the impurities. The percentage of graphite in the ore is of somewhat lesser importance, since ores running as low as 3 per cent have been successfully treated in the Alabama mills. The average of the ore treated in Canadian mills is 7 to 12 per cent. In the former case, however, the ore-bodies are very large and the ore is of more or less uniform grade, while in the latter, lenses or bands of richer ore merge into poorer material that has not been considered worth milling.

The proportion of flake of larger than 90 mesh in the ore, and the employment of a milling process that will preserve the maximum amount of such flake from destruction as it passes through the various stages of concentration and refining, are also important, since it is only the larger flake that commands a price commensurate with profitable operation. Some flake graphite ores, while rich enough to be paying ores in themselves, are so hard that it is difficult to free the flake and at the same time preserve its size. Many of the graphite-gneisses may be included in this category, and often only the upper, weathered portions of such ore-bodies can be treated satisfactorily. In the case of both the Pickering graphite-gneiss, in Pennsylvania, and the Talladega slates (schists), in Alabama, the former carrying 5 per cent and the latter 3 per cent of graphite, operations are confined almost exclusively to the weathered rock above ground-water level. These ores require only the action of a muller-pan, or chaser-mill, to break them down sufficiently for concentrating.

Amorphous graphites seldom possess a high graphitic carbon content, though a notable exception are the altered coal beds of Sonora, Mexico, which yield a high grade graphite that is in especial demand for lead pencil manufacture. Amorphous graphite is not uncommon in slates and shales, and such graphitic sediments have been worked quite extensively in cases where the carbon content is sufficiently high. Low grade material, how-

ever, is only suitable for the cheaper qualities of commercial graphite, such as enter into foundry facings and paints, since, owing to the fine state of division of the graphite and the difficulty of separating it from its earthy matrix, it cannot be refined successfully. The cost of refining this class of material would be prohibitive, especially as the demand for pure, natural, amorphous graphite is limited; and apart from pencil manufacture, there are few, if any, industries employing graphite, to which it is essential as possessing properties not possessed by either the crystalline or artificial varieties.

The increasing production of artificial graphite (5785 short tons in 1917)¹, its high degree of purity, low price and general suitability for many of the uses to which the natural amorphous is put, rather tend to reduce the general economic importance of deposits of the latter.

It is difficult, unfortunately, to ascertain whether the composition of graphites as quoted in the various reports, etc., consulted, refers to the ores or to the graphite after milling and refining, and in many cases, tables would appear to include both without proper differentiation. Hence it is useless for comparative purposes to tabulate these analyses. G. C. Hoffmann,² however, has determined the composition of a number of Canadian ores, and the results of his analyses are appended:—

Disseminated Flake.

Locality.	Carbon.	Ash.	Water.	Total.
Buckingham, Quebec	27.52	72.44	0.04	100.00
"	23.80	75.02	1.18	100.00
"	30.52	69.35	0.13	100.00

Vein Graphite—foliated.

Locality.	Carbon.	Ash.	Volatile.	Total.
Buckingham, Quebec	99.68	0.14	0.18	100.00
Grenville, Quebec	99.82	0.07	0.11	100.00

Vein Graphite—columnar.

Locality.	Carbon.	Ash.	Volatile.	Total.
Buckingham, Quebec	97.63	1.78	0.59	100.00
Grenville, Quebec	99.76	0.13	0.11	100.00

The flake samples were of the average ore from different deposits, while the vein material was selected for its purity. In the case of the flake, the proportion of rock matter soluble (calcite) and insoluble in hydrochloric acid ranged from 2:66 to 21:53.

¹ Output of the Acheson Graphite Company, Niagara Falls and Buffalo.

² Geol. Surv. Can., Rep. Prog., 1876-7, p. 492.

Hoffmann also conducted analyses of Ceylon and Ticonderoga (New York) graphites, the samples in all cases being selected material:—

Vein Graphite—columnar.

Locality.	Carbon.	Ash.	Volatile.	Total.
Ceylon	99.70	0.05	0.16	100.00
"	98.82	0.28	0.90	100.00

Vein Graphite—foliated.

Locality.	Carbon.	Ash.	Volatile.	Total.
Ceylon	99.68	0.21	0.11	100.00
"	99.28	0.42	0.50	100.00
Ticonderoga, N.Y.	96.66	2.15	1.19	100.00
"	97.42	1.76	0.82	100.00

Summary.—The crystalline, vein graphites are the purest natural graphites known, and can usually be turned into marketable material simply by a process of hand sorting. The veins, however, in most cases, are narrow and cannot be worked profitably without extremely cheap labour. With few exceptions, the vein graphites heretofore found on this continent have proved to be of little economic value on this account. Even with the supply of Ceylon plumbago shut off, these deposits would offer few possibilities, since the available tonnage would be small, and the expense of production probably too great to enable the material to compete with the flake graphites. The latter, while not as refractory as the more massively crystalline plumbago, could, if the necessity arose, be substituted for the latter in crucibles. Columnar graphite from Buckingham, Que., is illustrated in Plate III.

The principal part of the world's production of graphite is made up of amorphous material. In 1913, the latest year for which more or less complete figures are available, the output of amorphous graphite amounted to over 80,000 tons, as against about 30,000 tons of plumbago and the same amount of flake. The greater part of the flake may be assumed to represent graphite that has undergone some sort of refining process, and has been derived from ores carrying from 3 per cent graphite upwards. Since in 1916, the production of Madagascar flake had risen to 28,000 tons, or more than 20,000 tons in excess of the 1913 output, while the Ceylon shipments had only increased 9,000 tons in the same period, the proportion of flake to plumbago in the total supply for 1916 was probably far greater than in 1913. No figures are available since 1913 for the outputs of Germany and Austria; these countries in that year produced almost as much graphite as the rest of the world put together, and it may be assumed that the production in the interim has increased rather than diminished, owing to the shutting off of Ceylon imports.

Transportation, fuel and other factors, of course, play an important role in governing the economic possibilities of graphite, as of other ore deposits. Commercial flake graphite ores, however, may be said to range all the way from 3 per cent carbon content upward, although the former are of exceptionally low grade, and can only be regarded as of possible economic importance in the case of large ore-bodies. The average graphite

content of the ores worked in Canada is 10 to 15 per cent, which is considerably higher than that of most of the deposits in the United States. The economic importance of a flake graphite deposit is in very large degree dependent on a cheap and efficient concentrating process. Should oil flotation prove the solution of the difficulty which has long embarrassed the flake graphite industry in this country, large quantities of material hitherto considered of too low grade to work will be converted into milling ore.

CHAPTER IV.

GRAPHITE IN CANADA.

INTRODUCTORY REMARKS.

The graphite occurrences in Canada that have hitherto received any measure of attention lie in the eastern portion of the country. The disseminated flake deposits are found in the Provinces of Ontario and Quebec, and within a radius of 150 miles of Ottawa. The Canadian graphite industry at its inception (1866-70) centered in the more or less immediate vicinity of Buckingham, Que., about 25 miles east of Ottawa, but the earlier mills in this district have long been out of operation. In recent years, some half dozen mills have been in more or less intermittent operation in the Buckingham area, all engaged in the production of flake graphite. Crystalline graphite, or plumbago¹, also occurs in this region, but the veins, as a general thing, have been regarded as too narrow for profitable development. In more recent years, several flake graphite properties have been exploited in Ontario, in the region lying immediately to the west of Ottawa, and five mills have been erected in this section. Little, if any, crystalline graphite has been reported to occur in this district, the graphite all being of the flake variety. The occurrence on concession I, township of Brongham, in Renfrew county, (Black-Donald mine), of a mass of high grade flake ore is noteworthy, since such a graphite body is probably unique among known graphite deposits. The ore consists of rather small flake, the greater part of which is too small for the requirements of the crucible trade, but containing local streaks of larger flake. The richness of the ore varies from 60 to 80 per cent graphitic carbon, and the ore-body, which dips approximately vertically and is enclosed in crystalline limestone, has an average width of about 40 feet.

Flake graphite has also been reported from several points in British Columbia, but none of the occurrences have been worked. Crystalline graphite has been found at various localities in the Northwest Territories and Labrador, and a deposit of this material was worked during 1917 and 1918 on the south side of Baffin island. A small tonnage was secured during these operations and shipped to the crucible trade. The material is reported to be equal to the best Ceylon plumbago for this class of work.

Amorphous graphite was worked a number of years ago near St. John, New Brunswick. The ore here consists of impure, graphitic shales and slates, and the material found employment in foundry facings and paint stock.

The number of graphite mines and mills in operation during the last few years has averaged about half a dozen; in addition to which there has been intermittent work on a few deposits which, for one reason or another, have not reached the producing stage.

The average annual production of graphite of all grades for the nine years 1910-1918 was 2,438 tons, this quantity comprising chiefly milled graphite; in certain years, however, a small tonnage of crude ore is included in the total.

¹ Note:—In this report the terms "crystalline graphite", "vein graphite" and "plumbago" are used synonymously. While flake graphite also is essentially crystalline in character, it is not commonly so alluded to by the trade.

TYPES OF DEPOSITS.

The two predominant modes of occurrence of the disseminated flake graphite are (1) in more or less irregular bodies in sillimanite gneiss and (2) in crystalline limestone. Several ore-bodies of the latter type have been opened in Hastings and Haliburton counties, Ontario, but in Quebec, work has been, for the most part, confined to the graphitic bands in the gneisses. While it is clear that the latter type of deposit is the result of the graphitization of certain bands in the (Grenville (sedimentary) series, this formation has suffered such intensive deformation and metamorphism that the original continuity of the bands' has been to a large extent destroyed, and they can seldom be traced for any great distance along the general line of their strike. Furthermore, the degree of graphitization and the shape of the ore-bodies would seem to bear a relation to local conditions of composition and structure, respectively, that prevailed in these rocks prior to their intrusion by the pegmatitic types, to the action of which the formation of the graphite would appear to be due. As a result, the ore-bodies are of somewhat irregular shape and extent, being in some instances saddle-shaped, as if they had formed at the crests of anticlinal or drag folds. In such cases, the formation of the graphite would seem to have been favoured by conditions of relief of pressure obtaining at such structural points.

The ore-bodies are far from uniform in their graphite content, and are often characterized by zones of local enrichment. This may be due either to differences of composition or texture in the original rock, distance from the intrusive rock that caused the graphitization, or degree of influence that the latter has been able to exert. It is the zones of richer ore (10-20 per cent) that constitute, for the most part, the ore-bodies that have hitherto been exploited. These, however, commonly grade into poorer ore that, while not capable of profitable treatment by the concentrating processes heretofore employed, may well be regarded as of considerable potential value for treatment by flotation.

The graphite deposits in crystalline limestone commonly occur in immediate proximity to pegmatitic intrusions, the ore-bodies being in the silicated portions of the limestone along its contact with the intrusive. In some cases, the limestone rock has been in the nature of a relatively narrow calcareous band intercalated in gneisses, in which case the ore-body has more or less definite form. In other instances, pegmatites have been intruded into large limestone masses, with the formation of a graphitic zone varying in richness with distance from the contact. Since the pegmatites often have the form of laccoliths rather than well defined dikes, and since the entire complex appears to have suffered intensive deformation subsequent to the period of intrusion, the ore-bodies usually possess decidedly irregular form and the true relationship is often obscured, thus rendering the blocking out of an ore-body a difficult task. In such cases, diamond drilling is the only reliable means of determining the general form and extent of the ore-body.

Another type of graphite deposit that is of less common occurrence, but of which several instances are known and have been exploited, is that in which both crystalline and flake graphite occur associated together. Such deposits are essentially contact-metamorphic in type, and are characterized by the intimate association of such minerals as wollastonite, scapolite, pyroxene, vesuvianite, garnet and sphene with the graphite, the whole forming a rather loose aggregate of coarsely crystalline individuals. The interstices are usually filled out with calcite. Except that it is prone

to be more impure, by reason of the occurrence through its mass of the above minerals in greater or lesser amount, much of the crystalline graphite from this type of deposit is essentially similar to the foliated graphite of the true veins. The former, however, is usually less lustrous, is often of a grey shade rather than black, and is softer and less compact, breaking up rather readily into fragments of flake form, as contrasted with the more angular particles yielded by vein plumbago. The graphite is evidently of contemporaneous origin with its associated minerals, being often conspicuous within the larger individuals of scapolite, pyroxene, etc. These deposits, in their general character, closely resemble the mica-apatite bodies found in the same series of rocks in the Buckingham district, Que.

Leaving out of consideration the amorphous variety, Canadian graphite thus occurs in deposits of three types, each essentially different in its general characteristics, though possibly alike genetically. The geology of the graphite-bearing areas in Ontario and Quebec has been studied in detail during the past few years by M. E. Wilson and J. Stansfield, of the Geological Survey, and for a discussion of the mode of occurrence and origin of the graphite bodies and their associated rocks the reader is referred to the articles in the footnote¹.

Briefly summarizing the salient points respecting the occurrence and origin of the graphite deposits, it may be stated that three hypotheses have been proposed to explain the mode of origin of graphite. These hypotheses attribute the source of the graphite to:—

(1) Carbon, of organic origin, originally present in sedimentary rocks, which latter have been metamorphosed by dynamic- or contact-metamorphism (or a combination of both), with conversion of the carbonaceous material to graphite.

(2) Deposition by pneumatolytic agency, the graphite having been introduced into rocks immediately adjacent to igneous intrusions. In this case, the source of the graphite is ascribed either to cyanogen or hydrocarbon compounds originally present in the igneous magma or to carbon dioxide accompanying the intrusive.

(3) Reduction of the carbon dioxide derived from the breaking down of the calcium carbonate of rocks (limestones, calcareous schists and gneisses, etc.) by contact-metamorphic action along the borders of igneous masses (pegmatites) intrusive into such rocks.

While the above hypotheses have been adduced to explain the origin of graphite deposits in general, one particular theory being proposed for one or other of the types of deposits mentioned above and not being regarded as necessarily applicable to all types, the close association of all three classes of deposits in Canada within a comparatively limited area of rocks of essentially similar character (crystalline limestones and gneisses intruded extensively by pegmatite rocks of different periods and types, but all, alike, of Pre-Cambrian age) would suggest that the graphite has, in all cases, been derived from a similar source.

While, of the three classes of deposits referred to, that of flake graphite disseminated in limestone or gneiss is the only one to which the theory of original carbon content can rationally be applied, there is little evidence to adduce in support of such a hypothesis. Against this theory, however, is the fact that although the entire system of limestones and gneisses (Grenville series) in which the graphite bodies occur has suffered a degree

¹ Trans. Can. Min. Inst., Vol. XVI, 1913, pp. 401-11; Vol. XIX, 1916, p. 362; Geol. Surv. Can., Summary Report, 1917, Part E, pp. 29-42.

of dynamic- and (locally) contact-metmorphism sufficient to bring about the formation within and throughout the mass of these rocks of many typically secondary minerals, such as mica, garnet, tremolite, wollastonite, pyroxene, etc., graphite ore-bodies seem to be confined to the immediate vicinity of bodies of intrusive rock, and probably of intrusive rock of a certain type, namely, one high in lime-soda (plagioclase) feldspars. It seems probable, therefore, that if an original carbon content of the Grenville series were the source of the graphite found in this series, graphite bodies would be of far more widespread occurrence throughout the mass of these rocks than is the case.

Relatively little underground work has been done in connexion with the exploitation of graphite bodies, and small, surface excavations have largely had to suffice for a study of the nature of the deposits to their associated rocks. The general impression gained from an examination of the ore-bodies exposed in such surface workings is that the carbon of the rocks is of secondary rather than of primary origin, and that its formation is connected in some manner with intrusions of pegmatite rocks into the gneisses or limestones. Whether, however, the source of the graphite is to be sought in the intrusives themselves or is to be ascribed to reduction of the carbon dioxide liberated from the calcium carbonate of the invaded rocks is a matter of speculation. The latter question is perhaps not of such particular import with regard to the exploitation of graphite deposits. The establishing of a direct connexion between the occurrence of ore-bodies with intrusive rocks of a certain type would, however, be of decided interest and possibly, also, of material assistance in the development of deposits. In this connexion, also, the question of the influence of structure, and the possible tendency of graphite to accumulate at the crests of folds or at other points at which a relief of pressure occurred, should be taken into consideration.¹

MINING METHODS.

There is little of particular interest to be recorded as to the method of working Canadian graphite deposits. The usual procedure has been to exploit the occurrences, both of the disseminated flake bodies and of the veins or contact zones of plumbago, by surface pits opened on the most promising outcrops, and to continuous sinking as long as the ore-body held out. Such pits have seldom been carried to any great depth, 100 feet being an extreme. Where the outcrop occurs in the face of a declivity, an open cut is started on the level ground at the foot and a drift carried into the face. If the ore-body warrants it, stoping of the ore is conducted from this drift, but underground workings of such nature are seldom extensive. Most of the workings in the Buckingham district consist of rather shallow open pits, of which there are often a considerable number on the one property. The entire complex of crystalline rocks in which the graphite bodies occur has suffered such an intense degree of deformation that any systematic development along the lines of blocking out ore is usually out of the question, and exploitation of the deposits resolves itself into the most economical method of extracting the ore in sight with the removal of the least amount of dead rock.

At only three mines has any extensive underground work taken place. At these mines, a more than usually well defined ore-body has been exploited

¹ See Geol. Surv. Can., Summary Report, 1917, Part E, p. 40.

by means of shafts respectively 125, 200, and 250 feet deep, with levels from which stoping of the ore has been carried out. In two cases, the shaft is inclined, and in the third, vertical.

The rock enclosing the graphite bodies is usually tight and little timbering of the workings is required.

Hoisting is performed in the case of the shallow open pits by bucket and derrick, and at the deeper mines on skipways.

Most of the mines situated at a distance from the railroad employ hardwood as fuel for boilers and drying kilns.

Physiographically, the graphite bearing region of Ontario and Quebec consists of low hills and ridges of crystalline rocks, the intervening valleys being largely occupied by areas of glacial drift. Numerous lakes occupy the major depressions, and are usually elongated in the direction of the prevailing strike of the rocks, which is northeast. The country is wooded, with an abundance of second growth maple, birch, cedar, spruce, balsam, etc.

GRAPHITE MINES AND OCCURRENCES.

PROVINCE OF BRITISH COLUMBIA.

There is no recorded production of graphite from this Province, and no references to the presence of the mineral is contained in the reports of the Provincial Mineralogist. Several occurrences of the mineral are known, however, the principal being the following:—

Alkow harbour, Dean channel, Bella Coola mining district: Graphite was recorded from this locality as far back as 1860. The graphite occurs in minute flakes, associated with pyrites, in a matrix of heulandite. A sample of the material, analysed in the laboratory of the Geological Survey, contained 23 per cent of graphite. (G.S.C. Ann. Rep., Vol. IX, 1896, p. 16R.)

Matthew creek, Marysville, Fort Steele mining district: An occurrence of graphite at this point was examined by the writer in 1916, and is described in the Mines Branch Summary Report for that year, p. 34. The graphite is amorphous and occurs disseminated in a matrix of earthy silicates. The occurrence appears to be a vein formed at the contact of a dioritic rock with mica schist. The graphite content of a selected sample was found to be 25 per cent. The maximum width of the deposit, as exposed in a small surface cut, is 2 feet. The low graphite content of the ore and the narrowness of the vein do not indicate that the deposit possesses any economic value.

Harrison lake, New Westminster mining district: According to a communication received from W. A. Blair, of the Vancouver Board of Trade, graphite occurs in the above district, and two carloads of ore were shipped from the deposit some years ago. Nothing further is known of this occurrence.

PROVINCE OF NEW BRUNSWICK.

New Brunswick in the past has produced considerable quantities of amorphous graphite, which is found in bedded deposits in limestone at several localities, but hitherto in commercial quantities only near St. John. The workings at this locality were at Split rock and Marble cove, near the suspension bridge over the St. John river, Lancaster parish, St. John county. The earliest work here appears to have taken place in 1853, the

initial production being 45 tons of crude ore. After lying idle for some years, the workings were re-opened in 1868 and produced an average of about 1000 tons of crushed and screened graphite for several years. The deposits were worked intermittently, either at the original locality or in its more or less immediate vicinity, for a number of years, most of the output finding employment in foundry facings. The price secured for the crude material in 1890 was \$7 per ton f.o.b. cars, and most of the output went to the United States. An annual production ranging from 100 to 400 tons is recorded for the years 1885-88.

In 1892, Ingall reports that a certain amount of ore was being ground and cleaned in a mill erected on the property. In 1895, the Canada Paint Company, of Montreal, commenced to operate the deposits, their workings being at Marble cove, and from this year until 1908 took out about 100 tons of graphite annually. This material was shipped to the Company's paint works at Montreal. Since 1908, no further work has been conducted at this or any other graphite locality in the Province.

According to Bailey and Matthew,¹ the graphitic bands occur in argillites and sub-crystalline limestones, and vary from 1 to 4 feet in thickness. Graphite also occurs in a finely disseminated form throughout large areas of the limestones.

According to Ingall², the graphite occurs at the contact of crystalline limestone and a trap dike. The deposit on the Hazen property was worked by a drift run along the ore-body from the bottom of a 50-foot shaft. At 30 feet, the deposit was found to be 10 feet thick.

A sample of the ore from the old Split rock workings was analysed by G. C. Hoffmann³, of the Geological Survey, in 1878, and was found to contain 49 per cent of graphitic carbon, 50 per cent of insoluble, and 1 per cent of water. The sample had a loose, shaly structure and contained a considerable amount of pyrites.

This locality was visited by A. O. Hayes, in 1913, who gives⁴ the following notes on the occurrence of the graphite:—

"Graphite occurs on the northeast shore of the St. John river, at the falls. It may be seen outcropping at intervals from the shore a few hundred feet north of the railway bridge, northerly for about 500 yards along a small valley, to a point east of Murray and Gregory's sawmill. Near the sawmill, an old dun of considerable size has been taken from a shaft, and other old workings are seen in the valley. A section across the occurrence may be seen at its southern extremity near the river, where a small tunnel 20 feet long has been driven.

"Here the graphite occurs in a vertical fault zone mixed with dark coloured pyritiferous shales much reddened with iron oxide. The country rock to the east of the fault zone is dark blue limestone and in order from east to west, the following section was measured.

- 2 feet graphitic shale with calcite.
- 3 " green shale somewhat graphitic.
- 6 " shaly graphite.
- 6 " green limestone.
- 8 " hard graphitic shale.
- 6 " green earthy rock which does not effervesce with acid."

References:—

Geol. Surv. Can., ¹Report of Progress, 1870-1, p. 231; Report of Progress, 1876-7, p. 329; ³Report of Progress, 1878-9, p. 3H; ²Annual

Report, Vol. V, 1890-1, p. 7188; Annual Report, Vol. VI, 1892-3, p. 63; Annual Report, Vol. X, 1897, pp. 72-74M; Bulletin on Graphite, 1904, pp. 6-10; Summary Report, 1913, p. 242.

Mines Branch, Monograph on Graphite, 1907, p. 50.

Other localities in New Brunswick from which amorphous graphite has been recorded are: near Dumbarton station, on the St. Andrews branch of the Canadian Pacific railway; Thorn Brook, parish of Havelock, in Kings county; near Dorchester, in Westmorland county; Goose river, St. Martin's parish, St. John county; Lepreau harbour, in Charlotte county; and in the parishes of St. Stephen and St. Patrick, Charlotte county.

The Lepreau harbour material somewhat resembles the well-known Rhode Island graphite, being a graphitic anthracite. The deposit was mined around 1880 for coal, and several shafts were sunk, one of which reached a depth of 140 feet. (G.S.C., Rep. Prog., 1878-9, p. 13D.)

The Thorn Brook occurrence is described as a band of earthy graphite, 20 feet wide, in jointed and broken slates. The deposit is said to have been traced for over a mile along its strike. (G.S.C., Ann. Rep., 1890-1, Vol. V, p. 7188.) A sample of material from this deposit, analysed in the laboratory of the Geological Survey, showed only 7.5 per cent of graphitic carbon.

PROVINCE OF NOVA SCOTIA.

There is no recorded production of graphite from Nova Scotia, though occurrences of amorphous material are recorded from various localities, most of them in Cape Breton. According to Ellis¹, several attempts to exploit graphite deposits have been made at different times, but without much success. The following notes on graphite occurrences in the Province are taken from the reference in the footnote.

The deposits in Cape Breton island are found in rocks consisting of crystalline limestones, slates and shales, which are intruded by granitic types. The principal localities comprise the following:—

Glendale, river Inhabitants, southern part of Inverness county; graphitic shale, carrying from 14 to 32 per cent of graphite, according to analyses made in the laboratory of the Geological Survey. An analysis of the shale from Christmas island, which is part of the same series, showed as high as 50 per cent of graphite. Graphite from this locality was awarded diplomas at the Paris and Glasgow exhibitions, in 1901. The syenite intruding the shales at Glendale carries graphite specks disseminated through it. At Dallas Brook, near West bay, graphitic limestones and shales were at one time mistaken for coal measures.

Guthro lake, near Frenchvale, Boisdale hills, northern part of Cape Breton county: graphitic shale, carrying 38 to 45 per cent of graphite, and occurring in a band 2 to 3 feet wide. Some development work was done on this occurrence in 1895².

Other graphite localities on Cape Breton island include Boularderie island, Victoria county, and Gillis and Gregwa brooks, about the head of East bay, Cape Breton county.

On the mainland, graphitic shales are reported to occur near Parrsboro, on Minas basin, Cumberland county, and in Guysborough county, on Salmon river, flowing into Chedabucto bay.

¹ Geol. Surv. Can., Bulletin on Graphite, 1904, p. 5.

Graphite is also present in the slates of the Nova Scotia gold-bearing series, as at Musquodoboit, Fifteen-mile stream and Hammond plains, in Halifax county.

References:—

Geol. Surv. Can., Rep. Prog., 1878-9, p. 2H; Rep. Prog., 1879-80, pp. 19 and 125F, and p. 1-2H; ²Ann. Rep., 1896, Vol. IX, p. 52R; Bulletin on Graphite, 1904, pp. 5-6.

Economic Minerals of Nova Scotia, Department of Public Works and Mines, Halifax, 1903, p. 22.

Mines Branch, Monograph on Graphite, 1907, p. 52.

Mineral Map of the Province of Nova Scotia, Department of Mines, Halifax, 1912.

PROVINCE OF ONTARIO.

The earliest mining and milling of graphite in Ontario took place in 1870, in which year the Port Elmsley deposit was opened up and a refining plant erected at Oliver's Ferry, on the Rideau canal. This mine remained the sole producer until 1896, when operations were commenced at the famous Black Donald mine, in Renfrew county. This deposit is unique among known occurrences of flake graphite, both on account of its size and the phenomenal richness of its ore. The latter runs so high in graphite that a considerable tonnage is shipped crude for employment in certain industries.

The Black Donald mine has continued practically unbroken operations since 1896 to the present time, and probably has produced more graphite than all other Canadian mines together.

The graphite deposits of Ontario occur associated with crystalline limestones, rather than with gneiss, as is the more general mode of occurrence in Quebec, and all of the five mines in the Province have limestone as the rock enclosing the ore-body.

The following table shows the production of graphite in Ontario from 1896 to 1918:—

Production of Graphite in the Province of Ontario, 1896 to 1918.¹

Year.	Short tons.	\$	Year.	Short tons.	\$
1896.....	650	13,000	1908.....	10	1,600
1897.....	400	8,500	1909.....	730	37,624
1898.....	300	6,000	1910.....	992	55,637
1899.....	1,220	16,179	1911.....	894	36,492
1900.....	1,802	27,030	1912.....	1,246	65,076
1901.....	1,000	20,000	1913.....	1,788	93,054
1902.....	1,923	17,868	1914.....	1,363	87,167
1903.....	4,400	20,636	1915.....	2,534	115,274
1904.....	355	4,700	1916.....	3,446	249,586
1905.....	152	9,825	1917.....	3,173	296,587
1906.....	1,772	15,000	1918.....	2,934	171,227
1907.....	2,000	20,000			

Descriptions of the graphite mines in the Province are given in the following pages.

¹ Compiled from Annual Reports of the Ontario Bureau of Mines.
67945-3}

FRONTENAC COUNTY.

Township of Bedford.

Concession IV, lot 4, and concession V, lot 4.—These lots are understood to have been recently taken up by the Mining Corporation of Canada, 1511 Bank of Hamilton Building, Toronto, with a view to their development.

Concession VI, lot 2.—According to a statement by J. Bawden,¹ a 30-foot shaft was sunk on this lot some years previous to 1890, and about 100 barrels of crystalline graphite were taken out and shipped to the United States. The occurrence is described as "a well defined vein fully three-quarters of a mile in length and 10 feet wide" in crystalline limestone. No further work appears to have been done on this deposit.

HALIBURTON COUNTY.

Township of Cardiff.

Concession XXII, lots 9, 10 and 11.—Owned by the National Graphite Company, Royal Bank Building, Toronto. The property lies a few hundred yards south of the Irondale, Baneroff and Ottawa branch of the Canadian Northern railway, $\frac{3}{4}$ of a mile west of Mumford station. It was taken up originally in 1912 by the New York Graphite Company, who erected a large mill and proceeded to develop an ore-body outcropping along the north slope of a low ridge facing the railway. A series of small pits opened along this ridge showed the presence of a rather flat-dipping ore-body having an easterly strike and dipping south. The deposit has been proved for a distance of several hundred feet, and several small drifts were run, from which a small tonnage of ore was secured. The largest opening is an open pit 40 feet deep, by 60 feet long and 15 feet wide. The deposit has also been tested by a number of diamond drill holes. The New York Graphite Company continued intermittent operations up to 1915, when it was merged into the present Company. Mining was thenceforth largely discontinued on the above lots, and ore was shipped to the mill from a deposit in Hastings county, near Maynooth.

The latter property is situated on lot 24, concession XIII, township of Monteagle, and adjoins that of the Tonkin-Dupont Graphite Company. The ore is essentially similar to that found on the adjoining lot (see page 28), and consists of crystalline limestone, mixed with silicates, and carrying about 7 per cent of large sized, lustrous flake graphite. An appreciable amount of molybdenite was noticed on the waste dump. A considerable quantity of ore was taken off this lot during 1915 and 1916, but neither mine nor mill have been producing actively since early in 1917. At the present time it is understood that re-opening of the mine at Mumford is contemplated. Experiments are being made, also, with a new system of flotation concentration.

The workings in Monteagle township comprise one main pit and two smaller openings, the latter 50 feet and 20 feet deep respectively. The main pit is an irregular shaped opening, measuring 150 × 30 feet and 150 feet deep, following an ore-body with a northwesterly trend and a slight dip to the southwest. This pit is cribbed and timbered for part of the way, and is equipped with a skidway for bucket hoisting. The openings, being

¹ Report of the Royal Commission on the Mineral Resources of Ontario, 1890, p. 52.

ood
ada,
lop-

! a
out
ited
ree-
No

hite
few
the
was
who
ping
small
ping
has
drifts
rgest
The
The
p to
ence-
o the

anship
pany.
e 28),
rying
eiable
erable
either
t the
ord is
em of

d two
The
d 150
slight
e way,
being

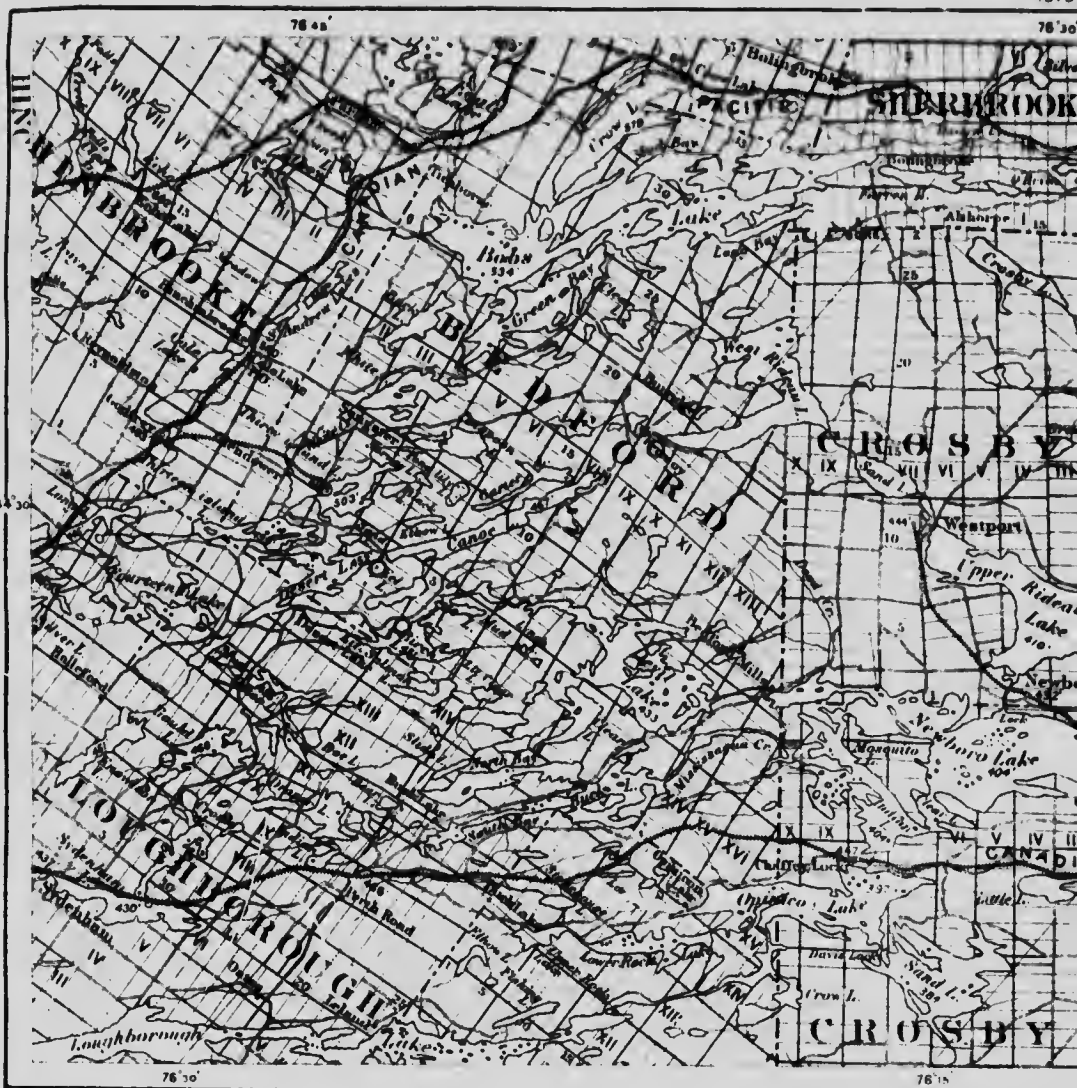

Base map, Dept. of Interior

**GRAPHITE OCCURRENCES
 IN
 BEDFORD, LOUGHBOROUGH
 AND ELMSLEY N.**

Scale: 3.95 miles

Refer to

- 1 N. A. Timmins
- 2 Globe Graphite Mines
- Mine equipped with machinery
- Mine
- Undeveloped prospect

CANADA

DEPARTMENT OF MINES

MINES BRANCH

MINISTER R. G. MCCONNELL DEPUTY MINISTER

MAANFL PH. O., DIRECTOR

1919

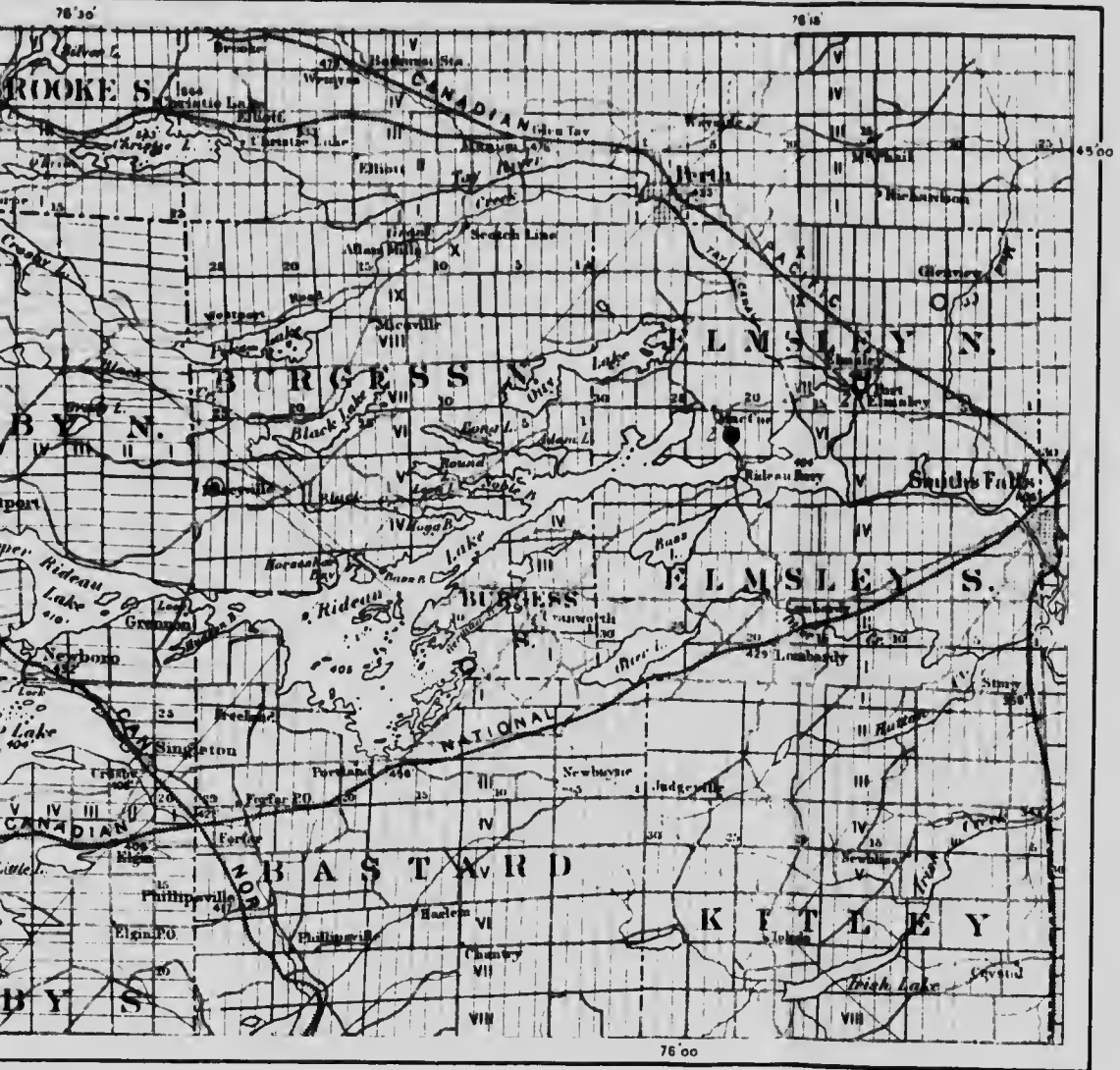

MINERAL OCCURRENCES

IN

BURGESS, BURGESS, N. AND S.,

KITLEY N. Tps., ONTARIO

Scale: 0.95 miles to one inch

Reference

mining
 Ontario Mining and Refining Co.
 worked with mill

1 prospect

to
15
m

30
10
St
qt
fu

C
h
C
t
r
a
l
p
i
o
b
w
o
d
N
l
f
c
m

o
l
T
a
a
a
q
n
p
c
f
f

s
n
f
d
a
-



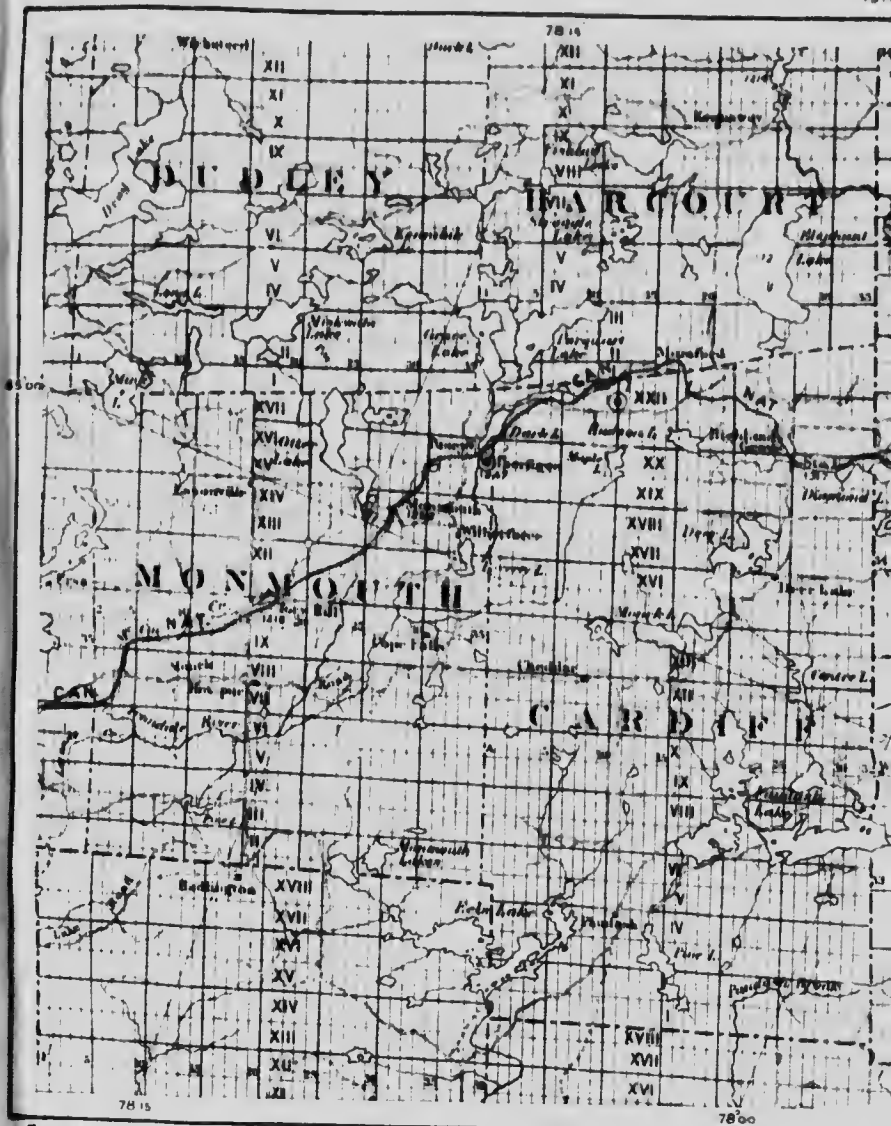

Base map, Dept. of Interior

GRAPHITE OCCURRING IN MONMOUTH, CARDIFF, MONTEAGLE

Scale, 3.95 miles

References

- 1 National Graphite
- 2 Lockin-Dupont
- Mine equipped
- Undeveloped property

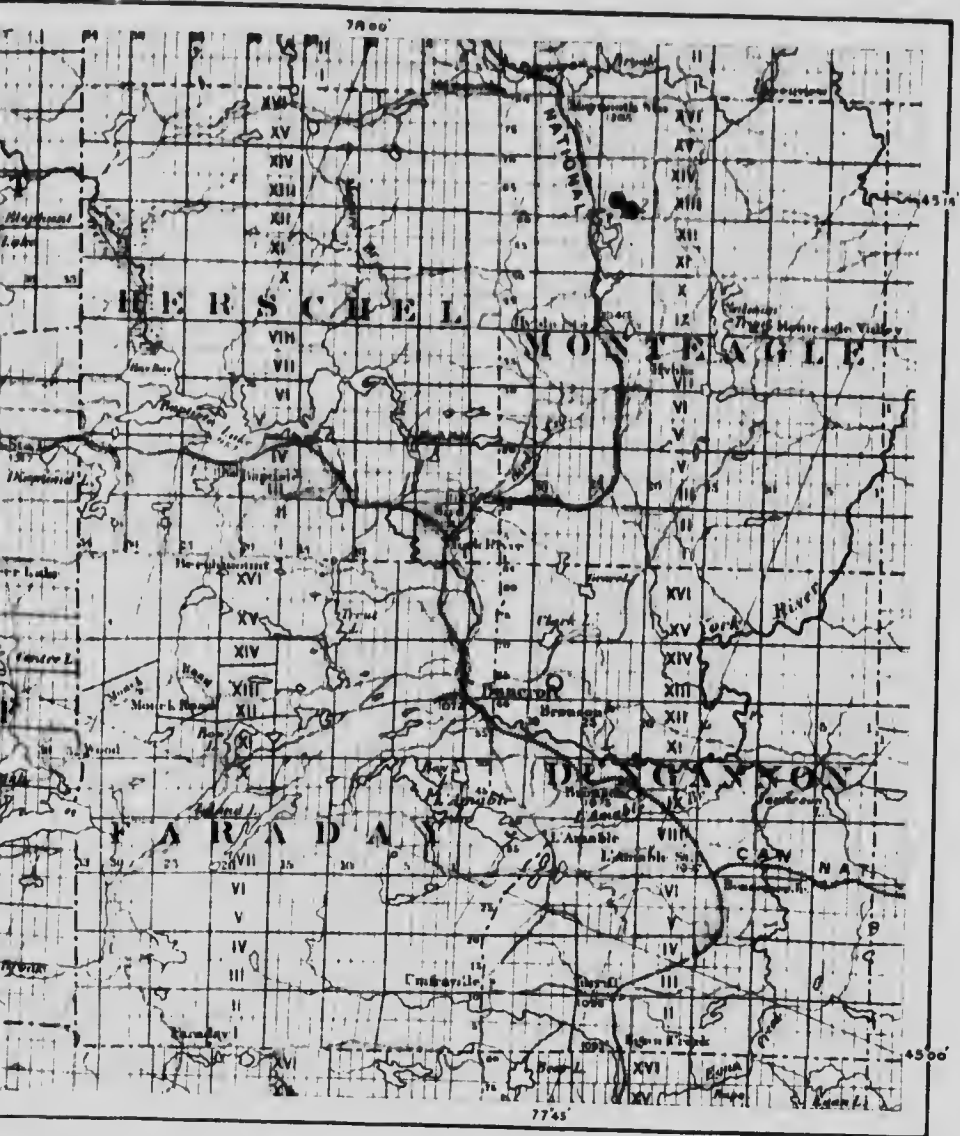

GEOLOGICAL OCCURRENCES
 IN
MONTSEARLE AND DUNCANNON TPS., ONTARIO

Scale: 1 inch = 2.5 miles

References

- 1. Graphite Co.
- 2. Dupont Co. (private)
- 3. Unexplored prospect



situated on high ground, make little water. There is a steam plant and compressor at the mine, and in addition, a similar installation at Graphite siding on the railway. The latter was put in in 1916, but has never been in operation.

The Company's mill at Mumford is a large, 3-story, wooden building, designed to treat 200 tons of ore per 24 hours. Steam is furnished by three 150 H.P. boilers, and one 250 H.P. engine drives the mill machinery and electric lighting plant. An inclined tramway (see Plate VI) conveys the ore from the dump alongside the spur connecting the mill with the railway, to a tippie, where it is dumped into cars that take it to the drying kilns. The latter are oil-fired. The system of concentrating and refining is dry throughout, and in a general way similar to that described on pages 74-8. Two Huff electrostatic separators were installed in 1916. It was claimed that the No. 1 product turned out by this mill had an average carbon content of 92 per cent, while the No. 2 ran around 90 per cent. The output of milled graphite in 1916 was 900,000 pounds.¹

References—

Annual Reports of the Ontario Bureau of Mines, 1913 to date.

Township of Monmouth.

Concession XVI, lot 35, S $\frac{1}{8}$.—Owned by the Tonkin-Dupont Graphite Company; Ltd., 2345 Broadway, New York. The property adjoins the Irondale, Bancroft and Ottawa branch of the Canadian Northern railway, near Wilberforce station. A large mill, erected by the original owners, the Virginia Graphite Company, in 1910, is situated alongside the railway tracks, close to the station.

The first work at this point was carried out in 1910 by the last mentioned Company, who proceeded simultaneously with the erection of the mill. A small amount of mining was performed on the above and adjoining lots, but results apparently were not very promising, as in the following year the mill ran largely on ore brought by rail from Maynooth, some 30 miles away, where, on concession XIII, lot 23, of the township of Montegale, in Hastings county, the Company carried out more extensive mining operations. The workings at Wilberforce comprise a few small side hill quarry openings, a large open pit said to be about 100 feet deep and measuring 75 feet \times 40 feet, and an inclined drift 8 feet \times 15 feet and 100 feet deep. The latter opening has been made on a graphitic zone in silicated crystalline limestone, the graphite occurring in narrow bands of disseminated flake, separated by limestone only slightly graphitic. The prevailing rock on these lots is crystalline limestone, in which occur silicated bands. It is to these bands that the graphite is confined. The ore is comparatively low grade, probably averaging about 5 per cent of graphite. A cursory examination of these lots did not reveal any indication of the presence of an important ore-body.

In 1913, the name of the Company was changed to the Tonkin-Dupont Graphite Company. Some prospecting by drill was carried out on the Wilberforce property during the year, but most of the ore milled was brought from Maynooth and from several prospects in Monmouth and Cardiff townships. Since 1913, the mines and mill of the Company have been idle.

The mill at Wilberforce is a large, 3-story building (see Plate VII), and is equipped with dry concentrating machinery. The kilns for drying the

¹ This mill has since been remodelled for flotation concentration.

ore are situated on a ridge back of the mill, being fed by a skidway leading from the ore dump situated alongside the railway siding which runs to the mill. The concentrating process was modelled on the lines described on pages 74-8, the concentrates being refined by Huff electrostatic separators. The mill was designed for a capacity of 200 tons of ore per 24 hours. Steam was supplied by two 125 H.P. boilers.

The workings of the Company on lot 23, concession XIII, township of Monteagle, in Hastings county, comprise one main pit 200 feet long by 20 feet wide and 75 feet deep, and several other smaller openings to the southeast of the above. The large pit yielded most of the ore taken off the property. The ore-body worked consists of a graphitic band in crystalline limestone, having a northwesterly trend and dipping slightly to the southwest. It is a continuation of the same band worked on the adjoining lot (XIII, 24) by the National Graphite Company.

The ore consists of large-sized, lustrous graphite flakes, disseminated in silicated, crystalline limestone, the average graphite content being about 7 per cent. Calcite forms the bulk of the impurities in the ore, with mica and pyrrhotite in subsidiary amount. The ore-body is bordered by zones of silicated limestone, of which diopside, tremolite, mica, garnet, apatite, pyrrhotite, sphene, scapolite and other typical contact-metamorphic minerals are the most conspicuous components. The occurrence of small, clear, lustrous prisms of scapolite is of mineralogical interest.

The mine is equipped with a small steam plant, compressor and hoist. The ore was hauled to a siding at Graphite, on the Central Ontario railway, about 1 mile distant, and shipped via Bancroft to the Company's mill at Wilberforce.

References—

Annual Reports of the Ontario Bureau of Mines, 1912-15.

LANARK COUNTY.

Township of North Burgess.

Concession V, lots 24, 25 and 26.—Owned by N. A. Timmins, Canadian Express Building, Montreal. Development of this property commenced in 1918, and a mill is now in course of erection.

The graphite occurs as disseminated flake in a band of silicated limestone, the graphite content being about 7 per cent. The width of the graphitic zone as exposed in the main pit is 12 feet. Ore is being mined open-cast at the present time on lot 24, at a point about 700 yards east of the mill, where the graphite body outcrops on the south side of a small hill. When the mine was visited early in 1919, this pit was 75 feet long and 20 feet deep.

The property was diamond drilled in 1918, six holes being put down to depths ranging from 90 to 200 feet. These holes are reported to have shown the presence of a large tonnage of ore that will assay 5-7 per cent carbon. The graphitic band has been traced on the surface and proved by drilling for a distance of $\frac{3}{4}$ mile. The chief impurities in the surface ore are calcite, pyroxene, mica and iron sulphides.

The mill is being equipped for film flotation by a newly patented system. The equipment consists of Gates gyratory crusher, ball mill, flotation washers, rotary dryer, burrstones and polishing rolls. A pipe line 5,000 feet long has been constructed between the mill and Black lake, and it is planned to connect the pit and mill by tramway.

The mine lies 14 miles southwest of Perth, and 7 miles from Westport, the nearest rail point.

Township of North Elmsley.

Concession VI, lots 21 and 22.—Property of the Globe Graphite Mining and Refining Company, of Syracuse, N.Y. This property lies 7 miles southeast of the town of Perth, and 4 miles from Elmsley station on the Montreal-Toronto line of the Canadian Pacific railway. The distance to Rideau lake is less than 1 mile, and from here shipments may be made or received by way of the Rideau canal connecting Ottawa with Kingston, on Lake Ontario.

Work on this deposit—the earliest worked graphite occurrence in the Province—was commenced about 1870, by the International Mining Company, of New York, and continued until 1875, the ore being hauled to a mill erected at Oliver's Ferry, on the Rideau canal. From 1875 to 1893, the property was idle. In the latter year it was taken over by the Northern Graphite Mining Company, who put down boreholes on lots 21 and 22 in concession VI, and on lot 23 in concession VII. Eight holes were put down, ranging from 50 to 100 feet in depth, and a considerable body of graphite was proved. No active mining was conducted by the above Company, and the property lay idle until 1901, when it was again drilled, by R. A. Pyne, who put down four diamond drill holes on lot 21. The holes ranged from 64 to 140 feet. In 1902, mining was commenced by Rinaldo McConnell, who carried out considerable development work, put down seven diamond drill holes and established a 20-ton mill at Port Elmsley, 3 miles to the east of the mine. From 1903 to 1908, operations were again suspended, but the mine and mill were run almost continuously between 1908 and 1911 by the Globe Refining Company. From 1912 to 1915 the property was idle, but in October of the latter year the Globe Graphite Mining and Refining Company was formed and work was resumed. The assets of this Company were taken over in 1916 by the present owners, who have continued to operate the mine and mill to date,¹ and have carried out several hundred additional feet of diamond drilling.

This property was examined in 1917 by M. E. Wilson, of the Geological Survey, and from his report² the following notes on the occurrence of the graphite are largely taken.

The graphite ore-body, as disclosed by mining and drilling operations, forms a saddle-shaped mass in highly silicated Grenville limestone intruded by masses of peginatitic rock. The latter ranges in composition from a gabbro to a syenite, and commonly contains pyroxene and biotite. The graphite is associated principally with silicated zones in the limestone, and the graphite content increases in proportion to the degree of silication. The silicated rock consists chiefly of diopside with subsidiary amounts of scapolite, mica, pyrite, and orthoclase feldspar, and apparently represents a contact-metamorphic product formed along the borders of the peginatitic rocks. The silicated zones merge gradually into the normal Grenville limestone.

In addition to the graphite being found in the more highly silicated portions of the limestone, the shape of the ore-body indicates a possible connexion between its formation and the structure of the enclosing limestone. In general form, the ore-body is an unsymmetrical, saddle-shaped mass—40 feet thick at its crest—developed on the limbs of a pitching

¹ Went into liquidation in February, 1919.

² Geol. Surv. Can., Summary Report, 1917, Part E, pp. 29-42.

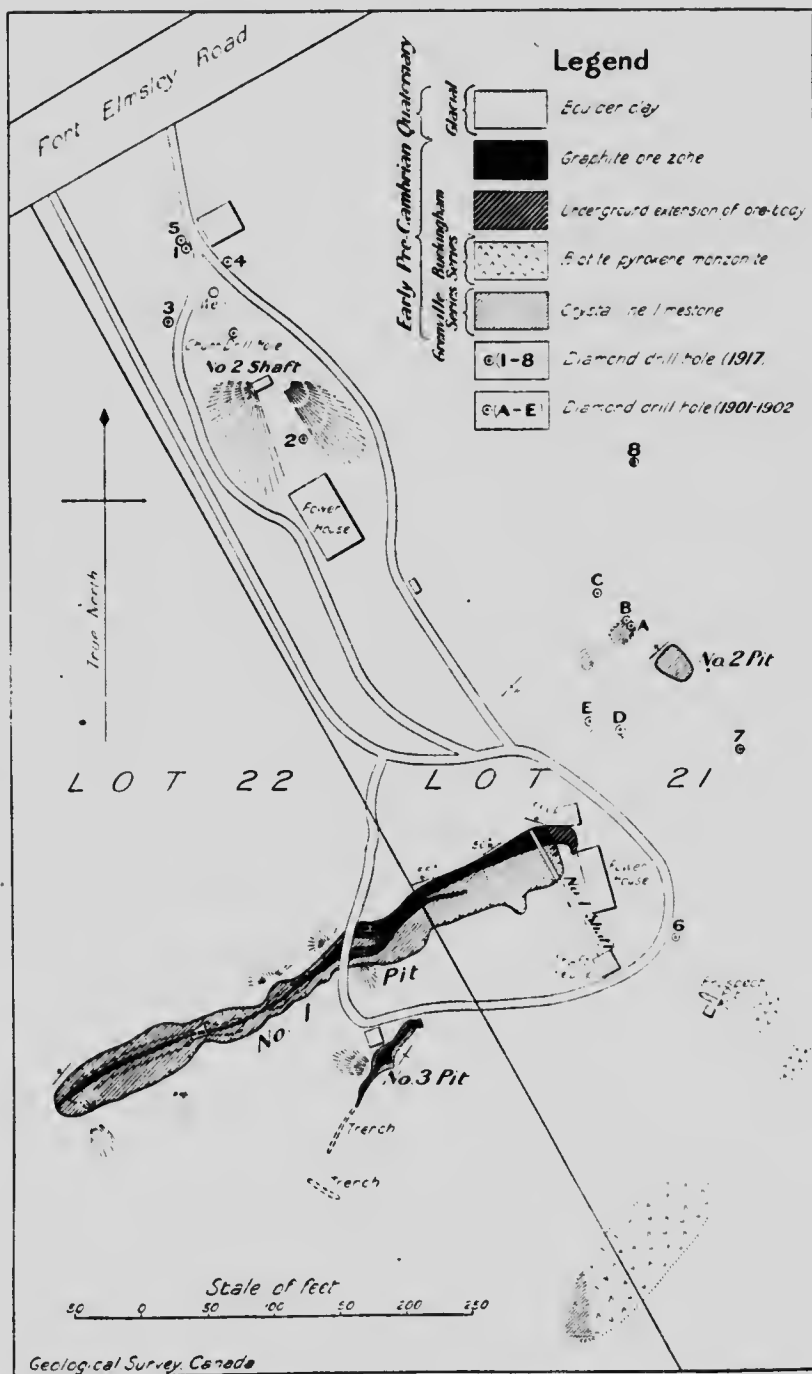

Fig. 1. Surface plan at mine of Globe Graphite Mining and Refining Company, lots 21 and 22, concession VI, North Elmsley township, Lanark county, Ontario.

anticline; the saddle thus occupies a highly-tilted position, the axis of the anticline being horizontal rather than vertical (see Fig. 2). The general trend of the limestone is northeast, paralleling the larger direction of the pit, with a steep dip to the north. At the eastern end of the pit, however, the banding in the limestone turns abruptly to the south, forming an anticline pitching steeply to the northeast. The graphite body is developed

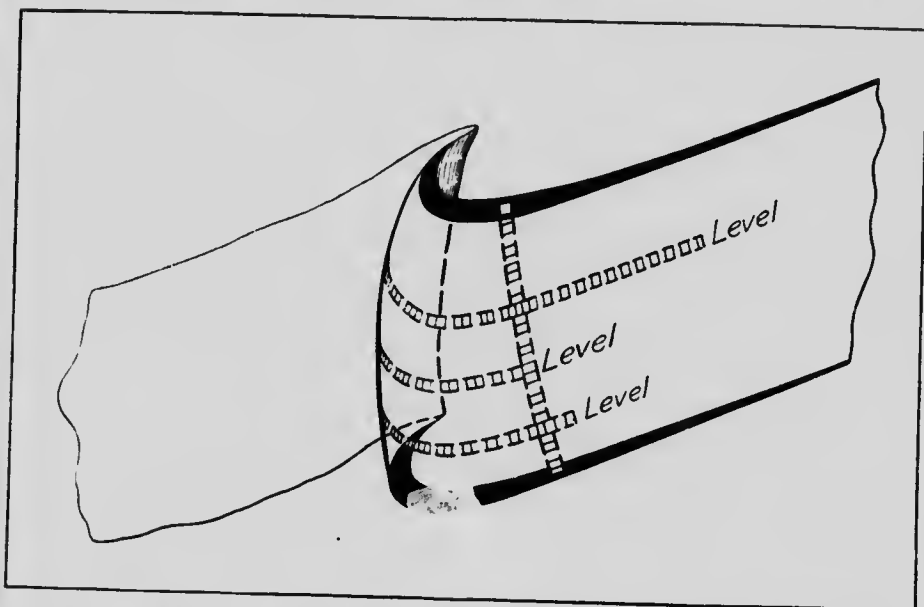

Fig. 2. Diagram showing approximate form of graphite ore-body on crest of pitching anticline, lots 21 and 22, concession VI, North Elmsley township, Ontario.

for a distance of 400 feet along the northwest limb of this anticline, gradually increasing in width from west to east, until at the crest it attains a thickness of 40 feet.

With regard to the possible bearing of structural relationships in the Pre-Cambrian rocks on the formation of graphite bodies, Wilson says:—

The outstanding structural feature which characterizes the graphite deposits occurring in the Pre-Cambrian complex of eastern Ontario and the southern Laurentians of Quebec is the general occurrence of the richest graphite ore-bodies at the crests of folds or at other points where the structural relationships indicate that a relief of pressure has occurred, and this relationship is strikingly illustrated by the principal Port Elmsley deposit.

It is possible that the main pit is situated close to the crest of the north limb of a major fold in the Grenville limestone and that the pitching anticline at the east end of the main pit is the continuation of this fold, but it seems more probable that the pitching anticline is a minor fold of the drag type developed on the north limb of a still larger folds of the drag type in the limestone, as for example on the east face of the main pit directly above the southern termination of the graphite ore mass, the northeasterly strike of the limestone in the outcrops directly east of the main pit, and the unsymmetrical form of the main ore-body, the larger part of its mass forming the northwest limb of the saddle.

This explanation of the structure of the limestone adjacent to the graphite ore-body has obviously a bearing on development operations, for if the pitching anticline in which the saddle-shaped mass occurs is a major fold, the continuation of the graphite lead at the surface should be found to the south of the main pit; on the other hand, if the pitching anticline is a fold of the drag type, the continuation of the graphite lead should be found to the east of the main pit. In either case, however, it is probable that the continuation of the lead beyond the southeast limb of the anticline, like the continuation of the northwest limb, is not of workable dimensions.

With regard to the origin of the graphite Wilson says further:—

The Port Elmsley graphite deposits, according to the sedimentary hypothesis, are presumably parts of highly carbonaceous beds in the Grenville limestone that have been broken up into detached masses by deformation. If a bed of this type were less competent than the associated limestone, it might be squeezed into a saddle-shaped mass similar in form to the main deposit.

The association of the graphite with zones of silicification in the limestone, and the increase in the graphite content of the ore in proportion to the intensity of silicification, would seem to indicate, however, that the graphite was in some way associated with the intrusions of the pegmatitic rocks by which the silicification of the limestone was effected. Gaseous or aqueous emanations derived from an igneous intrusion would tend to accumulate at the crests of folds or other points where pressure was less intense, and in consequence silicification might occur most completely at such points. There would likewise probably be a greater accumulation of graphite at such points, whether it emanated from the igneous intrusive or was derived from the carbon dioxide set free by the silicification of the limestone. On the whole, therefore, the relationships of the Port Elmsley deposits can be best explained on the assumption that they are either igneous emanations or a product derived from the carbon dioxide of the limestone, rather than by the sedimentary hypothesis.

The Port Elmsley ore consists of silicated Grenville limestone carrying disseminated flake graphite. The most highly silicated rock carries the most graphite and forms the richest portion of the ore-body (15 to 20 per cent of graphite), and this grades into limestone carrying disseminated silicates and graphite. The latter is considered milling ore as long as the graphite content does not sink below about 5 per cent. The more common accessory minerals in the ore are diopside, orthoclase, calcite, pyrite and titanite. Analyses of several samples of the ore, made by H. A. Leverin, of the Mines Branch, showed a graphite content ranging from 6.67 per cent to 16.70 per cent.

This property has been prospected by means of drilling probably to a greater extent than any other graphite deposit in the country, 28 holes having been put down between 1893 and 1917, in an endeavour to locate fresh ore. The results of this drilling, however, as well as of mining operations, do not tend to show that any graphite bodies of workable dimensions other than that exposed in the main pit, and described above, occur on the property.

The workings consist of the original main pit, from which practically all the ore raised has been secured; a shaft sunk some 400 feet to the north of the above, and a third small pit sunk about 100 feet to the south. The main opening consists of a shallow trench, or rather series of small trenches, for the greater portion of its 400-foot length, becoming wider and deeper towards its eastern end. At the eastern extremity, a shaft has been sunk to a depth of 250 feet, following the ore-body. This shaft is on an incline of about 60° N.W. for 150 feet of its depth, from which point it gradually approaches the vertical (see Fig. 3). Development of the ore-body underground has been carried out by means of three main levels run in both directions from the shaft for a distance of about 200 feet along the ore-body. The levels are placed at depths of 100, 150, and 200 feet, and work has lately been proceeding on a fourth, at 250 feet, which is being carried in an easterly direction, toward the crest of the anticline.

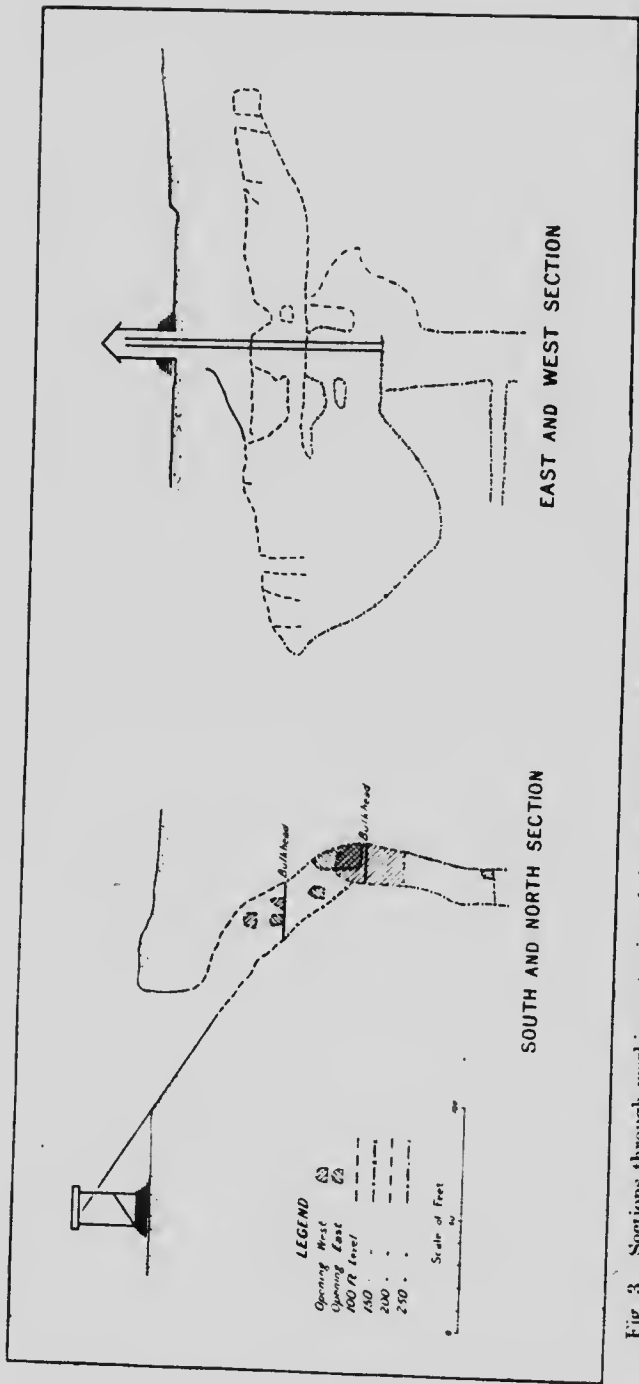

Fig. 3. Sections through workings at mine of the Globe Graphite Mining and Refining Co., Ltd., township of North Elmsley, Ont.

In 1916, a shaft was sunk to a depth of 106 feet at a point 400 feet to the northwest of the main opening, and from it two drifts were run 40 feet towards the latter at depths of 50 and 100 feet. No ore of any consequence is reported to have been met in these workings.

Fig. 1 shows the general layout of the workings, position of drill holes, etc.

The deposit, as exposed at the various levels, and more particularly in the deeper workings, consists of a series of three rich graphite bands, separated by graphitic limestone, rather than of a single ore-body. Of these bands, the centre one is the thickest and has been most worked, but the width of all three is decidedly variable in the different depths. The total thickness of the graphitic zone is 40 feet at its widest point, as so far determined, namely at the extreme eastern end of the main pit. While the graphite content of the rich zones will run as high as 20 per cent, the average is considerably lower; that of the graphitic limestone separating the bands of rich ore will possibly average from 3 to 5 per cent.

The graphite is flake of good quality and fair average size. In addition to the ordinary, more or less equi-dimensional flake, small bodies of so-called "needle flake" are met with. (Plate XII.) The latter consists of lath-shaped individuals, whose length may be 5 or 6 times their width. Such material, however, breaks down readily, on milling, into particles of the ordinary flake form. No occurrence of vein graphite (plumbago) has been reported from this locality.

The main shaft is equipped with an inclined skipway to the second level and from here to the bottom of the shaft hoisting is performed with a bucket and winch. The ore is dumped into a bin at the shaft house, from which it is loaded onto waggons and teamed to the mill at Port Elmsley. Two boilers of 60 and 80 H.P. supply steam for the hoist, compressor, pumps, drills, etc.

Mill.

In the original mill erected at Oliver's Ferry for the treatment of the ore from this property, the process of concentration was a wet one. The equipment¹ consisted of a battery of ten stamps, to which the ore was fed after being crushed to egg size, three buddles working in sequence, and a settling tank. The concentrate from the first buddle was fed to the second, and that from the second buddle to the third, thus effecting a progressive concentration of the graphite. The tails from all these buddles were returned to the stamps. The heads from the last buddle were transferred to a circular settling tank (4 feet high, 4 feet in diameter at the top and 2½ feet at the bottom) and gently agitated with water, thus effecting a concentration of the gangue particles in the lower portion of the tank. This material was returned to the stamps. The graphite passed to a dryer, and thence to a reverberatory furnace, after which it was graded, by screening, into four products. The largest flake (60 mesh) was placed in a set of three small ball mills, set up in a special small chamber fitted with shelves around the walls. After grinding in these mills for some hours, the plates covering the feed-doors were removed and perforated plates or fine mesh screens were substituted. On re-starting the mills, the graphite was gradually discharged through the screens, the coarser flake settling on the floor of the chamber and the finer material on the shelves.

¹Rep. Ont. Bur. Min., 1896, p. 35.

Graphite for all sorts of purposes, including electrotyping, lubricating, pencils, stove polish and foundry facings, was turned out by this mill.

In 1902, an old woollen mill at Port Elmsley on the River Tay, three miles east of the mine, was equipped with concentrating and refining machinery, and this mill is the one at present in use. The building is a 3-story stone structure, and is situated on the bank of the river, which supplies water power for the operation of the machinery. The concentrating process as originally installed here consisted of drying the ore, crushing, screening and concentrating by pneumatic jigs. The concentrates were then fed to burrstones, and a finished product made by a system of buddling, followed by screening. This installation was capable of treating 20 tons of ore per day.

In 1908, the above system was discarded and a system of wet concentration installed. The ore was crushed in jaw crushers and rolls, and then underwent a process of concentration in a classifier. The concentrates were dried in a revolving dryer, sized, and passed between burrstones to make a finished product. This installation, with various modifications, continued in use till 1911.

In 1915, dry concentrating methods were again adopted, the system installed being the one that has found extensive adoption in Canadian graphite mills in recent years, and consisting in kiln-drying the ore, coarse crushing, alternate crushing between rolls of flour-mill type and screening, followed by concentrating on dry tables. The finishing process consisted in subjecting the concentrates to practically a duplication of the above treatment, employing rolls, screens, dry tables and burrstones. (For a detailed description of such a refining process, see pp. 74-8.) The above installation is capable of treating 100 tons of ore per 24 hours, consumes 110 H.P., and requires 25 men for operation. The average graphite content of the ore treated by this process was stated to be 8 per cent, of which 62 per cent was recovered. Of this, 82 per cent was No. 1 flake, and 18 per cent No. 2 flake and dust.

At the time of writing (December 1918), experiments are being conducted with a novel system of film flotation, with a view to installing this method if the results are satisfactory.

References:—

Report of the Royal Commission on the Mineral Resources of Ontario, 1890, p. 181; Annual Reports of the Ontario Bureau of Mines, 1893 to date.

Geol. Surv. Can., Report of Progress, 1872-73, p. 178; Bulletin on Graphite, 1904, p. 22; Summary Report, 1917, Part E, p. 29.

Catalogue of Economic Minerals of Canada, prepared for the International Exhibition, Philadelphia, 1876, p. 121.

Mines Branch, Report on the Mining and Metallurgical Industries of Canada, 1907-8, p. 404.

RENFREW COUNTY.

Township of Brougham.

Concession I, part of lot 20; Concession III, lots 17, 18, and 19; Concession IV, part of lots 15, 16, 17, and 18.—Black Donald Mine, property of the Black Donald Graphite Company, Limited, Calabogie, Ontario. Mining operations have been confined entirely to the third concession, the principal openings being on the south edge of Whitefish lake. The

distance from the nearest shipping point, Calabogie, on the Kingston and Pembroke branch of the Canadian Pacific railway, is 14 miles, and transportation between mine and rail is effected by motor trucks.

The deposit of graphite on this property was discovered in 1896, and work was commenced upon it in the same year by the Ontario Graphite Company, Limited, who erected a refinery at Ottawa to treat the ore chemically. Of the 300 tons of graphite ore produced in 1897, 200 tons were shipped in the crude state, and 100 tons were refined. In 1902, a three-story mill was erected at the mine, and a power plant was constructed on the Madawaska river, $2\frac{1}{2}$ miles to the southeast. In 1909, the mill was completely overhauled and an entirely new refining process installed by the Black Donald Graphite Company, Limited. The annual production of refined graphite of all grades from this mill since 1909 has greatly exceeded the combined production of all other Canadian refining plants.

A great part of the underground workings on this property lie under Whitefish lake. A cave in, in 1902, on the shore line, due to carelessly mining too close to the cap rock, resulted in a flooding of the shaft, necessitating its temporary abandonment. In 1904, the property was leased from the Ontario Graphite Company by R. McConnell, who constructed a dam around the break and shut out the water from that portion of the lake overlying the open cut workings. In 1908, the property was taken over on a long term lease by the present owners, the Black Donald Graphite Co., Ltd., who finally purchased the property from the Ontario Graphite Co., in 1917.

The 400 H.P. generator at the Company's power house on the Madawaska river furnishes all the power required in both mining and milling operations. The power is generated and transmitted to the transformer house at the mine at 4,400 volts, and is there stepped down to 550 volts. The Company has in use four 75 H.P. motors, one 60 H.P. motor, three 30's, two 15's, and two 5's. In addition to the electrical installation, there are two 120 H.P. boilers, and the compressor house contains two Rand and one Blaisdell compressor, which have until recently been used for operating air-driven pumps and air drills. Two of the compressors and the air-driven pumps have lately been discarded, and an electrically driven centrifugal pump installed in the mine in their stead.

A considerable amount of diamond drilling was done on the property in 1901-2, which resulted in the location of two distinct and well-defined veins.

The Black Donald deposit exhibits very unusual features as compared with the general run of flake graphite occurrence, chief among them being its size and the richness of the ore. This deposit is the richest and largest body of flake graphite so far known in either the United States or Canada. The average graphitic content of the ore is 65 per cent, but zones of richer material, ranging as high as 80 per cent, occur locally. Much of the ore secured, therefore, has been pure enough in its natural state to find employment in foundry work, and practically the entire output of the mine was sold in a crude state previous to 1909. The ore-body in the vertical vein worked consists of a more or less homogeneous mass of graphite, averaging about twenty feet in width. The maximum width, as determined in the underground workings, is 70 feet. The ore-body strikes northeast and has been traced for a distance of 800 feet, the width increasing from about 15 feet at the westerly outcrop to 70 feet in the east workings. The deposit has a vertical dip, with well-defined walls, and pitches to the northeast

CANADA
 DEPARTMENT OF MINES
 MINES BRANCH

HON. MARTIN BURRELL, MINISTER. F. G. MCCONNELL, DEPUTY MINISTER.
 EUGENE HAANEL, P. E., DIRECTOR.
 1919

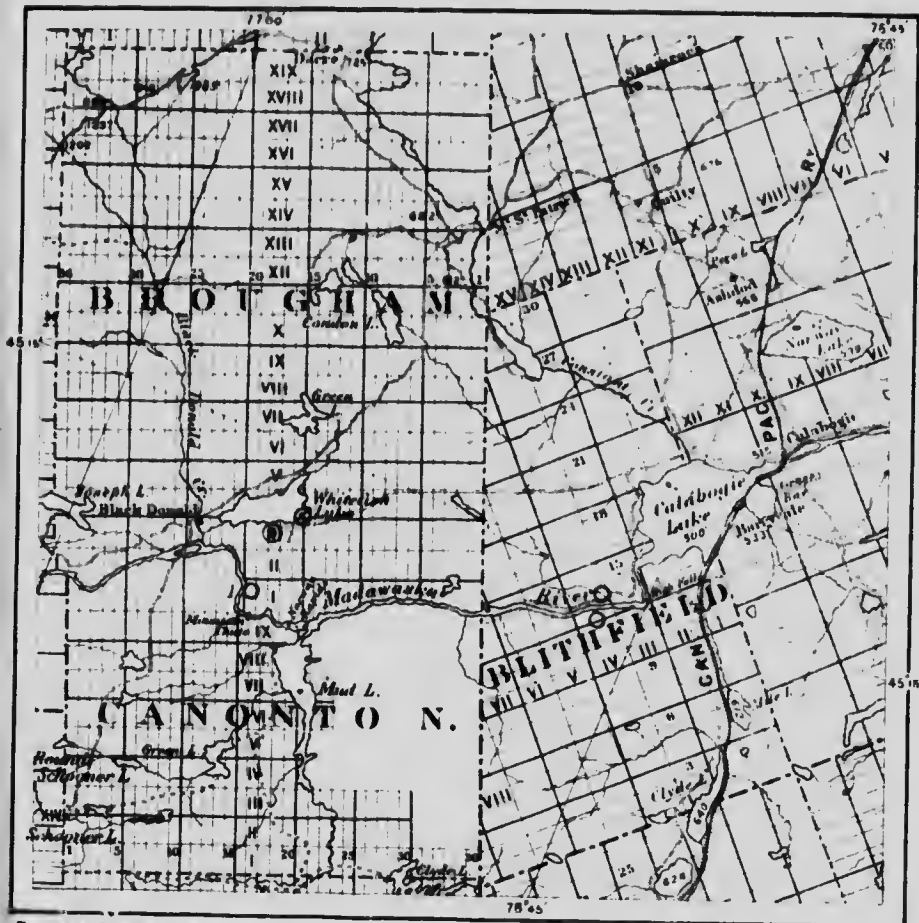

Base map, Dept. of Interior

GRAPHITE OCCURRENCES

IN

BROUGHAM AND BLITHFIELD Tps., ONTARIO

Scale: 3.95 miles to one inch

References

- 1 Black Donald Graphite Co.
- Veins tapped with mill
- Undeveloped prospect



at an angle varying from twenty to forty degrees. It is capped by limestone, and has been found to extend to a depth of at least 125 feet. At this point it appears to be cut off by limestone. This may be due to faulting, or more possibly, folding. Its thickness varies from eighteen to twenty-four feet for a proved distance of 600 feet, from which point it swells out to a width of 70 feet. It is enclosed in crystalline, Grenville limestone, which is graphitic for several feet on each side of the ore-mass. At several places in the underground workings, narrow dikes of pegmatite have been encountered cutting across the vein, and these are thus younger than the latter. While the ore consists of flake graphite, the greater part of the flake is of such small size as to preclude being classed as No. 1. It is, in fact, so fine as to have caused the misleading term "amorphous" to be commonly applied to the intermediate and lower grades of Black Donald graphite. Such a term is incorrect, however, as the fine-grained graphite is essentially of flake form. Disseminated through this fine graphite is a certain amount of larger flake. The proportion of such flake to fine, dust graphite in the average ore is approximately 1:3; that is, taking the average grade of ore as containing 60 per cent of graphite, about 15 per cent will consist of flake and 45 per cent of dust.

The principal impurity in the ore is calcite, which occurs both intimately mixed with the graphite and in the form of narrow seams or stringers. Chlorite, as well as small amounts of other silicates, also occurs.

While the deposit presents much similarity to a true vein, the fact that the graphite is of the flake variety tends to discount this view. So far as known, vein graphites are invariably of the crystalline or plum-bago variety, and veins of such material have not heretofore been found to carry even a small proportion of flake. Then again, such veins are almost invariably narrow, and, in the case of the Canadian occurrences, usually of decidedly irregular form. It seems likely, therefore, that the Black Donald ore-body is of metasomatic origin rather than a true vein; that is, that the graphite constitutes a replacement product of a certain zone of the limestone enclosing the deposit, and that, while exhibiting certain unusual features, the latter has an analogous origin to other flake deposits of the Pre-Cambrian rocks in Ontario and Quebec. In this particular instance, a far more intense degree of graphitization of the limestone than usual would appear to have taken place, accompanied by a correspondingly lesser degree of silification. In view of the fact that the ore-body tends to increase in width from west to east, and that it appears to pinch out in the former direction, it would seem probable that the deposit may be in the nature of a saddle-shaped mass of graphite developed on an anticlinal fold in the limestone. (See Fig. 2, p. 31.)

As already stated, most of the mining work has been carried on near the shore of the lake, the shafts, drifts, and stopes being carried along the easterly extension of the deposit. The first shaft sunk reached a depth of 80 feet and was vertical. From the bottom of the shaft a level was run northeast, under the lake for 200 feet, and southwest 24 feet. The east drift was stoped out to a height of 50 feet for a distance of 120 feet, and 30 feet for the remainder, at which point the ore-body had a width of 26 feet. A number of smaller pits and trenches were opened up still farther to the southwest along the ore-body. Three diamond drill holes, put down in 1901 on the 80-foot level in the main shaft, proved ore to a further depth of 40 feet. In 1901 water from the lake broke through into these workings and necessitated their abandonment. In the following year, a 34-foot

vertical shaft was sunk in an old pit 200 feet west of the main shaft, from the bottom of which a drift was carried 50 feet to the west, from which point an inclined raise was driven a distance of 30 feet to the surface. In this drift, the ore-body was found to widen over a short distance to 46 feet. The extent of the workings to date show a proved length of ore-body of 800 feet, with the easterly workings still in ore, and a gradual widening of the deposit from 15 feet to the extreme western end to 70 feet at the east face.

In 1905, following an unsuccessful attempt to reopen the flooded workings, a new shaft was sunk at a point 100 feet west of the original main shaft. This was put down on an incline of 30 degrees northeast and reached a depth of 170 feet on the incline. From this shaft the ore-body was stoped out in both directions, but principally to the east, and the opening was later converted into an open pit. This pit continued to supply most of the ore mined until 1916, a depth of 145 feet, vertical, being reached. Hoisting from the present workings is done by an inclined skipway.

Prior to 1917, sufficient ore was mined during the summer months to keep the mill supplied for the whole year; but for the past two years the mine has been operated on a double shift, summer and winter.

Thirty feet southeast of the main ore-body, and at ninety feet depth, a fourteen-foot, flat-dipping body of graphite was struck. Mining operations on this vein produced some of the richest flake ore ever raised on the property. After satisfactorily proving this second vein, operations were resumed in the big pit.

At the present time work is proceeding at a point 500 feet northeast of the shaft head and 200 feet below the level of the lake, where a stope is being carried to the northeast. The ore-body here has a width of 70 feet.

In addition to the three story refinery, boiler, compressor and hoist houses, warehouse, and other mine buildings, a small village of some forty dwellings (Black Donald P.O.) has grown up on the property for the accommodation of the employees.

Mill.

While various modifications of the system installed by the original owners were made from time to time, operations did not prove satisfactory until an entirely new refining process was installed by the present owners and operators of the property in 1909. The buddle system practised here is the same method of concentration, with modifications to meet the local conditions, as was installed in the earliest Canadian mills, and it is worthy of note that their use has been persisted in despite the wide-spread adoption of numerous other and varied concentration processes that have been evolved in more recent years. The mill has a capacity of twelve tons of refined graphite per day of two shifts. The Nos. 1 and 2 flakes produced are reported to average about 88 per cent carbon and owing to the absence of siliceous material in the ore, are particularly well adapted to the lubricating trade.

A flow sheet of the mill¹ is given on page 82.

References:—

- Annual Reports of the Ontario Bureau of Mines, 1896 to date, more particularly 1896, 1901, and 1903.
- Geol. Surv. Can., Bulletin on Graphite, 1904.
- Mines Branch, Report of the Mining and Metallurgical Industries of Canada, 1907-8, p. 406.

¹NOTE.—The mill has since been remodelled for Callow pneumatic oil flotation.

a
n
n
B
-
al
et
d
in
ed
as
ng
st
d.

to
he

th,
er-
on
ons

east
e is
eet.
oist
ome
for

ginal
ctory
rners
here
local
orthy
ption
been
ns of
flakes
ng to
apted

more

ries of

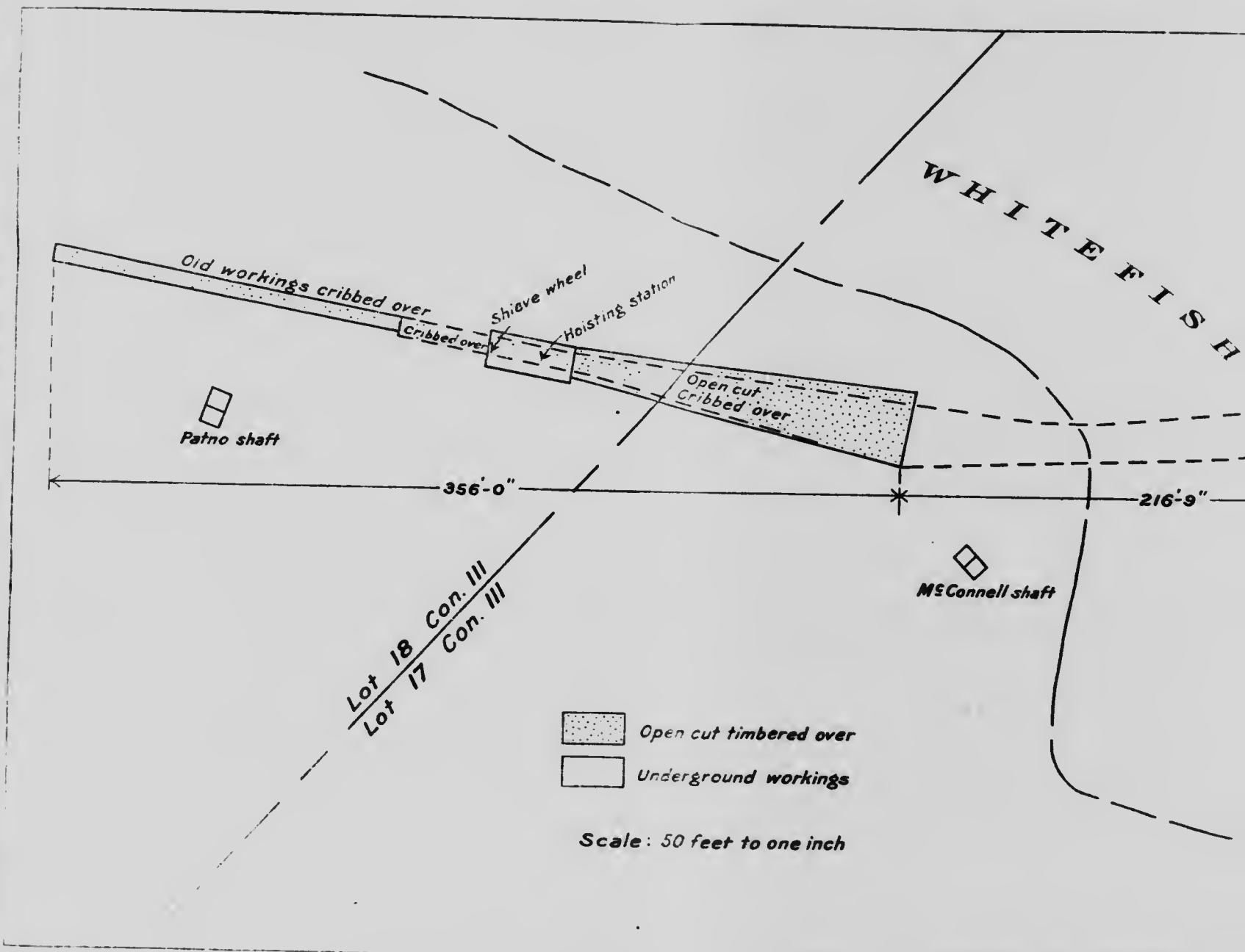
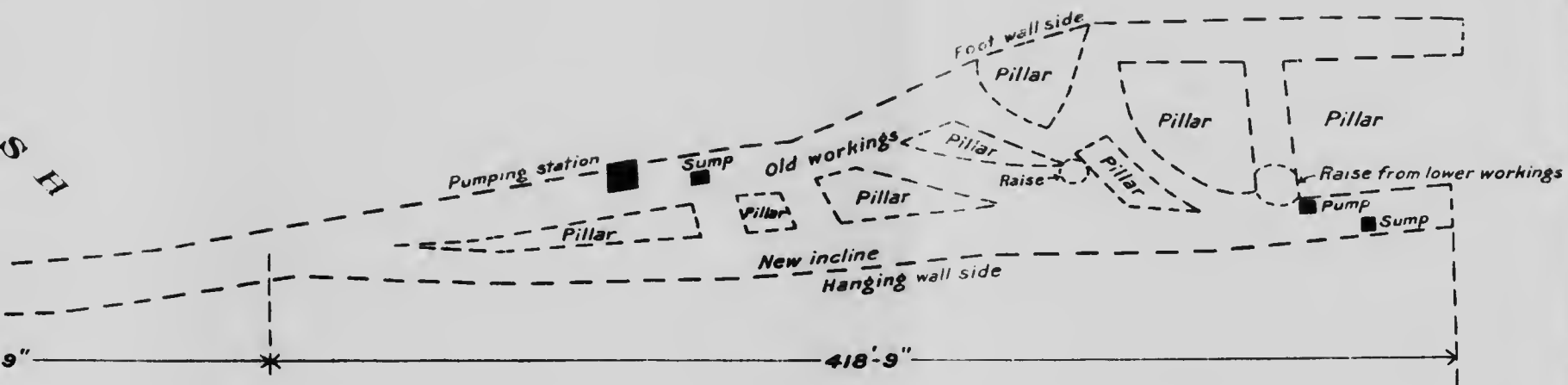

Fig. 4. Plan of workings, Black Donald

S H



L A K E

Ast. North





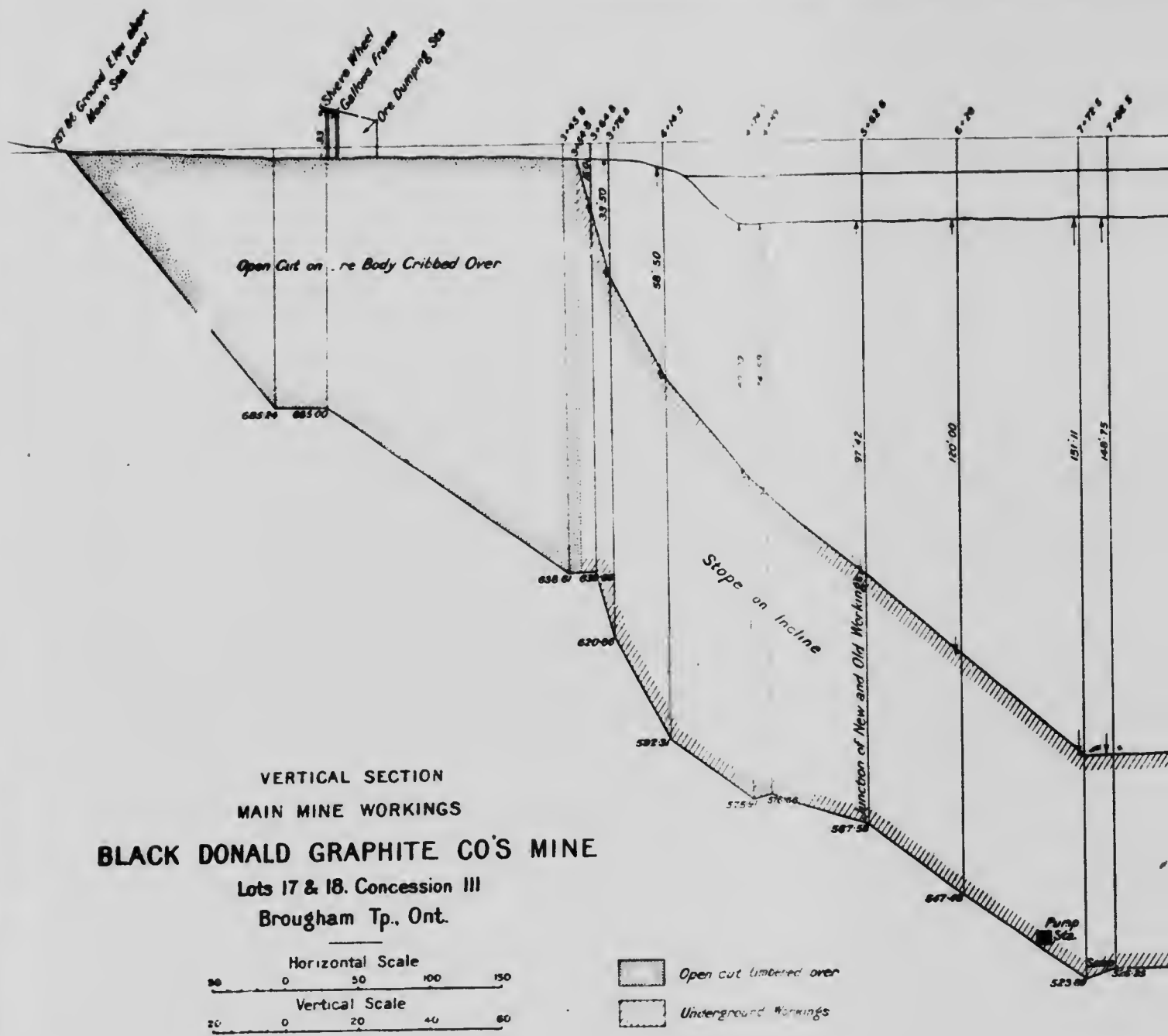

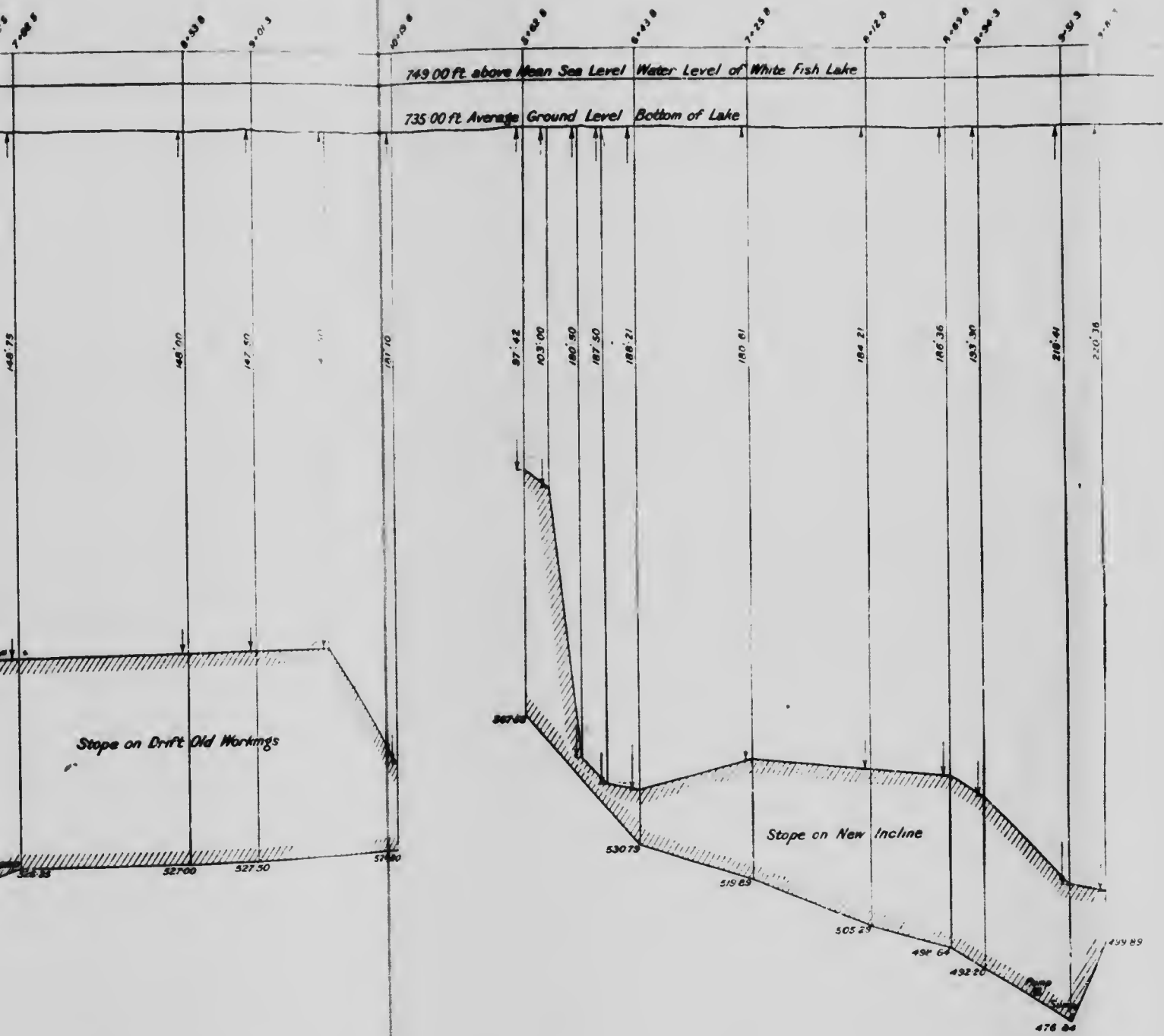

Working, Black Donald Mine, Brougham Township, Ont.



Township of Lyndoch.

Concession II, lots 1 and 2. Owned by Messrs. Beidelman and Lyall, 701 Transportation Building, Montreal. Only a small amount of work of a prospecting nature has been carried out on this property, which was not visited by the writer. The following details regarding it have been kindly supplied by the owners.

The property lies 25 miles from the nearest rail point, Caldwell station, on the Ottawa-Parry Sound branch of the Grand Trunk railway, and 33 miles southwest of Renfrew. The workings lie on the left bank of the Madawaska river, a few hundred feet from the water. The trend of the deposit is northeast, and the main graphitic zone, as proved by trenching, is about 250 feet wide, though outcrops of graphite are also found outside of this belt. Trenching has been carried out over a total distance of 1,800 feet along the strike of the deposit and has exposed graphite for the entire distance. The deepest pit on the property is a 7'×9' shaft, sunk to a depth of 35 feet: this was in good ore all the way. The ore consists of flake graphite, and rather resembles that of the Black Donald mine, in Brougham township, being made up largely of very small flake carrying a proportion of larger flake scattered through it. The graphitic zone would appear to comprise several bands of richer ore separated by belts of more or less graphitic limestone. The country rock is crystalline, Grenville limestone.

The present owners acquired the property in 1917, and carried out most of the development work that has been done, with the exception of the main shaft, which was put down in 1917 by Mr. McHale, of Ottawa.

A sample of ore from this property was made the subject of concentrating tests by the Callow oil flotation system, the work being done at the Ottawa office of the General Engineering Company. These tests showed that by this system of treatment, there could be produced from every ton of ore:—

143 pounds No. 1 flake (+80 mesh) assaying 89 per cent carbon, and 154 pounds No. 2 flake (−80 mesh) assaying 85.1 per cent carbon, with a recovery of 91.1 per cent of the graphite in the ore. Assay of the sample treated showed a carbon content of 12.9 per cent.

Fig. 5 is a surface plan of the workings and outcrops on this property.

ADDITIONAL GRAPHITE LOCALITIES IN ONTARIO.

In the Report of the Ontario Bureau of Mines for 1904, p. 93, a graphite deposit is stated to have been worked in 1913 a few miles from Kinmount station in Victoria county. There is no record of any further development of this property.

On lot 34, concession VIII, township of Denbigh, in Addington county, a small amount of mining was carried out during 1902-3, by J. G. Allan, of Hamilton, Ont. In the bulletin on Graphite, issued by the Geological Survey in 1904, p. 25, the ore on this property is stated to run as high as 76 per cent carbon, with an average of 50 per cent, and to be of the amorphous variety. The latter term probably signifies flake so small as to give the ore a powdery character. About 200 tons of ore were mined from a shaft 50 deep feet and shipped in the crude state. No further work has been performed at this locality. On lot 1, concession VIII, of Ashby township, (the adjoining lot to the west) similar ore is stated to occur.

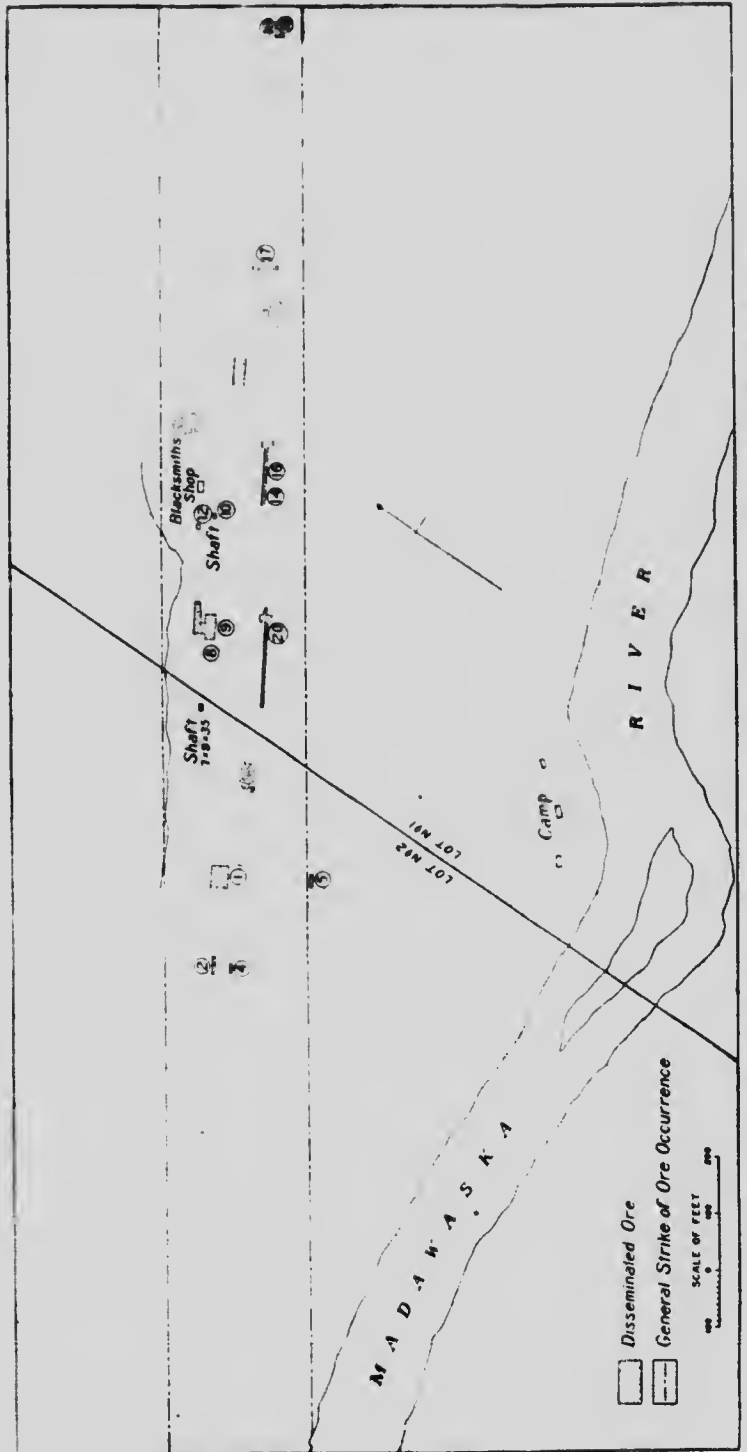

Fig. 5. Surface plan of graphite showings on lots 1 and 2, concession 11, township of Lyndoch, Ont.

In Annual Report of the Geological Survey, vol. VII, 1894, p. 11R, fine-grained ("amorphous") graphite is stated to occur on lot 13, concession VIII, township of Marmora, in Hastings county. An analysis of a sample, made in the laboratory of the Geological Survey, showed a graphite content of 72 per cent.

On lots 13 and 14, concession IV, township of Blithfield, in Renfrew county, a deposit of flake graphite is stated to have been worked to a small extent previous to 1896. (Bulletin on Graphite, p. 25).

Other localities where graphite is reported to occur, but about which no further published information is available, are:—

- Frontenac county: township of Bedford, IX, 18.
- " " Loughborough, IX, 6.
- Lanark county " North Burgess, I, 10.
- " " North Elmsley, IX, 7.
- " " Darling, near Tatlock.
- Hastings county " Dungannon, XIII, 28.
- Renfrew county " South Canoto, III, 23.
- " " Westmeath, Front A, 21.

LAKE OF THE WOODS.

(Carbonaceous Schists.)

Enquiries having been received by the Mines Branch as to the nature of the carbonaceous schists of this region, the following extracts from reports on this section are quoted to show the character of the carbon contained in these rocks:—

Associated with the soft, fissile, hydromicaeous or magnesian schists of the lake, there occur in several localities bands of jet black carbonaceous or sub-graphitic schists. These schists have a very characteristic vesicular structure and are strongly impregnated in most cases with pyrite. The present note is not for the purpose of calling attention to any economic value of these schists, but rather the reverse, viz., to point out their worthless character from an economic standpoint and so endeavour to save time and money to prospectors, who may be tempted to explore those bands in the belief that they have discovered a graphite mine. As I have been consulted several times by prospectors at Hat Portage respecting the value of these carbonaceous schists, and as some seemed persuaded of their graphitic character, it may be useful to repeat that specimens from the band of carbonaceous schists that crops out on the shore, one mile south of the mouth of Ptarmigan Bay, examined in the laboratory of the Survey by Mr. Frank Adams, yielded only 3.773 per cent of carbonaceous matter, after drying at 100°C; and another specimen lost 7.47 per cent on ignition, nearly all, probably, carbonaceous. The opinion of Mr. W. F. Downs, chemist to the Joseph Dixon Crucible Co., Jersey City, is decisive as regards its commercial value. Half a dozen specimens from different localities were submitted to him, and speaking of the general character of the schist, he says:—"It is hardly plumbeous, though certainly highly carbonaceous, and it lacks most of the distinguishing features of graphite. Its only possible economic value would be in the manufacture of cheap facings, but the ingredients of these are very cheap, so I see no value in it."

The origin and structure of these schists presents a difficult problem. A chemical analysis yields very little evidence as to the origin. So much alteration has taken place both in the removal of certain ingredients, and the introduction of others that the evidence obtained from an analysis is largely of a speculative nature,

An analysis gives:—

SiO ₂	76.10
TiO ₂	0.44
Fe ₂ O ₃	7.48
Al ₂ O ₃	4.14
CaO.....	0.74
MgO.....	0.84
Sulphur.....	0.74
Carbon.....	3.24
Loss on heating to 150°C.....	0.10

The writer would draw attention to the form in which the carbon now occurs. Very little, if any, is true graphite but is amorphous carbon and can be burnt in air at temperatures no higher than a Bunsen flame. It is quite reasonable to expect that if this were organic matter deposited simultaneously with these Keewatin rocks, it would by this time have been converted into true graphite. All our Archaean rocks containing carbon at all, have it in the form of graphite.

¹Lawson, A. C., Geol. Surv. Can., Ann. Rep., 1885, Part CC, p. 150.
²Greenland, G. W., Trans. Can. Inst., Vol. XVI, 1913, pp. 556-5.

Fig. 5. Surface plan of graphite showings on lots 1 and 2, concession II, township of Lyndoch, Ont.

Carbonaceous schists, usually pyritiferous, and in a general way similar to those described above, occur also in the Kenora district, 14 miles southwest of English River station, on the Canadian Pacific railway; also in the Nipissing district, McCart township, concession V, lot 7, northwest of Parquis Junction, on the Timiskaming and Northern Ontario railway. Finer-grained carbonaceous schist, running about 8 per cent carbon, occurs on the north shore of Beaver lake, in Saskatchewan, near the Flin Flon and Mandy mines.

PROVINCE OF QUEBEC.

Graphite mining in Canada had its inception in the Province of Quebec, about the year 1846, when a deposit of crystalline graphite, or plumbago, was worked on lot 10 in range V of the township of Grenville, in Argenteuil county. Work was continued for a few years, and the property then lay idle for a number of years, being subsequently re-worked as the Miller mine, and later again, in 1899, as the Keystone mine.

Disseminated flake graphite was first mined in 1866 on lot 24 in range VIII, and lots 23 and 24 in range XI, of the township of Lochaber, in Labelle county. The output of these mines was refined at a mill erected on the Blanche river, on lot 28 in range X of the above township. These operations were conducted by the Lochaber Plumbago Company. At this period, considerable interest commenced to be evinced in the possibilities of the graphite resources of this district, and Logan, in the Report of Progress of the Geological Survey for 1863-6, pp. 22-27, describes a number of localities in Buckingham and Lochaber townships at which graphite deposits had been discovered and in some cases worked in a small way. Among these early operators, the New England Plumbago Company is stated to have acquired mining rights on lot 22 in range VII of Buckingham, as well as on lots 1 W $\frac{1}{2}$ and 2 E $\frac{1}{2}$ in range III, and lot 17 in range IX of the township of Wentworth. On pp. 218-23 of the above report, T. Sterry Hunt discusses at some length the quality, occurrence and possible origin of the graphite from the Buckingham district.

In the Report of Progress for 1871-2, p. 148, graphite is stated to have been worked during the preceding three years on lot 28 in range VI of Buckingham by the Canada Plumbago Company, the production being 450 tons.

H. G. Vennor, in Report of Progress for 1873-4, pp. 139-43, describes a number of graphite occurrences in the township of Buckingham, some of which had been worked in a small way.

In the Report of Progress for 1876-7, pp. 308-20, Vennor enters into greater detail regarding the occurrences of graphite in this area and the mining work carried out upon them. The most important operations to date appear to have been those of the Buckingham Company, on lot 27 in range VII, and of Messrs. Pugh and Weart, on lot 27 in range VI. The properties of the Canada Plumbago Company were taken over in this year by the Montreal Plumbago Company. Graphite mining appears to have about come to a standstill in 1876. On pp. 489-510 of the above Report, G. C. Hoffmann gives the results of a number of analyses conducted on samples of Canadian graphite, both crude and refined, and discusses the relative quality of Canadian and foreign graphites.

In Report of Progress for 1882-4, p. 30—2 J, J. F. Torrance states that in these years all Canadian graphite mines were idle, and attributes the reason for the stagnation of the industry to the poor grade of refined product turned out by the mills.

In 1888, mining was resumed at several localities in Quebec, and was continued thenceforth intermittently till 1899, the chief operators being the Walker Plumbago Mining Company, range VIII, lot 19; the North American Graphite Company, range VI, lot 28; and the Buckingham Graphite Company, range VI, lots 26 and 27, all in the township of Buckingham.

In the Annual Report for 1897, Vol. X, pp. 66-73 S. A. A. Cole describes the deposits and workings at the above mines in detail.

All the mines in the Buckingham district were practically idle from 1899 till 1906. In the latter year, several new mills were erected, two near Buckingham and one at Calumet, in Argenteuil county; and from that time to the present, operations have been conducted intermittently at the various properties. Several other mills have been put up and other deposits developed, but none of the mines or mills have been run continuously, and there have seldom been more than a couple of mills in operation at one and the same time. With the abandoning of the original wet system of concentrating, which, while perhaps wasteful of graphite, was cheap to operate, graphite refining became largely the subject of experiment on a large scale. These experiments have, on the whole, been both unsatisfactory and costly, with the result that the graphite industry is still on a far from established basis. It is to be hoped that the work that has lately been done in adapting oil flotation to graphite ores, may remedy this state of affairs and enable the exploitation of graphite deposits to be taken up with a greater measure of success and profit than has heretofore been the case.

Hitherto, a graphite content of at least 12-15 per cent has been considered requisite in an ore that would repay treatment by the concentration methods in use, and, consequently, large bodies of lower grade ore have been left at many of the mines as unprofitable to work, while search was made for fresh deposits of rich material. Much of this low grade ore should prove capable of profitable treatment by flotation. Probably the maximum graphite content of the flake graphite ores of the district is 25-30 per cent, but only selected material will run as high as this. This rich ore occurs as streaks, which merge into material of gradually diminishing graphite content, and when the latter falls below 10 per cent, a deposit is usually abandoned. Flotation, which combines cheaper and more efficient methods of recovery of the graphite content of the ore with the ability to treat considerably lower grade material, should do much to place the graphite industry on a profitable footing, if this is in any way feasible.

The graphite deposits of Quebec Province lie mainly in the township of Buckingham, where they have been found to extend almost from the border of the Palæozoic rocks, that overlie the Archæan in the southern part of the township, as far north as range XII. This district is served by the North Shore, Montreal-Ottawa branch of the Canadian Pacific railway, the nearest station being Buckingham junction, which connects with the town of Buckingham, 3 miles to the north, by a spur line.

Scattered deposits also occur in the county of Argenteuil, to the east of the above area, while occurrences have been recorded, but not worked, at many points throughout the area of crystalline rocks extending westward into Pontiac county. The deposits hitherto found in this latter district appear to be too small to be of economic importance.

The fluctuating production of graphite from this Province from 1898 to 1918 is shown by the figures of value in the appended table:—

Value of Graphite Produced in the Province of Quebec, 1898-1918.¹

Year.	Value.	Year.	Value.
	\$		\$
1898.....	8,500	1909.....	10,339
1899.....	14,257	1910.....	15,896
1900.....	9,464	1911.....	33,613
1901.....	4,090	1912.....	50,680
1902.....	2,160	1913.....	9,620
1903.....		1914.....	18,886
1904.....	2,300	1915.....	2,416
1905.....		1916.....	75,776
1906.....	8,300	1917.....	99,024
1907.....	5,000	1918.....	17,760
1908.....	165		

The more important occurrences of graphite in the Province are listed in the following pages. In addition to these, outcrops of graphite, both of the flake and plumbago varieties, occur at many scattered points in the townships of Buckingham, Loehaber, Chatham, Grenville and others, in Pontiac, Hull, Labelle and Argenteuil counties.

ARGENTEUIL COUNTY.

Township of Grenville.

Ranges II and III, lots 16.—These lots were worked in a small way in 1901 by the Calumet Mining and Milling Graphite Company, who mined about 100 tons of ore. In 1906, the Company erected a mill near Calumet station and carried out some mining during this and the succeeding two years. Both mine and mill have been idle since 1908.

The workings comprise several small surface pits, an open cut with a 50-foot shaft sunk at one end, and a drift carried into the side of a ridge close to the mill. This drift has now caved in, and it was found impossible to make any examination of it. It is stated, however, that neither in this nor in any of the other workings were graphite bodies of any size encountered. The graphite occurrences on these lots consist mainly of plumbago, which is found in veins ranging from 3 to 18 inches in width. About 100 tons of such material is stated to have been obtained during the period of operation.

The property lies just west of Calumet station, on the Montreal-Ottawa, North Shore line of the Canadian Pacific railway. The mill which is situated alongside the track, is a large, 3-story, wooden structure, and was equipped with dry concentrating machinery, run by electric power. Very little ore is reported to have been treated. Much of the electric equipment has now been removed and part of the building has subsided.²

The property is at present owned by the estate of J. K. Ward; administrator, C. I. Root, 8 Rosemount Avenue, Westmount, Que.

References:—

Reports of the Department of Mines, Province of Quebec, 1901-1908.
Monograph on Graphite, Mines Branch, 1907, p. 40.

¹ Compiled from Annual Reports of the Department of Mines of the Province of Quebec.
² Note.—The mill has since been converted into a calcining plant for magnesite.

Value.

\$
0,339
5,896
3,613
0,680
9,620
8,886
2,416
5,776
9,024
7,760

listed both in the others,

way in mined lumet g two

with a ridge possible in this account- abago, at 100 iod of

ntreal- e mill cture, ower. lectric led. 2 dmin-



CANADA
DEPARTMENT OF MINES
MINES BRANCH

HON. MARTIN BURRIS, MINISTER. R. G. MCCONNELL, DEPUTY MINISTER.

EUGENE HAASEL, PH. D., DIRECTOR.

1919

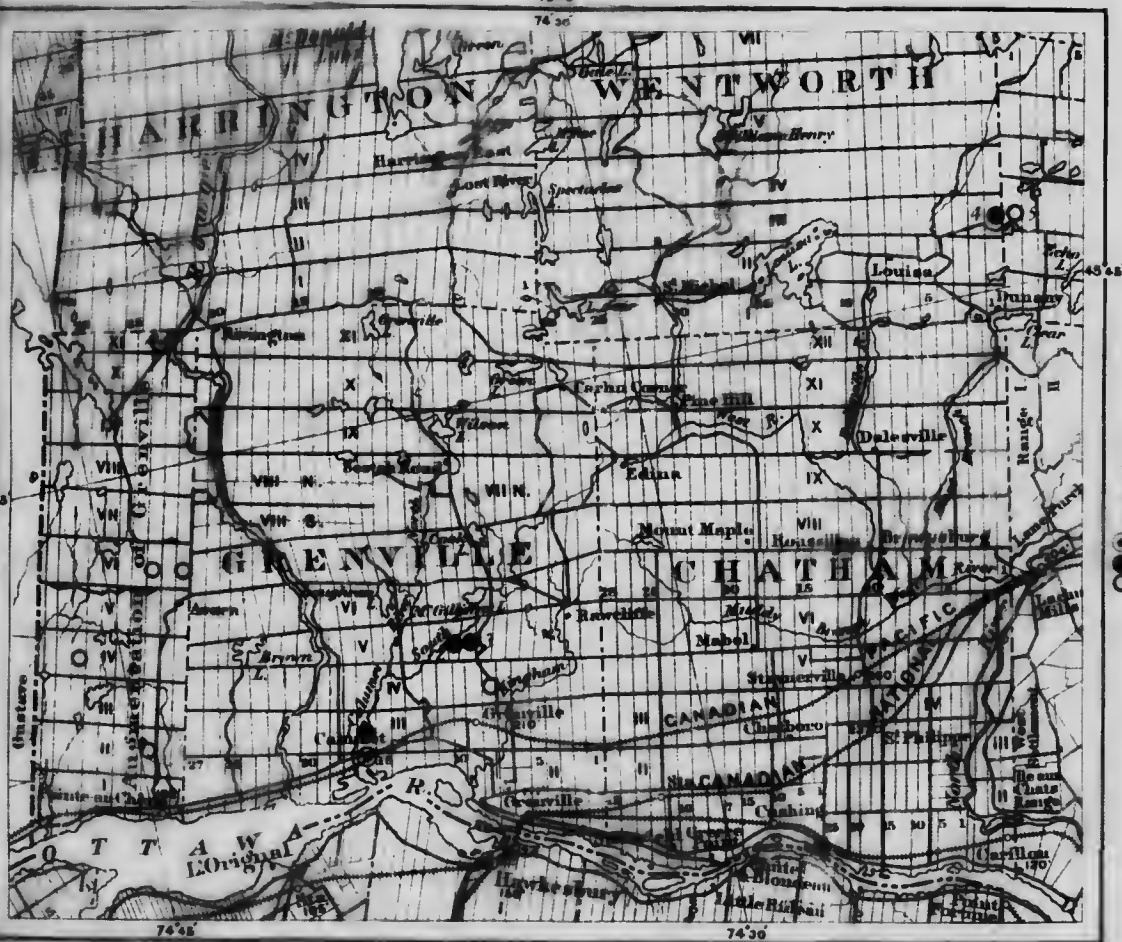

Reference

- 1 Calumet Mining and Milling Graphite Co.
- 2 Müller or Keystone
- 3 National Graphite Co.
- 4 Canadian Graphite Co.
- 5 Patterson
- Mine equipped with mill
- Mine
- Undeveloped prospect

GRAPHITE OCCURRENCES

IN

GRENVILLE AND WENTWORTH TPS., QUEBEC

Scale: 3.95 miles to one inch



Range V, lot 10.—Known as the Miller mine. This occurrence of graphite was perhaps the earliest to be exploited in Canada, having been worked around the year 1845 by R. V. Harwood, of Vaudreuil. The deposit was examined, and reported on, by Logan in several of the earlier (1845 to 1863) reports of the Geological Survey. Five veins of plumbago were stated to occur, varying from 5 to 22 inches in thickness. After lying idle for a number of years, the property was taken over in 1889 by Messrs. Rae & Co., of Montreal, but very little work was done. In 1900, the Keystone Graphite Company, of Wilkesbarre, Pa., conducted operations, and are said to have shipped 25 cars of hand picked plumbago. This constitutes the last work on the property.

While a few small surface pits have been opened at various places on this lot, operations have chiefly centered in one main excavation. This is an open cut, 200 feet long, 30 feet deep for the most part but increasing to 75 feet in a shaft-like opening midway of its length, and 20 feet wide at both ends, while at the shaft the width increases to 50 feet. The course of this opening is mainly northeast, but is not constant for its entire length, the pit rather describing the arc of a circle.

The greater part of the graphite found here is of plumbago type, with a small amount of large flake included in the associated minerals. The ore-body is of contact metamorphic type, similar to that occurring on lots 15 and 16, range VII, township of Amherst, about 30 miles to the north. The plumbago occurs associated with such minerals as wollastonite, vesuvianite, garnet, titanite, pyroxene, calcite, etc., the whole forming an aggregate of coarsely crystallized individuals and probably constituting a silicated zone at the contact of an intrusive with crystalline limestone. The graphite is thus intimately intergrown, for the most part, with foreign mineral substance, and though a proportion can be cobbled sufficiently clean to be marketed, a greater proportion will require milling in order to turn it into a No. 1 product.

All of the graphite shipped from this mine was in a hand cobbled state, there being no mill on the property. In addition to the type of ore described above, small veinlets of plumbago are seen traversing the country rock on the west side of the pit. Most of the richer ore is reported to have come from the shaft put down in the middle of the cut. This shaft has been sunk alongside a well defined slip-face or fault, (see Plate XVI) having a northeasterly trend.

The intrusive, to the action of which the formation of the ore-body may be ascribed, is not exposed in the accessible portions of the workings and material of a pegmatitic nature was not observed on the dumps. The latter contain, however, considerable quantities of a grey, porphyry-like rock, which is of younger age than the other members of the Archæan complex and cuts the latter at the north end of the big pit.

Some development work was commenced in 1899 by the National Graphite Company, of Scranton, Pa., on the adjoining lot to the east (V. 9), but was soon afterwards abandoned.

The property lies $3\frac{1}{2}$ miles by road north of Grenville station, on the Montreal-Ottawa, North Shore line of the Canadian Pacific railway, and is understood to be owned by S. Hirsch, Wilkesbarre, Pennsylvania.

References:—

Geol. Surv., Can., Report of Progress, 1849-50, p. 111; 1851-2, pp. 42 and 118; Ann. Rep., Vol. IV, 1888-9, p. 139K; Vol. XII, 1899, p. 73 O;

Summary Report, 1916, p. 214; Catalogue of Economic Minerals of Canada at Philadelphia International Exhibition, 1876, p. 121.

Report of Department of Colonization and Mines, Province of Quebec, 1900, p. 16.

Monograph on Graphite, Mines Branch, 1907, p. 39.

Township of Wentworth.

Range III, lots 1A and 1B.—This property was taken up for graphite originally by the New England Plumbago Company, in 1863. No work, other than of a prospecting nature was done, however, until 1911, when the Canadian Graphite Company, 34 Coristine Building, Montreal, Que., acquired the property. This Company, who are the present owners, have carried out a certain amount of development work on various parts of the above lots, and by surface pits and trenches have shown the presence of graphite over a considerable area. In 1918, lot 1B was diamond-drilled by an American syndicate, under option of purchase, and the results are stated to have shown the existence of a large body of disseminated flake ore.

The graphite occurs disseminated in a band of calcareous gneiss some 30 feet wide, which extends for a distance of 600 feet along and paralleling the side of a low ridge. This band is in contact to the south with a body of anorthosite, and to the north with a belt of quartzite. The greatest depth reached in the drilling operations on this ore-body was 212 feet, and at this depth the hole is stated to have been still in ore. The average graphite content is given as 15-20 per cent, and the flake is of good size and quality.

A 100-foot adit was driven into the south side of a parallel ridge, about $\frac{1}{4}$ mile to the south of the above deposit, with the intention of working several veins of plumbago which outcrop here. Results were not encouraging, however, and work was abandoned.

The property lies 12 miles north of Lachute, on the Montreal-Ottawa North Shore line of the Canadian Pacific railway.

The adjoining lots to the east, namely lots 1A and 1B, in the township of Gore, also carry showings of graphite, and a small amount of surface work has been conducted on them. This property is owned by T. W. Patterson, 34 Coristine Building, Montreal.

LABELLE COUNTY.

Township of Amherst.

Range VII, lots 15 and 16.—This property was first actively exploited in 1909 by Graphite, Ltd., of Montreal, who put down a 90-foot shaft, besides carrying out a lot of surface work. Work was prosecuted for several years, and in 1912 a large mill was erected. After only a few months work, however, the Company went into liquidation in 1913. For six months during 1914, work was conducted under lease by Messrs. Reilly & Layfield, and again for a few weeks in 1916, under option, by the Multipar Syndicate, of London. Since the last-named ceased work, the property has been idle: it is now understood to be under purchase by Graphite Products, Ltd., of 55 St. Francois Xavier Street, Montreal, who contemplate installing flotation treatment in the mill, and who also own lots 11 to 14 and 20, 21 in the same range.



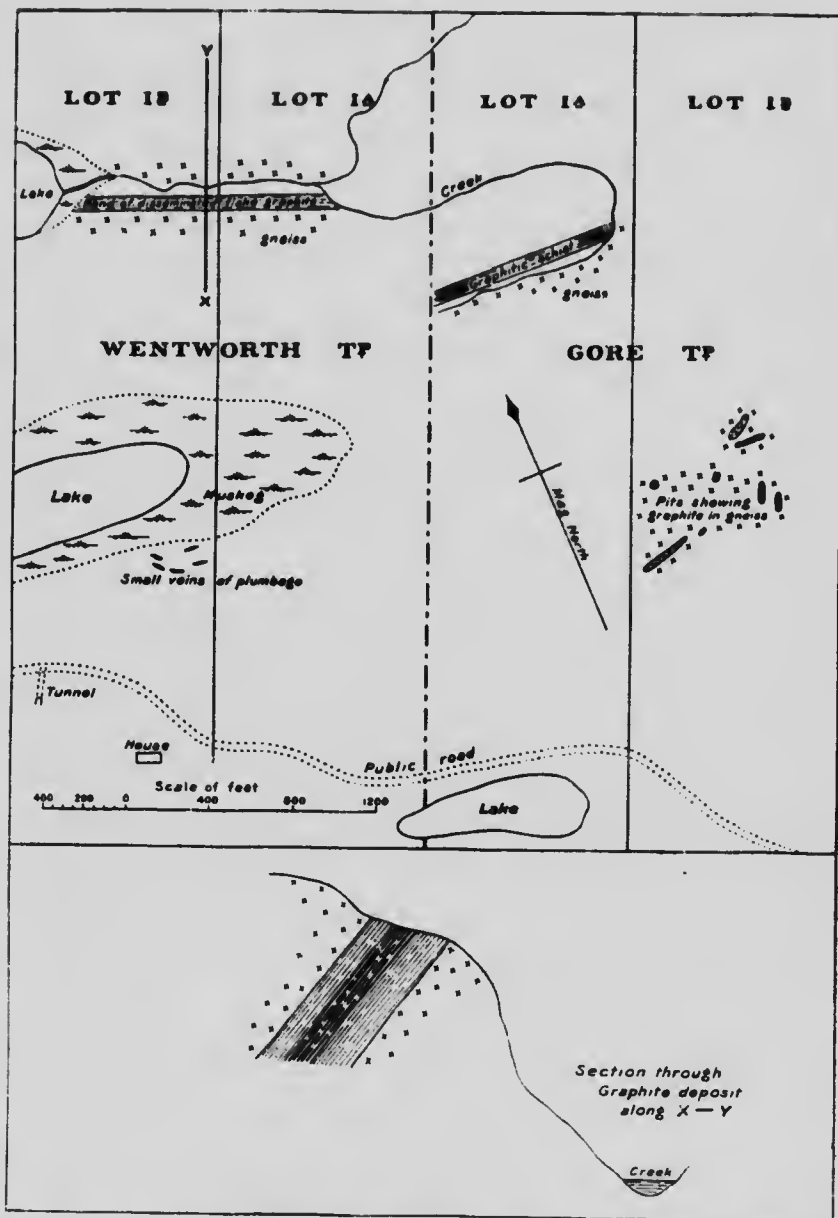

Fig. 6. Plan and section of graphite deposit, lots 1A and 1B, township of Wentworth, and lots 1A and 1B, township of Gore, Que.

The graphite body on these lots is in the nature of a contact deposit between crystalline limestone and an intrusive rock, probably of gabbro type. The occurrence closely resembles that at the Miller mine, on lot 10

in range V of Grenville township, being characterized by an abundance of typical contact metamorphic minerals, such as wollastonite, diopside, titanite, hornblende, vesuvianite, scapolite, etc. These minerals, together with the graphite, occur as an aggregate of coarsely crystallized individuals in a silicated zone in the Grenville limestone, probably at its contact with pegmatite. The underground workings, being flooded when the property was visited, could not be examined.

These workings consist of a shaft 125 feet deep, from which levels were run at 40, 80, and 125 feet. The extent of these levels was not ascertained but is said to be considerable. From the uppermost level, a raise has been put through to the surface, terminating in an open cut, 50 × 30 feet and 30 feet deep.

While a certain amount of flake graphite occurs disseminated in the adjacent limestone and also, in greater quantity, in narrow bands in this rock, the majority of the ore consists of foliated graphite, approaching plumbago in character. Most of this, however, is so intimately associated with foreign mineral substance as to require milling in order to fit it for market. A certain proportion might, perhaps, be cleaned sufficiently by hand cobbing to render it suitable for crucible work, but it would probably prove more expedient to put the whole of the ore through a milling process.

The irregular form of the ore-bodies, which appear to consist of pockety and discontinuous masses, enclosed in limestone, necessitate the mining of large quantities of dead rock, so that the proportion of graphite to the amount of rock mined is low.

The workings are connected by 150 feet of tramway with the drying kiln, situated back of the mill building. The latter is a large 3-story, wooden structure equipped with dry concentrating machinery of the usual type (see pp. 74-8), and has a capacity of 200 tons of ore per 24 hours.

According to Cirkel¹, the graphite bearing zone here has a width of 200 feet and extends for a distance of over two miles. In this zone occur lenticular bodies and nests of graphite ranging up to several feet in diameter, with other irregular shoots of both plumbago and disseminated flake. From 640 tons of rock mined, 15 tons of cobbing ore and 227 tons of milling ore were obtained. By cobbing ore is meant ore that can be cleaned sufficiently by hand to be marketed without undergoing crushing and refining. The milling ore is stated to carry about 15 per cent of graphite.

The mine lies 12 miles from St. Jovite station, on the Montreal-Mont Laurier branch of the Canadian Pacific railway.

References:—

- Reports of the Department of Mines, Province of Quebec, 1910 to date.
- Monograph on Graphite, Mines Branch, 1907, p. 42.
- Geol. Surv. Can., Memoir 113, 1919, pp. 38-43.

Township of Buckingham.

Range IV, lots 1, 2, 3, $\frac{1}{2}$ 4, and $\frac{1}{2}$ 5.—Property of the Quebec Graphite Company, Craven House, Kingsway, London, W.C. Mining was commenced here in 1912 by the Quebec Graphite Company, who erected a mill and continued to operate till 1914. In 1915, the Company was reorganized and its name changed to the New Quebec Graphite Company. The latter have produced steadily from 1915 to 1918, but

¹Trans. Can. Min. Inst., Vol. xv, 1912, pp. 261-9. Can. Mining Jour., Vol. 33, 1912, pp. 435-7.

dance
pside,
gether
iduals
with
perty

were
ained
been
t and

n the
n this
ching
iated
it for
ently
would
illing

st of
ce the
phite

rying
story,
usual
s.

th of
occur
acter,
flake.
illing
eamed
and
phite.
Mont

date.

uebec
ining
who
pany
phite
, but

435-7.



Base map



MICROCOPY RESOLUTION TEST CHART

(ANSI and ISO TEST CHART No. 2)

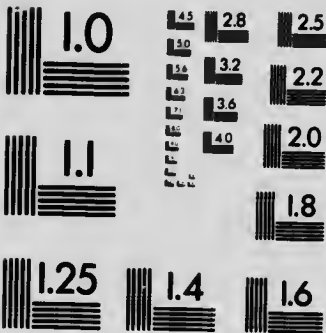

APPLIED IMAGE Inc

1653 East Main Street
Rochester, New York 14609 USA
(716) 482 - 0300 - Phone
(716) 288 - 5989 - Fax

CANADA
DEPARTMENT OF MINES
MINES BRANCH

HON MARTIN BURRELL, MINISTER, R G MCCONNELL, DEPUTY MINISTER
EUGENE HAANEL, PH D, DIRECTOR.

1919

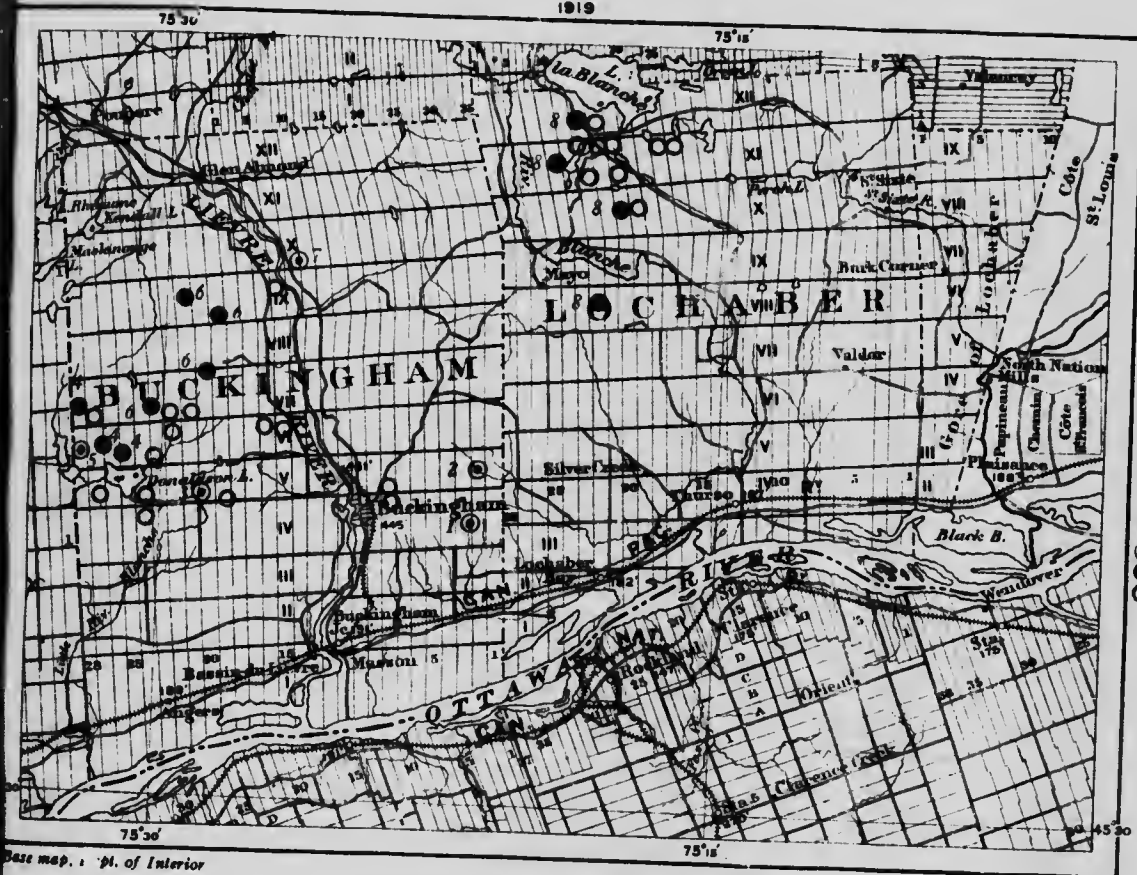

Reference

- 1 New Quebec Graphite Co.
 - 2 Bell Graphite Co.
 - 3 Plumbago Syndicate (Dominion mine)
 - 4 Pugh and Weart
 - 5 Buckingham Graphite Co. (North American mine)
 - 6 M. P. Davis (Walker mine)
 - 7 Consolidated Graphite Mining and Milling Co. (Peerless mine)
 - 8 Lochaber Plumbago Mining Co.
- Mine equipped with mill
○ Undeveloped prospect

Base map: 91. of Interior

GRAPHITE OCCURRENCES
IN
BUCKINGHAM AND LOCHABER Tps., QUEBEC

518

Scale: 3.95 miles to one inch

operations were suspended in the latter year, pending alterations to the mill.

Most of the ore raised has been obtained from a number of surface openings scattered over the above lots, the majority being on lot 3, on which lot the mill also is situated. Two shafts were also sunk on this lot, but encountered little ore and were abandoned after reaching a depth of 70 feet.

All the graphite encountered on this property is of the disseminated flake type, which occurs in a series of bands in calcareous gneiss. No very large deposit has hitherto been discovered, but small bodies of ore appear to be distributed rather extensively all over the property. From exposures in one of the larger surface pits, it would appear probable that at this locality, as at a number of others carrying flake graphite, both in Quebec and Ontario, the graphite ore-bodies are to be looked for at or near the crests of anticlinal or drag folds in the gneiss (see Plate XVIII). In several of the pits, slickensided walls were noticed bordering the graphite bodies.

The graphitic zones are commonly highly weathered at the surface, due to the decomposition of sulphides present, and a deposit of rusty-coloured, sandy material is often a good indication of graphite. The weathering, however, is purely surface and persists only for a few feet down.

A large portion of the above lots is bush-covered, and carries a soil overburden, so that trenching is generally necessary in prospecting for new ore-bodies.

The ore consists of disseminated flake of good quality and size, mixed with mica, quartz, calcite, pyrrhotite and lime silicates. The average mill-feed is stated to run 14 per cent graphite. Here, however, as at other mines in the district, only the richer ore is considered a milling proposition, and the outer zones of lower grade rock which usually border the richer portions of the deposit are left. The graphitic bands are usually narrow, a thickness of 9 feet being the extreme.

Mill.

The mill is a 3-story wooden structure, with a capacity of 40 tons of ore per 24 hours. The concentrating system is a wet one, designed by Krupp, and is modelled along lines quite distinct from any other graphite mill in the country. The greater part of the mill equipment was supplied by the Krupp firm, and the concentrating process consists, briefly, in grinding in a ball mill, followed by a tube mill, concentrating on a series of Ferraris-type tables, followed by classifying in hydraulic classifiers. The concentrates are de-watered in a vacuum filter, dried, and then pass to polishing rolls. (For complete flow sheet of mill, see p. 87). The recovery is stated to be 65-70 per cent of the graphite in the ore.¹

Power is furnished by a 160 H.P. Diesel oil engine, using crude oil.

Twelve men are employed in the mill and about 25 outside.

The property lies 3 miles east of Buckingham.

References:—

Reports of the Department of Mines, Province of Quebec, 1912 to date.
Monograph on Graphite, Mines Branch, 1907, p. 37.

Range IV, lot 8 N $\frac{1}{2}$.—Good showings of plumbago and flake graphite are reported to occur on this property, which was taken up in 1916 by J. E. Hardman, 107 St. James Street, Montreal. Only work of a prospecting nature has been carried out.

¹NOTE.—This mill is at the present time being remodelled for Callow pneumatic oil flotation

Plumbago, as well as disseminated flake graphite, is stated to occur also, on the adjoining lot 8 S $\frac{1}{2}$, in range V.

Range V, lots 1, 2, and 3.—Known as the Bell mine, and owned by the Bell Graphite Company, Friar House, New Broad Street, London, E.C. Work was commenced here in 1906 by the present owners, who developed a bed of disseminated flake ore on lot 2 W $\frac{1}{2}$ and erected a mill. Mining operations were continued till the end of 1912, and a considerable tonnage of ore was run through the mill. Since 1912 the property has lain idle.

The workings are confined to the escarpment which forms the northerly termination of the small plateau on which the workings of the New Quebec Graphite Company are situated. In the face of this bluff, a series of overlying, short drifts have been run in on a 12-foot ore-body having a northerly trend and a dip of 60° to the west. The ore-body is a graphitic, calcareous band enclosed in gneiss, and can be traced for some distance up the slope. The best ore is stated to have been found in a winze at the base of the hill, from which point good showings are said to have been found on the northerly extension of the ore-body below the present workings. The ore-body has been stoped out from the different drifts, leaving supporting pillars. The horizontal distance from the lowest workings at the foot of the hill to a point below the limit of work up the slope is 500 feet, and the total distance for which the graphitic band has been traced is stated to be 2,000 feet. About 3,000 tons of ore have been mined from the above workings, which are connected with the mill by a tramway. The lowest drift has been carried a distance of 200 feet into the hill. The graphite content of the ore is said to have averaged 8 per cent.

About 30 feet to the east of this ore-body, a small amount of work has been carried out on a narrower, parallel graphitic band.

The property lies 4 miles east of Buckingham village.

Mill.

The mill consists of a large, 3-story wooden structure, the smaller wing of which is the original mill built in 1907, the west section being added in 1910.

The mill system was dry throughout and was modelled along the lines shown in the flow sheet on p. 76, concentration of the ore being effected by means of alternate crushing between rolls of flour mill type and screening. At one stage, experiments were conducted with a patented, cone-shaped oil flotation tank, but results were not satisfactory.

Power was derived from a 400 H.P. compound engine, steam being supplied by two 200 H.P. Davey-Paxman boilers.

Most of the mill equipment still remains in the building, but the latter is in bad condition, owing to subsidence of its foundations.

References:—

Report of the Department of Mines, Province of Quebec, 1910, p. 63.

Report on the Mining and Metallurgical Industries of Canada, Mines Branch, 1907-8, p. 496.

Range V, lot 19 S $\frac{1}{2}$.—Worked in a small way about the year 1865 by Mr. Labouglie. "Lenticular masses of graphite in crystalline limestone," as well as small veins of plumbago, occur on this lot (St. Mary mine) as well as on the adjoining lot 20. On lot 24 in the same range (St. Louis mine), a band of graphite in limestone was worked by the above, several pits being sunk and about 50 tons of ore secured.

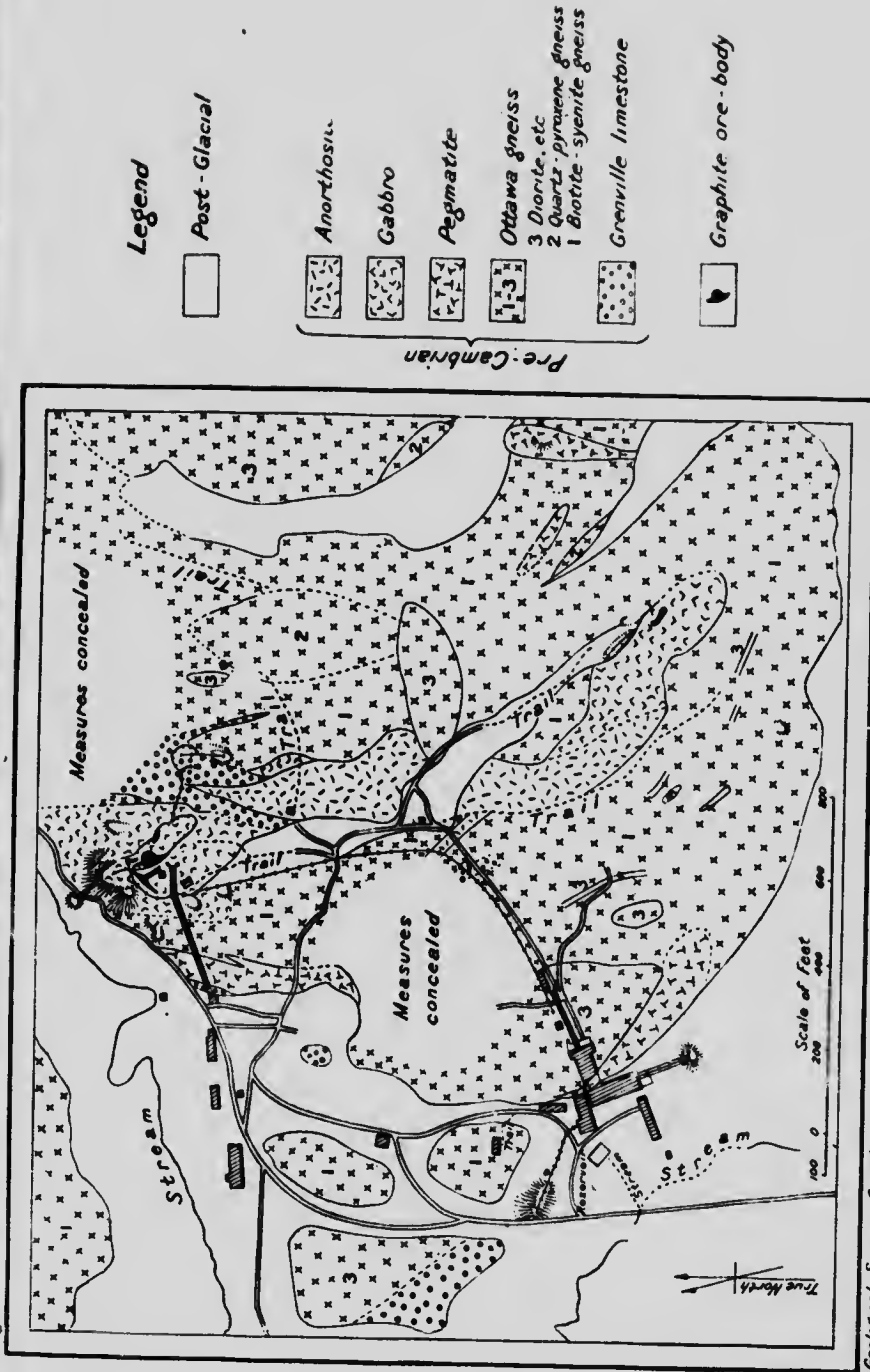

Geological Survey, Canada
 Fig. 7. Geologic relationships at Dominion mine, range V, lots 20 and 21, township of Buckingham, Que

Vennor reports the above properties as long since abandoned when visited by him in 1876, and no further work upon them has been done.
Reference:—

Geol. Surv. Can., Report of Progress, 1863-6, pp. 23-5; 1876-7, pp. 309 and 318.

Range V, lots 20 and 21.—Known as the Dominion mine. This mine was opened in 1910 by the Dominion Graphite Company, of Toronto, who erected a large mill on lot 21 in 1912 and conducted mining and milling operations for about six months, when the Company went into liquidation. In 1916 and 1917 mine and mill were operated under option by Plumbago Syndicate, 1104 Excelsior Life Building, Toronto. The mill was closed down during the greater part of 1918, pending the installation of an experimental, Callow oil flotation unit, but before the process had been properly tried out, the mill was destroyed by fire.

This property was one of the best equipped mines in the district, but it would appear that the plant erected was out of all proportion to the amount of ore available and that lack of ore contributed to the failure of operations.

The principal workings lie on a low ridge, on the side of which the mill was erected. The latter was connected with the main pit by 1,000 feet of tramway, the ore being hauled by locomotive. The principal opening is a large open pit on the line between lots 20 and 21. This pit (Lime pit) measures 150×80 feet and is 75 feet deep. Practically all the ore taken off these lots was obtained from this opening, which follows irregular bodies of graphitic limestone. At this point, a body of limestone appears to have been caught up in a large mass of gabbro, and the graphite follows the approximate contact of this rock with the limestone. Graphite is found to a lesser extent, also, disseminated through the mass of the limestone, as well as along joints and seams in it, and in smaller amount in the igneous rock. The latter forms a body of considerable size, and appears to have disrupted the limestone, with the result that masses of limestone occur separated by "horses" of gabbro.

Other small, surface pits exist on the above lots, but have yielded comparatively little ore. The Plumbago Syndicate obtained most of its ore from what is known as the Stewart pit, on lot 23 in the same range, and from the Hogg lot, 23 in range IV. At the former, two small surface pits have been opened on a promising body of ore. The deposit lies rather flatly and is capped where opened up by 10 feet of limestone. The ore consists of banded graphitic limestone, and the deposit, though measuring only a few feet in thickness, appears to be well defined. On lot 23, range IV, an open cut measuring 100×25 feet was worked in 1917, a well defined band of flake ore, occurring along the contact of gneiss with pegmatite, being exploited to a depth of 25 feet. The occurrence here is characterized by flake of phenomenal size, individuals over 5 inches in diameter being found.

Mill.

The mill, situated on lot 21, was a large, wooden building erected at the foot of the ridge on which the main pit is situated. The mill system was dry throughout, and was modelled on the usual lines of Canadian dry practice (see pp. 74-8). The ore, trammed from the mine, was dumped into pockets from which it was drawn into cars and taken up an inclined skipway to the kilns (Plate XXVIII). The latter were fired with wood.

Power was furnished by one 450 H.P. Goldie-McCulloch engine, supplied by three 150 H.P. boilers. The actual power consumption in the mill was stated to be 225 H.P. Coal was used for firing the boilers, the daily consumption being 12 tons. The mill capacity was 60 tons of ore per day.

References:—

Geol. Surv. Can., Summary Report, 1911, p. 284; Guide Book No. 3, International Geological Congress, 1913, p. 105. (Contains a geological map, showing the relations of the associated rocks at this mine.)

Report of the Department of Mines, Province of Quebec, 1917, p. 57.

Range V, lot 27.—Worked about 1870 by West and Company, who shipped "twenty barrels of pure graphite."

Reference:—

¹Geol. Surv. Can., Report of Progress, 1873-4, p. 141.

Range VI, lot 27.—Worked by Messrs. Pugh and Weart in a small way about the year 1872. A considerable amount of graphite is stated¹ to have been taken from a 4-foot vein of plumbago, upon which a pit 40 feet deep was sunk, in addition to an open cut 60 feet in length. This lot is stated to have yielded 200 barrels of pure, lump plumbago. Vennor reports this mine as abandoned when visited in 1876. All the graphite shipped from this lot was in a hand cobbled state.

The above also owned lot 26 N $\frac{1}{2}$ in range V, lots 25 and 26 in range VI, and lots 25 S $\frac{1}{2}$, 26 S $\frac{1}{2}$, and 28 in range VII. Most of the ore mined came off lots 25 and 26 in range VI.

In 1891, the property was more actively exploited by S. J. Weart, of Jersey City, who erected a mill on lot 25 in range VI. The mill system is described as "separating by air currents and the bolting of the crushed and powdered material,"² the ore being first dried in a kiln. This mill apparently represents the first application of dry concentrating methods to graphite in Canada. The graphite refined in this mill was shipped to the Weart plant in Jersey City, where it was used in the manufacture of self-lubricating bearings. The mine and mill were operated intermittently by the above up till 1895, when the property was leased by the Buckingham Company. The latter continued intermittent operations until 1903, since which time work has been conducted. The mill was subsequently destroyed in 1910. The workings comprise ten main pits, all open-cast: the largest is described in detail in the reference below.³ In one of the larger pits a vein of plumbago measuring 18 inches at the surface was followed to a depth of 70 feet, where it split up into a number of narrow stringers. This vein occurs in gneiss, adjacent to a pegmatite mass. In a second pit, which has yielded most of the ore taken off the property and is 85 feet long, small veinlets of plumbago traverse a band of gneiss carrying disseminated flake. The graphitic zone here, also, occurs at the contact of the gneiss with pegmatite.

The property lies 7 miles from Buckingham, and is owned by Spencer Weart, 273 $\frac{1}{2}$ Washington Street, Jersey City, N.J.

References:—

Geol. Surv. Can., ¹Report of Progress, 1873-4, p. 143, and 1876-7, pp. 309 and 315; ²Annual Report, Vol. V, 1890-1, p. 72 SS; ³Annual Report, Vol. X, 1897, p. 68 S.

Report of the Commissioner of Colonization and Mines of the Province of Quebec, 1896-7, p. 93; Reports of the Department of Mines, Province of Quebec, 1899-1903.

Range VI, lot 28.—North American mine. This property was worked between 1870 and 1872 by the Canada Plumbago Company, 450 tons of refined graphite being produced. In 1875, the holdings of the above were taken over by the Montreal Plumbago Mining Company, and in the same year the refinery was destroyed by fire and the property abandoned. Vennor states that both plumbago and beds of disseminated flake occur on this lot, the most important of the latter measuring 7 feet in thickness. This bed was worked by an open cut 350 feet long and 25 feet wide, and later two small shafts were sunk in the bottom of this pit 200 feet apart and 30 feet deep. A 70-foot shaft was also sunk on the principal vein of plumbago. The crude ore from these workings was shot down the hill into scows, which carried it across Twin lake to the Company's mill, situated on lot 28 in range V. This mill was erected in 1867, and treated the ore by the stamp and buddle system.

From 1873 to 1875 the only work carried on at this mill was the manufacture of stove polish from stock.

The Company also owned lot 23 N $\frac{1}{2}$ in range V, as well as lots 1, 2, and 3 S $\frac{1}{2}$ in range X of the adjoining township of Templeton.

In 1895, the holdings were taken over by the North American Graphite Company, who erected a new mill on lot 28 in range VI, modelled on the wet concentration system, employing buddles. The mill equipment, as described by Obalski,² comprised a crusher, battery of ten stamps, cyclone grinder, four buddles, rotary dryer and two burrstones, as well as the necessary screens, etc. The mill capacity was 15 tons of ore per day, and the recovery 60 per cent.

The workings on this property are extensive, and comprise a number of surface pits as well as drifts carried into the hill rising between the mill and Twin lake. There are eight main openings, which are described in detail in the accompanying reference.¹ From the exposures in the various pits, there appears to be a series of parallel graphitic bands occurring in a belt about 300 feet wide and extending for a distance of some 2,000 feet. The largest opening is a drift run 300 feet into the hill just south of the mill. Two shafts have been sunk on this hill to meet the drift, which follows a band of graphite dipping 60° east. The ore-body is stated to attain a maximum width of 10 feet. The other workings lie to the south of the above drift, and have been opened on graphite bands having the same general direction as that worked near the mill. All the pits are connected by a tramway with the drying kiln, situated close to the mill building.

The above Company continued operations intermittently until 1901. In 1904, the Anglo-Canadian Graphite Syndicate acquired the property, and remodelled the mill, but went out of business after a few years of intermittent work.

In 1910, the Buckingham Graphite Company, who are the present owners, took over the mine and mill, and operated both for the greater part of the year. The mill process was dry throughout and in a general way similar to that described on pp. 74-8. The capacity of the mill was 60 tons of ore per 24 hours. After operating for two years, the Company abandoned work and the property has since lain idle. Some of the mill machinery has since been removed, and the building itself is in a dilapidated condition.

The mine lies 8 miles west of Buckingham.

References:—

Geol. Surv. Can., Report of Progress, 1876-7, pp. 309 and 316; Annual Report, Vol. IX, 1896, p. 548; Annual Report, Vol. X, 1897, p. 668; Monograph on Graphite, Mines Branch, 1907, p. 31.

²Report of the Commissioner of Colonization and Mines of the Province of Quebec, 1896-7, p. 93; Report of Department of Mines, Province of Quebec, 1910, p. 62.

Range VII, lots 21 S₂, 22, and 27 S₂.—These lots were taken up in 1875 by the Buckingham Company. Vennor¹ states that "as a source of pure lump plumbago, perhaps there are few others that can equal this location." Beds of disseminated flake also occur on these lots.

In addition the Company owned lots 15 N₁, 16 N₁, 22 and 23 S₁ in range VI. On lot 23, a number of beds of disseminated flake occur, as well as a 20-foot pegmatite dike carrying plumbago. The holdings of the Company also embraced lots 24 and 27 in range V, and lot 24 in range IV.

Very little is recorded as to the operations of the above Company, and little work appears to have been carried out.

Reference:—

Geol. Surv. Can., Report of Progress, 1876-7, pp. 312 and 318.

Range VIII, lots 20 and 21.—Known as the Walker mine, and opened in 1876 by the Dominion of Canada Plumbago Company, who erected a mill on the adjoining lot 19, which was connected with the mine by 1,000 feet of tramway. Vennor¹ describes the graphite as occurring on lot 20 in a 5-foot bed of disseminated flake, and on lot 21 in irregular veins, ranging up to 18 inches in width. A great number of these veins occur on lots 21 in both the seventh and eighth ranges, but the country rock being in many cases of a pegmatitic character and the veins generally narrow, most of the work performed by this Company was on the bed of flake ore on lot 20. A 9-inch vein of columnar or fibrous plumbago occurs on lot 21 in range VIII, on the contact of a mass of pegmatite with crystalline limestone. The mineral is very pure and has been pronounced equal in every way to the best Ceylon plumbago.

The method of concentrating the flake ore was by buddles, and crushing was carried out by a battery of 20 stamps. Stove polish was manufactured at the mill from the lower grades of product.

The Company also owned the adjoining lots to the south, lots 21 N₁, 23, and 24 in the seventh range, but carried out little work here.

After lying idle for a number of years, the property was taken over by W. H. Walker, or *Walker*, in 1886, and in 1889, 450 tons of refined graphite of various grades were produced. Previous to this time, about 100 tons of vein graphite are estimated to have been taken off the various lots comprising the property.

The mill system in 1889, as described by Obalski,³ consisted of two batteries of 10 stamps, 8 buddles, dryer, and 3 sets of burrstones, in addition to blowers, mixers, and screens. The mill was run by one 100 H.P. engine, and had a capacity of 20 tons of ore per 24 hours. The ore was estimated to run 25 per cent graphite, and the mill achieved a 60 per cent recovery, or 3 tons of product per day.

After some intermittent work between 1890 and 1896, operations ceased until 1906, when the Buckingham Graphite Company partially remodelled the mill, installing a dry process of concentration, and mined some ore. This represents the last work on the property.

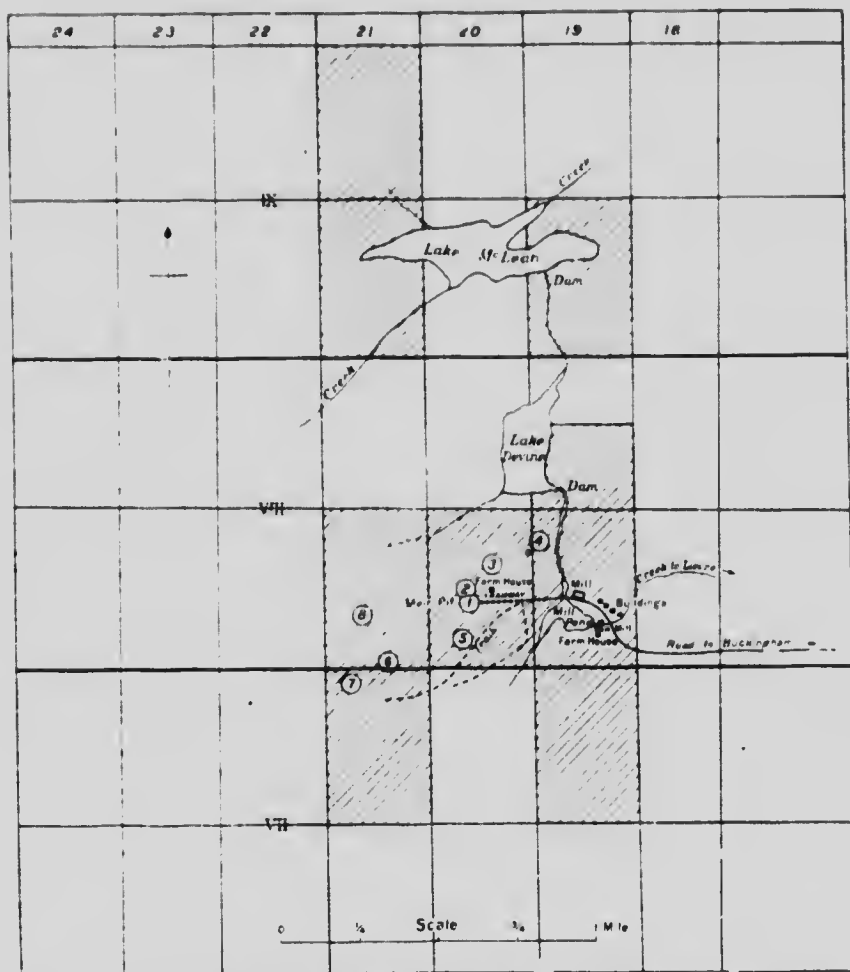

Fig. 8. Plan of workings, etc., at Walker mine, township of Buckingham, Quec. Openings 1-5 are in flake graphite; 6-8 in phosbago.

The dry process is called briefly as follows: the kiln-dried ore was passed through a jaw crusher, followed by a Gates gyratory crusher and heavy rolls, then to a vibratory sizer, the oversize from which went to rolls and trommels and the fines to Hooper dry tables. The fines from the trommels went to waste, and the overs to burrstones. The burred product was screened, the fines going to waste, and the overs constituting the finished product.

The workings comprise over 30 pits, scattered over the above lots, and most of them small surface openings. The main pit is a drift carried 75 feet into the side of a low ridge near the mill. This drift has been stoped out to form a chamber 75 feet long, 15 feet wide and 25 feet high, and from it most of the ore treated at the mill has been obtained. The other workings are described in detail in the reference below.²

The mine is at present owned by M. P. Davis, 285 Charlotte St., Ottawa. The lots comprising the property at the present time are the following: range VII, 19 N $\frac{1}{2}$, 21 N $\frac{1}{2}$, 23, and 24; range VIII, 19 S $\frac{1}{2}$, 20 S $\frac{1}{2}$, and 21 S $\frac{1}{2}$; range IX, 19 S $\frac{1}{2}$ and 21.

The mill, which is a 3-story, wooden structure, is in a dilapidated condition, and most of the machinery has been removed.

The property lies 6 miles northwest of Buckingham.

References:—

Geol. Surv. Can., ¹Report of Progress, 1876-7, p. 311; Annual Report, Vol. V, p. 738; ²Annual Report, Vol. X, 1897, p. 708; Vol. XII, 1899, Part O, pp. 66-73; Summary Report, 1911, p. 283; Guide Book No. 3, International Geological Congress, 1913, p. 101.

Report of the Commissioner of Crown Lands of the Province of Quebec, 1889, p. 95. ²Mines and Minerals of the Province of Quebec, 1889-90, p. 89.

Report on the Mining and Metallurgical Industries of Canada, 1907-8, Mines Branch, p. 496; Monograph on Graphite, Mines Branch, 1907, p. 35.

Range IX, lot 12 N $\frac{1}{2}$; range X, lots 12C, 13B, 14B and C, 15B, 17A and B.—Peerless or Diamond mine.

Work was commenced on lot 14, range X, in 1906, by the Diamond Graphite Company, of Rochester, N.Y., who, besides mining a small quantity of ore, proceeded with the erection of a mill, and turned out some refined graphite during 1907. The mill was modelled on the dry concentrating system, and had a daily capacity of 100 tons of ore.

In 1910, the property was taken over by the Peerless Graphite Company, of Rochester, who, however, did not carry out any mining, finally selling out in 1917 to Messrs. Earle and Jacobs. The latter worked only a short time, ownership then passing to the Consolidated Graphite Mining and Milling Company, of Nashville, Tennessee, who are the present owners.

A few small openings exist on the mill lot, above the drying kiln, and are connected with the latter by tramway. Most of the ore put through the mill, however, was taken off lot 12 in range IX, distant $\frac{1}{2}$ mile from the mill, and from what is known as the Gorman property in range VII. At the first-named locality, a six-foot, flake ore-body has been worked by an open pit 100 feet long and 70 feet deep. This ore is stated to contain 8 per cent of graphite.

The Peerless Graphite Company added to the existent mill equipment by installing a Sutton, Steele and Steele electrostatic separator for final treatment of the flake. This machine, it is claimed, successfully eliminates any mica that is mixed with the graphite.

The mill has recently been equipped with Callow oil flotation cells. Using this method of concentrating, a quantity of graphite was recovered during 1919 from old crucibles shipped in from Montreal and Lachine steel works. The product made is reported to be of good quality, though the flakes are inclined to be thinner and lighter than the natural article.

References:—

Report of the Department of Mines, Province of Quebec, 1910, p. 64.

Report on the Mining and Metallurgical Industries of Canada, 1907-8, Mines Branch, p. 497; Monograph on Graphite, Mines Branch, 1907, p. 35.

Range IX, lot 15B.—Stripping operations, carried out on this lot in 1917, disclosed a body of graphitic gneiss and limestone extending for a distance of 1,000 feet. The graphite occurs in several narrow bands,

which are found at irregular intervals in a zone having a width of about 100 feet.

The property lies alongside the road on the west bank of the Lièvre river, and is 5 miles north of Buckingham. The owner is Dr. Cummings, of Buckingham.

Range X, lot 13.—Worked in 1875 by Mr. Miller, who took out some 300 tons of disseminated flake ore.

The adjoining lots, 12 and 14 in the same range, were worked in a small way in 1892 by J. Claxton, who shipped a trial consignment of crude ore, said to run 20 per cent graphite, to England.

Reference:—

Geol. Surv. Can., Report of Progress, 1876-7, p. 310.

Township of Lechaber.

Range VIII, lot 23, and range XII, lot 23.—On this property is the earliest worked flake graphite deposit in Canada, operations having been commenced about the year 1864 by the Lechaber Plumbago Mining Company, of Boston. Little is recorded of the mining operations, the principal reports on the work done being those given in the references below. According to these accounts, the ore mined and milled would appear to have been both of the disseminated flake and vein types. On lot 23 in range VIII, the occurrence is described as a number of irregular veins of graphite in crystalline limestone bordering a pegmatite dike. The graphitic zone was 30 feet wide and was exploited by a pit 40 feet deep, from which 600 tons of ore were taken.

The occurrence on lot 23 in range XII consisted of a 10-foot band of flake graphite disseminated in limestone. The ore was stated to run 20 per cent of graphite. The bed lay fairly flat and was worked by a 30-foot drift.

The ore from these occurrences was refined in the Company's mill erected on the Blanche river, on lot 28 in range X. Concentration was effected by means of buddles, the ore being first crushed by stamps, and the concentrates were refined by burring and screening.

The Company also owned the mining rights on lots 24 and 25 in range XI, and lot 21 in range X, on which properties promising showings of graphite were reported to occur.

Both mines and mill of this Company were reported by Vennor in 1876 as having been idle since 1868, and nothing further has ever been done.

References:—

Geol. Surv. Can., Report of Progress, 1863-6, p. 22; 1876-7, pp. 306 and 319.

HULL COUNTY.

Township of Low.

Range III, lots 17-20—Some prospecting was carried out on lot 18 during 1916-17 by the Gatineau Graphite Company, of Ottawa. In 1918-19, the same lot was diamond drilled by a Toronto syndicate, who put down three holes to a depth of about 100 feet, and opened up a number of small surface pits. Results were not satisfactory, however, and work was abandoned. The present owners are Messrs. McLean and Fitzsimons, 14 Metcalfe Street, Ottawa.

The graphite here is mainly of the plumbago variety, with a certain proportion of large flake scattered through the rock adjacent to the plumbago stringers. The occurrence consists of irregular bands of plumbago developed along the contact of gabbro dikes intruded into crystalline limestone. Along the borders of such dikes, irregular masses of plumbago occur, and the mineral is also found as narrow veins traversing the gabbro itself. The latter also contains aggregates of disseminated large flake. The plumbago is mostly of the foliated type, no columnar or fibrous material being noticed. The maximum width of the veins exposed is about 6 inches. (See Plates II and V.)

While a proportion of the plumbago may be cobbled to form a marketable product, it would be necessary to mill the greater portion of the ore, since much of the graphite contains an intimate admixture of foreign mineral matter, chiefly calcite, feldspar and various lime silicates. As far as could be seen in the limited number of exposures, the limestone adjacent to the dikes is not impregnated with graphite for more than a short distance from the contacts.

While of generally similar type to the occurrences in Amherst and Grenville townships to the east, this deposit differs from these in that there has been a less intensive degree of metamorphism exerted by the intrusive rock upon the limestone, with the result that there has been no development of a zone consisting of an aggregate of very coarsely crystallized lime silicates mixed with graphite, as at the above mines.

Graphite outcrops have been found over a considerable area on these lots.

The property lies 3 miles from Low station, on the Gatineau valley branch of the Canadian Pacific railway.

A shipment of about 30 tons of ore obtained from surface workings on this property was sent to the Mines Branch Ore Dressing Laboratory for cleaning. The material, as received, consisted of three lots of different grades, as follows:—

	Lot No. 1 (High Grade).
3,306 pounds.....	38.18 per cent carbon.
	Lot No. 2 (Medium Grade).
8,092 pounds.....	18.10 per cent carbon.
	Lot No. 3 (Low Grade).
48,874 pounds.....	4.33 per cent carbon.

The high grade material was broken to 1" and screened on $\frac{1}{2}$ ", the oversize being hand picked. The product thus secured assayed 79.2 per cent carbon.

The discard and the throughs from screening were crushed to $\frac{1}{4}$ ", oiled and passed over a Wilfley table. The concentrates assayed 77.1 per cent carbon.

The object of the above procedure was to determine whether high carbon products of coarse size (comparable to Ceylon "hump" and "chip") were obtainable from this class of ore by such methods. While the products secured were fairly satisfactory from the point of view of carbon content, the methods could hardly be employed commercially on account of the expense involved.

The low grade material was treated by the Callow oil flotation system. It was ground in a Hardinge ball mill, the discharge from which passed to a launder classifier, the oversize being returned to the mill. The first

concentrate from the flotation cells ran 71.6 per cent carbon. They were re-ground in the Hardinge mill and re-floated; by this means, the carbon content was brought up to 80 per cent.

The medium grade material, together with the table tailings from lot No. 1, was also cleaned on the Callow machine, a first concentrate running 80 per cent carbon being obtained.

Finally, the whole of the concentrates, both from the Callow machine and the Wilfley table, together with the hand picked material, was run through the Callow circuit, and a final concentrate was secured, for which the following values were obtained:—

Pounds.	Size.	Per cent carbon.	Carbon, pounds.
683	+ 50 mesh	95.05	649.19
625	+ 62 "	91.20	570.00
169	+ 74 "	89.75	151.68
637	+ 86 "	90.30	575.21
611	+109 "	87.40	534.01
362	+125 "	88.60	320.73
363	+150 "	87.10	316.17
116	+200 "	85.30	98.83
452	-200 "	85.05	384.43
4,018			3,600.25

The percentage of recovery was 76.41, and the average carbon content of the different sizes of product, 89.6 per cent.

Range III, lot 40.—A deposit of plumbago, resembling in a general way that found on lots 17-20, has been exposed by stripping operations, carried out by William Evans, of Low, in 1917. The graphite occurs in a 12-inch seam in crystalline limestone, and is mixed with quartz. The adjacent limestone carries no appreciable amount of disseminated flake.

Maniwaki Indian Reserve.

Gatineau front, lot 10.—A belt of graphitic limestone crosses this lot. The limestone is bordered to the east by a mass of igneous rock of granitic type, and is graphitic for a distance of some 500 feet from the contact. There is no exceptional development of graphite at the actual contact, and the graphite content of the limestone as a whole is low, probably not exceeding 2 or 3 per cent. Certain rich zones, however, carrying a large proportion of very large flake, might possibly prove of economic value.

ADDITIONAL GRAPHITE LOCALITIES IN QUEBEC.

In the township of Lochaber, Labelle county, excellent showings of disseminated flake graphite are reported to occur on a number of lots in the vicinity of the holdings of the old Lochaber Plumbago Mining Company (see p. 58). These occurrences have not been examined by the writer, but by several competent authorities the outcrops are regarded as some of the most promising in the district. A small amount of surface work has been carried out on some of the lots at different times, and the exposures indicate the presence of several parallel ore-bodies, having widths of from 3 to 20 feet. The average graphite content in samples of

the surface ore is stated to be 10-15 per cent. The above properties comprise the following lots:—

Range XI, lots 21, 22, and 23, N $\frac{1}{2}$'s; range XII, lot 22.—Owned by H. Dickson, 70 Gloucester Street, Ottawa.

Range XI, lot 21, S $\frac{1}{2}$.—Owned by Rev. Father Chatelain, Buckingham, Que.

Range X, lot 20; range XI, lots 17 and 18, N $\frac{1}{2}$'s, 23 S $\frac{1}{2}$.—Owned by Hon. W. C. Edwards, Sussex Street, Ottawa.

Other localities from which graphite has been recorded, but which are not known to have been actively worked, are:—

Argenteuil county, township of Grenville, IV, 8. (Rep. Comm. Col. and Mines, Prov. Que., 1896-7, p. 93.)

Hull county, township of Cameron, IV, 47.

Hull county, township of Hincks, XIV, 47. (G.S.C., 1892-3, p. 63 S.)

Hull county, township of Hull, XI, 9. (Rep. Comm. Crown Lands, Prov. Que., 1892, p. 80.)

Hull county, township of Northfield, B, 28-30.

Hull county, township of Wakefield, I, 7.

Hull county, township of Blake, VIII, 24.

Labelle county, township of Portland West, III, 11. (Rep. Comm. Crown Lands, Prov. Que., 1892, p. 80.)

BAFFIN ISLAND.

Graphite has been recorded from time to time as being found at various localities on Baffin island. Thus, R. Bell records¹ the receiving of specimens at Black Lead island, Cumberland Sound, in 1897, and in 1885 from Eskimos at Ashe inlet, on Big island.² In the latter case, the specimens

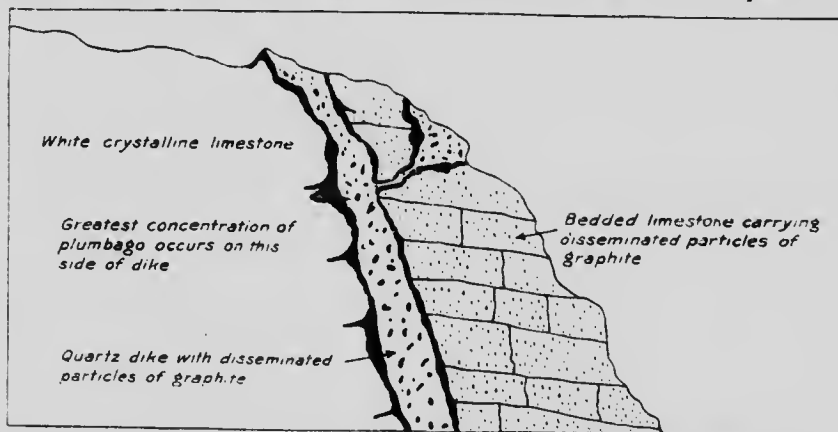

Fig. 9. Sketch showing occurrence of plumbago, at the Joker claim, Lake harbour, Baffin island. (J. Maltby.)

are said to have come from a point east of Big island, and were possibly found in the neighbourhood of Lake harbour (see above). A. P. Low, also, mentions³ veins of graphite occurring south of Port Burwell, on the east shore of Ungava bay, and near Cape Wolstenholme, as well as on the east side of Baffin island.

In 1916, the Hudson Bay Company commenced the development of a graphite deposit near Lake harbour, on the south shore of Baffin island, behind Big island, and in 1917 and 1918 shipped out a small tonnage. The graphite is of crystalline or vein variety, and requires only to be hand cobbled in order to fit it for market. The veins, of which several have been worked, occur in crystalline limestone, probably of Grenville age, on its contact with intrusive, quartz dikes. The accompanying sketch of the occurrence at the "Joker" claim, was kindly furnished by T. J. Maltby, the Company's engineer in charge of mining operations.

The graphite seened was shipped to a crucible firm, who report its quality as equal to the best grade of Ceylon plumbago.

References:—

¹Geol. Surv. Can., Ann. Rep., 1898, Vol. XI, p. 20M. ²Rep. Prog., 1882-5, p. 24DD.

³Cruise of the Neptune, Dept. of Marine and Fisheries, 1906, p. 245.

CHAPTER V.

CONCENTRATING AND REFINING OF GRAPHITE.

As a general thing, the natural graphites, whether of the plumbago or flake type, as well as, in some cases also, the amorphous variety, require to be subjected to some cleaning process before they can be utilized in the various industries.

PLUMBAGO.

In the case of plumbago, the amount of mineral impurities present is generally so low that sufficient purity can be attained by a system of hand picking and cobbing of the ore. The best grades of Ceylon plumbago, prepared for the market by such means, run well over 90 per cent carbon. At the Ceylon mines, the ore is first roughly picked over, the attached gangue reduced to 5 or 10 per cent, and then shipped to the curing or dressing compounds at the coast. Here, the larger pieces are picked out, and the remainder sized by means of stationary, inclined screens. The large pieces are broken up with small hatchets, and the impurities removed as far as possible by picking; the cleaned graphite then being similarly sized. The larger sizes are placed on pieces of wet sacking, where they are again picked over, and rubbed up by hand, then polished by being rubbed on a fine mesh screen placed flat on the ground. These larger sizes, which may measure up to 1 inch across, are graded as "ordinary lump," and "medium lump," and command the highest prices. The graphite that passes through the screens is graded according to size into "chip" and "dust."

The lower grade material is pulverized with wooden mauls or beaters, and is then placed on sacking, and sorted into various grades by hand. In some cases, the cleaning of this material is effected by washing it in saucer-shaped baskets, which are moved by hand with a "panning" motion beneath the surface of water. By this means the graphite is thrown off into the water, while the particles of gangue remain in the basket. The graphite is afterwards shovelled out and spread on drying floors, where it is dried by sun heat. The dried graphite is then winnowed by being placed in shallow baskets and thrown into the air, the heavier particles falling back into the basket, while the fine dust is blown forward and falls to the ground. These products are known respectively as "dust" and "flying dust."

Considerable attention is paid to the blending of Ceylon graphite: by which is meant the mixing of the product of various mines. The three main grades—lump, chip, and dust—are further classified into several sub-grades, according to quality.

Such a procedure as outlined above is, of course, only practicable in countries where cheap native labour is obtainable. In the case of deposits of plumbago on this continent, the usual method of treating the ore has been to break it by hand into pieces of medium size, cobbing out the gangue, the resulting waste being discarded, or, in the event of there being a mill near, run through the latter.

AMORPHOUS GRAPHITE.

Amorphous graphites vary so widely in their carbon content and physical character, that the treatment to be undergone, depends, largely,

on the use to which the material can be put. Mexican graphite, for instance, is of exceptionally high grade (86 per cent), and for this reason, and on account of its extreme softness, is well adapted for such purposes as pencils, lubricants, etc. Rhode Island graphite, on the other hand, is impure, and somewhat hard, for which reason it is employed almost exclusively in low grade foundry facings. Other impure, amorphous graphites, carrying 35 to 50 per cent of graphite, can be utilized in paints, stove polish, etc. For such purposes a high carbon content is not essential, and the presence of a considerable proportion of clayey matter is not prejudicial.

As it is practically impossible to refine the amorphous graphites mechanically, owing to the intimate association of graphite and impurities, much depends on the nature of the impurities as to what use the graphite can be put to. Practically, all amorphous graphite deposits represent either graphitized coal seams, or metamorphosed carbonaceous slates or shales, so that a wide diversity of composition is exhibited by the ores from different localities. Styrian graphite, for instance, while amorphous, contains no sulphur, and yields an infusible ash; for which reason it is said to have been found to be well adapted for crucible manufacture¹, while the same holds good to a certain extent for the Pinerolo deposits, in Italy. In the latter district, a number of dressing plants have been established.

As far as the writer is aware, no refining of amorphous graphite is practised on the American continent, the ore being merely hand picked at the mines, and then subjected to a fine grinding and air flotation process.

One firm having large graphitic slate deposits in Michigan—the ore from which averages 35 per cent graphite—subjects the material to the following process: the ore passes first to two jaw crushers, a coarse and a fine, then to a Raymond automatic pulverizer; the pulverized ore is then dried on trays in a chamber heated by steam coils, and when thoroughly dry is fed to two continuous feed and discharge tube mills. These are run in conjunction with two Raymond air separators and dust collectors. The fines from the former run about 350 mesh, and are employed principally as paint stock; the coarse returns to the tube mills for further grinding.

The United States Graphite Company treat large quantities of Mexican amorphous graphite at their plant at Saginaw, Mich. The run-of-mine ore averages 80–85 per cent graphite, and is screened to $\frac{3}{4}$ inch at the mine. At the mill it is screened to $\frac{1}{4}$ inch; the oversize, which commonly runs lower in graphite than the fines, being ground in a Raymond roller mill (Raymond Brothers Impact Pulverizer Company, Chicago) and made up into foundry facings. The fines are ground in continuous feed and discharge tube mills, and the product of the latter is floated in Raymond air separators (200 mesh). The air-floated graphite is employed in lubricating greases, stove polish, paints, electrotyping, and boiler graphite, and is in special demand for pencil manufacture.

In Fig. 10 is shown a grinding installation specially designed for the fine grinding of graphite (Raymond Bros., Chicago).

FLAKE GRAPHITE.

The extraction of flake graphite from its ores, and its preparation for the market—more particularly the crucible trade—has always been a problem presenting considerable difficulties from both the technical and the economic side. This is due in the first place to the fact that the prin-

¹ Dammer und Tietze, Die Nutzbaren Mineralien, Vol. I, p. 65.

cipal minerals with which flake graphite is usually associated, (quartz, calcite, feldspar, and mica), and which commonly form from 75 to 95 per cent of the ore, possess specific gravities varying but little from that of graphite itself; added to which, one of the most common impurities—mica—is of more or less identical form, hardness and toughness, and behaves in much the same fashion as the graphite particles at practically

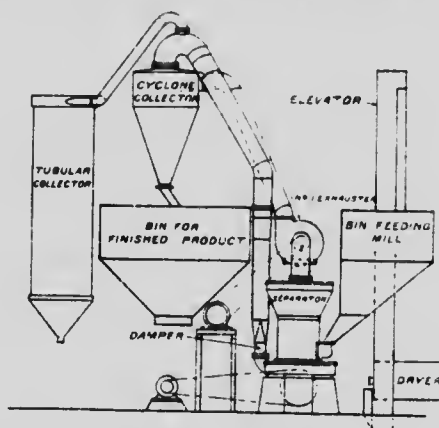

Fig. 10. Installation of Raymond high-side roller-mill equipment for grinding graphite.

all the stages of mechanical treatment, such as grinding, jigging, tabling, screening, etc. Owing to this latter fact, mica is one of the most difficult minerals to eliminate by any of the straight mechanical processes; and, being a mineral that fuses readily at the temperatures to which crucibles are subjected, its presence even in minor amount is highly prejudicial in graphite intended for the crucible trade.

The principal difficulty, however, in connexion with the concentrating and refining of flake graphites, is due to the fact that the crucible trade, which uses probably about three-fourths of the world's output of graphite, demands the best quality, and pays the highest prices, specifies that what is known as "No. 1 crucible flake" shall not only possess a high carbon content (90 per cent or better), but, in addition, must not exceed a certain degree of fineness. The limits usually set in this connexion are 20-90 mesh; that is, the flakes must pass a 20-mesh screen and be caught on 90-mesh. It will be readily seen, therefore, that the concentrating and refining of flake graphite have, since the inception of the industry, been attended with more and greater difficulties than have been encountered in possibly any other branch of ore-dressing. Processes have been devised, which have proved more or less satisfactory in as far as carbon content and size of flake were concerned; but such results have almost invariably been achieved at the expense of recovery, and frequently, also, by some system of re-treatment that rendered operations unprofitable. It is probably not an over statement to say that, by any of the concentrating processes hitherto employed—at any rate on the American continent—and excepting oil-flotation, the average loss of graphite in the tailings has been not less than 50 per cent of that contained in the ore treated. This has been due to the fact that it has always been found practically impossible to free all of the flake completely from the gangue without reducing an undue proportion

of it to powder form, in which state it is unsaleable to the crucible trade. Graphite ores vary widely as regards the relative proportions of large-sized flake that they carry. In some cases, notably in certain crystalline limestones, a considerable proportion of the flake is of relatively large size (plus 40 mesh); but this is discounted by the fact that such flake is often brittle and breaks up very readily during grinding of the ore. The schistose ores, on the other hand, usually carry flake of a uniformly smaller size, though, occasionally, exceptionally large flake is encountered. The flake of the schists is, as a general thing, somewhat tougher than that of the limestones, which enables it to resist destruction better during milling. Some schist-ores carry flake possessing very regular, elliptical form, and having perceptible thickness. Such flake frees readily on milling without breaking up, and yields little dust graphite. In others, the graphite flakes are decidedly irregular and break up easily into smaller particles, so that the amount of large flake recoverable is relatively small. Where such ores are highly siliceous, as is sometimes the case, the graphite is difficult to free, and the proportion of dust graphite made during milling may be so high as to render operations unprofitable. In Alabama and Pennsylvania, most of the ore milled is weathered surface schist, and although of low grade (3 and 5 per cent graphite content respectively) requires little grinding to free the flake. The New York and Canadian graphitic gneisses, on the other hand, are weathered for only a short distance down, and most of the ore raised is comparatively hard, and requires a considerable amount of grinding. For this reason, dry methods of concentration have found considerable favour in Canada, owing to the fact that the initial drying of the ore in kilns serves also to decrepitate the calcite present, thus rendering the rock more friable and easily milled.

Another problem encountered in exploiting Canadian graphite deposits is the not infrequent tendency of the ore to alter its character either in depth or along the strike of the ore-body, or both. Such alteration usually consists in local variations in the proportion of mica, quartz, calcite, or pyrites present in the ore.

In the upper, weathered portions of graphite deposits, also, a certain amount of enrichment due to decomposition of sulphides and solution of calcite may frequently be noticed, and the graphite content of such surface ore may, therefore, be considerably greater than that of the unweathered ore. In addition, Canadian flake graphites usually carry a perceptible amount of sulphides (pyrites and pyrrhotite), and in some cases, quartz also, as a sort of skeleton between the laminae of the flakes. These intergrown impurities are impossible to eliminate by mechanical means without reducing the graphite to powder, and it is to their presence that the relatively large amount of ash often yielded by apparently perfectly clean, selected flake is to be attributed.

Estimates of the graphite content of a deposit, based on analyses of surface material, are thus apt to be misleading; and, for the same reason, concentrating tests on such material may yield results that lead to erroneous conclusions. In the latter connexion, an additional cause of error is liable to be found in the fact that the flake in oxidized ore is more readily freed from its matrix, and, consequently, a smaller proportion of fines will result on milling. For these reasons, analyses and mill tests should always be

made on fresh, unweathered ore, as only in this way can reliable data be secured.

The more important points to be considered in connexion with the dressing of flake graphite ores include the following:—

Character of the ore, and the ratio of large size flake recoverable to the total graphite content. Tough, siliceous ores may require prolonged grinding in order to free the flake, with the result that much of the latter is destroyed; an undue amount of the graphite recovered being in the form of dust. The profitable operation of a dressing plant is essentially dependent on its production of No. 1 flake, the market for the No. 2 flake and dust grades being uncertain, and the prices offered out of all proportion to the cost of production; hence it is necessary that a graphite mill, to be successful, must recover from each ton of ore treated, sufficient No. 1 flake to meet the cost of mining and milling.

Selection of grinding machines that will free the flake in the ore with the production of the minimum amount of fines. This is a matter of supreme importance, but which, frequently, has not received the attention it demands. Various types of grinders are in present use in the various graphite fields, and include chaser mills, ball mills, fine rolls and stamps. There is a decided difference of opinion among operators as to the most efficient method of grinding, and a type of machine adapted to one class of ore will probably not give as good results on another. It would seem desirable, therefore, that more experimental work should be done in this connexion.

Graphite ores, even from one and the same district, vary so widely in the character of the flake they carry, nature of the associated minerals, hardness, graphite content, etc., that it is quite impossible to outline any mill method that will even approximately meet all conditions. In the following pages are described a number of the systems that have been tried out in mills in the Alabama, Pennsylvania, New York, and Canadian fields. While a number of the processes enumerated have not proved wholly efficient, owing to expense of operation, poor recovery, failure to make a clean product, or to a combination of these causes, their salient features are given here with the object of outlining what has been attempted in the province of graphite ore-dressing.¹

CONCENTRATION BY DRY METHODS.

Graphite concentration by dry methods has been more widely adopted in Canadian mills than elsewhere; eight plants having been equipped in the past along these lines. At the present time, however, all of these mills are either idle or have been remodelled along other lines. Dry concentration has also been attempted in one Pennsylvania mill, the system followed being that of rolls and screens, as in Canadian practice; except that a rotary dryer was employed in place of vertical kilns to dry the ore for the crushers. It is understood that this mill has since been remodelled for K. and K. oil flotation.

¹ To a bulletin entitled Preparation of Crucible Graphite by George D. Dub, issued by the Bureau of Mines of the United States, December 1918, the writer desires to make his acknowledgments for amplification of the data personally secured in the Alabama, Pennsylvania, and New York graphite districts, in 1918. Many of the figures depicting apparatus in use in the Alabama field are taken wholly or in part from this report.

A further bulletin, dealing with methods of cleaning Alabama graphite ores, and entitled Refining Alabama Flake Graphite for Crucible Use, by F. G. Moses, has also been published by the above Bureau (December, 1918). This report contains much data secured in the course of experimental work carried out at the Intermountain Station of the Bureau of Mines, at Salt Lake City, Utah, with various methods of concentrating and refining Alabama graphite. The bulletin came to the writer's attention too late for any of the data contained in it to be utilized, in the preparation of this report.

Several mills in Alabama were equipped for dry concentration in 1917-18, Sutton, Steele and Steele dry tables being used. The majority of these mills are believed to have since discarded this system for film or some other flotation process.

In any method of dry concentration of graphite, it is necessary that the ore be thoroughly dry before it enters the mill. This preliminary drying is usually effected in vertical kilns. The smaller mills use a single kiln, but the larger mills, designed to treat 150 to 200 tons of ore per 24 hours, are equipped with two kilns. These are usually of masonry construction, though sheet iron is used in some cases. (Plate XXVIII.) Wood is employed for fuel, $1\frac{1}{2}$ to 2 cords being necessary to dry 100 tons of ore.

In dry concentration, two essentially dissimilar methods have been practised. These are: (1) separation of the graphite and gangue on pneumatic tables or jigs; and (2) gradual elimination of the more brittle gangue constituents by means of a succession of rolls and screens. In some mills a combination of both methods is practised.

PNEUMATIC JIGS.

One of the first attempts at dry concentration was by means of the Krom pneumatic jig (Krom Machine Works, 170 Broadway, New York). This machine (see Fig. 11) consists of a swinging door blower **B** with check valves to prevent the downward passage of air, conveying rapid pulsations of air into the tubes **T**, one-half inch wide, of sieve cloth, through the sides and tops of which the air passes up through the bed of ore, and effects the separation between graphite and the gangue. These gauze tubes **T** are open at the end to the blower, to receive the wind, and on the

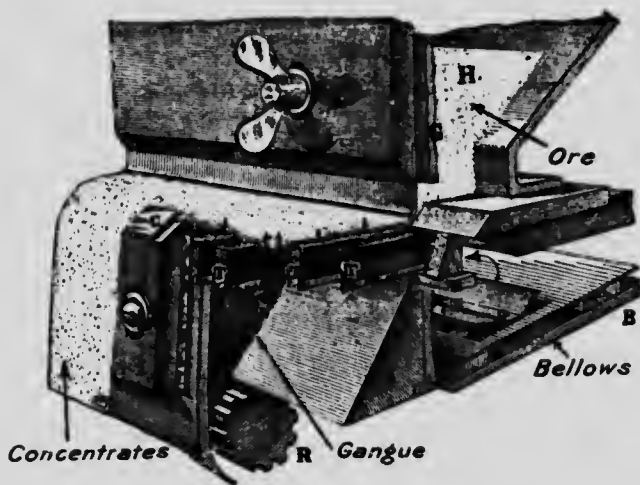

Fig. 11. Section through Krom pneumatic jig.

under side to prevent them from choking with fine ore. They are placed $\frac{3}{16}$, $\frac{1}{4}$, $\frac{3}{8}$, or $\frac{1}{2}$ inch apart, according to the grade of ore to be treated—the finer the feed, the closer the tubes are set. The ore is fed through a hopper **H**, passes under the adjustable gate **G**, and forms the jiggling bed.

Clean graphite is discharged over the adjustable apron **C**, while the tailings, which completely fill the hutch below the tubes **T**, settle slowly, and are discharged by the regulated roller **R**. The swinging-door blower is actuated by a cam on the main shaft, with six projections, which give the downward motion through an arm on the shaft; a spring which gives it the quick upward pulsation; and an adjustable strap which limits the amount of pulsation. Upon the cam is an adjustable crank pin, which serves as a pivot for a pawl acting upon a ratchet wheel to drive the discharge roller **R**. The roller, therefore, nets in concert with the blower. The width of the bed is four feet. The machine is run with 420 to 750 pulsations per minute. It treats from 300 to 600 pounds per hour, using one-eighth horse power. The coarsest size claimed as capable of being treated by this machine is 6 mesh, and the finest is 140 mesh. This machine is said to have given good results, but it needs careful adjustment to the graphite content of the ore; any rise or fall in the latter tending to effect a loss of graphite or a dirty concentrate respectively.

Krom jigs are not known to be employed in any graphite mills at the present time, either in the United States or Canada.

Another machine that has been employed in the concentration of graphite by the dry method is the Hooper pneumatic concentrator. This machine is shown in Plate XXX and Fig. 12.

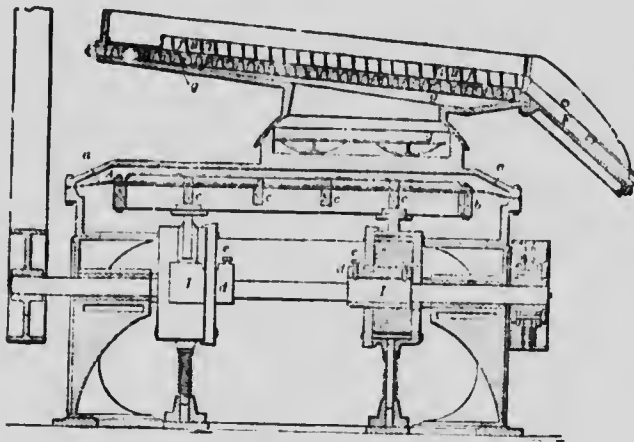

Fig. 12. Section through Hooper pneumatic concentrator.

Richards, in his work on "Ore Dressing", describes the Hooper concentrator as follows:—

Through the chamber **A** runs a rectangular diaphragm **a**. This diaphragm is composed of an outer rim of leather, the sides of which are firmly bolted between the upper and lower sections of the air chamber. Within the chamber the leather is firmly attached to a strong wooden frame, **b**, which is divided by transverse wooden braces **c**. Between these braces, and attached to them, are two rubber flaps resting upon a sheet of perforated metal. The diaphragm is connected to two eccentric boxes, **B**, in which revolve a fixed

¹ Richards, Ore Dressing, Vol. II, 1903, p. 320.

eccentric attached to the working shaft C, each eccentric being cased by a loose eccentric sleeve, d, which can be adjusted and held by a set screw, e, allowing a throw of $\frac{1}{4}$ to $1\frac{1}{2}$ inches. A movement is thus communicated to the diaphragm which discharges at each revolution an air blast to the chamber A, which blast then passes through the fixed diaphragm G—also arranged with rubber flaps—and is discharged through the grated sieve, z, upon a broadcloth bed, f, stretched over same. Resting upon the broadcloth bed is the concentrating top, which consists of two sets of guide strips, running diagonally to each other and at angles of 30° to 45° with the side of the frame. The lower set of strips, H, are of brass, $\frac{3}{8}$ inch thick, $\frac{1}{2}$ to $\frac{3}{4}$ inch high, and $\frac{1}{2}$ to $1\frac{1}{2}$ inches apart, depending upon the material to be treated. The upper set of strips, I, called skimmers, run upon, and diagonally across, the lower set. They are also of brass, $\frac{3}{4}$ inch thick, $3\frac{1}{2}$ inches high, and $\frac{1}{2}$ to 1 inch apart. These upper strips terminate 2 inches from the left or discharge side of the top for a distance of 23 inches from the discharge end, thus leaving a free discharge channel, K, for the concentrates. The concentrating top may be removed from the concentrating bed at will. Any desired vertical or lateral inclination of the concentrating bed is obtained by means of a universal joint, E, which is held in the desired position by means of two clamps situated at opposite sides of same, as shown at h. The maximum inclination toward the discharge side is 11° , and that toward the concentrating side 5° ; depending upon the character of the ore being treated and the mesh to which it has been sized. As a general rule the larger the mesh and the heavier the mineral, the greater the inclination in both directions. The crushed ore, after being closely sized, is fed from a hopper (not shown) placed at the head of the concentrating bed. This hopper is adjustable in position, and is provided with small sliding gates, by means of which the flow is adjusted.

It will be evident from the foregoing that when crushed ore, composed of particles of different gravities, is fed upon the concentrating bed, the pulsations through the broadcloth, due to the blasts before described, cause the heavier mineral particles to be thrown to the bottom, where they settle down between the lower metal strips and are thus guided toward the tailings side of the table, the lighter graphite being thrown to the top where it is subjected to successive skimming actions by the upper set of metal strips and thus guided in the opposite direction toward the concentrates side of the table. After the bed is filled to an even depth of $\frac{1}{2}$ to $\frac{3}{4}$ inch, and the resulting products of concentrates, middlings and tailings begin to flow regularly and smoothly over the discharge end of the table, they are guided to any point of disposition by means of wooden guide strips, F. It is found that the various minerals contained in an ore classify according to their specific gravities, the heavier mineral being interrupted in its flow by the side of the concentrating top, is spread out in a well defined strip by the action of the upper skimmer, the next heaviest taking its place beside it, etc. There is therefore a distinct separation of all the minerals should there be sufficient variance in their specific gravity.

To obtain the best results the ores treated should be below 2 mm. and should be closely sized, say through a 20-mesh screen on a 30-mesh, through 30 on 40, 40 on 60, 60 on 80, 80 on 120 and 120 on 250. Of course, when there is considerable variance between the mineral and gangue, close sizing is not so important. The speed of the machine varies from 350 revolutions per minute in the case of coarse material to 450 for fine. This variation in speed is obtained by means of cone pulleys. The stroke or force of air is varied by the length of eccentric throw by adjusting the eccentric sleeves before described. The greater the throw of these eccentrics the stronger the air blasts. The heavier the material treated the heavier the air blast required. All machines are now supplied with an adjusting device by means of which the throw of the eccentrics may be altered at will without stopping the machine. The capacity of the machine varies from 9 to 16 tons per day of 24 hours, according to the character of ore treated, and the horse-power required varies from 1 to 2.

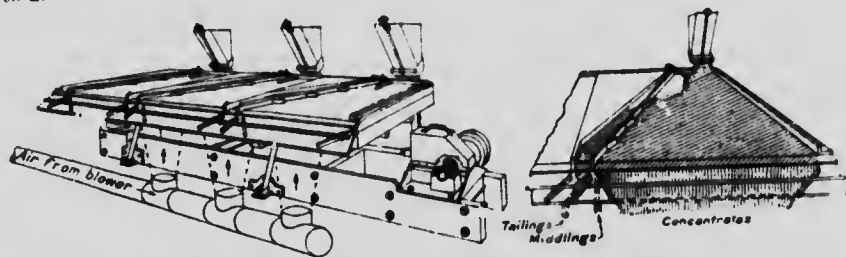
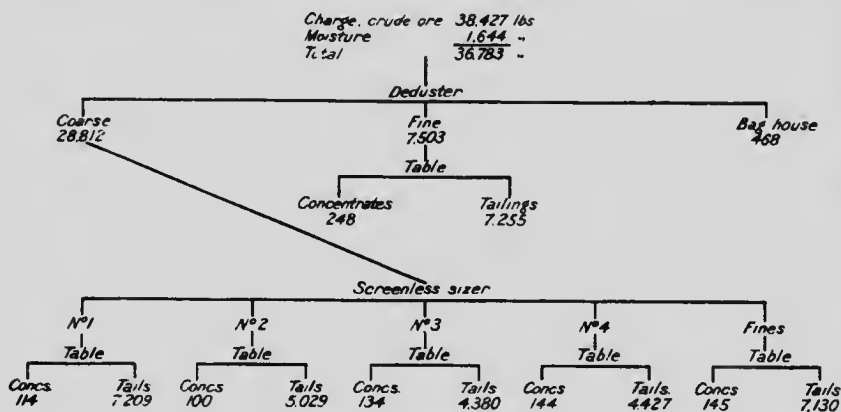

Fig. 13. Sutton, Steele and Steele three-section jig.

The Hooper table was used formerly on the graphite ores of the Buckingham district, Quebec, with what results is not known to the writer.

which is supported on the running gear and connected with a blower, and is oscillated lengthwise with a $\frac{1}{4}$ -inch stroke. The cover of the deck is porous, being made of fine-mesh canvas. The running gear rides on springs set at an angle, which imparts a slight rise to the deck as it travels forward. This motion causes the feed to travel rapidly across the table, and the air film, formed on the surface of the deck by the expansion of the air passing through the porous cover, stratifies the material. The lighter gravities come off the table nearest the feed end, so that the graphite concentrates are obtained from what would be the tailings spigot in the case of a metaliferous ore. The machine would not appear to be especially adapted to graphite concentration, owing to the relatively slighter difference in specific gravity between graphite and the majority of the minerals commonly associated with it—more especially mica. This difficulty is claimed to be overcome by the use of the volumetric sizer which classifies the feed for the tables; but it is doubtful whether this machine can be completely efficient on graphite, owing to the difference in shape of the particles to be sized.



RESUME.-

Concentrates	Deduster	Fines	248 lbs.	Waste	7723 lbs.
Sizer	N ^o 1	114	-	7209	-
-	N ^o 2	100	-	5029	-
-	N ^o 3	134	-	4380	-
-	N ^o 4	144	-	4427	-
-	Fines	145	-	7130	-
Total	885	-	-	35898	-

Recovery 2.40%
All over 80 mesh in size

Fig. 15. Result of test made on 20 tons of graphite ore from Clay county, Alabama, at the Denver testing plant of the Sutton, Steele and Steele M. M. and M. Co.

The accompanying flow sheet is that of an Alabama mill equipped with Sutton, Steele and Steele dry tables. Several other Alabama mills were similarly equipped, but to the best of the writer's knowledge the process did not prove successful. In its chief features, the system here outlined is similar to the dry concentrating process installed in a number

of Canadian mills. In the case of the latter, also, the method has not been a success, recovery averaging only 50-60 per cent of the graphite in the ore; in addition to which, mica was not wholly eliminated, and the cost of production, due largely to frequent shut-downs for repairs and adjustments to the numerous belts, pulleys, and elevators, proved excessive.

The entire mill system here outlined was devised by the Sutton, Steele and Steele, Mfg. Mining and Milling Company, Dallas, Texas, and most of the equipment was supplied by the same firm.

The results shown in Fig. 15 were obtained by the above-mentioned firm on a 20-ton trial consignment of Alabama ore. The tables used in this test appear to have been exclusively of 2-section type; whereas in the mill installation shown, 3-section tables were substituted, the middlings being returned to the deduster circuit. The heads do not appear to have been analysed, so that only the actual recovery and not the percentage of recovery is shown. Assuming a graphite content of 3 per cent for the heads, the results shown give a percentage of recovery of 80 per cent, which is unusually high for graphite concentrates made by a dry process.

AIR CLASSIFIERS.

The air classifier shown in flow sheets, Figs. 37 and 38, is a device peculiar to the Alabama field. It originated in one of the Ashland mills, and has since been installed in a number of plants. Fig. 16 shows the chief features of the classifier, which is exceedingly simple in design, and can be

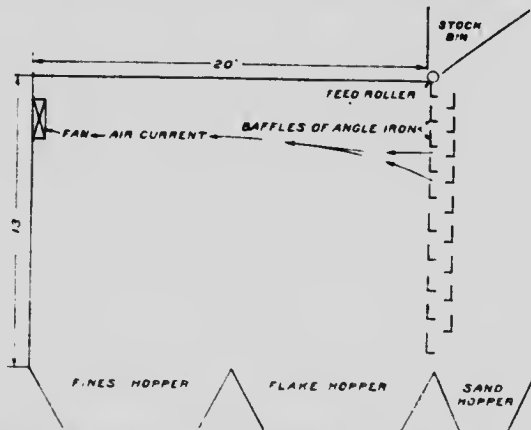

Fig. 16. Section through type of air classifiers used in Alabama mills. Dimensions approximate only.

quickly and cheaply installed. The device is nothing more than a large box or chamber, open at the front, and having an ordinary electric exhaust fan set into the back. In the front opening is arranged a series of angle-iron baffles, above which is set the feed hopper. This is fitted with a feed roller, over which the material falls to the baffles. The suction caused by the fan at the back draws the lighter graphite into the chamber, while the heavier gangue particles fall down through and in front of the baffles. The lightest particles are drawn to the back of the chamber, while the coarser flake falls immediately behind the baffles. The chamber is usually

provided with three collecting hoppers, for dust, middlings, and coarse graphite.

The device is used at different stages in the various mills, some employing it to effect an initial concentration of the crushed ore from the dryer, before it passes to the washers, while in other cases it is used to treat the concentrate from the washers. While it may possibly be used to advantage at either stage, it is most useful when employed to treat the crude ore, since by means of it a very large proportion of gangue is simply and cheaply eliminated at the outset.

There is a certain amount of loss of graphite incidental to the use of this classifier, owing to the fact that a proportion of the gangue particles carry attached graphite, but most of this loss would probably occur in any case in the washers, and it is doubtful if such attached graphite can be profitably recovered. In flow sheet Fig. 37, this heavy sand is passed through rolls and returned to the circuit. Results of operation of the classifier on both crude ore and concentrates are shown below:—

	Graphite in ore.	Graphite in tailings.	Percentage of loss.
Crude ore.....	3.45 per cent 2.55 "	1.35 per cent 1.01 "	39.1 39.6
Concentrates.....	62.80 per cent 48.80 "	4.68 per cent 1.83 "	7.4 3.7

A device operating on somewhat similar lines to the above was patented by J. Labouglie, of Buckingham, Quebec, in 1876, but never found adoption in Canadian mills.

Another and rather more elaborate air classifier that was installed in one Canadian mill about 30 years ago was known as the Nappenberger separator. In this device, the dry, ground ore was dropped down a deep well or shaft, measuring 1 foot X 2 feet, and in its fall encountered air blasts directed horizontally across the shaft. These blasts carried the lighter graphite through screens set in the opposite wall, while the gangue fell through them. The air blasts were arranged in increasing strength from top to bottom, so that the finest graphite particles were removed at the top, and the coarser flake near the bottom of the shaft.

What is sometimes called a "barrel machine" has been employed in several Canadian mills using the dry concentrating process. It consists of a revolving cylinder, slightly inclined, and having narrow flanges extending throughout its length. The discharge (lower) end is open, while the feed end fits snugly into a stationary chest connected to the suction pipe of an exhaust fan. The ore is fed into the upper end of the cylinder, and is carried up by the flanges, and dropped through the current of air sucked through the cylinder. The tails are discharged from the lower end, while the concentrates are blown into a dust collector. As in the case of all such pneumatic classifiers, it is essential that the feed be carefully sized.

ROLLS AND SCREENS.

In recent years, a number of Canadian mills have been equipped with a dry concentrating system employing a succession of rolls and screens to effect a gradual elimination of gangue, the graphite flakes passing

through the rolls with the production of a relatively small amount of fines, while the more brittle calcite, quartz, etc., are reduced to powder. The latter is removed by screens interposed between successive sets of rolls, while the fine dust is sucked out by means of fans. One of the chief causes of the failure of this system of concentration to make a clean product is the large amount of mica commonly present in Canadian graphite ores. The mica being tough, and of the same general form as the graphite flakes, passes through the rolls with the latter and forms the chief impurity in the concentrates made by this method. The extraction achieved is also low, and while exact figures are not available, it is estimated from assays of the tailings at several mills that the average recovery in the mills using rolls is not over 50-60 per cent of the graphite in the ore. While this loss may in some cases represent largely graphite fines, the tailings from one such mill, which were found to contain 6.14 per cent carbon, gave, on treatment by the Callow flotation process, a product containing 45.6 per cent of +80-mesh flake assaying 72.6 per cent carbon.

The style of machine used in the above system is that shown in Plate XXXI. This is a six roller mill of the type commonly used in grinding provender, and known as the "King Bee" mill (W. and J. G. Greey, Toronto). It contains three pairs of rolls, one above the other, each roll being belt-driven. The rolls are smooth and of equal diameter, the usual size being 9×30 inches. The machine requires 25 horse-power for operation. Both rolls of each pair are run at the same speed, which is about 500 r. p. m. The number of such machines used in series varies in the different mills, but is usually four or five, exclusive of the final so-called polishing rolls. The latter are machines of precisely similar type, but the rolls are differential, the respective speeds being 9:7. This adjustment is made in order to exert a certain degree of rubbing action on the flake, which tends to loosen any fine gangue that has become pressed into it during its passage through the grinding rolls.

Plate XXXII shows an installation of "King Bee" rolls in a mill in the Buckingham district, Que. The rolls of each machine are set a little closer than those of the preceding one, so that the product from each undergoes a further degree of comminution in the succeeding machine.

Fig. 17 shows a flow sheet of a mill in the Buckingham district equipped with the above system of concentration. The carbon content of the products made by this mill during a thirteen months' period is stated to have averaged as follows:—

No. 1,	91.3 per cent
No. 2,	76.1 per cent
Dust,	57.1 per cent.

In Fig. 18 is shown a combination system of rolls and dry tables, giving the approximate amounts of the various products made at the different stages.

The usual heavy crushing equipment in Canadian mills using the dry process consists of one or more gyratory crushers, followed by two sets of roughing rolls, respectively 36"×24" and 30"×20". The preliminary drying of the ore assists materially in rendering it friable, as it decrepitates a great part of the calcite present in most ores. Gyratory crushers give better results than jaw crushers, owing to the latter often becoming so coated with graphite that pieces of ore simply slide up and down without being broken.

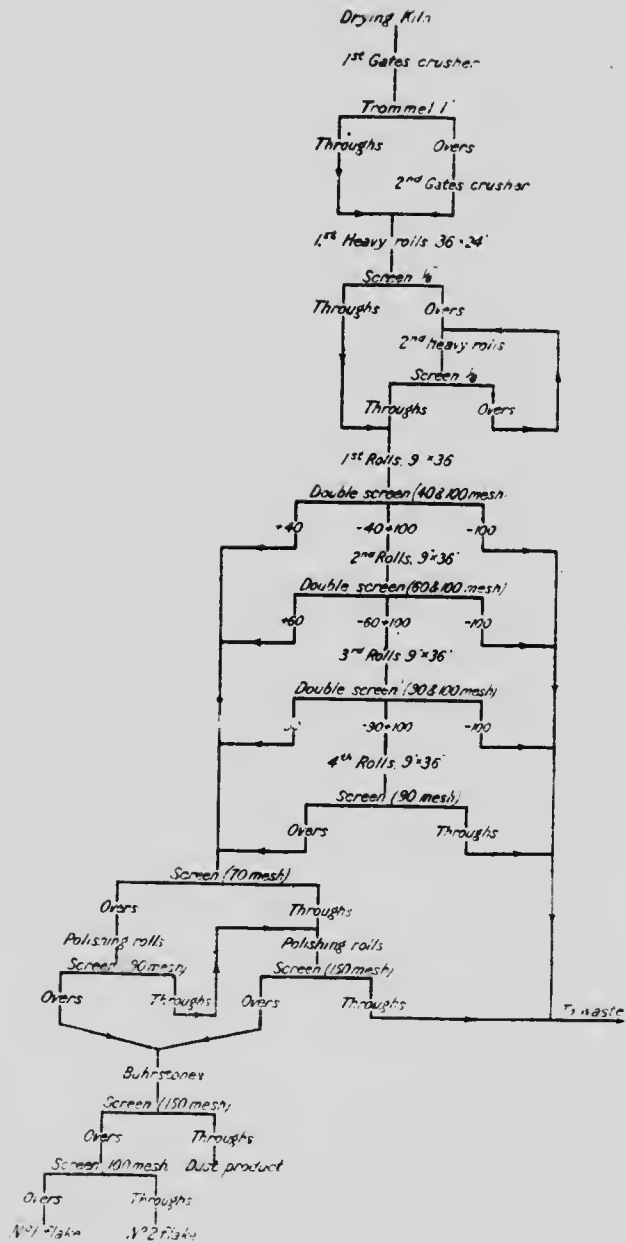

Fig. 17. Flow sheet of dry concentration system, employing rolls, as installed in a Quebec mill.

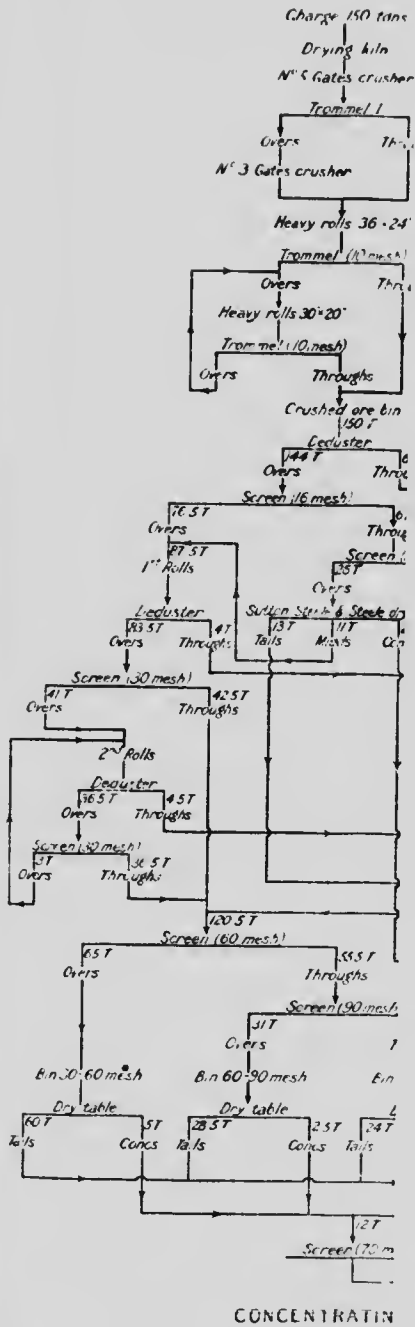

Fig. 19. Flow sheet of dry concentration and finishing plant for flake graphite.

Fig. 18. Flow sheet of dry concentration of dry concentration of

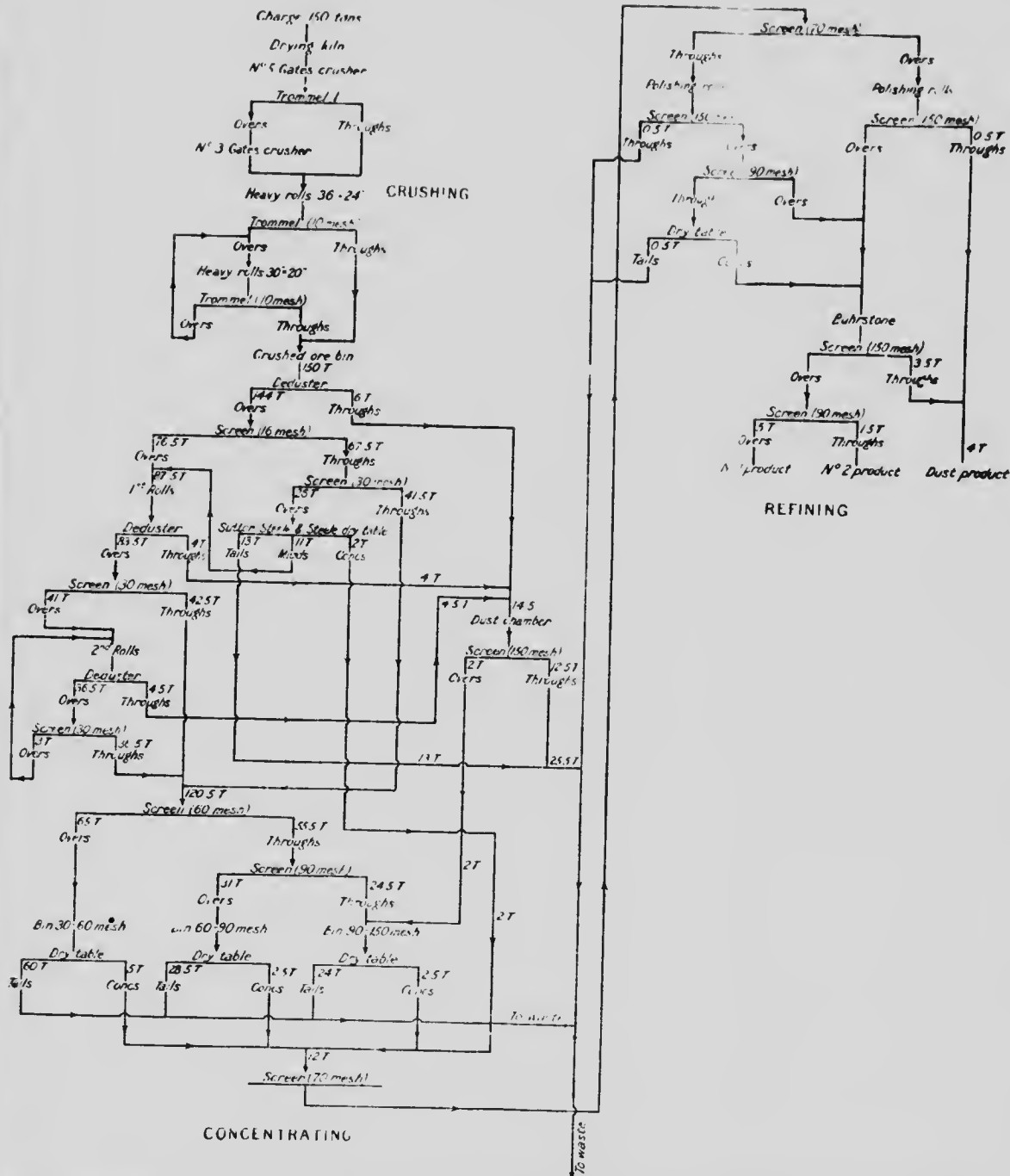

Fig. 18. Flow sheet of dry concentration system by means of a combination of rolls and tables, as installed in a Quebec mill.

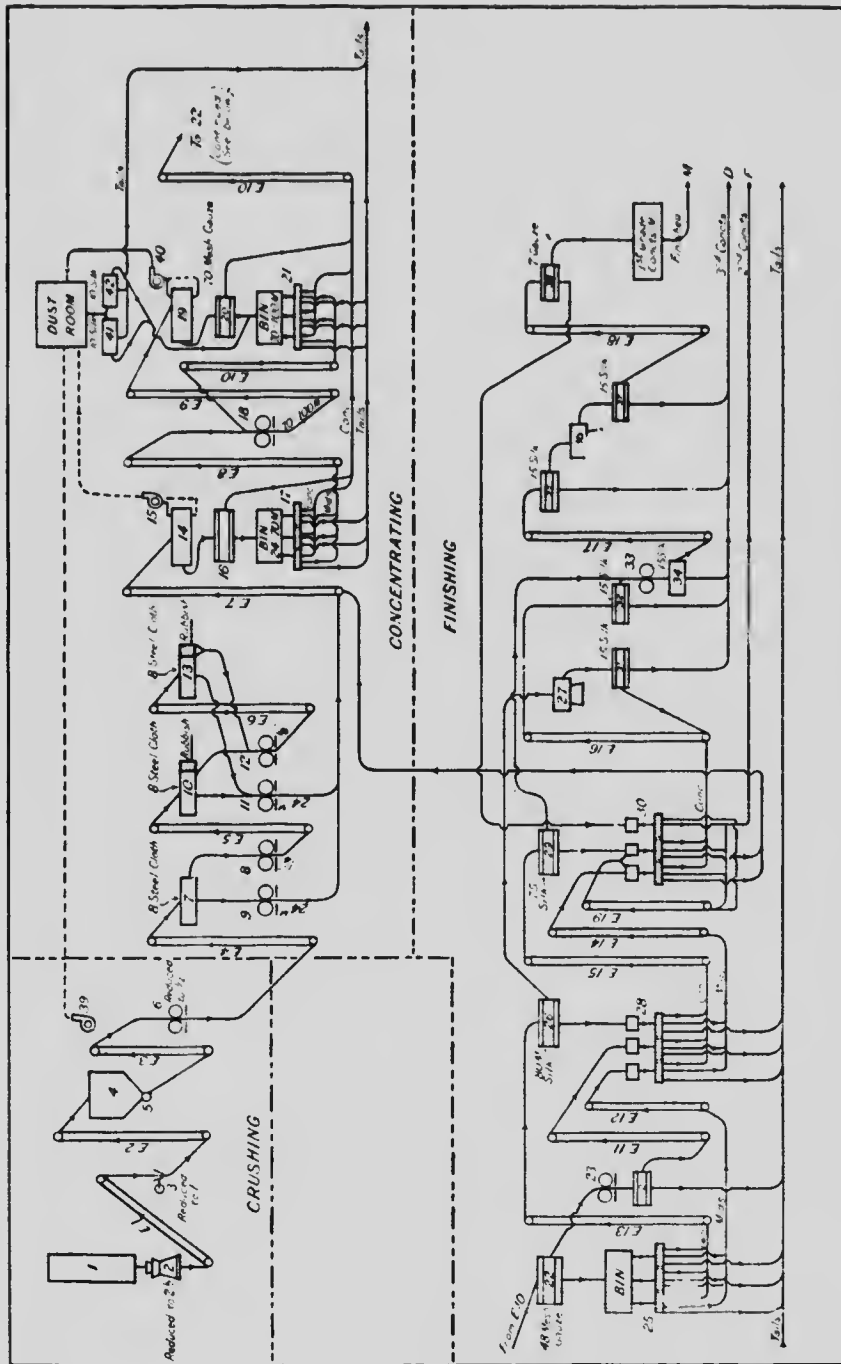

Fig. 19. Flow sheet of dry concentrating and finishing plant for flake graphite.

The large amount of dust produced in dry mills is very objectionable, and there is seldom any attempt made to install an adequate system of dust collection. The chief objections to the dry system outlined above include failure to make a satisfactory recovery; inability to eliminate mica from the concentrates, and the large number of belts, elevators, etc., required, necessitating frequent shut-downs for repairs.

Details of flow sheet Fig. 19:

1. Vertical kiln—oval, 5' x 7' x 18', plus stone base 14' high.
2. Tel-smith crusher No. 5—down to 2½". Inclined elevator E1.
3. Eureka jaw crusher—down to 1".
4. 40-ton steel, hopper-bottom bin. Vertical elevator E2.
5. Automatic roll feeder. Vertical elevator E3.
6. 26" x 16" ridged rolls—Jenckes Machine Co.—down to ¼". Vertical elevator E4.
7. Screen: hexagonal trommel, No. 8 steel cloth (¼"), 30" diam. x 8'.
8. Rolls 16" x 10" (Krom)—down to ¼". Vertical elevator E5.
9. Rolls 9" x 30" (special)—down to 24 mesh. (Double roll on one frame, 2 sets, feed split.)
10. Screen: hexagonal trommel, No. 8 steel cloth (¼"), 30" x 10'. (2 ft. of 1" punched plate.)
11. Rolls 9" x 30" (special)—down to 24 mesh. (Double roll on one frame, 2 sets, feed split.)
12. Rolls 16" x 10" (Krom)—down to ¼". Vertical elevator E6.
13. Screen: hexagonal trommel, No. 8 steel cloth (¼"), 30" x 10'. (2 ft. of ¼" punched plate.) Vertical elevator E7.
14. Barrel machine—to take off fines. Acts as classifier.
15. Suction fan.
16. Screen: hexagonal trommel, dressed with 24 mesh steel cloth (special).
17. Sutton, Steele and Steele dry table No. 1, treating 24-70 mesh feed. Vertical elevator (for middlings) E8.
18. Rolls 9" x 30" (special)—down to 70-100 mesh. Vertical elevator E9.
19. Barrel machine—to take off fines.
20. Screen: hexagonal trommel 30" x 10', dressed with 70 mesh gauze.
21. Sutton, Steele and Steele dry table No. 2—treating 70-100 mesh feed. Vertical elevator (to concentrates bin) E10.
22. Screen, 30" x 10', dressed with 48 mesh gauze.
23. Rolls 9" x 30": polishing rolls—single.
24. Screen: hexagonal trommel, 30" x 10', dressed with No. 10 silk bolting-cloth. Elevator E11.
25. Sutton, Steele and Steele dry table No. 3. Elevator E12 (middlings). Elevator E13 (concentrates).
26. Screen: hexagonal trommel, 30" x 10', dressed with 80 mesh silk cloth.
27. Burr mill.
28. Sutton, Steele and Steele dry table No. 4. Elevator E14 (middlings). Elevator E15 (concentrates).
29. Screen: hexagonal trommel, 30" x 10', dressed with No. 7 silk cloth.
30. Sutton, Steele and Steele dry table No. 5.
31. Screen: hexagonal trommel, 30" x 10', dressed with No. 15 silk cloth. Elevator E16.
32. Screen: hexagonal trommel, 30" x 10', dressed with No. 15 silk cloth.
33. Rolls, 9" x 30" (special): polishing rolls.
34. Screen, 30" x 10', dressed with No. 15 silk cloth. Elevator E17.
35. Screen, 30" x 10', dressed with No. 15 silk cloth.
36. Burr mill.
37. Screen, 30" x 10', dressed with No. 15 silk cloth. Elevator E18.
38. Screen, 30" x 10', dressed with No. 7 gauze. Elevator E19.
39. Suction fan.
40. Suction fan.
41. Screen, 30" x 10', dressed with No. 10 silk bolting cloth.
42. Screen, 30" x 10', dressed with No. 10 silk bolting cloth.

ELECTROSTATIC MACHINES.

In this method of concentration, separation of the mineral particles is effected by dropping them through an electric field, where the graphite

flakes behave differently to the gangue particles, owing, in part, to their higher electrical conductivity, and are deflected from the course followed by the latter. By an arrangement of successive electric fields, the tailings from each may be re-treated.

Two types of electrostatic machines have been employed in the concentration of graphite ores, namely the Sutton, Steele and Steele di-electric separator and the Huff electrostatic separator. Both machines operate on essentially the same principle, but the two types vary considerably in their construction.

As far as known, the Sutton, Steele and Steele separator (Sutton, Steele and Steele Company, Dallas, Texas) has been installed in only one graphite mill, situated in the Buckingham district, Province of Quebec. The machine was installed some years ago, and is reported to have given satisfactory results. It was used to clean the concentrates produced by the Canadian dry process, employing rolls and screens, the No. 1 and No. 2 flake being treated separately. It is claimed that the No. 1 flake concentrates from the rolls are raised from 65 per cent carbon content to 92 per cent by this machine.

The machine measures about 5 feet in length by 4 feet in width, and stands about 6 feet high. The feed falls onto a steam-heated apron, and thence to a bin, similarly heated. From the latter, it passes over a shaking apron, which spreads the particles evenly and from which they pass over a slowly revolving brass roller. In front of this roller is set a parallel, wood-covered brass rod, from which extends a single row of 1" needles. These needles, with the revolving brass roller, act as the electrodes for creating the electric field. They project toward the feed roller, and are spaced $\frac{1}{4}$ inch apart, their points being set at a distance of about 2 inches from the roller. Both roller and rod electrode are insulated from the rest of the machine, the former being grounded. The latter is connected with a generator (in the mill in question, this is a Holtz type electrical machine). The amount of current required is small, but the potential is high, being about 20,000 volts. On passing into the electric field formed between the needle points and the feed roller, the graphite flakes are attracted toward the former and fall into the concentrate hopper, while the gangue particles tend to follow the roller. Through interference by the particles, and for other reasons, all of the graphite present in the feed is not removed in the one operation, and the tailings from the first field pass through a second, which extracts the remaining free flake. Plate XXXIII shows a view of a Sutton, Steele and Steele separator, equipped for three electric fields.

The Huff electrostatic separator (International Carbon Products Company, 120 Broadway, New York) is illustrated in Fig. 20. This type of machine was formerly in use in two Ontario graphite mills, and was employed, as in the case of the preceding type, to clean concentrates produced by the dry process. At the present time, no Canadian graphite mill uses the machine, and its use is believed to be confined to one Alabama plant and a mill in Texas. The former is reported to produce an extremely high grade flake. The separator is stated to have operated with considerable success, also, in the two Canadian mills alluded to above.

The machine differs from the preceding type in the greater number of electric fields employed, and also in the style of electrodes used, these being plain, uncased rods, instead of needle points. Depending on the richness of the ore to be treated, the number of electrodes in operation can be varied from a maximum of eighteen, down, and many minor adjustments, such as

the distance between electrode and roller (width of electric field), angle of fall, etc., are possible. For a 200-ton installation, a 3 horse-power motor is required, delivering the current at from 10,000 to 40,000 volts, depending on the nature of the ore.

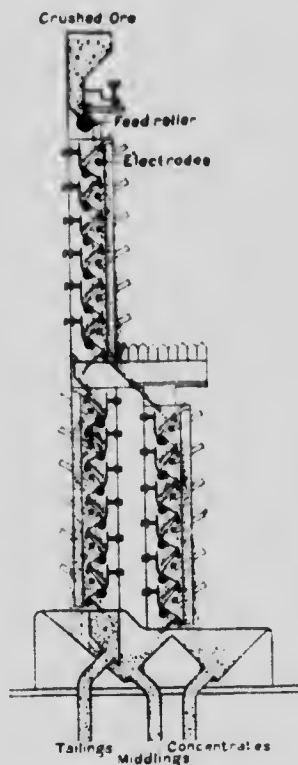

Fig 20. Section through Huff electrostatic separator.

In Plate XXXIV is shown diagrammatically the principle of operation of an electrostatic separator. For good results, the ore must be bone dry and preferably warm, and the air of the chamber in which the machines are placed should also be dry. On account of limited capacity and the close attention that the machines require for successful operation, it is questionable whether electrostatic separation can be profitably practised on graphite ores.

CONCENTRATION BY WET METHODS.

BUDDLES.

Buddles were probably the earliest method used for concentrating graphite on this continent, and the mill of the Lochaber Plumbago Mining Company, the first recorded graphite operators in Canada, was equipped with buddles. While many and varied methods of concentration have

been practised and discarded since those early days, it is noteworthy that two of the largest graphite mines on the American continent (the American Graphite Company, in New York, and the Black Diamond Graphite Company, in Ontario) retained the buddle system until 1918. The latter Company still continue their use¹, but the former discarded them during 1918 in favour of the Callow oil flotation process.

Buddles effect a satisfactory recovery from practically all types of graphite ore, and they have the merit of being simple to operate and of requiring little attention. Their capacity is rather limited, however, and they take up an excessive amount of floor space, besides which the products

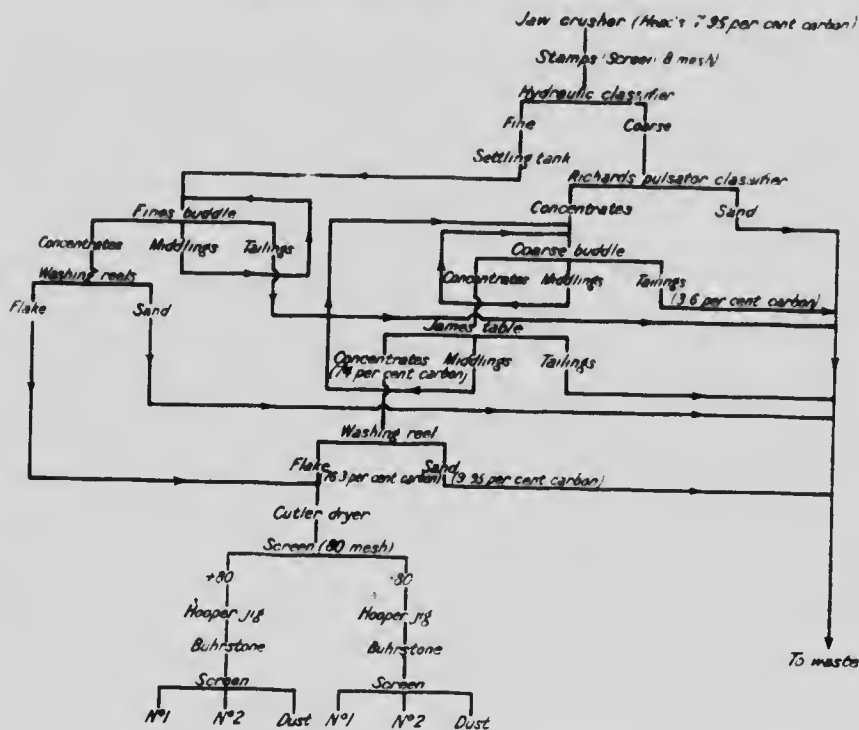

Fig. 21. Flow sheet showing mill system using buddles, as installed in a New York mill.

made must be removed by hand, necessitating duplicate equipment, one buddle filling while the other is being emptied. When treating low grade ores, this entails the handling of large quantities of tailings.

In Figs. 21 and 22 are shown flow sheets of two mills effecting concentration of graphite by means of buddles. In the case of the former, the ore treated is a hard graphitic gneiss carrying 5 per cent of graphite, and concentrates are made containing 65 per cent, the recovery being about 50 per cent of the graphite in the ore.

The mill, Fig. 22, treats an exceptionally rich ore (65 per cent of graphite), carrying calcite and chlorite as the chief impurities, and while

¹ See note p. 38.

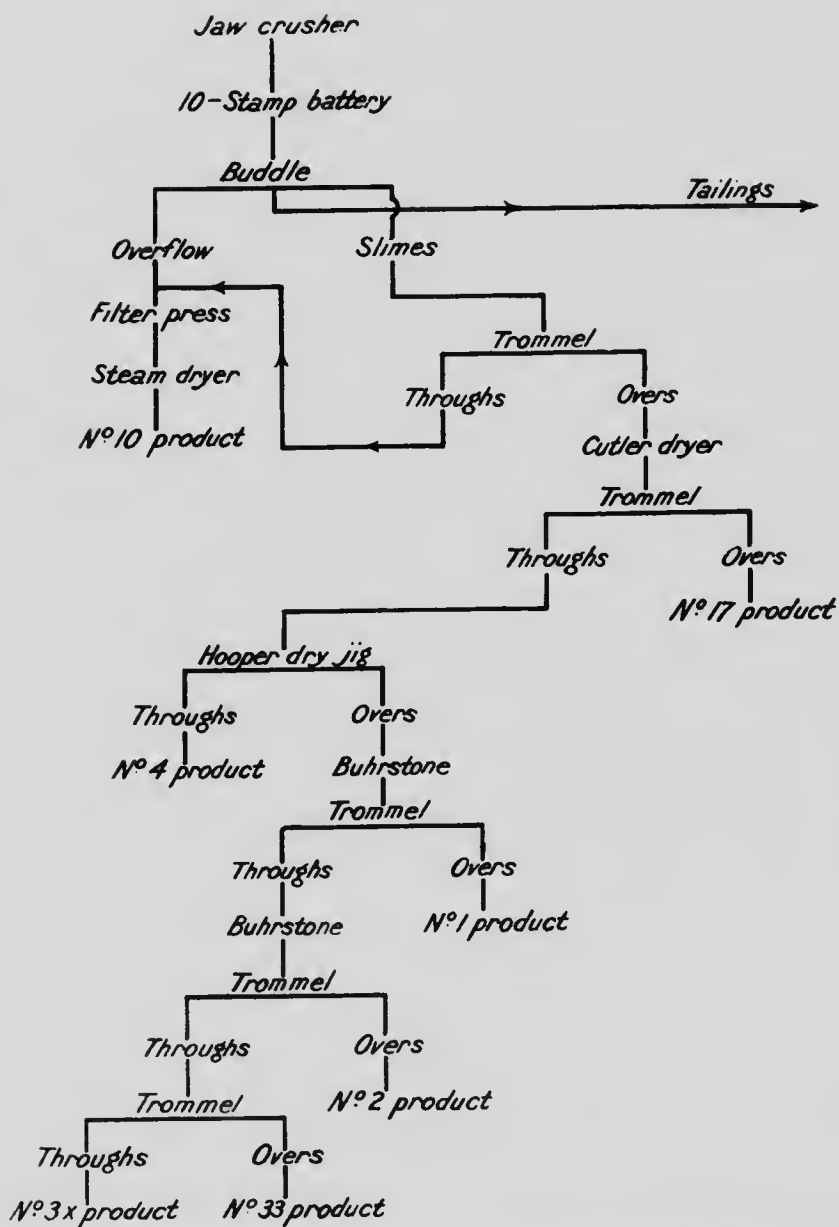

Fig. 22. Flow sheet of combined wet and dry concentrating system, as installed in an Ontario mill.

no exact figures are available, the buddles probably make concentrates approximating 80 per cent.

The buddles used in graphite mills are of the circular type, and are about 16 feet in diameter. In more recent years, their use has been largely confined to the New York graphite field.

MECHANICAL WASHERS.

Log Washers.

This method of concentration has found its greatest adoption in Pennsylvania mills. Most of the mills in this State treat a highly decomposed, surface ore, the graphite content of which is between 4 and 5 per cent. The gangue consists principally of quartz and kaolinized feldspar with a little mica. In some cases, the ore as it comes to the mill is in the form of gravel; in others it is somewhat harder, but is still soft enough to be crushed readily in a muller pan.

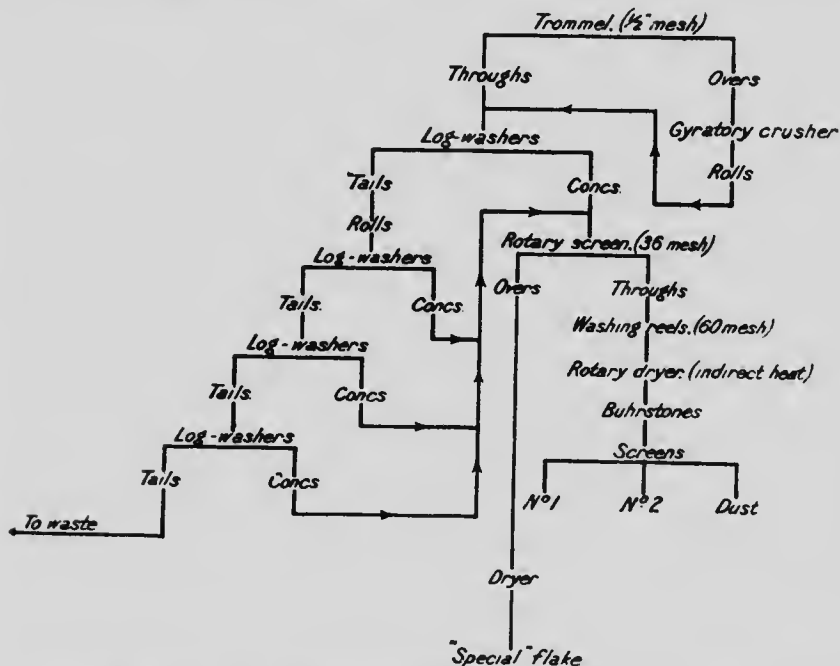

Fig. 23. Flow sheet of mill employing log-washer concentration, Byers, Pennsylvania. The ore is very decomposed, and comes to the mill in the form of gravel.

Log washers are stated to be used, also, in two Alabama mills.

The log washers used are of two types, continuous-screw and blade. The latter are stated to give rather better results than the screw type, owing to there being less attrition of the large flake. Fig. 23 shows a flow sheet of a Pennsylvania mill equipped with log washers. At this mill, of the graphite recovered in the log washer concentrates, about 35 per cent

remains on a 36-mesh screen. The consumption of water is 120,000 gallons per 24 hours.

Rake Washers.

In some Pennsylvania mills, washers of the rake type have supplanted log washers, and are reported to give more satisfactory results. This type of washer is a home made appliance and works on the principle of the Dorr classifier. It consists of a table 18 feet long and 4 feet wide, set on an incline of about 1 in 25. On the two sides are boards 12 inches high for holding in the ore. Strips are set along these boards to serve as runways on which the rake frame travels on its forward and return stroke. The frame is provided with cross pieces at 18-inch intervals, to which are attached the rake teeth. These are of iron, 1 inch wide, and are set

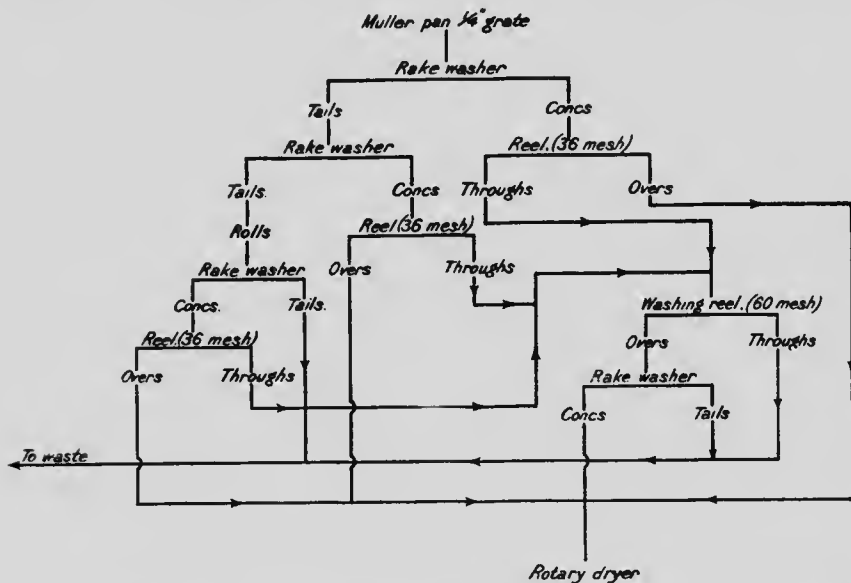

Fig. 24. Flow sheet of wet concentration system, using rake washers, in a Pennsylvania mill. This mill has a capacity of 100 tons of ore per 24 hours, requires 60 H.P. for operation, and three men to a shift.

1½ inches apart. The rows are staggered, and the teeth extend to within 1 inch of the surface of the table. The frame is actuated by a crank at the upper end, and has a play of 18 inches. The rate of travel is twelve up-and-down movements in one minute. The ore is fed to the table from a central spout set about 3 feet from the lower end. A pipe crosses the table 2 feet below the upper end, and from it sprays of water impinge on the surface of the ore. Four adjustments are possible, namely pitch of table, rate of rake travel, amount and velocity of feed water, and rate of feed of ore. In operation, the rake frame travels up the slope with the teeth in the ore; at the end of its stroke, the frame is raised and travels back with the teeth elevated above the bed. In this way, the coarse sand is raked to the upper end of the table, where it discharges, while the water

washing down the table carries the finer material, including the light graphite, to a collecting launder at the lower end. A bed of ore about 1 inch thick remains undisturbed between the ends of the rakes and the table surface, and the total thickness of the ore on the table is about 2 inches.

It is claimed that by adding coal oil or kerosene to the feed water, a material improvement is effected in the amount of graphite recovered in this type of washer.

According to Dub¹, the following results have been obtained by the use of these washers, kerosene oil being added to the feed:--

Heads.	Concentrates.	Tailings.
4.52 per cent carbon	62.00 per cent carbon	2.19 per cent carbon
3.56 " "	72.07 " "	1.79 " "

WET TABLES.

Wet tables have not been adopted to any large extent in graphite concentration. One Canadian mill, however, is at the present time equipped with Krupp-Ferraris tables, and the James table has been employed in New York and Pennsylvania mills. It is a common practice to lightly oil the feed for wet tables, this resulting in a marked improvement in extraction. The plants using James tables report satisfactory results, especially with the addition of oil to the feed. The Canadian mill using

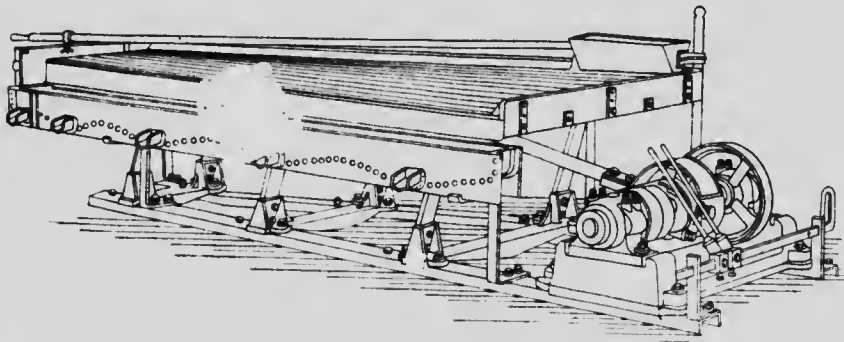

Fig. 25. Ferraris type of wet table.

Krupp-Ferraris tables has been in operation for the past five years, and makes concentrates running 60 per cent carbon, or, better, from a 20-12 per cent ore.

An installation of Ferraris wet tables is shown in Plate XXXV, and the James table is illustrated in Fig. 26. The power required for operation of both types is 0.5 to 1 H.P., and the water consumption 5 to 9 gallons per minute. Their capacity is about 1,000 pounds per hour.

¹Dub, G. D., Preparation of Crucible Graphite, U. S. Bureau of Mines, Dec. 1918, p. 15.

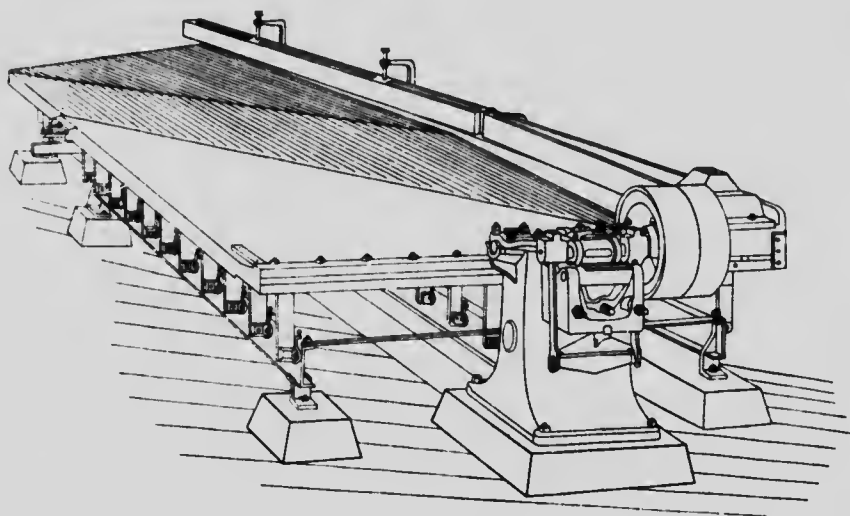

Fig. 26. James type of wet table.

FLOTATION.

Considerable attention has been devoted in the last few years to the possibilities of flotation as a method of concentrating graphite ores.

Flotation, as applicable to graphite concentration, may be of two kinds, each embodying quite different features and based upon different systems of manipulation. These two methods are, respectively, frothing oil flotation, and film or surface tension flotation.

Frothing Oil Flotation.

This method utilizes the property possessed by fine particles of certain minerals—notably sulphides, as well as by graphite, when made into a pulp with water to which a certain small proportion of frothing oil or oils has been added, and upon the subsequent formation within the pulp of a mass of bubbles (froth) either by mechanical agitation or by the injection of air—of being carried to the surface, while the gangue, (silica, calcite, mica, feldspar, etc.) sink. The reason for this selective action on the part of the various mineral particles is not definitely known, and has been ascribed to many causes, including a superior affinity by metallic surfaces for air, which preference is enhanced by the presence on them of oil or grease. In this way, the metallic (and graphite) particles become attached to the bubbles formed in the pulp and are carried by them to the surface, where they may be skimmed off, or, as takes place in actual practice, are automatically carried forward by surface flow over the lip or edge of the tank or cell in which the operation is carried out.¹

All systems of concentration of ores by the frothing oil flotation method are alike in their basic principles. These are, briefly, the mixing

¹ For a consideration of the underlying principles of frothing flotation, see *The Flotation Process*, by T. A. Rickard, published by the Mining and Scientific Press, San Francisco; also, *The Flotation Process*, by H. A. Megraw, 2nd edition, 1918, McGraw-Hill Publishing Company, New York.

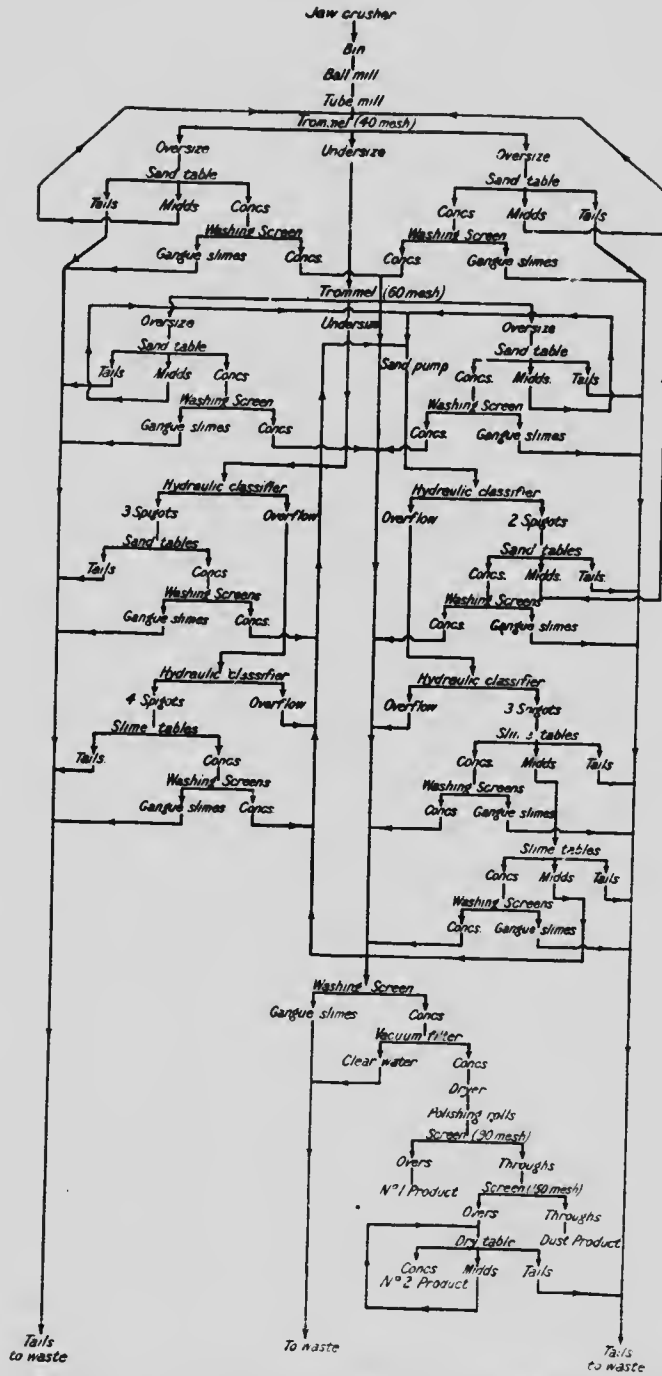

Fig. 27. Flow sheet of wet concentration system, using Ferraris tables, as installed in a Quebec mill.

of the finely ground ore with water to form what is known as the pulp, the emulsifying of the pulp by the addition of a suitable frothing oil, and finally the production within the pulp of a mass of air bubbles (froth), which floats the valuable mineral to the surface. The production of the froth is dependent upon the presence of air in the pulp, and various methods of introducing this air have been devised. Thus, by the Minerals Separation system the air is beaten into the pulp by means of paddles or stirrers; by the Callow system, it is injected through a canvas or other suitable porous bottom; by the Simplex system, it is introduced by means of jets of water impinging on the surface of the liquid in the cell.

All of the above-mentioned systems of oil flotation have been installed in Alabama graphite mills, and, it is claimed, have given satisfactory results. According to Dub,¹ eight of the mills employ the Callow system, four, the Simplex, and four, Minerals Separation cells; in addition to which, six plants have installed, or intended to install, cells combining some of the principles of these systems.

In Pennsylvania, one mill is equipped with the Minerals Separation system.

In New York, the mill of the American Graphite Company has lately been equipped with the Callow system, and excellent results are claimed to have been secured.

In Canada, the Callow system was installed in 1918 in one mill in the Buckingham district, but unfortunately the mill burned down before any definite results were achieved. At the present time, (March 1919) one other mill in the same district has almost completed the installation of Callow cells, and the same system is under consideration by a third plant.

Frothing oil flotation for concentrating graphite has only been employed in actual practice for the last two or three years, and for the greater part of this period the process may be said to have been merely in its experimental stages. It is, therefore, perhaps, a little early to generalize on what the method can achieve, since, for best results, considerable knowledge of the principles of flotation is necessary, and the adjustments that are required to be made in the mills of different districts owing to variations in the character of the ore to be treated, size of flake, etc., are many and varied. Results obtained in the Alabama mills, however, and also in the one mill in New York, using oil flotation, have demonstrated that the process can cheaply and effectively treat the ore of both districts. Considerable experimental work has been carried out, also, on Canadian ores with the Callow system, the results being very satisfactory. Frothing oil flotation would appear to offer the cheapest and most efficient means of concentrating graphite that has yet been devised.

One of the chief difficulties connected with the process is in combining good recovery with a high grade of concentrates. If a froth be produced sufficiently strong to float all of the flake, both large and small, a considerable proportion of fine and attached gangue is also floated, and a dirty concentrate results; while if the froth be adjusted to make a clean concentrate, much of the larger flake passes into the tailings. The difficulty may be at least partially overcome by close attention to sizing of the feed, and the treatment of the different sizes by individual cells.²

¹ Op. cit., p. 9.

² Data relating to the various factors that may affect the efficient operation of flotation plants are contained in *Flotation for the Practical Mill Man*, by F. G. Moses, Chem. and Metall. Engineering, June 1, 1919, pp. 571-7.

While the figures quoted of experimental work on Canadian ores with the Callow system would tend to indicate that the graphite delivered from the cleaner cell is sufficiently pure to be marketed as No. 1 flake without any further cleaning, such good results are probably not obtainable in actual mill practice, the flotation concentrates requiring finishing over burrstones or polishing rolls.

Ball or pebble mills are almost invariably used for grinding the feed for oil flotation cells, and most of the leading types of such mills are represented in the various plants. While comparative data on the destructive effect of different grinding machines on graphite flake is lacking, wet grinding in a ball mill of ore to be concentrated by wet means seems to be gaining increased favour. For use with oil flotation installations, and treating a hard ore, ball mills are perhaps to be preferred, as, by adding the frothing oil to the charge, the ore is ground and the pulp emulsified at one operation. Where rolls or other grinding machines are employed, emulsifying of the pulp may be effected satisfactorily by the action of elevators and in the hydraulic classifier.

While differing in certain details of construction and operation, all systems of frothing oil flotation employ a series of tanks, or cells, in which frothing of the pulp takes place. The first cell effects an initial concentration, and the concentrates from it pass to a second, and so on, through as many cells as may be found necessary to raise the grade to the point desired. By interposing additional ball mills or other grinding machines between successive cells or groups of cells, the concentrate made by the last cell can be raised to a high degree of purity.

It has been conjectured that graphite refined by the oil flotation method may possibly become so contaminated by the flotation oils used as to be unsuitable for crucible work. The amount of such oils used, however, is relatively very small, and since the finished product is subjected to a considerable degree of heat in the final drying, any oil that may adhere to the flake is driven off during this operation.

A system of concentration that may be described as a combination of the oil flotation method with log washing was devised by J. F. Latimer, of Toronto, Ontario, in 1908. The apparatus employed¹ consists of a round washer or cell, tapering to a point at the bottom, where the tailings discharge spigot is situated. A screen is placed within the washer at the point where it starts to taper. A hollow, vertical shaft passes down through the centre of the washer and screen, terminating just below the latter. Adjustable paddles are fixed to the shaft just above the screen, and the shaft is rotated by a pulley. In operation, the pulverized ore is first mixed with a small amount of crude oil. Water is led into the washer through the hollow shaft, and as soon as it starts to flow up through the screen, the ore is fed in near the centre of the washer. The gangue particles pass down through the screen, while the graphite floats out through a spout near the top of the washer. If necessary, a series of such washers may be employed, each one taking the concentrates from the preceding one. The concentrates from the last washer pass into an inclined trough, or log washer, which discharges clean graphite at the upper² end.

The Kendall separator (U. S. Patent, No. 771,075) is operated along very similar lines to the above. A mill in the Buckingham district, Quebec,

¹ See Can. Min. Journ., Vol. 29, 1908, p. 142. U. S. Patents 851,599 and 851,600, April 23, 1907.

² This would be the reverse of what takes place in actual log washer concentration, (the gangue discharging at the upper end and the graphite at the lower end).

was equipped about ten years ago with this type of separator, but the results did not prove satisfactory and the process was abandoned.

The following list of United States patents relating to the concentrating of graphite by oil flotation, or by methods akin to oil flotation, is taken from Bulletin No. 8 of the Utah Engineering Experiment Station, June 1916, by R. S. Lewis and O. C. Ralston. The abstracts of each patent, given in the above Bulletin, are not quoted, but copies of the patents may be obtained at a cost of 5 cents each from the Commissioner of Patents, Washington, D.C.:

486,485.	Nov. 22, 1892.	Nibelius.
678,860.	July 23, 1901.	Brumell.
679,473.	July 30, 1901.	Davis.
688,279.	Dec. 10, 1901.	Allen.
734,641.	July 28, 1903.	Wheelock.
736,381.	Aug. 18, 1903.	Glogner.
745,960.	Dec. 1, 1903.	Good.
763,859.	June 28, 1904.	Darling.
771,075.	Sept. 27, 1904.	Kendall.
795,823.	Aug. 1, 1905.	Darling.
816,303.	Mar. 27, 1906.	Davis.

Callow System.

The Callow system of oil flotation has probably been more extensively adopted in graphite mills than any other, and while still in process of development for the treatment of graphite ores, has successfully demonstrated its ability to concentrate graphite both cheaply and efficiently. In this system, frothing is effected by forcing air into the pulp through a porous medium, such as canvas, forming the bottom of the cell.

Figs. 28 and 29 show Callow installations at two mills in the United States. Fig. 28 is the flow sheet of a mill in Alabama, while Fig. 29 shows the installation at a mill in New York. In the case of Fig. 28, the ore is soft, and carries about 3 per cent of graphite, while that treated by flow sheet Fig. 29 is hard and runs about 6 per cent. The latter type of installation, with minor modifications, is suggested as the more suitable for treating Canadian gneissic ores. In the case of the softer, graphitic limestones, the second ball mill might possibly be dispensed with. The original Callow installation at the New York mill contained only the Hardinge mill A, and with this equipment a one-product concentrate was secured running 70-75 per cent carbon, with a 95 per cent extraction. With the additional mill B, it is hoped to raise the grade of product to 90 per cent or better. The concentrates from this mill undergo a further refining by means of burrstones and screens.

On the following pages are shown the results of tests made on a series of samples of Canadian graphite ores with the Callow system.

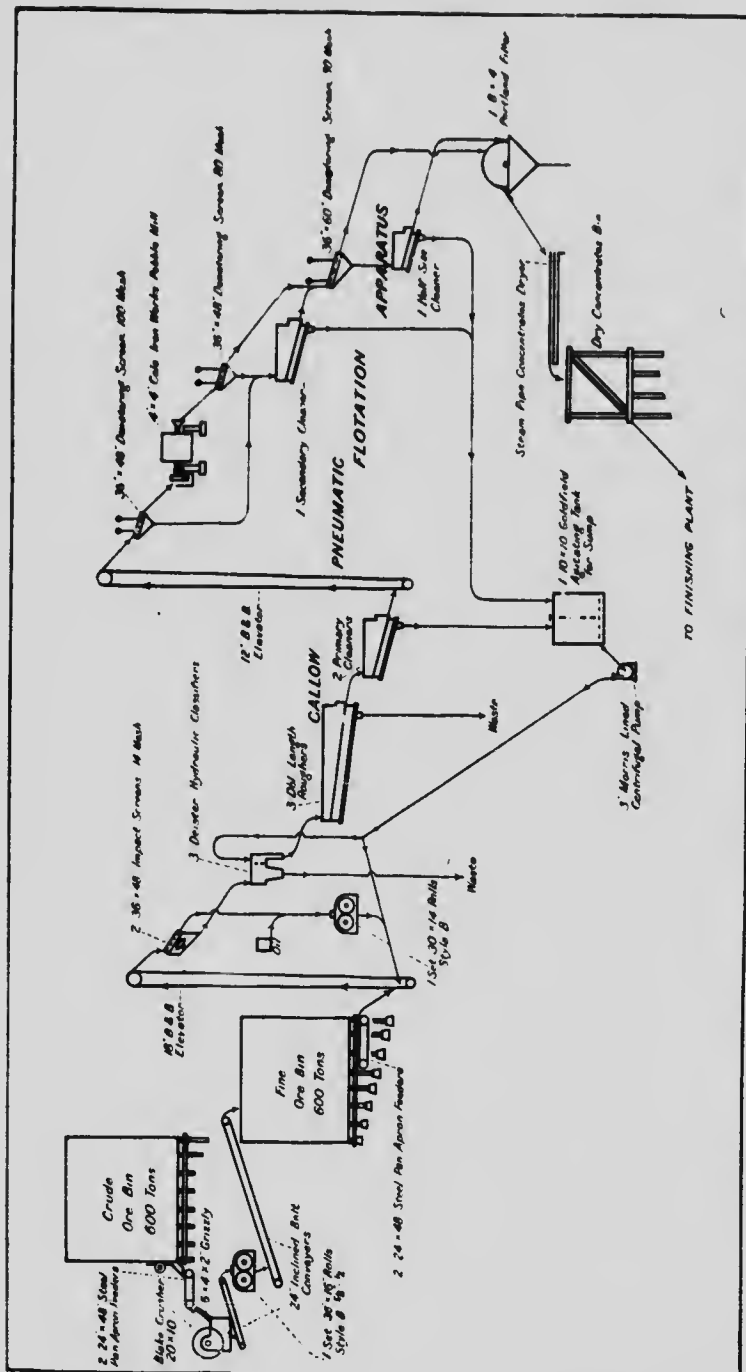

Fig. 28. Flow sheet showing Callow pneumatic flotation system as installed in an Alabama graphite mill.

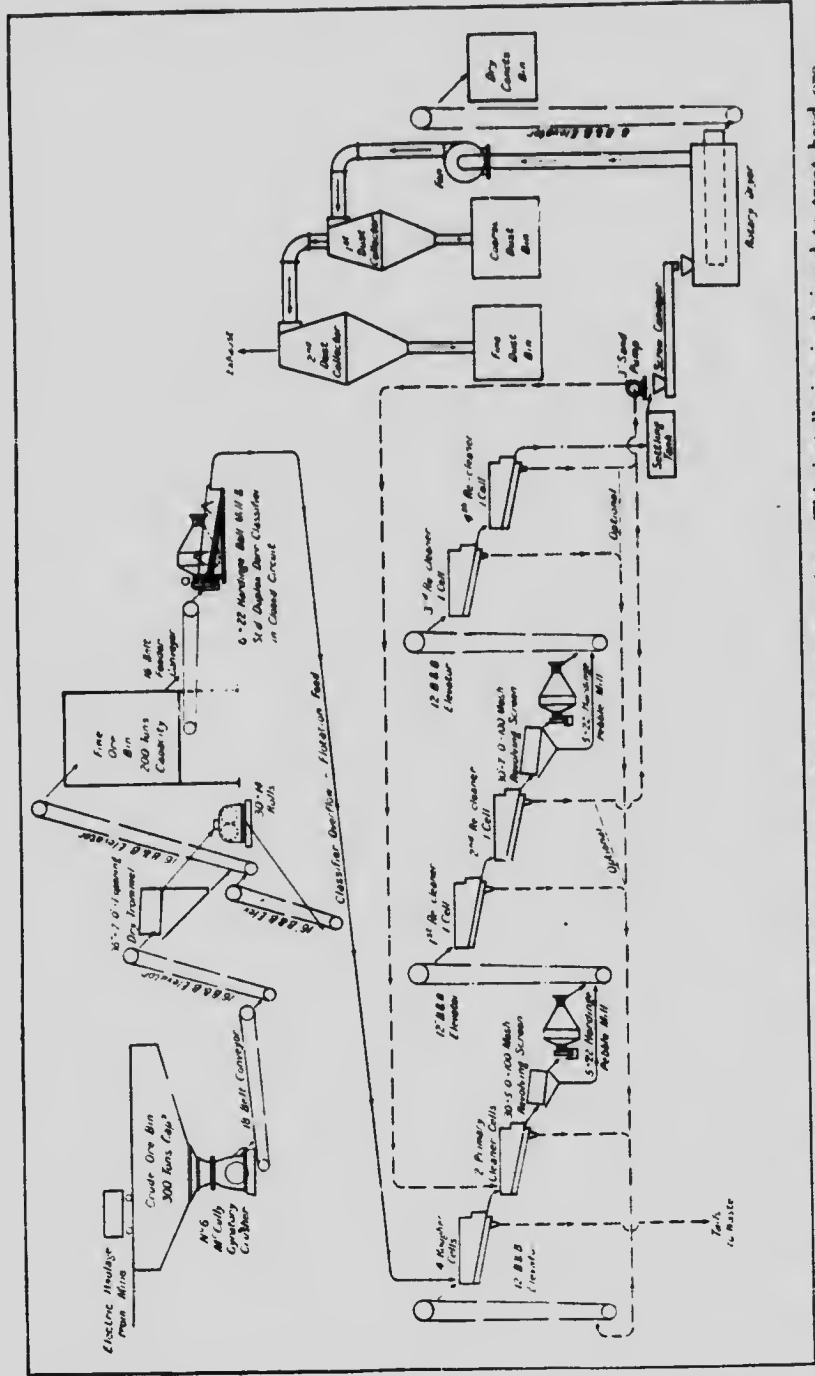

Fig. 29. Flow sheet of mill using Callow pneumatic flotation concentration. This installation is designed to treat hard ore carrying about 6 per cent of graphite.

Ore: Disseminated flake graphite—chief impurities, calcite, mica, quartz, pyrites. Heads, by products, 12.81 per cent carbon. Ground to 40 mesh and oiled at the rate of 11 pounds per ton. Oils used: General Engineering Company's No. 136, 90 per cent; No. 56, 10 per cent.

Test made by General Engineering Company's laboratory, Ottawa.

Treatment.	Sample No.	Description.	Weight, per cent.	Assay, per cent carbon.	Carbon content = assay X per cent of weight.	Percentage of recovery or loss, carbon.
Sample No. 1 floated in Cal- low pneumatic machine.	2	First flotation concen- trates.....	24.8	50.28	1,246.86	97.3
	3	First flotation tailings	75.2	0.46	34.60	2.7
	1	Heads, by products.....	100.0	12.81	1,281.46	100.0
Sample No. 2 (flotation concen- trates) re- floated in Cal- low pneumatic machine	4	Second flotation concen- trates.....	14.2	85.2	1,209.76	94.41
	5	Second flotation midd- lings.....	10.6	3.5	37.10	2.89
	2	Feed, by products.....	24.8	50.3	1,246.86	97.30
Sample No. 4 (second flota- tion concen- trates) sized as indicated	6	+ 80 mesh.....	9.0	91.5	823.50	64.27
	7	- 80 ".....	5.2	74.3	386.26	30.14
	4	Feed, by products.....	14.2	85.2	1,209.76	94.41

SUMMARY.

YIELD PER TON OF ORE.

Pounds.	Product.	Carbon, per cent	Per cent of concentrates.	Percentage of total carbon in ore.
180	+ 80 mesh.....	91.50	63.4	64.27
104	- 80 mesh.....	74.28	36.6	30.14
212	Re-treatment product.....	3.50	2.89
1,504	Tailings.....	0.46	2.70
2,000			100.0	100.00

Ore: Plumbago or crystalline graphite, mixed with some flake. Chief impurities, calcite, quartz, feldspar and pyroxene. Heads, by products, 45.51 per cent carbon. Ground to 30 mesh, and oiled at the rate of 14 pounds per ton. Oils used: General Engineering Company's No. 136, 70 per cent; No. 6, 15 per cent and No. C-41, 15 per cent.

Test made by General Engineering Company's laboratory, Ottawa.

Treatment.	Sample No.	Description.	Weight, per cent.	Assay, per cent carbon.	Carbon content = assay \times per cent of weight.	Percentage of recovery or loss, carbon.
Sample No. 1 floated in Cal-low pneumatic machine	2	First flotation concentrates.....	54.6	82.40	4,498.6	98.9
	3	First flotation tailings.....	45.4	1.16	52.7	1.1
	1	Heads, by products.....	100.0	45.51	4,551.3	100.0
Sample No. 2 (flotation concentrates) re-floated in Cal-low pneumatic machine	4	Second flotation concentrates.....	49.9	89.40	4,461.6	98.1
	5	Second flotation middlings.....	4.7	7.88	37.0	0.8
	2	Feed, by products.....	54.6	82.4	4,498.6	98.9
Sample No. 4 (second flotation concentrates) sized as indicated	6	+ 80 mesh.....	30.3	95.35	2,889.1	63.5
	7	+ 150 ".....	11.8	85.42	1,007.9	22.0
	8	- 150 ".....	7.8	72.38	564.6	12.6
	4	Feed, by products.....	49.9	89.40	4,461.6	98.1

SUMMARY.

YIELD PER TON OF ORE.

Pounds.	Product.	Carbon, per cent.	Per cent of concentrates.	Percentage of total carbon in ore.
606	+ 80 mesh.....	95.35	60.7	63.5
236	+ 150 ".....	85.42	23.7	22.0
156	- 150 ".....	72.38	15.6	12.6
94	Re-treatment product.....	7.88	0.8
908	Tailings.....	1.16	1.1
2,000			100.00	100.00

The following test was made on a representative sample of a tailings dump at a mill in the Buckingham district. This mill employed a dry system of concentration, which succeeded in extracting only about 50 per cent of the graphite in the ore. The graphite was all flake, and the chief impurities were calcite, mica, feldspar, and pyroxene. The sample showed, by products, 6.14 per cent carbon. The sample was ground to 40 mesh, and was oiled at the rate of 2.8 pounds per ton. Oils used: General Engineering Company's No. 136, 60 per cent; No. 8, 20 per cent; No. 6, 20 per cent.

Test made by General Engineering Company's laboratory, Ottawa.

Treatment.	Sample No.	Description.	Weight, per cent.	Assay, per cent carbon.	Carbon content = assay × per cent of weight.	Percentage of recovery or loss, carbon.
Sample No. 1, floated in Callow pneumatic machine	2	First flotation concentrates.....	12.30	45.10	554.82	90.30
	3	First flotation tailings.....	87.70	0.68	59.63	9.70
	1	Heads, by products.....	100.00	6.14	614.45	100.00
Sample No. 2, (flotation concentrates) re-floated in Callow pneumatic machine	4	Second flotation concentrates.....	9.35	58.32	545.26	88.73
	5	Second flotation middlings.....	2.95	3.24	9.56	1.57
	2	Feed, by products.....	12.30	45.10	554.82	90.30
Sample No. 4, (second flotation concentrates) screened as indicated	6	+ 80 mesh.....	4.27	72.66	310.26	50.49
	7	- 80 ".....	5.08	46.26	235.00	38.24
	4	Feed, by products.....	9.35	58.32	545.26	88.73

SUMMARY.

YIELD PER TON OF TAILINGS TREATED.

Pounds.	Product.	Carbon, per cent.	Per cent of concentrates.	Percentage of total carbon in heads.
85	+ 80 mesh.....	72.66	45.5	50.49
102	- 80 ".....	46.26	54.5	38.24
59	Re-treatment product.....	3.24	1.57
1,754	Tailings.....	0.68	9.70
2,000			100.00	100.00

Below are given the average results out of a series of five tests made on a sample of graphite ore from Lachute, Que., with the Callow pneumatic testing machine at the ore testing laboratory of the Mines Branch, Department of Mines. The ore consisted of flake graphite in a gangue of calcite, quartz and mica, with a small amount of pyrites, and the sample was typical of the graphite schists of the Quebec area. The carbon content was 15 per cent. It was found necessary to crush to a fineness of 30 mesh in order to free the flake. In three out of the five runs, the samples were crushed to 30 mesh, and in the remainder to 40 mesh. In the case of the former, pine oil and coal oil were used, and with the latter No. 25 F.P.L. creosote oil. The amount of oil used was between one and two pounds per ton of ore. In all cases, the crushed ore was ground for 5 minutes in a pebble jar, floated, and the concentrates re-ground in a pebble jar and re-floated.

The results of the tests show that 96.5 per cent of the total graphite in the ore is recovered in the concentrates.

Pounds.	Product.	Carbon, per cent.	Percentage of total carbon in ore.
73	+ 80 mesh.....	92.1	23.4
101	- 80 + 115 mesh.....	78.3	23.1
311	- 115 mesh.....	55.8	50.0
401	Middlings.....	1.9	2.7
1,114	Tailings.....	0.2	.8
2,000			100.0

A further test was made in the Mines Branch laboratory with the Callow pneumatic machine on concentrates from one of the Quebec mills. This mill employs a wet system of concentration by means of Ferraris tables. The concentrates submitted for test ran carbon 60.10 per cent, silica 20.10 per cent, iron 2.20 per cent. The silica was present both as attached particles and as a skeleton of either quartz or mica within the body of the flakes. The iron was chiefly pyrites and pyrrhotite in the form of microscopic particles within the flakes.

The material was floated, and the grade raised to 72.3 per cent carbon. These concentrates were then ground in a pebble mill and re-floated, and the final concentrates were found to assay 83.45 per cent carbon. On screening, the following results were obtained:—

Mesh.	Carbon content.	Per cent of concentrates.
+ 100.....	86.50	73.2
- 100 + 150.....	82.05	13.3
- 150 + 200.....	68.45	3.8
- 200.....	48.32	4.7
		100.0

The presence of microscopic quartz, mica, and pyrrhotite within the graphite flakes was determined by carefully picking out the largest clean flakes from the flotation concentrates and analysing them. It was found that these apparently clean flakes assayed as follows:—

Carbon.....	92.25 per cent
Silica.....	3.00 "
Iron and alumina.....	3.60 "
Undetermined.....	1.15 "

100.00

Under the microscope, also, the presence of quartz, pyrrhotite, and pyrite, intimately intergrown with the graphite is clearly visible.

The presence of these microscopic impurities explains why it is impossible by mechanical methods of concentration to raise the carbon content of some flake graphites beyond a certain point. It also shows that con-

concentrates running higher in carbon may more often be secured from weathered surface ore than from unweathered, since most of the iron sulphide is commonly leached out of the former. The resulting acid also attacks any calcite present, thus bringing about a still higher graphite content in such ores. For reliable results, therefore, all tests should be carried out on fresh, unweathered ore and not on surface samples.

The following cost data for a Callow installation designed to treat 100 tons of ore per day have been kindly supplied by the General Engineering Company. The plant in question is designed for Alabama ore, and the estimated mining costs are, accordingly, considerably lower than the actual figures for work in hard rock, as in New York and Canada. On the other hand, the average graphite content of the ore in the latter fields is from two to five times as high as that of Alabama ore, so that the two things may thus be considered as offsetting one another to a large extent. It should be stated, also, that the estimated cost of \$0.75 per ton for mining Alabama ore appears high as compared with the figure quoted to the writer by operators, which was \$0.25 to \$0.35 per ton delivered to the crusher.

Mini operating costs for plant treating 100 tons graphite per 24 hours in the Alabama graphite districts.

Callow Oil Flotation System.

1918.

Labour—

1 Crusher man.....	\$ 4.00
3 Ball mill or roll men at \$4.....	12.00
3 Flotation men at \$4.....	12.00
3 Labourers at \$3.....	9.00
1 Meehanie.....	7.50
1 Superintendent at \$300 per month.....	10.00

\$54.50 or 54½ cents
per ton of ore.

Power—

Crusher.....	20
Ball mill or rolls.....	50
Blower.....	25
Re-grinding mill.....	15
Miscellaneous.....	15

125

Frietion..... 25

Total..... 150 or 1½ H.P. per ton of ore. 150 H.P.
at \$75 per H.P. year, or \$0.25 per H.P. day = \$37.50 per day or 37½¢.
per ton of ore.

Flotation Oils—

200 lbs. coal oil at 7 lbs. per gal. or 30 gals. at 10c. per gal.....	\$ 3.00
100 lbs. G.N.S. No. 5 at 7½ lbs. per gal. or 14 gals. at 50c. per gal.....	7.00

\$10.00 or 10c. per ton

Steel Balls and Liners—

300 lbs. at 10c. per lb. or \$30 per day or 30c. per ton.

Oil, Waste and Incidental Repairs—

Estimated at \$15 per day or 15c. per ton.

Summary.

Labour.....	\$ 54.50	per day or	.54½c.	per ton.
Power.....	37.50	"	.37½	"
Flotation oils.....	10.00	"	.10	"
Balls and liners.....	30.00	"	.30	"
Oil, waste and incidentals.....	15.00	"	.15	"
	<u>\$147.00</u>		<u>\$1.47</u>	"
		say	1.50	"

Recapitulation.

Mining (open cut, soft ore), estimated	\$0.75	per ton
Milling.....	<u>1.50</u>	"
	\$2.25	

On 3% ore approximately 2½% would be recovered
or 50 lbs. per ton, at a cost of 4.5 cents per lb. of all grades.

Minerals Separation System.

In this system of frothing oil flotation, frothing of the pulp is effected by air entrained or beaten into it by paddles attached to a vertical shaft rotating in the frothing tank.

The system is reported to have been installed in four Alabama mills, and is used also in one small plant in Pennsylvania.

Fig. 30 shows the flow sheet of a mill in Alabama equipped with the system.

According to information furnished by the management, the ore treated in this mill contains 2.75 per cent of graphite, 2.25 per cent being regarded as recoverable. The flotation concentrates average 80 per cent carbon, and a recovery of 85 per cent (of 2.25) has been achieved.

It has been found difficult, however, to combine high recovery with a clean concentrate, and at the same time preserve the large flake, owing to the latter carrying up attached gangue. The denser froth also floats more slime gangue. In order to secure a high carbon content for the No. 1 flake, therefore, it has been found necessary to lower the percentage of recovery. With a 65 per cent extraction, it has been found possible to make a finished product carrying 85 to 90 per cent carbon. Of the total graphite recovered, 45 per cent is in the form of No. 1 flake and 55 per cent No. 2 and dust. The ore costs 25 cents delivered to crusher, and the cost of production per pound of No. 1 flake is 5 cents.

At a small mine near Chester Springs, Pennsylvania, soft, powdery ore running about 7 per cent graphite is broken up in a No. 2 Jeffrey "Lime Pulver" crusher and fed in small batches to a single Minerals Separation cell. The concentrates are washed in an 80 mesh reel, drained and dried on a hot plate. While only an experimental plant, the concentrates produced by the single rougher cell are reported to assay 80 to 85 per cent of graphite. The results secured would indicate that, with proper

equipment, this type of ore is well adapted to concentration by frothing oil flotation.

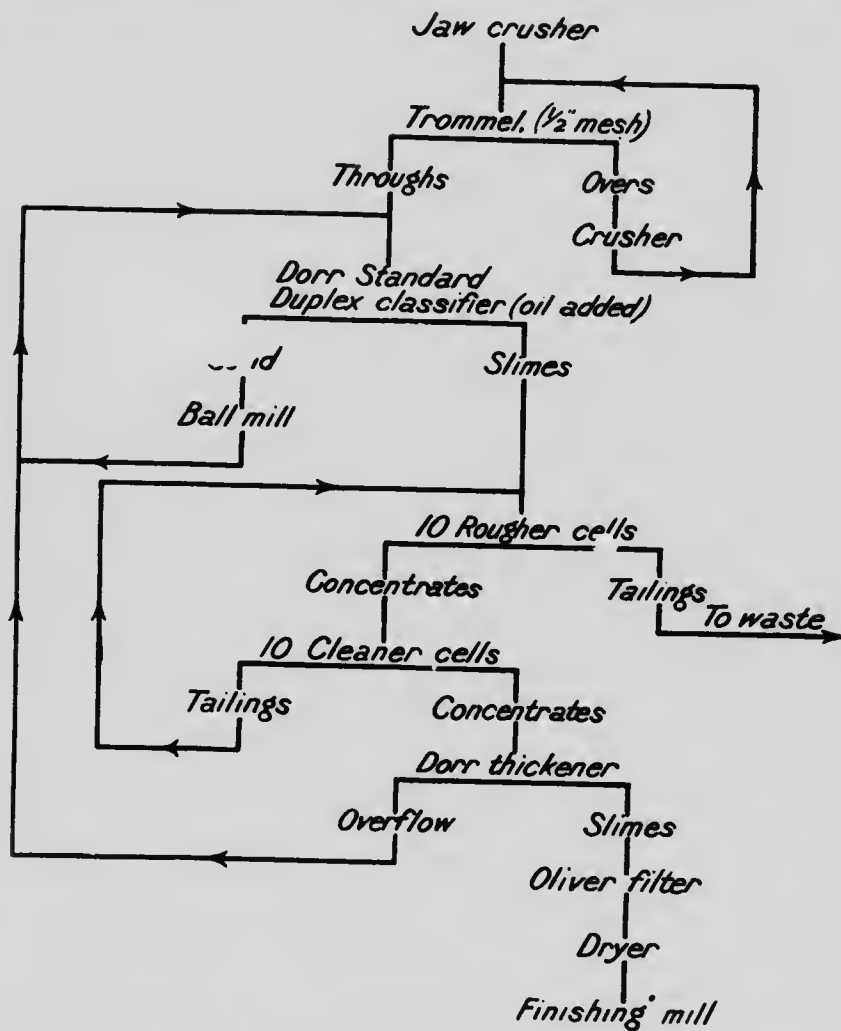

Fig. 30. Flow sheet of Minerals Separation oil flotation system, as installed in an Atabama mill.

Simplex System.

By this system of oil flotation, frothing is effected by jets of water which impinge on the surface of the pulp. The pulp is fed unclassified to the centre of the washer, and the frothing oil is introduced with the water from the jets. This water is under a pressure of about 40 pounds per square inch.

The Alabama graphite field is believed to be the only one in which this system of oil flotation has been adopted.

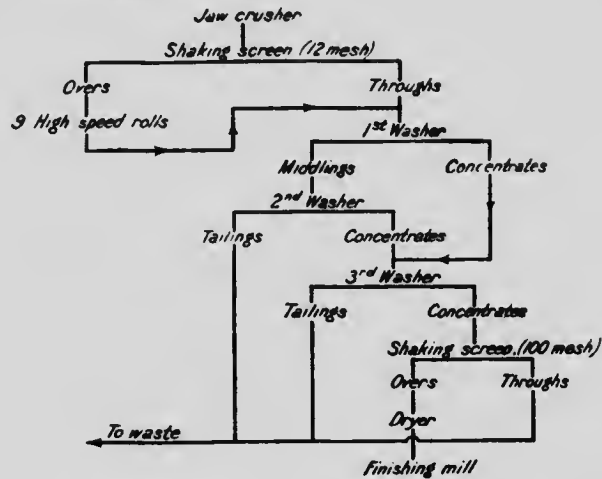

Fig. 31. Flow sheet showing Simplex oil flotation system, as installed in an Alabama graphite mill.

Figs. 31 and 32 show a flow sheet of a Simplex installation and a section through a Simplex washer, respectively. While data relating to results achieved, costs, etc., are lacking, the system is reported to have effected a satisfactory concentration.

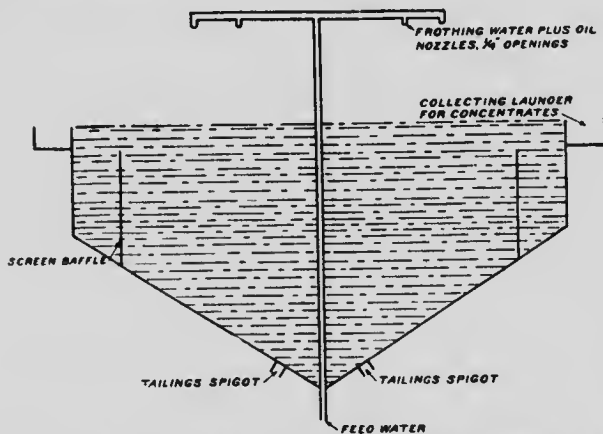

Fig. 32. Section through Simplex washer: not drawn to scale. Washer is elliptical, and measures about 6 feet by 3½ feet. (United States Bureau of Mines.)

K. and K. System.

In 1918, one mill in Pennsylvania was planning the installation of this system of oil flotation, but the writer lacks further details.

Surface Tension or Film Flotation.

This system of concentration depends on the ability of flat, flaky mineral particles to float on the surface of water by surface tension, without the addition of oil. This method of concentration has been employed in a large number of Alabama mills and is, in fact, practically confined to the mills of this State at the present time, though attempts at concentration along similar lines were made in Canadian mills a number of years ago.

The process has the merit of being relatively cheap to operate, the mill equipment required is not elaborate, and there are few appliances to suffer wear and tear or get out of order. The percentage of recovery by this system is, however, not very satisfactory, being probably not more than 40 to 50 per cent of the graphite in the ore. It is difficult to arrive at reliable figures, as few of the mills keep any record of the graphite content in the mill feed, and, for one reason or another, some mills effect better recovery by this system than do others. The grade of concentrate made is claimed to average about 65 per cent graphite.

Various types of washers, i.e., the tanks in which concentration is effected, are employed. That most generally used and the oldest type is the Munro washer, or, as it is usually termed in Alabama, the "Ashland wet box". This is a rectangular tank, (Fig. 33) above which is set a feed

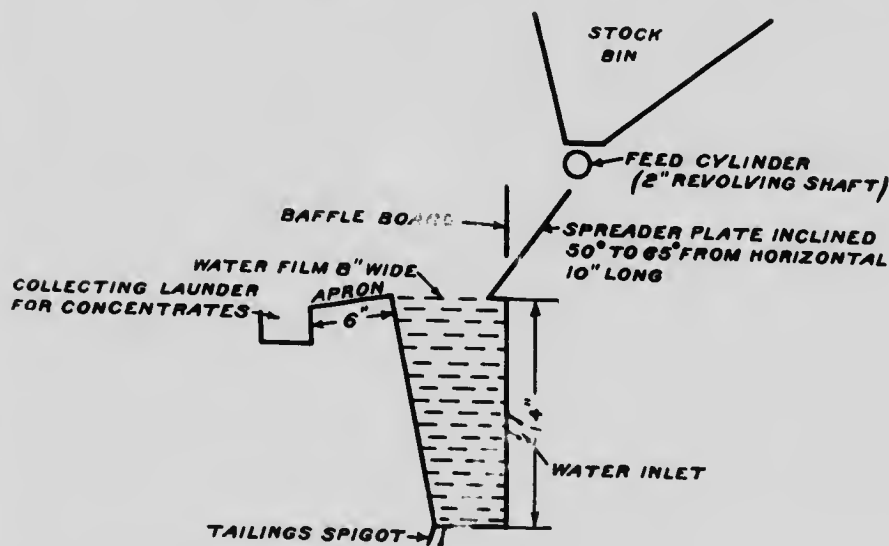

Fig. 33. Section through original Munro washer. These washers are built in units about 4 feet long, placed end to end and back to back. Not drawn to scale; dimensions indicated are approximate. (United States Bureau of Mines.)

cylinder, from which the ore drops onto an inclined spreader plate. A baffle board, hung slightly in advance of the point of impact of the ore on the spreader, ensures the feed flowing quietly onto the surface of the water. On meeting the water, the heavier gangue particles sink to the bottom of the washer and are discharged through the tailings vent, while the graphite,

together with an appreciable amount of fine dust gangue, floats over into the collecting launder. These washers are built in units 4 feet in length, placed end to end and back to back.

What is termed the New Munro washer is shown in Fig. 34. This consists of a circular tank, into which the feed water is introduced through

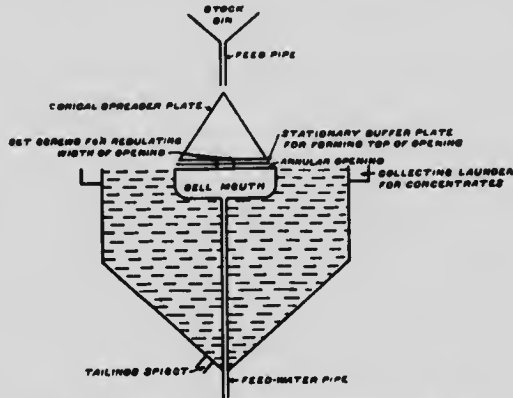

Fig. 34. Section through New Munro washer; not drawn to scale. Washer is circular, and about 42 inches to 48 inches in diameter; water film is about 12 inches wide. (United States Bureau of Mines.)

a vertical pipe terminating in a funnel whose lip is level with the surface of the water in the washer. Slightly above the funnel is set a stationary plate, which serves to prevent material falling into and clogging the feed pipe. The distance between this plate and the funnel lip can be regulated by set screws, so as to increase or diminish the size of the annular opening through which the feed water flows. The ore falls onto the surface of the water over a conical spreader, and the graphite is carried over the washer lip into the concentrates launder by the radial flow of the feed water.

A third type of washer in common use in Alabama mills is the Colmer. This, also, is circular in shape, and much resembles the foregoing in general construction. The ore in this case, however, is spread onto the surface of the water by means of a revolving disc, the surface of which is ribbed (Fig. 35). The feed water inlet, also, is situated near the bottom of the tank instead of at the surface. The diameter of the washer is about $3\frac{1}{2}$ feet, giving a water film of about 9 inches, as against 12 inches in the New Munro. The revolving disc is designed to feed the ore particles onto the surface of the water with a tangential fling, thereby reducing their tendency to break the surface film. Some operators claim that better concentrates are obtained by keeping the feed disc stationary than when it is revolved, so that the superiority of this type of washer over the ordinary wet box would not appear to be very pronounced.

A drawback involved in the use of these washers, and indeed, in any system of film flotation, is that the ore needs to be thoroughly dry before being fed onto the water film. Rotary, direct heat dryers are generally employed in the Alabama field, and the ore is dried either after undergoing a preliminary crushing to about $\frac{3}{8}$ inch, or, as is more usual, after screening to 8-12 mesh, the size at which the ore is fed to the washers. Wood is

employed for fuel, the consumption being about 3 cords per dryer each 24 hours. The cost of cordwood delivered at the mills in the Ashland district is about \$2.35 per cord.

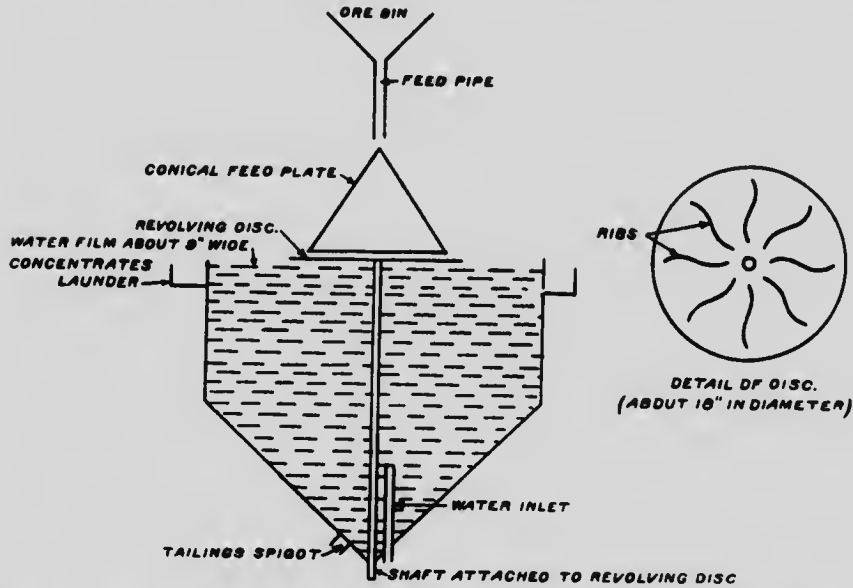

Fig. 35. Section through Colmer washer (not drawn to scale). The washer is about 3 feet in diameter. (United States Bureau of Mines.)

The graphite content of concentrates made in three mills in the Ashland district using the above types of washers was stated to range from 65 to 80 per cent, the ore carrying 2.5 to 3 per cent.

Alabama graphite ores are particularly amenable to this method of concentration, the flake being thin and light, and, owing to the decomposed nature of the ore, freeing readily from gangue particles.

On the following pages are shown flow sheets of three Alabama mills employing film flotation. In the case of the mill of which Fig. 36 is a flow sheet, the cost per pound of graphite of all grades produced during the year 1917 was stated to be 4.89 cents. The ore ran about 3 per cent graphite and cost 20 cents per ton delivered to the crusher. From a total of 31,278 tons of ore milled, 1,222,282 pounds of graphite of all grades were recovered. This represents a percentage of recovery of 65 per cent, assuming that the run-of-mine averaged 3 per cent graphite. The above total was made up as follows:—

No. 1 flake, 87 per cent carbon,	656,100 pounds or 53.7 per cent.
No. 2 flake, 82 per cent carbon,	150,380 pounds or 12.3 per cent.
Dust, 42 per cent carbon,	415,802 pounds or 34.1 per cent.

1,222,282 pounds or 100.0 per cent

According to information furnished by the management, the mill shown in Fig. 37 treats a 3 per cent ore, and effects a recovery of 60 per cent of the graphite in the ore. The mill has a capacity of 150 tons of ore

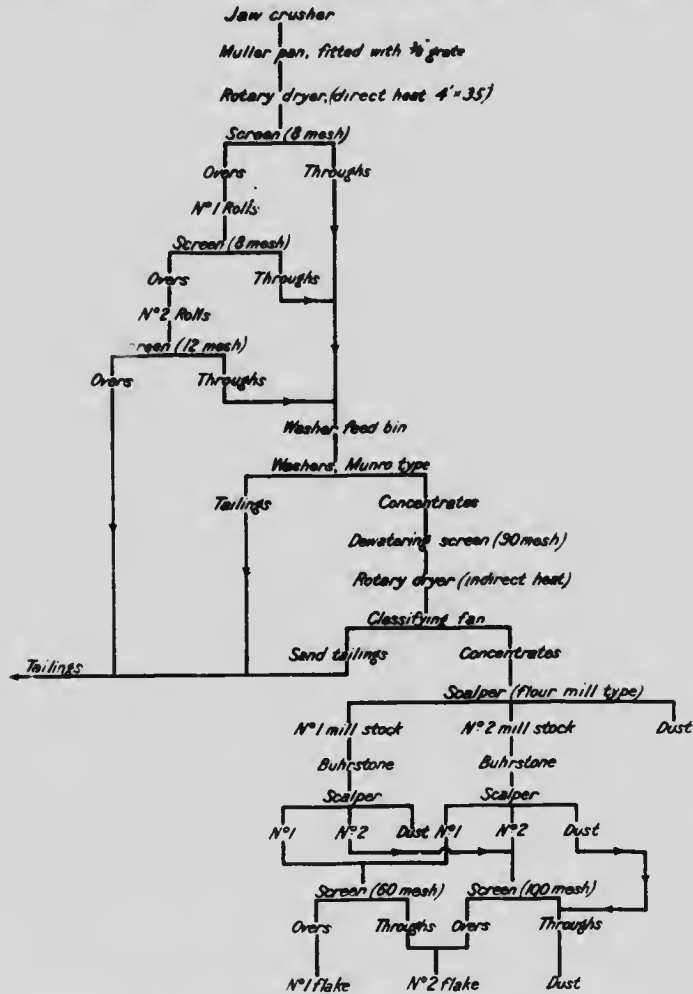

Fig. 36. Flow sheet of surface tension concentration installation, using Munro washers, in an Alabama mill.

per 24 hours and employs 11 men to a shift. Ore is delivered to the crusher for 20 cents a ton, and the cost of production of finished graphite of all grades averages $4\frac{1}{2}$ cents per pound. The proportion of the different grades made is:—

- No. 1 flake, 90 per cent carbon, 60 per cent.
- No. 2 flake, 85 per cent carbon, 20 per cent.
- Dust, 44 per cent carbon, 20 per cent.

1.05

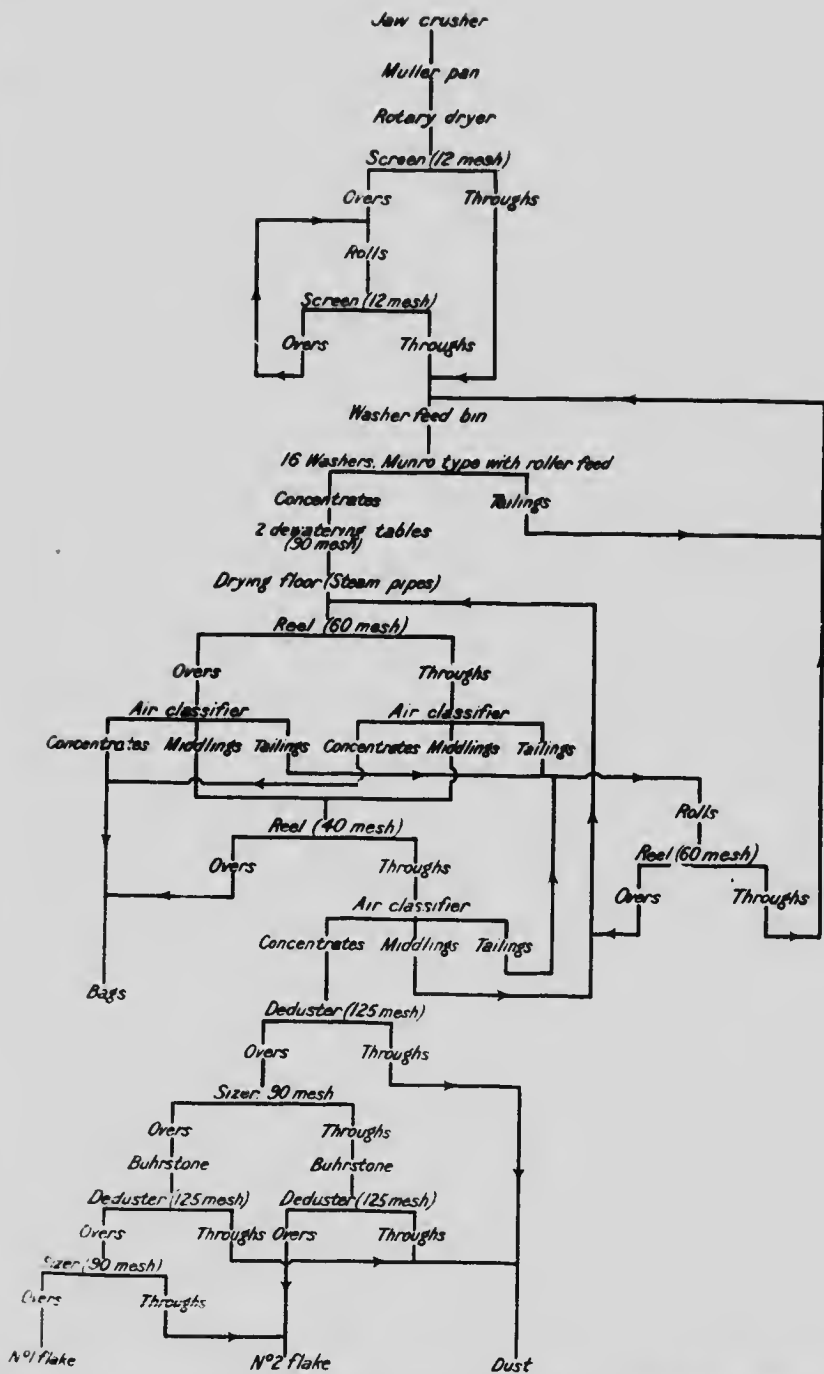

Fig. 37. Flow sheet of surface tension concentration installation, using Munro washers, in an Alabama mill.

Only about 50 per cent of the total concentrates made passes to the burrstones.

This mill, in common with practically all of the mills in the Alabama field, employs electric power, which costs 3 cents per K.W.H. up to a minimum consumption, and 0.6 cents per K.W.H. over this, or \$33 per H.P. year. The plant is equipped with three motors of 100, 75, and 50 H.P. respectively, which operate the mill machinery, pump, lighting installation and haulage system from pit to mill.

At another mill in the same district, equipped on similar lines to that described above, but using, in addition, the air separator described above to eliminate the heavy gangue particles from the feed for the washers, the following amounts of graphite of various grades were obtained from a total of 123,950 pounds of concentrates running 65.5 per cent carbon.

No. 1 flake, 92.8 per cent carbon, 62,850 pounds or 50.7 per cent.
 Special dust, 60 per cent carbon, 11,600 pounds or 9.4 per cent.
 Regular dust, 30 per cent carbon, 49,500 pounds or 39.9 per cent.

123,950 pounds or 100.0 per cent.

At the mill using flow sheet, Fig. 38, it was claimed that the concentrates from the Colmer washers ran 75-80 per cent carbon, and that the No. 1 flake went as high as 92 per cent. This mill has a capacity of 100 tons of ore per 10 hours and employs 10 men.

While concentration of graphite by surface tension or film flotation is practically confined to the Alabama field at the present time, it is noteworthy that the method was practised in mills in the Buckingham district, in Canada, as far back as 1901. In that year, H. P. Brumell, of Buckingham, patented¹ a device (Brumell's wet box) which is to all intents and purposes identical with the Munro type of washer now employed in Alabama. The appliance was installed in several mills in the Buckingham district and is said to have effected a satisfactory concentration. The fact that Canadian ores usually carry a large proportion of mica, much of which floats off with the graphite, may have been the cause of the device being discarded.

Experiments are being conducted at the present time by the Department of Mining Engineering, University of Toronto, with a system of film flotation by which the ore has a small amount of coal oil added to it and is fed wet to the washer.²

Below are shown the results of assays³ made on the three grades of product turned out by a mill in the Buckingham district, Que., using Brumell wet boxes for concentrating, the concentrates being afterwards cleaned on burrstones:—

	No. 1.	No. 2.	Dust.
Carbon.....	93.87	91.77	71.82
Silica.....	5.01	4.11	15.80
Alumina.....	1.33	1.98	7.64
Ferric oxide.....	1.35	1.74	3.10
Alkalies.....	0.20	0.10	0.64
Lime.....	.24	0.30	1.00
	100.00	100.00	100.00

¹ United States patent No. 678,860, July 23, 1901.

² Preliminary Report of an Investigation into the Concentration of Graphite from some Ontario Ores, Can. Min. Journ., March 26th, 1919, pp. 189-97.

³ Assays by Dunstan, Birmingham, England.

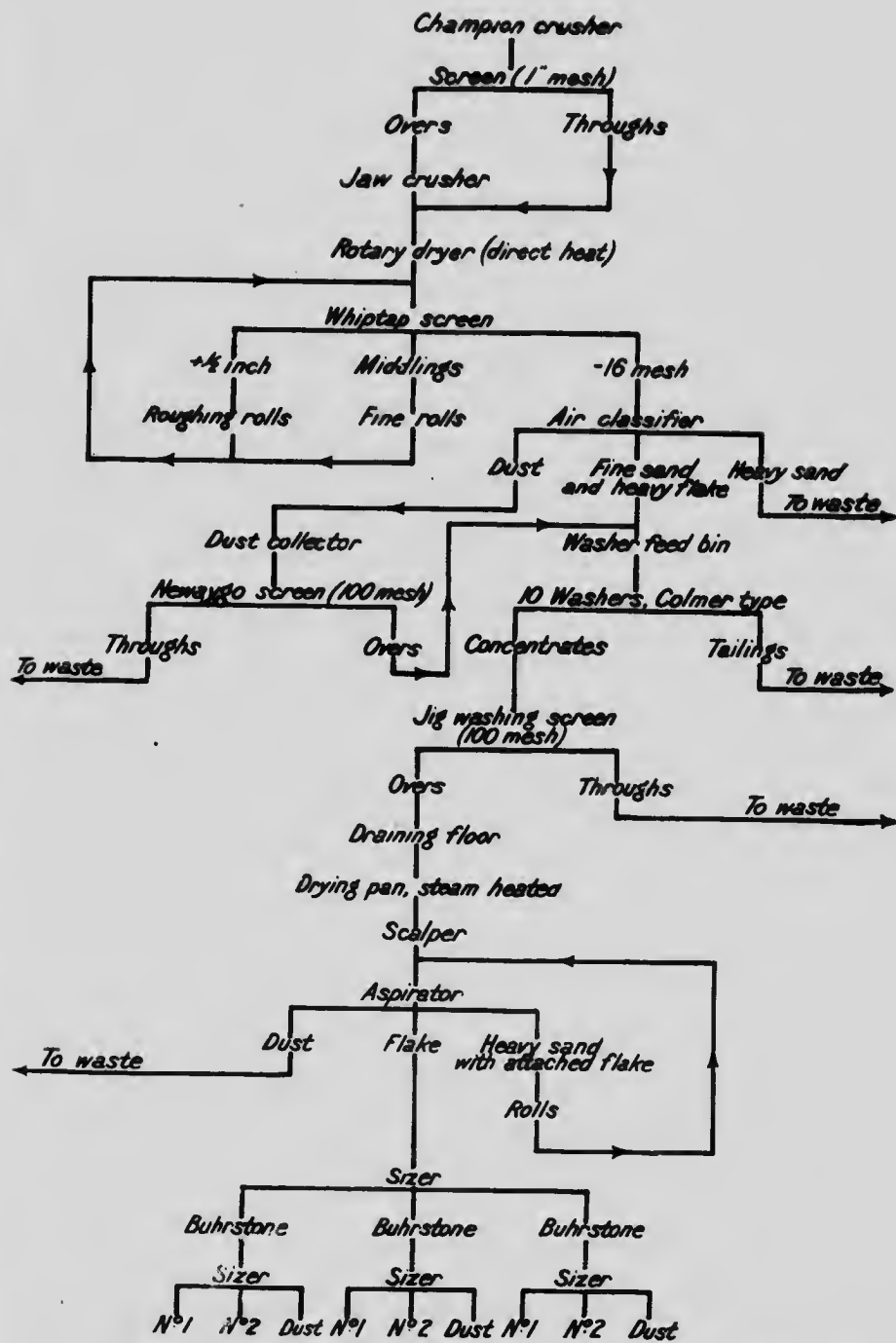

Fig 38. Flow sheet of surface tension flotation installation, using Colmer washers, in an Alabama mill.

Composition of ash calculated from above:

Silica.....	51.88
Alumina.....	23.79
Ferric oxide.....	17.68
Alkalies.....	2.91
Lime.....	3.74
	100.00

MISCELLANEOUS.

A modified system of oil flotation has lately been installed in several Canadian mills. Details of operation of this process are not divulged, and its success has not yet been demonstrated. It is understood that the ore is ground in a ball mill, with the addition of a small quantity of petroleum. The pulp is then classified by a patented device and flows onto the surface of water in a wash tank, the graphite flakes being carried over a lip and the gangue settling. It is claimed that, in this way, a concentrate of very high purity is obtained.

A system of concentration that is believed to have been adopted extensively in Germany is that introduced in 1903 into the graphite mills of the Passau district, in Bavaria. This process, patented by H. Patz, consisted in mixing the raw graphite with petroleum and water, in the proportion of 1 part of oil to 2-3 parts of water, the mixing taking place in a mill of the burr type or between rolls. After sufficient grinding, the mixture of graphite and oil passed to a cylinder containing a larger amount of oil and water, in which it was thoroughly worked up, the graphite flakes separating from the sand and clay and remaining on the surface, while the gangue sank and was taken off through an opening in the cylinder. The graphite passing off with the overflow from the cylinder was caught in a tank, in which a wire screen was fixed some 6 inches below the surface of the water. The purpose of this screen was to catch the small aggregates of graphite flakes which surface tension did not suffice to suspend. On stirring the liquid, these aggregates broke up and the component flakes rose to the surface. The graphite pulp remaining in the cylinder was drawn off into a similar tank. By repeating the above process a sufficient number of times, according to the character of the ore, a product of high purity was obtained. The larger sand particles, which often carried graphite attached to them, were screened out from the tailings and returned to the circuit. The initial removal of the oil from the graphite was accomplished by means of a filter bag or a fine mesh wire container suspended in water, after which the graphite passed to a press to remove water, the remaining oil being then got rid of by distillation. The foregoing process was designed particularly to treat the more earthy, soft graphites, but by a series of modifications, involving chiefly a preliminary grinding in chaser mills, was made applicable also to the harder, unweathered graphite-gneiss of the district. In the above process, there was no attempt made to create a froth, as in the modern systems of oil flotation proper, the separation of graphite from gangue being accomplished by coating the former with oil.

A system of cleaning graphite by means of petroleum, similar to that described above, has been practised for some years at a small plant near Chester Springs, Pennsylvania. The material cleaned consists mainly of low grade dust graphite from crucible works and graphite mills.

The efficacy of petroleum or similar oils in any wet system of graphite concentration has long been known, and it has been a common practice to make the addition of small amounts of such oils to the graphite and water pulp at some stage of the various concentrating processes used, thereby often materially increasing recovery. Some wet installations, indeed, may be said to have depended on the addition of oil for their successful operation. In such cases, however, the amount of oil added was so small as not to necessitate its removal from the finished product by the agency of heat or by other special means, washing of the concentrates on reels with either warm or cold water sufficing.

A means of converting the fine graphite dust or slimes resulting unavoidably from almost all milling and concentrating processes to a product suitable for crucibles, lubricating, etc., has also been devised by H. Putz, and is reported to have found successful adoption in the Passau district. Many of the graphites of this region could not be treated by the above oil process, owing to the fineness of the flake, much of which passed through the screens with the sand slimes. To obviate this, the crude graphite was first passed through sets of rolls, either with or without the addition of some bonding substance, such as powdered pitch, asphalt, paraffin, etc. The material may be heated or not, according to requirements. As a result of this process,¹ the fine flakes are pressed into larger aggregates and these latter are then broken up and sized by screening. The more compact the aggregates are made, that is the greater the pressure exerted by the rolls, the more refractory is the resulting material. Even amorphous graphite can, it is claimed, be converted into marketable flake by the above means. Whether this class of material can be used as satisfactorily in crucible work as the natural flake is open to question, however, and the raw material must in any case undergo some cleaning process to remove the impurities that are almost invariably present in natural graphites. It is reported, however, that such built-up flake has been extensively employed for crucible manufacture in Germany during the last few years.

Experimental work on the briquetting of flake graphites has recently been carried out by R. T. Stull and H. G. Schurecht, of the United States Bureau of Mines.² In the experiments undertaken, an attempt was made to convert Alabama flake graphite to a granular form by briquetting it with tar, coking, crushing and screening. In this way it was hoped to secure a denser material that would approximate Ceylon plumbago in character and be the equal of the latter for crucible work. Varying proportions of tar binder were used, and briquetting was effected at different pressures. In testing the graphite prepared in this manner in crucible bodies, alongside of ordinary Alabama flake and Ceylon plumbago, it was found that the best crucibles, as far as moulding properties were concerned, were made with the prepared graphite. In foundry use, however, the all-flake crucibles proved to give better service than the prepared graphite pots, and both proved superior to pots made with straight Ceylon plumbago. The investigators' comment on the experiments is that the results are interesting, but not conclusive, as only four crucibles of each mix were tested.

¹ German patent No. 161,722.

² Journ. Amer. Ceramic Soc., May 1919, pp. 391-9; also March, 1919, p. 298.

REFINING OF GRAPHITE CONCENTRATES.

By most of the methods hitherto employed, it has proved impracticable to raise the carbon content of graphite concentrates to much over 60-70 per cent, and it has been necessary to refine or finish the concentrates, with the object of separating as far as possible the remaining 20-30 per cent of gangue from the large flake and concentrating it in the fine dust product. It has thus been customary to regard the milling process as divided into two stages: the concentrating, wherein a progressive elimination of gangue is effected; and the finishing, which achieves no further removal of gangue, but concentrates as much of it as possible in the fines. Many of the flow sheets given on preceding pages include both concentrating and finishing departments.

Recent developments in oil flotation concentration indicate the possibility of making concentrates sufficiently high in carbon as not to require any further cleaning, so that in this case a separate finishing department may be regarded as eliminated. The same holds good in some cases where electrostatic separators are used, since these machines are really concentrators and function by throwing out mechanically admixed gangue: on certain ores, especially weathered ones, the resulting concentrates may be sufficiently clean to be marketed without any finishing.

For refining, the concentrates must be dry, and where wet methods of concentrating are employed, this necessitates the use of some style of dryer. The dryer most generally used is the rotary, direct heat type. This machine has the advantage of large capacity, and being automatic in its operation, no handling of the concentrates is required. In some mills, pan dryers, heated by steam pipes, are used. In one Quebec mill the concentrates are shovelled on to trays, which are placed in tiers in a steel frame, and the latter is run into a drying chamber.

Before drying, the concentrates usually have the surplus water removed. In Pennsylvania and Alabama mills, this is effected by passing the material over de-watering screens, as well as by allowing the overs from the washing reels to accumulate on inclined cement floors, where the water automatically drains out. In an Ontario mill, using buddle concentration, the slimes contained in the overflow are de-watered in a filter press. An Alabama mill employing oil flotation, uses an Oliver filter, in conjunction with a Dorr thickener, for de-watering the concentrates from the cleaner cells, and a vacuum type filter is used in a Quebec mill.

The most general method of finishing graphite concentrates is to pass them over burrstones, followed by screens. In place of burrs, closely set polishing rolls are sometimes employed. The purpose of both burrs and rolls is the same, namely to subject the graphite flakes to sufficient pressure to pulverize the fine gangue included between the laminae, as well as to remove any mechanically admixed gangue particles. With burrs, considerable care is necessary in setting the stones at the correct interval to pulverize the gangue and at the same time to avoid undue destruction of the graphite flakes. The burrstone mills used are of horizontal type, and as a general thing it is the lower stone that revolves. In this way, only the grit particles are broken down, while the graphite flakes pass through without being subjected to the weight of the upper stone. The stones are very lightly dressed, having relatively few and shallow furrows.

Polishing rolls in place of burrs are employed in a few cases, but their use has been practically confined to Canadian mills. The rolls used are of the same type as shown in Plate XXXI. One Quebec mill uses a Seck polisher, of German manufacture. (Plate XXXVII.)

After passing through the burrs or rolls, the product is screened, usually over 90 and 150-mesh screens, these yielding the three commercial grades of graphite, No. 1 flake (+90 mesh), No. 2 flake (-90 +150 mesh) and dust (-150 mesh).

SUMMARY.

While maximum extraction and purity (carbon content) of the finished graphite are prime essentials in the successful operation of a graphite mill, an equally important factor is the proportion of graphite recovered in the form of No. 1 (+90 mesh) flake.

By practically all mechanical methods of treatment, high carbon content and largeness of flake are concomitant within limits; that is, after grinding has proceeded sufficiently far to free the large flake of attached gangue.

Many of the processes hitherto employed have succeeded in making finished products of satisfactory purity only at the expense of extraction. The difficulties attending the concentrating of graphite ores may be gauged to some extent from the flow sheets given on the preceding pages, which show the variety of methods that have been employed in different mills. With the exception of oil flotation, few, if any, of the systems outlined have been consistently successful in making concentrates assaying more than 60 to 65 per cent carbon, with an extraction of much over 50 per cent.

In the above connexion, the following data¹ are quoted to show the average results obtained in Alabama mills during 1918:—

Material.	Carbon, per cent.	Weight, pounds.	Weight X per cent.	Recovery or loss, per cent.
No. 1 flake.....	87	19	1,653	33.06
No. 2 flake.....	77	5	385	7.70
Dust.....	30	3	90	1.80
Total.....		27	2,128	42.56
Tails, by difference.....	1.46	1,973	2,872	57.44
Crude ore.....	2.5	2,000	5,000	100.00

Important considerations to be noted in connexion with the treatment of graphite ores include the following:—

(a) Subjection of the ore to the least possible degree of coarse grinding consistent with maximum extraction of large flake. The choice of the grinding machine best adapted to any particular ore is important. Wet grinding in ball mills, stamps, muller pans, etc., achieves this by allowing the flake to float off as soon as freed.

(b) Separation, after successive grindings, of larger graphite flakes from gangue particles, in order to prevent the latter cutting and destroying the flake during passage through the next machine.

¹ Dub, G. D., op. cit., p. 11.

(c) Elimination of fine dust or slimes from the ground material as soon as made. Fine gangue particles have a tendency to be pressed into the flakes by the grinding machines, forming what are known as pancakes.

CHEMICAL REFINING OF GRAPHITE.

While the refining of graphite to a degree of purity sufficient for most commercial purposes (90 per cent carbon) can be effected by mechanical means, the complete elimination of mineral impurities often present in a very fine state of division, such as silica and iron sulphides and oxide, can only be achieved by chemical treatment. These substances are often present in a state of microscopic fineness, intimately intergrown with the graphite, and thus cannot be removed without reducing the flakes to powder; in which form the graphite loses most of its value for such purposes as crucibles and lubricants. However, for some special purposes, it is desirable to have extremely pure graphite, even at the expense of the flake size, and to this end a number of methods of chemical refining have been proposed and in some cases actually employed in commercial practice. The advent of cheap artificial graphite, which can be produced in a degree of purity approaching practically pure carbon, has largely dispensed with any necessity for chemically refining natural graphite; but the following details of the more important methods that have been devised for such chemical treatment may be of interest. No one process is applicable to all graphites, since the impurities present vary considerably in different ores.

Schlössel treats graphite with hydrochloric acid, followed by caustic soda, afterwards heating with sodium carbonate and washing in warm water. The caustic soda treatment would appear to be superfluous, and the hydrochloric acid might be employed to greater advantage at the end of the operation than at the beginning.

Winkler mixed finely ground graphite with a mixture of equal parts of calcined sodium carbonate and sulphur and heated at a low red heat in a crucible till all the sulphur was burnt off. The cooled mass was then boiled in water and washed by decanting, the residue being treated with dilute hydrochloric acid, which removed the iron present. After washing, the residue was ignited, and the silica removed by boiling in a solution of caustic soda.

Brodie's process, alluded to elsewhere,¹ may be included here, though its chief aim was to produce a very finely divided, rather than a specially pure graphite. Powdered graphite is mixed with one-fourteenth of its weight of potassium chlorate, and is then stirred into an iron vessel with a weight of concentrated sulphuric acid equal to twice that of the graphite. The whole is then heated on a water bath until action ceases. After cooling, the residue is washed in water, dried and heated to a red heat, whereupon the graphite swells up and crumbles to an extremely fine powder. This powder may then be further cleaned by elutriation. This process is specially adapted to Ceylon graphite. If silicates are present in any amount, sodium fluoride is added to the mixture, and the silica thus passes off as fluoride.

Pritchard takes 18 parts by weight of graphite, 1 part of potassium chlorate, and 36 parts concentrated sulphuric acid, heats the mixture

¹ See page 7.

till all chlorinated vapour is driven off, pours off the remaining acid and adds a small amount of sodium fluoride to the graphite. This is then washed and heated to red heat.

Brochadon takes finely powdered graphite and fuses with sodium carbonate, washes with water, followed by hydrochloric acid, and again with water. After drying, a soft, powdery graphite is obtained, which when moistened can be pressed into blocks by hydraulic pressure. These blocks have all the appearance, hardness, etc., of natural graphite, but possess an electrical conductivity eighteen times that of natural graphite.

What was essentially a forerunner of present day oil flotation, and should, therefore, perhaps be more properly classed as a mechanical process, was patented by Bessell Bros., in Germany, in 1887. They mixed graphite with from 1 to 10 per cent of an organic substance, such as petroleum, benzine, fat or wax, and stirred the mixture into water at 30–40°C. A current of gas was then generated in the pulp by adding chalk or some other substance and introducing a dilute acid. The particles of graphite were thereby brought to the surface, while the impurities sank. A graphite containing 40 per cent carbon could be refined to 90 per cent by this process.

Luzi's process of refining consisted in moistening graphite with concentrated nitric acid and igniting. The graphite thereupon exfoliates into peculiar, vermiculate forms (see p. 7), and the impurities present between the laminae are released and can be readily removed by washing. The heating is carried out in retorts, and the acid recovered. The graphite obtained by this process is remarkably plastic and can be readily pressed into blocks or plates.

A process used commercially by Douglas Bros., in Germany, in recent years, consists in treating graphite with an aqueous solution of hydrofluoric acid, thereby converting the accessory mineral impurities into fluorides. These fluorides are then removed by the addition of a solution of sodium bisulphate, which converts them into salts soluble in water, followed by washing with water.

CHAPTER VI.

ARTIFICIAL GRAPHITE.

Graphite is made commercially on a very large scale by the Acheson Graphite Company, of Niagara Falls and Buffalo. The original discovery that graphite could be produced in the electric furnace was made in the course of experimenting with the effect of very high temperatures on carborundum. It was found that carborundum is decomposed at about 7500°F, the silicon being vaporized and the carbon left behind. A process was eventually developed for making graphite from anthracite coal. The powdered coal is heated for several hours in the furnace, and the carbon is first of all converted into carbides of the various constituents of the ash. On carrying the temperatures still higher, these carbides are decomposed, and the silicon, iron and aluminium vaporized, the residue being a graphite free from all trace of amorphous carbon. The purity of the graphite depends on the temperature reached in the furnace. After removal from the furnace, the graphite is ground to the varying degrees of fineness required for the different uses to which it is to be put. In some cases it is air floated, and for the production of high grade lubricating compounds deflocculated (see below).

The following details of the methods of manufacture and properties of Acheson artificial graphite are taken from a paper by Dr. Edward Acheson.¹ The first commercial graphite was produced in 1897, when 162,000 pounds of graphite electrodes were made. These electrodes were produced by the direct conversion of non-graphitic carbon rods, made from a mixture of petroleum coke with tar as a binder, into graphite. About the same time, the manufacture of graphite in powder form was undertaken, the raw material being anthracite coal, and even coal waste or culm. This material is crushed fine and placed in the furnace, which is of long, narrow, trough-like form with an electrode at either end. On the passing of the current, innumerable small arcs are formed between adjacent particles, and the mass becomes incandescent and is allowed to remain so until all the impurities have been vaporized, the length of time required being dependent on the purity of the raw material. The temperature reached is in the neighbourhood of 7,500°F.

A guaranteed purity of 99 per cent carbon is claimed for this graphite. For lubricating purposes, it is ground to 200 mesh, and this fine material is still further reduced, for the purpose of suspending it in oil or water, by what is termed the deflocculating process (see page 158). In preparing this deflocculated graphite for practical use, it is first diluted with water, and the mixture is run into large settling tanks where it remains four days. It is then decanted and passed through a filter press fitted with rubberized canvas sheets. In this way, a paste is obtained consisting of about 50 per cent graphite and 50 per cent water. In order to replace the water by oil, the paste is placed in a pug mill, and small additions of oil are made, until eventually the water is completely replaced by oil. This paste of graphite and oil, mixed with kerosene, yields the Acheson lubricating product

¹ Paper read before the National Gas and Gasoline Engine Trades Association, in Cincinnati, June 14th, 1910. Issued in booklet form by the Acheson Graphite Company.

known as "Oildag", while a mixture of water with the paste of graphite and water is termed "Aquadag".

The combined production of Acheson artificial graphite in 1917 at both the company's American and Canadian works totalled 5,785 short tons. This represents only the graphite that comes into competition with natural graphite and does not include graphitized products, such as electrodes.

Artificial graphite is not suitable for use in graphite crucibles, but is recommended for many of the uses to which natural graphite is put, such as lubricants, paints, boiler graphite, dry battery filler, pencils, etc.

Dr. Acheson¹ says, further, regarding the deflocculation process:—

The effect was produced by treating the graphite in the disintegrated (ground) form with a water solution of tannin, the amount of tannin being from three to six per cent by weight of the graphite treated. The results are much more pronounced when the mass of graphite, water and tannin has been pugged or masticated for a considerable time, I having to advantage carried on this process continuously, without interruption, for a period of one month. I have also found that while the effect may be produced in a very satisfactory way with distilled water, the waters as found in rivers, deep wells, etc., are improved by the addition of a trace of ammonia. The presence of carbon dioxide in the water will prevent deflocculation.

If water, graphite, a drop of ammonia and a little gallo-tannic acid be shaken up together in a test tube, enough of the graphite will remain suspended in the liquid to give it a black colour. Most of it, however, will settle, and to cause a complete suspension of all the graphite necessitates prolonged mastication in the form of a paste with the water and tannin. I find that after this mastication has been carried out, the effect is very much improved by diluting the mass with considerable water and allowing it to remain some weeks with occasional stirring.

After the prolonged masticating and additional time of exposure of the graphite to the water and tannin, an intensively black liquid is obtained consisting of water, a small amount of tannin, and graphite; the latter may be present in varying amounts. In this condition, I call the graphite deflocculated, a state of subdivision much finer than possible of attainment by mechanical means, one that may perhaps be correctly spoken of as molecular. It is in that condition called colloidal. I have found this liquid would pass through the finest of filter papers and the contained graphite would remain in suspension for weeks and months,—apparently for all time.² One per cent of graphite makes the liquid so thick that it runs through the filter paper slowly. Reduced to 0.2 of one per cent, it goes through quickly.

I have found that the addition of a very minute amount of hydrochloric acid causes the contained graphite to flocculate, i.e. group the molecules into masses so that it will no longer pass through the paper.

This graphite, even after such flocculation, is so fine in its particles that when dried *en masse* it forms a hard article. It is self-bonding, like a sun dried clod of clay.

For further details of the technology of artificial graphite see Journal of the Franklin Institute, Vol. CLIV, 1902, pp. 321-348.

The following extracts are taken from a monograph³ on artificial graphite by A. J. Fitzgerald, chemist to the International Graphite Company, Niagara Falls:—

If carbon, in the form in which it usually occurs in nature and in general use, is to be altered to graphite by heating in the electric furnace, it is a natural assumption that the higher the carbon content of the charge is, the greater will be the amount of graphite obtained. This would be the case, provided that the carbon were altered directly to graphite, but I have found that such an alteration does not take place and that in actual practice it is not advisable to heat carbon very highly, since the amount of graphite that results is small. What actually occurs in making graphite out of coal is an indirect alteration, consisting in a disassociation of the compounds of carbon with other substances (carbides). The first stage of the process consists, therefore, in the combination of carbon with such other substances, and I have found that the quantity of graphite obtained is considerably greater and a better product is secured, when a coal is used that contains

¹ Journ. Franklin Inst., Vol. CLXIV, 1907, p. 376.

² Cf. C. H. Bierbaum's remarks on Brownian movements in such liquids, p. 156.

³ Monographien über Angewandte Elektrochemie, Vol. XV, Halle, 1904.

a considerable amount of foreign mineral substance, or when a certain proportion of such mineral substance (silica, clay, alumina, lime, iron oxide) is mixed with the coal.

Acheson's experiments showed that a relatively small amount of such carbide-forming substances can bring about the alteration of a large quantity of carbon into graphite, and that this amount is much less than is theoretically necessary to convert all the carbon into carbides. For example, an anthracite coal containing 5.78 per cent ash, the composition of which was essentially silica, alumina and iron oxide, is converted into practically pure graphite containing only 0.03 per cent ash.

The furnace used is of the same general type as that used in the production of carborundum, but is preferably a little smaller in diameter. It is lined with carborundum as a refractory. The charge consists of pulverized anthracite, or even culm, which is packed around a central core of carbon rods. These rods lie in close contact and extend the length of the furnace. This core of rods is connected with the electrode at either end and its purpose is to serve as a conductor for the current during the initial stage of the process.

After the furnace has been filled with coal, a covering of sand and coke is laid over the charge, in order to exclude air.

A furnace 30 feet long and taking a charge of 20' x 14" section will consume 800 k.w.

As the coal becomes graphitized, that is, with increasing temperature and conductivity of the charge, the voltage is reduced. The length of time that the heating is allowed to continue depends on the degree of purity of the graphite required. For most purposes, a purity of about 90 per cent carbon is sufficient. Where a very pure graphite is required, however, the heating is continued until practically all the impurities have been volatilized.

After cutting off the current, the sand and coke cover is removed, and the layer of carbide exposed that forms directly over the graphite. At this stage, the furnace is still white hot. After it has cooled down sufficiently, the carbide layer is removed and finally the graphite is taken out, and ground up for the various purposes for which it is required.

In Fig. 39 is shown the general form of an electric furnace for the production of graphite.



Fig. 39. Section through electric furnace for the production of artificial graphite. 2, electrodes; 3, core of powdered coal; 4, mixture of powdered coal or coke and sand; D, source of energy.

The manufacture of electrodes is carried out in the usual manner, except that a definite amount of carbide-forming substance is added to the material. The carbon or petroleum coke is first finely powdered, and is then intimately mixed with pitch, a small quantity of a carbide-forming substance, such as oxide of iron, in the form of fine powder, being added. The mixture is then warmed and fed in the form of blocks to the extruding machine, which presses out rods of the desired size and form. These rods are baked and are then ready to be graphitized. The latter operation is conducted in a furnace of the types shown in Figs. 40 and 41, the former being used for electrodes of rectangular section and the latter for round rods. The floor of the furnace is covered with a thin layer of pulverized coal upon which the electrodes are stacked, with their long axes at right angles to the long axis of the furnace. The piles of electrodes are separated by gaps about one-fifth the width of an individual electrode. Sheet iron is then placed in the furnace for its entire length, and at a distance of about one inch from the ends of the electrodes and the side walls of the furnace. In this way, a sort of double walled box is formed. The inner shell is filled with ground coke of about 2 mm. grain, while in the outer is placed a mixture of sand and ground coke. The inner shell is filled up with coke until the upper-

most electrode is covered about 2 inches deep. The sheet iron is then removed, and the upper part of the furnace covered over with the sand-coke mixture, after which the current is turned on.

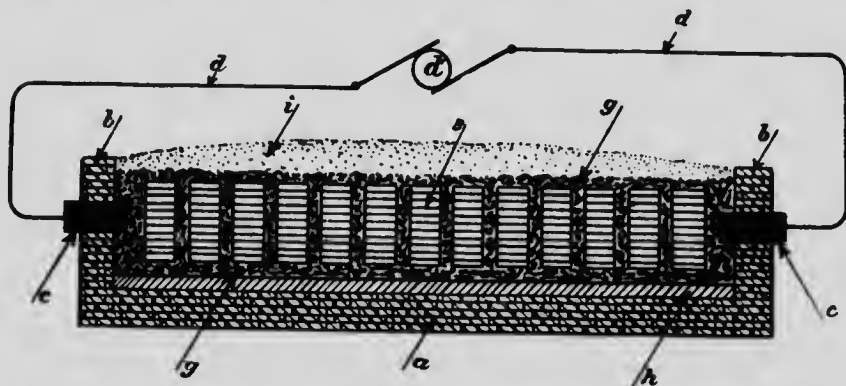

Fig. 40. Section through electric furnace arranged for graphitizing carbon electrodes of rectangular section. *a*, brick base; *b*, end walls; *c*, electrodes; *d*, connexions to source of energy *d'*; *e*, electrode charge; *g*, layer of powdered coal or coke; *h*, refractory lining; *i*, covering of sand and powdered coke.

As shown in Fig. 41, the furnace used for round rods is similar to that for those of rectangular sections, only in stacking the electrodes, they are placed in close contact, instead of in heaps separated by gaps.

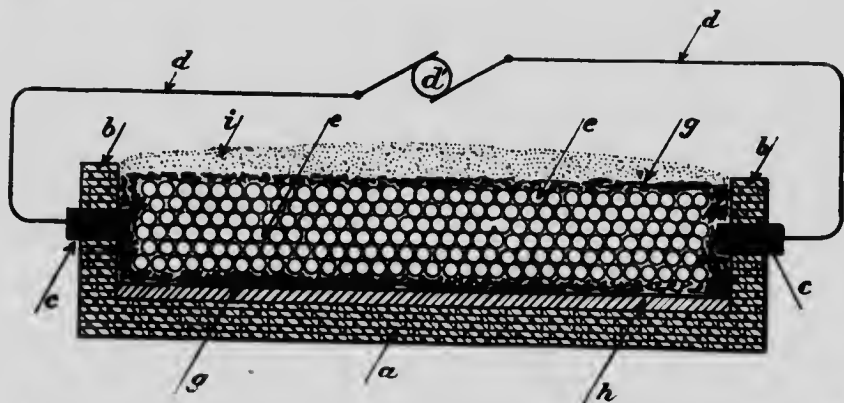

Fig. 41. Section through electric furnace arranged for graphitizing round carbon electrodes. *a*, brick base; *b*, end walls; *c*, electrodes; *d*, connexion to source of energy *d'*; *e*, electrode charge; *g*, layer of powdered coal or coke; *h*, refractory lining; *i*, covering of sand and powdered coke.

The process of graphitizing is the same as in the production of powdery graphite. The initial voltage used is 200 at which point it is kept until 750 k.w. are registered. Then, as the resistance sinks, the voltage is cut down proportionately, so as to keep the power consumption a constant. The resistance at first sinks very rapidly but gradually the rate slows down until it finally becomes constant. The alteration to graphite is now complete.

In considering the theory of the graphitizing of electrodes, the following points are of importance. A definite number of electrodes are required to be heated to a definite temperature, in order to graphitize them. To this end, a definite amount of electrical

energy must be transformed into heat in the furnace. This heat is consumed in a variety of ways: to bring the charge of electrodes to the required final temperature; to form carbides; to decompose these carbides and volatilize the carbide-forming substances; to replace the heat absorbed from the charge by the furnace walls and lining and that lost by radiation. It is thus a matter of experiment to determine the amount of electrodes that can be treated in actual practice. In proportion as the temperature of the furnace increases, so does the loss through radiation, and the larger the furnace, the longer it takes to reach the desired temperature, so that a point is eventually reached where an increase of dimensions is no longer economically practicable. In this connexion, the resistance of the furnace must also be taken into consideration.

In graphitizing electrodes having a rectangular section, the resistance of the furnace would soon sink very low if the electrodes were all stacked in close contact, and it is for this reason that they are packed in heaps separated by pulverized coke, which has a much higher resistance than the electrodes. It can readily be seen, when the furnace is running, how the heat energy is chiefly developed in the coke that separates the electrodes and serves to heat them up. In the case of round electrodes, the contact surface between individual rods is very small, and the resistance is consequently high enough for practical operation.

With regard to the properties of Acheson graphite, the writer goes on to say:—

The alteration of carbon to graphite is a complete one; that is, when treated with potassium chlorate and nitric acid, no trace of amorphous carbon is found. But, with respect to the above test, and also to Berthelot's definition of what constitutes graphite, i.e., a form of carbon that yields graphitic acid on oxidizing at a low temperature, it should be noted that all graphite, made in the above described manner, but from various materials, does not exhibit the same characteristics. For instance, electrodes made from soft coal and petroleum coke respectively, show decided differences in their properties. The former are hard and brittle, mark paper with difficulty and do not become shiny on rubbing; when ignited in air they are soon consumed, and when used as anodes in the electrolysis of sulphuric acid, their decomposition is rapid. Petroleum coke electrodes, on the other hand, possess the reverse of all the above characteristics. The specific gravity, also, is 2.05 for the former, as against 2.20 for the latter. According to Berthelot's definition, both the above are graphite, yet they are decidedly different in most of their physical properties. It appears useless to attempt to prescribe a descriptive nomenclature for all the different modifications of carbon, since the diversity of forms in which amorphous carbon and graphite occur seems to be limitless. Even the expressions used to distinguish the forms of carbon that yield graphitic acid from those that do not—namely, graphite and amorphous carbon, do not correspond to fact. A number of natural graphites are amorphous, while many of the artificial types possess crystalline structure. The graphite formed by the decomposition of carborundum, for instance, appears to be finely crystalline but is really amorphous. Graphites made from anthracite coal are very variable in their character, corresponding to the grade of coal used. Some are soft and lustrous, others hard and matt. The general range of specific gravity is between 2.20 and 2.25, and all the types burn in air more readily than Ceylon graphite, though they are more resistant to the action of potassium chlorate and nitric acid than the latter.

Graphite made from anthracite¹ is used chiefly as a paint pigment, in dry batteries, graphite brushes, etc., while that made from petroleum coke, and containing less than 2 per cent ash, is employed in lubricants, pencils and other articles requiring a very clean graphite.

¹ See also W. C. Arsen, Transformation of Other Forms of Carbon into Graphite. Trans. Amer. Electrochem. Soc., Vol. XX, 1911, pp. 105-19.

CHAPTER VII.
USES OF GRAPHITE.

The outstanding physical properties of graphite, namely its refractoriness, inertness, high electric and thermic conductivity and resistance to attack by chemical agents, render it of extreme importance in a variety of modern industries, while its lustre, complete opacity even in the thinnest flakes, softness and slipperiness, are additional properties that have extended its usefulness to several important branches of industry.

In order of present importance, the principal uses of natural graphite are in the manufacture of crucibles, lubricants, pencils, foundry facing, paints, stove polish and dry batteries, while small amounts are also used in electrotyping and as a boiler scale preventive. According to a competent authority, the world's production of natural graphite is divided among the more important of the industries mentioned above, approximately as follows:—

Crucibles.....	75 per cent
Lubricants.....	10 "
Pencils.....	7 "
Foundry facing and stove polish.....	5 "
Paints.....	3 "

It is obviously impossible to ascertain the proportions with strict accuracy, and the consumption of several of the minor industries will doubtless reduce the above percentages slightly, without, however, materially altering the ratio.

In addition to natural graphite, there is a large production of artificial graphite, for which no allowance has been made in the above table. Artificial graphite is manufactured from anthracite coal or petroleum coke in the electric furnace, and is largely utilized for graphite electrodes, for which there is an ever-increasing demand. A quantity of this manufactured graphite is consumed in the lubricant and paint industries, and it also enters into dry batteries and boiler scale preventives.

CRUCIBLES.

About 75 per cent of the world's output of graphite is estimated to be consumed in the manufacture of crucibles and such refractory accessories as stoppers, stirrers, nozzles, phosphorizers, etc., used in melting metals, such as steel, brass, and other non-ferrous alloys.

The chief raw materials entering into the composition of a graphite crucible—namely, clay, graphite, and sand—need to be selected with great care as to their purity and suitability for the purpose. Even the most refractory fireclay will stand up for only a short time when in contact with molten metal, especially molten steel. If, however, graphite is added to the clay, the crucible will last as long as there is sufficient graphite left to enable it to carry the weight of metal and to stand handling. Aside from its refractoriness and its function of preserving a crucible from corrosion, graphite is an extremely good conductor of heat, and a graphite crucible is thus able to stand sudden changes of temperature, while the charge

melts much more quickly than in a clay crucible. Although a good graphite crucible will withstand sudden changes of temperature repeatedly, it is bad practice to subject a crucible to such treatment, and careful handling by pre-heating and gradual cooling between melts will materially extend its life. The great expansion of the steel trade in recent years has led to the establishment of large crucible works in Europe and the United States; in addition to which, many of the large iron and steel works manufacture their own crucibles.

In addition to the quality of the raw materials entering into crucibles, physical and mechanical considerations are important factors. The materials used should be mixed in a manner to impart to the finished article the proper density and solidity and at the same time give it a certain toughness, both in the unannealed state and when exposed to furnace conditions. Size of grain and their cohesive properties, as well as proper mixing, all materially affect the quality of the finished product.

The superiority of a graphite over a clay crucible, due to higher heat conductivity, permits of a far larger charge in the case of the former. While a clay crucible in steel work is given a charge of only about 60 pounds, a graphite crucible is commonly given over 100 pounds. For the same reason, the number of charges taken from a steel furnace using graphite crucibles, in 24 hours, is as high as seven or eight, while with clay crucibles only about four charges are taken in the same time.

The conductivity of a crucible varies directly with the percentage of graphite employed in the mixture, and the loss of heat in transmission through the crucible wall varies with the wall's thickness. If graphite possessed the necessary cohesive properties and strength, the ideal crucible would be one made entirely of graphite, but in actual practice, the higher the percentage of graphite used, the weaker is the crucible wall, and consequently the proper proportions of clay and graphite to be used have to be gauged to a nicety, according to the treatment to which the crucible is to be subjected.

It is evident from the nature of the conditions that crucibles are required to stand up under, that the purity of the ingredients forming the crucible mixture, once a satisfactory formula has been obtained, is a matter of the greatest importance, and for satisfactory results, the strictest control is necessary. Particularly is this the case in the matter of the graphite used, and graphite containing more than an unavoidable minimum of such foreign minerals as mica, calcite, pyrites, quartz, etc., at once affects the life and strength of the crucible. Of the minerals mentioned quartz is probably the least injurious, as a certain proportion of quartz is added to the crucible mixture in any case. Mica fluxes readily and pin-holes the crucible wall, and is considered the worst impurity in a crucible grade of graphite. Being of similar size and shape to the graphite particles, mica flakes are extremely hard to eliminate from certain American and Canadian micaceous graphite ores, and the processes hitherto employed for cleaning the graphite have in many cases failed to make a sufficiently clean separation to satisfy the crucible trade. It is hoped that with the introduction of oil flotation this state of affairs may be remedied, and that, at the same time, a better recovery of the graphite in the ore may be effected. Calcite is objectionable, since it loses mass on heating, the carbon dioxide expelled forming blow-holes.

Ceylon plumbago has always been considered pre-eminently suitable for crucible work, owing to its extreme purity and, in addition, its dense

character. The latter quality is considered of high importance, since on grinding, this graphite breaks up into more or less angular fragments of a wedge or rod-like shape; these possess material thickness and are commonly considered to form a better bond with the clay used than do the thin, flat flake graphites, as well as to resist oxidation longer. On the other hand, some authorities claim that since one of the important functions of the graphite particles in a crucible wall is to take up expansion and contraction strains, a large number of thin, overlapping flakes is preferable to a smaller number of more or less angular fragments. The thin flakes would permit of a certain amount of slipping movement amongst themselves during expansion and contraction, being in more or less parallel arrangement, and would counteract the tendency of the wall to crack. As a matter of fact, there is a considerable divergence of opinion on these points, and there would appear to be a lack of actual evidence as to which of the views held is in accordance with the facts. At the present time, the matter of the suitability of flake graphite for crucibles is being investigated by the United States Bureau of Standards, in conjunction with a similar investigation of American clays for the same purpose. It is to be hoped that this research work may throw some light on what has been rather a vexed question, and that the tests, conducted under actual working conditions, and under government supervision, of crucibles made with the different grades of graphite, may definitely decide as to their respective merits or demerits. The importance of the above question is evidenced by the fact that the United States Government early in 1918 decided to declare a partial embargo on graphite imports and to limit the quantity that might be brought into the country from overseas during the current year to 5,000 tons¹. This action was taken in order to conserve ocean tonnage and to encourage domestic production of graphite. In Alabama alone, early in 1918, something like forty companies were operating or about to operate; and as the object was to produce a crucible grade of graphite, producers demanded some measure of protection from the competition of Ceylon plumbago. Should it be shown satisfactorily that flake graphite can be used to replace Ceylon plumbago in crucibles, the Alabama field would be in a position to supply a large part of the graphite required by American crucible manufacturers, while Canadian graphite will also doubtless continue in considerable request for the same purpose. In this connexion, it may be noted that previous to the removal of all restrictions on January 16, 1919, the United States Government, as a war measure, required crucible makers to add 20 per cent of American flake graphite to their crucible stock.

In the above connexion, it may be noted that there was a considerable falling off in the demand for graphite crucibles for steel work during 1917-18, due to the increasing number of electric furnaces making tool steel. These furnaces take a charge of from four to ten tons as compared with 60 to 75 pounds for a crucible, and their adoption has been attributed largely to the difficulty of obtaining satisfactory graphite crucibles and their high price. The cutting off of the supply of Klingenberg clay, which was considered essential to satisfactory crucibles, and the rise in price from 10 cents per pound in 1914 to 30 cents per pound in 1917 for Ceylon plumbago, laid down at New York, caused American crucible makers to experi-

¹ Under War Trade Board ruling No. 157, made in July, 1918, the above embargo was made absolute for the remainder of the year, rail borne shipments from Canada and Mexico excepted. (Embargo lifted January 16, 1919.)

ment with domestic clays, at the same time using varying amounts of flake graphite mixed in with the Ceylon plumbago. These experiments may be said to be still proceeding, although manufacturers claim to have already found satisfactory substitutes for the German clay and to be making pots of equal quality to those made with the imported article. While this may be partially true, as regards brass crucibles, the new steel pots do not appear to have the same life as those formerly made. Even with the high price of electrical power at many steel making centres, the use of electric furnaces for making tool steel would appear to effect considerable economy over that of graphite crucibles, and it seems probable that their adoption will become even more general, resulting in a corresponding decline in the demand for graphite crucibles for this class of work. In February, 1918, several of the larger American crucible works reported a decided falling off in orders, and were working at about only 60 per cent capacity, most of the demand being for brass pots.

While Ceylon graphite is claimed to be the best procurable for crucible work, manufacturers have long made a practice of mixing in a small amount—15 to 25 per cent—of flake graphite. This material is considerably cheaper than the Ceylon mineral, and its use in amounts not exceeding the percentage quoted is claimed not to affect the quality of the crucible. The flake graphite used comes from various sources, domestic mines, Canada, and in recent years, in increasing quantities, from Madagascar. The latter graphite has the merit of being produced much more cheaply than American flake.

The size of the graphite particles used in crucible mixtures is commonly 20-90 mesh, these being the limits stipulated for by makers. As both the Ceylon and flake graphites are usually re-treated by the manufacturer by a grinding and screening process, a certain amount of fine dust is produced. This dust is not used in crucibles but can be employed in lubricants, paints, etc. Graphite for the latter purposes brings a considerably lower price than what is known as crucible flake, and it is therefore to the crucible maker's advantage to obtain as large a flake as possible in order to reduce the amount of dust produced on grinding. This grinding is commonly performed between burrstones. Any gritty impurities that there may be in the graphite are eliminated by this process, being reduced to powder and falling off with the fine dust graphite on screening. While the milling process that the flake graphites have to undergo removes the majority of these impurities, the flake in its natural form being of the size and form required, Ceylon graphite is imported in the form of "lump" or "chip", having undergone only a rough hand sorting and screening before shipment. This treatment, known as curing, suffices to remove most of the mineral impurities present; the graphite occurring in a massive form and being relatively clean in the natural state.

The degree of purity demanded for crucible flake graphite is not less than 90 per cent carbon, but mica is always regarded as highly objectionable and a 90 per cent carbon material in which the remaining 10 per cent is all mica would not be considered suitable. As a rule, however, the impurities include mica, quartz, calcite, pyrites, feldspar, etc., and it has proved impracticable hitherto in ordinary milling practice to secure a product carrying much under 10 per cent of these substances. In the case of Canadian flake graphites, mica, quartz and pyrites are often extremely intimately intergrown with the graphite. The quartz and pyrites are largely present in a state of extremely fine division between the graphite

laminae, and it is almost impossible, to remove them entirely without destroying the flake; the mica is largely interleaved with the graphite flakes.

It is considered essential that crucible graphite possess a scaly or lamellar structure, as this type of graphite enables a pot to stand up in the furnace far more effectively than does earthy or amorphous graphite. This, as explained above, is considered due to the fact that a certain amount of slipping takes place between the graphite particles during contraction and expansion of the crucible and that this prevents cracking. Very finely divided graphite, also, burns more readily than larger particles.

As regards the relative refractoriness of graphite for crucibles, the variation exhibited by the flake and Ceylon graphites appears to be comparatively slight. Hoffmann made some experiments along these lines upon Ceylon, Ticonderoga and Canadian graphites, and the results showed¹ a practically negligible difference between the various samples in the amount of carbon burnt off in a given time.

A. V. Bleining² has pointed out in a recent article that the question of the utilization of Ceylon or flake graphite in crucibles is one of the relative crucible value of the two materials per dollar, and does not imply that flake graphite cannot be used for the purpose. From a dollar's worth of Ceylon graphite, however, greater crucible value is obtained than from a dollar's worth of flake, as a better crucible can be made from it. This is well shown in the following extract³:—

It is a difficult matter to replace Ceylon graphite altogether with the domestic mineral. In the first place the greater density of the reported material, 2.25, which imparts to it the characteristic resistance to oxidation of its fibrous structure, and the low ash content of the best grades combine to make it extremely satisfactory for the purpose of crucible making. This graphite can be bonded together with a comparatively small amount of clay, since the surface factor per unit weight is smaller than for that of any other kind of graphite.

This point may be illustrated by the volumes occupied by the same weight of several types of graphite. Thus, 100 grams of ground Ceylon graphite after thorough shucking occupies a volume of 90.7 c.c., Canadian graphite 119.6 c.c., and Alabama graphite 152.0 c.c. In other words, it would be impossible to make graphite mixtures of maximum carbon content from the two American materials. Since they offer a much larger surface the amount of clay used must be greater. From this it follows that the ultimate density and thermal conductivity are certain to be lower.

To what extent American flake graphite can be admixed with the Ceylon graphite remains to be seen. The writer has seen mixtures in which the flake added amounted to 20 per cent of the total graphite content and gave fair foundry results. It might be possible, however, to perfect processes which will enable the crucible maker to employ larger percentages of domestic graphite, and at the same time secure practically the same results as with Ceylon graphite. On the other hand, there is no reason why a large quantity of domestic graphite should not be used in the making of stoppers and similar articles. The comparison made between the Ceylon and flake graphite is, of course, relative, and refers to crucible value obtained per dollar at the present time. If for some reason this country could no longer obtain Ceylon graphite, the production of metal certainly would not be diminished in any way, as we could get along very well with flake and amorphous graphite, furnace carbon and coke.

The United States Bureau of Mines has lately conducted experiments designed to determine the fusibility of the ash yielded by graphites from various sources, and its influence on the refractoriness of the bond clays used in crucible making. The results of these experiments showed³ that, while the ash of different graphites varies widely in relative fusibility, the softening point cannot be taken as a true criterion of the behaviour of the

¹ Geol. Surv. Can., Rep. Prog., 1876-7, p. 489.

² Canadian Chemical Journal, October, 1918, page 253.

³ Journal of the American Ceramic Society, Vol. II, No. 1, Jan. 1919, p. 68.

ash in a crucible body. Also, that the tendency of graphite ash to lower the refractoriness of a crucible is not evident at brass-melting temperatures and would seldom be detrimental even in steel-melting crucibles. It was also shown that the ash of Alabama graphite exerts a lesser degree of fluxing action than that of Ceylon, Canadian, Pennsylvania, and New York graphites.

In the course of the experiments conducted by the above Bureau in the manufacture of crucibles from graphites from various sources, the following figures of chemical and screen analyses were secured on samples of graphite obtained from American producers¹.

Results of Chemical and Screen Analyses of American Graphites.

Description.	Percentage of Carbon.		Cumulative percentages.				
	Volatile.	Graphitic.	On 20-mesh.	On 35-mesh.	On 65-mesh.	On 100-mesh.	Through 100-mesh.
Artificial.....	1.27	87.82	0.3	11.7	54.9	95.9	4.1
No. 1 flake.....	1.68	82.02		0.1	42.0	94.8	5.2
".....	1.32	92.09		2.5	28.0	60.0	40.0
".....	3.65	74.67		3.3	30.3	89.6	10.4
".....			0.1	15.4	69.6	95.6	4.4
".....				5.7	58.5	93.0	7.0
".....	1.98	86.18	0.1	6.7	56.4	97.0	3.0
".....				9.7	62.2	92.4	7.6
".....	1.08	92.43		8.2	69.6	99.7	0.3
No. 2 flake.....	2.96	80.44				10.5	89.5
".....	2.31	81.43		0.2	9.9	67.6	32.4
".....	2.17	86.30		0.1	0.3	22.2	77.8
Dust.....	6.06	41.33		0.1	1.2	3.2	96.8
".....	7.37	32.41				0.2	99.8
".....	7.20	31.47			0.4	3.9	96.1

The screen analyses were made with Tyler Standard Ro-tap apparatus, the samples being screened for 45 minutes. In connexion with the carbon determinations, a tentative standard was adopted for what is here termed volatile carbon; by this is meant the carbon burnt off during a preliminary ignition lasting 3 minutes, at a temperature of 800°C. The table shows that the amount of such volatile carbon was found to be greatest in the dust samples, practically all of which passes a 100-mesh screen; and it therefore appears probable that a proportion at least of such loss represents graphitic carbon, which burns off more rapidly in the case of finely divided material than of that consisting of large sized particles.

The figures quoted illustrate the wide variation both in the carbon content and size of flake of the various grades of commercial graphite as supplied by different producers.

In the following table² is shown the complete chemical composition of seven samples of graphite as prepared for crucible work:—

¹ Dub, G. D., op. cit., p. 20.

² Dub, G. D., op. cit., p. 21.

Composition of Seven Samples of Crucible Graphite.

	Alabama.	Alabama.	Alabama.	Alabama.	New York	Penn- sylvania.	Ceylon.
Volatile carbon.....	2.08	1.40	2.66	1.31	1.30	1.53	1.68
Graphitic carbon.....	84.52	90.58	81.82	91.18	88.97	88.80	85.06
Silica.....	7.02	3.99	8.33	4.08	4.34	5.24	7.81
Alumina.....	5.06	2.96	6.35	2.31	2.40	2.05	2.82
Ferric oxide.....	0.53	0.18	0.39	0.40	1.08	1.75	1.61
Titanic oxide.....	0.14	0.19	0.13	0.13	0.38	0.05	0.13
Lime.....					0.07		0.19
Magnesium.....	0.23	0.16	0.06	0.08	0.76	0.09	0.21
Potash.....	0.15	0.23	0.14	0.31	0.55	0.08	0.25
Soda.....	0.01	0.01	0.11	0.03	0.12	0.12	0.11
	99.74	99.70	99.99	99.83	99.97	99.71	99.87

These figures show that, from the point of chemical composition, flake graphites, properly refined, compare well with Ceylon plumbago.

A most interesting and instructive paper on the "Structure of Graphite in Relationship to Crucible Making," recently appeared in the *Journal of the American Ceramic Society*, (July, 1919, pp. 508-542.) The author, R. Thiessen, of the United States Bureau of Mines, has conducted an exhaustive investigation of the structure of graphite from Alabama, Pennsylvania, Canada, Madagascar, and Ceylon, and of the effect of burning on the crucibles made with them. The investigation consisted in (1) a microscopical examination of the various graphites to determine both the predominant size and shape of particles and, at a very high magnification, the inner structure of such particles; (2) a similar examination of cross-sections of crucible walls made with different graphites, both before and after burning. It was found that the graphite of a crucible made with flake graphite whose flakes were uniformly small rather than uniformly large, were evenly and closely packed and were arranged parallel to one another and to the crucible wall, resisted oxidation longest, and such a crucible, therefore, might be expected to give the best foundry service.

This is in direct contradiction to the opinion held by many crucible makers that Ceylon plumbago, by reason of its greater density, is superior for crucibles to flake graphite. The paper contains a number of microphotographs that illustrate admirably the structure of the graphites examined and also the effect of burning on the crucibles made with different graphites, and is an important contribution to our knowledge of what has long been a very vexed question.

Clays for Crucibles.

In view of the importance of the quality of the clays employed in crucibles, it may be pertinent to include here some remarks as to the requirements of the crucible trade in this connexion.

Although fireclays are of widespread occurrence, relatively few such clays have proved suitable for crucible manufacture. Probably the best clays for this purpose so far found are the Stourbridge (English) clay, and the Passau and Klingenberg clays, of Bavaria. The Klingenberg clay, especially, on account of its high purity, homogeneity and refractoriness, was employed almost exclusively in pre-war days for crucible work, not

only in Europe but also in the United States. The cutting off of the supply has forced crucible manufacturers to experiment with other clays, and in the United States substitutes have been found in mixtures of clays from different localities. The Bureau of Standards, United States Department of Commerce, has made a laboratory study of the subject¹; and, as a result, it is suggested that, although there seems to be no reason to think that such clays cannot be found in the United States, it is believed the best solution of the problem would probably be to depend on a mixture of two or more clays representing both those of the open and more refractory and those of the dense and vitrifying variety, such as the well known clays of the St. Louis region and the ball clays of Tennessee and Kentucky, or the plastic fireclays of Ohio and Pennsylvania². It has proved, however, apparently not a simple matter to produce in practice, from a mixture of clays, a product in every way the equal of a high grade fireclay, such as the Klingenberg variety; and crucible makers, basing their statements on the reports of their customers, are by no means agreed that a satisfactory substitute for the imported crucible clays has yet been produced from a blend of domestic clays³. It is manifestly difficult to secure satisfactory data as to the relative quality of the pots made from these experimental mixtures, since the life and general behaviour of a crucible are largely dependent on the treatment and handling it receives, and these necessarily vary considerably in different plants. The experiments that the Bureau of Standards now have under consideration, that is, the manufacture on a commercial scale of crucibles from mixtures of different domestic clays, followed by a testing of the pots under actual working conditions and under government supervision, should provide much needed and reliable data on this head.

The following excerpts from Technologic Paper No. 79, of the Bureau of Standards, serve to illustrate some of the more important points in connexion with the choice of clays for crucible purposes.

The requirements of such clays are very exacting and may be summarized as follows: First, they must possess sufficient refractoriness to withstand the high heat of the furnaces, under the pressure of the liquid charge, without showing deformation; second, great plasticity and bonding power, making possible the cementing together of the grains of calcined material to a satisfactory compact mass; third, considerable mechanical strength and toughness, especially in the dried state; fourth, the quality of becoming dense at comparatively low temperatures, in order to produce a structure impervious to the liquid metal and resisting its corroding influence; fifth, the property of retaining a sound structure, free from vesicular development upon long continued heating; sixth, the quality of resisting sudden temperature changes without checking or spalling; seventh, the property of drying and firing safely without cracking. These requirements are severe and are possessed by comparatively few clays.

The chemical, and with it the mineral, composition of the plastic fireclays is obviously of fundamental importance; but it is influenced and modified so largely by physical conditions that as a guide in the selection of suitable clays it is of secondary service. This is illustrated by the fact that we have in the United States a large number of clays practically identical or closely approaching the chemical composition of the best known European bond clays but which fail completely in satisfying the requirements. We are compelled, therefore, to assign to chemical composition a secondary value. This does not mean, of course, that the composition is to be entirely neglected. It must always correspond to that of refractory clays. Any excess of fluxes would evidently render the material valueless, since refractoriness is one of the conditions to be met. The fact to be

¹ Bleininger and Schurecht, Properties of Some European Plastic Clays, Tech. Paper No. 79, U. S. Bur. Standards, 1916.

² Mineral Resources of the United States, 1916, Part II, p. 560.

³ See M. McNaughton, The Crucible Situation, Trans. Amer. Inst. Metals, Vols. XI XII, 1917-8, p. 208.

realized is that it fails to differentiate between the several types of fireclays, all of which are sufficiently refractory for the purpose.

The strong plastic clays of the type under discussion show considerable contraction in volume upon drying. At the same time, there is a distinct tendency on the part of some clays, such as the well known Klingenberg material, to air check. Both of these items deserve attention. The difficulty due to air cracking is, of course, largely overcome in actual use by the employment of a large proportion of non-plastic material in the form of refined clay, crushed potshells (grog) and graphite. The volume shrinkage is a function of the rate of drying, which is governed by the temperature (humidity) and the velocity of flow of the air around the piece being dried. As a rule the shrinkage is found to be smaller when the drying proceeds rapidly and larger when the process is taking place more slowly.

Plastic fireclays may be roughly divided into two classes, namely, open, and dense burning materials. The former, when fired to high kiln temperatures, say corresponding to pyrometric cone 14 to 16 (1410° to 1450°C.) retain their open structure, owing to the small amounts of fluxes, iron oxide, lime, magnesia, and the alkalis. The second type burns to a dense mass at these temperatures or below and may even show overburning or the formation of a vesicular, spongelike structure. Both types of clay are necessary. The first type is inherently more refractory and is able to withstand load conditions at furnace temperatures more satisfactorily. The second type is useful in closing up the pores of the material and producing a dense mass resistant to the corrosive action of slags. The ideal condition would be obtained by the use of a mixture of the two classes of clays and restricting the amount of the dense-burning material to the minimum necessary to bring about the desired density. The study of the rate of condensation or vitrification . . . is usually followed by determining the decreasing absorption of water, or porosity, at a series of increasing temperatures. Decreasing porosity must, in the nature of the case, parallel the process of vitrification. The higher the content of fluxes the larger must be the quantity of the matter softening under the influence of the heat, so that condensation or minimum porosity is reached at a comparatively low temperature. The open-burning clays, on the other hand, show no striking drop in porosity and retain their porous structure at the temperatures involved. This behaviour undoubtedly is due to their more refractory character, viz., the low content of fluxes. The term over burning is used to indicate the formation of vesicular structure, due to the evolution of gases. This is evidenced by the fact that during this stage the porosity again increases, since the clay becomes more or less spongelike in character. The usefulness of the clay is seriously lowered even during the incipient formation of this structure, as it is evident that the clay has softened to a very great extent, and owing to the resumption of the greater porosity, becomes more subject to the action of corroding slags. Fortunately, in the presence of fine and coarse grained calcined clay of high refractoriness (grog), the formation of the vesicular structure is opposed by allowing the gases to escape more readily, by the solution of the fine grained refractory clay, with consequent stiffening, and by the mechanical effect of the skeleton of coarser grog particles. This condition is subject to regulation by the sizing of the grog, which makes necessary both the introduction of very fine particles and a series of coarser sizes. The adjustment of the sizes should be such that maximum density is produced in the dried state. It is specially important to keep in mind the function of the fine grog, a fact not as commonly realized as it should be.

A plastic fireclay which shows some formation of vesicular structure need, therefore, not be condemned on this evidence alone. If, however, it persists in bloating when admixed with grog, its use becomes decidedly questionable.

Clays do not possess a definite melting point like minerals and metals, and softening takes place during a long temperature interval. In this connexion it is important to note, in determining the so-called fusion or melting point of clays by means of pyrometric cones, that time is an important factor, which is illustrated by the fact that this arbitrary degree of softening occurs at a lower temperature when the heating is continued for a longer time and vice versa.

The ultimate softening temperature is apt to be a misleading criterion as regards the practical usefulness of a refractory. Thus, based upon the Seger kaolin-silica fusion curve, siliceous clays are considered of an inferior grade compared with the high-clay materials. As a matter of fact, clays high in silica and low in fluxes may show excellent refractory qualities in practical use and may stand up under severe conditions. The fact that the siliceous clays may fuse at a lower temperature is not of much practical significance. Such materials possess the important advantage of not softening throughout a considerable temperature range, as is the case with the clays approaching the composition of the pure clay substance, and usually stand up at heats close to their ultimate softening point.

Klingenberg clay, from Bavaria, is especially favoured for the manufacture of graphite crucibles, and up to the present time has been used exclusively for this purpose.

by American makers. The best selection mentioned in the literature is said to approach closely the following composition:—

	Per cent
Silica.....	54.06
Alumina.....	33.11
Ferrie oxide.....	1.50
Lime.....	0.49
Magnesia.....	0.45
Potash and soda.....	1.37
Loss on ignition.....	9.12

This clay is one of the most plastic clays known. It appears to be quite high in organic matter. Unmixed with non-plastic matter it has a decided tendency to check and crack on drying. There are several grades of this clay on the market which differ in refractoriness.

For the purpose of comparison with clays under trial for crucible work, the following data obtained by tests on Klingenberg clay are quoted:—

Minimum water content with which clay can be worked—	
Per cent water.....	17.95
Per cent linear drying shrinkage.....	2.02
Water content between minimum and normal—	
Per cent water.....	31.00
Per cent linear drying shrinkage.....	3.06
Normal consistency—	
Per cent water.....	40.12
Per cent linear drying shrinkage.....	9.41
Water content between maximum and normal—	
Per cent water.....	52.25
Per cent linear drying shrinkage.....	18.33
Maximum water content with which clay can be worked—	
Per cent water.....	66.20
Per cent linear drying shrinkage.....	24.92
Difference between maximum and minimum water content.....	48.25
Difference between maximum and minimum shrinkage.....	22.90
Fineness=amount of clay removed by water current of 0.18 mm. per second, per cent by weight.....	54.6
Tensile strength in plastic state, pounds per square inch.....	4.05
Time of disintegration of dried clay in water, minutes.....	120
Tensile strength of dried clay, pounds per square inch.....	62.9
Modulus of rupture of dried clay, pounds per square inch.....	301.0
Tensile strength of dried clay with 50 per cent grog, pounds per square inch.....	177.5
Modulus of rupture of dried clay with 50 per cent grog, pounds per square inch..	538.0
Drying factor.....	75.3
Drying behaviour of clay.....	Cracks.

From a test of five European plastic fireclays, the most suitable for graphite crucibles were found to be the above Klingenberg clay and a plastic pot clay from St. Loupe, in France. It is suggested that the Klingenberg clay might be improved for the above purpose by an admixture of an easy drying clay having low shrinkage, such as the glass pot clay from Gross Almerode, Germany.

Klingenberg clay has a low vitrification temperature, reaching a state of advanced density at 1125°C and retaining this condition up to 1350°C, when it begins to become porous owing to the formation of a vesicular structure due to overheating. The low vitrification temperature is an important property in graphite crucibles for brass melting, but is not of such value in steel work. For the latter purpose, the French St. Loupe clay would seem to be better adapted, showing a more gradual vitrification and retaining a lower density than Klingenberg clay up to, and evidently beyond, 1375°C.

For crucibles used at lower temperatures, Klingenberg clay is undoubtedly highly superior, since it becomes dense at low temperatures and thus protects the graphite from oxidation. A slower vitrifying clay may be of advantage in some cases where temperatures above 1250° are involved, but at lower temperatures it tends to leave the structure open too long and hence causes oxidation of the carbon. The low vitrification temperatures of Klingenberg clay is due to the high content of total fluxes.

Summarizing, it is shown that the best clay serving best for graphite crucibles to be used in brass melting evidently is one which becomes dense at a comparatively low temperature, thus excluding the oxygen of the air from the carbon grains by enveloping

them with a protective layer of clay. Klingenberg clay stands pre-eminent for this purpose up to temperatures of 1350°C and somewhat higher, the admixture of graphite apparently tending to increase the refractoriness of the mass. For melting steel, the French St. Loupe clay is probably slightly to be preferred, owing to its somewhat higher density at temperatures between 1250°C and 1375°C, which enables it to resist corrosion by slag to a greater degree.

Regarding the possibility of finding satisfactory substitutes amongst domestic clays for the foreign crucible clays the authors conclude:—

Some of the users of such materials have sought to replace these clays by individual American clays. There is no reason to believe that such clays can not be found in the United States; in fact, materials have been tested in this laboratory which approach the foreign clays in quality. It would be far better, however, to depend upon a mixture of two or more clays, representing both clays of the open and more refractory, and of the dense and vitrifying variety to secure the desired condition. Among clays of the latter type are listed the ball clays or semiball clays of Tennessee and Kentucky, and some of the plastic No. 2 fireclays of Pennsylvania and Ohio. It is important to realize that an open-burning clay of the Gross Amberode type, whether it be like the plastic clays from Missouri or New Jersey or the siliceous clays from Arkansas, should be blended with one or more clays of the opposite type and not with materials of the same class, a mistake which is sometimes made. Likewise it should be realized that a bond clay suitable for glass work is not necessarily adapted for use in graphite crucibles, where greater density of structure at lower temperatures is essential. By adjusting the proportions of the two kinds of clay, and by thorough mechanical blending through fine grinding, the desired quality can be obtained as well as maintained with results which should be superior to those which have been had with the single imported clays. The claim that no American clays are available which answer the purposes of the industries involved is fallacious, a fact supported by actual foundry results communicated to the writers. Open-burning plastic clays of good refractoriness are found in Alabama, Colorado, Georgia, Arkansas, Illinois (southern part), Kentucky, Missouri, New Jersey, Ohio (southern part), and Tennessee. In the same States, and frequently close to other deposits, dense-burning clays are also found, to which must be added materials of this class found in Maryland. There is no lack of materials, and it is a question only of selection.

Based on the results of the tests conducted on a series of high grade European plastic fireclays, the writers suggest the following tentative specifications as being of service in selecting plastic bond clays for crucibles:—

Plastic bond clays should possess a considerable water shrinkage range, one of about 40 per cent between the minimum and the maximum water contents, permitting of mulling of the clay. In the case of siliceous clays, allowance should be made for the content of nonplastic constituents and the permissible range reduced to 20 per cent, provided the materials fulfill all other essential requirements. The Atterberg plasticity number should not be lower than 50 nor higher than 110. The ratio of the percentage of the shrinkage to the per cent of pore water should not be greater than 1:1.2. The total water content, for normal consistency, expressed in terms of the dry weight, should be between 30 and 45 per cent. When intimately mixed with 50 per cent of potters flint (by weight) the time of complete disintegration in water of a seven-eighth inch cube in the dried state, made of the mixture, should not be less than 50 minutes, the water being at room temperature. The tensile strength of the clay in the plastic state should be close to 4 pounds per square inch. The linear drying shrinkage should not be less than 6.5 and more than 10 per cent of the dry length, the drying to be done at room temperature.

When made up with 50 per cent, by weight, of hard burned grog, which passes the 20-mesh sieve and shows residues of 34 per cent on the 40 mesh, 27 per cent between 40 and 100 mesh, 12 per cent between 100 and 150 mesh, and of which 27 per cent passes through 150 mesh, suitable dried test specimens should show the following minimum strengths: Tensile strength, 150 pounds per square inch; modulus of rupture, 350 pounds per square inch. The drying should be so conducted that the specimens are kept at room temperature until shrinkage has ceased, when they are to be heated to 75 and 110°C, respectively, and to constant weight in each case.

Dried specimens of the clay should be fired in a suitable kiln at a rate corresponding to a temperature increase of approximately 20°C per hour, beginning at 1000°C and withdrawn from the kiln at intervals of 20° or 25°C. Absorption and porosity determinations should be made upon all pieces. The clays should show a porosity of not more than

10 per cent at 1150°C, at 1250° approximately 5 per cent, and should then maintain practically constant porosity up to 1350° in the case of materials intended for graphite crucibles used in brass melting and 1400° for crucibles employed for steel. The linear burning shrinkage may vary, for the unmixed clay, from 5 to 8 per cent, in terms of the dry length, and should not exceed the higher limit. The softening temperature of the plastic clays should not be below that corresponding to cone No. 30.

The percentage content of total fluxes, Fe_2O_3 , CaO , MgO , K_2O , and Na_2O may approach 5 per cent.

Dr. Bischoff, a German authority on clays, conducted a special investigation of Klingenberg clay, the results being published in a separate paper in 1903. The tests were conducted on both the No. 1 and the No. 2 grades, which are stamped before shipment with a coat of arms and the letters K. B. 2 respectively.

The tests included:—

- (1) Comparison of physical qualities;
- (2) Elutriation test for fineness of grain;
- (3) Pyrometric determinations;
- (4) Chemical analysis.

Chemical analysis showed:—

	No. 1.	No. 2.
Alumina.....	31.16	30.43
Silica.....	54.16*	55.76**
Magnesia.....	0.38	0.27
Lime.....	0.40	0.34
Ferric oxide.....	1.66	1.37
Potash.....	0.97	0.72
Iron pyrites.....	trace	trace
Loss on ignition.....	11.48	11.42
	100.21	100.31

Calculated as free from water and carbon the above results show:—

	No. 1	No. 2
Alumina.....	35.18	34.36
Silica.....	61.15	62.95

It is concluded from the tests made that the No. 1 clay is more suitable for crucibles than the No. 2, important considerations being that the former has a considerably higher content of finely divided clay material and that it acquires greater volume when mixed with water. Both of these facts make it extremely suitable for use in crucible bodies, as the graphite is thus more completely enclosed and incorporated in the clay mass and is better protected from oxidation.

With regard to the occurrence in Canada of clays suitable for crucibles, the following statement has been furnished by the Ceramic Division of the Mines Branch:—

Fireclays which may be suitable for use in the manufacture of crucibles are found at the following localities in Canada. None of these clays appear to have the precise qualities of the English and German crucible clays, but two or more varieties could be assembled in order to arrive at the proper requirements.

* 31.11 chemically combined; 23.05 sand containing 22.91 silica and 0.10 alumina.
 ** 33.81 chemically combined; 21.95 sand containing 21.80 silica, 0.12 alumina.

Nova Scotia.

Shubenacadie.—Grey plastic fireclay occurs here. It burns to a fairly dense body and the shrinkages are low, i.e. the total shrinkage when burned to cone 9 is 10 per cent. This clay softens at cone 30.

Middle Musquodoboit.—A series of beds of pink, red, white and mottled clays occur at this locality.

These clays are very fine-grained and plastic. They burn to an impervious body at cone 6 to 9, depending on the quantity of red clays present, with a total shrinkage of 15 per cent. The softening points are from cone 20 to cone 27.

A small quantity of these clays might be used in a crucible body, but not more than 15 per cent or so.

Inverness, Cape Breton.—The most important deposit in this district is the clay overlying the 13 foot or Hussey coal seam. It outcrops on Big river and on McClellan brook. It is a very smooth, plastic, and rather sticky clay when wet. It burns to an impervious body at cone 5, with a total shrinkage of 17 per cent, and it softens at cone 25.

On account of its good bonding and dense-burning properties this would be a useful clay to mix with more refractory open-burning materials for a crucible body.

Coxheath, Cape Breton.—A deposit of felsite having a composition somewhat resembling that of a siliceous fireclay occurs at this locality. It is hard and non-plastic when ground and wetted, and resembles in this respect the flint clays in the United States. This material could be ground and screened to suitable size of grain to furnish the grog or coarse material in a crucible body.

Quebec.

St. Remi d'Amherst.—Kaolin or china clay occurs at this locality in workable quantities. The white kaolin is very refractory but there is some discoloured material also present which is not quite so refractory. These materials do not burn to a dense body at the ordinary temperatures at which refractory goods are made, so that they would require to be mixed with a dense-burning clay of lower refractoriness. This is the only body of refractory clay at present known in Quebec.

Ontario.

Refractory clays are not known to occur in the southern part of the province of Ontario. In the northern portion, however, there are deposits of high grade clays which would be suitable for crucible manufacture, but unfortunately they are situated beyond the reach of transport at present.

Saskatchewan.

Fireclays occur abundantly in the southern part of the province of Saskatchewan, in the vicinity of Claybank, Willows, Yellowgrass and other points.¹ These clays are very plastic and somewhat sticky, so that they would require the addition of some non-plastic ingredient to reduce their shrinkages. As natural, non-plastic, refractory material appears to be absent in this region it would be necessary to calcine a portion of the raw clay to furnish the grog.

Reference has been frequently made in the preceding pages to the use of grog in crucible bodies. The term grog is used to denote material consisting of used crucibles that have stood a maximum number of heats or have broken in handling. These discarded pots are returned to the crucible works and are broken up, crushed and incorporated in the body of fresh crucibles. A usual proportion of grog in a brass pot is 10 per cent, but in steel pots its place is generally taken by silica sand.

Manufacture of Crucibles.

The materials for the manufacture of crucibles, while differing in some minor details, are practically the same everywhere. The preparation of the mixture, and the proportions of the various ingredients—graphite,

¹ Clay Resources of Southern Saskatchewan, by N. B. Davis, Mines Branch, Ottawa, 1913.

clay, and grog or sand—entering into it, are generally the rather jealously guarded property of the individual makers, and this is more especially the case at the present time when so much experimental work with various clay and graphite mixtures is being carried on.

The following are approximate mixtures for brass and steel pots:—

Brass crucibles.		Steel crucibles.	
Graphite.....	45 per cent		50 per cent.
Clay.....	35 “		30 “
Grog.....	10 “	Sand	10 “
Kaolin.....	10 “		10 “

In exceptional cases, where very high refractory qualities are demanded, the proportion of graphite used may reach as high as 80 per cent, and over, but this amount is exceptional and results in a weak crucible. According to Ledebur,¹ crucibles for the manufacture of tool steel in Austrian steel works contain only 33-60 per cent of graphite, but the graphite used is the best grade of Ceylon, specially cleaned for the purpose.

The clay is first kiln dried at a temperature of 120°C., until all moisture is driven off. It is then ground in small stamp mills, or, more generally, by edge-runners (chasers), and is then screened to remove lumps and any foreign matter.

The graphite, whether it be Ceylon or flake, undergoes a certain amount of preparation at the crucible works, over and above what it has received previous to shipment. The standard grades of Ceylon crucible graphite comprise the following:—

- Lump No. 1
- Lump No. 2
- Chip No. 1
- Chip No. 2
- Dust

The above grades vary considerably in their carbon content, ranging from as high as 92 per cent in the case of lump No. 1 to 70-75 per cent for dust, and the price of the different grades varies accordingly.

The lump and chip grades undergo a grinding and screening process at the works, the graphite used in the crucible mixture consisting of a mixture of various sizes of grain, in the proportions decided upon by the individual manufacturer as giving the best results. The very fine, or dust graphite, produced in the grinding process is not suitable for crucible work, owing both to its fineness and to its containing a great deal of the gritty impurities originally present in the graphite. This dust is generally disposed of to the foundry facing and other trades.

It may be noted that the grading, or “curing,” as it is termed, of graphite at the compounds in Ceylon, before shipment to the coast, is done entirely by hand and consists in chipping the impurities from the lump material, and in washing and sizing the various grades produced. What is known as Lump No. 1, or “Ordinary Lump” (abbreviated to O.L.) is therefore the purest material shipped, outside of one or two special high carbon grades for which there is only a limited market. Most of the imports of Ceylon graphite into the United States in 1917 consisted of Lump No.

¹ Thonindustrie-Zeitung, 1895, No. 3.

1 and Chip No. 1, as under existing ocean tonnage conditions and freight rates these grades were the most economical to import.

Flake graphite, though purchased on a basis of an understood 90 per cent, or approximately 90 per cent, carbon content and a size of flake of from 20 to 90 mesh, is usually re-screened previous to use and may even, in some cases, be re-ground in burr mills. A certain amount of fine dust is thus produced which is disposed of for other classes of work. Flakes of more than ordinary size, *i.e.* much above 20 mesh, are not desirable, as they decrease the density of the crucible and detract from its strength.

The sand used in small amount (about 10 per cent) in steel crucible mixtures is a clean, fine-grained quartz sand, while the burnt fireclay or grog used in brass pots has already been referred to above. The sand serves to diminish shrinkage of the crucible body, while the grog tends to keep the body open and, by permitting the escape of steam or gas during burning, to prevent cracking or bursting.

The cleaned and sized materials are first of all weighed and charged in the proper proportions, together with water, to a pug mill or mixer holding about two tons, where they are thoroughly incorporated. After mixing, the dough is kneaded by hand into lumps of the required size. Before being worked up in the pug mill, the dry materials may be sprinkled with water and left to become thoroughly impregnated with moisture, though this procedure is a matter of individual rather than general practice. The lumps of kneaded material are sometimes allowed to season for several weeks, and when commencing to show a dry surface crust, they are again worked up in a pug mill to a homogeneous mass.

The material is now ready to be moulded into crucibles. In American practice, crucibles are made almost entirely by mechanical means, though the original practice was to form them by hand. The appliance used is styled a jolley and jigger.

A given weight of the mixture is taken, kneaded by hand into a ball and placed in the mould which stands on a mould board base on a revolving table. It is then tamped down flat with a wooden pestle, the table is set revolving and a small, curved arm, known as the rib or jigger, attached to a vertical shaft, is lowered into the mould. On meeting the clay mixture, the rib forces or squeezes it upward between itself and the wall of the mould. The rib sinks at a distance from the mould required to form a crucible wall of the desired thickness and to a depth that will give the proper thickness of bottom. The necessary adjustment for the purpose can all be readily made on the machine, so that the whole process of moulding is practically automatic, and the same machine can be used to make pots of various sizes. As the weight of clay mixture necessary to form a pot of a certain size is known, there is practically no surplus forced up out of the mould. The top edge of the crucible is then smoothed off by hand, and the lip formed by cutting out a small piece with a tool made for the purpose.

The moulds are made in two vertical halves, provided respectively with tongue and slot to ensure proper junction when set up. The moulds are formed by building up a sheet iron casing around a solid model of the size and shape of the exterior of the crucible to be made, a space equal to the desired thickness of the mould wall being left between model and casing. This varies of course with the size of the mould, and must be sufficient to give the mould the necessary strength during handling. Two metal strips are inserted in this space, half way around the periphery, so as to divide

the space into two equal halves, and plaster of Paris is then poured in, the solid model being first well soaped to prevent sticking. When this is set, the mould is removed and finished off to the exact size by turning and trimming. The mould is open at the bottom and rests on a mould board during formation of the crucible. The two halves are held together during this process by means of flexible straps of steel or other material, provided with brass clamps for tightening. After finishing, the crucibles remain in the moulds for a few days to harden sufficiently for handling, and are then removed and piled in tiers in large drying rooms, where they air dry for from 4 to 9 weeks, according to the size of the pot. From here they are taken to other drying rooms, supplied with hot air at 150°F, where they remain about a week, after which they are ready for the kilns. The shrinkage during drying usually amounts to from $\frac{1}{2}$ " to $\frac{3}{4}$ ", measured along the diameter of the pot. After thorough seasoning, the crucibles are placed in large muffle kilns, about 15 feet in diameter, and heated at a temperature of from 1500° to 1800°F for from 30 to 48 hours, after which the kiln is allowed to cool off for five or six days before unloading. Muffle kilns fired with hard coal are preferred to the open, down-draught type, as the former dispense with the necessity of sappers and ensure a more uniform heating of the kiln's contents. Oil fired kilns, it is claimed, do not give as good results as coal fired, owing to the heat not penetrating uniformly to the centre.

The following notes on the raw materials for crucibles and the manufacture of crucibles are taken from Searle, "Refractory Materials," 1917, pp. 304-325. The details given relate, in the main, to English practice:—

Plumbago crucibles are usually made of equal parts of clay and graphite, but some are made of 1 part of clay and 3 or even 4 parts of graphite or coke, whilst crucibles for steel and very sensitive alloys contain only 6 per cent of carbon, usually in the form of coke dust. The graphite has a much lower relative weight than clay and so occupies a much larger volume than its weight suggests. A mixture which is extensively used in Germany consists of 36 parts of fireclay, 23 of coarse grog, 23 of powdered coke and 18 of graphite.

In steel manufacture, crucibles hold 75 to 80 lbs. of metal and are made chiefly of a mixture of fireclays. The proportions of the ingredients vary with the quality of steel to be made. The following mixtures are used by firms of high standing:—

Crucible Mixtures for Various Metals.

—	Hard steel. (German)	Mild steel. (German)	Razor steel.	Very pure steel.	Copper, alloys, brass, etc.		Cast iron.	
					a	b	a	b
Graphite or coke.....	54	40	12	3	8	12	53	50
Fireclay.....	36	38	40	87	67	50	43	40
China clay.....	36	38	40	10	67	13	43	40
Grog.....	10	22	8	10	25	25	4	10

Some brass foundries prefer crucibles with 50 per cent of graphite.

The fine particles should be removed from the grog by passing it over a 40-mesh sieve and rejecting what passes through the latter. Crucibles in which no fine grog is used are more durable than others.

The following mixtures are largely used in Sheffield, but it must be clearly understood that each maker works according to his own ideas and alters his recipes whenever there appears any advantage in doing so:—

Crucible Mixtures for Steel.

	A	B	C	D	E	F
White china clay.....	10	20	20	15		
Stourbridge clay.....	16	10	20	33	17	
Derby clay.....	20	18	13	23		10
Stamington clay.....	20	18	10	23	17	28
Coke or plumbago.....	4	1	7	6		4
Grog.....					6	28

When a high-carbon steel is to be made, the crucible may contain more graphite than when a mild steel is to be produced. Crucibles with a high content of graphite are objectionable for melting steel, as the metal absorbs flakes of graphite, which become embedded in it, producing small holes, flaws and weak places in the casting. As crucibles containing graphite last longer, they are cheaper to use than those made exclusively of clay. They are employed for all but the highest grades of crucible steel, the proportion of graphite (or coke dust) diminishing as the quality of the steel increases.

Though nearly every steel melter has his own mixture for crucible manufacture, all agree in preferring several clays rather than a single one, no matter how refractory its character.

The various materials, in the correct proportions, must be mixed with water to form a stiff uniform paste. There are several methods of doing this, but the ones most generally used are treading, panning and pugging, the first named being chiefly for large crucibles.

When the materials are to be mixed by treading, they are spread out on a concrete floor and are sprinkled with water. The mass is turned over repeatedly with spades and when it becomes too pasty to be worked in this way, it is again spread out and is trodden by men with bare feet, who squeeze the clay between their toes, and so mix it thoroughly. Each portion of the material has to be squeezed between the toes, compressed and then pressed on to the previously worked paste.

The trodden mass is then made up into balls of 40 to 45 lbs. weight, and is afterwards beaten into a dense mass. In some works it is pugged after being trodden.

Various firms have endeavoured to replace this labour by means of pug mills or open mixers, but without much success, the makers declaring that clay mixed mechanically does not suit their purpose so well as that which has been trodden. The reason for this is difficult to understand, as a mechanical mixer effects a much better distribution of the particles and produces a sounder mass.

French crucible manufacturers mix the dry materials together and then pass them through a pug mill, water being added to the contents of the latter by means of a sprinkler. The paste is allowed to sour for several days and is again passed through a pug mill, this process of souring and pugging being repeated several times. Some German manufacturers adopt this method for all crucibles. It is also used extensively in the U.S.A., though in the latter country, crucibles made from a semi-dry material are popular.

The author has made careful microscopical and other tests of the same materials treated (a) by treading and (b) in a trough mixer and has always found that the mechanically mixed material is more uniform and homogeneous in texture than that which has been trodden. Yet so conservative are the users of steel crucibles and so serious is the loss occasioned by defective ones, that only a very small number of firms use a mechanical mixer, notwithstanding the fact that it can be made to produce a better material at a lower cost.

For small and medium sized crucibles, the materials are mixed in a trough mixer or pug mill, or preferably by panning. For the latter purpose, sufficient quantities of each material to form a charge for a pan mill are weighed out, placed in the mill and the latter is set in motion. The necessary quantity of water is then added slowly through a sprinkler attached to the mill and the pan is kept in motion until the materials are properly mixed. In most cases, half an hour's treatment is sufficient, but for special crucibles the mixture is sometimes panned for several hours.

A pan mill, or tempering mill, consists of an edge runner mill with a non-perforated (solid) revolving pan. The construction of a tempering mill resembles an edge runner grinding mill but it is much lighter, and the runners are supported on bearings, so that they rub rather than crush the material.

The paste is allowed to remain in cellars for several days in order that it may sour and its plasticity be fully developed. At the same time it may, if too soft, be allowed to dry partially, so as to produce a paste of the desired stiffness. The paste may then be placed in a small pug mill, the material passing out of the latter being cut into clots each large enough for one crucible. Some makers pass the paste twice or three times through a pug mill, but so thorough a treatment is not usually necessary.



MICROCOPY RESOLUTION TEST CHART

(ANSI and ISO TEST CHART No. 2)



APPLIED IMAGE Inc

1653 East Main Street
Rochester, New York 14609 USA
(716) 482 - 0300 - Phone
(716) 288 - 5989 - Fax

The souring is an important part of the preparation of the mixture, during which the clay becomes more plastic, the moisture is distributed uniformly and various chemical reactions occur. The effects of souring are increased if the material is pugged repeatedly during the souring stage.

During the souring, the surface of the paste is prevented from drying by covering it with cloths which are kept constantly wet.

The mass used for crucibles should be as dry as possible consistent with good working.

Crucibles may be made (1) by hand in moulds, (2) by throwing on a wheel, (3) in jiggers and jolleys, (4) in presses, or (5) by casting.

Jiggers and jolleys are specially used for plumbago crucibles, but if granular plumbago is one of the ingredients the material should be in an almost dry state and should be shaped in a wooden mould. Flaky graphite is not subject to this limitation.

Hand-moulding is usually confined to the larger crucibles, as it is a slow and somewhat costly process, but gives excellent results. In making crucibles for melting steel, the wooden or cast iron moulds are technically known as flasks. They consist of an outer flask, the inside of which is the shape of the exterior of the crucible, but has an opening rather more than an inch in diameter at the bottom. The interior portion or stopper forms the core of the mould and is provided with a handle, so that it may be worked about until the paste in the flask is properly compressed into shape. The stopper has a projecting piece on the bottom. This passes through the hole in the bottom of the flask, and serves as a pivot and to keep the core in position during the shaping of the crucible. Unless the plunger is guided by the projecting piece, it is difficult to make large crucibles of regular shape.

The flask is well oiled, the paste put into it and then gradually forced to the desired shape by inserting the core and working it to and fro in a rotary manner. If desired, the clay may be added in several portions instead of all at once, each addition being worked into place before the next is added.

When the paste has been properly compressed, any superfluity is cut off, the core or stopper is withdrawn and a blunt knife is inserted between the clay and the outer flask so as to form the contracted mouth of the crucible, enabling it to be more readily covered in the furnace, protecting the surface of the metal to some extent from oxidation and serving several other useful purposes. Some makers prefer to effect this shaping of the mouth of the crucible after it has been taken out of the mould by rotating it on a small table, somewhat resembling a potter's wheel.

The greatest care must be taken in filling up the hole at the bottom of the crucible and in making good defects in any other portions. It is always difficult to secure an absolutely satisfactory joint or patch and any carelessness in this respect may lead to the loss of a considerable quantity of molten metal.

In another method of hand moulding, the mould consists of a block of dense, close textured wood, which is covered with a wet cloth free from loose threads. The mixture is thrown on this with some force and in small handfuls at a time, until a solid and uniform mass of suitable thickness is obtained. The mass must be repeatedly kneaded and stabbed so as to secure the absence of weak places, air bubbles, etc. The thickness of the bottom of the crucible should be about twice that of the sides. The bottom of the crucible being prepared, it is lifted on to a sanded board, placed quite level and covered with a linen disc. The draun or sides of the mould is fastened to the board and the paste worked around the sides. If the crucible is sufficiently large, this may be done with the feet; otherwise, the hands or a small rounded stick is employed. The surface is then roughened with an iron comb and fresh clay thrown on to the mould, handful by handful, until, after sufficient kneading and working the mould is lined with paste to the requisite thickness. The inner surface of the crucible is then smoothed with hand tools.

In a third method of moulding crucibles by hand (this is a combination of hand moulding and throwing) the clay paste is thrown on to a hollow wooden core, the shape of the interior of the crucible and mounted on a vertical steel spindle so that the core may be rotated by hand or power. The workman forms the outside of the crucible by working the paste with his hands or with a tool at the same time as the core rotates. A sliding vertical gauge or a profile may also be used to ensure the crucible being accurate in shape and thickness. When the shaping is finished and the crucible smoothed, the core is lifted from the spindle and inverted over a board. The crucible then easily slips off the core, and the latter is again ready for use. A linen cover may be put over the core to facilitate the removal of the crucible. The pouring spout is made by pressing part of the edge of the crucible between the thumb and fingers.

Plaster cores are occasionally used in this method instead of wooden ones, but they are costly and not particularly advantageous. The chief reason for their use is that the crucible separates more readily from plaster than from wood, but with a skilled workman plaster confers no advantage.

Crucibles are made in large numbers by means of a jolley and jigger. A piece of paste is placed in a plaster of Paris or iron mould, which is then rapidly rotated, and a profile or jigger is pressed on to the clay so as to make it to conform to the interior of the mould and produce a crucible the walls of which are of the requisite thickness. The mould is then removed from the machine and taken to the dryer, its place being taken by a fresh one. This is a good method, but somewhat costly, owing to the frequent renewals of the plaster moulds. It has also the drawback that the clay paste must be very soft and the crucibles are not as dense as desirable.

Hand presses are more suitable for small crucibles and scorifiers, but are occasionally used for large ones. They consist of a plunger and lower mould or die, the paste being placed in the die and then compressed by the plunger.

In power driven presses either the plunger or die, or both, may be made to rotate during the application of the pressure. This prevents the adhesion of the paste to the metal. A large number of different presses have been suggested for the manufacture of crucibles, but most of them are unsatisfactory because they make the various parts of the crucible irregular, some being much denser than others, thereby setting up strains and cracks. The author has made an extensive series of trials with all the advertised presses (both British and foreign), and has concluded that the most suitable press consists of a rotating plunger and a loose mould which is lifted by a treadle to the plunger. The sides of the plunger are slightly flattened and grooved so as to permit the escape of air between the plunger and the clay. The mould or die is carried on a plate which can be rotated on an oiled bed or on ball bearings. This plate is not driven mechanically, but is caused to rotate by the friction between it and the clay. To use such a machine a piece of stiffish clay paste of suitable size is dipped in paraffin and placed in the mould. The treadle of the machine is then depressed and the mould is lifted until the clay is forced against the rapidly revolving plunger. As the mould rises, the clay is gradually squeezed into the desired shape and the friction causes the mould to rotate rapidly. Finally, when the mould has reached its highest point, the surplus clay is cut off automatically by the pressure of the top of the mould on the lower side of the plunger head and the treadle is then released. The mould then descends and, when a suitable point is reached, a stop comes into operation and prevents the crucible from descending further, while permitting the mould to do so. The crucible is then removed and the machine is ready to make another. A daily output of 6,000 crucibles, each 6 inches or less in diameter, or 1,400 crucibles of 12 inches diameter, can easily be obtained with one of these machines and two strong youths. The clay is supplied in the form of discs, which are made in a small pug mill fitted with a circular mouth piece and a wire-cutting table. This arrangement saves the necessity of weighing out the clay.

All machines with plungers and dies which do not rotate appear to be unsatisfactory for any but the smaller sizes of crucibles; as their output is lower, the quality of the crucibles is inferior and much trouble is caused by the adhesion of the clay to the metal.

In all mechanical presses used for crucibles it is necessary to dip the lump of paste into paraffin or other lubricant, unless the mixture is so rich in graphite that no other lubricant is needed. Unless the clay is well lubricated, it will adhere to the metal of the machine, and will cause difficulty in making crucibles of good shape.

At the present time, the use of a jolley and jigger is by far the most popular method of making crucibles, but as the value of the more recent mechanical presses and methods of casting become more appreciated, there can be no doubt that they will be used more extensively.

The best crucibles are usually finished or fettled by rubbing the surface with a wet sponge and with leather or rubber so as to make it smooth. Sometimes they are washed with a slip of fine clay so as to produce a fire coating inside. This treatment makes the crucibles more resistant to slags, etc., as it is similar to a special lining.

Crucibles must be dried slowly and uniformly, or they will crack when in use. It is specially necessary to protect them from all draughts and from direct sunlight, as these would cause fine cracks. They are usually dried on racks in rooms heated by steam pipes or by heat radiated from the kilns or ovens in which the crucibles are to be burned later. In some works the crucibles are first placed in a room kept at 30°C (86°F), and are then transferred to another kept at 50°C (120°F), where they remain for a fortnight or more.

Another method of drying consists in placing the crucibles on racks in small unventilated chambers or stoves, which are then heated by steam until the crucibles are almost dry. The drying is completed by stacking them on racks around the kiln or oven.

Crucibles for melting steel are usually placed on shelves around the walls of the shop in which they are made, each shelf being wide enough to hold two or three rows. They are turned occasionally, and, when nearly dry, may be taken to the furnace room, where they are stored on shelves until perfectly dried by the heat radiated from the furnaces and castings.

Direct heat should be avoided in drying and crucibles for steel should not be placed too near the fire until they are perfectly dry. This takes about three months in all, the first month being spent in the making room and the last two in a store, where a small amount of heat may be admitted. The longer the crucibles remain untouched, the better they are likely to prove in use, so that prolonged storage is more profitable than it appears to be at first sight.

When plumbago crucibles are properly dried they should emit a clear metallic tone on being struck.

Dry crucibles must be kept in a warm place, as they are very sensitive to frost. On no account should they be stored in an open shed.

Where crucibles are manufactured in the works in which they will afterwards be used, they are not burned in kilns, but are warmed through in the furnaces in which they are to be used, or in a preliminary furnace consisting of a long, low chamber with a fireplace at one end on which coke is burned. The hot gases from the coke pass through the chamber containing the crucibles and away to the chimney. During the warming through, the crucible should be placed upside down on the fuel, as this reduces its tendency to crack.

Crucibles which are made for sale and for transport over considerable distances must be burned in order to give them sufficient strength. The temperature at which this burning is effected will depend on the purpose for which the crucibles are to be used. The majority of crucibles should not be burned very hard, though the longer they are heated to bright redness the greater will be their durability. If insufficiently heated, the crucibles will be weak and will need more careful treatment during the first heating than is usually bestowed upon them.

Plumbago crucibles are usually burned at 710°C to 900°C (Seeger cones 018 to 010a) in muffles or saggars packed with coke-dust or sand, to prevent the undue combustion of the graphite. According to the patent specification published by D. B. Williams and J. R. Stauffer in 1904, the carbon monoxide and other gases evolved in this treatment penetrate the crucibles and convert the clay into a very refractory substance.

If a plumbago crucible has become reddened, by the oxidation of any iron present, it is given a coating of black lead to restore it to its proper colour.

The temperature in the kiln must rise very gradually, particularly at first. For forty-eight hours it should not exceed 110°C, the final temperature being reached after a further forty-eight hours or more.

It is essential that crucibles and scorifiers should be (a) sufficiently refractory to withstand any temperature to which they are likely to be exposed, (b) unaffected by rapid cooling, (c) sufficiently dense to cause no loss of contents by absorption, (d) sufficiently resistant to the corrosive action of the contents, particularly metallic oxides, slags and ashes, (e) sufficiently strong to hold the contents safely, *e.g.*, a crucible full of steel weighs about half a hundredweight and it is necessary to carry such crucibles full of molten metal for considerable distances. It is extremely difficult to produce crucibles having all these properties in a high degree, especially when large crucibles are required.

The greatest damage is done to crucibles by the use of unsuitable tongs or by handling the tongs improperly. If they do not fit the crucible properly, or grip it too tightly, they will produce severe strains which rapidly reduce its durability. The heat of the furnace soon causes the tongs to lose their original shape, so that they should be tested frequently against an iron disc turned to a suitable shape. This involves very little trouble and greatly increases the life of the crucibles.

Large crucibles should be lifted out of the furnace by some kind of block tackle, as this strains them less than when men lift them by means of tongs and handhooks.

An oxidising atmosphere will burn the graphite from the outside of the pot and weaken it; hence, for a long crucible life in any furnace, especially in oil or gas fired ones, a reducing flame should be maintained.

It is clearly impossible to give any accurate figures showing how many times a crucible may be used. Some men can use a crucible eighty times or more for cast iron, whilst others can only use a similar crucible half a dozen times. Similarly with the melting of alloys, steel, and all other purposes for which crucibles are used, the manner in which the tongs fit and the handling of the crucible being much more important than is usually imagined. The following figures represent fair averages:—

For brass, a crucible should serve	70 to 100 times.
For bronze,	“ about 50 times.
For iron,	“ 70 to 90 times.
For steel,	“ 6 to 10 times.

With regard to the qualities desired in a graphite crucible, W. J. Downs gives the following notes¹:—

The requisites of a good graphite crucible are refractoriness, strength, heat conduction, long life—*i.e.*, capability of standing many heats—and resistance to the action at high heat of materials in contact within or without. The refractory quality of a crucible is much misunderstood. It is not so difficult to arrange for the refractory quality alone as for the other requisite qualities of a good crucible. A mixture of graphite and high grade fireclay would give a mixture refractory enough to stand the fusion of platinum but would utterly fail in the other requisites.

The range of refractoriness of a graphite crucible is very great. The crucible giving good service at the temperatures of nickel fusion is not well adapted for service in spelter castings. This means that the mixture has to be varied according to the temperature of the service required. This would not be the case if the refractory quality were not so intimately associated with the other requisites of a good crucible. The graphite in the wall of a crucible begins to oxidize at a temperature of about 600°C. Its rate of oxidation increases with the temperature and varies with the composition of the furnace gases. The life of the crucible depends largely on the non-oxidation of the graphite. This is prevented by the production of a glaze on the outer surface of the crucible. The production of this glaze depends on the refractoriness of the crucible mixture. Hence, if the material be too infusible, the life of the crucible is very much shortened. On the other hand, if it be too fusible, it softens and fails utterly. The production of the glaze depends on the component parts of the crucible mixture, the temperature of service and the nature of the fuel used. Some users coat the outside of the crucible with a mixture more fusible than the wall of the crucible itself. If the first heat to which a crucible is subjected is high enough to produce this protective glaze, its life at lower subsequent heats is much prolonged.

It is usually more difficult to make a good crucible for low heat service than for high heat work, though this is not so much due to the crucible maker as to the fact that low heat fusions are apt to be overheated. Hence, a crucible should not be too refractory, but should be so made that oxidation of the graphite is prevented at the temperature and condition of service and yet kept strong enough to stand the burden of metal and the handling it is to receive. This last remark has its bearing on the size of the crucible in relation to strength. It is possible for a crucible to fill all the requirements and not be able to stand the burden of the metal it is capable of holding, nor the more severe strain of handling by tongs. Every such handling shortens the life of the crucible, and the movement in the direction of the adoption of various types of tilting furnaces for large crucibles shows that the users of crucibles are appreciating this point.

Graphite crucibles may be classified according to the kind of metal to be melted and the kind of fuel used, the different types varying in shape and also in composition. The principal division is into (1) steel crucibles and (2) brass crucibles. Other metals or alloys are melted in one or the other of these two types. According to the class of fuel used, crucibles may be divided into gas, coke, and coal.

The general shape of all these as made in the United States is that of an egg cut off flat at each end. The steel crucibles are of nearly the same diameter at each end or are often smaller at the top, and the bilge or greatest diameter is a little more than half way up. The brass crucibles are of the same general shape, except that the diameter at the top is considerably greater than at the bottom, the bilge being about in the same position. The ratio of diameter to height is less in steel than in brass crucibles, and this is more pronounced in the foreign makes than in American pots. The narrower crucibles are more economical in fuel than the broader American type.

Many special shapes are made to suit special work or furnaces, but the egg shape is the prevailing one for ordinary work. The notation of the size of a graphite crucible is quite arbitrary and has changed from time to time. It is based on the capacity of the crucible in pounds of metal and is expressed in numbers. At present the unit of size of a brass crucible is

¹ Iron Age, May 10, 1900, p. 10.

3 pounds per number; that is a No. 60 crucible has a capacity of 180 pounds of metal. As the specific gravity of the metals and alloys melted in these crucibles varies, the capacity in pounds also varies, but the metal in whose terms the capacity is expressed is ordinary brass, having a specific gravity of about 8. A No. 70 crucible will melt 200 pounds of bronze, 250 pounds of silver and 350 pounds of gold. The following table showing the standard sizes of graphite crucibles, as approved by the American Institute of Metals, is taken from Vol. X of the Transactions of the Institute, 1916, p. 5:—

Standard Sizes for Graphite Crucibles.

Number.	Height.	Top.	Bilge.	Bottom.
12.....	8 $\frac{1}{2}$	6 $\frac{1}{2}$	6 $\frac{1}{2}$	5
14.....	8 $\frac{3}{4}$	7	7 $\frac{1}{4}$	5 $\frac{1}{2}$
16.....	9 $\frac{1}{4}$	7 $\frac{1}{2}$	7 $\frac{3}{4}$	5 $\frac{3}{4}$
18.....	10	7 $\frac{3}{4}$	8	5 $\frac{1}{2}$
20.....	10 $\frac{1}{4}$	7 $\frac{3}{4}$	8 $\frac{1}{2}$	6 $\frac{1}{4}$
25.....	11	8 $\frac{1}{2}$	9	6 $\frac{3}{4}$
30.....	11 $\frac{1}{2}$	8 $\frac{1}{2}$	9 $\frac{1}{2}$	7
35.....	12 $\frac{1}{4}$	9 $\frac{1}{2}$	10	7 $\frac{1}{4}$
40.....	12 $\frac{1}{2}$	9 $\frac{3}{4}$	10 $\frac{1}{2}$	7 $\frac{3}{4}$
45.....	13 $\frac{1}{4}$	10	10 $\frac{3}{4}$	7 $\frac{3}{4}$
50.....	13 $\frac{3}{4}$	10 $\frac{1}{2}$	11 $\frac{1}{2}$	8
60.....	14 $\frac{1}{4}$	10 $\frac{1}{2}$	11 $\frac{1}{2}$	8 $\frac{1}{2}$
70.....	14 $\frac{1}{2}$	10 $\frac{3}{4}$	12	8 $\frac{3}{4}$
80.....	15 $\frac{1}{4}$	11 $\frac{1}{2}$	12 $\frac{1}{2}$	8 $\frac{3}{4}$
90.....	16	11 $\frac{3}{4}$	12 $\frac{3}{4}$	8 $\frac{3}{4}$
100.....	16 $\frac{1}{4}$	12 $\frac{1}{4}$	13 $\frac{1}{4}$	9
125.....	16 $\frac{1}{2}$	12 $\frac{1}{2}$	14	9 $\frac{1}{2}$
150.....	17	13	14 $\frac{1}{2}$	10
175.....	19 $\frac{1}{4}$	14 $\frac{1}{4}$	16	11
200.....	20 $\frac{1}{4}$	15	16 $\frac{1}{4}$	11 $\frac{1}{4}$
225.....	20 $\frac{3}{4}$	15	16 $\frac{3}{4}$	12 $\frac{1}{4}$
250.....	21	15 $\frac{1}{2}$	17 $\frac{1}{2}$	12 $\frac{1}{2}$
275.....	22 $\frac{1}{4}$	15	17 $\frac{1}{4}$	12 $\frac{1}{4}$
300.....	22 $\frac{1}{2}$	16 $\frac{1}{2}$	17 $\frac{1}{2}$	12 $\frac{1}{2}$
400.....	24 $\frac{1}{2}$	17 $\frac{1}{2}$	19 $\frac{1}{2}$	14

Steel crucibles are usually made in two sizes only, viz., No. 50 and No. 60, and the size numbers do not correspond to the capacity of melted metal. A No. 50 steel pot has a capacity of about 95 pounds, and No. 60, about 110 pounds.

Another and larger type of graphite crucible is the retort used in the distillation of zinc in silver refineries. These retorts range from 31 inches to 40 inches in length, with a bilge of from 16 inches to 22 inches, and are used in furnaces of the tilting type. Still another type of crucible is designed for the tempering of files.

The number of heats that a brass crucible may be expected to stand is essentially dependent on the materials used in its composition, the care taken in its manufacture and the handling it receives in service. Even the best of crucibles, that is, a crucible made from the best materials and with the greatest attention paid to their proportioning and mixing, will have its life very materially shortened by careless handling, while careful treatment may secure a relatively large number of heats from a poorer grade of pot. Equal care on the part of both the maker and the foundry man is essential, therefore, to secure best results. It is due to the failure in many foundries

to observe the proper precautions in the use of crucibles that so little really reliable data on the quality of the pots made from substitutes for German clay and Ceylon graphite is available. American crucible makers report the most divergent opinion from their customers on this point.

In this connection, it may be again noted that of the two principal ingredients of a crucible mixture, graphite and clay, graphite is used because of its refractoriness and good heat conductivity. It has no binding qualities whatever, and it oxidizes readily under high temperatures when exposed to the air. The clay serves as a binder to hold the graphite particles together, and even before having the necessary amount of water of plasticity added to it, and in its natural state, under ordinary atmospheric conditions, contains an appreciable amount of moisture. The total amount of water in a crucible when newly made is about 20 per cent, and the slow drying process that crucibles undergo before burning dispels the mechanically added water, or water of plasticity, but not the hygroscopic moisture. The latter is driven off in the burning process, the object of which is to calcine the clay. On removal from the kiln, the crucible immediately begins to absorb hygroscopic moisture and continues to do so until saturated. Just how much moisture will be taken up, obviously depends on the humidity of the air surrounding the crucible. A test made on a crucible that, when taken from the kiln, contained less than 0.25 per cent moisture, showed that after standing for four hours in a room at 90°F, the moisture content had risen to 2.7 per cent. After a further five hours under ordinary atmospheric conditions of average humidity this had increased to 4.5 per cent.

It is clear that by subjecting a crucible that has stood for some time exposed to ordinary atmospheric humidity to sudden heating, the absorbed moisture will be expelled violently in the form of steam, with attendant damage to the crucible. Such a procedure often results in what is termed scalping, *i. e.* the breaking away of a section of the crucible wall or the flaking off of irregularly shaped pieces (see Plate XLV). Even if no actual fracture is evident, internal cracks or lines of weakness may develop, resulting after a few runs, in leaks or pin holes.

Scalping may also result from one portion of the crucible being heated to a temperature considerably higher than that of adjoining portions, when the unequal expansion causes the crucible to fly.

In order to prevent the absorption of more than a minimum of hygroscopic moisture, crucibles should be stored in a warm, dry room kept at a temperature of preferably 100°F, for at least four weeks before using. By adopting this precaution, the risk of blowing or scalping is reduced to a minimum.

The annealing of crucibles at the foundry, that is, the preliminary warming up before being subjected to the full heat of the furnace, is variously carried out and often in a manner detrimental to the crucible. The best device for annealing purposes is an oven built expressly for the purpose, using the wasted heat from the furnace on the way to the stack. These can be built so that the heat can be controlled and the temperature brought gradually to 250°F or beyond. The average size crucible, say a No. 60, should be kept at the above temperature for at least 48 hours before being placed in the furnace, while large sizes require still longer. The common practice of annealing crucibles in core ovens, where they are exposed to the moisture driven off from the cores, is a frequent cause of failure to secure proper service.

Allowing a crucible, at the end of a day's run, to remain in the furnace and to cool down with the fire often materially assists in prolonging its life.

A practice sometimes followed in order to dry out crucibles before heating is to make a small fire of shavings and charcoal inside the pot a few hours before use, but this is, at best, only a makeshift and does not give as good results as annealing in a proper oven. Careful handling with the tongs also plays an important role in a crucible's service. In tilting furnaces, where the constant lifting in and out is eliminated, a crucible will often run more than double the average number of heats. When a crucible is lifted from the furnace with its load of melted metal it is plastic and readily adjusts itself to the shape of ill-fitting tongs. After pouring and cooling off, this shape is retained, and unless the tongs happen to be applied in exactly the same position at the next pour, the crucible will again be distorted. Such repeated treatment will seriously weaken the crucible and shorten its life.

Tongs should never grip a pot above the bilge but should extend below it to within six inches or so of the bottom. A crucible is made heavier here for this purpose and the bilge helps to withstand the strain of the tongs.

Improper fuel, too, is extremely detrimental to crucibles, the gases from such fuels, especially from those high in sulphur, penetrate the crucible wall and cause serious alligator cracks to develop. This is especially pronounced in the case of wet or damp fuel, either coal or coke. Imperfect combustion with oil or gas will also have this result. These gases are always produced at low temperatures, usually in a coal or coke fire immediately after a fresh charge of fuel, and in oil and gas furnaces at a slight adjustment of the air or fuel valves.

Allowing the crucible with its melted charge to remain longer than necessary in the furnace is also bad practice. Such procedure is known as soaking, and obviously shortens the life of the crucible by burning up the graphite in its walls, besides weakening it in other ways.

The following remarks on methods of securing better service from graphite crucibles are from a publication of recent date.¹

Back in June, 1916, the crucible situation became most serious, due to increased demands on the part of crucible steel and munition makers, together with lack of certain kinds of material entering into the make up of the crucible, and prices soared from 4 cents to 25 cents a number. Among others that encountered unpleasant inconveniences was the Portsmouth Navy Yard smelting plant, with 26 crucible furnaces in operation, getting one, two, and sometimes three heats per crucible; this trouble covering a period of about four weeks. The many attempts to increase the life of the crucible became discouraging, the only consolation being in the fact that the trouble was universal, and up to maker and user to tax his wits to master the situation if possible. Something had to be done quickly to save the day at the smelting plant where the nonferrous scrap metals from all the yards are sent to be put into ingot metal for reuse at the various navy yard foundries.

The writer undertook to solve the problem of preventing the flaking and cracking of the crucibles, and in one week's time succeeded in overcoming the difficulty by three simple moves:—

1. Getting away from core oven annealing.
2. By a preparation of coating (our own make) and annealing in the furnace pit, drawing our supply from that source as needed.
3. Using a flux that prevented cleavage of slag and metals to the inside of the crucibles, with the result:—That the life of the crucibles went up to 20 heats immediately, and, as our records show, to 30 heats for the latter part of 1916.

From January 1, 1917, to May 1, 1918, the supply department invoiced to the smelting plant 376 No. 100 crucibles. The number of heats from January 1, 1917, to May 1, 1918, amounted to 20,295, giving a total average of 54 heats per crucible. The fuel used

¹ T. F. Durning, in the Brass World, August 1918, p. 227.

is hard coal, with cooling space around crucible 2½ in., and with a sufficient coal bottom to carry through the heat without recooling or disturbing crucible until drawn for pouring.

The various kinds of work in which graphite crucibles are used as the melting vessel include malleable castings, small iron castings, crucible cast steel, all kinds of copper alloys, spelter castings, file tempering, gold and silver melting and refining. Oblong, square, and round shapes, also, are used in liquid brazing, and as calcining trays or boxes for materials requiring careful, even heating, without exposure, such as pencil leads, incandescent light carbons, etc. The graphite retorts or flasks used in the distillation of zinc in silver refining works have a holding capacity of 1,500 pounds of metal. (Plate XLIX).

As already outlined, the principal advantage of graphite crucibles is their ability to stand sudden changes of temperature without cracking; they can be used repeatedly, until so much of the graphite is burnt that the pot cannot support the weight of the charge and handling with the tongs. Even when the graphite near the surface of the crucible has burnt away, that within the wall is protected for a considerable time by the coating of fused clay that envelops the particles and retards oxidation.

Graphite crucibles are not so porous as clay crucibles, and thus do not absorb so much of the melted metal as the latter. For this reason they are to be preferred in the melting of precious metals.

With regard to the future of the graphite crucible industry, it has already been noted that there is at the present time a decided tendency toward the adoption of the electric furnace for melting steel, and that this dispenses with the necessity for graphite crucibles for this class of work. In the brass industry, also, there are indications that electric furnaces may in the near future replace crucible furnaces. In this connexion, the following extract from an article by H. W. Gillett and A. E. Rhoads in the "Brass World" is of interest.¹

It seems inevitable that the next few years will see electric furnaces largely replacing crucible furnaces in the brass industry; a development comparable to that which the last few years have seen in the steel industry.

With Klingsberg clay not available and Ceylon graphite requiring shipping needed for other purposes, crucibles, despite the good work done by crucible manufacturers, the Bureau of Standards, and others on the problem, are, speaking generally, still of much poorer quality, and many times more costly than they were under pre-war conditions.

Besides the avoidance of crucibles and the ability to melt larger charges, electric furnaces (in a suitable type of furnaces) decrease the loss of metal by oxidation and by sulphurization, prevent the taking up of sulphur from the fuel, give better and more healthful working conditions, and has many minor advantages such as freedom from handling of burning fuel and ash. Electric furnaces give crucible quality of metal without using crucibles.

Tilting furnaces obviate the use of tongs for lifting the crucibles in and out, and in this way help materially to prolong their life. Tilting furnaces, however, are not suitable for many classes of foundry work and involve, in addition, considerable expense over ordinary crucible furnaces, since they hold only one pot, and thus a large number are needed. Crucibles for this type of furnace are made with a special lip for pouring. (Plate XLIV).

Modified forms of the ordinary steel or brass crucible are the bottom-pour and self-skimming pots. In the former, the pouring edge is made extra thick and has a hole or spout extending downwards through it about two-thirds of the height of the wall. In this way, the metal is poured

¹ A Rocking Electric Brass Furnace, Brass World, August 1918, p. 217.

always from the bottom and no oxidized metal has a chance to get into the casting. The self-skimming crucible is designed for melting the precious metals, and is provided with a bridge at the pouring lip, which holds back the charcoal and molten fluxes and ensures clean metal in the pour. The bottom-pour type of crucible is illustrated in Plate XLVII.

OTHER GRAPHITE REFRACTORY PRODUCTS.

Besides crucibles, a variety of refractory articles used in smelting and foundry work contain graphite as one of their constituents. These articles include crucible covers, stopper heads for open-hearth and Bessemer steel ladles, pouring nozzles, stirrers, rings, jackets, stopper sleeves, crucible rests or stools, skimmers, dippers, phosphorizers, funnel or extension tops for crucibles, pyrometer shields, boxes for burning pencil leads and incandescence light filaments and for case hardening and carbonizing, graphite furnace bricks, etc. A number of the above articles are illustrated in Plates L to LIII.

Tempering crucibles for files and tool steel are of approximately the same diameter at top and bottom, a sample of size being height 25" and diameter 9". The crucibles are filled with molten lead or chemicals, and the heated steel from the forge is immersed in the latter, so as to effect a gradual cooling.

The brazing crucibles shown in Plate XLVIII illustrate some of the shapes used in the direct brazing of bicycle frames.

Extension tops or funnels (Plate L) are placed on the top of crucibles in order to insert a larger charge of turnings or chips, thus reducing the necessity of frequent additions of small quantities of such material.

Pyrometer shields (Plate L) serve to protect the pyrometer from contact with the metal or other substance under test. Those used in calibrating pyrometers are made entirely of graphite without clay admixture, in order to avoid contamination of the check metal. The same holds good for the graphite crucibles used in this work. Shields and crucibles for this line of work are usually made of artificial graphite.

Phosphorizers (Plate LII) are used to introduce phosphorus into the metal in the manufacture of phosphor-bronze. An iron rod is fastened into the hole in the neck, and the phosphorus, securely wrapped to prevent spontaneous ignition, is placed in the lower chamber. The phosphorizer is then plunged into the molten metal. Phosphorizers need the same care as crucibles before use, that is, they require to be annealed in order to prevent cracking.

Graphite bricks are used for lining certain portions of furnace walls, in order to prevent clinkers from adhering to them.

Graphite is also added in some cases, to refractory cements, as it causes them to work more easily under the trowel.

Graphite has been used, also, in the manufacture of the smaller sizes of retorts, using 2 parts of graphite to 1 part of fireclay.

PENCILS.

The manufacture of graphite pencils¹ on a commercial scale originated

¹ For fuller details of pencil manufacturing methods see the following: Haenig, A., *Der Graphit* 1910, pp. 104-125; Hardmuth, L. and C., *Die Bleistifterzeugung*, 1902; *Die Bleistiftfabrik von A. W. Faber, zu Stein, bei Nürnberg* (an historical sketch, prepared for the Vienna Exhibition, in 1873); Buchwald, A., *Bleistifte, Farbstifte, farbige Kreide- und Pastellstifte, und ihre Herstellung*, etc., 1904; Donath, E., *Der Graphit*, 1904, pp. 107-128; Cirkel, F., *Graphite, Its Properties, Occurrence, Refining and Uses*, Mines Branch, Department of Mines, Ottawa, 1906, pp. 253-276. The last contains most of the information given in the preceding works. This report is out of print, but may be consulted in many of the libraries of technical, engineering and scientific Societies, Government Mining Departments, etc.

with the discovery of the famous Borrowdale graphite deposit in Cumberland, England.

This deposit was discovered and worked in 1564, that is, in the reign of Queen Elizabeth. Much of the graphite here was of such purity that it could be taken out in large blocks and cut up into pencil rods, without the necessity of subjecting the material to any refining process. The graphite that was too much mixed with impurities in the form of other minerals to be suitable for pencils was used in the manufacture of crucibles.

The high grade pencil graphite from the Borrowdale mine was so prized and brought such high prices that much trouble regarding titles and ownership arose and the Government was forced to assume control of the deposits. A period of six weeks was set as the maximum time during each year that the mine might be worked, and even under this limitation, the average annual output amounted in value to £40,000 or about \$200,000.

All of the graphite produced was sent to the graphite auctions held in London on the first Monday in each month, where it commonly brought as much as \$40 per pound. In order to foster the new industry, the Government soon prohibited all exports of graphite except in the form of pencils.

After the richer portions of the Borrowdale deposits were exhausted, an attempt was made to concentrate the poorer ore, but the material so obtained never equalled the richer grades of crude graphite.

Borrowdale graphite was long known by the names black cawke and wad, the latter being the modern name of an ore of manganese. This deposit has long been exhausted, the last active work having been carried out in 1833. Some prospecting was conducted in 1875, and the graphite obtained is reported to have sold for \$10 per pound. The mineral occurred in pipes, strings and nests, in association with a dike of altered diorite intruded into volcanic ash¹.

At about the time when the Borrowdale pencil graphite deposit became exhausted, an occurrence of similar mineral was discovered at Mount Batongol, in Siberia, and this deposit for many years supplied the Faber pencil factory at Nürnberg with all the graphite required.

The first pencils consisted merely of rods of pure graphite cut from the massive material as it came from the mine. Later, these rods were inserted between two pieces of grooved wood, forming pencils of the same type as those used at the present day, though they were probably larger and contained thicker leads.

To obtain a harder lead, the graphite rods are reported to have been heated in a sulphur before being placed between the wood strips. Pencils continued to be made in this manner up to 1795, when Conté devised the present method of manufacture, consisting in mixing finely ground clay and graphite together into a thick paste or dough from which the leads were moulded, and afterwards baking. By this means, a much more uniform product was possible, and by changing the proportions of clay and graphite in the mixture varying degrees of hardness were obtainable.

This method naturally effected a great saving in graphite over the old procedure, which was very wasteful. Attempts had been previously made to eliminate the waste from the Borrowdale graphite mines by pulverizing and subjecting it to a chemical process to remove gangue, after which the graphite sludge was pressed into a compact mass which could be cut

¹ Mem. Geol. Surv. Great Britain, Vol. V, 1916, p. 25; see also Haenig, *op. cit.*, p. 41.

into leads in the same way as the natural mineral. This method did not prove successful, however, nor did later attempts to incorporate ghte, isinglass, tallow, wax, and other bonding substances into the powdered graphite in order to form a compact, sectile mass. Equally unsuccessful was the experiment of mixing graphite with melted sulphur or antimony.

At the present day, only the soft, earthy or so-called amorphous graphites are employed in the manufacture of pencils. The flake graphites, as well as Ceylon plumbago, do not possess nearly the same marking power as the earthy kinds, such as the Siberian and Mexican graphites. In American pencil factories, Mexican graphite forms the bulk of the graphite used. The Bavarian and Bohemian mineral is also suited to this purpose.

The well known firms of Faber and Hardtmuth, located respectively at Stein, near Nürnberg, in Germany, and at Vienna, in Austria, were for years the largest pencil manufacturing concerns in the world, but in the early sixties, the industry obtained a foothold in America, and within three years the exports of pencils from Germany to the United States fell off almost one half.

In 1909, the year of the last census, there were 11 pencil factories in the United States, employing 4,513 persons and paying out nearly two and a half million dollars in wages and salaries. The output of these factories was valued at almost seven and a half million dollars¹.

About 7 per cent of the total world's production of graphite is estimated to be consumed in the pencil industry.

In modern methods of pencil manufacture² a soft, amorphous graphite is employed, since this material may more readily be ground to a powder consisting of uniform particles than a flake graphite, which, however finely ground, still preserves its flake form.

Clay is used as a binder, and varying degrees of hardness in the finished pencil are secured by varying the proportions of clay and graphite in the mix. At the present day, much attention is devoted by manufacturers to producing extremely high grade pencils especially adapted to different classes of sketching and draughting work, and the correct mixing of the graphite and clay entering into the different grades is given the closest supervision. One celebrated firm in the United States offers seventeen degrees of hardness in its best grade of pencil, and the maintenance of strict uniformity throughout the different hardnesses requires the closest attention to the quality of the raw materials and their proportioning, as well as to the grinding and mixing.

The graphite is first of all ground dry and then air-floated, after which it is floated on water, to remove grit particles. A high grade stoneware clay is used as the binder. This clay must be highly plastic and refractory, and free from iron and lime. A suitable clay should have the composition, approximately:—

Silica.....	50-60 per cent.
Alumina.....	50-40 “

The clay is ground dry, water floated, and settled in tanks. Graphite and clay are then mixed in the required proportions and further ground between burrstones in a closed tank. This grinding is wet, and according

¹ This total may include certain side lines, such as erasers, pencil cases, pen holders, etc., but probably represents pencils for the most part.

² From information courteously supplied by the Joseph Dixon Crucible Co., Jersey City, and the Eagle Pencil Company, New York.

to the degree of fineness required, lasts from two weeks to three months. The sludge from the burr mill is then passed to a filter press or vacuum filter, preferably the latter, since the cloth screens of the former tend to clog. The product from the filter is kneaded by hand to the required consistency, and the dough is fed to hydraulic presses which force it, under a pressure of 2,000 pounds per square inch, through dies of the diameter of the finished lead. The lead issues from the die in the form of a continuous string, and the die head, being mounted on a toggle joint, the string is coiled as it exudes from the die and is caught in a shallow metal dish. The dish is removed when full, and the lead is uncoiled by hand and pinched off into lengths, each equal to three pencil lengths. At this stage, the material is quite tough and pliable and can be readily handled without breaking or deformation. The lengths of lead are laid between boards and allowed to air dry, after which they are cut by hand into pencil lengths and arranged in bundles in graphite crucibles or boxes. They are then placed in a kiln and baked for several hours at a temperature of 1,500° to 2,000° F., after which they are ready to be placed in the wood casings. An intermediate drying may take place before the final baking, and is effected in iron boxes in a hot air chamber having a temperature of about 150° F.

The wood casings consist of cedar blocks, grooved to receive the leads, and measuring $7\frac{1}{4}'' \times 2\frac{1}{4}'' \times 3\frac{3}{8}''$. Each block is provided with six grooves and after insertion of the leads, the blocks are dipped in glue and clamped together in bundles of a dozen or less, and allowed to dry. Finally, the glued blocks are cut up into individual pencils, which are then trimmed, sandpapered, painted, varnished, and stamped.

To impart the necessary strength, the softer grades of pencils have leads of greater diameter than the harder grades, in which the larger proportion of clay used serves the same purpose.

Artificial graphite is not suitable for pencils, as it is apt to contain particles of carborundum. A small proportion of flake graphite enters into certain grades of pencils, but, as noted above, the bulk consists of the amorphous variety.

A common proportion in pencil making is two parts of graphite to three of clay; while such other substances as sulphide of antimony, lamp black and finely divided metallic lead are sometimes incorporated into the mixture. The leads may also be boiled in wax or tallow, in order to remove grittiness or to render them tough.

Practically all of the pencil graphite consumed on this continent comes from the Santa Maria mines near La Colorado, in central Sonora, Mexico, which are owned and operated by the United States Graphite Company, of Saginaw, Michigan. This graphite is wholly amorphous, and even under a high power microscope shows only shapeless particles. The deposits are the result of the metamorphism of coal seams by a granite intrusive. An analysis of run-of-mine ore showed!—

Carbon.....	86.75
Silica.....	7.60
Iron oxide.....	0.65
Alumina.....	5.00

100.00

¹ Graphite Mining in Mexico, issued by the United States Graphite Company, Saginaw, Mich., 1910.

The above deposits contain sufficient graphite to meet the limited demand for pencil graphite for an indefinite period, and there is thus little likelihood of the amorphous graphite of the St. John, N.B., district¹, or of other localities in New Brunswick and Nova Scotia, coming into request for the purpose. These are the only Canadian graphites so far known that might possibly be suitable for pencil manufacture, but, the graphite content of the ore being relatively low, (under 50 per cent), the material can hardly hope to compete with the Mexican or other high grade, amorphous graphites.

There are, of course, a great many recipes for the composition of pencil lead, practically every manufacturer having his own formula.

The proportions in which the clay and graphite are mixed depends largely on the quality of these ingredients and the grade of pencil desired. Two parts by weight of graphite and three parts of clay, or even parts of both, are considered good proportions for ordinary pencils, but it is evident that a variety of hardnesses and degrees of marking power may be produced. The greater the amount of clay used, the harder and less lustrous will be the lead.

The following² mixtures have been employed in pencil leads:—

Graphite.....	30	parts
Clay.....	9	"
Stibnite (grey antimony).....	9	"
Tallow.....	1	"

The graphite is first ground and washed, and then dried and burnt for several hours. The tallow is melted and added to the mixture, which is then worked up in a lead mill. After burning, the leads are immersed in boiling wax.

For very hard drawing pencils, the following mixture is used:—

Graphite.....	36	parts
Clay.....	18	"
Stibnite.....	8	"
Lampblack.....	2	"

The use of clay in pencil lead mixtures is governed by its property of hardening when heated, as well as by its plasticity; and as the degree of hardness is dependent upon the temperatures at which the leads are burnt, it is clear that temperature control plays a very important part in the securing of the various degrees of hardness desired.

If burnt too quickly, springing or warping of the leads will result. Leads spoilt in this way cannot be ground up and reburnt, but are useless for any further purpose. The leads are usually packed in powdered carbon in the burning crucibles.

Thorough washing or elutriation of the ground clay is very important, in order to avoid grittiness of the leads.

The wood usually employed in pencils is southern red cedar, but for the cheaper grades such woods as pine and fir are sometimes used. The lead pencil industry in the United States, alone, in 1906, is stated to have consumed 110,000 tons or 7,300,000 cubic feet of wood.

¹ See p. 22.

² Cirkel, *op. cit.*, p. 263.

FOUNDRY FACINGS.

While the term "facings" in general usage is applied to the facing sand which forms a layer about an inch thick around the pattern, in the specific sense it relates to those materials which are used to give the skin of moulds a smooth finish, so that the castings peel freely and cleanly on cooling.

While different materials are used for this purpose, including talc or soapstone, carborundum, and various forms of carbon, such as sea-coal, charcoal, coke, gas retort carbon, etc., graphite is the most important of the facing materials for mould surfaces, and large quantities are used in foundry work. Practically the only market for the low grade dust graphite from the refining mills, which contains between 40 and 60 per cent carbon, is the foundry facing trade.

It should be noted that foundries do not, generally, manufacture their own facings, but procure them from foundry supply firms having specially equipped plants for grinding, mixing, and otherwise treating the wide variety of material used in foundry work.

The preparation of graphite for facings, apart from the preliminary drying and crushing that may be necessary when the raw material is crude ores, such as Korean, Mexican, etc., and which are not required in the case of mill dust, involves grinding in tube mills, the product from which is air floated.

Inasmuch as graphite possesses no adhesive property, it is necessary to add a proper bonding constituent to it when used as a facing for mould surfaces. This binding material is, usually, of a clayey, refractory nature. The binder absorbs a certain amount of moisture from the mould, and this holds the facing in place; and when the clay is calcined by the molten metal, the facing is rendered somewhat porous, thus allowing the exit of moisture and occluded gases. Proper proportioning of the graphite and binder is important, since, if there is too much of the latter, peeling becomes difficult, and if too little, the graphite runs before the metal.

Carbonaceous facings, such as graphite, coke, charcoal, etc., are commonly termed blackings, in foundry parlance, in contrast to silica, talc, soapstone, etc., which are called mineral facings.

In applying graphite to green sand moulds, it is usually dusted on and then slicked off with the tool, or else rubbed on with the hand and the excess blown away. It is also laid on with a fine brush, care being taken not to disturb the sand surface.

For dry sand work, the graphite is applied wet, in the form of a wash, the liquid used being molasses water or some other solution containing vegetable substance possessing adhesive qualities, such as the waste liquor from pulp mills ("glutrin"). The graphite is usually mixed with fireclay, and a syrupy mixture is obtained which is applied with a swab.

With regard to the grade of graphite best adapted for foundry facings, the best results are obtained by the use of high grade flake. This material may be adulterated considerably and yet be better than the poorer varieties of graphite. Soapstone, coke, anthracite, and even bituminous coal is often ground up with graphite in order to cheapen the mixture. The preparation of proper specifications, based upon reliable tests, is one of the urgent problems of the foundry¹.

In the manufacture of foundry facings, more graphite is utilized than in the making of any other article in common use, with the exception of crucibles.

¹ See R. Moldenke, Principles of Iron Founding, 1917, p. 305.

DRY BATTERIES.

Graphite is employed extensively in dry batteries, where it serves to give conductivity to the mass of manganese dioxide. Formerly the amount of powdered carbon in a dry cell, amounting to nearly half the total solid ingredients, consisted largely of coke, retort carbon, petroleum coke, ground carbon rods and electrodes, etc., all of which are considerably cheaper than graphite of the required purity, though not of such good conductivity.

According to Burgess and Hambuechen¹, the following may be taken as representing the filling mixture in well known types of dry cells:—

Manganese dioxide.....	10	pounds
Carbon or graphite, or both.....	10	"
Sal ammoniac.....	2	"
Zinc chloride.....	1	"

Much of the variation found in dry batteries is due to varying quality of the carbon used in the filler, and the above-named writers consider that the "more recent improvement in dry cells is undoubtedly due largely to the liberal use of this highly conductive, though more costly, form of carbon."

According to Dr. E. Acheson², a very large percentage of the dry batteries manufactured in the United States are filled with artificial graphite.

Natural flake graphite is also used, and for this class of work the fine dust from graphite mills or other low grade concentrates may be cleaned and rendered suitable. Such low grade materials are cleaned with the aid of kerosene oil at Chester Springs, Pennsylvania, and a product claimed to be practically free of all impurities is secured and sold to dry battery makers.³

ELECTROTYPING GRAPHITE.

Very finely powdered graphite is used in electrotyping for two purposes:

(1) The forms, after being made up, are dusted over with the graphite and placed in a machine and highly polished, this enabling them to strip clean and sharp from the wax mould.

(2) The wax mould with the impression of the original is then dusted with graphite, which spreads freely and smoothly over the whole surface and into the fine interstices of the mould; it is then polished and is ready for immersion in the copper bath.

Natural amorphous, flake, and Ceylon graphite are all used for the above purpose. To ensure a uniformly polished and conducting surface, upon which the preliminary plating has instantaneous effect and upon which deposition of the copper proceeds immediately upon applying the electric current, without creeping and gradual covering, only the purest graphite should be used.

W. Pfanhauser⁴ gives the following details regarding the use of graphite in electrotyping:—

The use of graphite as a conducting coating for the forms was proposed by St. W. Wood, in 1873. Only the purest graphite is suitable, and several processes for

¹ Trans. Amer. Electrochem. Soc., Vol. XVI, 1909, p. 99.

² Paper read before the National Gas and Gasolene Engine Trades Association, 1910.

³ It is probable that this material is employed largely, also, in the manufacture of high grade, lighting carbons.

⁴ Die Galvanoplastik, Monographie über angewandte Elektrochemie, Vol. XI, 1904, p. 25.

cleaning graphite chemically for the above purpose have been patented. In consequence of its unctuous character, graphite adheres better to forms than the various metallic powders that have been suggested as substitutes, and forms polished with graphite have a smoother surface than those on which such powders are used.

The graphite is shaken onto the forms and rubbed on with a fine camels hair brush, to which is given a rapid, rotating movement. A correctly graphitized surface should possess a lustrous, metallic black appearance, and great care must be taken to leave no portion of the form untouched by the brush, as this results in an imperfect deposition of the copper. A very soft brush is not essential; in fact a rather stiff bristle brush may be used for all except wax or gelatine moulds. It is advantageous, in the case of gutta percha forms, to breathe upon the surface before applying the graphite, as this results in better adhesion.

On wood or plaster moulds, that are saturated with stearine, it is best to apply a paste of graphite and water. This is allowed to dry, and the superfluous graphite is then brushed off.

Special machines for applying the graphite are used where large surfaces have to be covered, and these give much quicker and more even results than hand work. These machines consist essentially of a rotating horizontal plate on which the form is laid, and above which a wide brush moves with a rapid whirling movement. Large forms are coated in about 5 minutes with such a machine. Such a machine makes 300 revolutions and is fitted with a brush about 30 inches wide.

GRAPHITE BRUSHES.

While brushes for dynamo and motor commutators were formerly made of copper, such brushes have now been almost entirely superseded by carbon or graphite brushes. Graphite brushes are self lubricating, have long life and are of high conductivity as compared with carbon brushes. The graphite used may be the natural flake variety or Ceylon plumbago, but for direct current machines brushes of artificial graphite are also extensively used.

According to the amount of current that the brushes are required to carry, the composition may be varied as under:—

Graphite

Graphite + petroleum coke

Graphite + petroleum coke + powdered copper.

The heavier types of brush may contain as much as 90 per cent of copper.

The above materials¹ in a finely powdered state, together with coal tar, to serve as a binder, and benzol, are thoroughly incorporated in a steam jacketed mixer. The hot material from the mixer is then placed in steel forms and moulded in a hydraulic press under a pressure of 10-20 tons per square inch into slabs of varying thickness but of more or less uniform surface (3 × 5 inches). These slabs are then packed into saggars with powdered coke and are baked at a temperature of 1300°C for about 8 hours. The total time of remaining in the kilns is 3½ days.

The baked slabs are then cut into the required sizes by carborundum saws and smoothed. They are then bored and countersunk for the pigtail attachment. Certain types of brushes have their upper ends a 1 pigtail socket electroplated with copper, and others are tinned by dipping the copperplated brush into a bath of molten tin. This is done to ensure a perfect contact between pigtail and brush.

The pigtail is attached to the brush either by soldering it into a hole bored for the purpose or by riveting it onto the brush.

The Morgan Crucible Company, of London, make graphite brushes which are constructed in layers, in such a way that the resistance across the brush is from seven to eight times that in the opposite direction. In

¹ Information courteously supplied by the United States Graphite Company, Saginaw, Mich.

this way, a path of high conductivity is provided for the current into the external circuit while the cross resistance of the brush tends to reduce the current in the short circuited coil. The brushes made by this Company are of a composition known as Morganite, which consists of Ceylon or flake graphite ground to 100 mesh and moulded under a pressure of 20 tons per square inch.

Metal brushes are objectionable for several reasons, chief of which are that it is difficult to keep the surface of the commutators smooth, since the soft copper bars and the soft metal brushes do not wear well, and there is always a tendency for soft metals to become rough when rubbed together. The tendency of a dynamo to spark at the brushes, also, is greatly lessened by using brushes made of comparatively high resistance material, such as carbon or graphite, in place of low resistance material like metal.

The following notes on the manufacture and composition of graphite brushes are taken from an article by Warren C. Kalb, in "Power," February 18, 1919, p. 241:—

The carbon-graphite brush is the type usually spoken of as an ordinary carbon brush. It is composed principally of amorphous carbon, usually in the form of coke, to which is added sufficient graphite to give the brush some lubricating property and increase its conductivity to some extent. Natural graphite is generally used for this purpose, and as this usually contains a considerable percentage of foreign material of more or less abrasive nature, brushes of this class as a rule are abrasive to an appreciable degree.

The practice is quite common among both manufacturers and users to impregnate brushes of this class with some lubricating material. This not only tempers the abrasive characteristic of the brush and reduces its friction, but improves the commutating property as well, due to the higher contact resistance created by the film of lubricating material, which forms at the brush face.

The disadvantages of this treatment are that it is driven off when the brush encounters conditions of high temperature. It has a tendency to collect dust from the atmosphere, and if this happens to be of an abrasive nature, as is the case around cement mills and similar service, the commutator wear resulting from this cause may be quite severe. Finally, brushes with lubricating treatment have a much greater tendency than others to collect copper on the face of the brushes.

Most brushes of the carbon-graphite class are within the medium range of hardness. They are not adapted to undercut mica, due to their abrasiveness and the artificial lubrication they generally require. Most grades of this class are of low carrying capacity and are not adapted to high peripheral speed. However, this type of brush will take care of a wide range of operating conditions within the limits of its characteristics and, considering its moderate price, must be classed as a good all-around brush.

There is another class of brushes in which a considerable or even the predominating percentage of the composition is graphite, the remainder being coke or some other form of amorphous carbon. These are known as graphite-carbon brushes. A great many grades of brushes fall within this class, so that the class as a whole covers a very large field of application, although the individual grades may not apply to such a broad range of service.

Brushes in this class usually contain sufficient graphite for lubrication, so that lubricating treatment is seldom used. Artificial as well as natural graphites are used, depending on the characteristics that it is desired to incorporate in the brush, and the abrasive properties will depend upon the graphite that is selected. Some brushes within this class possess very little abrasive action, while there are others possessing considerable. In point of hardness these brushes will range from soft to medium hard. The carrying capacity will usually be higher than the grades in the carbon-graphite class, but the contact drop of most of these brushes is medium or low unless a lubricating treatment is used.

Brushes of this type find an extensive application on industrial motors, moderate-speed generators, mining and mill service, and railway motors. Certain grades of this type are especially well adapted to fan motors, magnetos and other small machines both of the direct current and universal types. Some excellent grades of moderate priced brushes will be found among the various makes of graphite-carbon brushes.

There are numerous grades of brushes on the market composed entirely of graphite except for the binding material necessary to hold the particles of graphite together. These

are characterized by high carrying capacity, medium contact drop and low coefficient of friction, adapting them especially to high commutator speeds.

There are a few grades of graphite brushes on the market manufactured by special methods that give the material a very high resistance and a somewhat improved commutating characteristic over the ordinary type of graphite brush. These grades, however, have a rather limited field of application. There are also grades possessing very low specific gravity. These are manufactured in this way to reduce the inertia of the brush as much as possible, adapting it to very high rotative speeds.

Most brushes in the graphite class are non-abrasive or at most but slightly abrasive and should generally be used on commutators of which the mica is undercut. A few of the slightly abrasive grades can be used on unslotted commutators where conditions are not severe. All the brushes in this class are soft, some of them being very soft. They possess low mechanical strength, so are incapable of meeting severe mechanical conditions and should be operated at low spring pressure. Where quietness of operation is an essential characteristic, this type of brush has much in its favour. Classes of service in which they are used to a considerable extent are as follows: Turbo-generators and other high-speed types, automobile lighting generators, electric vehicle and battery locomotive motors, battery charging and other low voltage generators, slip rings and occasionally as lubricating brushes on electro-plating generators.

ELECTROGRAPHITIC BRUSHES.

Perhaps the highest stage in the development of carbon brush manufacture up to the present time has been reached in the electrographitic brush. This type is made up in the first place of certain forms of amorphous carbon carefully selected to give the desired characteristics to the finished product. In the final baking operation it is carried to an extremely high temperature, which results in a modification of the material composing the brush, leaving all or part of it in the form of graphite. It is possible to make this type as near absolutely nonabrasive as any brush can be made. It is also manufactured with varying degrees of abrasiveness to meet special requirements.

In relation to other types of brushes this class is hard and some grades are extremely so; still, owing to its dense structure high conductivity is attained. Mechanical strength and toughness are pronounced characteristics of nearly all grades. The commutating properties of brushes of this class are above the average, and by proper selection of raw materials it is possible to secure a very high contact drop without the use of any impregnating treatment. This high contact drop, combined with the high conductivity and low coefficient of friction, gives an ideal combination of brush characteristics, making certain grades applicable to a very wide field of service.

Electrographitic brushes have been used on practically every conceivable application except electroplating generators, and even on these the more graphitic grades are sometimes used for lubrication. The non-abrasive grades are especially well adapted for use on undercut commutators, the hardness of the brush giving a cleaning action, which polishes the surface of the commutator well without causing any wear. For use on collector rings the electrographitic brush is well adapted wherever mechanical conditions are severe, due to its greater ruggedness.

These brushes may be used up to current densities as high as 80 amperes per square inch on the alternating current rings of rotary converters, and occasional instances of successful application at even higher current densities have been noted.

TREND IN THE USE OF BRUSHES.

The trend of development at the present time seems to be away from the use of metal-graphite brushes on slip rings and toward the use of graphite and electrographitic brushes at current densities that are suited to these grades. There are many things to be said in favour of this tendency on all classes of alternating current machines. However, a serious objection is met with on induction motors of the slip ring type where it is desired to keep the slip at as low a figure as possible. Here the higher contact drop of graphite and electrographitic brushes will result in a greater percentage of slip than will be experienced with metal-graphite brushes.

For certain classes of service a brush is required having a contact drop much lower than that possessed by any carbon brush, yet above that of pure metal. For this purpose brushes are manufactured of a composition made up of graphite and metal powder. Copper powder is used in some grades. However, pure copper powder does not make the best brush for use on slip rings, owing to its tendency to cut the rings. For this reason it is customary to alloy the copper to some extent with tin, zinc, lead, or some other metal

making a brush that is much less liable to score the rings. Copper, however, remains the predominant element in the composition.

The materials are thoroughly mixed in the desired proportions with a binding material to hold the metal and graphite particles together. It is then molded at high pressure, after which it is baked to carbonize the binder. In some grades the binding material is omitted and the temperature carried to a point of partial fusion of the metal, so that the material is bound together into a compact mass without the use of any additional binding agent. In addition to raising the contact drop somewhat above that of the pure metal, thus making it possible to secure good commutation on machines of low voltage, the graphite has another function—that of lubrication. Where properly applied, these brushes can be used on commutators and slip rings at a fairly high peripheral speed without difficulty being encountered.

GRAPHITE ELECTRODES.

Electrodes were formerly made of powdered petroleum coke, mixed with tar as a binder. This mixture was moulded under pressure and baked at a bright red heat, when the tar is carbonized. At this stage the process stopped. The first stage in the manufacture of graphite electrodes is essentially the same as described above. Anthracite coal is largely used to replace the petroleum coke, and provided it is clean, gives good results. Hand picking or some other method of cleaning should be resorted to in the case of coal containing much slate or other foreign substance. The carbon rods, made as above, are now placed in an electric furnace and converted into graphite at a temperature of about 7500°F. (see page 116).

Graphite electrodes possess an electrical conductivity four times that of carbon rods. They can, also, be shaped, threaded or planed, whereas the carbon rods cannot be so worked: they can thus be tapped and threaded and fed into the furnace as a continuous rod, whereas, as soon as the carbon rods have been partly consumed, the outer connexions can no longer withstand the high temperatures produced and about half the electrode has to be thrown away.

It has not been found satisfactory to make an electrode out of powdered graphite mixed with some sort of binder, as no plastic form of graphite possessing the requisite bonding properties is known. In place of the latter, some form of hydrocarbon bonding agent must be used, and these do not possess the necessary strength and soon break down, especially when the electrodes are used in electrolytic work.

The tensile strength of graphite electrodes is about 20 per cent less than that of ordinary carbon electrodes and they are much softer.

In the forming of carbon electrodes, previous to graphitizing, two methods are used. They can either be placed in a mould and formed under pressure, or they can be extruded through a die. For electrolytic work, extruded electrodes have been shown to be superior to the moulded ones, being more homogeneous and of lower porosity, and most of the Acheson graphitized carbon electrodes are made by the extrusion method.

Since graphitized carbon rods are so readily machined, many small articles such as discs, bushings, washers, etc., can be made from solid rods far more satisfactorily than by moulding. Graphite moulds, made from solid blocks, have also been used with success in casting the precious metals, as well as in the glass industry.

High grade arc carbons (electrodes) for use in searchlights, moving picture lanterns, etc., are made from specially refined natural graphite. (See footnote, p. 150.)

GRAPHITE FOR LUBRICATING.

Graphite possesses a very low coefficient of friction, a property that it retains under practically all working conditions. In addition, it is soft and readily adheres to metallic surfaces under light pressure, filling up the pores in the metal and smoothing the microscopic roughness of the surfaces in rubbing contact. The surfaces thus coated are covered with a veneer of graphite which reduces their coefficient of friction to practically that of graphite itself and also serves to protect them from the action of corrosive solution or vapours. This applies especially to cylinder lubrication, where high pressure steam, oil or gas is used. Under such conditions, oil and grease lubricants tend to lose body or to char or vapourize under the action of the heat and vapour to which they are exposed, and graphite has now largely supplanted lubricants of the above nature for cylinder lubrication.

In heavy bearings, also, grease and oil tend to squeeze out from between the surfaces, with the result that the metal parts touch. Graphite, on the other hand, forms a veneer or coating on both bearing surfaces, so that a graphite-graphite contact instead of a metal-metal contact is secured.

Of other natural lubricants, talc and mica may be mentioned, but neither of these is adapted for work under severe conditions to anything like the extent that graphite is.

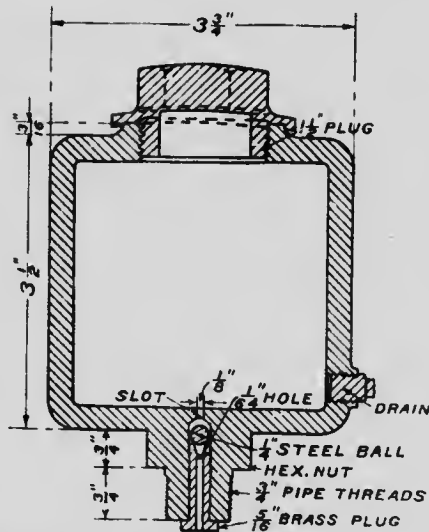

Fig. 42. Type of automatic graphite lubricator (United States Graphite Company, Saginaw, Mich.)

For ordinary lubricating purposes in loose, open bearings, gears, slides, etc., graphite is commonly mixed with oil or grease, and there are a variety of such compounds on the market, many of them designed for work under special conditions, such as exposure to salt water, acids or alkalies, in dredges, pump plungers, winches, mining machinery, etc., or at different temperatures, where varying degrees of viscosity are required.

In cylinder lubrication for steam and gas engines, compressors, etc., modern practice is to feed dry, flake or powdered graphite in addition to grease or oil. For this purpose, numerous special lubricators have been devised, one of which is shown in Fig. 42. In marine engines, the use of graphite for cylinder lubrication is especially advantageous, as by its use, the amount of oil finding its way into the condensers and boilers is materially reduced.

Graphite is also used in pipe joint compounds, for lubricating and sealing the threads and flanges of steam, water, gas, oil and air pipes, and for bolts, nuts, studs, caps, boiler plugs, manhole plates of boilers, gas retort doors, metal gaskets, etc. Such compounds replace, and are claimed to be superior to, red or white lead. As in the case of graphite paints, superior merit is claimed for each of the three types of graphite—artificial, natural flake, and natural amorphous—for use in lubricating oils and greases.

It is claimed for the amorphous and artificial graphites that they are both purer and more capable of being reduced to an impalpable powder, that will remain in suspension in oil, than the natural flake graphite, for which reasons they are to be preferred. The matter of the suspension of graphite in oil (with special reference to lubricating oils) has been considered by C. H. Bierbaum, in a paper read before the American Society of Mechanical Engineers¹.

The following abstract of this paper is of interest:—

From a purely mechanical viewpoint, the suspension of graphite in oil should be a relatively simple matter; unfortunately, however, when the particles of graphite are fine enough to be able to defy the force of gravity, they are then subject to another force known as the Brownian movements. Under the latter force the graphite particles are subject to what approaches perpetual motion; it is not a continued movement in one direction, but a zigzag course, caused by the free electrons striking the particles of graphite. A particle on being struck starts with a jerky movement and continues moving until arrested by the fluid friction of the oil, provided it has not already been struck by another electron causing it to bound off in another direction. An observer who saw this fascinating action for the first time expressed himself to the effect that the particles seemed to be on a St. Vitus dance. During these erratic movements the particles of graphite collide with each other, and as a result adhere; they in turn are struck by other particles, and in this manner there is gradually built up a mass of adhering particles which is subject to the action of gravity and results in settling out. It is obvious that the greater the number of free electrons present in the oil, the more rapidly the coagulation and settling out process should proceed, and such is the case. It is fully borne out by experience that the addition of a free acid or salt greatly accelerates the precipitation; in fact, any electrolyte present has this effect, such as the acid residue or its resultant neutralized salt remaining in a lubricating oil after refining, or the rancidity of an oil, all tending to increase the number of free electrons and the precipitation of the fine particles of graphite.

Various expedients have been resorted to in order to effect so called permanent suspension of graphite in oil. The one most commonly made use of is, that of coating the finely ground particles with a foreign substance and then effecting a high dispersion of these coated particles throughout the oil. The coating material is usually a vegetable compound; if an oil it should be one insoluble in the mineral oils, such as castor oil, or it may be tannic acid or an allied tannin compound.

The value of a so-called permanent suspension of graphite in oil is more fanciful than real, for the reason that in all such attempts the graphite is ground to such an extreme degree of fineness that this very fineness mitigates against its being useful. In a bearing properly constructed, lubricated and in operation, the bearing surfaces are completely separated by the oil film and the extremely fine particles of graphite simply float in the film, exerting no appreciable effect either beneficial or otherwise.

The time, however, when graphite can be of benefit and perform its only and supreme function is when the oil film between the bearing surfaces is destroyed and the graphite serves as a solid lubricant. The graphite is carried between the bearing surfaces by the

¹ See Iron and Coal Trades Review, January 1918, p. 718.

oil, and in the same manner, when the oil film is destroyed by being squeezed out, the graphite particles are carried along with the oil from between the bearing surfaces until the film is reduced to a thickness corresponding to the dimensions of the largest particles of graphite which at this stage will be arrested and held between the surfaces. Upon the complete destruction of the film, these particles so held are crushed and embedded into the grain and pores of the surfaces, and thus are made to perform their function of solid lubrication. It is evident that the smaller the particles are, the less will be the amount of graphite so intercepted between the bearing surfaces; therefore, a given amount of graphite is most efficient if it exists in particles of the largest possible size. The more nearly permanent a graphite suspension is, the more nearly does it approach the colloidal state and the more completely is it carried out from between the bearing surfaces when the oil film is being destroyed.

This can be demonstrated in a most striking manner by taking a light coloured lubricating oil, thoroughly mixing with it a definite amount of graphite, and then placing it between two highly accurate glass surfaces and observing the amount of colour left after a definite pressure has been applied for a definite time, while maintaining a fixed temperature. An amorphous natural graphite, ground so that its coarsest particles did not exceed 0.0002 in., showed under the foregoing conditions an almost opaque surface, while a commercial graphite suspended in tannin, and whose largest particles did not exceed 1-250,000 in., showed a substantially colourless surface. This is readily accounted for by the fact that the largest particles in the one graphite contained 125,000 times the bulk of those in the other, a condition existing at the time the glass surfaces in each case had approached each other near enough to arrest the flow of the respective particles.

The carbon content of graphite is not an indication of its lubricating value or its purity, for the reason that the percentage of amorphous carbon in some varieties is comparatively high. Amorphous carbon, or carbon not completely graphitised, can best be classed as an inert impurity; its presence always shows extreme blackness. The same is true of another common impurity, hydrogen, as a hydrocarbon; this is also black, whereas the purest graphite is a dark steel-grey when mixed with a clear white oil. The chemical laboratory can only give valuable information on the subject of the graphites when the work is done by an expert or specialist.

Dry graphite powder is used for lubricating the actions and bridges of pianos and organs, and in short, any wooden or other surface when the use of oil or grease might be detrimental, such as in textile machines. It is employed, also, in type-setting machines, to give the space bands, channel plates, etc., a dry, smooth surface.

To minimize water friction, yacht and launch bottoms are sometimes dusted with graphite, after a preliminary light coat of varnish or shellac has been applied, and when dry, are polished with cloths or waste. The graphite used for this purpose is sometimes termed *potlead*.

For the lubrication of bearings and bushings that are difficult or impossible of access, the Bound Brook Oilless Bearing Company, Bound Brook, New Jersey, make specially designed, self-lubricating devices. One type (*Nigrum* bearings) consists of ironwood, impregnated with a special lubricating compound containing graphite. Such bushings are used extensively for light duty parts in automobiles, such as for shackle pins, spring eyes, etc. Saddles of spinning frames and roll holders in grinding mills of all descriptions may also with advantage be made of such impregnated wood; and it is also recommended for friction clutches and loose pulleys, and for use in the bearings of printing presses, paper, textile and winding machines.

Some types of *Nigrum* bearings are illustrated in Plate LV.

The same firm also make what is known as the Bound Brook bearing. This is a bronze bearing, cast with grooves or holes, into which a special mixture containing graphite is forced. After this lubricating material has been inserted, the bearings are baked for some hours, and are then broached. Some of the uses for which such self-lubricating bearings are especially adapted are trolley wheel and windmill bushings, clutch release

shoes, gas engine and starting motor bushings, etc. Several types of these oilless bearings are illustrated in Plate LVI. The graphite used in the manufacture of the above is a finely ground, natural flake, that is air floated to remove all trace of grit.

Attempts have been made to produce a self-lubricating metal by introducing graphite into the metal while the latter is in a molten state, but this procedure does not appear to have met with success.

Such an antifriction alloy has been proposed by E. C. Miller, and consists of lead, antimony, tin, bismuth, and graphite. The individual metals are all melted separately. The lead and antimony are then mixed together, and to them the graphite is added, after which the tin and bismuth are inserted. The proportions in which the above ingredients are to be mixed are given as:—

Lead	36	parts.
Antimony	7	“
Tin	21	“
Bismuth	$\frac{1}{6}$	“
Graphite	$\frac{1}{4}$	“

The Morgan Crucible Company, of London, make bearings and bushings machined out of solid Morganite, a special graphite material made by the Company. These bearings are claimed to be mechanically strong, and being composed entirely of self lubricating material, to possess practically the lowest possible coefficient of friction.

The Acheson Graphite Company, of Niagara Falls, use so called “deflocculated graphite” in their Oildag lubricating compound. This deflocculated graphite is claimed to be “graphite reduced to the molecular form, the finest possible state of subdivision”. It is so finely divided that “when diffused in water, it will run with the water through the finest filter paper”. Such graphite is prepared from artificial graphite, made in the electric furnace, which is first ground very fine and airfloated. This air-floated graphite is termed disintegrated graphite, and from it the deflocculated graphite is prepared by a process involving the addition of tannic acid. According to Spear¹, on masticating artificial graphite with gallo-tannic acid, stable solutions of colloided graphite containing as much as 1 per cent of graphite can be obtained. In order to produce an oil suspension, it is first necessary to make a paste of graphite and tannin in water, oil being gradually substituted for the water during the mastication and the oil paste diluted to the desired consistency. The graphite particles may be precipitated out of solution by the action of acids.

GRAPHITE PAINTS.

Graphite is used extensively as the pigment in paints that are called upon to withstand the corroding attack of sulphurous gases, acids, alkalis, etc. It is considered especially valuable in paints for metal and other roofs in a smoke laden atmosphere, tanks, pipes, trestle work, boiler fronts, smoke stacks, standpipes, gasometers, steel railroad cars, bridges, etc.

There is a diversity of opinion as to the most suitable kind of graphite for graphite paints, and the natural amorphous, natural flake and artificial varieties are all employed by different manufacturers. (See under Lubricants).

¹ The Chemistry of Colloids, Zsigmondy and Spear, 1917, p. 266.

The following remarks on the subject of graphite paints are taken from "The Chemistry and Technology of Paints," by M. Toch, second edition, 1916, p. 101, Van Nostrand Company, New York:—

The purer a paint pigment is as to its content of carbon the poorer is the paint produced. If graphite be taken with a content of 80 or 90 per cent carbon and mixed with linseed oil, it forms a porous, fluffy film, and the particles of graphite congregate in the linseed oil and produce a very unsatisfactory covering. If graphite be diluted with a heavier base, its weakness then becomes its strength and a very good paint is formed. Many of the characteristic chemical and physical defects of red lead are largely reduced and frequently eliminated when it is mixed in proper proportion with graphite, a high grade of graphite when finely ground with linseed oil acting as a lubricant and sliding under the brush.

Pure graphite paint, as is well known, will cover from 1,000 to 1,600 square feet to the gallon. Such a paint film is so exceedingly thin that, while it looks good to the eye, in a short period decomposition more easily takes place beneath it than beneath many poorer paints. It is therefore essential to reduce graphite with a heavier base, and to this end it has been found that a mixture of silica and graphite produces very good results; but even this paint has the objection of having too much spreading power.

Misnomers have crept into the paint trade in regard to graphite paints, such names as green graphite, red graphite, brown graphite, etc., being in use, when in reality such graphites do not exist, excepting as far as graphite has been mixed with pigments of these colours.

A six year test of a linseed oil paint made with a neutral ferric oxide, containing in its composition 75 per cent ferric oxide and 20 per cent silica mixed with graphite containing 85 per cent graphitic carbon, has proved itself to be as good a paint as can be desired for ordinary purposes. The pigment in a paint of this kind will withstand the chemical action of gases and fumes, but the oil vehicle is its weakest part.

Since the electro-chemical industry has been developed at Niagara Falls graphite has been made artificially and is sold under the name of Acheson Graphite. This graphite is to be considered as a paint material on account of its uniformity and fineness of grain, but it should not be used alone as a pigment, for as such it possesses the physical defect of lightness just described. A graphite paint containing more than 60 per cent graphite does not serve its purpose very well unless 40 per cent of heavy pigment is added, such as a lead or a zinc compound. A rather unfortunate defect in the graphite paints containing a large amount of graphite is the smooth and satin-like condition of the paint film, which is poorly adapted for repainting. It has often been noted that a good slow drying linseed oil paint will curl up when applied over certain graphite paints, because it does not adhere to the graphite film. On the other hand, if particular forms of calcium carbonate, silica, or ferric oxide are added to graphite, a surface is presented which has a tooth, to which succeeding films adhere very well.

STOVE POLISH.

For stove polish, an amorphous natural graphite is usually employed, which is worked up into the form of a paste, cream, cake, powder or liquid, with the addition of a clay, rosin, asphaltum or soap binder in the case of the solid polishes, and of a gasoline or water vehicle for the liquid kinds.

Both Korean and Mexican graphite are suitable for this class of work. A high degree of purity is not essential, and the addition of carbon black, prepared by condensing the products of combustion of natural gas, is sometimes made to intensify colour. The graphite used in all the forms of polish is ground to an impalpable powder, and in the case of cake polishes, the graphite and clay are first moulded or poured into the desired shapes and then baked.

Donath¹ gives the following as the constituents of a liquid stove polish: benzine, 30 parts; graphite, 30; coconut oil and palm oil, $\frac{1}{2}$; dilute ammonia, 30; oak bark, 1; oxide and sulphate of iron, $\frac{1}{2}$.

¹ Op. cit., p. 131.

BOILER GRAPHITE.

In recent years, the use of graphite in boilers, for preventing scale, has been widely advocated. Boiler scale greatly lowers the conductivity of the boiler heating surfaces. Scale also prevents the cooling action of the water from protecting the metal against burning, and in consequence, the plates are liable to become so overheated as to lag or crack.

The action of graphite in the elimination of boiler scale is purely mechanical, and is not affected in any degree by acidity or alkalinity of the water or by heat. Small particles of graphite simply work their way through the minute fissures existing in old scale, and gradually penetrate between the scale and the metal, loosening the former so that it may be readily rapped off or removed with regular cleaning tools. Even a thick accumulation of old scale may be removed in this way, but a period of several months may be required to completely loosen it. If the use of graphite is adopted when a boiler first comes into use, any great accumulation of hard scale may be effectually prevented, as the particles become incorporated with the scale as it forms, rendering it soft and friable, in which form it may readily be removed with a minimum of labour.

The graphite usually recommended for the above purpose is a very finely ground flake, though the amorphous and artificial varieties also are used.

The amount of graphite recommended to be used in average practice is two-fifths of a pint for a boiler up to 100 H.P., with an additional one-fifth of a pint for each 50 H.P. rise. One pint of ordinary flake boiler graphite weighs about half a pound. The most satisfactory results are obtained by the regular introduction of small amounts of graphite, but it is also recommended to put about two quarts into a boiler after cleaning.

The graphite may be conveniently introduced into the boiler by mixing it with hot water and feeding through the pump suction after blowing down about two gauges.

For locomotives, about one pound (one quart) of graphite per day is considered sufficient for ordinary engines, and two pounds for the large types. A simple method of introducing the graphite in this case is to place it directly in the tank.

GRAPHITE FOR POWDER GLAZING AND SHOT POLISHING

Graphite is employed for giving a protective finish to powder grains, in order to protect them from damage by moisture. It is also used to give a polish to shot.

SUBSIDIARY USES.

Minor uses to which graphite is put are in engine packing, hard rubber compositions, cord and twine manufacture, hat polishing, and in the manufacture of wire ropes and cables.

It is also employed in rubber valve discs and washers for steam and hot water connexions, in sheet packing for steam joints and as a coating on piston ring packing.

In addition to being used to polish and coat black powder grains in order to protect them from moisture, graphite is similarly employed in connexion with smokeless powder¹, for the purpose of avoiding difference of potential with consequent danger of sparking between the grains.

¹ Haenig, *Der Graphit*, p. 150.

According to Donath, graphite is mixed to the extent of 25 per cent with gelatinized nitro-cellulose, in order to reduce its destructive effect on the weapons in which it is used¹.

Graphite also has found application in the manufacture of certain kinds of carbon paper.

According to Miller², amorphous graphite is sometimes employed as a filler in fertilizers, where it serves to coat the particle and prevent the absorption of moisture, with consequent caking; also, to colour and glaze tea leaves and coffee beans, and in printer's ink and dyes for felt hats.

What are known as graphite slabs are used in flattening window glass. They must not be sensitive to sudden changes of temperature and must have great mechanical strength. They are satisfactorily made³ from a coarse-grained material, but are surfaced with finer material. A common mixture for these slabs is:—

Fireclay... ..1 part	}	or	{	2 parts
Grog.....1				2 "
Graphite.....2				1 "

The above materials are mixed dry, screened and pugged into a stiff paste. This paste is then allowed to sour for a few days and is again pugged and soured on alternate days for about a fortnight. The slabs are moulded in a wooden frame, the working surface being made with fine clay. The latter is usually placed in the bottom of the mould, which is then filled in with the coarser material. The slabs are afterwards polished successively with wet sand, finely ground grog and pumice stone or talc, friction being applied by a sandstone block held in a double handled frame.

Graphite is sometimes added to the material used in making magnesia bricks, and its use increases the facility with which the material can be moulded, as well as increasing the heat conductivity of the bricks.

In European practice, the graphite of old crucibles is often recovered. The pots are first carefully cleaned of slag and other impurities, crushed to powder and the graphite recovered by some form of separator, such as a vanner. Provided that the material is crushed fine enough, by using an air separator a fairly fine graphite is obtained, as well as a useful grog.

¹ The percentage of graphite given seems high enough to seriously reduce the propelling power of the explosive, and the writer has been unable to find corroboration of this alleged use of graphite in explosive manufacture. Donath quotes von Romoeky, *History of Explosives*, Vol. II, p. 173, as authority for the above use of graphite.

² Report No. 6, Topographic and Geologic Survey Commission of Pennsylvania, 1912, p. 38.

³ See A. B. Searle, *Refractory Materials*, p. 274.

CHAPTER VIII.

THE CANADIAN GRAPHITE INDUSTRY.

PRODUCTION, EXPORTS, IMPORTS, ETC.

The production of graphite in Canada in 1918 was 3,114 tons. The above figure includes the three standard mill products—No. 1 and No. 2 flake, and dust—ore shipped crude, and a small quantity of crystalline graphite or plumbago. The 1918 output was considerably lower than that of the previous year (3,714 tons), and the relative value was very much lower. About one-third of the total of 3,114 tons was crude shipping ore.

As shown in the following table, the 1916 production was the largest in the history of the industry, but the value of the smaller 1917 output was considerably greater.

Annual Production of Graphite in Canada, 1886-1918.¹

Calendar Year.	Tons.	Value.	Calendar Year.	Tons.	Value.
1886.....	500	\$ 4,000	1903.....	728	\$ 23,745
1887.....	300	2,400	1904.....	452	11,760
1888.....	150	1,200	1905.....	541	16,735
1889.....	242	3,160	1906.....	387	18,300
1890.....	175	5,200	1907.....	579	16,000
1891.....	260	1,560	1908.....	251	5,565
1892.....	167	3,763	1909.....	864	47,800
1893.....	Nil.	Nil.	1910.....	1,392	74,087
1894 (a).....	3	223	1911.....	1,260	60,576
1895.....	220	6,150	1912.....	2,060	117,122
1896.....	139	9,455	1913.....	2,162	90,282
1897.....	436	16,240	1914.....	1,647	107,203
1898.....		13,698	1915.....	2,635	124,223
1899.....	1,130	24,179	1916.....	3,955	325,362
1900.....	1,922	31,040	1917.....	3,714	402,892
1901.....	2,210	38,780	1918.....	3,114	248,970
1902.....	1,095	28,300			

(a) Exports.

No amorphous graphite has been produced in Canada for a number of years, the New Brunswick deposits having been abandoned in 1908. (See page 23).

The price of Canadian flake graphite of crucible grade almost doubled during the war, attaining a maximum of 16 cents per pound in 1917. The prices of No. 1 flake, from 1914, to date, are shown below. These figures are for graphite consigned to the United States:—

Prices of Canadian flake graphite, f. o. b., mills, 1914-19.

1914.....	5 - 7	cents per pound.
1915.....	8 - 9	"
1916.....	9 - 12	"
1917.....	13 - 16	"
1918.....	15 - 16	"
1919 (February).....	10 - 12	"

¹ From returns furnished to the Mines Branch, Division of Mineral Resources and Statistics.

As a war measure, the exportation of crucible grades of graphite from Canada was prohibited on November 7, 1914, to all foreign countries except France, Russia, Spain, and Portugal. On November 28, the prohibition was made absolute, but on December 10 was modified to the extent of permitting export to the United States under license from the Minister of Customs. The above restriction remained in force all through the war period.

In the following tables are shown statistics of exports and imports of graphite from and into Canada from 1910 to 1918, as well as the imports into Great Britain and the United States, 1914-1917.

In connexion with the Canadian export figures it should be noted that the classification as required by the Tariff Act is somewhat obscure. The material included under "*Crude ore and concentrates*" consists, mainly, of crude ore, the product of a single mine, whose ore is sufficiently rich to be employed for certain purposes (foundry facings and the like) without being subjected to any cleaning process. The nature of this material is, perhaps, sufficiently obvious from the low value—2 to 3 cents per pound. There are no exports of graphite concentrates, all concentrates being further refined at the mills to a finished product. The term "*Manufactures*" includes refined graphite, i.e. the finished product of the mills, as well as articles manufactured wholly or in part of graphite. Canada, however, would appear to export little if any of such graphite manufactures, and the bulk of the values quoted probably relates to refined flake graphite.

With regard to the imports classification, "*Plumbago, not ground*" probably may be taken as comprising chiefly Ceylon graphite for crucibles or other purposes; while "*Ground and manufactures*" includes, variously, refined flake, amorphous graphite, low grade foundry facing material, and articles composed wholly or in part of graphite (crucibles excepted).

The import duty on graphite and graphite products into Canada is as follows:—

	Source.	
	British.	Foreign.
Plumbago, not ground or otherwise manufactured.....	5 per cent	10 per cent
Plumbago, ground and manufactures of.....	15 per cent	25 per cent
Graphite crucibles.....	Free	Free

In addition, a war tax is levied on all the above; this amounts to 5 per cent in the case of British shipments and 7½ per cent for foreign products. The war tax is imposed on crucibles, though these are otherwise on the free list.

The United States tariff on graphite and graphite products is as under:—

Graphite, plumbago or black lead.....	Free
Black lead, advanced in value.....	15 per cent.
Crucibles, black lead.....	15 "
Crucibles, plumbago.....	20 "

Exports of Graphite from Canada, 1910-1918.*

Year.	Crude ore and concentrates.		Manu- factures.	Total value.
	Short Tons.	Value.	Value.	
1910.....	788	\$53,008	\$ 66,658	\$119,666
1911.....	813	43,249	33,956	77,205
1912.....	1,654	70,763	58,920	129,683
1913.....	1,642	85,368	24,284	109,652
1914.....	919	50,528	72,718	123,246
1915.....	263	12,009	84,316	96,325
1916.....	311	13,114	304,919	318,033
1917.....	112	7,455	384,505	391,960
1918.....	664	32,710	205,993	238,703

* Reports of the Department of Customs.

Exports of Graphite from Canada, by Countries, 1910-1918.*

Calendar Year.	Crude ore and concentrates.						Manufactures of plumbago.		
	Great Britain.		United States.		Other Countries.		Great Britain.	United States.	Other Countries.
	Short Tons.	Value.	Tons.	Value.	Tons.	Value.	Value.	Value.	Value.
1910.....	223	\$16,453	556	\$35,555	9	\$1,000	\$ 3,051	\$ 63,466	\$ 141
1911.....	30	3,631	752	36,295	31	3,323	2,289	30,062	1,605
1912.....	59	4,984	1,550	62,680	45	3,099	3,932	46,796	8,192
1913.....	19	1,700	1,618	82,758	5	910	3,278	20,279	727
1914.....	77	6,730	814	41,168	28	2,630	12,051	58,816	1,851
1915.....			263	12,009			2,381	81,467	468
1916.....			311	13,114			5,450	299,256	213
1917.....			112	7,455			3,115	381,226	164
1918.....			664	32,710				205,761	232

* Reports of the Department of Customs.

Imports of Graphite into Canada, 1910-1918.*

Calendar Year.	Plumbago, not ground.	Ground and manufactures.	Crucibles, clay or plumbago.
1910.....	\$ 4,867	\$ 55,090	\$ 52,896
1911.....	4,940	51,192	56,814
1912.....	7,249	65,911	82,324
1913.....	9,375	72,887	73,971
1914.....	801	49,478	49,913
1915.....	3,436	41,681	106,761
1916.....	3,231	99,919	520,341
1917.....	47,218	123,991	798,004
1918.....	93,956	132,821	113,856

* Reports of the Department of Customs.

Imports of Plumbago into Great Britain, b. Countries, 1914-1917.*

	1914.		1915.		1916.		1917.	
	Short tons.	Value. \$	Short tons.	Value. \$	Short tons.	Value. \$	Short tons.	Value. \$
Germany.....	1,590	6,498	41					
France.....	225	13,402	60	156,712	117	482,168	514	100,867
Madagascar.....	4,931	460,678	93	460,465	90	1,590,724	11,387	1,873,269
Italy.....	1,258	24,861	19	48,311	20	74,990	2,409	119,624
Austria.....	96	3,672	38					
Japan (Chosen).....	4,667	142,097	30	107,422	25	205,130	1,720	62,073
United States.....	431	34,017	79	92,038	106	192,900	1,654	295,283
Other Foreign.....	282	9,180	33	146	37	7,777	68	4,407
British India.....	2,938	278,009	95	17,389	195	88	125	47,021
Ceylon.....	189	14,328	76	775,547	122	1,765,778	4,518	1,491,759
Other British possessions.....	16,607	986,742	110	10,390	95	10,731	25	5,328
			20,604	1,668,420		4,316,286	22,420	4,000,451

*British Trade Report.

Imports of Graphite into the United States, by Countries, 1914-1917.*

	1914.		1915.		1916.		1917.	
	Short tons.	Value.	Short tons.	Value.	Short tons.	Value.	Short tons.	Value.
Ceylon.....	8,374	\$ 920,147	12,275	\$1,564,917	24,411	\$5,816,515	24,304	\$7,075,143
Mexico.....	4,259	190,075	1,680	75,000	5,331	238,000	7,570	285,568
Canada.....	1,806	92,536	2,945	116,407	4,127	314,177	3,476	349,034
Japan (Chosen, via Japan).....	6,327	96,433	2,373	35,292	5,375	103,619	2,462	83,558
Austria-Hungary.....	78	1,258						
Italy.....	254	3,203	27	904	151	4,133	115	3,092
Germany.....								
England.....	381	42,446	2,216	261,321	561	166,847	6	1,566
France.....	194	20,378	1,432	181,236	1,631	241,863	4,363	1,057,081
British India.....	127	9,815			1,590	343,170	265	102,489
Madagascar.....	155	18,426	36	2,831				
Netherlands.....			36	2,811				
Other countries.....	47	5,644	5	354	170	21,559	18	4,447
	22,002	1,398,261	23,075	2,241,163	43,017	7,279,883	42,609	8,961,968

*Compiled from reports of the Department of Commerce.

NOTE.—In this table, the figures given for England and British India may be taken as representing Ceylon graphite, re-exported, and may therefore be added to the figures for Ceylon. Similarly, the figures for France represent Madagascar graphite, and those for Japan, Korean graphite for the most part.

DOMESTIC CONSUMPTION OF GRAPHITE.

From data furnished to the Mines Branch¹ in 1912-13, the total annual consumption of graphite by Canadian manufacturers at that time amounted to 950 short tons. Of this amount, 192 tons represented domestic, and 758 tons imported graphite.

The bulk of the graphite used went to the foundry facings, stove polish and paint trades. The following table shows the consumption by industries:—

	Number of firms using graphite.	Domestic, tons.	Imported, tons.	Total, tons.
Explosives.....	2		9	9
Foundries.....	267	78	351	429
Lubricants.....	13	1	17	18
Stove polish.....	12	20	270	290
Paints.....	18	81	109	190
Rubber goods.....	1	7		7
Various.....	6	5	2	7
Total.....	319	192	758	950

The above list of industries has since been increased by at least three, namely, dry battery, crucible, and pencil. The first-named uses chiefly artificial graphite produced at Niagara Falls, Ont. In crucibles, both domestic and imported graphite is used, and in pencils, imported amorphous graphite.

Prior to 1915, a certain amount of Ceylon plumbago was imported for use in the best grades of foundry facing, but the trade at the present time uses chiefly Mexican, Korean, American, and domestic graphite.

The paint trade uses both artificial and imported amorphous graphite.

In powder and shot polishing, Mexican amorphous graphite is used.

Both flake and amorphous graphite is employed in lubricants. In addition, the Acheson Oildag Company, at Sarnia, Ont., manufacture so-called "deflocculated graphite"—a very finely divided artificial graphite—for use in their lubricating compound.

The Dominion Crucible Company, with plant at St. Johns, Que., commenced operations in 1916, and is the first works of the kind to be established in Canada. The output of this plant has been confined to date to special order crucibles and accessories, but it is intended to enter the market in competition with English and American makers. At the present time, the bulk of the crucibles consumed in Canada are believed to be of English manufacture.

A list of names and addresses of Canadian consumers of graphite will be furnished on application to the Director, Mines Branch, Department of Mines, Ottawa.

GENERAL REVIEW OF THE INDUSTRY.

The great increase in the price of crucible flake, due to the war, did not lead, in Canada, to the increased mining activity that perhaps might have been anticipated. No new mines or mills came into operation, and a large

¹ Fréchette, H., Report on the Non-Metallic Minerals used in the Canadian Manufacturing Industries, Mines Branch, 1914.

proportion of the existent mills were idle or in only intermittent operation. This may be ascribed to a combination of causes, amongst which figures prominently the lack of success which has for years past attended efforts to evolve efficient mill processes for the refining of graphite in this country. This, coupled with the great general increase in the cost of labour and materials in the last few years, has effectually discouraged the investment of capital in an enterprise which, while offering possibilities during a period of excessive, war time prices, in ordinary times has yielded only slight returns and then only with the most capable of management and under exceptionally favourable conditions. In a number of instances, large mills, out of all proportion to the size of the ore-bodies as determined at the time of their construction, have been erected at great expense, and owing either to lack of ore, expense of running, or a combination of these causes, have been in only intermittent operation ever since. Most of the mills erected in recent years have been equipped with a dry process of concentration, consisting in repeated crushing by rolls of flour mill type, with screening between successive crushing operations, as well as treatment on dry tables. Such an installation required an excessive amount of floor space and often an elaborate system of elevators, added to which the ore required to be kiln-dried prior to milling. The above called for a mill building of large size, relatively high power consumption and a large expenditure for fuel for firing the boilers, heating the plant in winter, and drying the ore. While wood fuel can usually be obtained in the vicinity of the mines, coal has sometimes been used for firing the boilers; this involved considerable expense for haulage, since many of the mills are situated at a considerable distance from rail.

Dry methods for the concentration of graphite first came into prominence in Canada about the year 1906, and between 1906 and 1912 nine mills were installed with dry concentrating machinery. The process was adopted to supersede the wet system of buddles, originally employed in the older mills of the Buckingham district, in Quebec. Speaking generally, while there may have been some exceptions, dry concentration of graphite by the above methods has proved a failure in all respects. The expense involved has been high; a high grade of product has been obtained with difficulty and generally at the expense of an excessive loss of graphite in the tailings and the destruction of an undue proportion of the larger flake in the ore. Recent experience in the Alabama field, where a number of dry mills using similar or modified styles of concentrating machines have been erected in the last two or three years, has been along similar lines, and in various instances the dry installations have been discarded in favour of some form of wet concentration.

Some part of the failures that have attended efforts to develop the graphite industry in Canada has frequently been ascribed to the impersistence of the ore-bodies. While this is doubtless true in the case of a number of properties upon which mills have been erected, it is not to be inferred that all or even the majority of the known deposits are of such nature, and any such statement requires certain qualifications. For one thing, up to comparatively recently, few attempts to prove ore-bodies by diamond-drilling had been made, and opinions on the extent of deposits were based merely on outcrops or an insignificant amount of surface work.

The great majority of Canadian graphite deposits are represented by graphitic gneisses and limestones, originally bedded sediments, which have been subjected to an extreme degree of dynamic and contact metamorphism

accompanied by intense squeezing, folding, fracturing, and intrusion, so that they, together with the rocks intrusive into them, now form an exceedingly complex series with most involved structural relations. It is evident that little that is definite can be learned about the size and form of ore-bodies forming an integral part of such a complex from mere surface indications, and even underground work will often fail to reveal anything of a really definite nature. Little underground mining has been carried out, however, the majority of workings being shallow and open-cast, so that our knowledge of the deposits is necessarily scanty. What holds good in the case of any one particular deposit, also, could probably not be taken as a criterion in the case of another, owing to local variations in the structural relations of the rocks. Hence, apart from actual mining operations, diamond-drilling is the only reliable method of ascertaining the extent of graphite ore-bodies, and it is apparent that this fact is becoming recognized, five properties having been drilled during the past few years—three of them in the last half of 1918.

An additional feature that has some bearing on the question of the impersistence of ore-bodies is that Canadian graphite deposits, as a general thing, are apt to vary considerably in richness, and that operators usually confine their attention to the better class of ore (10–20 per cent grade) and regard the leaner portions of an ore-body as not worth taking out. This practice has arisen through the difficulties and expense attending the concentration and refining of graphite, it being found that ore running over 10 per cent of graphite might be considered of commercial grade, while anything much under this percentage was too expensive to treat. Frequently, in the case of the graphitic gneiss ore-bodies, the rich ore occurs as a succession of streaks or lense-shaped bodies, that gradually merge into the adjacent non-graphitic country rock, and are separated along their strike by patches of lower grade ore or barren rock. With cheaper methods of concentration, much of this lower grade ore (5–10 per cent graphite) might very well be utilized; in this connexion, it may be noted that the milling ore in Alabama does not average over 3 per cent of graphite, the Pennsylvania ore from 3 to 5 per cent and the New York ore 5 to 6 per cent. The two former are, however, soft and extremely easy to crush, whereas the Canadian gneiss ores are unweathered and hard.

While, therefore, the statement that Canadian graphite ore-bodies are generally small and impersistent is correct in the sense that what has heretofore been considered milling ore is apt to occur in rather small and irregular bodies, such bodies are often bordered or connected by masses of ore of lower grade, representing material whose graphite content may possibly be capable of profitable recovery by improved methods of concentration.

Much interest has been shown in the last year or two in the possibilities of oil flotation for the concentration of graphite ores, and it has been demonstrated that by this system flake graphites can be treated both cheaply and efficiently. The elimination of the preliminary drying of the ore, necessary in all methods of dry concentration and in surface tension or film flotation, is an important consideration from the standpoints of expense and mill capacity. Additional features are, that a much smaller mill building, involving less initial expenditure, is required to treat an equal tonnage of ore as compared with dry concentration; that there are fewer machines and appliances requiring constant attention and repairs.

and that a smaller force of men is required for operation of the plant. A number of the graphite mills in Alabama are employing oil flotation machines of one type or another at the present time, and the system has also been applied successfully to Pennsylvania ore. In both cases, the ore treated is of relatively low grade, carrying only 3 to 5 per cent of graphite. Oil flotation has also been installed recently (September, 1918) at the mill of the American Graphite Company, in New York state, and is reported to be giving every satisfaction. The New York ore is similar in its general characteristics—hardness, texture and associated minerals—to the Canadian graphitic gneiss ores. A number of tests with oil flotation have lately been made on Canadian ores, and a Callow plant was installed in August, 1914, at one of the mines in the Buckingham district. Unfortunately, however, the mill was destroyed by fire before the system had had an opportunity of being properly tried out.¹

Thus, while it must be admitted that graphite enterprises in Canada in the past have been attended by numerous failures, this result has, in many cases, been due largely to inefficient and expensive methods of concentration that rendered profitable the treatment of only the richer portions of ore-bodies; could not be depended upon to produce either a clean or a standard grade of product; made poor recovery of the graphite in the ore; and necessitated frequent shut downs of the mills to effect repairs. In not a few cases, also, capital was expended on the erection of mills without proper investigation of the amount of ore available.

A pronounced recrudescence of interest in the possibilities of Canadian graphite has lately been evidenced, and it is to be hoped that, with efficient management and a proper appreciation of the difficulties attending the development of deposits and the treatment of graphite ores, the industry may recover from its depression, and the production of flake graphite proceed on more profitable lines than heretofore. The fact, however, must not be ignored that the prices that have obtained for crucible flake graphite during the war period have been abnormal, and that with reduced ocean freight and insurance rates, Canadian and American graphite generally may expect to find a serious competitor in Madagascar flake. The production of this material has risen rapidly during the last four years, despite embargoes and transportation difficulties, and the resources of graphite appear to be very large. Cheap native labour, also, even with the somewhat crude concentrating and refining methods that are largely employed, enable the Madagascar product to be placed on vessels at a very low cost.

The fact too, that in steel melting, electric furnaces have in recent years come into decided prominence in the United States, (hitherto, the principal market for Canadian graphite) and that there are indications that in the brass industry, also, electric melting may ultimately largely supersede crucible melting, must not be lost sight of when the development of the Canadian graphite industry is considered.

It is perhaps, pertinent to state here that in the opinion of prominent New York graphite importers, in order to compete in the American graphite market when normal conditions are re-established, Canadian crucible flake graphite will have to be produced at a price of about 5 cents per pound.

REVIEW OF MARKET CONDITIONS, 1914-1918.

Graphite, at the present day, is employed in so many branches of industry that the supply can hardly meet the demand. At the same time,

¹Three Canadian mills have since been equipped with this system of oil flotation.

any one particular type of graphite (crystalline, flake, amorphous, or artificial) is particularly adapted to certain lines of work, and thus the various industries have come to utilize only that kind which best suits their needs. A case in point is the crucible industry. In the first crucibles made, Bavarian flake graphite was used, but, with the discovery of the Ceylon plumbago deposits, flake graphite was largely discarded in favour of the crystalline form. In the same way, pencils were formerly made from either crystalline or flake graphite, but are now manufactured almost solely from amorphous graphite. During 1918, in the United States, curtailment of imports of Ceylon plumbago led to the use of an increased proportion of flake graphite in crucibles, and experiments have been undertaken by the Bureau of Standards with a view to determining whether plumbago cannot be replaced to a still larger extent by flake without any serious detriment to the quality of the crucibles so made.

Thus, while in many of the industrial uses of graphite, a certain type of graphite is considered essential for best results, in those industries which consume the bulk of the graphite used, some one of the other forms of graphite than that at present employed could probably be substituted, either wholly or in part, without serious detriment¹.

In view of the dependence of Canadian producers on the American market, and the fact that the great bulk of Canadian graphite is exported to American consumers, the following notes on the graphite situation in the United States are given below.

Several factors have had an important bearing on the graphite situation in the United States during the war period. At the outset, it should be noted that the graphite market is very largely regulated by the Ceylon supply, and that a shortage of Ceylon plumbago, with a corresponding rise in its price, stimulates the flake graphite industry. The year 1913 saw a decrease in production and a material increase in price of Ceylon graphite, while in the same year Madagascar came prominently to the fore as a producer of flake. High prices prevailed generally during the year and resulted in relatively small sales. In 1914 the market declined considerably, and during the latter months, owing to the embargoes imposed by the British and French Governments on Ceylon and Madagascar shipments respectively, production in these countries virtually ceased. The embargoes were first of all imposed only against Germany and Austria, but were later extended to all neutral countries, the purpose being to prevent shipments finding their way to enemy countries and to ensure sufficient supplies for British and French crucible firms. The low stocks of Ceylon graphite laid in, in 1913, followed by the total cessation of shipments in 1914, caused a serious shortage of crucible graphite in the following year, and all grades of flake were eagerly sought and fetched high prices. Owing to the large munitions contracts placed in the United States, representations were made to the British Government early in 1915 by American crucible makers and resulted in the embargo on Ceylon graphite being partially lifted in May of that year and totally in September. In the course of a few months the situation was relieved to a large extent, owing to the special efforts made by the British Government to facilitate shipments. During 1915-16, the price of crucible graphite rose to an unprecedented figure. Whereas, in January, 1915, the best Ceylon lump sold ex dock New York for 9 cents per pound, in January, 1916, it was bringing 20

¹ See A. V. Bleining, *Chemical and Metallurgical Engineering*, Sept. 27, 1918, p. 467.

cents, and in the following April had still further advanced to 27 cents. The great increase was partly due to increased mining costs, but chiefly to high freight and insurance rates. In some cases, the latter amounted to over 8 cents per pound. Shortage of bottoms and high freight charges resulted in very little of the lower grades of Ceylon graphite being imported, the great bulk of the imports consisting of best lump.

While the embargo by the French Government on Madagascar shipments had been modified early in 1915, practically the whole of the island's production for that year went to France. Owing to difficulties of transshipment at Marseilles and the prohibitive cost of direct shipments to the United States, the price of Madagascar flake rose to 12 cents per pound ex dock New York during the latter part of 1915, as compared with 4-5 cents before the war.

In 1916, lack of bottoms and the insistent demand for crucibles rendered it increasingly difficult for manufacturers to obtain sufficient supplies of Ceylon graphite, and other kinds of graphite entered into crucible manufacture to a larger degree than in any previous year. As a result, the price of American flake rose to 13-16 cents per pound, according to quality, as compared with 6-8 cents in 1913, and the production was more than double that of the latter year.

Similar conditions persisted on into 1917, but in the latter part of the year, shipments more than met the demand, owing to the falling off of munitions orders, and the consequent decreasing demand for crucibles. Best Ceylon lump brought the maximum price of the war period, 29-32 cents per pound, ex dock New York, in 1917, and Madagascar No. 1 flake brought 14-16 cents. During the early part of 1918, crucible makers and foundries had large stocks of pots on hand, and many crucible factories were working at only half their capacity. At the same time, graphite shipments ordered for future delivery were accumulating, so that supplies of both Ceylon and flake graphite soon became considerably in excess of requirements. Reduction in marine freight and war insurance towards the end of the year brought the price of Ceylon plumbago down to about 30 per cent below the figures prevailing in the early part of the year. To illustrate the downward trend in prices, the figures for the different grades in 1917 and 1918 are shown below:—

Average prices of Ceylon plumbago, ex dock New York, during 1917 and 1918.

Grade.	1917.	Feb., 1918.	Dec., 1918.
No. 1 lump.....	30 cents per pound	25 cents per pound	18 cents per pound
No. 1 chip.....	20 " "	18 " "	14 " "
No. 1 dust.....	12 " "	11 " "	10½ " "

The total imports of Ceylon graphite into the United States in 1917 are estimated at about 80,000 barrels, or 26,666 tons. The spot price of the mineral in this year suffered some decline, and the c.i.f. New York price was caused largely by the excessive ocean freight charges—536 shillings per ton.

As stated above, the rise in price of crucible grades of graphite has given a very considerable impetus to the flake graphite industry of the United States, the most marked effect being seen in the Alabama field, where over forty mills were in operation and under construction by 1917.

The increase in production of refined crystalline graphite of all grades between 1913 and 1917 amounted to nearly nine million pounds.

The graphite industry, in common with many others, has been subjected to a variety of war time restrictions. In order to control the importations of graphite into the United States, a body called the Plumbago-Graphite Association, Inc., was formed in 1917, under the direction of the War Trade Board. This body was composed of prominent graphite importers and brokers, and all foreign shipments of graphite had to be consigned in care of the Association. The Association was also empowered to collect from manufacturers and importers periodical statements of stocks on hand, consumption, etc., for the information of the Government, with a view to providing for such allotment and distribution of graphite and plumbago supplies as would ensure the best interests of manufacturers, importers, and the country in general. By a War Trade Board ruling of March 23, 1918, restriction of graphite and plumbago imports was ordered, to the extent of limiting the total quantity of such imports during the last six months of 1918 to 5,000 tons. This ruling, however, only applied to ocean borne shipments and did not affect rail or lake borne Mexican and Canadian supplies. By a subsequent ruling, 1,000 tons of the 5,000 tons allowed was permitted entry previous to July 1. On July 3, however, a further ruling was made prohibiting all further overseas imports for the remainder of the year.

In common with other articles, all graphite importations into the United States have been made subject to license, and on October 2, 1918, the July 3 ruling was modified to grant such license, in the case of crucible grades of graphite, when satisfactory guarantees were given that the ultimate consumers of such graphite were using at least 20 per cent of domestic or Canadian flake in the manufacture of their products. By the same amendment, all importation of amorphous graphite, other than Mexican or Canadian shipments, was prohibited. Plumbago for any purpose other than crucible manufacture was to remain fully restricted, and the importation of foreign made crucibles was likewise prohibited.

On January 16, 1919, all restrictions governing the importation of foreign graphite or plumbago and the required use of 20 per cent or more of domestic or Canadian flake in crucible mixtures were removed. Restrictions against the importation of foreign crucibles were also removed.

CHAPTER IX.

SOURCES OF THE WORLD'S GRAPHITE SUPPLY.

Graphite is a most widely distributed mineral, and is found in practically all parts of the world. The bulk of the world's production is at the present time derived from some ten countries, but deposits are known, and have in many cases been worked in a small way, in a number of others. Many of the occurrences, however, consist of material that it has not proved practicable to utilize, whether through lack of adequate refining processes to treat the ore or by reason of the graphite being of unsuitable character.

The crucible trade, consuming 75 per cent of the world's total production of graphite, has for many years been supplied mainly from Ceylon, the natural purity of the Ceylon product and its superiority for this class of work, combined with cheap labour and low freight rates, enabling it to compete with flake graphite in practically all markets. In the last few years, however, increasingly large amounts of flake have been derived from Madagascar, and this material has successfully demonstrated its suitability for certain kinds of crucible work. The fact that Madagascar graphite can be mined cheaply, due to native labour and its mode of occurrence, and that expensive refining processes are not required to fit it for the market, will probably lead to its more extensive use, and graphite from this source of supply seems likely, when normal export and freight conditions are established, to exert considerable influence over the flake graphite industry in other countries.

Brief notes on the graphite industry in the world's chief producing countries are given below.¹

AUSTRIA.

Austria, in 1913, the last year for which statistics are available, was the largest producer of graphite in the world, the output for the year being 54,500 short tons. The greater part of the Austrian graphite is amorphous in character, or is so finely crystalline that it cannot properly be termed flake, and it is, therefore, not of crucible grade².

The Austrian production is derived from deposits in four distinct fields. In Bohemia, graphitic slates or schists were worked as far back as 1767 in the Krumau and Schwurzbach districts. The ore undergoes a wet process of concentration, and the production in 1908 is given as 22,160 metric tons. Most of the graphite is consumed in foundry work. The Bohemian deposits are regarded as an easterly extension of the Bavarian

¹ For fuller details see the following:—
de Launay, L., *La Géologie du Graphite*, Annales des Mines, X Series, Vol. 3, 1903, pp. 49-86. (Descriptions of graphite deposits in various countries.)

Dammer, B. und Tietze, O., *Die Nutzbaren Mineralien*, Stuttgart, 1913, Vol. I, pp. 57-85. (Describes the world's graphite deposits and gives notes on uses, etc., of graphite.)

Stutzer, O., *Die Nicht-Erze*, Berlin, 1911, pp. 1-88. (Discusses the occurrence and geology of the more important graphite deposits in various parts of the world.)

² Breitschoff, J., *Das Graphitvorkommen in Südlichen Böhmen*, *Zeitschr. f. Berg. u. Hüttenwesen*, Vol. 58, 1910, pp. 131, 153, 167. (Describes the southern Bohemian graphite deposits and the methods of mining and refining.)

(Passau) ore-bodies; the latter having suffered a greater degree of metamorphism, with consequent conversion of the graphite to the flake form. In the adjoining province of Moravia, graphite is mined at a number of localities. Eight mines were in operation in 1908, and the production totalled 10,285 metric tons. A small amount of graphite is obtained also in the vicinity of Spitz, Lower Austria. In Styria, a number of deposits have been worked; all of the graphite is amorphous in character and the carbon content varies widely, from 42 to 87 per cent. Some of the mines yield a soft, earthy graphite and others a hard material, resembling anthracite. Four mines in 1908 produced 10,000 metric tons.

CEYLON.

The Ceylon¹ graphite deposits came into prominence as far back as 1834, and have grown steadily in importance. The island owns a practical monopoly of the world's supply of crystalline graphite, or plumbago, and since this form of graphite, owing to its greater refractoriness over flake and other kinds, is in great demand for crucibles, the deposits are of paramount importance for the metallurgical industries. While Ceylon graphite was formerly used to some extent in pencils, practically the whole of the present output finds its way into crucibles.

In 1913, the United States took one half of the island's total production of 32,000 tons, the remainder being divided between Germany, 7,000 tons, the United Kingdom, 6,000 tons, Belgium, 2,000 tons, and all other countries 600 tons.

The mineral occurs in veins and also, to a small extent, in the form of flake disseminated in gneiss and crystalline limestones. The veins alone, however, are the source of the entire output, and they range from mere seams to bodies several feet in width. Under favourable conditions, small stringers two or three inches in width are worked. The walls are usually well defined, and the adjacent country rock is not impregnated with graphite to a distance of more than half an inch from the veins.

In the smaller veins, the graphite usually occurs in the form of a mass of parallel fibres or needles set at right angles to the vein walls. In the larger veins, most of the graphite exhibits a coarse, platy or foliated structure, though fibrous graphite often occurs in a narrow zone between the main portion of the vein and the walls, or surrounding included masses of the country rock. This fibrous graphite, known as needle lump, finds high favour commercially.

While usually consisting entirely of graphite, the veins sometimes carry other minerals in appreciable amount. Pyrites is common in disseminated form between the plates and fibres, and sometimes forms more or less definite bands in the central portion of the veins, and quartz occurs in a similar manner. Other accessory minerals are biotite mica, orthoclase feldspar, pyroxene, apatite, allanite, and rutile. In some cases the vein material has been crushed to an earthy consistency by later tectonic disturbances.

¹ Abstract of an article by E. S. Bastin, in *Mineral Resources of the United States, 1911*, Part 11, pp. 1094-1102. The article contains an extensive bibliography on Ceylon graphite.

See also: Weinschenk, E., *Die Graphitlagerstätten der Insel Ceylon*, Abh., d.k. Bayr. Akad. d. Wissensch., Vol. 21, 1901, pp. 233-334.

Weinschenk, E., *Zeitschrift f. p. Geol.*, 1900, p. 179.

Pettinos, C., *Mining and Sorting Graphite in Far-off India*, *Fountry*, Vol. 40, 1912, pp. 315-9.

The veins are worked either by open cast methods or by vertical shafts from which drifts are run. The average depth of the workings does not exceed 100 feet, though in a few cases 400-500 feet has been reached. Flooding of the workings, due to the heavy rainfall, is a great obstacle to deep mining. Mining appliances are, generally, extremely crude, and only a few of the mines are equipped with steam pumps and hoists.

According to the "Mineral Industry", the production of graphite in Ceylon in 1916 was 33,411 long tons. New York prices for the various grades in 1917-8 were:—

	1917.	February, 1918.	December, 1918.
No. 1 lump....	29-32 cts. per lb.	24-25 cts. per lb.	15 cts. per lb.
No. 1 chip.....	19-22 " "	17-19 " "	12 " "
No. 1 dust.....	11-13 " "	10-12 " "	9-10 " "

The carbon content of the above grades averages 88-90 per cent for the lump, 70-85 per cent for the chip, and 70-75 per cent for the dust.

In 1917, the United States took over 81 per cent (by quantity) of the island's output. Owing to the numerous restrictions placed on the exportation of graphite during the last few years, there has been an appreciable curtailment of mining, and in the last half of 1918, due to the embargo placed on graphite imports into the United States, the industry experienced stagnation.

The mines are largely in the hands of natives, who employ only a few hands, and any marked falling off in the market causes many of the mines to shut down.

The following table¹ shows the prices of Ceylon plumbago, ex dock London, that obtained from 1914 to 1918:—

	Best Lump, cents per pound.	Best Chip, cents per pound.
1914, pre-war.....	7	6½
1915, opening.....	7	5½
1915, ending.....	15½	10½
1916, opening.....	17	14
1916, middle.....	23	21½
1916, ending.....	21	17½
1917, opening.....	21	17½
1917, middle.....	16	15
1917, ending.....	15	12½
1918, opening.....	12	7½
1918, ending.....	12	7½

The following extracts from British technical journals, quoted in U.S. Geological Survey Press Bulletin, No. 399, February, 1919, give the latest information available regarding the graphite situation in Ceylon:—

"The Ceylon export last year (1917) approximated to 26,000 tons. The demand suffered considerably by the control, especially in the matter of freights, so that a large number of small mines ceased to work. At the beginning of the year the number of properties in operation was 1,288 and at the end of the year 764, with a corresponding decline in the labour force of about 4,500. Naturally the boom which the industry experienced led to a large number of new properties being opened, but nothing fresh of any

¹ Courtesy of the Morgan Crucible Company, Ltd., London.

importance has been revealed. Generally speaking, the industry is said to be in an unsatisfactory condition, but with the restoration of free markets it is thought that the output can be improved up to a production of perhaps 30,000 tons a year for some years to come."—London Mining Journal, August 31, 1918.

"Ceylon Graphite industry in 1917.—After about a year of stagnation the industry became active toward the end of 1915. This activity continued throughout 1916, which was a record year, the output being 33,400 tons, valued at £1,500,000. The year 1917 commenced with every prospect of similar prosperity, the demand was brisk, high prices were ruling, and the Government was asking for an increased output. During the first 6 months 13,000 tons were exported, realizing £800,000, but during the latter half of the year prices dropped and by the end the demand had practically ceased. The smaller mines have in consequence been shut down, although the larger ones are continuing work and accumulating stocks. There were 1,288 mines working during the first 6 months, but only 764 during the second.

"Over 3,000 new enterprises have been registered during the year, but no new valuable deposits have been discovered. Several abandoned workings have been restarted with good results.

"The output of plumbago depends entirely on the demand and ruling prices; while these are favourable there is every possibility of a yearly production of 30,000 tons for several years.

"The present state of the industry is decidedly bad, and very little can be done to mend matters until markets improve. When this occurs, the exploitation of new lands should be taken in hand, with a view to finding new deposits to take the place of the present mines as they become exhausted."—Board of Trade Journal, August 29, 1918.

The following quotation from Commerce Reports No. 51b, December 17, 1918, gives a summary of the Ceylon industry for 1917:—

"Plumbago, Ceylon's most speculative industry, again had a phenomenal year, owing to the demand created by the war. Toward the end of the year, however, exports fell off, and prospects for 1918 are not good. The total quantity shipped in 1917 was 523,940 hundredweight, valued at \$7,071,803, as compared with 668,216 hundredweight, valued at \$7,298,128, in 1916. In 1915 the exports were valued at only \$2,569,434, which was the record up to that time. According to the Ceylon customs returns, the United States took 84 per cent of the value of Ceylon's plumbago in 1917, and practically all of the remainder went to the United Kingdom. France is said to get her supplies from Madagascar.

"During 1917 the average f.o.b. price of Ceylon plumbago was \$270 per long ton, a slight increase over 1916. Medium to fine grades of ordinary lump ranged during the year from \$210 to \$446 per long ton, while medium to fine chips varied in price from \$130 to \$290 per ton."

"Prices of Ceylon graphite at New York in the beginning of 1918 were 22½ cents a pound for best lump, 21¼ for best chip and 10 to 12 for dust. At the end of the year prices had fallen to 15¼ for best lump, 12¼ for best chip and 9 to 10½ for dust.

"Imports of Ceylon graphite during 1918 amounted to about 9,100 short tons, compared with 24,575 short tons in 1917."

CHOSEN (KOREA).

Shipments of graphite from Korea commenced in 1903, and in 1913 there were six producing mines. Most of the Korean graphite is amorphous, and the carbon content of the material shipped ranges from 60 to 85 per cent. The exports for 1916 totalled 18,704 short tons, valued at \$243,000. Mining operations are controlled chiefly by Japanese firms, and most of the foreign shipments come by way of Japanese ports.

Considerable quantities of Chosen graphite have been consumed in the United States, the material competing with the Mexican amorphous graphite for certain purposes, such as stove polish, paints, etc. The imports of Chosen graphite into the United States in 1917 totalled 2,500 tons.

GERMANY.

The Passau district, in Bavaria, is well known for its deposits of flake graphite. Passau graphite found employment as far back as the Middle

Ages for alchemists' crucibles, and much of the production at the present day enters into crucible manufacture.

The graphite is found¹ in lenses and pockets in gneiss and schists, and is of disseminated flake type. The graphite-gneiss is often weathered to considerable depths, and the ore consists largely of soft, sandy material that is both easy and cheap to mine. The average graphite content ranges from 20-30 per cent. In 1913, the last year for which figures are available, Bavaria produced 13,263 short tons of graphite. In the same year Germany imported over 7,000 tons of Ceylon graphite, being the next largest consumer of this material after the United States. The cutting off of the Ceylon supply is reported to have resulted in a greatly increased output from the Bavarian mines. A process was evolved nearly twenty years ago for pressing or briquetting the smaller Passau flake into aggregates which would be more refractory, and thus better suited to crucible manufacture (see page 109). It is reported that this method has been practised extensively during the war.

ITALY.

Graphite is found in disseminated form in the gneissic rocks of the Pinerolo district, in Piedmont. Most of the graphite found in these rocks is amorphous in character, and is regarded as metamorphosed coal or similar carbonaceous matter.

While the graphite bearing zone has a considerable width, only specially rich ore is worked, this being found in the form of beds or lenses in the schists. The carbon content of the best graphite averages 70 per cent. No system of refining appears to have been practised, the material undergoing only a grinding process at the mines. Similar graphite is found near Bagnaseo, in Liguria.

The Italian graphite production in 1916 was 9,000 short tons. The bulk of the output appears to find use in foundry facings.

MADAGASCAR.

Madagascar has come rapidly to the front in the last few years as an important graphite producer. From 7,000 tons in 1913, the production has risen to 35,000 tons (estimated) in 1917². The country is now one of the world's largest producers of flake graphite, and reports on the extent of the deposits indicate that the output may be expected to be materially increased³. The graphite is of excellent quality and is used extensively in crucible manufacture. Shipping restrictions and embargoes during 1917 and 1918 materially affected the industry. Most of the output goes to England and France, exports to the United States in 1917 totalling 3,000 long tons.

The graphite occurs disseminated in schists, which carry up to 60 per cent of graphite. These schists are found over a very large area, and the quantity of graphite that will be available appears to be enormous. At present, development of the deposits has taken place mainly in terri-

¹Weinschenk, E., Die Graphitlagerstätten des bayrisch-böhmischen Grenzgebirges, *Abh. d.k. Bayr. Akad. d. Wissensch.*, Vol. 19, 1898, pp. 509-64; *Zeitschrift f. p. Geol.*, 1897, p. 287.

²*Mineral Industry*, 1917, p. 310.

³*Mining Magazine*, Vol. XIV, 1916, pp. 324-330. See also Lévat, M. D., *Richesses Minérales de Madagascar*, Paris, 1912, pp. 192-203.

tory adjacent to the principal transportation routes, and the graphite so far obtained appears to have been secured chiefly from surface deposits derived from the weathering down of the schists. This surface material is more or less clayey in character, and the graphite is extracted by either simply washing out the clay and sand in sluices or by passing the material through a rice mill (chaser or muller pan type) to break down any grit or lumps that may be in it, and then washing. These methods, however, as might be expected, recover only about 30 per cent of the graphite in the ore. About 60 per cent of the graphite recovered is of crucible grade.

The ore appears to vary rather widely in character, due to the presence locally of varying amounts of mica and other minerals, and modified systems of concentrating and refining doubtless will have to be devised to meet local conditions once the industry becomes established along modern lines.

Vein graphite resembling that from Ceylon is said to occur in certain localities, but such material has not figured so far to any extent in the exports.

Much information on the Madagascar graphite industry up to 1914 is contained in reports by J. G. Carter, in Daily Consular and Trade Reports of the United States, January 29, 1913, and December 24, 1913. Abstracts from these reports are contained in Mineral Resources of the United States, 1913, Part II, pp. 239-244.

Below are shown¹ the prices that obtained for Madagascar No. 1 flake on the London market from 1914 to 1918:—

	Cents per pound.
June 1914.....	7 ½
April 1915.....	7 ½
April 1916.....	8 ½
April 1917.....	10 ½
Early 1918.....	9 ½

} War risk and rise in freight to buyer's account.

The following data regarding the graphite situation in Madagascar is extracted from U. S. Geological Survey Press Bulletin, No. 399, February, 1919:—

Information has been received from the War Trade Board to the effect that on October 11, 1918, the stocks of graphite in Marseille amounted to 12,000 metric tons. The price asked at that time was 1,500 francs a ton at Marseille, equivalent to 10 cents a pound. In addition, stocks on the island of Madagascar are available at 600 francs a ton (5 cents a pound). The present productive capacity of the Madagascar deposits is estimated at 40,000 metric tons a year. Of the production in 1917, amounting to 35,000 tons, from 10,000 to 15,000 tons were available for export in July, 1918 (Commerce Report, August 16, 1918, p. 630). The "Union des Producteurs de Graphite de Madagascar," recently offered to furnish this country annually 15,000 to 20,000 tons of flake graphite, minimum 85 per cent carbon, at 600 francs a ton (5 cents a pound) f.o.b. Tamatave, with 15 francs difference for each 1 per cent over or below 85 per cent. (Information from Bureau of Foreign and Domestic Commerce). During October and November the London price for Madagascar graphite c.i.f. British ports, as quoted by the London Mining Journal, was £50 a long ton (10 cents a pound). Since December 1 there has been practically no market and quotations have been only nominal. The issue of December 28 stated that a single transaction in Madagascar graphite had been made at £46, ex ship London.

In a recent article (Jour. Chem. Met. & Min. Soc. of South Africa, vol. 19, p. 32, 1918) it is stated that the exports from Madagascar in 1917 amounted to 27,000 metric

¹ Courtesy of the Morgan Crucible Company, Ltd.

tons, but that by the middle of 1918 mining had practically stopped on account of lack of shipping, the principal buyer (Morgan Crucible Co.) having reduced its purchases to one-sixth of the former amount.

L. de Pritzbauer, in a recent article (*L'Avenir de Madagascar, Chimie et Industrie*, vol. 1, p. 679, 1918) states that it is feared that there will be great overproduction after the war and that it will be necessary for the colony to take measures to maintain the production within reasonable limits. The costs of mining and transportation to a seaport are estimated at 450 to 500 francs per metric ton (about 4 cents a pound). The tenor of flake in favourable deposits is 20 to 30 per cent, but anything over 10 per cent is considered workable.

It has been the policy of the War Trade Board to give preference to import licenses for Ceylon graphite. Consequently only 970 short tons were imported from Madagascar during 1918 against 4,393 short tons during 1917.

MEXICO.

Large deposits of amorphous graphite exist in the State of Sonora¹. The graphite has been formed by the metamorphism of coal seams, and the beds are enclosed in altered sandstone. The whole series is extensively intruded by granite, which has effected the metamorphism. The average graphitic carbon content of the main bed worked is 86 per cent, but picked samples are said to run as high as 95 per cent.

The deposits are owned and worked by the United States Graphite Company, of Saginaw, Michigan, to which point the crude graphite is shipped for refining. The refining process consists of grinding and air-floating. (See p. 64).

Sonora graphite is much in demand for pencil manufacture, and it is also used in lubricants, graphite brushes, paints, electrotyping, powder glazing and various other branches of industry.

SOUTH AFRICA.

According to P. Wagner², a considerable part of the domestic demand for graphite and graphite products in South Africa is supplied from a deposit now being worked in the Transvaal. The occurrence is said to be a narrow lense of very fine flake graphite lying between pyroxenite and quartzite. The crude ore is shipped to Johannesburg, where it is milled and worked up into various graphite products, including paints, lubricants, foundry facings, boiler graphite, etc.

SPAIN.

A small production of graphite of crucible grade has been secured intermittently from deposits in the province of Malaga. Attention is now being directed to flake graphite occurrences in the province of Huelva³, and there appears to be some prospect of refining plants being erected to treat the ore, which carries up to 10 per cent of graphite.

In 1916, Spain produced 1,364 short tons.

¹ Hess, F. L., Graphite Mining near La Colorado, Sonora, Mexico, *Eng. Mag.*, Vol. 38, 1909, pp. 36-48. Hornaday, W. D., The Santa Maria Graphite Mines, Mexico, *Min. and Eng. World*, December 7, 1912.

² South African Journal of Industries, Vol. I, No. 6, 1918, p. 497.

³ Mining Magazine, September, 1918, p. 133.

UNITED STATES.

Graphite is found in many localities, and deposits have been worked in seventeen states, but the greater part of the production of flake graphite has so far been derived from New York, Pennsylvania, and Alabama. The occurrences include all three varieties of graphite, flake, amorphous and crystalline or vein graphite. The production of flake graphite in 1917 totalled 5,292 short tons, and of amorphous, 8,301 tons. Details of marketed production and value are given below:—

Domestic Graphite Sold in the United States in 1917.¹

	No. 1 and No. 2 Flake. Pounds.	Other Grades. Pounds.	Total.		Amorphous.	
			Pounds.	\$	Tons.	\$
Alabama.....	4,295,233	1,927,862	6,223,095	719,575
New York.....	1,656,897	1,284,143	2,941,040	261,548
Pennsylvania.....	549,783	255,162	804,945	77,475
Other States*	315,000	300,000	615,000	35,800	8,301	73,481
Total.....	6,816,913	3,767,167	10,584,080	1,094,398	8,301	73,481

*Crystalline: Alaska, California, Montana, and Texas.

Amorphous: Colorado, Michigan, Nevada, and Rhode Island.

The actual production for the year totalled 14,000,000 pounds, but owing to various causes (embargoes and freight congestion) a considerable amount remained over as stocks on hand at the mills.

With the exception of a small quantity produced in California and Texas, all of the flake graphite produced during the year was derived from Alabama, New York, and Pennsylvania. The production from Alaska and Montana consisted of crystalline or vein graphite, resembling that from Ceylon.

According to a preliminary estimate by H. G. Ferguson, of the Geological Survey, the amount of flake graphite produced in the United States in 1918 was nearly 6,500 short tons, valued at about \$1,500,000. This is the largest output so far recorded. Approximately 4,400 tons of the above amount represented No. 1 and No. 2 flake, the remainder being dust and low grade flake. Alabama produced over one-half, and New York about one-fourth of the total output. The production of amorphous graphite is estimated at 7,000 tons.

Below are given brief notes on the more important of the American graphite occurrences.

Alabama.

The Alabama graphite deposits lie in Clay, Chilton, and Coosa counties, in the vicinity of Ashland, Mountain Creek, and Goodwater, respectively. All of the occurrences are similar, and consist of rather low grade graphitic schists carrying from 3 to 5 per cent of graphite. In the majority of cases, the ore worked consists of the rather soft, weathered material that is found above ground-water level, or to a depth of some 50-75 feet below the surface. The large quantity of such ore available makes it unnecessary to mine the underlying, harder rock, which is more difficult to mill. The ore consists for the most part of quartz, with subsidiary sillimanite, mica, graphite and clayey material containing iron oxide. Pyrites and feldspar

¹ Mineral Resources of United States: Part II, 1917, p. 100.

are present in the fresh, unweathered rock. Much of the ore is taken out with the pick, and all the workings are open cast.

The graphitic strata form conformable bands in a mica schist formation, the bands ranging from 30 to over 100 feet in width and extending for many hundreds of feet along the strike. The graphitic bands carry very little mica, and there is great uniformity throughout in the size and character of the flake.

The size of the graphite flakes is rather on the small side, compared with that of the flake from the Pennsylvania, New York, and Canadian deposits.

The graphite industry in Alabama underwent greater expansion in 1917 than in any preceding year. While only three companies were active in 1913, the number of mills operating or under construction in 1917 was over forty, and more than sixty companies had been incorporated.

A variety of concentrating and refining methods is practised, including film flotation by wet boxes, Callow, Minerals Separation and Simplex oil flotation, electrostatic separation and dry table concentration. The Alabama Graphite Producers' Association was formed in 1917 to secure mutual cooperation between the various operators, with the object of standardizing mill products and assisting the industry in its development.

For descriptions of milling methods see Chapter VII.

New York.

The Adirondack region of New York¹ has long been an important producer of flake graphite, the deposits being situated for the most part in Essex, Warren, and Saratoga counties, in the neighbourhood of Ticonderoga and Saratoga Springs. The largest producing mine in the United States—that of the American Graphite Co., a subsidiary of the Joseph Dixon Crucible Co., of Jersey City—is located at Graphite, near Lake George.

The graphite bearing series of this State consists of metamorphosed Pre-Cambrian rocks, chiefly crystalline limestones, schists and gneiss, the whole being extensively intruded by pegmatites. In their general nature, the deposits are similar to those of the Quebee region, in Canada. In some cases, the rock worked is a crystalline limestone carrying 3-5 per cent of graphite; in others, graphitic gneiss or schist forms the bulk of the ore. At some localities, somewhat pockety masses of graphite occur as contact deposits between limestone and pegmatitic intrusions, this mode of occurrence closely paralleling that at Grenville, St. Remi, and other localities in the Province of Quebec. Small veins of graphite also occur, but are considered too narrow to work. As a general thing, the milling ore of this region is somewhat lower in graphite than that worked in Canada, 5-8 per cent probably being the average of the various mines.

The number of producing mines in the State in 1917 was three. A variety of concentrating methods has been employed in the different mills, including the dry process by means of rolls and screens, but wet concentration by means of buddles has been the system most generally practised. The mill of the American Graphite Company has been recently (September, 1918) equipped with the Callow oil flotation system. (See also Chapter VII.)

¹ Newland, D. H., *The Mining and Quarry Industry of New York State*, New York State Museum Annual Bulletin, 1904-18. Alling, H. L., *The Adirondack Graphite Deposits*, New York State Museum Bulletin, No. 199, July 1917.

Pennsylvania.

The graphite deposits of Pennsylvania¹ are situated in the Pickering valley, near Byers and Chester Springs, in Chester county. The graphite-bearing rock is a gneiss with local mica schist phases. Numerous accessory minerals occur, and the rock is extremely variable both in mineralogical composition and texture. Pyrites and pyrrhotite are commonly present in considerable amount in the graphitic bands. The rocks have suffered much deformation, and it has not proved possible to trace any one band of graphite for a very great distance. There are a number of graphitic bands, which as a rule merge gradually into the enclosing gneiss. The amount of graphite carried varies from 3 to over 10 per cent and probably averages about 4 to 5 per cent. The width of the bands ranges from 6 to over 100 feet. The gneiss is intruded extensively by pegmatite dikes, and these also usually contain some graphite. Small veins of graphite also are found, but they have in no instance proved large enough to work.

Mining operations are in most cases confined to the decomposed surface rock, which extends to a depth of about 100 feet. This rock is so soft that it can readily be broken down with the pick, and the ore fed to the mill is in some cases practically a gravel. A great deal of the mining is by open cast methods, though in some cases drifts and shafts are employed.

Much of the flake is rather larger than that usually found in rocks of the above type; and the ore being soft and requiring little crushing, the proportion of No. 1 flake recovered is relatively high.

Five companies reported production in 1917. Various methods of concentration have been employed in the different mills, log- and rake-washers, buddles, oil flotation, and dry concentration by means of rolls and screens all having been tried. (See Chapter VII).

CRYSTALLINE GRAPHITE OR PLUMBAGO.

Alaska.

Small shipments of hand picked crystalline graphite have been made during the last ten years from deposits in the Seward peninsula. The graphite occurs in the form of lenses enclosed in mica schists. The lenses have a width of 1 to 6 feet.

Montana.

Crystalline graphite occurs near Dillon, in veins ranging up to 16 inches in width. The material of the veins consists of practically pure graphite in the form of aggregates of bladed or fibrous crystals. The deposit has been worked for several years past, the method of working being by means of an adit, from which a shaft has been sunk on the vein. Two levels have been driven from the shaft at depths of 75 to 100 feet below the adit. The graphite occurs in irregular veins following fracture planes in quartz- or mica-schists and pegmatite, and the general mode of occurrence would seem to be similar to that of the graphite veins found in the Grenville series in Canada.

¹ Miller, B. L., Graphite Deposits of Pennsylvania. Pennsylvania Topographic and Geologic Survey Commission, 1912.

FLAKE GRAPHITE.

California and Texas.

Small amounts of flake graphite have been produced in recent years in California (Los Angeles and San Diego counties) and Texas (Llano and Burnet counties). In both these States, the graphite occurs in the disseminated form in schists.

AMORPHOUS GRAPHITE.

Colorado.

Deposits of amorphous graphite are worked in Chaffee and Gunnison counties. Both occurrences are regarded as altered coal seams, and the beds range from 3 to 6 feet in thickness.

Michigan.

Graphitic slate, carrying up to 35 per cent of graphite, has been mined for a number of years near L'Anse, Baraga county. The material is pulverized and air floated, the product so obtained being used in paint manufacture. (See page 64.)

Nevada.

Graphite suitable for paint, and carrying 30-50 per cent of graphitic carbon, is mined near Carson, Ormsby county.

Rhode Island.

Graphitic shale has been worked for many years in the vicinity of Providence and Tiverton. The Providence material averages 50 per cent graphitic carbon, and is in considerable demand for certain classes of foundry facing. The Tiverton graphite is employed chiefly in paints. Both occurrences consist of graphitized anthracite, and the material is hard and brittle and often carries a large amount of fibrous quartz. The alteration of the coal to graphite is regarded as due to regional rather than contact metamorphism, and the greatest degree of graphitization is observed where the bed has been intensively crumpled and squeezed.

It is reported¹ that more extensive mining operations for graphite have lately been undertaken near Portsmouth, and that a mill for grinding and refining the ore has also been erected.

MISCELLANEOUS LOCALITIES.

In addition to the deposits in the countries mentioned, occurrences of graphite are known, and in some cases have been worked in the past, in many other parts of the world. Among these may be mentioned Borrowdale², in England; the Alibert mine, west of Irkutsk, in Siberia; Norberg, in Sweden; the Marbella mine, Malaga province, in Spain; Cantons Wallis and Graubünden, in Switzerland; Senjen, in Norway; Travancore and Mysore, in India; Barrieros, in Brazil; near Ladysmith, in Natal; Pietersburg district, in the Transvaal; Mount Bopple, in Queensland; Munglinup, Western Australia; Eyre peninsula, South Australia; Pakawau, New Zealand³.

¹ Brass World, May 1919, p. 133.

² See Special Reports on the Mineral Resources of Great Britain, Vol. V, 1917, p. 27. New Zealand Journal of Science and Technology, May 1919, pp. 198-209.

World's Production of Graphite.

Complete statistics of the world's annual production of graphite are only available to 1913. In that year, a total of 139,283 short tons was produced¹. This total comprises graphite of all grades, and approximately one-half of it may be taken as amorphous graphite. Assuming that the German and Austrian outputs only kept up to the pre-war level of 1913, the total world's output in 1916 probably will not have fallen far short of 150,000 tons. The increasing importance of Madagascar as a producing country is shown by the fact that the production increased from 7,000 tons in 1913 to 28,000 tons in 1916.

The following table and diagram of production for the periods 1913-17 and 1907-17 respectively, are taken from the reference in the footnote on this page:—

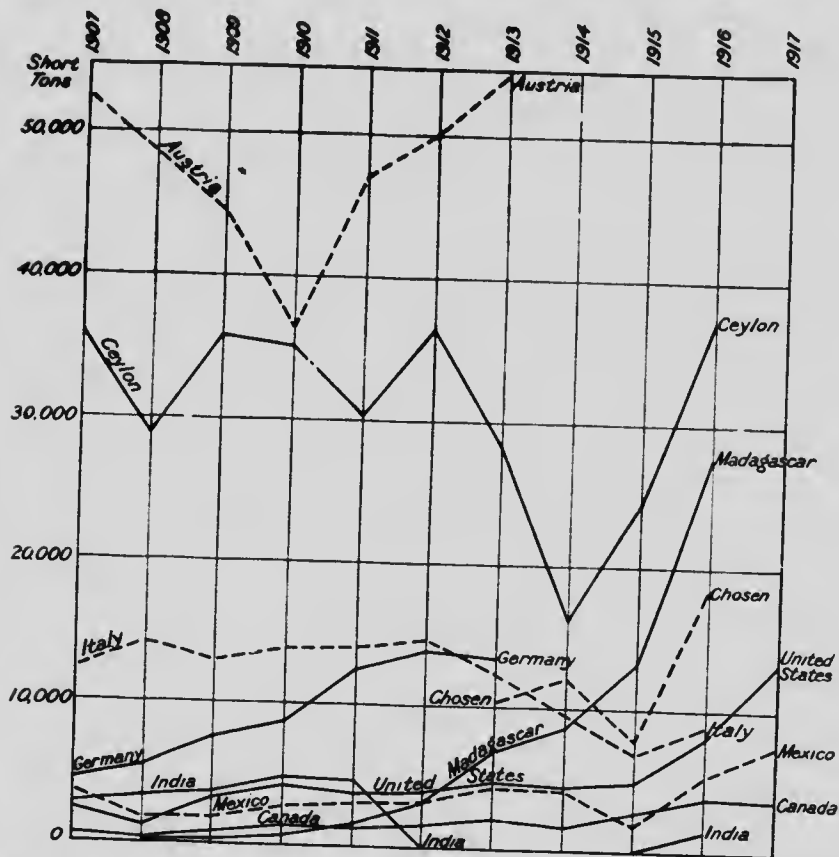

Fig. 43. Diagram showing production of graphite in principal countries in 1907-1917. Full lines indicate that bulk of the production is crystalline or flake graphite; dotted lines, amorphous. (United States Geological Survey.)

¹ Mineral Resources of the United States, 1917, Part II, p. 106.
67945-133

World's Production of Graphite, 1913-17.

	1913.		1914.		1915.		1916.		1917.	
	Quantity (short tons).	Value.	Quantity (short tons).	Value.	Quantity (short tons).	Value.	Quantity (short tons).	Value.	Quantity (short tons).	Value.
United States(a).....	4,775	\$ 293,756	4,335	\$ 524,118	4,718	\$ 429,631	8,068	\$ 935,471	13,593	\$1,167,879
Canada.....	2,162	90,282	1,647	167,203	2,635	124,233	3,971	285,362	3,714	402,862
Mexico(b).....	4,435	196,000	4,259	190,075	1,680	75,000	5,331	238,000	7,570	285,568
Germany.....	13,263	63,308	(c)	(c)	(c)	(c)	(c)	(c)	(c)	(c)
Austria.....	54,501	412,745	(c)	(c)	(c)	(c)	(c)	(c)	(c)	(c)
Spain.....	1,194	3,441	(c)	(c)	33	(d)2,000	1,364	(d)79,000	(c)	(c)
France.....	97	2,831	(c)	(c)	(c)	(c)	(c)	(c)	(c)	(c)
Sweden.....	12,282	65,790	62	1,813	87	(c)	214	(c)	(c)	(c)
Italy.....	10,264	116,389	9,441	(d) 50,051	6,793	(d)33,000	9,017	(c)	(c)	(c)
Japan.....			632		734		1,261	25,903	(c)	(c)
Chosen (Korea).....			(b)12,000	(d)156,000	(b)7,767	101,041	(b)18,704	(d)243,000	(c)	(c)
India.....	28,540	2,935,529	15,929	1,142,000	78	769	1,476	7,304	(c)	(c)
Ceylon(b).....	6,958	(d)423,000	8,540	(d)F 6,000	24,436	2,569,434	37,420	7,296,128	(c)	(c)
Madagascar.....	39	6,117	(c)	(c)	13,060	(d)686,000	28,090	(d)2,213,000	(d)38,500	(c)
South Africa.....			38	4,718	46	5,856	67	8,657	(c)	(c)
Australia.....					77	144	(c)	(c)	(c)	(c)
	139,283	4,611,188								

(a)Sales at mines.

(b)Export figures.

(c)Data not available.

(d)Estimated.

ARTIFICIAL GRAPHITE.

The chief producer of artificial graphite is the Acheson Graphite Company, with plants at Niagara Falls and Buffalo, N.Y., and Niagara Falls, Ont. The demand for this class of graphite has grown rapidly, and the material now proves an important addition to the supply of natural graphite. Artificial graphite is made either from anthracite coal or from petroleum coke (see p. 114) and is employed chiefly in lubricants, paints, foundry facings, battery fillers, and boiler scale preventives.

In addition to the bulk graphite produced, there is a large output of graphite electrodes, the demand for which has risen rapidly during the last three years owing to the great development of certain electro-chemical industries and the large increase in the adoption of electric furnaces in steel manufacture. There has been a growing tendency to employ electric furnaces in place of crucibles for melting steel, and the production of crucible steel in the United States is said to be now only one-eighth of that of electric furnace steel. The number of electric steel furnaces in use in the United States in 1917 was 223, as compared with 136 in 1916.

The following table shows the production of artificial graphite in the United States from 1899 to 1917:—

Production of Manufactured Graphite, 1899-1917¹.

Year.	Quantity. Pounds.	Value.	Price per Pound. Cents.
1899.....	405,870	\$ 32,475	8-00
1900.....	860,750	68,860	8-00
1901.....	2,500,000	119,000	4-76
1902.....	2,358,828	110,700	4-69
1903.....	2,620,000	178,670	6-82
1904.....	3,248,000	217,000	6-70
1905.....	4,505,500	313,079	6-83
1906.....	4,868,000	312,764	6-42
1907.....	6,924,000	481,717	6-97
1908.....	7,385,511	502,667	6-80
1909.....	6,870,529	467,196	6-80
1910.....	13,149,000	945,000	7-19
1911.....	10,144,000	664,000	6-54
1912.....	12,896,347	830,191	6-44
1913.....	13,633,312	973,397	7-14
1914.....	10,455,139	698,800	6-69
1915.....	(a) 5,580,437	109,102	1-96
1916.....	(a) 8,922,329		
1917.....	(a) 10,474,649		

(a) Powdered graphite only; electrode material not included.

The production of artificial graphite at the Canadian plant of the above Company from 1906 to 1917, is shown in the following table:—

Production of Artificial Graphite in Canada, 1906-17².

Calendar Year.	Pounds.	Calendar Year.	Pounds.
1906.....	445,017	1912.....	2,302,625
1907.....	407,779	1913.....	2,184,472
1908.....	428,540	1914.....	1,234,239
1909.....	513,436	1915.....	407,271
1910.....	2,442,166	1916.....	525,048
1911.....	2,172,098	1917.....	1,096,172

¹Mineral Industry, 1917, p. 312.

²From returns furnished to the Mines Branch, Division of Mineral Resources and Statistics.

CHAPTER X.

DETERMINATION OF THE CARBON CONTENT OF GRAPHITE AND GRAPHITE ORES.

The value of a graphite for most purposes depends essentially on the amount of carbon it contains, so that for all practical purposes the determination of the latter may be considered sufficient. In certain cases, it may be necessary to determine the amount of foreign matter present, and also what mineral or other substances this consists of. For crucibles, for instance, it is important to know the amount of mica, calcite, pyrite, etc., present, since these substances are highly detrimental to the quality of the crucibles made from graphite containing them in appreciable amount. The presence of silica in graphite for this class of work is not objected to for any deleterious quality it possesses, since silica is added to most crucible mixtures in any case, and, provided the amount did not exceed the permissible limit, its presence would not be prejudicial. For lubricating purposes, however, a graphite containing silica is obviously unsuitable, whereas mica would not be an injurious impurity.

Since, however, many commercial uses of graphite call for some sort of further treatment of the material as received from the mills, which treatment often results in a certain amount of waste that cannot be utilized for the particular purpose in view and that is disposed of for use in some other industry, it is desirable, if only to obviate the necessity of repeated analysis, to start out with a product of the highest guaranteed purity consistent with cheapness of production. By the various mechanical refining processes now practised, many of the flake graphites can be brought up to a purity of 88 to 92 per cent carbon, and thus a carbon content of 90 per cent is the standard usually stipulated for by the trade. The remaining 10 per cent as a general thing includes varying amounts of mica, pyrites, quartz or calcite as the chief mineral substances, and these may be eliminated to a certain extent by the further treatment that the graphite often undergoes in the factory.

A number of methods for the determination of the carbon content of graphites, as well as for ascertaining the amount of the various impurities present, have been proposed. Some of these are rather involved and take too long to have found adoption in general practice.

The exact method, or combination of methods, to be followed is largely dependent on the class of material to be investigated. For instance, to determine the carbon content of a high grade sample that can be seen to consist for the greater part of graphite, requires a different procedure to that where a graphite ore of relatively low carbon content is in question.

The determination of graphitic carbon with scientific exactness is a matter of difficulty, and can, perhaps, not be accomplished satisfactorily by ordinary methods. For practical purposes, however, such accuracy is not required, and entirely adequate results are obtained by any one of the several methods ordinarily employed in commercial practice.

COMBUSTION METHOD.

In determining the graphite present in a sample of commercial graphite, that is to say, of a graphite that has undergone a process of refining and has been brought to a purity of between 80 and 90 per cent, the combustion method is the one often practised. By this method, the percentage of graphite is calculated from the loss in weight of the sample after all of the carbon has been burnt off at a high temperature, the process of combustion preferably being accelerated by the admission of a current of oxygen into the crucible in which the operation is conducted. At such temperature, the carbon combines with the oxygen and passes off as carbonic acid gas, leaving the impurities in the form of an ash, which is weighed and the weight subtracted from that of the sample.

In employing this method, the following points have to be taken into consideration, and the necessary allowance made:—

1. Hygroscopic water is almost sure to be present, and is driven off at a comparatively low temperature. The amount of such water must therefore be determined by a preliminary heating. This determination is usually made by placing the sample on a watch glass and heating to 110°C in the electric oven.

2. Allowance must also be made for combined water. This is determined by igniting the sample in a platinum crucible, well covered to exclude air, for one minute at a temperature of 500° – 600°C . As a certain small amount of graphite may be burnt off during this operation, it is well to repeat the procedure a second time, in order to secure a check on this loss. Any volatile hydrocarbon present will also be removed at this stage.

3. Certain graphites contain calcite, or calcium carbonate, and combustion will drive off carbonic acid gas, which loss will also have to be allowed for. The determination of the calcite is preferably to be made before combustion, by treating the sample with dilute hydrochloric acid. By determining the loss in weight after washing and drying, the calcite may be calculated from the amount of lime necessary to combine with the carbonic acid expelled.

4. If iron pyrites or pyrrhotite (the latter is a common accessory mineral in Canadian flake graphites) be present, there will be a loss of sulphur during combustion. This loss would appear to be frequently overlooked, but may materially affect the accuracy of the analysis. The most convenient way of determining any loss from this side is to treat the sample before combustion with dilute nitric acid. This converts the sulphide into soluble sulphate. Nitric acid also dissolves any calcite present, so that this acid may conveniently be used in all cases where it is not desired to determine the amount of such substance. Since the object generally in view is to ascertain with a sufficient degree of accuracy merely the graphitic carbon content of the sample, and not to determine the nature of the impurities, the nitric acid treatment is the most convenient, since it dissolves both calcite and pyrites, while quartz, mica, and any other silicates present, all of which are unattacked, remain in the ash after combustion.

The above are the principal points that have to be considered in a graphite determination, with special regard to the impurities likely to be present. The presence of hydrogen, oxygen and nitrogen may also affect the strict accuracy of the result, but for all practical purposes, the loss in weight from this source may be neglected. Some graphites yield a fusible ash, which envelopes the graphite particles and prevents complete

combustion by excluding oxygen. With such graphites, the combustion method is liable to give inaccurate results, and other more involved procedure must be resorted to.

The size of sample usually taken for the combustion method is 0.3 to 1.0 gram, and the time required for the operation, when a current of oxygen is used, from 1 to 2 hours. If combustion in air alone be practised, the time for complete combustion will be 2 to 5 hours. The operation should take place in a platinum crucible, provided preferably with a perforated lid, the round hole in which measures 5 millimetres in diameter, for the insertion of the oxygen feed tube. The sample should be finely ground, and the crucible fixed in an inclined position, with the lid so placed that about one-fourth of the opening is left uncovered. Heat may be supplied by a Bunsen burner.

Combustion is accelerated by exposing a fresh surface of the sample, either by turning the crucible occasionally or by stirring with a platinum wire. For strict accuracy the crucible should be weighed before and after combustion, in order to check any loss of weight. If it be desired to analyse the ash of a graphite sample, combustion may be effected in a muffle, using a platinum dish instead of a crucible. In this way, a larger amount of material may be taken as a sample without unduly prolonging the time required for combustion, and a correspondingly larger amount of ash is thus secured for analysis.

The most satisfactory method for commercial practice, working on graphites that contain calcite and pyrites or pyrrhotite, as is commonly the case with Canadian flake graphite, is probably the following:—

Reduce the graphite to a powder fine enough to pass an 80-mesh screen. Take two samples of equal weight, say from 0.5 to 1.0 gram. On one sample determine the hygroscopic and combined water as follows. First heat to 100°C–110°C on a watch glass in the electric oven and determine loss = hygroscopic water, by weighing. Then ignite in a well covered platinum crucible at lower than a red heat, (500°–600° t²) for one minute. Weigh to ascertain loss = combined water¹, and repeat the procedure as a check. Remove crucible cover to restore atmosphere and get rid of any carbonic acid gas formed by the decomposition of carbonates present, replace cover and ignite as above for two minutes. Weigh, in order to ascertain amount of graphite burnt off in these two minutes, as a check on any loss of graphite during two previous ignitions. Boil the second sample with 15 c.c. of dilute nitric acid, wash, filter on a Gooch crucible and dry at 110°C. Weigh, and then ignite at full heat of Bunsen burner in a covered platinum crucible in a current of oxygen led in through a tube inserted in an opening in the lid. The gas is conveniently passed through a wash bottle or bubble tube, in order to control the flow. During combustion, the contents of the crucible should be stirred frequently with a platinum wire. Heating is continued until the material assumes a light grey colour. Determine weight of the ash and deduct from that of the sample before ignition.

In the case of graphites containing negligible amounts of sulphides and calcites, it is not necessary to employ two samples, and the treatment with nitric acid may be dispensed with. Most flake graphites of the crystalline rocks, however, contain these minerals, and this is especially true of those from unweathered deposits, such as are found in the Grenville series of Canada¹. In these, both silica and sulphides are present in a state of

¹ Any organic and volatile matter will also be removed at this stage.

microscopic fineness in the flakes, and cannot be removed entirely by any process, mechanical or chemical, without destroying the flake form.

FUSION METHOD.

In the case of graphite ores, whose carbon content may range from 70 per cent upward, determination of the graphite may preferably be made by means of fusion with caustic alkali. Such a method has been described by Hyde¹. About 35 grams of caustic potash are melted in a silver crucible over a very low Bunsen flame, and 0.5 to 1.0 gram of the powdered sample is carefully brushed onto the surface of the liquid. The crucible is then covered, and the contents allowed to simmer quietly for half an hour. After cooling, dissolve the melt in 250 c.c. hot distilled water, and filter by suction on a weighed filter, previously treated first with a solution of caustic potash and then with hot, dilute hydrochloric acid. After washing the graphite on the filter, iron oxide is dissolved with hot dilute hydrochloric acid, and the filter with the graphite washed with hot water and dried.

In place of the caustic potash used above, a mixture of this substance and caustic soda may be employed to advantage.

In the fusion method, it is, however, not always easy to judge when the action of the molten alkali is complete, and its power of penetration into the graphite would seem to be to some extent dependent on the nature of the latter and on the temperature of fusion. Results obtained by this method have been found, as a general thing, to be considerably lower than those yielded on the same material by combustion, the difference being considered as due to loss by oxidation of graphite in contact with red hot alkali and to some extent, also, to loss in filtering, etc. The method, however, is useful, when the sample contains material that is fusible at the temperatures reached in the combustion method, or when a supply of oxygen is lacking. It obviates, also, preliminary determinations for moisture and volatile matter. Alumina, lime and magnesia, also, may be determined in the alkaline filtrate, and iron in the acid washings from the graphite residue.

ABSORPTION METHOD.

A second method suitable for use on graphite ores or tailings is the absorption method. In this, the carbonates and sulphides are first removed by boiling the sample with dilute nitric acid. The residue is then washed and dried, and ignited in a combustion tube through which a current of dried and purified oxygen is passed. The graphite is oxidized, the carbon combining with oxygen to form carbonic acid gas, which is passed through a drying agent, such as calcium chloride, and then absorbed by leading through a previously weighed amount of caustic potash, the carbon being calculated from the increase in weight of the latter after combustion is complete. The results by this method check satisfactorily with those obtained by straight combustion.

RE-CARBONATING METHOD.

What is known as re-carbonating is sometimes practised in analysing graphites, but the method is inaccurate and unsatisfactory where other

¹ Mineral Industry, Vol. IX, 1900, p. 381.

impurities than carbonates are present, such as sulphides. By this method, the sample is ignited in the ordinary way, and after complete combustion, the allowance to be made for any carbonates that may have been present is determined by treating the ash with a concentrated solution of ammonium carbonate, drying and gently heating. The lime present in the ash thus is re-converted into the original carbonate form. When sulphides are present, however, the loss of sulphur during combustion constitutes an error that affects the results.

FURTHER NOTES ON ANALYTICAL METHODS.

Heinisch¹ gives the following procedure for the qualitative and quantitative determination of graphite:—

Qualitative Determination.—For a rough test, in which merely the detection of the presence of carbon will suffice, as, for instance, where it is desired to distinguish between graphite and other non-carbon substances of similar appearance, (e.g. molybdenite), any of the three following methods may be followed. (1) Ignite a small, finely powdered sample on platinum foil and observe the change of colour that takes place. Molybdenite loses sulphur and yields an ash that is at first yellow and later grey, while graphite retains its black colour. (2) Treat the powdered sample with dilute hydrochloric acid to remove any carbonates present, dry, ignite in a hard-glass tube in the presence of a stream of oxygen and pass the gas evolved through milk of lime. If graphite be present, a white precipitate of calcium carbonate will be formed. (3) Mix intimately about 0.1 grams of the finely powdered sample with 2 grams of lead oxide and heat in a closed glass tube, when, if carbon be present, the lead oxide will be reduced to metallic lead.

For precise results, however, Berthelot recommends the graphitic acid test by means of nitric acid and potassium chlorate. This mixture has no effect whatever on the diamond, completely dissolves amorphous carbon and with graphite yields a greenish-yellow residue of graphitic acid, which, on drying, turns brown. The procedure to be adopted in making this test is as follows.

A mixture of 50 c.c. concentrated sulphuric acid with 25 c.c. concentrated nitric acid is placed in a shallow porcelain dish and into it is stirred first 1.25 grams of the finely powdered sample and then, at short intervals, 22.5 grams of potassium chlorate. The mixture should be stirred frequently and the chlorate added in small quantities in order to avoid too rapid oxidation, which may result in the conversion of part of the graphitic acid to carbon dioxide. After no more graphite is visible in the bottom of the dish and the evolution of gas has stopped, a small portion of the greenish residue may be tested with a solution of potassium permanganate, which turns graphitic acid yellow. The contents of the dish are then poured into a large beaker of water and allowed to settle, after which the liquid is decanted and the residue again washed with water. The wash-water usually becomes strongly discoloured, but the resultant loss of graphitic acid is small.

After thorough washing, the residue of green graphitic acid is rendered yellow by the addition of potassium permanganate, 0.35 grams of the latter sufficing for 1.25 grams of graphite. The permanganate is first dissolved

¹ Doelter, C., *Handbuch der Mineralchemie*, Vol. 1, 1912, p. 58.

in 6 c.c. of warm water, and, after cooling, is mixed with dilute sulphuric acid (0.6 c.c. concentrated acid to 3.75 c.c. water), after which it is added to the green residue. This operation, also, may take place conveniently in a porcelain dish, which is then placed on the water-bath and the contents stirred continuously until the red colour disappears. A small quantity of hydrogen peroxide is then added, and the whole allowed to stand. The graphitic acid is finally washed, first with dilute nitric acid, then with alcohol and ether, and is dried in a dessicator. Drying should proceed in the dark, since graphitic acid turns brown when exposed to the light. The same thing takes place when it is dried by warming. The brown colour, however, changes back to green on the addition of concentrated nitric acid and potassium chlorate, or to yellow when potassium permanganate and sulphuric acid are added. Moist, freshly prepared graphitic acid is yellow and crystalline. On drying, it forms a sticky, brown, amorphous mass, which is unaffected by all solvents. On heating alone, it is rapidly decomposed and glows strongly, leaving a carbonaceous substance, which is termed pyrographite oxide. When the latter is ignited, it forms, not amorphous carbon as was long supposed, but graphite.

If the material to be tested contains much in the way of impurities, it is advisable to first fuse it with caustic potash and then treat it with aqua regia and finally with hydrofluoric acid.

In order to detect the presence of coal, coke, charcoal, lampblack, etc., in a commercial graphite, the following methods are recommended. The material is first powdered, and then heated for some time with concentrated nitric acid. If no reddish-brown coloration results, there is no anthracite, soft coal, lignite or charcoal present. In order to detect coke, the powder is fused with a small amount of sodium sulphate, the fused mass extracted with little water and the solution tested with lead paper. If there is an important amount of coke present, the paper will turn black, owing to the formation of lead sulphide. Graphite itself has little if any reducing action on the sulphate. Coke is an active reducing agent for sodium sulphate at fusion point, so that the filtered solution of the fused material will contain both sodium sulphide and sodium sulphate, according to the proportion of coke present. The presence of coke may also be suspected if the sample, when treated with dilute hydrochloric acid, gives off sulphuretted hydrogen, due to the acid attacking the sulphides generally present in coke in some amount.¹

Should the powdered sample, when heated with concentrated nitric acid, yield a reddish-brown solution, this indicates the presence of either coal, charcoal or lampblack, or all three. On heating a small amount of the material in a closed glass tube, the presence of soft coal or lignite is evidenced by the driving off of volatile matter in some quantity. Anthracite yields only minute amounts of such volatile distillation products, while none at all are given off by charcoal. If soft coal alone is present, and in some amount, the volatile matter will give a decidedly alkaline reaction. Lignite is indicated, if, on heating a small sample of the material with dilute nitric acid (1:10) a solution of a brownish-red colour is obtained. To detect lampblack, a sample of the material is extracted with petroleum ether. If lampblack be present, a solution is obtained that is either colourless or only very slightly yellow. On evaporation, this solution leaves behind a distinct tarry or smoky smell, due to small amounts of matter soluble in petroleum ether that were present in the lampblack. Pure graphite is quite unaffected by petroleum ether.

¹ It should be noted that certain graphites also contain sulphides, and thus these tests may not be positive.

Quantitative Determination.—The most accurate method consists in burning the finely powdered sample in a current of oxygen, and collecting the carbon dioxide driven off. The sample is very finely powdered, then boiled in dilute hydrochloric acid to remove any carbonates that may be present, washed and dried. From 0.1 to 0.2 grams of the material is placed in a clay or platinum boat, which is inserted in the tube of a combustion furnace and burned in a current of oxygen. The gas driven off is led through a weighed tube filled with calcium chloride, which absorbs any moisture present, and then into a weighed tube containing soda-lime and a small quantity of a dryer, such as phosphoric pentoxide. The carbon dioxide is caught in this second tube, which is weighed and the carbon content of the sample calculated. Combustion takes 45 to 50 minutes. Since many graphites contain pyrites or pyrrhotite, it is necessary to place lead chromate in the combustion tube in order to absorb the sulphur dioxide evolved.

Artificial graphites that contain no chemically combined water or other volatile constituents, may be burned in a large platinum crucible over the blast, oxygen being led in through a clay tube inserted in a hole in the lid.

In determining the carbon content of a graphite sample by the loss in weight after combustion, that is, by weighing the ash, the following must be taken into consideration: Any water chemically combined in silicates that may be present is not driven off at temperatures below 150°C., and if this temperature is exceeded, in order to determine such water as loss on ignition, the figures obtained are unreliable. Precaution must always be taken against carbonates by treating the sample before combustion with dilute hydrochloric acid. After drying, the resultant loss is determined by weighing, and a portion of the residue is then taken as the sample for combustion. If pyrites or pyrrhotite is present, sulphur dioxide is liberated on burning, leaving iron oxide in the ash. As 240 parts of pyrites yield 160 parts of iron oxide, it is clear that the carbon content will appear too high unless the above is taken into consideration. In addition, the hydrogen, oxygen, nitrogen, and sulphur content of the graphite is a source of minor error.

Many graphites when burned yield a sinter or fusible ash, which encloses particles of the graphite and protects them from oxidation. In such cases, it is advisable to add a small, weighed quantity of well-calcined magnesia to the sample.

In many cases, complete combustion may be effected by burning the finely powdered sample in a shallow platinum dish placed in the strongly heated muffle of an assay furnace, until the ash turns white.

APPENDIX.

BIBLIOGRAPHY OF CANADIAN GRAPHITE.

Geological Survey Publications.

- Bailey, L. W. and Matthew, G. F., Report of Progress, 1870-1, p. 230. (New Brunswick.)
 Ells, R. W., Annual Report, Vol. IV, 1888-9, Part K, pp. 134-9. (Quebec.)
 Ells, R. W., Annual Report, Vol. XII, 1899, Part J, pp. 107-10. (Quebec.)
 Ells, R. W., Annual Report, Vol. XIV, 1904, p. 69J.
 Ells, R. W., Bulletin on Graphite, 1904. (General.)
 Ells, R. W., Geology and Mineral Resources of New Brunswick, 1907, p. 114.
 Hayes, A. O., Summary Report, 1913, p. 242. (New Brunswick.)
 Hoffmann, G. C., Report of Progress, 1876-7, pp. 489-510. (General and analyses.)
 Hoffmann, G. C., Report of Progress, 1878-9, p. 311. (New Brunswick.)
 Hunt, T. Sterry, Geology of Canada, 1863, pp. 529, 793; 1863-6, pp. 218-23. (General.)
 Ledoux, A., Summary Report, 1915, p. 164. (Quebec.)
 Logan, Sir W., Geology of Canada, 1863-6, pp. 22-27. (Quebec.)
 Osann, A., Annual Report, Vol. XII, 1899, Part O, pp. 66-82. (Quebec.)
 Stansfield, J., International Geological Congress, Guide Book No. 3, 1913, pp. 101-7. (Quebec.)
 Vennor, H. G., Report of Progress, 1872-3, p. 178. (Ontario.)
 Vennor, H. G., Report of Progress, 1873-4, pp. 139-143. (Quebec.)
 Vennor, H. G., Report of Progress, 1876-7, pp. 308-20. (Quebec.)
 Wilson, M. E., Summary Report, 1911, p. 283. (Quebec.)
 Wilson, M. E., Summary Report, 1913, pp. 196-207. (Quebec.)
 Wilson, M. E., Summary Report, 1915, p. 156. (Geology of Quebec graphite area.)
 Wilson, M. E., Summary Report, 1916, pp. 214 and 219. (Graphite in Argenteuil County, Que.)
 Wilson, M. E., Summary Report, 1917, Part E, pp. 29-42. (Port Elmsley, Ontario.)
 Wilson, M. E., Memoir 113, 1, pp. 38-43. (Amherst, Que.)
 Young, G. A., and Brock, R. W., Geology and Economic Minerals of Canada, 1909, p. 100. (Ontario and Quebec.)
 Annual Volumes, Statistical section, 1885 to 1906. (General and statistical.)
 Catalogue of Economic Minerals of Canada sent to the International Exhibition in London, 1862, p. 27.
 Catalogue of Economic Minerals of Canada sent to the International Exhibition in Philadelphia, 1876, p. 121.
 Catalogue of Economic Minerals of Canada sent to Colonial and London Exhibition, 1886, p. 150.
 Catalogue of Section One of the Museum, 1893, p. 134. (List of Canadian graphite occurrences.)
 Report of Progress, 1851-2, pp. 42, 118.
 Report of Progress, 1852-3.
 Report of Progress, 1853-6, p. 41.

Mines Branch Publications.

- Cirkel, F., Graphite, Its Properties, Occurrence, Refining and Uses, 1907. (Monograph on Graphite.)
 McLeish, J., Mineral Production of Canada, Annual volumes, 1906 to date. (General and statistical.)
 Economic Minerals and Mining Industries of Canada, 1913, p. 46. (General.)
 Report on the Mining and Metallurgical Industries of Canada, 1907-8, pp. 404-7 and 496-9. (Ontario and Quebec.)
 Spence, H. S., Summary Report, 1916, p. 34; 1917, p. 49.

Miscellaneous.

- Canadian Mining Institute, Journal and Transactions:
 Bateman, G. C., Vol. VIII, 1905, pp. 343-7. (General.)
 Brumell, H. P., Vol. X, 1907, pp. 85-104. (General.)

- Brumell, H. P., Vol. XI, 1908, pp. 236-50. (General.)
Brumell, H. P., Vol. XII, 1909, pp. 205-17. (Concentration.)
Brumell, H. P., Vol. XXII, 1919. (Concentration.)
Cirkel, F., Vol. XV, 1912, pp. 261-9. (Quebec.)
Greenland, C. W., Vol. XVI, 1913, pp. 584-97. (Carbonaceous schists of Lake of the Woods.)
Stansfield, J., Vol. XVI, 1913, pp. 401-11. (General.)
Wilson, M. E., Vol. XIX, 1916, pp. 362-8. (Quebec.)

Annual Reports of the Department of Mines, Province of Quebec, 1891 to date.
Annual Reports of the Ontario Bureau of Mines, 1896 to date.
Canadian Mining Journal: Vol. XXIX, pp. 15-18; 70-2; 361-3.
Canadian Mining Journal: Vol. XXX, pp. 267-72.
Canadian Mining Journal: Vol. XXXIII, pp. 433-7.
Canadian Chemical Journal: Vol. III, No. 7, July 1919, pp. 213-6.

INDEX

A

	PAGE
Acheson Graphite Co.....	114, 153, 187
" Oildag Co.....	167
Air classifiers.....	73
Alabama: graphite deposits.....	181
" Graphite Producers' Association.....	182
Alaska: graphite deposits.....	183
Allan, J.G.—mining operations, Denbigh township.....	39
Alibert mine.....	184
Alkow harbour B.C.—graphite occurrence.....	22
American Graphite Co.—largest producing mine in United States.....	182
" " use of buddles.....	81
" " Callow system.....	88
Amherst township: graphite property.....	46
Amorphous graphite: characteristics.....	9
" manner of treatment.....	63
Analysis: Canadian graphites.....	15
" carbonaceous schists, Lake of the Woods.....	41
" Ceylon and Ticonderoga graphites.....	16
" Low township graphite.....	59
" New Brunswick graphite.....	23
" North Elmsley township graphite.....	32
" Nova Scotia graphite.....	24
Anglo-Canadian Graphite Syndicate.....	54
Aquadag.....	115
Argenteuil county: graphite deposits.....	43, 44, 61
Artificial graphite.....	114, 187
Ashby township: graphite ore.....	39
Ashland wet box.....	101
Australia, South: graphite deposit.....	184
" West:.....	184
Austria: graphite deposits.....	174

B

Baffin island: graphite deposits.....	18, 61
Bedford township: graphite occurrences.....	26, 41
Beidelman and Lyall: graphite operations.....	39
Bell Graphite Co.....	50
" mine.....	50
" R.—specimens received from Baffin island.....	61
Bessell Bros.—process of refining.....	113
Bibliography of Canadian graphite.....	195
Big island: specimens from.....	61
Black Donald Graphite Co.....	35, 36
" " use of buddles.....	81
" " mine.....	18, 25, 35
" " exceptionally rich.....	36
Black Lead island: specimens from.....	61
Bliethfield township: graphite deposit.....	41
Boiler graphite: use of to prevent scale.....	160
Borrowdale: graphite mines.....	3, 145, 184
Bound Brook Oilless Bearing Co.....	157
Brazil: graphite deposit.....	184
British Columbia: graphite in.....	18, 22
Brochadon process chemical refining.....	113
Brodie's process chemical refining.....	112
Brougham township: graphite deposits.....	35
Brumell's wet box.....	106
Brushes, graphite: use of graphite for.....	151
Buckingham Graphite Co.—operations of.....	42, 43, 53, 54, 55
" township: chief deposits of Quebec in.....	43
" " graphite deposits.....	18, 48
Buddles.....	80

C

	PAGE
California: graphite deposits.....	184
Callow system: result of tests.....	90
Calumet Mining and Milling Graphite Co.....	44
Canada Paint Co.—graphite deposits in New Brunswick worked by.....	23
Canada Plumbago Co.....	42, 54
Canadian Graphite Co.—property in Wentworth township.....	46
“ “ industry—production, exports, imports, etc.....	162
Cape Breton island: graphite occurrences.....	24
Carbon content of graphite, determination of.....	188
Carbonaceous schists.....	41, 42
Cardiff township: graphite occurrences.....	26
Ceylon: graphite deposits.....	175
Chatelain, Rev. Father: graphite property.....	61
Chemical refining of graphite.....	112
Chosen: graphite deposits. See Korea.	
Claxton, J.—mining operations by.....	53
Clays for crucibles.....	125
Cole, A. A.—description of Quebec graphite deposits.....	43
Colmer washer.....	102
Colorado: graphite deposits.....	184
Concentrates: refining of.....	110
Concentration by dry methods.....	67
“ “ wet “.....	80
“ “ miscellaneous systems.....	108
Consolidated Graphite Mining and Milling Co.....	57
Crucibles: Ceylon graphite in demand for.....	175
“ comparison of clays for.....	125
“ large consumption of graphite for.....	119
“ manufacture of.....	131
“ standard sizes.....	140
Crystalline graphite: characteristics.....	9
Cummings, Dr.—graphite property.....	53

D

Darling township: graphite occurrence.....	41
Davis, M. P.—graphite mine.....	57
Deflocculation process.....	114, 115
Denbigh township: mining operations.....	39
Diamond Graphite Co.....	57
Dickson, H.—graphite property.....	61
Dominion Crucible Co.....	167
“ Graphite Co.....	52
“ mine.....	52
“ of Canada Plumbago Co.....	55
Douglas Bros.—process of refining.....	113
Dry batteries: use of graphite for.....	150
Dungannon township: graphite occurrence.....	41

E

Earle and Jacobs: graphite operations.....	57
Edwards, W. C.—graphite property.....	61
Electrodes: use of graphite for.....	154
Electrostatic machines.....	78
Electrotyping: use of graphite for.....	150
England: graphite deposits.....	184
Evans, William: mining operations in Low township.....	60

F

Ferraris tables. See Krupp-Ferraris.	
Film flotation: modified form of.....	10
“ “ See Surface tension.	
Fitzgerald, A. J.—monograph on artificial graphite.....	115
Flake graphite: characteristics.....	9
“ “ manner of treatment.....	64
Flotation as method of concentration.....	86
Foundry facings: use of graphite for.....	149
Frontenac county: graphite occurrences.....	26
Frothing oil flotation.....	86

G

PAGE		PAGE
184	Gatineau Graphite Co.—prospecting by.....	58
90	General Engineering Co.—concentration tests.....	39, 93, 94, 95
44	Germany: graphite deposits.....	177
23	Globe Graphite Mining and Refining Co.—graphite property, North Elmsley.....	29
42, 54	Globe Refining Co.—mining operations.....	29
46	Glutrin.....	149
162	Graphite: amorphous, meaning of term.....	6
24	" artificial.....	8, 15
188	" chemical and physical properties.....	4
41, 42	" composition of ores.....	13
26	" concentrate from Low township mine.....	60
175	" concentrating and refining of.....	63
61	" concentration: summary.....	111
112	" domestic consumption.....	167
53	" electrodes: manufacture of.....	114, 119
125	" general review of the industry.....	167
43	" geology of.....	31
102	" history of.....	3
194	" in Canada.....	18
110	" Limited, mining operations of.....	46
67	" made from anthracite coal.....	114
80	" " carborundum.....	114
108	" market conditions in United States.....	171
57	" mining, inception in Quebec province.....	42
175	" " methods.....	21
125	" mode of occurrence.....	9
119	" name first given.....	4
131	" origin.....	11, 32
140	" origin of, three hypotheses.....	20
9	" other names for.....	3
53	" percentage of in ores.....	16
	" principal part of world's production amorphous.....	16
	" production of in Canada.....	18, 162
	" " in Quebec.....	44
41	" Products, Limited: graphite property.....	46
57	" specific gravity.....	5
114, 115	" " heat.....	5
39	" subsidiary uses.....	160
57	" types of deposit.....	19
61	" uses of.....	119
167	" world's production of.....	185
52	" supply sources.....	174
52	Grenville township: first graphite mining in.....	42
55	" graphite deposits.....	44

H

	Haliburton county: graphite occurrences.....	26
	Hardman, J. E.—graphite property, Buckingham.....	49
	Harrison lake, B.C.—graphite occurrence.....	22
57	Harwood, R. V.—Miller mine worked by.....	45
61	Hayes, A. O.—New Brunswick graphite described by.....	23
154	Hirsch, S.—graphite property, Grenville township.....	45
78	Historical.....	3
150	Hoffmann, G. C.—analyses of Canadian graphite.....	15, 42
184	" " New Brunswick graphite.....	23
60	Hogg lot.....	52
	Hooper pneumatic concentrator.....	69
	Hudson Bay Co.—development work Baffin island.....	62
	Huff electrostatic separator.....	79
	Hull county: graphite deposits.....	58, 61
	Hunt, T. Sterry: graphite discussed.....	42

I

	India: graphite deposits.....	184
115	International Graphite Co.....	115
9	" Mining Co.—first operators in Ontario.....	29
64	Introductory.....	1
86	Italy: graphite deposits.....	178

J

	James tables.....	85
	Joker claim, Baffin island.....	62

K

	PAGE.
Kendall separator	89
Keystone Graphite Co.—Miller mine worked by	45
King Bee rail	75
Korea: graphite deposits	177
Krom pneumatic jig	68
Krupp-Ferraris tables	85

L

Labelle county: graphite property	46, 61
Labouglie, J.—classifier patented by	74
" Mr.—mining operations Buckingham township	59
Labrador: graphite found in	18
Lake of the Woods: carbonaceous schists of	41
Lanark county: graphite deposits	28
Latimer, J. F.—system of concentration devised by	89
Lochaber mill equipped with buddles	89
Lochaber Plumbago Co.	42, 53
" township: graphite in	42, 58, 69
Log washers	83
Logan, Sir Wm.—reference to graphite in early report	42
Loughborough township: graphite occurrence	41
Low, A. P.—graphite occurrences Baffin Island, etc	61
" township: graphite deposits	58
Lubricating: use of graphite for	155
Luzi's process of refining	113
Lyndoch township: graphite occurrences	39

M

McConnell, Rinaldo: mining operations by	29, 36
McHale, Mr.—mining operations, Lyndoch township	39
McLean and Fitzsimons: graphite property, Low township	58
Madagascar: graphite deposits	178
Maniwaki Indian reserve: graphite on	69
Marbella mine	184
Marmora township: graphite occurrence	41
Matthew creek, B.C.—graphite occurrence	22
Mechanical washers	83
Mexico: graphite deposits	180
Michigan: graphite deposits	184
Miller, E. C.—antifriction alloy proposed by	154
" mine: earliest to be exploited	45
" Mr.—mining operations by	58
Minerals separation system of concentration	98
Mines Branch: concentration tests	95
Mining Corporation of Canada: graphite property	26
Molybdenite: confused with graphite	3
Monmouth township: graphite occurrences	27
Montana: graphite deposits	183
Monteagle township: workings in	42, 54
Montreal Plumbago Co.	42, 54
Morgan Crucible Co.—graphite bearings and bushings	158
" " " brushes	151
Multipar Syndicate: operations of	46
Munro washer	101

N

Nappenberger separator	74
Natal: graphite deposit	184
National Graphite Co.—operations in Cardiff township	26
" " " Grenville township	45
" " " Monmouth township	28
Nevada: graphite deposits	184
New Brunswick: graphite production	22
New England Plumbago Co.	42, 56
New Quebec Graphite Co.—operations Buckingham township	48
New York Graphite Co.—operations in Cardiff township	26
" graphite deposits	182
New Zealand: graphite deposit	187

	PAGE
Nigruni bearings.....	157
Norberg graphite deposit.....	184
North American Graphite Co.....	43, 54
mine.....	54
North Burgess township: graphite deposits.....	28, 41
" Elmsley township: graphite deposits.....	20, 41
Northwest territories: graphite found in.....	18
Northern Graphite Co.—operations in North Elmsley.....	20
Norway: graphite deposit.....	184
Nova Scotia: graphite occurrences.....	24
O	
Oil flotation: advantage of.....	43
Oildag.....	115
Ontario Graphite Co.....	36
" graphite deposits in.....	25
" production of graphite in.....	25
P	
Paint: use of graphite in.....	158
Patents: United States, oil flotation.....	90
Patterson, T. W.—graphite property, township Gore.....	46
Pencils.....	144
Pennsylvania: graphite deposits.....	183
Peerless Graphite Co.....	57
Petroleum coke: artificial graphite made from.....	114
Plumbago: manner of treating.....	63
" see Crystalline graphite.....	52
" Syndicate, operations by.....	43
Pontiac county: scattered deposits of uneconomic importance.....	160
Powder glazing: use of graphite for.....	112
Pritchard process chemical refining.....	42, 53
Pugh and Weart: mining operations.....	108, 109
Putz, H.—system of concentration.....	29
Pyne, R. A.—operations in North Elmsley.....	29
Q	
Quebec Graphite Co.—property Buckingham township.....	48
Quebec province: graphite mining in.....	42
Queensland: graphite deposit.....	184
R	
Rae and Co.—Miller mine worked by.....	45
Rake washers.....	84
Refining of graphite concentrates.....	110, 112
Refractory products, other.....	144
Reilly and Layfield: mining operations.....	46
Renfrew county: graphite deposits.....	35
Rhode Island: graphite deposits.....	184
S	
Schlüssel method chemical refining.....	112
Schurecht, H. G.—see Stull.....	160
Shot polishing: use of graphite for.....	184
Siberia: graphite mine.....	99
Simplex system of concentration.....	180
South Africa: graphite deposit.....	41
South Canonto township: graphite occurrence.....	180
Spain: graphite deposits.....	184
" mine.....	52
Stewart pit.....	159
Stove polish: use of graphite for.....	109
Stull, R. T., and Schurecht, H. G.—briquetting of flake graphites.....	101
Surface tension system of concentration.....	71
Sutton, Steele and Steele dry jig table.....	79
" separator.....	184
Sweden: graphite deposit.....	184
Switzerland: graphite deposits.....	184

T

	PAGE.
Tests of graphite: General Engineering Co.	93, 94, 95, 97
Texas: graphite deposits	184
Timmins, N. A.—graphite operations in North Burgess.	24
Toch, M.—graphite paints.	159
Tonkin-Dupont Graphite Co.	28, 27
Torrance, J. F.—reason for stagnation of industry	42
Transvaal: graphite deposit	184

U

United States Graphite Co.—process of creating amorphous graphite	64, 147
“ “ graphite deposit in Mexico	180
“ “ graphite deposit	181
Uses of graphite.	119

V

Vennor, H. G.—graphite occurrence in Virginia.	42
Virginia Graphite Co.	27

W

Walker mine.	55
“ Plumbago Mining	43
“ W. H.—operations in	55
Ward, J. K., estate of: graphite property, Cynthiana township.	44
Weart, S. J.—graphite property, Buckhorn township.	53
Wentworth township: graphite deposit.	46
West and Company: shipment of Buckingham graphite	53
Westmeath township: graphite occurrence	41
Wet tables.	85
Winkler method chemical refining	112
World's production of graphite.	185, 186



Typical high grade, Canadian flake graphite ore, 15-20 per cent carbon, from the Buckingham district, Que.

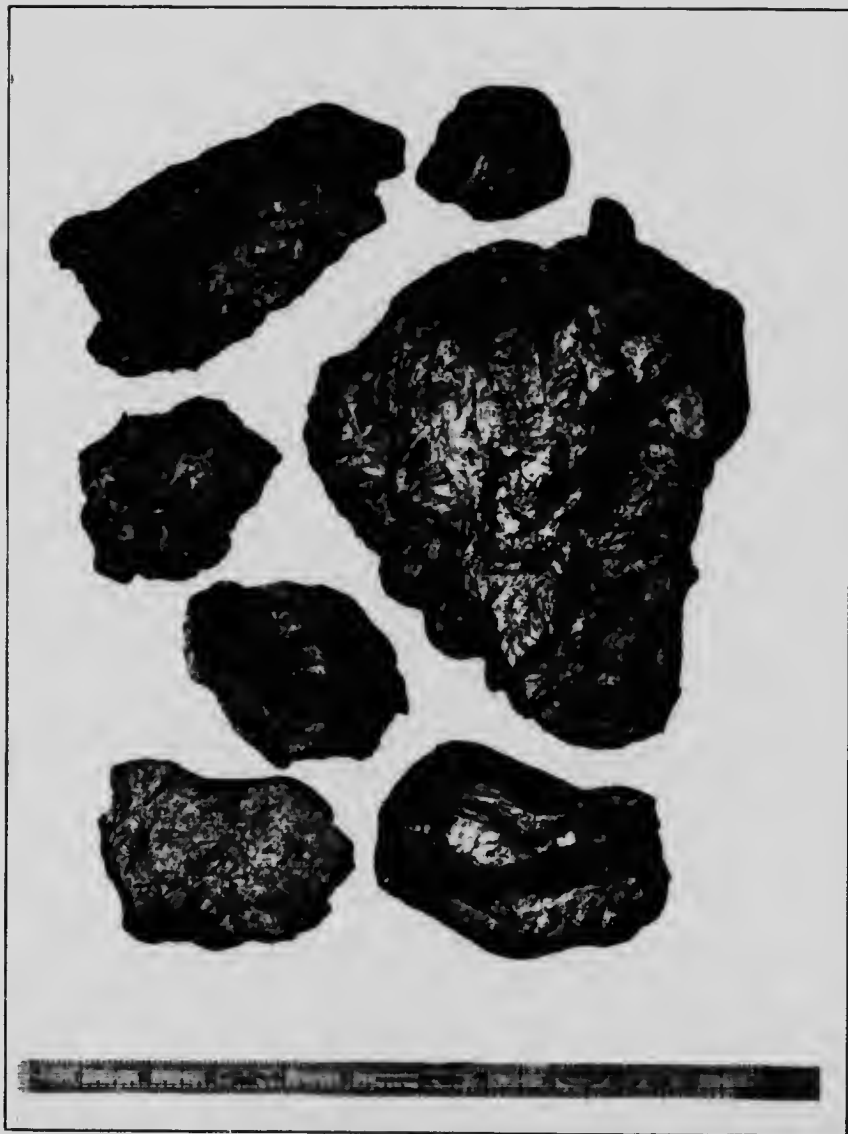

Foliated plumbago, range III, lot 18, township of Low, Que. This plumbago is of good quality, but is hardly as dense as that from Ceylon.

PLATE III.

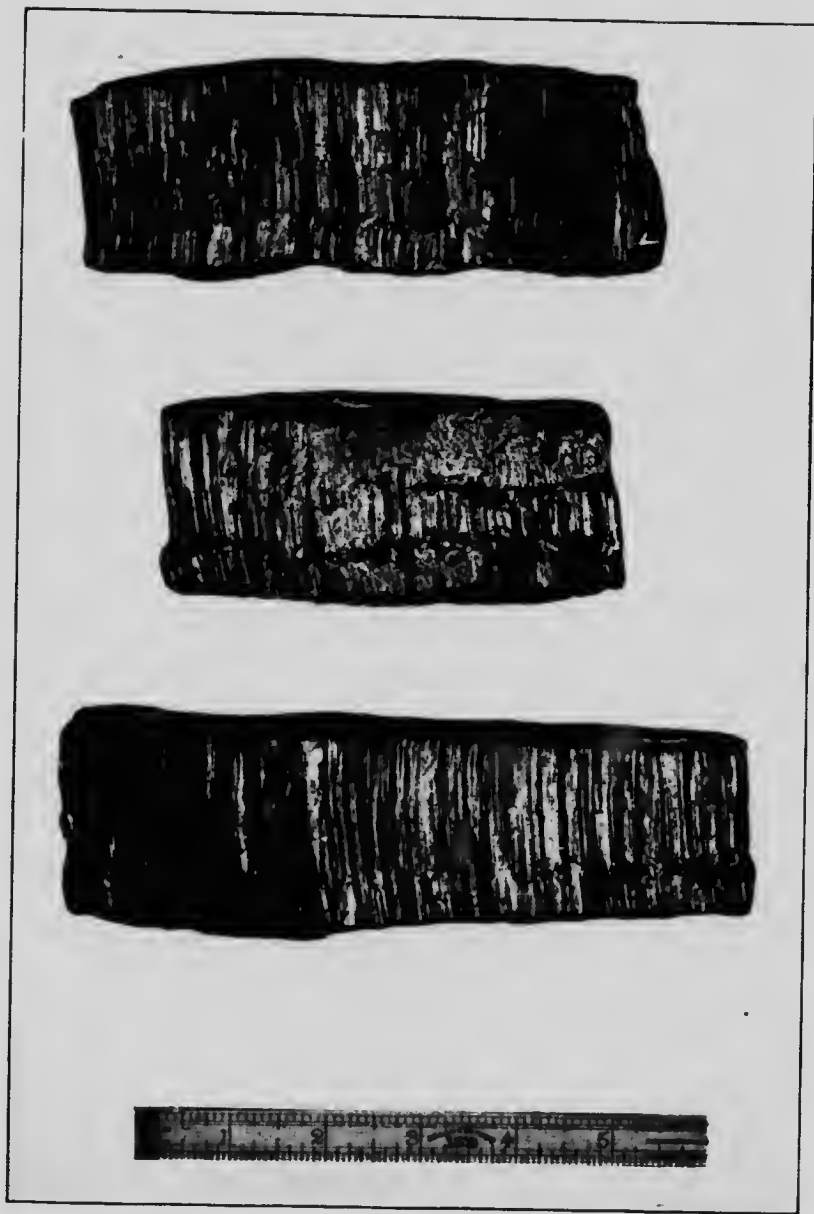

Fibrous or columnar plumbago, range VII, lot 21, township of Buckingham, Que. Narrow veins of such material are not uncommon in the Buckingham district, usually in the more or less immediate vicinity of bodies of flake ore.

67945—15½



Radiated, lamellar crystals of graphite penetrating a narrow band of highly silicated limestone enclosed between two pegmatite stringers. The original limestone has been almost completely altered to a mixture of granular quartz and feldspar, with subsidiary sphene and pyroxene. From range III, township of Low, Que.

PLATE V.



Foliated plumbago, developed along the contacts of pegmatite stringers with a narrow zone of crystalline limestone (C). In this instance, the limestone has been only slightly silicated, and very little flake graphitic occurs disseminated through it. From range III, township of Low, Que.

PLATE VI.



Mill of the National Graphite Company, concession XXII, lot 9, township of Cardiff, Ont.

PLATE VII.

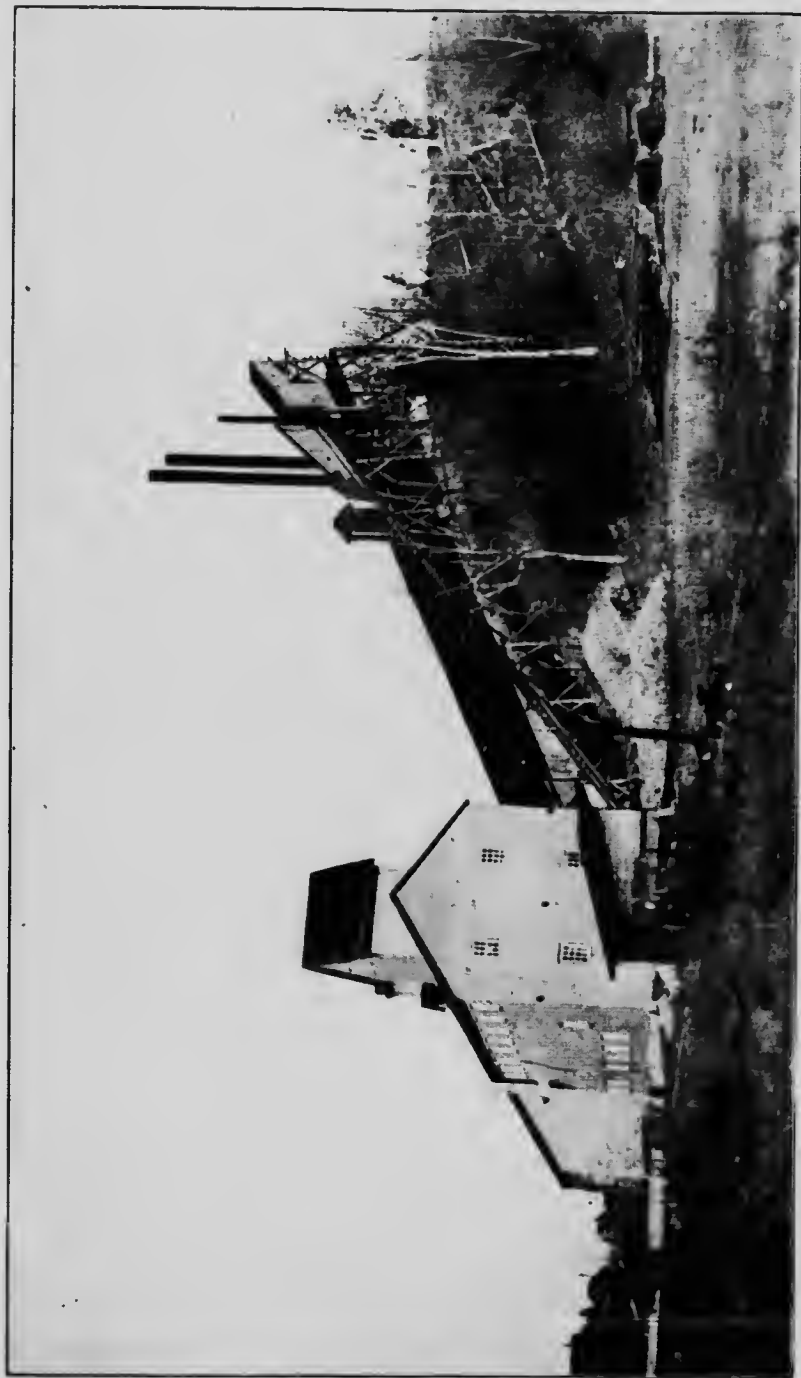

Mill of Tonkin-Dupont Graphite Company, Wilberforce, Ont.



Method of working graphitic limestone ore-body, concession XIII, lot 23, township of Montegale, Ont.

PLATE IX.



Mill on Timmins property, concession V, lot 25, township of North Burgess, Ont.

PLATE X.



Open cut above workings of Gilobe Graphite Mining and Refining Company, concession VI, lot 21, township of North Elmsley, Ont. The banding in the limestone is well shown, and a well defined fold is exhibited in the cap rock above the shaft. Graphite bodies tend to occur at the crests of such folds.



100-foot level at mine of Globe Graphite Mining and Refining Company, concession VI, lot 21, township of North Elmsley, Ont. The pillar indicates the thickness of the ore-body in the east workings.



"Needle-flake" graphite ore, from concession VI, lot 21, township of North Elmsley, Ont.

PLATE XIII.

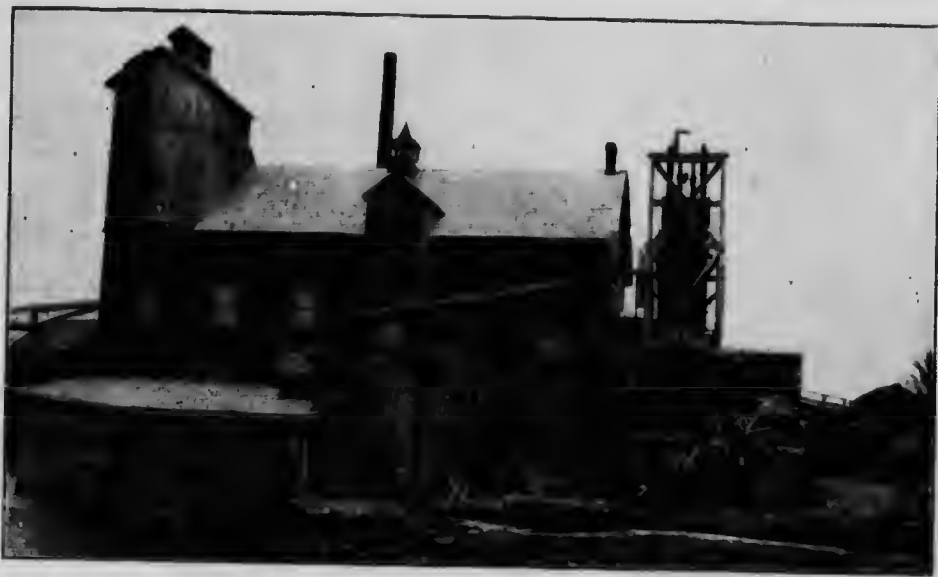

Mill of the Globe Graphite Mining and Refining Company, Port Elmsley, Ont. The mill is driven by water power.

PLATE XIV



Mill and part of surface plant, Black Donaki Mine, concession III, lot 18, township of Brougham, Ont. The workings extend several hundred feet under Whitefish lake, seen in the background.

PLATE XV.



North end of east or hanging wall stope, Black Donald mine, concession III, lot 18, township of Brougham, Ont. Photograph taken August, 1919. The ore-body at this point has a width of seventy feet. (See Fig. 4.)



Main pit of Miller mine, range V, lot 10, township of Grenville, Que. The ore-body is stated to have followed the well defined slip face on the far side of the pit.

PLATE XVII.



Mill of Graphite, Ltd., range VII, lot 15, township of Amherst, Que.

PLATE XVIII.



Folded structure in gneiss, range IV, lot 3, township of Buckingham, Que. The ore-body follows the crest of the pitching fold shown above.

PLATE XIX.



Mill of the New Quebec Graphite Company, Buckingham, Que.

PLATE XX.



Mill and workings of Bell Graphite Company, range V, lot 2, township of Buckingham, Que. The dip and strike of the ore-body is shown in the opening to the right of the mill building.

PLATE XXI.



Exceptionally large sized graphite flakes, from range IV, township of Buckingham, Que. The flakes, measuring up to 5 inches across, occur at the contact of a pegmatite dike with gneiss.

PLATE XXII.

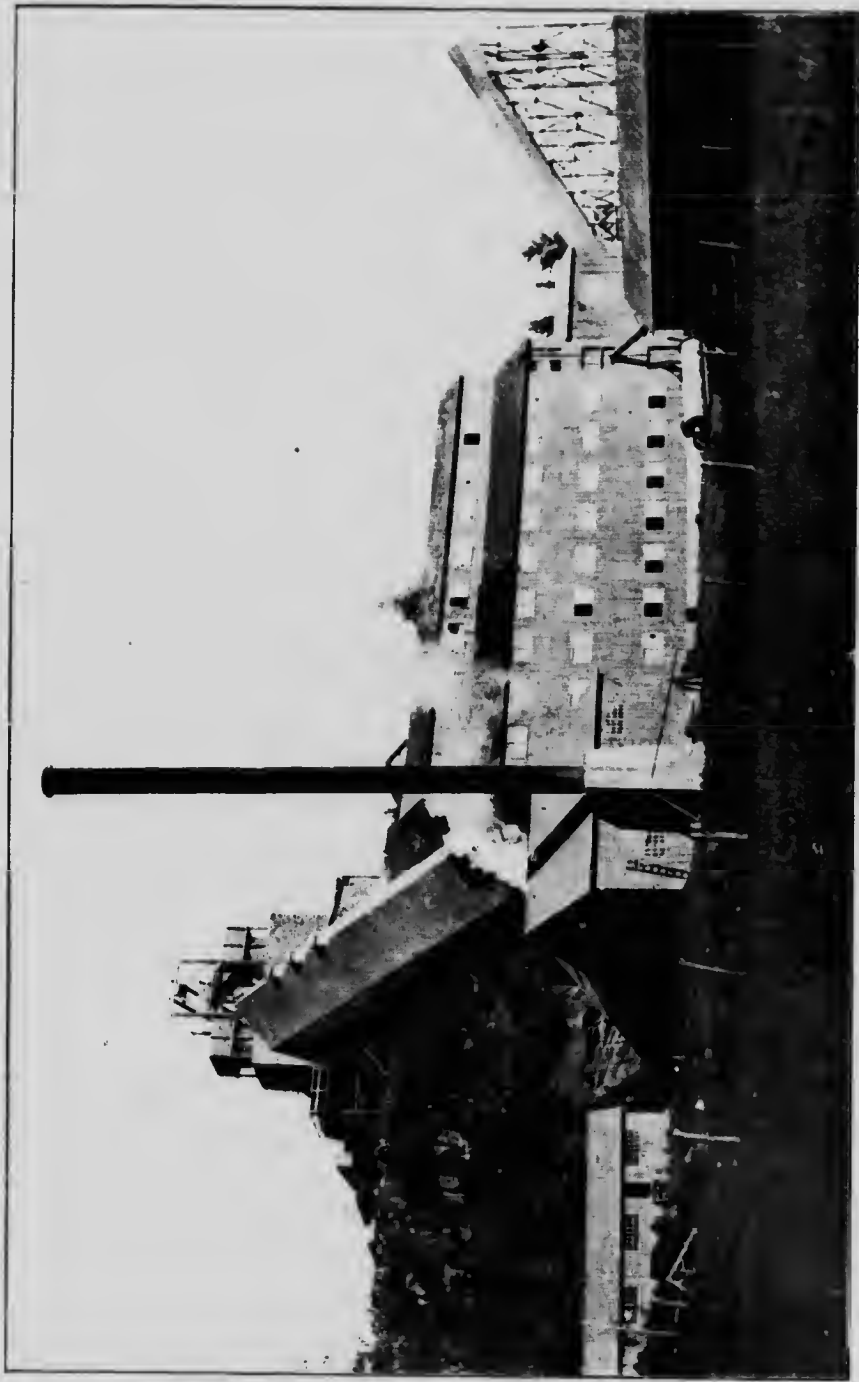

Mill of Plumbago Syndicate, township of Buckingham, Que., showing typical arrangement of a Canadian dry-concentrating mill.
(This mill was destroyed by fire in 1918.)

PLATE XXIII.



Mill of the Buckingham Graphite Company (North American mine), township of Buckingham, Que. The photograph was taken some years ago, and the buildings are now in a dilapidated condition. The strike of the ore-body is indicated by the tramway, and the main drift enters the mill to the left of the kiln.



Dike of pegmatite (anorthosite) A intruded into gneiss B, range VIII, lot 20, township of Buckingham, Que. Flake graphite is developed in the gneiss along its contact with the intrusive.

PLATE XXV.

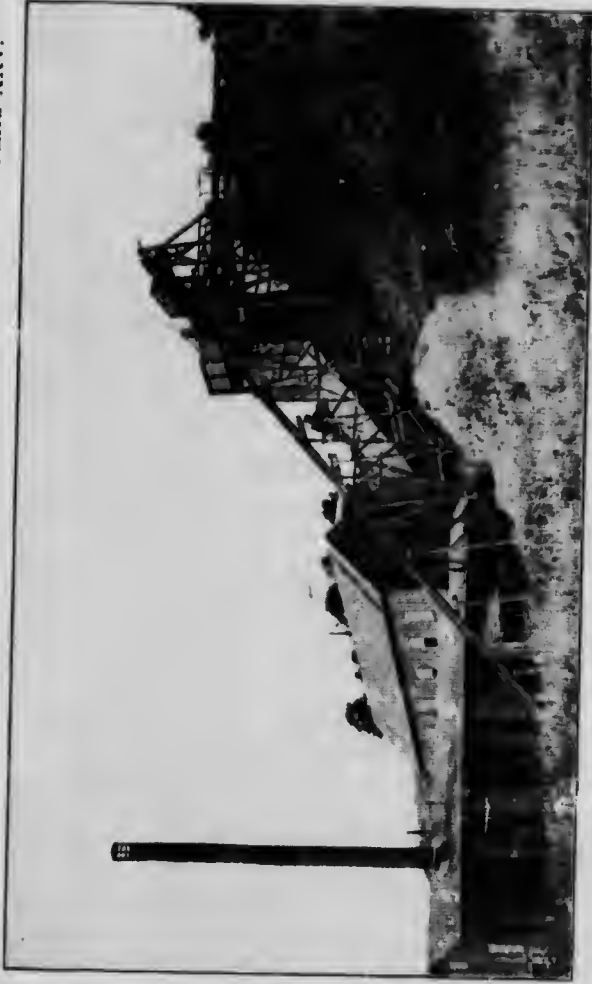

Mill of the Consolidated Graphite Mining and Milling Company, range X, lot 14, township of Buckingham, Que.



Poliated plumbago, from near Lake harbour, Baffin island. This material is reported to be the equal of Ceylon plumbago for crucible work.

PLATE XXVII.

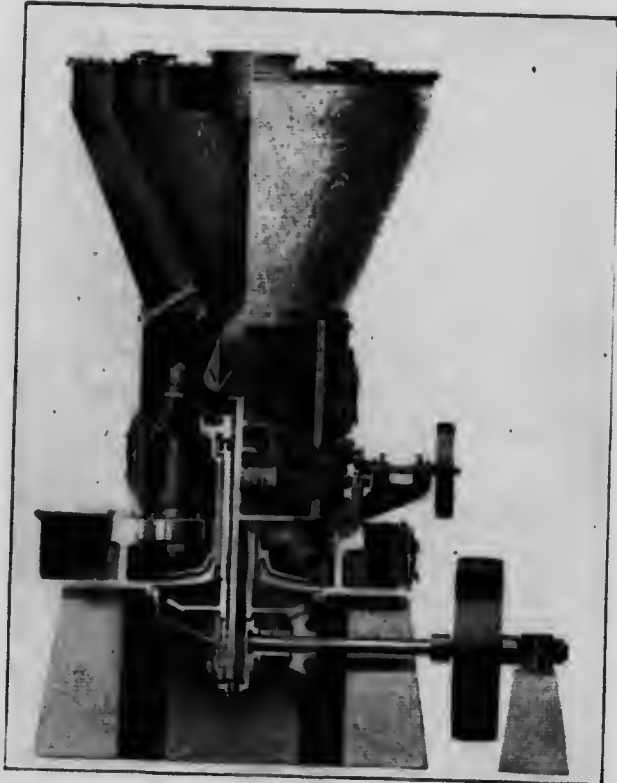

Sectional view of Raymond high-side mill and separator. (Raymond Bros. Impact Pulverizer Company, Chicago.) This machine is used for grinding amorphous graphite.



MICROCOPY RESOLUTION TEST CHART

(ANSI and ISO TEST CHART No. 2)

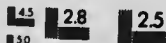
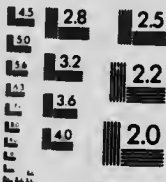

APPLIED IMAGE Inc

1653 East Main Street
Rochester, New York 14609 USA
(716) 482 - 0300 - Phone
(716) 288 - 5989 - Fax

PLATE XXVIII.

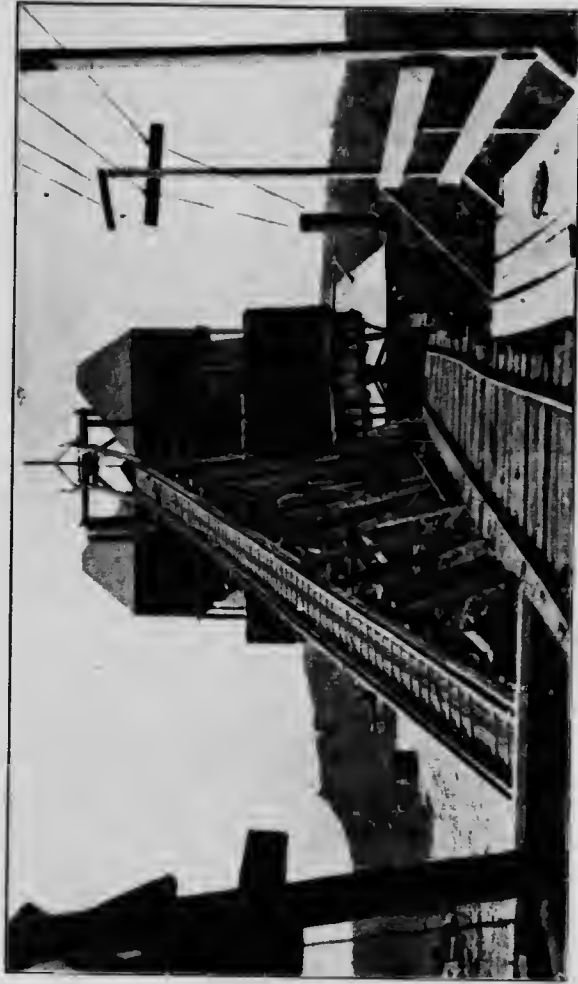

Type of kiln used for drying graphite ore, with charging skipway, Dominion mine, township of Buckingham, Que.

PLATE XXIX.

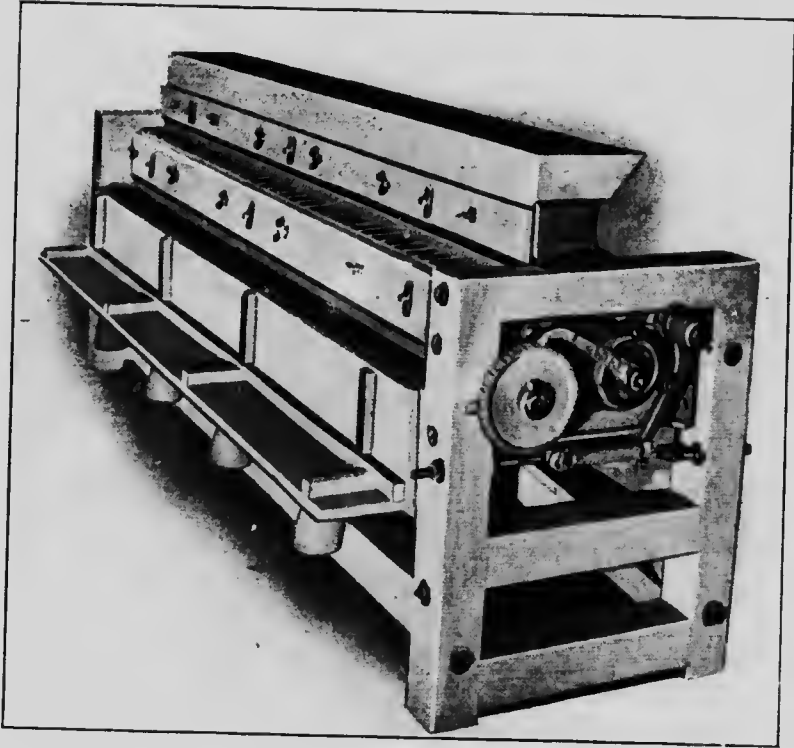

Krom pneumatic jig. (Krom Machine Works, 170 Broadway, New York.)

PLATE XXX.

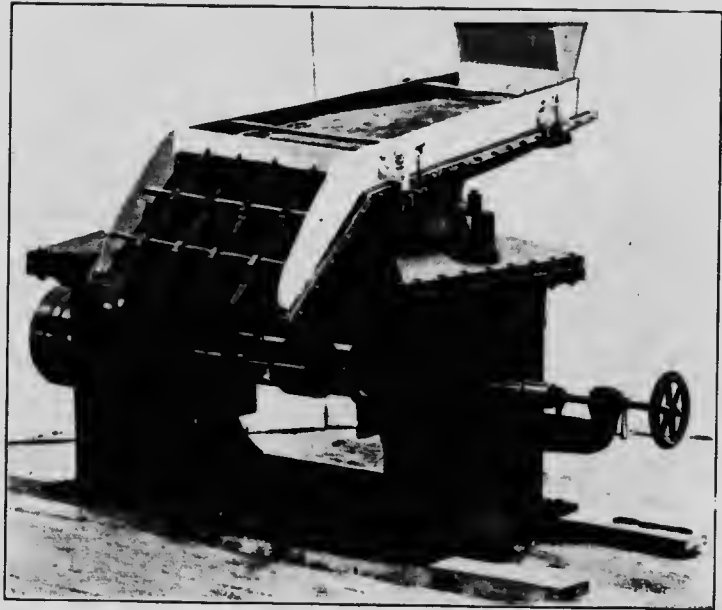

Hooper pneumatic concentrator. (Ticonderoga Machine Works,
Ticonderoga, N.Y.)

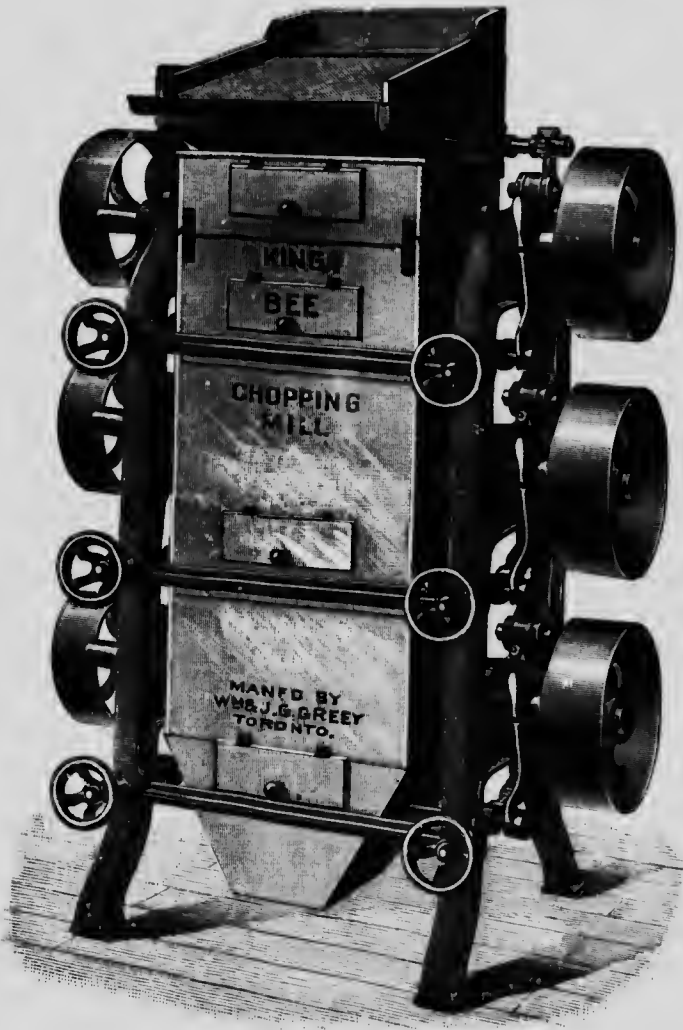

Type of rolls used in Canadian mills employing the dry concentrating process. (Wm. and J. G. Grey, Toronto, Ont.)

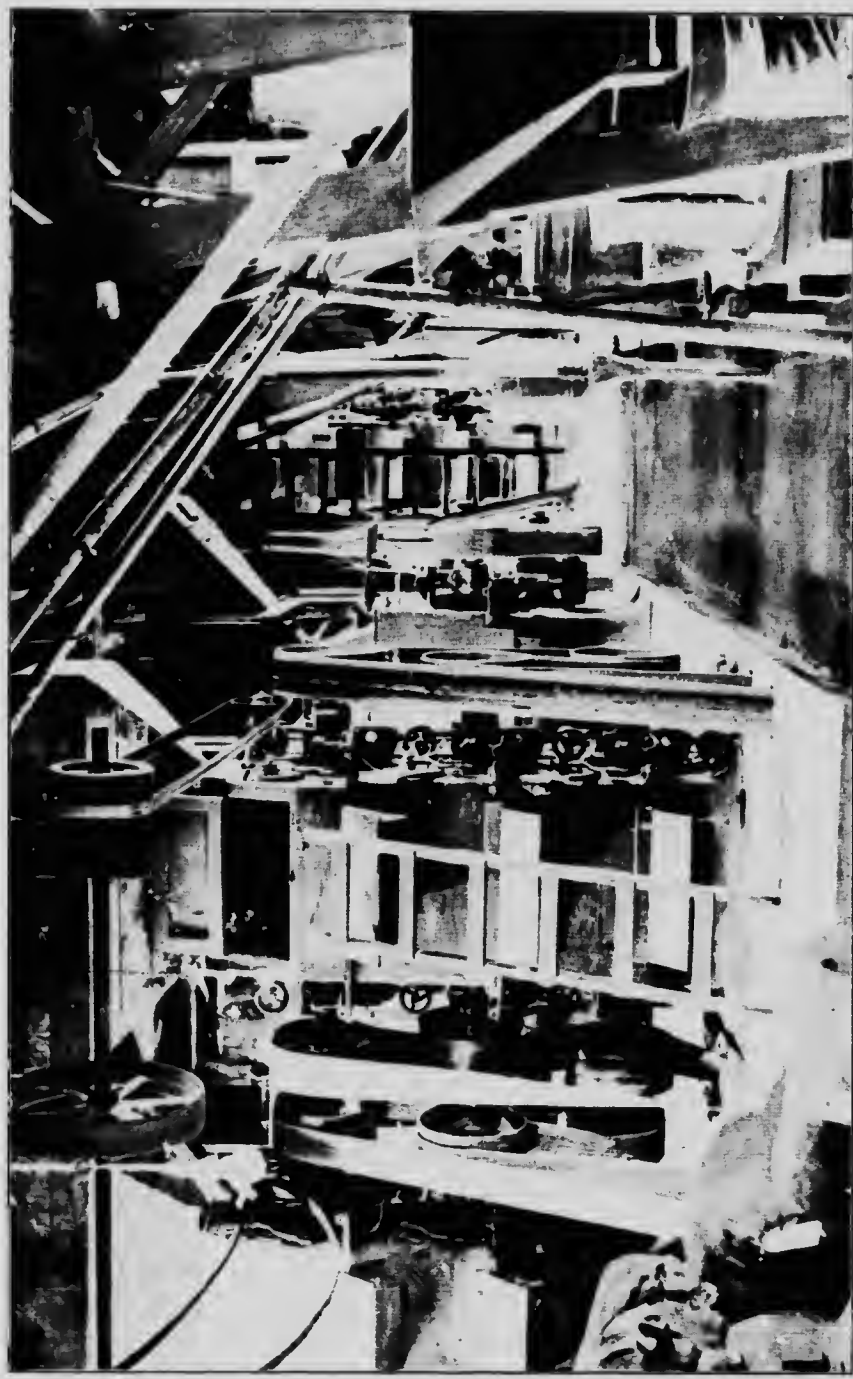

Installation of "King Bee" rolls at a mill in the Buckingham district, Que.

PLATE XXXIII.

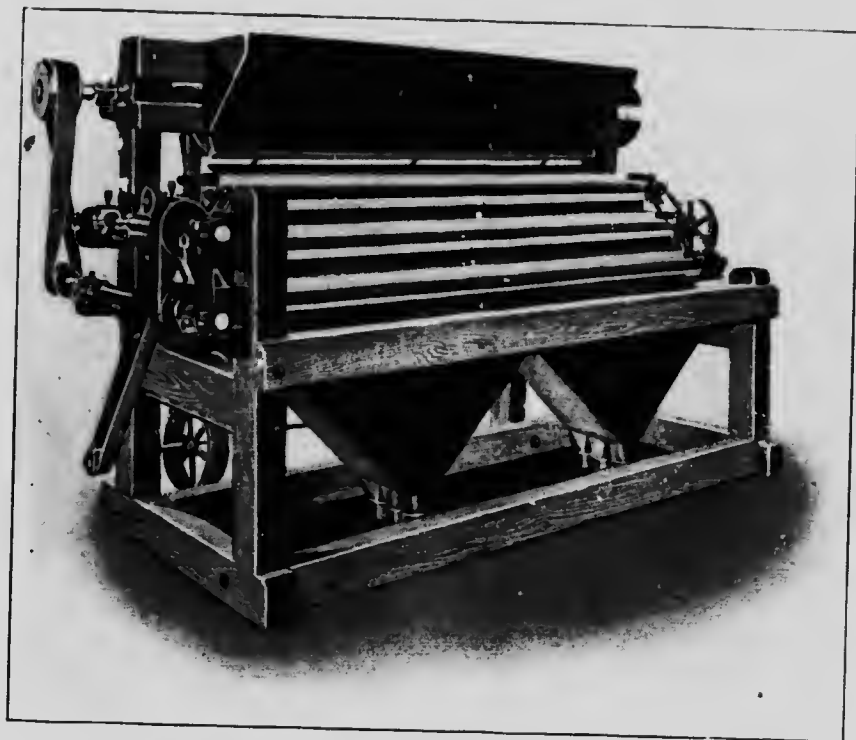

Sutton, Steele and Steele di-electric separator. (Sutton, Steele and Steele, Dallas, Texas.) The machine illustrated has three pairs of electrodes.

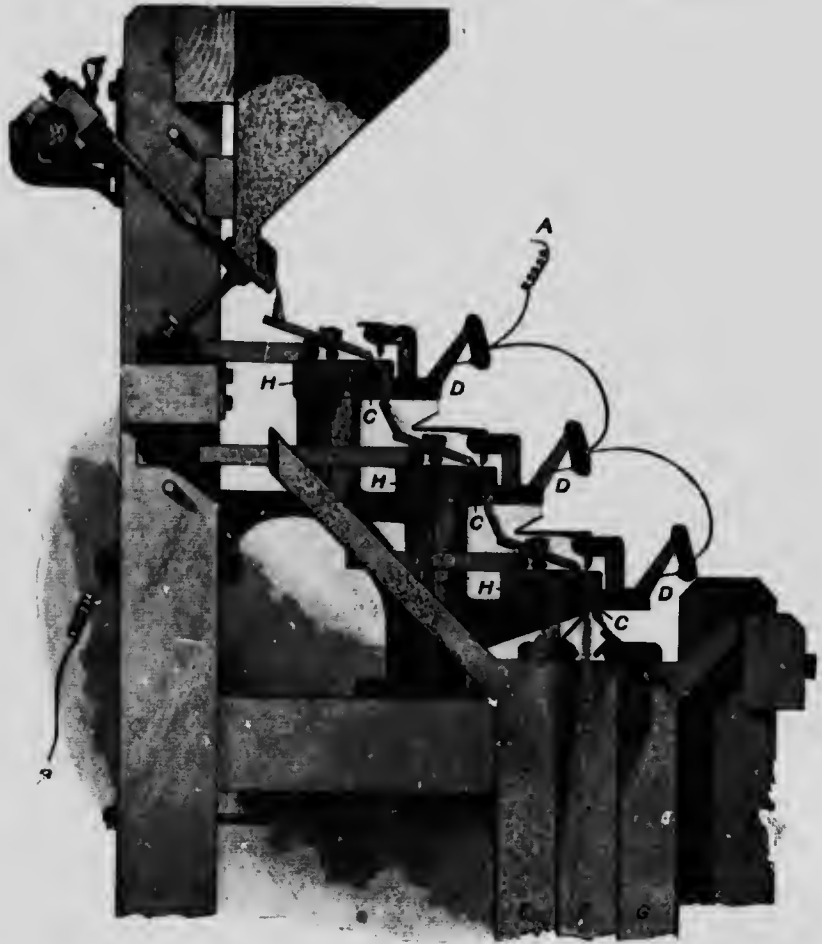

Details of Sutton, Steele and Steele dielectric separator. A connexion to generator, B connexion to ground, C revolving electrode, D needle electrodes, E tailings, F middlings, G concentrates, H roller to remove particles adhering to electrode C.



Section of mill, showing Krupp-Ferraris tables, slime tables and hydraulic classifiers, New Quebec Graphite Company, Buckingham, Que.

PLATE XXXVI.



Callow pneumatic flotation cells in operation, showing concentrates passing over in froth.

PLATE XXXVII.

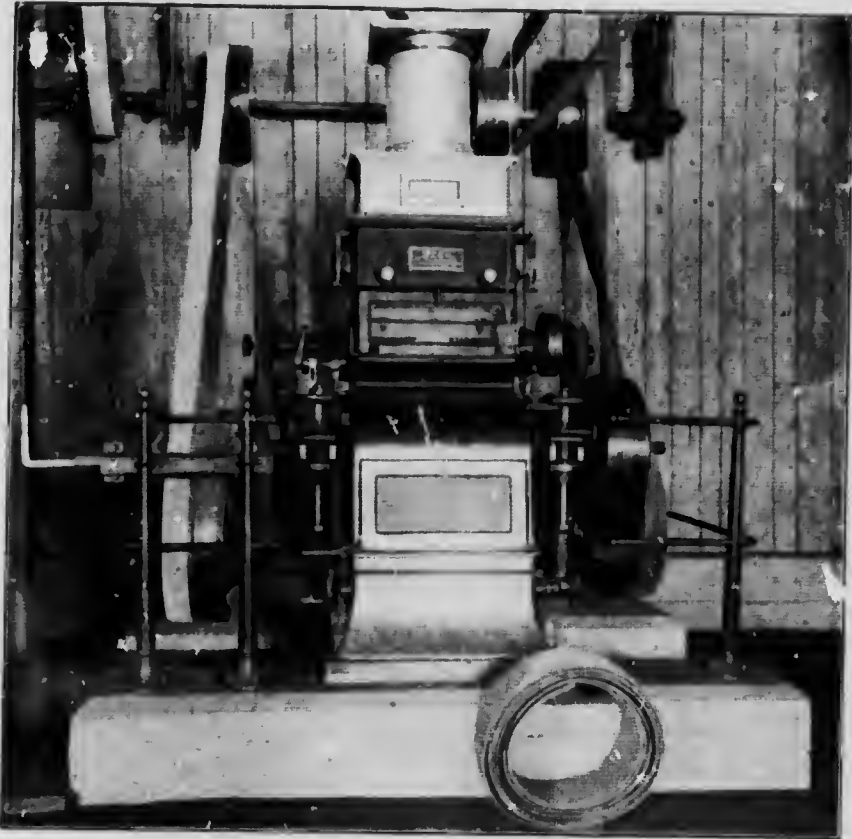

Photo, New Quebec Graphite Company, Buckingham, Que.

PLATE XXXVIII.

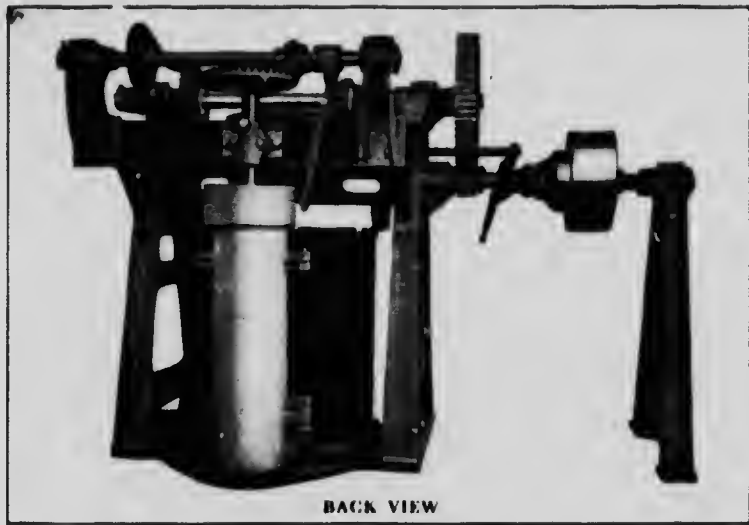

BACK VIEW

Mixer arranged for belt drive.

PLATE XXXIX.

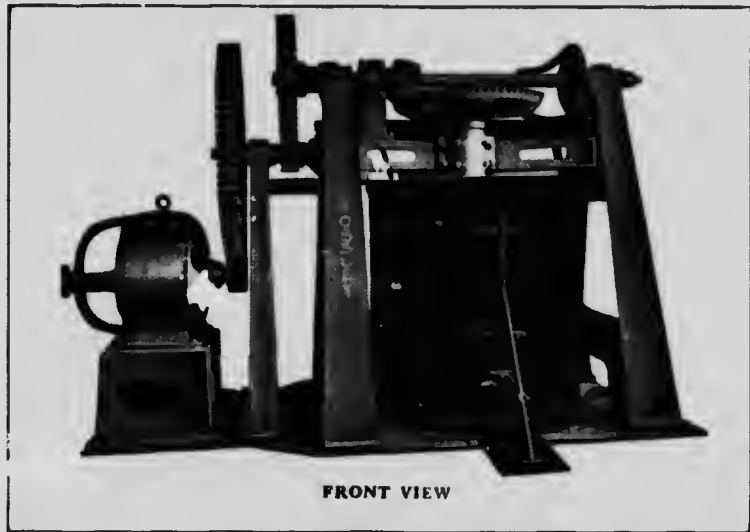

FRONT VIEW

Mixer arranged for motor drive.

Machines for mixing crucible bodies. (Crossley Machine Company, Trenton, N.J.) The upper mixer has a capacity of $\frac{3}{4}$ ton, and the lower $2\frac{1}{2}$ tons, per hour.

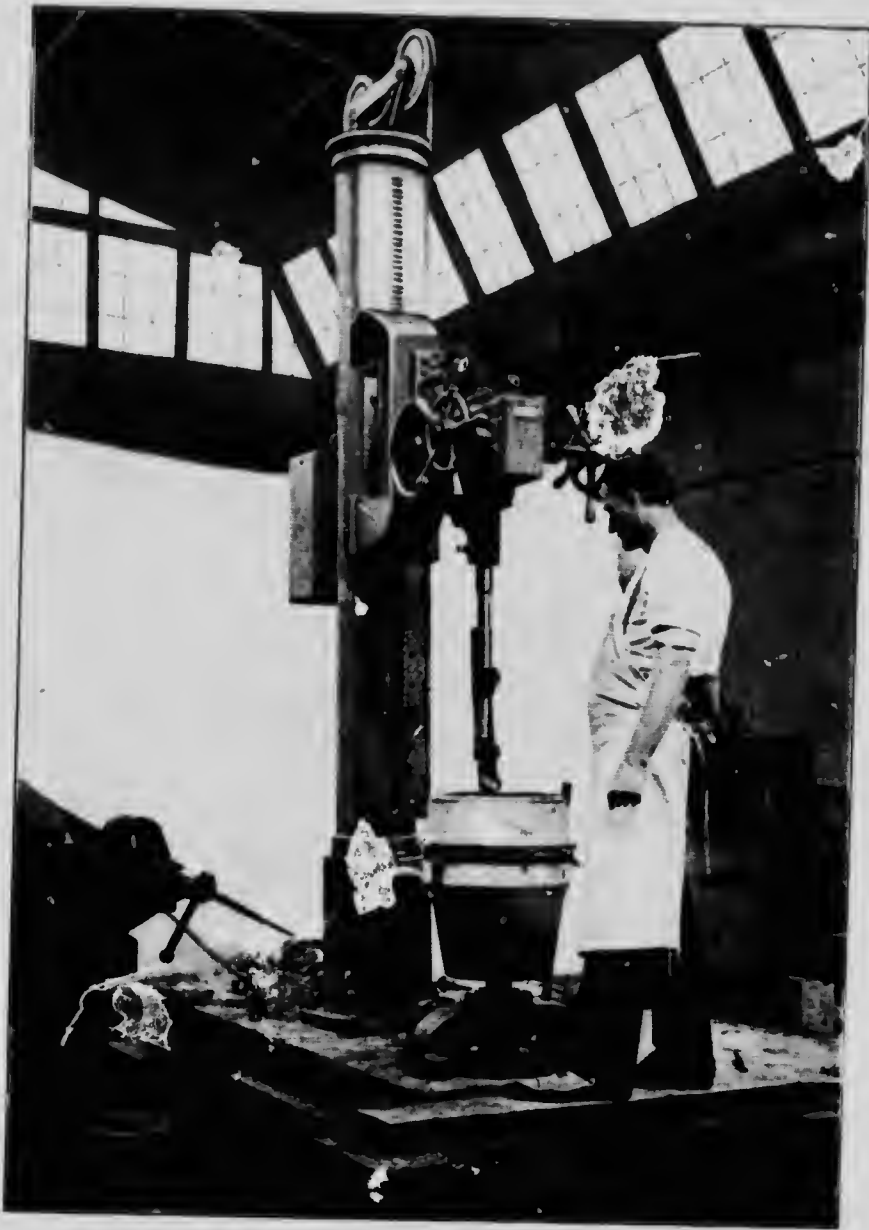

Pull-down and jigger used in making crucibles. (Crossley Machine Company, Trenton, N.J.) The illustration shows the profile or tool in position to be lowered into the mould by means of the right-hand wheel. The left-hand wheel controls the movement of the tool horizontally, in order to press the clay against the wall of the mould.

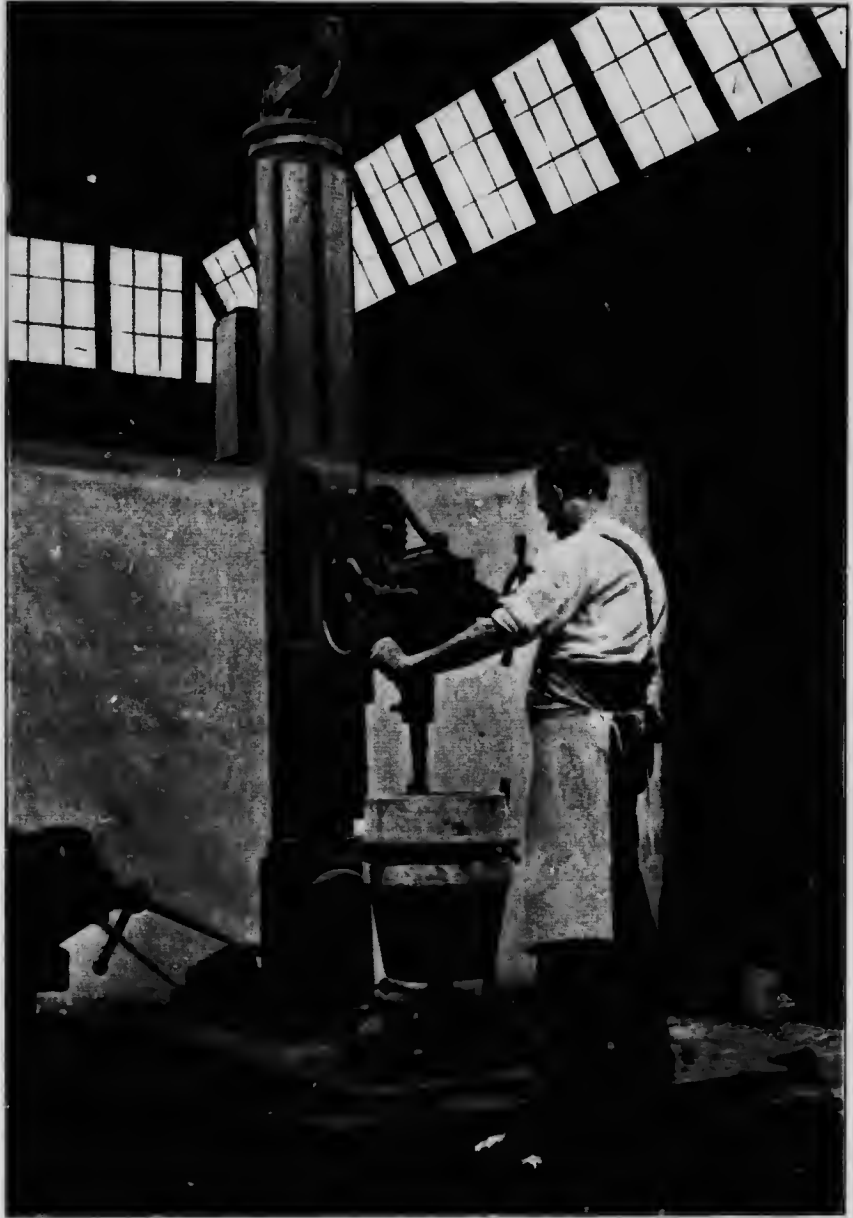

Pull-down and jigger used in making crucibles (Crossley Machine Company, Trenton, N.J.) The profile or tool is here shown lowered into the mould.

PLATE XI.H.



Crucibles as removed from the moulds. (Crossley Machine Company, Trenton, N.J.)

PLATE XLIII.



Types of crucibles used in melting non-ferrous metals. (Joseph Dixon Crucible Company, Jersey City, N.J.)

PLATE XLIV.



Types of crucibles used in tilting furnaces. (Joseph Dixon Crucible Company, Jersey City, N.J.)

PLATE XLV.



ALLIGATOR CRACKS



PIN HOLE OR LEAK

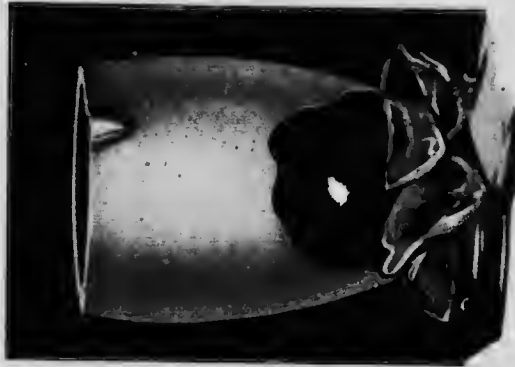

SCALPED CRUCIBLE

Defects developed in crucibles by improper usage. Scalping and pin holes are caused by improper annealing. Alligator cracks may be due to sulphurous gases from impure coal or coke, or to the imperfect combustion of oil or gas fuel.

PLATE XLVI.



Type of crucible used in melting steel.
(Joseph Dixon Crucible Company, Jersey City,
N.J.)

PLATE XLVII.



Bottom-pour crucible for preventing oxidized
metal and other impurities getting into castings.
(Joseph Dixon Crucible Company, Jersey City,
N.J.)

PLATE XLVIII.



Brazing crucibles, for dip-brazing. Below, graphite boxes, for case-hardening, carbonizing, etc. (Joseph Dixon Crucible Company, Jersey City, N.J.)

PLATE XLIX.



Type of retort, used in the smelting of gold, silver, zinc, etc. (Joseph Dixon Crucible Company, Jersey City, N.J.)

PLATE I.

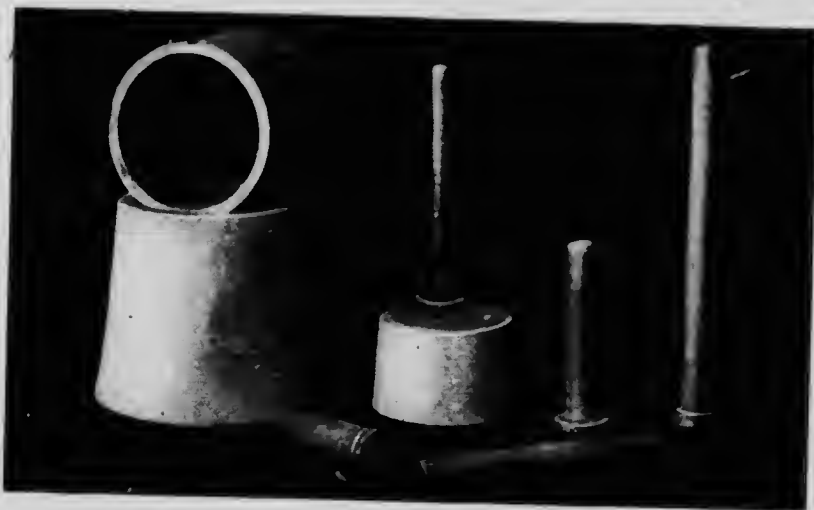

Funnel or extension tops, for increasing the capacity of crucibles, and pyrometer shields. (Joseph Dixon Crucible Company, Jersey City, N.J.)

PLATE II.



Types of graphite stoppers and nozzles for steel-pouring ladles. (Joseph Dixon Crucible Company, Jersey City, N.J.)

PLATE LII.



Types of phosphorizers used in the manufacture of phosphor bronze. (Joseph Dixon Crucible Company, Jersey City, N.J.)

PLATE LIII.



Types of stirrers, skimmers, and dippers. (Joseph Dixon Crucible Company, Jersey City, N.J.)

PLATE LIV.

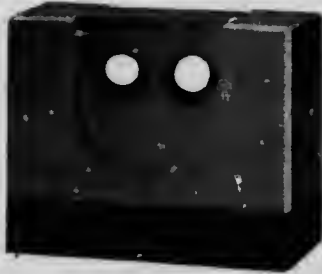

Types of graphite commutator brushes. (United States Graphite Company, Saginaw, Mich.)



Types of oilless bushings. (Bound Brook Oilless Bearings Company,
 Bound Brook, N. J.) The bushings are of hardwood, impregnated with a graphite
 lubricating compound.



Types of Bound Brook oilless bushings. (Bound Brook Oilless Bearings Company, Bound Brook, N.J.) The bushings are cast with grooves, which are afterwards packed under hydraulic pressure with a graphite lubricating compound.

