

vol. 16, cat. 8

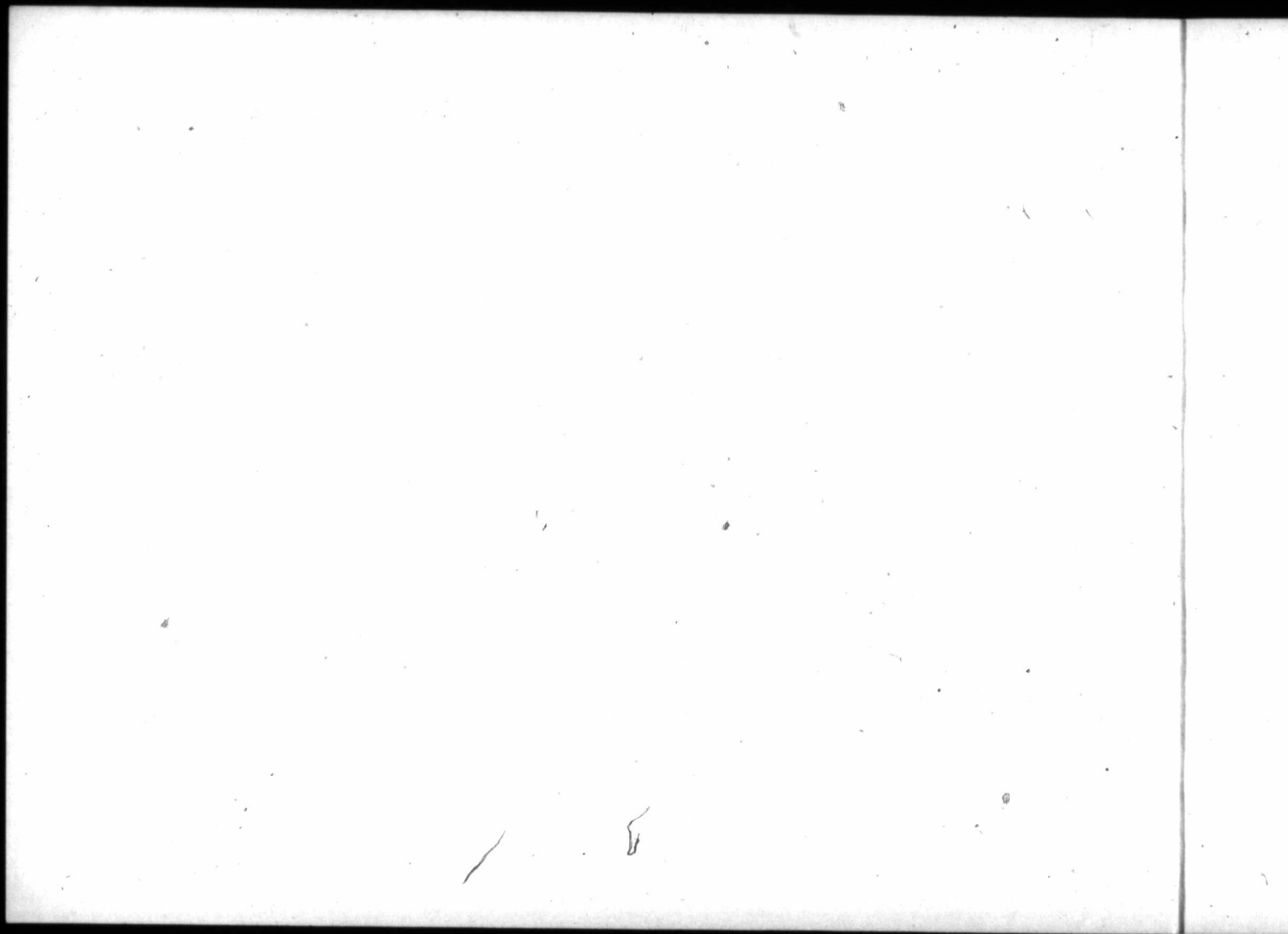

“Fenestra”
Steel Window Sash
and
Casements



Patented June 9th, 1908 No. 112319

Manufactured by

The
Expanded Metal and Fireproofing Co.
Limited
Toronto, - Canada

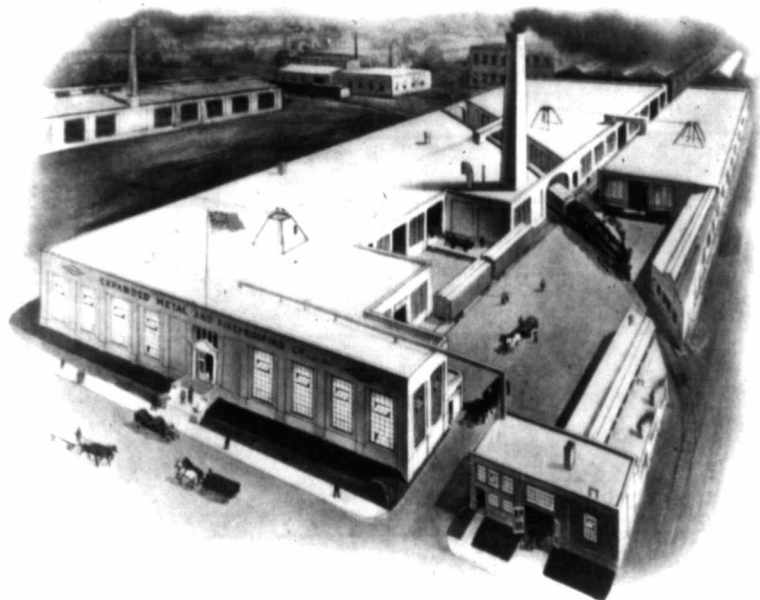

GENERAL OFFICES AND WORKS, EXPANDED METAL AND FIREPROOFING CO., LIMITED, TORONTO, CANADA.

Introductory

WE take pleasure in again bringing to the notice of Architects, Engineers and Contractors, "**Fenestra**" Steel Sash and Casements, which we are manufacturing in our Toronto plant, specially built for this purpose, equipped with the most perfect machines and operators.

"**Fenestra**" Sash has become standardized in Great Britain and Continental Countries, and we know it has and will commend itself to those interested in good buildings in Canada.

In submitting this second edition "**Fenestra**" Catalogue, we feel that we must mention the most complimentary reception which has been tendered "**Fenestra**" Sash and Casements since they were introduced into Canada a few months ago.

In this comparatively new country, which, only a few short decades ago, might rightly have been termed "wooden," one naturally might have expected that Steel Window Frames and Sash for all classes of buildings would have been looked on with a considerable degree of conservatism. But one short year has shown that such is not by any means the case. Leading architects and engineers, from Halifax to Vancouver, have given their unqualified approval of "**Fenestra**" Sash, as the large, though incomplete, list of users on page 44 will testify.

"**Fenestra**" Sash must not be classed as "frills." It is an every-day, commercial article, which no good building can afford to be without. "**Fenestra**" Solid Steel Sash makes the most fire-proof window protection ever known. It is being adopted every day by shrewd, cost-versus-value-considering business men, simply because of its great durability, handsome appearance and weather-proofness under all conditions, and because it affords the maximum amount of light and ventilation for the wall opening. The cost is wonderfully low, when the great efficiency of the article is considered. In many cases the price for "**Fenestra**" windows has been lower than the price of good wood frames and sash, and in no case is the difference sufficient to deter any far-seeing and truly economical man from deciding in favor of "**Fenestra**."

Expanded Metal and Fireproofing Co., Limited.

About "Fenestra" Sash

"Fenestra" Steel Sash are manufactured from specially rolled, solid sections, and the composition of the material is such that it is possible to furnish sash which has at once the strength of steel and the weather-resisting qualities of iron.

Because of the strength of the "Fenestra" joint, it is practical to use sections which permit of twenty-five per cent. more light being delivered through a given opening than has heretofore been possible.

By making a sash which requires no frame, sash weights, heavy mullions, etc., the cost of each window is thereby reduced to a minimum.

"Fenestra" looks better than any other sash. A natural curve at each joint breaks the monotony which is characteristic of the old mitre joint sash, and gives "Fenestra" an appearance which is quite its own.

For use in institutions and insane asylums, its combined value as a grating, without the apparent visible effect, can be at once understood.

In paper mills, breweries, soda ash works, and similar plants where chemical action or dampness destroys sheet metal and wood, the "Fenestra" Sash are used to special advantage.

The Sash, however, finds its great field of general usefulness in Factories, Power Houses, Railroad Shops, Warehouses, Barracks, etc., where the use of wood sash is a thing of the past, and where the lighter weight and more bulky sheet metal cannot endure.

The cardinal points of merit in a sash are **strength, minimum obstruction of light, adequate provision for ventilation, and fire resisting qualities.** On all these points "Fenestra" excels, as a very short consideration of details of construction will prove.

Strength

The efforts of the architect or engineer have always been directed towards designing construction to obtain the requisite strength with the minimum material. In steel sash construction previous to the invention of the "Fenestra" Joint, the old-style Mitre Joint was used, and is still used by all other solid steel sash manufacturers. In the Mitre Joint fully 50 per cent. of the bars is cut away, which is only compensated for, to a more or less degree, by the "so called" welding and by using a heavier section of bar.



“Fenestra” Steel Sections

The “Fenestra” sections and bars are made from a special grade of steel of a very high tensile strength—at the same time, of sufficient toughness to stand the fabrication necessary to allow the cross bar and section to pass through.

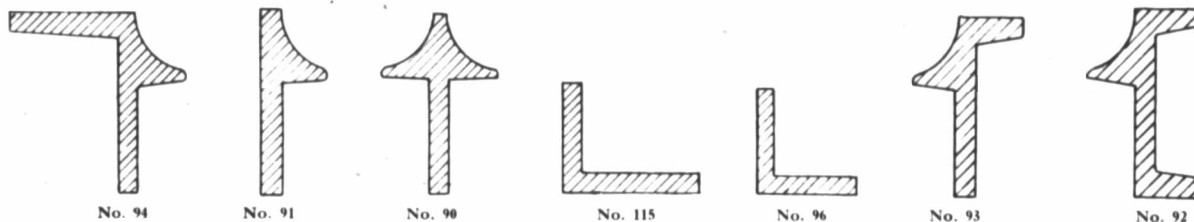







Full size “Fenestra” Steel Sections.

Unlike the old mitre joint, the fabricating required for the “Fenestra” construction, removes only about ten per cent. of the material. The material removed is from the centre, not affecting in any degree the strength of the bar. In fact, the special process of fabrication stretches the steel, greatly increases its tensile strength at that point, the whole resulting in a much stronger, yet lighter, joint.

An interesting and reliable test was made at the National Physical Laboratory, Teddington, England, and the copy of report of same on following page is worth careful study. Official tests were also made by the authorities of the Royal Arsenal, Woolwich, with a result most satisfactory to “Fenestra” Sash. A perusal of this report on page 8 will be found interesting.

Report of Tests made at the National Physical Laboratory (Teddington, England) of
"FENESTRA" AND MITRE CROSS JOINTS
 Showing relative strengths.

Load in tons.	 <u>1½ Fenestra.</u>	 <u>1×1 Tee Fenestra.</u>	 <u>1½ Mitre Joint.</u>	 <u>1½ Mitre Joint.</u>	 <u>1½ Fenestra.</u>	 <u>2" Mitre Joint.</u>	 <u>1½ Fenestra.</u>
	PERMANENT DEFLECTION IN INCHES.						
0							
.1							
.2	.01						
.3		.02					
.4			.05				
.5				.06	.03		
.6						.04	
.7							.02

The frames were supported at all four corners and loaded in the middle, the long and thin web always being at the bottom. The supports were 22 inches apart.

(Signed) R. T. GLAZEBROOK, Director.

A report from this source is entirely above suspicion of error, and speaks loudly as to the relative strength of "Fenestra" and mitre joints.
 The Expanded Metal and Fireproofing Co., Limited.

Report of Official Tests made by the Authorities at the
Royal Arsenal, Woolwich, of

Patent "Fenestra" Joint Sashes

Test of "Fenestra" Joint Sashes supplied by The Crittall Manufacturing Company, Limited, London and Braintree, England, to ascertain whether they would resist wind pressure equal to static load of 30 lbs. per square foot. The panes were 2 ft. 1 in. by 1 ft. 6 in.

The two Sashes tested were glazed and placed in a horizontal position, with supports at points of fixing.

LARGE SASH

9 ft. 5½ in. by 10 ft. 6½ in. = 99½ ft. super.	
Weight (glazed)	567 lbs.
Weight of sand, spread evenly over surface	2418 lbs.
Total load	2985 lbs.
Maximum deflection	1¼ in.
Set after removal of sand	¼ in.
No glass was broken.	

SMALL SASH

10 ft. 6½ in. by 7 ft. 7¼ in. = 80 ft. super.	
Weight (glazed)	416 lbs.
Weight of sand, spread evenly over surface	1984 lbs.
Total load	2400 lbs.
Maximum deflection	1½ in.
This Sash was further loaded with 800 lbs. of sand, bringing total load to 40 lbs. per square foot.	
Maximum deflection	1¾ in.
Set after removal of sand	¼ in.
No glass was broken.	

A quantity of the above "Fenestra" Sash were selected for use in the new Shrinking Pits Building, by the authorities at the Royal Arsenal, Woolwich, as a result of the above tests. We may further say that the conditions at Woolwich are particularly trying. Previous to this test, the Royal Arsenal Authorities had used other steel sash with so discouraging results that it was only by the greatest amount of persuasion that our friends, The Crittall Manufacturing Company, Limited, could gain the necessary consent to submit the "Fenestra" Sash, for the test. Of course the difference is all in the "Fenestra" Patented Joint.

The "Fenestra" Joint

Like all other useful inventions, the process of making the "Fenestra" joint is perfectly simple. The only wonder is that it has never been thought of before. On this page are a few illustrations which will suffice to show how the "Fenestra" joint is made.

A small cross slot is made in the vertical bar (only sufficiently large to allow the flange of the horizontal bar to pass through), the moulded portion is then pressed out so as to fold closely round the moulded portion of the horizontal bar.

All that happens to the horizontal bar is that a small notch is made in it to act as a lock. From this it will readily be seen that the amount of metal removed in making a "Fenestra" joint is comparatively infinitesimal. This allows a far lighter section to be used than is possible with the mitre joint, thus making a great saving in the weight of the material used, and consequently in the ultimate cost of the sash.

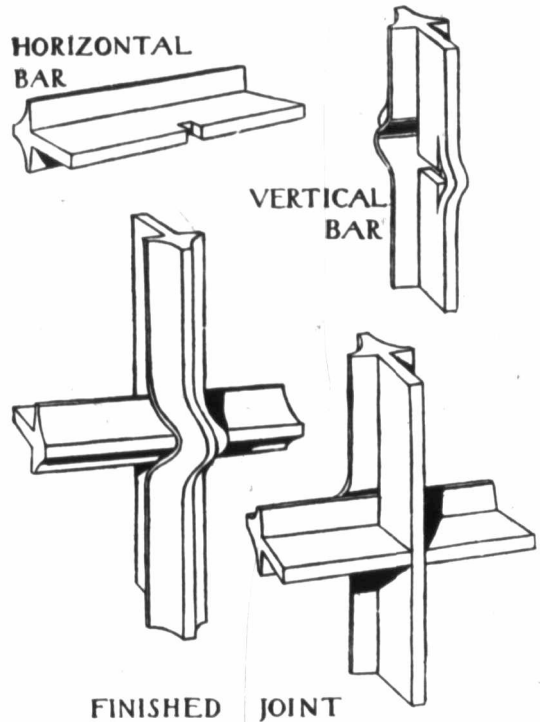

Minimum Obstruction of Light

A most important and valuable feature of any building is **plenty of daylight**. Daylight is cheap, and surely the sash which combines the maximum strength with lightness of the construction of steel bars, is the **Ideal Sash**. Where wood sash are used in ordinary-sized windows, twenty-five per cent. of the actual window space or opening is blocked by frames and sash. If the window is large, a still greater percentage is taken up by the necessary mullions to provide requisite strength. Where hollow metal sash are used, the same disadvantage in a greater degree is found, with the added objection that this make of sash is liable to bulge or bend, consequently making it difficult, if not impossible, to operate.

"Fenestra" Steel Sash has none of these objections. It stands alone as the real "daylight" sash, giving the maximum light from every window opening.

In factories, when it is desired to open the entire window area, either in sections or altogether, **"Fenestra"** Sash should be used. Its rigidity makes it the ideal sash for this purpose. Note cut of new shop, Detroit Steel Products Company. These windows are worked from two levers only.



NEW WORKS, DETROIT STEEL PRODUCTS COMPANY, DETROIT, MICH.

P

"Fe
extending
or owner
be arran
or opera
to the v

Provision for Ventilation

"Fenestra" Sash lends itself to any one of several schemes of ventilation, extending from the whole window to any percentage of same which the architect or owner might consider necessary. The ventilating or opening part can be arranged in any section or sections of sash. This ventilator can be hinged or operated in many ways, as shown in cuts. The hinges are simply fastened to the vertical "Fenestra" bar, which is sufficiently strong for this purpose.

The cuts also show the many available devices for the opening and locking of ventilators.

Another method that may be adopted is to hinge the ventilator on top or bottom, as shown in accompanying cuts. Suitable devices to operate these are supplied and guaranteed to work satisfactorily.

All these side, top or bottom hinged ventilators can be arranged to open inward or outward, and fittings to suit all requirements are provided.

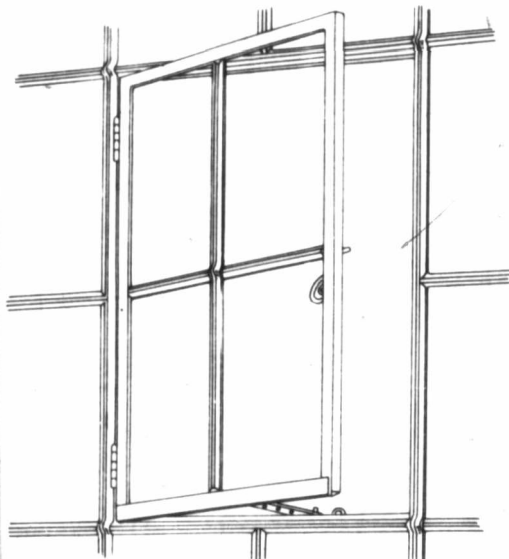

Side hinged, to open out or in.

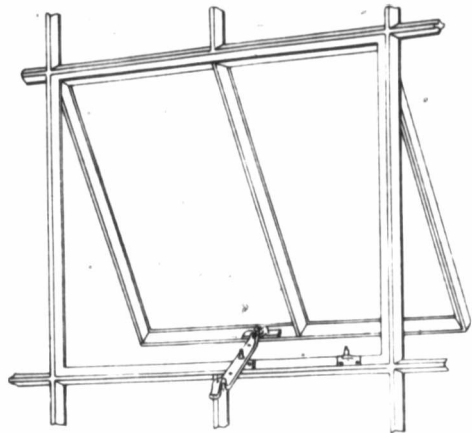

Top hinged, to open out or in.

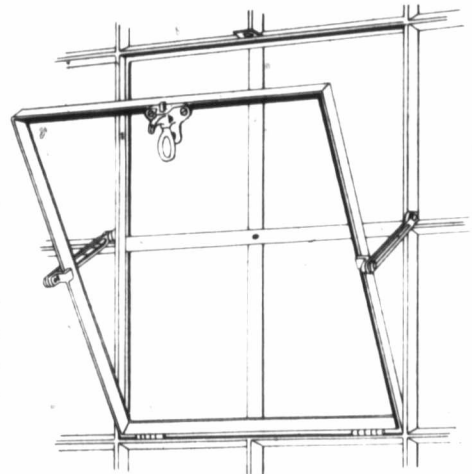

Bottom hinged, to open out or in.

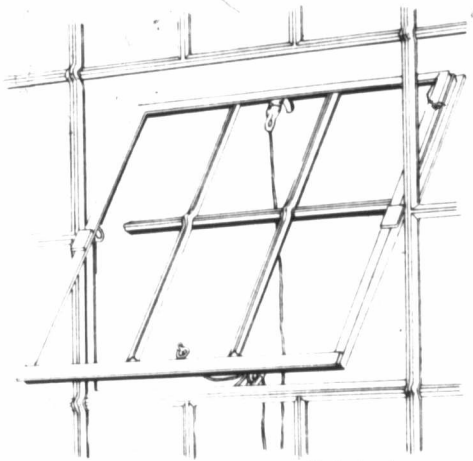

Side pivotted, balanced or self-closing top.

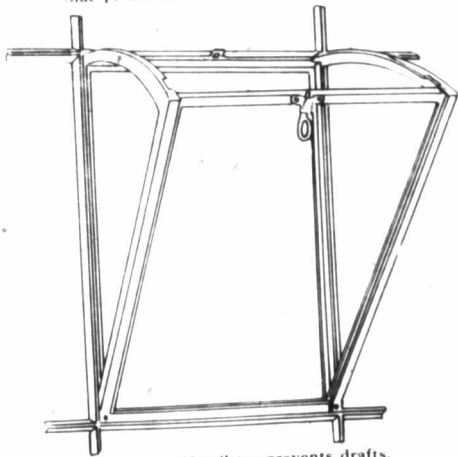

Hopper Ventilator prevents drafts.

The most generally used method of hanging ventilator is by centre pivots on sides. This arrangement is more economical and stands more hard usage than other methods. Where the ventilator is large in area, best results are often obtained by hanging on pivots, top and bottom, as shown in cut.

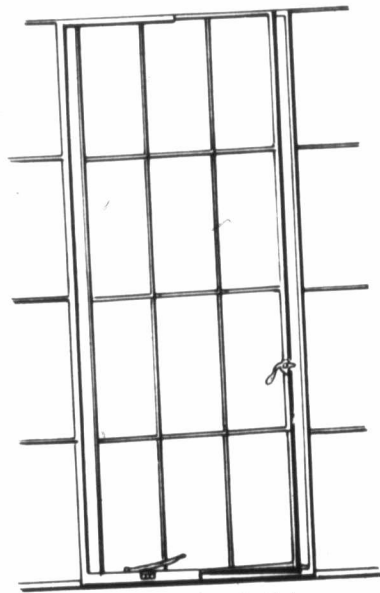

Top and bottom pivotted.

"F
investigati
would bu
joint is a
for expans
the wire

Tests
Laborator
establishe
Sash is f
any other

Beside
actual fire
Although
mained in
out with t
steel sash

The N
factory in
Mutuals o
every cas
considera

D
th
W
th
so

Th
extended

T
ch
ch
pa
ap
gl

Fire Resisting Qualities

"Fenestra" Steel Sash is fireproof, nearer absolutely fireproof than any other sash made. An unprejudiced investigation by persons capable of appreciating sash perfection will prove this fact. It may be stated that the solid steel bar joint is a "slip-joint" or expansion joint, and allows for expansion and contraction, remaining intact even after the wire glass has melted out.

Tests similar to those applied at the Fire Underwriters' Laboratories, Chicago, have been carried out, and have established beyond any doubt the fact that "Fenestra" Sash is fireproof—a better fire protection in fact than any other sash on the market.

Besides these tests, solid steel sash have been through actual fires, one of which is shown in the following cut. Although this factory was entirely gutted, the sash remained in place and intact, while the wired glass melted out with the extreme heat. This surely proves that solid steel sash is fireproof.

The New England Mutuals, who do a large business in factory insurance, strongly favor "Fenestra" Sash. The Mutuals consider every risk on its own merits, so that in every case "Fenestra" Sash, where used, is given due consideration. Note reference to sash in following letter:

DETROIT STEEL PRODUCTS CO., Detroit.

Gentlemen:—We would like to suggest that you communicate with Messrs. Patterson and Davidson, Engineers, Monadnock Building, this city, who are now designing two or three buildings which are to be insured in our companies, and upon the subject of your windows. We have informed the gentlemen referred to that we would gladly accept same, in fact, suggested their use, and believe in this regard that we can advance the use of the window of your concern to a reasonable extent at least. In any event, we will take pleasure in doing so all that we can.

Dated by P.J.H.—E.S.

Yours very truly,

(Signed) P. J. HALLA, Secretary.

The Canadian Fire Underwriters' Association, after careful examination, have recognized "Fenestra" Sash, and have extended the consideration shown in the following letter:

THE EXPANDED METAL CO., Toronto.

Dear Sirs:—Referring to our conversation this afternoon, I now beg to confirm what was then stated, that our allowance from the charge for exposure for a standard labeled wired glass window, when in solid brick or stone building, is fifty per cent. of the exposure charge. For an ordinary hollow frame metal sash window of good make, we allow three-quarters of this fifty per cent., and we are prepared to make the same allowance for "Fenestra" Sash, pending its submission to the Underwriters' Laboratories. Of course, if it is approved by the Laboratories, the full allowance will be given for this sash that would be given for any other labeled sash with wired glass lights.

Yours very truly,

(Signed) JOHN A. ROBERTSON, Secretary.

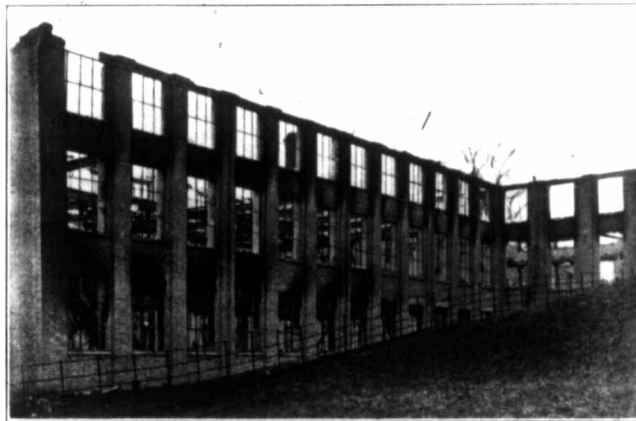

CHICAGO, April 28th, 1909.

The home of "**Fenestra**" Sash and "**Steelcrete**" Expanded Metal, Toronto, is a good example of a daylight shop. "**Fenestra**" Sash makes this construction possible and economical.

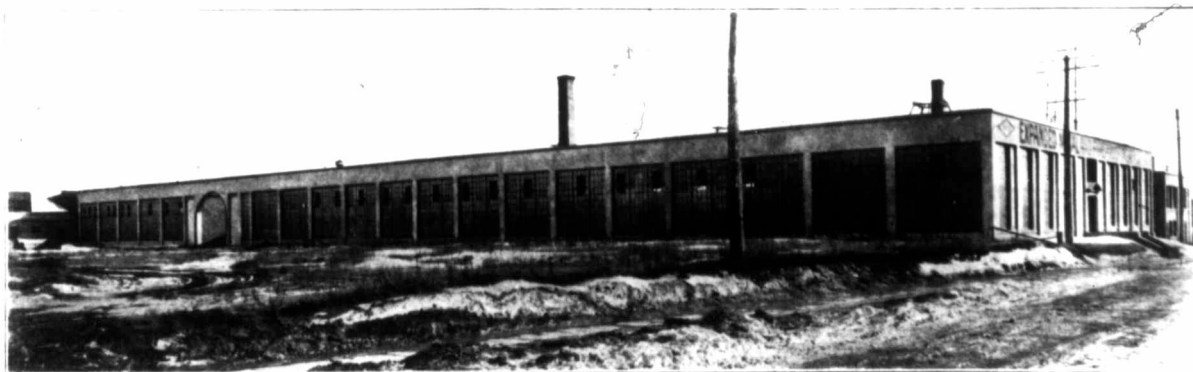

NORTH VIEW OF EXPANDED METAL AND FIREPROOFING COMPANY'S PLANT

Fraser Avenue, Toronto.

F. H. Herbert, Architect.

Suggestions have been made that where the wall is practically all glass the building cannot be properly heated. This is not the case. Modern schemes of distributing heat have overcome this objection. The result is, without any extra expense in construction, buildings can be made light, healthy and comfortable. Use "**Fenestra**" Sash and daylight.

Where "**Fenestra**" Sash is Made

In equipping the plant for the manufacture of "**Fenestra**" Sash in Canada, advantage was taken of the experience of the plants established in England, Germany and United States. The result is that the equipment of the Canadian plant is thoroughly up-to-date. In every department the machines and tools are of the most improved type, and the workmen employed are skilled mechanics under the supervision of a superintendent who has worked on "**Fenestra**" Sash since its invention.

In the Casement Department men have been secured who have had a long training in the best shops abroad, so that Casements of all kinds can be manufactured in Canada equal to any produced in England or other countries.

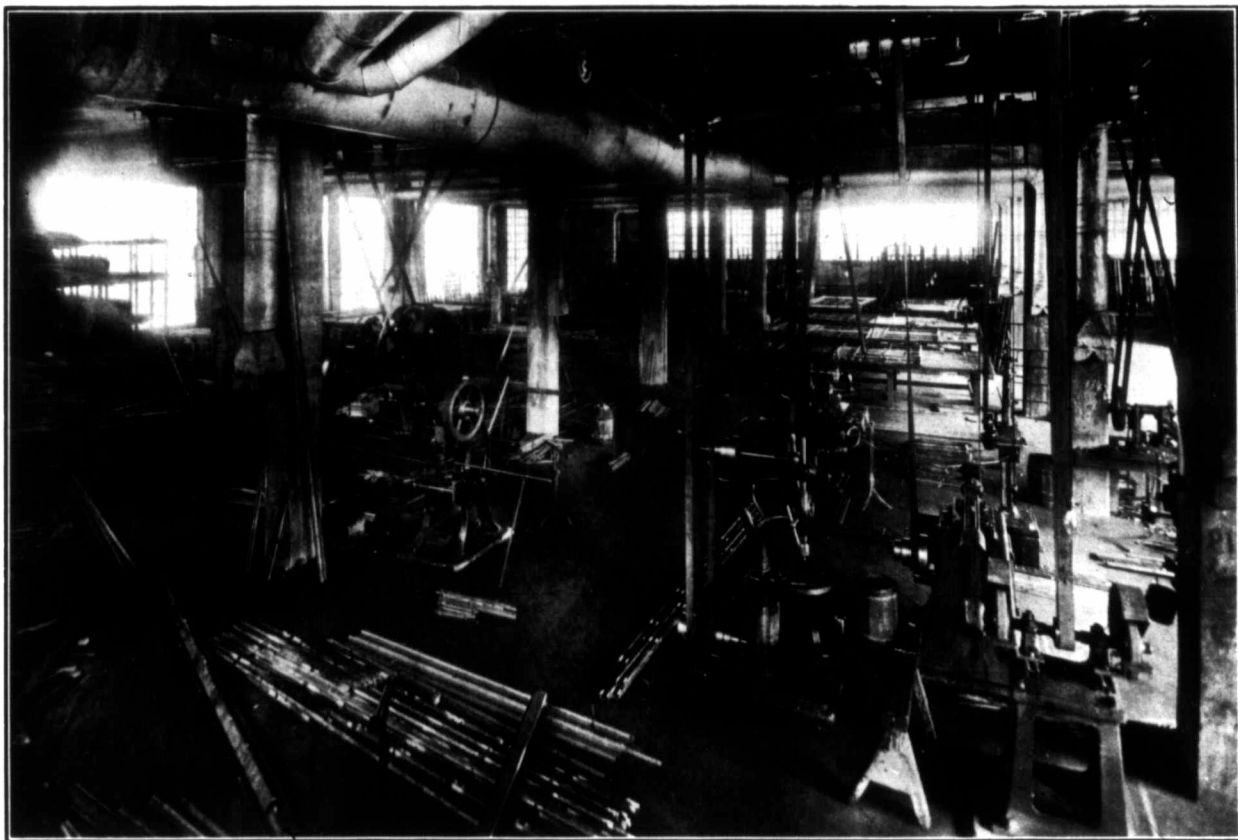

WHERE "FENESTRA" SASH ARE MADE

Manufacturing Feature

To keep pace with all improved methods adaptable to the manufacture of "**Fenestra**" Sash and Steel Casements, the **Davis-Bournonville** Process of **Oxy-Acetylene Welding** has been installed. This process, which is one of the most wonderful developments in metal working in recent years, **welds** or **fuses** together the **corners of ventilators** where special strength and rigidity are required.

The **Oxy-Acetylene Process** is particularly adaptable to the manufacture of a steel frame, such as is used in making a "**Fenestra**" Ventilator or Steel Casement, making all corners rigid and just as strong as the original bar.

The **Oxy-Acetylene Process** is also adaptable to attaching fittings to sash and ventilators, making a much neater job. By this process, brass, copper or cast iron can be welded as readily as steel.



Shipping "Fenestra" Sash

Besides inspection of all parts during construction, when "**Fenestra**" Sash arrives in the Finishing and Shipping Department a final and thorough inspection is made, and all working parts of ventilators are tested. After this inspection the sash is given one coat of paint, and the ventilators, catches, etc., are all tied up to prevent damage in transportation.

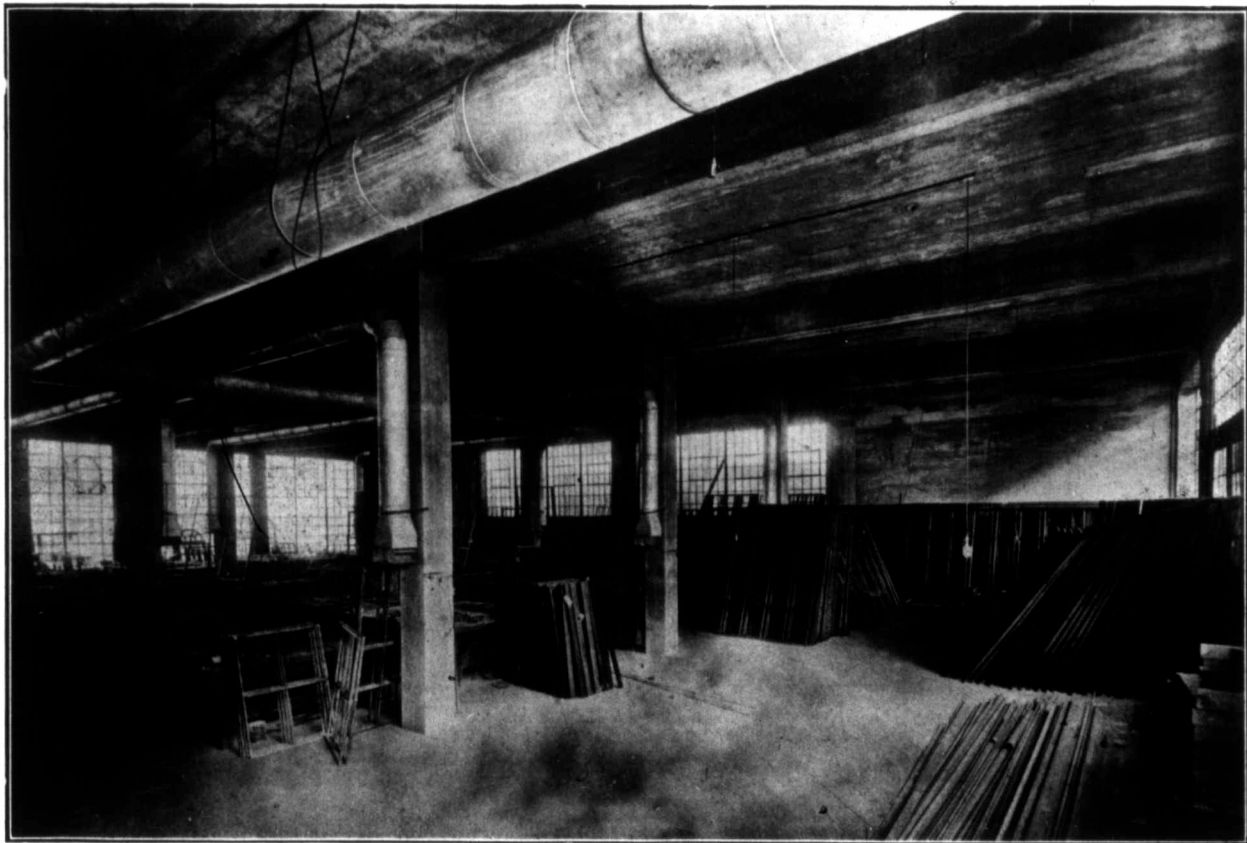

FINISHING AND SHIPPING DEPARTMENT

Page Seventeen

Daylight in Factories

Up-to-date manufacturers recognize the primary importance of abundance of daylight. It means better and more work, less waste, better spirit among workmen and cleaner premises—the difference between the new systematized modern plant and the old-time rule-of-thumb shop. Can any person afford to build and sacrifice any possible daylight? Daylight costs nothing, and is far superior to any artificial light.

Perhaps one of the best examples of the new era, up-to-date plants now being erected, is that but recently completed for the Ford Motor Company in Detroit. This immense plant is equipped with “Fenestra” Sash throughout; and the owners are delighted with results.

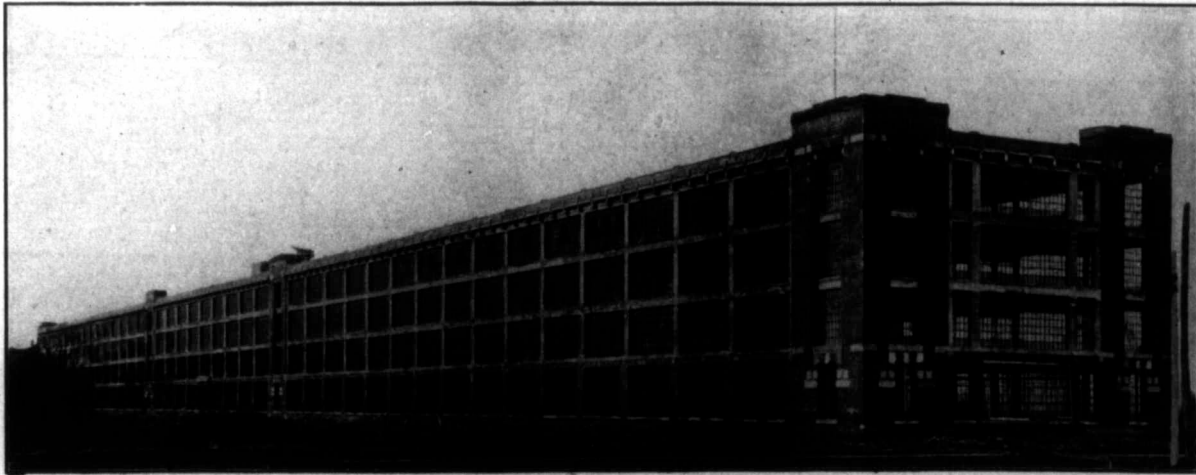

FORD MOTOR COMPANY'S PLANT, DETROIT, MICH.

Designing for "Fenestra" Sash

In designing for "Fenestra" Steel Sash, in order to obtain the best results at cheapest cost, a few cardinal points should be kept in mind.

Repetition of sizes of sash and sizes of glass panes reduce the cost of construction very materially.

Repetition of size and method of hanging ventilation section also reduces cost.

Strength of "Fenestra" bars allow the use of larger panes of glass. This, however, is governed somewhat by the possible danger of breakage and cost of replacement.

Any variation from the flat top sash increases cost to some extent. However, very often the construction of wall is such that flat top cannot be used without a lintel, which adds to the expense. This is sometimes economically overcome by using cambered top or semi-circular head. In this catalogue is shown a number of designs suggesting construction of sash economical in size to manufacturer, the suggestions as to use of material for mullions, or strengthening bars, and generally, sketches and data to assist the Architect and Engineer in arriving at a design most suitable for intended purpose.

Where desired, special designs will be furnished on receipt of information as to requirements.

Suggestions for Specifications for "Fenestra" Sash

In order to ensure accuracy, besides showing sash in elevation, the size and number of panes in width and height checks size of sash.

If the cambered tops are used, the amount of spring ought to be stated in figures, as particularly in blue prints it is difficult to scale the correct measurements.

The number of panes in each ventilator, method of handling ventilator, which may be any one of the several methods indicated in this catalogue.

Any special attachment for operating ventilators, such as use of fusible links, or automatic opening or closing, as desired.

To save expense in setting "Fenestra" sash on the job, specifications ought to direct some trade already employed on the job to do the necessary installing, otherwise the expense of sending men for this purpose is considerable, as it is not always convenient for two trades to work together at specific point at the same time.

When sash installed in brick wall or brick piers, the usual practice is for bricklayer to set and build in. Where sash installed in concrete construction, the usual practice is for concrete contractor to set and build in.

In some cases Architects have asked that the carpenter set and true up all sash, leaving for the mason or concrete contractors to build in only.

In making the above suggestions it is hoped to bring to the notice of the Architect or the Engineer making design, some little points in the specification which might otherwise be overlooked, and thus cause the necessity of a further interview or communication using up time of all concerned.

Glazing "Fenestra" Sash

Any painter and glazier who understands glazing any sash can glaze "Fenestra" Sash. No special training is required. Pegs are furnished with sash, which are easily placed in position in holes provided for same; in fact, a good workman with good putty will make a better job of glazing in "Fenestra" Sash than in any other class of sash construction, because of the rigidity of the sash. **The one item to be observed is the use of putty that will dry and set quickly.** The steel sash bar absorbs nothing, so that a cheap putty of a light consistency will not give a good job.

All glass should be back puttied, that is to say, bedded in putty. By doing this, and striking off same flush on the outside, possible lodgement of water and frost troubles is prevented.

In glazing "Fenestra" Sash, the wooden wedges with which the ventilator sections are provided for the purpose of holding same in position during transportation and while being installed, should be left in place without disturbing, as long as possible, as they ensure the maintenance of the proper position of the ventilators until everything is made complete and rigid by the completion of the whole window.

"Fenestra" Sash being made in larger sections is almost invariably glazed after being put in position.

The usual practice is to glaze from the inside.

Pricing "Fenestra" Sash

On account of the many and varied conditions which affect the cost of making "Fenestra" Sash, it is found impossible to publish a price list which could cover all conditions and be to any extent satisfactory to either manufacturer or customer.

Prices will be furnished on any quantity of sash required on receipt of particulars, as indicated through this catalogue.

To ensure against mistakes and delays, it is suggested that, even at the expense of some repetition, the following points be always covered:

Give name of station and routing by which goods are desired to be shipped.

Give total number of sash required of each size.

Give width of opening first, and give **height of opening** second.

Give amount of ventilation desired, naming the style of ventilator, referring to page illustrating same.

Give date when first sash are required.

Setting “Fenestra” Sash

The Sash leaves the factory complete, ready for setting in masonry, screws for assembling mullions and hook bolts for attaching to structural work, where any of these special features are necessary. In the case of ventilated sash, the ventilators are kept in position by wooden wedges and twine, care must be taken that these wedges are not removed until the greater part of the sash is glazed.

The sash should be stood on the sill of the opening which it is to fill, in its correct position. It should then be plumbed for square and perpendicular. The sides of the sash then serve, in a brick building, as a guide for the bricklayer, and all that is asked of him is that he shall build in the flange of the frame as his wall goes up.

It should then be understood that the sash will carry no great weight on its head, and when the walls of a building continue above the sash, adequate structural work (see sketch No. 5, page 32) or brick arches or stone head must be provided to support the brick work.

In all special cases, special instructions will be sent to meet the peculiarities of the case.



Typical "Fenestra" Sash

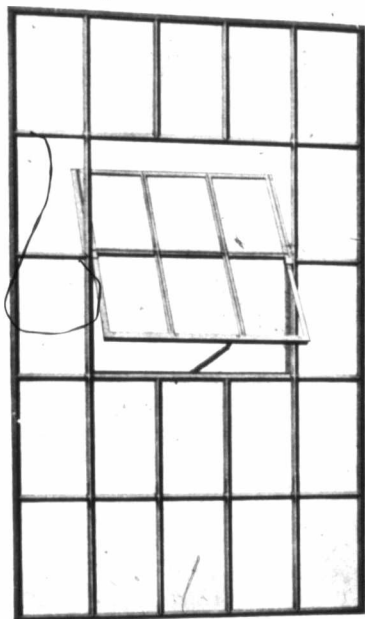

Type "A"

Size, 5 2³/₄" x 7 8³/₄".

Panes, 12 x 18.

Ventilator, 6 panes, side hung pivotted

Sash shipped complete, with individual opening and locking device, steel glazing pins, fixing lugs, bolts, etc.

Typical Sash "A" and "B" can be built with any of the outside sections shown in sketches 1, 2, 3, 4 or 5, pages 28 to 32, and may be used singly or in series with flat mullions, as illustrated in sketch 6, page 33.



Type "B"

Size, 5 2³/₄" x 9 3¹/₈".

Panes, 12 x 18.

Ventilator, 9 panes, side hung pivotted.

Typical "Fenestra" Sash "C"

Size, 5' 2 $\frac{3}{4}$ " x 12' 3 $\frac{1}{2}$ ". Glass, 12' x 18'.

VENTILATOR.—Two sections of six panes each, side hung pivoted, and fitted with individual opening and locking device.

Sash "C" also can be built with any of the outside sections, illustrated on pages 28 to 32, and may be used singly or in series.

Fusible Links

Where "Fenestra" Windows are required to meet the Underwriters' requirements for automatic closing of ventilators, they are fitted with Regulation Gravity Catches and Fusible Links, also "Fenestra" Fireproof Putty.

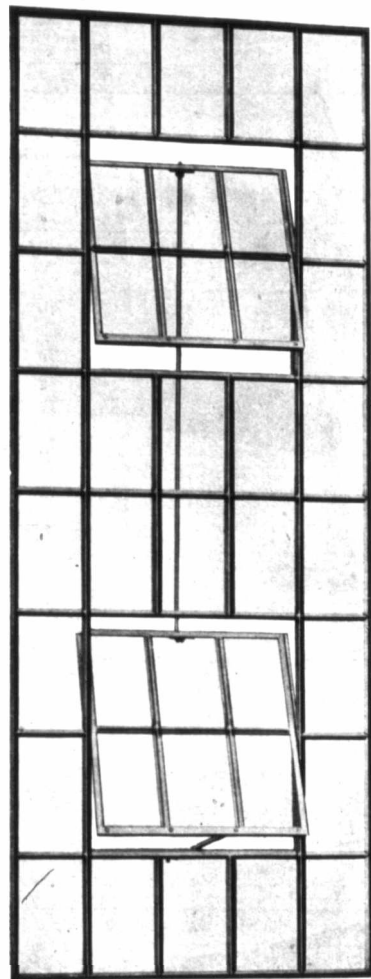

Typical "Fenestra" Sash

(Cambered Heads)

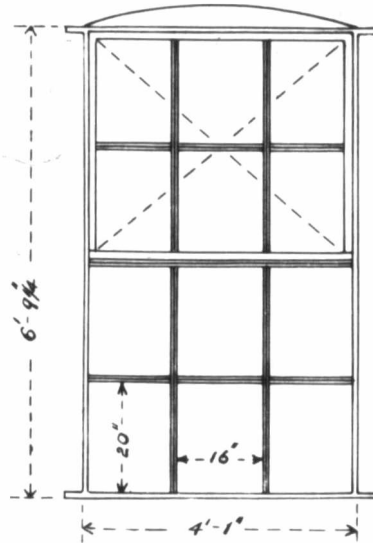

Sash "D"

Size, 4 1' x 6 9 1/4" Glass, 16 x 20

VENTILATOR.—Top half, 6 panes, side hung, pivotted. Cambered Top 10 ga. sheet steel. Sections as per sketch on page 29.

Sash D with 10 ga. sheet steel head makes a cheaper Sash than head shown on Sash E. The appearance is good.

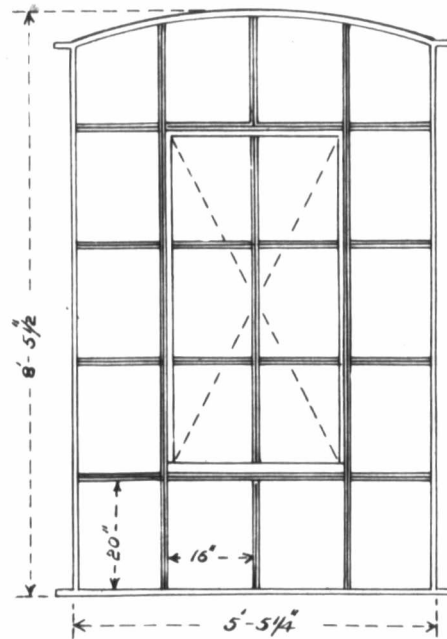

Sash "E"

Size, 5 5 1/4" x 8 5 1/2" Glass, 16 x 20

VENTILATOR.—6 panes, side hung, pivotted.

All sash complete, with opening and locking device, glazing pins, fixing lugs, bolts, etc.



Tables

Giving
Brick
Openings
for
Varying
Number
of
Panels.

Standard
Size
Glass.



Number of Panes in Height.	Height of Glass.									
	8	10	12	14	16	18	20	22	24	
2	1 4 $\frac{1}{4}$	1 8 $\frac{1}{4}$	2 0 $\frac{1}{4}$	2 4 $\frac{1}{4}$	2 8 $\frac{1}{4}$	3 0 $\frac{1}{4}$	3 4 $\frac{1}{4}$	3 8 $\frac{1}{4}$	4 0 $\frac{1}{4}$	
3	2 1	2 7	3 1	3 7	4 1	4 7	5 1	5 7	6 1	
4	2 9 $\frac{1}{4}$	3 5 $\frac{1}{4}$	4 1 $\frac{1}{4}$	4 9 $\frac{1}{4}$	5 5 $\frac{1}{4}$	6 1 $\frac{1}{4}$	6 9 $\frac{1}{4}$	7 5 $\frac{1}{4}$	8 1 $\frac{1}{4}$	
5	3 5 $\frac{1}{2}$	4 3 $\frac{1}{2}$	5 1 $\frac{1}{2}$	5 11 $\frac{1}{2}$	6 9 $\frac{1}{2}$	7 7 $\frac{1}{2}$	8 5 $\frac{1}{2}$	9 3 $\frac{1}{2}$	10 1 $\frac{1}{2}$	
6	4 1 $\frac{1}{4}$	5 1 $\frac{1}{4}$	6 1 $\frac{1}{4}$	7 1 $\frac{1}{4}$	8 1 $\frac{1}{4}$	9 1 $\frac{1}{4}$	10 1 $\frac{1}{4}$	11 1 $\frac{1}{4}$	12 1 $\frac{1}{4}$	
7	4 10	6 0	7 2	8 4	9 6	10 8	11 10	13 0	14 2	
8	5 6 $\frac{1}{4}$	6 10 $\frac{1}{4}$	8 2 $\frac{1}{4}$	9 6 $\frac{1}{4}$	10 10 $\frac{1}{2}$	12 2 $\frac{1}{4}$	13 6 $\frac{1}{4}$	14 10 $\frac{1}{4}$	16 2 $\frac{1}{4}$	
9	6 2 $\frac{1}{2}$	7 8 $\frac{1}{2}$	9 2 $\frac{1}{2}$	10 8 $\frac{1}{2}$	12 2 $\frac{1}{2}$	13 8 $\frac{1}{2}$	15 2 $\frac{1}{2}$	16 8 $\frac{1}{2}$	—	
10	6 10 $\frac{3}{4}$	8 6 $\frac{1}{4}$	10 2 $\frac{1}{4}$	11 10 $\frac{3}{4}$	13 6 $\frac{1}{4}$	15 2 $\frac{1}{4}$	16 10 $\frac{3}{4}$	—	—	
11	7 7	9 5	11 3	13 1	14 11	16 9	—	—	—	
12	8 3 $\frac{1}{4}$	10 3 $\frac{1}{4}$	12 3 $\frac{1}{4}$	14 3 $\frac{1}{4}$	16 3 $\frac{1}{4}$	—	—	—	—	

Size of Brick Opening

Number of Panes Wide.	Width of Glass.						
	6	8	10	12	14	16	18
3	1 7	2 1	2 7	3 1	3 7	4 1	4 7
4	2 1 $\frac{1}{4}$	2 9 $\frac{1}{4}$	3 5 $\frac{1}{4}$	4 1 $\frac{1}{4}$	4 9 $\frac{1}{4}$	5 5 $\frac{1}{4}$	6 1 $\frac{1}{4}$
5	2 7 $\frac{1}{2}$	3 5 $\frac{1}{2}$	4 3 $\frac{1}{2}$	5 1 $\frac{1}{2}$	5 11 $\frac{1}{2}$	6 9 $\frac{1}{2}$	7 7 $\frac{1}{2}$
6	3 1 $\frac{1}{4}$	4 1 $\frac{1}{4}$	5 1 $\frac{1}{4}$	6 1 $\frac{1}{4}$	7 1 $\frac{1}{4}$	8 1 $\frac{1}{4}$	9 1 $\frac{1}{4}$
7	3 8	4 10	6 0	7 2	8 4	9 6	10 8
8	4 2 $\frac{1}{4}$	5 6 $\frac{1}{4}$	6 10 $\frac{1}{4}$	8 2 $\frac{1}{4}$	9 6 $\frac{1}{4}$	10 10 $\frac{1}{4}$	12 2 $\frac{1}{4}$

Size of Brick Opening

“Fenestra” Steel Sash

In Series for Buildings, where an abundance of light is appreciated.

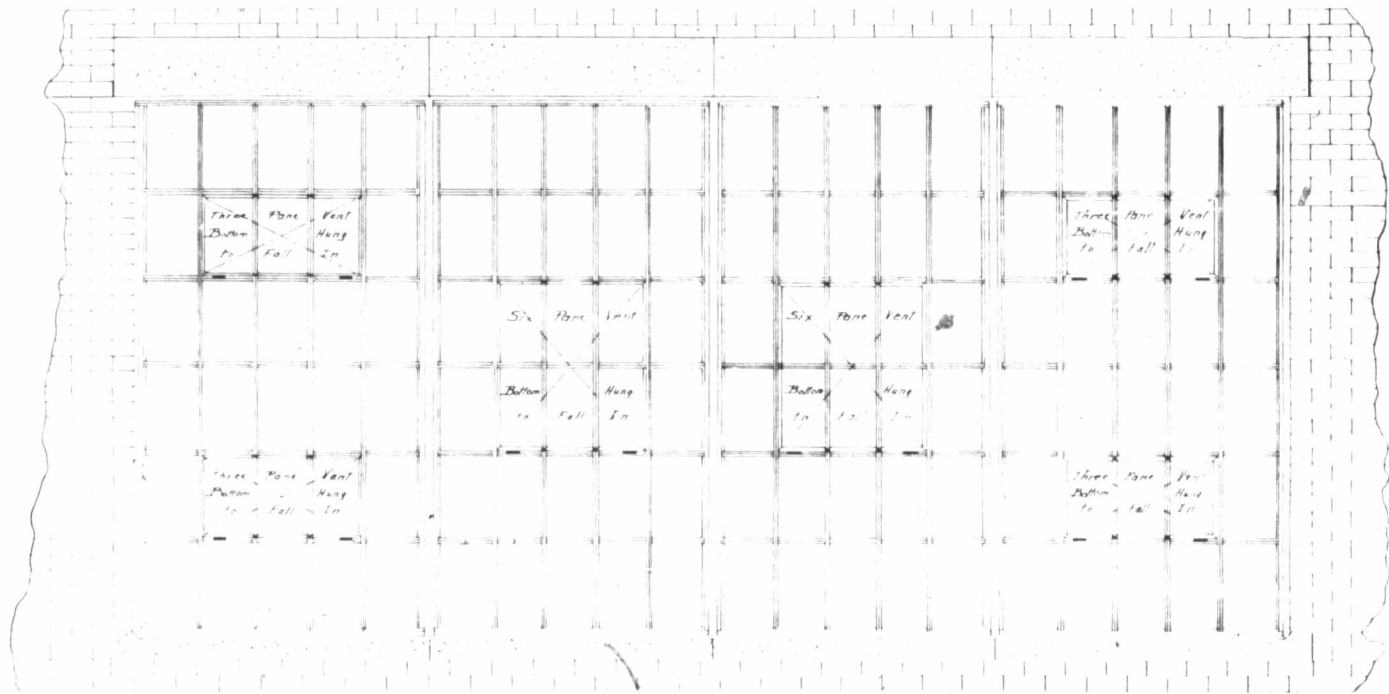

Either typical Sash "A," "B," or "C," illustrated on pages 23 and 24, could be thus grouped with 2 or 3 channel or flat mullions.

Note illustrations of Ford Motor Company and Detroit Steel Products Company plants on pages 10 and 18.

“Fenestra” Steel Basement Sash

The Permanent Burglar Guard

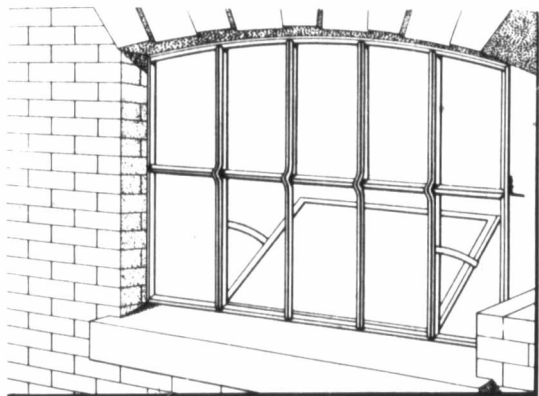

Size of Sash, as shown 2 6 x 2 0

Size of Vent 1 6 x 1 0

The ventilator, in angle frame, falls inward in the basement sash shown above while the bars form a most efficient guard.

The area of sash and ventilator and the spacing of bars may be varied to suit requirements.

Every good residence, as well as public and business buildings, should have “Fenestra” Burglar Proof Basement Sash.

“Fenestra” Steel Sash With Semi-circle Head

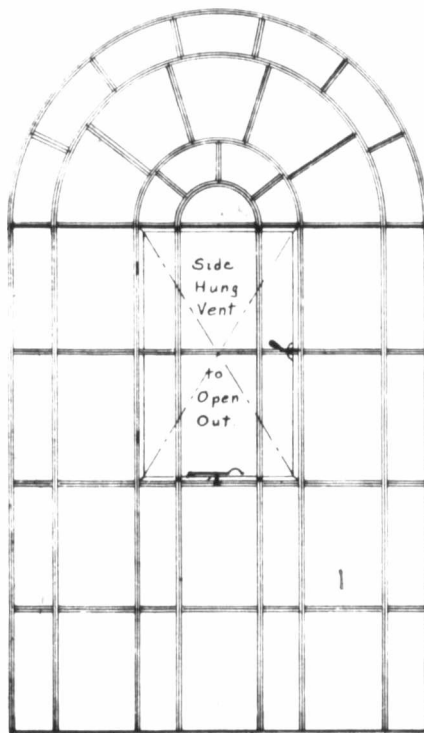

Caseament Ventilator

Suitable for Banks, Libraries, Churches, Schools, etc.

Sketch N°1.

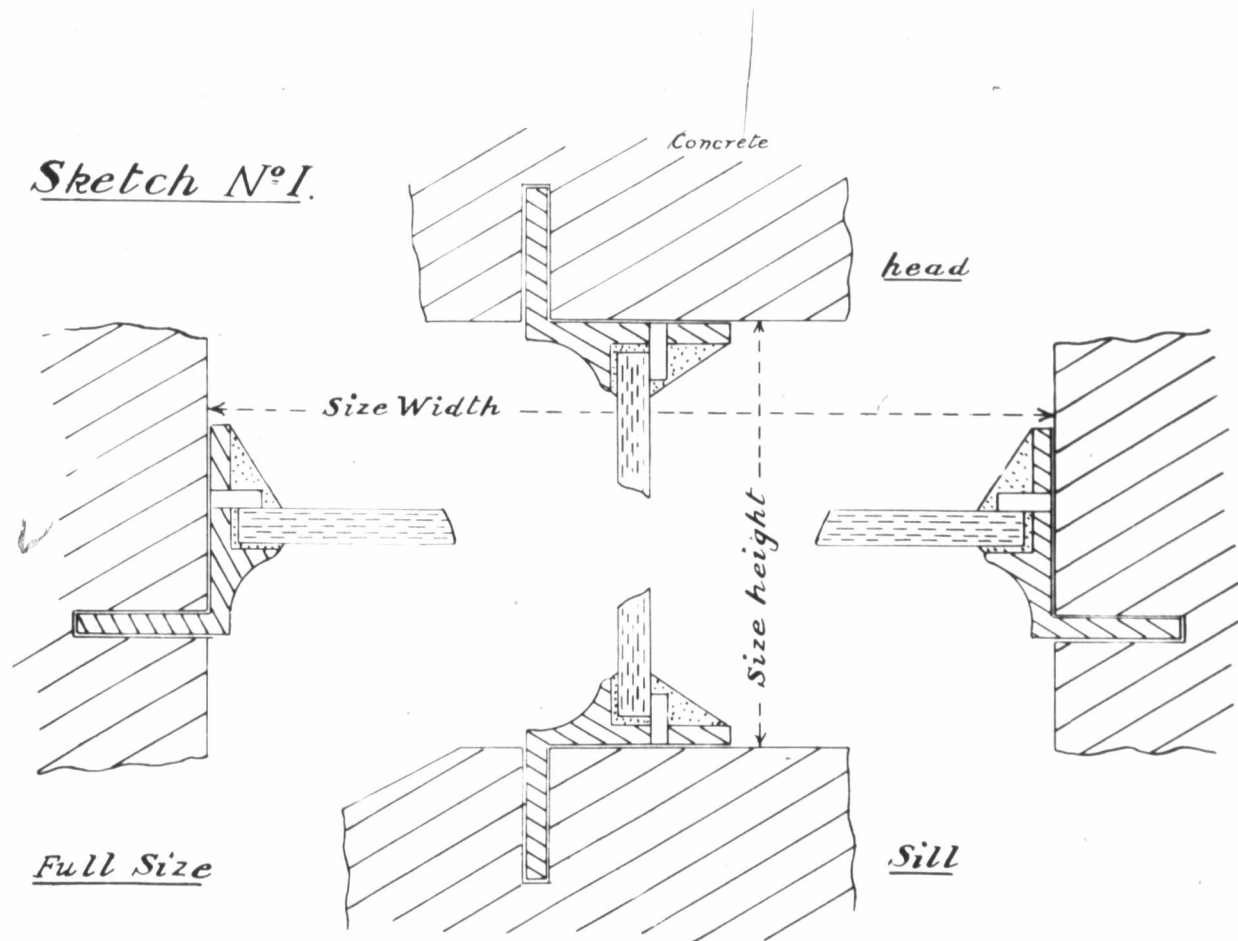

Illustrates Section No. 94, used all around outside of frame, and embedded full depth in concrete wall.

Sketch N^o 2

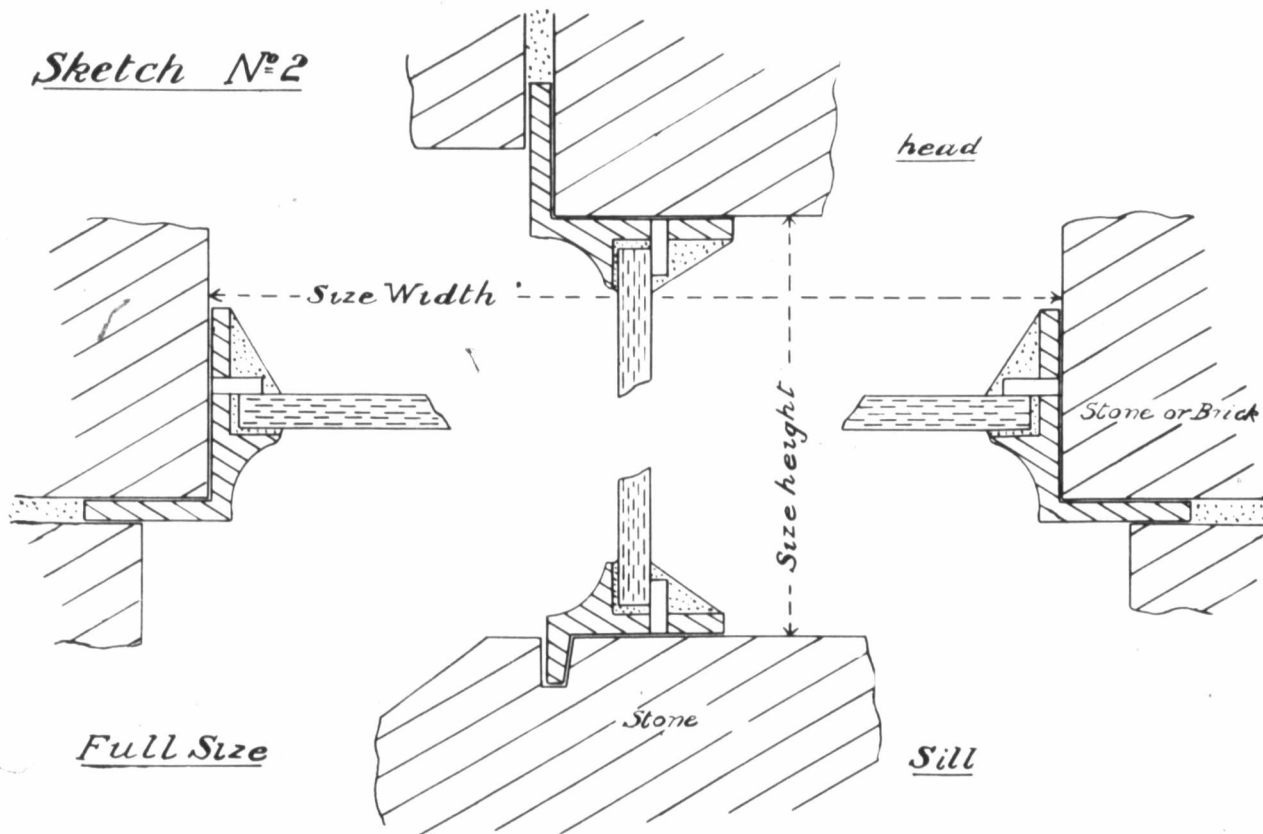

Shows Section 94, used for head and jambs in stone or brick walls, with half the flange revealed outside.
Section No. 93 is shown for sill, with groove cut in stone sill to receive narrow flange.

Sketch N^o 3

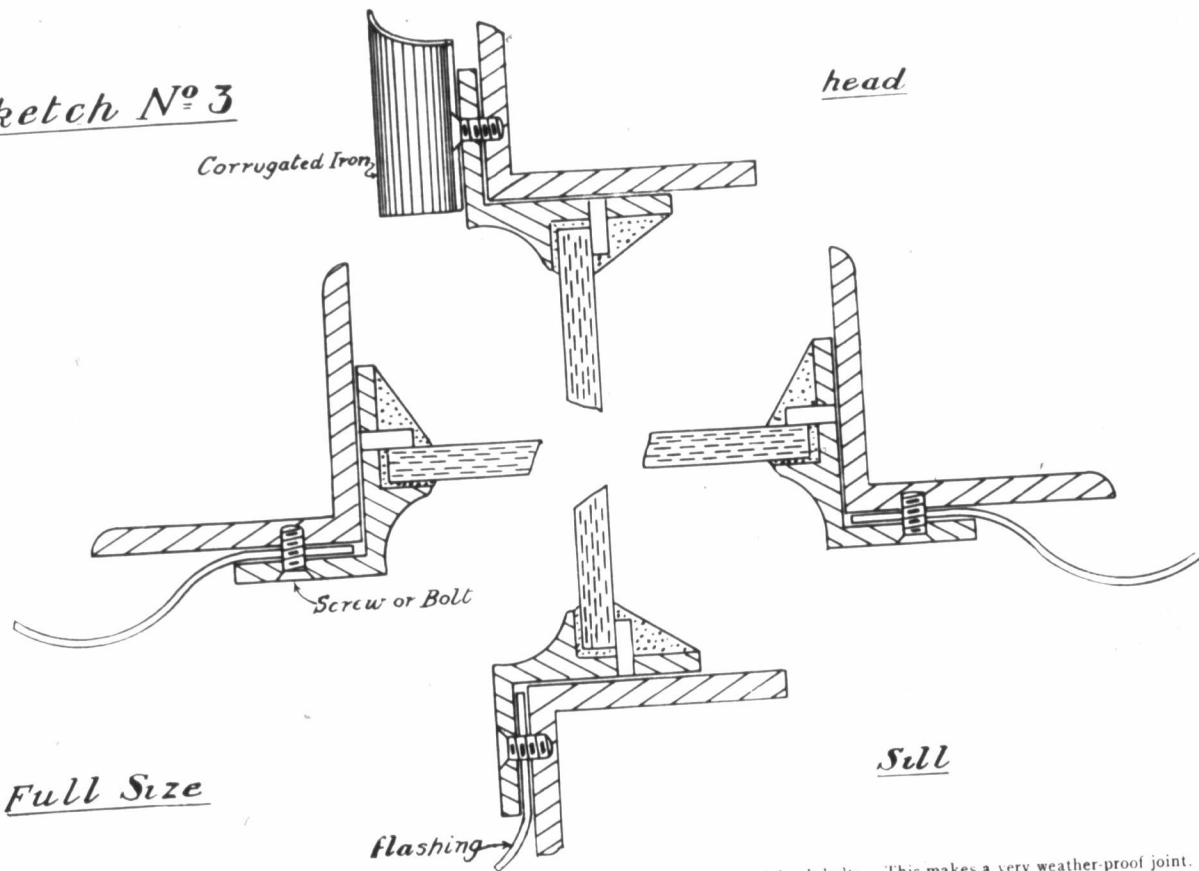

Full Size

Sill

Illustrates Section No. 92, used in conjunction with steel frame work, and secured by means of hook bolts. This makes a very weather-proof joint.

Sketch N^o 4.

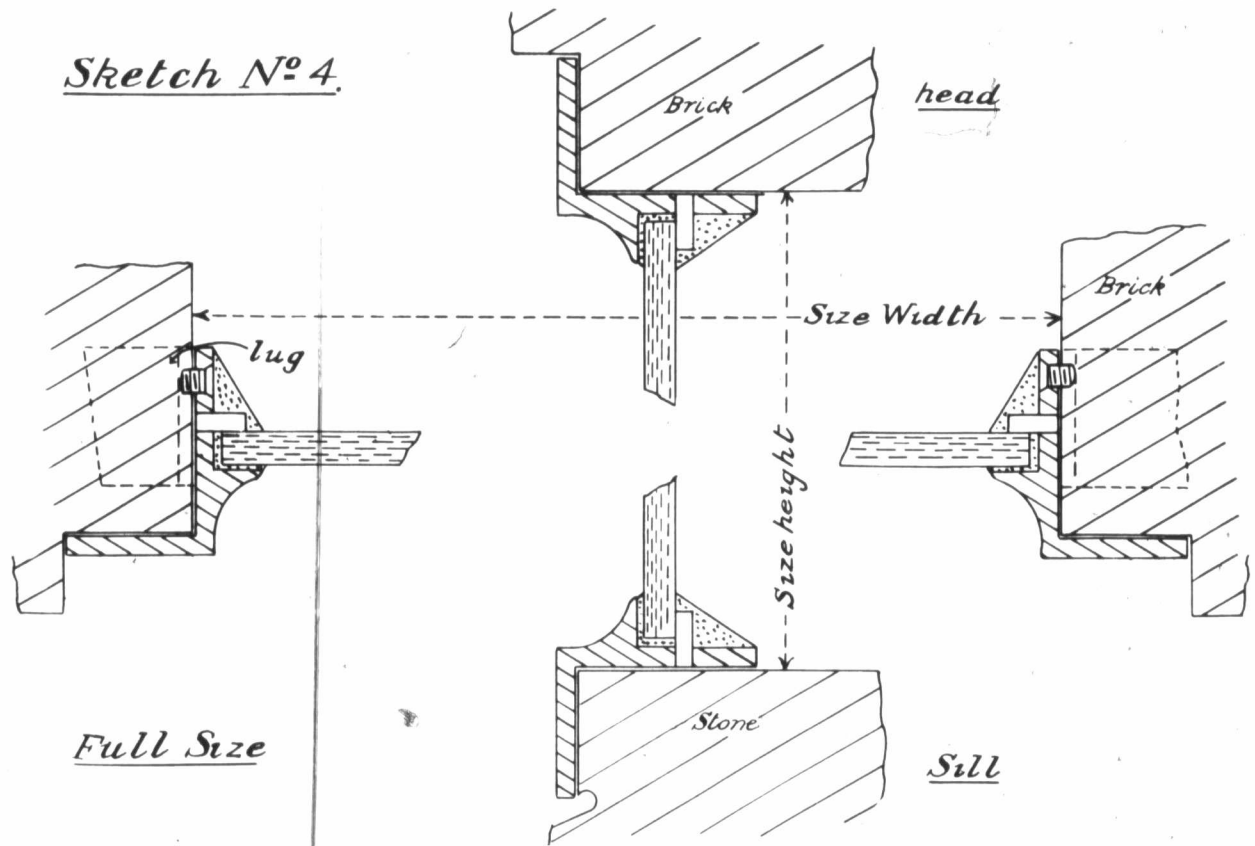

Shows Section No. 94, with outside flange fully revealed all around and with lugs built into brick at sides.

Sketch No 5.
Details for
fixing to steel
lintel

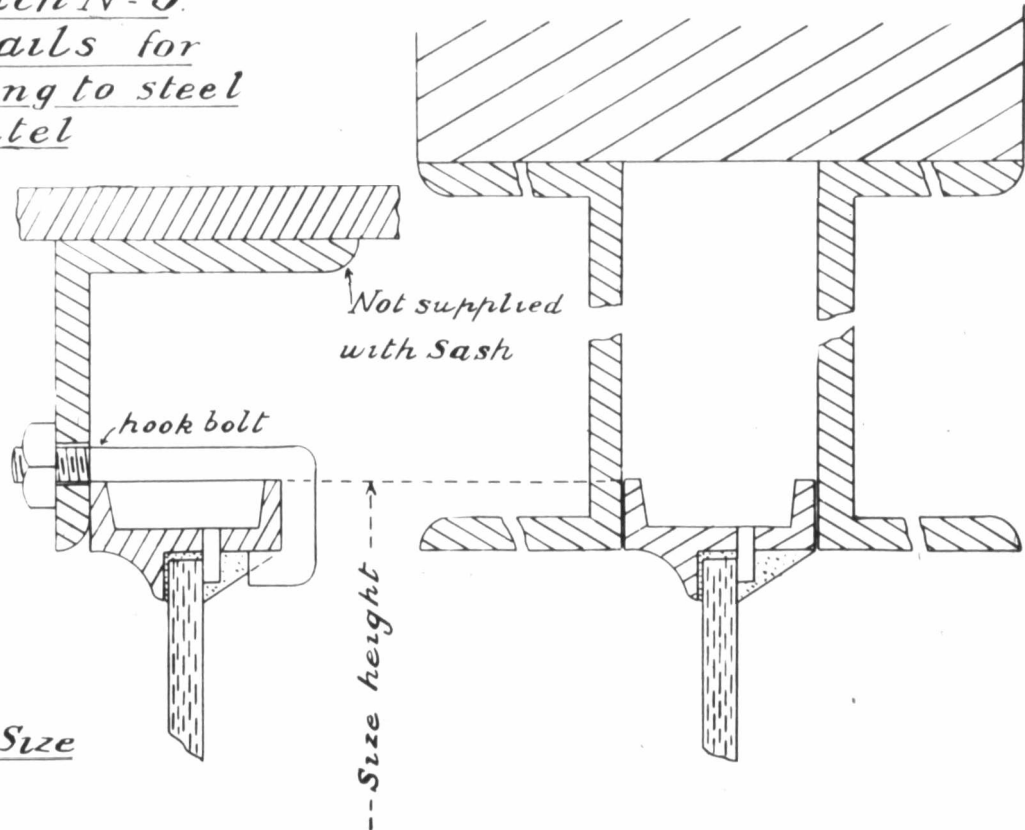

Full Size

Suggests methods of fixing to steel lintels where same are used.

Sash showing flat mullion & Channel transome

Sketch N°6

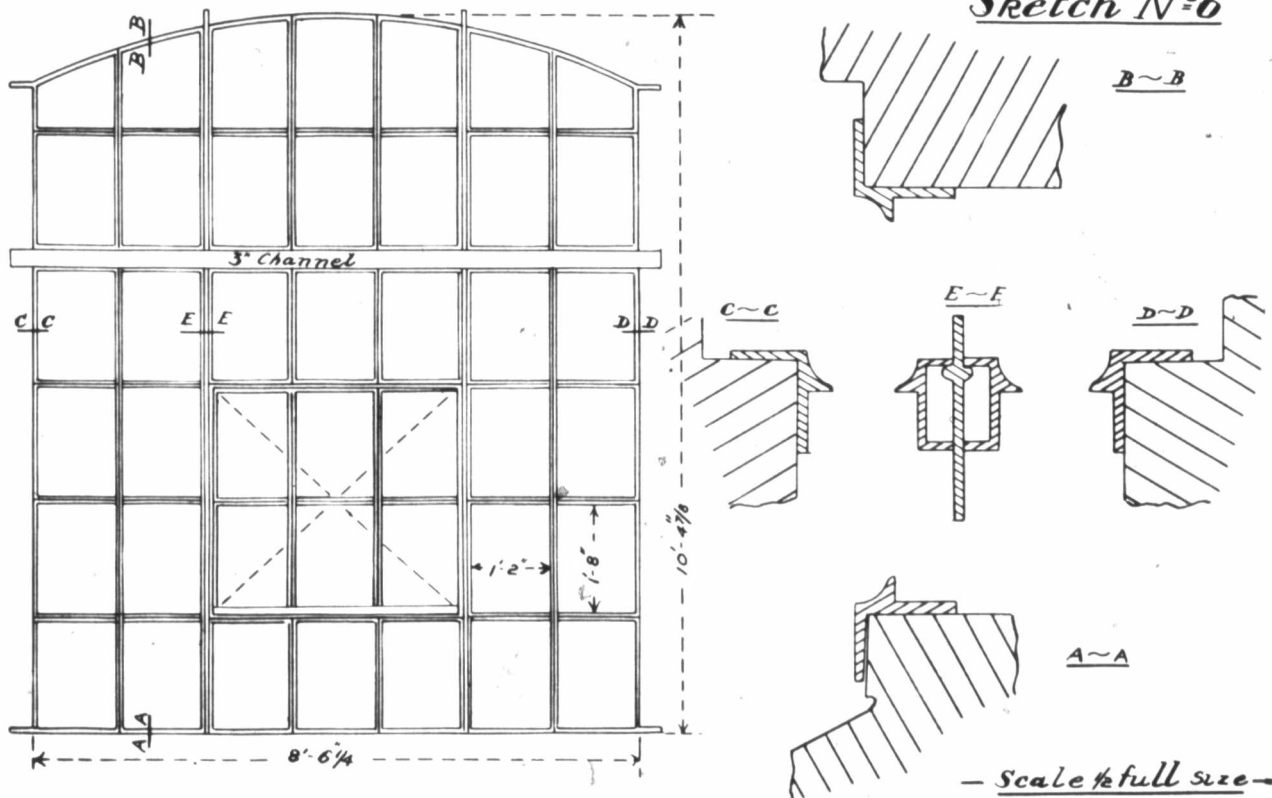

Shows method of reinforcing very large windows. "Fenestra" Sash up to 100 square feet area, require no reinforcement, but we are able to strengthen very large windows by means of flat mullions E-E without taking up any light area, or in any way disfiguring the general effect.

Sketch, N^o 7.

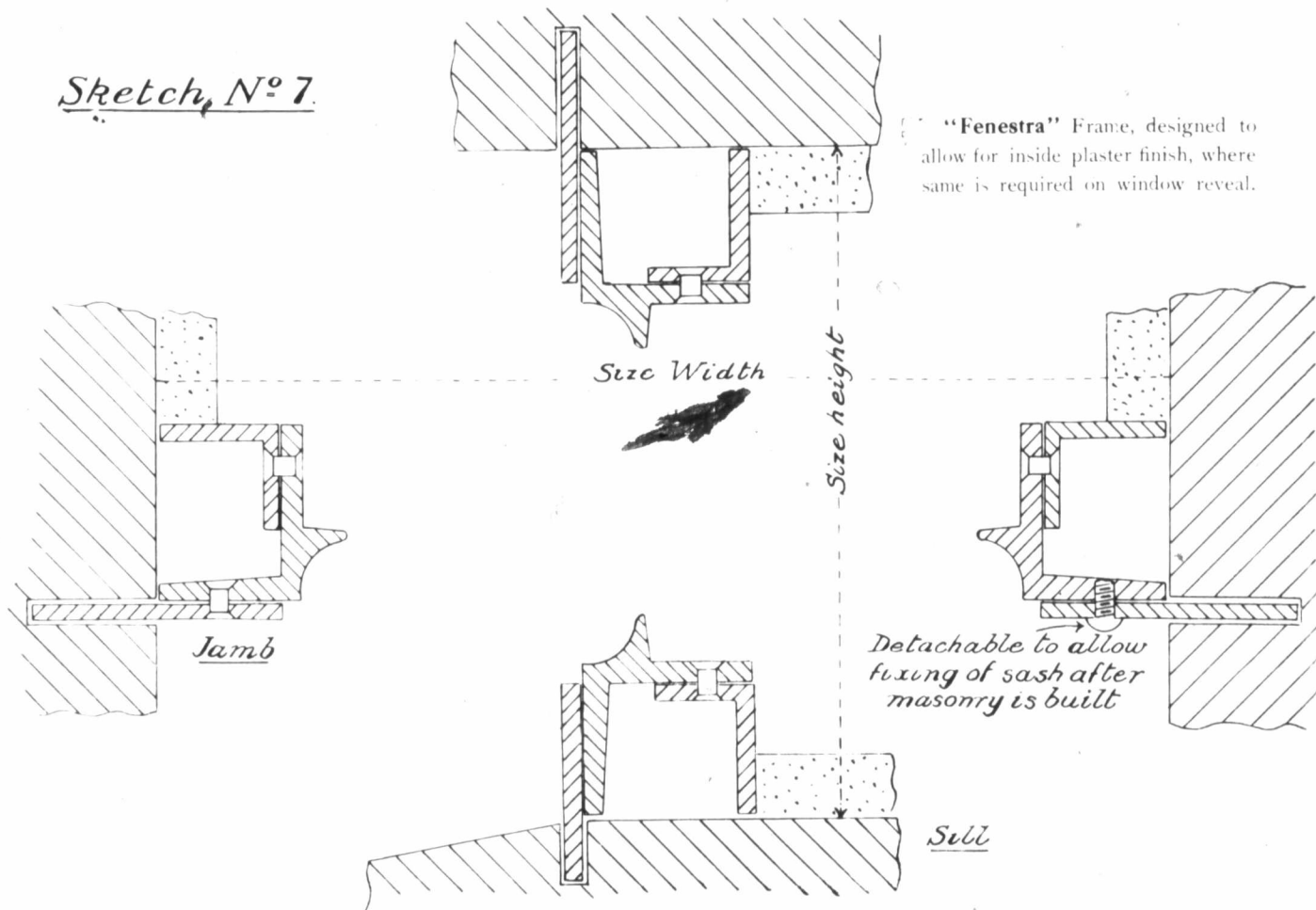

Casements

A complete equipment for manufacturing **Casements**, including **both tools and mechanics**, is now in operation.

These Casements are made of best mild solid steel sections (made from English rolls), hung on heavy gun metal hinges, every joint welded, fitted with copper weather bar at sill, and equipped with any one of several ornamental handles, plates, striking plate stays and other devices for fastening and operating.

Casements are made to hinge at side or top, to open outwards or inwards, to operate same as French windows—opening either outwards or inwards—or to comply with any other desired method of operation.

Besides the line manufactured, arrangements have been completed with the **Crittall Manufacturing Company**, of **London and Braintree, England**, to handle on the Canadian market a full line of their special Casements, and a catalogue published by this firm, who are **the leading manufacturers of Casement Windows in the world**, will be furnished any one desiring same.

The Crittall products include Casements manufactured of **steel, gun metal** or any other material adaptable for such work. **The workmanship of the firm** stands highest, and its products have been used in the **highest-grade government and domestic construction**, both in **Great Britain** and her **Dominions beyond the seas**.

Prices will be gladly furnished on application.



Hinged at Side or Top

The Economic Steel Casement

The Economic Steel Casements, as the following page indicates, is designed for fixing to wooden frames and to open outwards.

It is easily manipulated and is not affected by changes in weather, and can be relied upon to withstand wind, rain and sleet.

The Economic Steel Casement can be constructed in styles varying up to 2' 4" wide by 5' 0" high.

It can be constructed in panes as shown, with intersections formed of patent "Fenestra" Sash Joint; or can be constructed in one pane and glazed with a single sheet of glass.

The "Economic" has a most effective appearance, makes a thoroughly sound, strong casement and is recommended for use in residences.

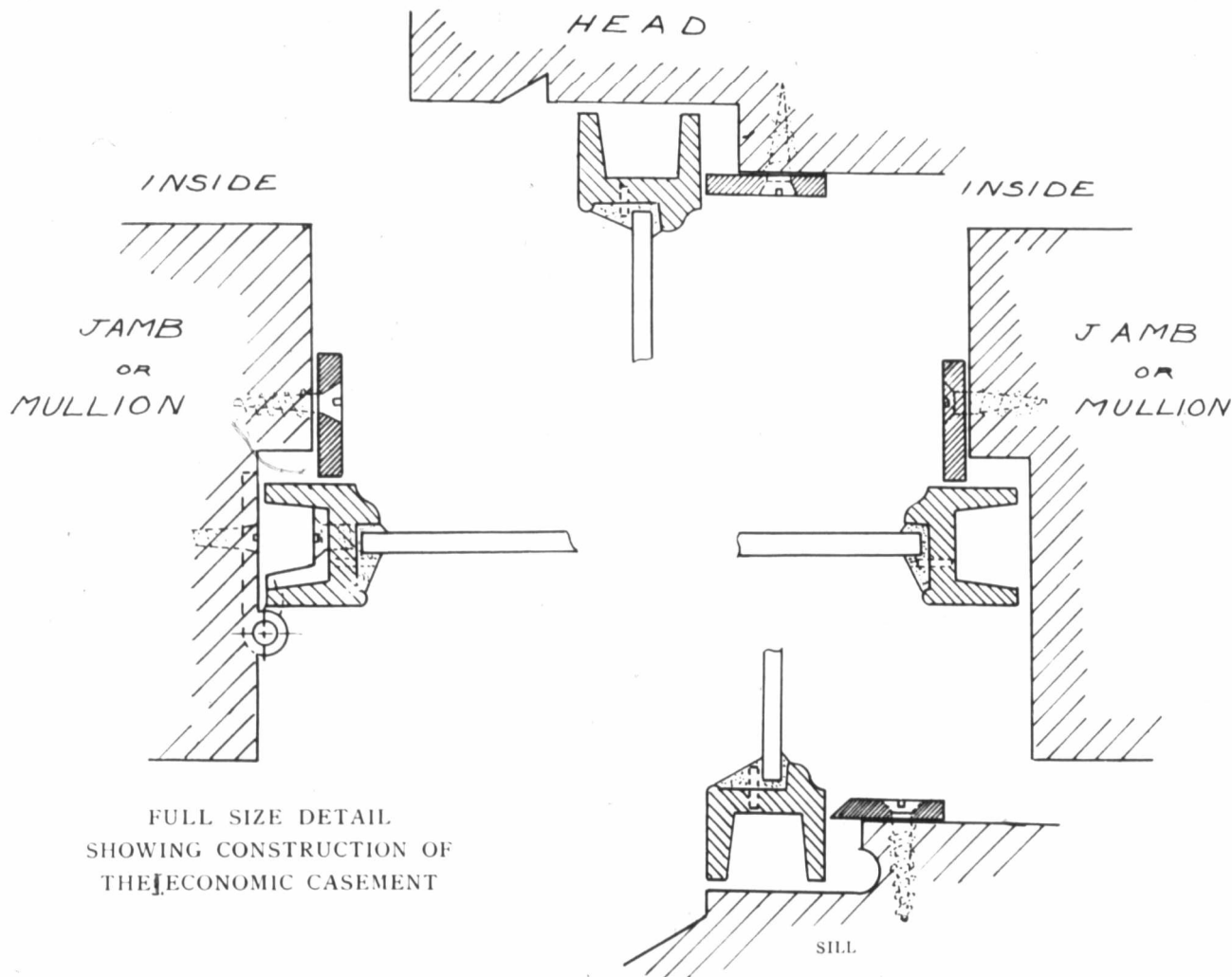

FULL SIZE DETAIL.
 SHOWING CONSTRUCTION OF
 THE ECONOMIC CASEMENT

The Standard Steel Casement

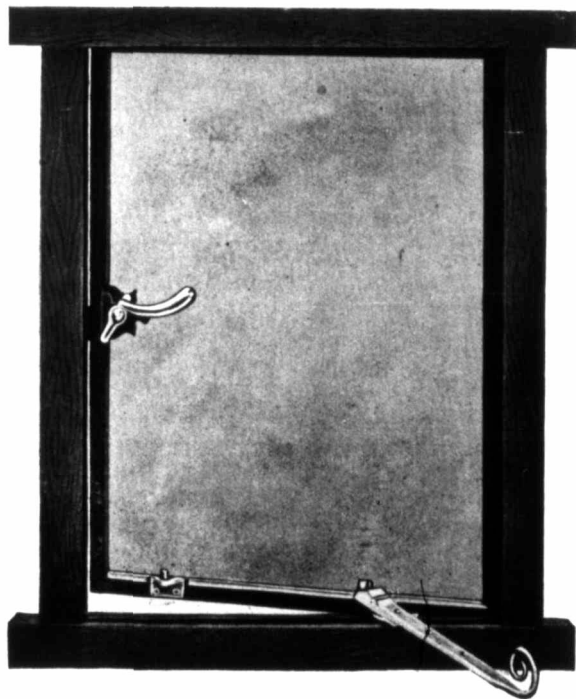

Hinged at Side, Top or Centre.

The **Standard Steel Casement** is designed for fixing to wooden, terra-cotta, stone and brick mullions or jambs, and to open inwards or outwards.

The **Standard Casement** is slightly superior in construction to the "Economic" Steel Casement, as it is hinged to an outside steel frame, and consequently makes the entry of wind, rain, sleet and snow an impossibility.

It can be constructed in sizes varying up to 2' 0" wide by 5' 0" high.

The design of fittings and fasteners can be varied to suit individual taste. (See cuts on page 42.)

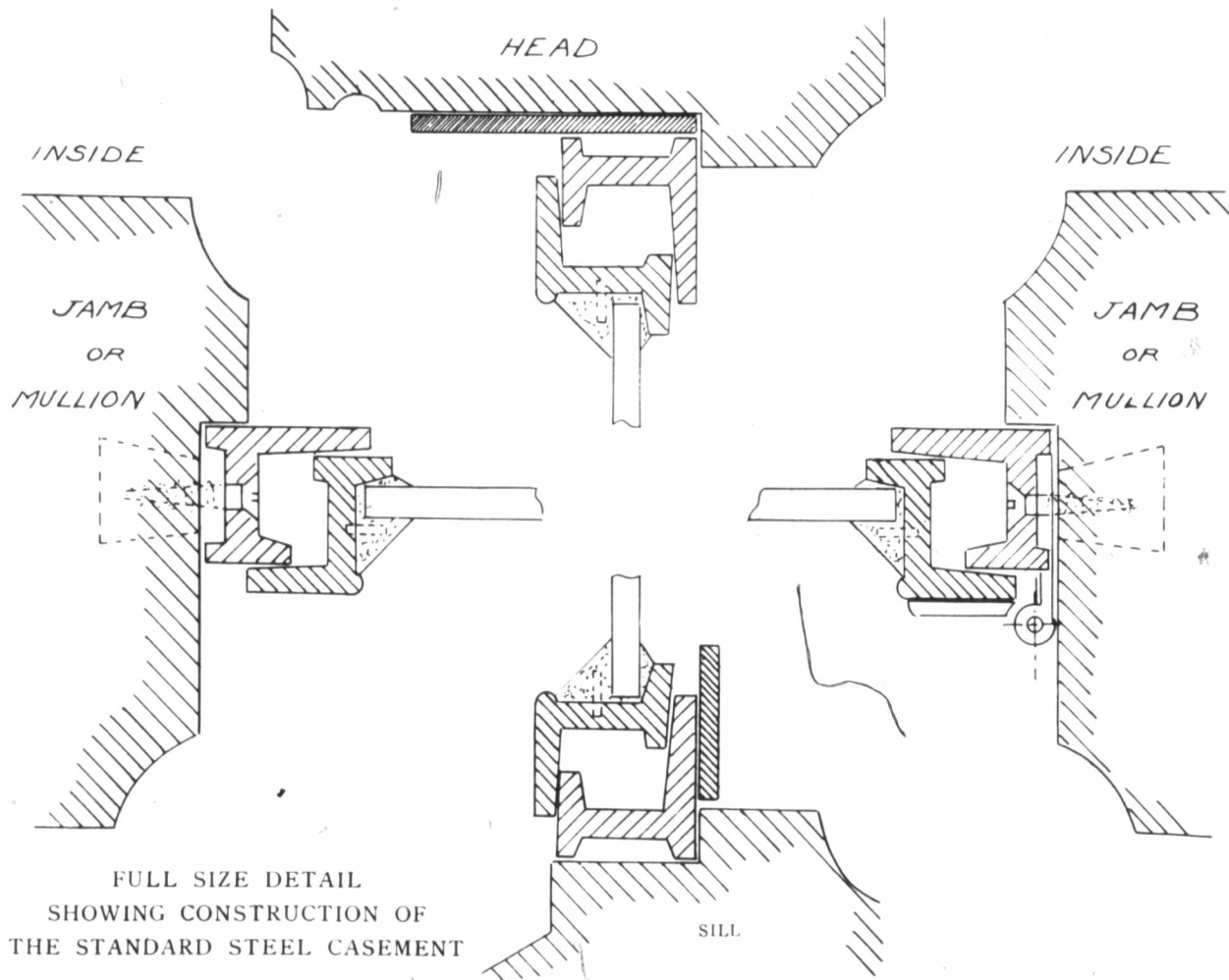

FULL SIZE DETAIL
 SHOWING CONSTRUCTION OF
 THE STANDARD STEEL CASEMENT

N^o 1 Casement

Section
Sizes upto 5'6" x 2'0"

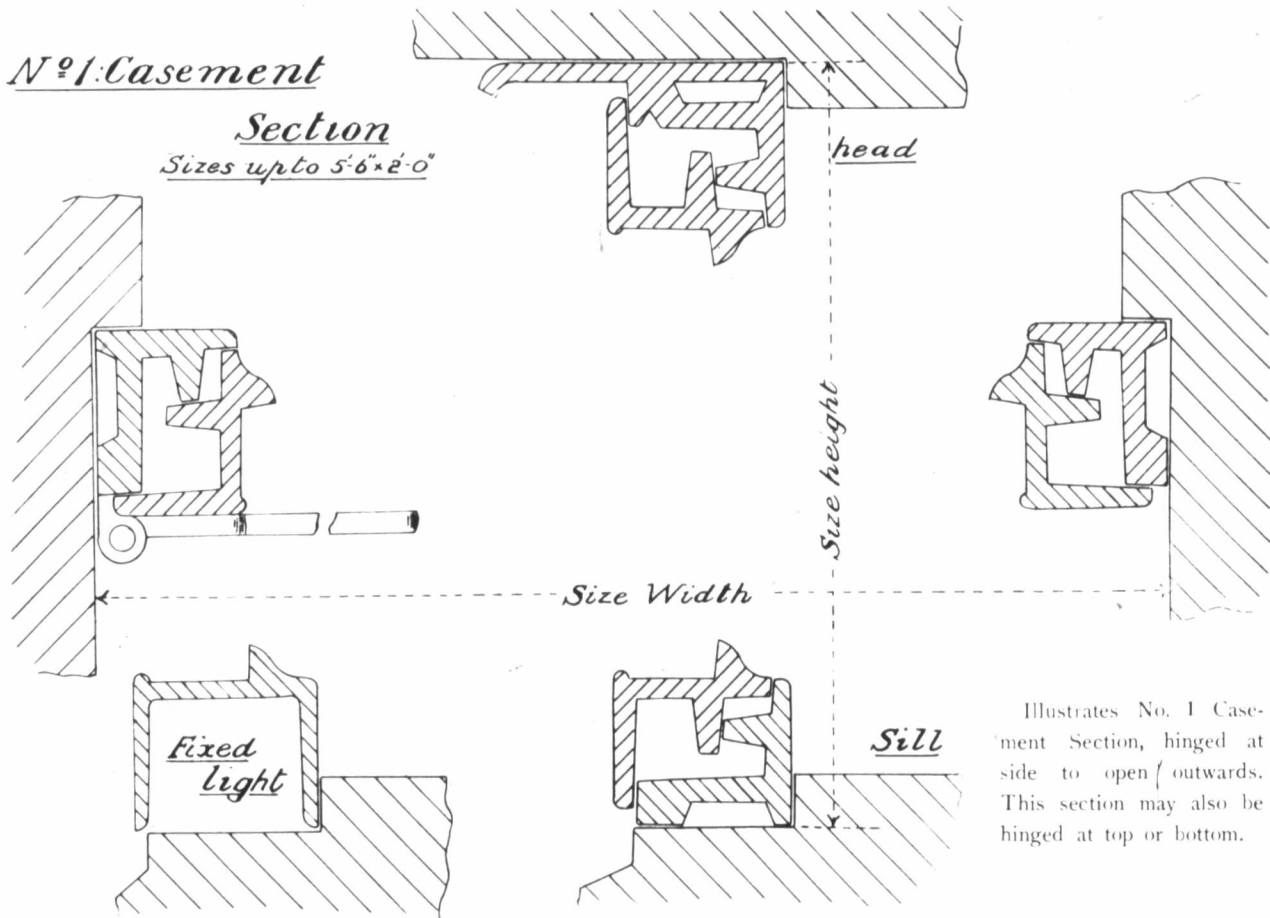

Illustrates No. 1 Casement Section, hinged at side to open outwards. This section may also be hinged at top or bottom.

N°3: Casement
Section

Vert: Pivoting

Size 6'-0" x 6'-0"

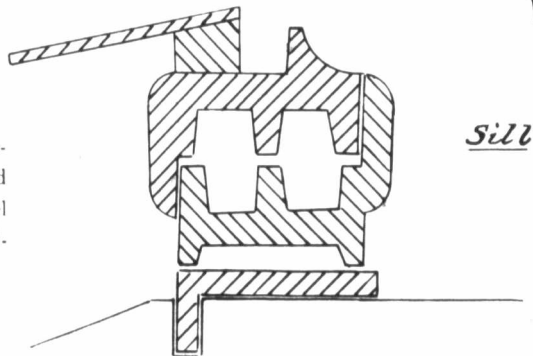
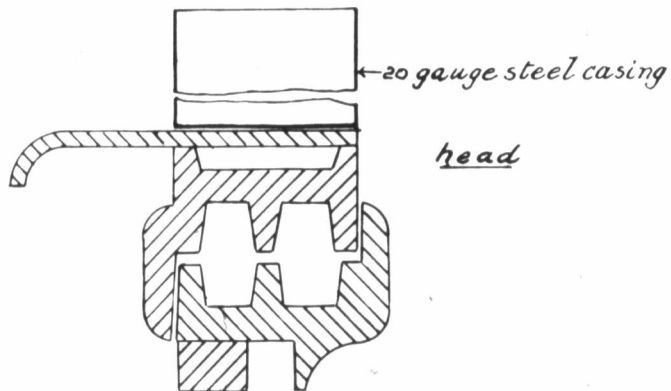
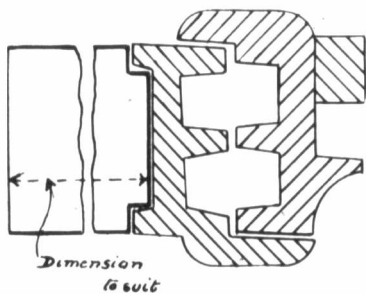

Special heavy design for large windows, may be hinged at sides or pivotted top and bottom. Wood filling, steel covered, may be utilized where conditions of installation would warrant.

Casement Fittings

HANDLES AND PLATES



No. 101



No. 102



No. 103



No. 104



No. 106



No. 107



No. 108



No. 114



No. 242



No. 225



No. 262
Cord Operated Arm for
Top Hinged F. Vent.



No. 243



No. 206



No. 221



No. 244



No. 207



No. 261
Cord Operated Arm for
Top Hinged F. Vent.



Standard Set of Fittings
for Side Pivotted
Fenestra Vent.



Cord Operated Fittings
for Bottom Hinged
Fenestra Vent.

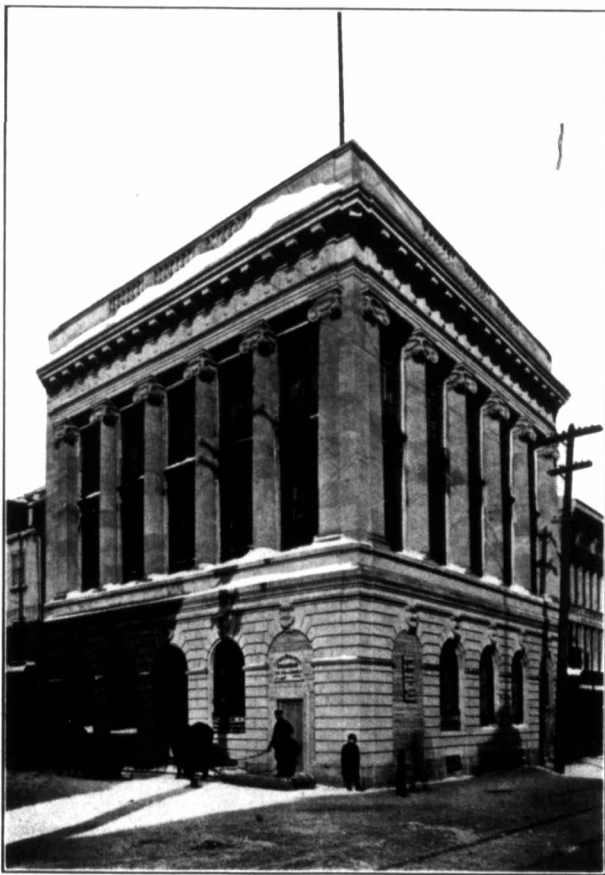

CAISSE D'ECONOMIC, QUEBEC.

R. P. Le May, Architect.



OFFICES AND RESIDENCE, QUEBEC.

R. P. Le May, Architect.

Where "Standard" Casements were used with best results.

Some Canadian Users of "Fenestra"

The following is a partial list of important representative buildings which have been fitted with "Fenestra" Steel Sash and Casements, since introduced in Canada less than a year ago. A perusal of this list will be proof positive that "Fenestra" Sash and Casements "are appreciated."

Hudson Bay Co. Stables, Vancouver, B.C.	Dalton & Eveleigh, Architects	Copp, Clark Co., Limited, Toronto	Wickson & Gregg, Architects
Wood, Vallance & Leggat Co. Warehouse, Vancouver, B.C.	Dalton & Eveleigh, "	R. B. Harcourt, Store Building, Toronto	Wickson & Gregg, "
Edmonton Power Station, Edmonton, Alta.	R. W. Lines, Architect	Kindel Bed Co., Limited, Toronto	F. H. Herbert, Architect
McLaughlin Garage, Winnipeg, Man.	Jno. D. Atchison, "	Rudd Paper Box Co., Limited	Ashton Pentecost, "
Can. Permanent Loan and Mortgage Co., Winnipeg, Man.	Jno. D. Atchison, "	Consumers Gas Co., Limited, Toronto	W. H. Pearson, Jr., Engineer
Manitoba Gypsum Co. Winnipeg, Man.	G. H. Archibald & Co. Engrs.	Planet Bicycle Co., Limited, Toronto	Owners
Provincial Jail, Winnipeg, Man.	S. Hooper, Architect	Toronto Carpet Co., Limited, Toronto	Geo. W. Gouinlock, Architect
Simpson & Co. Warehouse, Winnipeg, Man.	F. R. Evans, "	W. K. George, Esq., Residence, Toronto	Geo. W. Gouinlock, "
Alberta Asylum, Penoka, Alta.	C. J. Adams, "	Imperial Varnish and Color Co., Toronto	Owners
Bowerman Block, Saskatoon, Sask.	W. W. LaChance, "	Lake Superior Power Co., Soo, Ont.	Owners
Baldwin Block, Saskatoon, Sask.	W. W. LaChance, "	International Ferry Co., Fort Erie, Ont.	Owners
Munro Block, Pembroke, Ont.	C. P. Meredith, "	Southam Press Building, Toronto	Sproatt & Rolph, Architects
Dunlop and Co. Warehouse, Pembroke, Ont.	C. P. Meredith, "	University Library, Toronto	Darling & Pearson, "
Penetanguishene Public Library, Penetang, Ont.	C. P. Band, "	Addition to General Post Office, Toronto	David Ewart, Architect
St. Thomas Registry Office, St. Thomas, Ont.	N. R. Darrach, "	Standard Sanitary Manufacturing Co., Toronto	Frank Painter, Superintendent
Seymour Power and Electric Co., Cambellford, Ont.	Smith, Kerry & Chase, Engrs.	Cudahy Packing Co., Toronto	J. C. Claxton & Son, Contrs.
John Garvey, Esq., Warehouse, London, Ont.	H. C. McBride, Architect	Metropolitan Apartment House, Toronto	F. H. Herbert, Architect
Sunbeam Incandescent Lamp Co., Limited, Toronto	F. H. Herbert, "	National Iron Works, Toronto	Geo. Service, Resdt. Engineer
Canada Metal Co., Toronto	F. H. Herbert, "	McLean Publishing Co., Toronto	Jno. L. Wood, Supt. of Consn.
R. Bigley and Co., Limited, Toronto	F. H. Herbert, "	City Dairy Co. Stables, Toronto	Sproatt & Rolph, Architects
		Victoria Presbyterian Church, W. Toronto	Geo. M. Miller & Co. "
		Hydro-Electric Power Stations:—Toronto, Dundas, Niagara Falls, London, Berlin, Guelph, Stratford, Preston, St. Mary's, Woodstock and St. Thomas	Jno. A. Howson, Contractor
			J. M. Lyle, Architect
			P. W. Sothman, Engineer

Work
M
Drur
Mont
Chas
Exhi
Carli
Jacol
Georj
M
Nipis
Sepa
West
A

class

Some Canadian Users of "Fenestra" — Continued

Workman Building, McGill University, Montreal	Byers & Anglin, Contractors	Public School Lindsay	W. Hanly, Contractor
Drury Hotel, Montreal	Robert Findlay, Architect	Chatham Coll. Institute, Chatham, Ont.	J. L. Wilson & Son, Architects
Montreal Jail, Montreal	Marchard & Brassard, Archs.	Bank of Montreal, Stirling	Peden & McLaren, "
Chas. F. Smith, Esq., Residence, Montreal	E. & S. Maxwell, "	Bank of Montreal, Weyburn, Sask. .. .	Peden & McLaren, "
Exhibition Grand Stand, Ottawa .. .	W. E. Nofke, Architect	Tudhope Carriage Co., Orillia .. .	J. W. Siddal, Architect
Carling Building, Ottawa	C. P. Meredith, "	Colonial Weaving Co., Peterboro .. .	W. Blackwell, "
Jacobs' Building, Cobalt	Mitchell & Creighton, Archs.	A. Davis and Sons, Tannery, Kingston ..	O. E. Tench, "
Georgian Bay Shook Mills, Limited, Midland	Owners	Hamilton Steel and Iron Co., Hamilton ..	Chas. H. Roberts & Co. Engrs.
Nipissing Power Co., Callander, Ont. ..	Smith, Kerry & Chase, Engrs.	Otis Fensom Elevator Co., Hamilton .. .	Mills & Hutton, Architects
Separate School, Prescott	C. P. Meredith, Architect	Brantford Collegiate Institute	Chapman & McGiffen, "
Westmount Incinerator and Power Sta., Westmount	Ross & Holgate, Architects	Bank of New Brunswick, St. John, N.B. ..	F. Neil Brodie, Architect
		Bank of New Brunswick, Fredericton, N.B.	F. Neil Brodie, "
		Robinson Building, St. John, N.B. .. .	F. Neil Brodie, "

Type of Buildings

It is impossible to publish all the buildings in which "Fenestra" Sash has been used, but following are a few, the class and importance of which requires no comment.



Geo. Service, Resdnt. Engineer.

NATIONAL IRON WORKS, TORONTO

Jno. L. Wood, Supt. of Constn.

Splendid daylight construction made possible by the use of "Fenestra" Steel Sash.

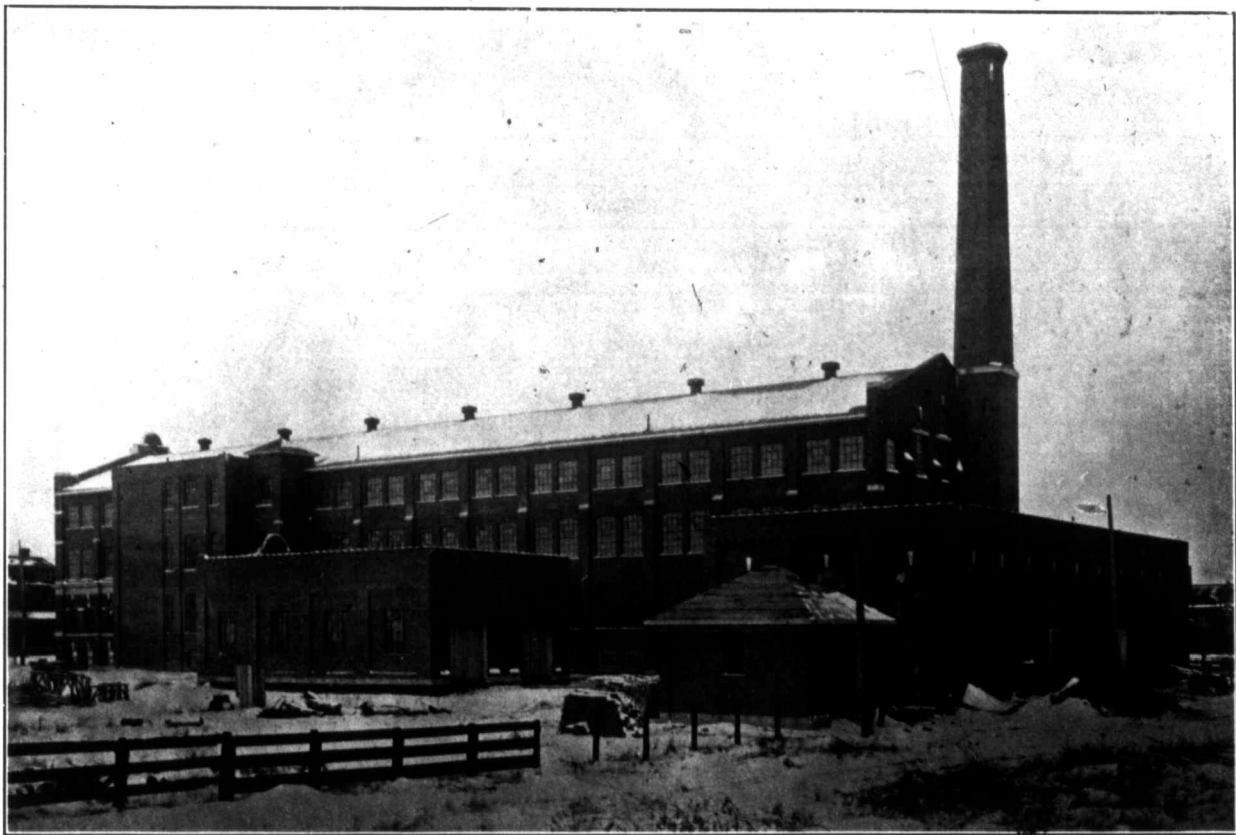

WHERE "SUNBEAM" INCANDESCENT LAMPS ARE MADE—DUFFERIN STREET, TORONTO E. H. Herbert, Architect.
"Fenestra" Steel Sash throughout, supplied by Expanded Metal and Fireproofing Co., Limited, Toronto.

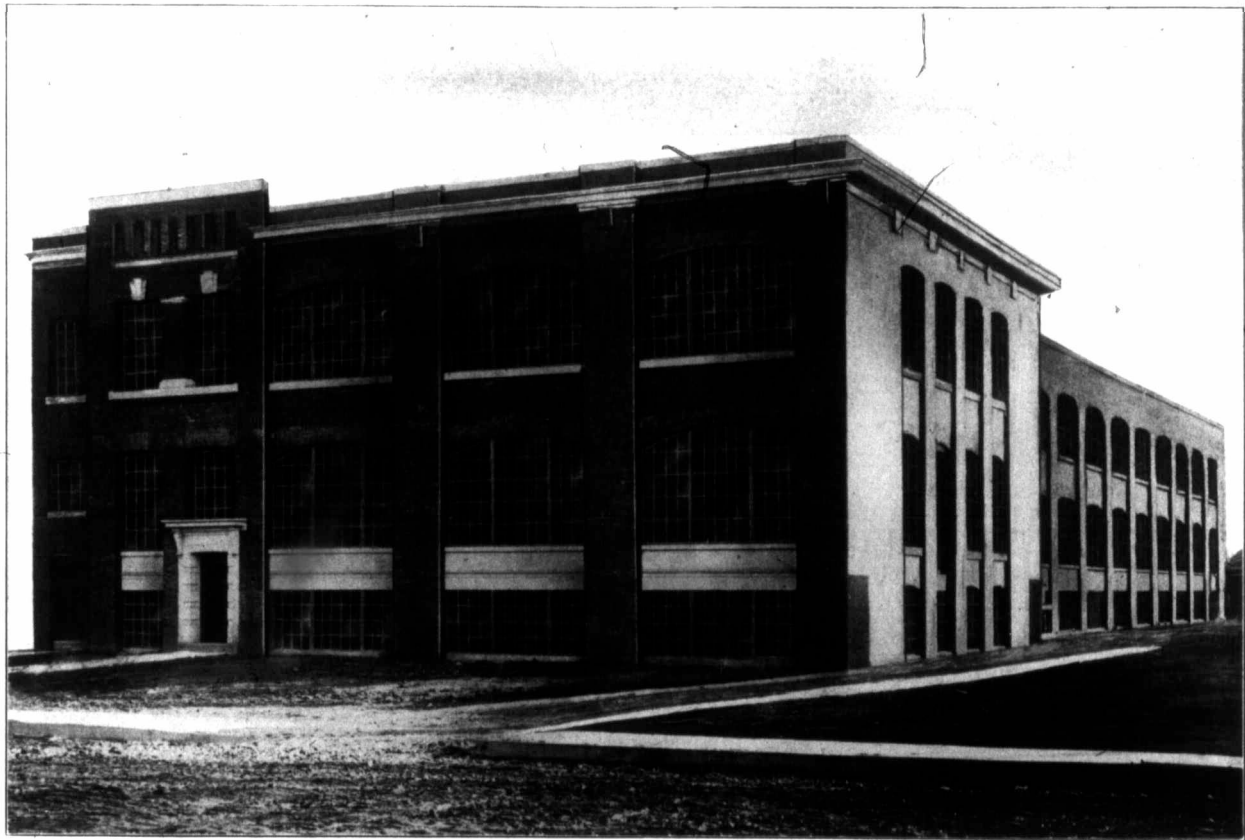

PLANT OF THE COPP, CLARK COMPANY, LIMITED, PUBLISHERS, TORONTO

Office windows in front fitted with Casement Ventilators; all others pivoted, "Fenestra" construction.

Messrs. Wickson & Gregg, Architects.

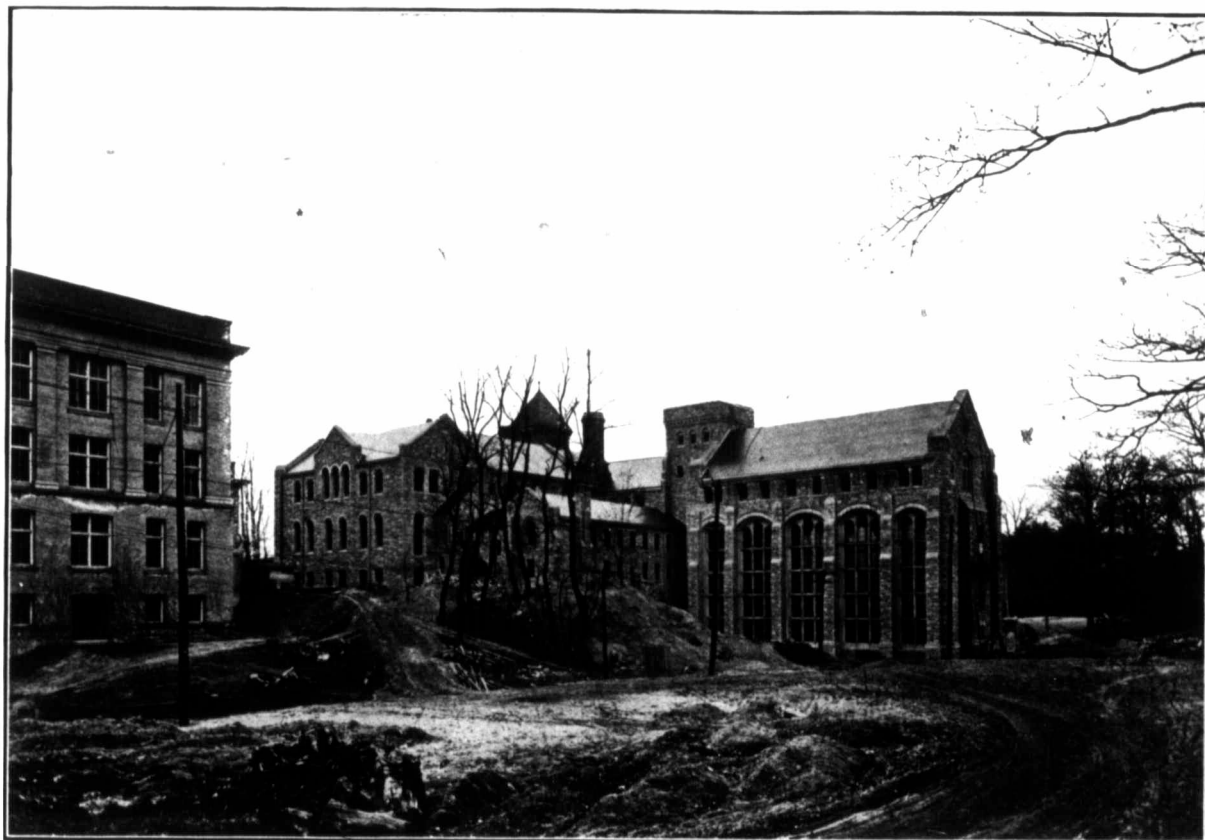

TORONTO UNIVERSITY LIBRARY BUILDING.

Darling & Pearson, Architects.

"Fenestra" Steel Sash gives splendid light, ventilation and affords perfect fire protection.

Page Forty-nine

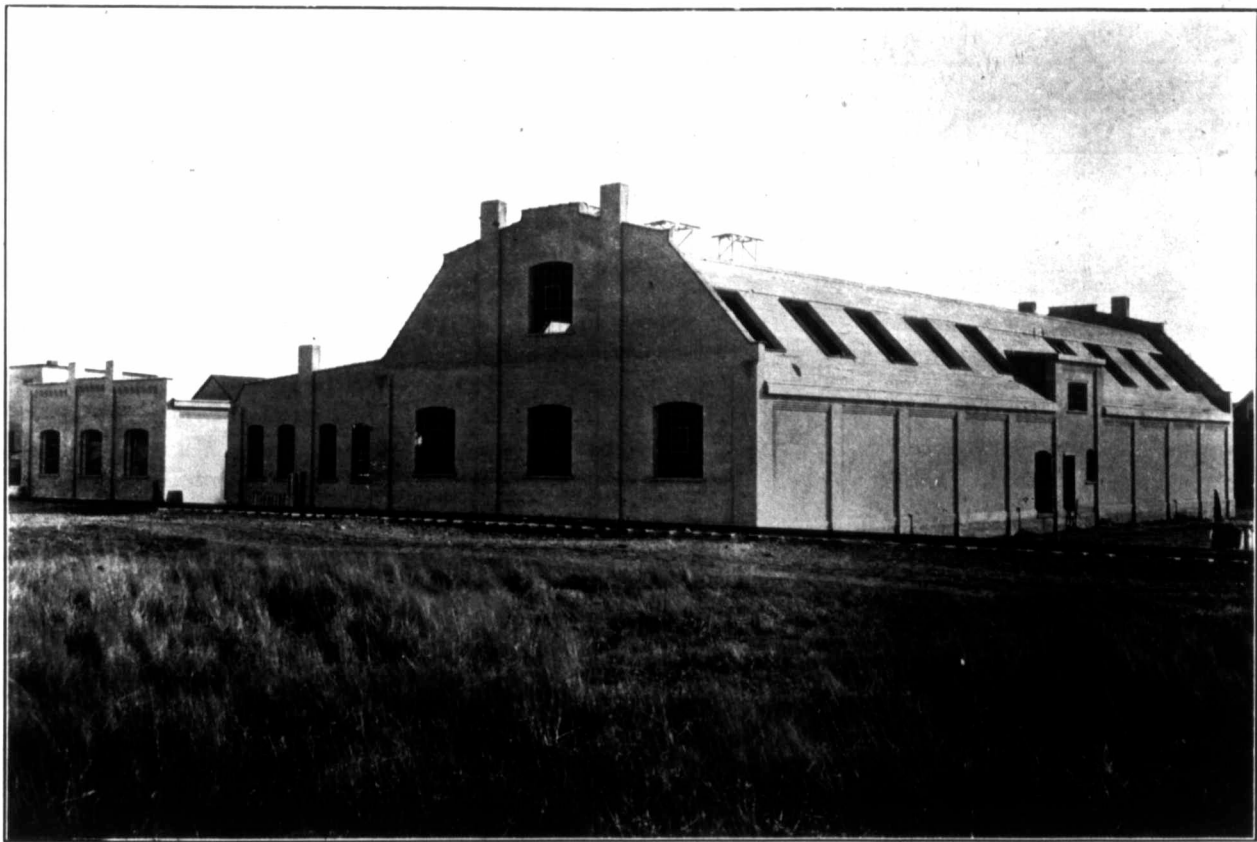

R. BIGLEY'S NEW PLANT, TORONTO

F. H. Herbert, Architect.

Supplied throughout with "Fenestra" Steel Sash—Expanded Metal and Fireproofing Co., Limited, Manufacturers.

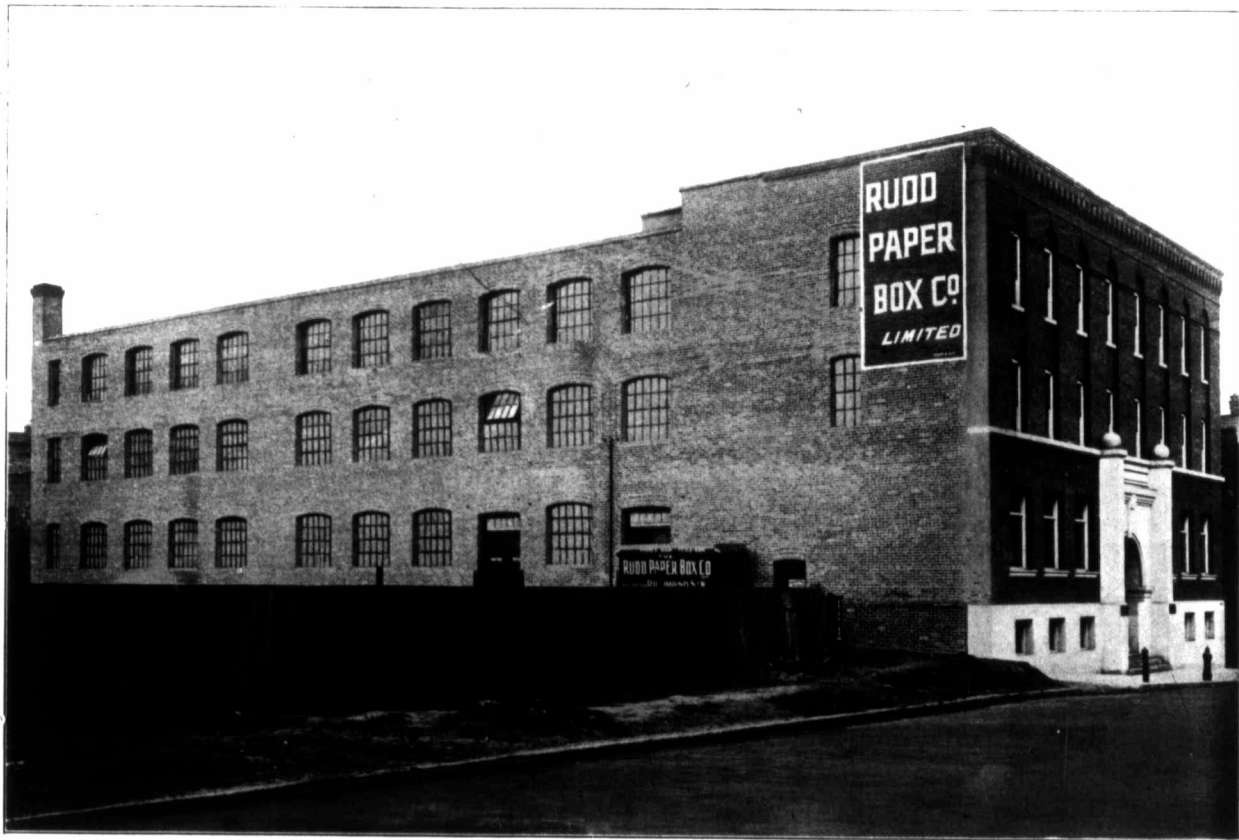

THE NEW BUILDING OF THE RUDD PAPER BOX COMPANY, LIMITED, TORONTO
Splendid light, ventilation and fire protection afforded by "Fenestra" Steel Sash.

Ashton Pentecost, Architect.

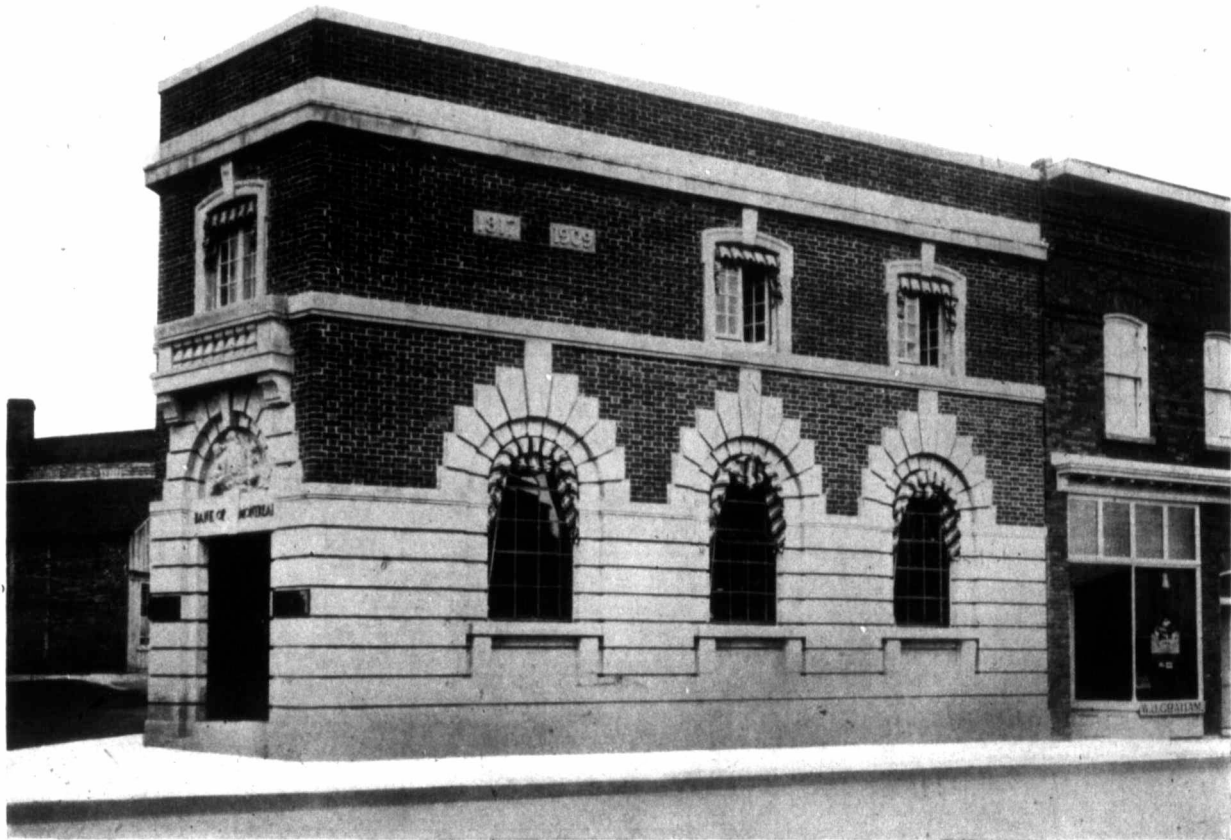

BANK OF MONTREAL BUILDING, STIRLING, ONT.
"Fenestra" Steel Sash, handsome in appearance, burglar-proof in strength.

Messrs. Peden & McLaren, Architects.



REINFORCED CONCRETE AND STEEL GRANDSTAND, LANSDOWNE PARK, OTTAWA

"Fenestra" Steel Sash were used here with the greatest satisfaction.

W. E. Noffke, Architect.

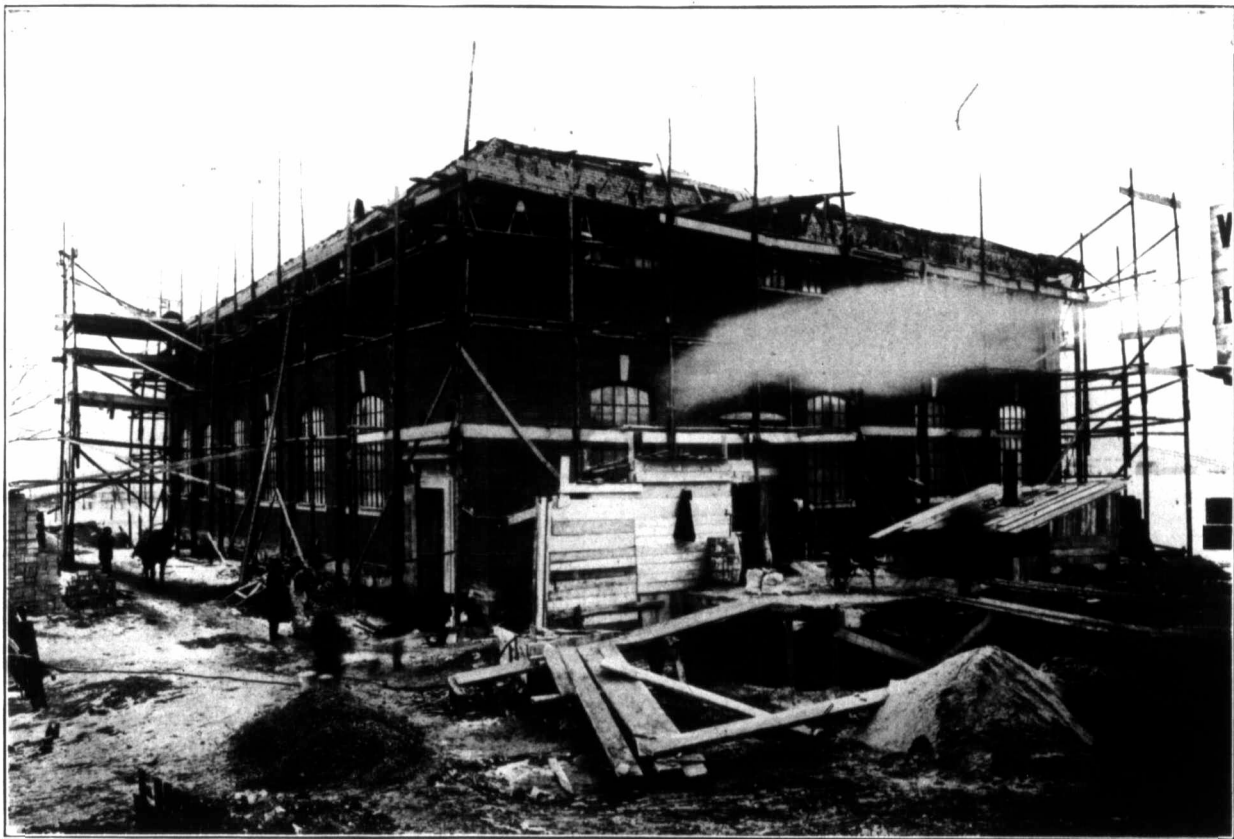

P. W. Sothman, Chief Engineer.

THE HYDRO-ELECTRIC POWER STATION AT TORONTO

J. M. Lyle, Architect.

"Fenestra" Sash are used throughout this fine building, as well as the Commission's Stations at Niagara Falls, Dundas, Woodstock, London, St. Thomas, St. Mary's, Stratford, Berlin, Preston and Guelph.



THE CAPITAL AND COUNTIES BANK, KENSINGTON BRANCH, LONDON, ENGLAND

"Fenestra" Sash in ground floor windows; Economic Casements in upper windows.

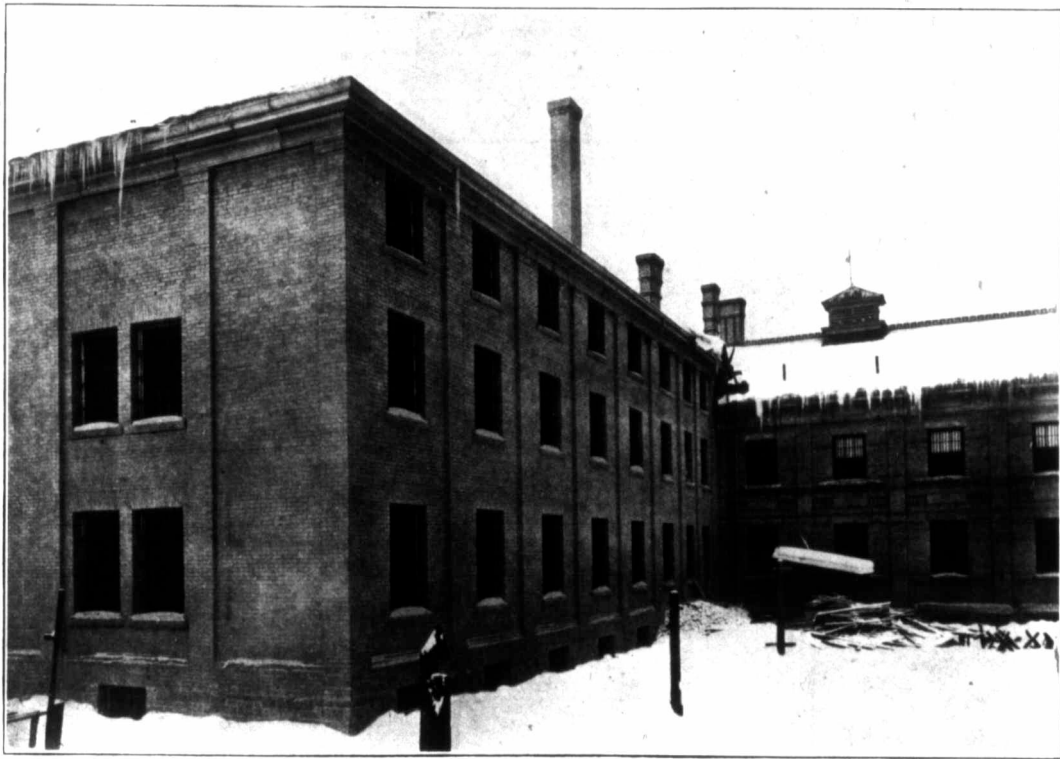

In the large addition to the Provincial Jail, Winnipeg, Manitoba (S. Hooper, Esq., Architect), "Fenestra" Steel Sash are used with the best results. Several other like institutions throughout Canada have been similarly fitted.

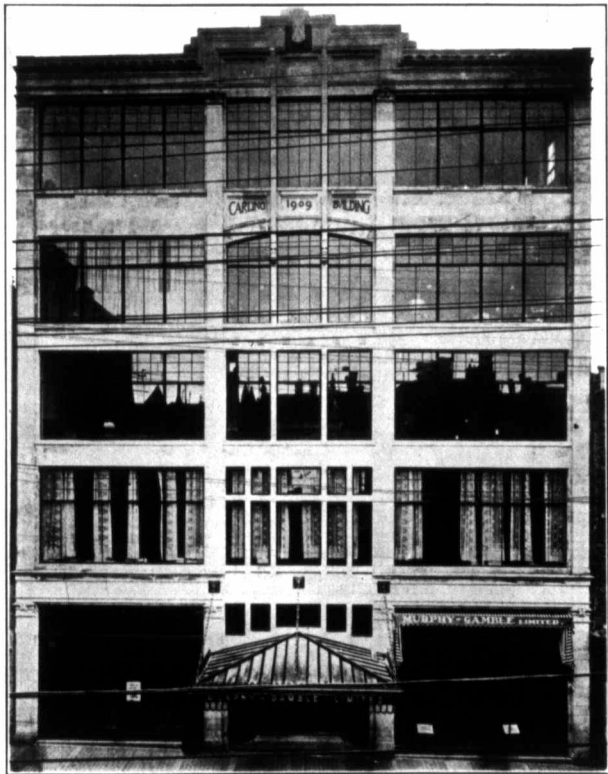

CARLING BUILDING, OTTAWA

(C. P. Meredith, Architect.)

Splendid light and ventilation afforded by "Fenestra" Steel Sash and No. 3 Casement construction.



NEW OFFICES AND PRINTING ESTABLISHMENT

of the McLean Publishing Company, Limited, Centre Avenue, Toronto.
(Sproatt & Rolph, Architects.)

The best lighted premises for the purpose—made possible by the use of "Fenestra" Steel Sash.

Addenda

Following the phenomenal development of Canada and the increase in wealth and importance of its manufacturing industries, we have from time to time added to our line new devices which have made for perfection in building construction. On the possibility of it proving a convenience to any friend receiving this "Fenestra" Catalogue, we have added a reference to some of our more important products. A more complete detailed description will be found in our "Steelcrete" Catalogue Number S.-5, a copy of which we will send you upon request.

Expanded Metal and Fireproofing Co.

Limited

Twenty Years Ago the Best—The Best To-Day

A Reinforcement in Readily Handled Sheets

The Reinforcement for Unskilled Labor—Reduces Labor Cost on Job. **A Unit System Expanded Metal is the World-Wide adjunct to Thin Plates.** Entire Weight per Square Foot operative. Manufactured from best open-hearth steel plates.

The Automatic Machine slits and opens the meshes simultaneously from the cold sheet, thus increasing the Elastic Limit and Ultimate Strength.

The Method of Manufacturing is an Absolute Test of the Steel

Meshes Diamond Shaped

Joints of Meshes Rigid

Strands not Corrugated or Twisted



No "Straightening out" Ensues when Load is Applied to Split the Concrete before the Reinforcement comes into Tension.

Expanded Metal Lies Flat. Required Sectional Area placed precisely as designed.

Once Placed Disarrangement is Impossible as with Rods.

The Experience of Years Teaches its Lesson—Nothing is just as Good as Expanded Metal.

Ask for Catalogue "S-5" for full information.

“Steelcrete” Expanded Metal Concrete Reinforcement

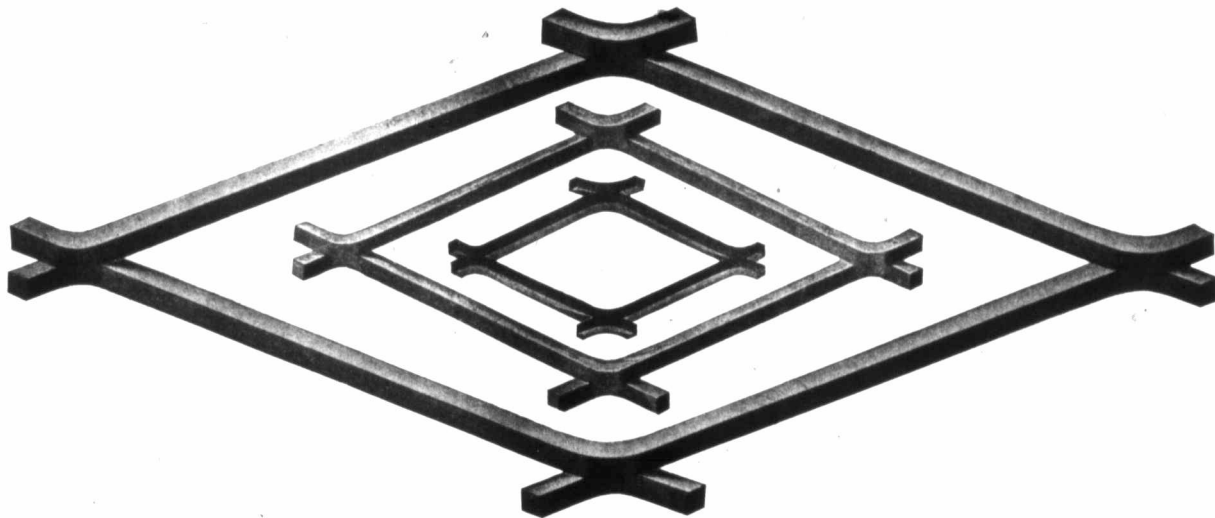

“Steelcrete” Expanded Metal has for years been the standard concrete reinforcement, by which all others have been judged.

We carry an immense stock of 16, 14, 12, 10 and 6 Gauge Sheets, in 8, 10, 12, 14, and 16 foot lengths, and in 1, 2, 3 and 6 inch mesh. We are the leaders in this line. Get full particulars from our Catalogue S-5.

"Klutch" Reinforcement Bars



"Klutch" Bar



"Klutch" Bar

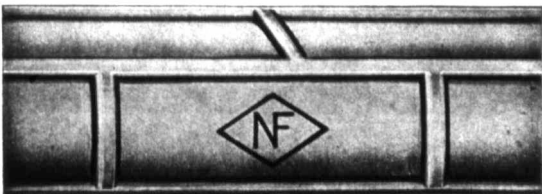

"Klutch" Bar

As an accessory to Expanded Metal, the "**Klutch**" Bar has been designed for reinforcing beams, columns, girders, and other sections of buildings where Expanded Metal is not adaptable.

The "**Klutch**" Bar is made from medium steel and is designed so as to provide an anchor in the concrete without detracting from the strength of the bar. In the "**Klutch**" construction the ribs are added to the bar, not cut out of the body of same, as in other designs of deformed bars.

In the manufacture of the "**Klutch**" Bar each heat is tested by chemical analysis to ensure the highest possible constructive quality, together with uniformity of same. After rolling, the steel is submitted to careful tension tests, and if found not to come up to required standards, is rejected and utilized for other purposes. All bars are guaranteed by manufacturers to meet the following specification:

Ultimate tensile strength, lbs. per sq. ft.	60,000 to 70,000
Elastic limit, lbs. per sq. ft. not less than $\frac{1}{2}$ ult. strength	
Minimum percentage of elongation in 8"	22 per cent.
Bending test, cold, without fracture	180 " flat
Minimum reduction of area	45 "
Maximum Phosphorus	.06 "
Maximum Sulphur	.05 "

The "**Klutch**" Bars are stocked in sizes $\frac{3}{8}$ ", $\frac{1}{2}$ ", $\frac{5}{8}$ ", $\frac{3}{4}$ ", $\frac{7}{8}$ ", 1", $1\frac{1}{4}$ ", $1\frac{1}{2}$ ", $1\frac{3}{4}$ ", 2". All bars are brought from mills in from 60' to 65' lengths, and cut to suit requirements from stock.

The "**Klutch**" Bar furnishes a better bonding, is made of better material, and for results obtained, is cheaper than any deformed bar on the market.

A complete line of above sizes is always kept in stock, so that all deliveries are assured without long waits incident to procuring stock from mills.

“Steelcrete” Expanded Metal Lath

Our New Square Mesh Lath. Entirely in a class by itself. Must be seen and handled to be appreciated. No picture can do it justice. Ask for a sample.

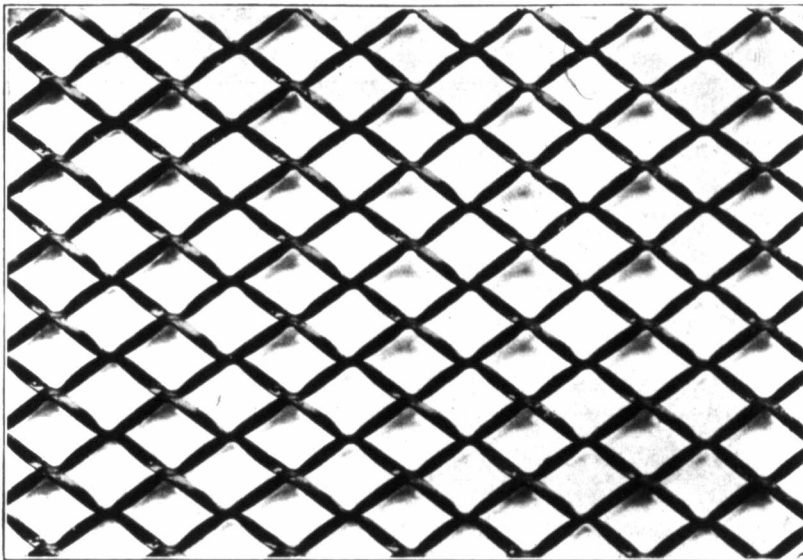

Square Corrugated Mesh

24 Gauge

Sheets 96 x 27 , 2 square yards.
Weight, 3 lbs. per square yard.

26 Gauge

Sheets 96 x 27 , 2 square yards.
Weight, 2.15 lbs. per square yard.

Full particulars re “Steelcrete” ceilings, wall and partitions in Catalogue S-5.

Steelcrete Expanded Metal Lath

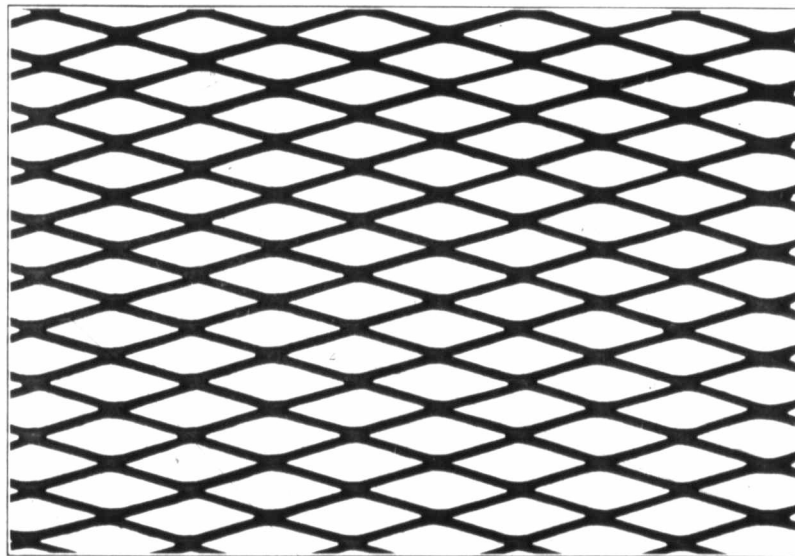

Diamond Mesh

In 23 Gauge only

Sheets, 96" x 30", 2 $\frac{1}{3}$ square yards. Weight, 3 $\frac{1}{4}$ lbs. per square yard.
Full particulars re Steelcrete Ceilings, Walls and Partitions in Catalogue S-5.

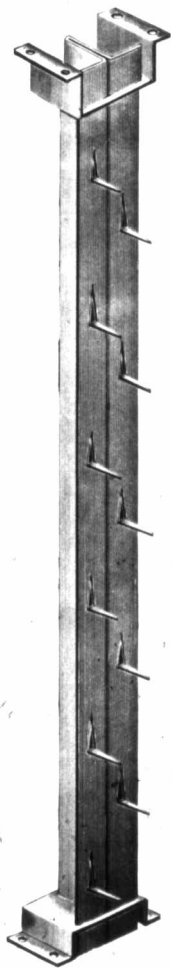

**"Steelcrete"
1 T
Stud**
For
solid
partitions.



**"Steelcrete"
U
Furring**
For
exterior
walls,
ceilings,
etc.

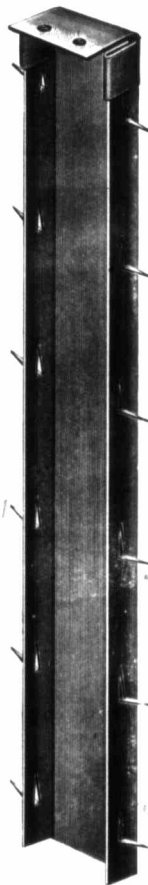

**"Steelcrete"
Channel
Stud**
For
hollow
partitions.

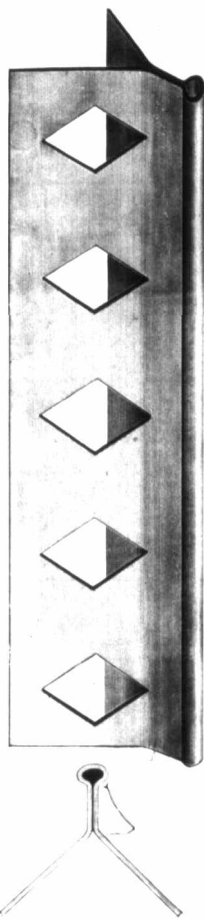

"Steelcrete" Fireproof Furring, Studding, Corner Bead, etc.

We manufacture and carry a large and complete stock of fireproofing materials of this description, which are fully shown and explained in Catalogue S-5.

**"Steelcrete"
Plasterers'
Corner
Bead**

The proper
finish for all
plaster
corners.

"Steelcrete" Expanded Metal Lockers, Screens, Etc.

Expanded Metal Lockers

Neat and attractive in appearance, easily cleansed, reasonable in price.

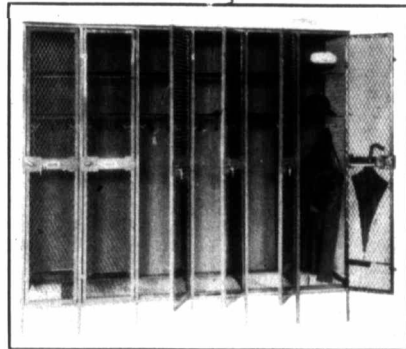
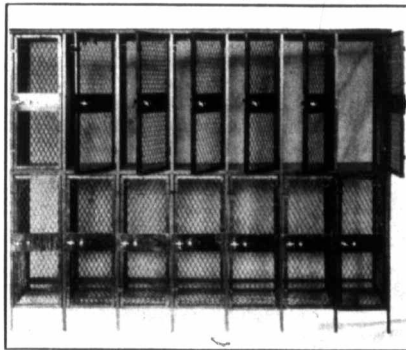

We make a large range of Standard Lockers, and can make anything special to order. Get our Locker Booklet.

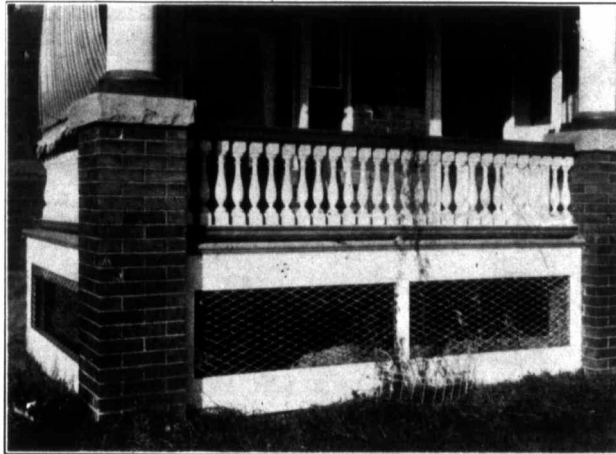

Above cut illustrates one of many uses to which "Steelcrete" Expanded Metal Sheet may be put.

Window Guards

Wagon Guards

Railings

Wicket Screens

Ash Sifters

Gravel Screens

Stove Gratings

Furnace Insulation

Lockers

Waste Paper Baskets

Desk Trays

Elevator Enclosures

Stair Enclosures

Tool Room Partitions

Store Room Partitions

Tree Boxes

Flower Guards

Fences

The Fish Automatic Fire Shutter

Pat., Dec. 8th, 1908. No. 115482

Construction

The Fish Automatic Fire Shutter is constructed of No. 24 Gauge Basic Open Hearth Steel Sheets, heavily galvanized, in uniform sections or leaves 12 inches to the weather, two thicknesses of the Steel being employed with a lining of asbestos, and having angle flanges at top and bottom of leaners, which adds rigidity to the surface of the Shutter in the face of flame.

Each Section slides over the one above by means of iron bolts or rods running through brass grummetted holes in the flanges, and all are contained or telescoped into a weather-proof hood over the opening, held in position by double levers, bound with a link fusible at a temperature of 155 degrees Faht. The instant the link fuses, the levers are released, and the shutter drops into position over the opening, shutting off draft, and forming a perfect steel barrier.

The Fish Automatic Fire Shutter is built upon practical lines, the result of years of study and experiment by the inventor. Every feature of its construction being worked out with mathematical precision, with a view to presenting to flames the greatest barrier; and it is justly maintained that this Shutter stands pre-eminently the first in the field as a fire retardant from the following reasons: It has been given the "break down test" of the Underwriters' Laboratories at Chicago, and withstood the enormous heat of 2,020 degrees Faht. After one hour of this test and application of water at 60 lbs. pressure, it was perfectly intact upon the opening. The Canadian Fire Underwriters' Association have given the Fish Shutter the highest rating, which is its best guarantee, and the rebate which this assures is a concession to its merit.

Firemen when obliged to force their way in a building installed with Fish Automatic Shutters simply have to raise a section of shutter to insert the hose, this feature has appealed strongly to Fire Chiefs to whom shutter has been submitted. The Fish Automatic Fire Shutter is particularly adapted for use on mullioned windows.

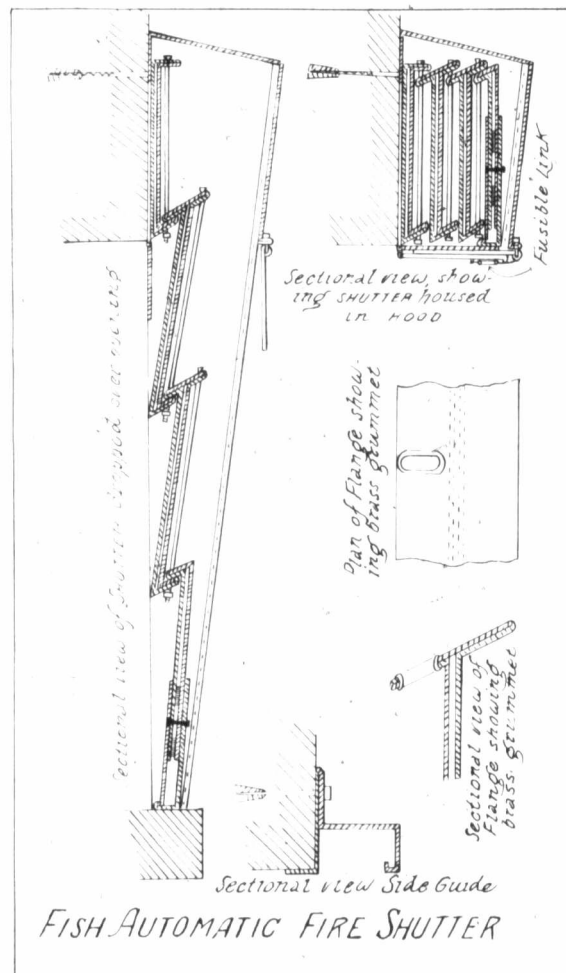

The Architect will find this shutter a great benefit. He is not obliged to provide space for sliding doors, neither will he have to disfigure the building with swinging shutters, which are unsightly and uncertain, as they depend upon human agency to close.

The Fish Automatic Shutter adds to the attractiveness of a building, and are equally effective on exterior or interior installation.

Elevator openings are considered the worst of hazards, as they act as a chimney and allow fire to communicate from one floor to another. Owing to the construction of walls or lack of space in many instances, it is impossible to close them with ordinary shutters, but the Fish Automatic Shutters solve this problem.

When writing for quotation, please furnish the following information: -

- 1st. Inside or outside installation.
- 2nd. Width of opening.
- 3rd. Height of opening at sides.
- 4th. Height of opening at centre, if arched.
- 5th. Height from top of opening to ceiling, if inside.
- 6th. If cased with wood give width of casing, if inside.
- 7th. Of what material is wall.

Good Points of the Fish Automatic Fire Shutter

It is Simple, having no springs nor gears to get out of order.

It is positively Automatic and reliable.

It shuts out no light or air.

It is up out of the way, occupying no valuable space.

It needs no attention.

The first cost is the whole cost.

The rebate on your Insurance Premium will pay for installation.

It being heavily galvanized will last indefinitely.

All movable joints are brass bushed, preventing corrosion.

It drops of its own weight.

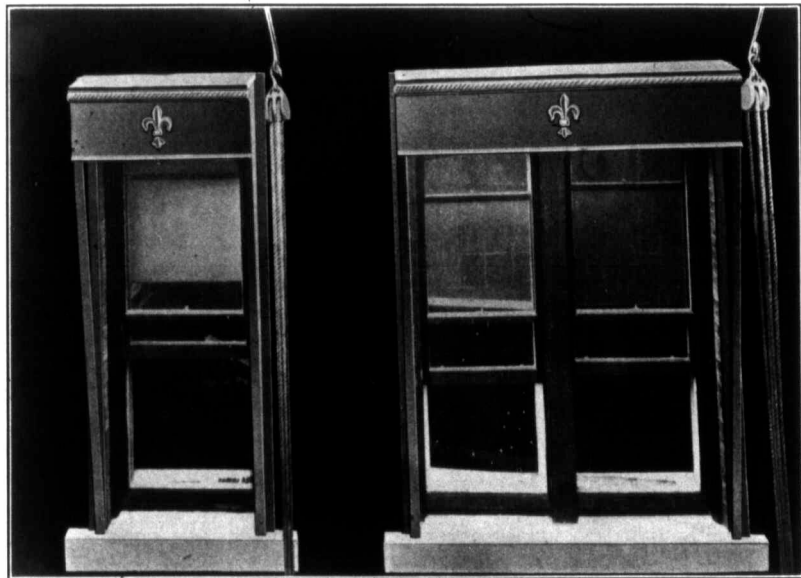

Two classes of Shutters installed for the Department of Labor, Ottawa.

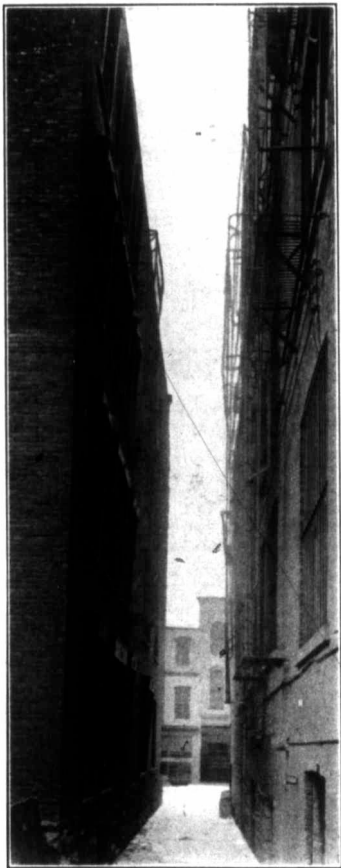

Installation of Fish Shutters at the Department of Labor, Ottawa.

The Fish Shutter Closed

When the Fish Shutter stands open, the leaves or sections are housed in the hood and secured by fusible link.

Immediately on the fusible link being broken by heat, the leaves or sections fall and make a solid barrier against fire.

