

Technical and Bibliographic Notes / Notes techniques et bibliographiques

The Institute has attempted to obtain the best original copy available for filming. Features of this copy which may be bibliographically unique, which may alter any of the images in the reproduction, or which may significantly change the usual method of filming, are checked below.

L'Institut a microfilmé le meilleur exemplaire qu'il lui a été possible de se procurer. Les détails de cet exemplaire qui sont peut-être uniques du point de vue bibliographique, qui peuvent modifier une image reproduite, ou qui peuvent exiger une modification dans la méthode normale de filmage sont indiqués ci-dessous.

Coloured covers/
Couverture de couleur

Covers damaged/
Couverture endommagée

Covers restored and/or laminated/
Couverture restaurée et/ou pelliculée

Cover title missing/
Le titre de couverture manque

Coloured maps/
Cartes géographiques en couleur

Coloured ink (i.e. other than blue or black)/
Encre de couleur (i.e. autre que bleue ou noire)

Coloured plates and/or illustrations/
Planches et/ou illustrations en couleur

Bound with other material/
Relié avec d'autres documents

Tight binding may cause shadows or distortion along interior margin/
La reliure serrée peut causer de l'ombre ou de la distorsion le long de la marge intérieure

Blank leaves added during restoration may appear within the text. Whenever possible, these have been omitted from filming/
Il se peut que certaines pages blanches ajoutées lors d'une restauration apparaissent dans le texte, mais, lorsque cela était possible, ces pages n'ont pas été filmées.

Additional comments: / Various pagings.
Commentaires supplémentaires:

Coloured pages/
Pages de couleur

Pages damaged/
Pages endommagées

Pages restored and/or laminated/
Pages restaurées et/ou pelliculées

Pages discoloured, stained or foxed/
Pages décolorées, tachetées ou piquées

Pages detached/
Pages détachées

Showthrough/
Transparence

Quality of print varies/
Qualité inégale de l'impression

Continuous pagination/
Pagination continue

Includes index(es)/
Comprend un (des) index

Title on header taken from: /
Le titre de l'en-tête provient:

Title page of issue/
Page de titre de la livraison

Caption of issue/
Titre de départ de la livraison

Masthead/
Générique (périodiques) de la livraison

This item is filmed at the reduction ratio checked below/
Ce document est filmé au taux de réduction indiqué ci-dessous.

10X	14X	18X	22X	26X	30X
<input type="checkbox"/>	<input type="checkbox"/>	<input type="checkbox"/>	<input type="checkbox"/>	<input checked="" type="checkbox"/>	<input type="checkbox"/>
12X	16X	20X	24X	28X	32X

The Canadian Patent Office

RECORD



Vol. V.—No. 10.

OCTOBER, 1877.

{ Price in Canada \$2.00 per An
 { United States - \$2.50

CONTENTS.

INVENTIONS PATENTED	149
INDEX OF INVENTIONS.....	CXLVIII
INDEX OF PATENTÉES	CXLIX
ILLUSTRATIONS	159

INVENTIONS PATENTED.

No. 7802. Improvements in Car Wheels.

(*Perfectionnements dans les roues de wagons.*)

Gordon Elmstie, Toronto, Ont., 30th August, 1877, (Extension of Patent No. 1628), for 5 years.

Claim.—The combination of the curved web A, large curved ribs B (extending from the rim C to the hub D) and small curved ribs E.

No. 7803. Fanning Mill. (*Tarrarc.*)

Thomas Wilson, Richmond Hill, Ont., 31st August, 1877, (Extension of Patent No. 1641), for 5 years.

Claim.—The suspending of the two parts of the shoe *jj* by the steel spring straps *kk* and *ll*, the lower part by two vertical steel spring straps *kk* and the upper part by two oblique steel spring straps *ll* on each side of the shoe, also the forming of the combined zinc sieves, arranged parallel and one inch apart or so, near to each other as to allow but a small portion of the wind to pass between them, as shown by *mm*; also the dividing of the shoe into two parts, each part being hung separately by four steel spring straps.

No. 7804. Improvements on Plaiting Machines.

(*Perfectionnements aux machines à plisser.*)

Hermann Albrecht, Philadelphia, Pa., U.S., (Assignee of Jacob F Burrow and John Solter), 29th August, 1877, for 5 years.

Claim.—The combination of a base, a presser and a reciprocating or vibrating blade, by which fold after fold a fabric may be formed, thrust beneath the said presser, and converted by the latter into plaits; 2nd. The combination of the base, reciprocating or vibrating blade, and a presser constructed to be heated by a hot bar or otherwise, so that the folds thrust beneath the presser may be made into plaits by combined heat and pressure; 3rd. The combination with the base and presser of two blades D and G, and mechanism whereby the said blades are caused to co-operate in the manner described; 4th. The combination of the blades D and G with adjustable stops to determine the extent of their movement; 5th. The combination of the operating levers K K connected to the blade D with the links L L connected to the said levers K K and to the blade G; 6th. The combination of the levers K K, links L and blade G with the adjustable stop M; 7th. The combination of the levers K K, blade D and adjustable stop M; 8th. The presser B having arms e hinged to the base.

No. 7805. Combined Trap and Ventilator for Sewers and Drains.

(*Trappe-ventilateur d'égouts et de fossés.*)

François X. Rousseau, Montreal, Que., 29th August, 1877, for 5 years.

Claim.—1st. The combination of sewers *d* and *q* with the trap *h* and with the shaft *k*; 2nd. In the trap *h* the combination of the openings *l* and an opening closed by the door *m*, together with door *m*.

No. 7806. Improvements on Lamp Collars.

(*Perfectionnements aux cols de lampes.*)

William E. S. Baker, (Assignee of John H. Lewers and Charles Kluitz), Philadelphia, Pa., U.S., 29th August, 1877, for 5 years.

Claim.—The combination in with the fixed or supplemental collar of a lamp, of a valve and valve seat struck up in corresponding dies, and provided with the guide G and spring S; the combination of the valves with the cap or covering of a lamp oil feeder or filter thereby making the lamp non-explosive without interfering with the ordinary fixed lamp collar.

No. 7807. Improvements on Tube Expanders.

(*Perfectionnements aux dilateurs de tuyaux.*)

John E Minshall, Middleton, N.Y., U.S., 29 h August, 1877, for 5 years.

Claim.—1st. In combination with the expending dies I pivoted within the head E, the mandrel B provided with the tapering dimble L fitted into said head, and caused to move longitudinally through the same by means of the nut N; 2nd. The expanding dies I provided with the rearward projecting stud *i*, in combination with the head E having the recesses *e* and *e'* and set screws K; 3rd. In combination with the head E and nut M, the washers N and interposed collar O provided with radially pivoted rollers *o*; 4th. As a means for rotating the head E in the toothed wheel F, the bifurcated lever section G provided with a recess *g* and outer section G' having a reduced threaded end *g'* the pawl H and the spring *h*; 5th. In combination with the head E provided with the recesses *e* and arranged to rotate upon the mandrel B, the cutter head P provided at its inner end with lugs *p* that fit into said recesses, and having upon its outer end cutting teeth *p'*; 6th. In combination with the cutter head P having a threaded periphery, the gauge collar Q fitted upon said threaded periphery; 7th. The described device in which the mandrel A provided with the tapering portion *a* and the threaded portion *a'* the hollow mandrel B having the slotted head B' b and threaded end *b'*, the dogs C, the nut D, the head E provided with the recesses *e* and *e'*, the ratchet wheel F, the lever G G' *g*, the pawl H, the spring *h*, the expanding jaws I, the set screws K, the nut M, the washer N and the roller collar O.

No. 7808. Improvements in Saw Teeth.

(*Perfectionnements dans les dents des scies.*)

Nathan W Spaulding, San Francisco, Cal., U.S., 29th August, 1877, for 5 years.

Claim.—1st. The saw tooth A provided with a bonnet-shaped gouge or cutting point *c* the entering point of which is in advance of the side edges, said entering point and side edges forming one continuous curved cutting point; 2nd. The saw tooth A provided with an angular bonnet-shaped gouge or cutting point, which point is flared, upset or expanded in; 3rd. A swage for expanding, flaring, upsetting or sharpening saw teeth, provided with a brace or guide G which projects beyond the end of the swage bar so as to straddle the tooth in advance of the die or counter-sink; 4th. The combination with a swage for expanding, flaring, upsetting or sharpening saw teeth of a centering clamp or holder for preventing lateral displacement by clamping the tooth near its point.

No. 7809. Improvements in Pumps.

(*Perfectionnements dans les pompes.*)

Edward Stovel, Guelph, Ont., 29th August, 1877, for 5 years.

Claim.—1st. In combination with a pump A, of the solid standard B with projection C and openings D and H; 2nd. In combination with a pump A and standard B of the circular headed handle G with toothed segment *d*; 3rd. In combination with a pump A standard B and handle G of the toothed piston rod *i*; 4th. The combination of the pump A standard B, toothed piston *i*, brackets E E F F, friction roller *c* and handle G.

No. 7810. Improvements on Brick Kilns.

(*Perfectionnements aux fours à brique.*)

Holland B. Evans, Saint-Charles, Mo. U.S., 29th August, 1877, for 5 years

Claim.—The graduated compartments A B C having the flues D E arranged as specified.

No. 7811. Improvements on Saw Grinders.

(*Perfectionnements aux remouleurs des scies.*)

Enoch P. Tetrell, Bellefontaine, Ohio, U.S., 29th August, 1877, for 5 years

Claim.—The combination of shafts F J and L with gear wheels G I K and K' and grinding wheel M, all journaled in sliding sash D.

No. 7812. Machine for Cleaning and Separating Grain.

(*Machine à nettoyer et séparer les grains.*)

Francois R Hawkins, Tilsburg, Ont., 29th August, 1877, for 5 years.

Claim.—The peculiar combination of the sieves B B and C C and the spouts E E and F F with the shaker, and of the whole with any ordinary winnowing machine.

No. 7813. Machine for Stuffing Horse Collars.

(Machine à bourrer les colliers de cheval.)

John M. Lichliter, Luray, Va., U.S., 29th August, 1877, for 5 years.

Claim.—1st. The combination of the carriage K, hopper L, endless toothed belt M, rollers N and the stationary forked rod U with the frame B; 2nd. The combination of the pulley O, the pawl and ratchet wheel P, the strap Q, the spring R, the armed segment S, and the stop T with the feed belt and rollers N, the carriage K and the frame B; 3rd. The combination of the rope and pulley I, J, the pulley and shaft G, H and the rope and weight V, W, with the carriage K and the frame B; 4th. The combination of the pulley, rope and hook D, E, F with the pulley and shaft G, H, the rope and weight V, W and the frame B; 5th. The combination of the lever X, the rope Z and the treadle A with the weight W and the frame B.

No. 7814. Improvements on Portable Fences.

(Perfectionnements aux clôtures mobiles.)

James B. Goff, Curdco, Ont., 29th August, 1877, for 5 years.

Claim.—The main post B combined with a fence length composed of the upright pieces D and C, trace stakes e, e, horizontal rails with bevelled ends a and trace rails K x i fitted together.

No. 7815. Improvements in Car Couplers.

(Perfectionnements aux attelages de wagons.)

David D. Wright, Oakville, Ont., 29th August, 1877. (Extension of Patent No. 1640), for 5 years.

Claim.—1st. The combination with a box draw head A in the gates B; 2nd. Constructing the gates B with recesses G to form an upper projecting shelf; 3rd. The jamps or stops I, 4th. The combination of the draw-head A and guide E provided with a hole to admit of the use of a round or flat pin; 5th. The manner of adjusting the gates B by means of side apertures K in the draw head, or by the operation of the pivot shaft C; 6th. Forming the upper surface of the lower floor of the draw-head inclining downwards from before, backwards, and from within outwards.

No. 7816. Improvements on Water Purifiers.

(Perfectionnements aux filtres à eau.)

James Foley, Montreal, Que., 29th August, 1877, for 5 years.

Claim.—1st. A water purifier to connect with water service pipes, having tanks A A', bands M M' attached to board N. 2nd. The tanks A A' of different diameters and lengths, placed one within the other, having perforated horizontal partitions B I I' forming chambers C d J J' and having perforations h, ports or trap screws E E', K K', and discharge cocks f and L; 3rd. The tanks A A' having inlet-pipes O P with cocks or valves Q R for reversing the flow or circulation.

No. 7817. Machine for Making Bungs.

(Machine à faire des boudons.)

William Craig, James S. McLurray and Thomas R. Fuller, Toronto, Ont., 29th August, 1877, for 5 years.

Claim.—1st. Two or more segments G of a barrel saw, and the taper cutter H bolted or otherwise fastened to the chuck D, in combination with the revolving spindle B; 2nd. The bar I provided with the buttons s and passing through the chuck D, in combination with the spiral spring C contained within the hollow revolving spindle B.

No. 7818. Improvements on Movable Fences.

(Perfectionnements aux clôtures mobiles.)

Hiram Harrington, Blandford, Ont., 29th August, 1877, for 10 years.

Claim.—The construction of the fence the fastening of the boards or rails to the posts a a on opposite sides from where the braces b b are fixed to allow the braces b b to fold snugly by the posts a a when the fence is being moved; the erection of said sections into a line of fence, the mode of setting the sections with the braces b b alternately on each side of the line of fence; the sharpening of the lower ends of the posts a a and the movable braces b b, the iron hook d d attached to the lower end of the braces b b, and pin or bolt f for fastening the sections together.

No. 7819. Spool Stamping Machine.

(Machine à estamper les bobines.)

Theodore E. King, Rockville, Conn., U.S., 29th August, 1877, for 5 years.

Claim.—1st. The rotating carrier I I' in combination with the feeding trough H and a fixed spring J attached to the frame; 2nd. The combination of the spindles K K', the spindles N N' and the carriers I I' arranged to move conjointly, and to stamp the ends of the spool while moving through the machine; 3rd. The combination of the spindles K K' with their dies R R', the discs E F and the inking rollers U U'; 4th. The yielding frame A S T in combination with the stamping mechanism; 5th. The combination of the spindles K and N, and the springs M and O arranged upon a rotating shaft with the fixed cam Q; 6th. The combination of the stamping spindles K K', with the carriers I I' arranged to move conjointly around the same central shaft to stamp the ends of the spools while in motion through the machine.

No. 7820. Improvements in Steam Engines.

(Perfectionnements dans les machines à vapeur.)

Josiah M. Simpson, Oshkosh, Wis., U.S., and Wellington Ault, Toronto, Ont., 29th August, 1877, for 5 years.

Claim.—1st. The cone I secured to the main shaft J and provided with the diametrical slots R R' in combination with the stand E provided with pipes L, L', S and T and the revolving cylinder A; 2nd. The vertically revolving cylinder A secured to the shaft J and provided with the ports a and b, the piston rod B and eccentric crank C, in combination with the stand E having pipes L, L', S and T and the cone I provided with diametrical slots R R'. 3rd. The stand E having steam, water and exhaust pipes L, L', S and T, and the cone I having slots R R', in combination with the vertically revolving cylinder A having ports a and b secured to the fly

wheel F upon the main shaft J; 4th. The vertically revolving cylinder A having ports a b secured to the fly-wheel upon the main shaft J, in combination with the stand E having steam, water, and exhaust pipes, a slotted cone I secured near the opposite end of the main shaft, and the band wheel screwed upon the end of the main shaft.

No. 7821. Improvement in Book-binding.

(Perfectionnement dans la reliure.)

Benjamin Horsley, (Assignee of Florenz E. Schmitz), Middletown N.Y., U.S., 29th August, 1877, for 5 years.

Claim.—1st. A book composed of single leaves united by means of binding threads passed through orifices formed by the crossing of diagonal cuts in the alternate sections of the leaves; 2nd. Uniting the leaves by passing the binding threads through the opposite diagonal cuts in the alternate sections, whereby the threads are securely fastened within the orifices cuts by means of the alternately projecting corners made by the cuts.

No. 7822. Improvements in Puddling and Heating Furnaces.

(Perfectionnements dans les fournaux à puddler et recuire.)

Samuel Caddick, Pembroke, Maine, U.S., 29th August, 1877, for 5 years.

Claim.—1st. A puddling furnace, in combination with the bed plate e the attached water pipes a; 2nd. A puddling or heating furnace, in combination with the fire box or grate G, the supplementary fire box or grate H with or without the hopper S and with or without blast; 3rd. The supplementary fire box of a puddling or heating furnace, in combination with the blast opening or pipes T and the damper S', the hopper S; 4th. The supplementary fire box of a puddling or heating furnace, in combination with the hopper S and the blast openings or pipes I, the damper S'; 5th. A puddling or heating furnace, in combination with the supplementary fire box or grate H the blast openings or pipes T with or without the hopper S.

No. 7823. Mode of Ventilating Waterproof Garments.

(Mode de ventilation des habits imperméables.)

Samuel L. Worth and Joseph H. Pontifex, London, England, 29th August, 1877, for 5 years.

Claim.—1st. Ventilating garments by forming a space between the two fabrics, at the parts required, into which air is free to enter by the mesh or perforations of the outer fabric, and leave by the meshes or perforations of the inner fabric; 2nd. The arrangement of the two fabrics of a coat or other garment by which a free, yet graduated, current of air is permitted to pass from the outside to the inside for ventilating purposes.

No. 8824. Improvements on Port Holes of Ships.

(Perfectionnements aux sabords des navires.)

William H. Forbes, Baltimore, Md., U.S., 29th August, 1877, for 5 years.

Claim.—1st. A seal or protector for ships' ports, having a countersunk metallic frame on the ship's side, as a means for securing and clamping thereto a rubber seal or cover for said port; 2nd. The fixed countersunk metallic frame, the outside rubber cover and the independent outside securing metallic frame or plate; 3rd. The combination with the port hole box or casing, the plug or stopper and the screw bolts, cross-bar and nuts for securing the same, of the fixed countersunk frame, the rubber cover, its outside securing frame and the outside screw bolts.

No. 7825. Improvements on Barrel Stands.

(Perfectionnements aux chantiers de barils.)

David Scott, Olney, Ill., U.S., 29th August, 1877, for 5 years.

Claim.—1st. The combination of a barrel-stand having supporting braces or handles, with a front box and covering stop-stay for storing a set of measures and funnels for each barrel; 2nd. The combination of a barrel stand, with a treadle operated rack-piece and a sliding and guided spring catch-rod, operated from the front of the stand, to tilt and lower barrel; 3rd. The combination with the vertically sliding and treadle operated rack-piece, being locked by the spring catch rod, of a pivoted top-section that follows the motion of the barrel without obstructing the raising of the same.

No. 7826. Device for Securing and Protecting Tapes.

(Appareil à attacher et protéger les rubans.)

William H. Stafford and Simon S. Cook, Woonsocket, R. I., U. S., 29th August, 1877, for 5 years.

Claim.—1st. The combination with the foot a of the curved spring b; 2nd. The curved metallic spring centered in the spool and arranged to support the sides of a roll of tape or other narrow fabric and hold the ends as described.

No. 7827. Board for Ironing and Blocking Shirt Fronts.

(Planche à repasser et former les devants des chemises.)

Orville Lingenfelter and Harry R. Morris, Merrickville, Ont., 29th August, 1877, for 5 years.

Claim.—1st. The formation of the expansive or adjustable frame B by means of the side springs, the adjusting bar D and the springs acting upon the lower bar b of the frame B; 2nd. The combination of the ironing board or raised panel A, with the adjustable or expansive frame B.

No. 7828. Improvements on Water Filters.

(Perfectionnements aux filtres à eau.)

James Foley, Montreal, Que., 29th August, 1877, for 5 years.

Claim.—1st. The tank A with flat bottom B and removable cover C fitted with cocks K K' and ports or trap screws J J'; 2nd. The tank A provided with a plain horizontal partition D and perforated partitions D', D''; forming unfiltered water reservoirs E E', filtered water reservoir E' and cham

bers F¹ for filtering medium, having tube G, perforated boxes H H, and air tube L, 3rd The tank A having unfiltered water reservoirs E E above and below the filtering medium chambers F¹ to filter upwards under a pressure; 4th. The tank A to filter from the bottom upwards under the influence of a pressure, having filtered water reservoir F² above the filtering medium, 5th The tank A having cock K¹ for cleansing the filtering medium.

No. 7829. Improvements on Snow Shovels.

(*Perfectionnements aux pelles à neige.*)

Charles H. Victory and Alouzo P. Adams, Albany, N.Y., U.S., 29th August, 1877, for 5 years.

Claim.—1st. The combination of the shovel blade A with the detachable chisel pointed handle C, 2nd. The detachable handle C of a shovel or other implement provided with a metallic chisel point D.

No. 7830. Machine for Making Barbed Fence Wire.

(*Machine à faire les clôtures en fil métallique barbelées.*)

Henry W. Putnam, Bennington, Vt., U.S., 29th August, 1877, for 10 years.

Claim.—1st. The combination with barb winding shaft F¹, of lever R provided with wire holding feet a and G, 2nd. The combination with guide plate z of notched guide-piece A, 3rd. The combination with cog-gear M¹ provided with pins y and z, of blank cog-gear M² provided with locking lever u and arm v, 4th. The combination with notched wheel or pulley T and standard 17 of spring lever P provided with tubular guide piece to, 5th. The combination with the feed and guide rolls G (G), the latter rolls being provided with barb receptacles f f of the cog-gears Y and Y¹ upon shafts le and 19; 6th. The combination with the feed and guide roll G¹ provided with barb receptacles f f, of grooved table 39 and vertical flange 40; 7th. The combination with the bearings of the upper feed rolls G of the self-adjusting compressing devices 30, consisting of the parts marked and lettered 31, 32, 33, 34, and 35, 37 and Z Z¹; 8th. The combination with locking gear V and notched wheel 23 of blank gear wheel V provided with lever 25; 9th. The combination with spring-actuated feed-rolls G¹, of the inclined arm 63, provided with curved end 68; 10th. The combination with twister-frame 48, of the skeleton-guide arm twisting rolls 49 and 50; 11th. The combination with the twister-frame 48 of combined pulley and ratchet wheels 56 double threaded screw shaft 72, provided with pulleys 76 and sliding table 51; 12th. The combination with the mechanism for barbing the wire B and feeding the barbed wire B and the wire C of mechanism for at once both twisting or cabling the wires to form the finished barbed cable wire or fencing H and winding the same up on its spool or reel in a uniform and even manner.

No. 7831. Improvements on Harvesters.

(*Perfectionnements aux moissonneuses.*)

George Pye, St John, N.B., 1st September, 1877, (Extension of Patent No. 3893), for 5 years.

No. 7832. Improvements on Harvesters.

(*Perfectionnements aux moissonneuses.*)

George Pye, St. John, N.B., 1st September, 1877, (Extension of Patent No. 3893), for 5 years.

No. 7833. Improvements on Hose-Couplings.

(*Perfectionnements aux joints de boyaux.*)

Charles A. Bissett, St. John's, Que., 30th Augt., 1877, for 5 years.

Claim.—The coupling members A B and C D, the former having elastic ring F, and the latter grooved ways E E, metal cylinder H and elastic cushion I whereby coupling is effected by both members sliding together.

No. 7834. Improvements on Car Axle Boxes.

(*Perfectionnements aux boîtes d'essieux de wagons.*)

Thomas A. Bissell, Detroit, Mich., U.S., 30th August, 1877, for 5 years.

Claim.—1st. An axle-box cast with the pocket E and with a slot to receive the forked plate D, adapted to ride the axle collar and return its chips to the oil cellar, 2nd. The shoe G cast with a pendant flange G¹ at its front end adapted to receive and secure the stop-plate H.

No. 7835. Improvements on Gas and Water Pipes.

(*Perfectionnements aux tuyaux à gaz et à eau.*)

Frederick Jarecki, Erie, Pa., U.S., 3rd September, 1877, for 5 years.

Claim.—1st. A casing having two different diameters A₁ A₂, 2nd. In combin.ⁿ on with the casing A₁ A₂, the upper adjustable section B; 3rd. In combination with the casing A and the upper adjustable section B, the spring f and stop g, 4th. The cut off rod I provided with a guide collar b and flattened upper end; 5th. The key or wrench H having its handle formed at one end in a fork L, and at the other end in a hatchet M; 6th. The cap C having its upper or flat part of iron and its screw bush of brass.

No. 7836. Improvements in Boiler Cleaners.

(*Perfectionnements dans les nettoyeurs des chaudières.*)

John R. Fordon, Bay, and James E. Thomas, West Bay, Mich., U. S., 3rd September, 1877, for 5 years.

Claim.—1st The combination of the flow-pipe A, funnel mouth B and receiving chamber C, 2nd. The pipe A provided with the cock L, in combination with the pipe H and cock I; 3rd. Forcing a current through the pipe by so locating and arranging said pipe, that part of the steam generated at the bottom of the boiler may pass into and rise through the pipe.

No. 7837. Improvements on Spring Bed Bottoms.

(*Perfectionnements aux fonds de lits à ressorts.*)

William H. Palmer, Warren, Pa., and Henry F. Roesser, Buffalo, N. Y., U.S., 3rd September, 1877, for 5 years.

Claim.—1st. The plates D provided with single or double notched flanges d₁ and made in two parts, with their adjacent ends inclined to cause them to meet at an angle, in combination with the frame A B and with the spring C of the bed bottom, 2nd. The couplings formed of two short rods E rigidly connected by an arm F, in combination with the springs C of a bed bottom.

No. 7838. Improvement on Churns.

(*Perfectionnement aux barattes.*)

James Pennock, Bastaw, Ont., 3rd September, 1877, for 5 years.

Claim.—An improved churn power which may be operated by any person sitting in the seat S, with the feet on the tread bars D D giving motion, by the ordinary crank and axle movement with balance wheels B B and arm F, to the pinion bar G.

No. 7839. Improvement on Riding and Driving Reins.

(*Perfectionnement des rênes et des quils.*)

David T. Shaw, New York, U.S., 3rd September, 1877, for 5 years.

Claim.—1st The metallic cases or tabs B B enclosing the spring, 2nd The supplemental rein strap E attached to the loops of bar of bit.

No. 7840. Improvements on Bread Knives.

(*Perfectionnements aux découpeurs de pain.*)

Peter Payette and Thomas A. Cook, Toronto, Ont., 3rd September, 1877 for 5 years.

Claim.—1st A steel blade or knife C having a sharpened corrugated edge and pivoted to a bar E, connected to the bar F by the knife joint a, in combination with the pin H fitting into the slotted stud G which is attached to the bed plate A, provided with vertically slotted guides B B, 2nd The steel blade or knife C having a sharpened corrugated edge and held within the guides B B, in combination with the discs I eccentrically pivoted upon the bed plate A, 3rd. A steel blade or knife having saw teeth cut in one edge, the opposite to which is a sharpened corrugated edge.

No. 7841. Art of Constructing Brick and Stone Buildings.

(*Art de construire des bâtiments en brique et en pierre.*)

Joseph F. Patten, Yarmouth, N.S., 3rd September, 1877, for 5 years.

Claim.—1st The double self supporting walls B B and water tight space L which in case of fire can be filled with water; 2nd. Supports or rests C C for securing and supporting trimmers, joists, rafters and other timbers necessary for building purposes, 3rd. The F F with fusible coupling D, 4th. The projection of end and middle walls, also extension of said walls above the roof of buildings to prevent fire from spreading.

No. 7842. Improvement in Treating Hair.

(*Perfectionnement dans le traitement du crin.*)

John F. Greene, Brooklyn, N.Y., U.S., 3rd September, 1877, for 5 years.

Claim.—1st. The mode of producing colored fibre from hair that is to say, subjecting animal hair to the action of strong nitric acid solution or the described equivalent, and then drying the same, 2nd. The described colored fibre consisting of animal hair, having a light colour indestructible by acid.

No. 7843. Improvements on Coloring Compositions.

(*Perfectionnements aux composés colorants.*)

George S. Wolff, Philadelphia, Pa., U.S., 3rd September, 1877, for 5 years.

Claim.—1st. A black coloring composition, consisting of blue, red and yellow or equivalent aniline colors, combined with alcohol; 2nd. The described black stain, consisting of coloring composition, castor oil, resin and benzine. 3rd. The described black varnish produced by adding shellac to the coloring composition. 4th. The described harness renewing compound, consisting of coloring composition, castor oil, bees-wax, and benzine. 5th. The described dressing for boots and shoes, consisting of coloring composition gum shellac Venice turpentine, gum-camphor, castor oil, bees wax and benzine.

No. 7844. Improvements in Wind Mills.

(*Perfectionnements aux moulins à vent.*)

Christian Nysewander, John Nysewander, New-Carlisle, and David Nysewander Jr. Springfield, Ohio U.S., (Assignees of Daniel Nysewander), 3rd September 1877, for 5 years.

Claim.—1st A wind wheel E having the points of vanes brought together and attached to a central plate; 2nd. The combination of the segmental gear wheels K L, the two regulating vanes O P and the weight Q, with the turn table A and the main vane N, 3rd. The combination of the flaring flanges e₁ with the edges of the wings of the wheels E; 4th. The combination of the bars e₂ with the flanges e₁ and the wings of the wheel E; 5th. The combination of the upright bar m, the cross-bar W, the hinge-bar Y and the brace bars X Z, with the turn table A and the vane N.

No. 7845. Wagon Spring Attachment.

(*Ajustage des ressorts de wagons.*)

Reuben Doty and Joseph Doty, Wellesville, N. Y., U. S., 3rd September, 1877, for 5 years.

Claim.—An improved device for attaching springs to wagon-body, composed of a top plate, a cross bar, encircling clip or band, and downward extending lugs to form shackles for springs, the whole made in one piece.

No. 7846. Improvements on Earth Augers.*(Perfectionnements aux tarières de sonde.)*

Charles D. Pierce, Philadelphia, Pa., U.S., 3rd September, 1877, for 5 years.

Claim.—1st. An earth auger having pods A A' expanded at the lower ends, where the cutting blades are located, 2nd. An earth auger having pods and cutters, and provided with side plates E E bent outwards at their lower ends; 3rd. The pods A A' having arms D D' pivoted together, 4th. The combination of the pods A A', the pivoted arms D D' carrying the same, the sleeve a and the key b, 5th. The arms D D' having lower ends d bent to conform to the lower bent ends of the pods, 6th. An earth auger having cutters arranged in respect to each other and to the axis of the auger; 7th. The cup shaped plate f secured to the pods so as to stiffen and strengthen the same at the lower ends, 8th. An earth auger composed of two independent sections, arranged parallel to each other and carried by adjustable arms D D', 9th. The pods A A' provided with side plates E E made in two parts lapping in the centre; 10th. The pods A A', their slotted arms D D', the recessed block F and retaining bolt i; 11th. The combination of the block F and its pinion m with the arms D D' having racks n; 12th. The segmental rings G adapted to the body of the auger and carrying cutters B; 13th. The cutting plates B having hollowed upper faces, forming curved or mole-shaped passages for the earth, 14th. An earth auger provided with a rod g and the pivoted spring valves w opening upwards, 15th. The combination of the valves w with the operating rods y; 16th. An earth auger having a body provided with a valve composed of two or more hinged sections, 17th. The combination of the hinged sections to w and w' of the valve with the stop z.

No. 7847. Invalid Chair and Lounge.*(Chaise-cauuse d'invalid.)*

Antonete M. S. Goldschmidt, Preston, Ont., 3rd September, 1877, for 5 years.

Claim.—1st. The removable sliding commode seat L, cushioned seat N and an adjustable back E; 2nd. The removable retaining bar H and table J, sliding on the arms B and held by a spring fastening; 3rd. An adjustable back E and a lounge attachment O, adapted to replace the removeable seats L and N.

No. 7848. Fire Escape Ladder.*(Echelle de sauvetage d'incendie.)*

Peter Lord, St. John's, Que., 3rd September, 1877, for 5 years.

Claim.—1st. A frame A mounted on wheels B carrying a reel C, and ladder H constructed in sections hinged together, winding on said reel, and elevated by a windlass, or cog-gear, 2nd. In combination with the ladder H winding on a reel C, the down haul rope N and windlass O preventing the backing of the ladder; 3rd. The escape basket P in combination with the ladder H winding on the reel C and operated by the rope R, pulley S and windlass T.

No. 7849. Shoe Sole Buffing Machine.*(Machine à polir les semelles des chaussures.)*

Josiah W. Rogers, Salem, Mass., U.S., 3rd September, 1877, for 5 years.

Claim.—The combination of the driving pulley I, leading pulleys d e, single band H, pivoted arm E, furcated shaft C, pulley a and buffer spindle B; the combination of the rotary brush N, its pulley M and driving band L with the double grooved pulley e, driving pulley I, leading pulley d, band H, pivoted arm E, furcated shaft C, pulley a and buffer spindle B, the combination of the stationary arm G, the spring F, carrying arm E, furcated arbor C and the buffer spindle B provided with mechanism for revolving it; the combination of the spring S, the furcated arbor C, carrying arm E, buffer spindle B and mechanism for revolving it.

No. 7850. Grind Stone for Mower Knives.*(Meule à aiguiser les couteaux des moissonneuses.)*

Henry F. Bush and Martin L. Bush, Douglassville, Pa., U.S., 3rd September, 1877, for 5 years.

Claim.—The combination of a driving main grind-stone with a second revolving grind-stone, turning in bearings of a swinging frame, centered to shaft of main grind-stone, and with a reciprocating knife, supporting bar or plate.

No. 7851. Revolving Roasting Furnace for Ores.*(Fournneau rotatoire pour griller les minerais.)*

Robert G. Leckie, Actonvale, Que., 3rd September, 1877, for 5 years.

Claim.—1st. The roasting or oxidizing of oxidizable substances in a revolving cylinder, in such manner that the reducing gases from the fire-place do not come into contact with the materials to be oxidized, 2nd. The heating of the air for the aforesaid purpose by the waste heat or escaping gases from furnace, by means of the pipes F or in a separate fire-place by fuel, 3rd. The arranging of the shelves or ridges with a screw pitch, by which the ore is gradually carried forward from the feeding to the discharging end while the cylinder itself sits level, 4th. The discharging ports M with covers and guide pieces N, with screw for raising or lowering same, 5th. The combination of the cylinder or furnace A with the chamber and pipes D D, and channel or main-pipe E E or their equivalent.

No. 7852. Improvements on Tramways.*(Perfectionnements aux chemins à ornieres.)*

George F. Deacon, Liverpool, Eng., 3rd September, 1877, for 5 years.

Claim.—1st. The novel combination of the washer a, the concrete or sleeper b, the bolt c, the sleeper d, the rail e, the nut h, all arranged part to part and operating in the manner described; 2nd. The mode of fastening tramway rails such as e, to the substructure, or foundation such as b, by a bolt such as c, which is free to move except in relation to the rail, and by which the rail is fastened to the underside of the substructure, 3rd. The novel section of rail e furnished with a central web and a double tread, 4th. The improved joint with narrowed and raised groove.

No. 7853. Improvements in Hoisting Machines.*(Perfectionnements aux monte-charge.)*

Thomas Mann, Portland, Oregon, U.S., 3rd September, 1877, for 5 years.

Claim.—1st. In combination with two pairs of parallel guiding posts D E and F G, each of which serves to guide a sliding frame or carriage V and both of which carriages are suspended by the same rope, the upper cross-timber H made in two parts so that the frame can be adjusted to any desired angle to each other, 2nd. The combination and arrangement of the supporting and guiding frame rope I, and carrying frames V V, and one or more pulleys U; 3rd. The double cross-timbers H H with side notches arranged to receive the pulleys J J, 4th. The bars K, provided with V-shaped notches as seats to receive the bottom of the hods, and with a detachable safety box K' to receive droppings from the hods.

No. 7854. Combined Clothes Wringer and Wash Bench.*(Essoreuse-banc de baigneur.)*

Peter E. Rudel, Grand Rapids, Mich., U.S., 3rd September, 1877, for 5 years.

Claim.—1st. The combination with a central self-supporting standard A of the frames B C hinged to opposite sides thereof, and thus adapted to fold against the standard; 2nd. The combination of the frame A, pressure bar F, and lever G with the rollers D and sliding water-table J, 3rd. The combination of the frame A, roller D and sliding water-table J.

No. 7855. Improvements on Vehicle Springs.*(Perfectionnements aux ressorts de voitures.)*

William Foote, Fillmore, N.Y., U.S., 3rd September, 1877, for 5 years.

Claim.—The supporting block M M in combination with equalizing bars L L, lower springs I I and uppersprings J J, pivotally attached to the rear axle and head block, the springs I I being arranged under the sides of the body and inside the springs J.

No. 7856. Improvements on Door Thresholds.*(Perfectionnements aux seuils de portes.)*

Robert B. Hamar, Eden, Me., U.S., 3rd September, 1877, for 5 years.

Claim.—A door-threshold having its open chamber provided with a series of ribs, and a trough arranged in combination with a flanged cover arranged with and applied thereto, and provided with studs to enter elongated cavities in the ribs.

No. 7857. Improvements on a Tea-kettle.*(Perfectionnements a une théière.)*

Jacob Keller, Chatham, Ont., 4th September, 1877, for 5 years.

Claim.—A tea-kettle made of sheet metal, the spout of which is formed from, and is a part or continuation of the sheet, or sheets which constitute the outer rim or body of the tea-kettle.

No. 7858. Improvements in Clothes Dryers.*(Perfectionnements aux séchoirs à linge.)*

Hiram W. Coulter, Bingham Road, Ont., 4th September, 1877, for 5 years.

Claim.—1st. The standard A provided with a rod C having a cap D, in combination with the moveable clothes frame formed by the ropes E, arms F and centre piece G; 2nd. The rope or chain H attached to the centre piece G and passing over the pulley I in the cap D, in combination with the drum J provided with a handle K and ratchet wheel I, engaging with pawl M.

No. 7859. Improvements on Churns.*(Perfectionnements aux barattes.)*

William Pettis, Port Greville, N. S., 4th September, 1877, for 5 years.

Claim.—The elliptic upright milk chamber, in the iron frame for holding the driving gear, in combination with metal heads and the clamps and screw.

No. 7860. Improvements in Door Fastenings.*(Perfectionnements aux fermetures de portes.)*

Jacob Wright, Toronto, Ont., 4th September, 1877, for 5 years.

Claim.—The bolt A inserted into the stile B or other convenient part of the door, and provided with a projecting handle C having an ornamented head or knob D, in combination with the plate F having a slot E with a recess f or its equivalent.

No. 7861. Improvements on Pulp Engines.*(Perfectionnements aux piles à cylindre.)*

Simeon L. Gould, Gardiner, Me., U.S., 4th September, 1877, for 5 years.

Claim.—1st. The annular stationary grinding bed B and rotary disc, in combination with the case or curb A, when the contiguous faces of the two are flat and the whole so arranged that the "stuff" in circulation takes a course through the centre of the bed B, passes between the latter and the disc D, and is discharged at the circumference of the two, the said bed being secured to the walls of the case as stated, and the disc supported upon a shaft which passes through the bed, 2nd. The water box F containing a quantity of water which surrounds the end of the shaft and stop, and maintains a low temperature of the same, as well as constituting a lubricant thereto, 3rd. The general construction of a paper pulp engine, consisting of the case A, annular flat faced grinding bed B, rotary flat faced disc D and water box F; 4th. The hollow annular grinding bed provided with water inlet and outlet ports.

No. 7862. Improvements in Steam Engines.*(Perfectionnements aux machines à vapeur.)*

Ward Clubine, Goodwood, Ont., 4th September, 1877, for 5 years.

Claim.—A cylindrically shaped steam chest C provided with posts E F F and D D, in combination with the piston valves B B' keyed or otherwise fastened to the spindle A.

No. 7863. Improvements on Burial Cases.

(Perfectionnements aux cercueils.)

Joseph Askins, Elida, Ohio, U. S., 4th September, 1877, for 5 years.

Claim.—1st. A burial case composed of a metallic bottom provided with upright bars or posts cast in one piece therewith, the frame piece secured to the top of said posts. The cover and the glass panels secured in the sides, end and top; 2nd. A metallic glass panel burial case provided with handles projecting from the bottom thereof. 3rd. A burial case combining in its construction the bottom plate A, posts A₁ A₂, studs a₁ a₂ thereon, and perforated frame piece C. 4th. The frame piece C constructed with a series of holes along its inner edge to receive the threads for attaching the inner lining. 5th. In combination with a metallic burial case, the interior wooden frame D. 6th. In combination with a metallic burial case formed with an opening for the escape of gases, the safety valve covering said opening.

No. 7864. Machinery for the Manufacture of Boots and Shoes.

(Machine pour la fabrication des chaussures.)

Samuel Henshall, Philadelphia, Pa., U.S., 4th September, 1877, for 5 years.

Claim.—1st. A channelling machine in which the channelling knife is capable of moving vertically independently of the feed wheel, during the operation of the machine. 2nd. The combination of the arm D carrying the feed wheel d, with the spring sliding bar I carrying the channelling knife. 3rd. The combination of the lever M and the spring sliding bar T with the intermediate lever P. 4th. The combination of the levers M and P with the adjusting screw u. 5th. The combination in an edge turner of a feed-wheel and an edge turning disc, independent of each other as regards vertical movement. 6th. The combination of the fixed shaft D and its collar a with the feed wheel M and turning disc d, the shafts of which are carried by pivoted spring frames E and F. 7th. The combination of the spring frame E carrying the shaft I with the operating lever P. 8th. The combination of the spring frame F carrying the shaft J with the operating lever R. 9th. The combination in a shoe sewing machine of the feeding jaws i and the moveable finger m with devices, whereby the said finger is depressed when the jaws are in the act of feeding. 10th. The combination in a shoe sewing machine of the spring lasting arm n with the finger m, the two presenting a recess for the reception and guidance of the upper and sole. 11th. The combination in a shoe sewing machine of the finger m, bell crank lever L, connecting rod K and scroll cam a. 12th. The combination in a shoe sewing machine of the feeding jaws i and r with the supporting finger m, in advance and independent of said jaws, whereby the manipulation and feeding of the work is facilitated. 13th. The combination in a shoe sewing machine of the spring rod F and its block g, and the vibrating plate J with the lever G, bar H and connecting plate h. 14th. The combination in a shoe sewing machine of the needle bar D and pinion y connected together, with the sliding plate R and its rack, and the disc V with the cam groove V.

No. 7865. Improvements on Sheet Metal Pipes.

(Perfectionnements aux tuyaux en feuilles métalliques.)

John F. Starr, Jr., Camden, N. J., U. S., 4th September, 1877, for 5 years.

Claim.—A sheet metal square pipe A bulged at the four corners a a a a affording facilities to fasten it without interfering with its resting firmly on a flat surface, when attached to buildings.

No. 7866. Improvements in Harness.

(Perfectionnements dans les harnais.)

Ambrose B. Coleman, Lyndenville, N. Y., U.S., 4th September, 1877, for 5 years.

Claim.—1st. The draw-lever A made in a single piece and adapted to pass under both horses and having a trace f fastened to each end only, so as to bring but one-half of the draft to bear upon it; 2nd. The combination of the draw-lever A, the first pulley draw trace B, the second pulley draw-trace C, the first pulley D and the second pulley E, and the lever traces f f.

No. 7867. Method of Separating Sulphur from its Ores.

(Méthode pour séparer le soufre du minerai.)

Robert G. Leekie, Acton Vale, Que., 4th September, 1877, for 5 years.

Claim.—1st. The production of sulphureted hydrogen from sulphur ores by super-heated steam while burning. 2nd. The pipes H for super-heated steam and pipes or opening I for air, by which the kilns may be worked in such a manner as to produce sulphurous acid, and sulphureted hydrogen alternately. 3rd. The intermixing of the gases in the flue and chamber for the separation of the sulphur. 4th. The steam-pipe F or its equivalent for the introduction of moist steam, to prevent the recombination of the fine sulphur separated or set free by the mutual decomposition of the gases. 5th. The combination of the kilns A A with the flue C and chamber D D, together with the pipes F H and I, and water pipe G or their equivalent.

No. 7868. Improvements on Railway Switches.

(Perfectionnements aux aiguilles de railroads.)

Justin J. Golden Toronto, Ont., 4th September, 1877, for 5 years.

Claim.—1st. The wheel A in combination with lever B hinged in radial groove s, with counter-weight C and ring O encircling the axle F. The outer end of lever operating in notches in semi-circular bar e. 2nd. The level wheels f and g for turning the signal board G, in combination with the axle F. 3rd. The lever M in combination with the upright linked rod N, lever H, cable L and lever K. 4th. The eccentric E pivoted in spring d, in combination with bracket E₁ and hange P, for securing the wheel H and prevent the switch being tampered with. 5th. The wheel H with cable I, in combination with the wheel A, with radial groove s secured on the upright cranked axle F of the ordinary switch gear.

No. 7869. Stump Extractor.

(Arrache-souche.)

Martin Van B. Center, Mount Albert, Ont., 4th September, 1877, for 5 years.

Claim.—1st. The ratchet wheel E and chain wheel G attached to the leg A on the spindle F, in combination with the hooked rod I and lever J working

In conjunction with the pawl H, 2nd. The chain K passing over the pulley D at the apex of the tripod, in combination with the notched chain pulley G.

No. 7870. Electrical Apparatus to Indicate Overstrain or Weakness in Roofs and Bridges.

(Appareil électrique pour indiquer la tension ou la faiblesse dans les toitures et les ponts.)

John Forbes Dartmouth, N.S., 4th September, 1877, for 5 years

Claim.—The combination with a bridge roof or other structure, of a system of insulated conductors and a circuit-closer so arranged that any abnormal condition resulting from overstrain or other cause tending to reduce the originally designed margin of safety, shall be indicated (by completion or rupture of the circuit) upon an annunciator suitably situated and connected.

No. 7871. Improvements in Heating Stoves.

(Perfectionnements dans les calorifères.)

Phillip O. Jenkins, Gilman, Ill., U.S., 4th September, 1877, for 5 years.

Claim.—1st. The combination of the platform a b b₁ G with the stove cylinder, pivoted and adapted to operate as described. 2nd. The combination, with the body of the stove, of the pipe D and bucket F. 3rd. The combination, with the outer containing cylinder, of the interior bucket H, perforated tube H₁ and protecting rods.

No. 7872. Improvements in Air Registers.

(Perfectionnements dans les registres d'air.)

Norma K. Joyce Brooklyn, N.Y., U.S., 4th September, 1877, for 5 years.

Claim.—1st. The combination of the link L, thumb piece T, spring S, and slide slot S₁, located in the face of an air register. 2nd. The thumb piece T, spring S₁ and link L, in combination with the fans L and link L₁. 3rd. The frame F provided with the pin sockets S S on the inner edges of two of its sides, the leaves L L provided with the pivots P P, in combination with the angle plates P₁ P₂.

No. 7873. Improvements in Wood Pulping Engines.

(Perfectionnements aux mûles à cylindre.)

Albert Fickett, Rochester, N.Y., U.S., 6th September, 1877, for 5 years.

Claim.—1st. The cylindrical case A provided with one or more stone annulars C. 2nd. In combination with the grinding cylinder the table D and guides or gauges c. 3rd. In combination with the internally grinding cylinder, the guides c having their outer end made adjustable for the purpose of permitting the wood to be presented more or less obliquely to the grinding surface. 4th. The perforated water pipe T, in combination with the hollow shaft A₁, grinding cylinder A and table D.

No. 7874. Improvements on Waggon Jacks.

(Perfectionnements aux chèvres de wagons.)

James A. Fox, Newfane, N.Y., U.S., 12th September, 1877, for 5 years.

Claim.—The slide C connected with standard B by means of straps E D in combination with the bifurcated lever G straddling the standard, and ball F attached to the bifurcated ends of the lever G and to the slide.

No. 7875. Improvements in Under-garments.

(Perfectionnements dans les vêtements de dessous.)

Philo H. Lee, Binghamton, N.Y., U.S., 12th September, 1877, for 5 years.

Claim.—1st. In a skin under-garment, the combination of apertures B with coverings for the apertures, the coverings being made of a material more porous than such skin and being firmly secured to such skin near to and completely about the several apertures; 2nd. In a skin under-garment, the additional apertures B covered by a more porous material and interposed between the skin portions, throughout the longitudinal seams of the body or of the limbs of the garment, whereby the person is protected from cold and abrasion, and the garment is ventilative and relieved from warping and strain; 3rd. The combination with the body or limb of a partially or completely tanned animal skin under-garment, of the pieces B of more porous material situated where the seams occur and extending the length of such seams.

No. 7876. Improvements on Fog Signals.

(Perfectionnements aux signaux de brume.)

The Neptune Fog Horn Company, (Assignees of George Swearing), Quebec, Que., 12th September, 1877, for 5 years.

Claim.—1st. In combination with a winding mechanism operating a piston in an air cylinder for giving audible sounds by means of a whistle or reed, one or more air pumps adapted to control the speed, and thereby regulate the intervals of sounds; 2nd. The combination in a fog-signal giving audible sounds by means of compressed air, a winding mechanism consisting of two sets of gears, one set capable of being wound while the other is running off and a cylinder having a piston operated thereby to expel air through a whistle or reed for giving audible sound. 3rd. The combination in a fog-signal giving audible sounds by means of air forced through a whistle or reed, of an air cylinder having a piston automatically raised and dropped therein at intervals by the operation of a spring and clutch, and lever and cam, a train wheel winding mechanism and one or more air pumps to regulate the length of interval between the sounds.

No. 7877. Stump Machine.

(Arrache-souche.)

William R. Brandon and Henry Wheeler, Walsingham, Ont., 12th September, 1877, for 5 years.

Claim.—1st. The simplification and strengthening of the upright piece L by fastening it directly to the beam a. 2nd. The pulley H inserted in the lever s. 3rd. The extensions G of the beam a. 4th. The perpendicular wooden braces D; 5th. The iron braces E; 6th. The chain N; 7th. The chain M.

No. 7878. Improvements on Tire Upsetters.*(Perfectionnements aux machines à refouler les bandages des roues.)*

Morris W. Griffiths, Middle Granville, N.Y., U.S., 12th September, 1877, for 5 years.

Claim.—1st. The combination of the bar or plate B having lugs or bearings *b* formed upon its ends, the eccentrics C, the levers D, the connecting rods E, the treadle F and the spiral spring G with each other, and with the frame A; 2nd. The combination of the equalizer H with the treadle F, rods E, levers D, eccentrics C and plate B; 3rd. The lugs *b* formed upon the eccentrics C; 4th. The combination of the steel plate I with the plate B, eccentrics C, levers D, rods E and treadle F.

No. 7879. Improvements on Blind Hinges.*(Perfectionnements aux peintures des persiennes.)*

William Jones, Oshawa, Ont., 12th September, 1877, for 5 years.

Claim.—1st. The combination of the knuckle joint E E with shaft or rod F F and cog-wheel D D; 2nd. The combination of the cog wheel A A with shoulder piece *a a*, pivot B B with wall plate C C; 3rd. The lug handle H H and lug I I with wall plate G G, in combination with knuckle joint E E and shaft F F; 4th. The upper hinge with extended plates K K.

No. 7880. Improvements on Cultivators and Sowers.*(Perfectionnements aux cultivateurs et aux semailles.)*

Richard B. Sheldon, Shortsville, N.Y., U.S., 12th September, 1877, for 5 years.

Claim.—1st. The application of three or any number of holes E in ends of tooth C to receive pin *e* in the upper end of link F; 2nd. The combination of rod K attached by pin to links F and working in stud I, and having jam nuts L I to set it as required; 3rd. The combination of spiral spring M on rod K with links I and bar G by which F and G are kept in position, and when tooth C is moved it is drawn back to its former position.

No. 7881. Combined Shoulder Braces and Suspenders.*(Bratelles de pantalons et harnais combinés.)*

Noah Van Allen, Chicago, Ill., U.S., 12th September, 1877, for 15 years.

Claim.—1st. The brace and draw being close garment fitting around the arm-pits, and shoulder-points, at the junction of the arms with shoulders cause the draw to spread the shoulder points open towards the front, widening the expansion of the breast, adds to the height of the shoulder points; 2nd. The draw and bearing being up over from in front of the shoulder points, and also from across the lower arm pits, both centering in a combined draw and bearing equalized across the back over the whole of the shoulders, and principally on a line with the lower parts of the shoulders, pressing the shoulder blades forward; 3rd. The draw and bearing so constructed, being over the whole back of the lower shoulders, especially near the arm-pits; 4th. The draw across the back being adjustable so as to be tightened or loosened circumstances require; 5th. The draw and fitting around the arm pits and over the shoulder-points, being adjustable at the front of the shoulder-points in such manner as to effect an elevating, and forcing back the shoulder-points pursuant to the wish of the wearer; 6th. The width of the bar across the back being variable according to size and form of persons; 7th. The brace made of woven fabric, and for cases of deformity, of steel or other metallic substance, and of the same combined; 8th. The brace being non-yielding unless otherwise required, the main parts *g*, flanges B B are each of firm material, and of double thickness (single if desired), firmly sieved, the front and back suspender combination are composed of best rubber web, viz: D D and A A, and are attached by being inlaid between the thickness of the main parts of the flanges and firmly sieved; viz: D D at *d* and *d*, and A A at *a* and *a*, straps E E are quilted and are attached by being inlaid and firmly sieved at *e* and *e*, and from those parts passing under the arms and buckle on to the front parts of the flanges at C C; the main flanges buckle together at F.

No. 7882. Improvements on a Letter Envelope.*(Perfectionnements à une enveloppe à lettres.)*

Charles K. Marshall, Vicksburg, Miss., U.S., 12th September, 1877, for 5 years.

Claim.—A letter envelope, having two sets of superscription lines as at *b* and *b*, two postage stamps for pre-payment of postage as at *c* and *c*, and two sealing surfaces on its sealing flap as at *d* and *d*.

No. 7883. Improvements on Vehicle Seats.*(Perfectionnements aux sièges de voitures.)*

Wellington Bristol, Madoc, Ont., 12th September, 1877, for 5 years.

Claim.—1st. The combination of front seat A and back seat B of the vehicle; 2nd. The combination of rod C, seat B, plate E and wedge D.

No. 7884. Improvements in Harrow Cultivators.*(Perfectionnements aux cultivateurs-harrows.)*

Charles La Dow, Albany, N.Y., U.S., 12th September, 1877, for 5 years.

Claim.—1st. The disc gaugs, connected at their inner ends by a universal joint, 2nd. The combination of two disc shafts connected at their inner ends by a universal joint, and adjustable relatively to the line of draft, 3rd. The combination of the draft bars G, boxes G, braces J, pole E and seat I with the flexible-jointed axles C and wheels A; 4th. The combination of the draft-bars G G and universal joints G G with the axles C C and the center joint D connecting the axles, and adjustably connected to the rear end of the pole; 5th. The combination of the axles C C, universal joints G G, braces G G, and universal centre joint D with the pivoted rod *b* adjustably pivoted stirrup H, pole E and nut *a*; 6th. The combination in a jointed harrow cultivator of the axles, having the cutting wheels affixed thereto; 7th. The combination in a jointed harrow cultivator, of two series of discs having the inner wheels of each gang brought near to a cutting edge, near the centre of

the harrow; 8th. The combination of the rod *b* with its fastenings, for the purpose of changing the axle of the disc gaugs relatively to the line of draft and both at one time.

No. 7885. Devices for Preventing the Accumulation of Frost and Steam upon Store Windows.*(Appareil pour empêcher l'accumulation du givre et de la vapeur dans les vitrines de magasins.)*

Charles S. Anthony and Jacob Manheim, Taunton, Mass., U.S., 12th September, 1877, for 5 years.

Claim.—The combination of the air supply pipe P having branches B covered with wire netting, and supply-regulating slide E.

No. 7886. Improvements on Cigar Machines.*(Perfectionnements aux machines à cigares.)*

Robert Roberts, St. Joseph, Mo., U.S., 12th September 1877, for 5 years.

Claim.—1st. An endless feed belt and rolls, compound moulds and shears, a reciprocating plunger, an intermittently revolving plunger, and a number of spring acted rollers for laying the wrapper on the bunch; 2nd. The combination of the endless belt or apron and revolving feed rolls, with a fixed mould and cutting edge and a vertically reciprocating mould section and cutting edge, said moulds pressing the tobacco to a size smaller than the transverse of the cigar; 3rd. The combination with the compound mould of a horizontal reciprocating plunger, and of a revolving guide tube to conduct the bunch forward; 4th. The combination with the intermittently revolving guide tube, and a reciprocating plunger, of a number of spring acted rollers to revolve the bunch and rollers for laying on the wrapper; 5th. The combination with the intermittently revolving tube, having spring fingers for holding the bunch of a number of friction rollers, mounted in hinged and spring acted semi-frames; 6th. The combination of the guide-tube with a sliding revolving tube and clutch *d* via *e*, a small belt attached to the end, the guide-tube and the wrapping rollers to revolve the guide tube and lay on the wrapper, as the bunch issues from the tube; 7th. The combination with the revolving tube of spring-acted rollers, which are turned by friction or gears at the end of said revolving tube.

No. 7887. Improvements on a Postal Card.*(Perfectionnements à une carte postale.)*

Charles K. Marshall, Vicksburg, Miss., U.S., 12th September, 1877 for 5 years.

Claim.—1st. A single unfolded or unfoldable postal card consisting of the sections A B C D and the duplicate stamps, whereby a communication can be made and an answer returned, simply employing a single card; 2nd. A section of a single postal card constructed with a writing surface to receive the address and the written communication of the person sending it, and a stamp for paying the postage, in combination with a duplicate section of said postal card, which duplicate is an extension on the same plane of the first mentioned section of the postal card, and is attached thereto and spread out when mailed, and is used, when received by the person to whom the communication is addressed, for writing an answer and an address upon, and for paying the return postage.

No. 7888. Improvements on Ships' Pumps.*(Perfectionnements aux pompes de navires.)*

Edwin Sanders, Yarmouth, N.S., 12th September, 1877, for 5 years.

Claim.—1st. The combination of the pumping cylinder 3, cylinder 12 and cylinder 7 valved and connected to pump tube 22, provided with stop *e* valve 16 and chamber 23, connecting with bilge water tube 21 having adjustable valve 27; 2nd. The piston cylinder 3 having valve 10 and connected by ports 13 and 20 to cylinder 12 having suction inlet 14, and to cylinder 7 by valved port 5 and port 10, the cylinder 7 having a valved diaphragm and discharge port 11, and pump tube 22, having a stop valve 16; 3rd. The chamber 23 connecting the pump tube 22, and bilge water tube 21 having an adjustable valve 27; 4th. The pump tube 22 having a stop off valve *b* secured by a screw 17, in combination with cylinders 3, 7 and 12; 5th. A pump gear consisting of the combination of the shaft B, cam D and lifter frame F, sliding on post G.

No. 7889. Improvements in Plaiting Machines.*(Perfectionnements aux machines à plisser.)*

Leonard B. Berrien, Galesburg, Ill., U.S., 12th September, 1877, for 5 years.

Claim.—1st. The plaiting bars constructed with a longitudinal slot *e* in each bar; 2nd. Longitudinally slotted plaiting bars C having a crank *d* on their ends; 3rd. Longitudinally slotted plaiting bars C having a journal *d* on each end, combined to operate with the frame bars B B and a base A; 4th. The locking bar G arranged to operate with the slotted plaiting bars C, base A and bars B, in which the bars C are journaled; 5th. In combination with slotted plaiting bars C and the frame in which they are mounted, an actuating bar G for rotating them successively; 6th. The actuating bar G having fingers *g* *g* and recessed *g* at one end, arranged for operation with the pivoted slotted bars C.

No. 7890. Improvements on Car-Couplings.*(Perfectionnement aux attelages de wagons.)*

Joseph P. Edwards, Annapolis, N.S., 12th September, 1877, for 5 years.

Claim.—1st. The arrangement of the pintle-rod H passing horizontally through the draw-head to hang the latch B pivotally in its slot; 2nd. The triangular shaped latch B having extension plate E for attachment of the lifting ring or pin *e*.

No. 7891. Lasting Machine for Boots and Shoes.*(Machine à enformer les chaussures.)*

George W. Copeland, Malden, Mass., U.S., (Co-inventor with and Assignee of Erastus Woodward and Mathias Brock), 12th September, 1877, for 5 years.

Claim.—1st. A girth consisting of a series of independent straps or of a series of straps which unite into a single piece, the straps being secured at

one end to finger pieces and at the other end to sets of springs or weights; 2nd. The combination of the tension compensating levers *b*, *b*, the straps *b*, *b* and the springs *b*, *b*; 3rd. The jointed fingers *C*, *C*, in combination with the sliding pieces *C*, *C* and the lastings girth; 4th. In a lasting machine for girth lasting, the combination of the rigid adjustable fingers *C*, *C*, having a rising and closing motion and the girth; 5th. In combination with an elastic heel pad *R*, the reciprocating folding plates, the spring rods *R*, *R*, and *R*, *R* and the arm *R*, *R*; 6th. A spring toe stretching and smoothing pad *N* having a vertical motion, and also adapted to move against the upper at the toe, in combination with suitable devices for folding the upper over upon the sole; 7th. For toe lasting devices the combination of winkle sweeping fingers *P*, *P* with oscillating, turning and smoothing finger plates *J* moving in unison therewith; 8th. The right and left screw *V*, in combination with blocks *K*, *K* and *K*, to bring the shoe, without regard to its size, into the proper position with reference to the girth; 9th. The automatically acting toe support *M*, consisting of a post *M* resting upon a cam or wedge, the cam or wedge being actuated at the commencement of the upward rise of the girth carrying cross-head; 10th. The combination of the cam *C*, adjusting screw *C*, lever *C* and *C*, actuating the girth carrying cross-head; 11th. In combination with the oscillating toe rest *M*, post and wedge *M*; 12th. The combination with reciprocating toe lasting plates, of a reciprocating toe clamp *H* arranged to operate between such plates acting alternately; 13th. The automatically removable toe clamp forming an abutment for the toe of the boot or shoe, to rest against when adjusted in place, and also serving as a clamp to prevent the boot or shoe from rising when acted upon by the girth; 14th. In combination with the cam *J* or other actuating mechanism, the folding plates provided with an oscillating or rocking motion; 15th. Oscillating plates *J* for lasting the heel or toe provided with fingers controlling the position of the wrinkles or folds; 16th. Oscillating finger plates *J*, provided with fingers for sweeping the wrinkles or folds into the desired position; 17th. The combination of the finger plates *J*, oscillating plates *J*, housings *J*, levers *J* and cam *J*; 18th. The upping square spindle *E*, in combination with the last mortised or bored for the reception of the spindle at right angles, with a line across the tread of the toe portion of the last; 19th. The combination of the heel lasting mechanism, the cam *K* and cam spindle *K*, with the oscillating yoke *K*; 20th. The combination of the housing *J* with the swinging plate *J* and adjusting thumb screw *J*.

No. 7892. Improvement on Hinges.
(*Perfectionnement des pentures.*)

John Beaudet, Cambriège, Mass., U. S., 12th September, 1877, for 5 years.

Claim.—1st. The combination of the two hinge screws *A* with the pivotal screw or pin *B*, inserted into the head of one and screwed into that of the other of such hinge screws; 2nd. In combination with the door *D* and its frame *E* and the two lower hinge screws *A* inserted therein and arranged and provided with the pivot or pin *B* and flange *b*, the two upper hinge screws *A*, and their headed pivotal screw or pin *B* inserted through the upper of such hinge screws, and screwed into that next below it, such upper pair of hinge screws being screwed into the door and frame.

No. 7893. Machine for Gathering Potato Bugs.
(*Machine à recueillir les chrysomèles à potates.*)

Joseph Labelle, Sault-aux-Récollets, Que., 12th September, 1877, for 5 years.

Resumé.—1o. La combinaison de l'essieu *h* supporté par les poteaux *p*, afin de mettre en mouvement, par l'emploi des courrois *g*, la moissonneuse à chrysomèle; 2o. La combinaison d'un brancard mobile *b* supportant les deux rans *f*, au moyen desquels on bat les tiges des potates pour en dégager les chrysomèles; 3o. L'emploi d'un anneau *c* suspendu au brancard inférieur *b* au moyen des chaînes *d* pour recueillir les chrysomèles.

No. 7894. Improvements on Taps and Dies.
(*Perfectionnements aux tarauds et aux filières.*)

James Flower, Detroit, Mich., U. S., 12th September, 1877, for 5 years.

Claim.—The combination of removable chaser-cutters *C* the radially slotted chuck head *A* to receive said cutters, and the flanged collar *B* and set screws *a* to secure them in their relative positions.

No. 7895. Rock Drilling Machine.
(*Machine à forer le roc.*)

Franklin Keenan, Brownville, N. Y., U. S., 12th September, 1877, for 5 years.

Claim.—1st. The arrangement of the cable *C* and drop rope *E* and the former winding on reel *D* and the latter passing over pulley *d* and tripping frame *F*, and winding on reel *G*; 2nd. The combination with the tripping frame *F*, of reels *D* and *G* for operating the cable *C* and drop *E*; 3rd. The combination of the clutch and lever *V*, chain *T* and wheel *S*, with the reel *D* for winding the cable *C*; 4th. The arm *W* having a reversible rubber bumper *X*, in combination with a shoe or saucer *Y* on the tripping frame *E*; 5th. The mast *B*, trunnioned to the frame *A* and held in a step *b*.

No. 7896. Mode of Putting up Baked Beans.
(*Mode d'apprêter les fèves crütes.*)

Edwin W. Brown (Assignee of W. K. Lewis), Boston, Mass., U. S., 12th September, 1877, for 5 years.

Claim.—1st. The process of putting up beans for the market, by par-boling the same, hermetically sealing them in cans, and baking by steam heat, while thus hermetically sealed; 2nd. Baked beans and pork put up in hermetically sealed cans.

No. 7897. Improvements on Bed Bottoms.
(*Perfectionnements aux fonds de lits.*)

Judson Bostwick, Buffalo, N. Y., U. S., 12th September, 1877, for 5 years.

Claim.—1st. The combination with groove *d*, the frame *C* basket work *b* strap *c* and springs *a*; 2nd. Forming in the wooden frame *C*, the groove *d*.

No. 7898. Portable Water Power Apparatus.
(*Motiv hydraulique portatif.*)

Marcus L. King, Oblong, Ill., U. S., 12th September, 1877, for 5 years.

Claim.—The channel *B*, inclined plane *A* and top cover *C*, in combination with the water wheels *E*, *E*, with axles *g* and *g*, chain *M*, and cog wheels *L*, and *n*.

No. 7899. Chuck for Holding Pipe Fittings.
(*Mandrin pour saisir les manchons de tuyaux.*)

James Flower, Detroit, Mich., U. S., 12th September, 1877, for 5 years.

Claim.—1st. The combination with the chuck frame *A*, chuck heads *B*, *C* and right and left hand screw *D*, of the revolving heads *E*, *F* and the spring bolt *b*; 2nd. In combination with the heads of a chuck, the revolving heads *E*, *F* and spring bolt *b*.

No. 7900. Railway Journal Box.
(*Boîte d'essieu de railroads.*)

William E. Wilcox and Lorenzo A. Kelsey, Cleveland, Ohio, U. S., 12th September, 1877, for 5 years.

Claim.—1st. The collar rollers *1*, *2*, *3* and arranged in relation to and in combination with the grooved rollers *5*, *6*, *7* and *8*; 2nd. In combination with grooved and collared rollers, the grooved axle *H* and grooved journal box consisting of sections *B* and *C*; 3rd. The combination of the grooved and collared rollers, radially slotted rings *g* and axle journal *H* and grooved journal box; 4th. Journal boxes slotted segmental sections, more or less in number, having pivoted therein anti-friction rollers arranged in relation to each other; 5th. In combination with the axle box and car sill *A*, the bar *M*, bolts *k*, braces *l* and springs.

No. 7901. Manufacture of Paper Bags.
(*Fabrication des sacs en papier.*)

James C. Wilson, Montreal, Que., (Assignee of L. D. Benner), 12th September, 1877, (Extension of Patent No. 1944), for 5 years.

No. 7902. Process of Seasoning and Preserving Wood.
(*Procédé de séchage et de conservation du bois.*)

Louis S. Robbins, N. Y., U. S., 13th September, 1877, for 5 years.

Claim.—1st. The air pump *C* in combination with the air heating pipe or tube *B* surrounded by a suitable furnace *D* and the wood chamber *A*, with or without a steam heating arrangement; 2nd. In combination with the apparatus the process of curing wood by heating the same, increasing under an atmosphere or gaseous pressure.

No. 7903. Improvement on a Waggon Box.
(*Perfectionnement d'une caisse à voiture.*)

Edwin R. Laugs, Langford, Ont., 13th September, 1877, (Extension of Patent No. 7719), for 5 years.

No. 7904. Improvements in Moccassins.
(*Perfectionnements dans les moccassins.*)

George Boulter, Montreal, Que., 13th September, 1877, for 5 years.

Claim.—The combination with a moccassin, the rings or loops *D*, rings *E* and rings *F*, through which the lace passes.

No. 7905. Improvements in Reaping Machines.
(*Perfectionnements aux moissonneuses.*)

John Abell, Woodbridge, Ont., 13th September, 1877, for 5 years.

Claim.—1st. The segmental guide block *A* arranged in connection with a rake head of a reaping machine, for the purpose of guiding and supporting the rakes during a portion of their revolution; 2nd. The pivoted switch *B* in combination with the guide block *A* and pivoted tilting and locking lever *H*; 3rd. The guide block *A* with upwardly projecting tilting shoulder *A*, in combination with tilting and locking lever *H* and connections; 4th. The rake bracket *E* with pivoted tilting and locking lever *H*, in combination with the rake arm *D*, with lug *D*; 5th. The rake bracket *E* mounted on the pin *F* of the rake arm *D*, in such manner that by means of the lugs *e* *d* and *D*, or their equivalent, a limited turning only of the rakes on the pin *F* as an axis is permitted, ensuring a positive degree of revolution (say one quarter); 6th. The rakes of a reaping machine.

No. 7906. Improvement in Pessaries.
(*Perfectionnement dans les pessaires.*)

Charles N. Fowler, Youngstown, Ohio, U. S., 13th September, 1877, for 15 years.

Claim.—The modification of the fodge pessary, the pessary being filled out and rounded to conform to the parts broader at the posterior portion than at the interior portion, and having a swell at the posterior part.

No. 7907. Improvements on Sofas.
(*Perfectionnements dans les sofas.*)

James H. Corrin, Bruce Mines, Ont., 13th September, 1877, for 5 years.

Claim.—A combined sofa and bed consisting of the hinged seat *A* with box enclosure underneath, hinged back *D*, false sliding back *C*, with raised ends *C* and heads *A*, provided with the detachable slides *E*, *E*.

No. 7908. Machine for Making Match Splints.
(*Machine à fendre le bois d'allumettes.*)

Henry Wright, Danmariscotta, Me., U. S., 13th September, 1877, for 5 years.

Claim.—1st. The frame *A* a forming ways for the sliding head *B* the sliding head *B* with its cutters *F* and *F*, the feeding bar *D* and the cutter head *G* with its slitting knives *g*; 2nd. The feeding bar *D* arranged to slide laterally in its

holds *d* and moved in a reciprocating lateral manner, by means of the grooved plates *d*, and the pins *d*. 3rd. The knives *F* and *F'* arranged upon a common sliding head *B*, so as to chamber off one side of the card as at *e* and shave off the card from the belt *E*, at one and the same operation; 4th. The slitting knives *g* fixed upon the cutter head *G* and arranged behind the feeding bar *D*, so that when the belt *E* is placed in the seat or notch *d*, and the said sliding bar is given its required lateral motion, the said slitting knives will slash into the seat of the belt. 5th. The side shaving knife *g* placed in bearings on the cutter head *G* and actuated by the inclined surfaces *b*, and *f*, so as to move at the proper moment across the edge of the card piece for the purpose of reducing the same to a uniform width. 6th. The foot cutter *H* fixed to the sliding head *B*, so as to cut off the foot end of the card piece to a uniform length; 7th. The spring stop *I*, attached to the back of the feeding bar *D*.

No. 7909. Artificial Stone. (*Pierre factice.*)

Llewellyn L. Leathers, Oakland, Cal., U. S., 13th September, 1877, (Extension of Patent No. 7552), for 5 years

No. 7910. Artificial Stone. (*Pierre factice.*)

Llewellyn L. Leathers, Oakland, Cal., U. S., 13th September, 1877, (Extension of Patent No. 7552), for 5 years

No. 7911. Improvements on Barbed Wire Fences.

(*Perfectionnements aux clôtures barbelées en fil métallique.*)

Edward M. Crandal, Chicago, Ill., U. S., 19th September, 1877, for 5 years.

Claim.—1st. As part of a fence wire cable provided with barbs, in a section consisting of a short piece of wire folded in the middle, returned upon itself, and near its two ends, bent so as to form outward-projecting barbs, and also so as to engage and clasp the folded middle part of the adjoining section of similar formation; 2nd. A ring link for the fence wire chain-cable provided with barbs; 3rd. A series of barbed ring-links forming a wire-fence cable, composed of a length of wire bent and turned back and over so as to form an eye out of the centre of the length, and having its two ends barbed or pointed crossed over, and under each other and then twisted and interlocked, so as to leave the points projecting outward; 4th. A series of barbed ring links, forming a wire-fence cable provided with an eye at one end and interlocked barbed points at the other, the barbs of which project outward in the plane of the link and its eye; 5th. A series of barbed wire ring links, interlocked end to end in regular order, so as to form a barbed chain fence-cable; 6th. A series of ring links having an eye at one end and barbed, interlocked and twisted points at the other end, these points being engaged in the eye of its adjoining link at one end, and engaged in its own eye with the barbed, interlocked and twisted points of the adjoining link at the other end; 7th. Ring links provided at one end with an eye, and at the other end with barbed points interlocked in regular order, eyes with barbed points, and each set of points standing at right angles to the planes of the two adjoining sets of barb-points; 8th. Ring-links provided at one end with an eye formed in a common plane, with the body of the link, and at the other end with barbs or points interlocked in regular order, eyes with barbed-points, and each set of barb points standing at right angles to the planes of the two adjoining sets of barb-points; 9th. A barbed wire-fence chain-cable composed of barbed ring-links; 10th. A barbed-fence-wire chain-cable composed of short pieces of wire each folded in the middle, returned upon itself, and bent near its two ends so as to form outward projecting barbs and also so as to engage and clasp the folded middle part of the adjoining piece of similar formation.

No. 7912. A Mast Ball. (*Une pomme de mâit.*)

Edwin C. Seely, Port Medway, N.S., 19th September, 1877, (Extension of Patent No. 1670), for 5 years.

No. 7913. Improvement on a Mortising Chisel. (*Perfectionnement d'un ciseau à mortaiser.*)

Eli Cole and Albert N. Whitmarsh, Horseheads, N.Y., U.S., 20th September, 1877, for 5 years.

Claim.—A mortising chisel having a longitudinal rib projecting at right angles from its rear edge *d* and provided with barbs *e*.

No. 7914. Combined Potato and Corn Planter.

(*Semoir à pommes de terre et à blé d'inclé*)

Joseph Custer, Goshen, Ohio, U.S., 20th September, 1877, for 5 years.

Claim.—1st. The axle *B*, long-armed clips *C* and pivoted braces *b*, in combination with planter frame *D*, pilot wheel *U* and hopper *H*; 2nd. In combination with frame *D* and sliding hopper *H* of the dropping plate *J* having bevel wheel *O*, the shaft *R* having gear wheels *Q*, *S*, and the concentric wheels *T* on the side of ground wheel *L*; 3rd. The combination with hopper *H* of the dropping wheel *J*, guard *L* and knife *M*.

No. 7915. Improvement on Stench Traps.

(*Perfectionnement des trappes d'égouts.*)

John P. Schmittz, San Francisco, Cal., U.S., 20th September, 1877, for 5 years.

Claim.—1st. The S-trap having an opening *E*, base *I*, sloping tube *P* and lug *L*; 2nd. The combination with the sloping tube *P* having lugs *L*, of the weighted lever *M*, carrying the loosely attached cover *F* having flange *K*; 3rd. The casing *W*, in combination with the flap trap and the S-trap, having a base *I*; 4th. The combination of the flap trap and S-trap.

No. 7916. Apparatus for Manufacturing Illuminating Gas.

(*Appareil à fabriquer le gaz d'éclairage.*)

James H. Needles, Toronto, Ont., 20th September, 1877, for 5 years.

Claim.—1st. The combination of the tank *A* with the oval cap *F*, mixing diaphragms *E* and *E*, and porous material; 2nd. The combination of the air pump *O* with pipe *H*, seal *C*, pipe *J*, valves *S*, pipe *R*, pipe *L*, pipe *N*; 3rd. Valve *T*, pipe *W*, pipe *V*, pipe *M*, gasometer *B*; 4th. The valves and valve chambers *S*, pulleys or sheaves, wire cards and stuffing boxes.

No. 7917. Improvements in Shingle Machines. (*Perfectionnements aux machines à barbes*)

Joseph A. Mumford, Avondale, N.S., 20th September, 1877, for 5 years.

Claim.—1st. The endless rack *H*, pinion *P*, movable shaft *F* with its running supports *R*, driving pulley *D*, friction pulley *F* and friction block *V*; 2nd. The oscillating swing carriage composed of the double feeding frame *O*, notched set rollers *S*, weighted levers *W*, adjustable tabs *Y* and the carriage guides *T*, *T'*, supported on the ends of frame *C*, *C'*; 3rd. The triangular frame, composed of the legs *C*, *C'* and their extensions to an apex at *E*, cross pieces *K*, *K'* and the small frame *Y* with the slot *A* for lengthening and shortening the connecting rod.

No. 7918. Machine for Upsetting and Welding Tires.

(*Machine à refouler et souder les bandages des roues.*)

Hugh Ross, Sr., Plattsburgh, N.Y., U.S., 20th September, 1877, for 5 years.

Claim.—1st. The block *B* fixed to bar *A*, block *B*, sliding block *B'*, conical block having a standard *C*, cam *D*, lever *E*, block *F*, cam lever *G* and block *H*, and cam lever *i* fulcrumed to bar *A*; 2nd. A block *L* sliding in the bar *A*, carrying friction wheels *L*, having connection with block *B*, and interposed to receive the pressure of the cam lever *J* and traction by the pitman *K*.

No. 7919. Art of, and Mechanism for, Constructing Dental Plates.

(*Art de faire les plaques dentaires et machine pour cet obj^t*)

Charles F. Barnard, Victoria, B.C., 20th September, 1877, for 5 years.

Claim.—1st. The method of forming metallic dental mouth plates by shaping the same between dies by constant increasing pressure, in contra distinction to percussive force; 2nd. The combination of the screw press, platen, flask, dam and cast perforator or point; 3rd. The combination of the melting vessel *H* and *I*, lamp *M* and operating lever or bar *L*; 4th. The combination of the dies, screw press, platen and flask.

No. 7920. Improvements on Cooking and Heating Ranges.

(*Perfectionnements aux fourneaux de cuisine et de chauffage.*)

Johnson Briggs, Montreal, Quebec, 20th September, 1877, for 5 years.

Claim.—1st. The range *A* for insertion in partition walls of apartments constructed with a front having ovens, pot holes, broiling chambers and fire aperture, &c., and a front having sliding or other doors, whereby both fronts for cooking and heating are served by one fire chamber centrally in the range; 2nd. A cast metal chimney to be built in a partition, constructed in sections formed by plates connected by vertical flanged joints; 3rd. In a cast metal chimney, the top section constructed to flare outwardly and having weather flanges *a*.

No. 7921. Improvements on Stump Extractors. (*Perfectionnements aux arrache-souches.*)

John Bruce, Cartwright, Ont., 20th September, 1877, for 5 years.

Claim.—A stump extractor, employing lever and tackle, having the frame constructed of the inclined posts *B*, *D*, *C* footed into shoes *A*, beam *F*, pulley beam *D*, rollers *G*, *H* and posts *I* connectedly arranged.

No. 7922. Improvements on Skates.

(*Perfectionnements aux patins.*)

Samuel Horsford, Halifax, N.S., 20th September, 1877, for 5 years.

Claim.—The sole fasteners *E*, heel fasteners *F* the right and left-hand screws *D*, in combination with the spring-lock *G*, swivel *H*, binding screw *I*, binding screw seats *J* and friction roller *N*.

No. 7923. Areameter. (*Apomécomètre.*)

James H. Williams, Newton, and Charles W. Holden, Boston, Mass., U.S. (Assignees of M. Van B. Ethridge), 20th September, 1877, for 5 years.

Claim.—The movable perforated bed and platen, their series of pins, and the supporting lever index arm, platen, counter-balance, and the pointer and scale; the bed being provided with a lever or means of forcing it upward as explained; The combination of the perforated platen and bed, and a series of pins.

No. 7924. Improvements on Sash Fasteners.

(*Perfectionnements aux arrête-croisets*)

Almon A. Gerrish and Daniel A. Bolton, (Assignees of David T. Gerrish) Lewiston, Me., U.S., 20th September, 1877, for 5 years.

Claim.—The combination of the upper and lower sashes of a window, having end recesses or sockets *d* with a double fastener, composed of two spring-acted bolts *A* and *B* working one within the other, and having locking catches *C* and operating thumb pieces *D*.

No. 7925. Improvement in Stench Traps.

(*Perfectionnement dans les trappes d'égouts.*)

Erasmus D. Smith, Jr., and Sarah M. Rice, (Assignees of Obed M. Rice) Rochester, N.Y., U.S., 20th September, 1877, for 5 years.

Claim.—1st. The combination of the obliquely truncated pipe *A*, the valve *B*, and arms *C*; 2nd. The combination of the pipe *A* provided with flanges *D*, and the flap valve *B* supported by arms *C* *C* on opposite sides of pipe *A*.

No. 7926. Improvement on Watch Winding Devices.

(*Perfectionnement des appareils à monter les montres.*)

William H. Bracy, Timothy Kyle and Benjamin Wormells, Boston, Mass., U.S., 20th September, 1877, for 5 years.

Claim.—1st. A detachable winding device, consisting of a base, a pipe secured thereto and a thumb-piece pivoted thereon, all arranged and adapted

to be applied to the arbor, and contained and folded beneath the outer case of a watch; 2nd. The combination with the thumb-piece C and plate B, of a spring E.

No. 7927. Improvements on Harvesting Machines.

(Perfectionnements aux faucheuses-moissonneuses.)

Melville P. Neave, Richmond, England, 21st September, 1877, for 5 years.

Claim.—1st. The use in combination with the forward part 31 of the platform, of curved form, on to which the stalks are moved into position for being gathered up into a bundle or sheaf, 2nd. The combination with the curved rearward part 34 of the platform, of the reciprocating fork and guides, whereby the cut stalks that have been moved on to the said part 34 of the platform are gathered together, are held whilst they are bound, and are subsequently delivered, 3rd. The combination of apparatus for forming simultaneously two loops in the binding material, and means whereby one end of the binding material is passed through said loops, 4th. The use, in combination with a carrier whereby binding material is carried round a collection of stalks, of loopers arranged to form two loops in the said binding material, and reciprocating pincers whereby the ends of the binding material that has been carried round the collected stalks is passed through the said loops; 5th. The use, in combination with the loopers and reciprocating pincers, of a pusher, whereby the loops that have been formed by the loopers are caused to pass on to the binding material to form the knot, whilst the end of the binding material is held by the reciprocating pincers; 6th. The combination with a shaft 59 and an arm furnished with means for carrying binding material round a collection of stalks, of a porlion 49 fixed on said shaft, a quadrant 48 operated and geared with said pinion 49 for causing the apparatus, whereby the end of the binding material is held to pass at the proper intervals around the collected stalks, and a ratchet 146 and pawl 147 for preventing the return movement of the arm; 7th. In combination with the compound or adjustable arm 51 and means for intermittently rotating it, the tube 52, twine carrier pincers 53, their sleeve f and tube 52, the knife holder 55 and knife 56, arranged to slide backwards and forwards in the recess e in the underside of the stem, and jaws of the pincers, 9th. The combination with the tube 52, the twine carrier pincers 53 and other parts, the rod or tail piece 57, arranged to slide in supports or guides, and the spring 58, whereby said rod or tail piece is kept in its outward position, 10th. In combination with the sleeve f, of the pincers 53, the sliding rod or tail piece 57, and means for keeping said rod or tail piece in its outward position, the lever 71 with its projections or tappets 72, 73 and means for operating said lever; 11th. The use, in combination of two loopers, and means for rotating the same in opposite directions, so as to form two loops in the twine or binding material simultaneously; 12th. The looper 82 with its slot formed with straight parts 87 and 88, and a curved part 85 passing three-quarters round the looper, in combination with the fixed pin or projection 26, whereby the loopers is partially rotated as it descends; 13th. The looper formed at its lower part with a shoulder 9x and opening 10x for the passage of the pincers 89 and sheath 107, and terminating in four prongs or projections; 14th. The combination with the looper for simultaneously forming two loops, of the loop lifter 67 on the shaft 66, and means for operating the same, so that it shall raise the twine or binding material, to enable the reciprocating pincers to pass freely between

the two loops; 15th. The combination with the loopers 82 83, shaft 66, and loop lifter 67, of the reel rotating pincers 89, their sheath 107 and the pusher 103; 16th. The combination with the cylindrical stem piece 89a with its lug a, the jaws 89b, means for forcing the same apart, and the springs 89c on the outer sides of said jaws, of the sheath 107 with its stud piece 111, slot d, and slots 107a, 17th. The combination with apparatus for simultaneously forming two loops in twine or binding material, and apparatus whereby one end of said binding material is passed through said loops, of a tension device whereby the formation of the knot is completed, and the end of the twine or binding material is presented to the twine carrier pincers, 18th. The use, in combination of the guide 133 slotted arm 135, with its pulley 134 and holding device 137; 19th. In combination with the striker L & c the looper frame, and the striker 141 of the rake lever the holding device constructed with two flat discs h and i, with rounded edges axis K, with quick thread and nut l, with its projections n o and their respective pins, 20th. In combination with the guide 133, slotted arm 134 and holding device 137, the pulley 142, its rod, spring, and tube 143, pulley 144 pulley 97 roller 98 and the slide 96, operated for exerting the necessary tightening action, 21st. The combination with the reciprocating fork 122 duplex lever 118, and means for operating same, of the compound connecting rod 121 with its spiral spring 124, 22nd. The combination with the cam 125 on the shaft 17 of the sling 126 lever 127, shaft 128 and guides 129 130, 23rd. The combination with the loop lifter lever 63, the twine carrier pincer levers 70 71, the looper operating sling 76, the tension device lever 92, the pusher lever 99, the pincer operating lever 105, the pincers sheath lever 109, the reciprocating fork lever 118 and the guide operating sling 120 of the loop lifter operating device 60, 61, and the canns 69 91 99 105 108 116 117 and 125 keyed together on the grooved shaft 17, and arranged to be moved together along said shaft by the bracket 59 of the movable frame 37.

No. 7928. Boiler Flue and Water Pipe Cleaner.

(Nouveau des appareils de chaudières et des tuyaux d'eau.)

Joseph S. Godfrey Jackson, Mich. U.S.A., 21st September 1877 for 5 years.

Claim—1st. A cutting blade pivoted at or near the middle, 2nd. The spiral cutting blade, pivoted at or near the middle and attached to adjustable springs, 3rd. The springs B having a portion of their length arched near the middle in combination with a nut and screw threaded rod for expanding the same, 4th. The combination of the spiral cutting blades C pivoted at or near the middle to the springs B the springs B arched a portion of their length near the middle nut E, screw threaded rod D and head A.

No. 7929. Machine for Preparing the Edges of Soles.

(Machine a polir les tranches des semelles.)

James H. Busell, Boston, Mass., U.S.A., 24th September, 1877, for 5 years.

Claim—1st. The combination of the tool C and its shaft B with the guide G and its flexible shaft, 2nd. The combination of the tool C guide G and annular tool K, 3rd. The revolving round guide G, so mounted that it may have a motion bodily in addition to its revolving motion; 4th. The tool C consisting of a hub with a series of blades, each dovetailed into it.

Lists of Patents issued up to 16th October, 1877, but not yet Officially published in the Patent Office Record.

- No. 7930. Jno. B. Tibbitts, Hoosick, N. Y., U. S. A., "Apparatus for Propelling Cars," 25th September, 1877.
- No. 7931. J. Bliss, Jersey City, N.J., and F. O. Badger, Brooklyn, N. Y., U.S.A., "Process of Treating Blood," 25th September, 1877.
- No. 7932. H. Knight, Liverpool, Eng., "Manufacture of Pigments," 25th September, 1877.
- No. 7933. J. D. Johnson, Richmond, Que., "Vacuum Railway Brake," 25th September, 1877.
- No. 7934. B. S. Wells, Byron, Ont., "Loose Grain Loading Fork," 25th September, 1877.
- No. 7935. D. Felton, Manchester, Eng., "Process of Waterproofing Paper and other Ligneous Tissues," 25th September, 1877.
- No. 7936. Jas. Amess, Rosemount, Ont., "Window Fire Escape," 25th September, 1877.
- No. 7937. N. W. Brown, Whitby, Ont., "Reaping Machine," 25th September, 1877.
- No. 7938. S. T. Packham, Newmarket, Ont., "Grind Stone Frame," 27th September, 1877.
- No. 7939. J. Solomon, Solomon's Island, Md., U. S. A., "Motor Spring," 27th September, 1877.
- No. 7940. E. Burstow, Horsham, Eng., "Railway Key," 27th September, 1877.
- No. 7941. David Shields, of Long, and R. Z. Liddle, of Albany, N. Y., U.S.A., "Oil Stove," 27th September, 1877.
- No. 7942. E. Mets, Rochester, N.Y., U.S.A., "Musical Flying Top," 27th September, 1877.
- No. 7943. U. Cummings, Buffalo, N. Y., U. S. A., "Process for Manufacturing Lime and Cement," 27th September, 1877.
- No. 7944. J. H. N'orris, Seward, Nn., U.S.A., "Animal Trap," 27th September, 1877.

- No. 7945. C. Holland, Chicago, Ill., U. S. A., "Hydrocarbon Burner and Gas Generator," 27th September, 1877.
- No. 7946. E. De F. Waterbury, Rockford, Ill., U. S. A., "Measuring Rule," 27th September, 1877.
- No. 7947. D. Shields, Sing-Sing, N. Y., U.S.A., "Oil Stove," 27th September, 1877.
- No. 7948. A. A. Stinson and C. T. Sahin, of Montpelier, Vermont, U.S.A., "Double-Acting Spring Hinge," 27th September, 1877.
- No. 7949. T. A. McDonald, Durham N.S., "Lace Fastenings," 27th September, 1877.
- No. 7950. S. Horsford, Halifax, N. S., "Ice Creeper," 27th Sept., 1877.
- No. 7951. S. M'Jhr, Quebec, Que., "Telegraph Alarm Box," 27th September, 1877.
- No. 7952. H. Mott, (Assignee of W. M. Edmunds, Troy, N. Y., U. S. A.,) "Spring Bed Bottom," 2nd October, 1877.
- No. 7953. W. Buchannan and D. C. Lynn, N.Y., U.S.A., (Assignees of D. W. De Forest, Brooklyn, N.Y., U.S.A.,) "Cigarette Making Machine," 2nd October, 1877.
- No. 7954. R. W. Semple and G. A. Shaw, Toronto, Ont., "Door," 2nd October, 1877.
- No. 7955. J. Sager and A. Getlach, Monroe, Mich. U. S. A., "Fruit Picker," 2nd October, 1877.
- No. 7956. A. F. Gue and G. F. Field, Boston, Mass., U.S.A., "Car Bake," 2nd October, 1877.
- No. 7957. J. E. Stong, Newtonbrook, Ont., "Farm Gate," 5th October, 1877.
- No. 7958. H. Sherman, Flushing, Mich. U. S. A., "Dividing and Siding Hoek Combined," 5th October, 1877.
- No. 7959. N. N. Horton, Kansas, Miss., U. S. A., "Reclining Chair," 5th October, 1877.

- No. 7960. H. Jones, St. Thomas, Ont., "Iron Fence," 5th October, 1877.
- No. 7961. G.W. Emerson, Kenton, Ohio, U.S.A., "Binder," 5th October, 1877.
- No. 7962. L. C. Spencer and P. Barrett, Rochester, N.Y., U.S.A., "Thill Coupling," 5th October, 1877.
- No. 7963. P. Jablochhoff, Paris, France, "Electric Candle," 5th October, 1877.
- No. 7964. J. W. Rogers, Salem, Mass., U.S.A., "Shoe Solo Buffer," 5th October, 1877.
- No. 7965. J. Keats, Wood Green, Eng., "Hardening Machine for Felting Purposes," 5th October, 1877.
- No. 7966. J. Keats, Wood Green, Eng., "Sole Channelling Machine," 5th October, 1877.
- No. 7997. L. W. Huxton and J. P. Greeley, Nashua, N.H., U.S.A., "Heel Plate," 5th October, 1877.
- No. 7968. J. Vance, Forest, Ont., "Fence," 5th October, 1877.
- No. 7969. H. Leggett, Renfrew, Ont., "Dumping Waggon," 5th October, 1877.
- No. 7970. J. B. Lafitte, New Orleans, La., U.S.A., "Method of Preparing Hay as Food for Animals," 5th October, 1877.
- No. 7971. J. E. Hudden, Picton, Ont., "Carriage Shaft and Pole Coupling," 5th October, 1877.
- No. 7972. E. M. Lowdon, N.Y., U.S.A., "Lamp," 5th October, 1877.
- No. 7973. K. C. Naylor, New Sharon, Iowa, U.S.A., "Nut Lock," 5th October, 1877.
- No. 7974. S. Darling, Providence, R. I., U.S.A., "Eraser," 5th October, 1877.
- No. 7975. J. Collins, Montreal, Que., "Funnel Closing Bag," 5th October, 1877.
- No. 7976. Jas. Churchill, T. H. Churchill and W. Churchill, Uxbridge, Ont., "Basket Making Machine," 5th October, 1877.
- No. 7977. C. Edwards, Jamaica, N.Y., U.S.A., "Improvements on Boots and Shoes," 5th October, 1877.
- No. 7978. T. R. Rhoder, Westminster, Ont., "Paper Bag Machine," 5th October, 1877.
- No. 7979. Jas. Tomlinson, Goderich, Ont., "Barrel Making Machine," 5th October, 1877.
- No. 7980. E. Prescott, Hampton Falls, N.H., U.S.A., "Mode of Hanging Doors and Blinds," 5th October, 1877.
- No. 7981. W. Muir, Montreal, Que., (Assignee of D. McC. Smyth, Orange, N.J., U.S.A.) "Sewing Machine," (Extension of Patent No. 1681,) 5th October, 1877.
- No. 7982. W. Muir, Montreal, Que., (Assignee of D. McC. Smyth, Orange, N.J., U.S.A.) (Extension of Patent No. 1711,) 5th October, 1877.
- No. 7983. E. L. Bushnell, Poughkeepsie, N.Y., U.S.A., "Spring Mattress," (Extension of Patent No. 1716,) 9th October, 1877.
- No. 7984. B. C. Bort, Chateaugay, N.Y., U.S.A., "Milk Pan," 9th October, 1877.
- No. 7985. B. C. Bort, Chateaugay, N.Y., U.S.A., "Churn," 9th October, 1877.
- No. 7986. A. C. Otty and A. J. Elliott, Rothesay, N.B., "Dash Churn," 9th October, 1877.
- No. 7987. A. McCallum, Kars, Ont., and J. F. Cass, L'Orignal, Ont., "Waggon Rack," 9th October, 1877.
- No. 7988. R. Thomson and A. R. Williams, Stratford, Ont., (Assignees of O. Cooley, Brockport, N.Y., U.S.A.), "Harvesting Machine," 9th Oct., 1877.
- No. 7989. R. Thomson and A. R. Williams, Stratford, Ont., (Assignees of O. Cooley, Brockport, N.Y., U.S.A.), "Rake Cam Support for Harvesters," 9th October, 1877.
- No. 7990. R. Thomson and A. R. Williams, Stratford, Ont., (Assignees of O. Cooley, Brockport, N.Y., U.S.A.), "Harvester Pitman," 9th Oct. 1877.
- No. 7991. John Kinleyside and M. Wilson, Hamilton, Ont., "Clothes Wringer," 9th October, 1877.
- No. 7992. W. F. Wilkins and Jas. T. Sawyer, Montreal, Que., "Wash Board," 9th October, 1877.
- No. 7993. W. Weaver, Greenwich, N.Y., L. Flagg, Central Falls, Rhode Island, U.S.A., and Hon. P. Mitchell, Montreal, Que., "Wood Working Machine," 11th October, 1877.
- No. 7994. J. F. Howell, Sarnia, Ont., "Retort and Method of Treating Refractory Ores," 15th October, 1877.
- No. 7995. E. Garon, Sherbrooke, Que., "Railway Gate," 15th Oct., 1877.
- No. 7996. Jos. Kasz, Buffalo, N.Y., U.S.A., "Still for Rectifying Spirits," 15th October, 1877.
- No. 7997. A. F. Holmes, Chicago, Ill., U.S.A., "Smelting Furnace," 15th October, 1877.
- No. 7998. John Keats, Wood Green, England, "Sewing Machine," 15th October, 1877.
- No. 7999. C. C. Dusenbury, N.Y., U.S.A., "Device for Burglar Alarm," 15th October, 1877.
- No. 8000. G. Leve, Montreal, Que., "Sleeping Car," 15th October, 1877.
- No. 8001. C. Peare, Unionville, Ont., "Snow Plough," 15th October, 1877.
- No. 8002. R. D. Hyerson, Clinton, Maine, U.S.A., "Stove Legs," 15th October, 1877.
- No. 8003. K. Knott, London, England, "Dry Air Refrigerating, and Apparatus used therefor," 15th October, 1877.
- No. 8004. F. G. Wallace, Jackson, and John Webster, of Detroit, Mich. U.S.A., "Bolter and Bran Duster Combined," 15th October, 1877.
- No. 8005. J. H. Keyser, N. Y., U.S.A., "Water Closet," 16th Oct., 1877.
- No. 8006. A. Bijur, N.Y., U.S.A., "Shutter," 15th October, 1877.
- No. 8007. John E. Gauthier, Sambrieh, Ont., "Ice Box for Freezing Fish," 15th October, 1877.
- No. 8008. G. Warin, Toronto, Ont., "Shooting Skiff," 15th October, 1877.
- No. 8009. M. Sudderick, Buffalo, N.Y., U.S.A., "Wrist Check and Finger Guard for Piano Students," 15th October, 1877.
- No. 8010. W. A. Kirby, Auburn, N.Y., U.S.A., "Harvesting Machine," (Extension of Patent No. 1700,) 15th October, 1877.
- No. 8011. W. A. Kirby, Auburn, N.Y., U.S.A., "Harvesting Machine," (Extension of Patent No. 1700,) 16th October, 1877.
- No. 8012. Jef. Chase, Orange, Mass., U.S.A., "Wood Pulping Engine," 16th October, 1877.
- No. 8013. D. M. Lamb, N.Y., U.S.A., "Process for Producing Water proof Gum," 16th October, 1877.
- No. 8014. J. B. Hyde, Milton, Ont., "Railway Steam Brake," 16th October, 1877.
- No. 8015. T. S. Bowman, St. Louis, Miss., U.S.A., "Numbering Machine for Printing Press," 16th October, 1877.
- No. 8016. H. A. Stearns, Lincoln, Rhode Island, U.S.A., "Gate," 16th October, 1877.
- No. 8017. R. W. Park, Philadelphia, Pa., U.S.A., "Hydro-carbon Gas Lamp," 16th October, 1877.
- No. 8018. M. H. Pearson, Leeds, England, "Wax Thread Sewing Machine," 16th October, 1877.
- No. 8019. W. Rushton, Atlanta, Georgia, U.S.A., "Spark Arrestor," 16th October, 1877.
- No. 8020. T. H. Roberts, Stratford, Ont., "Welding Machine," 16th October, 1877.
- No. 8021. C. A. Gregory, Montreal, Que., "Portable Fire Escape," 16th October, 1877.
- No. 8022. H. F. Smith, Richmond, Mich., U.S.A., "Hay Rake and Loader Combined," 16th October, 1877.
- No. 8023. N. A. Otto, Dentz, German Empire, F. W. Crossley and W. J. Crossley, Manchester, England, "Gas Motor Engine," 16th October, 1877.

INDEX OF PATENTEES.

Abell, J., reaping machines.....	7905	Keenan, F., drilling machine.....	7895
Adams, A. P., et al., snow shovels.....	7829	Keller, J., tea-kettle.....	7857
Albrecht, H., plating machines.....	7804	Kelsey, L. A., et al., journal box.....	7900
Anthony, C. S., et al., store windows.....	7855	King, M. L., water power.....	7898
Askins, J., burial cases.....	7863	" T. E., spool stamping.....	7819
Ault, W., et al., steam engines.....	7820	Klantz, C., et al., lamp collars.....	7806
Baker, W. E. S., lamp collars.....	7806	Kyle, T., et al., watch winding.....	7926
Barnard, C. F., dental plates.....	7919	Labelle, J., potato bugs.....	7893
Barrow, J. F., et al., plating machines.....	7801	La Croy, C., harrow cultivators.....	7884
Beaudet, J., hinges.....	7892	Langs, E. R., waggon box.....	7908
Benner, L. D., paper bags.....	7901	Leathers, L. L., artificial stone.....	7909
Berrien, L. B., plating machines.....	7889	Leckle, R. G., roasting furnace.....	7851
Bissell, T. A., car axle boxes.....	7831	" " separating sulphur.....	7867
Bissett, C. A., hose couplings.....	7833	Lee, P. H., under-garments.....	7875
Bolton, D. A., et al., sash fasteners.....	7924	Lewers, J. H., et al., ironing collars.....	7806
Bostwick, J., bed bottoms.....	7897	Lewis, W. K., baked beans.....	7896
Boulter, G., moccasins.....	7904	Lichter, J. M., horse collars.....	7813
Bracy, W. H., et al., watch winding.....	7926	Lingenfelter, O., et al., ironing board.....	7827
Brandon, W. R., et al., stump machine.....	7877	Lord, P., fire-escape ladder.....	7848
Briggs, J., cooking ranges.....	7920	Manheim, J., et al., store windows.....	7885
Bristol, W., vehicle seats.....	7883	Mann, T., hoisting machines.....	7853
Brock, M., et al., boots and shoes.....	7891	Marshall, C. K., letter envelope.....	7882
Brown, E. W., baked beans.....	7896	" " postal cards.....	7887
Bruce, J., stump extractors.....	7921	Mishall, J. E., tube expanders.....	7807
Bussell, J. H., preparing sole edges.....	7929	Morris, H. R., et al., ironing board.....	7827
Bush, H. F. and M. L., grind-stone.....	7850	Mumford, J. A., shingle machines.....	7917
Caddick, S., puddling furnaces.....	7822	Neale, M. T., harvesting machines.....	7927
Center, M. V., stump extractor.....	7869	Needles, J. H., illuminating gas.....	7916
Clubine, W., steam engines.....	7862	Neptune Fog Horn Co., The, fog signals.....	7876
Cole, E., et al., mortising chisel.....	7913	Nysewander, C. and D., windmills.....	7844
Coleman, A. B., harness.....	7866	Palmer, W. H., et al., bed bottoms.....	7837
Cook, S. S., et al., securing tapes.....	7826	Patten, J. F., constructing buildings.....	7841
" T. A., et al., bread knives.....	7810	Payette, P., et al., bread knives.....	7840
Copeland, G. W., boots and shoes.....	7891	Pennock, J., churns.....	7838
Corrin, J. H., sofas.....	7907	Pettis, W., ".....	7859
Coulter, H. W., clothes dryers.....	7858	Pierce, C. D., earth augers.....	7846
Crandal, E. M., barbed wire fences.....	7911	Pontifax, J. H., et al., waterproof garments.....	7823
Custer, J., potato planter.....	7914	Putnam, H. W., fence wire.....	7830
Deacon, G. F., tramways.....	7852	Pye, G., harvesters.....	7831
Doty, R. and J., spring attachment.....	7845	Rice, S. M., et al., stench traps.....	7925
Edwards, J. P., car couplings.....	7890	Robbins, L. S., wood preserving.....	7902
Elmslie, G., car wheels.....	7802	Roberts, R., cigar machines.....	7886
Ethridge, M. Van B., areameter.....	7923	Roeser, H. F., et al., bed bottoms.....	7837
Evans, H. B., brick kilns.....	7810	Rogers, J. W., shoe sole buffing.....	7849
Fickett, A., pulping engines.....	7873	Ross, H., upsetting tires.....	7918
Flower, J., pipe holding chuck.....	7899	Rousseau, F. X., sewers and drains.....	7805
" " taps and dies.....	7894	Rudel, P. E., clothes wringer.....	7854
Foley, J., water filters.....	7828	Sanders, E., ships' pumps.....	7888
" " purifiers.....	7816	Schmitz, F. E., book binding.....	7821
Foote, W., vehicle springs.....	7855	" J. P., stench traps.....	7915
Forbes, J., electrical apparatus.....	7870	Scott, D., barrel stands.....	7825
" W. H., port holes of ships.....	7826	Seely, E. C., mast ball.....	7912
Forton, J. A., et al., boiler cleaners.....	7836	Shaw, D. T., riding and driving reins.....	7839
Fowler, C. N., pessaries.....	7906	Sheldon, R. B., cultivators and sowers.....	7880
Fox, J., waggon jacks.....	7871	Simpson, J. M., et al., steam engines.....	7820
Fuller, T. R., making bungs.....	7817	Smith, E. D., et al., stench traps.....	7925
Gerrish, A. A., et al., sash fasteners.....	7924	Solter, J., et al., plating machines.....	7804
Godfrey, J. S., boiler flue cleaner.....	7928	Spaulding, N. W., saw teeth.....	7808
Goff, J. B., portable fences.....	7814	Stafford, W. H., et al., securing tapes.....	7826
Golden, J. J., railway switches.....	7868	Starr, J. F., Jr., sheet metal pipes.....	7865
Goldschmidt, A. J. S., chair and lounge.....	7847	Stovel, E., pumps.....	7809
Gould, S. L., pulp engines.....	7861	Sweenor, G., fog signals.....	7876
Greene, J. F., hair treating.....	7842	Terrel, E. P., saw grinders.....	7811
Guthrie, M. W., tire upsetters.....	7878	Thomas, J. E., et al., boiler cleaners.....	7836
Hamor, R. B., door threshold.....	7856	Van Allen, N., braces and suspenders.....	7881
Harrington, H., movable fences.....	7818	Victory, C. H., et al., snow shovels.....	7829
Hawkins, F. R., grain cleaning.....	7812	Wheeler, H., et al., stump machine.....	7877
Henshall, S., boot- and shoes.....	7864	Whitmarsh, A. N., et al., mortising chisel.....	7913
Hoden, C. W., et al., areameter.....	7923	Williams, J. H., et al., areameter.....	7923
Horsford, S., skates.....	7922	Wilcox, W. E., et al., journal box.....	7900
Horsley, B., book binding.....	7821	Wilson, J. C., paper bags.....	7901
Jarecki, F., gas and water pipes.....	7835	" T., fanning mill.....	7808
Jenkins, P. O., heating stoves.....	7871	Wolff, G. S., coloring composition.....	7843
Jones, W., blind hinges.....	7879	Woodward, E., et al., boots and shoes.....	7891
Joyce, N. K., air registers.....	7872	Wormell, E., et al., watch winding.....	7926
		Worth, S. L., et al., waterproof garments.....	7828
		Wright, D. D., car-couplers.....	7815
		" H., match splints.....	7805
		" J., door fastenings.....	7860

THE CANADIAN PATENT OFFICE RECORD.

ILLUSTRATIONS.

Vol. V.

OCTOBER, 1877.

No. 10.

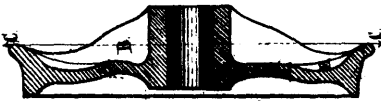

7802 Elmslie's Improvements in Car Wheels.

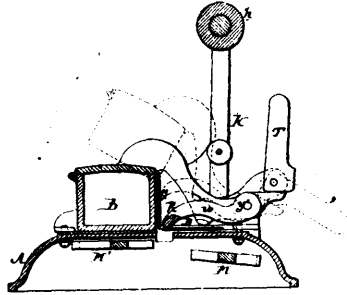

7804 Burrow & Solter's Improvements on Plating Machines.

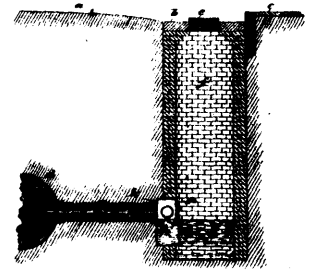

7805 Rousseau's Combined Trap and Ventilator for Sewers and Drains.

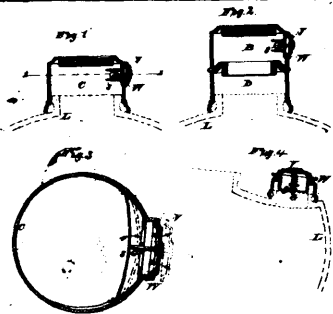

7806 Lewers & Klaitz's Improvements on Lamp Collars.

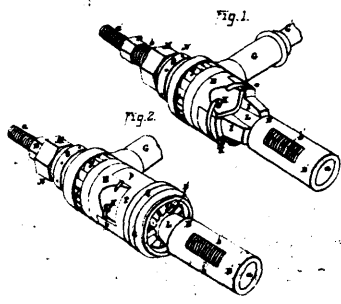

7807 Minshall's Improvements on Tube Expanders.

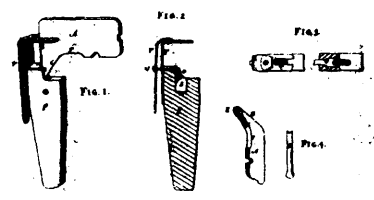

7808 Spaulding's Improvements in Saw Teeth.

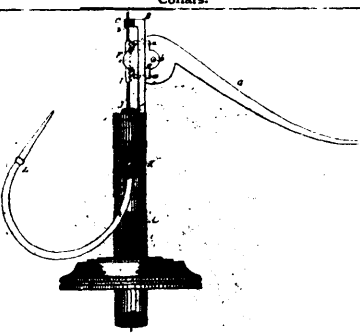

7809 Stovel's Improvements in Pumps.

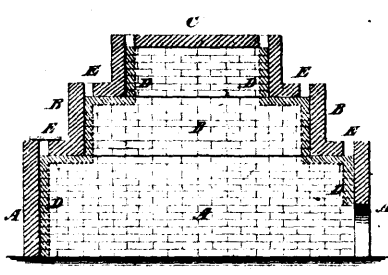

7810 Evans' Improvements on Brick Kilns.

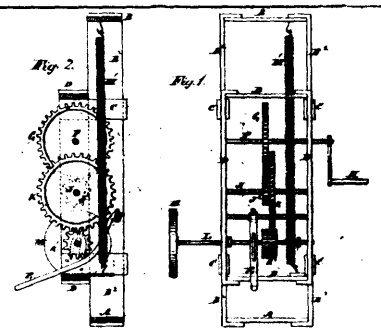

7811 Terrell's Improvements on Saw Grinders.

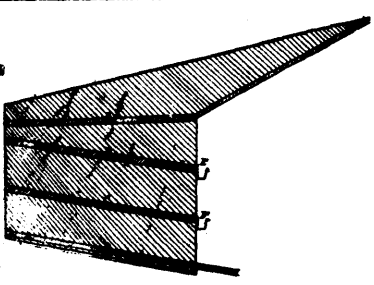

7812 Hawkins' Machine for Cleaning and Separating Grain.

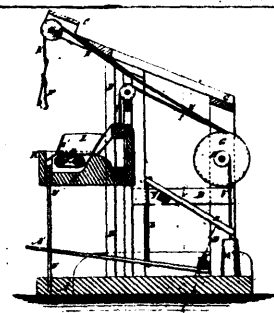

7813 Lichter's Machine for Stuffing Horse Collars.

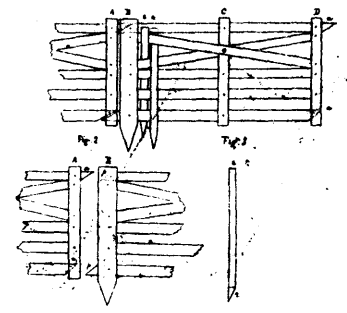

7814 Goff's Improvements on Portable Fences.

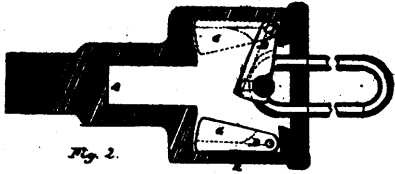

7815 Wright's Improvements in Car Couplers.

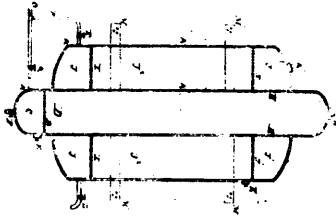

7816 Foley's Improvements on Water Purifiers.

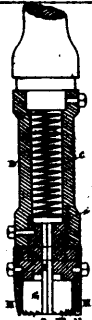

7817 Craig, McMurray & Fuller's Machine for Making Bungs.

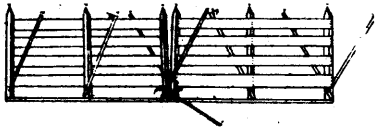

7818 Harrington's Improvements on Movable Fences.

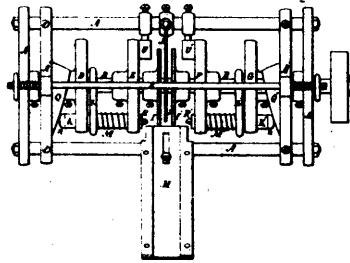

7819 King's Spool Stamping Machine.

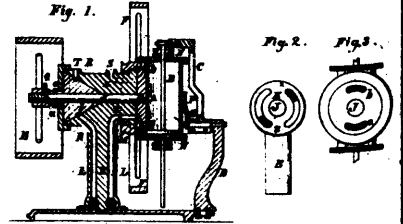

7820 Simpson & Ault's Improvements in Steam Engines.

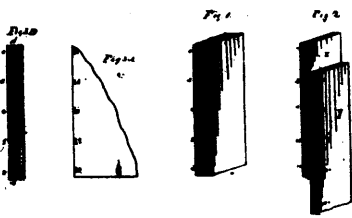

7821 Schmitz's Improvement in Book-binding.

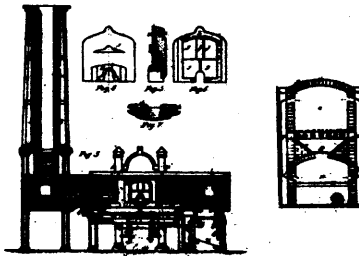

7822 Caddick's Improvements in Puddling and Heating Furnaces.

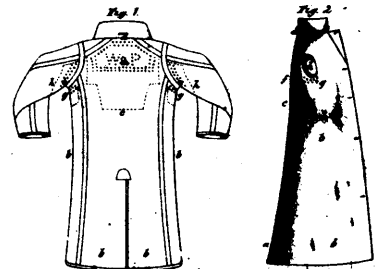

7823 Worth & Pontifex's Mode of Ventilating Waterproof Garments.

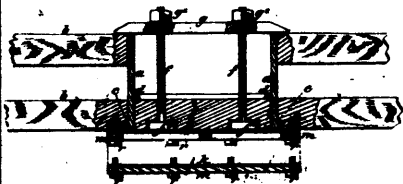

7824 Forbes' Improvements on Port Holes of Ships.

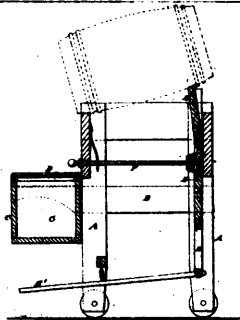

7825 Scott's Improvements on Barrel Stands.

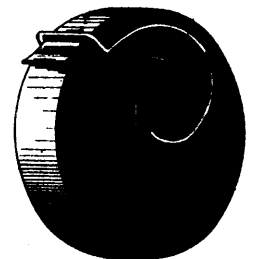

7826 Stafford & Cook's Device for Securing and Protecting Tapes.

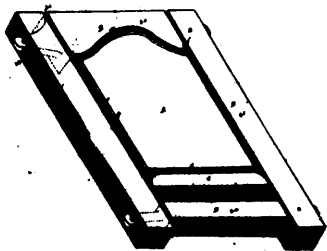

7827 Lingenfelter & Morris' Board for Ironing and Blocking Shirt Fronts.

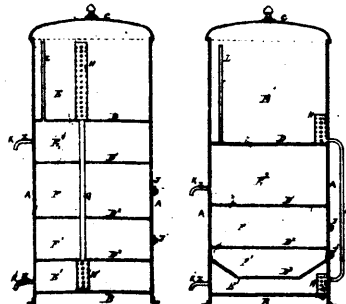

7828 Foley's Improvements on Water Filters.



7829 Victory & Adams' Improvements on Snow Shovels.

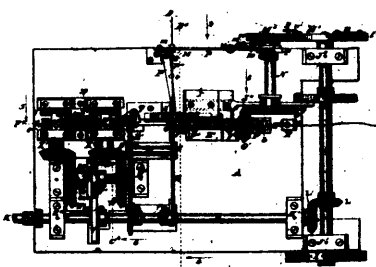

7830 Putnam's Machine for Making Barbed Fence Wire.

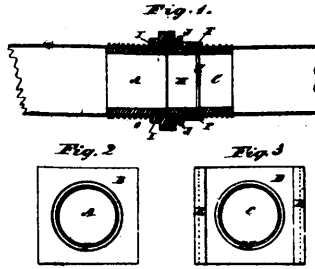

7833 Bissett's Improvements on Hose-Couplings.

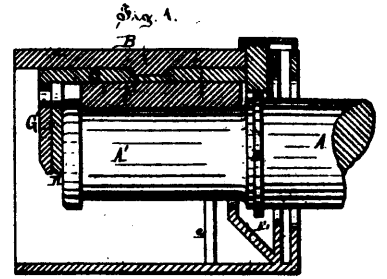

7834 Bissett's Improvements on Car Axle Boxes.

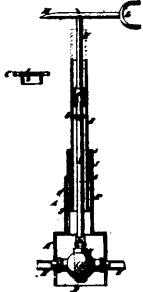

7835 Jarecki's Improvements on Gas and Water Pipes.

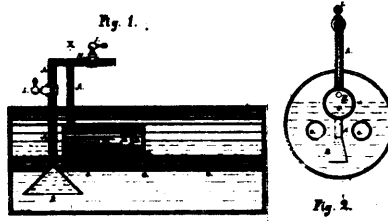

7836 Fordon & Thomas' Improvements in Boiler Cleaners.

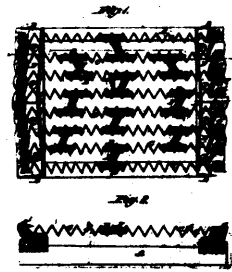

7837 Palmer & Roesser's Improvements on Spring Bed Bottoms.

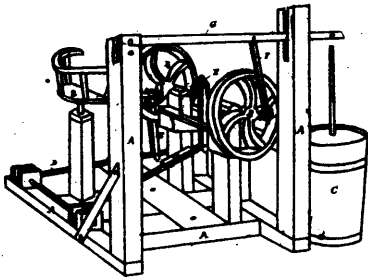

7838 Pennock's Improvement on Churns.

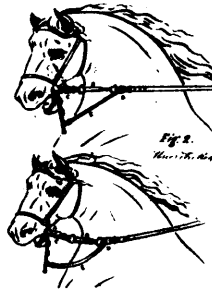

7839 Shaw's Improvement on Riding and Driving Reins.

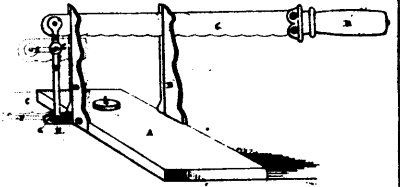

7840 Fayette & Cook's Improvements on Bread Knives.

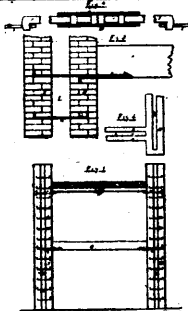

7841 Patten's Art of Constructing Brick and Stone Buildings.

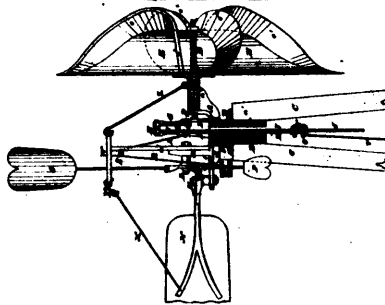

7844 Nysewander's Improvements in Wind Mills.

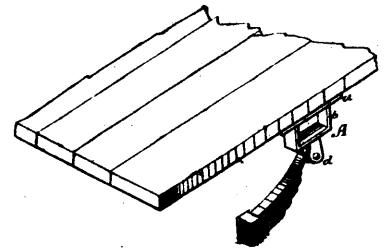

7845 Doty's Wagon Spring Attachment.

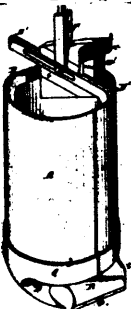

7846 Pierce's Improvements on Earth Augers.

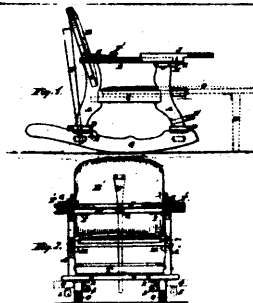

7847 Goldschmidt's Invalid Chair and Lounge.

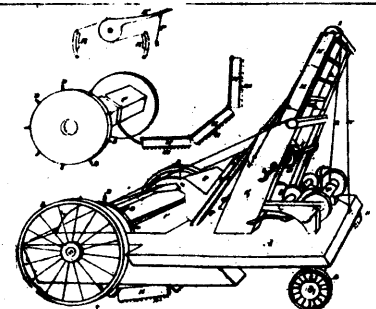

7848 Lord's Fire Escape Ladder.

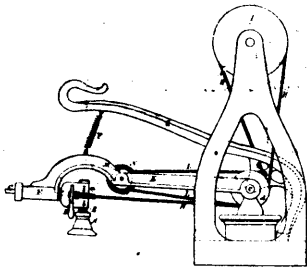

7849 Rogers' Shoe Sole Buffing Machine.

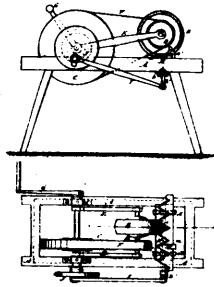

7850 Bush's Grind Stone for Mower Knives.

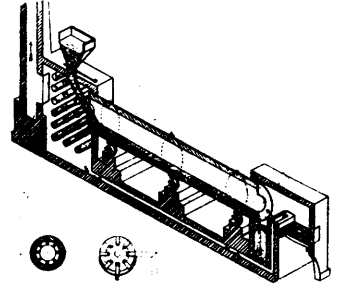

7851 Leckie's Revolving Roasting Furnace for Ores.

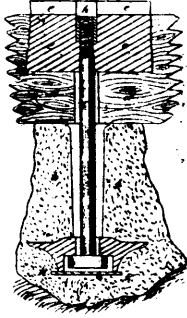

7852 Deacon's Improvements on Tramways.

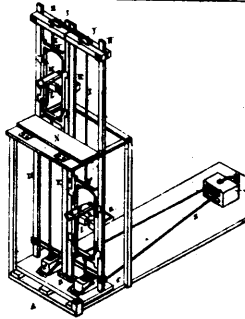

7853 Mann's Improvements in Hoisting Machines.

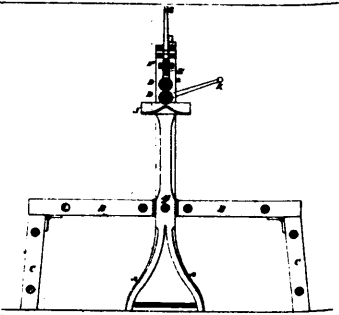

7854 Rudel's Combined Clothes Wringer and Wash Bench.

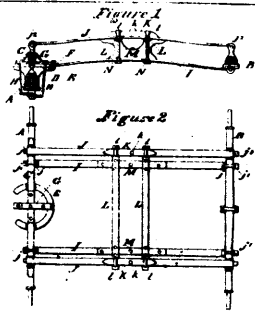

7855 Foote's Improvements on Vehicle Springs.

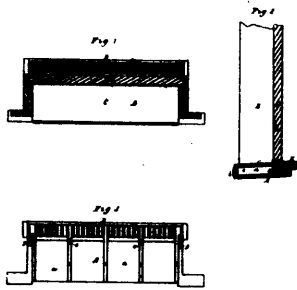

7856 Hamar's Improvements on Door Thresholds.

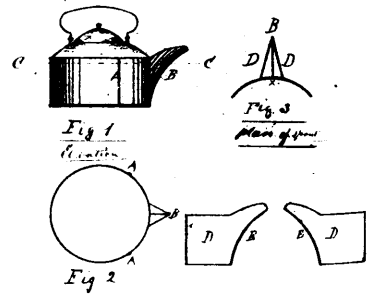

7857 Keller's Improvements on a Tea-kettle.

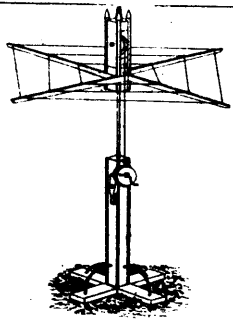

7858 Couler's Improvements in Clothes Dryers.

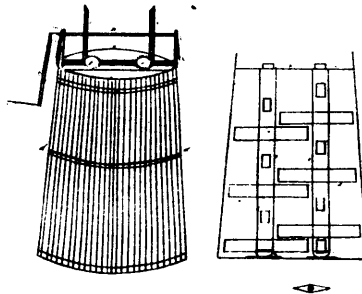

7859 Pettis' Improvements on Churns.

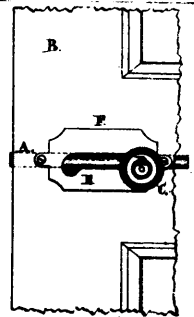

7860 Wright's Improvements in Door Fastenings.

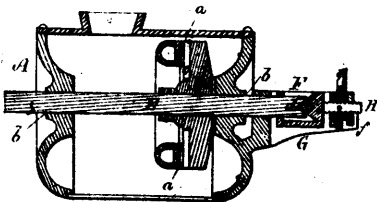

7861 Gould's Improvements on Pulp Engines.

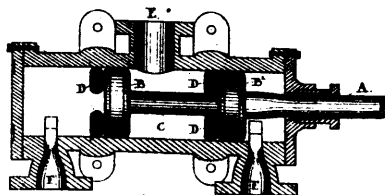

7869 Clubine's Improvements in Steam Engines.

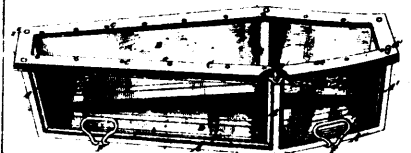

7863 Askins' Improvements on Burial Cases.

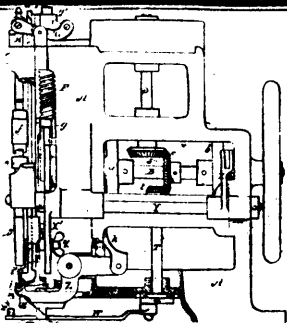

7864 Houghill's Machinery for the Manufacture of Boots and Shoes.

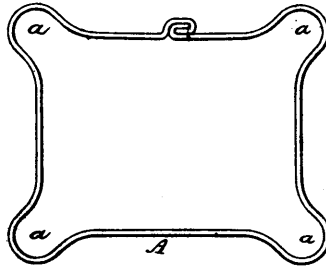

7865 Starr's Improvements on Sheet Metal Pipes.

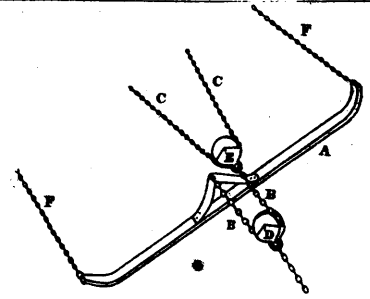

7866 Coleman's Improvements in Harness.

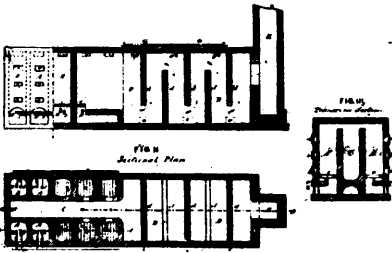

7867 Leckie's Method of Separating Sulphur from its Ores.

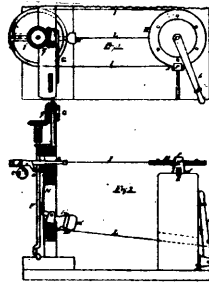

7868 Golden's Improvements on Railway Switches.

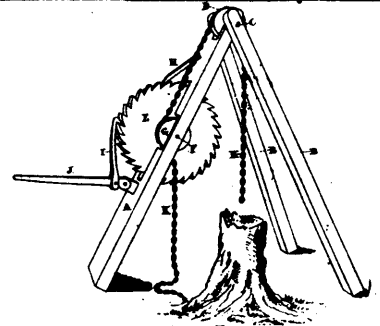

7869 Center's Stump Extractor.

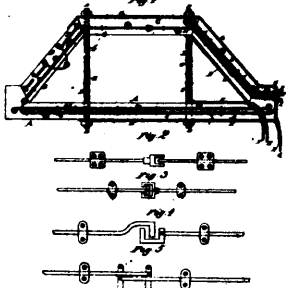

7870 Forbes' Electrical Apparatus to Indicate Over-strain or Weakness in Roofs and Bridges.

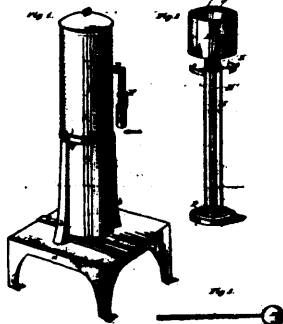

7871 Jenkins' Improvements in Heating Stoves.

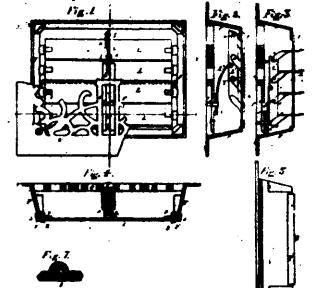

7872 Joyce's Improvements in Air Registers.

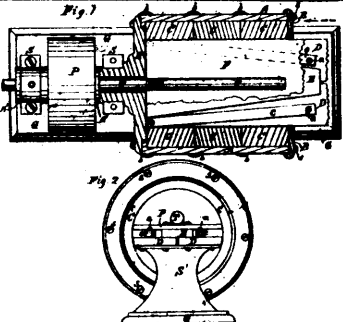

7873 Fickett's Improvements in Wood Pulping Engines.

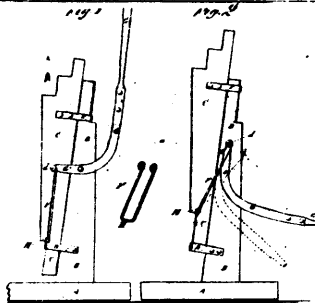

7874 Fox's Improvements on Waggon Jacks.

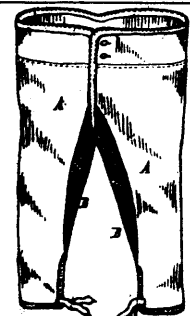

7875 Lee's Improvements in Under-garments.

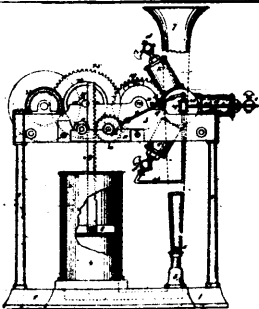

7876 Swanson's Improvements on Fog Signals.

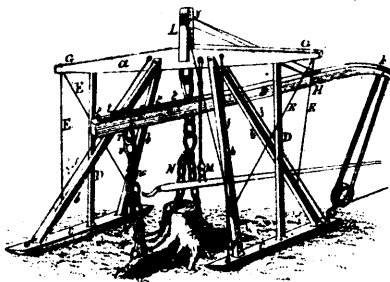

7877 Brandon & Wheeler's Stump Machine.

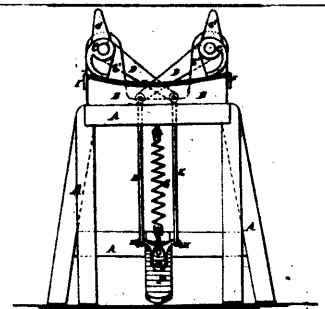

7878 Griffiths' Improvements on Tire Upsetters.

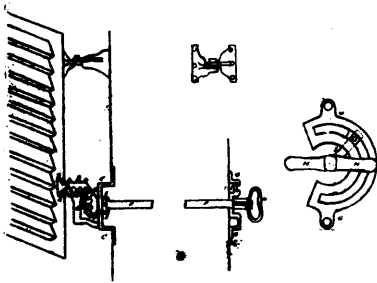

7879 Jones' Improvements on Blind Hinges.

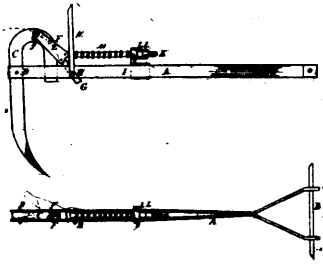

7880 Sheldon's Improvements on Cultivators and Sowers.

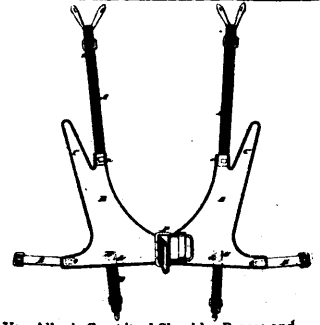

7881 Van Allen's Combined Shoulder Braces and Suspenders.

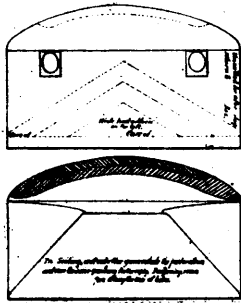

7882 Marshall's Improvements on a Letter Envelope.

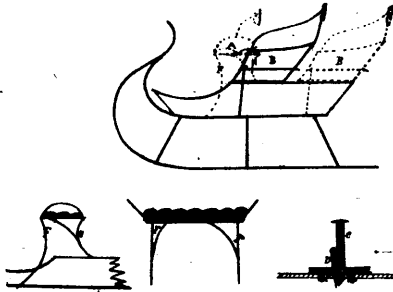

7883 Bristol's Improvements on Vehicle Seats.

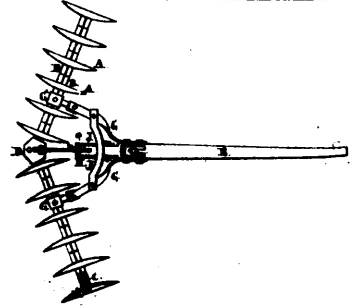

7884 La Dow's Improvements in Harrow Cultivators.

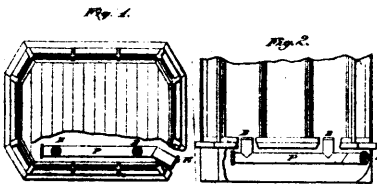

7885 Anthony & Manheim's Devices for Preventing the Accumulation of Frost and Steam upon Store Windows.

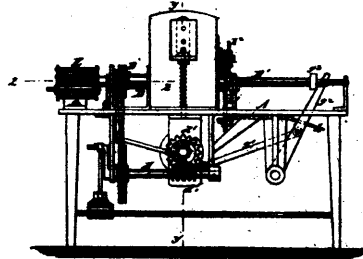

7886 Roberts' Improvements on Cigar Machines.

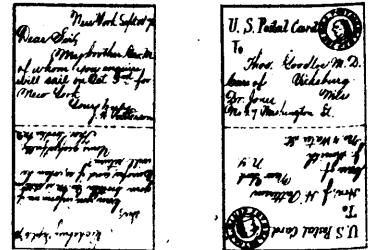

7887 Marshall's Improvements on a Postal Card.

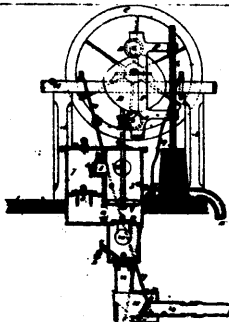

7888 Senders' Improvements on Ships' Pumps.

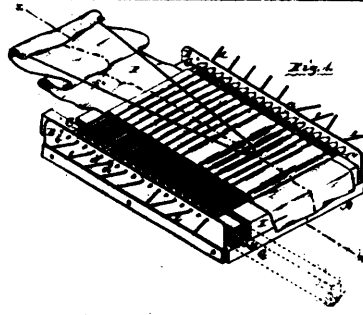

7889 Borriera's Improvements in Plating Machines.

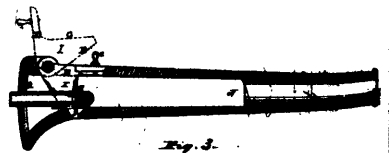

7890 Edwards' Improvements on Car-Couplings.

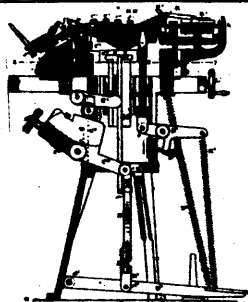

7891 Woodward & Brock's Lasting Machine for Boots and Shoes.

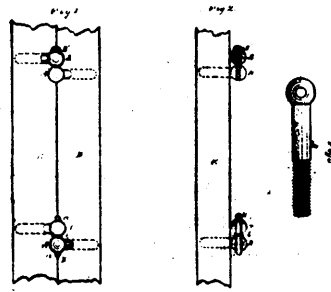

7892 Beaudet's Improvement on Hinges.

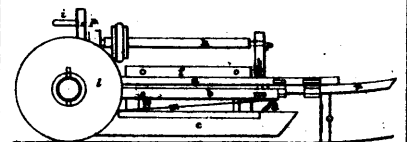

7893 Labelle's Machine for Gathering Potato Bugs.

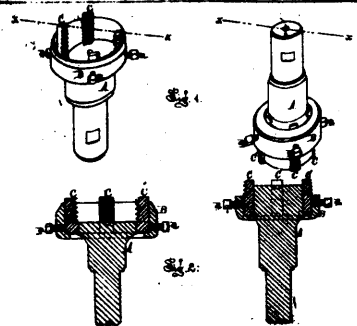

7894 Flower's Improvements on Taps and Dies.

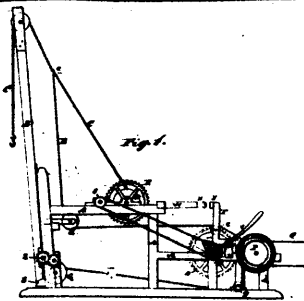

7895 Keenan's Rock Drilling Machine.

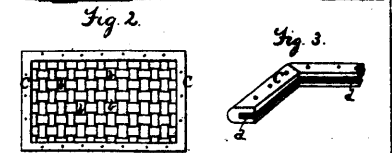
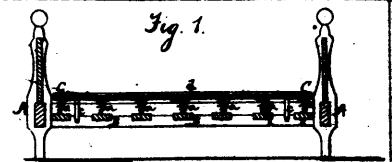

7897 Bostwick's Improvements on Bed Bottoms.

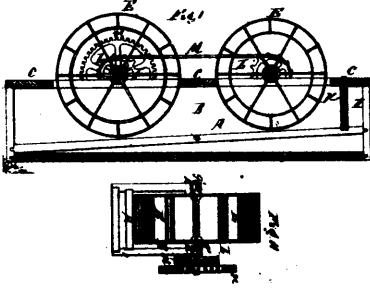

7898 King's Portable Water Power Apparatus.

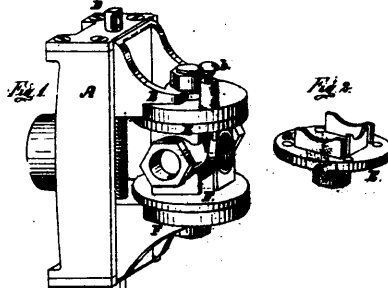

7899 Flower's Chuck for Holding Pipe Fittings.

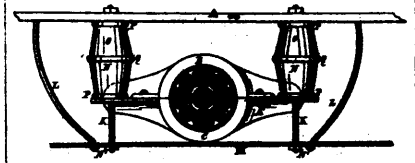

7900 Wilcox & Kelsey's Railway Journal Box.

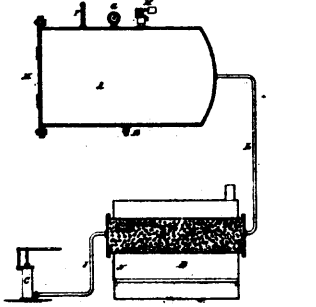

7902 Robbins' Process of Seasoning and Preserving Wood.

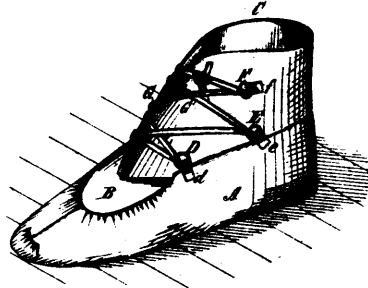

7904 Boulter's Improvements in Mocassins.

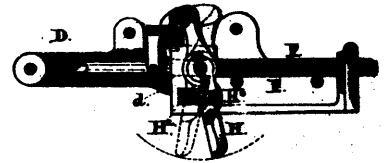

7905 Abell's Improvements in Reaping Machines.



7906 Fowler's Improvement in Pessaries.

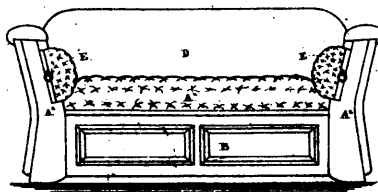

7907 Corrin's Improvements in Sofas.

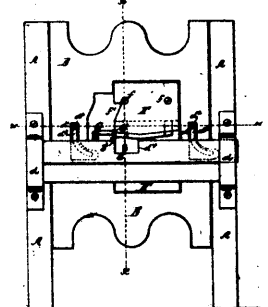

7808 Wright's Machine for Making Match Splints.

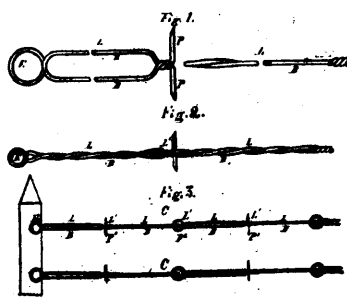

7911 Crandal's Improvements on Barbed Wire Fences.

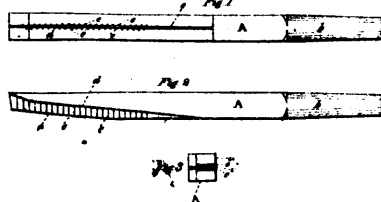

7913 Cole & Whitmarsh's Improvement on a Merging Chisel.

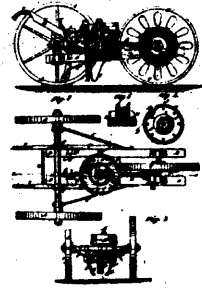

7814 Custer's Combined Potato and Corn Planter.

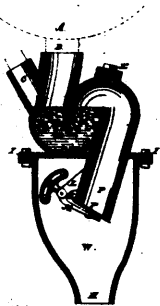

7915 Schmitz's Improvement on Stench Traps.

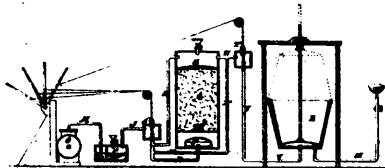

7916 Needles' Apparatus for Manufacturing Illuminating Gas.

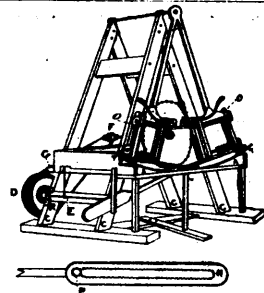

7917 Mumford's Improvements in Shingle Machines.

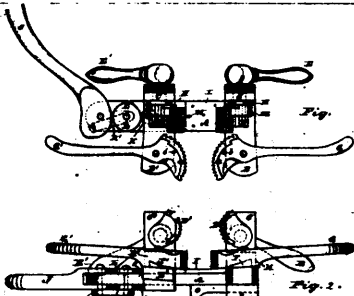

7918 Ross' Machine for Upsetting and Welding Tires.

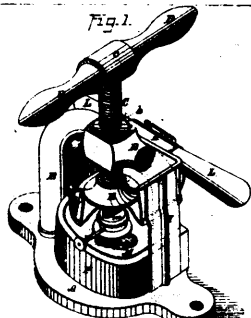

7919 Barnard's Art of, and Mechanism for, Constructing Dental Plates.

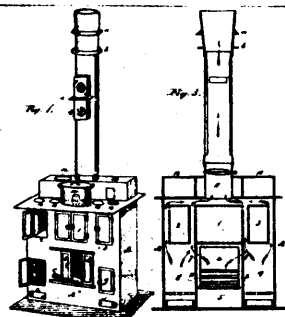

7920 Briggs' Improvements on Cooking and Heating Ranges.

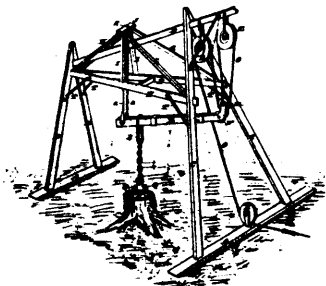

7921 Bruce's Improvements on Stump Extractors.

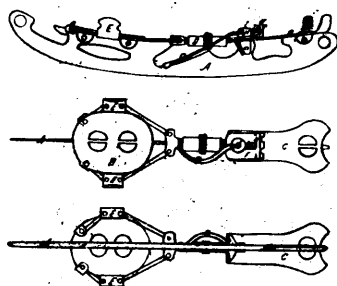

7922 Horsford's Improvements on Skates.

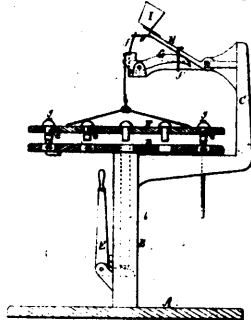

7923 Ethridge's Anemometer.

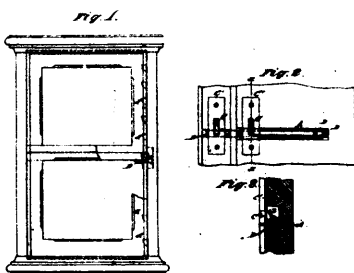

7924 Gerrish's Improvements on Sash Fasteners.

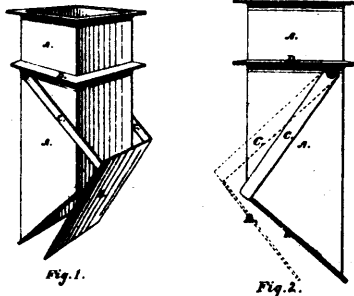

7925 Rice's Improvement in Stench Traps.

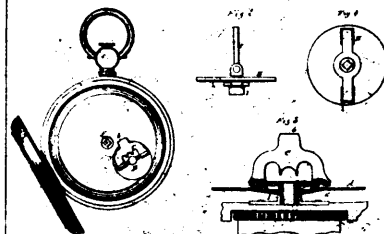

7926 Bracy, Kyle & Wormell's Improvement on Watch Winding Devices.

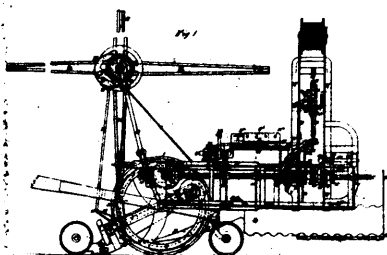

7927 Neale's Improvements on Harvesting Machines.

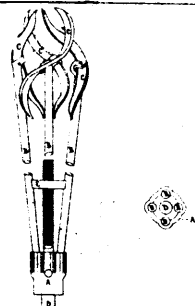

7928 Godfrey's Boiler Flue and Watch Pipe Cleaner.

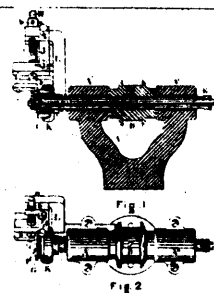

7929 Busell's Machine for Preparing the Edges of Soles.