



69606  
(accessed 24/11/45)

THE CONSOLIDATED

# ORDERS IN COUNCIL

OF

CANADA.

C-146-242  
0-27  
LIBRARY  
SUPREME COURT  
OF CANADA  
S-114-146

---

UNDER THE AUTHORITY AND DIRECTION OF HIS EXCELLENCY  
THE GOVERNOR-GENERAL IN COUNCIL.

---

By HARRIS H. BLIGH, Q.C.

1772



OTTAWA :

PRINTED BY BROWN CHAMBERLIN, PRINTER TO THE QUEEN'S MOST EXCELLENT  
MAJESTY.

1889.



Many regulations - 10<sup>th</sup> June 1907

Asst. Secy - Cap. 90, full order  
making out

*Regulations on matériel de coin from*

*to low scale Act.*

TABLE OF CONTENTS.

*all export*

*ad export manu*

*1. Imports Gold & Silver - ad export manu*

*Green & Silver marking Act -*

DEPARTMENT OF AGRICULTURE.

CHAPTER	PAGE
1. Mortuary Statistics	1
2. Criminal Statistics	5
3. Patents of Invention	8
4. Copyright	31
5. Trade Marks and Designs and Timber Marks	37
6. Quarantine Regulations—General	41
7. Contagious Diseases among Animals	71
8. Customs Warehouses	89
9. Regulations for Slaughtering and Curing imported Swine in bond	97
10. Foreign Reprints of British Copyright Works	100
11. Drawbacks on exportation of Imported Goods	101
12. Drawback on Corn used in the manufacture of Distilled Spirits	108
13. Special Regulations	109
14. Forms of Oath	113
15. Free List	118
16. Fruits, Berries, Seeds, Trees, Plants, Vegetables	122
17. Directions respecting Duties	123
18. Bounty on Pig Iron	126
19. Coasting Trade—General Regulations	127
20. Coasting Trade—Foreign Vessels	132
21. Foreign Trading Vessels	135
22. Carriage by Railway through Canada	137
23. Values of Foreign Currencies	144
24. Vessels arriving at St. John, N.B.	146
25. Ports and Places of Entry	147
26. Warehousing Ports	157

*ad*  
*11*

*meat & Carcasses - ad - voc -*  
*9. Coasting Trade - ad - voc -*  
*DEPARTMENT OF CUSTOMS*  
*10. Foreign Reprints of British Copyright Works - ad - voc -*

## DEPARTMENT OF INDIAN AFFAIRS.

CHAPTER	PAGE
27. Protection of Indian Reserves - - - - -	163
28. Enfranchisement of Indians - - - - -	165
29. Regulations for the Disposal of Indian Lands - - - - -	166
30. Sale of Timber on Indian Lands in Ontario and Quebec - - - - -	170
31. Indian Lands, Mining Regulations - - - - -	182
32. Coal Lands within Indian Reserves in Manitoba and the North-West Territories - - - - -	210

## DEPARTMENT OF FINANCE.

33. Government Savings Banks Regulations - - - - -	212
--	-----

## DEPARTMENT OF INLAND REVENUE.

34. Districts and Divisions - - - - -	221
35. Classification for Inland Revenue - - - - -	223
36. Bonded Manufactories, Regulations - - - - -	231
37. Warehousing Regulations, Excise - - - - -	238
38. Regulations respecting Spirits - - - - -	246
39. Tobacco and Cigar Regulations - - - - -	255
40. Analysts under the Adulteration Act - - - - -	305
41. Agricultural Fertilizers - - - - -	308
42. Weights and Measures,—Regulations - - - - -	311
43. Wany or Octagonally shaped Timber, Mode of Measuring - - - - -	328
44. Inspection of Staple Articles - - - - -	329
45. Grades of Wheat and other Grain - - - - -	337
46. Gas Inspection - - - - -	342
47. Petroleum and Naphtha - - - - -	348
48. Licensed Maltsters' Regulations - - - - -	351
49. Cullers' Fees - - - - -	352
50. Upper Ottawa Improvement Company - - - - -	353
51. Lower Ottawa Boom Company - - - - -	358
52. Rouge Boom Company - - - - -	359
53. Ferry Regulations - - - - -	360

## DEPARTMENT OF JUSTICE.

54. Tariff of Fees in Crown Cases in the North-West Territories - - - - -	401
55. Regulations for the Dominion Police - - - - -	405
56. Petition of Right - - - - -	419

*Table of Contents.*

v

DEPARTMENT OF JUSTICE—*Continued.*

CHAPTER	PAGE
57. The Naturalization Act - - - - -	420
58. Fines and Forfeitures - - - - -	423
59. Maritime Court of Ontario - - - - -	424
60. Penitentiary Regulations - - - - -	507

POST OFFICE DEPARTMENT.

61. Post Office Savings Banks - - - - -	565
62. Postal Inspection Divisions - - - - -	575

DEPARTMENT OF SECRETARY OF STATE.

63. Regulations under the Trade Unions Act - - - - -	579
64. Incorporation of Companies by Letters Patent - - - - -	588
65. Commissions to Public Officers - - - - -	592
66. Canada Temperance Act - - - - -	597
67. Civil Service Examinations - - - - -	600
68. The Revised Statutes of Canada - - - - -	611

DEPARTMENT OF FISHERIES.

69. Province of Nova Scotia; General Fishery Regulations - - - - -	615
70. Province of New Brunswick; General Fishery Regulations - - - - -	640
71. General Fishery Regulations, Province of Ontario - - - - -	655
72. General Fishery Regulations, Province of Quebec - - - - -	657
73. General Fishery Regulations, Prince Edward Island - - - - -	661
74. General Fishery Regulations, Province of Manitoba and North- West Territories - - - - -	663
75. General Fishery Regulations, Province of British Columbia - - - - -	664
76. Protection of Navigable Waters - - - - -	666
77. Propagation of Fish - - - - -	667

DEPARTMENT OF MARINE.

78. Examinations and Certificates of Masters and Mates - - - - -	671
79. Harbor Masters',—Regulations - - - - -	690
80. Harbor Master's,—Ports - - - - -	700
81. Harbor Master for the Port of Halifax - - - - -	710
82. Harbors, Piers and Breakwaters - - - - -	716
83. Pilotage Districts - - - - -	726
84. Port Wardens - - - - -	737

DEPARTMENT OF MARINE—*Continued.*

CHAPTER	PAGE
85. Port Warden, Montreal - - - - -	747
86. Port Warden, Quebec - - - - -	749
87. Registration of Shipping,—Ports - - - - -	750
88. Shipping Offices - - - - -	753
89. Wrecks and Salvage - - - - -	755
90. Inspection of Boilers of Steam-boats - - - - -	760
91. Inspection of Hulls of Steam-boats - - - - -	800

## DEPARTMENT OF PUBLIC WORKS.

92. Slides and Booms - - - - -	809
93. Transfer and abandonment of Public Works - - - - -	827
94. Telegraph Lines, British Columbia - - - - -	844
95. Southwest Boom Company - - - - -	845
96. Classification of Bridges - - - - -	846

## DEPARTMENT OF INTERIOR.

97. Regulations affecting Dominion Lands in the Province of Manitoba and the North-West Territories - - - - -	847
98. Regulations affecting Timber on Dominion Lands - - - - -	861
99. Regulations governing the disposal of Dominion Lands containing Minerals - - - - -	870
100. Regulations affecting Dominion Lands in Railway Belt in British Columbia - - - - -	902
101. Trails ordered to be Surveyed in the North-West Territories - - - - -	928
102. Trails ordered to be Surveyed in Manitoba - - - - -	930
103. Trails leading to Minnedosa established as Public Highways - - - - -	931
104. Trails transferred to North-West Territories - - - - -	932
105. Boundaries of Provisional Districts in the North-West Territories - - - - -	935
106. Registration Fees in the North-West Territories - - - - -	937
107. Payment of Fines for violation of an Act respecting the North-West Territories prohibiting the introduction of Intoxicants - - - - -	941
108. Judicial Districts in the North-West Territories - - - - -	942
109. The Westerly and South-Westerly Boundary of Manitoba Established - - - - -	943
110. Keewatin, Powers of Lieutenant Governor and Council to make Ordinances - - - - -	944

## DEPARTMENT OF RAILWAYS AND CANALS.

CHAPTER	PAGE
111. General Regulations for Government Railways - - -	945
112. The Intercolonial Railway - - - - -	976
Canadian Joint Freight Classification - - - - -	994
113. Windsor Branch of the Intercolonial Railway - - -	1018
114. Prince Edward Island Railway - - - - -	1023
115. Canals, Regulations and Tolls - - - - -	1024
Supplement - - - - -	1063

---

# THE CONSOLIDATED ORDERS IN COUNCIL OF CANADA.

DEPARTMENT OF AGRICULTURE.

## CHAPTER 1.

### MORTUARY STATISTICS.

Government House, Ottawa.

The 12th day of May, 1888.

On the recommendation of the Minister of Agriculture and under the provisions of Chapter 59 of the Revised Statutes of Canada, intituled: "An Act respecting Statistics,"

His Excellency in Council has been pleased to approve and assent to the following regulations and forms for the collection and publication of mortuary statistics:—

Section 1. The following regulations and forms shall apply to the collection of statistics of death and their causes within the limits of the following named cities or towns, being the capitals of Canada and of the Provinces and others having a population of 25,000 inhabitants or upwards, according to the census of 1880-81, that is to say: Montreal, Toronto, Quebec, Halifax, Hamilton, Ottawa, St. John, N.B., Charlottetown, Winnipeg, Fredericton and Victoria, B.C., to which neighboring localities may be added from time to time, or to such other cities, towns or localities, or joint cities, towns and localities whenever by experience it will appear that the system is satisfactorily worked and when sufficient means are granted by Parliament for that purpose.

Capitals, and cities having a population of 25,000.

Sec. 2. In pursuance of section 4 of the said Act, the system involved in the following regulations and forms may be put in operation in each of the above mentioned cities by the Minister of Agriculture, whenever it is satisfactorily demonstrated to him that there is in existence for the said city a local "board of health" to which is attached a permanent salaried medical officer, whether such "board of health" and "sanitary medical officer" are appointed and paid by the corporation of the said city or by the Provincial Government, or in any other way provided by the local laws or by-laws; and on the further condition that the application of the system to any city can

Local "board of health" and "sanitary medical officer."

## Chap. 1.

*Mortuary Statistics.*

be withdrawn by the Minister of Agriculture for inability or negligence to carry it to such degree of accuracy as is necessary for the purpose intended.

When Minister shall put system into operation.

Sec. 3. On being satisfied of the existence of such "board of health" and of the appointment of such "sanitary medical officer" being a licensed medical practitioner, the Minister of Agriculture shall take the necessary means to put the system of mortuary statistics, provided by these regulations, into operation in such city as aforesaid.

Expenses of working the system.

Sec. 4. The Minister of Agriculture may, out of the grant voted by Parliament for vital or sanitary statistics, devote the sums necessary for the printing of schedules, forms, circulars and other necessary papers, for the collection, compilation and publication of the necessary information, and for all other expenses connected with the working of the system of mortuary statistics as aforesaid.

Allotment for defraying expenses.

Sec. 5. The Minister of Agriculture may, subject to his own direction and arrangements, make out of the Parliamentary grant hereinbefore mentioned an allotment equal to one cent (\$0.01) for every individual unit of the population, in favor of each of the cities aforesaid, in order to defray the expenses of collecting the said mortuary statistics, to be paid by monthly instalments, or otherwise, and such allotment may be withdrawn in case of unsatisfactory working of the system.

\$400, may be added.

Sec. 6. The Minister of Agriculture may, if he deems it necessary, add to such allotment for every one of the said cities, a lump sum not to exceed four hundred dollars (\$400) in any case, to assist the local authorities in their procuring the necessary information of Mortuary Statistics, and may withdraw the granting of such lump sum.

Statistical officer, when to be appointed.

Sec. 7. Pursuant to section 3 of said Act the Governor in Council will, whenever one or more or all of the said cities have complied with the requirements hereinbefore stated, appoint the sanitary medical officer of the local board of health, a statistical officer for the collection of mortuary statistics from the local records, which appointment may be made to terminate for reason of unsatisfactory working of the system.

Salary of statistical officer.

Sec. 8. The salary of the statistical officer aforesaid shall consist of twenty-five per cent. (25 per cent.) of all the sums allotted as aforesaid to the city for which he is appointed; which salary shall be paid to him by the Minister of Agriculture.



*Mortuary Statistics.*

## Chap. 1.

Sec. 9. In case of epidemics, endemics or in the case of contagious or infectious diseases threatening or breaking out, the Minister of Agriculture may cause special investigations to be made in any locality, by any or several of the said statistical officers, and regulate and defray out of the parliamentary grant the cost of such investigations.

In case of epidemics &c.

Sec. 10. The forms for collecting the said mortuary statistics shall be as prescribed in the schedule hereunto annexed and marked A, the blanks of which shall be furnished by the statistical officers free of charge, to be made use of and a copy returned with the required information, in accordance with the instructions given from time to time by the Minister of Agriculture.

Blank forms, free of charge.

Sec. 11. The form for the death and burial certificate from which the information sought for is to be derived shall be as indicated in the schedule hereunto annexed and marked B, the blanks of which shall be furnished to the local board of health or statistical officer by the Minister of Agriculture, free of charge.

Death and burial certificate.

Sec. 12. The Minister of Agriculture may request the statistical officer to supplement the numerical returns by such statements and information as relate to the various medical and other questions relevant to the subject of accidents, crimes, diseases and public health as causes of deaths reported by the mortuary statistics as aforesaid.

Supplement to numerical returns.

13. The sums allotted by the Minister of Agriculture for the collection of such mortuary statistics shall be employed in the manner and for the objects which, from time to time, shall be directed by the Minister of Agriculture, who may, at any time, withdraw the payment of such sums for non-compliance with his instructions.

Sums allotted, how to be employed.

## SCHEDULE.

## A.

Form under which the information is to be collected for the mortuary statistics:—

*Columns with their headings.*

1. Class of disease.
2. Order of disease.
3. Name of disease.
4. Serial number of reference.
- 5 and 6. Sexes of the deceased—male, female.

## Chap. 1.

*Mortuary Statistics.*

7 to 21 inclusive. Age of the deceased.

22 to 24 inclusive. Marriage state of deceased—single, married or widowed.

25 to 30 inclusive. Religion of the deceased—Roman Catholic, Anglican, Presbyterian, Methodist, Baptist, other creeds.

31 to 35 inclusive. Origin of the deceased—English, French, Irish, Scotch, other origins.

36 to 42 inclusive. Occupation of the deceased or of the head of the family of the deceased—agricultural, commercial, domestic, industrial, professional, laborers, not classed.

The said information to be tabulated as regards ruling and space as shall suit the requirements of the operation of the system adopted by the regulations.

## B.

*Death Certificate.*

Day of 18

1. Name and surname of deceased.

2. Sex of deceased.

3. Age of deceased at

4. Marriage state.

5. Religion.

6. Nationality.

7. Occupation.

8. Time of death.

The \_\_\_\_\_ of the  
month of \_\_\_\_\_, 18

9. Disease or other cause of death.

Signature.

## HEALTH DISTRICTS.

Each of the electoral districts of the Provinces of Ontario, Quebec, New Brunswick and Nova Scotia, is constituted a Health District for the purpose of statistics, under the provisions of the said Act.

O. C. July 12, 1882.

To be looked up by Messrs. Davis, Secy of A. D.

CHAPTER 2.

CRIMINAL STATISTICS.

Government House, Ottawa.

The 12th day of May, 1888.

On the recommendation of the Minister of Agriculture and under the provisions of Chapter 60 of the Revised Statutes of Canada, intituled: "An Act respecting Criminal Statistics,"

His Excellency in Council has been pleased to sanction the following forms of schedules to be transmitted and used under said Act:—

CRIMINAL STATISTICS.

FORMS

I.

Year.....

DOMINION OF CANADA.

Province of.....

RETURN of Persons tried before the Court of.....during the year ending 30th September, 18 .

Serial Number.	Name of the Accused.	Residence.	Profession or Trade.	Age and Sex.		Place of Birth.	Religion.	State of Education.			Habits.		Married, single or widowed.	Offence.	Conviction, acquittal.	Sentence.	Whether previously convicted, and how many times.	Remarks.	
				M.	F.			Unable to read.	Unable to write.	Elementary instruction.	Superior instruction.	Temperate.							Intemperate.

Signed.....

Dated.....

To the Minister of Agriculture,  
Ottawa.



*Criminal Statistics.*

Chap. 2.

IV.

DOMINION OF CANADA.

Province of .....

RETURN of Convictions made by me (or us, as the case may be) in the month of.....18 .

Serial Number.	Name of the Prosecutor.	Name of the Defendant.	Nature of the charge	Date of conviction.	Name of convicting Justices.	Amount of penalty, fine or damage.	Time when paid or to be paid to said Justice.	To whom paid over by said Justice.	If not paid, why not, and general observations, if any.
						\$ cts.			

A. B., Convicting Justice, or A. B. and C. D., Convicting Justices (as the case may be).

To the Minister of Agriculture,  
Ottawa.

O. C. Dec. 15, 1876.

Received by G. O. Dalton -  
23 Feb 1884 J. O.

## CHAPTER 3.

### PATENTS OF INVENTION.

#### RULES, REGULATIONS AND FORMS.

Government House, Ottawa.

The 12th day of May, 1888.

On the recommendation of the Minister of Agriculture and under the provisions of Chapter 61 of the Revised Statutes of Canada, intituled "The Patent Act,"

His Excellency in Council has been pleased to approve the following Rules, Regulations and Forms made by the Commissioner of Patents:—

#### GENERAL RULES.

- Personal appearance not required.**      **Section 1.** A personal appearance of the applicant or his representative at the Patent Office is not required, unless specially called for by the Commissioner or Deputy Commissioner.
- Responsibility of applicant.**      **Sec. 2.** In all cases the applicant or depositor of any paper is responsible for the merits of his allegations and the validity of the instruments furnished by him or his agent.
- Correspondence.**      **Sec. 3.** Correspondence may be carried on either with the applicant, or his agent, but only with one person, and will be conveyed through the Canadian mails free of charge.
- Documents, how to be prepared.**      **Sec. 4.** All documents must be legibly and neatly written or printed on foolscap paper (13 inches long and 8 wide), with an inner margin of one inch and a-half wide.
- Address.**      **Sec. 5.** All communications are to be addressed—"The Commissioner of Patents, Ottawa, Canada." Papers forwarded to the Office should be accompanied by a letter, and a separate letter should be written on every subject.
- Forms of proceedings.**      **Sec. 6.** As regards proceedings not specially provided for in the accompanying forms, any other form being conformable to the letter and spirit of the law may be accepted, and if not conformable therewith will be returned for correction.
- Models.**      **Sec. 7.** Models must be neat and substantial working ones, not exceeding 12 inches on the longest side, unless

otherwise allowed by special permission; models must be so constructed as to show exactly every part of the invention claimed and its mode of working. In cases where samples of ingredients are required by law, they must be contained in glass bottles properly arranged, but dangerous or explosive substances must not be sent. Both models and bottles must bear the name of the inventor, the title of the invention and the date of the application; they must be furnished to the Patent Office free of charge and in good order.

Samples.

Sec. 8. All fees required by law should be transmitted with the application for any action by the office, in current bankable funds, inclosed in registered letters. Bank drafts, money orders, and cheques which must be certified, should be made payable to "The Commissioner of Patents, Ottawa." *In no case should money be inclosed with models.*

Fees, how to be transmitted.

Sec. 9. An application for a Patent must be proceeded with and perfected within two years after the lodging of the petition, in default of which it will be regarded as abandoned, as well as all proceedings had in relation thereto, and any fees paid will be held at the expiration of that period to be forfeited.

Limit of time for perfection of application.

Sec. 10. Two or more separate inventions can not be claimed in one application, or patented in one Patent. But if separate matters are represented to be so dependent on, and connected with each other as to be necessarily taken together, to obtain the end sought for by the inventor, the Commissioner of Patents shall be the judge whether or not the pretensions of the applicant in such respect can be entertained.

Separate inventions.

Sec. 11. The filing of a protest against the issuing of a Patent shall not be taken in itself as sufficient reason to withhold the granting of such Patent to an applicant.

Filing of a protest.

Sec. 12. A *Caveat* can only be filed by an inventor and shall be composed of a specification (*and drawings*), certified on oath [Form No. 23] and the applicant may, while it is pending, lodge additional papers, provided they relate exclusively to the same invention. The person filing a *Caveat* will not be entitled to notice of any application pending at the time of filing his *Caveat*. A *Caveat* must be limited to a single invention.

Caveat.

The specification of a *Caveat* should be sufficiently precise to enable the Office to judge whether there is a probable interference when a subsequent application is filed.

## Chap. 3.

*Patents of Invention.*

## Drawings.

Sec. 13. Drawings in duplicate to be attached to the duplicate specification must be made in India or carbon ink, on sheets of tracing linen (eight by thirteen inches), neatly executed and without colors. [Form No. 14.]

All drawings must be clear, sharp, well-defined, and not too fine.

Lines that are pale, ashy, very fine, ragged or rotten, give bad results when photo-lithographed.

Brush-shading, tinting and imitation surface graining should never be used; and in fine shading the result should be attained with as few lines as possible.

## Section lines.

Section lines also should be as open in their spacing as the case will admit of, and these, as well as all right lines, in order to insure clearness, should be made with a ruling pen. The shading of convex and concave surfaces may be dispensed with when the invention is otherwise well illustrated.

## Shade lines.

Shade lines may sometimes be used with good effect, but heavy shadows where they would obscure lines or letters of reference, should be avoided.

With each application an extra drawing must be supplied for the Patent Office Record, on a sheet of Bristol Board 8 by 13 inches, without writing on its face, merely the usual lettering; no title, certificate nor signatures; on the back of the sheet the name of the inventor and the title of the invention must be written in pencil.

Where several figures are furnished, any one figure which will best give a general idea of the invention will be sufficient.

## Card board.

The card board to be used must have a smooth or calendered surface; a sheet of "double thick Bristol Board," or "Whatman's drawing paper," is recommended.

The card board drawing should be rolled on a roller for transmission to the office, as folding will prevent its usefulness for photo-lithographing.

A sample card board drawing will be furnished on application.

## Re-issue under Section 23 of the Act.

Sec. 14. In the matter of a re-issue, under Section 23 of the Act, whatever is really embraced in the original application and so described or shown in the same, that it might have been embraced in the original Patent, may be ground for a re-issue. No new matter can be introduced into the specifications, nor shall the models or drawings be amended except each by the other. In the absence of model or drawing, the re-issue may contain amendments, upon satisfactory proof to the Commissioner that such amendments were part of the invention, although omitted in the original application. Separate patents may be issued for each separate and



*Patents of Invention.*

## Chap. 3.

distinct part of the invention, comprehended in the original patent.

Sec. 15. Information in relation to pending cases will be furnished only so far as it becomes necessary in conducting the business of the office. Pending cases.

Sec. 16. The office can not respond to inquiries as to the probability of an alleged invention being patented in advance of an application for a patent; nor to inquiries founded on brief or imperfect descriptions, propounded with a view of ascertaining whether alleged improvements have been patented, nor unless the name of the patentee and, as nearly as possible, the date of the patent, be given; nor can it act as an expounder of the Patent Law, nor as councillor for individuals, except as to questions within the office. Office can not respond to certain inquiries.

In order to avoid unnecessary explanations and useless loss of time and labor, it is particularly recommended that reference be made to the law before writing on any subject to the Patent Office.

A copy of the rules with a particular section marked, sent to any person making an inquiry, will be deemed a respectful answer by the Office.

Sec. 17. It is desirable, in the interest both of the applicant and of the public service, that the papers and drawings should be prepared by competent persons, as despatch and regularity in the proceedings will be thereby promoted. Papers and drawings.

Sec. 18. All business with this office should be transacted in writing. The action of the office will be based exclusively on the written record. No attention will be paid to any alleged verbal promise or understanding in relation to which there is any disagreement or doubt. Transactions to be in writing.

Sec. 19. Assignments of patents are to be accompanied by a copy thereof; the original will be kept in the Patent Office, and the copy will be returned to the person sending it, with certificate of registration thereon. Copy and original.

Sec. 20. All cases connected with the intricate and multifarious proceedings arising from the working of the Patent Office, which are not specially defined and provided for in these Rules, will be decided in accordance with the merits of each case under the authority of the Commissioner; and such decision will be communicated to the interested parties in writing. Oaths, how taken.

## APPENDIX OF FORMS.

---

 PETITIONS.
 

---

## FORM 1.

BY A SOLE INVENTOR.

*To the Commissioner of Patents, Ottawa :*

The petition of John Smith, of the City of Toronto, in the Province of Ontario, carpenter, sheweth :

That he hath invented new and useful improvements in machines for breaking stones, not known or used by others before his invention thereof, and not being in public use or on sale, with his consent or allowance as such inventor, for more than one year previous to his application, for a patent therefor in Canada.

Your petitioner therefore prays that a Patent may be granted to him for the said invention, as set forth in the specification in duplicate relating thereto, and, for the purposes of the Patent Act, your petitioner elects his domicile in the city of Ottawa, Province of Ontario.

JOHN SMITH.

TORONTO, 1st September, 1887.

---

 FORM 2.

BY JOINT INVENTORS.

*To the Commissioner of Patents, Ottawa :*

The petition of James Thomas, blacksmith, and George Robert Major, tinsmith, both of the city of Ottawa, in the County of Carleton, in the Province of Ontario, sheweth :

That they have jointly invented a new and useful improvement in the art or process of separating smut from wheat, not known or used by others before their invention thereof, and not being in public use or on sale, with their consent or allowance as such inventors for more than one year previous to their application for a patent therefor, in Canada.

Your petitioners, therefore, pray that a Patent may be granted to them jointly for the said invention as set forth

*Patents of Invention.*

## Chap. 3.

in the specification in duplicate relating thereto, and, for the purposes of the Patent Act, your petitioners elect their domicile in the city of Ottawa, Province of Ontario.

JAMES THOMAS,  
GEORGE ROBERT MAJOR.

OTTAWA, 1st September, 1887.

## FORM 3.

BY AN ASSIGNEE, OR LEGATEE "MUTATIS MUTANDIS."

*To the Commissioner of Patents, Ottawa :*

The petition of Solomon Lang, of the city of Boston, State of Massachusetts, one of the United States of America, laborer, showeth :

That Thomas Tardy, of the city of Ottawa, Province of Ontario, saloon keeper, hath invented new and useful improvements in planing machines not known or used by others before his invention thereof, and not being in public use or on sale, with the consent or allowance of the said Thomas Tardy as such inventor, for more than one year previous to this application, for a patent therefor in Canada,

That your petitioner, by assignment bearing date 1st September, 1887, acquired the right of obtaining a patent from Thomas Tardy, aforesaid, for the said invention.

Your petitioner therefore prays that a Patent may be granted to him, as the assignee of the said Thomas Tardy, for the said invention as set forth in the specification in duplicate relating thereto, and for the purposes of the Patent Act, your petitioner elects his domicile in the city of Ottawa, Province of Ontario.

SOLOMON LANG.

NEW YORK, 1st September, 1887.

## FORM 4.

BY AN INVENTOR AND AN ASSIGNEE.

*To the Commissioner of Patents, Ottawa :*

The petition of John Smith, of the city of Toronto, in the Province of Ontario, carpenter, and David Brown, of the city of New York, in the State of New York, one of the United States of America, painter, showeth :

That the said John Smith hath invented new and useful improvements in machines for breaking stones, not known

or used by others before his invention thereof, and not being in public use or on sale, with his consent or allowance as such inventor, for more than one year previous to this application, for a patent therefor in Canada.

That by assignment, dated on the 1st September, 1887, the said John Smith transferred to the said David Brown, an undivided one-half interest in the said invention.

Your petitioners therefore pray that a Patent may be granted to them jointly for the said invention as set forth in the specification in duplicate relating thereto and, for the purposes of the Patent Act, your petitioners elect their domicile in the city of Toronto, Province of Ontario.

JOHN SMITH,  
DAVID BROWN.

TORONTO, 1st September, 1887.

---

FORM 5.

BY AN ADMINISTRATOR OR EXECUTOR.

*To the Commissioner of Patents, Ottawa :*

The petition of James Clayton, of the city of Kingston, in the Province of Ontario, stone-cutter, administrator of the estate (or executor of the last will and testament) of Thomas Clayton, in his lifetime, of the said city of Kingston, deceased, millwright (as reference to the duly certified copy of letters of administration (or letters testamentary) hereto annexed will more fully appear), showeth :

That the said Thomas Clayton did invent a new and useful composition of matter for making artificial stone, not known or used by others before his invention thereof, and not being in public use or on sale, with the consent or allowance of the said Thomas Clayton as such inventor, for more than one year previous to this application for a patent therefor, in Canada.

Your petitioner therefore prays that a Patent may be granted to him as administrator (or executor) of the estate of the said Thomas Clayton for the said invention, as set forth in the specification in duplicate relating thereto, and, for the purposes of the Patent Act, your petitioner elects his domicile in the city of Ottawa, Province of Ontario.

JAMES CLAYTON.

KINGSTON, 1st September, 1887.

---

*Patents of Invention.*

Chap. 8.

## FORM 6.

FOR A RE-ISSUE (BY THE INVENTOR).

*To the Commissioner of Patents, Ottawa :*

The petition of Thomas Brown, of the city of Ottawa, in the Province of Ontario, lumber manufacturer, sheweth :

That your petitioner obtained a Patent bearing date the twelfth day of August, A.D. 1886, for a new and useful improvement in churns.

That your petitioner is advised that the said Patent is deemed defective or inoperative by reason of insufficient description or specification, and that the errors arose from inadvertence, accident or mistake, without any fraudulent or deceptive intention.

Your petitioner being desirous of obtaining a new Patent in accordance with an amended description and specification in duplicate, therefore prays that he may be allowed to surrender the aforesaid Patent, and a new Patent be granted to him, in accordance with the amended description and specification of the said invention, for the unexpired period for which the original patent was granted.

THOMAS BROWN.

OTTAWA, 1st September, 1887.

## FORM 7.

FOR A RE-ISSUE (BY THE ASSIGNEE).

*To the Commissioner of Patents :*

The petition of David Lane, of the town of Cobourg, in the County of Northumberland, Province of Ontario, tanner, sheweth :

That your petitioner, by assignment, bearing date the 24th day of June, 1887, obtained the exclusive right to a Patent granted to Thomas Tardy, of the city of Ottawa, Province of Ontario, broom maker, on the 1st of July, 1885, for new and useful improvements in planing machines.

That your petitioner is advised that the said Patent is deemed defective or inoperative by reason of insufficient description or specification, and that the error arose from inadvertence, accident or mistake, without any fraudulent or deceptive intention.

Your petitioner being desirous of obtaining a new Patent in accordance with an amended description and specification in duplicate, therefore prays that he may be allowed to

surrender the aforesaid Patent, and a new Patent be granted to him, as assignee of the said Thomas Tardy, in accordance with the amended description and specification of the said invention, for the unexpired period for which the original Patent was granted.

DAVID LANE.

COBOURG, 1st September, 1887.

(The above form is to be altered to suit the case, when the re-issue is to the administrator or executor of a deceased inventor.)

FORM 8.

SURRENDER TO BE WRITTEN ON THE ORIGINAL PATENT.

To all to whom these presents shall come, Thomas Brown, of the city of Ottawa, in the Province of Ontario, lumber manufacturer, within named, sends greeting :—

Whereas the within written Patent, for an improvement in churns, is deemed defective or inoperative by reason of insufficient description or specification, and the error arose from inadvertence, accident or mistake, without any fraudulent or deceptive intention, and the Commissioner of Patents accordingly, in pursuance of the Statute in such respect, hath agreed to accept the surrender of the same ;

Now know ye that the said Thomas Brown, within named, doth by these presents, surrender and yield up the within written Patent, granted to him for improvements in churns, and bearing date the 8th day of June, 1886.

In witness whereof the said Thomas Brown hath set his hand and affixed his seal this first day of September, A.D. 1887.

THOMAS BROWN. [L.S.]

Signed, sealed and delivered at the city of Ottawa, in the County of Carleton, in the Province of Ontario, in the presence of

HENRY COCKBURN.

*Patents of Invention.*

Chap. 8.

## FORM 9.

FOR THE CERTIFICATE OF PAYMENT OF FEE FOR FURTHER  
TERM (INVENTOR.)

*To the Commissioner of Patents, Ottawa :*

The petition of Martin Scott, of the city of Montreal, in the Province of Quebec, cooper, sheweth :

That on the 23rd June, 1883, your petitioner obtained a Patent for new and useful improvements in churns on which the partial fee for five (or ten) years was paid.

That he is the holder of the said Patent, and therefore prays that the usual certificate of payment of fee for a second (or third) term may be attached thereto.

Signed this first day of September, 1887.

MARTIN SCOTT.

## FORM 10.

FOR THE CERTIFICATE OF PAYMENT OF FEE FOR FURTHER  
TERM (ASSIGNEE.)

*To the Commissioner of Patents, Ottawa :*

The petition of Simon Smith, of the city of Halifax, in the Province of Nova Scotia, mariner, sheweth :

That by assignment, dated 1st July, 1887, he obtained from John Brown, of the village of Bridgetown, in the County of Annapolis, in the Province of Nova Scotia, stonemason, the exclusive right to a Patent granted on the 27th June, 1886, to the said John Brown, for new and useful improvements in ploughs, on which the partial fee for five (or ten) years was paid.

That your petitioner being the holder of the said Patent, therefore prays that the usual certificate of payment of fee for a second (or third) term may be attached thereto.

Signed this first day of September, 1887.

SIMON SMITH.

## FORM 11.

## POWER OF ATTORNEY.

*To the Commissioner of Patents, Ottawa :*

The undersigned, John Brown, of the town of Cornwall, in the County of Stormont, in the Province of Ontario, store-keeper, hereby appoints John Smith, of the city of Ottawa, Province of Ontario, his attorney, with full power of substitution and revocation, to prosecute an application for new and useful improvements in sewing machines ; to sign the drawings, to receive the Patent, and to transact all business in the Patent Office connected therewith.

Signed at Cornwall, this first day of September, 1887.

In the presence of

JOHN BROWN.

JOHN SMITH.

## FORM 12.

## REVOCATION OF POWER OF ATTORNEY.

*To the Commissioner of Patents, Ottawa :*

The undersigned, John Brown, of the town of Cornwall, in the County of Stormont, in the Province of Ontario, store-keeper, having on or about the 1st September, 1887, appointed John Smith, of the city of Ottawa, Province of Ontario, his attorney, to prosecute an application for a Patent for new and useful improvements on sewing machines, hereby revokes the power of attorney then given.

Signed at Cornwall, this thirteenth day of September, 1887,

In the presence of

JOHN BROWN.

JOHN SMITH.



## SPECIFICATIONS.

*(To be in Duplicate.)*

## FORM 13.

## FOR A MACHINE.

To all whom it may concern :

Be it known that I, William Woodworth, of the town of Poughkeepsie, in the County of Dutchess, in the State of New York, gentleman, have invented certain new and useful improvements in planing machines, and I do hereby declare that the following is a full, clear and exact description of the same.

Reference being made to the accompanying drawing in which :

Figure 1 is a side elevation of a machine embodying my invention.

Figure 2 is a plan of the same.

Figure 3 is an elevation showing the end of the machine which is at the right hand in figure 1.

Figure 4 is a vertical traverse section, showing those parts of the machine which are at the right hand of the line *x x* drawn across figures 1 and 2.

The first part of my invention relates to the combination of rotary cutters and feeding-rollers in such a manner that the said feeding-rollers shall be capable of feeding the lumber to the cutters, and also of effectually resisting the tendency of the cutters to draw the lumber upwards towards them ; the object of this part of my invention being to reduce the lumber operated upon to a uniformity of thickness, and give it a planed and even surface upon one side thereof.

The second part of my invention relates to the combination, with feeding-rollers and rotary cutters, for planing one of the principal surfaces of the lumber, of rotary machine cutters so as to form a tongue or groove, or both, upon the edge or edges of the lumber, at the same time that one of its principal surfaces is planed.

In the drawing, A is the frame of the machine, which frame should be substantially constructed to resist the vibrations of the operating parts. B is the driving pulley, which is hung on the main shaft C of the machine, from which latter, motion is communicated to the operating parts. D is the shaft of the rotary cutters by which the lumber is planed. This shaft is made flat upon two of its sides, between its bearings, for the reception of the cutters E, E, which are firmly secured to it by bolts *a a*, the holes

through these cutters for the reception of these bolts elongated in the direction of the width of the cutters to allow the necessary adjustment of the cutters. The shaft D is hung in adjustable bearings, by which it may be elevated and depressed to regulate the thickness of the planed lumber. F is a pulley on the shaft D, which receives motion from belt G, from the band-wheel H, on the driving shaft. I, I, J, J, are the feeding rollers, each pair of which is connected by finger pinions *b, b*, and the upper roller of each pair is hung in spring bearings, which allow it to yield slightly upward to the pressure, to adapt it to any differences or inequalities in the thickness of the lumber. The lower roller of each pair is provided with a worm wheel *c*, which meshes into a worm or endless screw *d* on the shaft *k*, which is propelled by a bevel wheel *l* on the main shaft, working into the bevel wheel *f* on the shank *k*.

L, M, are cutters hung upon vertical shafts N, O, one set of these cutters being adapted to form a groove, and the other to form a tongue upon the edge of the board to be operated upon. These cutters are attached to the shafts in the manner already described with relation to the cutters E, E.

The shafts N, O, are provided with pulleys *g, g*, and rotation is communicated to them by belts *h, h*, from pulleys *i, i*, on the main shaft; rotation being given in the direction of the arrow to the driving pulley.

The lumber to be planed is introduced from the end of the machine, which is shown at the right hand in figures 1 and 2, and being grasped by the rollers I, I, is by them drawn forward to the cutters E, E, which being rapidly revolved towards the advancing lumber, plane it to the proper thickness; and as the lumber continues to advance it is grasped by the rollers J, J, which aid in the feeding motion, and discharge the board after it has passed the cutters. The upper rollers I, J, being hung in spring bearings, always exert a pressure on the top of the board, and thus prevent it being raised up by the action of the cutters E, E.

When the lumber is designed for floors or ceilings, or other purposes for which it is required to be matched, a tongue is formed on one edge of it and a groove on the other by the cutters L, M, which both revolve towards the advancing board; and these operations are performed at the same time that the upper surface of the board is planed, the whole being done at a single operation.

When the lumber is required to be matched, it should be first reduced to a uniform width, and guided in its introduction into the machine by a gauge, P, attached to the bed, Q, of the machine.

*Patents of Invention.*

## Chap. 3.

When the lumber is not to be matched, this gauge and the cutters L, M, should be taken off and dispensed with.

I make no claim to the mode in which the cutters are secured upon their shaft, nor to the adjustable bearings, which permit of the elevation or depression of the shaft, for I am aware that these are not new; but what I claim as my invention, and desire to secure my patent, is:

1. The combination of the cutters E, E, and the feeding rollers I, I, J, J, substantially as and for the purpose hereinbefore set forth.

2. The combination, with the cutters E, E, and the feeding rollers I, I, J, J, of the cutters L, M, substantially as and for the purpose hereinbefore set forth.

WILLIAM WOODWORTH.

POUGHKEEPSIE, 1st September, 1887.

Signed in the presence of  
                           JETHRO WOOD, }  
                           OLIVER EVANS. }

FORM 14.

DRAWINGS.

*(To be in duplicate.)*

Each sheet on tracing linen shall contain the following: The title of the invention on the top of the sheet; the following certificate at the bottom: "Certified to be the drawings referred to in the specification hereunto annexed," and signed by the inventor or his attorney; place, date, and signature of two witnesses.

FORM 15.

FOR AN ART OR PROCESS.

To all whom it may concern:

Be it known that we, Marion Ellsworth, of Chicago, County of Cook, and State of Illinois, gentleman, and Joseph Richard Shaw, of Indianapolis, County of Marion, and State of Indiana, gentleman, have jointly invented a new and useful improvement in the art or process of separating smut and other impurities from wheat, and we do hereby declare that

---

*Patents of Invention.*

---

the following is a full, clear and exact description of the same :

Take of lime, newly slaked and while yet warm, one and a half pound to each one hundred pounds of wheat. Mix the lime well with the wheat, let it stand one hour, then pass it through a smut mill in the usual way and it will be found that all the lime, smut, dirt and other impurities of every kind attached to the wheat, and which no smut mill without our liming process will fully separate, will be entirely removed, and the flour will be as white and as sweet as though made from the best of wheat.

We are aware that lime has before been used for the purpose of cleaning wheat, being first mixed with the grain as above proposed and the whole being then passed through a smut mill ; but in all previous processes, so far as we are aware, the lime has been used in a cold state, and for this reason such processes prove ineffectual. We propose to take lime *newly slaked, and while yet warm.*

What we claim as our invention, and desire to secure by Patent, is: the process of cleaning wheat by mixing with it lime newly slaked and warm before passing it through a smut mill, so as to cleanse the wheat from all impurities, substantially as described.

MARION ELLSWORTH.  
JOSEPH R. SHAW.

CHICAGO, 1st September, 1887.

Signed in the presence of  
                                   MAURICE JONES, }  
                                   HENRY ELIAS.     }

— — —  
 FORM 16.

FOR A COMPOSITION OF MATTERS.

To all whom it may concern :

Be it known that I, Ebenezer Whitney, of the City of Charleston, in the District of Charleston and State of South Carolina, gentleman, am the administrator of the estate of Benjamin Browning, in his life time of the said city, gentleman, and that the said Benjamin Browning did invent a certain new and useful composition of matter to be used in the manufacture of wool, and I do hereby declare that the following is a full, clear and exact description of the same :

The nature of the invention of the said Benjamin Browning consists of mixing olive, lard or rape-seed oil, with a solution of oil soap dissolved in hot water.

To prepare the wool oil, take a quantity of oil soap of any kind, provided the quality is good, and dissolve the same in hot water, say about thirty pounds of oil soap in thirty gallons of water, or a sufficient quantity of soap to saturate the water. Then take equal parts, by measure, of olive, lard, rapeseed, or any other kind of oil which can be used on wool in the process of its manufacture, and mix it with the preparation aforesaid, to wit, the soap solution; which, after such mixture, is ready to be used on wool with as beneficial an effect as if pure oil only had been used. This wool oil will not decompose by age, because the oil of soap neutralizes the stearine in the oil, hence there is nothing to decompose. And for the same reason spontaneous combustion cannot be produced.

What I claim as the invention of the said Benjamin Browning, and desire to secure by Patent is: a compound composed of any of the oils ordinarily used on wool in its manufacture, and a solution of oil soap, substantially in the proportions and for the purposes set forth.

EBENEZER WHITNEY,  
*Administrator.*

CHARLESTON, 1st September, 1887.

Signed in presence of

JOHN JAMES,  
HENRY SMITH. }

### OATHS.

NOTE.—Where oaths are made out of Canada, and before a judge, the seal of the court, presided over by such judge, should be affixed, and if before a notary public, his seal should be affixed to such oaths.

When the invention has been assigned before the issue of Patent the affidavit must be made by the “inventor,” not by the “assignee.”

If the inventor is dead, the administrator or executor will make the affidavit that the person named as inventor was the inventor.

## FORM 17.

BY SOLE INVENTOR FOR HIMSELF.

CANADA,  
 PROVINCE OF ONTARIO, }  
*County of York.*

I, John Smith, of the City of Toronto, in the County of York, in the Province of Ontario, carpenter, make oath and say, that I verily believe that I am the inventor of the new and useful improvements in machines for breaking stone, described and claimed in the specification in duplicate relating thereto, and for which I solicit a Patent by my petition, dated 1st of September, 1887. And I further say that the several allegations contained in the said petition are respectively true and correct.

JOHN SMITH.

Sworn before me, at the City of Toronto, the first day of September, 1887.

THOMAS BROWN,  
 J. P. for the County of York.

## FORM. 18.

JOINT INVENTORS.

CANADA,  
 PROVINCE OF ONTARIO, }  
*County of Carleton.*

We, James Thomas, of the City of Ottawa, in the County of Carleton, in the Province of Ontario, in the Dominion of Canada, blacksmith, and George Robert Major, of the same place, tinsmith, do hereby severally make oath and say,

1st. I, this deponent, James Thomas, for myself do hereby make oath and say that I verily believe that I and the said George Robert Major are the inventors of the new and useful improvement in the art or process of separating smut from wheat, described and claimed in the specification in duplicate relating thereto, for which we solicit a Patent by our petition to the Commissioner of Patents, dated first September, 1887. And I further say that the several allegations contained in the said petition are respectively true and correct.

*Patents of Invention.*

Chap. 3.

2nd. I, this deponent, George Robert Major, for myself do hereby make oath and say that I verily believe that I and the above named James Thomas are the inventors of the new and useful improvement in the art or process of separating smut from wheat, described and claimed in the specification in duplicate, relating thereto, for which we solicit a patent by our petition to the Commissioner of Patents, dated first September, 1887. And I further say that the several allegations contained in the said petition are respectively true and correct.

JAMES THOMAS.

GEORGE ROBERT MAJOR.

Sworn before me, by the said James Thomas and George Robert Major, this first day of September, 1887, at the City of Ottawa.

JOHN SMITH,

J. P. for the County of Carleton.

## FORM 19.

BY SOLE INVENTOR FOR HIMSELF AND ASSIGNEE.

CANADA,  
 PROVINCE OF ONTARIO, }  
*County of York.*

I, John Smith, of the City of Toronto, in the County of York, in the Province of Ontario, carpenter, make oath and say, that I verily believe that I am the inventor of the new and useful improvements in machines for breaking stone, described and claimed in the specification in duplicate relating thereto, and for which I (and Edwin Morrison) solicit a Patent by our petition, dated 1st of September, 1887. And I further say that the several allegations contained in the said petition are respectively true and correct.

JOHN SMITH.

Sworn before me, at the City of Toronto, the first day September, 1887.

THOMAS BROWN,

J. P. for the County of York.

## FORM 20.

BY SOLE INVENTOR FOR ASSIGNEE ONLY.

CANADA,  
 PROVINCE OF ONTARIO, }  
*County of York.*

I, John Smith, of the City of Toronto, in the County of York, in the Province of Ontario, carpenter, make oath and say, that I verily believe that I am the inventor of the new and useful improvements in machines for breaking stone, described and claimed in the specification in duplicate relating thereto, and for which James Goodwin solicits a Patent by his petition, dated 1st of September, 1887. And I further say that the several allegations contained in the said petition are respectively true and correct.

JOHN SMITH.

Sworn before me, at the City of Toronto, the first day September, 1887.

THOMAS BROWN,  
 J. P. for the County of York.

## FORM 21.

FOR A RE-ISSUE (INVENTOR).

CANADA,  
 PROVINCE OF ONTARIO, }  
*County of Carleton.*

I, Thomas Brown, of the City of Ottawa, in the Province of Ontario, lumber manufacturer, make oath and say that the several allegations contained in my petition to the Commissioner of Patents, dated first September, 1887, for a re-issue of the Patent granted to me on the 4th of September, 1886, for a new and useful improvement in churns are respectively true and correct ;

That I am the sole owner of the said Patent ;

And that I am the inventor of the improvement set forth and claimed in the amended specification in duplicate relating thereto.

THOMAS BROWN.

Sworn before me, at the City of Ottawa, in the County of Carleton, in the Province of Ontario, this first day of September, 1887.

WILLIAM MILLS,  
 J. P. for the County of Carleton.

NOTE.—If the patent has not been exclusively assigned, the affidavit must state that the application for re-issue is made with the consent of all the assignees.



*Patents of Invention.*

Chap. 3.

## FORM 22.

FOR A RE-ISSUE (ASSIGNEE OF THE ENTIRE INTEREST.)

CANADA,  
 PROVINCE OF ONTARIO, }  
*County of Carleton.*

I, David Lane, of the Town of Cobourg, in the County of Northumberland, Province of Ontario, tanner, make oath and say that the several allegations contained in my petition to the Commissioner of Patents, dated 1st September, 1887, for a re-issue of the Patent granted to Thomas Tardy, of the City of Ottawa, Province of Ontario, broom maker, for new and useful improvements in planing machines, are respectively true and correct ;

That I am the sole owner of the said Patent ;

And that Thomas Tardy was the inventor of the improvements set forth and claimed in the amended specification in duplicate relating thereto.

DAVID LANE.

Sworn before me, at the Town of Cobourg, in the County of Northumberland, Province of Ontario, this first day of September, 1887.

THOMAS PARSONS,

J. P. for the County of Northumberland.

## FORM 23.

## CAVEAT.

*To the Commissioner of Patents, Ottawa :*

The undersigned, James Thompson, of New Edinburgh, in the County of Russell, in the Province of Ontario, school teacher, an intending applicant for a Patent, who has made certain new and useful improvements in locomotive engines, and has not perfected his invention, prays that his specification may be filed as a *Caveat* in the Patent Office. (Here describe the invention as far as possible, and refer to letters in drawing, as in specification given before. Form No. 13.)

JAMES THOMPSON.

CANADA, }  
 PROVINCE OF ONTARIO, }  
*County of Russell.* }

I, James Thompson, of New Edinburgh, in the County of Russell, Province of Ontario, school teacher, make oath and say that I am the inventor of the invention described in the foregoing specification, and that the allegations contained therein are respectively true and correct.

JAMES THOMPSON.

Sworn before me, at New Edinburgh, the first day of September, 1887.

ALEXANDER BUSH,  
 J. P. for the County of Russell.

— — —  
 ASSIGNMENTS.

FORM 22.

OF AN ENTIRE INTEREST (OR AN UNDIVIDED ONE-HALF INTEREST) IN AN INVENTION BEFORE THE ISSUE OF PATENT.

In consideration of the sum of ten dollars, to me paid by Solomon Lang, of the City of Montreal, I do hereby sell and assign to the said Solomon Lang all (or an undivided half of all) my right, title and interest in and to my invention for new and useful improvements in planing machines, as fully set forth and described in the specification which I have signed preparatory to obtaining a Patent. And I do hereby authorize and request the Commissioner of Patents, to issue the said Patent to the said Solomon Lang (or jointly to myself and the said Solomon Lang) in accordance with this assignment.

Witness my hand and seal this first day of September, 1887, at the City of Montreal.

THOMAS LORD [L.S.]

— — —  
 FORM 23.

OF AN ENTIRE INTEREST IN A PATENT.

In consideration of five hundred dollars, to me paid by Nathan Wilcox, of Keokuk, Iowa, I do hereby sell and assign to the said Nathan Wilcox, all my right, title and interest in and to the Patent of Canada, No. 23,460, for an

*Patents of Invention.*

Chap. 3.

improvement in locomotive head lights, granted to me July 30, 1878, the same to be held by and enjoyed by the said Nathan Wilcox to the full end of the term for which said Patent is granted, as fully and entirely as the same could have been held and enjoyed by me if this assignment and sale had not been made.

Witness my hand and seal this first day of September, 1887, at Keokuk, Iowa.

HORACE KIMBALL [L.S.]

## FORM 24.

## DISCLAIMER.

(*To be in duplicate.*)

I, William Lookup, of the City of Hull, in the County of Ottawa, Province of Quebec, having on the 1st September, 1887, obtained a patent for the Dominion of Canada, for new and useful improvements in waggon brakes;

And through mistake, accident or inadvertence, without any wilful intent to defraud or mislead the public, I have made the claim in my specification too broad (or as being the inventor of a material or substantial part of the invention patented of which I was not the inventor, and to which I had no legal right);

I, therefore, hereby disclaim the part of the claim in the specification, which is in the following words:

"I also claim the use of the lever A, in combination with crank D, as described."

WILLIAM LOOKUP.

HULL, 30th September, 1887.

Signed in duplicate in the }  
presence of }

DAVID BROWN,  
FRANCIS LEMIEUX.

O. C., Sep. 4, 1872, part.

TITLE OF INVENTION.

FIG. 1.

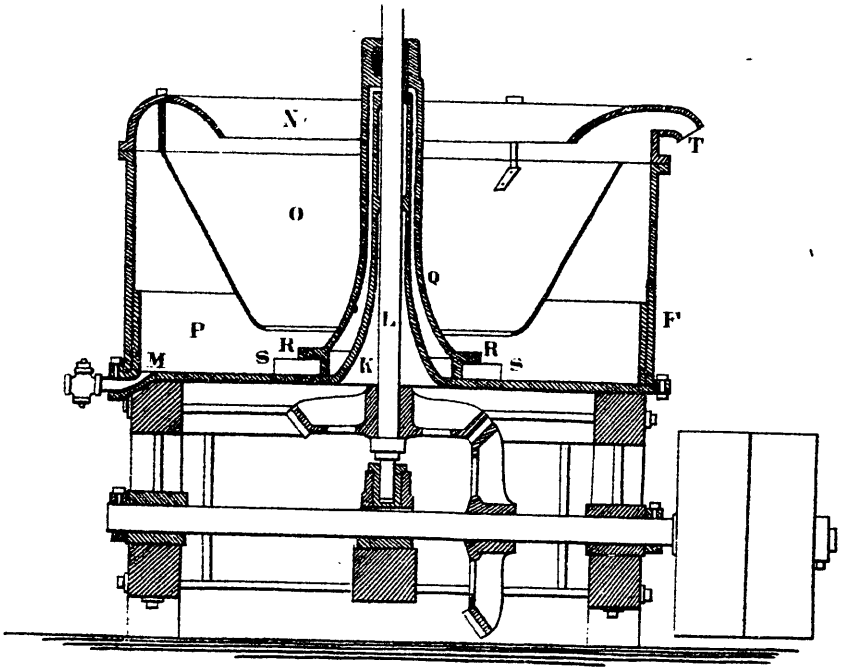
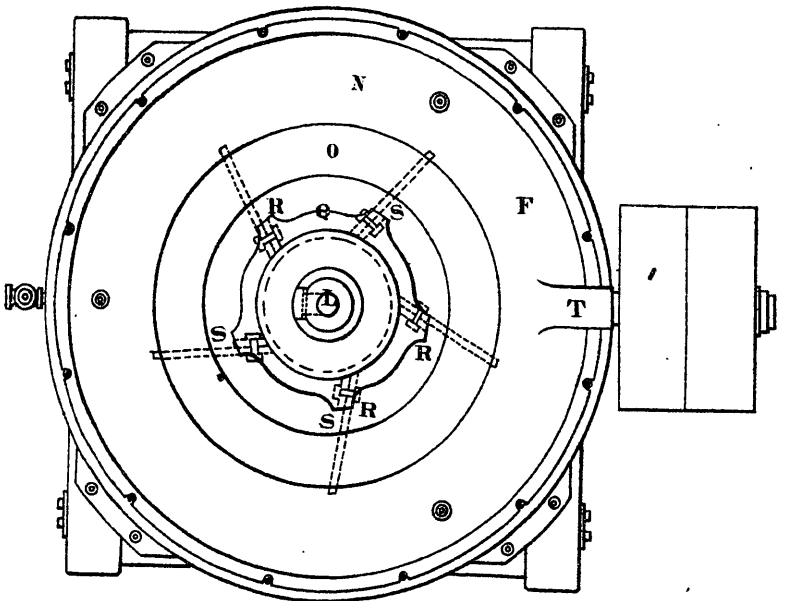

FIG. 2.



Certified to be the Drawings referred to in the specification hereunto annexed.

(Place and date.)

(Signature of two witnesses.)

(Signature of Inventor or his Attorney.)

This chap. revised by me dated  
3<sup>d</sup> day of Sept 1907 -

## CHAPTER 4.

### COPYRIGHT

#### RULES AND FORMS.

Government House, Ottawa,  
The 12th day of May, 1888.

On the recommendation of the Minister of Agriculture and under the provisions of Chapter 62 of the Revised Statutes of Canada, intituled "The Copyright Act,"

His Excellency in Council has been pleased to approve the following Rules and Forms:—

#### GENERAL RULES.

Section 1. There is no necessity for any personal appearance at the Department of Agriculture, unless specially Transactions to be in writing. called for by order of the Minister or the Deputy, every transaction being carried on by writing.

Sec. 2. In every case the applicant or depositor of any paper is responsible for the merits of his allegations and for Responsibility of applicant. the validity of the instruments furnished by him or his agent.

Sec. 3. The correspondence is carried on with the applicant, or with ~~the agent who has remitted or transmitted the papers to the office, but with one person only.~~ Correspondence. *to be done by agent*

Sec. 4. All papers are to be clearly and neatly written on foolscap paper, and every word of them is to be distinctly legible, in order that no difficulty shall be met with in the taking cognizance of, and in the registering and copying of them. Papers, how to be prepared.

Sec. 5. All copies of books deposited in accordance with Section 9 of "The Copyright Act," must be furnished with board covers or full bound, and all copies of maps deposited must be mounted. Copies of books, &c.

Sec. 6. All communications are to be addressed in the following words: *To the Minister of Agriculture, (Copyright Branch,) Ottawa.* Address.

Assignments,  
how to be  
made.

Sec. 7. In preparing an assignment in duplicate pursuant to Section 15 of "The Copyright Act," care should be taken to allow on the back of the document a sufficient space for the insertion of the certificate.

Forms of  
proceedings.

Sec. 8. As regards proceedings not specially provided for in the following forms, any form being conformable to the letter and spirit of the law will be accepted, and if not conformable will be returned for correction.

Inquiries,  
how  
answered.

Sec. 9. A copy of the Act and the Rules with a particular section marked, sent to any person making an inquiry is intended as a respectful answer by the office.

## APPENDIX OF FORMS.

### REGISTRATION OF COPYRIGHTS.

#### FORM 1.

An application for the registration of a Copyright *if made by the proprietor himself*, shall be made after the following form: --

*To the Minister of Agriculture,  
(Copyright Branch),  
Ottawa.*

I (*name of person*), domiciled in *Canada*, (*state the place and province*) or *in any part of the British Possessions* (*state the place*), or *being a citizen of any country*, (*state the country*); which has an *International Copyright treaty with the United Kingdom*, (*as the case may be*) hereby declare that I am the proprietor of the (*book, map, chart, &c., &c., as the case may be*), called (*title or name as the case may be*) and that the said (*book, map, &c., as the case may be*) has been published in *Canada* by (*name of the publisher thereof*) in the (*name of the locality where the publication has taken place*) in the Province of (*Quebec, Nova Scotia, New Brunswick, &c., as the case may be*) and hereby request the Registration of the same, and for that purpose I herewith forward the fee required by "The Copyright Act," together with two copies of the (*book, map, chart, &c., as the case may be, if the object is a painting, a sculpture or any other work of art, a written description of such work of art.*)

In testimony thereof, I have signed in the presence of the two undersigned witnesses at the place and date hereunder mentioned.

(Place and date)

(Signature of the proprietor.)

Signature of the two witnesses. }

## Copyright.

## Chap. 4.

## FORM 2.

An application for the Registration of a Copyright, *if made by the agent of the proprietor*, shall be made after the following form:—

*To the Minister of Agriculture,  
(Copyright Branch),  
Ottawa.*

The undersigned, resident in the (*designation and name of the locality and Province where the agent resides*) being the Agent authorized by (*name of the proprietor, stating where domiciled in Canada or in any part of the British Possessions, or being a citizen of any country (state the country) which has an International Copyright treaty with the United Kingdom, (as the case may be)*) hereby declare that (*name of the proprietor*) is the proprietor of the (*book, map, chart, &c., &c., as the case may be,*) called (*title or name, as the case may be*) and that the said (*book, map, chart, &c., as the case may be*) has been published in Canada by (*name of the publisher thereof*) in the (*designation and name of the locality where the publication has taken place*) in the Province of (*Ontario, Quebec, Nova Scotia, New Brunswick, &c., as the case may be*) and hereby request the registration of the same, and for that purpose I herewith forward the fee required by "The Copyright Act," together with two copies of the (*book, map, chart, &c., &c., as the case may be, if the object is a painting, a sculpture, or any other work of art, a written description of such work of art*).

In testimony thereof I have signed this application in the presence of the two undersigned witnesses at the place and date hereunder mentioned.

(*Place and Date.*)

(Signature of the agent of the proprietor.)

Signature of the two witnesses. }

## Chap. 4.

## Copyright

## FORM 3.

## REGISTRATION OF INTERIM COPYRIGHT.

An application for the registration of an Interim Copyright, if made by the proprietor himself, shall be made after the following form :

To the Minister of Agriculture,  
(Copyright Branch,)  
Ottawa.

I (name of person) domiciled in Canada, (state the place and Province,) or in any part of the British Possessions (state the place) or being a citizen of any country (state the country), which has an International Copyright treaty with the United Kingdom, as the case may be) hereby declare that I am the proprietor of a (book, map, chart, &c., as the case may be) called (title or name as the case may be) for which I hereby request a privilege of an Interim Copyright, in the terms of the Act, and for that purpose, I herewith forward the fee required by "The Copyright Act," together with a copy of the title of the said (Book, Map, Chart, &c., as the case may be).

In testimony thereof I have signed, in the presence of the two undersigned witnesses, at the place and date hereunder mentioned.

(Place and date) (Signature of the proprietor).  
Signature of the two witnesses. }

## FORM 4.

An application for the registration of an Interim Copyright, if made by the agent of the proprietor, shall be made after the following form :—

To the Minister of Agriculture,  
(Copyright Branch,)  
Ottawa.

The undersigned, resident in the (designation and names of the locality and province where the agent resides) being the agent authorized by (name of the proprietor, stating where domiciled, in Canada or in any part of the British Possessions, or being a citizen of any country (state the country) which has an International Copyright treaty with the United Kingdom, as the case may be) hereby declare that (name of the



*Copyright.*

## Chap. 4.

*proprietor*) is the proprietor of the (*book, map, chart, &c., &c., as the case may be*) called (*title or name, as the case may be*), for which I hereby request the privilege of an Interim Copyright, in the terms of the Act, and for that purpose I herewith forward the fee required by "The Copyright Act," together with a copy of the title of the said (*book, map, chart, &c., &c., as the case may be*).

In testimony thereof I have signed in the presence of the two undersigned witnesses, at the place and date hereunder mentioned.

(*Place and Date.*)

(Signature of the agent of the proprietor.)

Signature of the two witnesses. }

## FORM 5.

## REGISTRATION OF TEMPORARY COPYRIGHTS.

An application for the registration of a Temporary Copyright, if *made by the proprietor himself*, shall be made after the following form :

*To the Minister of Agriculture,  
(Copyright Branch,)  
Ottawa.*

I (*name of person*) domiciled in *Canada, (state the place and Province), or any part of the British Possessions, (state the place), or being a citizen of any country, (state the country), which has an International Copyright treaty with the United Kingdom, (as the case may be)* hereby declare that I am the proprietor of the (*book, story, novel, &c., &c., as the case may be*) called (*title or name*) which is now being preliminarily published in separate articles, in the (*state the name, place and Province of the newspaper or periodical in which the work is being published*) for which I hereby request the privilege of a Temporary Copyright in the terms of the Act, and for that purpose I herewith forward the fee required by "The Copyright Act," together with a short analysis of the said work.

In testimony thereof I have signed in the presence of the two undersigned witnesses, at the place and date hereunder mentioned.

(*Place and date.*)

(Signature of the proprietor.)

Signature of the two witnesses. }

## FORM 6.

An application for the Registration of a Temporary Copyright, *if made by the agent of the proprietor*, shall be made after the following form :

*To the Minister of Agriculture,  
(Copyright Branch,)  
Ottawa.*

The undersigned, resident in the (*designation and name of the locality and Province where the agent resides*) being the agent authorized by (*name of the proprietor stating where domiciled, in Canada, or in any part of the British Possessions, or being a citizen of any country, (state the country), which has an International Copyright treaty with the United Kingdom, as the case may be*) hereby declare that (*name of the proprietor*) is the proprietor of the (*book, story, novel, &c., &c., as the case may be*) called (*title or name*) which is now being preliminarily published in separate articles in the (*state the name, place and Province of the newspaper or periodical in which the work is being published*) for which I hereby request the privilege of a Temporary Copyright, in the terms of the Act, and for that purpose I herewith forward the fee required by "The Copyright Act" together with a short analysis of the said work.

In testimony thereof, I have signed in the presence of the two undersigned witnesses, at the place and date hereunder mentioned.

*(Place and date.)*

*(Signature of the agent of the proprietor.)*

Signature of the two witnesses. }

O. C., April 12, 1887.

Re-considered. by C, date - 25-7 Oct  
1407 - Regulations etc

## CHAPTER 5.

### TRADE MARKS AND DESIGNS AND TIMBER MARKS.

#### RULES AND FORMS.

Government House, Ottawa.

The 12th day of May, 1888.

On the recommendation of the Minister of Agriculture and under the provisions of Chapters 63 and 64 of the Revised Statutes of Canada, intituled "The Trade Mark and Design Act," and "An Act respecting the Marking of Timber."

His Excellency in Council has been pleased to approve the following Rules, Regulations and Forms :

#### GENERAL RULES.

Section 1. There is no necessity for any personal appearance at the Department of Agriculture, unless specially called for by order of the Minister or the Deputy, every transaction being carried on by writing. Transactions to be in writing.

Sec. 2. In every case the applicant or depositor of any paper is responsible for the merits of his allegations and of the validity of the instruments furnished by him or his agent. Responsibility of applicant.

Sec. 3. The correspondence is carried on with the applicant, or with the agent who has remitted or transmitted the papers to the office, but with one person only. Correspondence.

Sec. 4. All papers are to be clearly and neatly written on foolscap paper, and every word of them is to be distinctly legible, in order that no difficulty shall be met with in the taking cognizance of, and in the registering and copying of them. Papers, how to be prepared.

Sec. 5. All communications are to be addressed in the following words :—*To the Minister of Agriculture (Trade Mark and Copyright Branch), Ottawa.* Address.

Sec. 6. As regards proceedings not specially provided for in the following forms, any form being conformable to the Forms of proceedings.

## Chap. 5.

*Trade Marks and Designs and Timber Marks.*

letter and spirit of the law will be accepted, and if not so conformable will be returned for correction.

Inquiries, how answered.

Sec. 7. A copy of the Act and the Rules with a particular section marked, sent to any person making an inquiry, is intended as a respectful answer by the office.

## APPENDIX OF FORMS.

## REGISTRATION OF TRADE MARKS.

## FORM 1.

An application for the registration of a *General Trade Mark* shall be made *in duplicate* after the following form:—

*To the Minister of Agriculture,  
(Trade Mark and Copyright Branch),  
Ottawa.*

I, (name of person), of the (city, town, or other locality, as the case may be), in (name of county, province or state, as the case may be), hereby furnish a duplicate copy of a *General Trade Mark*, in accordance with sections 4 and 9 of "The Trade Mark and Design Act," which I verily believe is mine, on account of having been the first to make use of the same, (or on account of having acquired it from, (naming the person,) whom I verily believe to be the original proprietor thereof).

The said *General Trade Mark* consists (here must be inserted a description of the Trade Mark, recital of the motto or mottos, &c., &c., in order to explain the pattern furnished) and I hereby request the said *General Trade Mark* to be registered in accordance with the law.

I forward herewith, the fee of \$30, in accordance with Section 10 of "The Trade Mark and Design Act."

In testimony thereof, I have signed in the presence of the two undersigned witnesses, at the place and date hereunder mentioned.

(Place and date.)

Signature of the two witnesses. } (Signature of the Proprietor.)

*Trade Marks and Designs and Timber Marks.*

Chap. 5.

## FORM 2.

An application for the Registration of a *Specific Trade Mark* shall be made *in duplicate* after the following form :—

*To the Minister of Agriculture,  
(Trade Mark and Copyright Branch),  
Ottawa.*

I, (*name of person*), of the (*city, town, or other locality, as the case may be*), in (*name of county, province or state, as the case may be*), hereby furnish a duplicate copy of a *Specific Trade Mark*, to be applied to the sale of (*description of the class of merchandise*), in accordance with sections 4 and 9 of "The Trade Mark and Design Act," which I verily believe is mine, on account of having been the first to make use of the same (*or on account of having acquired it from, (naming the person,) whom I verily believe to be the original proprietor thereof*).

The said *Specific Trade Mark* consists (*here must be inserted a description of the Trade Mark, recital of the motto or mottoes, &c., &c., in order to explain the pattern furnished*), and I hereby request the said *Specific Trade Mark* to be registered in accordance with the law.

I forward herewith the fee of \$25, in accordance with section 10 of "The Trade Mark and Design Act."

In testimony thereof, I have signed, in the presence of the two undersigned witnesses, at the place and date hereunder mentioned.

(*Place and date.*)

(Signature of the proprietor.)

Signature of the two witnesses. }

## FORM 3.

## REGISTRATION OF INDUSTRIAL DESIGNS.

An application for the registration of an *Industrial Design* shall be made *in duplicate*, after the following form :—

*To the Minister of Agriculture,  
(Trade Mark and Copyright Branch),  
Ottawa.*

I, (*name of the person*), being a resident of Canada, and now residing in the (*city, town or other locality, as the case may be*), in the (*name of the Province, as the case may be*), hereby declare that I am the proprietor of the *Industrial Design* of

## Chap. 5.

*Trade Marks and Designs and Timber Marks.*

which duplicate copies are herewith forwarded, and which consists (*here insert a description of the design, and an explanation of its use*), and I hereby request that the said Industrial Design be registered in accordance with the law.

I forward herewith the fee of \$5, in accordance with Section 26 of "The Trade Mark and Design Act."

In testimony thereof, I have signed, in the presence of the two undersigned witnesses, at the place and date hereunder mentioned.

(Place and date.)

(Signature of the proprietor.)

Signature of the two witnesses. }

}

## FORM 4.

## REGISTRATION OF TIMBER MARKS.

An application for the registration of a Timber Mark or Marks shall be made *in duplicate* after the following form:—

To the Minister of Agriculture,  
(Trade Mark and Copyright Branch),  
Ottawa.

I, (*name of person or firm*), of (*residence*), engaged in the business of lumbering (*or getting out timber and floating or rafting the same*), within the Provinces of Ontario and Quebec, hereby request the registration of the accompanying Timber Mark (*or Marks*), which I (*name of person or firm*) declare was not in use, to my knowledge, by any other person than myself at the time of my adoption thereof, and of which the following are a description and drawing (*or impression*), in duplicate.

I herewith forward the fee of \$2.00 required by "An Act respecting the Marking of Timber."

In testimony thereof, I have signed this application in the presence of the two undersigned witnesses at the place and date hereunder mentioned.

(Place and date.)

(Signature of the proprietor.)

Signature of the two witnesses. }

}

O. C. May 9, 1887.

Revised by A.C. dated 20<sup>th</sup> June  
1877.

## CHAPTER 6.

### QUARANTINE REGULATIONS—GENERAL.

Government House, Ottawa,

The 12th day of May, 1888.

On the recommendation of the Minister of Agriculture and under the provisions of Chapter 68 of the Revised Statutes of Canada, intituled "An Act respecting Quarantine;"—

His Excellency in Council has been pleased to make the following Regulations:—

#### REGULATIONS FOR QUEBEC, HALIFAX AND ST. JOHN.

##### *Vessels coming up the St. Lawrence.*

Section I. That all boats, ships and other vessels, except the Canadian mail steamers, which henceforth and during the eight months next following the first day of April in each and every year shall arrive in the port of Quebec, from any port or ports, place or places, in Europe or elsewhere out of Canada, by way of that part of the River St. Lawrence which is below Grosse Isle, and which shall have at the time of their said arrival, or shall have had during their passage from the places where they respectively cleared, any person on board laboring under Asiatic cholera, fever, small pox, scarlatina or measles, or other infectious and dangerous disease, or on board of which any person shall have died during such passage, or which, being of less tonnage than seven hundred tons measurement, shall have on board thirteen or more steerage passengers, or which being of greater tonnage than seven hundred tons measurement, shall have on board fifty or more steerage passengers or which shall have come from some infected port, shall make their quarantine at Grosse Isle in the River St. Lawrence, and there remain and continue until such boats, ships or vessels shall be discharged from such quarantine, by such license or passport, and discharge, given without fee or emolument of any kind, as shall be directed or permitted by such order or orders as shall be made by the Governor, with the advice of the Privy Council and until the said boats, ships and vessels shall respectively have performed such quarantine, and shall be discharged therefrom by such license or passport and discharge as aforesaid, persons, goods or merchandise, which shall be on board such boats, ships or vessels, shall not come or be brought on shore, or go or be put on board of any other ship or

Vessels having, or having had on board Asiatic cholera, fever, small-pox, scarletina or measles or other infectious or dangerous disease, or having come from an infected port.

## Chap. 6.

*Quarantine Regulations—General.*

vessel in Canada, except on Grosse Isle aforesaid, when duly required by competent authority.

*Port of Quebec.*

Further quarantine at Quebec.

Sec. 2. That all boats, ships and vessels which henceforth and during the eight months aforesaid, shall arrive at the port of Quebec, from any port or ports in Europe, place or places, or elsewhere as aforesaid, of the class or description hereinbefore mentioned, as liable and bound to make their quarantine at Grosse Isle, do make their further quarantine in the harbor of Quebec, according to the Regulations hereinafter provided.

*Grosse Isle.*

Quarantine limits and districts described.

Sec. 3. All boats, ships and vessels of the class and description hereinbefore mentioned, as liable to make their quarantine at Grosse Isle shall anchor within the space included between Grosse Isle and a line drawn parallel to it, through the red buoy, to be placed as heretofore under the direction of the superintendent of pilots, and bounded on the east and west by lines drawn due south from the western extremities of Cliff Island and Grosse Isle. The island shall be so divided as to leave one portion thereof for the hospitals, and for the treatment and reception of those who are laboring under or who are threatened with any of the following diseases, namely: Asiatic cholera, fever, small pox, scarlatina or measles, or any other infectious and dangerous disease; and the remaining portion for the reception and accommodation of all passengers and other persons who shall be landed and detained upon the said island, who shall not labor under or be threatened with any of the said diseases, and no person or persons, unless on duty, shall be permitted to pass from one of the said portions of the said island to the other, unless they have passports signed by the medical superintendent.

*Establishment at Grosse Isle.*

Medical superintendent and other officers comprising the quarantine establishment at Grosse Isle.

Sec. 4. The establishment at Grosse Isle shall consist of a medical superintendent, an hospital steward, and such officers, employes and orderlies as may be appointed or employed to meet the exigencies of the service. The medical superintendent shall be authorized to see the quarantine duly performed, and for this purpose shall have full power and authority over all officers and other persons whatsoever in Grosse Isle, or attached to that station, and be authorized to call upon all persons to aid him in enforcing the law and these regulations, and in case of his death, sickness or absence, the officer next in rank employed on the island, shall have the power and authority aforesaid.



*Medical Superintendent.*

Sec. 5. The medical superintendent (or in case of his death, sickness or absence, the officer next in rank employed on the Island) shall enforce the said law and these regulations, and shall direct boats, ships or vessels to go to such place or places to perform quarantine, as it may be necessary to send them to. He shall direct all boats, ships or vessels, liable to perform quarantine, to be brought to anchor within the limits of the quarantine anchorage, and generally to do all that may be required to enforce rigid obedience to the said law and these regulations. He shall permit all passengers, or other persons landed on the said island, to be re-embarked or shipped on board any steam-boat or other vessel when the vessel is in a fit state to receive them, and that they have been examined by him and found in a fit state for re-embarkation or for leaving the said island and that all such passengers and persons, with their luggage, have been washed, cleansed, and purified, and that there does not exist amongst those who are about to proceed, or leave the said island, any case or symptoms of Asiatic cholera, fever, small-pox, scarlatina or measles, or other infectious and dangerous disease.

Duties and requirements of medical superintendent.

He shall also go off to vessels bound to make their quarantine at Grosse Isle as aforesaid, and put the following questions to the masters or persons in charge, viz. :

Questions to be put to master or person in charge of vessel.

1. What is your name and that of your vessel ?
2. From whence did you sail, and date ?
3. What is your cargo, and whence taken on board ?
4. At what place or places did your vessel touch in her voyage ?
5. Was such place or places, or any and which of them, infected with the cholera, plague, or any pestilential fever or disease ?
6. How many persons were on board when the vessel sailed ?

Cabin passengers ?

Steerage passengers ?

Crew ?

7. Have any person or persons during the voyage been infected ? or are there now any infected with the cholera, plague or any pestilential fever or disease ?

8. Did any person or persons, and how many die during the voyage, and from what distemper ?

9. Did you or any of the ship's company or passengers, with your privity, go on board any ship or vessel, or did any of the company of any ship or vessel come on board your ship in the voyage, and from what port did she sail last ?

## Chap. 6.

*Quarantine Regulations—General.*

10. Did you or any of your ship's company or passengers with or without your privity or consent, land at any place within Canada ?

11. Have you any person on board who is lunatic, idiotic, deaf and dumb, blind or infirm, and are such accompanied by relations able to support them ?

Clean bill of health, when refused.

If the answers be satisfactory, he shall give a clean bill of health to the master or person in charge ; and such vessels may then proceed to the harbor of Quebec. If the answers be not satisfactory, or the medical superintendent has any reason to suspect fraud on the part of the master or person in charge, crew or passengers, he shall immediately order the vessel to such place as may be appointed for vessels detained under quarantine of observation ; he shall call for the ship's papers, passengers' lists and log books, and inspect them thoroughly so as to ascertain the whole of the occurrences during the voyage, and should he meet with any resistance, he will make such signal as may be determined on to show that assistance is necessary.

Medical superintendent to board vessels and to have charge in cases of quarantine.

The medical superintendent shall also board all vessels he may consider necessary to inspect. He shall have charge of all vessels detained in quarantine. He shall direct, if necessary, all steerage passengers to be landed with their luggage, and shall superintend the cleansing and disinfection of vessels. He shall direct the number of passengers to be landed, distinguishing those who require to be treated for pestilential or infectious diseases, and who are to be landed at that part of the said island set apart for such treatment, from those who do not require such treatment, and who may be landed at that part of the said island set apart for the reception of the healthy and those free from pestilential or infectious diseases, and he shall be careful that all such persons shall be landed at such places respectively. He shall have medical charge of all cabin passengers who do not disembark, and who may be laboring under any other than pestilential or infectious disease ; and shall order all passengers and persons on board any such ship or vessel who shall labor under any pestilential or infectious disease, to be landed with their luggage according to the foregoing regulation.

Medical treatment on board in cases of slight diseases.

He shall give medical treatment on board in all cases of slight diseases which are not by these regulations specially required to be treated on shore, and when it shall be deemed advisable not to land the passengers on the said island. He shall whenever a vessel is cleansed, ventilated and purified, direct such vessel to receive on board the whole or any portion of the passengers, or whether the whole or any and which of the said passengers shall remain on the said island to proceed up the river by some other mode of conveyance,

*Quarantine Regulations—General.*

## Chap. 6.

and he shall, so soon as the passengers are re-embarked on board their ship, or on board any ship or vessel leaving the said island, give a passport or clean bill of health to the master or person having such vessel in charge, to proceed to Quebec. He shall make returns of the vessels boarded by him as soon as possible after such vessels are visited.

The medical superintendent shall have charge of the hospitals. He shall receive into the hospitals set apart for the treatment of pestilential and infectious diseases, all persons laboring under or threatened with any such disease. He shall have the general superintendence and direction of everything relating to the sick. He shall visit and inspect all passengers who shall be landed from any vessel, and distribute them as he shall think expedient either on that part of the island appropriated for the treatment of pestilential or infectious diseases, or on the part of the said island appropriated to healthy passengers. Upon the recovery of persons treated for any such disease he shall, after due precaution, transfer such persons to the healthy part of the said island. He shall superintend the cleansing, washing and purifying of all passengers, and the unpacking and ventilating of their baggage, and when they are in a fit state to proceed, he shall, if need be, cause any baggage or any part of it to be burned or otherwise destroyed.

Charge of the hospitals, inspection and superintendence of passengers.

*Traders, Sutlers, Grocers and Others*

Sec. 6. No persons following the business of sutlers, traders, grocers or other occupations, or concerned in buying or selling, shall be allowed to reside upon the island, except under the license and strict control of the medical superintendent, who will have full authority to discharge and send from the island, all or any such persons, reporting the fact of such discharge and the reason therefor, for the information of the Governor General or person administering the government. All such persons in any way engaged in selling or traffic on the said island shall be regulated as to prices by lists to be furnished by the medical superintendent from time to time, assisted by the emigrant agent at Quebec. He shall strictly inquire into and decide upon all complaints of misconduct or breach of the regulations by persons so trading; he shall see that no officer or person employed by the Government, or in any public employment, on the said island, has directly or indirectly any interest or concern in any supply of provisions, or other things to be supplied or furnished, bought or sold upon the said island, or directly or indirectly receives or takes any private gratuity or reward for any service rendered to any masters or crews of vessels, passengers or other persons upon the said island. And it shall be the duty of all persons to

Persons engaged in traffic must be licensed and shall be under the control of medical superintendent.

## Chap. 6.

*Quarantine Regulations—General*

whose knowledge any breach of this Regulation shall come, to report the same forthwith to the medical superintendent, who shall enquire into the facts alleged, and may suspend from his office any person so charged until the pleasure of the Governor General shall be known respecting the person so charged.

*Saint Lawrence Pilots.*

Pilots to be furnished with copies of the Act, of regulations, &c., and shall exhibit the same to master.

Sec. 7. Pilots having been furnished with copies of the said Act and of these regulations, and also of the laws regulating emigration, shall exhibit the same to the master or person in charge of every vessel they may board. Every pilot having charge of a vessel of the description of those liable to make quarantine at Grosse Isle as aforesaid shall bring her to anchor within the limits of the anchorage ground at Grosse Isle hereinbefore defined. They shall also keep a Union-Jack flying at the peak of all vessels under their charge, until boarded by the proper officers. On arriving at Quebec, if the vessel has received a clean bill of health from the medical superintendent at Grosse Isle, and has not been detained there on account of sickness or suspicion thereof, she may bring to at any place within the following limits in the port of Quebec, viz.: the whole space of the River St. Lawrence, from the mouth of the River St. Charles to a line drawn across the said River St. Lawrence, from the flag-staff on the Citadel, or Cape Diamond, at right angles to the course of the said river, but must not communicate with the shore or with any other vessel or boat until boarded by the inspecting physician; but if the vessel be of the class of those not liable to make their quarantine at Grosse Isle, she may either bring to at any place within the aforesaid limits, in the port of Quebec, or she may proceed at once to the ballast ground.

Quarantine limits at Quebec, defined.

*Passengers.*

Steerage passengers and cabin passengers.

Sec. 8. On the arrival of any vessel at Grosse Isle, on board of which there shall be or shall have been during the passage any case of cholera, fever, small pox, scarlatina or measles, or other infectious or dangerous disease, and in all other cases when it shall be considered necessary by the medical superintendent, the steerage passengers shall be landed with their luggage, and washed and purified and shall be permitted to re-embark and proceed in the same vessel, or shall be detained and embarked in some steamboat or other vessel, as shall be directed by the medical superintendent. The passengers in the principal cabin shall not be landed except in cases of sickness, and may at all times

*Quarantine Regulations—General.*

## Chap. 6.

proceed with the vessels, or otherwise, after having washed and purified their luggage to the satisfaction and with the passport of the medical superintendent.

*Vessels.*

Sec. 9. All vessels liable to make their quarantine at Grosse Isle, on their arrival there, shall anchor within the limits of the anchorage ground at Grosse Isle hereinbefore defined, until boarded by the medical superintendent: and if they shall not be detained at Grosse Isle on account of sickness or suspicion thereof, shall receive a clean Bill of health, and may proceed to the harbor of Quebec, and there anchor at any place within the limits of that portion of the port of Quebec hereinbefore defined, and there remain without communication with the shore, or any other vessel or boat until finally discharged from quarantine by the license or passport aforesaid; but if any such vessel shall have been detained at Grosse Isle from sickness or suspicion thereof, it shall anchor at the mouth of the River St. Charles, and there remain until finally discharged from quarantine as aforesaid.

Clean bill of health; when vessel shall anchor at the mouth of River St. Charles.

Vessels arriving at Grosse Isle from any infected port or place, or one supposed to be infected, and on board of which no pestilential disease shall have declared itself during the passage, may be kept under quarantine of observation for a period of not more than three days; during which time the passengers and crew thereof shall be subjected to a strict purification under the direction of the medical superintendent. All vessels detained in quarantine shall be cleansed and ventilated, and their between decks, if not painted or varnished, shall be well whitewashed, but if painted or varnished, shall be thoroughly scrubbed with soap and water or lye, and such portion of the ballast as the medical superintendent shall order, shall be thrown over board, under his immediate superintendence, or that of some person to be appointed by him for that duty.

Passengers and crew subject to purification: Vessels to be cleaned, &c.

In all cases where vessels having passengers on board, on account of sickness amongst such passengers, shall be detained in quarantine, the master or person in charge may, on application to the medical superintendent at Grosse Isle, be allowed to land the said passengers with their luggage; and the vessel being properly cleansed, purified and disinfected under the superintendence and with the license of the medical superintendent, may proceed up the river without the said passengers, upon the master or person in charge paying to such person as shall be appointed to receive the same, twenty-five cents for each passenger, to bear the expense of their conveyance to Quebec, also at the rate of twenty cents *per diem* for each of the said pas-

Conditions on which passengers may be allowed to land and the expenses in connection therewith.

69606

Chap. 3.

Quarantine Regulations—General.

sengers, to reimburse the expense of their maintenance at Grosse Isle, for the time during which such vessel, in the judgment of the medical superintendent, would have had to be detained in quarantine waiting for the passengers not affected with any of the pestilential or infectious diseases aforesaid, otherwise such vessel shall be detained in quarantine until the passengers not sick of the aforesaid diseases, shall be cleansed, washed, purified and disinfected.

Inspecting Physician at Quebec.

Questions to be put to the master or person in charge.

Sec. 10. An inspecting physician at Quebec shall go off to all vessels arriving at Quebec or at the mouth of the river St. Charles, and put the following questions to the masters or persons in charge, viz.:

1. When did you leave Grosse Isle ?
2. Exhibit to me your passport from Grosse Isle ?
3. How many persons have you on board ?  
Cabin passengers ?  
Steerage passengers ?  
Crew ?
4. Number left at Grosse Isle ?
5. Have any person or persons been taken sick since you left Grosse Isle ?
6. Have any died ? State number, names and disease ?
7. Have any person or persons come on board or left your vessel since you left Grosse Isle ?
8. Have you any person on board who is lunatic, idiotic, deaf and dumb, blind or infirm, and are such accompanied by relations able to support them ?

Masters to exhibit license or passport, to receive certificate of health. Yellow flag, when to be hoisted. Conduct of inspecting physician, &c.

And moreover, he shall require all masters, or persons in charge of vessels, liable to make their quarantine at Grosse Isle, to exhibit to him the license or passport which they shall have received from the medical superintendent at the quarantine station; and such masters or persons in charge shall forthwith exhibit the same for examination, to the said inspecting physician at Quebec, who, if he shall find, as well from the answer he may receive as from the tenor of the passport and the actual state of the health of the passengers and crew, that sickness does not exist on board, he shall then grant to the master, or person in charge of such vessel, a certificate in writing setting forth the healthy state of the passengers and crew, to the end that such vessel may obtain a final discharge from quarantine. But, if on the contrary, such inspecting physician at Quebec shall find any case of pestilential or infectious disease on board, or shall have just cause to apprehend the breaking out of any such malady, it shall then be his duty to hoist a yellow flag at the main top-gallant mast head, and shall cause the

*Quarantine Regulations—General.*

## Chap. 6.

vessel to return to or remain and be detained at the mouth of the River Saint Charles for further observation and inspection; and having acquainted the master or person in charge with the penalties to be incurred if he should permit any communication with his vessel until released from quarantine, he shall report all the circumstances to the Minister of Agriculture for the information of the Governor General; and if it shall appear to the said inspecting physician at any time that such vessel shall have passed the quarantine station at Grosse Isle without stopping to make quarantine, being liable thereto, and should therefore be sent down to Grosse Isle, or that such vessel having already cleared from Grosse Isle, should return thereto, there to land the passengers, he shall order the master, or person in charge, to proceed or return with such vessel to Grosse Isle, and such master, or person in charge, shall obey such order. And the proper officers at Grosse Isle shall observe, in respect of such vessels, the same rules and regulations as are provided for vessels arriving at Grosse Isle with sick. Should the inspecting physician at Quebec meet with any resistance in the discharge of the duty required of him by this regulation, he will immediately enforce the same by all lawful means at his disposal.

Any steamboat or other vessel that shall have towed or otherwise communicated with a vessel of the class of vessels liable to make their quarantine at Grosse Isle, not having the discharge from quarantine of the medical superintendent at Grosse Isle, shall be subject to the same regulations and instructions as hereinbefore provided, respecting vessels not discharged from quarantine.

*Steamboat, &c., towing vessels liable to quarantine.*

No steamboat shall be allowed to proceed to Grosse Isle for the purpose of taking on board passengers direct from that Island, without previously obtaining from the collector of customs of the port of Quebec, a written permit to that effect; subject nevertheless to the regulations hereinbefore provided.

*Steamboat, when requiring a written permit.*

No vessel shall be entered or cleared at the port of Quebec or Montreal, until all the requirements of the foregoing regulations in reference to such vessel shall have been fully complied with.

*Port of Halifax.*

Sec. 11. That all boats, ships or vessels coming into the harbor of Halifax, in the Province of Nova Scotia, which shall have at the time of their said arrival, or shall have had during their passage from the places where they respectively cleared, any person on board laboring under Asiatic cholera, fever, small-pox, scarlatina or measles, or other infectious and dangerous disease, or on board of which any

*Vessels having, or having had on board Asiatic cholera, fever, small-pox, scarletina or measles or other infectious disease.*

## Chap. 6.

*Quarantine Regulations - General.*

person shall have died during such passage, or which, being of less tonnage than seven hundred tons measurement, shall have on board thirteen or more steerage passengers, or which being of greater tonnage than seven hundred tons measurement, shall have on board fifty or more steerage passengers or which shall have come from some infected port, shall make their quarantine in the harbor of Halifax, on board such vessels or at such place on shore, and in such manner as shall be directed by the inspecting physician of the said port of Halifax, and there remain and continue until such ships or vessels shall be discharged from such quarantine, by such license or passport, and discharge, given, without fee or emolument of any kind, as shall be directed or permitted by such order or orders as shall be made by the Governor, with the advice of the Privy Council; and until the said ships and vessels shall respectively have performed such quarantine and shall be discharged therefrom by such license or passport and discharge as aforesaid, persons, goods or merchandise, which shall be on board such boats, ships or vessels, shall not come or be brought on shore, or go or be put on board of any other ship or vessel in Canada, except at such place indicated as aforesaid when duly required by competent authority.

Vessels having come from an infected port.

Quarantine limits defined.

All boats, ships or vessels of the class and description hereinbefore mentioned, as liable to make their quarantine in the harbor of Halifax, shall anchor within a mile of the southern end of George's Island, there to be inspected by the inspecting physician, and ordered, according to circumstances as aforesaid.

Inspecting physician shall visit vessels and give directions.

The inspecting physician of the port of Halifax shall visit, on their arrival, such boats, ships or vessels, and shall direct them as best calculated for the public health, and in accordance with the intent and meaning of the present regulations and Orders in Council, which may be communicated to him from time to time.

*Port of St. John.*

Vessels having, or having had on board Asiatic cholera, fever, small-pox, scarletina or other infectious or dangerous disease or having come from an infected port.

Sec. 12. That all boats, ships or vessels coming into the harbor of St. John, in the Province of New Brunswick, which shall have at the time of their arrival, or shall have had during their passage from the places where they respectively cleared, any person on board laboring under Asiatic cholera, fever, small-pox, scarlatina or measles, or other infectious and dangerous disease, or on board of which any person shall have died during such passage, or which, being of less tonnage than seven hundred tons measurement, shall have on board thirteen or more steerage passen-



*Quarantine Regulations—General.*

Chap. 6.

gers or which, being of greater tonnage than seven hundred tons measurement, shall have on board fifty or more steerage passengers, or which shall have come from some infected port, shall make their quarantine in the harbor of St. John, on board such vessels or on Partridge Island, and in such manner as shall be indicated by the inspecting physician of the said port of St. John, and there remain and continue until such ships or vessels shall be discharged from such quarantine, by such license or passport, and discharge, given without fee or emolument of any kind, as shall be directed or permitted by such order or orders as shall be made by the Governor with the advice of the Privy Council; and until the said ships or vessels shall respectively have performed such quarantine, and shall be discharged therefrom by such license or passport and discharge as aforesaid, persons, goods or merchandise, which shall be on board such boats, ships or vessels, shall not come or be brought on shore, or go or be put on board of any other ship or vessel in Canada, except on the said Partridge Island when duly required by competent authority.

All boats, ships or vessels of the class and description hereinbefore mentioned as liable to make their quarantine in the said harbor of St. John, shall anchor within a mile of the outside or southern end of Partridge Island (unless forced by stress of weather to anchor inside the said island, in which case such vessels shall anchor as close as practicable to the said island,) there to be inspected by the inspecting physician and ordered according to the circumstances as aforesaid.

Quarantine limits defined.

The inspecting physician of the port of St. John shall visit, on their arrival, such boats, ships or vessels, and shall direct them as best calculated for the public health, and in accordance with the intent and meaning of the present Regulations and such Orders in Council as may be communicated to him from time to time.

Inspecting physician.

*Inspecting Physicians of the Ports of Halifax and St. John.*

Sec. 13. The inspecting physicians of the ports of Halifax and St. John (or any medical officer nominated to act as assistant or in their absence) shall have, respectively, the control over all officers and employés, who may be appointed or employed for the service of the quarantine in the said ports, respectively, and the medical attendance over the sick and healthy passengers, or crew detained on board, or who may have been landed to undergo the said quarantine on shore, and the said inspecting physicians shall have, respectively, the same duties to perform and the same authority as those hereinbefore assigned to the medical superintendent of the quarantine of Grosse Isle, and shall fulfil the said duties

Inspecting physicians shall have control over all officers and employes.

## Chap. 6.

*Quarantine Regulations—General.*

and exercise the said authority in the same manner as prescribed for the said medical superintendent.

*Vessels in Quarantine at the Ports of Halifax and St. John.*

Conditions on which passengers may be allowed to land and the expenses in connection therewith.

Sec. 14. In all cases where vessels having passengers on board, on account of sickness amongst such passengers, shall be detained in quarantine, the master or person in charge may, on application to the inspecting physician of the said ports of Halifax or St. John, respectively, be allowed, to land the said passengers with their luggage; and the vessel being properly cleansed, purified and disinfected under the superintendance and with the license of the inspecting physician, may proceed up the harbor without the said passengers, upon the master or person in charge paying to such person as shall be appointed to receive the same, seventeen cents for each passenger, to bear the expense of their conveyance, and also at the rate of twenty cents *per diem* for each of the said passengers, to reimburse the expense of their maintenance for the time during which such vessel, in the judgment of the inspecting physician, would have had to be detained in quarantine waiting for the passengers not affected with any of the pestilential or infectious diseases aforesaid, otherwise such vessel shall be detained in quarantine until the passengers not sick of the aforesaid diseases, shall be cleansed, washed, purified and disinfected.

*Pilots of the Ports of Halifax and St. John.*

Pilots to be furnished with copies of the Act, of regulations, &c

Sec. 15. Pilots of the ports of Halifax and St. John respectively, having been furnished with copies of the said Act, and of these regulations, shall exhibit the same to the master or person in charge of any boat, ship or vessel they may board:—every pilot having charge of a vessel of the description of those liable to make quarantine at the ports of Halifax or St. John respectively, shall bring her to anchor within the limits of the anchorage grounds hereinbefore defined for the said ports respectively;—they shall also keep a Union Jack flying at the peak of all vessels under their charge, until boarded by the proper medical officer aforesaid.

Limits within which vessels shall be brought to anchor.

Proc. May 23, 1863.

*Vessels of War exempted.*

Regulations, when not to apply.

Sec. 16. These regulations shall not apply to any vessel of war, or to transports or vessels having Queen's troops on board accompanied by a medical officer, and in a healthy state, or to any steamer, unless sickness or death may have occurred during the passage.

Proc. Jan. 21, 1873.

*Quarantine Regulations - General.*

## Chap. 6.

*General Provisions.*

Sec. 17. No vessel shall be entered or cleared at the ports of Quebec or Montreal, until all the requirements of the foregoing regulations in reference to such vessel shall have been fully complied with.

Any person who shall contravene, either by omission or commission, any of the foregoing regulations, shall for every such offence incur and pay a fine not exceeding four hundred dollars, to be recovered in the manner prescribed by the said Act; and every person who, upon conviction of any such offence, shall fail to pay the amount of fine which he shall have been condemned to pay, shall be imprisoned until such fine be paid.

Penalty for  
contraven-  
tion of these  
regulations.

Proc. May 23, 1868.

*Pauper Immigrants.*

Sec. 18. (a.) Upon the arrival of any immigrant or passenger, sailing or steam vessel, at the port of Quebec, the inspecting physician at that port shall have power, and it shall be his duty, to make inquiry of any immigrant or immigrants as to the means in his, her or their possession for providing upon landing the necessaries of life and for disbursing all sums necessary for the transport of them and their families to their point of destination; and such inspecting physician, if satisfied that such immigrant or immigrants is or are not a pauper or paupers, but in possession of sufficient money, for the purposes herein mentioned, may grant a permit to the same to land, provided that all the provisions of any statute and all other regulations in force under the Act hereinbefore mentioned or any proclamation thereof be complied with. And no immigrant or immigrants as to whom such inquiry shall be made shall be allowed to depart from the said vessel, without such permit.

Inspecting  
physician to  
make inquiry.

(b.) If upon any such inquiry the inspecting physician shall see fit to refuse a permit, it shall be his duty to cause the said vessel to return to, or remain and be detained at the mouth of River St Charles, and the master of such vessel shall not allow the immigrant or immigrants in respect of whom the permit has been refused, to land in any part of Canada, or to depart from the vessel, but he shall keep such immigrant or immigrants on board the same and transport them therein on the departure of the said vessel, from Quebec, unless the inspecting physician shall subsequently see fit to grant such permit.

Return of ves-  
sel to mouth  
of River St  
Charles.

(c.) Any master, officer or seaman of a vessel, who shall allow the departure of any immigrant or immigrants without such permit, and any person who shall aid, assist or connive at the landing of any immigrant without such permit

Penalty for  
contravention  
of this section.

## Chap. 6.

*Quarantine Regulations—General.*

or who shall contravene, either by commission or omission any of the clauses of this section 18, shall be liable to a penalty not exceeding \$400 in any case, and the offender may be imprisoned until the same is paid.

Report of  
inspecting  
physician.

(d.) The inspecting physician shall report to the collector of Customs at the port, the case of any vessel in which have arrived any immigrant or immigrants, to whom such permit has been refused, and no vessel shall be entered or cleared at any custom house, until all the clauses of this section 18 have been complied with.

Proc. June 19, 1868.

*Regulations for Ports other than regular Quarantine Stations.*

Application of  
regulations.

Sec. 19. The following regulations to end of section 33 shall not apply to the regular quarantine stations of the ports of Quebec, Halifax and St. John, N. B., nor to any regular quarantine station that has been or hereafter may be established by proclamation of the Governor General.

Vessel coming  
from infected  
port, &c.

Sec. 20. Every vessel is and shall be liable to quarantine which has come from any infected port, or on board of which any death from contagious disease has taken place during the passage, or on board of which there has been or shall be any infectious or contagious disease.

Master to  
hoist yellow  
flag.

Sec. 21. The master of any vessel on board of which any such death has taken place during the passage, or on board of which there has been or shall be any infectious or contagious disease, shall, when within two marine miles of any part of the shores of Canada, hoist a yellow flag at the mast head, and shall continue the same until entry of the harbor, and until permitted by the quarantine officer to lower the same.

Pilots.

Sec. 22. Whenever pilots are employed they shall be supplied by the quarantine officers of the port with copies of these regulations, that is to say "Regulations for Ports other than regular Quarantine Stations" and it shall be the duty of such pilots to exhibit the same to the master of every ship boarded by them; any pilot neglecting to perform this duty shall be subject to a fine for every such omission not exceeding twenty dollars.

Vessel to be  
anchored.

Sec. 23. The master of any such vessel as aforesaid upon entering any harbor, whether during the day or by night, shall either anchor or come to at a distance of not less than a mile and a-half from the landing place to which she is bound, until examined and license has been granted to

*Quarantine Regulations—General.*

## Chap. 6.

proceed to any landing place to land passengers or to discharge cargo.

Sec. 24. Every master of a vessel liable to quarantine, shall, upon being thereunto instructed by the quarantine officer, take his vessel to the quarantine ground assigned to him by such officer, and in the event of contravention or breach of such orders the quarantine officer may cause the vessel to be sent to such quarantine ground, and in addition thereto the vessel and the master thereof shall be liable to a penalty of four hundred dollars.

Penalty for contravention of quarantine orders.

Sec. 25. Quarantine officers may proceed alongside of all vessels arriving at any port in Canada, and in their discretion may, in the event of the yellow flag being hoisted as hereinbefore required, shall proceed on board without delay, and shall then forthwith submit the following questions to the master or person in charge:—

Questions to be put to master or person in charge

1. What is your name and that of your vessel?
2. Whence did you sail, and date? Was any infectious disease then, there prevalent?
3. Has or have any person or persons been taken sick during the passage?
4. Have any died? State number and disease.
5. Has or have any person or persons come on board or left your vessel since sighting this port?

The quarantine officer may, in his discretion, submit these question on a printed paper, and require the master of the vessel to sign his replies thereto.

Sec. 26. If the master gives such answers as shall be satisfactory to the quarantine officer, a clean bill of health shall be granted by him to such vessel; but if such answers be not satisfactory, or if there is reason to believe that the master is answering such questions falsely, or has misrepresented the facts, or concealed any information, or if the quarantine officer has reason to anticipate danger to the public health, such quarantine officer shall report the facts of the case to the Department of Agriculture at the city of Ottawa, and the Minister of Agriculture may direct that the vessel shall be sent to any one of the regular quarantine stations, or the quarantine officer may use the vessel itself for purposes of quarantine and as a quarantine depot, when the medical attendant shall certify that it is unnecessary to remove the passengers, crew or cargo from the vessel, and in such latter case the medical fees shall be payable by the master of the vessel as provided by section 28 hereof.

Clean bill of health.

When vessel may be quarantined.

## Chap. 6.

*Quarantine Regulations—General*

Quarantine officer in case of contagious or infectious disease.

Sec. 27. In every case in which the quarantine officer may find or ascertain that any death from contagious disease has taken place during the passage or that there has been or is any contagious or infectious disease such as Asiatic cholera, fever, small-pox, scarlatina, measles or other disease of a like kind, he shall forthwith employ a medical attendant, if in the opinion of such quarantine officer the same is requisite and desirable, and such quarantine officer shall forthwith telegraph or transmit to the Department of Agriculture at the city of Ottawa a report of the facts, and shall act upon such instructions as he may receive in respect thereto.

Compensation for medical attendance and fees.

Sec. 28. The quarantine officer may pay the medical attendant employed by him for each visit which, in his opinion, shall be requisite, a reasonable compensation not to exceed the sum of four dollars, and the aggregate amount of medical fees so payable in such respect shall be refunded and paid by the master of the vessel to the quarantine officer and no clearance shall be given to the ship until such fees have been paid. But such fees as aforesaid shall not be required or exacted in cases where the vessel has proceeded to a regular quarantine station.

Before breaking bulk.

Sec. 29. A vessel shall have the right, before breaking bulk, to put to sea in preference to being quarantined as provided for by Section 9 of the Act intituled: "An Act respecting Quarantine," Chap. 68, R. S. Canada.

Masters shall come to when hailed.

Sec. 30. Masters of vessels, whether liable to quarantine or not, shall come to when hailed by a quarantine officer or any person thereunto deputed by a quarantine officer in that capacity.

Collectors of Customs: quarantine officers and Justices of the Peace.

Sec. 31. The collector of Customs of each and every port of Canada, except the regular quarantine stations of Quebec, Halifax and St. John, New Brunswick and any other regular quarantine station which has been or hereafter may be established by proclamation of the Governor General, is hereby authorized to act as a quarantine officer, under the provisions of these regulations, and shall by virtue of such office, be a justice of the peace under the authority and for the purposes of the Act intituled: "An Act respecting Quarantine," Chap. 68, R. S. Canada.

Penalty for contravention of regulations.

Sec. 32. Any person contravening any regulation hereby made shall be liable to a penalty not exceeding four hundred dollars in any case, and the offender upon conviction shall be imprisoned until such penalty be paid.

*Quarantine Regulations—General.*

## Chap. 6.

Sec. 33. No vessel shall be entered or cleared at any Custom house in Canada, until all the requirements of these regulations are fully complied with, and any person, vessel or thing who or which has passed or departed or been removed from any quarantine ground before all the requirements of such regulations are fully complied with in respect of such person, vessel or thing, or without the written permission of the officer empowered to authorize such passing or departure may be compelled to return or be carried back to such quarantine ground or be sent to any regular quarantine station, and, by force, if necessary.

Vessels not to be entered or cleared until, &c.

Proc. Jan. 21, 1873.

## SUPPLEMENTARY REGULATIONS

*For steamships or sailing vessels by the St. Lawrence.*

Sec. 34. Every steamship or sailing vessel from any port outside of British North America coming to Canada by way of the St. Lawrence, shall be inspected by a duly appointed quarantine medical officer before passing Grosse Isle, and shall not proceed or be allowed to proceed on her voyage until she receives a clean bill of health ; with the exception that,—

Clean bill of health.

Each of the steamships conveying Her Majesty's mails, shall be met and inspected by a quarantine medical officer at the point of Rimouski, and a clean bill of health from such officer shall be equivalent to a clean bill of health granted by the quarantine officer at Grosse Isle, such mail vessel being amenable in all other respects to the quarantine regulations.

Steamships conveying Her Majesty's mails.

Sec. 35. No passenger nor any other person shall be allowed to land from any mail steamship at Rimouski until declared by the quarantine officer free from infectious disease or well founded suspicion thereof, nor unless the said officer is satisfied that such person may be allowed to land without danger to the public health.

Passengers, &c., when not allowed to land.

Sec. 36. Any person or persons ill with cholera, small-pox or other contagious disease as defined in the foregoing quarantine regulations, or any of them, shall be landed at Grosse Isle for treatment, and the vessel disinfected and allowed to proceed or be detained in such manner as may be deemed expedient by the medical officer for the protection of the public health, under the provisions of the said quarantine regulations.

Persons ill with cholera &c.

## Chap. 6.

*Quarantine Regulations—General.*

Certificate called "a protection card", when required and how obtained.

**Sec. 37.** No steerage passenger shall be allowed to pass the inspection stations,—that is Rimouski for the mail steamships, and Grosse Isle for all other vessels, without furnishing evidence to the satisfaction of the quarantine medical officer of having been vaccinated within the seven previous years, or having had the small-pox within that period; and, in case when the small-pox has occurred in any vessel during the voyage, this regulation shall also apply to every person on board. The production of a certificate by a ship's surgeon, called "a protection card," and his testimony under oath verifying the truth of such certificate, may be taken by the quarantine medical officer as evidence of such vaccination and protection. The quarantine medical officer shall, however, from time to time, make personal examination of holders of such certificates to satisfy himself of the manner in which they have been issued.

Persons not having been vaccinated &c.

**Sec. 38.** Any person to whom the definitions in the next preceding section would apply as not having shown satisfactory evidence of having been vaccinated within the seven previous years, or having had the small pox within that period, in accordance with the requirements of such section, shall be vaccinated by the examining quarantine medical officer, or in the event of refusal shall be landed at Grosse Isle, subject to a quarantine of observation; and the expense of the maintenance of such person during such quarantine of observation shall be a charge against the vessel.

Examination of ship's officer, &c., under oath.

**Sec. 39.** The quarantine medical officer at Grosse Isle or Rimouski shall examine any officer or surgeon or medical man of any steamship or sailing vessel, under oath, touching the state of health of such ship or vessel and of every person on board, in such form as shall be prescribed by the Minister of Agriculture, and it shall be the duty of the pilot on each such steamship or sailing vessel to hand to the ship's officer or surgeon a printed copy of the questions required to be answered under oath.

Vessel arriving with infectious disease liable to be detained, &c.

**Sec. 40.** Every steamship or sailing vessel arriving with infectious disease shall be liable to be detained at the quarantine station for disinfection, together with its cargo and passengers and crew, but every steamship or vessel provided with one isolated hospital for men, and another for women, on the upper deck, ventilated from above and not by the door only, may, in the discretion of the quarantine medical officer, if he is furnished with satisfactory evidence that such hospitals have been promptly and intelligently made use of, be allowed to proceed after the landing of the



*Quarantine Regulations—General.*

## Chap. 6.

sick and the disinfection of such hospitals; any vessel, however, arriving with infectious disease, without having such special isolated and ventilated hospitals, or having them, without satisfactory evidence that such hospitals have been promptly and intelligently made use of, shall be liable to be detained for disinfection at the quarantine station.

Sec. 41. The master of every steamship or sailing vessel arriving from any port outside of Canada shall produce a certificate of quarantine inspection and clearance from Rimouski or Grosse Isle, in the case of mail steamships, and from Grosse Isle, in the case of all other vessels, before being allowed to make a Customs entry at the port of Quebec or Montreal.

Certificate and clearance.

Sec. 42. A second quarantine inspection shall not be held to be necessary at Quebec; but in the event of the inspecting Physician at Quebec, in pursuance of his port duties, finding infectious disease, as defined in section 36 of these regulations, in any steamship or sailing vessel, he shall promptly order it to go back to Grosse Isle.

Second quarantine.

*For all other organized Quarantine Ports of the Dominion.*

Sec. 43. Every steam or sailing vessel from any port outside of Canada, arriving at any regularly organized quarantine port (having a quarantine station), that is to say: At Halifax, or Pictou, or Hawkesbury, or Sydney (Cape Breton), in the Province of Nova Scotia; or St. John, or the Harbor of Miramichi, in the Province of New Brunswick; or Charlottetown, in the Province of Prince Edward Island; or Victoria, in the Province of British Columbia, shall be subject, in so far as they can be made to apply, to the foregoing supplementary regulations relating to the St. Lawrence, as respects inspection, by the quarantine medical officers of the said several ports or harbors, before being allowed to make a Customs entry; and any vessel which it shall be considered necessary to detain shall be dealt with in accordance with the foregoing quarantine "Regulations for Quebec, Halifax and St. John."

Regulations, how far applicable.

*For all ports under Quarantine directions of Collectors of Customs.*

Sec. 44. At every other port in Canada, at which there is not a regularly organized quarantine station and at which the collector of Customs is authorized by section 31 of the foregoing "Regulations for ports other than regular quar-

Inspection of vessel, Customs entry, clean bill of health.

antime stations." the collector shall, in the case of any steamship or sailing vessel arriving from any port known to be infected, and of which notification has been published in the *Canada Gazette*, cause a medical inspection to be made of such vessel, and shall not grant a Customs entry except on the production of a clean bill of health after such inspection.

"Regulations for ports other than regular stations," when to apply.

Sec. 45. In the event of any infectious disease, such as defined in section 36 of these "supplementary regulations," being found in any steam or sailing vessel arriving at any port which is under quarantine direction of a collector of Customs, such vessel shall be dealt with in the manner prescribed in the "Regulations for ports other than regular quarantine stations," aforesaid, applying to such port, supplemented by the foregoing "Supplementary regulations" in so far as they can be made to apply.

#### *Signals for Quarantine Inspection.*

Yellow flag or red light, when to be displayed.

Sec. 46. Every steam or sailing vessel from any port outside of Canada requiring quarantine inspection shall, on arrival at any port in Canada, display a yellow flag at the fore, for a distinctive quarantine signal, in order to inform the quarantine officer or collector of Customs acting as such, that his services are required, as directed by the quarantine regulations, aforesaid, and any such vessel by the St. Lawrence, arriving at the quarantine station of Grosse Isle by night, shall display a red light for such signal.

#### *How rags are to be dealt with.*

Rags from countries in which infectious disease prevails.

Sec. 47. Rags coming from countries or ports in which infected disease prevails, as defined in section 36 of these "Supplementary regulations," the names of such countries or ports being, from time to time, published in the *Canada Gazette*, shall be prohibited from landing at any port in Canada, but rags collected in countries which have been free from the prevalence of infectious disease during the six months prior to the shipment of such rags, shall be admitted without any special treatment, if accompanied by a proper evidence of origin, provided however, that rags coming from any port in Italy or any port of the Mediterranean Sea, or from the ports of Toulon or Marseilles in France or from the port of London in England, or having called at any of said ports shall be and the same are hereby prohibited from landing at any port in Canada

Rags from Italy, France, England.

*Quarantine Regulations - General.*

## Chap. 6.

*Hours of Inspection.*

Sec. 48. The hours during which quarantine inspection, the mail steamships excepted, shall take place at any quarantine station or any port in Canada, shall be between sunrise and sunset; with the further exception that at the quarantine station of Grosse Isle, inspection will be made during any hour of the twenty-four.

Between sunrise and sunset, except at Grosse Isle.

*Penalties for Pilots and all Officers and Masters of Vessels.*

Sec. 49. Every pilot shall be furnished with printed copies of these "supplementary regulations," one of which it shall be his duty to hand to the master of every steam and sailing vessel coming from a port outside of Canada immediately after going on board of such vessel, under a penalty not exceeding \$200.

Penalty for not furnishing pilot with regulations.

Sec. 50. Every collector of Customs, officer or other person charged with putting into effect or having any duties in connection with the foregoing "supplementary regulations," shall be liable to a penalty not exceeding four hundred dollars and imprisonment until such penalty is paid, for any contravention of such regulations or for omission or neglect of duty in relation to them.

Penalty for contravention by Collector of Customs.

Sec. 51. Every master of a steam or sailing vessel shall be liable to a penalty not exceeding four hundred dollars and to imprisonment until such penalty is paid for any contravention of any of the foregoing "supplementary regulations," and such vessel shall be held liable for any pecuniary penalty imposed on the master.

Penalty for contravention by master.

## FORM.

Sec. 52. *Questions to be answered under oath to quarantine officers by master, surgeons or officers of vessels.*

Questions to be put to master, surgeons or officers of vessels.

Date 18 .

1

What is your vessel's name and your name?

2

Whence and at what date did your vessel sail?

3

What is your cargo and whence taken on board?

4

Has your vessel touched at any place or places on her voyage?

5

Was such place or places or any of them to your knowledge infected with cholera, small pox, plague, or any pestilential fever or disease ?

6

How many persons were on board when the vessel sailed ?

Cabin passengers.....	Intermediate.....
Steerage.....	Cattlemen.....
Total.....	Crew.....

7

State whether any person on board during the voyage has been ill, or whether there is any person now ill, with any of the diseases above referred to, and if so how many ?

8

Has any person died on board during the present voyage and if so state all particulars ?

9

Has each of the steerage passengers on board signs of having been vaccinated within seven years, or of having had the small pox within that period ?

10

(*Question to be asked to ship's surgeon, if such is on board.*) Have you personally during the present voyage, examined each one of the passengers and crew for proof of satisfactory vaccination within seven years, or of having had the small pox within that period ?

11

Did you or any of the crew or passengers, within your knowledge, land at any place or places within Canada during the present voyage ?

12

Is there any person on board lunatic, idiotic, deaf and dumb, blind or infirm, and if so, is such person accompanied by relatives or guardians ?

13

Have you an isolated hospital for men and another for women, ventilated from above and not from the passage ?

14

Were such hospitals or one of them immediately made use of on the occurrence of disease ?

*Quarantine Regulations—General.*

Chap. 6.

15

Are there any other facts which, in your opinion, should be communicated?

Signature.

*Master,*

“

*Surgeon.*

I,

Master Oath of master or surgeon.

Surgeon,

(*here state whether ship's master, or occupying another position on board*) do solemnly and sincerely swear to the exactness and truth of the answers to the above questions signed by me. So help me God.

*Master.**Surgeon.*

Sworn before me at this  
day of 18 .

Quarantine Officer and Justice of }  
the Peace authorized by Order }  
in Council under Chapter sixty- }  
eight of the Revised Statutes of }  
Canada, intituled: "An Act }  
respecting Quarantine." }

FORM.

Sec. 53. *Quarantine Officers Certificate for Customs Collector.* Certificate of inspection.

PORT OF

Quarantine Station,

18

I hereby certify that the master, has been inspected and admitted to pratique and has permission to proceed.

*Quarantine Officer.*

Proc. July 18, 1887; Oct. 5, 1887.

## Chap. 6.

*Quarantine Regulations—General.*

## PORTS OF RICHIBUCTO, MIRAMICHI, PICTOU, CHARLOTTE-TOWN, VICTORIA, SYDNEY AND HAWKESBURY.

Vessels having, or having had on board Asiatic cholera, fever, small-pox, scarlatina or measles or other infectious and dangerous disease or having come from an infected port.

Sec. 54. All boats, ships and vessels coming into the harbor of Richibucto, in the Province of New Brunswick, the harbor of Miramichi, in said Province, the harbor of Pictou, in the Province of Nova Scotia, the harbor of Charlottetown, in the Province of Prince Edward Island, the harbor of Victoria, in the Province of British Columbia, the harbor of Sydney, Cape Breton, in the Province of Nova Scotia, or into the port of Hawkesbury, in the Province of Nova Scotia [*See dates below*], which shall have at the time of their said arrival or shall have had during their passage from the places where they respectively cleared, any person on board laboring under Asiatic cholera, fever, small pox, scarlatina or measles or other infectious and dangerous disease, or on board of which any person shall have died during such passage, or which being of less tonnage than seven hundred tons measurement, shall have on board thirteen or more steerage passengers, or which, being of greater tonnage than seven hundred tons measurement, shall have on board fifty or more steerage passengers, or which shall have come from some infected port, shall make their quarantine in the said harbors respectively on board such vessels or at such place on shore and in such manner as directed by the inspecting physicians of the said harbors respectively, and there remain and continue until such ships or vessels shall be discharged from such quarantine, by such license or passport, and discharge given without fee or emolument of any kind, as shall be directed or permitted by such order or orders as shall be made by the Governor, with the advice of the Privy Council; and until the said ships and vessels shall respectively have performed such quarantine and shall be discharged therefrom by such license or passport and discharge as aforesaid; persons, goods or merchandise, which shall be on board such boats, ships or vessels, shall not come or be brought on shore, or go or be put on board of any other ship or vessel in Canada, except at such place indicated as aforesaid when duly required by competent authority.

Richibucto quarantine limits

(a) All boats, ships and vessels of the class and description mentioned in the next preceding clause of this section as liable to make their quarantine in the said harbor of Richibucto shall not be navigated farther from the sea into the river of Richibucto than at or opposite Marsh Point so called, there to anchor, then to be inspected by the inspecting physician and ordered according to circumstances as aforesaid.

Proc. June 30, 1871.

*Quarantine Regulations—General.*

## Chap. 6.

(b.) All boats, ships and vessels of the class and description mentioned in the preceding regulation as liable to make their quarantine in the said harbor of Miramichi shall anchor as near as possible to the lower or east end of Middle Island, there to be inspected by the inspecting physician and ordered according to circumstances, as aforesaid.

Miramichi  
quarantine  
limits.

(c.) All boats, ships and vessels of the class and description mentioned in the preceding regulation as liable to make their quarantine in the said harbor of Pictou, shall anchor on the northern side of the said harbor of Pictou, between a point immediately inside of Cole's Reef, and the eastern end of the Beaches, there to be inspected by the inspecting physician and ordered, according to circumstances, as aforesaid.

Pictou quar-  
antine limits.

Proc. Oct. 8, 1873.

(d.) All boats, ships and vessels of the class and description mentioned in the preceding regulation as liable to make their quarantine in the said harbor of Charlottetown, shall anchor as near as may be safe to the quarantine station, there to be inspected by the inspecting physician, and ordered, according to circumstances, as aforesaid.

Charlotte-  
town quaran-  
tine limits.

Proc. July 15, 1875.

(e.) All boats, ships and vessels of the class and description mentioned in the preceding regulation as liable to make their quarantine in the said harbor of Victoria, shall anchor inside a line drawn from Albert Head to Fisgard Lighthouse, and in a depth of water varying from ten to fifteen fathoms, within a distance of one mile from Albert Head, there to be inspected by the inspecting physician, and ordered, according to the circumstances, as aforesaid.

Victoria quar-  
antine limits.

(f.) All boats, ships and vessels of the class and description mentioned in the preceding regulation as liable to make their quarantine in the said harbor of Sydney, shall anchor in the North-West Arm of the said harbor of Sydney, in a space between two lines drawn due south, running across the harbor from Allan's Point and Jackson's Point, as near as may be, in the middle of the harbor, in the space between the said points, or at a point as near to the quarantine hospital in the said harbor as may be indicated by the inspecting physician, there to be inspected by the inspecting physician and ordered, according to circumstances, as aforesaid.

Sydney quar-  
antine limits.

Proc. June 17, 1885, part.

## Chap. 6.

*Quarantine Regulations—General.*

Hawkesbury  
quarantine  
limits.

(g.) All boats, ships and vessels of the class and description mentioned in the preceding regulation as liable to make their quarantine in the said port of Hawkesbury, in the Province of Nova Scotia, shall anchor in that part of the Strait of Canso, between the points known as Point Tupper and Port Hastings, opposite Grant's Cove, for a distance of about one-third of the strait from Cape Breton shore, as near as may be, or in six to twelve fathoms of water, there to be inspected by the inspecting physician, and ordered, according to circumstances, as aforesaid.

Inspecting  
physicians to  
visit vessels,  
&c.

Sec. 55. The inspecting physicians of the harbor of Richibucto, the harbor of Miramichi, the harbor of Pictou, the harbor of Charlottetown, the harbor of Victoria, the harbor of Sydney and the port of Hawkesbury respectively shall visit on their arrival, such boats, ships and vessels, and shall direct them as best calculated for the public health, and in accordance with the intent and meaning of the present regulations, and of any Orders in Council which may be communicated to them from time to time.

Proc. Aug. 3, 1886.

Powers and  
duties of  
inspecting  
physicians.

Sec. 56. The inspecting physician appointed for the harbor of Richibucto, the harbor of Miramichi, the harbor of Pictou, the harbor of Charlottetown, the harbor of Victoria, the harbor of Sydney or the port of Hawkesbury, respectively, shall have the power to go on board, examine and inspect boats, ships and vessels entering the said harbors or port, and to direct such boats, ships and vessels to go to such place or places within the shelter of the said harbors or port to perform quarantine as it may be necessary to send them to, and shall grant to such boats, ships and vessels permission to dispense with further quarantine whenever they are satisfied that no further dangers are threatened by the admission of the same to pratique. The said inspecting physicians shall have the medical attendance over the sick and healthy on board such boats, ships and vessels, or on shore, if allowed to perform their quarantine on shore, and shall be the judge of the preventive and precautionary measures to be taken either in the treatment of persons or in the washing, cleansing and purifying of luggage and other articles, and shall have power to order such preventive and precautionary measures to be taken as aforesaid.

Master or pilot  
shall bring  
vessel to  
anchor and  
display flag.

Sec. 57. Every master and every pilot having charge of a boat, ship or vessel of the class and description hereinbefore mentioned as liable to make their quarantine at the said harbor of Richibucto, the harbor of Miramichi, the har-



*Quarantine Regulations—General.*

## Chap. 6.

bor of Pictou, the harbor of Charlottetown, the harbor of Victoria, the harbor of Sydney and the port of Hawkesbury, aforesaid, shall bring such boat, ship or vessel to anchor within the limits of the anchorage grounds hereinbefore defined for the said ports respectively, and shall display a flag in the fore-shrouds, or a yellow flag at the fore, for a distinctive quarantine signal, until boarded by the inspecting physician as aforesaid.

Sec. 58. These regulations shall not apply to any vessel of war, or to transports or vessels having Queen's troops on board, accompanied by a medical officer, and in a healthy state, or to any steamer unless sickness or death may have occurred during the passage.

Vessels of war, &c.

Sec. 59. No boat, ship or vessel shall be entered and cleared at the harbor of Richibucto, the harbor of Miramichi, the harbor of Pictou, the harbor of Charlottetown, the harbor of Victoria, the harbor of Sydney or the port of Hawkesbury, aforesaid, until all the requirements of the foregoing regulations in reference to such boat, ship or vessel shall have been fully complied with.

Vessel when to be entered or cleared.

Sec. 60. Every pilot shall be furnished with printed copies of these regulations, one of which it shall be his duty to hand to the master of every steam and sailing vessel coming from a port outside of Canada, under a penalty not exceeding two hundred dollars.

Pilot to be furnished with regulations.

Sec. 61. Every collector of Customs, officer or other person charged with putting into effect, or having any duties in connection with the foregoing regulations, shall be liable to a penalty not exceeding four hundred dollars, and imprisonment until such penalty is paid, for any contravention of such regulations or for omission or neglect of duty in relation to them.

Penalty for contravention by Collector of Customs.

Sec. 62. Every master of a steam or sailing vessel shall be liable to a penalty not exceeding four hundred dollars, and to imprisonment until such penalty is paid, for any contravention of any of the foregoing regulations, and such vessel shall be held liable for any pecuniary penalty imposed on the master.

Penalty for contravention by master.

Sec. 63. Any person who shall contravene, either by omission or commission, any of the foregoing regulations, shall for every such offence incur and pay a fine not exceeding one hundred dollars, to be recovered in the manner prescribed by the said Act; and every person who, upon con-

Penalty for contravention of these regulations.

viction of any such offence, shall fail to pay the amount of fine which he shall have been condemned to pay, shall be imprisoned until such fine be paid.

Proc. June 30, 1871 [Richibucto]; Oct. 8, 1873 [Miramichi, Pictou]; July 15, 1875 [Charlottetown]; June 17, 1885 [Sydney, Victoria]; Aug. 3, 1886 [Hawkesbury].

#### General Provisions.

Trading between ports within Canada.

Sec. 64. All vessels trading between any ports or places within Canada, and not having touched at any ports or places without the Dominion nor communicated with any other vessel which shall have arrived from any port without the Dominion, shall be exempt from the foregoing rules and regulations so far as respects the necessity of going to or stopping at the anchorage ground aforesaid.

#### INFECTED PORTS.

Vessels from the Baltic, Black Sea, Sea of Azoff or Sea of Marmora.

Sec. 65. (a) All vessels coming from the Baltic, or from the Black Sea, or from the Sea of Azoff, or from the Sea of Marmora, or from or having touched at any place in, or any place the passage from which is by, or through any of the said seas shall be reputed coming from an infected port, and shall be suspected of being capable of introducing in Canada, some infectious disease or distemper dangerous to the public health.

Subject to quarantine regulations.

(b.) The fact of such vessel or vessels coming from or having touched at such place or places aforesaid, shall render them subject to the application of the quarantine regulations in force for the ports of Quebec, St. John, Halifax, Pictou and Charlottetown, and to the quarantine regulations in force concerning all other ports of the Dominion.

Duties of medical superintendents and collectors of Customs.

(c.) The medical superintendents of the regular quarantines established in virtue of the regulations first mentioned, and the collector of Customs of each and every port of Canada, except the regular quarantine stations above mentioned, are to apply the regulations defining their duties to each such vessel or vessels coming from the Baltic, or from the Black Sea, or from the Sea of Azoff, or from the Sea of Marmora, or from or having touched at any place in, or any place the passage from which is by or through any of the said seas, dealing with said ships *ipso facto* as if it were ascertained that they appertained to the class of vessels ordered to be visited and dealt with by the said medical superintendents and collectors of Customs for the purpose of Quarantine.

Proc. April, 27, 1879.

*Quarantine Regulations—General.*

## Chap. 6.

Sec. 66. (a.) All vessels coming from the Mediterranean Sea or having gone through the said Mediterranean Sea, shall be reputed as coming from an infected port and suspected of being capable of introducing into Canada cholera, or some other infectious disease or distemper dangerous to the public health.

Vessels from  
Mediterranean  
Sea.

(b.) The fact of such vessel or vessels coming from or having gone through the said sea shall render them subject to the application of the quarantine regulations in force for the ports of Quebec, St. John, Halifax, Pictou and Charlottetown, and to the quarantine regulations in force concerning all other ports of the Dominion.

Subject to  
quarantine  
regulations.

(c.) The medical superintendents of the regular quarantines established in virtue of the regulations first mentioned, and the collector of Customs of each and every port of Canada, except the regular quarantine stations above mentioned, are to apply the regulations defining their duties to each such vessel or vessels coming from or having gone through the Mediterranean Sea, dealing with said ships *ipso facto*, as if it were ascertained that they appertained to the class of vessels ordered to be visited and dealt with by the said medical superintendent and collectors of Customs for the purpose of quarantine.

Duties of  
medical su-  
perintendents  
and collectors  
of Customs.

Sec. 67. (a.) All vessels coming from the ports of Toulon and Marseilles, in France, or having stopped at the said ports on their voyage, shall be reputed as coming from an infected port, and suspected of being capable of introducing cholera into Canada.

Vessels from  
Toulon and  
Marseilles.

(b.) All vessels coming from the port of London, in England, or having called at the said port on their voyage, shall be reputed as coming from an infected port and suspected of being capable of introducing small pox into Canada.

Vessels from  
London,  
England.

(c.) The fact of such vessel or vessels coming from or having stopped on their voyage at the said ports, shall render them subject to the application of the quarantine regulations in force for the ports of Quebec, St. John, Halifax, Pictou and Charlottetown, and to the quarantine regulation in force concerning all other ports of the Dominion.

Subject to  
quarantine  
regulations.

(d.) The medical superintendents of the regular quarantines established and above mentioned, and the collector of Customs of each and every port of Canada, except the said regular quarantine stations, are to apply the regulations defining their duties to each such vessel or vessels coming

Duties of  
medical su-  
perintendents  
and collectors  
of Customs.

from or having stopped on their voyage at the ports of Toulon and Marseilles or London, dealing with said ships *ipso facto*, as if it were ascertained that they appertained to the class of vessels ordered to be visited and dealt with by the said medical superintendents and collectors of Customs for the purpose of quarantine.

Proc. June 23, 1834.

JUSTICES OF THE PEACE.

Medical  
officers who  
are appointed  
Justices of  
the Peace.

Sec. 68. Frederick Montizambert, M.D., Medical Superintendent, Grosse Isle, Que. ; William N. Wickwire, M.D., Inspecting Physician, Halifax, N.S. ; William S. Harding, M.D., Inspecting Physician, St. John, N.B. ; John McMillan, M.D., Inspecting Physician, Pictou, N.S. ; William H. Hobkirk, M.D., Inspecting Physician, Charlottetown, P.E.I. ; William McK. McLeod, Inspecting Physician, Sydney, N.S. ; William Jackson, M.D., Inspecting Physician, Victoria, B.C. ; A. Rowand, M.D., Inspecting Physician, Quebec, Que. ; Pierre A. Gauvreau, M.D., Inspecting Physician, Rimouski, Que. ; Patrick Coote, M.D., Assistant Medical Superintendent for Grosse Isle ; P. A. McDonald, M.D., Port Hawkesbury, N.S., and John McDonald, M.D., Chatham, N.B., have been duly appointed justices of the peace within their respective quarantine stations, under the Act respecting quarantine.

Proc. June 17, 1835 ; Sep. 3, 1837, part.

Chapter 7 inserted with exception  
of paragraph 29 on 35 & 5-2. by one date  
25 June 1897 & the keeper's case  
Section number by one 31<sup>st</sup> Mar 05

CHAPTER 7.

CONTAGIOUS DISEASES AMONG ANIMALS.

Government House, Ottawa.

The 12th day of May, 1888.

On the recommendation of the Minister of Agriculture, and under the provisions of Chapter 69 of the Revised Statutes of Canada, intituled: "The Animal Contagious Diseases Act:"

His Excellency in Council has been pleased to order and it is hereby ordered as follows:—

A new order  
to be out-  
in Dec. 1904  
dealing  
with them

HEALTH OF ANIMALS ORDER.

Section 1. This Order comprising all that follows to and including section 29 may be cited as the Health of Animals Order, and is divided as follows:—

Health of animals order.

Part I.—*Prohibition.*

Part II.—*Quarantine.*

Part III.—*Transit of Animals in Bond.*

Part IV.—*Conveyance and Shipment of Animals.*

PART I.

*Prohibition.*

Sec. 2. It is hereby ordered that the importation or introduction into the Provinces of Ontario, Quebec, New Brunswick, Nova Scotia and Prince Edward Island, of neat cattle and swine from the United States of America, be and the same is hereby prohibited, except in so far and in the manner hereinafter provided by sections 14 to 19 inclusive of this Order; and the importation and introduction of animals from Europe is prohibited, except at the ports of Charlottetown, Halifax, St. John, N.B., and Quebec, as provided and regulated in the following sections of Part II.

Importation, how far prohibited.

PART II.

*Quarantine.*

Sec. 3. The importation into the Provinces of Nova Scotia, Prince Edward Island, New Brunswick and Quebec, of live cattle, sheep and swine, coming from Europe, shall be pro-

Importation, coming from Europe.

## Chap. 7.

*Contagious Diseases among Animals.*

hibited, except at the ports of Charlottetown, Halifax, St. John, N.B., and Quebec.

Inspection.

Sec. 4. All cattle, sheep and swine arriving in Canada through either of the said ports of Charlottetown, Halifax, St. John or Quebec, shall be subject to inspection at those ports by officers who may, from time to time, be appointed for that purpose.

Probationary quarantine.

Sec. 5. All neat cattle coming from Europe shall be subject, on entering the Ports of Charlottetown, Quebec, Halifax and St. John N.B., to a probationary quarantine of ninety days before being allowed to come in contact with Canadian cattle, or to be exported to any other country, and shall not leave such quarantine until duly discharged therefrom by the quarantine officer.

Sheep and swine.

Sec. 6. All sheep and swine arriving in Canada through the said ports of Charlottetown, Quebec, Halifax and St. John, N.B., may, in the discretion of any quarantine officer, either be permitted to enter or be detained in quarantine at such place and in such manner as shall be directed by the quarantine officer, until duly discharged therefrom.

Duties of inspecting officers.

Sec. 7. The inspecting officers shall visit the boats, ships, vessels, cars or vans, and the cattle, sheep and swine coming into the said ports, and superintend the landing of such animals, order them to be placed and disposed of according to the requirements of the case, and see that they be conveyed to the grounds assigned for quarantine, and shall also superintend the landing and disposal of fodder, litter, blankets, troughs and other objects which may have been used by or for the said animals in transit to Canada, either on board ships or cars.

The quarantine stations and grounds at the several places above mentioned shall be established by, and be managed under regulations made and established by the Minister of Agriculture.

Direction of inspecting officer.

Sec. 8. The animals thus subjected to quarantine shall be treated and dealt with under the direction of the inspecting officer, and the articles used in connection with the said animals shall be in like manner employed in their care and maintenance, under the same direction and supervision.

Destruction of animals.

Sec. 9. Should it be found necessary to destroy any of the said animals, or all or any portion of the articles used in the care of the said animals, such destruction shall take place under the orders and supervision of the superintending

*Contagious Diseases among Animals.*

## Chap. 7.

officer, and in the manner prescribed by him, but not unless permission to that effect has been previously given by the Minister of Agriculture.

Sec. 10. The officers appointed to carry out the law and the foregoing regulations shall have free access to any boat, ship, vessel, car, van, or to any place where cattle, sheep or swine may be found, in order to inspect the same, and under instructions from the Minister of Agriculture, deal with infected animals and the articles employed in their service, in the manner contemplated by the Act, under the penalties prescribed thereby against any person contravening any of the provisions thereof, or of any regulations made thereunder.

Free access of officers.

Sec. 11. The said inspector or officers may, if it be deemed necessary, order the cleansing and purifying of any infected place, vehicle or other article so inspected, and direct such precautionary measures to be taken as may by him or them be considered advisable, pending the decision of the Minister of Agriculture as to the ultimate disposal of such vehicle or other article.

Cleansing and purifying, &c.

Sec. 12. The expense of feeding, attending to, and of providing for any cattle, sheep or swine, detained in quarantine shall be borne by the owner thereof, with the exception of that for the use of grounds and shelters; and such cost, if incurred by the inspector of quarantine, shall be paid before the animals are permitted to leave the quarantine; and in case of refusal or neglect to pay the same, the inspector shall, on being so ordered by the Minister of Agriculture, cause the said animals to be sold to meet the said cost,—the balance, if any, to be handed over to the owner.

Expenses of quarantine.

Sec. 13. The quarantine shall be under the care and subject to the orders of the officers appointed for that purpose, who shall have the general superintendence of the servants or other persons, and of all other matters connected therewith.

Quarantine to be under control of officers.

## PART III.

*Transit of Animals in Bond.*

Sec. 14. American cattle and swine, the importation and introduction of which are prohibited as ordered by Part I, section 2, may, nevertheless, be permitted to enter Canada in bond, at the Ports of Sarnia, Windsor and Amherstburg, to be conveyed, under surveillance and strict rules of

American cattle and swine.

isolation, through Canada to the American frontier, at Rouse's Point, St. Armand Station, Island Pond, the Suspension Bridge, (Niagara) and the International Bridge (Fort Erie); but no such transit shall be allowed, unless an agreement between the Minister of Agriculture and the railway company interested in and conducting such transit has been communicated to the collector of customs of each of the said ports or stations.

Arrangements with certain railway companies.

Sec. 15. The transit of cattle and swine between the points mentioned in the next preceding paragraph, shall be subject to such regulations as the Minister of Agriculture shall prescribe, and in accordance with the arrangements which may be made between the said Minister and the Grand Trunk, the Great Western and the Canada Southern Railway Companies, for the proper carrying out of the present order, and the necessary measures to save the live stock of Canada from the dangers of contagion and infection.

Inspection of cattle and swine.

Sec. 16. Amongst other things, these arrangements of the Minister of Agriculture shall provide:—

(a.) That an inspection of the said cattle and swine shall be made before they are admitted in transit, permission for which transit shall only be given on a certificate or clean bill of health from the inspector,—he being a veterinary surgeon appointed by the said Minister;

(b.) That each train carrying American cattle or swine, or both, from frontier to frontier in bond, shall be accompanied by one of the staff of guardians also to be appointed by the said Minister;

(c.) That the cars and trucks employed for such traffic be specially and exclusively devoted to such purpose;

(d.) That no Canadian animals shall be carried at any time in the same train, in company with, nor in close proximity to American cattle or swine, and that no car or truck employed in the transit of American cattle and swine shall be used to carry, at any time, Canadian animals;

(e.) That no unnecessary delay occur with any train engaged in the said transit passing through Canadian territory;

(f.) That due precautions be taken to retain in the cars or trucks, and disinfect, if need be, the droppings of cattle and swine thus carried in transit;

(g.) That no such cattle nor swine, nor their carcasses in case of death occurring (unless immediately buried under the directions of the proper guardian), nor parts thereof, nor articles having been employed about them, be permitted to remain in Canada, nor to come in contact with any person other than those engaged on the train or thing whilst thus undergoing the said transit.



*Contagious Diseases among Animals*

## Chap. 7.

Sec. 17. Inasmuch as it is of absolute necessity, owing to the length of the trip on the Grand Trunk Railway, to provide for a place where American cattle and swine can be fed, watered and rested, it is ordered that the said resting place shall be established at the station of Lyn, in the Province of Ontario, where a double, isolated inclosure shall be provided by the railway company, selected, established and fitted to the satisfaction of the Minister of Agriculture, before the said company is permitted to transport American cattle or swine over their line. The said inclosure, besides other requisites, shall be provided with a high board fence and a vacant space around the said board fence, the said outside space to be also fenced, in order to prevent any approach to the inner inclosure; the said inner inclosure shall be provided with a special siding, with two locked doors, for the admission and isolation, under key, of the cars or trucks carrying American cattle or swine in transit.

Resting place  
at the station  
of Lyn.

Sec. 18. The two fenced inclosures mentioned in the next foregoing section, situated at the Grand Trunk Railway Station at Lyn, in the Province of Ontario, with all appurtenance therein, or things belonging thereto, are hereby declared to be infected places, in the meaning and for all purposes of "The Animal Contagious Diseases Act."

Station at  
Lyn an "infected  
place."

Sec. 19. The inclosures through which American cattle and swine enter Canada, in transit at Sarnia, on the Grand Trunk Line, must be arranged, fitted and isolated in like manner, to the satisfaction of the Minister of Agriculture, and the said inclosures situated on the Grand Trunk Railway grounds, on the frontier, near Sarnia Station, in the Province of Ontario, with everything thereto appertaining, are also declared hereby to be an infected place.

Sarnia an  
"infected  
place."

## PART IV.

*Conveyance and Shipment of Animals.*

Sec. 20. To provide against the possibility of diseased animals being carried from place to place, through Canadian territory, or conveyed to and shipped from Canadian ports, it is ordered as follows:—

Carriage of  
diseased  
animals.

Sec. 21. An inspection of animals will be made at any place or port in Canada to which animals are carried in the manner prescribed by the instructions which may be given from time to time by the Minister of Agriculture.

Inspection.

## Chap. 7.

*Contagious Diseases among Animals.*Animals  
exposed.

Sec. 22. Such animals as may be found to have been exposed to contagious or infectious disease, or to be laboring under contagious or infectious disease, shall be either detained or slaughtered in pursuance of the provisions of the said Act, under the direction of the Minister of Agriculture.

Free access of  
officers.

Sec. 23. The officers appointed to carry out the law and the present regulations shall have free access to any boat, ship, vessel, car, van, or other vehicle, or to any place where animals may be found, in order to inspect the same, and under instructions from the Minister of Agriculture, deal with animals having been exposed to disease or with diseased animals, and the articles employed in their service in the manner contemplated by the said Act, under the penalties prescribed thereby against any person contravening any of the provisions thereof or of any regulations made thereunder.

Cleansing  
purifying, &c.

Sec. 24. The said inspectors or officers may, if it be deemed necessary, order the cleansing and purifying of any place, vessel, vehicle or other article having been made use of to receive or transport, or being about to receive and transport, animals, and direct such precautionary measures to be taken as may be considered advisable.

Proprietors  
and dealers,  
to give notice  
and afford  
assistance to  
inspector.

Sec. 25. Proprietors of or dealers in stock having moved, or intending to move, animals towards a port of embarkation in Canada for export, must give notice to the inspector appointed for such port by telegraph or by letter, at least twelve hours in advance of the time of arrival of the said animals for shipment, and during the progress of inspection shall, with the hands at their disposal, give every required assistance to the inspector at such port, and move the animals according to the directions given to them by the said inspector. In case the owner refuses or neglects to furnish the necessary assistance, the inspector may employ men at the cost of the shipper, which shall be paid to the inspector before a clean bill of health is given.

Inspector;  
when not to  
permit cattle  
to be laden on  
board ship.

Sec. 26. In order to prevent the danger of contagion or infection resulting from the overcrowding or overlading of animals on board ship in any port in Canada, the inspector shall not permit cattle or other animals to be laden on board any ship in such port, until he shall be satisfied that suitable space and provision has been made for the number of cattle or other animals to be shipped on board such vessel, and that a greater number of animals shall not be shipped than such ship can safely and properly carry, and such in-

*Contagious Diseases among Animals.*

## Chap. 7.

spector shall not grant clean bill of health to such ship until all such provisions as aforesaid shall be made to his satisfaction.

Sec 27. The collector of customs of any port where such inspection as aforesaid is adopted and required, shall not give a clearance to any ship having cattle or other animals on board for exportation without being shown a clean bill, signed by the inspector, to the effect that the measures provided by the said Act and the present regulations as hereinbefore set forth have been obeyed and carried out.

"Clean bill" to precede clearance of ship.

O. C. April 23, 1880 ; April 5, 1881.

*Head Ropes.*

Sec. 28. The importation of head-ropes which have been used for tying up cattle in the United Kingdom or on board ship is prohibited, and all vessels neglecting to observe this regulation shall be liable to be declared to be infected under "The Animal Contagious Diseases Act,"

Importation of head ropes.

O. C. April 27, 1881 ; Feb. 9, 1882.

*General Disposition.*

Sec. 29. Collectors of customs throughout Canada shall see that the various exigencies and requirements of the present order are fulfilled before granting any permit which requires, before it is given, any act to be performed, or any inspection or other proceeding to be made or taken, and they shall see that the prohibitions prescribed and rules established by this order as hereinbefore mentioned, and the instructions which may be issued by the Minister of Agriculture are obeyed, and in case of any infraction of the provisions of the present order, as hereinbefore mentioned, or any of them, taking place, they shall report at once to the Minister of Agriculture the nature and extent of such infraction.

Collectors of Customs, to see that certain requirements are fulfilled and certain duties performed.

O. C. April 23, 1880.

## CATTLE QUARANTINE STATION AT POINT EDWARD.

Sec. 30. Whereas it is expedient to admit neat cattle for breeding purposes from the Western United States subject to the restrictions and regulations hereinafter referred to. it is ordered :-

Neat cattle from the Western United States.

(a.) That a point of land on the River St. Clair, closely adjoining the frontier of the United States, at Point Edward, to the north of the Grand Trunk Railway Company's line, be declared a cattle quarantine station.

River St. Clair.

## Chap. 7.

*Contagious Diseases among Animals.*Cattle for  
breeding.

(b.) That cattle for breeding purposes may be admitted for Quarantine at such station, subject to the regulations and restrictions contained in the Health of Animals Order aforementioned.

O. C. Feb. 20, 1882.

## CATTLE QUARANTINE AT PARTRIDGE ISLAND.

Partridge  
Island.

Sec. 31. (a) That Partridge Island, near St. John, New Brunswick, be a cattle quarantine station between the dates of 30th April and 30th September in any year.

Cattle for  
breeding.

(b) That cattle for breeding purposes may be admitted for quarantine at such last mentioned station, subject to the regulations and restrictions contained in the Health of Animals Order aforementioned.

## CATTLE QUARANTINE STATION AT RED RIVER.

Red River,  
Ste. Agathe,  
an "infected  
place."

Sec. 32. The buildings and property formerly occupied by the British-North American Boundary Commission and lately as a Government Immigrant Station, situated on the Red River, and comprising lots Nos. 31 and 33, in the Parish of Ste. Agathe, and being the property of the Government, are hereby set aside for a cattle quarantine Station, and are declared an "infected place" within the meaning of "*The Animal Contagious Diseases Act*," and all communication with them prohibited, except such as shall be ordered by the Minister of Agriculture for carrying into effect the regulations heretofore approved and published.

O. C. Sep. 14, 1884.

## CATTLE COMING FROM THE UNITED KINGDOM.

Neat cattle  
from the  
United King-  
dom.  
Pleuro-  
pneumonia.

Sec. 33. Any neat cattle coming from any county in the United Kingdom, in which pleuro-pneumonia is officially reported to exist, either on the authority of the Imperial Privy Council, or any legally constituted local authority, are prohibited from entering at any port in Canada; and all importers or their agents, before embarking any neat cattle for Canada, from the United Kingdom, are required to obtain a certificate from the High Commissioner for Canada, or some officer named by him, that the county from which they come, is free from the disability above stated.

Certificate  
under oath.

Sec. 34. All importers are obliged to certify under oath, before making customs entry, the locality in the United Kingdom from which any neat cattle have come.

O. C. Aug. 25, 1886; Sep. 16, 1886.

*revised*

Contagious Diseases among Animals.

Chap. 7.

*Amended by Act 31*

THE DISEASE OF SHEEP SCAB.

*Amended 05*  
Duty of sheep owners, &c.

Sec. 35. It is the duty of every farmer, owner or breeder of, or dealer in sheep, on perceiving the appearance of the disease of "sheep scab" among any one of the animals owned by him or under his care, to give immediate notice to the Minister of Agriculture at Ottawa of the fact discovered by him, as required by section 3 of the said Act.

Penalty for non-compliance.

Sec. 36. Negligence to comply with this obligation shall entail upon the owner of the said diseased sheep the penalty of not being entitled to, nor granted any compensation for such animals as may be slaughtered in accordance with the provisions of the said Act, and further that concealment of such disease shall subject such person, on conviction thereof, to forfeit and pay a sum not exceeding two hundred dollars.

Penalty for grazing sheep infected with "sheep scab."

Sec. 37. If any person turn out, keep or graze any sheep knowing such animal to be infected with the disease of "sheep scab," or to have been exposed to infection or contagion therefrom, in or upon any forest, wood, moor, beach, marsh, common, waste land, open field, or other undivided or uninclosed land, such person shall, on conviction thereof, forfeit and pay a sum not exceeding two hundred dollars.

Penalty for marketing such sheep

Sec. 38. Any person bringing into any market, or other place, any animal known by him to be infected with the disease of "sheep scab" shall, upon conviction thereof, forfeit and pay for every such offence a sum not exceeding two hundred dollars.

Penalty for placing in rivers, &c., such sheep.

Sec. 39. Any person throwing or placing or causing to be thrown or placed in any river, stream, canal, navigable or other water, or in the sea within ten miles of the shore, the carcass of any sheep which has died of "sheep scab," or been slaughtered as having been so diseased shall, on conviction thereof, forfeit and pay a sum not exceeding two hundred dollars.

Penalty for digging up carcass of such sheep.

Sec. 40. Any person who digs up or causes or allows to be dug up a carcass buried of a sheep having died or been suspected of having died, or been slaughtered, from the disease of "sheep scab," shall, on conviction thereof, forfeit and pay a sum not exceeding one hundred dollars.

Offering for sale such sheep.

Sec. 41. In case any sheep affected with the disease of "sheep scab" be exposed or offered for sale, or be brought for such purpose into any market, fair or other open or

## Chap. 7.

*Contagious Diseases among Animals.*

Duty of Municipal officers. public place where other animals are commonly exposed for sale, then any police or municipal officer or duly authorized inspector shall cause the same, together with any pens, hurdles, troughs, litter, hay, straw or other articles, to be forfeited, destroyed or otherwise disposed of in such manner as he may deem proper or as may be directed.

Treatment of such sheep. Sec. 42. It shall be unlawful for any person to have in his possession or under his charge a sheep affected with the disease of "sheep scab," without causing it to be treated with some dressing, dipping or remedy for "sheep scab."

Removal of such sheep. Sec. 43. No sheep being affected with "sheep scab" of sheep which have been in contact with other sheep suffering from "sheep scab," or have been in any field, stable, cowshed or other premises in which "sheep scab" is found to exist, shall be allowed to be removed therefrom without a written order from an inspector authorized by the Minister of Agriculture for that purpose.

Cleansing and disinfecting sheds, &c. Sec. 44. All sheds, outhouses and places used by sheep affected by "sheep scab" must be thoroughly cleansed and disinfected by scrubbing with hot water and carbolic acid—one pound to four gallons—and afterwards white-washed with hot lime to which chloride of lime—one pound to a gallon—has been added, to a height of at least five feet from the ground or floor.

Slaughter, &c., of badly affected sheep. Sec. 45. When found necessary an inspector shall order the slaughtering and burial of all badly affected sheep, and any person having in possession any sheep affected with "sheep scab" without treating such sheep by some dressing or dipping fluid shall be liable to such penalties as may be enacted under the provisions of the aforesaid Act.

O. C. April 20, 1882.

## VETERINARY INSPECTOR IN CASE OF SHEEP SCAB.

Segregation and isolation. Sec 46. In order to provide for the segregation or isolation or otherwise dealing with animals affected with the disease of "sheep scab," a veterinary inspector, or other person appointed by Order in Council acting under the direction of the Minister of Agriculture, may declare any farm or place or common or yard, or any building; where such diseased animals are found, to be an infected place within the meaning of the Act aforesaid.

Improper removal of sheep. Sec. 47. No person whatever, except a veterinary inspector, or other person duly appointed as aforesaid, and acting

*Contagious Diseases among Animals.*

## Chap. 7.

under the direction of the Minister of Agriculture, shall remove any sheep from such infected place, and then only for the purpose of carrying into effect the provisions of said Act, under a penalty of two hundred dollars.

Sec. 48. A veterinary inspector, or other person duly appointed as aforesaid, acting under direction from the Minister of Agriculture, may make a selection of a particular place or places within or without the limits of an infected district for the purpose, in such cases in which it may be considered advisable, of isolating and segregating such animals as may have been exposed to the disease of sheep scab. Such veterinary inspector, or other person duly authorized as aforesaid, shall alone have the power to order the removal of such animals, as he may consider advisable to or from such selected places. Veterinary inspector may select places.

Sec. 49. Such duly appointed veterinary inspector or other officer acting under the direction of the Minister of Agriculture, may, under the provisions of section 13 of the Act aforesaid, order any animal found to be affected with sheep scab, or in contact with animals so affected, to be slaughtered, a compensation to an amount not exceeding two-thirds of the value of such animal before it became affected to be paid to the owner thereof, but such compensation never to exceed the sum of four dollars for any one animal. Veterinary inspector may order affected sheep to be slaughtered.

Sec. 50. The value of such animals is to be, in all cases, appraised by a veterinary inspector, or other person appointed for that purpose by the Minister of Agriculture; but no compensation whatever is to be allowed in any case in which it is found that fraudulent attempts at concealment of such disease shall have been made; or in any case in which such animals shall have been removed from any place declared to be infected under the provisions of the Act aforesaid. Compensation for slaughtered animals.

Sec. 51. Any market, or railway yard, or pen, or wharf, or part or parts of such, or other place where sheep are exposed for sale, or where, or in which they may be placed for the purpose of transit for removal to market, or from the Province, for the purpose of exportation, shall, in the event of any animal affected with the disease of sheep scab being found therein, by a veterinary inspector, or other person duly appointed by Order in Council, and acting under instructions from the Minister of Agriculture, on a declaration to that effect made by him, be held to be an infected place within the meaning of the Act aforesaid; no animal Market, railway yard, pen, &c., when to be declared an "infected place."

## Chap. 7.

*Contagious Diseases among Animals.*

being allowed to be removed from such infected place, except on order of such duly appointed veterinary inspector, or other person aforesaid, under a penalty of two hundred dollars.

Cleansing  
and disinfection  
of sheds,  
&c.

Sec. 52. All sheds, out-houses, or places used for sheep affected by sheep scab must be thoroughly cleansed and disinfected under the directions of a veterinary inspector or duly appointed person.

## INFECTED VESSELS.

Vessels which  
have carried  
cattle from  
the United  
States.

Sec. 53. (a.) All vessels which have carried cattle from any port in the United States, shall be prohibited from loading cattle in Canada for a period of twenty-one days thereafter; and, further, until such vessels shall have been thoroughly cleansed and disinfected under the supervision of an inspector appointed by the Minister of Agriculture.

"Foot and  
mouth dis-  
ease."

(b.) All vessels which have carried cattle from any United States port, among any of which "*Foot and Mouth Disease*" shall have been found, shall be prohibited, for a period of sixty days thereafter, from loading cattle in any Canadian port; and, further, until such vessels shall have been thoroughly cleansed and disinfected, under the supervision of an inspector appointed by the Minister of Agriculture.

"Pleuro-  
Pneumonia."

(c.) All vessels which have carried cattle from any United States port, among any of which shall have been found the disease known as "*Pleuro-Pneumonia*," shall be prohibited, for a period of ninety days thereafter, from loading cattle in any Canadian port; and, further, until such vessels shall have been thoroughly cleansed and disinfected under the supervision of an inspector appointed by the Minister of Agriculture.

O. C. April 9, 1881.

*Regulations respecting the Inspection and Quarantine of  
Animals in Manitoba the North-West Territories and  
British Columbia.*

## PROVINCE OF MANITOBA.

Sec. 54. *Neat Cattle.*

1. The importation of neat cattle from the United States, or from the United States Territories, into the Province of Manitoba, is prohibited except:

Cattle from  
the United  
States.

(a.) At Emerson, or at a point on the frontier opposite to the Canadian Pacific Railway station, named Oak Lake, or at such point or points as may hereafter be indicated by the Minister of Agriculture; and



*Contagious Diseases among Animals.*

## Chap. 7.

(b.) For stock or breeding purposes, or in transit to western points in the United States, neat cattle may be allowed to cross the Canadian frontier, subject to the following regulations :

2. For stock or breeding purposes, at Emerson, neat cattle shall be allowed to cross the frontier if, after inspection by a duly authorized veterinary surgeon appointed by the Minister of Agriculture, they shall be declared free from contagious disease, and also from well founded suspicion thereof. After crossing the frontier such cattle shall be immediately and directly conveyed to the quarantine station at Dufferin, and be there detained for a period of ninety days, or such other period as to the Minister of Agriculture may appear advisable.

Neat cattle for breeding purposes, when permitted to cross frontier at Emerson.

3. Such cattle, when it is desired to have them entered at Oak Lake, must cross the frontier at a point opposite the Canadian Pacific Railway station named Oak Lake, and must not be driven beyond two townships north of the frontier, where they will be inspected by a duly authorized veterinary surgeon appointed by the Minister of Agriculture, and if declared to be free from contagious disease or well founded suspicion thereof, they will be detained in quarantine for a period of ninety days, or such other period as may be indicated by the Minister of Agriculture in such manner as shall be ordered by him, but if not so declared they shall be immediately sent back across the frontier.

Oak Lake, C. P. R. Station.

4. Cattle in transit by railway for the Western United States or Territories shall be allowed to enter at the points above named, and also at Gretna if, on inspection by a duly qualified veterinary surgeon authorized by the Minister of Agriculture, they are found to be free from contagious disease or well founded suspicion thereof, but not otherwise.

Cattle in transit by railway, Gretna.

5. No car which has been loaded with cattle in the United States and crossing the Canadian frontier shall be allowed afterwards to carry Canadian cattle, and the number of each of such cars shall be registered by the collectors of customs at Emerson and Gretna.

Cars from United States.

6. No car nor train carrying such United States cattle in transit shall be allowed to be or remain shunted in close proximity to any Canadian cattle.

Car, when not to be shunted.

Chap. 7.

*Contagious Diseases among Animals.*

7. Every car containing cattle in transit shall be kept as far as possible apart from cars or trains containing Canadian cattle or Canadian goods.

8. No car containing such United States cattle in transit shall form any part of a train carrying Canadian cattle.

Fixed places for the stopping of cattle cars.

9. Every car or train carrying cattle in transit shall stop at such fixed place or places as shall be named by the Minister of Agriculture for the purpose of rest, feeding or watering, and such place or places shall be declared "infected" within the terms of the "Animal Contagious Diseases Act," being strictly isolated and all communication with them prohibited, except by the officers and men in charge of such infected place or places.

Cleansing, &c., cattle cars.

10. Every car which has been used for carrying animals from the United States or Territories in transit, shall be thoroughly cleansed and disinfected before re-entering the Province of Manitoba, in such manner as shall be ordered by the Minister of Agriculture, in the manner prescribed in paragraph No. 23 hereinafter. [See *post* page 87.]

Certificate by owner of cattle.

11. The owner or owners of any neat cattle for stock or breeding purposes, or in transit desired to be entered at one of the points aforesaid shall, on making application for entry, produce a duly attested certificate indicating the State or Territory, and the particular locality from which they have been brought, and if such certificate should not be found satisfactory, the cattle to which it refers shall not be allowed to enter.

12. The importer of neat cattle, whether for stock or breeding purposes, or in transit, shall pay a fee graded on a scale hereto annexed, to the customs officer or other person duly authorized to act as such, for defraying the expense of such inspection, that is to say :

Inspection fees for neat cattle.

One animal.....	\$1 00
5 animals and under.....	0 50 each.
But total fee for over 5 animals not less than \$2.50	
10 animals and under.....	0 30 each.
But total fee for over 10 animals not less than \$3.	
20 animals and under.....	0 20 each
But total fee for over 20 animals not less than \$4.	
50 animals and under.....	0 12 each.
But total fee for over 50 animals not less than \$6.	
Over 50 animals.....	0 10 each

*Contagious Diseases among Animals.*

Chap. 7.

Sec. 55. *Horses and Mules.*

13. The importation of any horse or mule into the Province of Manitoba from the United States or United States Territory is prohibited, except on inspection by a duly qualified veterinary surgeon, appointed by the Minister of Agriculture, it shall be declared to be free from the disease of glanders or other contagious disease.

Inspection of horses and mules.

14. The following is a scale of fees payable by the owner or importer, for the purpose of defraying the expenses of such inspection :—

For one horse or mule up to five, each.....	\$ 1 00	Inspection fees for horses and mules.
For over five and up to ten.....	7 50	
For over ten and up to twenty.....	12 50	
For over twenty and up to thirty.....	15 00	
For over thirty and up to fifty.....	20 00	
For any number over fifty, 25 cents each, but fee not to be less than.....	20 00	

Sec. 56. *Sheep.*

15. The importation of sheep into the Province of Manitoba shall be prohibited, unless, after the inspection of each animal by a duly qualified veterinary surgeon approved by the Minister of Agriculture it shall be found free from the disease of sheep scab or other contagious disease.

Inspection of sheep.

16. The following is a scale of fees payable by the owner or importer, for the purpose of defraying the expenses of such inspection :—

For one animal, 25 cents	
For five animals, 10 cents each, but fee for inspecting more than one and under five, not less than 50 cents.	Inspection fees for sheep.
For ten animals, 6 cents each, but fee for the inspection of over five and under ten, not to be less than 60 cents.	
For twenty animals, 4 cents each, but fee for inspection of any animals over 10 and under 20, not less than 80 cents.	
For fifty animals, 2½ cents each, but for inspecting over 20 and under 50, not less than \$1.25.	
For over 50 animals, 2 cents each, but fee not to be less than \$1.25.	

Sec. 57. *Swine.*

17. Swine imported into the Province of Manitoba from the United States or Territories, shall be subject to a quarantine of twenty-one days, no animal being allowed to leave the quarantine, unless certified to be healthy by a veterinary inspector appointed by the Minister of Agriculture.

Certificate of inspection.

## Chap. 7.

*Contagious Diseases among Animals.*

Inspection  
fees for swine.

18. The fees for the inspection of swine shall be the same as those for the inspection of sheep, as defined in paragraph 16 of these Regulations. [See *ante* page 85.]

O. C. July, 18, 1887.

PROVISIONAL DISTRICTS OF ASSINIBOIA, SASKATCHEWAN AND ALBERTA.

Sec. 58. *Neat Cattle.*

Importation  
of neat cattle  
from the  
United States.

19. The importation of neat cattle from the United States or United States Territories into the Provisional Districts of Assiniboia, Saskatchewan and Alberta is prohibited, except—

(a.) For stock or breeding purposes, subject to an inspection for crossing the Canadian frontier, and to a quarantine of ninety days, within the limits hereinafter defined;

(b.) For transit through the Provisional Districts and the Province of Manitoba, by the route of the Canadian Pacific Railway for exit at Emerson or Gretna.

Regulations  
same as  
Manitoba.

20. The regulations as respects the conditions of entry for stock or breeding purposes or in transit of neat cattle into the provincial districts, in relation to inspection, certificates of locality where from, freedom from contagious disease, conditions on which the entry shall be allowed, payment and scale of fees, and conditions of quarantine, shall be the same as in the above regulations for the Province of Manitoba, as defined in paragraphs numbered from 1 to 12 inclusive. [See Section 54, pages 82 to 84.]

Department  
of Interior  
reserve, an  
"infected  
place."

21. The Department of the Interior *reserve* of two townships along the frontier between Canada and the United States shall be declared an "infected place" within the meaning of "The Animal Contagious Diseases Act" for the purpose of serving as quarantine ground, along which animals in quarantine will be allowed to graze, subject to such directions as shall be ordered by the Minister of Agriculture.

Milk River  
district an  
"infected  
place."

22. The quarantine ground for cattle entering the Provisional District of Alberta, at or near the trail leading to Fort McLeod, shall be that portion of the territory formed by the curve of the Milk River, from the point of its entering the District of Alberta to the point of its crossing the United States frontier, in the district of Assiniboia, and the area within such points shall be declared an infected place within the meaning of "The Animal Contagious Diseases Act" for the purpose of a special station to be known as McLeod Quarantine Station. Cattle entering for quarantine shall be placed in such localities within the above

*Contagious Diseases among Animals.*

## Chap. 7.

named limits as shall be allocated by the Veterinary Inspector appointed by the Minister of Agriculture.

23. Neat cattle for eastern transit for exit at Emerson or Gretna, may enter the District of Assiniboia from the United States Territory of Montana at the point of Maple Creek, or such other point or points as may be hereafter designated by the Minister of Agriculture, subject to the following regulations, additional to those referred to in paragraph 20 herein:—

(a.) The production of a certificate from the territorial veterinarian or other official person to the effect that no pleuro-pneumonia or other infectious disease among cattle exists, or has existed within twelve months, in the district whence such animals have come. Certificate.

(b.) That such animals be not moved nearer than within twenty-five miles of the shipping point of Maple Creek until they have been inspected by a duly qualified veterinary officer, appointed by the Minister of Agriculture and by him declared to be free from contagious disease. Inspection.

(c.) That the yard or places provided by the Canadian Pacific Railway Company for the shipment of such cattle shall be at least half a mile distant from any yard or place used for the shipment of Canadian cattle, and further, that Maple Creek shall not be used as a feeding station by the Canadian Pacific Railway Company for Canadian cattle in transit either east or west on their line. Places provided by the C. P. R.

(d.) That the cars used by the Canadian Pacific Railway Company for carrying cattle from Montana in transit east for exit at Emerson or Gretna shall have each a distinguishing mark, that the numbers of each of such cars shall be registered by the officer of Customs at Maple Creek, and that each of such cars be prohibited from being used for the carriage of Canadian cattle, or settlers' effects. Cars, to be marked and registered.

(e.) That no car which has been used for carrying such cattle in transit shall be allowed to re-enter Canada until it has been thoroughly disinfected, first, by scraping and sweeping the floors and sides, and second, by washing the entire interior of the car with lime wash, in which one pound of commercial carbolic acid to four gallons of the lime wash has been mixed. Car, to be disinfected.

(f.) That the numbers and marks of the cars used for such transit shall be reported by the collector of Customs to the Minister of Agriculture. Cars, to be reported.

## Chap. 7.

*Contagious Diseases among Animals.*

Regulations  
same as  
Manitoba.

**Sec. 59.** *Horses, Mules, Sheep, Swine.*

The regulations respecting the importation of horses, mules, sheep or swine to be the same as for the Province of Manitoba, as defined by paragraphs numbered 13 to 18 inclusive. [See Sections 55, 56 and 57, pages 85 and 86.]

## PROVINCE OF BRITISH COLUMBIA.

Regulations  
same as  
Manitoba.

**Sec. 60.** *Horses and Mules.*

The regulations respecting the importation of horses or mules into the Province of British Columbia from the United States or the United States Territories to be the same as in the Province of Manitoba, with the exception that the fee for the inspection of one horse shall be \$2, for over one and up to five \$1.50 each, or over five and up to ten, \$1 each; and over ten, the same fee as in the Province of Manitoba, as defined in paragraph numbered 14 hereinbefore. [See page 85.]

Regulations  
same as  
Manitoba.

**Sec. 61.** *Sheep and Swine.*

The regulations respecting the importation of sheep and swine in the Province of British Columbia, shall be the same as for the Province of Manitoba hereinbefore defined in paragraphs numbered 15 to 18 inclusive, and the inspection fees the same. [See Sections 56 and 57, pages 85 and 86.]

**Regulations for Slaughtering and Curing imported Swine in Bond**

See *post* Chapter 9, page 97.

# DEPARTMENT OF CUSTOMS.

## CHAPTER 8.

### CUSTOMS WAREHOUSES.

Government House, Ottawa,  
The 25th day of July, 1888.

On the recommendation of the Minister of Customs and under the provisions of Chapter 32 of the Revised Statutes of Canada, intituled "The Customs Act,"

His Excellency in Council has been pleased to make the following regulations respecting the bonding Warehouses in Canada:—

#### REGULATIONS, GENERAL.

Section 1. Warehouses for the storage of imported goods shall be known as Customs warehouses and be designated as follows:—

Classifica-  
tion of ware-  
houses.

Class 1.—Stores occupied by the Government of Canada.

Class 2.—Warehouses occupied by importers exclusively for the storage of goods subject to duty, imported by, or consigned to them, or purchased by them.

Class 3.—Warehouses occupied for the general storage of such imported goods.

Class 4.—Yards, sheds and other buildings used for the storing and slaughtering of dutiable animals.

Class 5.—Warehouses exclusively for the manufacture or refining of sugar.

Class 6.—Sufferance warehouses.

#### *Warehouses of Class 1.*

Sec. 2. At all ports where there are Government stores, they shall be used for the examination and appraisement of imported goods, and for the storage of unclaimed and seized goods, and where there are no such stores, the collector may, under the direction of the Minister of Customs, make temporary arrangements for suitable premises for those purposes, or may deposit such unclaimed or seized goods in any warehouse of class 3.

Class one.

#### *Warehouses of Class 2.*

Sec. 3. A warehouse of class 2 shall consist of an entire building, or not less than one whole flat of such building, and in the latter case there must be a separate entrance to such flat, and the warehouse must be so arranged as that the

Class two, an  
entire build-  
ing, or one  
whole flat;  
separate en-  
trance.

## Chap. 8.

*Customs Warehouses.*

customs locks will prevent all access to the floor set apart and established as a warehouse, within the meaning of the term as above, and no partitions of slats shall in any case be allowed, but all divisions between the part of a building occupied as a warehouse, whether door or partition shall be of the most solid and secure description possible in each case.

*Warehouses of Class 3.*

Class three.

Sec 4. A warehouse of class 3 shall in every case consist of an entire building and shall be used solely for the storage of merchandise subject to duty, or of unclaimed and seized goods ordered thereto by the collector of customs.

Rates of storage and compensation.

The rates of storage and compensation for labor in the handling of goods in warehouses of this class shall be subject to agreement between the owner or importer of the goods and the proprietor of the warehouse, who will collect all amounts due for storage and labor, the duty of the collector or proper officer of customs being to look after the safe custody of the goods for the security of the revenue only.

Unclaimed and seized goods.

Should the collector of customs require to deposit in any such warehouse unclaimed and seized goods, the charges for storage and labor thereupon shall not exceed the regular rates, and the proprietor shall be liable as in other cases for their safe-keeping.

*Applications for establishment of Warehouses.*

Application for second or third class; how made and granted.

Sec. 5. For a warehouse of the second or third class, the owner shall make application in writing to the collector of the port, describing the premises, the location and capacity of the same, and stating the purpose for which the building is to be used, whether for the storage of merchandise imported by, or consigned to himself exclusively or for the general storage of merchandise in bond.

Examination and inspection of premises.

The collector will thereupon examine or direct the surveyor or other proper officer of customs, in whom he can repose confidence, to examine and inspect the premises and to report to him in writing the particulars of the location, construction and dimensions of the building, its capabilities for the safe-keeping of merchandise, and all other facts bearing upon the subject.

Report to Commissioner.

When the examination has been made, the collector will transmit the report, together with the proprietor's application, with his own report as to the necessity of granting the application to the commissioner of customs.

Notice to owner or occupant.

Sec. 6. If on examination of the foregoing documents the Minister of Customs is satisfied that the public interest



*Customs Warehouses.*

## Chap. 8.

will be subserved thereby, the application will be granted, whereupon the owner or occupant will be notified by the collector, and on fulfilment of the conditions hereinafter provided, the collector will assign a number for the warehouse and add the same to his register, placing a warehouse locker in charge thereof.

Sec. 7. All warehouses of either class 2 or class 3 shall be secured by customs locks, provided by the Department of Customs; but this will not prevent the proprietors or occupants of the building from having their own locks on the same doors in addition thereto, subject, however, to the provisions of "The Customs Act," as amended.

Customs locks provided; private locks allowed.

Sec. 8. No free or duty paid goods shall be stored in any such warehouse; and all goods, when entered for consumption, removal or exportation, shall immediately be removed therefrom, unless permission to the contrary be first obtained from the collector upon an application made to him in writing, specifying the goods and the time for which it is desired they should remain, and in such case the goods shall be legibly and conspicuously marked and set apart from those remaining dutiable; but no such privilege shall be granted in any case except for good and urgent reasons.

Free or duty-paid goods, and removal and marking of goods.

*Warehouses of Class 4.*

Sec. 9. Application for the establishment of a warehouse of this class shall be made in the same manner as for classes 2 and 3, and shall be subject to the "Regulations for Slaughtering and Curing Swine in Bond." [See *post* page 97.]

Application for class four.

*Class 5.—Warehouses for refining Sugar.*

Sec. 10. Applications for the establishment of warehouses of class 5 shall be made in accordance with the terms of the Regulations respecting the Refining of Sugar and Molasses in Bond [See *post* page 95] except that the application and description shall be submitted for approval of the Minister of Customs before acceptance, as in the case of warehouses of classes 2 and 3.

Application for class five.

*Class 6.—Sufferance Warehouses.*

Sec. 11. Warehouses of this class for the accommodation of steamers and other vessels may be established in accordance with the regulations contained in sections 9 and 10 of Chapter 13. [See *post* page 109.]

Steamers and other vessels.

## Chap. 8.

*Customs Warehouse.*

Railway stations and depots.

Sufferance warehouses at railway stations and depots shall be established in accordance with section 18 of Chapter 22 under "Regulations respecting transporting, manifesting and reporting dutiable goods by Railway in or through Canada" [See *post* page 137] and shall be subject to all the rules for safe-keeping of merchandise stored therein, provided in the case of warehouses of any other class.

O. C. June 14, 1875.

*Sufferance Wharves and Warehouses.*

Application for sufferance wharf or warehouse; how made and granted.

Sec. 12. On application to the Minister of Customs by the owner or master of any packet steamer, or other vessel being a regular trader, specifying the name and tonnage of the said steamer or other vessel, the general time of her arrival and departure, and the ports between which she is accustomed to sail, also designating the wharf at which she is accustomed to land and the building in which it is proposed to store her cargo, it shall be lawful for the said Minister of Customs to declare the said wharf and building to be a sufferance wharf and warehouse for the purposes of the Act, and to authorize the collector of the port to grant a warrant or license, for a specified time, to the master of such steamer or other vessel to land his cargo and store the same at the wharf and in the building so declared to be a sufferance wharf and warehouse, without previous entry, the said master having previously executed a bond to the Crown in such penal sum as the said Minister of Customs may consider equitable, but not less than one thousand dollars, providing that the said master will not fail to leave in the hands of the landing waiter or other officer of customs, appointed for the purpose, a report of the contents of his vessel for each voyage, and that he will in all other respects conform to the requirements of the law in such case, and will use his utmost diligence to prevent any infraction thereof by any person or persons arriving at such port in his vessel.

O.C. Oct. 23, 1868.

Master of vessel to execute a bond to the Crown in not less than \$1,000.

Payments for warehouses of class 2 or 4.

Sec. 13. The proprietor of every warehouse of class 2 and class 4 shall pay, for the privileges granted him in the use of such warehouse, the sum of forty dollars per annum, in half-yearly payments, in advance to the collector of customs.

Payments for warehouses of class 3 or 5.

The proprietor of every warehouse of class 3 and class 5 shall pay in like manner not less than forty dollars, nor more than one hundred dollars per annum, according to the capacity of the building and the nature and amount of

*Customs Warehouses.*

## Chap. 8.

business—the exact sum to be determined by the Minister of Customs at the time of accepting the proprietor's application.

All the foregoing payments shall date from the establishment of each warehouse, and no warehouse of either of the classes named in this article shall be recognized by the collector of customs as an established warehouse until or unless the said half-yearly payments are made within not over ten days after the proper date.

Date and mode of payments.

*General Provisions.*

Sec. 14. (a.) No alteration can be made in any bonded warehouse without permission of the collector of customs; and if any material change in the premises is contemplated it must be submitted for approval of the Minister of Customs.

Alterations in warehouses.

(b.) The collector of customs shall advise the commissioner of customs of any changes in the surroundings of bonded premises likely to affect their general security, and if burned or plundered immediate notice must be given to the commissioner, with full particulars of all facts connected therewith.

Changes in the surroundings.

(c.) Proprietors of bonded warehouses may relinquish the business at any time, on giving timely notice to the owners of merchandise deposited therein, but no part of any half-yearly payment made by them shall be refunded for any portion of a term unexpired.

Relinquishment by proprietors.

(d.) The Minister of Customs may, at any time, for reasonable cause, order the discontinuance of the right to store bonded goods in any premises established as a bonded warehouse; and when thus discontinued such warehouse can only be re-established after renewed application as at first.

Discontinuance of right by Minister.

(e.) All moneys received from proprietors of warehouses, as provided in section 13 shall be paid over by the collector of customs to the Receiver General, and shall form part of the Consolidated Revenue Fund of Canada.

Moneys to be paid to Receiver-General.

Sec. 15. The collector of customs will cause the proprietor or occupant to place over the gate or door leading into or on some conspicuous place on every customs warehouse, a board or sign with the following painted thereon:

Sign over gate or door.

" V. R.

*Customs Warehouse."*

O. C. June 14, 1875.

## Chap. 8.

*Customs Warehouses.*

## GRAIN.

*Regulations respecting the Grinding and Packing of Wheat, Maize and other Grain in bond.*

Entries of grain in bond.

Sec. 16. The collector of customs at any port of entry shall receive entries of wheat, maize or other grain to be ground and packed in bond for exportation or consumption, and such collector shall deliver or cause to be delivered such wheat, maize, or other grain to be forwarded to the port of destination where may be situated the mill or mills at which the said wheat, maize or other grain is to be ground and packed in bond, as by law permitted.

Forwarding of grain under bonds; regulations in relation thereto.

Sec. 17. The wheat, maize or other grain shall be so forwarded under bonds to be taken either by the collector at the port of entry or by the collector at the port of destination, as may best suit the convenience of the importer, which bonds shall be taken for an amount that will cover the duties chargeable upon the said wheat, maize or other grain, and be conditioned for the due payment of such duties, should such wheat, maize or other grain or the quantity of flour and meal representing such wheat, maize or other grain, go into consumption, or for the due exportation of such wheat, maize or other grain, or the product thereof in flour or meal; and on proof of the payment of such duties or of the due exportation as aforesaid, within one year from the date of the said bond or bonds, the said bonds shall be duly cancelled; and, if such bonds shall be given at the port of destination, a certificate of such payment or exportation, under the hand of the collector of customs at such port, shall be forwarded to the collector at the port of entry at which such wheat, maize or other grain shall have been imported or entered for manufacture in bond.

O. C. April 22, 1880.

## COAL.

*Regulations providing for the Warehousing of Coal imported into Canada.*

Yards, sheds and buildings.

Sec. 18. The yards, sheds or other buildings in which importers of coal, for the purposes of sale, desire to store the same for the purpose of sale, may be accepted as warehouses, and coal may be entered for warehouse and stored therein without payment of duty in the same manner and under like conditions for ex-warehousing for consumption, removal or exportation, as is provided by law for the warehousing of any other goods, except as hereinafter provided.

*Customs Warehouses.*

## Chap. 8.

Sec. 19. The importer of coal, desiring to warehouse the same, as above provided, shall make due entry of the same for warehouse, giving full particulars as required by the established form of such entries, and shall also give bonds for double the amount of the duty accruing upon the same, according to the terms of the tariff then in force,—such bonds to be duly executed by himself as principal and two persons of good standing acceptable to the collector or the Minister of Customs, as sureties, and conditioned for the due payment of duty or export of the whole quantity so warehoused prior to the first day of May then next ensuing.

Entry, how to be made; and bonds, how to be executed.

Sec. 20. The proprietor of coal so warehoused shall make due entry once a week of the quantity removed, sold or exported, and the whole quantity warehoused must be so entered prior to the first day of May then next ensuing the date of the warehousing as aforesaid, subject to all penalties, fines and forfeitures provided by "The Customs Act" for frauds connected with warehousing and warehoused goods.

Entries, how and when to be made.

O.C. Dec. 22, 1881.

## SUGAR AND MOLASSES FOR REFINING.

*Regulations respecting the Refining of Sugar and Molasses in Bond.*

Sec. 21. The collector or other proper officer of the customs at any warehousing port in the Dominion of Canada may deliver, without payment of duty, to the proprietor of any sugar refinery, being also the importer or owner of any warehoused sugar, molasses or other material from which refined sugar can be produced, on proper entry of the same, any quantity of such sugar, molasses or other material for the purpose of being refined in the Dominion of Canada, in such place and on such premises as shall be particularly described by such proprietor so being the importer or owner.

Entry for refining, how made.

Sec. 22. Such sugar refinery and the premises thereunto belonging in accordance with the description to be given thereof, as aforesaid, shall, for the purposes of refining sugar under the above-mentioned Act, be deemed and considered as a Government bonded warehouse, and that none of the sugar, molasses or other material, so brought into the said refinery or upon the said premises, shall be removed therefrom without a proper ex-warehouse entry and due payment of all duties on the same, if entered for home consumption, or upon due entry thereof for exportation, under the usual bonds; nor shall any refined sugar or other

Regulations for removal of sugar, molasses, &c.

## Chap. 8.

*Customs Warehouses.*

extract produced from the sugar, molasses or other material aforesaid, be removed from the said refinery and premises without entry, as aforesaid, either for consumption, for removal or exportation, and payment of all customs duties legally due on the sugar, molasses or other material from which the said refined sugar shall have been manufactured, as the case may be.

Security, how to be given, for the refining of sugar, molasses, &c., in bond.

Sec. 23. Before the importer or owner of any sugar, molasses or other material aforesaid shall, for the purpose of refining the same, as aforesaid, be entitled to obtain the delivery thereof—either ex ship, upon their importation into the Dominion of Canada, to be carried immediately to the sugar refinery and premises aforesaid, or out of any of the Queen's warehouses in which the same may be warehoused — he shall give bond with two sufficient sureties, to the satisfaction of the collector of customs, at the port where such sugar, molasses or other material is imported or warehoused, in a penalty of double the amount of the duties payable on the same, with the condition that the whole amount of the duties so payable upon the quantities of sugar, molasses or other material so delivered upon arrival or out of warehouse, as aforesaid, for the purpose of being so refined in bond, shall, within six months from the date of the bond to be so entered into, be well and truly paid to the collector of customs aforesaid for the use of Her Majesty in the Dominion of Canada. And the said importer or owner shall, before he can obtain the delivery aforesaid, further enter into and execute to the collector, for the use of Her Majesty, as aforesaid, a general bond,—the said importer or owner in the penal sum of \$10,000, and two approved sureties in the sum of \$5,000 each,—conditioned that at no period shall the quantity of sugar, raw or refined, in the said refinery or warehouse be less than the quantity on which the bond or bonds for duties hereinbefore mentioned shall be outstanding and unpaid.

Free access, as to officials.

Sec. 24. And for the purpose of further securing the due observance of the foregoing regulations, the collector of customs, the surveyor or warehouse keeper, or other approved officer of customs, at the port where the goods shall be so bonded, or at the port nearest to the said sugar refinery, shall, at all times, have free access to and upon the said refinery and premises, and all parts thereof, for the purpose of verifying the quantity of sugar, molasses or material aforesaid therein; and any reasonable expenses attending such inspection shall be borne and defrayed by the importer or owner of the sugar, molasses or other material so undergoing refinement in bond.

O. C. June 13, 1879.

## CHAPTER 9.

### REGULATIONS FOR SLAUGHTERING AND CURING IMPORTED SWINE IN BOND.

Government House, Ottawa,  
The 25th day of July, 1888.

On the recommendation of the Minister of Customs and under the provisions of "The Customs Act," and of "The Animal Contagious Diseases Act," Chapter 69 of the Revised Statutes of Canada,

His Excellency in Council has been pleased to make and prescribe the following regulations for slaughtering and curing imported swine in bond,—The "Health of Animals Order" [See *ante* page 71] remaining in force except in so far as the same may be inconsistent with the present order.

Section 1. Swine may be imported into Canada, for the purpose of being slaughtered; the importer shall enter the same for warehouse upon the usual form of such entries, stating upon its face the number, live weight and value of the herd, and the rate and amount of duty as prescribed by the tariff in force at the time of making such entry. Such importer shall then execute a bond to the Queen, with two sufficient sureties to the satisfaction of the collector of customs at the port where such carcasses are imported or warehoused, in double the amount of such duty; the condition of such bond shall be that upon due exportation within one year of the products of the swine so imported, slaughtered and cured in the form of pork, bacon, hams, shoulders and lard, or payment of the duty secured by the said bond, then the said bond shall be and become null and void; otherwise shall remain in full force and virtue.

Entry of swine, how to be made; and security, how to be given.

Sec. 2. After the reception of the swine into the bonding warehouse or slaughter house, it shall not be lawful to remove any of them alive therefrom, under any pretence or for any reason whatever.

Removal prohibited.

Sec. 3. The product of such swine, after having been slaughtered, shall not be removed for any purpose from the bonding place, without a permit from the collector or proper officer of customs, as in the case of all other bonded goods.

Product of swine, how removed.

O.C. May 3, 1880.

Sec. 4. The bond given by the importer as before specified shall be cancelled upon the payment of the current rate of duty imposed upon swine imported into Canada, or

Terms of cancellation of bond.

---

Chap. 9. *Regulations for slaughtering and curing Swine in bond.*

---

upon the exportation of sixty per cent. of the live weight of swine weighing two hundred pounds each and under, or upon the exportation of sixty-five per cent. of the live weight of the swine weighing over two hundred pounds each, as originally entered, in the form of pork, bacon, hams, shoulders and lard; and if a less quantity than the sixty or sixty-five per cent. herein named is exported, then duty shall be paid on the quantity deficient at the rate imposed upon the live animal in proportion to value.

O. C. Jan. 27, 1882.

Slaughtered swine, how entered.

Sec. 5. Slaughtered swine may be imported to be cured and packed in bond and entered in the usual way for warehouse, and be placed in the premises established as a warehouse of this class for the special purpose of curing and packing. The weight and value of such carcasses shall be stated upon the face of the entry for warehouse, and the importer shall execute a bond to the Queen with two sufficient sureties to the satisfaction of the collector of customs at the port where such carcasses are imported or warehoused, in double the amount of duty accruing thereupon, to be calculated according to the highest rate of duty imposed by the tariff upon any part or parts of the said carcasses, conditioned for the due exportation of the same or payment of duty within one year from date of first entry.

Weight and value of carcasses to be stated on face of entry and bond to be executed.

Calculations for exportation or duty.

Sec. 6. The meats, being the produce of such carcasses, shall be calculated for exportation or duty, as the case may be, after allowing in respect of meat in pickle a reduction of five per cent. from the original weight, or weight for first entry, and these percentages may be deducted by compensation entries from the warehouse books at the time of each ex-warehouse entry, in proper proportions, and if any less quantity is exported than the original weight, less the allowance above specified; the duty shall be collected upon such deficiency at the rate of duty required at the time by law upon meats of the kinds exported.

Isolation of swine and carcasses.

Sec. 7. The live swine imported for slaughter and the swine carcasses introduced for curing and packing shall not be permitted to come in contact with Canadian animals.

Use of cars and vehicles prohibited.

Sec. 8. The cars, trucks and other vehicles employed in such traffic shall not be used for the transport of Canadian animals.

Infected places.

Sec. 9. The bonding places hereinbefore mentioned are hereby declared to be infected places, subject to such regulations as the Minister of Agriculture may see fit to adopt



*Regulations for slaughtering and curing Swine in bond.*

Chap. 9.

for the purpose of preventing the introduction of disease among the live stock of the country.

Sec. 10. The transport of the swine imported for slaughter and of the carcasses imported to be cured and packed, and every proceeding in relation to the said traffic shall be subjected to inspection and regulation, in pursuance with the meaning of "The Health of Animals Order," aforesaid under the direction of the Minister of Agriculture: and the "General disposition," being the 29th section of the said order, shall apply to the execution of the present regulations.

"The Health of Animals Order," and "General Disposition," to apply.

Sec. 11. The "Health of Animals Order," in so far as the same or any of its clauses may be inconsistent with the ten preceding sections of this Order, is hereby declared to be rescinded.

"Health of Animals Order," how far rescinded.

O. C. May 3, 1880.

Sec. 12. Swine may be imported at any Customs warehousing port of entry in Canada, in bond, subject in all respects to the provisions in relation thereto contained in the "Health of Animals Order" aforesaid, and the eleven preceding sections of this Order.

Importation of swine in bond.

O. C. Nov. 5, 1883.

## IMPORTATION OF SWINE FOR BREEDING PURPOSES.

Sec. 13. Swine shall be admitted for breeding purposes only, at the quarantine station on the River St. Clair, closely adjoining the frontier of the United States at Point Edward.

River St. Clair.

Such swine for breeding purposes shall be subject to a quarantine of twenty-one days, and to the regulations and restrictions contained in the "Health of Animals Order" aforesaid

Quarantine of 21 days.

In order to insure that the animals imported are for *bona fide* breeding purposes, they shall consist of boars and sows and not of fattened hogs; and the importers of such swine shall be required to produce a certificate stating that they are intended for breeding purposes only, and that there is no disease among swine in the particular localities from which they come.

Certificate required; what to state.

O. C. Nov. 7, 1884.

## CHAPTER 10.

### FOREIGN REPRINTS OF BRITISH COPYRIGHT WORKS.

Government House, Ottawa,  
The 25th day of July, 1888.

On the recommendation of the Minister of Customs, and under the provisions of "The Customs Act" and of "The Copyright Act," Chapter 62 of the Revised Statutes of Canada,

Copyright works first composed or written or printed in the United Kingdom, and printed or reprinted in any other country.

His Excellency in Council has been pleased to order and it is hereby ordered, that all copyright works being first composed or written and printed in the United Kingdom, and printed or reprinted in any other country, and with regard to which the notice to the Commissioners of Customs required by any Act of the Imperial Parliament in that behalf, shall have been given, and a list of which shall have been published by the proper authority in England, from time to time, and as the list in the form established by law, shall have been furnished the Customs Department for that purpose, by the Imperial authorities, may be entered for duty on payment of twelve pounds ten shillings upon every one hundred pounds value thereof and under and subject to the same regulations as dutiable goods are now, or may hereafter be, admitted to entry for payment of duty under the authority of any law of this Dominion relating to customs, trade or navigation.

Sums collected as duty, to whom to be remitted.

That all sums collected as duty on such copyright works shall (less the cost of advertising, postage and making up the accounts of the same,) after the end of every fiscal year, be remitted to Her Majesty's Principal Secretary of State for the Colonies, or such other officer or person as may be from time to time appointed by competent authority to receive the same, together with a statement showing the amounts collected for each copyright work, in order that the proceeds of such duty may be paid over to or among the party or parties beneficially interested in the copyright of the works which may be imported under these regulations.

Whereof the Minister of Customs shall take due notice and give the necessary directions for carrying the same into effect.

O. C. Sep. 28, 1863.

## CHAPTER II.

### DRAWBACKS ON EXPORTATION OF IMPORTED GOODS.

Government House, Ottawa,

The 25th day of July, 1888.

On the recommendation of the Minister of Customs, and under the provisions of Chapter 32 of the Revised Statutes of Canada, intituled "The Customs Act,"

His Excellency in Council has been pleased to approve of the following regulations respecting drawbacks claimed on the exportation of goods under the said Act above referred to, viz:

#### GENERAL REGULATIONS.

*Governing Drawbacks under section 247 of said Act, on the exportation of duty paid articles in certain cases.*

Section 1. The manufacturer of any article, wholly manufactured in this Dominion out of materials imported into it, and upon which any duty of customs has been paid, may, unless otherwise provided, upon the exportation of the said manufactured article, be entitled to a drawback equal to ninety per cent of the duties that shall have been paid upon such quantity of the raw or duty paid material as shall have entered into and been consumed in the production of the manufactured article to be exported.

Drawback equal to 90 per cent. on raw material, &c.

Sec. 2. To entitle himself to the drawback, the manufacturer shall make due entry of the manufactured article for exportation, and deliver to the collector of the port where such entry is made, a statement showing the marks and numbers of the packages, the designation of the contents of such packages,—the quantity of the manufactured article,—the place where manufactured,—the quantity of the raw and duty paid materials entering into the composition of the said manufactured articles,—the date or dates of the importation of such raw material,—the number of the entry or entries of such raw material,—the amount of duty paid on the same, and the port at which entered and paid,—the port or place in the foreign country to which such manufactured article is to be exported, and the name of the vessel or line of railroad by which the exportation is intended to be made.

Statement to be delivered to Collector, how made and what to contain.

O. C. May 28, 1868.

## Chap. 11.

*Drawbacks on exportation of Imported Goods.*

## DRAWBACK ON BRITISH AND FOREIGN MANUFACTURES.

Drawback of 90 per cent. on manufactures of a kind not produced in Canada, but used in Canadian manufactures.

Sec. 3. Subject to the usual regulations and restrictions governing the payment of drawback on imported articles used in the manufacture in Canada of goods exported therefrom, and to such further regulations and restrictions as are herein named and except when otherwise provided; there may be paid to the manufacturer of any goods manufactured by him in Canada and exported therefrom a drawback of ninety per cent of the duty paid upon any articles of foreign manufacture used as materials wrought into or attached to any goods manufactured in Canada and exported therefrom; provided always, that when articles of foreign manufacture are so used and a drawback claimed thereon, it shall be shown to the satisfaction of the Minister of Customs that such imported manufactured articles are of a kind not manufactured in Canada, and that no other article manufactured in Canada could be substituted and used in the place thereof in the manufacture of such grade so manufactured and exported,—the proof whereof shall consist in part of the sworn testimony of the claimant of such drawback in the form hereto annexed.

The exportation shall have been made and claim substantiated within two years from the date of the importation of the articles on which drawback is claimed.

*Form.*

Oath by claimant of such drawback.

“ I, \_\_\_\_\_ of \_\_\_\_\_ do solemnly and truly swear that the following named articles of British or foreign manufacture, viz.:

were used as materials wrought into or attached to the

named in the accompanying claim for drawback, and that they are of a kind not manufactured in Canada, and that no other articles are manufactured in Canada that could have been substituted and used in the place thereof, and that the said articles of British or foreign manufacture so used were imported into Canada and duty was paid thereon at the port of \_\_\_\_\_ within two years from the date of the exportation of the said \_\_\_\_\_ to wit, on the day of \_\_\_\_\_ 18\_\_\_\_, as per entry No. \_\_\_\_\_, that such articles were so entered at the value of \$ \_\_\_\_\_ and duty paid thereon amounting to the sum of \$ \_\_\_\_\_.

Subscribed and sworn to before }  
me at \_\_\_\_\_ this }  
day of \_\_\_\_\_ 18\_\_\_\_ .” }

O. C. May 10, 1881.

*Drawbacks on exportation of Imported Goods.*

## Chap. 11.

Sec. 4. No drawback shall be allowed on any articles, materials or goods whatsoever, unless the amount of such drawback shall exceed \$50. Drawback, when not allowed.

O. C. May 28, 1868.

## DRAWBACK ON GOODS EXPORTED TO NEWFOUNDLAND.

Sec. 5. Regulations governing the drawback of Customs duties paid on goods exported to Newfoundland :— Regulations.

(a.) There may be paid, under the authority of the said Act and on the following conditions, a drawback on the customs duties paid on goods imported into Canada and subsequently exported to Newfoundland direct. Goods exported direct to Newfoundland.

(b.) The exportation of such goods must have been within two years after the time duty was paid thereon. Two years' limit.

(c.) The claim for drawback must have been made and fully completed within six months of the date of the exportation. Claim within 6 months.

(d.) The claimant for drawback must have been the importer as well as the exporter of such goods and the original value thereof on which duty was paid must have been not less than one hundred dollars. Claimant must be both importer and exporter.

(e.) The claimant upon making claim for such drawback shall deliver to the collector of customs at the port where entry outward was made for transmission to and approval of the Customs Department at Ottawa,— Particulars of claim—

1st. A certified copy of the export entry of such goods, to which shall be attached a certificate signed by the Collector or other proper officer of customs at the port from whence exported, showing the date of clearance and sailing of the vessel named in the said export entry, in which such goods were shipped and naming the port in Newfoundland for which such vessel was cleared with the said goods on board, and further showing that the said goods had been properly examined and identified prior to the said shipment; Certified copy of export entry, with date and name of port, &c.

2nd. A certificate, signed by the collector or other proper officers of customs in Newfoundland to which such goods were shipped, setting forth and testifying that the said goods, as described and valued in the said copy of export entry, have been duly landed and entered at said port of destination; Certificate by collector.

3rd. His own declaration, subscribed under oath showing that he was the importer and also the exporter of the goods on which claim for drawback is made, that he has exported Declaration by claimant, what to contain.

## Chap. 11.

*Drawbacks on exportation of Imported Goods.*

them to a port in Newfoundland giving the name thereof and the name of the consignee, that none of them are intended to be re-landed in Canada, that the value assigned to said goods in the certified copy of export entry attached and on which the drawback of duty is claimed was the value on which he paid duty when the same were imported; that the amount of drawback claimed is the same as the duty paid by him on said goods and no more; that the said goods were entered inwards for duty within two years of the exportation thereof, and (where possible to do so) he shall give the number or numbers of and date or dates of the entries on which duty was paid, or if, in consequence of the exportation being made of goods taken from a promiscuous lot, and for that reason he is unable to give the numbers and dates of the entries thereof, he shall so declare.

Schedule to be attached, and what to show.

(f) He shall, in all cases where the shipment where drawback is claimed consists of more than one article or class of goods, attach to the claim a schedule (properly classified according to the rates of duty paid) distinctly showing the quantities and original value on which duty was paid and the rate and amount of duty paid on each article or class of goods therein named. This schedule shall be so indorsed over the proper signature of the claimant as to identify it with the claim and with the certified copy of export entry attached, and it shall be held to form a part thereof.

Minister to prepare forms.

Sec. 6. The Minister of Customs is hereby empowered to cause to be prepared such form or forms for claims and vouchers, not inconsistent with the foregoing, as he may deem expedient, and to require from claimants such further evidence respecting the claims as circumstances may seem to him to require.

O. C. July 17, 1879; May 25, 1883.

## DRAWBACK ON CORN FOR STARCH.

Five cents per bushel on corn.

Sec. 7. A special rate of drawback is allowed of five cents for each bushel of duty-paid corn the product of which in starch is shown to have been exported.

O. C. Jan. 6, 1880.

## DRAWBACK ON COTTON USED IN PACKING BACON AND HAMS.

Regulations to govern as to cotton packing.

Sec. 8. A drawback is directed to be allowed on cotton used in packing bacon and hams for export, subject in all cases to the same restrictions and regulations as are imposed in

*Drawbacks on exportation of Imported Goods.*

## Chap. 11.

respect to duty paid goods used in the manufacture in Canada of goods exported therefrom.

O. C. Dec. 16, 1880.

## DRAWBACK ON COTTON COVERINGS FOR CHEESE.

Sec. 9. A drawback is allowed of duty paid on all imported cheese cloths, cottons and like materials used in the manufacture of packages, bands or coverings for cheese or other similar products of Canada exported therefrom, subject in all cases to the same restrictions and regulations as are imposed in respect to duty paid goods used in the manufacture in Canada of goods exported therefrom.

Restrictions and regulations as to cheese-cloths, &c.

O. C. Feb. 21, 1881.

## DRAWBACK ON SHIPS' MATERIALS.

Sec. 10. A drawback may be granted and paid by the Minister of Customs on materials used in the construction of ships or vessels built and registered in Canada, and built and exported from Canada under Governor's pass, for sale and registry in any other country at the rate of 85 cents per registered ton on iron kneed ships or vessels classed for 9 years; at the rate of 75 cents per registered ton on iron kneed ships or vessels classed for 7 years, and at the rate of 65 cents per registered ton on all ships or vessels not iron kneed.

Rates of drawback on various classes of ships.

O. C. May 15, 1880; Nov. 15, 1833.

## DRAWBACK ON HORSE-SHOE NAILS.

Sec. 11. Subject to the general restrictions and regulations governing the payment of drawback on goods manufactured and exported from Canada, there may be paid to the Canadian manufacturer of horse-shoe nails so manufactured and exported, a drawback at the rate of 90 per cent. of the duty actually paid upon an equal weight of the imported iron from which such horse-shoe nails were manufactured; or in case the manufacturer cannot show the exact amount of duty so paid, then at the rate of 35 cents per 100 pounds of such nails, provided that in the latter case they were manufactured exclusively from imported rolled rods.

Rates of drawback on horse-shoe nails.

And that there may be in like manner paid to the Canadian manufacturer of horse-shoes so manufactured and exported, a drawback at the rate of 90 per cent. of the duty actually paid upon an equal weight of the imported iron from which such horse-shoes were manufactured, or in case the manufacturer cannot show the exact amount of duty paid, then

## Chap. 11.

*Drawbacks on exportation of Imported Goods.*

at the rate of 10 cents per hundred (100) pounds of such horse-shoes.

O. C. July 9, 1883.

## DRAWBACK ON COMMON CUT NAILS.

Rates of drawback on common cut nails.

Sec. 12. Subject to the general regulations and restrictions governing the payment of drawback on goods manufactured in Canada and exported therefrom, there may be paid to the Canadian manufacturer of common cut nails, of sizes not smaller than "fine 3rds," so manufactured and exported a drawback at the rate of ninety (90) per cent. of the duty actually paid upon an equal weight of the imported and duty paid iron from which such nails were manufactured, or in case the manufacturer cannot show the exact amount of duty so paid, then there may be paid a specific rate of sixteen (16) cents per 100 pounds of such cut nails, when, in the manufacture thereof, there was used exclusively imported and duty-paid "bar iron," "nail strips," or "steel," or at the rate of eight (8) cents per 100 pounds of such cut nails, provided that in the manufacture thereof there was used imported and duty-paid "puddle bar," together with "scrap" or other duty-free material, the latter in quantity not to exceed twenty-five per cent. of the whole quantity used in the manufacture of the cut nails so manufactured and exported.

O. C. April 19, 1881.

## BOXES, BARRELS AND CRATES.

Shooks, staves or slats, cut to shape, &c.

Sec. 13. Subject to the following regulations, any boxes, barrels, crates and similar packages complete, or the materials of which—known as shooks, staves or slats, cut to shape and dimensions and finished ready for setting up, and upon which no drawback has been allowed—have been duly exported under regular export entry, to the Bermudas or any West India Islands, and when there perfected, by being nailed, hooped or otherwise fastened, and filled with the products or manufactures of the said Islands, and from thence directly re-imported into Canada, shall be free of customs duty on proof of the Canadian origin of said articles or materials.

*Regulations.*

18 months' limit.

(a.) In order to be entitled to free entry, such packages or packages completed from such shooks, staves or slats, must have been returned to Canada within eighteen months from the date of first exportation therefrom.

Marks and numbers.

(b.) On such first exportation they shall have been so marked and numbered, and such marks and numbers and



*Drawbacks on exportation of Imported Goods.*

## Chap. 11.

the quantity so expressed in the entry outwards, that the Customs officers may be enabled to identify them on their return to Canada.

(c.) On the return of such packages, or of packages completed from such shooks, staves or slats, the importer shall be required to declare in his import entry thereof the quantity, number and other distinguishing marks thereon, and the present contents thereof, and the name and date of clearance of the vessel by which, and the name of the port from whence originally exported from Canada.

Declaration of the importer and contents.

(d.) The proper customs officer shall in every case report to the collector the distinguishing marks and numbers found on the imported packages; the collector will compare the same with the marks, etc., stated in the entry outward on which they are claimed to have been exported, or with a copy thereof duly certified by the collector of the port whence exported, and if such marks, etc., do not agree and the identity of such package is not fully established, free entry thereof shall be refused.

Report to the collector, what to contain.

(e.) If the packages or packages completed from the shooks, staves or slats are returned to the port from whence they were originally exported, such re-importations shall be indorsed on the original export entry thereof, and if they are returned to another port, the port from whence exported must be advised in order that the indorsement may be properly made on the original export entry. The importer must make affidavit that no drawback has been allowed on the original exportation of such articles, which affidavit must be duly executed on the face of the import entry, and in the following form:—

Indorsement on the original export entry.

“ I, \_\_\_\_\_ do solemnly and truly swear that the several packages containing the merchandise named in the entry for \_\_\_\_\_ hereto annexed are, to the best of my knowledge and belief, truly and *bona fide* the production or manufacture of Canada, and that they were truly exported therefrom as above stated, or as stated in the copy of original export entry hereto attached, and that no drawback or allowance had been admitted or allowed thereon, or on any part thereof.

Affidavit of the importer.

Subscribed and sworn to before me at \_\_\_\_\_ this  
day of \_\_\_\_\_ 18 \_\_\_\_\_

Collector.”

O.C. Oct. 15, 1880.

## CHAPTER 12.

### DRAWBACK ON CORN USED IN THE MANUFACTURE OF DISTILLED SPIRITS.

Government House, Ottawa,  
The 25th day of July, 1888.

On the recommendation of the Minister of Customs, and under the authority of sub-section (*m*) of section 245 of "The Customs Act" and section 153 of "The Inland Revenue Act,"

His Excellency in Council has been pleased to make the following regulations respecting the drawback on corn used in the manufacture of distilled spirits in the manufacture of which foreign duty paid corn has been used :

Drawback of two-thirds upon each bushel of foreign corn.

Section 1. Subject to the following regulations and restrictions there may be paid to the Canadian manufacturer of distilled spirits exported, in the manufacture of which foreign duty paid corn has been used, a drawback of two thirds of the duty paid upon each bushel of foreign corn so used in the spirits exported, and that proof satisfactory to the Minister of Customs shall be submitted by the claimant that the corn claimed upon was foreign corn, and such proof may be in the form of a certificate from an Inspector or a Collector of Inland Revenue, to the effect that the records of such Department show that in the manufacture of each package of spirits claimed upon (and specially designated in such certificate) there was used a stated quantity of foreign corn.

Minister must be satisfied that duty was paid.

Sec. 2. The Minister of Customs shall also be satisfied from evidence presented that duty was paid at certain times and places on the corn claimed to have been used as aforesaid.

Proof supplied by claimant, what to consist of, and how to be made.

Sec. 3. There shall further be supplied by the claimant proof that the various packages of spirits claimed upon were duly exported from the Dominion, such proof to consist of the bill of lading for the spirits, and a form of Customs outward entry, bearing upon its face a certificate of a Canadian Customs Officer that the spirits therein mentioned were despatched in a designated railway car or vessel, from a given Canadian port, on a given day, for a stated destination in a foreign country;—and the claimant shall be required to supply a certificate from a proper officer of foreign Customs, that the spirits described in such outward entry at Canadian Customs were, in each case, duly landed in such foreign country.

O. C. Dec. 17, 1887.

## CHAPTER 13.

### SPECIAL REGULATIONS.

Government House, Ottawa,

The 25th day of July, 1888.

On the recommendation of the Minister of Customs and under the provisions of Chapter 32 of the Revised Statutes of Canada, intituled "The Customs Act,"

His Excellency in Council has been pleased to make the following regulations in respect to certain articles therein mentioned:

#### DUTY ON SUGAR AND MELADO.

Section 1. Sugar and melado purchased by importers resident in the Province of British Columbia, at the place of growth and production thereof, and imported thence into the Province of British Columbia *via* San Francisco, California, shall be held to be a direct importation from such place of growth and production, and the duty shall be levied and collected thereon accordingly.

Importation of sugar and melado into British Columbia *via* San Francisco.

O. C. March 4, 1881.

#### CARBOYS AND DEMI-JOHNS.

Sec. 2. Whereas importers of sulphuric and other acids for the manufacture of fertilizers and exporters of sulphuric acid manufactured in Canada frequently require to return the carboys and demi-johns in which such acids have been imported, to the countries whence the same were imported, or to Canada, for the purpose of being refilled and returned or re-imported. It is ordered that on the first importation of such carboys or demi-johns, and on payment of the duty, provided by the tariff then in force upon the same, such carboys or demi-johns shall be stamped or branded in such manner as will secure their identification on any future importation of the same, and, under authority of subsections *b* and *c* of the 245th section of "The Customs Act," then, on any such subsequent importation, and on identification by the collector or proper officer of customs, the said carboys or demi-johns shall be, and they are hereby exempted from any further payment of duty, until otherwise provided by Order in Council.

Carboys and demi-johns, when once stamped, exempted from further duty.

O. C. April 3, 1882.

#### COAL DUST.

Sec. 3. The term "coal dust" as expressed in the Customs Tariff is to be held to be only such screenings or fine bituminous coal as is capable of being passed through a

Size of coal dust screens ings. 2-

## Chap. 13.

*Special Regulations.*

screen the distance between the longitudinal bars of which shall not exceed one-half of an inch in diameter.

O.C. June 7, 1883.

## VINEGAR.

Acetic acid,  
distinguished  
from vinegar.

Sec. 4. The standard for vinegar shall be taken to be that strength which requires thirty five (35) grains of bicarbonate of potash to neutralize one ounce troy of vinegar, and so-called vinegar of greater strength shall be taken and held to be acetic acid and be rated for duty accordingly.

O.C. June 27, 1884.

## FUR SKINS.

"Dyed"  
skins, 15 per  
cent. *ad va-*  
*lorem.*

Sec. 5. The item in the tariff of Customs Duties now in force, which reads "fur skins, wholly or partially dressed, fifteen per cent. *ad valorem*," is declared and held to include such skins when "dyed," but not further manufactured, and such dressed and dyed skins may be entered for duty at fifteen per cent. *ad valorem*.

O.C. July 25, 1884.

## CELLULOID.

Moulded cel-  
luloid balls  
and cylinders,  
10 per cent. *ad*  
*valorem.*

Sec. 6. The following articles are included in the provisions of item No. 86 of the schedule "A," of "An Act respecting the Duties of Customs," Chapter 33, Revised Statutes of Canada, viz.: Moulded celluloid balls and cylinders, coated with tinfoil or not, but not finished or further manufactured; and the duty of ten per cent. *ad valorem* is to be assessed and collected thereon.

O.C. April 12, 1887.

## TARE AND DRAFT UPON PACKAGES CONTAINING IMPORTED SUGARS.

Allowances  
fixed for tare  
and draft—

Sec. 7. The following allowances are fixed for tare and draft upon the packages containing imported sugars, the said allowances to be deducted from the actual gross weight of the sugars as ascertained by weighing on their arrival at their ports of destination in Canada, the weighing to be performed by customs officers and the labor required in handling and weighing to be furnished by the importer:—

12 p.c.  
14 p.c.  
25 lbs.  
10 p.c.  
1½ p.c.

On hogsheads or tierces weighing 1,300 lbs. gross or over, 12 p. c. On hogsheads or tierces weighing less than 1,300 lbs. gross, 14 p. c. On barrels weighing 250 lbs. gross or over, 25 lbs. each. On barrels weighing less than 250 lbs. gross, 10 p. c. On bags or mats containing beet root, centrifugal or refined sugars, 1½ p. c. On double bags or

*Special Regulations.*

## Chap. 13.

mats containing beet root, centrifugal or refined sugars,  $2\frac{1}{2}$   $2\frac{1}{2}$  p.c. p. c. On bags or mats containing East India, China, Brazil, 2 p.c. Muscovado or other similar raw sugars, 2 p. c. On double  $3\frac{1}{2}$  p.c. bags or mats containing East India, China, Brazil, Muscovado or other similar raw sugars,  $3\frac{1}{2}$  p. c. On baskets,  $7\frac{1}{8}$  p.  $7\frac{1}{8}$  p.c. c. On any packages other than those provided for above, the allowance shall be such as the weighing officer may find to be just and equitable, but in no case to exceed the original weight of such packages before the sugar was placed therein.

O. C. Nov. 13, 1886.

EXPENSES OF GAUGING AND TESTING SPIRITS, WINES AND MALT LIQUORS.

Sec. 8. In all cases of importation of spirits, wine and malt liquors, requiring to be weighed, gauged or tested for strength or quantity—and in which the goods are imported for the purpose or with the intention of immediate exportation,—in order to cover the expenses attending such gauging and testing, a charge of 50 cents shall be made for each package so gauged or tested, and the importer of the goods shall be required to pay such charge before exportation can be allowed.

Charge of 50 cts. for each package, &c.

O. C. July 21, 1884.

REFUND ON RE-EXPORTED GOODS.

Sec. 9. Goods having been entered for duty and having passed into the hands of the importer, in cases where said goods are found not to be the goods ordered, notice of such fact may be given to the collector of customs at the port of entry, within one month of the date of such entry, accompanied by a request for leave to return the said goods to the place and party where and from whom the same were purchased, and that the duties paid thereon be refunded; whereupon the collector having verified the statement of the importer, and having ascertained that the package to be exported is a whole package, and that its contents are identically the same as originally entered for duty, shall report the same to the Department, and the Minister of Customs shall thereupon issue an order to the collector to refund the duties upon due proof of importation: Provided that if such goods are not actually exported within one month from the date of such order it shall be void and of no effect.

Notice to be given within one month.

Collector having verified statement, &c., to report to Department.

Sec. 10. Whereas cases frequently arise for which no general order or regulation is provided, in which goods upon which duty has been paid require to be exported, and

## Chap 13.

*Special Regulations.*

Injury or hardship endured; how to be compensated.

injury or hardship may be endured by imports, to the disadvantage of the commercial interests of the Dominion, unless some means of redress be provided,—It is therefore ordered that in all such special cases, it shall be lawful for the Minister of Customs to consider the grounds and examine the merits of each application and make such order thereupon subject to the approval of the Treasury Board, as may, in his judgment, be necessary for the relief of the parties, and consistent with the interest and security of the revenue.

O.C. Oct. 23, 1868.

## POLARISCOPIC TEST.

Fractions of degrees not to be considered.

Sec. 11. In computing the duties payable on sugars for refining purposes subject to polariscopic test, all fractions of degrees as shown by the instrument are not considered, and all entries passed inconsistent herewith are to be re-adjusted.

O. C. July 1, 1886.

## IMPORTATION OF SPIRITS.

Brandy, gin, whiskey or other distilled spirit, regulation for importing, &c.

Sec. 12. (a.) Brandy, gin, whiskey, or other distilled spirits shall not be imported to any part of Canada in any undecked vessel or in any vessel under the burden of twenty tons registered tonnage, or in any vehicle by land other than a railway car, or in any package (except bottled spirits) containing less than one hundred gallons, wine measure, except that spirits may be imported in casks of not less than thirty-five (35) Imperial gallons capacity when for the purpose of being manufactured with other articles under regulations and surveillance of the Department of Inland Revenue; provided, however, that such spirits may be imported direct from Great Britain and other European countries, and from any British colony, and from the West India Islands in packages of not less capacity than half octaves or in glass.

Wine and malt liquor, how imported.

(b.) Wine and malt liquor shall not be imported in any other conveyance than those above described; but may be thus imported in any of the packages usual according to the ordinary custom of trade.

Spirits seized and forfeited.

(c.) Any spirits imported contrary to or in violation of this regulation or any part thereof shall be seized and forfeited.

O. C. Nov. 20, 1882; June 14, 1883; Oct. 4, 1883.

## CHAPTER 14.

### FORMS OF OATH.

Government House, Ottawa,

The 25th day of July, 1888.

On the recommendation of the Minister of Customs, and under the provisions of Chapter 32 of the Revised Statutes of Canada, intituled "The Customs Act,"

His Excellency in Council has been pleased to prescribe the following forms of oath required under the above cited Act:—

The following forms are hereby prescribed to be used in connection with invoices and entries in all cases to which they respectively apply, at all custom houses or places where such oaths may be taken or lawfully administered, except the form of "declaration to be made by the foreign owner of any goods shipped to Canada on consignment," which may be made and declared before any British or other Consul duly accredited by any established Government, and resident in the country from whence the said goods are exported to Canada.

#### FORM 1.

##### *Oath or Affirmation of an Owner, Consignee or Importer.*

"I (*name of the owner, consignee or importer making the entry*) do solemnly and truly (swear or affirm as the case may be) that I am (the owner, consignee or importer; or a member of the firm of [*giving name*] *the owners, consignees or importers as the case may be*) of the goods mentioned in the invoice now produced by me, and hereunto annexed and signed by me, and that the said invoice is the true and only invoice received by \_\_\_\_\_ or which expect to receive of all the goods imported as therein stated for account of (*name of person or firm being the owner or owners*) that the said goods are properly described in the said invoice and in this entry thereof, and that nothing has been, on my part, nor to my knowledge on the part of any other person, done, concealed or suppressed, whereby Her Majesty the Queen may be defrauded of any part of the duty lawfully due on the said goods; and I do further solemnly and truly (swear or affirm as the case may be) that the prices of the goods as shown in said invoice and as aggregated in this bill of entry now presented by me, exhibit the fair market value of the said goods at the time and place of their exportation to Canada, without any deduction or

Oath or affirmation of an owner, consignee or importer.





*Forms of Oath.*

Chap. 14.

that the said invoice and entry exhibit the fair market value of the said goods at the time and place of their exportation to Canada, without any deduction or discount for cash, or because of the exportation thereof, or for any other cause whatsoever, and that nothing has been, on my part, nor to my knowledge on the part of any other person, done, concealed or suppressed whereby Her Majesty the Queen may be defrauded of any part of the duty lawfully due on the said goods; and I do further solemnly and truly (swear or affirm) that to the best of my knowledge and belief the said (*name of the owner, consignee or importer*) is the (owner, consignee or importer, *as the case may be*) of the goods mentioned in the bill of entry, and that the prices of said goods as shown therein and in the said invoice were the prices thereof for consumption at the time and place of their exportation to Canada. So help me God.

Sworn (*or affirmed*) before me this        day of        , 18 .

*Collector."*

## FORM 4.

*Oath or Affirmation of an Owner or his Agent. required whenever goods are entered at a lower rate of duty for a specific purpose than would otherwise be chargeable thereon.*

"I (*name of owner or agent*), do solemnly and truly (swear or affirm) that any goods included in this entry as paying a lower rate of duty for a specific purpose than would otherwise be chargeable thereon, are to be, and will be used for such specific purposes only.

Oath or affirmation when goods are entered at a lower rate of duty, &c.

Sworn (*or affirmed*) before me this        day of        , 18 .

*Collector."*

## FORM 5.

*Oath or Affirmation of an Owner, Consignee, Importer or Agent, on entering Goods without Invoice.*

"I,        , do solemnly and truly swear (*or affirm*) that the within bill of entry contains a just and true account of all the goods imported for me or on my account, or on account of        for whom I am authorized to enter the same, in the        , whereof        is master, from        , that the bill of lading now produced by me is the true, genuine and only bill of lading by me received of the said goods; and that I have not received, and do not know of any invoice or other account whatever having been received of the said goods; I do further swear (*or affirm*, that if I hereafter discover any other or greater

Oath or affirmation on entering goods without invoice.



*Forms of Oath.*

## Chap. 14.

agent of the firm of [*giving name*] as the case may be) the consignee of the goods described in the entry delivered by me to the collector of this port, and that said goods are the identical ones mentioned in a "removal entry" made at the Custom House at (*name of port from whence transferred*) by (*name of person making removal entry*) on the day of \_\_\_\_\_, 18\_\_\_\_, numbered \_\_\_\_\_, and that the said goods are the same in quantity, quality, value and package, as therein stated.

goods, &c.,  
re-ware-  
housed.

Sworn (*or affirmed*) before me \_\_\_\_\_ at the port of  
this \_\_\_\_\_ day of \_\_\_\_\_, 18\_\_\_\_.  
Collector."

O. C. May 10, 1881 ; Aug. 18, 1881.

SETTLERS EFFECTS, ITEM 766 OF "AN ACT RESPECTING DUTIES OF CUSTOMS."

The following form of affidavit, in addition to the settler's oath, shall be made by intending settlers when importing live stock into Manitoba or the North-West Territories, free of duty, under the said Act:—

I, \_\_\_\_\_, do solemnly swear that I am now moving into Manitoba (*or the North-West Territories*) with the intention of becoming a settler therein, and that the "Live Stock" enumerated and described in the entry hereunto attached, is intended for my own use on the farm which I am about to occupy (*or cultivate*) and not for sale or speculative purposes, nor for the use of any other person or persons whomsoever.

Oath in case  
of intending  
settlers.

O. C. May 27, 1880.

## CHAPTER 15.

### FREE LIST.

Government House, Ottawa,  
The 25th day of July, 1888.

On the recommendation of the Minister of Customs and under the provisions of Chapter 32 of the Revised Statutes of Canada, intituled "The Customs Act,"

His Excellency in Council has been pleased to order that the following articles be transferred to the list of goods which may be imported into Canada free of Customs duty :—

- Woollen rags. Section 1. Woollen rags.  
O. C. June 13, 1879.
- Show cases. Sec. 2. Bent glass, for the manufacture of show-cases.  
O. C. Aug. 14, 1879.
- Goods and packages to be branded and marked. Sec. 3. Any goods or packages being the growth, produce or manufacture of Canada, and having been exported therefrom and intended to be returned, may be admitted free of duty on being re-imported to Canada, provided such goods or packages were entered for exportation and branded or marked by a collector or proper officer of customs, when fully identified by the collector or proper officer, at the port or place where they are so re-imported; and further, provided that the property in such goods or packages has continued in the same person or persons by whom they were exported, and that such re-importation takes place within one year of the exportation thereof.  
O. C. June 21, 1884.
- Crucible sheet steel. Sec. 4. Crucible sheet steel, eleven to sixteen gauge, 2½ to 18 inches wide, when imported by manufacturers of mower and reaper knives, for manufacture of such knives in their own factories.  
O. C. Nov. 6, 1885.
- Lastings, mohair cloth or other manufactures of cloth, for buttons. Sec. 5. Lastings, mohair cloth, or other manufactures of cloth when imported by manufacturers of buttons for use in their own factories, and woven or made in patterns of such size, shape or form, or cut in such manner as to be fit for covering buttons exclusively—these conditions to be ascertained by special examination by the proper officer of customs, and so certified on the face of each entry.  
O. C. Nov. 6, 1885.
- Seed and breeding oysters. Sec. 6. Seed and breeding oysters imported into Canada for the purpose of being planted in Canadian waters are

*Free List.*

## Chap. 15.

remitted, and collectors of customs are to accept free entry of such seed and breeding oysters when it is shown to their satisfaction and by the affidavit of the importer on the entry, that said oysters are imported for and will be used solely for such purpose.

O. C. May 3, 1886.

Sec. 7. Books printed in any of the languages or dialects of any of the Indian tribes of the Dominion of Canada. Indian books.

O. C. July 1, 1886.

Sec. 8. Hatters' bands, bindings, tips and sides, and linings, both tips and sides, when imported by hat manufacturers only, for use in their factories in the manufacture of hats. Hatters' materials.

O. C. July 5, 1886.

Sec. 9. Hickory billets, not further manufactured than sawn to shape, to be used in the manufacture of axe, hatchet, hammer, and other tool handles, when imported into the Dominion for such use. Hickory billets.

O. C. July 15, 1886.

Sec. 10. Steel strip, when imported into Canada by manufacturers of buckthorns and plain strip fencing, upon the importer in each case making oath in terms as follows:— Steel strip, fencing, &c.

“I, \_\_\_\_\_, the undersigned importer of the steel strip mentioned in this entry, do hereby solemnly \_\_\_\_\_ that such steel strip was imported by me and is of a kind used in the manufacture of buckthorn and plain strip fencing. I further \_\_\_\_\_ that such steel strip was specially imported by me for use in my factory for the manufacture of buckthorn and plain strip fencing, and that no portion of the same will be used, sold or disposed of by me, or by any person in my employ, for any other purpose than as aforesaid.” Oath of importer.

O. C. July 17, 1886.

Sec. 11. Twisted brass and copper wire, when imported by manufacturers of boots and shoes for use in their factories, upon the importer making oath at the time of entry in terms as follows:— Twisted brass and copper wire for boots, &c.

“I, \_\_\_\_\_, the undersigned, \_\_\_\_\_ the importer of the twisted \_\_\_\_\_ wire mentioned in this entry, do hereby solemnly \_\_\_\_\_ that the said wire was imported by \_\_\_\_\_ for use in \_\_\_\_\_ factory in the manufacture of boots and shoes. I further \_\_\_\_\_ that the said wire will be used by \_\_\_\_\_ for such purposes, and that no portion of the said \_\_\_\_\_” Oath of importer.

## Chap. 15.

*Free List.*

wire will be used, sold or disposed of by \_\_\_\_\_ or any other person in \_\_\_\_\_ employ for any other purpose than as aforesaid."

O.C. July 20, 1886.

Wood of persimmon and dog-wood trees.

Sec. 12. The wood of the persimmon and dog-wood trees, when imported in blocks for the manufacture of shuttles, upon the importer making oath at the time of entry in the following terms:—

Oath of importer.

"I, \_\_\_\_\_, the undersigned, importer of the \_\_\_\_\_ mentioned in this entry, do hereby solemnly \_\_\_\_\_ that the said wood was imported by \_\_\_\_\_ for use in the manufacture of shuttles. I further \_\_\_\_\_ that the said wood will be so used by \_\_\_\_\_ and that no portion of the same will be used, sold or disposed of by \_\_\_\_\_ or by any person in \_\_\_\_\_ employ for any other purpose or use than as aforesaid."

O.C. July 20, 1886.

Ultramarine blue.

Sec. 13. Ultramarine blue.

O.C. Aug. 18, 1886.

Brass cups.

Sec. 14. Brass cups, being rough blanks, for the manufacture of paper shells or cartridges, when imported by manufacturers of brass and paper shells or cartridges for use in their own factories.

O.C. Sep. 23, 1886.

Hair of alpaca or angora goat for braid.

Sec. 15. Yarn spun from the hair of the alpaca or angora goat, when imported by manufacturers of braid for use exclusively in their factories in the manufacture of such braids only, under such regulations as may be adopted by the Minister of Customs.

O.C. Nov. 18, 1886.

Fishskins and fish offal.

Sec. 16. Fish skins and fish offal, when imported by manufacturers of glue for use in their own factories.

O.C. Dec. 13, 1886.

Sweat leathers.

Sec. 17. Sweat leathers, when imported by hat manufacturers only for use in their factories in the manufacture of hats.

O.C. July 1, 1887.

Whip manufactures.

Sec. 18. Square reeds and raw-hide centres, textile leather or rubber heads, thumbs and tips, and steel, iron or nickel caps for whip ends, when imported by whip manufacturers for use in the manufacture of whips in their own factories.

*Free List.*

## Chap. 15.

Sec. 19. Noils, being the short wool which falls from the combs in worsted factories.

Noils.

O.C. July 2, 1887.

Sec. 20. Copper rollers for use in calico printing, when imported by calico printers for use in their factories, in the printing of calicoes, and for no other purpose (such rollers being manufactured in Canada) upon the importer in each case making oath at the time of entry, in terms as follows:

Copper rollers for calico printing.

I (1) the undersigned, importer of the copper rollers mentioned in this entry, do solemnly (2) that such copper rollers were specially imported by (3) for use in the printing of calicoes in (4) factory.

Oath of importer.

I further (2) that the said rollers will be used for the said purpose and that the same will not be used, sold or disposed of by (3) or by any person in (4) employ, for any other purpose or use than as aforesaid.

(1) Name of importer.

(2) Swear or affirm.

(3) Me or the firm of \_\_\_\_\_, of which I am a member.

(4) My or our, as the case may be.

Sec. 21. Anthracite coal dust.

Anthracite.

O.C. Nov. 22, 1887.

Sec. 22. Retorts, pans, condensers, tubing and pipe, made of platinum, when imported by manufacturers of sulphuric acid for use in their works in the manufacture or concentration of sulphuric acid.

Sulphuric acid manufactures.

O.C. Dec. 17, 1887.

Sec. 23. Typewriters, tablets with moveable figures, geographical maps and musical instruments, when imported by and for the use of schools for the blind, and being and remaining the sole property of the governing bodies of said schools and not of private individuals, the above particulars to be verified by special affidavit on each entry when presented.

Type-writers, tablets, geographical maps, &amp;c.

O.C. July 6, 1888.

Sec. 24. Wire of iron or steel, galvanized or tinned or coppered, or not, of No. 16 gauge or smaller, when imported by manufacturers of wire cloth, wire work, brushes, pianos and plated ware, to be used for these purposes only, in their own factories.

Wire of iron or steel, &amp;c.

O.C. July 11, 1888.

## CHAPTER 16.

### FRUITS, BERRIES, SEEDS, TREES, PLANTS, VEGETABLES.

Government House, Ottawa,  
The 25th day of July, 1888.

On the recommendation of the Minister of Customs and under the provisions of Chapter 33 of the Revised Statutes of Canada, intituled, "An Act respecting the Duties of Customs,"

His Excellency in Council has been pleased to order that the following articles, that is to say:—

- Green fruits and edible berries. Section 1. Green fruits and edible berries, in their natural condition, viz.: apples, apricots, bananas, cherries, mangoes, olives, peaches, pineapples, plantains, plums, pomegranates, quinces, and shaddocks.
- Berries. Sec. 2. Blackberries, cranberries, gooseberries, raspberries, and strawberries.
- Seeds; clover, &c. Sec. 3. Seeds, viz.:—Clover, grass and flower, canary, chia, cotton, jute, mustard (brown and white) sesame, sugar beet, sugar cane seed, and seeds of fruit and forest trees not edible.
- Seeds; aromatic. Sec. 4. Seeds aromatic, which are not edible and are in a crude state, and not advanced in value or condition by refining or grinding or by any other process of manufacture (in addition to those already on the free list) viz:—anise-star, caraway, cummin seed and tonquin beans.
- Trees, shrubs and plants. Sec. 5. Trees, shrubs and plants, viz.:—Apple, cherry, peach, pear, plum, quince and all other fruit trees and the seedling stock of the same. Blackberry, currant, gooseberry, raspberry and rose bushes, grape and strawberry vines.
- Shade trees, &c. Sec. 6. Shade, lawn and ornamental trees, shrubs and plants.
- Vegetables; Citrons, &c. Sec. 7. Vegetables, viz.:—Citrons, melons and yams,—shall until otherwise provided be imported into Canada free of duty.
- When in force. Sec. 8. And that this order shall have and take effect from and after the fourth day of April, A.D. 1888.  
Proc. April 13, 1888.



## CHAPTER 17.

### DIRECTIONS RESPECTING DUTIES.

Government House, Ottawa,  
The 25th day of July 1888.

On the recommendation of the Minister of Customs and under the provisions of Chapter 32 of the Revised Statutes of Canada, intituled "The Customs Act,"

His Excellency in Council has been pleased to order and it is hereby ordered that the following regulations in respect to certain goods admitted free of duty be and the same are hereby approved :

#### HORSES, MULES ETC., FROM UNITED STATES.

Section 1. Horses and mules or other pack animals bringing provisions or other merchandise from the United States territory across the southern boundary of the Province of British Columbia shall be admitted without payment of duty, on bonds being given in an amount equal to double the duty on the animals brought in and conditioned for the due exportation thereof within a period of three months from the date of their entry into such Province, or the payment of the duties upon due entry before the expiration of that delay.

Horses and mules from British Columbia, how admitted without duty.

O.C. May 25, 1872.

#### FISH-HOOKS, NETS AND SEINES, LINES AND TWINES.

Sec. 2. The words in clause 624 of Schedule C of "An Act respecting the Duties of Customs," Chapter 33, Revised Statutes of Canada, viz. : "Fish-hooks, nets and seines, lines and twines," shall be taken to mean fish-hooks, fishing nets, and seines and fishing lines and twines and no other ; and the collector of customs at any port at which such goods shall be imported is authorized and directed, before passing a free entry of such articles, to require the importer thereof to make oath to the fact that such nets, seines, lines and twines are so imported for fishing purposes only.

Importation of articles for fishing purposes.

O.C. March 6, 1874.

Sec. 3. A special form of oath is to be required by all collectors of customs to be made and subscribed to before them by the importer concerned in each case, whenever any free entry is tendered at customs for fish-hooks, nets, and seines and lines and twines, such form of oath to be in the following terms :—

Oath of importer of fishing articles.

## Chap. 17.

*Directions respecting Duties.*

Form of oath  
of importer of  
fishing arti-  
cles.

" I, the undersigned importer of the  
mentioned in this entry, do solemnly that  
such were specially imported by me and are  
of a kind used for the fisheries, and entitled to free entry  
as being for the use of the fisheries. I further that  
such were specially imported by me for use  
in the fisheries, and that no portion of the same will be  
used, sold or disposed of by me, or by any person in my  
employ for any other purpose than for use in the fisheries  
as provided by the tariff now in force."

O.C. July 17. 1886.

## MODELS OF INVENTION.

Free entry of  
models and  
improve-  
ments in arts.

Sec. 4. The following item in the list of goods entitled to  
free entry when imported into Canada, viz. :—

" Models of inventions and other improvements in the  
arts, but no article or articles shall be deemed a model or  
improvement which can be fitted for use"—

Shall be construed to refer only to original models or  
patterns of such inventions or improvements, and not to  
castings or copies made therefrom of other material than  
that of which the original model was made.

O.C. Sep. 21, 1885.

## WIRE ROPE FOR SHIPS' RIGGING, OATH REQUIRED.

Free entry for  
wire-rope.

Sec. 5. A special form of oath is to be required by all  
Collectors of Customs to be made and subscribed before  
them by the importer concerned in each case, whenever any  
free entry is tendered at Customs for wire rope, on the ground  
that it is intended for use in rigging for ships and vessels,  
—such oath to be in the following terms :—

Oath of im-  
porter.

" I, the undersigned importer of the  
wire rope mentioned in this entry as being free of duty  
under the present tariff, do hereby solemnly that  
such wire rope was imported by me and is intended for use  
in rigging for ships and vessels, and that no portion of the  
same will be sold, used or disposed of by me, or by any  
person in my employ, for any other purpose than for use in  
such wire rigging for ships and vessels."

O.C. July 17, 1886.

## WATER HOG LEATHER.

Water-hog  
leather,  
classified for  
duty.

Sec. 6. Whereas a dispute has arisen as to what duty is  
payable on certain glove leather not being either buck, deer,  
or antelope, as mentioned in item 276 in schedule "A"  
of the Revised Statutes of Canada, Chapter 33, but being  
the hide of what is known as the water hog, and tanned  
in imitation of such glove leather, and not distinguishable

*Directions respecting Duties.*

Chap. 17.

therefrom except by an expert,—such leathers when so tanned and imported shall be classed for duty as provided by item 276 as aforesaid.

O.C. Nov, 22, 1887.

## ANIMALS FOR THE IMPROVEMENT OF STOCK.

Sec 7. Regulations authorized by item 517 in Schedule C to Chapter 33 of the Revised Statutes of Canada, intituled: "An Act respecting the Duties of Customs," referring to "Animals for the improvement of stock, viz.: horses, cattle, sheep and swine, under regulations made by the Treasury Board and approved by the Governor in Council." Horses, cattle, sheep and swine.

*Regulations.*

(a) In all cases of importation and entry of animals under the provisions of the above mentioned item in the said Act, a certificate of purity of blood given by the breeder of the animals, and accompanied by a certificate of identification, signed and sworn to by the importer, shall be furnished to the Collector at the port of entry and in addition thereto there shall be required the further evidence hereinafter mentioned, viz.:— Certificate of purity of blood by breeder, &c.

(b) *Re* Blood Horses. A proper pedigree referring to the English or American Stud book to be given by the breeder in his certificate, but in the case of such blood horses whose pedigree is not entered in a Stud book, an authenticated certificate of purity of blood and identification will be sufficient, provided the animal is found on inspection to have the properties and qualification essential to improvement of breed. Blood horses.

(c) Short horn cattle.—The breeder's certificate shall embody a correct pedigree, referring to a recognized short horn herd book. Short-horn cattle.

(d) Hereford cattle.—The pedigree shall refer to a recognized Hereford herd book. Hereford cattle.

(e) Devon cattle.—The pedigree shall refer to a recognized Devon herd book. Devon cattle.

(f) Ayrshire cattle, Angus cattle, Galloway cattle or Alderney cattle.—A certificate of purity of blood and identification as mentioned in clause (a) will be sufficient. Ayrshire, Angus, Galloway or Alderney cattle.

(g) Any other breed or description of cattle which is not specially named in the foregoing shall be held to be included in the general description embodied in clause (a) of these regulations. Cattle not named.

(h) Sheep, pigs, and poultry.—In these cases a similar certificate and identification will be required as in the next preceding case. Sheep, pigs and poultry.

O. C. Nov. 8, 1887.



## CHAPTER 19.

### COASTING TRADE—GENERAL REGULATIONS.

Government House Ottawa,  
The 25th day of July, 1888.

On the recommendation of the Minister of Customs and under the provisions of Chapter 32 of the Revised Statutes of Canada, intituled "The Customs Act,"

His Excellency in Council has been pleased to make the following regulations respecting the Coasting Trade of Canada:

#### COASTING REGULATIONS.

##### *British Registered Vessels.*

Section 1. Vessels and boats employed in the transport of goods or passengers from one port or place to another port or place within the limits of the Dominion of Canada, shall be deemed to be engaged in the coasting trade, and shall be subject to the regulations governing the same.

Vessels and boats deemed to be engaged in coasting trade.

Sec. 2. None but British registered vessels and boats wholly owned by British subjects, and such other vessels or boats as may be owned by the subjects of countries included in any treaty with Great Britain by which the coasting trade is mutually conceded, can lawfully be engaged in the coasting trade of the Dominion of Canada, and the names of such vessels or boats and the names of their port of registry shall be distinctly painted on the stern of the said vessels or boats.

British vessels and vessels owned by subjects of countries included in any treaty.

Sec. 3. Such vessels and boats may, without being subject to entry or clearance, as required by law, for vessels trading between ports in the Dominion of Canada, as well as with foreign ports, carry goods the produce of Canada, or goods duty free, or goods duty paid, or passengers from any ports or places in the Provinces of Ontario, Quebec, New Brunswick, Nova Scotia and Prince Edward Island to any other ports or places in the said several Provinces, provided always, that the owners or masters of such vessels or boats shall take out a license for the year or part of the year always terminable on the 30th day of June, for that purpose, from a collector of Customs in Canada, and that the owners or masters in taking out the said license shall enter into bonds of \$500 conditioned that such vessels or boats shall not be employed in the foreign trade, unless as hereinafter provided, and provided also that the master of every

License to be taken out by masters or owners of such vessels; provisions concerning bond and report of the master of vessel or boat.

such vessel or boat shall report inwards and outwards on entering or leaving a port, on the forms hereinafter prescribed.

License to be produced to customs officer. Penalty of \$100 for contravention.

Sec. 4. The master of any such vessel or boat shall produce his license to any officer of Customs, whenever the same shall be demanded, and answer all questions put to him, and such officer of Customs shall be at liberty to go on board any such coasting vessel when he may deem proper, and if he should find any dutiable goods therein which have not been entered at the Customs, or any prohibited or smuggled goods, or if any goods had been unladen therefrom before the master had reported to a Customs officer, the goods and vessel shall be forfeited, and the master shall incur a penalty of \$100.

Report from master of vessel to collector. Penalty of \$100 for contravention.

Sec. 5. Before any coasting vessel or boat shall depart from any port of lading in any one of the Provinces of the Dominion of Canada for any other port in the said Dominion, a report with a duplicate thereof, in the form or to the effect following, and signed by the master, shall be delivered to the collector or some officer of Customs who shall retain the duplicate and return the original report dated and signed by him; and such report shall be the clearance of the vessel or boat for the voyage, except for goods under bond, or goods liable to excise or internal revenue duty, which shall require the entries and warrants for landing to be signed by the proper officers as required by law; and if any report be false, the master who signed it shall forfeit the sum of \$100.

*Report Inwards.*

Coastwise for a registered coasting vessel or boat arriving at one port from another in the Dominion of Canada.

Port of	Registered Tonnage,	tons.
Name of Vessel,	Where from,	
Master's name,		
Port of Registry,		

I, the undersigned, master of the above described vessel, do solemnly declare that I have not touched at any foreign port, nor have I taken on board, nor landed nor put off of said vessel any goods liable to Customs duty, or other

*Coasting Trade—General Regulations.*

revenue impost, since leaving the above named port of departure.

, 18

*Collector of Customs.*

Master.

*Report Outwards.*

Coastwise for a registered coasting vessel or boat proceeding from one port to another in the Dominion of Canada.

Port of	Port of Registry,	
Name of Vessel,	Registered Tonnage,	tons.
Master's name,	Whither bound,	

I, the undersigned, master of the above named vessel, do solemnly swear that I am bound for, and will proceed directly to, the Port of \_\_\_\_\_, and that I will not, during said voyage, touch at any foreign port, nor take on board nor land, nor put off of said vessel any goods liable to Customs duty, or other revenue impost, before arriving at the above named port of destination.

Affidavit of the master.

day of \_\_\_\_\_, 18

*Collector of Customs.*

Master.

Sec. 6. Vessels and boats employed in the coasting trade that shall not have taken up a license for carrying goods, shall report inwards and outwards at the nearest port to their place of arrival or destination, and require clearances whenever they depart from any port or place within the Dominion of Canada; and in default of their so reporting the vessel and cargo, the master shall in such cases be subject to the penalty of \$100 for departing and arriving without due entry inwards or outwards, as the case may be. Provided that when a vessel shall sail from any place where there is no Custom House or officer of Customs, it shall be sufficient for the carrying out of this regulation that the owner or master of such vessel do, as soon afterwards as possible, forward to the nearest Custom House a similar report in duplicate, or lodge the same at the first port at which he shall touch where there is a Custom House Officer.

Penalty of \$100 for departing without due entry.

Report of the master to the nearest Custom House when no Custom House in place.

Sec. 7. Goods under a removal bond from one Canadian port to another may be carried in any British registered vessel or boat trading coastwise with a proper

Goods under removal bond from one Canadian port

## Chap 19.

*Coasting Trade—General Regulations.*

to another;  
how carried.

license, upon such goods being properly entered in the report outwards and clearance in duplicate,—the Collector at the port from which such goods are removed being required to forward by mail, to the Collector of the port for which the goods are destined all the particulars and description of the goods so forwarded, and the packages shall be properly marked in red as now provided; but no goods under bond shall be carried in any coasting vessel or boat without being so reported and cleared.

Touching at  
any foreign  
port when  
forced by cir-  
cumstances.

**Sec. 8.** No coasting vessel or boat shall touch at any foreign port unless forced by unavoidable circumstances, or thereunto authorized by a Collector or proper officer of Customs; and the master of any coasting vessel or boat which has touched at any foreign port shall declare the same in writing under his own hand to the Collector or proper officer of Customs at the port or place in Canada where his vessel or boat afterwards first arrives, under a penalty of \$100.

Penalty for  
not declaring  
the same.

Goods un-  
shipped from  
vessel on  
Sundays and  
holidays:  
penalty of  
\$100 for vio-  
lation.

**Sec. 9.** If any goods are unshipped from any vessel or boat arriving coastwise, or unshipped or water borne to be shipped, to be carried coastwise, on Sundays or holidays, or unless in the presence or with the authority of the proper officer of Customs, or unless at such times and places as shall be appointed and approved by him for that purpose,—the same shall be forfeited, and the master of the vessel or boat shall forfeit the sum of \$100.

Boarding,  
searching and  
examining of  
vessels by  
customs offi-  
cers.

**Sec. 10.** Officers of Customs may board any vessel or boat in any port or place, and at any period of the voyage search her, and examine all goods on board, and demand all the documents which ought to be on board; and the Collector may require such documents to be brought to him for inspection.

Fishing-boat  
or boat ferry-  
ing under 15  
tons.

**Sec. 11.** No fishing boat or boat used in ferrying under fifteen tons burthen shall, except by special license or permission, carry any goods from a foreign country, which are liable to duty, under pain of seizure, unless the same (in the case of ferry boats) be for the sole use of some passenger then on board.

Goods taken  
into or put  
out of coast-  
ing vessels.

**Sec. 12.** No goods shall be carried in any coasting vessel or boat, except such as are laden to be so carried at some port or place in Canada, and no goods shall be taken into or put out of any coasting vessel or boat while on her voyage by river, lake or sea.

Reports in-  
wards and  
outwards

**Sec. 13.** The reports inwards and outwards coastwise required by these Regulations may, in the case of any steam



*Coasting Trade—General Regulations.*

## Chap. 19.

vessel carrying a Purser, be signed by such Purser, with the like effect in all respects, and subject to the like penalty on the Purser, and the like forfeiture of the goods, in case of any untrue statement, or violation of Customs law, as if the report was signed by the master; and the word master, for the purposes of these Regulations, shall be construed as including the Purser of any steam vessel; but nothing herein contained shall preclude the Collector or proper officer of Customs from calling upon the master of any steam vessel to answer all such questions concerning the vessel, passengers, cargo and crew, as might be lawfully demanded of him if the report had been made by him, or to exempt the master from the penalties imposed by these Regulations for failure to answer any such question or for answering untruly or to prevent the master from making such report, if he shall see fit so to do.

coastwise,  
how made;  
duty of the  
collector.

Sec. 14. The foregoing Regulations are also to govern the Coasting Trade of the Province of British Columbia so far only as relates to vessels trading or making voyages between the several ports in that Province.

Coasting  
trade in Brit-  
ish Columbia,  
how to be  
governed.

O. C. April 17, 1883.

*In Copy 113. R.S. Cap 83  
Sec's 95-2 st 804*

## CHAPTER 20.

### COASTING TRADE—FOREIGN VESSELS.

Government House, Ottawa,  
The 25th day of July, 1888.

On the recommendation of the Minister of Customs and under the provisions of Chapter 83 of the Revised Statutes of Canada, intituled "An Act respecting the Coasting Trade of Canada,"

His Excellency in Council has been pleased to declare as follows :

#### VESSELS OF ITALY.

Section 1. Whereas by the 2nd section of chapter 83 of the Revised Statutes of Canada, intituled, "An Act respecting the Coasting Trade of Canada," it is, amongst other things, enacted that no goods or passengers shall be carried by water from one port of Canada to another, except in British ships;

And whereas by the 5th section of the said Act it is further enacted that the Governor in Council may, from time to time, declare that the foregoing provisions of said Act shall not apply to the ships or vessels of any foreign country in which British ships are admitted to the coasting trade of that country, and permitted to carry goods and passengers from one port or place to another in such country;

*A.S.C. of Cap 113  
sec 95-2*

Goods and passengers in British ships.

Ships or vessels of any foreign country.

*sec 95-2  
R.S. Cap 83  
Sec 113*

*see 2 side of Cap 83. Sec 6 & 7*

Sec. 2. And whereas British ships are allowed to participate in the coasting trade of Italy on the same footing as the vessels of that Kingdom,—

His Excellency in Council has been pleased to order and declare, that the provisions of the said Act shall not apply to the ships or vessels of Italy, but that such vessels shall be, and they are hereby admitted to the coasting trade of the Dominion of Canada on the same terms and conditions as are applicable to Canadian vessels.

O. C. Oct. 13, 1873.

British ships, Italy.

Admitted to coasting trade in Canada.

#### VESSELS OF GERMANY.

Sec. 3. And whereas British ships are allowed to participate in the coasting trade of Germany on the same footing as the vessels of that Empire,—

His Excellency in Council has been pleased to order and declare that the provisions of the said Act shall not apply to the ships or vessels of Germany, but that such vessels

British ships, Germany.

Admitted to coasting trade in Canada.

*Coasting Trade—Foreign Vessels.*

## Chap. 20.

shall be, and they are hereby admitted to the coasting trade of the Dominion of Canada on the same terms and conditions as are applicable to Canadian vessels.

O. C. May 14, 1874.

## VESSELS OF THE NETHERLANDS.

Sec. 4. And whereas British ships are allowed to participate in the coasting trade of the Netherlands on the same footing as vessels of that country,—

British ships,  
Netherlands.

His Excellency in Council has been pleased to order and declare that the provisions of the said Act shall not apply to the ships or vessels of the Netherlands, but that such vessels shall be, and they are hereby admitted to the coasting trade of the Dominion of Canada on the same terms and conditions as are applicable to Canadian vessels.

Admitted into  
Canada.

O. C. Nov. 5, 1874.

## VESSELS OF SWEDEN AND NORWAY.

Sec. 5. And whereas British ships are allowed to participate in the coasting trade of Sweden and Norway on the same footing as the vessels of that country,—

British ships,  
Sweden and  
Norway.

His Excellency in Council has been pleased to order and declare that the provisions of the said Act shall not apply to the ships or vessels of Sweden and Norway, but that such vessels shall be, and they are hereby admitted to the coasting trade of the Dominion of Canada on the same terms and conditions as are applicable to Canadian vessels.

Admitted into  
Canada.

O. C. Nov. 5, 1874.

## VESSELS OF AUSTRO-HUNGARY.

Sec. 6. And whereas British ships are allowed to participate in the coasting trade of the Austro-Hungarian Empire on the same footing as the vessels of that country,—

British ships  
in Austro-  
Hungarian  
Empire.

His Excellency in Council has been pleased to order and declare that the provisions of the said Act shall not apply to the ships or vessels of the Austro-Hungarian Empire, but that such vessels shall be, and they are hereby admitted to the coasting trade of the Dominion of Canada on the same terms and conditions as are applicable to Canadian vessels.

Admitted into  
Canada.

O. C. June 1, 1876.

## VESSELS OF DENMARK.

Sec. 7. And whereas British ships are allowed to participate in the coasting trade of Denmark on the same footing as the vessels of that country,—

British ships,  
Denmark.

## Chap. 20.

*Coasting Trade - Foreign Vessels.*Admitted into  
Canada.

His Excellency in Council has been pleased to order and declare that the provisions of the said Act shall not apply to the ships or vessels of Denmark, but that such vessels shall be, and they are hereby admitted to the coasting trade of the Dominion of Canada on the same terms and conditions as are applicable to Canadian vessels.

O. C. Jan. 25, 1877.

## VESSELS OF BELGIUM.

British ships,  
Belgium.

Sec. 8. And whereas British ships are allowed to participate in the coasting trade of Belgium on the same footing as the vessels of that country, —

Admitted into  
Canada.

His Excellency in Council has been pleased to order and declare that the provisions of the said Act shall not apply to the ships or vessels of Belgium, but that such vessels shall be, and they are hereby admitted to the coasting trade of the Dominion of Canada on the same terms and conditions as are applicable to Canadian vessels.

O. C. Sep. 13, 1879.

## VESSELS OF THE ARGENTINE REPUBLIC.

British ships,  
Argentine Re-  
public

Sec. 9. And whereas British ships are allowed to participate in the coasting trade of the Argentine Republic on the same footing as the vessels of that country, —

Admitted into  
Canada.

His Excellency in Council has been pleased to order and declare that the provisions of the said Act shall not apply to ships or vessels of the Argentine Republic, but that such ships shall be and they are hereby admitted to the coasting trade of the Dominion of Canada on the same terms and conditions as are applicable to Canadian vessels.

O. C. May 10, 1881.

*Shipping*  
*R.S. C/106. Cap 113*  
*see 952 et seq also*  
*R.S. Cap 106*  
*+ 2 Sec 7 Cap 7*  
*see 97*

CHAPTER 21.

FOREIGN TRADING VESSELS.

Government House, Ottawa,  
The 25th day of July, 1888.

On the recommendation of the Minister of Customs, and under the provisions of Chapter 32 of the Revised Statutes of Canada, intituled, "The Customs Act,"

His Excellency in Council has been pleased to make the following regulations, that is to say :

*Foreign Vessels.*

All foreign vessels trading on the coast and entering the harbors of Canada from sea or inland waters, are governed by the following rules:—

Vessels trading on coast and entering harbors.

Section 1. Foreign vessels may transport cargo and passengers from a foreign port and land the same at two or more Canadian ports, clearing from each in succession until all of said cargo and passengers are landed.

Transporting cargo, &c., from foreign ports to Canadian ports.

Sec. 2. Foreign vessels may take cargo and passengers from two or more Canadian ports and transport the same to a foreign port, clearing from each in succession, but taking final clearance for such foreign port at the last Canadian port which they enter on such voyage.

Taking cargo, &c., from Canadian ports to foreign ports.

Sec. 3. Foreign vessels shall not take freight or passengers at one Canadian port and land the same at another Canadian port, and the master and owner of any vessel found to have violated this rule shall be subject to a penalty of \$400 for each such offence, and the vessel may be detained until the same is paid.

Penalty of \$400 for contravention.

Sec. 4. Foreign vessels bringing cargo or passengers from a foreign port may, after landing the same, be permitted to clear light to another Canadian port for the purpose of loading cargo for a foreign port, and may clear from port to port to complete such cargo, taking final clearance as above.

Foreign vessels, final clearance.

Sec. 5. Foreign vessels may tow other vessels or things from a foreign port to a Canadian port; but if they drop or part from any such vessel or thing in Canadian waters, they shall not again take such vessel or thing in tow for the purpose of moving the same further in Canadian waters.

Towing from foreign port to Canadian port.

## Chap. 21.

*Foreign Trading Vessels.*

Towing from  
Canadian  
port to foreign  
port.

Sec. 6. Foreign vessels may tow other vessels or things from a Canadian port to a foreign port, but having parted from such vessels or things, or any of them, in Canadian waters, they cannot again take such vessels or things in tow to move them further in Canadian waters; but this and the preceding rule are not to apply to an accidental parting of such vessel by breaking hawser or other temporary damages.

Vessels must  
report in-  
wards and  
outwards.

Sec. 7. Foreign vessels shall be entitled to the foregoing privileges only on condition of strict compliance with the provisions of "The Customs Act," respecting reporting inwards and outwards on entering and leaving Canadian ports by the masters of such vessels.

Report of  
master of ves-  
sel, how  
made.

Sec. 8. Where vessels bring cargo or passengers from a foreign port consigned to more than one Canadian port, the masters of such vessels must make a full report of the whole contents at the first port of entry, and distinguish therein the items to be there landed and the ports at which all other items are to be landed. Such report must be made in duplicate, with an additional copy for each succeeding port at which there are goods to be landed; and the collector or proper officer of Customs shall mark each item in such report with the entry number, if entered, and in case of any item landed and placed in sufferance warehouse without entry, it shall be marked with the letter "L" in the said report; duplicate copies to be filed at said first port of entry, and the others to be carried with the vessel, and one to be filed at each succeeding port of entry.

Customs offi-  
cer must mark  
each item.

Entrance and  
clearance fee,  
above Mon-  
treal.

Sec. 9. As required by section 112 of "The Customs Act," the fee of 50 cents for each vessel not over 50 tons, and \$1.00 if over 50 tons, shall be paid by each such vessel on reporting inwards, and the same on obtaining clearance outwards, at each port she enters above the port of Montreal.

Fine of \$400  
for contra-  
vention.

Sec. 10. For any violation of the requirements of these rules the master or owner of any such vessel shall be subject to a fine of \$400, or such other fine or penalty provided by the said Act as may be applicable to the case, and the vessel may be detained until such fine or penalty is paid.

Deep sea fish-  
eries.

Sec. 11. Vessels fitted for and engaged in the deep sea fisheries are not included in these rules.

O. C. Nov. 10, 1886.

## CHAPTER 22.

### CARRIAGE BY RAILWAY THROUGH CANADA.

Government House, Ottawa,  
The 25th day of July, 1888.

On the recommendation of the Minister of Customs, and under the provisions of Chapter 32 of the Revised Statutes of Canada, intituled "The Customs Act,"

His Excellency in Council has been pleased to make the following regulations:—

*Regulations respecting transporting, manifesting and reporting Dutiable goods by Railway in or through Canada.*

Section 1. All goods removed in bond ex-warehouse under removal entry when the transportation is intended to be partly through a foreign country shall be manifested to the customs port of destination in Canada, and one copy shall be forwarded by mail to the frontier port of exit, to be there recorded and remailed without delay to the port of destination.

Transportation of goods in bond under removal entry.

Sec. 2. All goods exported in bond, ex-warehouse or otherwise, shall be manifested to the frontier port of exit from Canada, but the foreign port of destination shall be recorded on the face of the manifest.

Goods exported in bond.

Sec. 3. All goods forwarded from one port in Canada to another, under frontier or general bond, shall be forwarded under manifest.

Goods to be forwarded under manifest.

Sec. 4. All goods received at frontier ports, to be forwarded under bond to other ports in Canada, shall be forwarded to the ports of destination under manifest.

Goods at frontier ports.

Sec. 5. Manifests shall be in such form as may be prescribed by the Minister of Customs, who shall also direct the information to be given therein.

Form of manifest.

Sec. 6. Manifests shall be made in triplicate for each car, one copy to be attached to the way-bill and forwarded therewith to the customs port of destination, one to be forwarded to the same port by mail or first train, and the third copy to be retained on file at the sending port; provided that instead of a third copy of the separate car manifest a general or train manifest may be substituted, to be kept on file at the sending port.

Manifests, how made and used.

## Chap. 22.

*Carriage by Railway through Canada.*

Transfers to be noted on car manifest.

Sec. 7. All transfers from road to road, or from car to car, which may occur between the sending and receiving ports, shall be noted on the separate car manifest accompanying the way-bill by the customs officer in attendance; and no transfer shall be made except in the presence of a Canadian customs officer, except as hereinafter provided.

Conductor's declaration in case of accidents.

Sec. 8. In the case of accidents between stations, where an officer cannot be procured to supervise the transfer, the conductor shall make and subscribe a declaration to the effect that the goods described in the manifest have been transferred under his supervision from the wrecked or damaged car, giving the No., &c., to car No.—using the forms provided, such declaration to be forwarded with the way-bill to destination.

Manifests must be numbered.

Sec. 9. A separate consecutive number must be given at sending ports to manifests for each port of destination; where there is more than one station at such ports, under charge of different officers, from which manifests may be forwarded, the series of numbers at each station are to be kept distinct by prefixing a letter to the number to distinguish the particular station at which such manifests are made. Manifests of foreign goods in transit through Canada must be separately recorded at the ports of entrance and departure.

Duplicate and triplicate manifests.

Sec. 10. Duplicate and triplicate manifests must be compared with the original, and with the way-bill before being forwarded; and the way-bill numbers must be shown on the manifest.

Recording manifests with reports.

Sec. 11. Manifests are to be recorded at the receiving ports, with consecutive numbers in the order of their arrival with ships or other reports inwards, and the sending port numbers also recorded. When the packages are all checked out of the cars the manifests are to be receipted and one copy returned to the sending port, the receiving port numbers and the entry or re-manifest number and stamp of the port being first placed thereon, with overs and shorts, if any, marked on both copies. All manifests received are to be returned to sending port within thirty days from date of reception as above, but if any goods received have not been entered the item must be marked with the number of the unclaimed list or the page of the book in which account of the unclaimed goods is kept.

Manifests are to be returned within 30 days to sending post.

Cancelling transit manifests, duty of

Sec. 12. Transit manifests are to be cancelled at the frontier port of exit by the officer whose duty it is to see



*Carriage by Railway through Canada.*

## Chap. 22.

that the cars have passed out with unbroken seals, and if any seals are found broken or the car bears evidence of having been tampered with in Canada, the officer shall satisfy himself as to the correctness of the contents by a comparison of the packages with the manifest.

officers when seal broken.

Sec. 13. Manifests must be legibly filled in with ink; in no case is a pencil of any kind to be used for the purpose.

Manifests in ink.

Sec. 14. Excise goods when removed or exported by railway under customs supervision must be manifested in the same manner as customs goods, but such excise goods must be delivered to the customs officer by the proper officer of excise with a removal entry or warrant, otherwise they are not to be taken charge of by customs officers.

Excise goods removed or exported must be manifested, &c.

Sec. 15. Inquiries as to goods short received should be made by the officers of both receiving and sending ports, as both are responsible for the due discharge of all goods called for by manifest.

Inquiries, by whom made.

Sec. 16. Should receipted manifests not be received within 30 days after the forwarding of the goods, the collector of the sending port will cause a copy of the missing manifest to be sent to the port in arrear, with request that it may be returned with receipt or explanation.

Manifests not received within 30 days.

Sec. 17. Each Canadian railway company, before being permitted to manifest goods in bond, shall enter into a general bond to be duly executed in the penal sum of eighty thousand dollars conditional for the due and faithful production at the respective ports or destination in Canada of all packages passing over such road under manifest, and for the general compliance with the customs laws and regulations governing such traffic.

Canadian railway company to enter into a bond of \$80,000 before manifesting goods in bond.

Sec. 18. All railway companies shall provide secure and commodious sufferance warehouses, and other necessary premises, in connection with their stations at every customs port or outport, for landing, storing, transferring, delivering and forwarding bonded goods; also, suitable office accommodation, with fuel and light, for the officers of customs appointed to attend such stations. All such premises to be made secure to the satisfaction of the collector or proper officer of customs.

Warehouses to be provided by railway companies.

Sec. 19. Loading, transferring or landing bonded goods before or after regular customs hours, or on Sundays or legal holidays, shall only be permitted upon application to

Working after office hours, Sundays and holidays.

the collector or proper officer of customs; and railway companies shall pay such sum or sums for the extra services of officers, either weekly or monthly, appointed to attend to such duty, to the collector of the port, as may be considered fair and reasonable; but no such money shall be paid by any railway company to any officer of customs, except through the collector of the port, who will, in every case, give his receipt for the same.

Goods under bond to have preference.

Sec. 20. All goods under bond, in charge of any railway, should have preference over other goods, and be promptly landed in presence of the officers of Customs in attendance.

Locks, seals and fastenings for freight cars.

Sec. 21. Such locks, seals or other fastenings, for freight cars as may be approved by the Minister of Customs shall be provided by the Customs Department, and furnished for use of railway companies at their expense.

O.C. March 19, 1883.

Transit of merchandise.

Sec. 22. Transfers of merchandise in course of transportation *in transitu* through Canada may be allowed as follows:—

When cars partially loaded arrive under United States customs seal, at any railway station at which there are both Canadian and United States officers of customs in attendance, such car may be unsealed by a United States officer in the presence of a Canadian officer, and the contents transferred to another car under the joint supervision of the said officers, and all such changes and transfers shall be duly recorded on the back of the manifest accompanying the car in the same manner as is permitted in case of accidents, and be signed by both of said officers.

O. C. July 5, 1886.

Unsealing of cars, how made.

#### TRANSIT THROUGH THE UNITED STATES.

*Regulations for the transportation of goods in transit through the United States.*

Goods of domestic origin, how transported.

Sec. 23. Goods of domestic origin, duty paid or free of duty, may be transported from one port to another of Canada over the territory of the United States, with the consent of the proper United States authorities, by routes duly designated and bonded for such purpose.

Cars transporting goods to be locked and sealed, &c.

Cars must be specially appropriated for such transportation, placed under customs lock and sealed by an officer of the customs at the port of departure in Canada, and remain thus fastened and sealed until they shall have passed through such foreign territory and again arrived in Canada, when all goods of domestic origin, duty paid or free, may be released from further customs surveillance.

*Carriage by Railway through Canada.*

Chap. 22.

Railroad iron, sugar and molasses in hogsheads, and all other merchandise in bulk which is incapable of being put in locked cars, may be transported on platform cars duly corded and sealed.

Merchandise in bulk.

Sec. 24. Imported goods in bond may be transported in like manner, under the usual transportation entry and bond.

Imported goods in bond, how transported.

The owner or shipper must, before the merchandise is laden, present to the collector at the port of departure manifests, in triplicate, for each car, subscribed by the proper agent of the railroad or other company, which shall be prepared by the said company at the port of departure, and shall contain a particular description of the merchandise, by packages, marks, numbers and contents; the ports of destination, to whom consigned, and the route over which the transportation is to be made, distinguishing articles that are of native, from those of foreign growth, production or manufacture, and those free of duty or duty paid, from goods in bond subject to duty. The manifest shall be in the following form:—

Manifests to be presented to collector by owner or shipper; what to contain.

“(Form )

“Special manifest of merchandise in transit through the United States:—

Manifest form.

Port of \_\_\_\_\_

18

“We certify that the following described merchandise has been laden on car No. \_\_\_\_\_ of the \_\_\_\_\_ railroad at \_\_\_\_\_ for transportation to \_\_\_\_\_, across foreign territory, by way of \_\_\_\_\_, and that said car has been duly secured with customs seal (or) lock.

Certificate of railroad agent.

Marks.	Numbers.	Packages.	CONTENTS.		Consigner.	Consignee.
			Articles.	Free or in Bond.		

Agent of Railroad Co'y.  
Landing Waiter.

“(Seal)

Collector.”

## Chap. 22.

*Carriage by Railway through Canada.*

Manifests for each car.

**Sec. 25.** The landing waiter charged with the lading and sealing of cars shall see that the manifests are provided for each car, and that they are correct by an actual comparison with the lading.

Duties of landing waiter.

He shall then seal the car, certify each of the triplicate manifests, deliver one to the conductor of the car, and immediately return the other two to the custom house.

Filing of manifests and forwarding of same to collector.

One of such manifests shall be filed at the custom house, and the other verified by the signature and official seal of the collector, forwarded by the first mail to the collector at the port of entry where the car is expected to re-enter Canada; care will be taken to score with lines the blank portion of each manifest, so that no additional articles can be interpolated after signing.

Fastenings and seals of car to be examined by collector.

**Sec. 26.** On arrival at the frontier port of exit from Canada, the manifest accompanying the car shall be presented to the collector, who shall cause the fastenings and seals of the car to be examined, and if they appear intact he shall so certify, with the date on the manifest, and return the same to the conductor.

Contents of cars to be compared with manifests.

**Sec. 27.** On arrival at the first port in Canada after the transit, a careful examination must be made of the seals and other fastenings, and the seals having been removed the contents of the cars shall be unladen and carefully compared with the manifest received from the port of departure, as well as with the copy accompanying the goods, except as hereinafter provided.

If the car arrive at such port before the manifest sent by mail, the contents of the car will be compared with the manifest accompanying it, and that manifest with the copy subsequently received by mail.

Merchandise when re-warehoused, and how and when delivered to consignee.

If found correct, the merchandise will, if in bond, be forwarded to its destination to be re-warehoused in like manner as other goods transported in bond—or if not in bond, delivered to the consignee. The officer who compares the manifest with the merchandise will certify the result on the back of one of the manifests, and the collector will return the other, with a similar certificate, to the collector from whom it issued.

Goods, when detained for seizure; examination of packages, when to take place.

If the merchandise does not correspond with the manifest, if the seals be lost or broken, or if the packages, cars or seals appear to have been tampered with, the goods will be detained, if the circumstances justify it, for seizure and condemnation. In ordinary cases a comparison by marks and numbers will be sufficient, but if there be any well-grounded suspicion of fraud, the examination will extend to the contents of packages.

---

*Carriage by Railway through Canada.*

---

Chap. 22.

Sec. 28. Cars may pass to a port of destination, not on the frontier without being unladen or opened, if a careful examination at the frontier port of the seals or locks by which the cars are secured show them to be intact; if otherwise, or if any such cars be found without proper seals or locks, they will be detained and reported to the Commissioner of Customs for instructions.

When cars allowed to pass without being unladen or opened.

O. C. Dec. 4, 1883.

---

## CHAPTER 23.

### VALUES OF FOREIGN CURRENCIES.

---

Government House, Ottawa,  
The 25th day of July, 1888.

The standard  
dollar of  
Canada.

On the recommendation of the Minister of Customs and under the provisions of section 10 of Chapter 32 of the Revised Statutes of Canada, intituled, "The Customs Act,"

It is ordered and declared that the values of the foreign currencies as compared with the standard dollar of Canada as hereunder named, shall be the values of such foreign currencies for Customs purposes ; and all invoices of foreign goods made out in such currencies shall be reduced to Canadian currency at the rates so assigned to them, viz :

*Values of Foreign Currencics.*

Chap. 23.

Country.	Monetary Unit.	Standard.	Value in Canadian Currency.	Coins.
Argentine Re-Republic	Peso.....	Gold and silver.	\$0.965	Gold, Argentine \$4.824, and $\frac{1}{2}$ Argentine silver, peso and divisions.
Austria.....	Florin.....	Silver.....	0.359	Gold, 4 florins \$1.92.9, 8 florins \$3.85.8, 1 ducat \$3.28.7 and 4 ducats \$9.15.8 - Silver, 1 and 2 flors.
Belgium.....	France.....	Gold and silver.	.193	Gold, 10 and 20 francs—Silver, 5 francs.
Bolivia.....	Boliviano.....	Silver.....	.727	Boliviano and divisions.
Brazil.....	Milreis of 1000 reis..	Gold.....	.546	Gold, 5, 10 and 20 milreis—Silver, $\frac{1}{2}$ , 1 and 2 milreis.
Chili.....	Peso.....	Gold and silver.	.912	Gold, escudo \$4.82.4, doubloon \$4.56.1, and condor \$9.12.3—Silver, peso and divisions.
Cuba.....	Peso.....	Gold and silver.	.932	Gold, doubloon \$3.01.7—Silver, peso
Denmark ...	Crown.....	Gold.....	.298	Gold, 10 and 20 crowns.
Ecuador.....	Sucre .....	Silver.....	.727	Gold, doubloon \$3.85.5, condor \$9.64.7 and double condor—Silver, sucre and divisions.
Egypt.....	Pound (100 piastres)	Gold.....	4.943	Gold, pound (100 piastres) 50, 20, 10 and 5 piastres—Silver, 1, 2, 5, 10 and 20 piastres.
France.....	Franc.....	Gold and silver..	.193	Gold, 5, 10, 20, 50 and 100 francs—Silver, 5 francs.
German Empire .....	Mark.....	Gold.....	.238	Gold, 5, 10 and 20 marks.
Greece .....	Drachma.....	Gold and silver..	.193	Gold, 5, 10, 20, 50 and 100 drachmas—Silver, 5 drachmas.
Hayti.....	Gourde.....	Gold and silver..	.965	Gold, 1, 2, 5 and 10 gourdes—Silver, gourde.
India.....	Rupee of 16 annas..	Silver.....	.346	Gold, mohur \$7.10.5—Silver, rupee and divisions.
Italy.....	Lira .....	Gold and silver..	.193	Gold, 5, 10, 20, 50 and 100 liras—Silver, 5 liras.
Japan.....	Yen.....	* Gold and silver	99.7	Gold, 1, 2, 5, 10 and 20 yen.
Liberia.....	Dollar.....	Gold.....	1.00	Silver, yen.
Mexico.....	Dollar.....	Silver.....	.79	Gold, dollar \$0.98. 3, 2 $\frac{1}{2}$ , 5, 10 and 20 dollars—Silver dollar (or peso) and divisions.
Netherlands	Florin.....	Gold and silver.	.402	Gold, 10 florins—Silver, $\frac{1}{2}$ , 1 and 2 $\frac{1}{2}$ florins.
Norway.....	Crown.....	Gold.....	.268	Gold, 10 and 20 crowns.
Peru.....	Sol.....	Silver.....	.727	Silver, sol and divisions.
Portugal....	Milreis of 1000 reis..	Gold.....	1.08	Gold, 1, 2, 5 and 10 milreis.
Russia.....	Rouble of 100 copecks	Silver.....	.582	Gold, Imperial \$7.71.8 and $\frac{1}{2}$ Imperial \$3.85.9†—Silver $\frac{1}{2}$ , $\frac{1}{4}$ and 1 rouble.
Spain.....	Peseta of 100 centimes	Gold and silver..	.193	Gold, 5, 10 and 25 pesetas—Silver, 5 pesetas.
Sweden.....	Crown.....	Gold.....	.268	Gold, 10 and 20 crowns.
Switzerland.	Franc.....	Gold and silver.	.193	Gold, 5, 10, 20, 50 and 100 francs—Silver, 5 francs.
Tripoli.....	Mahbab of 20 piastres	Silver.....	.656	Gold, 25, 50, 100, 250 and 500 piastres.
Turkey.....	Piastre.....	Gold.....	.044	Gold, 25, 50, 100, 250 and 500 piastres.
United States of Columbia	Peso.....	Silver.....	.727	Gold, condor \$9.64.7, and double condor—Silver, peso.
Venezuela ...	Bolivar.....	Gold and silver..	.193	Gold, 5, 10, 20, 50 and 100 bolivars—Silver, 5 bolivars.

\* Gold, the nominal standard. Silver, practically the standard.

† Coined since 1st January, 1886. Old  $\frac{1}{2}$  Imperial, \$3.98.6.

## CHAPTER 24.

### VESSELS ARRIVING AT ST. JOHN, N.B.

Government House, Ottawa,  
The 25th day of July, 1888.

On the recommendation of the Minister of Customs, and under the provisions of Chapter 32 of the Revised Statutes of Canada, intituled "The Customs Act,"

His Excellency in Council has been pleased to approve of the following regulations respecting vessels arriving from sea at ports on the River St. John, New Brunswick, viz.:—

#### REGULATIONS.

Duty of master of vessel arriving with cargo bound for port on St. John River.

Master, when subject to penalty of \$400.

The master of any vessel arriving with cargo at the port of St. John, in the Province of New Brunswick, bound for Fredericton, or any other port on the St. John River, shall report at the office of the Collector of Customs before proceeding up the river, and shall take on board an authorized officer to remain until such vessel shall have been entered at Fredericton or some other port, provided that the said master shall be only required to report to said Collector at St. John, the fact of the arrival of such vessel with a cargo, without producing any manifest, statement or other specification thereof, and for any failure to so report, or for refusing to take on board such officer, the said master shall be subject to a penalty of four hundred dollars, and if such master shall not provide room under deck in the fore-castle or steerage for the officer's bed, with good and sufficient food, he shall be liable to a penalty of fifty dollars for each offence.

O. C. Oct. 23, 1868.



## CHAPTER 25.

### PORTS AND PLACES OF ENTRY.

Government House, Ottawa,  
The 25th day of July, 1888.

On the recommendation of the Minister of Customs and under the provisions of Chapter 32 of the Revised Statutes of Canada, intituled "The Customs Act,"

His Excellency in Council has been pleased to order, and it is hereby ordered that the following ports and places having been made Customs Ports or Outports of Entry by legislative enactment, or by His Excellency in Council, for the purposes and under the provisions of "The Customs Act," be and the same are hereby confirmed as such :—

#### PORTS OF ENTRY.

##### *Ontario.*

Amherstburg	Kingsville.	Ports of entry, Ontario.
Belleville.	Lindsay.	
Berlin.	London.	
Bowmanville.	Morrisburg.	
Brantford.	Napanee.	
Brighton.	Niagara.	
Brockville.	Oakville.	
Chatham.	Oshawa.	
Clifton.	Ottawa.	
Cobourg.	Owen Sound.	
Colborne.	Paris.	
Collingwood	Penetanguishene.	
Cornwall.	Peterboro.	
Cramahe.	Picton.	
Deseronto.	Port Arthur.	
Dover.	Prescott.	
Dundas.	St. Catharines.	
Dunnville.	St. Thomas.	
Fort Erie.	Sarnia.	
Galt.	Saugeen.	
Gananoque.	Sault Ste. Marie.	
Goderich.	Stratford.	
Guelph.	Toronto.	
Hamilton.	Trenton.	
Hope.	Wallaceburg.	
Kincardine.	Whitby.	
Kingston.	Windsor.	
	Woodstock.	

## Chap. 25.

*Ports and places of Entry.**Quebec.*

Ports of entry, Quebec.

Clarenceville.	Quebec.
Coaticook.	Rimouski.
Dundee.	Russeltown.
Frelighsburg.	St. Armand.
Gaspé.	St. Hyacinthe.
Hemmingford.	St. Johns.
Magdalen Islands.	Sherbrocke.
Montreal.	Sorel.
New Carlisle.	Stanstead.
Percé.	Sutton.
Potton.	Three Rivers.

*New Brunswick.*

Ports of entry, N. B.

Bathurst.	Richibucto.
Caraquette.	Sackville.
Chatham.	St. Andrews.
Dalhousie.	St. John.
Dorchester.	St. Stephen.
Fredericton.	Shippegan.
Moncton.	Woodstock.
Newcastle.	

*Nova Scotia.*

Ports of entry, N. S.

Amherst.	Lunenburg.
Annapolis.	Margaretsville.
Antigonish.	North Sydney.
Arichat.	Parrsboro.
Baddeck.	Port Hawkesbury.
Barrington.	Pictou.
Bridgetown.	Port Hood.
Digby.	Port Medway.
Guysboro.	Shelburne.
Halifax.	Sydney.
Kentville.	Truro.
Liverpool.	Weymouth.
Lockeport.	Windsor.
Londonderry.	Yarmouth.

*British Columbia.*

Ports of entry, B. C.

Nanaimo.	Vancouver.
New Westminster.	Victoria.

*Manitoba.*

Manitoba.

Emerson.	Winnipeg.
----------	-----------

*Prince Edward Island.*

P. E. I.

Charlottetown.	Summerside.
----------------	-------------

*North-West Territories.*

N. W. T.

Fort McLeod.

*Ports and places of Entry, Outports.*

Chap. 25.

## OUTPORTS.

[In some cases the Orders in Council establishing Outports can not be found and consequently the dates of their establishment are omitted from the following list.]

*Ontario.*

Algoma Mills, under the survey of Sault Ste. Marie,		O. C. June 28, 1886.	Outports in the Province of Ontario.
Almonte	do	Ottawa, O. C. July 14, 1883.	
Arnprior	do	Ottawa, O. C. Jan. 12, 1884.	
Aultsville	do	Cornwall.	
Barrie	do	Toronto, O. C. May 7, 1877.	
Bath	do	Kingston.	
Belle River	do	Windsor.	
Brampton	do	Toronto, O. C. Aug. 25, 1881.	
Bruce Mines	do	Sault Ste. Marie.	
Burwell	do	St. Thomas.	
Cardinal	do	Prescott, O. C. March 30, 1880.	
Carleton Place	do	Ottawa, O. C. Nov. 10, 1886.	
Chippewa	do	Clifton, O. C. July 30, 1877.	
Clinton	do	London, O. C. Oct. 26, 1881.	
Cockburn Island	do	Sault Ste. Marie, O. C. Nov. 29, 1883.	
Fort William	do	Port Arthur, O. C. June 6, 1874.	
Grafton	do	Coburg.	
Hagersville	do	Hamilton, O. C. May 2, 1878.	
Ingersoll	do	Woodstock, O. C. Aug. 11, 1875.	
Iroquois	do	Morrisburg.	
Killarney	do	Sault Ste. Marie.	
Leamington	do	Kingsville, O. C. Sep. 11, 1879.	
Listowel	do	Stratford, O. C. July 18, 1885.	
Maitland	do	Prescott, O. C. April 1, 1884.	

## Chap. 25.

*Ports and places of Entry, Outports.*

Outports in the Province of Ontario.	Meaford, under the survey of Owen Sound,		O. C. May 14, 1872.
	Midland	do	Penetanguishene,
	Milford	do	Picton,
	Moose Factory	do	O. C. April 3, 1882.
	Newcastle	do	Sault Ste. Marie,
	Parry Sound	do	O. C. June 20, 1872.
	Pembroke	do	Hope,
	Perth	do	O. C. Feb. 23, 1886.
	Petrolea	do	Collingwood,
	Point Edward	do	O. C. July 5, 1881.
	Port Dalhousie	do	Ottawa,
	Port Robinson	do	O. C. June 14, 1875.
	Port Rowan	do	Ottawa,
	Port Ryerse	do	O. C. Nov. 10, 1886.
	Prinyer	do	Sarnia,
	Queenston	do	O. C. May 16, 1878.
	Renfrew	do	Sarnia,
	Ridgetown	do	O. C. Nov. 17, 1885.
	Rockeport	do	St. Catharines.
	Rondeau	do	St. Catharines.
	St. Mary	do	Dover,
	Simcoe	do	O. C. Sep. 8, 1885.
	Southport	do	Dover.
	Stanley	do	Picton,
	Strathroy	do	O. C. May 24, 1886.
	Streetsville	do	Niagara,
	Tilsonburg	do	O. C. Feb. 4, 1871.
	Thorold	do	Ottawa,
			O. C. July 31, 1885.
			Chatham,
			O. C. July 18, 1885.
			Gananoque.
			Chatham.
			Stratford,
			O. C. March 16, 1878.
			Dover,
			O. C. May 23, 1878
			Kingsville,
			O. C. July 10, 1879
			St. Thomas,
			O. C. March 27, 1879
			London,
			O. C. Feb. 17, 1873
			Toronto,
			O. C. May 29, 1888.
			Dover,
			O. C. Dec. 3, 1886
			St. Catharines.
			O. C. July 18. 1874.

*Ports and places of Entry, Outports.*

Chap. 25.

Walkerton, under the survey of Guelph,			Outports in the Province of Ontario.
		O. C. May 23, 1878.	
Walkerville	do	Windsor.	
Weller's Bay	do	Picton,	
		O. C. Sep. 5, 1885.	
Wellington	do	Picton.	
Wellington Square	do	Oakville,	
		O. C. June 14, 1875.	
Warton	do	Stratford,	
		O. C. Sep. 26, 1886.	
Wingham	do	Kincardine,	
		O. C. June 27, 1882.	

*Quebec.*

Agnes, under the survey of Sherbrooke,			Outports in the Province of Quebec.
		O. C. Dec. 17, 1887.	
Athelstan	do	Russeltown.	
Beauce	do	Quebec.	
Chicoutimi	do	Quebec.	
Esquimaux Point	do	Gaspé,	
		O. C. April 6, 1871.	
Georgeville	do	Stanstead.	
Hereford	do	Coaticook.	
Lacolle	do	St. Johns,	
		O. C. Dec. 30, 1887.	
Madeline River	do	Gaspé.	
Matane	do	Rimouski.	
Phillipsburg	do	St. Armand.	
Richmond	do	Sherbrooke,	
		O. C. July 11, 1879.	
Rivière du Loup	do	Quebec,	
		O. C. July 31, 1885.	
St. Régis	do	Dundee.	
Ste. Anne des Monts	do	Gaspé.	
Stanstead Junction	do	Stanstead.	
Trout River	do	Dundee.	
Valleyfield	do	St. Johns.	
		O. C. July 2, 1883.	

*New Brunswick.*

Alma, under the survey of Moncton,			Outports in the Province of New Bruns- wick.
		{ O. C. May 25, 1872.	
		{ July 8, 1872.	
Aroostock Junction	do	Woodstock,	
		{ O. C. June 30, 1869.	
		{ Dec. 16, 1884.	
Bay Verte	do	Sackville,	
		O. C. Aug. 14, 1879.	

## Chap. 25.

*Ports and places of Entry, Outports.*

Outports in the Province of New Brunswick.			
	Buctouche, under the survey of	Richibucto,	O. C. June 30, 1869.
	Campbellton	do	Dalhousie, O. C. June 30, 1869.
	Campobello	do	St. Andrews, O. C. Dec. 13, 1886.
	Centreville	do	Woodstock.
	Cocagne	do	Moncton, O. C. Aug. 23, 1883.
	Debec	do	Woodstock, O. C. Dec. 16, 1884.
	Edmundston,	do	Woodstock, O. C. Sep. 30, 1874.
	Grand Falls	do	Woodstock, O. C. Dec. 16, 1884.
	Grand Manan	do	St. Andrews, O. C. Dec. 13, 1886.
	Harvey	do	Moncton, } O. C. June 30, 1869. Nov. 11, 1887.
	Hillsboro	do	Moncton, O. C. Nov. 11, 1887.
	Lower Andover	do	Woodstock, O. C. Sep. 30, 1874.
	McAdam Junction	do	St. John, O. C. Oct. 19, 1884.
	Milltown	do	St. Stephen.
	Musquash	do	St. John, O. C. July 31, 1871.
	New Bandon	do	Bathurst, O. C. June 30, 1869.
	Point Lepreaux	do	St. John, O. C. Sep. 26, 1870.
	Quaco	do	St. John, O. C. July 31, 1871.
	Rockland	do	Dorchester, O. C. June 30, 1869.
	Rockport	do	Sackville, O. C. April 17, 1883.
	St. George	do	St. John, O. C. Dec. 13, 1886.
	St. Leonards	do	Woodstock, O. C. Jan. 10, 1885.
	Shediac	do	Moncton, O. C. July 20, 1885.
	Sussex	do	St. John, O. C. May 16, 1879.
	Tracadie	do	Caraquette, O. C. April 7, 1875.

*Ports and places of Entry, Outports.*

Chap. 25.

<i>Ports and places of Entry, Outports.</i>		<i>Chap. 25.</i>
West Isles, under the survey of St. Andrews,		West Isles.
		O. C. Jan. 10, 1880.
<i>Nova Scotia.</i>		
Acadia	do	Weymouth, O. C. June 30, 1869.
Advocate Harbor	do	Parrsboro, O. C. June 30, 1869.
Apple River	do	Parrsboro, O. C. June 20, 1872.
Aspey Pay	do	Baddeck, O. C. June 7, 1871.
Bayfield	do	Antigonish.
Bear River	do	Digby, O. C. June 30, 1869.
Belleveau Cove	do	Weymouth, O. C. June 30, 1869.
Bridgewater	do	Lunenburg, O. C. June 30, 1869. } Oct. 30, 1875.
Caledonia	do	Sydney, O. C. June 30, 1869.
Canada Creek	do	Kentville, O. C. June 30, 1869.
Cape Canso	do	Guysboro, O. C. June 30, 1869.
Chester	do	Lunenburg, O. C. June 30, 1869.
Cheverie	do	Windsor, O. C. June 30, 1869.
Clementsport	do	Annapolis, O. C. June 30, 1869.
Clifton	do	Truro, O. C. Oct. 15, 1883.
Cornwallis	do	Kentville, O. C. July 11, 1888.
Cow Bay	do	Sydney, O. C. June 30, 1869.
Economy	do	Londonderry, O. C. Dec. 14, 1881.
Five Islands	do	Londonderry, O. C. June 30, 1869.
Freeport	do	Digby, O. C. June 30, 1869.
French Cross	do	Kentville, O. C. June 30, 1869.
Gaberouse Bay	do	Sydney, O. C. Feb. 25, 1880.

Outports in  
the Province  
of Nova  
Scotia.

## Chap. 25.

*Ports and places of Entry, Outports.*

Outports in the Province of Nova Scotia.	Glace Bay, under the survey of Sydney,		O. C. June 30, 1869.
	Great Bras d'Or	do	Baddeck, O. C. June 30, 1869.
	Hantsport	do	Windsor, O. C. June 30, 1869.
	Harbor au Bouche	do	Antigonish, O. C. June 30, 1869.
	Harborville	do	Kentville, O. C. June 30, 1869.
	Ingonishe	do	Baddeck, O. C. July 12, 1877.
	Isaac's Harbor	do	Guysboro, O. C. June 30, 1869.
	Joggins	do	Amherst.
	Jordan Bay	do	Shelburne, O. C. April 2, 1873.
	La Have	do	Lunenburg, { O. C. June 30, 1869. } Oct. 30, 1875.
	L'Ardoise	do	Arichat, O. C. Oct. 7, 1872.
	Little Bras d'Or	do	North Sydney, O. C. June 30, 1869.
	Liscombe	do	Guysboro, O. C. June 14, 1875.
	Louisbourg	do	Sydney, O. C. June 30, 1869.
	Mahone Bay	do	Lunenburg, O. C. June 30, 1869.
	Main à Dieu	do	Sydney, O. C. June 30, 1869.
	Maitland	do	Windsor, O. C. June 30, 1869.
	Margaree	do	Port Hood, O. C. June 30, 1869.
	Merigonish	do	Pictou, O. C. June 30, 1869.
	Meteghan	do	Weymouth.
New Glasgow	do	Pictou, O. C. April 2, 1873.	
Northport	do	Amherst, O. C. July 2, 1879.	
Port George	do	Margaretsville.	
Port Gilbert	do	Weymouth, O. C. June 30, 1869.	
Port Greville	do	Parrsboro, { O. C. June 30, 1869. } Sep. 30, 1884.	



*Ports and places of Entry, Outports.*

Chap. 25.

<i>Ports and places of Entry, Outports.</i>		<i>Chap. 25.</i>	<i>Outports in the Province of Nova Scotia.</i>
Port Hastings, under the survey of Port Hawkesbury.		O. C. May 23, 1878.	
Port La Tour	do	Barrington, O. C. June 30, 1869.	
Port Lorne	do	Bridgetown, O. C. Sep. 25, 1885.	
Port Mulgrave	do	Port Hawkesbury, O. C. May 3, 1873.	
Port Williams	do	Kentville, O. C. July 7, 1873.	
Pubnico	do	Yarmouth, O. C. June 30, 1869.	
Pugwash	do	Amherst, O. C. June 30, 1869.	
River Bourgeoise	do	Arichat, O. C. April 14, 1873.	
St. Anns	do	Baddeck, O. C. June 30, 1869.	
St. Mary's River	do	Guysboro, O. C. June 30, 1869.	
St. Peters	do	Arichat, O. C. June 30, 1869.	
Salmon River	do	Weymouth, O. C. April 23, 1888.	
Sandy Cove	do	Digby, O. C. June 30, 1869.	
Sheet Harbor	do	Halifax, O. C. Sep. 23, 1869.	
Steep Creek	do	Port Hawkesbury.	
Tatanagouche	do	Pictou, O. C. June 30, 1869.	
Thorne's Cove	do	Annapolis, O. C. June 30, 1869.	
Tidnish	do	Amherst, O. C. June 7, 1871.	
Tusket Wedge	do	Yarmouth, O. C. April 17, 1873.	
Wallace	do	Amherst, O. C. June 30, 1869.	
Walton	do	Windsor, O. C. June 30, 1869.	
Westport	do	Digby, O. C. June 30, 1869.	
Wolfville	do	Kentville, O. C. June 30, 1869.	
<i>British Columbia.</i>			
Kootenay	do	New Westminster, O. C. March 5, 1880.	<i>Outports in B. C.</i>

## Chap. 25.

*Ports and places of Entry, Outports.*

Outports in British Co- lumbia	Osoyoos, under the survey of New Westminster;		O. C. March 5, 1880.
	Port Simpson	do	New Westminster, O. C. Feb. 9, 1885.
	Stickeen*	do	Victoria, O. C. March 28, 1878.

*Manitoba and North-West Territories.*

Outports in Manitoba and North-West Territories.	Brandon, under the survey of Winnipeg.		
	Calgary	do	Winnipeg, O. C. March 12, 1884.
	Gretna	do	Emerson, O. C. March 12, 1883.
	Lethbridge	do	Fort McLeod, O. C. Dec. 1, 1837.
	Portage la Prairie	do	Winnipeg, O. C. June 27, 1882.
	Regina	do	Winnipeg.
	York Factory	do	Winnipeg, O. C. June 20, 1872.

*Prince Edward Island.*

Outports in Prince Ed- ward Island.	Alberton, under the survey of Summerside,		O. C. Nov. 24, 1884.
	Cardigan	do	Charlottetown.
	Crapaud	do	do
	Georgetown	do	do
	Grand River	do	do
	Malpeque	do	Summerside,
	Montagne Bridge	do	Charlottetown.
	Murray Harbor	do	do
	New London	do	do
	Orwell	do	do
	Pinette	do	do
	Port Hill	do	Summerside.
	Rustico	do	Charlottetown.
	St. Peters	do	do
	Souris	do	do
Tignish	do	Summerside.	

\*The outport of Stickeen is situated on the Stickeen River from the conventional boundary line upwards, comprising the shores on both sides of the said river.  
See *Canada Gazette*, Vol. 11, p. 1003.

## CHAPTER 26.

### WAREHOUSING PORTS.

Government House, Ottawa,  
The 25th day of July, 1838.

On the recommendation of the Minister of Customs and under the provisions of Chapter 32 of the Revised Statutes of Canada, intituled "The Customs Act,"

His Excellency in Council has been pleased to order and it is hereby ordered that the following Customs Ports or Outports of Entry having been made Warehousing Ports by Legislative enactment or by Orders in Council be and the same are hereby confirmed as such, viz:

[The following ports have been made Warehousing ports by legislative enactment or by His Excellency in Council, for the purposes and under the provisions of "The Customs Act," at which goods may be entered for warehouse without payment of duty under the provisions of "The Customs Act" aforesaid, on the licensing of warehouses under regulations as per Order in Council to that effect. See *ante* Chapter 8. *At some of the ports hereinafter named warehouses have not yet been erected.*]

#### *Ontario.*

Algoma Mills.....	O. C. June 28, 1886.
Almonte .....	" July 14, 1883.
Amherstburg.....	" Dec. 24, 1867.
Arnprior .....	" Jan. 12, 1888.
Belleville .....	31 Vic., c. 6, s. 54.
Berlin .....	O. C. April 26, 1870.
Bowmanville .....	See <i>post</i> Darlington.
Brampton .....	O. C. Aug. 25, 1881.
Brantford .....	" Dec. 24, 1857.
Brighton .....	<i>Not known.</i>
Brockville.....	31 Vic., c. 6, s. 54.
Carleton Place.....	O. C. Nov. 10, 1886.
Chatham .....	" Dec. 24, 1867.
Chippewa .....	" July 30, 1877.
Clifton .....	" Dec. 24, 1867.
Clinton .....	" Oct. 26, 1881.
Cockburn Island.....	" Nov. 20, 1883.
Cobourg.....	31 Vic., c. 6, s. 54.
Colborne .....	31 Vic., c. 6, s. 54.
Collingwood.....	<i>Not known.</i>
Cornwall.....	O. C. Dec. 24, 1867.
Cramahe .....	" Dec. 24, 1867.

Warehousing  
ports in the  
Province of  
Ontario.

## Chap. 26.

## Warehousing Ports.

Warehousing  
ports in the  
Province of  
Ontario.

Darlington, (to be known as Bowmanville, after July 1, 1888, O. C. March 9, 1888,)	"	Dec. 24, 1867.
Deseronto .....	"	Feb. 11, 1882.
Dover .....	"	Dec. 24, 1867.
Dundas .....	"	Dec. 24, 1867.
Dunnville .....	"	Dec. 24, 1867.
Fort Erie .....	<i>Not known.</i>	
Galt .....	O. C.	March 5, 1868.
Gananoque.....	"	March, 5, 1868.
Goderich .....	31 Vic., c. 6, s. 54.	
Guelph .....	O. C.	Dec. 24, 1867.
Hagersville.....	O. C.	May 2, 1888.
Hamilton .....	31 Vic., c. 6, s. 54.	
Hope .....	31 Vic., c. 6, s. 54.	
Ingersoll .....	O. C.	Aug. 10, 1875.
Iroquois.....	<i>Not known.</i>	
Kincardine .....	O. C.	Oct. 8, 1875.
Kingston .....	31 Vic., c. 6, s. 54.	
Kingsville.....	<i>Not known.</i>	
Leamington .....	O. C.	Sep. 11, 1879.
Lindsay .....	"	April 2, 1873.
Listowel .....	"	July 18, 1885.
London .....	31 Vic., c. 6, s. 54.	
Maitland.....	31 Vic., c. 6, s. 54.	
Midland.....	O. C.	April 3, 1882.
Morrisburg.....	"	April 19, 1871.
Napanee.....	"	April 27, 1868.
Newcastle .....	"	March 5, 1868.
Niagara .....	31 Vic., c. 6, s. 54.	
Oakville.....	O. C.	Dec. 24, 1867.
Oshawa .....	"	Dec. 24, 1867.
Ottawa.....	"	Dec. 24, 1867.
Owen Sound.....	"	Oct. 16, 1870.
Paris.....	"	Dec. 24, 1867.
Pembroke .....	"	June 14, 1875.
Penetanguishene.....	<i>Not known.</i>	
Perth .....	O. C.	Nov. 10, 1836.
Peterboro.....	<i>Not known.</i>	
Petrolia .....	O. C.	May 16, 1878.
Picton .....	"	Dec. 24, 1867.
Point Edward... ..	"	Nov. 17, 1885.
Port Arthur.....	"	June 6, 1874.
Port Ryerse.....	<i>Not known.</i>	
Prescott .....	31 Vic., c. 6, s. 54.	
Queenston.....	O. C.	Feb. 4, 1871.
Renfrew .....	"	July 31, 1885.
Ridgetown .....	"	July 18, 1885.
St. Catharines.....	"	May 16, 1878.

*Warehousing Ports.*

## Chap. 26.

St. Mary .....	<i>Not known.</i>
St. Thomas .....	O. C. March 27, 1879.
Saugeen .....	<i>Not known.</i>
Sarnia.....	O. C. Dec. 24, 1867.
Sault Ste. Marie.....	" Dec. 24, 1867.
Simcoe .....	" May 23, 1878.
Stanley .....	31 Vic., c. 6, s. 54.
Stratford .....	O. C. Dec. 24, 1867.
Streetsville.....	O. C. May 29, 1888.
Thorold.....	" July 18, 1874.
Tilsonburg .....	" Dec. 3, 1886.
Toronto .....	31 Vic., c. 6, s. 54.
Trenton.....	O. C. Dec. 24, 1867.
Walkerton.....	" May 23, 1878.
Wallaceburg.....	" Nov. 25, 1872.
Weller's Bay.....	" Sep. 5, 1885.
Whitby .....	" Dec. 24, 1867.
Warton.....	" Sep. 26, 1882.
Windsor.....	" Dec. 24, 1867.
Wingham .....	" June 27, 1882.
Woodstock .....	" Dec. 24, 1867.

Warehousing  
ports in the  
Province of  
Ontario.

*Quebec.*

Agnes.....	" Dec. 17, 1887.
Coaticook.....	" Dec. 24, 1867.
Gaspé.....	" Dec. 24, 1867.
Hemmingford .....	<i>Not known.</i>
Magdalen Islands.....	O. C., Dec. 24, 1867.
Montreal.....	31 Vic., c. 6, s. 54.
New Carlisle.....	O. C. Dec. 24, 1867.
Percé .....	" May 6, 1872.
Quebec.....	31 Vic., c. 6 s., 54.
Richmond.....	O. C. July 11, 1879.
Rimouski.....	<i>Not known.</i>
Rivière du Loup.....	O. C. July 31, 1885.
St. Armand.....	" May 7, 1877.
St. Hyacinthe.....	" June 14, 1875.
St. Johns.....	31 Vic., c. 6, s. 54.
Sherbrooke .....	O. C. Dec. 12, 1874.
Sorel .....	<i>Not known.</i>
Stanstead.....	"
Sutton .....	"
Three Rivers.....	O. C. June 28, 1869.
Valleyfield.....	" July 2, 1884.

Warehousing  
ports in the  
Province of  
Quebec.

*New Brunswick.*

Aroostook Junction.....	<i>Not known.</i>
Bathurst .....	O. C. Dec. 24, 1867.
Buctouche.....	" Dec. 24, 1867.

Warehousing  
ports, New  
Brunswick.

## Chap. 26.

## Warehousing Ports.

Warehousing ports, New Brunswick.	Cambellton.....	O. C. Dec.	24, 1867.
	Campobello.....	" Dec.	24, 1867.
	Carquette.....	" Dec.	24, 1867.
	Chatham.....	" Dec	24, 1867.
	Dalhousie.....	31 Vic., c. 6,	s. 54.
	Debec.....	<i>Not known.</i>	
	Dorchester.....	O. C. Jan.	18, 1869.
	Edmundston.....	" Sep.	30, 1874.
	Fredericton.....	31 Vic., c. 6,	s. 54.
	Grand Falls.....	O. C. Dec.	24, 1867.
	Hillsboro.....	" March	8, 1870.
	Lower Andover.....	" Sep.	30, 1874.
	McAdam's Junction.....	<i>Not known.</i>	
	Milltown.....	"	
	Moncton.....	O. C. Dec.	24, 1867.
	Newcastle.....	" Dec.	24, 1867.
	Richibucto.....	" Dec.	24, 1867.
	Sackville.....	" Dec.	24, 1867.
	St Andrews.....	" Dec.	24, 1867.
	St. George.....	" Dec.	24, 1867.
	St. John.....	31 Vic., c. 6,	s. 54.
	St. Leonards.....	O. C. Jan.	10, 1885.
	St. Stephen.....	" Dec.	24, 1867.
	Shediac.....	" Dec.	24, 1867.
	Shippegan.....	<i>Not known.</i>	
	Sussex.....	O. C. May	16, 1879.
	Tracadie.....	" April	7, 1875.
	West Isles.....	" Dec.	24, 1867.
Woodstock.....	" Dec.	24, 1867.	

## Nova Scotia.

Warehousing ports, Nova Scotia.	Amherst.....	" Dec.	24, 1867.
	Annapolis.....	" Dec.	24, 1867.
	Antigonish.....	" Dec.	24, 1867.
	Arichat.....	" Dec.	24, 1867.
	Baddeck.....	" Dec.	24, 1867.
	Barrington.....	" Dec.	24, 1867.
	Bear River.....	" Dec.	24, 1867.
	Bridgetown.....	" Dec.	24, 1867.
	Bridgewater.....	" Oct.	30, 1875.
	Clifton.....	" Oct.	15, 1883.
	Cornwallis.....	" Dec.	24, 1867.
	Digby.....	" Dec.	24, 1867.
	Economy.....	" Dec.	14, 1881.
	Great Bras d'Or.....	<i>Not known.</i>	
	Guysboro.....	O. C. May	3, 1873.
	Halifax.....	31 Vic., c. 6,	s. 54.
Ingonish.....	O. C. July	12, 1877.	

*Warehousing Ports.*

Chap. 26.

Kentville.....	O. C. July 18, 1877.
La Have.....	<i>Not known.</i>
Liverpool.....	O. C. Dec. 24, 1867.
Lockeport .....	" Dec. 24, 1867.
Londonderry.....	" June 26, 1868.
Lunenburg.....	" Dec. 24, 1867.
Mahone Bay.....	" Dec. 24, 1867.
Maitland.....	" June 20, 1868.
Margaretsville .....	" Dec. 24, 1867.
New Glasgow.....	" April 2, 1873.
North Port.....	" July 10, 1879.
North Sydney.....	" Dec. 24, 1867.
Parrsboro'.....	" Dec. 9, 1868.
Pictou .....	" Dec. 24, 1867.
Port Gilbert.....	" Dec. 24, 1867.
Port George.....	" Dec. 24, 1867.
Port Hastings.....	<i>Not known.</i>
Port Hawkesbury.....	O. C. Dec. 24, 1867.
Port Hood.....	" Dec. 24, 1867.
Port Lorne.....	<i>Not known.</i>
Port Medway.....	O. C. Dec. 24, 1867.
Port Mulgrave.....	" April 6, 1868.
Port Williams.....	" July 7, 1873.
Pugwash .....	" Dec. 24, 1867.
St. Annes.....	" Dec. 24, 1867.
St. Mary's River.....	<i>Not known.</i>
St. Peters.....	O. C. Dec. 24, 1868.
Shelburne.....	" May 12, 1868.
Sydney.....	" Dec. 24, 1867.
Tatamagouche.....	" Dec. 24, 1867.
Truro .....	" March 31, 1875.
Tusket Wedge.....	" April 17, 1883.
Wallace.....	" Dec. 24, 1867.
Weymouth.....	" Dec. 24, 1867.
Windsor .....	" Dec. 24, 1867.
Wolfville.....	<i>Not known.</i>
Yarmouth .....	O. C. Dec. 24, 1867.

Warehousing  
ports, Nova  
Scotia.

*British Columbia.*

Nanaimo .....	O. C. July 21, 1884.
New Westminster.....	" May 1, 1874.
Stickeen.....	" March 28, 1878.
Vancouver.....	" July 1, 1887.
Victoria .....	<i>Not known.</i>

Warehousing  
ports, British  
Columbia.

*Manitoba.*

Emerson .....	O. C. March 14, 1882.
Gretna .....	" March 12, 1883.

Warehousing  
ports, Mani-  
toba.

## Chap. 26.

*Warehousing Ports.*

Portage la Prairie.....O. C., June 27, 1882.  
 Winnipeg ..... " Nov. 18, 1870.

*Prince Edward Island.*

Warehousing  
ports, Prince  
Edward Is-  
land.

Charlottetown .....*Not known.*  
 Georgetown ..... "  
 Summerside ..... O. C. May 23, 1878.

*North-West Territories.*

Warehousing  
ports, North-  
West Terri-  
tories.

Calgary ..... O. C. March 12, 1884.  
 Fort McLeod..... " May 23, 1887.  
 Lethbridge ..... " Dec. 1, 1887



# DEPARTMENT OF INDIAN AFFAIRS.

## CHAPTER 27.

### PROTECTION OF INDIAN RESERVES.

Government House, Ottawa,

The 9th day of August, 1888.

On the recommendation of the Superintendent General of Indian Affairs and under the provisions of Chapter 43 of the Revised Statutes of Canada, intituled "The Indian Act,"

His Excellency in Council has been pleased to order, and it is hereby ordered, that the following provisions and regulations for the protection of Indian reserves be, and the same are hereby made and adopted:—

#### CUTTING MAPLE TREES.

Section 1. No Indian, or other person may, without the consent in writing of the Indian agent for the Reserve at Caughnawaga or Sault St. Louis, in the Province of Quebec, cut, carry away, or remove from said Reserve, or any part thereof, any hard or sugar maple tree or sappling; and whosoever shall cut, carry away, or remove from the aforesaid Reserve, or any part thereof, or buy or otherwise acquire from any Indian or other person, any hard or sugar maple tree or sappling so cut, carried away or removed from the aforesaid Reserve, or any part thereof, contrary to the provisions or regulations hereby made, shall be liable to be fined and imprisoned in accordance with the thirty-second Section of the aforesaid Act.

Caughnawaga or Sault St. Louis Reserve; removal of maple trees therefrom; punishment.

O. C. July 11, 1881.

#### SELLING GRAIN AND OTHER PRODUCE.

Sec. 2. No band or irregular band of Indians, and no Indian of any band or irregular band in the North-West Territories may, without the consent in writing of the Indian agent for the locality, sell, barter, exchange, or give to any person or persons whomsoever, any grain, or root crops, or other produce grown on any Indian Reserve in the North-West Territories, or any part of such Reserve; and any such sale, barter, exchange or gift shall be absolutely null and void, unless the same be made in accordance with the provisions and regulations hereby prescribed; and any such grain, or root crops, or other produce, unlawfully in the

Band of Indians in the N.W.T. not to sell grain or root crops.

---

**Chap. 27.***Protection of Indian Reserves.*

---

possession of any person or persons shall be liable to be seized and taken possession of by any person acting under the authority, either general or special of the Superintendent General of Indian Affairs, and to be dealt with as the said Superintendent General or any officer or person thereunto by him authorized may direct.

O. C. July 14, 1881.

---

## CHAPTER 28.

### ENFRANCHISEMENT OF INDIANS.

Government House, Ottawa,

The 9th day of August, 1888.

On the recommendation of the Superintendent General of Indian Affairs and under the provisions of Chapter 43 of the Revised Statutes of Canada, intituled "The Indian Act,"

His Excellency in Council has been pleased to proclaim order and direct that the following bands of Indians, that is to say :—

Section 1. (a.) The band of chief John Smith, whose reserve is situated on the right bank of the south branch of the Saskatchewan, within the territory covered by treaty six, in the district of Saskatchewan, in the North-West Territories ;

Band of John Smith.

(b.) The band of chief James Senum or Pecan, whose reserve is situated south, west and north of White Fish Lake, which is within the territory covered by treaty six, in the district of Alberta, in the North-West Territories ;

Band of Jas. Senum or Pecan.

(c.) The band of headman Gambler, whose reserve is situated on the east bank of the Assiniboine and Silver Creek, being within the territory covered by treaty two, in the province of Manitoba,—

Band of headman Gambler.

Being sufficiently far advanced to admit of some of the members of the said bands taking advantage of the provisions of "The Indian Act" to become enfranchised ; if, after serving the term required by law, they are found to be qualified for enfranchisement :

Sec. 2. The Sections numbered eighty-three to ninety-three, both inclusive, of "The Indian Act," aforesaid, are extended and applied to the several bands of Indians above name as provided in section 82 of the said Act.

Sections of Act extended.

Proc. May 20, 1886.

## CHAPTER 29.

### REGULATIONS FOR THE DISPOSAL OF INDIAN LANDS.

Government House, Ottawa,

The 15th day of September, 1888.

On the recommendation of the Superintendent General of Indian Affairs and under the provisions of Chapter 43 of the Revised Statutes of Canada, intituled "The Indian Act,"

His Excellency in Council has been pleased to make and does hereby make the following regulations for the disposal of surrendered Indian lands, prescribing the conditions on which sales of the same may be made subject to the conditions of surrender and the provisions of the aforesaid Act.

### REGULATIONS FOR THE DISPOSAL OF SURRENDERED INDIAN LANDS.

Number and size of lots.

**Section 1.** Not more than four lots of 100 acres each, more or less, nor less than one such lot, or more than one section of 640 acres, more or less, or less than one-quarter of such section shall be sold to any one purchaser.

Purchase-money, how and to whom to be paid.

**Sec. 2.** Not less than one-fifth of the purchase money shall be paid at date of sale, and the balance must be paid in equal annual consecutive instalments with interest at six per centum on each instalment from date of sale to date of payment;—payment to be made into a branch of any chartered bank of Canada, to the credit of the Minister of Finance and Receiver General, on account of Indian funds, and bank certificates—duplicate and triplicate,—and drafts to be handed or sent to the agent within whose agency the lands on account of which such payment has been made, are situated.

Settlement, how made, within what limits, and the conditions thereof.

**Sec. 3.** Settlement on the lot or lots included in any sale, is one of the conditions thereof, and shall consist of actual occupation and improvement of the land, which must commence within six months from the date of sale and be continuous for a period of three years; within which time there shall be cleared and fenced at least five acres in every one hundred acres, or in that proportion; also a dwelling house of not less than 18 x 24 feet must be erected on the land included in any sale.

*Regulations for the disposal of Indian Lands.*

## Chap. 29.

Sec. 4. No timber, saw-logs, staves, lathwood, shingle bolts, cordwood, or any other description of wood, may be cut for sale until the patent for the lot shall have issued, except that the same may be cut under license, issued under existing regulations governing the issue of such licenses, to the party residing thereon by the Indian Lands Agent, covering any trees cut on the location in actually clearing the land for cultivation, other than pine or spruce, which are reserved from the operation of the sale of the land, and may be otherwise disposed of by the Department, and may be cut and removed by the purchaser of said pine or spruce up to the date on which the patent covering the land shall issue.

Timber, &c., not to be cut till license issued.

Sec. 5. Any violations of the above conditions of sale will render the land in respect to which the same has taken place, as well as all moneys paid on account thereof, forfeitable, by order of the Superintendent General of Indian Affairs.

Forfeiture in case of violation.

Sec. 6. The above regulations as to occupation and improvement shall not apply to any lands in respect to which the Superintendent General of Indian Affairs has received a report sworn to by a competent, reliable and disinterested person, appointed by the Superintendent General of Indian Affairs to examine such lands, that the same are in whole or for the most part unfit for cultivation. In the case of such lands the Superintendent General of Indian Affairs may dispose of the same, or of the timber or other valuables thereon or therein, to the best possible advantage in the interest of the Indians, without reference to occupation or improvement.

Lands unfit for cultivation, how dealt with.

O. C. Oct. 26, 1887.

## PINE AND SPRUCE TIMBER.

Sec. 7. Notwithstanding anything to the contrary in the Timber and Land Regulations of the Department, the Superintendent General of Indian Affairs is authorized to sell to any *bona fide* actual settler on a wood lot or lots being the purchaser of the same, the pine and spruce timber thereon, on such terms as may be arranged upon between the purchaser of the said lot or lots and the Superintendent General of Indian Affairs, always provided that the timber has not been previously disposed of by the Department of Indian Affairs.

Terms to *bona fide* settlers.

O. C. May 8, 1888.

## PINE AND SPRUCE TREES IN TIMBER LICENSES.

Sec. 8. All pine trees and all spruce trees being or growing upon any Indian land hereafter sold, and at the time of such

Special regulations

## Chap. 29.

*Regulations for the disposal of Indian Lands.*

Reservations  
in case of pine  
and spruce  
trees.

sale, or previously, included in any timber license, shall be considered as reserved from such sale; and such land shall be subject to any timber license covering the same which may be in force at the time of such sale, or may be granted within three years from the date of such sale; and all pine trees of larger growth than nine inches diameter at the butt may be cut and removed from such land under a timber license lawfully in force; but the purchaser of the land, or those claiming under the purchaser, may cut and use such trees as may be necessary for the purposes of building, fencing and fuel on the land so purchased; and may also cut and dispose of, (but the latter only under a settler's license, duly obtained from the local Indian Superintendent or Agent) all trees required to be removed in actually clearing the land for cultivation; but no pine or spruce trees except for necessary building, fencing and fuel, as aforesaid, shall be cut beyond the limit of such actual clearing before the issue of the patent for such land; and pine trees and spruce trees so cut and disposed of, except for said necessary building, fencing and fuel, as aforesaid, shall be subject to the payment of regular dues, and one hundred per cent. added thereto for trespass fine.

All trees on the land when the patent issues are to become the property of the patentee.

O. C. Nov. 12, 1877; Oct. 26, 1887.

REGULATIONS RELATING TO ACTUAL SETTLERS ON INDIAN LANDS.

Five acres to  
be cleared.

Sec. 9. (a.) Purchasers of Indian land are required to clear five instead of fifteen acres; no license fee to be charged for the said five acres or dues to be charged upon the timber removed therefrom (pine and spruce being reserved), but each purchaser before receiving a license to cut and remove the timber from the said five acres, shall be required to declare by written declaration at the time of sale that he intends becoming an actual settler on the land, and to obtain from the agent a license to cut on the five acres.

Settler's li-  
cense; when  
granted.

(b.) Upon it being established to the satisfaction of the Indian agent by affidavit or statutory declaration of two reliable disinterested parties that the purchaser has cleared on the land purchased ready for cultivation and fenced at least five acres, and that he has built thereon a habitable dwelling house of not less than 18 x 24 feet, and that he resides and that they believe he intends to continue to reside on the said land, the agent may grant him a settler's license covering the land included in the sale to him, which must exceed the area stated in Section 1 of the "Regulations for the disposal

*Regulations for the disposal of Indian Lands.*

Chap. 29.

of Indian Lands," namely, 400 acres or 640 acres as the case may be. [See *ante*, page 166.]

(c.) Said license shall be issued for one year only on payment of a fee of four dollars (\$4), which may be renewed yearly on payment of a fee of one dollar (\$1), provided there has been no violation of the terms of the said license. Fee for license.

(d.) Dues shall be paid on timber cut under said license in accordance with the following tariff, which dues or such portion thereof as may be necessary may be applied on behalf of the purchaser towards payment of the land, and any balance in excess of what is required shall be placed at the credit of Indian funds :— Dues on timber cut under license.

1. Oak and black walnut and basswood, square timber, per M. cubic feet.....	\$30 00
2. Oak and black walnut and basswood, saw-logs, per M. feet board measure.....	4 00
3. Tamarac, elm, beech, ash, maple, hickory and butternut, per M. cubic feet.....	16 66
4. For the <i>same</i> , as saw-logs, per M. feet board measure.....	2 00
5. Cedar, birch, basswood and boom timber, per M. cubic feet.....	15 00
6. For the <i>same</i> , as saw-logs, per M. feet board measure.....	1 00
7. Hemlock, per M. cubic feet, including bark.....	5 00
8. Hemlock, per M. feet, board measure.....	0 60
9. Hemlock bark, per cord.....	0 40
10. Pipe staves, per M. standard.....	15 00
11. West India do do .....	5 00
12. Railway ties, tamarac, or cedar, per 100, of 12 inches and under at the butt.....	2 00
13. Telegraph poles, per 100, up to 30 feet long....	5 00
14. Over and above that length the rate to be increased in proportion to the length.	
15. Boom timber, per M. cubic feet.....	6 00
16. Boom timber, per M. feet board measure.....	0 40
17. Cedar pickets, per 100.....	1 00
18. Tamarac knees, lineal measurement, per M. feet.....	15 00
19. Shingle bolts, per cord.....	0 40
20. Shingle bolts, in advantageous localities.....	0 50
21. Cordwood, hard, per cord .....	0 15
22. Cordwood, hard, do in advantageous localities .....	0 20
23. Cordwood, soft, per cord.....	0 10
24. Cordwood, soft, do in advantageous localities .....	0 12

O. C. June 7, 1888.

## CHAPTER 30.

### SALE OF TIMBER ON INDIAN LANDS IN ONTARIO AND QUEBEC.

Government House, Ottawa,

The 15th day of September, 1888.

On the recommendation of the Superintendent General of Indian Affairs and under the provisions of Chapter 43 of the Revised Statutes of Canada, intituled "The Indian Act,"

His Excellency in Council has been pleased to make, and does hereby make the following regulations for the sale of timber on Indian lands in the provinces of Ontario and Quebec:—

Limit lines to  
be properly  
surveyed.

**Section 1.** The Superintendent General of Indian Affairs may, at his discretion, cause the limit lines of any timber berths under license, which have not been already surveyed, or when the lines of survey have been obliterated by fire or from other cause, to be properly surveyed and run, the costs of such survey to be paid by the holder of the license; and where two or more licensees are interested in the survey, the Superintendent General of Indian Affairs shall determine what portion of the costs of the survey shall be paid by each, and such costs of survey shall be a charge upon the timber berth, to be paid with the ground rent before renewal of the license.

Timber berths  
to be sur-  
veyed.

**Sec. 2.** The Superintendent General of Indian Affairs before granting any licenses for new timber berths in unsurveyed Indian reserves or lands, shall cause such berths to be surveyed, and the Superintendent General of Indian Affairs may cause any reserve or other Indian lands to be subdivided into as many timber berths as he may think proper.

Berths and  
limits to be  
offered for  
sale.

**Sec. 3.** The berths or limits when surveyed and set off, and all new berths or limits in surveyed territory, shall be explored and valued, and then offered for sale by public auction at the upset price fixed by such valuation, at such time and place, and on such conditions, and by such officer, as the Superintendent General of Indian Affairs shall direct, by public notice for that purpose, and shall be sold to the highest bidder for cash at the time of sale.

**Sec. 4.** All forfeited timber berths may be offered for sale by public auction, and such sale shall be at such upset price,



*Sale of timber on Indian lands in Ontario and Quebec.*

## Chap. 30.

and at such time and place as the Superintendent General of Indian Affairs may fix and appoint by public notice, and shall be awarded to the highest bidder making payment at the time of sale; but should the said timber berth not be then sold, the same may be granted to any applicant willing to pay the said upset price and ground rent, or, on such other terms as the Superintendent General of Indian Affairs may direct.

Sale of forfeited timber berths by auction.

Sec. 5. License-holders who shall have complied with all existing regulations, shall be entitled to have their licenses renewed on application to the Superintendent General of Indian Affairs.

Renewal of licenses.

Sec. 6. The Superintendent General of Indian Affairs shall keep a register of all licenses granted or renewed, and of all transfers of such licenses, and a copy of such register, with a plan of the licensed limits, shall be kept by the Indian agent, or Indian land agent of the locality, and shall be open to public inspection.

Register and plan of licenses and limits.

Sec. 7. All transfers of timber berths shall be made in writing, but shall be subject to the approval of the Superintendent General of Indian Affairs, to whom they shall be transmitted for approval or rejection, and they shall be valid only from the time of such approval to be expressed in writing. In all cases of transfer of limits or timber berths, they will be subject to the payment of two dollars per square mile for each limit or berth, and in proportion if only a part is transferred, or if the license holder takes in one or more partners with him.

Transfers, how to be made.

Sec. 8. Timber berths are to be described in new licenses as "not to interfere with prior licenses existing or to be renewed in virtue of regulations." When the description of any berth or boundary, as given by any license, clashes with the description of any other licensed berth or territory, the license of more recent origin, (tracing back only to the time when such license or any previous license, of which it is a renewal, was first granted), shall give way, and the Superintendent General of Indian Affairs may amend or cancel such license wholly or in part, and substitute another in place thereof, so as to correct the description of the berth or limit intended to be licensed; and in all cases where any license has issued in error or mistake, or is found to be inconsistent with any other license, or inconsistent or incompatible with the regulations under which it was granted, the Superintendent General of Indian Affairs may cause it to be cancelled, or amended; or he may refer all matters in dispute with

Timber berths, how to be described.

Cancellation of licenses.

Matters in dispute.

---

**Chap. 30.**      *Sale of timber on Indian lands in Ontario and Quebec.*

---

Reference to arbitration.

reference to the boundaries and position of timber limits to arbitration, and each of the contending parties may choose one arbitrator, and the Superintendent General of Indian Affairs may appoint an arbitrator and name a day on or before which the award of such arbitrators, or a majority of them, shall be made and delivered to the parties; and such award made by the said arbitrators, or any two of them, shall be binding on the parties interested.

License suspended.

**Sec. 9.** Timber cut on limits for which license has been suspended or held in abeyance, shall be considered as having been cut without authority and treated accordingly.

Purchasers of Indian lands, who have not completed conditions of sale.

**Sec. 10.** Purchasers of Indian lands, who have not completed all the conditions of sale, shall not, unless under settler's license, or for clearing, fencing or building purposes on the said land, be permitted to cut timber or logs thereon, or to dispose of it to others. Persons found doing so shall be subject to the penalties established by law, for cutting timber on Indian lands without authority. On all lands sold on or after the issue of a license, the licensee may, in virtue of said license, not cut any description of timber excepting merchantable pine and spruce, which he may continue to cut until the purchaser of the land shall have fulfilled all conditions of sale entitling him to a patent for the said land, when the right of the licensee to cut pine or spruce thereon shall cease; but it will rest with the purchaser to notify the licensee, and, if required to do so, to furnish sufficient proof to him that he has fulfilled such condition of sale.

Expiry and renewal of licenses.

**Sec. 11.** All timber licenses are to expire on the 30th of April next after the date thereof, and all renewals are to be applied for before the 1st of July following the expiration of the last preceding license; in default whereof the berth or berths shall be treated as *de facto* forfeited.

Renewal of license; when not granted.

**Sec. 12.** No renewal of any license shall be granted unless the limit covered thereby has been properly worked during the preceding season, or sufficient reason be given under oath, and the same be satisfactory to the Superintendent General of Indian Affairs, for the non-working of the limit, and unless or until the ground rent and all costs of survey, and all dues to the Crown on timber, saw-logs or other lumber cut under and by virtue of any license, other than the last preceding, shall have been first paid.

Ground rent for timber berths.

**Sec. 13.** All timber berths or limits shall be subject to an annual ground rent of \$3 per square mile, payable in

*Sale of timber on Indian lands in Ontario and Quebec.* Chap. 30.

advance, before the issuing of any original license or renewal; and, in computing the ground rent, no license shall be charged at less than eight miles of area.

Sec. 14. All timber, saw-logs, wood, or other lumber, cut under any license now in force, or under any license which may be hereafter granted, shall be subject to the following Crown dues, that is to say: Crown dues on timber, &c.

TARIFF

*Of dues chargeable on Indian timber cut under license.*

1. Oak and black walnut, square timber, per M. cubic feet .....	\$30 00
2. Oak and black walnut, saw-logs, per M. feet, board measure.....	4 00
3. Tamarac, elm, beech, ash, maple and hickory, square timber, per M. cubic feet.....	16 66
4. Tamarac, elm, beech, ash, maple and hickory, saw-logs, per M. feet, board measure.. .....	2 00
5. Red and white pine, cedar, birch, basswood and boom timber, per M. cubic feet.....	15 00
6. Red and white pine, cedar, birch, basswood, saw-logs, per M. feet, board measure.....	1 00
7. Hemlock, spruce, or other wood, per M. cubic feet.....	10 00
8. Hemlock, spruce, or other wood, being saw-logs, per M. feet, board measure.....	0 80
9. Pipe staves, per 1,000 standard.....	15 00
10. West India staves, per 1,000 standard.....	5 00
11. Railway ties—tamarac, cedar or pine, per 100.	2 00
12. Telegraph poles, per 100.....	8 00
13. Cedar pickets, per 100 (over 8 inches in diameter) .....	2 00
14. Cedar pickets, per 100 (8 inches and under)...	1 00
15. Tamarac knees, lineal measure, per M feet....	12 00
16. Shingle bolts, per cord.....	0 60
17. Shingle bolts, per cord in advantageous localities .....	0 75
18. Cordwood, hard, per cord.....	0 30
19. Cordwood, hard, per cord in advantageous localities.....	0 40
20. Cordwood, soft, per cord.....	0 20
21. Cordwood, soft, per cord in advantageous localities.....	0 25
22. Hop poles, per 100.....	0 50
23. Hoop poles, hickory or ash, per 100.....	0 25
24. Hoop poles, soft maple, per 100.....	0 12½
25. Burnt cedar and tops of cedar trees which cannot be used for railway ties, per cord..	0 40

---

 Chap. 30. *Sale of timber on Indian lands in Ontario and Quebec.*

---

Maple and  
swamp elm.

Dues on maple and swamp elm, cut under license on the Saugeen Peninsula, have been reduced to \$1 per M feet board measure, and \$15 per M feet cubic measure.

Duties, how  
estimated.

Sec. 15. The duties on timber shall be charged upon the quantities shown by the specification of measurement furnished under oath by the licensee or his foreman to the Indian agent for the locality, or to the Superintendent General of Indian Affairs, or by other reliable measurement; but where such actual measurement can not be obtained, each stick of white pine timber shall be estimated as containing 70 cubic feet, red pine as containing 38 cubic feet, oak 50 feet, and elm 45 feet, and all other wood as containing 34 cubic feet.

Licenses or  
occupants to  
furnish proof,  
under oath,  
as to locality,  
number of  
pieces, and  
description,  
names of  
settlers, and  
other particu-  
lars.

Sec. 16. All licensees or occupants of timber berths shall furnish through themselves, their agents, cullers and foremen, to such agent or agents as the Superintendent General of Indian Affairs may appoint for that purpose, and at such time and place as such agent or agents may require, satisfactory proof upon oath as to the exact locality where all the timber, saw-logs and other lumber in his or their possession were cut, giving the number of pieces and description of timber, saw-logs and other lumber, including culls, cut by themselves and others to their knowledge upon each of the timber berths held or occupied by him or them respectively, designating what quantity, if any, had been cut on settlers' lands, giving the names of such settlers, the name of the township, and the number of each lot and concession, exhibiting at the same time for the inspection of such agent or agents, the books of count and measurement of such timber, saw-logs and other lumber under his or their control respectively; and shall moreover furnish such agent or agents all required information and facilities to enable him or them to arrive at a satisfactory determination as to the quantity and description of timber, saw-logs and other lumber made by him or them, or held in his or their possession respectively, on which Government dues are chargeable; and in the event of such agent or agents deeming it expedient to cause such timber, saw-logs and other lumber to be counted or measured, the said licensee or occupier of such timber berth, and his or their agents, cullers and foremen, shall aid and assist in such count or measurement, but should such licensee or occupier, or his or their agents, fail to comply with these conditions, such licensee shall forfeit all right to a renewal of his license, and the berth and limit shall become vacant. And to enable persons who sell their timber under settler's license to obtain their refund of dues, and timber cut on patented lands to pass

*Sale of timber on Indian lands in Ontario and Quebec.*

## Chap. 30.

duty free, it will be necessary for the parties interested to prove, on oath taken before such agent or agents, and to his or their satisfaction, the number of pieces and description of timber and saw-logs cut on each lot respectively. And in the event of such proof being deemed unsatisfactory, the said agent or agents may determine the same by causing a strict count of the stumps to be made, and then certifying according to such count.

Sec. 17. The Superintendent General of Indian Affairs, or any authorized agent, shall at all times have free access to and be permitted to examine the books and memoranda kept by any licensee, showing the quantity of lumber in board measure sawn by him from logs cut on his timber berth or berths, and failing to produce such books and memoranda when required so to do, will subject such licensee to a forfeiture of his right to a renewal of his license.

Free access to books, &c., of licensee.

Sec. 18. When any license-holder is in default for, or has evaded the payment of dues to the Crown on any part of his timber or saw-logs, such dues may be levied on any other timber or saw-logs belonging to such defaulter, cut under license, together with the dues thereon.

Dues, how levied in case of default.

Sec. 19. Before moving any raft or parcel of timber, lumber or saw-logs from the Indian agency in which it has been cut, the owner or person in charge thereof shall report the same to the Indian agent for the locality, making, if required, declaration upon oath, as to where the said timber was cut, the number of pieces and description of each kind of wood contained in such raft or parcel of timber, and the number of cribs, stating at the same time the number and description of pieces cut on private lands, also on lands under settler's license, giving the names of the owners or licensees of such land, with the name of the townships and number of each lot and concession; and should such Indian agent not be satisfied with the correctness of such report, he shall cause a strict count to be made of the timber in such raft; and on being satisfied of the correctness of such report or count, the Indian agent may grant a clearance in due form, for such raft, stating the number of pieces and description of timber contained therein, distinguishing the timber cut on private lands under settler's license, from that cut on Indian lands or reserve.

Report required before moving any raft or parcel of timber. What to contain. Clearance to be granted on receipt thereof by Indian agent.

Sec. 20. The owner or holder of any such raft or parcel of timber shall, within twenty-four hours after the same shall have arrived at its destination at Quebec, Sorel,

Report of arrival of such raft.

---

**Chap. 30.**      *Sale of timber on Indian lands in Ontario and Quebec.*

---

Montreal, or other port of sale or shipment, report the arrival of such raft to the collector of crown timber dues, or if at Sorel or Montreal, to the deputy supervisor of cullers; and should the said raft be found by the specification of measurement to contain a greater number of pieces of timber than is noted in the clearance, the surplus number of pieces, if not satisfactorily explained, shall be held as having been cut on Indian lands without authority, and subject to payment of dues accordingly.

Raft found to contain more pieces than is noted in clearance.

Forfeiture in case of violation.

**Sec. 21.** Parties omitting to obtain their clearance at such agency, or omitting to report the arrival of such raft at its destination as above mentioned, may be refused further license, and may be subject to forfeiture of the timber for evasion of regulations, as provided in Chapter 43 of the Revised Statutes of Canada.

Refusing payment of timber dues, taking forcible possession.

**Sec. 22.** Persons evading or refusing the payment of timber dues, or the final settlement of bonds or promissory notes for payment of such dues, or in default with the Indian Department or agent; also, persons taking forcible possession of disputed ground before obtaining decision in their favor, and persons refusing to comply with the decision of arbitrators as provided by the 8th Section of these regulations, or with the regulations established by Order in Council, or who forcibly interrupt surveyors in the discharge of their duty, shall be refused further licenses, and their berths shall be forfeited at the expiration of the then existing license.

Timber dues subject to interest.

**Sec. 23.** Dues of all kinds on timber cut under license, remaining unpaid on the 30th November following the season in which it was cut, shall be subject to interest from that date, but without prejudice to the power of the Crown to enforce payment of such outstanding dues at any time the Superintendent General of Indian Affairs may think proper.

Purchasers who have not completed conditions.

**Sec. 24.** Purchasers of Indian lands who have not completed all conditions of sales, and have not obtained their patents for such lands, cutting timber without license (except for clearing, building, or fencing thereon) or others doing so by their permission, shall be subjected to the penalties established by law for cutting timber without authority.

Security to be given before issue of license.

**Sec. 25.** Before the issue of any timber license, the licensee or licensees thereof shall furnish security by a bond of himself or themselves, and two responsible sureties, for

*Sale of timber on Indian lands in Ontario and Quebec.*

Chap. 30.

such amounts as the Superintendent General of Indian Affairs may consider sufficient to ensure the proper working of the limit, the due fulfilment by him or them of the conditions of the license, and the due observance of all the regulations of the Department in respect to the timber to be cut. The giving of such security shall not, however, in any way prejudice the right of the Superintendent General of Indian Affairs, or his agent, to levy upon any timber cut or owned by the holder or holders of the license, or to cancel the said license should there appear to him to be sufficient cause for so doing.

Sec. 26. Licenses are to be granted on the following form, in triplicate, and the description of each berth is to be written on the back thereof, and is to be dated and signed by the Deputy Superintendent General of Indian Affairs, as well as the license itself, the duplicate to be kept of record by the local Indian agent.

Licenses to be  
granted in  
triplicate.

## FORM OF LICENSE.

Sec. 27. *License to Cut Timber on Indian Lands.*

(Royal Arms)

By authority of the 43rd Chapter of the Revised Statutes of Canada and amendments thereto, and for and in consideration of the payments made, and to be made to the credit of Indian funds, I do hereby give unto

Form of  
license.

and unto agents  
and workmen, full power and license to cut

upon the location described upon the back hereof, and to hold and occupy the said location to the exclusion of all others, except as hereinafter mentioned:—from

, 18 , to thirtieth day of April, 18 , and no longer; with the right of conveying away the said timber, through any ungranted or waste Indian lands.

And by virtue of this license the said licensee has right by the said statute, to all timber cut by others in trespass on the ground hereby assigned, with full power to seize and recover the same anywhere within the Dominion of Canada.

But this license is subject to the following conditions, viz.:—

That the dues to which the timber cut under its authority are liable, shall be paid as follows, namely:—

That all lots sold prior, and all lots sold subsequently, to the date hereof, and which have been settled upon and are being cleared for cultivation, shall be exempt from the operation of this license, excepting in so far as pine and

spruce merchantable timber are concerned, which this license will continue to control until all conditions of sale have been fulfilled.

That any person or persons may under authority of the Superintendent General of Indian Affairs, at all times, make and use roads upon and travel over the ground hereby licensed.

That nothing herein shall prevent any person or persons having authority from the Superintendent General of Indian Affairs to do so, from taking standing timber of any kind to be used for the making of roads and bridges, or for public works.

And that persons settling under lawful authority or title within the location hereby licensed, shall not in any way be interrupted in clearing and cultivating by the said licensee, or any one acting for \_\_\_\_\_ or by \_\_\_\_\_ permission.

And further, upon condition that the said licensee or \_\_\_\_\_ representatives shall comply with all regulations that are or may be established by Order in Council, and shall submit all the timber cut under this license to be counted or measured, and shall settle for the duties chargeable thereon when required by me or any officer thereunto authorized, otherwise the said timber will be forfeited to the Crown, and the said licensee be subject to such other penalty or penalties as provided by law.

Given under my hand at \_\_\_\_\_, this \_\_\_\_\_ day of \_\_\_\_\_, in the year of Our Lord one thousand eight hundred and \_\_\_\_\_

*Deputy of the Superintendent  
General of Indian Affairs.*

Amount payable on giving this license	}	Bonus.....	\$
		Ground rent...	\$
		License fee.....	\$

[The above named licensee shall be bound before or when paying the ground rent and renewal fee—if the license is renewed—to declare on oath whether

\_\_\_\_\_ still the *bona fide* proprietor of the limit hereby licensed, or whether \_\_\_\_\_ sold or transferred it, or any part of it, or for whom \_\_\_\_\_ hold it.]

Statement by  
Licensee.

☞ We have read and we comprehend the nature of the obligations contained in this license, and we bind ourselves jointly and severally, and each of our heirs, executors, curators, and administrators, to pay all duties that may become due and payable to Her Majesty, her heirs or suc-



*Sale of timber lands in Ontario and Quebec.*

Chap. 30.

cessors, on any timber cut or acquired by virtue of this license, in the event of the above named licensee failing or refusing to pay the same, or to give satisfactory bonds for payment thereof.

.....  
 .....  
 Kinds and descriptions of timber to be cut, and the rate of dues to be paid under authority of this license ;

\* \* \* \* \*

The timber limits comprehended by the within license consist of the following :—

\* \* \* \* \*

OFFENCES AND TRESPASSES.

Sec. 28. All persons cutting timber on Indian lands or reserves, without authority of license, will be punished as the law provides. Cutting without license.

Persons hindering any officer or agent of the Department of Indian Affairs in the discharge of his duty in seizing timber illegally cut, or taking away, or causing to be taken away, any timber seized under the Act, Chapter 43, Revised Statutes, Canada, are guilty of felony. Hindering officer or agent, a felony.

Parties cutting timber on Indian lands purchased by them on pretence of settlement, but really for the purpose of cutting the timber, are trespassers as above. Cutting on pretence.

Railway companies, contractors and others, cutting without the authority of the Superintendent General of Indian Affairs timber for railway purposes on Indian lands and on lands sold but not yet patented, are also trespassers and subject to the same penalties. Railway companies, &c.

Sec. 29. From and after the date of the passing of the present regulations, in cases of timber which although cut in trespass was so cut through error in good faith on Indian lands, by licensees or other parties, it shall be lawful for the Superintendent General of Indian Affairs to exact in settlement of such wood goods a penalty equivalent to double, treble or quadruple the ordinary dues as established by tariff above, according to circumstances, besides costs of seizure and other expenses connected with all investigations into such trespasses. Penalty for cutting through error.

Sec. 30. It shall be no longer permitted to cut, on Indian lands, pine trees measuring less than nine inches in diameter at the stump. Pine trees.

TRANSFERS.

Sec. 31. All limit owners are to notify the Superintendent General of Indian Affairs of any transfer which they Limit owners to give notice.

## Chap. 30.

*Sale of timber lands in Ontario and Quebec.*

may have effected, as soon as any transaction of the kind may have taken place; and should they fail to give due notification to the Superintendent General of Indian Affairs, he may rule the forfeiture of such license or licenses comprising the limit or limits so transferred.

**Limit holders may pledge limits.**      **Sec. 32.** Limit holders, in order to enable them to obtain advances necessary for their operations, shall have a right to pledge their limits as security without a bonus becoming payable. Such pledge, in order to effect the limit against the debtor, shall require to be noted on the back of the license by an authorized officer of the Department of Indian Affairs. But if the party giving such pledge should fail to perform his obligations towards his creditors, the latter, on establishing the fact to the satisfaction of the Superintendent General of Indian Affairs, may obtain the next renewal in his or their own name, subject to payment of the bonus, the transfer being then deemed complete.

**Limit, how effected by pledge.**

**Party giving pledge failing to perform his obligations.**

**Transfers of berths, how made.**

**Sec. 33.** Transfers of timber berths are to be in writing, and if not found objectionable by the Department of Indian Affairs, are to be valid from the date on which they may be deposited in the hands of the latter; but no transfer is to be accepted while the party transferring is in default for non-payment of dues on timber to the Crown.

## SURVEYS.

**Boundaries, how established.**

**Sec. 34.** The Department of Indian Affairs shall, at the joint written request of conterminous license holders, issue instructions stating how the boundaries of such limits should be run to be in conformity with existing licenses. The surveys shall be performed at the expense of the parties requiring them, who must cause copies of the plans and field notes of the surveys to be delivered to the said Department subject to approval, to be paid for and kept of record by the Department.

Boundaries so established at the joint request of the parties interested shall be fixed and permanent, and shall in no case be altered.

**Refusal of limit holder to join his neighbor to have boundaries defined.**

**Sec. 35.** If a limit holder refuses to join his neighbor to have the boundaries defined, the party wishing to have the survey made, shall be entitled to have it performed at his own expense, under instructions which shall be furnished to him for that purpose, as provided in the foregoing section.

**On completion of survey, notice to be given.**

On the completion of the survey, notice of the same shall be given in writing to the adverse party at his residence or place of business. And if within one year after such noti-

fication, the adverse party shall have made no opposition to the same in the manner hereinafter prescribed, or if, having done so, such opposition has not been maintained, the boundary so surveyed shall be fixed permanently and irrevocably. But if within the space of one year from the date of such notice, the adverse party shows that he has sufficient reasons to doubt the exactness of such survey, and deposits in the hands of the agent of the Department of Indian Affairs, such sum of money as that Department may deem sufficient to cover all the expenses of a new survey, the Superintendent General of Indian Affairs shall name a surveyor to establish finally the boundary in dispute, and this second survey shall be binding upon the interested parties. All the expenses shall be borne by the applicant if his objections be not maintained. If, on the contrary, they be confirmed and the first survey be declared erroneous, the expenses shall be borne share and share alike by both parties.

Expenses, how  
to be borne.

Sec. 36. All limit lines or boundaries already established in virtue of official instructions, are hereby declared valid and permanent, if a report or field notes, or at least a plan describing such boundaries, have been filed of record in the Department of Indian Affairs, and if, within the space of one year from the date such documents or plan were filed, their correctness be not disputed. If, on the contrary, within this delay one of the interested parties objects to them, a final survey shall be made as prescribed in the thirty-fifth section of these regulations, unless, however, the interested parties agree to have a final survey effected in virtue of the thirty-fourth section.

Limits established; when declared valid and permanent.

O. C. Jan. 12, 1888.

## CHAPTER 31.

### INDIAN LANDS, MINING REGULATIONS.

Government House, Ottawa,

The 15th day of September, 1888.

On the recommendation of the Superintendent General of Indian Affairs, and under the provisions of Chapter 43 of the Revised Statutes of Canada, intituled "The Indian Act,"

His Excellency in Council has been pleased to make and does hereby make the following regulations to govern the disposal of Indian lands containing minerals other than coal :—

#### MINING REGULATIONS TO GOVERN THE DISPOSAL OF MINERAL LANDS OTHER THAN COAL LANDS.

Lands containing gold, silver, cinnabar, &c.

**Section 1.** These regulations shall be applicable to all Indian lands containing gold, silver, cinnabar, lead, tin, copper, petroleum, iron or other mineral deposit of economic value, with the exception of coal.

Vacant lands may be explored with a view to obtaining mining location.

**Sec. 2.** Any person may explore vacant Indian lands that have been surrendered by the Indians and not appropriated or reserved by the Department of Indian Affairs for other purposes, or Indian reserve lands, provided the approval of the Superintendent General of Indian Affairs shall have been previously obtained, and may search therein, either by surface or subterranean prospecting, for mineral deposits, with a view to obtaining under these regulations a mining location for the same, but no mining location or mining claim shall be granted until the discovery of the vein, lode or deposit of mineral or metal within the limits of the location or claim.

#### I.—QUARTZ MINING.

Area and boundaries of mining location in Algoma and elsewhere.

**Sec. 3.** A location for mining, except for iron, on veins, lodes, or ledges of quartz or other rock in place, shall not exceed forty acres in area; except in the district of Algoma, where the area of a mining location shall not exceed one

*Indian Lands—Mining Regulations.*

## Chap. 31.

hundred and sixty acres. Its surface boundaries shall be straight due north and south and east and west lines not more than four in number. Its length shall not be more than three times its breadth. Its boundaries beneath the surface shall be the vertical planes in which its surface boundaries lie.

Sec. 4. Any person having discovered a mineral deposit may obtain a mining location therefor, under these regulations, in the following manner:—

(a) He shall mark the location on the ground by placing at each of its four corners a wooden post, not less than 4 inches square, driven not less than 18 inches into the ground, and showing that length above it. If the ground be too rocky to admit of so driving the posts into it, he shall build about each of them, to support it and keep it in place, a cairn or mound of stones, at least 3 feet in diameter at the base, and 18 inches high. On the most north-easterly post he shall mark, legibly with a cutting instrument, or with colored chalk, or with a pencil, his name in full, the date of such marking, and the letters M.L. 1, to indicate that the post is a mining location post No. 1. Proceeding next to the most south-easterly post, he shall mark it with M.L. 2, and with his initials. Next, the most south-westerly post shall be marked M.L. 3, and with his initials; and, lastly, the most north-westerly post with his initials and the letters M.L. 4. Furthermore, on one of the faces of each post, which face shall in the planting thereof be turned towards the post which next follows it in the order in which they are here named and numbered, there shall be marked in figures the number of yards' distance to such next following post. If means of measurement are not available, the distance to be so marked on each of the posts may be that estimated. If the corner of a location falls in a ravine, bed of a stream, or any other situation where the character of the locality may render the planting of a post impossible, the corner may be indicated by the erection at the nearest suitable point of a witness post, which in that case shall contain the same marks as those prescribed in this clause in regard to corner posts, as well as the letters W.P., and an indication of the bearing and distance of the site of the true corner from such witness post.

(In this manner any subsequent prospector informed of these regulations, will, on meeting any one of the posts or mounds, be enabled to follow them all round, from one to another, and avoid encroachment, either in search or in marking out another location in the vicinity for himself).

Discoverer of mineral deposit shall mark the location by placing at each of the four corners a post which shall be marked M. L., and numbered 1, 2, 3, 4, respectively, and initialed.

Subsequent prospector informed.

## Chap. 31.

*Indian Lands—Mining Regulations.*

Within 90 days claimant shall file declaration on oath.

(b.) Having so marked out on the ground the location he desires, the claimant shall within ninety days thereafter file with the local agent, in the Indian office for the district in which the location is situate, a declaration on oath according to Form A in the Schedule to these regulations (which may be sworn to before the said agent, or may have been previously sworn to before a justice of the peace or commissioner), setting forth the circumstances of his discovery, and describing, as nearly as may be, the locality and dimensions of the claim marked out by him as aforesaid; and shall, along with such declaration, pay to the said agent an entry fee of five dollars

\* If land surrendered, agent shall give receipt.

(c.) If the land has been surrendered by the Indians for purposes of sale, the agent shall then give him a receipt, according to Form B in the Schedule to these regulations, for such fee. This receipt shall authorize the claimant, his legal representatives or assigns, to enter into possession of the location applied for, and during the term of one year from its date, to take therefrom and dispose of any mineral deposit contained within its boundaries.

If land within a reserve and unsurrendered, agent shall report to Superintendent General, who may direct matter to be submitted to Indians in Council.

(d.) If the land is within a reserve and unsurrendered, the agent shall report the facts of such discovery and application to the Superintendent General of Indian Affairs, and he shall state at the same time whether the interest of the Indians would be prejudicially affected by the location applied for being sold or otherwise, and should the Superintendent General of Indian Affairs decide that it would be in the interest of the Indians to sell the location, he shall instruct the local agent to submit the question of surrendering the same to be sold for their benefit to the Indians in council for a vote thereon, and should a majority of the Indians entitled to vote decide to surrender the land, a formal surrender in writing shall be taken from them signed by the chief and principal men and duly attested by one of them and the agent in the manner required by law.

Agent shall forward surrender to Superintendent General.

(e.) The agent shall then forward the surrender to the Superintendent General of Indian Affairs, who shall upon receipt of the same submit it to His Excellency the Governor General in Council for acceptance.

Surrender accepted, how dealt with.

(f.) Should the surrender be accepted by the Governor General in Council, the location applied for shall be dealt with in the manner prescribed by these Regulations for the sale of mineral lands.

Limit of time for claimant to purchase.

Sec. 5. At any time before the expiration of one year from the date of his obtaining the agent's receipt as afore-

*Indian Lands—Mining Regulations.*

## Chap. 31.

said, it shall be open to the claimant to purchase the location on filing with the local agent proof that he has expended not less than five hundred dollars in actual mining operations on the same, such proof to consist of his own sworn statement, accompanied and confirmed by the affidavits of two disinterested persons, setting forth in detail the nature of such operations and the amount expended. This section shall not apply to the District of Algoma; except that the right to purchase a location shall be limited to twelve months from the date of obtaining the agent's receipt as provided in sub-section (c.) of Section 4 above.

This section not to apply to Algoma, except, &c.

Sec. 6. The price to be paid for a mining location shall be at the rate of five dollars per acre cash, except in the District of Algoma, where the price shall be at the rate of three dollars per acre.

Price of mining location.

Sec. 7. On making the application to purchase a mining location, and paying the price therefor as hereinbefore provided, the claimant shall also deposit with the agent the sum of fifty dollars, except in the District of Algoma, where he shall deposit with the agent the sum of one hundred dollars, which shall be deemed payment by him to the Department of Indian Affairs for the survey of his location; and upon the receipt of the plans and field-notes, and the approval thereof by the said Department, a patent shall issue to the claimant in the Form D in the Schedule hereto. If, on account of its remoteness or other cause, a mining location cannot, at the time of the deposit of fifty dollars, or in the District of Algoma one hundred dollars, as aforesaid, by the applicant for the purpose, be surveyed by the said Department for that sum, he shall be subject to the alternative of waiting until the employment of a surveyor by the Department on other work in the vicinity of the claim renders it convenient to have the survey made at a cost not exceeding fifty dollars, or in the District of Algoma one hundred dollars, as aforesaid, or of sooner procuring at his own cost its survey by a duly commissioned surveyor of the province, district or territory in which the lands are situated, under instructions from the said Department; in the latter case, on receipt of the plans and field-notes of the survey and approval thereof by the said Department, as hereinbefore provided, the claimant shall be entitled to receive his patent, and to have returned to him the fifty dollars, or in the District of Algoma one hundred dollars, as aforesaid, deposited by him to defray cost of survey.

Claimant shall deposit with agent to defray cost of survey, in Algoma, \$100; elsewhere, \$50; to be returned on receipt of patent.

Sec. 8. Should the claimant, or his legal representatives as aforesaid, fail to prove within one year the expenditure

## Chap. 31.

*Indian Lands—Mining Regulations.*

Should claimant fail to prove expenditure, to pay price in full and deposit, his right shall lapse and revert to the Crown.

prescribed ; or, having proved such expenditure, fail within that time to pay in full, and in cash, to the local agent, the price hereinbefore fixed for such mining location, and also to pay the sum of fifty dollars hereinbefore prescribed for the survey of his location, then any right on the part of the claimant, or of his legal representatives, in the location, or claim on his or their part to acquire it, shall lapse, and the location shall thereupon revert to the Crown and shall be held, along with any immovable improvements thereon, for disposal, under these regulations, to any other person, or as the Superintendent General of Indian Affairs may direct ; provided that the Superintendent General of Indian Affairs may, upon sufficient cause being shown, extend the time within which the claimant may purchase his mining location for the additional term of one year, upon payment by the claimant of a new entry fee and the relinquishment of his original receipt, in exchange for which the Agent shall, when so directed by the said Minister, give him a new receipt in the Form C in the Schedule hereto.

Two or more persons claiming same right

Sec. 9. Where two or more persons lay claim to the same mining location, the right to acquire it shall be in him who can prove he was the first to discover the mineral deposit involved, and to take possession by demarcation, in the manner prescribed in these Regulations, of the location covering it.

Prior discovery alone, not to give right.

Sec. 10. Priority of discovery alone shall not give the right to acquire ; but a person subsequently and independently discovering, who has complied with the other conditions prescribed in these Regulations, shall take precedence of the first discoverer if the latter has failed to comply with the said other conditions : Provided, however, that in any case where it is proved that a claimant has in bad faith used the prior discovery of another, and fraudulently affirms that he made independent discovery and demarcation, he shall, apart from any other legal consequences, have no claim, and shall forfeit the deposit made with his application, and shall be absolutely debarred from obtaining another mining location.

Only one location on same lode.

Sec. 11. Not more than one mining location shall be granted to any individual claimant upon the same lode or vein.

Land used for milling or other purposes ; how patented.

Sec. 12. Where land is used or occupied for milling purposes, reduction works or other purposes incidental to mining operations, either by the proprietor of a mining location or other person, such land may be applied for and



*Indian Lands—Mining Regulations.*

## Chap. 31.

patented, either in connection with, or separate from, a mining location, in the manner hereinbefore provided for the application for, and the patenting of, mining locations, and may be held in addition to any such mining location; but such additional land shall in no case exceed five acres in extent and shall be paid for at the same rate as a mining location.

Sec. 13. The Superintendent General of Indian Affairs may grant a location for the mining of iron not exceeding 160 acres in area: Provided, that should any person making an application purporting to be for the purpose of mining iron thus obtain, whether in good faith or fraudulently, possession of a valuable mineral deposit other than iron, his right in such deposit shall be restricted to the area hereinbefore prescribed for other minerals, and the rest of the location shall thereupon revert to the Crown for such disposition as the Minister may direct.

Location for the mining of iron.

Sec. 14. When there are two or more applicants for any mining location, no one of whom is the original discoverer, or his assignee, the Superintendent General of Indian Affairs, if he sees fit to dispose of the location, shall invite their competitive tenders, or shall put it up to public tender, or auction, as he may deem expedient.

Applicants other than original discoverer, competition, tender, auction.

Sec. 15. An assignment of the right to purchase a mining location shall be endorsed on the back of the receipt or certificate of assignment (Forms B and E, in the Schedule hereto), and the execution thereof shall be attested by two disinterested witnesses; upon the deposit of the receipt or certificate with such assignment executed and attested as herein provided, in the office of the local agent, accompanied by a registration fee of two dollars, the local agent shall give to the assignee a receipt in the Form E in the Schedule hereto, which certificate shall entitle the assignee to all the rights and privileges of the original discoverer in respect of the claim assigned; and the said assignment shall be forwarded to the Superintendent General of Indian Affairs by the local agent at the same time and in like manner as his other returns respecting Indian lands, and shall be registered in the Department of Indian Affairs; and no assignment of the right to purchase a mining location which is not unconditional and in all respects in accordance with the provisions of this clause, and accompanied by the registration fee herein provided for, shall be recognized by the local agent or registered in the Department of Indian Affairs.

Assignment of right to purchase; how made, and regulations in reference to the same.

## Chap. 31.

*Indian Lands—Mining Regulations.*

Application by assignee of right; assignee, when entitled to purchase.

Sec. 16. If application be made under the next preceding section by the assignee of the right to purchase a mining location, and such claim is duly recognized and registered, as hereinbefore provided, such assignee shall, by complying with all the provisions of Sections 5 and 7, become entitled to purchase the location for the price and on the terms prescribed in these Regulations, whether or not his assignor may have previously acquired a mining location under them.

## II. — PLACER MINING.

Quartz-mining regulations, how far applicable.

Sec. 17. The Regulations hereinbefore laid down in respect of quartz mining shall be applicable to placer mining so far as they relate to entries, entry fees, assignments, marking of location, agents' receipts, and generally where they can be applied, save that the boundaries of placer mining claims need not be due north and south and east and west lines, and except as otherwise herein provided.

*Nature and Size of Claims.*

Size of claims

Sec. 18. The size of claims shall be as follows:—

Bar diggings.

(a.) For "bar diggings," a strip of land 100 feet wide at high water mark, and thence extending into the river to its lowest water level.

Dry diggings.

(b.) For "dry diggings," 100 feet square.

Creek and river claims.

(c.) "Creek and river claims," shall be 100 feet long, measured in the direction of the general course of the stream and shall extend in width from base to base of the hill or bench on each side, but when the hills or benches are less than 100 feet apart the claim shall be 100 feet square.

Bench claims.

(d.) "Bench claims," shall be 100 feet square.

Claim on face of hill.

(e.) Every claim on the face of any hill, and fronting on any natural stream or ravine, shall have a frontage of 100 feet, drawn parallel to the main direction thereof, and shall be laid out, as nearly as possible, in the manner prescribed by Section 4 of these Regulations.

Table of areas of claims.

(f.) If any miner or association of miners shall discover a new mine, and such discovery shall be established to the satisfaction of the agent, claims of the following size, in dry, bar, bench, creek, or hill diggings, shall be allowed:—

To one discoverer.....	300 feet in length
To a party of two.....	600 do
do three.....	800 do
do four.....	1,000 do

*Indian Lands—Mining Regulations.*

## Chap. 31.

and to each member of a party beyond four in number, a claim of the ordinary size only.

A new stratum of auriferous earth or gravel, situated in a locality where the claims are abandoned, shall for this purpose be deemed a new mine, although the same locality shall have been previously worked at a different level; and dry diggings discovered in the vicinity of bar diggings shall be deemed a new mine, and *vice versa*.

A new stratum deemed a new mine.

*Rights and Duties of Miners.*

Sec. 19. The forms of application for a grant for placer mining, and the grant of the same, shall be those contained in Forms F and G in the Schedule hereto.

Grants for placer mining.

Sec. 20. The entry of every holder of a grant for placer mining must be renewed, and his receipt relinquished and replaced, every year, the entry fee being paid each time.

Renewal every year.

Sec. 21. No miner shall receive a grant of more than one mining claim in the same locality, but the same miner may hold any number of claims by purchase, and any number of miners may unite to work their claims in common upon such terms as they may arrange, provided such agreement be registered with the local agent.

Only one claim granted in one locality.

Sec. 22. Any miner or association of miners may sell, mortgage, or dispose of his or their claims, provided such disposal be registered with, and a fee of two dollars paid to the local agent, who shall thereupon give the assignee a certificate in Form H. in the Schedule hereto.

Miner may sell or mortgage claim.

Sec. 23. Every miner shall, during the continuance of his grant, have the exclusive right of entry upon his own claim, for the miner-like working thereof, and the construction of a residence thereon, and shall be entitled exclusively to all the proceeds realized therefrom; but he shall have no surface rights therein; and the local agent may grant to the holders of adjacent claims such right of entry thereon as may be absolutely necessary for the working of their claims, upon such terms as may to him seem reasonable.

Exclusive right of entry and to proceeds, but not to surface.

Sec. 24. Every miner shall be entitled to the use of so much of the water naturally flowing through or past his claim, and not already lawfully appropriated, as shall, in the opinion of the local agent, be necessary for the due working thereof; and shall be entitled to drain his own claim free of charge.

Use of water and right to drain.

## Chap. 31.

*Indian Lands—Mining Regulations.*

When claim shall be deemed to be abandoned.

Sec. 25. A claim shall be deemed to be abandoned and open to occupation and entry by any person when the same shall have remained unworked on working days by the grantee thereof for the space of seventy-two hours, unless sickness or other reasonable cause be shown, or unless the grantee is absent on leave.

Claim shall be worked continuously.

Sec. 26. A claim granted under these Regulations shall be continuously and in good faith worked, except as otherwise provided, by the grantee thereof or by some person on his behalf.

Tunnelling under hills.

Sec. 27. In tunnelling under hills, on the frontage of which angles occur, or which may be of an oblong or elliptical form, no party shall be allowed to tunnel from any of the said angles, or from either end of such hills, so as to interfere with parties tunnelling from the main frontage.

Property in tunnels and shafts.

Sec. 28. Tunnels and shafts shall be considered as belonging to the claim for the use of which they are constructed, and as abandoned or forfeited by the abandonment or forfeiture of the claim itself.

Back claims on benches or slopes.

Sec. 29. For the more convenient working of back claims on benches or slopes, the local agent may permit the owners thereof to drive a tunnel through the claims fronting on any creek, ravine or water-course upon such terms as he may deem expedient.

*Leave of absence.*

Supply of water insufficient; leave of absence.

Sec. 30. In cases where water is necessary to the continuance of mining operations and the supply of water is insufficient, the agent shall have power to grant leave of absence to the holder of the grant during such insufficiency but no longer, except by permission of the Superintendent General of Indian Affairs.

Conditions on which leave of absence may be obtained.

Sec. 31. Any miner or association of miners shall be entitled to leave of absence for one year from his or their diggings upon proving to the satisfaction of the agent that he or they have expended on such diggings in cash, labor or machinery an amount not less than five hundred dollars on each of such diggings without any return of gold or other minerals in reasonable quantities from such expenditure.

Time going and coming.

Sec. 32. The time occupied by the locator of a claim in going to and returning from the office of the local agent to

*Indian Lands—Mining Regulations.*

## Chap. 31.

enter his claim, or for other purposes prescribed by these Regulations, shall not be counted against him, but he shall, in such cases, be deemed to be absent on leave.

*Administration.*

Sec. 33. In case of the death of any miner while entered as the holder of any mining claim, the provisions as to abandonment shall not apply either during his last illness or after his decease.

Death of miner; no abandonment

Sec. 34. The local agent shall take possession of the mining property of the deceased, and may cause such mining property to be duly worked, or dispense therewith, at his option, and he shall sell the property by private sale, or after ten days' notice thereof by public auction, upon such terms as he shall deem just, and out of the proceeds pay all costs and charges incurred thereby, and pay the balance, if any, to the legal representatives of the said deceased miner.

Local agent to take possession, &c., of property of deceased.

Sec. 35. The local agent, or any person authorized by him, shall in every case take charge of all the property of a deceased miner until the issue of letters of administration or the probate of his will.

Possession, pending administration.

## III.—BED-ROCK FLUMES.

Sec. 36. It shall be lawful for any local agent, upon the application hereinafter mentioned, to grant to any bed-rock flume company, for any term not exceeding five years, exclusive rights of way through and entry upon any mining ground in his district, for the purpose of constructing, laying and maintaining bed-rock flumes.

Local agent may grant right of way.

Sec. 37. Three or more persons may constitute themselves into a bed-rock flume company, and every application by them for such grant shall state the names of the applicants and the nature and extent of the privileges sought to be acquired. Between the months of June and November, ten clear days notice thereof shall be given, and between the months of November and June one month's notice shall be given, by affixing the same to a post planted in some conspicuous part of the ground or to the face of the rock, and a copy thereof conspicuously upon the inner walls of the Indian office of the district. Prior to such application, the ground included therein shall be marked out in the manner prescribed in sub-section *a* of Section 4 of these Regulations. It shall be competent for any person to protest before the local agent within the times hereinbefore prescribed for the notice of such application, but not afterwards, against

Three or more persons may constitute a bed-rock flume company.

Notices when and how to be given.

Marking out grounds.

## Chap. 31.

*Indian Lands — Mining Regulations.*

Deposit to accompany application.

such application being granted. Every application for a grant shall be accompanied by a deposit of \$100, which shall be returned if the application be refused, but not otherwise.

Grant in writing.

Sec. 38. Every such grant shall be in writing, in the Form I given in the Schedule hereto.

Holders of claims through which line of company's flume runs.

Sec. 39. The holders of claims through which the line of the company's flume is to run may put in a bed-rock flume in their claims to connect with the company's flume, upon giving the company ten days' notice in writing to that effect; but they shall maintain the like grade, and build their flumes as thoroughly, and of as strong materials, as that built by such company.

Amount of flume to be laid.

Sec. 40. Every bed-rock flume company shall lay at least 50 feet of flume during the first year and 100 feet annually thereafter, until completion of the flume.

Miners may tail their sluices, &c

Sec. 41. Any miners lawfully working any claims where a bed-rock flume exists, shall be entitled to tail their sluices, hydraulics and ground sluices into such flume but so as not to obstruct the free working of such flume by rocks, stones, boulders or otherwise.

Sums to be paid to obtain registration.

Sec. 42. Upon a grant being made to any bed-rock flume company, the local agent shall register the same, and the company shall pay for such registration a fee of \$10. They shall also pay, in advance, an annual rent of \$10 for each quarter of a mile of right of way legally held by them.

## IV.—DRAINAGE OF MINES.

Permission to run drain, &c., through occupied mining land.

Sec. 43. The Superintendent General of Indian Affairs may grant to any person, or association of persons, permission to run a drain or tunnel for drainage purposes through any occupied mining land, and may give such persons exclusive rights of way through and entry upon any mining ground for any term not exceeding five years, for the purpose of constructing a drain or drains for the drainage thereof.

Grantee shall compensate owner.

Sec. 44. The grantee shall compensate the owners of lands or holders of claims entered upon by him for any damage they may sustain by the construction of such tunnel or drain, and such compensation, if not agreed upon, shall be settled by the local agent and be paid before such drain or tunnel is constructed.

Property in such tunnel or drain.

Sec. 45. Such tunnel or drain, when constructed, shall be deemed to be the property of the person or persons by whom it shall have been so constructed.

*Indian Lands—Mining Regulations.*

## Chap. 31.

Sec. 46. Every application for a grant shall state the names of the applicants, the nature and extent of the proposed drain or drains, the amount of toll (if any) to be charged, and the privileges sought to be acquired, and shall, save where the drain is intended only for the drainage of the claim of the person constructing the same, be accompanied by a deposit of \$25, which shall be refunded in case the application is refused, but not otherwise. Notice of the application shall be given, and protests may be made, in the same manner as provided in regard to bed-rock flumes.

Application for grant, what to contain.

Deposit and notice.

Sec. 47. The grant of the right of way to construct drains or tunnels, shall be made in the Form J in the Schedule hereto. The grant shall be registered by the grantee in the office of the local agent, to whom he shall at the time pay a registration fee of \$5, or, if the grant gives power to collect tolls, a fee of \$10. An annual rent of \$10 shall be paid, in advance by the said grantee for each quarter of a mile of right of way legally held by him, save where the drain shall be for the purpose of draining only the claim of the person constructing the same.

Grant of right of way to construct drains. Form, registration and annual rent.

## V.—DITCHES.

Sec. 48. The Superintendent General of Indian Affairs may, upon the application hereinafter mentioned, grant to any person, or association of persons, for any term not exceeding five years, the right to divert and use the water from any stream or lake, at any particular part thereof, and the rights of way through and entry upon any mining ground, for the purpose of constructing ditches and flumes to convey such water; provided always, that every such grant shall be deemed as appurtenant to the mining claim in respect of which it has been obtained, and, whenever the claim shall have been worked out or abandoned, or whenever the occasion for the use of such water upon the claim shall have permanently ceased, the grant shall be at an end and determined. The grantee shall record the said grant with the local agent during each year of the continuance of the same, and whilst it shall be in operation.

Right to divert water, and to construct ditches and flumes to convey such water.

Sec. 49. Twenty days' notice of the application shall be given, by affixing the same to a post planted in some conspicuous part of the ground, and a copy thereof conspicuously upon the inner walls of the Indian Office for the district, and any person may protest within such twenty days, and not afterwards, against such application being wholly or partially granted.

Length and mode of giving notice.

## Chap. 31.

*Indian Lands—Mining Regulations.*

Deposit.

Sec. 50. Every application for a grant of water exceeding 200 inches, shall be accompanied by a deposit of \$25, which shall be refunded in case the application is refused, but not otherwise.

What application shall state.

Sec. 51. Every such application shall state the names of the applicants, the name or description of the stream or lake to be diverted, the quantity of water to be taken, the locality for its distribution, and the price (if any) to be charged for the use of such water, and the time necessary for the completion of the ditch. The grant shall be in Form K in the Schedule hereto.

Grant of water privilege subject to certain rights.

Sec. 52. Every grant of a water privilege on unoccupied creeks, shall be subject to the right of such miners as shall, at the time of such grant, be working on the stream above or below the ditch head, and of any other persons lawfully using such water for any purpose whatsoever.

Miner below the ditch head entitled to compensation.

Sec. 53. If, after the grant has been made, any miner or miners locate and *bona fide* work any mining claim below the ditch head, on any stream so diverted, he or they collectively shall be entitled to 40 inches of water if 200 inches be diverted, and 60 inches if 300 inches be diverted, and no more, except upon paying to the owner of the ditch, and all other persons interested therein, compensation equal to the amount of damage sustained by the diversion of such extra quantity of water as may be required; and, in computing such damage, the loss sustained by any claims using water therefrom, and all other reasonable losses, shall be considered.

Conditions respecting grants of water privilege.

Sec. 54. No person shall be entitled to a grant of the water of any stream, for the purpose of selling the water to present or future claim holders, on any part of such stream. The Superintendent General of Indian Affairs may, however, grant such privileges as he may deem just, when such ditch is intended to work bench or hill claims fronting on any such stream, provided that the rights of miners then using the water so applied for, be protected.

Enlargement or alteration of ditch.

Sec. 55. The Superintendent General of Indian Affairs may, on the report of the local agent that such action is desirable, order the enlargement or alteration of any ditch, and fix the compensation (if any) to be paid by parties to be benefited thereby.

Sec. 56. Every owner of a ditch or water privilege shall take all reasonable means for utilizing the water granted to



*Indian Lands—Mining Regulations.*

## Chap. 31.

him; and if he wilfully takes and wastes any unreasonable quantity of water, the Minister may, upon the report of the local agent, if such offence be persisted in, declare all rights to the water forfeited.

Waste of water to involve forfeiture.

Sec. 57. The owner of any ditch or water privilege may distribute the water to such persons, and on such terms, as he may deem advisable, within the limits mentioned in his grant; provided always that such owner shall be bound to supply water to all miners who make application therefor, in a fair proportion, and shall not demand more from one person than from another, except where the difficulty of supply is enhanced.

Distribution of water by owner of ditch, &c.

Sec. 58. Any person desiring to bridge any stream claim, or other place, for any purpose, or to mine under or through any ditch or flume, or to carry water through or over any land already occupied, may, in proper cases, do so with the written sanction of the local agent. In all such cases, the right of the party first in possession is to prevail, so as to enable him to compensation if the same be just.

Bridging stream, &c.

Sec. 59. In measuring water in any ditch or sluice, the following rules shall be observed:—The water taken into a ditch or sluice shall be measured at the ditch or sluice head. No water shall be taken into a ditch or sluice except in a trough placed horizontally at the place at which the water enters it. One inch of water shall mean half the quantity that will pass through an orifice 2 inches high by 1 inch wide, with a constant head of 7 inches above the upper side of the orifice.

Directions for measuring water.

Sec. 60. Whenever it shall be intended, in forming or upholding any ditch, to enter upon and occupy any part of a registered claim, or to dig or loosen any earth or rock, within 4 feet of any ditch not belonging solely to the registered owner of such claim, three days' notice in writing of such intention shall be given before entering or approaching within 4 feet of such other property.

Notice to be given before approaching within 4 feet of ditch.

Sec. 61. Any person engaged in the construction of any road or work may, with the sanction of the Superintendent General of Indian Affairs, cross, divert, or otherwise interfere with any ditch, water privilege, or other mining rights whatsoever, for such period as the Minister shall approve.

Right to cross, divert or interfere with ditch, &c.

Sec. 62. The Minister shall order what compensation for every such damage or interference shall be paid, and when,

Compensation and repairs.

## Chap. 31.

*Indian Lands—Mining Regulations.*

Interference.

and to whom, and whether any and what works damaged or affected by such interference as aforesaid shall be replaced by flumes or otherwise repaired by the person or persons inflicting any such damage.

Culverts for waste water.

Sec. 63. The owners of any ditch, water privilege, or mining right shall, at their own expense; construct, secure and maintain all culverts necessary for the passage of waste and superfluous water flowing through or over any such ditch, water privilege or right.

Owners to construct and repair culverts.

Sec. 64. The owners of any ditch or water privilege shall construct and secure the same in a proper and substantial manner, and maintain the same in good repair to the satisfaction of the local agent, and so that no damage shall occur to any road or work in its vicinity from any part of the works of such ditch, water privilege or right.

Owners to be liable for damages.

Sec. 65. The owners of any ditch, water privilege or right, shall be liable, and shall make good, in such manner as the local agent shall determine, all damages which may be occasioned by or through any parts of the works of such ditch, water privilege or right breaking or being imperfect.

North-West Territories.

Sec. 66. Nothing herein contained shall be construed to limit the right of the Lieutenant Governor of the North-West Territories in Council, or of the proper authority in any Province containing Indian lands, to lay out, from time to time, public roads across, through, along or under any ditch, water privilege or mining right, without compensation.

Public roads.

## VI.—GENERAL PROVISIONS.

*Interpretation.*

Interpretation—

Sec. 67. In these Regulations the following expressions shall have the following meanings respectively, unless inconsistent with the context:—

Minister.

“Minister” shall mean the Superintendent General of Indian Affairs.

Agent.

“Agent” or “local agent” shall mean the Indian agent, Indian superintendent or Indian lands agent, as the case may be, for the district, or other officer appointed by the Government for the particular purpose referred to.

Mineral.

“Mineral” shall include all minerals whatsoever other than coal.

Close season.

“Close season” shall mean the period of the year during which placer mining is generally suspended.

*Indian Lands—Mining Regulations.*

## Chap. 31.

“Miner” shall mean a person holding a mining location Miner.  
or a grant for placer mining.

“Claim” shall mean the personal right of property in a Claim.  
placer mine or diggings during the time for which the grant  
of such mine or diggings is made.

“Bar diggings” shall mean any mine over which a river Bar diggings.  
extends when in its flooded state.

“Dry diggings” shall mean any mine over which a river Dry diggings.  
never extends.

The mines or benches shall be known as “bench dig- Bench dig-  
gings,” and shall, for the purpose of defining the size of gings.  
such claims, be excepted from “dry diggings.”

“Streams and ravines” shall include water-courses Streams and  
whether usually containing water or not, and all rivers, Ravines.  
creeks and gulches.

“Ditch” shall include a flume or race, or other artificial Ditch.  
means for conducting water by its own weight, to be used  
for mining purposes.

“Ditch head” shall mean the point in a natural water- Ditch head.  
course or lake where water is first taken into a ditch.

“Claimant” shall mean a person who has obtained an Claimant.  
entry for a mining location with a view to patent.

“Placer mining” shall mean the working of all forms of Placer min-  
deposits excepting veins of quartz or other rock in place. ing.

“Quartz mining” shall mean the working of veins of Quartz min-  
quartz or other rock in place. ing.

“Location” shall mean the land entered by or patented Location.  
to any person for the purpose of quartz mining.

*Hearing and Decision of Disputes.*

Sec. 68. The local agent shall have power to hear and Disputes, how  
determine all disputes in regard to mining property arising determined.  
within his district, subject to appeal by either of the parties  
to the Deputy Superintendent General of Indian Affairs.

Sec. 69. No particular forms of procedure shall be neces- Procedure,  
sary, but the matter complained of must be properly ex- copy of com-  
pressed in writing, and a copy of the complaint shall be plaint, ser-  
served on the opposite party not less than vice.  
before the hearing of the said complaint. days

Sec. 70. The complaint may, by leave of the local Amendment.  
agent, be amended at any time before or during the pro-  
ceedings.

Sec. 71. The complainant shall, at the time of filing his Deposit on  
complaint, deposit therewith a bond-fee of \$10, which shall filing com-  
be returned to him if the complaint proves to have been plaint.  
well founded, and not otherwise, except for special cause by  
direction of the Superintendent General of Indian affairs.

## Chap. 31.

*Indian Lands—Mining Regulations.*

Appeal to  
Deputy Supt.  
General.

Sec. 72. In the event of the decision of the local agent being made the subject of an appeal to the Deputy Superintendent General of Indian Affairs, the appellant shall, at the time of lodging the appeal, deposit with the local agent a bond-fee of \$10, which shall be returned to the said appellant if his appeal proves to have been well founded, and not otherwise, except for special cause by direction of the Superintendent General of Indian Affairs.

Deposit of  
bond-fee.

Appeal in  
writing; time  
of lodging,  
must state  
what.

Sec. 73. The appeal must be in writing and must be lodged with the local agent not more than three days after he has given his decision, and must state the grounds upon which the said decision is appealed from.

Investigation  
may be order-  
ed on the  
ground, or  
land survey-  
ed.

Sec. 74. If the Deputy Superintendent General of Indian Affairs decides that it is necessary to a proper decision of the matter in issue to have an investigation on the ground; or in cases of disputed boundaries or measurements, to employ a surveyor to measure or survey the land in question, the expense of the inspection or re-measurement or re-survey, as the case may be, shall be borne by the litigants, who shall pay into the hands of the said Deputy Superintendent General of Indian Affairs, in equal parts, such sum as he may think sufficient for the same before it takes place; otherwise it shall not proceed, and the party who refuses to pay such sum shall be adjudged in default. The said Deputy Superintendent General of Indian Affairs shall subsequently decide in what proportion the said expense should be borne by the parties respectively, and the surplusage, if any, shall be returned to the parties as he may order.

Expenses,  
how to be  
borne.

All fees to be  
paid to  
Deputy Supt.  
General.

Sec. 75. All bond-fees adjudged as forfeited by the local agent or Deputy Superintendent General of Indian Affairs and all payments retained under the last preceding Section shall, as soon as decision has been rendered, and all entry and other fees or moneys shall, as soon as they have been received by him, be paid by the said agent or Deputy Superintendent General of Indian Affairs to the credit of the Receiver General in the same manner as other moneys received by him on account of Indian lands.

*Leave of Absence*

Agent may  
declare close  
season.

Sec. 76. The agent in each district shall, under instructions from the Superintendent General of Indian Affairs, declare the close season in his district.

Absence from  
mining loca-  
tion.

Sec. 77. Each holder of a mining location or of a grant for placer mining shall be entitled to be absent from his

*Indian Lands—Mining Regulations.*

## Chap. 31.

mining location or diggings and to suspend work thereon during the close season.

Sec. 78. The local agent shall have power to grant leave of absence to the holder of a mining location or grant for placer mining pending the decision of any dispute in which he is concerned under these Regulations. Leave of absence pending dispute.

Sec. 79. The Superintendent General of Indian Affairs shall, from time to time, as he may think fit, declare the boundaries of mineral and mining districts, and shall cause a description of the same to be published in the *Canada Gazette*. Boundaries, how declared and published.

Sec. 80. The Superintendent General of Indian Affairs may direct mineral and mining locations to be laid out within such districts wherever, from the report of the director of the Geological Survey, or from other information, he has reason to believe there are mineral deposits of economic value, and may sell the same to applicants therefor, who, in his opinion, are able and intend in good faith to work the same; or he may, from time to time, cause the said locations to be sold by public auction or tender. Such sales shall be for cash, and at prices in no case lower than those prescribed for locations sold to original discoverers, and shall otherwise be subject to all the provisions of these Regulations. Mineral and mining locations, where to be laid out; sale by public auction, prices, &c. Sales shall be for cash.

*Royalty.*

Sec. 81. The patent for a mining or mineral location shall reserve to the Crown, forever, a royalty of 4 per cent. on the sales of the products of all mines therein in trust for the Indians interested in the land patented. Royalty of 4 per cent.

Sec. 82. Returns shall be made by the grantee, sworn to by him, or by his agent or other employe in charge of the mine, at monthly or other such intervals as may be required by the Superintendent General of Indian Affairs, of all products of his mining location, and of the price or amount he received for the same. Returns to be made and sworn to.

The foregoing Sections numbered 81 and 82 shall not apply to the District of Algoma. Exceptions as to Algoma.

*Miscellaneous.*

Sec. 83. The local agent shall have the power to summarily order any mining works to be so carried on as not to interfere with or endanger the safety of the public, any public work or highway, or any mining property, mineral Mining works to be so conducted as not to endanger public safety.

lands, mining claims, bed-rock claims or flumes; and any abandoned works may by his order be either filled up or guarded to his satisfaction, at the cost of the parties who may have constructed the same, or in their absence upon such terms as he shall think fit.

Deposits of leavings and deads.

Sec. 84. The agent in each district, acting under instructions to be from time to time issued by the Superintendent General of Indian Affairs, shall cause to be laid out, at the expense of the person or persons applying for the same, a space of ground for deposits of leavings and deads from any tunnel, claim or mining ground.

#### Forfeiture.

Breach of regulations shall involve forfeiture.

Sec. 85. In the event of the breach of these Regulations or any of them, by any person holding a grant or right of any description from the Crown, or from the Superintendent General of Indian Affairs, or from any duly authorized officer of Indian lands, such right or grant shall be absolutely forfeited *ipso facto*, and the person so offending shall be incapable thereafter of acquiring any such right or grant, unless for special cause otherwise decided by the Superintendent General of Indian Affairs.

### SCHEDULE TO MINING REGULATIONS.

#### FORM A.—APPLICATION AND AFFIDAVIT OF DISCOVERER OF QUARTZ MINE.

I, (A.B.) of hereby apply, under the Indian Lands Mining Regulations for a mining location in (here give general location of premises)

for the purpose of mining for (here name the metal or mineral)

and I hereby and solemnly swear:—

1. That I have discovered therein a deposit of (here name the metal or mineral).
2. That I am to the best of my knowledge and belief the first discoverer of the said deposit.
3. That I am unaware that the land is other than vacant Indian land.

4 That I did, on the day of mark out on the ground, in accordance in every particular with the provisions of sub-section a, of Section 4 of the said Mining Regulations, the location for which I make this application, and that in so doing I did not encroach on any mining location previously laid out by any other person.

*Indian Lands—Mining Regulations.*

Chap. 31.

5. That the said mining location contains, as nearly as I could measure or estimate, an area of \_\_\_\_\_ acres, and that the description (and sketch, if any), of this date, hereto attached, signed by me, set forth in detail to the best of my knowledge and ability its position, form and dimensions.

6. That I make this application in good faith to acquire the land for the sole purpose of mining to be prosecuted by myself, or by myself and associates, or by my assigns.

Sworn before me at  
 this \_\_\_\_\_ day of \_\_\_\_\_ } (Signature.)  
 18 \_\_\_\_\_

FORM B.—RECEIPT FOR FEE PAID BY APPLICANT FOR  
 MINING LOCATION.

No ...

Department of Indian Affairs,  
 Office of the Indian Agency at \_\_\_\_\_ 18 .

Received from \_\_\_\_\_ (A.B.) of  
 five dollars, being the fee required by sub-section *b*, of Section  
 4 of the Indian Lands Mining Regulations, accompanying  
 his application No. \_\_\_\_\_, dated \_\_\_\_\_ 18 ,  
 for a mining location in  
 (insert general description of locality).

This receipt authorizes the said \_\_\_\_\_ (A.B.)  
 his legal representatives or assigns, to enter into possession  
 of the said mining location, and, during the term of one  
 year from the date of this receipt, to take therefrom and dis-  
 pose of any mineral deposit contained within its boundaries,  
 and, on due compliance at any time within that period with  
 the several requirements in that behalf of the said mining  
 regulations, entitles him or them to purchase the said loca-  
 tion which, provisionally, and until survey thereof, may be  
 made known and described as follows: (insert description  
 in detail).

If the said \_\_\_\_\_ (A.B.) or his legal representa-  
 tives or assigns, fail to comply, as aforesaid, with the condi-  
 tions that would entitle him or them to purchase within  
 one year from this date, or, having so complied, do not  
 within that time make payment in full for the land, and  
 also pay the sum of fifty dollars prescribed in the said  
 regulations for the survey of the location, then the right to  
 purchase shall lapse and the mining location shall revert to  
 the Crown, to be otherwise disposed of as may be directed  
 by the Superintendent General of Indian Affairs.

*Indian Agent.*

Chap. 31.

*Indian Lands—Mining Regulations.*FORM C.—RECEIPT FOR FEE ON EXTENSION OF TIME FOR  
PURCHASE OF A MINING LOCATION.

o.....

Department of Indian Affairs,  
Office of the Indian Agency at 18

Received from (A.B.) of five dollars, being the fee required by Section eight of the Indian Lands Mining Regulations, accompanying his application No. , dated 18 , for the extension of the time within which he may purchase the mining location described as follows: (insert description in detail) for which he obtained an entry No. on the 18 .

This receipt authorizes the said (A.B.) his legal representatives or assigns, to continue in possession of the said mining location, and during the term of one year from the 18 , to take therefrom and dispose of any mineral deposit contained within its boundaries, and, on due compliance at any time within that period with the several requirements in that behalf of the said mining regulations, entitles him or them to purchase the said location which, provisionally, and until survey thereof, may be known and described as above.

If the said (A.B.) or his legal representatives or assigns, fail to comply, as aforesaid, with the conditions that would entitle him or them to purchase within one year from this date, or having so complied, do not within that time make payment in full for the land, and also pay the sum of fifty dollars prescribed in the said regulations for the survey of the location, then the right to purchase shall lapse, and the mining location shall revert to the Crown, to be otherwise disposed of as may be directed by the Superintendent General of Indian Affairs.

*Indian Agent.*

## FORM D.—PATENT OF A MINING LOCATION.

Victoria, by the Grace of God, of the United Kingdom of Great Britain and Ireland, Queen, Defender of the Faith—To all to whom these presents shall come, Greeting:

Know Ye that We do by these presents, for Us, Our heirs and successors, in consideration of (the fulfilment of the Indian Lands Mining Regulations of Our Dominion of Canada) give and grant unto h heirs and assigns, all that parcel or lot of land situate



*Indian Lands -- Mining Regulations.*

Chap. 31.

and numbered \_\_\_\_\_ on the official plan of survey of the said \_\_\_\_\_, to have and to hold the said parcel of land, and all minerals, precious and base, which may be found therein, unto the said \_\_\_\_\_ heirs and assigns forever ;

Provided that it shall at all times be lawful for Us, Our heirs and successors, or for any person by Our authority, to resume any portion (not exceeding one-twentieth part) of the said lands for making roads, canals, bridges, towing paths, or other works of public utility or convenience, but no such resumption shall be made of land on which any permanent buildings may have been erected, without compensation ;

Provided, also, that it shall be lawful for any person duly authorized by Us, Our heirs and successors, to take and occupy such water privileges, and to have and enjoy such right of carrying water over, through or under any parts of the hereditaments hereby granted as may be reasonably required for agricultural or other purposes in the vicinity of the said land, upon paying therefor a reasonable compensation to the aforesaid \_\_\_\_\_ heirs and assigns ;

Provided further, that a royalty of two and one-half per cent. shall be paid to Us, Our heirs and successors, upon all the gold and silver produced from the said lands.

NOTE.—In the case of a patent of a mining location situate in the District of Algoma the last clause of Form D respecting royalty shall be omitted from said Form.

FORM E.—CERTIFICATE OF THE ASSIGNMENT OF A MINING LOCATION.

No.....

Department of Indian Affairs,  
Office of the Indian Agency at \_\_\_\_\_

18 .

This is to certify that (B.C.) of \_\_\_\_\_ has filed an assignment in due form, dated \_\_\_\_\_ 18 , and accompanied by a registration fee of two dollars, of the right of (A.B.) of \_\_\_\_\_ to purchase the mining location in (here insert general description of locality) applied for by the said (A.B.) on the \_\_\_\_\_ 18 .

This certificate entitles the said (B.C.) or his legal representatives or assigns, to all the rights and privileges of the said (A.B.) in respect of the claim assigned and hereinafter described ; that is to say, to enter into possession of the said mining location, and during the term of one year from the

date of the receipt No. \_\_\_\_\_, granted to the said (A.B.) dated the \_\_\_\_\_ day of \_\_\_\_\_ 18\_\_\_\_, to take therefrom and dispose of any mineral deposit contained within its boundaries, and on due compliance at any time within that period with the several requirements in that behalf of the said mining regulations, entitles him or them to purchase the said location, which, provisionally, and until survey thereof, may be known and described as follows:—(Insert description in detail.)

If the said (B.C.) or his legal representatives or assigns, fail to comply as aforesaid with the conditions that would entitle them to purchase within one year of the date of the receipt granted to (A.B.), and now deposited with me, or having so complied, do not within that time make payment in full for the land, and also pay the sum of fifty dollars prescribed in the said regulations for the survey of the location, then the right to purchase shall lapse, and the mining location shall revert to the Crown, to be otherwise disposed of as may be directed by the Superintendent General of Indian Affairs.

*Indian Agent.*

FORM F.—APPLICATION FOR GRANT FOR PLACER MINING AND AFFIDAVIT OF APPLICANT.

I, (A.B.), of \_\_\_\_\_, hereby apply, under the Indian Lands Mining Regulations, for a grant of a claim for placer mining, as defined in the said regulations, in (here describe locality) and I solemnly swear:

1. That I have discovered therein a deposit of (here name the metal or mineral).

2. That I am, to the best of my knowledge and belief, the first discoverer of the said deposit; or

(2.) That the said claim was previously granted to (here name the last grantee), but has remained unworked by the said grantee for not less than \_\_\_\_\_

3. That I am unaware that the land is other than vacant Indian land.

4. That I did, on the \_\_\_\_\_ day of \_\_\_\_\_, mark out on the ground, in accordance, in every particular, with the provisions of sub-section *a* of Section 4 of the said mining regulations, the claim for which I make this application, and that in so doing I did not encroach on any other claim or mining location previously laid out by any other person.

5. That the said claim contains, as nearly as I could measure or estimate, an area of \_\_\_\_\_ square feet, and that the description (and sketch, if any,) of this date hereto attached, signed by me, set forth in detail,

*Indian Lands—Mining Regulations.*

Chap. 31.

to the best of my knowledge and ability, its position, form and dimensions.

6. That I make this application in good faith to acquire the claim for the sole purpose of mining to be prosecuted by myself, or by myself and associates, or by my assigns.

Sworn before me at

this

day of

18

, }  
, } (Signature.)  
, }

FORM G.—GRANT FOR PLACER MINING.

No.....

Department of Indian Affairs,

Office of the Indian Agency at

18 .

In consideration of the payment of five dollars, being the fee required by the provisions of the Indian Lands Mining Regulations, Sections four and twenty, by (A.B.), of \_\_\_\_\_, accompanying his application No \_\_\_\_\_, dated \_\_\_\_\_, for a mining claim in (here insert description of locality) ;

The Superintendent General of Indian Affairs hereby grants to the said (A.B.), for the term of one year from the date hereof, the exclusive right of entry upon the claim (here describe in detail the claim granted) for the miner-like working thereof, and the construction of a residence thereon, and the exclusive right to all the proceeds realized therefrom.

The said (A.B.) shall be entitled to the use of so much of the water naturally flowing through or past his claim, and not already lawfully appropriated, as shall be necessary for the due working thereof, and to drain his claim, free of charge.

This grant does not convey to the said (A.B.) any surface rights in the said claim, or any right of ownership in the soil covered by the said claim; and the said grant shall lapse and be forfeited unless the claim is continuously and in good faith worked by the said (A.B.) or his associates.

The rights hereby granted are those laid down in the aforesaid mining regulations, and no more, and are subject to all the provisions of the said regulations, whether the same are expressed herein or not.

*Indian Agent.*

FORM H.—CERTIFICATE OF THE ASSIGNMENT OF A PLACER MINING CLAIM.

No.....

Department of Indian Affairs,  
Office of the Indian Agency at 18

This is to certify that (B.C.) of 18  
has filed an assignment in due form, dated 18  
and accompanied by a registration fee of two dollars, of the  
grant to (A.B.) of the right to mine  
in (insert description of claim) for one year  
from the 18

This certificate entitles the said (B.C.) to all  
the rights and privileges of the said (A.B.) in  
respect of the claim assigned, that is to say, to the exclusive  
right of entry upon the said claim for the miner-like work-  
ing thereof, and the construction of a residence thereon,  
and the exclusive right to the proceeds realized therefrom,  
for the remaining portion of the year for which the said  
claim was granted to the said (A.B.), that is  
to say, until the day of 18

The said (B.C.) shall be entitled to the use of  
so much of the water naturally flowing through or past his  
claim and not already lawfully appropriated as shall be  
necessary for the due working thereof, and to drain his  
claim free of charge.

This grant does not convey to the said (B.C.)  
any surface rights in the said claim, or any right of owner-  
ship in the soil covered by the said claim; and the said  
grant shall lapse and be forfeited unless the claim is con-  
tinuously and in good faith worked by the said (B.C.)  
or his associates.

The rights hereby granted are those laid down in the  
aforesaid mining regulations, and no more, and are subject  
to all the provisions of the said regulations, whether the  
same are expressed herein or not.

*Indian Agent.*

FORM I.—GRANT TO A BED-ROCK FLUME COMPANY.

No.....

Department of Indian Affairs,  
Office of the Indian Agency at 18

In consideration of the payment of a deposit of one hun-  
dred dollars, required by Section thirty-seven of the Indian  
Lands Mining Regulations to be made with the application  
of a bed-rock flume company, and of the further sum of ten

*Indian Lands—Mining Regulations.*

## Chap. 31.

dollars, being the fee for the registration of this grant required by Section forty-two of the said regulations ;

The Superintendent General of Indian Affairs hereby grants to (names of members of company) forming together a bed-rock flume company [known as the (title of the company) ], the following rights and privileges, that is to say :—

(a.) The rights of way through and entry upon any new and unworked river, creek, gulch or ravine, and the exclusive right to locate and work a strip of ground 100 feet wide and 200 feet long in the bed thereof to each individual of the company ;

(b.) The rights of way through and entry upon any river, creek, gulch, or ravine, worked by miners for any period longer than two years prior to such entry, and already wholly or partially abandoned, and the exclusive right to stake out and work both the unworked and abandoned portions thereof, 100 feet in width and  $\frac{1}{4}$  of a mile in length for each individual of the company ;

(c.) The rights of way through and entry upon all claims which at the time of the notice of application, are in good faith being worked, for the purpose of cutting a channel and laying their flume therein, with such reasonable space for constructing, maintaining and repairing the flume as may be necessary ;

(d.) The use of so much of the unappropriated water of the stream on which they may be located, and of other adjacent streams, as may be necessary for the use of their flumes, hydraulic power, and machinery to carry on their operations and the right of way for ditches and flumes to convey the necessary water to their works, subject to the payment of any damage which may be done to other parties by running such ditch or flume through or over their ground ;

Provided, that the rights herein granted shall apply only to such claims and streams as are here specified :

(insert description of claims and streams) and such other claims and streams as may after due notice and application, be subsequently added to the above list by the Superintendent General of Indian Affairs, under the hand of the local agent ;

Provided also, that the said company shall pay to the local agent, in advance, an annual rent of ten dollars for each quarter of a mile of right of way legally held by them ;

Provided further, that this grant is subject to all the provisions of the Indian Lands Mining Regulations in that behalf, whether the same are expressed herein or not.

This grant shall cease and determine at the expiration of years from the date hereof.

*Indian Agent.*

## FORM J.—GRANT FOR DRAINAGE.

No.....

Department of Indian Affairs,  
Office of the Indian Agency at

18 .

In consideration of the payment of a deposit of twenty-five dollars required by Section forty-six of the Indian Lands Mining Regulations to be made with the application for a grant of right of way to construct drains, and of the further sum of                   dollars, being the fee for the registration of this grant required by Section forty-seven of the said Regulations;

The Superintendent General of Indian Affairs hereby grants to                   (name or names of grantee or grantees) the right to run a drain or tunnel for drainage purposes through the occupied mining lands here specified (here describe mining lands) and further, for a term of                   from the date hereof, exclusive-rights of way through and entry upon the following mining grounds:                   (here insert description) for the purpose of constructing a drain or drains for the drainage thereof; and the right to charge the following tolls for the use thereof:                   (insert tariff of tolls);

Provided, that the grantee shall construct such drain or drains of sufficient size to meet all requirements within                   from the date hereof and keep the same in thorough working order and repair, and free from all obstructions; and shall, within a reasonable time, construct proper tap-drains from or into any adjacent claims, upon being requested to do so by the owners thereof, and in default thereof shall permit such parties to make them themselves, in which case such parties shall only be chargeable with one-half the rates of drainage toll herein authorized;

Provided, also, that the said grantee shall compensate the owners of lands or holders of claims entered upon by                   for any damage they may sustain by the construction of such tunnel or drain;

Provided, further, that the said grantee shall pay to the local agent, in advance, an annual rent of ten dollars for each quarter of a mile of right of way legally held by                   ;

Provided, further, that this grant is subject to all the provisions of the Indian Lands Mining Regulations in that behalf, whether the same are expressed herein or not.

*Indian Agent.*

*Indian Lands—Mining Regulations.*

## Chap. 31.

## FORM K.—GRANT OF RIGHT TO DIVERT WATER AND CONSTRUCT DITCHES.

No.....

Department of Indian Affairs,  
Office of the Indian Agency at 18 .

In consideration of the payment of a deposit of twenty-five dollars, required by Section fifty of the Indian Lands Mining Regulations to be made with the application for the right to divert water and construct ditches ;

The Superintendent General of Indian Affairs hereby grants to (A.B.) , for the term of years from the date hereof, the right to divert and use the water from (specify stream or lake) to the extent of inches, and no more, to be distributed as follows:— (describe locality of distribution) together with the right to charge the following rates for the use of the said water :— (insert rates to be charged) and the rights of way through and entry upon the following mining grounds (insert description) for the purpose of constructing ditches and flumes to convey such water, provided such ditches and flumes are constructed and in working order within from the date hereof ;

Provided that this grant shall be deemed to be appurtenant to mining claim No. , and shall cease and determine whenever the said claim shall have been worked out or abandoned, or the occasion for the use of such water upon the said claim shall have permanently ceased ;

Provided, also, that this grant is subject to all the provisions of the Indian Lands Mining Regulations in that behalf, whether the same are expressed herein or not.

*Indian Agent*

O. C. Oct. 1, 1887 ; May 2, 1888.

## CHAPTER 32.

### COAL LANDS WITHIN INDIAN RESERVES IN MANITOBA AND THE NORTH-WEST TERRITORIES.

Government House, Ottawa,

The 15th day of September, 1888.

On the recommendation of the Superintendent General of Indian Affairs, and under the provisions of Chapter 43 of the Revised Statutes of Canada, intituled "The Indian Act,"

His Excellency in Council has been pleased to make and does hereby make the following regulations respecting coal lands within Indian Reserves in the province of Manitoba and in the North-West Territories.

#### REGULATIONS.

The Indians owning Reserves on which coal lands are situated may surrender the same to Her Majesty the Queen, in accordance with the provisions of "The Indian Act," aforesaid, to be sold for their benefit under the following conditions:—

Royalty of  
10 cents.

Section 1. A royalty of ten cents on every ton of coal excavated shall be paid by the purchaser or purchasers of any coal lands situated within an Indian Reserve.

Reserve with-  
in the Cas-  
cade coal  
district.

Sec. 2. Coal lands situated on any Reserve within the Cascade coal district which have been surrendered shall be sold at an upset price of \$12.50 per acre, cash, and the lands situated on Indian Reserves within all other coal districts at an upset price of \$10.00 per acre, cash.

320 acres.

(a.) Not more than three hundred and twenty acres shall be sold to one applicant.

Several appli-  
cants for same  
location.

(b.) When there is more than one applicant for the same coal location, the Superintendent General of Indian Affairs may invite competition between the several applicants, or offer the land for sale at public competition by tender or by auction as he may think expedient, at the upset price of coal lands in the district in which such coal location is situated.

Locations  
outside of  
organized  
districts.

(c.) When applications are made to purchase coal locations situated outside of the organized coal districts, the Superintendent General of Indian Affairs may sell the same to the applicants at the price and on the terms which would apply if the lands were within an organized coal district.



*Coal lands within Indian Reserves in Manitoba and N.-W. T.* Chap. 32.

Sec. 3. The boundaries beneath the surface of coal mining locations shall be the vertical planes or lines in which their surface boundaries lie. Boundaries beneath surface.

Sec. 4. All the employés, not being Indians of the Reserve, engaged in mining on an Indian Reserve, shall be married men living with their wives and families at or in the vicinity of the mines. Employés must be married men.

Sec. 5. The purchaser or purchasers shall pay the wages of such number of constables, to be appointed by the Department, as may be necessary to prevent all intercourse between the Indians resident upon a Reserve and the employés engaged in mining, and to preserve order among the employés. This regulation, however, is not to apply to Indians resident upon such Reserve who are legitimately employed in connection with the said mines, but it is intended for the purpose of excluding from the mines, Indians, —male or female— not so employed, as well as to prevent employés other than Indians engaged in mining from visiting the portion of the Reserve occupied by the Indians. Purchasers shall pay wages of constables appointed to prevent intercourse.

O. C. Oct. 11, 1887.

# DEPARTMENT OF FINANCE.

## CHAPTER 33.

### GOVERNMENT SAVINGS BANKS REGULATIONS.

Government House, Ottawa,

The 30th day of October, 1888.

On the recommendation of the Minister of Finance and under the provisions of Chapter 121, of the Revised Statutes of Canada, intituled "An Act respecting Government Savings Banks,"

His Excellency in Council has been pleased to make the following regulations:—

Savings banks, within what hours to be open.

Section. **1.** The savings banks in the cities of Toronto, Halifax, St. John, Winnipeg, Victoria and Charlottetown, shall be open daily from 10 a.m. to 3 p.m., and the branch savings banks shall be open on such days and within such hours as the Minister of Finance may, from time to time, direct.

O. C. March 15, 1872, *part.*

Rate of interest, and how to be computed.

Sec. **2.** Until otherwise ordered interest shall be allowed at the rate of four dollars per cent. per annum, and shall be computed from the first day of the calendar month next following the day on which the deposit is made, up to the first day of the calendar month on which the moneys be withdrawn.

O. C. Sep. 4, 1880.

Manner of making first deposit; declaration to be made.

Sec. **3.** On making his first deposit every person must give his christian name and surname, and declare his occupation and place of residence, and if a deposit is made in the name of two or more persons, the names, occupation and residence of both or all such persons shall be declared. Such declaration shall be witnessed by the manager or other officer receiving the deposit, and shall be entered in a book to be kept for that purpose in the office where the deposit is made. Upon the opening of any such account, the manager shall give to the depositor a pass-book, having the number of the account, and authenticated by the signature of the manager.

Change of residence.

If any depositor changes his place of residence, he must, in making the next deposit or withdrawal give notice thereof to the manager, in order that it may be entered in the bank books.

*Government Savings Banks Regulations.*

**Chap. 33.**

Sec. 4. No deposit or withdrawal shall be made of less amount than one dollar, or in any other sums than in multiples of a dollar, excepting upon the final closing of an account.

Amount of deposit and of withdrawal.

Sec. 5. No deposit shall be received nor any withdrawal allowed without the production of the depositor's pass-book, except in the case provided for by the 7th section hereof. The manager or other officer shall enter in the pass-book the date and sum deposited or withdrawn, authenticating the same with his signature or initials; and upon the occasion of the presentation to him of the pass-book next after the 30th day of June in any year, he shall enter therein as a deposit the interest accrued up to the 30th of June then last past since the date when the last entry of such interest was made. Every depositor upon making a withdrawal shall sign a receipt in a book to be kept for that purpose; all entries in the pass-book of deposits or withdrawals shall be entered in words as well as in figures.

Production of pass-book.

Sec. 6. If any depositor shall be unable personally to attend to make any deposit or withdrawal, the deposit may be made by any person upon the presentation of the pass-book, but no withdrawal can be made except upon an order in the form following to another person to act for him, signed in the presence of a justice of the peace or clergyman in the place in which he resides, or in case of sickness by a licensed medical practitioner, or if resident abroad by some constituted authority of the place where he then resides.

Depositor who may be unable to attend in person.

Depositor's Pass Book.

Savings Bank at.....	ORDER BY A DEPOSITOR WHO CAN
No.....	NOT ATTEND PERSONALLY TO
	RECEIVE PAYMENT.

To the Manager of the Government Savings Bank at  
 I, the undersigned, do hereby authorize and direct  
 the bearer of this order, upon the production  
 of my pass-book, to receive on my account the sum of  
 due to me at the above mentioned savings bank,  
 for which sum the receipt of the above-named person shall  
 be a good and sufficient discharge.

As witness my hand, this                      day of                      18 .

Signature } Address } Occupation }	Of Witness	Signature } Address } Occupation }	Of Depositor
--	------------	--	--------------

Copies of the forms for such orders may be procured at the several savings banks, and such orders when presented shall be filed in the savings bank, and the number of such order upon which any withdrawal has been made shall be entered in the pass-book against such withdrawal.

Pass-book,  
lost or des-  
troyed;  
declaration  
in such case.

Sec. 7. If any pass-book has been lost or destroyed, then upon a declaration made before the manager, of the circumstances, and upon proof adduced, to the satisfaction of the manager, of the identity of the person claiming to be the depositor, a new pass-book may be issued, purporting to be in place of the pass-book lost or destroyed, and in such pass-book shall be entered the state of the account as it then stands in the manager's ledger; and thereupon the old account shall be closed and a new account shall be opened with the number of the new pass-book. In lieu of the declaration to be made in a book to be kept for that purpose, as provided in section 3, he shall execute a declaration in the form following:—

Pass-book No. \_\_\_\_\_  
Savings Bank at \_\_\_\_\_

#### DECLARATION OF DEPOSITOR.

Form of de-  
claration by  
depositor  
who has lost  
pass-book.

*I*, \_\_\_\_\_, of \_\_\_\_\_, do solemnly declare that *my* pass-book No. \_\_\_\_\_, issued by the Government Savings Bank at \_\_\_\_\_, was \_\_\_\_\_

(stating the facts), and *I* hereby declare that *I* surrender all claims to any deposits recorded in the said pass-book, and that *I* have no claim in respect thereof except that recorded in this pass-book No. \_\_\_\_\_. And *I* hereby testify *my* consent that *my* deposits in the said savings bank shall be managed in accordance with the regulations thereof.

Witness *my* hand, this \_\_\_\_\_ day of \_\_\_\_\_, in the year \_\_\_\_\_.

Signed in the presence of \_\_\_\_\_

*I* (or *we*) hereby declare that the above \_\_\_\_\_ is well known to *us*, and that we believe him to be the to whom the pass-book No. \_\_\_\_\_, which has been lost was issued.

Signed in the presence of \_\_\_\_\_

And if such declaration, or any part thereof, shall not be true, the depositor or depositors shall forfeit all right and title to the deposits therein recorded.

Circulars  
from the  
Finance  
Department  
to depositors.

Sec. 8. Circulars will, from time to time, be sent from the Finance Department to each depositor, with the balance then at his credit. The depositor is expected to compare his pass-book with the circular, and to send back the cir-

*Government Savings Banks Regulations***Chap. 33.**

cular signed by him in acknowledgment of its correctness, or otherwise to state what differences exist. If the depositor, having received a circular, does not acknowledge it as above within a reasonable time, the Government will not be liable for any error that may be found in his pass-book previous to the date of the circular.

Sec. 9. Any depositor may send his pass-book to the Finance Department at Ottawa for verification or he may produce it to the inspector when on his inspection visit. Verification of pass-book.

Sec. 10. Deposits may be made by, or for the benefit of any person under 21 years of age. In case of minors under the age of 10 years, the declaration must be made by one of his parents, or by a friend on behalf of the minor. Repayment to a minor over 10 years of age shall be made in the same manner as if he were of full age. Deposits may also be made by a married woman, and deposits so made, or made by a woman who shall afterwards marry, will be repaid to any such woman, and the receipt of any such woman, irrespective of her husband, shall be valid. Deposits by or for minors; declaration in such case.  
Deposits by married women.

Sec. 11. In case any depositor shall die, leaving any sum of money not exceeding \$300, exclusive of interest, deposited in any Government savings bank, and probate of his will, or letters of administration be not produced to the manager of the head office of the savings bank in which such deposit was made, or to the Minister of Finance, or if notice in writing of the existence of a will, and intention to prove the same, or to take out letters of administration, be not given to the said manager or the Minister of Finance within the period of one month from the death of the depositor; if such notice be given, but such shall not be proved, or letters of administration be not taken out, and probate or letters of administration produced to the said manager or Minister, within the period of two months from the death of the depositor; it shall be lawful for the said Minister, after such period of one or two months, as the case may be, to pay and divide such funds, at his discretion, to or amongst the widow, or relatives of the deceased depositor, or any one or more of them, or if he should think proper, according to the provisions of law concerning the distribution of property in such cases. Death of depositor; manner of proceeding; notice to be given and limit of time in such case.

Sec. 12. In case any depositor shall die leaving any sum of money in any Government savings bank, which (exclusive of interest) shall exceed the sum of \$300, the executor or administrator must produce the probate of the will, or letters of administration of the estate or effects of the Death of depositor leaving more than \$300; manner of proceeding in such case.

deceased depositor, to the agent of the savings bank in which such deposit was made. And the agent, upon being satisfied with the correctness of the documents produced, shall send a certificate to that effect, with all necessary details, to the Minister of Finance, whereupon authority will be given to pay the money, or to transfer the amount to the party entitled to it; but no such payment or transfer shall be made except upon such authority.

Death of illegitimate depositor; manner of proceeding in such case.

**Sec. 13.** If any depositor, upon being illegitimate, shall die intestate, leaving any person or persons, who, but for the illegitimacy of such depositor, or of such person or persons, would be entitled to the money due to such deceased depositor, it shall be lawful for the Minister of Finance, with the authority, in writing, of the Minister of Justice of Canada, to cause the money of such deceased depositor to be paid to any one or more of the persons who, in his opinion, would have been entitled to the same, according to law, if the said depositor, and such person or persons, had been legitimate.

Depositor becoming insane, or otherwise incapacitated.

**Sec. 14.** If any depositor shall become insane or otherwise incapacitated to act, and the same shall be proved to the satisfaction of the Minister of Finance, and if the said Minister shall be satisfied of the urgency of the case, he may authorize payment, from time to time, out of the funds of such depositor to any person whom he shall judge proper, and the receipt of such person shall be a good discharge for the same.

Dispute between department and depositor, or his representative, how settled.

**Sec. 15.** If any dispute shall arise between the Minister of Finance or other persons representing the Government of Canada, and any individual depositor, or any executor, administrator, next of kin, or creditor, or assignee of a depositor who may become bankrupt or insolvent, or any person claiming to be such executor, administrator, next of kin, creditor or assignee, or to be entitled to any money deposited in any Government savings bank, then, and in every such case, the matter in dispute shall be referred, in writing, to the Minister of Justice of Canada; and whatever award, order, or determination shall be made by the said Minister of Justice of Canada, shall be binding and conclusive on all parties, and shall be final, to all intents and purposes, without any appeal.

#### SAVINGS BANK OFFICERS.

Branch savings banks in N.S. and N.E.

**Sec. 16.** Branch savings banks may be established in Nova Scotia and New Brunswick, under agents who shall

*Government Savings Banks Regulations.*

Chap. 33.

report to the managers of the head offices at Halifax and St. John respectively; and such agent shall be included under the general term *Managers* when used in these regulations, unless such regulations be expressly limited to managers at the head offices.

Sec. 17. The manager or his clerk upon receiving a deposit or paying a withdrawal, shall enter the same with the date in the depositor's pass-book, with his signature or initials, and he shall at the same time make an entry of the transaction in the books of his office.

Entry in depositor's pass-book.

Sec. 18. The savings bank ledger shall be kept by consecutive balances, and at the same time that any entry is made the interest thereon to the end of the then current financial year shall be made, and at the end of every financial year, or whenever an account is finally closed, the balance of interest shall be added to the capital. The ledger shall be in the form following:—

Savings bank ledger, how to be kept.

Date.	Deposit.	Balance.	Withdrawal.	Interest Allowed.	Balance of Interest.	Interest Charged

Sec. 19. Every agent of a branch savings bank shall make a return weekly to the Finance Department at Ottawa, and a duplicate thereof shall also be sent to the Assistant Receiver General of the Province in which the savings bank is situated—of all the transactions in his office since the date of the last return, being a transcript of the entries in his ledger, together with a statement of the cash on hand: and the Assistant Receiver General shall enter in a book, to be kept for that purpose, an abstract of each such return, showing the total deposits, total withdrawals, total interest debited, credited, and paid; and he shall transmit to the Finance Department a copy of such abstract.

Weekly return by agent to Finance Department and to assistant receiver general.

Sec. 20. The manager of every head office of savings banks shall transmit weekly to the Finance Department at Ottawa a similar statement of all the transactions in his own head office during the past week, with separate statements of the cash received and deposited, and of the cash paid out with such vouchers as may be required.

Weekly return by managers of head offices.

Sec. 21. The manager of every head office shall keep absolutely distinct the moneys he may receive as manager

Manager of head office.

## Chap. 33.

*Government Savings Banks Regulations.*

Mode of keeping and depositing moneys.

of the savings bank from those he may pay out as such manager, and both distinct from any other financial transactions in which he may be required to engage as Assistant Receiver General. He shall deposit daily, to the credit of the Receiver General, in the bank in which he may be instructed to make deposits, all sums which he has received in deposit as manager of the savings bank.

Deposits in local banks, how made; manner of keeping accounts with such banks.

Sec. 22. If there is any bank receiving public deposits at any place where a branch savings bank is established, the manager shall be similarly instructed to pay daily into such bank, to the credit of the Receiver General, all the deposits he receives, and a credit may be given to him against which he may draw for withdrawals, such drafts being covered weekly by a remittance from the Assistant Receiver General. But if there be no bank where a branch is situated, the Assistant Receiver General shall advance such sums to the manager as may be deemed sufficient to meet withdrawals, and the manager shall at the end of each week, when sending in his weekly returns, draw upon the Assistant Receiver General for the amount actually paid for withdrawals, so as to leave him with the same sum in hand to meet withdrawals in the next week. In the case of unexpected demands being made upon the manager beyond what the funds in hand enable him to meet, he may render a subsidiary account before the end of the week, drawing upon the Assistant Receiver General for the amount of his withdrawals to that date. The manager shall also deposit weekly in the bank in which he is directed to make deposits, the exact amount received during the week from depositors, and to this end he may make the cheque or one of the cheques he may draw upon the Assistant Receiver General, payable to such bank for the amount of the deposits, if the withdrawals exceed the deposits, or for the amount of withdrawals, remitting the remainder in cash, if the deposits exceed the withdrawals. And at the end of each financial year he shall deposit to the credit of the Assistant Receiver General the whole amount advanced to him for withdrawals, obtaining a new advance for the following year.

Provision in case there is no local bank in the place.

In case of unexpected demands.

“ Weekly ”—  
meaning of  
term.

Sec. 23. When it is stated in the above regulations that a manager shall furnish a weekly statement, or deposit weekly, the weekly period therein meant is to be held to be the 8th, 15th, 22nd and last day of each calendar month.

## INSPECTION.

Inspector to visit each office.

Sec. 24. The inspector shall visit each office of which the supervision may be assigned to him once a year or oftener



*Government Savings Banks Regulations.*

## Chap. 33.

if need be. He shall receive from the Finance Department a statement of any discrepancies which may have been found in any one of the accounts.

Sec. 25. On visiting the several offices the manager or other officer shall afford the inspector every facility for making his inspection complete and effective. He shall deliver to the inspector all cash, books and documents which he may demand, and shall give all explanations which he may require, bearing in any way upon their management. The inspector shall compare the manager's books with the statements sent to him from the Finance Department, and with such depositors' pass-books as may be submitted to him, and if he finds any irregularity he shall forthwith report to the Finance Department, from which he shall receive instructions how to act.

Manager to assist inspector and deliver to him cash, books and documents.

Sec. 26. The inspector shall also, once a quarter, or oftener, if need be, report to the Finance Department the dates at which he has visited the several offices and the results of his investigations.

Report by inspector.

## REGULATIONS TO BE OBSERVED IN THE DEPARTMENTS.

Sec. 27. From the weekly returns from the various savings banks hereinbefore provided for, there shall be kept in the Finance Department a ledger for each savings bank or branch savings bank, showing the account of each depositor, which should be an exact counterpart of the manager's ledger. There shall also be kept a personal account with each manager, showing the weekly transactions passing through his office. There shall also be kept a general savings bank ledger, showing the aggregate business of each office.

Ledger and personal account with each manager to be kept in Finance Department.

Sec. 28. As soon as may be after the end of each month the Deputy Minister of Finance shall submit to the Treasury Board an aggregate statement in the same form of the transactions of all the savings banks, and such statement shall be published in the *Canada Gazette*.

Auditor to submit statement to Treasury Board.

Sec. 29. Circulars shall be sent periodically from the Finance Department in accordance with the said Act to each depositor, showing the balance at his credit and requesting him to compare it with his pass-book, and to return the circular with a signed acknowledgment of its correctness, or otherwise to state what differences exist. In case it shall be stated that the circular and pass-book do not agree, the fact shall be communicated to the inspector with instructions to investigate the case.

Circulars to be sent to depositors from Department.

O. C. March 15, 1872.

## Chap. 33.

*Government Savings Banks Regulations.*

Limit of  
amount of  
annual de-  
posits and of  
account.

**Sec. 30.** Deposits received on and after the 1st day of July, 1887, in any one fiscal year, from any one depositor, shall not exceed the sum of three hundred dollars (\$300), and the maximum limit of an account shall be one thousand dollars (\$1,000), exclusive of interest.

O. C. June 13, 1887.

## SCALE OF BONDS TO BE GIVEN BY AGENTS.

Security to  
be given by  
agent, &c.

**Sec. 31.** Every agent, officer, clerk and servant employed under the said Act, and who is intrusted with and has the custody of any moneys or valuable securities, shall give security in the following sums:—

\$25,000 or  
less.

(a.) When the balance on the 30th June is \$25,000 and under he shall give bonds in himself for \$1,000 and two sureties of \$1,000 each, or a guarantee company's bond for \$3,000.

Between  
\$25,000 and  
\$50,000.

(b.) When the balance on the same date is over \$25,000 and under \$50,000, he shall give bonds in himself for \$1,500 and two sureties of \$1,500 each, or a guarantee company's bond for \$4,500.

\$50,000, or  
more.

(c.) When the balance on the same date is over \$50,000 he shall give bonds in himself for \$2,000 and two sureties of \$2,000 each, or a guarantee company's bond for \$6,000.

Preference.

(d.) When practicable the preference shall be given to bonds guaranteed by some company.

O. C. June 19, 1880.

# DEPARTMENT OF INLAND REVENUE.

## CHAPTER 34.

### DISTRICTS AND DIVISIONS.

Government House, Ottawa,  
The 9th day of January, 1889.

On the recommendation of the Minister of Inland Revenue, and under the provisions of Chapter 29 of the Revised Statutes of Canada, intituled "The Consolidated Revenue and Audit Act,"

His Excellency in Council has been pleased to order, and it is hereby ordered, that the several Inland Revenue districts and divisions in the Dominion of Canada, enumerated in the list hereto appended, and the territory comprising them, be, and the same are hereby constituted and established:—

OFFICIAL LIST of *Inland Revenue Districts and Divisions in the Dominion of Canada and the territorial extent of each.*

Divisions.	Office at	Comprising	
<b>PROVINCE OF ONTARIO.</b>			
<b>Section 1.</b>	<b>G.—WINDSOR DISTRICT.</b>	Office at Windsor.	Windsor, Ont.
Brantford.....	Brantford. ...	The Counties of Brant, Norfolk and Oxford.	
London.....	London.....	Middlesex, Elgin and Lambton.	
Stratford.....	Stratford.....	Bruce, Huron and Perth.	
Windsor.....	Windsor.....	Essex and Kent.	
<b>Sec. 2.</b>	<b>F.—TORONTO DISTRICT.</b>	Office at Toronto.	Toronto.
Guelph.....	Guelph .....	Wellington and Waterloo.	
Hamilton.....	Hamilton .....	Hamilton (city), and Wentworth.	
Owen Sound.....	Owen Sound.....	Grey.	
St. Catharines.....	St. Catharines...	St. Catharines (city), Haldimand, Lincoln, and Welland.	
Toronto .....	Toronto.....	Toronto (city), Dufferin, Halton, Ontario, Peel, Simcoe, York, with the Districts of Muskoka, Parry Sound and Algoma as far west as Pic River.	
<b>Sec. 3.</b>	<b>E.—KINGSTON DISTRICT.</b>	Office at Kingston.	Kingston.
Bellefille.....	Bellefille.....	Hastings and Prince Edward.	
Cornwall.....	Cornwall .....	Glengarry, Prescott (county) and Stormont.	
Kingston.....	Kingston .....	Frontenac, Kingston (city), Lennox and Addington.	
Ottawa & Pontiac..	Ottawa.....	{ Ottawa (city), Carleton and Russell, in Province of Ontario. Ottawa (county), and Pontiac, in the Province of Quebec.	
Perth.....	Perth.....	Lanark and Renfrew, and District of Nipissing.	
Peterborough.....	Peterborough.....	Durham, Haliburton, Northumberland, Peterborough and Victoria.	
Prescott.....	Prescott.....	Dundas and Leeds & Grenville.	

Chap. 34. *Inland Revenue Districts and Divisions.*

Divisions.	Office at	Comprising.
------------	-----------	-------------

PROVINCE OF QUEBEC.

Montreal.	<b>Sec. 4.</b>	D.—MONTREAL DISTRICT. Office at Montreal.	
Montreal.....	Montreal.....	Montreal (city), Hochelaga, Jacques-Cartier, Laval, Vaudreuil, Soulanges, Laprairie, Chambly.	
Beauharnois.....	Ormstown.....	Beauharnois, Chateauguay, Huntingdon.	
Joliette.....	Joliette.....	Berthier, Joliette, Montcalm and L'Assomption.	
Pontiac.....		<i>Included in the Division of Ottawa.</i>	
Sherbrooke.....	Sherbrooke.....	Richmond, with town of Sherbrooke, Wolfe, Compton and Stanstead.	
Sorel.....	Sorel.....	Richelieu, Verchères, Yamaska.	
St. Hyacinthe.....	St. Hyacinthe.....	St. Hyacinthe (county and town), Rouville and Bagot.	
Iberville.....	Iberville.....	Brome, Iberville, Missisquoi, Napierville, Shefford and St. John's.	
Terrebonne.....	S. Janvier.....	Argenteuil, Two Mountains and Terrebonne.	
Three Rivers.....	Three Rivers.....	City of Three Rivers, Champlain, Maskinongé, Nicolet, St. Maurice, Drummond and Arthabaska.	

Quebec.	<b>Sec. 5.</b>	C.—QUEBEC DISTRICT. Office at Quebec.	
Quebec.....	Quebec.....	Quebec (city and county), Montmorency, Portneuf, Lotbinière, Bellechasse, Beauce, Megantic, and all to the East thereof, including the Magdalen Islands.	

PROVINCE OF NEW BRUNSWICK.

New Brunswick.	<b>Sec. 6.</b>	B.—NEW BRUNSWICK DISTRICT. Office at St. John.	
Chatham.....	Chatham.....	Restigouche, Gloucester, Northumberland, Kent.	
St. John.....	St. John.....	Albert, Carleton, Charlotte, Kings, Madawaska, Queens, St. John (city and county), Sunbury, Victoria, Westmorland, York.	

PROVINCES OF NOVA SCOTIA AND PRINCE EDWARD ISLAND.

Nova Scotia and P. E. Island.	<b>Sec. 7.</b>	A.—NOVA SCOTIA AND P. E. ISLAND DISTRICT. Office at Halifax.	
Cape Breton.....	Sydney.....	Cape Breton, Inverness, Richmond, Victoria,	
Halifax.....	Halifax.....	Annapolis, Colchester, Cumberland, Digby, Hants, Halifax, (city and county) Kings, Lunenburg, Queens, Shelburne, Yarmouth.	
Pictou.....	Pictou.....	Antigonish, Guysborough, Pictou.	
Charlottetown.....	Charlottetown.....	The Province of Prince Edward Island.	

PROVINCE OF MANITOBA.

Manitoba.	<b>Sec. 8.</b>	H.—MANITOBA DISTRICT. Office at Winnipeg.	
Port Arthur.....	Port Arthur.....	That part of Ontario West of Pic River.	
Winnipeg.....	Winnipeg.....	The Province of Manitoba and the N.W. Territories.	

PROVINCE OF BRITISH COLUMBIA.

British Columbia.	<b>Sec. 9.</b>	I.—BRITISH COLUMBIA DISTRICT. Office at Victoria.	
Victoria.....	Victoria.....	The Province of British Columbia.	

## CHAPTER 35.

### CLASSIFICATION FOR INLAND REVENUE.

Government House, Ottawa,  
The 9th day of January, 1889.

On the recommendation of the Minister of Inland Revenue and under the provisions of Chapter 29 of the Revised Statutes of Canada, intituled "The Consolidated Revenue and Audit Act,"

His Excellency in Council has been pleased to make the following regulations for the government of the Excise Branch of the Inland Revenue Department :—

#### CLASSIFICATION OF INLAND REVENUE DIVISIONS.

Section 1. The classification of Inland Revenue Divisions is hereby determined as follows:—

Classification of divisions determined.

- |            |  |  |
|------------|--|--|
| 1st Class— | Montreal, Toronto, Windsor, Winnipeg.  |  |
| 2nd "      | Hamilton, Prescott, London, Guelph.  |  |
| 3rd "      | Kingston, Quebec, St. John, Halifax, Stratford, Belleville, Ottawa.          |  |
| 4th "      | Brantford, Victoria, B.C., Perth.  |  |
| 5th "      | Sherbrooke, Peterborough, St. Catharines, Chatham, N. B., Charlottetown.     |  |
| 6th "      | Owen Sound, St. Hyacinthe, Iberville, Three Rivers, Sorel, Joliette, Pictou. |  |
| 7th "      | Cornwall, Port Arthur, Terrebonne, Beauharnois, Cape Breton.                 |  |

Sec. 2. From time to time hereafter the Inland Revenue Divisions shall be re-classified in accordance with the average volume of business annually transacted therein during the three years preceding such re-classification.

Re-classification provided for.

Sec. 3. The volume of business so transacted shall, for the purpose of such classification, be determined by adding the amount of duty collected within such division to the amount of duty accrued upon the goods entered for warehouse ex-manufactory.

Volume of business how determined.

Sec. 4. The classification shall be as follows:—

1st Class in excess of.....	\$1,000,000	
2nd " over \$500,000, under.....	1,000,000	
3rd " " 200,000 " .....	500,000	
4th " " 100,000 " .....	200,000	
5th " " 50,000 " .....	100,000	
6th " " 10,000 " .....	50,000	
7th " under 10,000		

Amounts specified for the determination of the several classes.

Chap. 35.

*Classification for Inland Revenue.*

Classification of division in the next higher or next lower class in certain cases, on report of Commissioner; provided for.

Sec. 5. Provided that on the report of the Commissioner of Inland Revenue in respect of any division, that the area under supervision is greater than that of other divisions of the same class, or that the number of manufactories subject to excise is greater in proportion to the revenue derived therefrom, or that for other sufficient reasons the mode of comparison hereinbefore adopted does not fairly represent the work of such divisions as compared with others, then the Governor in Council may authorize the classification of such division in the next higher or next lower class the case may be, than that to which under the preceding clauses it would belong.

CLASSIFICATION OF COLLECTORS.

Rank of Collector co-ordinate with his division.

Sec. 6. The rank or classification of a Collector of Inland Revenue shall be co-ordinate with that of the division to which he is appointed, or over which he may from time to time preside.

SALARIES OF COLLECTORS.

Salaries of Collectors according to class.

Sec. 7. The salaries of Collectors shall be as follows:—

	Minimum.	Maximum.
1st Class.....	\$1,800	\$2,200
2nd " .....	1,600	1,800
3rd " .....	1,400	1,600
4th " .....	1,200	1,400
5th " .....	1,000	1,200
6th " .....	700	1,000
7th " .....	500	700

Promotion of Collector and annual increase of salary.

Sec. 8. On appointment of any Collector, or upon promotion to a division of a higher class, his salary shall be determined at the minimum of that class, and he may thereafter receive an annual increase of 5 per cent. upon such minimum salary until the maximum of the class is attained.

Eligibility for promotion; "special class" examination.

Sec. 9. No officer shall hereafter be eligible for promotion to a first or second class collectorship unless he shall have previously passed a "special class" examination.

"Excise promotion examination," Record of good conduct "number one."

Any one who has obtained four-fifths of the aggregate marks in the "excise promotion examination," provided for by the 23rd section of these regulations, and whose record of good conduct has been "number one" for the previous three years, shall be eligible for promotion to a collectorship below the second class without further examination.

*Classification for Inland Revenue.*

Chap. 35.

DEPUTY COLLECTORS.

Sec. 10. Deputy Collectors shall be of four classes, their classification being co-ordinate with that of the division to which they are attached. Their salaries shall be as follows:—

	Minimum.	Maximum.
1st Class.....	\$1,300	\$1,500
2nd “ .....	1,200	1,300
3rd “ .....	1,100	1,200
4th “ .....	.....	1,100

Salaries of deputy collectors according to class.

Sec. 11. The term, Deputy Collector—as used throughout these regulations—refers only to those officers bearing that title by virtue of an Order in Council and being next in rank to the Collector at the head office of the division: it does not include officers at comparatively unimportant out-ports, whose salaries shall be determined by the Minister in accordance with the importance and responsibility of the office.

Term, deputy collector, to whom to refer.

Sec. 12. All Deputy Collectors shall, when first promoted to that rank, receive the minimum salary of the class to which they are promoted. After one year's service therein, such salary may be increased by annual increments not to exceed 5 per cent. upon such minimum salary until the maximum of the class is attained.

Promotion of deputy collector, and annual increase of salary.

ACCOUNTANTS OR BOOK-KEEPERS.

Sec. 13. Accountants or book-keepers shall be of four classes, their classification being co-ordinate with that of the division to which they are attached, and shall, as to salary, range as follows:—

	Minimum.	Maximum.
1st Class.....	\$1,000	\$1,200
2nd “ .....	900	1,000
3rd “ .....	800	900
4th “ .....	600	800

Salaries of accountants or book-keepers, according to class.

Sec. 14. On appointment or promotion to any of the aforesaid classes, such officers shall receive the minimum salary of the class to which they are promoted or appointed, and, after one year's service therein, may receive an annual increment of increase not to exceed 5 per cent. upon such minimum salary until the maximum of the class is attained.

Promotion of accountants and book-keepers, and annual increase of salaries.

EXCISEMEN.

Sec. 15. Excisemen “below the grade of special” shall be of three classes.

Excisemen, three classes.

Chap. 35.

*Classification for Inland Revenue.*

Exciseman of the third class.

Sec. 16. Any person who shall have obtained a certificate of qualification from the Civil Service Board of Examiners shall be eligible for appointment as exciseman of the third class (subject to the provisions and restrictions of the Civil Service Act.)

Salary of third class exciseman, during probation.

Sec. 17. During the probationary term provided for by the Civil Service Act, such third class exciseman shall be entitled to receive a salary at the rate of \$500 per annum.

Salary, after probationary term; and annual increase.

Sec. 18. At the expiration of such time he (if retained in the service) shall be entitled to a salary of \$600 per annum. After one year's service he may receive an annual increase not to exceed 5 per cent. thereon, until he shall reach a salary of \$750 per annum, which is hereby established as the maximum of the class.

In case of examination and promotion to second class, annual increase when to commence.

Sec. 19. Provided that, if before such year has expired, he shall by any subsequent examination obtain a second-class or a first-class certificate, then such annual increase may commence forthwith and may be continued until the maximum of the class is attained or until promoted to a higher class.

Exciseman qualified before the Civil Service Board of Examiners or prior to Civil Service Act of 1882.

Sec. 20. Any exciseman who has qualified before the Civil Service Board of Examiners, or who has prior to the coming into force of the Civil Service Act of 1882, obtained a third class certificate from the Inland Revenue Board of Examiners, may at any time hereafter present himself before the Board of Examiners (having complied with the conditions required by such Board) with a view to examination for promotion to the first or second class.

Examination papers to be used.

Sec. 21. The examination papers to be used at examinations for promotion shall be such as the Department of Inland Revenue may arrange with the Board of Civil Service Examiners in accordance with section 39 of the Civil Service Act.

Excise and special class promotion examinations, how to be conducted.

Sec. 22. All excise and special class promotion examinations shall be conducted by the Civil Service Board of Examiners, or whomsoever they may appoint to act in their stead, and if the Board deem necessary, an officer of the Department of Inland Revenue may be present.

EXCISE PROMOTION EXAMINATIONS.

Subjects comprised in, and values specified for excise promotion examinations.

Sec. 23. The papers shall, for "excise promotion examinations," comprise the following subjects and shall be valued as follows:—

	Value.
1. Book-keeping by double entry.....	200
2. Addition, vertical and horizontal .....	25



*Classification for Inland Revenue.*

Chap. 35.

	Value.
3. Inland Revenue laws .....	150
4. Arithmetic .....	150
5. Mensuration .....	150
6. Malt gauging and computation of commodities in bulk .....	150
7. Use of hydrometer and saccharometer	50
8. Malting and supervision of malt houses	125
9. Tobacco and cigar manufacturing and supervision of factories.....	125
10. Stamping, marking, warehousing and removal of exciseable goods .....	125
11. Petroleum inspection.....	50
12. Distillation and supervision of distilleries.....	150
13. Bonded manufactures and testing of products.....	50
Total.....	1,500

Sec. 24. Candidates securing three-fifths of the maximum number of marks at such examination for promotion shall be entitled to second class certificates, and those securing four-fifths of such maximum shall be entitled to first class certificates.

Values necessary for second class and first class certificates.

SALARIES OF EXCISEMEN.

Sec. 25. The salary of a second class exciseman shall begin at \$750 per annum and may rise by annual increments, not to exceed 5 per cent. thereon until the maximum of \$850 per annum is attained.

Salary of second class exciseman, and increase.

Sec. 26. The salary of a first class exciseman shall begin at \$850, and may rise by annual increments, not to exceed 5 per cent. thereon, to \$1,000.

Salary of first class exciseman, and increase.

SPECIAL CLASS.

Sec. 27. The "special class" list shall be limited in number to twenty-four; but on the appointment of any officer whose name is borne upon such list, to any deputy collectorship or office of higher grade, his name shall be removed from such list.

Limit of of "special class" list.

Sec. 28. No officer shall be eligible for appointment as a "special class" exciseman unless he shall have secured four-fifths of the maximum number of marks attainable at any "special class" examination, heretofore held before the Inland Revenue Board of Examiners, or hereafter to be held

Eligibility for appointment as a "special class" exciseman.

Chap. 35.

Classification for Inland Revenue.

by the Board of Examiners appointed in conformity with the provisions of the Civil Service Act; neither shall such four-fifths suffice to render him eligible unless he shall also have obtained at least 50 per cent. of the maximum number of marks upon each subject separately.

Subjects comprised in and values specified for special class examinations.

Sec. 29. "Special class examinations" shall comprise the following subjects:—

1. Book-keeping as practically applied to Excise purposes :

Value.

In distilleries*.....	}	In either.....	325 Marks.
In tobacco or cigar factories* .....			

2. Specific gravity of fluids including principles governing use of hydrometer, saccharometer, petroleometer and other similar instruments 175 "
3. Distillery supervision, including Inland Revenue laws, and regulations governing same.....250 "
4. Supervision of tobacco and cigar manufactures, including Inland Revenue laws, and regulations governing same.....200 "
5. Malting and brewing and survey of malthouses and breweries, including Inland Revenue laws, and regulations governing same.....150 "
6. Mensuration and computation of commodities in bulk as practically applied to stock taking .....250 "
7. Supervision of bonded manufactures, including Inland Revenue laws, and regulations governing same...150 "

Total.....1,500

When a greater number of officers qualify than are required to fill vacancies.

Sec. 30. If at any such special examinations a greater number of officers qualify than are required to fill the vacancies in such class (in order to bring the maximum number of such "special class" officers to 24 as hereinbefore provided); those to be placed upon the "special class" list, shall be those who have obtained the highest number of marks at such examination.

Officer hereafter obtaining a special class certificate.

Sec. 31. No officer hereafter obtaining a special class certificate shall be placed thereon in advance of those who at

\* Officers will be permitted to write either tobacco or distillery books as they prefer, but not both.

*Classification for Inland Revenue.*

## Chap. 35.

the date hereof had qualified for such promotion at any previous special class examination.

Sec. 32. The Minister of Inland Revenue may, from time to time, determine what surveys shall, from their importance, be determined "special surveys." "Special surveys."

Sec. 33. Officers placed in charge of special surveys shall be selected by the Minister from the "special class" list only, and may, while so employed, be paid an additional salary not exceeding \$200 per annum, and on relinquishing the survey the additional salary shall cease. Officers in charge of special surveys, how selected.

Sec. 34. In the selection of officers for "special surveys" as aforesaid, the Minister shall be free to take any officer whose name may be upon the "special class" list irrespective of his comparative rating. Officers on "special class" list.

Sec. 35. No exciseman or other person shall be admitted to a special class examination unless he shall have previously obtained a first class certificate in some general excise promotion examination. Admission to special class examination.

## CONDUCT RECORD.

Sec. 36. Every Collector shall annually make a report in regard to the "conduct" of each subordinate officer, and forward it to the district inspector, who shall transmit it to the Department with his comments. Report in regard to "conduct" of subordinate.

Sec. 37. The "conduct record" shall comprise industry, sobriety, reliability and integrity, and the valuation under these heads shall be as follows:— "Conduct record," what to comprise.

1. Very good.
2. Good.
3. Fair.
4. Indifferent.

## PROMOTION.

Sec. 38. No one shall be promoted to the rank of;— Promotion.

(a.) "Second-class exciseman" whose grading under any of these heads, for the previous two years, or for the full term of his service, if it be less than two years, has been less than number two; Second class exciseman.

(b.) "First class exciseman" whose grading for the previous two years, or for the full term of his service, if it be less than two years, has been less than number one under any of these heads; First class exciseman.

## Chap. 35.

*Classification for Inland Revenue.*

Special class exciseman.

(c.) "Special-class exciseman" whose grading for the previous three years, or for the full term of his service, if it be less than three years, has been less than number one under any of these heads.

Report believed to be unfair, how provided for.

Sec. 39. If the Department has reason to believe that the report of any Collector is unfair, the Commissioner may take such means as may seem best to inform himself thereon, and shall report the result to the Minister of Inland Revenue.

Annual increment may be stopped if report unfavorable.

Sec. 40. The annual increment of salary hereinbefore provided for, may be stopped by the Minister of Inland Revenue in the case of any officer respecting whom the report is of an unfavorable character.

## GENERAL PROVISIONS.

Requirement for appointment to position of district inspector.

Sec. 41. Except as provided in the next succeeding Section, no one shall be eligible for appointment to the position of District Inspector who has not passed the "special class examination" provided for in the 29th Section of these regulations, nor whose good conduct record (if his rank is below that of a collector) has not been number one on all subjects for the previous three years. But Collectors who at this date have held the collectorship of a first, second or third class division for a period of three years, and have performed the duties thereof to the satisfaction of the Department, shall be eligible for the position of District Inspector.

Collectors when eligible.

Regulations deemed to be supplementary to those of Oct. 22, 1888.

Sec. 42. The regulations as to examination for promotion so far as the excise branch of the Inland Revenue outside service is concerned, shall be deemed to be supplementary to those approved by The Governor in Council for the Board of Civil Service Examiners on the 22nd day of October, 1888.

Emolument of officer previously appointed.

Sec. 43. Nothing herein contained shall affect prejudicially the emolument enjoyed by any officer who before the date hereof had been permanently appointed by order of The Governor in Council.

No departure from these rules or rates except on special report by Minister of Inland Revenue.

Sec. 44. No departure from the rules hereby established nor from the rates of salary hereby attached to any office in the outside service of the excise branch, shall, at any time, be made, except upon a special report made by the Minister of Inland Revenue, specifically setting forth the reasons for such departure, and of the sufficiency of such reasons the Governor in Council shall be the judge.

O. C. Sep. 25, 1888, *part.*

## CHAPTER 36.

### BONDED MANUFACTORIES, REGULATIONS.

Government House, Ottawa,  
The 9th day of January, 1889.

On the recommendation of the Minister of Inland Revenue, and under the provisions of Chapter 34 of the Revised Statutes of Canada, intituled "The Inland Revenue Act,"

His Excellency in Council has been pleased to order, and it is hereby ordered, that the following regulations for the government of all Licensed Bonded Manufactures in the Dominion be and the same are hereby adopted; to take effect from the third day of July, 1888.

#### REGULATIONS.

Section 1. Subject to the provisions of the Inland Revenue Act, to these Regulations, and to such further regulations as may hereafter be made by competent authority, Licenses may be granted to manufacture in bond the articles herein enumerated, viz. :—Vinegar and Crude Fulminate in the form of paste. Licenses may be granted.

Sec. 2. Any bonded manufactory licensed under the above recited Act may be closed and the license forfeited whenever it is shown to the satisfaction of the Minister of Inland Revenue that there is just cause for believing that frauds upon the revenue are being perpetrated in connection with such manufactory. Bonded manufactory may be closed and license forfeited when.

Sec. 3. In addition to the license fee named in the Act above cited, every person to whom a "bonded manufacturing license" is granted shall pay to the Collector of Inland Revenue, in monthly instalments, such sums of money as shall be sufficient for the payment of the expenses incurred by the Inland Revenue Department for the effective supervision of the manufactures carried on under such license, and for taking account of the dutiable articles consumed in such manufacture, and of the articles produced therefrom: and the maximum sum to be so paid by the party aforesaid, shall, from time to time, be determined by the Minister of Inland Revenue, as he may deem necessary, and shall be as nearly as may be, in proportion to the magnitude and general character of the business carried on under such license. Payment in monthly instalments for "bonded manufacturing license."

Sec. 4. Goods manufactured in bond shall be removed from the apartments of the manufactory wherein the Goods manufactured in bond.

## Chap. 36.

*Bonded Manufactories—Regulations.*

When and whither to be removed.

same were made as soon as the process of manufacture is completed, and shall then be placed in apartments or store-rooms set apart for that purpose, and be either warehoused as per warehousing regulations then in force or entered ex-factory for duty, the duty to be collected on the monthly returns of the manufacturer, as in the case of other manufactures subject to Excise.

Specification or formula to be submitted, giving details.

**Sec. 5.** With every application for a license to manufacture in bond, there shall be submitted a specification or formula of all the articles to be manufactured thereunder, which specification or formula shall also set forth in detail the percentage or proportion of every ingredient to be used in the manufacture of each article, except that in the case of vinegar, the actual quantity of each ingredient to be used (water excepted) shall be given, for the production of one hundred gallons of standard vinegar.

Articles manufactured to correspond with specification, &c.

**Sec. 6.** The articles manufactured in bond shall be compounded carefully in accordance with the specification or formula submitted with the application for the license and approved by the Minister of Inland Revenue.

Collectors, &c., to see that specification, &c., adhered to.

**Sec. 7.** Collectors and officers in charge of bonded manufactures shall be, and they are hereby required, to see that the percentages, proportions and quantities set forth in the specification or formula are closely adhered to and in no case exceeded; but should it be ascertained by any process or by any test of any of the articles made that a greater proportion or percentage of alcohol has been used in the preparation thereof than is set forth in the specification or formula, the duty exigible upon spirits shall be collected upon the excess of alcohol so ascertained, which may be computed upon the article or articles made during the currency of the license then in force, and the manufacturer shall also be liable to the penalty of forfeiting his license as well as the other penalties set forth in "The Inland Revenue Act."

Liability of manufacturer.

Under side of flooring joists.

**Sec. 8.** The under side of the flooring joists of all bonded apartments in which spirits or other goods subject to Excise duty are stored or placed while under any process of manufacture, shall, if there is any space or other apartment below them, be sheeted or lathed to the satisfaction of the Inspecting Officer.

Dutiable vinegar produced in bonded factory.

**Sec. 9.** Dutiable vinegar produced in any bonded factory shall be in the proportion of 100 gallons of standard vinegar containing 6 per cent. of acetic acid, over and above the quantity taken for "mix" or used in the further pro-

*Bonded Manufactories—Regulations.*

## Chap. 36.

duction of vinegar, to 25 gallons of proof spirits taken into the manufactory and used for its production, with such addition to the standard quantity of vinegar as may, in the opinion of the Minister of Inland Revenue, be fairly due to any other article such as sour beer, or wine, acetic acid, or any like article brought into the manufactory, in addition to the alcohol used for its production.

Sec. 10. In estimating the quantity of spirits used in any bonded manufactory during any period for the production of vinegar, the inspector shall be guided by the books kept by the manufacturer as required by law or by the actual quantity discovered by stock-taking, thus by adding to the quantity on hand at commencement of period the quantity brought in and deducting therefrom the actual quantity found in stock, the difference may be taken as the quantity used, nevertheless due allowance must be made for the alcohol, that may be in process in the mixing or compounding tub at the beginning and end of the period, but no allowance whatever shall be made for the quantity said to be in process in the generators at the beginning or end of the period for which the calculation is being made.

Quantity of spirits used in the manufactory of vinegar how estimated.

Sec. 11. The percentage of acetic acid contained in any vinegar produced in any such bonded factory shall be determined by such established chemical tests, applied by such apparatus, as may be, from time to time, directed by regulations or instructions made in that behalf by the Minister of Inland Revenue.

Percentage of acetic acid, how determined.

Sec. 12. The officers of Inland Revenue may, at any time take such samples from any of the packages of vinegar, or other article made in or brought into any bonded manufactory as may be deemed necessary for determining their strength or quality. Samples of each package so tested shall be sent to the Department for confirmation, and in case the departmental test is at variance with the test so made by the officer in charge of the manufactory, then the test made at the Department shall be final.

Officers may take samples from packages.

Sec. 13. Every package of spirits and every other article or material brought into any bonded factory, whether subject to Excise or Customs duty or not, shall be immediately placed in an apartment appropriated thereto and secured by a crown lock, the sole key whereof shall be in the exclusive custody of an officer of Inland Revenue; and no spirits or other article shall be removed from such locked apartment, except in the presence of the officer who has the key thereof for the time being, and in his presence every

Every package to be secured by Crown lock.

Spirits, &c., how to be removed.

## Chap. 36.

*Bonded Manufactories—Regulations.*

article removed from such locked apartment shall be immediately conveyed to the mixing room or other place where it is to be used and applied to the purpose for which it is intended.

“ Non-potable ” to be printed on package.

Sec. 14. All packages containing spirits shipped to bonded factories shall have the word “ non-potable ” over-printed on both ends of the package, in letters not less than two inches in height and three-fourths of an inch in width and in a color different from that used for the other marks on the package.

Branding, when where and by whom to be done.

Sec. 15. Whether the spirits be domestic or imported, the branding shall be done by the vendor before they leave his premises; but if the bonded manufacturer be himself the importer, he shall have the branding done at a port of entry and before leaving the Customs premises where the spirits are examined.

Spirits removable only upon permit.

Sec. 16. Spirits shall be removed to a bonded factory only upon a permit countersigned by the Collector, which shall have the word “ non-potable ” distinctly written across its face.

Bonded factory and shippers' premises in separate divisions.

Sec. 17. If the bonded factory and the shipper's premises are situated in separate divisions, one copy of the permit (K 4) which will, in this case, be made in duplicate, shall accompany the bill of lading, and the spirits shall be consigned to the collector of the receiving division.

Duplicate must be designated.

Sec. 18. The *duplicate* permit must be designated as such and on stub of permit book may be accounted for by referring to original general number.

Weighing, testing and locking up spirits.

Sec. 19. In all cases, the collector shall detail an officer in addition to the officer in charge of the bonded factory, to weigh and test the spirits, and see them placed under lock in the bonding warehouse of the factory, and to certify the fact in writing upon the permit.

Removal of spirits from bonded factory.

Sec. 20. Spirits shall not be removed from a bonded factory without the written permission of the Minister of Inland Revenue, and then only to another bonded factory or to a licensed distillery.

The word “ non-potable. ”

Sec. 21. The word “ non-potable ” shall be conspicuously placed upon all removal entries, or other official documents, used in connection with the removing of spirits to a bonded factory.



*Bonded Manufactories—Regulations.*

## Chap. 36.

Sec. 22. No articles shall be kept or stored in any bonded manufactory other than such as are to be used in the manufacture of articles enumerated in the specification or formula accompanying the application for license. Article stored must correspond with formula.

Sec. 23. Every Excise mark on every package in which any excisable goods are taken to any bonded manufactory, shall be completely erased and removed from such package as soon as emptied. Erasure and removal of excise mark.

Sec. 24. No person licensed as a manufacturer in bond shall carry on any trade of buying or selling spirits or spirituous liquors on the premises for which such license is granted, nor in any other premises situated within five hundred yards of such licensed premises, except in so far as such buying and selling is a necessary consequence of the business for which the license is granted, and permission to carry on such business is specially granted in the license. Licensee shall not trade in spirits within five hundred yards of premises.

Sec. 25. No duty-paid spirits, except spirits on which the difference between customs and excise duty has been paid under section 234, of "The Inland Revenue Act," shall be taken into any bonded manufactory. Duty paid spirits.

Sec. 26. Whereas by the 234th section of "The Inland Revenue Act," it is provided that "whenever any article not the produce of Canada upon which the duty of excise would be levied if produced in Canada, is taken into a bonded manufactory, the difference between the duty of excise to which it would be so liable and the customs duty which would be levied on such article if so imported and entered for consumption shall be paid as a duty of excise when it is taken into the bonded manufactory; but in the case of spirits to be used for any chemical or manufacturing purpose only, the foregoing provisions of this section may be varied, in whole or in part by the Governor in Council, provided that no increase of duties shall accrue therefrom." His Excellency in Council, in pursuance of the provisions above recited, has been pleased to order, and it is hereby ordered, that the duty exigible upon foreign spirits, when taken into any duly licensed bonded manufactory, shall be determined at the rate of thirty cents (30c.) per proof gallon. Duty exigible on foreign spirits, determined at 30c. per proof gallon in pursuance of section 234 of Inland Revenue Act.

Sec. 27. Stock books must be kept in the factory, in which must be entered:— Stock books.

(a.) The quantity of each description of article or commodity brought into the factory, and in the case of spirits Articles brought into factory.

## Chap. 36.

*Bonded Manufactories—Regulations.*

Particulars, marks, number, &c.

the particulars of every package, stating where manufactured, the strength and quantity, the marks, &c., on the casks, and the general numbers of the permits under which it was conveyed to the factory;

Articles used in production, with particulars, &c.

(b.) The quantity of each description of article or commodity used in the production of the manufactured articles made in the manufactory, giving the particulars of every quantity mixed, showing the marks, &c., of the original packages from which they were taken;

Articles removed.

(c.) The quantity of each description of article or commodity removed from the factory, or disposed of otherwise than for the production of the articles therein manufactured or made;

Quantity each day.

(d.) The quantity of each description of manufactured article or commodity made or produced on each day;

Quantity removed.

(e.) The quantity of manufactured product removed from the factory;

Quantity entered.

(f.) The quantity entered for warehouse; and,

Quantity ex-warehoused.

(g.) The quantity ex-warehoused and entered for duty ex-factory.

Vinegar running from generators.

Sec. 28. All vinegar running from generators and having a strength of three per cent. or more of acetic acid must be conveyed directly to the closed receivers and must there be gauged and tested before being taken for "mix" or otherwise.

Quantity required for "mix."

The quantity required for "mix" when not exceeding the quantity stated in the specification or formula will be given by the officer when required, and at the end of the month the total quantity taken will be deducted from the total production of vinegar in the manufactory, leaving the balance as the actual quantity of dutiable vinegar produced.

Spirits in process in generators.

Sec. 29. On and after the first day of July, 1888, no allowance shall be made to the manufacturer for the quantities of spirits supposed to be in process in the generators, the Department giving up all claim against the manufacturer for an equivalent number of gallons of standard vinegar, nor shall such quantity be taken into consideration in any stock-taking or assessment that may have to be made in case of a deficiency of production.

Conveyance in closed pipes.

Sec. 30. When vinegar is conveyed from the generators through unlocked compartments of the factory, it must be conveyed in closed pipes properly secured.

*Bonded Manufactories—Regulations.*

## Chap. 36.

Sec. 31. Should the inspector of bonded manufactories, or any other superior officer of excise at any time on visiting a bonded manufactory, observe anything which in his judgment might lead to a loss of revenue or interfere with its proper collection, or which might offer facilities for fraud, he is empowered to give instructions as to the changes he may deem necessary for the proper protection of the revenue, and such instructions shall be complied with by the manufacturer or his agent, and if said changes be not made within the space of ten days his license shall be forfeited.

Inspector or other officer may give instructions to avoid loss or prevent fraud.

Sec. 32. The Minister of Inland Revenue may provide such tests for determining the percentage of free spirits contained in vinegar, and may deal with any vinegar found to contain such free spirits as may be deemed necessary for the proper protection of the revenue.

Minister may provide tests.

O.C. July 6, 1888.

## CHAPTER 37.

### WAREHOUSING REGULATIONS, EXCISE.

Government House, Ottawa,  
The 9th day of January, A.D. 1889.

On the recommendation of the Minister of Inland Revenue, and under the provisions of Chapter 34 of the Revised Statutes of Canada, intituled "The Inland Revenue Act,"

His Excellency in Council has been pleased to order, and it is hereby ordered, that the following General Warehousing Regulations for the Government of Excise Bonding Warehouses and the bonding of goods subject to duties of Excise, be and the same are hereby approved and adopted:—

#### GENERAL WAREHOUSING REGULATIONS.

Application must be in writing.

**Section 1.** All applications for the establishment of a warehouse for Excise purposes, must be made in writing by the party requiring it, on such form as the Department may prescribe; and every such application must fully and minutely describe the premises, with their exact locality.

Survey of premises and report to inspector of district.

**Sec. 2.** On receipt of such an application the Collector of Inland Revenue will survey the premises, and if satisfied that they are suitable for the purpose, and that they afford the requisite protection to the revenue, and on their being supplied with suitable locks, he will report the facts to the Inspector of the district, whose authority will be required to use such warehouse as a bonding warehouse for Excise purposes.

Locks and keys to be provided in duplicate.

**Sec. 3.** The door of every such warehouse shall be provided with two locks, one of which shall be supplied to the Collector by the Department, upon requisition being made therefor, the key of which shall be kept by the Collector, and the other provided by the owner of the goods, who shall retain the key thereof, and should there be more doors than one, all other doors and all windows and other means of ingress shall be fastened on the inside in a secure manner and to the satisfaction of the surveying officer.

Designation by letter of alphabet.

**Sec. 4.** When any warehouse has been surveyed and accepted as an Excise Bonding Warehouse, either in connection with a licensed manufactory or otherwise, it shall be designated by a letter of the alphabet.

*Warehousing Regulations—Excise.*

## Chap. 37.

Sec. 5. Over the principal entrance to every warehouse approved for Excise purposes, there shall be placed the following designation—

Principal entrance, how designated.

## EXCISE

## V. R.

## BONDING WAREHOUSE,

With its designating letter, the whole being in legible characters, painted in oil colors and not less than three inches in height.

Sec. 6. Every package entered for warehouse must (in addition to all other marks and numbers) be distinctly marked to the satisfaction of the Collector, with the number of the entry and the date when originally warehoused, except that in the case of cigars the entry number may be omitted. In the case of spirits the above marks shall be written or stencilled on the package in oil paint. The date will be sufficiently indicated by the number of the month and the last two numerals of the year in which the entry was made; thus, goods entered on the 20th January, 1883, may be dated 1-83, showing that the entry was made in the first month of the solar year 1883, or if 20th November, 1883, dated 11-83. All goods in any warehouse, except in the case of cigars, must also be so stowed or arranged that casks, boxes or packages, contained or described in one entry are placed together in separate lots as provided by law. Cigars shall be stowed or arranged in warehouse, in lots according to the denomination of the packages. The packages must also be so stowed or arranged that ample space will be left so that each package and the marks and numbers thereon can be examined. Officers of Inland Revenue may refuse subsequent entries for warehouse when these regulations as to arranging and stowing packages are not complied with.

Every package must be distinctly marked, numbered and dated.

Goods, other than cigars, how stowed and arranged.

Cigars, how stowed and arranged.

Sec. 7. All entries are to be numbered consecutively, and as license bonds are now made to cover the duty on goods remaining in warehouse from time to time during the currency of that license, the taking of warehouse bonds with each warehousing is dispensed with.

Entries to be numbered consecutively.

Sec. 8. No entry shall be passed for warehouse, or ex-warehouse, upon any authorized holiday, nor before the hour of nine o'clock in the morning, nor after four o'clock in the afternoon.

Hours of day for entry, holidays.

## Chap. 37.

*Warehousing Regulations—Excise.*

- Papers, &c., to be signed by owner or in his name.      **Sec. 9.** All entry papers, bonds, notices, and other documents herein required shall be made out and signed by the owner of the goods to which they relate, or in his name by his duly authorized attorney, and all packages shall be marked and numbered as herein required by the owner or his agent.
- Entry must be made on forms sanctioned by department.      **Sec. 10.** Entry of goods for warehouse must in all cases be made on the forms sanctioned by the department, and every such entry shall contain a full and complete specification of the goods so entered, stating,—
- Number.      (a.) The number and description of packages ;
- Marks.      (b.) Marks and numbers ;
- Contents.      (c.) Contents of each in pounds, gallons or number ; and in the case of spirits and vinegar, the contents are also to be stated in gallons of the strength of proof ;
- Duty.      (d.) The duty due on the goods so entered for warehouse.
- Entirety of package.      Every cask, barrel or package containing goods shall be whole and entire at the time it is warehoused.
- Entry in duplicate.      **Sec. 11.** Every warehouse entry shall be in duplicate.
- ENTRY OF GOODS EX-WAREHOUSE FOR EXPORTATION.**
- Goods subject to duties ; how, whence and whither exported, and quantity.      **Sec. 12.** Goods subject to duties of Excise shall only be exported in bond from a port where there is an officer of Customs, and only to British or foreign ports of entry where there are collectors or other officers of the Government having similar functions, and when ex-warehoused for exportation may be such quantity as exporter or manufacturer respectively may require, within the discretion of the collector, but nothing less than the contents of one whole package.
- Only from limits of port where laden.      **Sec. 13.** Goods can only be entered for exportation in bond ex-warehouse from a warehouse within the limits of the port at which they are actually laden on the ship, car or other vehicle in which they are handed over to the Customs by warrant for shipment.
- Casks, boxes, &c., to be branded.      **Sec. 14.** All casks, boxes, bales or other packages of goods entered for exportation shall, before leaving the warehouse, be conspicuously branded by the person entering the same ex-warehouse, and under the personal supervision of the officer in charge, with the letters EXPN., and any further information that may be required in any specific case or cases.

*Warehousing Regulations—Excise.*

## Chap. 37.

Sec. 15. Entry of goods ex-warehouse for exportation must be made on the forms sanctioned by the Department, and must contain an exact specification of the goods intended for exportation (See *ante* Section 10). With every such entry, an export bond shall be taken in the prescribed form.

Entry of goods ex-warehouse; bond to be taken.

Sec. 16. Export bonds shall be conditioned for the due delivery of the goods bonded at the place designated in the entry within a specified time,—which time in any case shall not exceed the time usually necessary for the performance of the voyage or journey by the conveyance adopted (allowing a reasonable time for detention within the discretion of the collector), and for returning the vouchers by the next mail; and in no case shall the period allowed for the cancellation of the export bond exceed six months, unless special authority has been granted by the Department.

Export bonds, how considered.

Cancellation limited to six months.

O.C. April 1, 1884.

Sec. 17. If within the period named in said bond there be produced to the proper collector or officer of Inland Revenue, the duly authenticated certificate of some principal officer of Customs or colonial Revenue at the place to which the goods were exported, or if such place be a foreign country, other than the United States, of any British or foreign consul or vice-consul, resident there, stating that the goods were actually landed and left at some place (naming it) out of Canada, as provided by the said bond, such bond shall be cancelled.

How such bond may be cancelled.

O.C. April 1, 1884; Oct. 19, 1884.

Sec. 18. The entry ex-warehouse for exportation shall, in all cases, be made in triplicate with the collector of Inland Revenue, who shall also take the export bond, and the copy forwarded to the Department shall bear on its face the certificate of an officer of Inland Revenue, that he has examined the goods,—such certificate being made in the form given in Schedule A to these regulations.

Entry ex-warehouse for exportation to be in triplicate.

Sec. 19. Two copies of the entry, together with a warrant to ship (H. 2) shall be sent to the Collector of Customs at the port where the goods were laden on the vessel, car or other vehicle in which they are to leave the division, who, on receipt thereof, shall grant a warrant for the lading of the goods described in the entry on the railway or vessel mentioned therein.

Two copies with warrant to go to collector of customs.

Sec. 20. So soon as the goods have been duly laden, the Collector of Customs shall certify the fact on the entry

When goods laden.

## Chap. 37.

*Warehousing Regulations—Excise.*

papers, one copy whereof shall be filed at the Custom house, and the other returned to the Collector of Inland Revenue of the division whence the goods were shipped.

Collector of customs to see that goods shipped correspond with description in entry.

Sec. 21. The Collector of Customs of the port, will, in each case, be charged with the responsibility of seeing them placed on board the ship, car or other vehicle in which they are to be exported, and must satisfy himself that they correspond with the description contained in the entry, and especially with reference to spirits, that they are of the strength specified.

## ENTRY OF GOODS FOR REMOVAL EX-WAREHOUSE IN BOND.

Entry for removal ex-warehouse to be in triplicate.

Sec. 22. Entries for goods for removal ex-warehouse are to be made in triplicate, with detailed specifications, as in export entries, two copies of which are to be forwarded to the Collector of the Inland Revenue division to which the goods are consigned.

Least quantity that can be ex-warehoused.

Sec. 23. The least quantity of such goods that can be ex-warehoused for removal or transfer in bond shall be that quantity which can, at the receiving point, be legally warehoused as prescribed by law.

Limits within which goods can only be entered for removal ex-warehouse.

Sec. 24. Goods can only be entered for removal ex-warehouse to another licensed warehouse within the limits of a warehousing port of entry, or to an Excise Bonding Warehouse previously licensed or authorized in another Inland Revenue division, or as provided by the next succeeding section, and when shipped to the order of the Collector of Inland Revenue the bond of the manufacturer or merchant for the removal of goods to warehouses in other Inland Revenue divisions upon the prescribed form will now be used in lieu of those required when not so shipped, upon the following conditions, viz :—

Goods so removed to be consigned to order of collector of I. R. division.

(a.) Goods so removed to be consigned to the order of the collector of the Inland Revenue division to which they are to be removed, and in cases in which permits are by law required for the removal of such goods, the permits shall in all cases state that the goods to which they refer are to be so consigned :

Receipt or "bill of lading."

(b.) The receipt given by the agent of the railway company (or other public carrier), usually known as the "bill of lading," is to be made out correspondingly, and is to be placed in the hands of the Collector of the Inland Revenue Division whence the goods are to be shipped, and by him transmitted to the Collector of the division to which they are to be removed :



*Warehousing Regulations—Excise.*

## Chap. 37.

(c.) The Collector upon being advised of their arrival, shall immediately notify the party for whom intended, and after they have been examined by the proper officer and found to be in accordance with the removal papers, and after the duties to which such goods are liable have been paid or the warehouse entry passed therefor, the Collector of Inland Revenue will write across the face of the bill of lading:—

Notice to be given.

“*Deliver to C. D. upon payment of freight and charges.*”

E — — F — — .  
Collector I. R.” :

(d.) Collectors are particularly notified that all orders for the delivery of goods must be made expressly and in writing “*subject to the payment of freight and charges,*” or they may, by the omission to specify such conditions, render themselves personally liable to the company for such payment in the event of default :

Orders for delivery must be in writing.

(e.) The requisition for a permit to remove spirits under § (a.) shall, in every such case, state that the goods are to be “*delivered into the possession of the Collector of the Inland Revenue division*” to which they are to be removed ; and across the face of such requisition is to be written the name of the party to whom (subject to the order of the collector) the consignor desires the goods to be delivered.

Requisition for permit ; what to state.

Sec. 25. Persons not having licensed bonding warehouses, and being desirous of receiving Excise goods in bond, and of paying the duty thereon immediately upon arrival, may do so, provided such goods are shipped to the place where the head office of an Inland Revenue division is situated, and are consigned to the order of the collector of the division : the goods must be constructively warehoused and ex-warehoused for duty at such place immediately upon arrival, and if tobacco or cigars, the stamping, &c., performed there.

Persons not having licensed bonding warehouses.

Sec. 26. When goods removed in bond are conveyed from the place of shipment by a foreign steamer, vessel or railway,—for example, by Ward’s Line of Steamers, from Windsor to Port Arthur’s Landing, thence by Canadian Pacific Railway to Winnipeg,—or when goods so removed are not consigned to the order of the collector of Inland Revenue, a removal bond must be given, with sureties acceptable to the collector of Inland Revenue.

When a removal bond must be given.

Sec. 27. Collectors of Inland Revenue will, on the arrival of the goods, examine them and ascertain whether they correspond with the removal entry ; and as soon as the goods

Collectors of Inland Revenue to examine.

## Chap. 37.

*Warehousing Regulations—Excise.*

Collector to certify. are placed in warehouse, or dealt with as provided in Section 25 hereof, will certify to the fact on the removal entry, and return it to the Collector of the Inland Revenue division from which the goods were shipped.

Removal bonds how cancelled. **Sec. 28.** Removal bonds can only be cancelled upon the receipt of the removal entry, bearing the certificate of the collector, deputy collector or the acting collector of the division to which the goods were consigned, that they have been received and re-warehoused.

## ENTRY OF GOODS EX-WAREHOUSED FOR CONSUMPTION.

Entry of goods ex-warehoused for consumption. **Sec. 29.** Entry of goods ex-warehoused for consumption, will be made in duplicate on the prescribed forms, and every such entry must contain a full specification of the goods as in an export or removal entry.

Collector of I. R. to sign warrant. **Sec. 30.** On receipt of the duty accruing on the goods so entered, the Collector of Inland Revenue will sign the warrant for the delivery of the goods; and the locker in charge of the warehouse must identify every package with the description contained in the warrant, before delivering it.

## MALT.

Malt warehoused how removed in bond. **Sec. 31.** Malt warehoused under "The Inland Revenue Act," may be removed in bond from one Inland Revenue division to another, or from one warehouse to another, and may be exported in bond without payment of duty; but every such removal or export shall be under the same restrictions and conditions as to entry and bonds, as are in force in respect of other goods liable to duties of Excise, except that bags or other packages containing malt are not required to be marked or numbered.

## TOBACCO AND CIGARS.

"Tobacco and cigar regulations" referred to. **Sec. 32.** In addition to the regulations herein established, the warehousing and ex-warehousing of tobacco and cigars shall be further governed by the terms of the "Tobacco and Cigar Regulations" [See *post* page 255] established under the authority of "The Inland Revenue Act."

## SCHEDULE A.

I, \_\_\_\_\_, do hereby certify that I have examined indiscriminately \_\_\_\_\_ packages numbered \_\_\_\_\_ of the goods referred to in this entry, and that I find the contents as therein represented.

O. C. April 1, 1884.

*Warehousing Regulations—Excise.*

Chap. 37.

GOODS SUBJECT TO EXCISE DUTIES AND EXPORTED, ALLOWED  
TO BE RE-IMPORTED FREE OF DUTY.

Sec. 33. Goods, wares and merchandise, the growth, produce or manufacture of Canada, being *subject to excise duty*, exported to any country beyond the limits of Canada and brought back into Canada in the same condition as when exported and in the original packages and upon which no drawback or bounty has been allowed; may be re-imported into Canada free of excise duty; provided that the property in such goods continues in the same person or persons by whom they were exported and that such re-importation takes place within three years of the date of the exportation, and that the identity of the said goods be established to the satisfaction of the Department of Inland Revenue, and all other regulations be complied with which may be prescribed in regard to such importations by the proper Department; and further that such goods, wares and merchandise on re-importation shall be warehoused subject to the excise duties to which they would have been liable had they not been exported from Canada.

Re-importation must take place within three years of the date of exportation, and identity of goods must be established to satisfaction of Department.

O.C. June 6, 1873.

## CHAPTER 38.

### REGULATIONS RESPECTING SPIRITS.

Government House, Ottawa,

The 9th day of January, 1889.

On the recommendation of the Minister of Inland Revenue and under the provisions of Chapter 34 of the Revised Statutes of Canada, intituled "The Inland Revenue Act,"

His Excellency in Council has been pleased to make the following regulations:—

#### REGULATIONS FOR BOTTLING SPIRITS IN BOND.

Licensed distiller may bottle spirits.

Section 1. The Department of Inland Revenue may authorize any person who has obtained a license as a distiller to bottle spirits, the product of his own or any other licensed distillery, such spirits having been continuously in the bonded warehouse of a licensed distiller, subject to the following regulations:—

Premises to be partitioned off and secured by crown lock.

Sec. 2. A portion of the distillery premises approved by the Department must be partitioned off by a substantial close partition and secured by crown lock,—such portion of the premises to be used solely for that purpose.

When accessible.

Sec. 3. The distiller is to have access to the said apartment only in the presence of the officer of Inland Revenue.

Six hours' notice.

Sec. 4. Six hours' notice is to be given of each intended removal of spirits from the bonded warehouse or distillery to the bottling apartments as aforesaid, by entering the same in a notice book (K. 8) to be furnished by the Department.

Notice to set forth number of packages.

Sec. 5. Such notice shall set forth the number of packages to be removed, and the entry number and serial number of the packages.

Bottles and flasks to be weighed in presence of officer.

Sec. 6. The bottles or flasks to be used are, after having been cleaned and dried, to be weighed in the presence of the officer who is to record the number and aggregate weight of such bottles or flasks in a book provided for that purpose by the Department.

Corks, labels, &c., to be weighed.

Sec. 7. He is then to weigh an equal number of corks, labels and all such other articles as may be used in connection with the said bottles or flasks, and to enter the aggre-

*Regulations respecting Spirits.*

Chap. 38.

gate weight thereof in such book, or such other book as the Department may provide for the purpose. (K. 61).

Sec. 8. The Collector will be careful to see that in every case the conditions of sections 20 and 21 of the "General Warehousing Regulations" [See *ante*, Chapter 37] or any amendment thereto, or any amendment hereafter to be made, are faithfully complied with. "General warehousing regulations to be complied with."

Sec. 9. Spirits when entered for removal to bottling room shall be so recorded in Distillers' Bonded Maturing Account No. 2 (K. 20 *f.*) and treated as a removal from warehouse proper, and the quantity so removed shall be carried to the Dr., of "daily record of bottling." (K. 34.) Spirits entered for removal to be recorded.

Sec. 10. The quantity thereof when bottled shall be entered to the Cr. of the aforesaid daily record and carried to Dr. of distillers' supplementary stock book No. 2, (K. 20 *c.*) and credited therein when removed or otherwise disposed of. Quantity to be entered.

Sec. 11. Both books above referred to are to be balanced monthly. Both books to be balanced.

Sec. 12. A tank or tanks of such capacity as the distiller may deem necessary shall be provided by him, into which all spirits, before being bottled, shall be placed and from which the bottles or flasks shall be filled. Tanks to be provided.

Sec. 13. No less quantity than the contents of the original package or packages must be placed in the said tank or tanks. Quantity to be placed in tanks.

Sec. 14. At the close of each transaction the deficiency arising thereon must be determined and recorded, and at the end of each month an ex-warehouse entry must be passed for and duty collected on such deficiencies. Deficiency to be determined at close of each transaction.

Sec. 15. The distiller will, on the first day of each month, make a supplementary return, on a form to be prescribed by the Department, giving such particulars of transactions which have occurred during the month next preceding the date of such return, as may be required by or in the said return. Supplementary return to be made on the first day of each month.

Sec. 16. Cases or packages in which bottled spirits are removed shall contain not less than 12 reputed quart bottles each, or a quantity equivalent thereto when in flasks. Cases, not to contain less than 12 bottles each.

## Chap. 38.

*Regulations respecting Spirits.*

Spirits so bottled subject to general regulations.

Sec. 17. All spirits so bottled when ex-warehoused or removed shall, as to such ex-warehousing or removal, be subject to all regulations and restrictions made and established in respect of other spirits, except as herein specifically provided.

Each bottle or flask to be labelled.

Sec. 18. Each bottle or flask so filled shall have attached thereto a label which shall be put on by the distiller and shall be placed over the cork and extend down each side of the bottle or flask in such a manner as to completely seal the package and prevent the removal of contents without breaking the label.

Label to be furnished by department. Its design and material.

Sec. 19. The label is to be furnished by the Department and to be of such design and material as the Department may decide upon, and to be supplied to the distiller upon a proper requisition being made therefor to the Collector of Inland Revenue,—the said labels to be furnished to the distiller in such quantities as may be required from time to time for immediate use, and to be supplied at the rate of one dollar (\$1.00) per hundred for reported quarts and twenty cents (20c.) per hundred for flasks containing one pint and under.

Each case shall be marked by the distiller.

Sec. 20. Each case shall be marked by the distiller, showing the number of bottles or flasks, strength and quantity in standard gallons contained therein, and also the registered number of distillery, month and year when originally warehoused and when bottled and the number of the Inland Revenue Division.

Quantity to be entered.

Sec. 21. No less quantity than twelve cases shall be entered for warehouse or ex-warehouse by one entry.

O. C. Aug. 25, 1883; Oct. 6, 1884., *part.*

## VENTILATOR FOR MATURING OF SPIRITS.

Description of ventilator to be used under the provisions of sec. 131, paragraph b, sub-sec. 2, of the Inland Revenue Act.

Sec. 22. The following description of ventilator to be used in connection with copper tanks for the maturing of spirits in distilleries as required by section 131, paragraph b, sub-section 2 of the Inland Revenue Act has been and is hereby approved, viz. :—

The ventilating pipe to be 4 inches in diameter with a cap for same  $6\frac{1}{4}$  inches in diameter and 2 inches deep. The said 4 inch pipe to be projected not less than 2 inches above the top of the man-hole of the tank. The cap to project below the top of the inner pipe 1 inch and the space between the top of inner pipe and inside of cap to be not less than 1 inch. Cap to be secured to inner pipe by three lugs

which are to be not more than  $\frac{5}{8}$ ths of an inch broad and to be rivetted to both parts. The flange on the bottom of the inner pipe to be turned over not less than  $\frac{3}{8}$ ths of an inch and to be fastened to the under side of the cover of the man-hole. A disc 8 inches in diameter, concaved one inch, is to be secured with three lugs, each  $\frac{5}{8}$ ths of an inch wide, securely suspended not less than one inch clear of under side of the man-hole covers and directly under the 4 inch pipe. The whole to be in accordance with a model deposited in the Department of Inland Revenue at Ottawa.

O. C. Oct. 28, 1886.

REGULATIONS RESPECTING REMOVAL OF SPIRITS.

Sec. 23. Permits for the removal of spirits from any distillery or from any warehouse wherein they have been bonded or stored, may be granted on the application of the owner of such spirits, or of his duly authorized agent, by the Collector, Deputy Collector or other officer of Inland Revenue for the division in which the spirits then are, who may have been duly authorized thereto by the Department.

Permits for the removal of spirits.

Sec. 24. Every application for such a permit shall state :—

Application shall state—  
Number.

- (a.) The number and description of the packages in which the spirits are contained ;
- (b.) The marks and numbers on each of the packages ;
- (c.) The quantity, in standard gallons, in each package, and its strength ;
- (d.) The total proof gallons included in each removal ;
- (e.) The place wherein it is then stored ;
- (f.) The place to which it is to be removed ;
- (g.) The conveyance by which the removal is to be made ;
- (h.) Whether the duty has been paid, and, if not, how secured ;
- (i.) The time at which it is to be removed ;
- (j.) The name, occupation and place of business of the owner ;
- (k.) The name, place of business and occupation of the person into whose possession the spirits are to be transferred ; and,
- (l.) The name of the person or corporation in whose custody they will be during their removal.

Marks.

Quantity and strength.

Total.

Where stored

Whither removed.

Conveyance.

Whether duty paid.

Time of removal.

Name, &c., owner.

Name, &c., transferee.

Name of custodian.

## Chap. 38.

*Regulations respecting Spirits.*

Application on printed form.

Sec. 25. Every application for a permit shall be made on a printed form, provided by the Department of Inland Revenue, and shall be signed by the person making it.

Permit on printed form supplied by department.

Sec. 26. Every permit granted shall be on the printed forms supplied by the Department of Inland Revenue, which forms shall be printed on paper especially prepared for the purpose, with such type or engraving as may be approved by the Minister of Inland Revenue.

Permit shall state period.

Sec. 27. Every permit shall state the period for which it is to remain in force, which period shall not be more than will, in the opinion of the officer granting it, be sufficient for effecting the removal of the spirits to which it relates.

Permit shall accompany spirits and remain in possession of person in charge.

Sec. 28. The permit shall accompany the spirits to which it relates, and remain in possession of the person having charge thereof, but it shall be produced for examination as often as may be required by any officer having authority thereto, and it shall be delivered to the Collector, or Deputy Collector of Inland Revenue, for the Inland Revenue division into which the spirits are to be removed, or wherein they are removed from one place to another, within the period mentioned in the permit.

Indorsation of examination of permit.

Sec. 29. Every indorsation of the examination of any permit shall be made on the back thereof, and every permit shall be defaced by writing the word "cancelled" across the face of it on the expiration of the period for which it has been granted.

Permits when not to be granted.

General warehousing regulations to be complied with.

Permits shall not be granted for the removal of spirits unless the packages in which they are contained have been marked and numbered, in conformity with the "General Warehousing Regulations" [See *ante*, Chapter 37] nor unless the application for such permits are made in the form, and filled in with all the particulars required by any departmental regulations in that behalf.

O. C. May 30, 1868.

REMOVAL OF SPIRITS UNDER "THE CANADA TEMPERANCE ACT."

Removal in quantities of ten gallons.

Sec. 30. In order to facilitate the operations of "The Canada Temperance Act," distillers are permitted to remove spirits from their respective distilleries into counties where the said Act is in force, in quantities of ten gallons.

O. C. May 13, 1885.



*Regulations respecting Spirits.*

## Chap. 38.

## REMOVAL OF NON-POTABLE SPIRITS.

Sec. 31. The following regulations respecting the removal of non-potable spirits from distilleries for chemical or mechanical purposes, are hereby approved:—

Removal for chemical or mechanical purposes.

(a.) The Minister of Inland Revenue may prescribe, from time to time, tests for determining a standard of purity below which spirits shall be deemed to be "non-potable;"

Test for determining standard.

(b.) No "non-potable" spirits shall be removed from any distillery except to the following parties, viz.:—

To whom removable

1st. To persons who have obtained a license to manufacture in bond;

To persons having license.

2nd. To the Department of Inland Revenue;

To Department.

(c.) All packages containing such spirits shall have the words "non-potable" printed on both ends of the package in letters not less than two inches in height and three-fourths of an inch in width and in a color different from that used for the other marks on the package;

Packages to have printed thereon—"non-potable."

(d.) No spirits other than such as are "non-potable" shall be removed from any distillery to a licensed bonded manufactory unless the formula accompanying the application of such bonded manufacturer expressly provides for the same, or when not so called for in the formula, upon written authority from the Minister which must be obtained in each specific case.

Spirits when not removable.

O. C. July 1, 1887.

## REMOVAL OF DUTY-PAID SPIRITS INTO BRITISH COLUMBIA.

Sec. 32. It is ordered, that authority be and is hereby granted to the Minister of Inland Revenue to issue special permits for the removal of duty-paid spirits in packages of five and ten gallons into British Columbia, provided the regulations assented to by the Lieutenant Governor of the North-West Territories as to transmission through the North-West Territories (by which their identification on arrival beyond the limits of said Territories is required), are fully complied with.

Regulations assented to by Lieutenant Governor of North-West Territories.

O. C. July 18, 1887.

## LICENSES TO MANUFACTURE SPIRITS.

Sec. 33. The Governor in Council has been pleased to name the following places at which licenses to manufacture spirits or other articles subject to Excise within the Provinces of Manitoba and British Columbia may be issued in addition

Places in Manitoba and British Columbia.

Chap. 38.

*Regulations respecting Spirits.*

to those places mentioned in the 26th section of "The Inland Revenue Act," and the same are hereby named and established:—

- Nanaimo,  
B.C. (a.) The Town of Nanaimo in British Columbia ;
- Parishes in  
Manitoba. (b.) The Parishes of St. Paul, Kildonan, St. James, St. Charles, St. Boniface and St. Vital in Manitoba.  
O. C. July 18, 1874.
- Barkerville  
and William's  
Lake. (c.) The Town of Barkerville, and the settlement on William's Lake in British Columbia ;  
O. C., Aug. 10, 1874.
- St. Andrews  
and St.  
Clement (d.) The Parishes of St. Andrews, North and South, and St. Clement, in Manitoba ;  
O. C. Nov. 17, 1874.
- Portage la  
Prairie. (e.) The Parish of Portage la Prairie, in Manitoba ;  
O. C. Sep. 1, 1879.
- Savonna's  
Ferry. (f.) Savonna's Ferry, in British Columbia.  
O. C. Dec. 1, 1883.

## FUSIL OIL, REMISSION OF DUTY ON.

The Governor in Council has been pleased to order and it is hereby ordered that the following regulations in respect of fusil oil be and the same are hereby adopted:—

Application ;  
and regula-  
tions to be  
complied  
with. Sec. 34. No application for remission of duty in respect of fusil oil or other deleterious ingredients extracted from spirits during the process of rectification shall be considered by the Department unless the following regulations shall have been complied with:—

Distiller shall  
give notice. Sec. 35. The distiller shall give notice in writing to the Commissioner of Inland Revenue of his intention to apply for such allowance subject to the restrictions contained in these regulations.

Vessel or  
vessels to be  
provided by  
distiller. Sec. 36. A vessel or vessels shall be provided by the distiller, of such form and capacity and secured in such manner as the Department may require and direct, into which the ingredients referred to shall be conducted, and in which they shall remain until released in the presence of the Inspector of Distilleries or such other officer as may be specifically authorized to that duty by the Department.

*Regulations respecting Spirits.*

## Chap. 38.

Sec. 37. The tail of the worm used in connection with the rectifying still or other apparatus used in the re-distillation of spirits, shall be secured in such manner as may be approved by the Department. Tail of worm to be secured.

Sec. 38. At such intervals as may be found necessary the "fusil oil receivers" shall be opened by the senior officer in charge of the distillery, in the presence of the Inspector of Distilleries, or such other person as may be specifically authorized by the Department. The contents shall then be gauged, and after having been well plunged and mixed, shall be tested, as in the case of spirits, by Sykes' hydrometer. The "fusil oil receivers" to be opened at intervals.

Sec. 39. A sample may be taken therefrom when deemed necessary, in the presence of the Collector, and shall be forthwith transmitted by him to the Department at Ottawa, for the purpose of analysis, together with an abstract of the lock-label, showing:— What sample shall show.

The "wet dip" in inches,  
Indication by hydrometer,  
Temperature,  
Standard gallons,  
Strength, and  
Proof gallons.

Sec. 40. The said contents shall then be destroyed in the presence of the said parties or otherwise disposed of by authority of the Department, and the number of proof gallons so ascertained and destroyed or otherwise disposed of shall be recorded in the diaries of any officer of Inland Revenue in attendance, and shall forthwith be entered in the mash book of the distillery. Contents to be destroyed in the presence of the parties.

Sec. 41. After the expiration of each distillery license, or so soon as the season's operations are concluded, and the results of stock-taking have been duly reported to the Department, and after the books and accounts of the distillery required by law and departmental regulations to be kept, have been checked by the Collector, examined by the District Inspector and reported upon by the Inspector of distilleries and pronounced satisfactory, the quantity so ascertained may, on the written authority of the Department, be written off the stock books of the distillery, subject, however, to the following conditions, viz.:— At expiration of distillery license, the quantity ascertained may be written off the stock books.

(a.) The Inspector of Distilleries, or other officer authorized by the department, shall certify, Inspector shall certify.

## Chap. 38.

*Regulations respecting Spirits.*

That he has tested and gauged.

1st. That he has tested and gauged the said fusil oil and other ingredients, and that the quantity ascertained is correctly represented by the aforesaid lock-label ;

That no foreign substances have been introduced.

2nd. That he has submitted it to such test (chemical or otherwise) as the Department may have required, and has thereby ascertained to his entire satisfaction that no foreign substances have been introduced, and that he is of opinion that the commodities so tested and gauged have been wholly extracted from the spirits produced in the said distillery ;

That the whole has been destroyed.

3rd. That the whole quantity so ascertained has been destroyed in his presence or otherwise disposed of as aforesaid ;

Allowance for fusil oil.

(b.) In no case shall the allowance for fusil oil exceed three per cent. of the entire quantity of rectified spirits warehoused.

Allowance shall not exceed deficiency.

(c.) Neither shall an allowance be made in any case (even if within the said limit of percentage) which shall exceed the actual deficiency shown upon the stock statements of the distiller.

"Close spirit receiver," cond

Sec. 42. All the conditions required by the law and regulations as to the "close spirit receiver," so far as such are deemed by the Department to aid in the protection of the revenue, shall be observed with respect to the receiver provided for in section 36 of these regulations.

O. C., Sep. 20, 1882, *part.*

## CHAPTER 39.

### TOBACCO AND CIGAR REGULATIONS.

Government House, Ottawa,

The 9th day of January, 1889.

On the recommendation of the Minister of Inland Revenue, and under the provisions of Chapter 34 of the Revised Statutes of Canada, intituled "The Inland Revenue Act,"

His Excellency in Council has been pleased to make and establish the following regulations in respect of tobacco and cigars and tobacco and cigar manufactories and the same are hereby made and established.

#### ARTICLE I.—RAW MATERIAL.

A.—FOR DEALING WITH RAW LEAF TOBACCO, SCRAPS, CUTTINGS, STEMS, LIQUORICE OR OTHER MATERIALS, WHEN BROUGHT INTO, PRODUCED OR USED IN, OR REMOVED FROM A TOBACCO OR CIGAR MANUFACTORY.

Section 1. So soon as any tobacco or other raw material is received at the manufactory, the quantity thereof shall be ascertained by the manufacturer, under the immediate supervision of the officer in charge, whose duty it shall be to test the accuracy of all weights, and when required so to do by the manufacturer, to ascertain the deduction to be made for moisture.

Quantity of tobacco to be ascertained by manufacturer.

Sec. 2. Standard tobacco, as defined by the Act, means tobacco which contains 10 per cent of moisture, but it is not intended to notice a discrepancy of 1 or 2 per cent. from this standard in either direction.

Standard tobacco.

Sec. 3. When, however, there is an evident excess of moisture beyond the proportion above mentioned, viz., 10 per cent., the manufacturer may, if he desires, have this excess ascertained, and if found to be as much as, or more than 12 per cent., the excess over 10 per cent. is to be deducted from the weight found: in other words, when an account is taken of excessive moisture at all, 10 per cent is to be understood as being the standard, and all over that is to be allowed.

Evident excess of moisture beyond ten per cent.

Sec. 4. All samples taken for the purpose of ascertaining the percentage of moisture contained therein are to be furnished by the manufacturer or owner free of cost.

Samples furnished free of cost.

## Chap. 39.

*Tobacco and Cigar Regulations.*

Samples need not be taken from each package.

Sec. 5. It is not necessary that samples should be taken from each package ; when two or more packages are, after careful examination, considered by the officer to be about the same as regards moisture, one sample can be taken to represent the lot. It is the desire of the Department that the manufacturer should suffer as little loss as possible by taking his tobacco for the purpose of ascertaining the moisture, and whenever any manufacturer is satisfied that the raw leaf and other unmanufactured tobacco brought into his manufactory at any time is not above or below the standard, he may enter the actual weight upon his books, without submitting a sample to be tested, but in such case the weight shall be considered as standard and no allowance made thereafter if the production in the manufactory should fall below the standard established by law.

Form of certificate under section 312 of Inland Revenue Act, provided for.

Sec. 6. The certificate to be given to the Collector of Customs, under Section 312 of "The Inland Revenue Act," is in future to be made out on the form (No. 28) now issued. The Collector shall see that this certificate is carefully filled up and attached (with gum) to the customs entry covering the raw leaf tobacco to which it relates.

Stems, scraps, &c., to be entered in standard pounds.

Sec. 7. All stems, scraps, cuttings, clippings, waste or other refuse of tobacco, when produced in, taken for use, removed from, or destroyed at or from any tobacco or cigar manufactory, shall be entered in standard pounds.

Raw leaf tobacco &c., to be stated in standard pounds.

Sec. 8. All raw leaf tobacco, stems, scraps, cuttings, clippings, waste and tobacco in process of manufacture at the time when stock is taken, shall be stated in standard pounds, and in all such cases care must be taken that samples for drying fairly represent the degree of moisture in each lot from which samples are taken.

In taking account of moisture, samples must be carefully taken, weighed and dried; weight to be from  $\frac{1}{4}$  lb.

Sec. 9. In all cases where it becomes necessary to take an account of the moisture, samples must be carefully taken in such a manner as to give a fair sample—as to moisture—of the whole: these samples should each be from one-quarter to one-half of one pound in weight, and must be carefully weighed immediately they are taken, and the samples are to be taken from the packages at the time of weighing thereof, and not at a date previous to or after such weighing: they are then to be carefully dried in the drying oven with which important offices have already been or will be supplied; the difference between the weight when put in and removed from the dryer will represent the moisture contained therein.

*Tobacco and Cigar Regulations.*

## Chap. 89.

Sec. 10. The principal offices are supplied with scales specially constructed for the purpose, by means of which the percentage of moisture in excess of the standard can be read on the arm of the scale, instead of having to resort to computations to ascertain it.

Offices supplied with scales.

This scale is so constructed that, by filling the counterpoise bucket at the end of the arm with shot sufficient to balance the oven tray on the platform, the weight as shown will be the net weight of the tobacco: by means of the adjustable weight on the arm the sample can be either one-quarter, one-half, or one pound, and by placing this weight at 100 when weighing the tobacco for drying, and then reading after drying on the lower scale on the arm, the exact percentage of moisture to be deducted can be seen at a glance.

Construction of scale.

Sec. 11. The officer in charge of each tobacco or cigar manufactory shall keep a record of the weight of all packages of raw leaf tobacco or other raw material received into manufactory: the entry shall be made in a book provided by the department for that purpose.

Officer to keep record of weights of raw leaf tobacco.

Sec. 12. Where stemmed raw leaf tobacco is received at any cigar manufactory the entry thereof, when received and, when subsequently taken for use, is to state its character as such, and the quantity so received and taken for use is to be likewise referred to by a foot note on the manufacturer's monthly return, (F. 4.) and on annual stock statement, (G. 15.)

Stemmed raw leaf tobacco; entry to state character.

Sec. 13. All packages of raw material received into warehouse shall be consecutively numbered, beginning with number one, on the 1st day of July, in each year.

Packages to be numbered.

Sec. 14. A ticket, or tag, shall be placed upon each package, showing the date when put in warehouse, the original and serial number of the package, the gross weight, the tare, and the net actual weight of tobacco or other raw material contained therein, and in the case of raw leaf tobacco, scraps and cuttings, stems and other unmanufactured products of raw leaf tobacco, the pounds, percentage of moisture and pounds of standard tobacco, contained therein. In order that there shall be uniformity of practice, the following is the form of ticket or tag to be used, until otherwise modified or altered by departmental regulations, which tag will be supplied by the department upon proper requisition being made therefor:—

Ticket or tag to be placed on each package and to show date, number, gross and net weight, tare, &c.

Chap. 39.

*Tobacco and Cigar Regulations.*

Form of ticket or tag.

No. 25. TAG FOR PACKAGES Excise.  OF  RAW LEAF TOBACCO, &c.	WRITE IN PARTICULARS HERE.		Details when less than contents of whole package are taken.	
	Number of Packages.		Date.	Quantity. Lbs.
	Original No.....	Serial No.....		
Manufacturer's name .....	.....	.....	.....	.....
Date when warehoused .....	.....	.....18	.....	.....
Nature of contents.....	.....	.....	.....	.....
Gross weight.....	.....	..... lbs.	.....	.....
Tare.....	.....	..... lbs.	.....	.....
Net weight.....	.....	..... lbs.	.....	.....
Deduction for moisture.....	..... per cent.=	..... lbs.	.....	.....
Standard.....	.....	..... lbs.	.....	.....
Signature of officer in charge.....	.....	.....	.....	.....

In case of liquorice, sugar, gum, &c.

In the case of liquorice, sugar, gum or other raw materials other than leaf tobacco, cuttings and other unmanufactured products of leaf tobacco, the last two lines will be left blank, as no deduction for moisture is to be made from these articles.

Leaf tobacco, &c, to be secured by crown lock.

**Sec. 15.** All leaf tobacco and other materials are, as soon as received and an account of them taken, to be placed in the warehouse provided for that purpose and secured by crown lock, the key thereof being in the possession of the officer in charge.

Raw leaf tobacco, &c., to be delivered in such quantities as may be required for use.

**Sec. 16.** Raw leaf tobacco and other raw materials are to be delivered to tobacco and cigar manufacturers in such quantities as may be required for use; and as they will have access to the warehouse daily, if required, and can take tobacco from as many different packages as if it were under their sole control, it is not necessary that greater quantities should be taken than is required for each day's use: when taken for use by whole packages it must be entered ex-warehouse at the weight marked on the packages when received:

Collector may authorize proportion to be stored in other parts of factory; regulations in such case.

(a.) If, in the opinion of the Department, the conveniences afforded by any tobacco or cigar factory will not permit of the storing of all raw leaf tobacco and other raw material within the locked apartment designated for that purpose, without unduly harassing the manufacturer, then the collector may authorize such proportion as he may see fit to be stored in other parts of the factory; and in such case each such package so withdrawn, if not required for proximate use, shall have placed upon it by the manufacturer a red card of not less than four inches square, with the words "in bond" printed thereupon in letters of not less than



*Tobacco and Cigar Regulations.*

Chap. 39.

one inch in height; and the removal of such card, or of any of the contents of such package, before the weight contained in such package has been entered to the debit of the "Daily Record" as "taken for use," shall be deemed to be an illegal abstraction of goods from warehouse, and shall subject the manufacturer to like penalty as by law provided;

(b.) When the contents of any package are taken for use at various times, the last entry from the package shall be made to balance the quantity originally warehoused and marked on such package;

Contents taken at various times.

(c.) A manufacturer will be permitted to take whole packages or such quantities as he may require for use, but if it is at any time evident that a manufacturer is entering for use quantities far in excess of what his business demands, the collector will apply to the Department for specific instructions.

Manufacturer may take whole packages.

Sec. 17. All stems produced in any tobacco or cigar manufactory must, unless used or intended for immediate use in the manufactory, or held by the manufacturer with a view to their exportation, be weighed up not less frequently than once a month and either destroyed or locked up as herein-after provided.

Stems to be weighed once a month.

All stems, scraps, cuttings and waste produced in any tobacco or cigar manufactory and charged back to stock and carried to debit of stock book No. 1, shall, unless immediately destroyed, removed or entered for use, be placed in raw-leaf warehouse.

Stems, scraps, cuttings, waste.

Sec. 18. The destruction shall be by burning, except when some other mode is specifically permitted. Collectors are authorized to deliver from time to time, to known gardeners, tobacco stems to be used for horticultural purposes only. The quantity furnished for such purposes and the security to be taken for the proper use of such stems to be within the discretion of the collector. Forms of bonds (A. 8,) and permits (Bb. 13,) can be had on requisition being made therefor to this Department. Stems may also be delivered to reliable persons for fertilizing purposes in such quantities as the collector may, in his discretion, deem advisable. In this case, however, it is required that the stems should be mixed with manure in the presence and to the satisfaction of an officer of this Department, which being done, no bond will be required. Either the manufacturer or the person receiving the stems, as may be mutually agreed upon, must bear the expense consequent upon the officer's attendance at the place where the stems are so destroyed. Stems delivered for either horticultural or fertilizing purposes will

Mode of destroying stems, &c.

Tobacco stems for horticultural purposes.

Tobacco stems for fertilizing purposes.

## Chap. 39.

*Tobacco and Cigar Regulations.*

be included in the "Monthly Return of Tobacco Stems," (G. 17.)

Stems, &c., to be carried to debit, &c,      **Sec. 19.** Stems, scraps, cuttings or waste must, before they can be entered for removal or destruction, be carried to debit of stock book No. 1.

Raw leaf tobacco removal from factory.      **Sec. 20.** Raw leaf tobacco, after being charged in a tobacco or cigar manufacturer's daily record as taken for use, can not thereafter be removed from factory in an unmanufactured state, unless by special permission, in each case obtained from the collector.

To be entered in standard pounds.      **Sec. 21.** Raw leaf tobacco and scraps and cuttings, when removed from a tobacco or cigar manufactory, must, before removal, be re-weighed and tested and deficiency (if any) ascertained and the quantity shall be entered in standard pounds as thus determined, and must be consigned to the order of the collector of the division to which entered for removal. If any deficiency is found to have arisen on the tobacco or scraps and cuttings while in warehouse, application must be made to the Department for authority to pass a free entry or to be otherwise dealt with as the Department may determine.

Weighing of packages, when taking stock.      **Sec. 22.** Where tobacco and other raw materials are secured under crown lock, it is not necessary to weigh each package in the warehouse when taking stock; only a sufficient number to satisfy the officer that the packages remain as shown on tag: when not secured by crown lock, each package must be carefully weighed.

Stems and waste to be charged back to stock book, No. 1.      **Sec. 23.** As stems and waste do not enter into computation in arriving at the production in cigar manufactories, collectors are requested to see that all such produced are properly charged back to stock book No. 1, so that no balance of same will remain to be included as in process of manufacture at time of stock-taking.

Flavorings not to be examined.      **Sec. 24.** Flavorings received at a tobacco or cigar manufactory are not to be examined by the officer in charge, but the weights are to be recorded by the manufacturer, as in the case of other raw material.

**B.—FOR SALE OF SCRAPS, CUTTINGS, STEMS AND SWEEPINGS OF TOBACCO IN BULK, BY ONE MANUFACTURER TO ANOTHER.**

Manufacturer desiring to sell refuse, scraps, &c.      **Sec. 25.** Whenever any manufacturer of tobacco or cigars desires to sell his refuse scraps, cuttings, stems and sweepings of tobacco, in bulk and as material, to another manu-

*Tobacco and Cigar Regulations.*

Chap. 39.

facturer of tobacco or cigars, to be further manipulated or manufactured, he is hereby permitted to do so under the following rules and conditions, viz :—

(a.) The scraps and cuttings, stems and sweepings of tobacco must be put up in separate packages, and in no case mixed, nor must any raw leaf be added thereto to fill up the package. The different classes of tobacco must be kept separate and distinct ;

Separate packages.

(b.) The removal must be made in bond, and the goods consigned to the order of the collector of Inland Revenue of the division to which the goods are to be removed, in the same manner as provided for manufactured articles ;

Removal in bond.

(c.) The packages containing the goods are to be consecutively numbered, and each to have marked thereon the gross weight, the tare, and the net weight, and also the standard weight of unmanufactured tobacco contained therein, and shall, in addition, have marked thereon the registered number of the manufactory, number of warehouse entry, date, and number of the Inland Revenue division ;

Packages to be numbered and marked with gross and net weight and tare, &amp;c.,

(d.) No person other than manufacturers of tobacco or cigars will be allowed either to purchase or sell this description of tobacco unless it is packed, stamped, and the duty paid thereon, as provided by law.

Privilege extended to manufacturers only.

Sec. 26. Whenever any manufacturer of tobacco or cigars desires to sell his refuse scraps, cuttings, stems, or sweepings of tobacco for export to a foreign country, he will enter the same for export in bond in the same manner and under the same regulations as govern the shipment and exportation of manufactured goods.

Sale for export to a foreign country.

Sec. 27. Cigar manufacturers will not be permitted to put up small packages of cuttings for consumption.

Small packages.

C.—FOR REMOVAL OF SNUFF-FLOUR AND FINE-CUT SHORTS, FROM ONE TOBACCO MANUFACTORY TO ANOTHER.

Sec. 28. Snuff-flour not prepared for use, but which needs to be subjected to further process of sifting, pickling, scenting or otherwise, before it is in a condition fit for use or consumption, may be sold by one tobacco manufacturer directly to another, under the following regulations :—

Snuff-flour not prepared for use may be sold under the following regulations.

(a.) The snuff-flour shall be put up in packages, and these packages consecutively numbered and marked with the gross weight, the tare, and the net weight thereof, and

How to be put up.

## Chap. 39.

*Tobacco and Cigar Regulations.*

shall, in addition, have marked thereon the registered number of the factory from which removed, the number of the warehouse entry, date, and number of the Inland Revenue division :

How removed.

(b.) The snuff-flour shall be removed from one manufactory to another in bond—the necessary warehouse and removal entries and removal bond being passed therefor, as in the case of other removals in bond.

Fine cut shorts, &c., how to be packed for sale.

Sec. 29. Fine-cut shorts, the refuse of fine-cut chewing tobacco, may be sold in bulk, like scraps, cuttings, &c., by one manufacturer of tobacco to another ; but when put up for sale and consumption, they must be packed in packages containing one-twentieth, one-sixteenth, one-tenth, one-eighth, one-fifth, one-fourth, one-half or one pound each, and stamped like other small packages of tobacco : the law does not authorize the packing of fine-cut shorts in five-pound or ten-pound packages, the same as fine-cut chewing.

Sec. 30. Fine-cut shorts may be sold in bulk by one tobacco manufacturer to another, under the following regulations :—

Packages to be numbered and marked.

(a.) They shall be put up in packages, and these packages consecutively numbered and marked with the gross weight, the tare, and the net weight thereof (the net weight being stated in apparent and also in standard pounds), and shall, in addition, have marked thereon the registered number of the manufactory where put up or from which removed, the number of the warehouse entry, the date and the number of the Inland Revenue division ;

To be removed in bond.

(b.) The fine-cut shorts, like snuff-flour, shall be removed from one manufactory to another in bond.

Snuff-flour or fine cut shorts how placed, &c.

Sec. 31. Upon the receipt of the snuff-flour or fine-cut shorts at the manufactory to which it is consigned, it shall be placed in the raw-leaf warehouse, and shall be delivered to the manufacturer in such quantities as he may require for treatment.

Snuff-flour or fine cut shorts to be treated as raw material.

Sec. 32. In all books, snuff-flour and fine-cut shorts shall, when entered for removal for further treatment at another licensed tobacco manufactory, be treated as raw material, and as the transactions are not likely to be such as to render it necessary to encumber the books with special columns for these articles, they will be dealt with in the books in the following manner, when removed, viz. :—

Red ink.

(a.) The entries to be made in red ink ;

*Tobacco and Cigar Regulations.*

Chap. 39.

(b.) Enter in column No. 21 in daily record when produced, and in columns Nos. 10 and 26 in stock book No. 1, when "charged back to stock" and "removed from manufactory" respectively; Mode of entry in daily record.

(c.) At receiving manufactory enter in columns Nos. 9 and 25 in stock book No. 1, when "brought in" and "taken for use," respectively, and in column No. 7 in daily record, when "taken for use;" Mode of entry at receiving manufactory.

(d.) Explanations to be made in columns Nos. 2 and 19 in stock book No. 1, and columns Nos. 2 and 15 in daily record; Explanations to be made.

(e.) Totals of fine-cut shorts and snuff-flour to be also shown in red ink, and separate and distinct from the totals of scraps, cuttings and waste, as shown in the columns referred to. Totals to be shown in red ink.

## D.—RAW LEAF TOBACCO SAMPLES.

Sec. 33. As some misapprehension appears to exist as to the manner of dealing with small quantities of raw leaf tobacco imported as samples, and on which the Department has no authority to collect duty, the following regulations are now issued for the guidance of Customs officers at the ports where such samples are imported:— Raw leaf tobacco imported as samples.

(a.) Such samples must be bonded in a Customs warehouse in the same way as all other imported raw tobacco is bonded; Samples must be bonded.

(b.) The removal of such samples from Customs warehouse in quantities not exceeding one hundred and fifty pounds at any one time may be permitted on a removal bond being executed with the Collector of Customs by the parties who desire to remove the tobacco, and another surety who must be a resident householder, or some responsible person resident at or near the port at which the bond is given; and each separate parcel or sample must be securely sealed and stamped, so that it may be identified; Removal of such samples.

(c.) The removal entry shall accurately state the quantity, description and quality of the tobacco, as known to the trade, to be removed, which description shall also include particulars necessary for the identification of the several samples or parcels; Removal entry, what to state.

(d.) Each removal paper shall have indorsed on it, by the Collector of Customs, the date at which the removal bond will expire, and shall set forth that the holder of the paper Removal paper to be indorsed.

## Chap. 39.

*Tobacco and Cigar Regulations.*

is permitted to carry with him the tobacco therein described for the purpose of exhibiting it to his customers ;

**Conditions of the bond.** (e.) The conditions of the bond are to be that the tobacco shall, within a specified time, be delivered to and entered upon the books of a licensed tobacco or cigar manufacturer, or that it shall be exported ;

**Bond, when to be cancelled.** (f.) And the bond shall only be cancelled on the production of the certificate of an officer of Excise that the tobacco has been entered on the books of a licensed tobacco or cigar manufacturer, or on the certificate of a Customs officer, that the tobacco has been exported and within the time mentioned ;

**Warehouse regulations to be complied with.** (g.) In addition to the above certificate, when the tobacco is exported all the warehouse regulations then in force in reference to the exportation of Customs goods shall be complied with before the bond is cancelled ;

**Whenever bond is not cancelled, collector of customs to call for payment of penalty.** (h.) Whenever the bond is not cancelled in the manner above stated, and within the time stated in the bond, it will be the duty of the Collector of Customs before whom it is taken, to call upon the parties for the immediate payment of the penalty inserted in the bond, which, in accordance with the 312th section of the Inland Revenue Act, will be for a sum equal to 30 cents per pound on the tobacco to which it relates ;

**Samples sent out by travelling agent.** (i.) When samples are sent out by the travelling agent of any person duly licensed to warehouse raw leaf tobacco under the Inland Revenue Act, an accurate account of such samples is to be taken by the proper officer of Excise and entered on the warehouseman's books, and the same means adopted for their identification, as is directed with reference to samples just imported ;

**Bond with reference to such samples.** (j.) A bond will be taken with reference to such samples of the same nature as is directed with reference to samples just imported ; but in lieu of making it an alternative that such samples shall be exported, the conditions shall be that they shall be returned to the warehouse of the licensed warehouseman, and by him entered on his books ;

**Importer may pay fee of 30 cents per lb., and exhibit samples without giving removal bond.** (k.) Whenever any importer desires to do so, he may pay the fee of thirty cents per pound on the raw-leaf samples, and have them stamped with the special raw-leaf tobacco sample stamp provided for that purpose, and may then bring in and exhibit his samples without any restrictions as to the giving a removal bond, procuring the certificate of officers of Excise as to its being entered on a manufacturer's book, or for the exportation of the sample ;

*Tobacco and Cigar Regulations.*

## Chap. 39.

(l.) The special raw-leaf tobacco sample stamps are to be destroyed when the tobacco is taken for use in any tobacco or cigar manufactory. Sample stamps to be destroyed.

## ARTICLE 2.—STAMPS.

## A.—STAMPS FOR TOBACCO.

Sec. 34. By virtue of the authority of the Inland Revenue Act, the following denominations of stamps for tobacco have been prepared, and their use is hereby prescribed, Denomination of tobacco stamps prescribed.  
viz. :—

(a.) Small stamps, in sheets, of the denominations of one-twentieth and one-fortieth of a pound, for cigarettes ; one-eighth and one-sixteenth of a pound for snuff, and one-eighth and one-tenth of a pound for cut tobacco ; For cigarettes, snuff, &c.

(b.) Strip stamps, in sheets, of the denominations of one-twentieth, one-sixteenth, one-tenth, one-eighth, one-fifth, one-fourth, and one-half pound, for use on all legal packages of cut and granulated tobacco, cigarettes, shorts, clippings, cuttings, and sweepings of tobacco ; Legal packages of cut and granulated tobacco, &c.

(c.) Strip stamps, in sheets, of the denominations of five and ten pounds for pails, kegs, or drums of fine cut chewing tobacco ; Fine cut chewing.

(d.) Strip stamps, in sheets, of the denominations of one sixteenth, one eighth, one fourth, one half and one pound, for packages of snuff, as well as on packages of cut and granulated tobacco, shorts, clippings, cuttings and sweepings as per clause (b) above. Packages of snuff, &c.

(e.) Strip stamps, in sheets of the denominations of five and ten pounds, for packages holding snuff when containing not more than forty per cent. of moisture ; Snuff, not more than 40 per cent. of moisture.

(f.) Strip stamps, in sheets, of the denominations of five, ten and twenty pounds, for packages holding snuff, when containing more than forty per cent. of moisture ; Snuff, more than 40 per cent. of moisture.

(g.) Coupon stamps, in books, of the denominations of five, ten, fifteen and twenty with one-half pound coupons ; thirty-five, sixty, seventy and one hundred with one pound coupons. Coupon stamps.

Sec. 35. Except in the case of cigarettes no stamp of a denomination less than one-eighth of a pound is provided for tobacco solely the product of Canadian raw leaf. Minimum stamps.

Sec. 36. It is the duty of every officer in charge of any tobacco or cigar manufactory to see that no greater quantity Duty of officer.

## Chap. 39.

*Tobacco and Cigar Regulations.*

Officer to see that packages are properly stamped.

tity of tobacco or cigars is contained in the packages to which the stamps are attached than the stamp is intended to cover, and the packages must in all cases be full, *i. e.*, a ten pound stamp must not be placed upon a package capable of holding fifteen to twenty pounds even if the package only contains ten pounds of tobacco. Should any package containing tobacco or cigars at any time be discovered with stamps thereon for a quantity less than the package contains, it is the duty of every officer to detain such packages as forfeited, and report the circumstances to this Department through the Collector of the division.

Colors of stamps.

Sec. 37. Stamps for use on packages of tobacco or cigars shall be of such color and description as the Department of Inland Revenue may provide.

## B.—STAMPS FOR CIGARS.

Denomination of cigar stamps.

Sec. 38. The Commissioner of Inland Revenue has caused to be prepared for the payment of duty on cigars, the following denominations of cigar stamps:—

Boxes from 3 to 200 cigars.

(a.) Strip stamps, issued in sheets, for boxes or packages containing three, six, ten, twenty-five, fifty, one hundred and two hundred cigars each ;

Sample boxes.

(b.) Strip stamps, issued in sheets, for sample boxes of cigars containing twenty-five cigars each ;

Imported cigars.

(c.) Strip stamps, issued in sheets, for boxes of imported cigars (rate of duty being on the pound as heretofore) ;

Requisition, what to specify.

(d.) Manufacturers must each time make requisition for a quantity of either three-cigar or six-cigar stamps not less than sufficient to cover 1,000 cigars.

Colors of stamps on sample boxes.

Sec. 39. Stamps for use on sample boxes of cigars are colored yellow, with the letter " F " thereon when used on cigars the product of foreign leaf, and " C " thereon when used on cigars the product of Canadian leaf.

## C.—STAMPS FOR CANADA TWIST.

Stamps for Canada twist.

Sec. 40. Stamps for Canada twist are supplied of the denominations one-fourth, one-half and one pound each.

Stamps supplied to postmasters, &c.

Sec. 41. Stamps of the above denominations will be supplied to postmasters or other persons throughout the country, who will keep a record of the names of the persons to whom they sell stamps, and of the license number and number and denomination of stamps sold to each (selling



*Tobacco and Cigar Regulations.*

## Chap. 39.

them only to licensed persons), for which purpose a suitable book is supplied; the register of sales above referred to is to be open at all times for the inspection of officers of Inland Revenue.

Sec. 42. In regard to the sale of stamps for "Canada Twist" the following regulations are to be observed —

Regulations for sale of stamps for "Canada twist."

(a.) A return of the sales is to be made daily (or as often as they occur) as is done in the case of other collections. Form D. 12 is to be used, and must show: (a) The names of the purchasers; (b) The denomination and consecutive numbers of the stamps; (c) The total weight represented by the stamps; and (d) The total amount of duty:

Return of sales, what to show.

(b.) It is not necessary to make a separate entry paper for each sale when more than one sale is made in a day; but the sales to persons who are authorized to sell stamps on commission should not appear on the same entry with sales to other persons:

Separate entry paper not necessary.

(c.) In the case of stamps sold on commission, the full amount of the duty chargeable upon the weight represented by the stamps is to be deposited to the credit of the Receiver General, the Collector taking the amount of the commission from his advance for contingencies:

Stamps sold on commission.

(d.) At the end of each month (or oftener if necessary) the Collector will forward to the Department a statement of the amounts allowed for commission quoting the number of each entry, the total amount of duty which it represents, and the amount of commission allowed thereon. The statement will be audited, and, if found correct, a cheque for the amount will be issued:

Statement at end of each month.

(e.) If at any time stamps are used for "Canada Twist" which has been seized, a separate entry paper must be used for them, or they may appear on the entry paper used to account for the proceeds of the seizure.

Stamps for "Canada Twist" seized.

Sec. 43. Canada twist cannot be manufactured for sale by the cultivator unless he has taken out a license, paying therefor the sum of two dollars, and the law imposes a heavy penalty on any cultivator who shall manufacture for sale any Canada twist without taking out such license; Collectors of Inland Revenue and others acting for this Department will, therefore, take all the means in their power to acquaint cultivators with the necessity of taking out such license and stamping the Canada twist before offering it for sale.

Canada twist, not to be manufactured without license.

## Chap. 39.

*Tobacco and Cigar Regulations.*

Directions as to attaching stamps.

Sec. 44. The stamps will be attached to the roll or coil by interlacing it through the coil when made and bringing the two ends of the stamp once around the coil and fastening securely by gum or paste. The stamp is to be attached in all cases by means of good strong gum, and every officer of this Department is instructed, so far as it lies in his power, to impress upon cultivators who manufacture Canada twist for sale, that the firm adherence of the stamp to the tobacco is necessary in order to protect it from seizure, for if any packages are found anywhere except in the possession of the licensed cultivator, manufacturer, or in the premises of a licensed tobacco manufacturer of Canadian leaf tobacco only, without a stamp properly attached, they will certainly be seized and confiscated, in accordance with the law.

Penalty for opening package without breaking stamp.

Sec. 45. The law also imposes heavy penalties on any person who shall open a package of tobacco without breaking the stamp thereon, or in whose possession a package unlawfully opened shall be found, or in whose possession any used stamps shall be found.

Every officer will, therefore, avail himself of every opportunity for bringing these matters under the notice of those concerned.

## D.—BONDED REMOVAL PERMIT STAMPS.

Denominations of stamps.

Sec. 46. The bonded removal permit stamps to be used on packages of tobacco when ex-warehoused for removal in bond are of the following denominations, viz. :—

For fine cut chewing.

(a). For use on pails, kegs, drums or other packages of fine-cut chewing tobacco, weighing five and ten pounds each ;

Snuff.

(b). For use on five, ten and twenty pound packages of snuff ;

Plug tobacco, 5 to 25 lbs.

(c). For use on packages of plug tobacco weighing from five to twenty-five pounds ;

Plug tobacco, 35 to 110 lbs.

(d). For use on packages of plug tobacco weighing from thirty-five to one hundred and ten pounds ;

Cigars.

(e). For use on packages of cigars.

Directions as to attaching stamps on packages.

Sec. 47. They are to be attached as follows :—

(a.), (b.) and (e.) are to be attached to the package in such a manner as to be about equally attached to the cover and the body of the package :

*Tobacco and Cigar Regulations.*

## Chap. 39.

(c.) and (d.) are to be attached at the same place on caddy or box as reserved for regular duty paid stamp, viz., "over one corner or angle of the box or caddy, at equal distances from each end; attaching about equally to each side." Stamps, how attached on caddy or box.

Sec. 48. Each package of tobacco or cigars removed in bond must be covered by a bonded removal permit stamp, of a denomination provided for the class of package upon which it is placed, and is to be attached to the package and cancelled by the manufacturer or his agent; the cancellation will be by means of the roller stamp used for the first cancellation on the regular duty paid stamps; if the manufacturer so desires it, the bonded removal permit stamps may be placed upon the packages intended for removal at the time the tobacco or cigars are put in the warehouse. As this is solely for the accomodation of the manufacturer, the understanding must be that he shall only ask for these stamps to attach to packages that he *knows* will be entered for removal or transfer in bond. If he cannot do this the stamps can only be furnished at the time of entry of goods for removal or transfer. Officers in charge of tobacco and cigar factories are required to see that these stamps are properly used. Each package must be covered by a bonded removal permit stamp.

## E.—STAMPS FOR CUSTOMS.

Sec. 49. Arrangements have been made with the Department of Customs, that in future stamps for imported tobacco shall be supplied by this Department, through the Collectors of Inland Revenue. Collectors will therefore put themselves in communication with the Collectors of Customs, who may require to obtain supplies through the Excise office, and request them to make requisitions on the Collector of Inland Revenue for such stamps as they are likely to require at their respective ports. Arrangements with Department of Customs for procuring stamps.

Sec. 50. As it takes considerable time to obtain stamps, when not in stock at the time the requisition is received, the Collectors of Inland Revenue aforesaid will request the Collectors of Customs to make their requisitions as early as possible. Requisitions to be made early.

Sec. 51. The denominations of stamps for imported tobacco and cigars are the same as those for like articles manufactured in Canada, with the addition of a stamp for raw leaf tobacco samples, and cigar stamps at rate of duty per pound instead of per M. Denominations of stamps.

## F.—SUPPLY OF STAMPS.

Sec. 52. Stamps will be supplied by the Department upon proper requisition being made therefor by the Collector

## Chap. 39.

*Tobacco and Cigar Regulations.*

Directions on receipt of stamps. of Inland Revenue, who will make requisition sufficiently in advance to insure having a supply always on hand equal to the probable demand for three months, as required by section 280 of the Inland Revenue Act: on receipt of a parcel of stamps the Collector or other officer receiving them is immediately to count them, and if they are found to be in accordance with the receipt accompanying the parcel, he is to sign, date and return the receipt to the Department by the next mail, and enter the stamps so received on the debit side of his "General Record of Tobacco Stamps (K. 21a);" if they are not found to be correct, he must immediately advise the Department of the error, and enter the exact number received by him to the debit of his stamp account: Collectors and other officers must account for every stamp acknowledged to have been received by them.

Entry of stamps, on debit side of "General Record of Tobacco Stamps (K. 21a)."

Separate account as to stamps.

Sec. 53. A separate account is to be opened for each denomination of stamp, and kept in the manner shown on first folio of stamp book, stating on the debit side the number received, and on the credit side the number issued. On opening the account the debit side is to commence with the number of stamps then on hand of the description to which it relates.

Collectors are to forward by mail all books containing stubs and unused coupons.

Sec. 54. Collectors are instructed to forward to the Department, by mail, registered, on the first day of each month, all books containing marginal stubs and unused coupons, the last stamps from which were detached during the previous month. The covers thereof are to be neatly cut even with the stubs, and those portions of the covers so detached need not be returned to the department, and all books containing coupon stubs so returned must show on the blank space opposite each sheet of coupons the number of pounds represented thereby on that page; and that a statement be attached to the fly leaf in front of each book, showing the number of pounds represented by the unused coupons on each page in detail and the total thereof. Collectors will take credit in their General Record of Tobacco Stamps (K. 21a) for the coupons so returned.

#### G.—MODE OF AFFIXING TOBACCO AND CIGAR STAMPS.

Directions for affixing stamps under section 280 of the Inland Revenue Act.

Sec. 55. Under the authority of section 280 of the Inland Revenue Act, it is hereby prescribed that stamps shall be affixed to packages of tobacco and cigars in the following manner, viz.:—All packages of tobacco, except fine-cut chewing and snuff, containing five pounds and upwards, shall have affixed a registered coupon stamp of a denomination corresponding with the net weight of the tobacco contained therein: for example, packages containing from ten to

*Tobacco and Cigar Regulations*

## Chap. 39.

twenty-five, and from sixty to eighty pounds, can be, and must be covered by a single stamp, by using coupons attached to stamps, when the weight of the package is not precisely ten, fifteen, twenty, sixty or seventy pounds (in which case the stamp alone is used, without the coupons attached) : when the weight of tobacco contained in the package ranges between ten and twenty-five, and between sixty and eighty pounds, the coupons are used in connection with the stamp bearing such weight, so that with one or more of the coupons attached thereto it will correspond with the weight required : half pounds will not be allowed on packages containing twenty-five pounds and upwards : all other packages of tobacco are to be covered by stamps of the denomination provided by the Department, and one stamp only is to be used on each package.

Sec. 56. Upon all descriptions of boxes and caddies of cavendish, plug, twist, or other description of tobacco, the stamp shall be affixed over one corner or angle of the box or caddy, at equal distances from each end, attaching about equally to each side : and on all such packages, when made of wood, a groove not less than one thirty-second of an inch deep shall be made to admit the stamp, and prevent its being torn or rubbed off by transportation.

Upon boxes, &c., of cavendish, plug, twist, &c.

Sec. 57. Upon all kegs, drums, pails, or other packages containing five and ten pounds of fine cut chewing, and five, ten and twenty pounds of snuff, as permitted by law, the stamp, being a strip stamp, shall be placed across the cover, so as to extend down each side of the package, and to effectually seal it.

Upon kegs, &c., of fine cut chewing, and upon snuff.

Sec. 58. Strip stamps, whether used for packages containing smoking tobacco, fine-cut chewing, snuff, cigars or cigarettes, must be so attached as to effectually seal the package, and render it impossible to open the same or remove its contents without destroying or breaking the stamps : stamps on cigar boxes must be placed at least three-fourths of an inch from the end of the box.

Stamps to effectually seal the package.

Sec. 59. The practice of putting up cigarettes in small parcels held together by a narrow band, and these parcels placed in a large package, which alone is stamped, will no longer be permitted. All cigarettes must be put up in packages as provided by the Act, and each package must bear the proper revenue stamp.

Cigarettes, how to be put up.

Sec. 60. The strip stamps for tobacco are made sufficiently long to pass over both ends of the package and turn

Stamps to pass over both ends.

## Chap. 39.

*Tobacco and Cigar Regulations.*

the opposite angles, thus effectually sealing the package, and they must be so affixed; and when applied to bags which open only at one end, they must be affixed so as to effectually close that end.

Directions as to affixing stamps.

Sec. **61.** The stamps are to be affixed to the packages by using an adhesive material that will cause them to stick to the wood, paper or other packages, securely and permanently: after the stamps on wooden or metal packages of tobacco have become dry, and the cancellation has been made, as herein described, they must be varnished over thoroughly, but not so as to obscure or obliterate the impression upon the stamp.

Tin-foil.

Sec. **62.** Tobacco or cigar stamps will not adhere to tin-foil with ordinary gum or paste: the manufacturer must therefore either envelop the tin-foil in an outer wrapper of paper or provide some kind of gum or paste by which the stamps may be so attached that they cannot be removed without destroying them.

Outer covering not permitted to be stamped.

Sec. **63.** Manufacturers or importers of cigars will not be allowed to wrap the box or package containing cigars in an outer covering of paper or other material and attach the stamp to the outer covering: the stamp must be attached to each package proper, so as to remain thereon as an evidence of its being legally in the possession of the holder thereof.

## RECIPES.

Cheap recipes.

Sec. **64.** The following recipes for cheap and practical paste and varnish, which have been fully tested, are prescribed for use:—

For paste.

For *paste*,—Dissolve one pound of gum arabic in one and three-fourths pints of boiling water; add from two to four ounces of acetic acid, and keep it corked when not in use: apply evenly to the stamp or notice and press it firmly upon the wood or other material of which the package is composed:

For varnish.

For *varnish*,—Place in a bottle of sufficient size one half pound of bleached gum shellac, broken fine, and add strong alcohol; shake occasionally until entirely dissolved, and keep it corked to prevent evaporation: should the varnish at any time become too thick, add a small quantity of alcohol.

Stamps on tobacco and cigars.

Sec. **65.** Stamps on packages of tobacco and cigars are to be attached at the manufactory, by the manufacturer or his agent, at the licensed bonding warehouse by the ware-

*Tobacco and Cigar Regulations.*

## Chap. 39.

houseman or his agent, and at the Customs bonding warehouse by the Customs officer: although the responsibility of stamping tobacco ex-warehoused from a merchant's Excise bonding warehouse remains with the owner of the warehouse, the officer delivering the tobacco is expected to aid in the attaching and cancelling of the stamps, where this can be done immediately after the delivery of the goods from warehouse.

Responsibility of stamping.

## H.—CANCELLING DIES AND STAMPS.

Sec. 66. By virtue of the authority conferred by section 281 of the Inland Revenue Act, the Commissioner of Inland Revenue will furnish steel dies for the cancellation of all stamps used on wooden packages, of packages made partly of wood and partly of other materials, containing tobacco: these dies will be forwarded to the several Collectors of Inland Revenue, and they will be loaned by them to the manufacturer of tobacco or other person mentioned in their requisition therefor and to no other.

Dies to be furnished by the Commissioner of Inland Revenue under section 281 of the Act.

Sec. 67. In effecting such cancellation, the die will be required to be applied twice to the stamp upon the package, once in the place on the stamp marked "cancellation by steel die," and a second time over and upon the vignette on the stamp.

Die to be applied twice.

Sec. 68. A steel cutting roller is also supplied for the cancellation of stamps on tin caddies or boxes of tobacco, which instrument is to be drawn across the stamp and on to the metal of which the package is composed: this instrument should be so used as to sever the stamp and continue the line of separation on to the metal: it is to be applied to the stamp on each side of the package, but is to be done in such a manner as not to disfigure the cancellation made by the rubber stamp.

Steel cutting roller for cancellation of stamps on tin caddies or boxes.

Sec. 69. Collectors will keep an account of all steel dies and other instruments intrusted to them, and a record of the names of all persons to whom they are furnished (furnishing them only to the legally authorized tobacco manufacturers and others, as instructed by the Department) and the date of their delivery: whenever any die shall have become broken or damaged in the hands of any manufacturer or other person, so as to be unfit for use, or whenever any person receiving such Government die shall have no longer any legitimate use for the same, it must be returned to the Collector, and held by him subject to departmental orders, and the person accredited therefor.

Collectors will keep account of dies, &c., intrusted to them.

## Chap. 39.

*Tobacco and Cigar Regulations.*

Government die to be used and no other, under penalty of forfeiture.

Sec. 70. The law makes it imperative upon every manufacturer of tobacco, putting up his tobacco in packages as heretofore described, and upon every person ex-warehousing tobacco from an Excise bonding warehouse, to use this die, and no stamps on such packages will be regarded as properly cancelled, and the packages and their contents will be liable to seizure, whenever found, unless the stamps are cancelled with a Government die, and in the manner hereinafter named, viz., the stamp must be so cancelled that a portion of every stamp shall be *driven into and lodged within the wood* of the package, or when on metal, by severing the stamp, and continuing the line of separation on to the metal of which the package is made.

Roller stamps for cancellation.

Sec 71. Roller stamps, for the cancellation of tobacco and cigar stamps, will also be supplied by the department, upon proper requisition being made therefor.

These roller cancellation stamps are as follows, viz. :—

Packages of paper, linen, &c.

(a.) For tobacco manufacturers' use in cancelling strip stamps used on tobacco put up in packages of paper, linen, or other soft or yielding material, and for the first cancellation on all other stamps used on packages of tobacco ;

Strip stamps on cigar boxes.

(b.) For cigar manufacturers' use in cancelling strip stamps used on cigar boxes ;

Licensed bonding warehouses.

(c.) For the use of persons having licensed bonding warehouses, in cancelling (in addition to steel die or instrument) the stamps on packages of tobacco ex-warehoused for duty from a warehouse other than the manufacturer's where tobacco was made ;

Collectors' use in cancelling stamps on packages removed in bond.

(d.) For Collectors' use in cancelling stamps on packages of tobacco and cigars removed in bond under the provisions of Section 25 of Warehousing Regulations [see *ante* page 243] and to cancel stamps on tobacco ex-warehoused from an Inland Revenue bonding warehouse established under authority of section 65 of the Inland Revenue Act.

Strip stamps on packages of paper, &c.

(e.) For Customs officers' use in cancelling strip stamps used on imported tobacco put up in packages of paper, linen or other soft or yielding material, and for the first cancellation on all other stamps used on packages of tobacco ;

Customs officers' use.

(f.) For Customs officers' use in cancelling strip stamps used on cigar boxes.

Formula to be used in asking for stamps.

Sec. 72. In asking for these roller stamps the following formula should be used, for the sake of uniformity. Quote factory number or warehouse letter, division number, and name of applicant, thus :—



*Tobacco and Cigar Regulations.*

Chap. 39.

- 1.30. Tobacco Factory roller for J. E. Tuckett.  
 2.28. Cigar Factory roller for S. Myers.  
 A.17. Tobacco Warehouse roller for D. C. Brosseau.

Sec. 73. The names of new applicants must be registered at Department before the roller is supplied. When through ordinary wear and tear new rubber bands are required, a new stamp complete will be supplied on requisition, on receipt of which the old stamp will be returned to the Department.

Names of new applicants.

Sec. 74. Collectors must keep an account of all cancellation stamps entrusted to them, as in the case of the steel cancellation dies.

Collectors to keep account of stamps.

Sec. 75. The law requires that all stamps upon packages of tobacco and cigars shall be cancelled by a Government stamp or die and it is now prescribed that when the stamps are upon other than wooden boxes and caddies of cavendish that the cancellation shall be by means of the roller stamp recognized by the Department; the stamps on wooden packages of tobacco being cancelled in addition to the above, by the steel die, and those on metal packages by the steel cutting roller supplied for that purpose.

Stamps upon other than wooden boxes, &amp;c.

Stamps on wooden packages.

## I.—MODE OF CANCELLING TOBACCO AND CIGAR STAMPS.

Sec. 76. All stamps are to be cancelled immediately after being placed upon the packages, but the cancellation by the roller stamp, except in the case of cigars, may be made by the manufacturer or other party, immediately before being placed thereon.

Stamps to be cancelled immediately.

Sec. 77. Stamps for tobacco must be cancelled by imprinting upon each stamp, in the oblong blank space left for that purpose, the registered number of the manufactory, or letter of dealer's bonding warehouse, and the number of the Inland Revenue Division. Rubber roller hand stamps will be furnished by the Department for this purpose, but if any manufacturer desires to use a stamp applied by any other means, permission may be granted for this form of cancellation only.

Directions for cancellation of stamps by rubber roller hand stamps.

Sec. 78. Stamps used on five or ten pound packages of fine-cut chewing, on five, ten and twenty pound packages of snuff, and on quarter caddies, half caddies, caddies and boxes of tobacco, when made of wood, must, in addition to the above, also be cancelled by means of the steel die supplied for that purpose, which die drives a portion of the stamp into the wood of which the package is composed—

Directions for cancellation of stamps by means of the steel die.

the die being applied to the stamp twice, once in the space reserved for this cancellation, and again on the vignette on the stamp: the further cancellation of stamps on metal packages will be by means of the steel cutting roller supplied for that purpose, which severs the stamp, and continues the line of separation beyond the stamp and on to the metal of which the package is made; the application being made to the stamp on each side of the package.

Directions for cancellation of stamps on imported tobacco.

Sec. 79. Stamps on packages of imported tobacco shall be cancelled as follows, viz.: stamps on packages composed of paper, cotton, tin-foil or other soft or yielding material, by means of a roller stamp, which shall imprint upon the stamp the name of the port where entered for duty, or this information may be written in on the stamps: stamps on wooden packages of plug, fine-cut chewing, and packages of snuff shall be cancelled as above, but in addition thereto shall be further cancelled by means of the steel die; stamps on packages made of metal, when imported, shall in addition to the above, be cancelled by means of the steel cutting roller supplied for that purpose, which severs the stamp and continues the line of separation beyond the stamp and on the metal of which the package is made.

Directions for cancellation of stamps on tobacco ex-warehoused for consumption by persons other than the manufacturer.

Sec. 80. Stamps on packages of tobacco ex-warehoused for consumption by a merchant or person other than a manufacturer and at the manufactory where made or put up, shall be cancelled by the person ex-warehousing the same by means of the roller stamps, which will imprint upon the stamp, in the oblong space reserved for that purpose, the letter of the warehouse, and the number of the Inland Revenue Division. Stamps, when on wooden packages, shall be further cancelled by means of the steel die supplied for that purpose, which die drives a portion of the stamp into the wood of which the package is composed; and when on metal packages, by means of the steel cutting roller provided for that purpose, which instrument severs the stamp and continues the lines of separation beyond the stamp and on the metal of which the package is made.

Tobacco ex-warehoused from manufactory.

Sec. 81. Stamps on packages of tobacco ex-warehoused from the manufactory where made or put up, shall be cancelled as described by sections seventy-nine (79) and eighty (80) of these regulations.

Stamps on cigar boxes, how cancelled.

Sec. 82. The stamps on cigar boxes will be cancelled by means of a roller stamp supplied for that purpose, which stamp carries the impression beyond the duty-paid Inland Revenue stamps, and on to the wood of which the package is

*Tobacco and Cigar Regulations.*

Chap. 39.

made: in all cases the impression is to be made across the stamp continuously, the lettering being distinctly imprinted over space reserved for cancellation: this cancellation stamp, so used, must imprint upon the stamp the registered number of the manufactory, and the number of the Inland Revenue Division, as required on all other stamps.

Sec. 83. The cancellation of Customs stamps upon packages of cigars will be by means of a roller stamp, as per the next preceding section, but the information to be imprinted upon the space reserved for cancellation will be the name of the port where ex-warehoused for duty.

Cancellation by roller stamp.

Sec. 84. In cancelling stamps by imprinting, as herein prescribed, where blank spaces are left on the stamps for that purpose, they must always be used.

Blank spaces to be filled up in cancelling.

Sec. 85. The cancellation of tobacco or cigar stamps will be done by the following persons, viz. :—

By whom cancellation shall be done.

(a.) At a tobacco or cigar manufactory, by the manufacturer or his agent ;

By manufacturer.

(b.) At a warehouse (other than the manufacturer's where tobacco or cigars were made), by the person who ex-warehouses the tobacco or cigars ; and,—

By person who ex-warehouses.

(c.) Stamps on imported tobacco and cigars, by the Customs officers at the port where the tobacco or cigars, were ex-warehoused for duty.

By customs officer.

Sec. 86. The importance to be attached to the cancellation of all stamps has been shown by the severe fines and penalties imposed upon any person who shall remove from any manufactory or place where tobacco or cigars are made, any such goods without stamps affixed and properly cancelled, and also the fines and penalties imposed upon any person who shall sell, or offer for sale, or have in his possession, any tobacco or cigars, the stamps upon which are *not properly cancelled*: the interest of the Government and the safety and protection of all who deal in tobacco or cigars, require that manufacturers and others shall properly affix and cancel all stamps.

Importance of cancellation, as shown by fines and penalties imposed.

J.—DESTRUCTION OF THE STAMPS ON PACKAGES OF TOBACCO AND CIGARS WHEN EMPTIED.

Sec. 87. Section 263 of the Inland Revenue Act makes it the duty of every person who empties any stamped box, bag, vessel, wrapper or envelope of any kind, containing

Stamp to be destroyed under section 263 of Act.

## Chap. 39.

*Tobacco and Cigar Regulations.*

tobacco or cigars, to destroy the stamp thereon; and any person who neglects or refuses so to do, is liable to a penalty for each such offence not exceeding one hundred dollars.

Purchaser  
must destroy  
stamps.

Sec. 88. This provision of the law applies not only to retail dealers who empty legal packages by retailing their contents, but also to every person who purchases tobacco or cigars for his own use, and empties such packages, who must destroy the stamp thereon.

Department  
will not pro-  
secute where  
stamp is  
destroyed by  
disfiguring,  
&c.

Sec. 89. Collectors and other officers are informed that while Section 263 of the Act requires that the destruction of a stamp shall consist of the removal of every part thereof from the package, the Department for the present will not prosecute where the stamp is destroyed by disfiguring or destroying it in such a manner as to render it incapable of being used again. This may be done by the removal of portions of the stamp from different places on each of the sides of the package, the proportion so removed to be equal in the aggregate to at least one-fourth of the stamp.

## K.—CAUTION NOTICES—TOBACCO AND CIGARS.

Packages to  
to be labelled.

Sec. 90. Upon every package of tobacco, weighing over one pound, whether put up in wooden packages or otherwise, the law requires that there shall be printed, or securely affixed by pasting thereon, a label, on which shall be printed the number of the manufactory, and the number of the division in which it is situated, together with the following notice:—

Form of  
notice.

“Notice.—The manufacturer of this tobacco has complied with all the requirements of the law: every person is directed to open this package in such a manner as to break the stamp, and is cautioned not to use this package for tobacco again, or the stamp thereon, nor to remove the contents of this package without destroying said stamp, under the penalties provided by law in such cases.”

Size of label  
when used on  
boxes, &c.

Sec. 91. When used on boxes, caddies, kegs, pails, drums or other packages of tobacco, weighing more than one pound, the label on which the above notice is to be printed is required to be not less than four and not more than six inches long, and not less than two and one-half inches in width, and to contain, in addition to the caution notice, the following facts, printed in plain, open, and legible letters, viz.: (1) the number of the manufactory, and (2) the number of the Inland Revenue Division. These labels will be in the following form, viz.:—

*Tobacco and Cigar Regulations.*

## Chap. 39.

“ Factory, No.....Inland Revenue Division, No..... Form of such label.

Notice.—The manufacturer of this tobacco has complied with all the requirements of the law: every person is directed to open this package in such a manner as to break the stamp, and is cautioned not to use this package for tobacco again, or the stamp thereon, nor to remove the contents of this package without destroying said stamp, under the penalties provided by law in such cases.”

Sec. 92. The law provides that “ every manufacturer of cigars shall securely affix, by pasting on each box containing cigars manufactured by or for him, a label, on which shall be printed, besides the number of the manufactory, and the number of the division in which it is situated,” a caution notice in the following form :— Caution notice on cigar boxes.

“ Factory, No.....Inland Revenue Division, No..... Form of such notice.

Notice.—The manufacturer of the cigars herein contained has complied with all the requirements of the law: every person is directed to open this package in such a manner as to break the stamp, and is cautioned not to use either this package for cigars again, or the stamp thereon, nor to remove the contents of this package without destroying said stamp, under the penalties provided by law in such cases.”

Sec. 93. This label for all cigar boxes is to be not less than three inches in length and two inches in width; or, if made in circular or oval form, it shall cover not less than six square inches of paper and be of a size sufficient to contain, in addition to the caution notice prescribed in plain, open, and legible letters, these facts: (1) the number of the manufactory, and (2) the number of the Inland Revenue Division. Size of label for cigar boxes.

Sec. 94. The following form of caution notice is prescribed and must be used on outer packages containing cigarettes when put up in packages of ten (10) or twenty (20) cigarettes each, and cut tobacco and snuff in packages of one pound and under, the caution notice on each of the small packages constituting the contents, not being necessary. Caution notice on outer packages.

“ Factory No .....Inland Revenue Division No ..... Form of such notice.

Notice.—The manufacturer of the cigarettes (cut tobacco or snuff) herein contained has complied with all the requirements of the law. Every person is cautioned not to use this package for packing cigarettes (cut tobacco or snuff) again, nor to use the stamp, nor the stamped wrappers upon the packages of cigarettes (cut tobacco or snuff) constituting the contents of this package, under the penalties provided by law in such cases.”

## Chap. 39.

*Tobacco and Cigar Regulations.*

Words to be omitted and others substituted therefor in certain cases.

The words "Factory No.," "Inland Revenue Division No.," and "manufacturer," should be omitted when the notice is attached to packages of imported cigarettes (cut tobacco or snuff) and "the name of the port where," and "the number of the entry under which the cigarettes (cut tobacco or snuff) are ex-warehoused for duty," and the word "importer" respectively substituted therefor.

"Special caution notice" to be used on packages seized, confiscated and sold.

Sec. 95. The following form of "Special Caution Notice" is to be used on packages of tobacco or cigars that have been seized and confiscated and sold under authority of this department, and will be supplied upon requisition being made therefor:—

**C. S.**

Seizure No.....

**SPECIAL CAUTION NOTICE.**

**Excise.**

Form of such notice.

NOTICE.—Every person is directed to open this package in such a manner as to break the stamp, and is cautioned not to use either this package for tobacco or cigars again, or the stamp thereon, or to remove the contents of this package without destroying the said stamp, under the penalties provided by law in such cases.

Information may be stencilled.

The information required is to be placed upon the packages by a manufacturer may, in this case, be stencilled, and in addition to this regular information, the seizure No. will be placed thereon.

Cigars in packages of 3 and 6 cigars each will not require caution notice.

Sec. 96. Cigars when put up in packages of three (3) and six (6) cigars each, will not require a caution notice attached to such small packages, but the outer package in which they are placed must bear the following form of caution notice: "NOTICE.—The manufacturer of the cigars herein contained has complied with all the requirements of the law. Every person is cautioned not to use again the stamped packages of cigars constituting the contents of this package, under the penalties provided by law in such cases."

Form of caution notice on outer package in such cases.

If imported, the word "Importer" is to be substituted for "Manufacturer."

Caution notice by importers.

Sec. 97. Importers of tobacco and cigars are also required by law to place a caution notice on each package of tobacco weighing more than one pound and on each package of cigars when in packages containing ten cigars and upwards imported by or for them.

Label to be affixed by manufacturer or importer.

Sec. 98. The affixing of this label or caution notice is made the duty of the manufacturer or importer; it is to be a printed label, or the necessary information may be imprinted on or impressed into the material of which the package is made. It is to be supplied and affixed by the manufacturer or importer before the tobacco or cigars are

*Tobacco and Cigar Regulations.*

## Chap. 39.

to be removed from the places where they were made or at which imported. No person has a right or will be allowed in any case to tamper with this caution notice, to remove it from the box, or package, to substitute another label for it, or to cover it up with a label either of his own or of any other person.

Sec. 99. This label or notice is to be distinctly and clearly the label required by law. The labels must be affixed to the package in a conspicuous place, where they will not be broken in opening the packages and where they will be exposed as little as possible to be worn or rubbed off, and in a manner so as not to be covered up or concealed by any other labels or marks, and so as not to conceal by them any other marks or brands required by law to be placed upon the package.

Label to be affixed in conspicuous place.

Sec. 100. The law imposes a penalty of \$50 on every manufacturer or importer of tobacco or cigars who neglects to affix such label to any package containing tobacco or cigars, made or imported by or for him, and on every person who removes any such label, so affixed, from any such package, such fine being for each package in respect to which such offence is committed.

Penalty for neglecting to affix label.

If the manufacturer desires to do so, he may increase the size of the paper on which the caution notice is printed, so as to allow the printing, *separate and distinct from the label*, of his name and trade-mark.

Manufacturer may increase size of label.

### ARTICLE 3.—MANUFACTURED TOBACCO AND CIGARS.

#### SPECIAL PROVISIONS FOR WAREHOUSING TOBACCO AND CIGARS AND FOR STAMPING SAME WHEN EX-WAREHOUSED FOR REMOVAL IN BOND, FOR CONSUMPTION, OR FOR BRANDING SAME WHEN FOR EXPORTATION.

In addition to the General Warehousing Regulations established by Order in Council, the following apply specifically to tobacco and cigars :—

Sec. 101. On all packages of tobacco and cigars, when placed in warehouse by the manufacturer thereof, all marks, numbers, weights and all other information required by law, must be written or branded thereon before the warehouse entry can be accepted, which entry must be compared with the packages of tobacco or cigars, and certified correct by the officer in charge of the manufactory, before it will be accepted by the Collector of Inland Revenue : Collectors will therefore

Marks, numbers and weights to be written or branded on packages placed in warehouse by manufacturer.

## Chap. 39.

*Tobacco and Cigar Regulations.*

permit the principal manufacturers to use out-numbers in order that these instructions may be fully complied with.

Tobacco must be placed in warehouse immediately on receipt of warrant.

Sec. 102. As all marks, numbers, weights, &c., are required to be placed upon the packages before the warehouse entry can be accepted by the officer for comparison, and as no stamps are required prior to being placed in bond, the tobacco must be placed in warehouse immediately upon the receipt by the officer of the proper warrant: in large manufactories, where an exact compliance with this regulation is impossible, from the quantities involved, the Collector may, at his discretion, extend the time for placing in the warehouse,—such extension not, at any time, to exceed three days.

Extension of time in large manufactories.

Packages removable in bond.

Sec. 103. The following are the only sized packages of tobacco that may be removed in bond, viz:—

Fine cut chewing.

(a.) Fine-cut chewing tobacco, in packages of five and ten pounds each;

Snuff.

(b.) Snuff, in packages of five, ten and twenty pounds each;

Cavendish, plug or twist.

(c.) Cavendish, plug or twist, in packages of from five to twenty-five pounds inclusive, or from thirty-five to forty-five pounds inclusive, or from sixty to eighty pounds inclusive, or from one hundred to one hundred and ten pounds inclusive; and—

Cigars.

(d.) Cigars in packages of twenty-five and upwards.

Smaller packages not removable.

Sec. 104. Tobacco, in smaller packages than those above mentioned, shall not be removed in bond, nor shall the product of Canadian leaf tobacco be so removed when in packages containing less than ten pounds.

Packages when ex-warehoused for removal in bond shall be stamped with the bonded removal permit stamp.

Sec. 105. Packages of tobacco or cigars when ex-warehoused at the manufactory for removal in bond to another Division, or transferred to another person within the same Division, shall be stamped by the manufacturer with the bonded removal permit stamp provided by the Department for that purpose, denoting the class of such goods. Packages of tobacco or cigars which have been placed in warehouse prior to the coming into effect of the provisions of The Consolidated Inland Revenue Act, 1883 and which may or may not be covered by the old red stamp when ex-warehoused from any warehouse for removal or transfer must be covered by a bonded removal permit stamp. If previously stamped the old form of stamps must be scraped off the pack-



*Tobacco and Cigar Regulations.*

## Chap. 39.

age and destroyed by the officer ex-warehousing the goods : each package removed or transferred in bond must bear one of these bonded removal permit stamps, which must be cancelled by the manufacturer or other person ex-warehousing the tobacco by means of the roller stamp provided for that purpose. Subsequent removals of same tobacco or cigars do not require additional stamping by bonded removal permit stamp.

Directions in case of old stamps having been used.

**Sec. 106.** Tobacco or cigars when entered ex-warehouse, whether for removal for transfer or for consumption, will require to be stamped with new form of stamps when so ex-warehoused, even if previously stamped under the requirements of regulations in force prior to July 1, 1883.

New form of stamps to be used.

**Sec. 107.** When ex-warehoused for consumption the regular duty-paid stamp is to be attached to the package and cancelled in the manner herein provided : when tobacco or cigars are ex-warehoused for consumption from a warehouse other than the manufacturer's where made,—the packages then bearing a bonded removal permit stamp,—the duty paid stamp is to be placed over the bonded removal permit stamp, so as to cover it as much as possible and the cancellation is to be made through both. The stamps for packages entered for consumption either by the manufacturer or merchant will be supplied upon receipt of proper entry papers ex-warehouse for consumption, the duty on the goods to be ex-warehoused, the warrant properly filled up, and a requisition on the form prescribed and issued by the Department, which requisition must show for tobacco, the number of stamps at each weight required to cover the tobacco ex-warehoused, and in the case of cigars the number of stamps of each denomination necessary to cover the cigars ex-warehoused, the aggregate number of packages and pounds of tobacco, or packages and number of cigars, agreeing with the entry ex-warehouse for consumption.

Directions as to location of stamps.

How supplied on requisition.

What requisition must show.

**Sec. 108.** The stamps are in all cases to be attached and cancelled by the manufacturer or person ex-warehousing the goods, and in accordance with regulations herein established.

Stamps, how and by whom attached and cancelled.

**Sec. 109.** Packages of tobacco or cigars, when ex-warehoused for exportation to a foreign country, shall be branded under the personal supervision of the officer in charge, with a brand of the following nature :—

Packages to be branded.

Chap. 39.

*Tobacco and Cigar Regulations.*

## EXPN.

TOBACCO—9-10-8-83.

Form and explanation of brand.

For tobacco read *cigars* when used on cigar boxes,—the first numeral or set of numerals representing the factory number, the second the number of the Inland Revenue Division, and the third and fourth numbers the month and year respectively: when ex-warehoused from a warehouse other than that at the manufactory where tobacco or cigars were made, the factory number shall be omitted and letter or number of warehouse substituted therefor.

Directions as to placing brand on packages.

Sec. 110. This brand is to be placed upon all wooden packages by means of a hot iron and upon metal packages by means of steel dies, or by such other means as shall leave the necessary information legibly and indelibly impressed into the metal of which the package is made. On either wooden or metal packages the above brand is to be placed upon the side of the package. These dies must be furnished by the exporter, and the letters and figures thereon are not to be less than one-fourth of an inch in height.

Tobacco or cigars already stamped; provisions in relation thereto; record to be signed and filed; contents.

Sec. 111. When the holder of tobacco or cigars in bond, which have already been stamped under the provisions of previous Acts, desires to export such tobacco or cigars, the stamps on the packages are to be removed by the officer in charge of the manufactory or warehouse, in the presence of another officer specially detailed therefor by the Collector of Inland Revenue: a record is to be kept by the aforesaid officers, giving the following information, which record is to be signed by them, and filed in the office of the Collector of Inland Revenue, viz.:—

Number and weight.

(a.) The number of each stamp removed and destroyed, and the weight of the tobacco or cigars covered thereby; and,—

License number.

(b.) The license number of the manufactory where the tobacco or cigars were put up and the name of the Division where stamp was issued:

The export papers cannot be finally accepted as complete until this has been done.

Placing brand on outer cases.

Sec. 112. When packages of tobacco weighing one pound and less intended for exportation are packed in large cases, it will only be required that the brand, as given in Section one hundred and nine (109) of these regulations, be placed upon the outer cases,—which cases must be consecutively numbered and have marked on them the total number of

*Tobacco and Cigar Regulations.*

## Chap. 39.

packages at each weight and the total weight of tobacco contained therein.

Sec. 113. Tobacco and cigars, when exported, cannot be packed in the same case. Tobacco and cigars exported.

Sec. 114. All goods entered for exportation must be examined by the officer ex-warehousing the same, and, in order to do so, packages must be opened to such extent as the Collector of Inland Revenue may determine. Goods to be examined, packages to be opened.

Sec. 115. Scraps and cuttings or stems, when put up for exportation must be packed under the personal supervision of an officer of Inland Revenue, and unless the whole case is packed at one time, the packing thereof shall be done in the raw leaf warehouse. Scraps, cuttings, stems.

Sec. 116. Each case or package when filled, shall be marked by the officer with his name, and date when packed, and in such a manner as to be distinctly and clearly seen and so that it can be identified by him and must be branded with the letters EXPN, as in the case of other tobacco for exportation. Case or package how marked.

## ARTICLE 4.

FOR PACKING AND STAMPING IMPORTED TOBACCO AND CIGARS, CANCELLING THE STAMPS THEREON, AND FOR REMOVAL OF SAME IN BOND, FROM ONE CUSTOMS PORT TO ANOTHER, BEFORE BEING PACKED IN PACKAGES SIMILAR TO THOSE USED FOR LIKE ARTICLES MANUFACTURED IN CANADA.

Sec. 117. The Inland Revenue Act states that "all manufactured tobacco or cigars imported from foreign countries shall have the stamps affixed and cancelled while they are in the custody of the proper Custom house officers," and that "such tobacco and cigars shall not pass out of the custody of the said officers until the stamps have been so affixed and cancelled." Directions for stamping imported tobacco and cigars.

Sec. 118. The cancellation of the stamps on tobacco, when put up in packages of paper, linen, or other soft or yielding material, shall be by means of the roller stamp provided for that purpose. Cancellation of stamps on packages of paper, linen, &c.

Sec. 119. The cancellation of the stamps on wooden packages containing imported tobacco shall be by sinking into the wood of which the package is composed a portion of the Cancellation of stamps on wooden packages.

## Chap. 39.

*Tobacco and Cigar Regulations.*

Stamps on wooden packages containing imported tobacco to be cancelled by means of a steel die and a roller stamp.

stamp by means of a steel die, which die shall be applied twice to every stamp, once in the place on the stamp reserved for cancellation and again on the vignette; and in addition to the cancellation by the steel die, they shall be further cancelled by means of the roller stamp supplied for that purpose,—the cancellation by roller stamp to be made in the space reserved on the stamps for that purpose, and it may be done immediately before the stamps are placed upon the packages if found more convenient; the cancellation of the stamps on metal packages containing tobacco will be by means of the steel cutting roller supplied for that purpose, which severs the stamp and continues the line of separation beyond the stamp and on to the metal of which the package is made: this instrument is to be applied to the stamp on each side of the package; the stamp is, in addition to this cancellation, to be further cancelled by means of the roller stamps used to cancel all stamps on packages containing tobacco.

Cancellation of metal packages, how done.

Cancellation of imported cigars by roller stamp, how done.

Sec. 120. The stamps upon packages containing imported cigars, will be cancelled by means of a roller stamp of the design furnished by the Department; this cancelling stamp shall be so used that the imprint shall project beyond the stamp and on to the wood of which the box is made; in all cases the impression is to be made across the cigar stamp.

Cancellation dies and stamps, how furnished.

Sec. 121. These cancellation dies and stamps will be furnished to the different Collectors of Customs upon requisition being made therefor; and no package containing tobacco or cigars, as defined by the Inland Revenue Act, shall be handed over to the importer or owner until the stamps on the same are cancelled, as herein directed.

Collector of customs to see that regulations are complied with.

Sec. 122. The Inland Revenue Act further states that "imported tobacco and cigars shall be put up in packages as prescribed by law for like articles manufactured in Canada, before the stamps are affixed." Every Collector of Customs will, therefore, see that these regulations are fully complied with.

Sizes of packages.

Sec. 123. The sizes of the different packages into which tobacco and cigars must be packed as permitted by law, are as follows, viz. :—

Cavendish, plug and twist in rectangular wooden boxes.

(a.) All cavendish, plug and twist, in rectangular wooden boxes containing from five to twenty-five pounds inclusive, thirty-five to forty-five pounds inclusive, or from sixty to eighty pounds inclusive, or from one hundred to one hundred and ten pounds inclusive.

*Tobacco and Cigar Regulations.*

## Chap. 39.

(b.) All fine cut chewing tobacco, and all other kinds of tobacco not otherwise provided for, in packages containing one-twentieth, one-sixteenth, one-tenth, one-eighth, one-fifth, one-fourth, one-half, or one pound—except that fine-cut chewing tobacco, when of a quality and description approved of by the Commissioner of Inland Revenue, may, at the option of the importer, be put up in wooden packages containing five or ten pounds each ;

Fine cut chewing, and other kinds not otherwise provided for.

(c.) All cut and granulated tobacco, other than fine-cut chewing, all shorts, the refuse of fine-cut chewing tobacco, which has passed through a riddle of thirty-six meshes to the square inch, in packages containing one-twentieth, one-sixteenth, one-tenth, one-eighth, one-fifth, one-fourth, one-half or one pound each ;

Cut and granulated and all shorts, refuse, &c.

(d.) All snuff in packages containing one-sixteenth, one-eighth, one-fourth, one-half, one pound, and in wooden packages containing five or ten pounds each,—except that snuff when containing more than 40 per cent. of moisture, may in addition to the above be put up in packages containing twenty pounds each, actual weight ;

Snuff in packages from  $\frac{1}{8}$  to 1 lb. and in wooden packages.

(e.) All cigarettes in packages containing one-fortieth, one-twentieth, one-sixteenth, one-tenth, one-eighth, one-fifth, one-fourth or one-half pound each ;

Cigarettes.

(f.) All cigars in boxes containing three, five, ten, twenty, fifty, one hundred and two hundred cigars each,—except that Manilla cigars or cheroots, but not imitations thereof, may, when imported from abroad, be contained in addition to the above-named quantities, in original packages containing five hundred each.

Cigars in boxes.

Sec. 124. The stamps are to be put on or affixed to the packages in the following manner :—

Manner of affixing stamps.

(a.) All packages of tobacco, except fine-cut chewing and snuff containing five pounds and over, shall have affixed a registered coupon stamp of a denomination corresponding with the net weight of the tobacco contained therein ; for example, packages containing from ten to twenty-five pounds and from sixty to eighty pounds, can be and must be covered by a single stamp, by using coupons attached to stamps when the weight of the package is not precisely ten, fifteen, twenty, sixty or seventy pounds (in which case the stamp alone is used without the coupons attached) : when the weight of the tobacco contained in the packages ranges between ten and twenty-five pounds, and between sixty and eighty pounds, the coupons are used in connection with the stamp bearing such weight, so that with one or more

Packages of tobacco, except fine cut chewing and snuff, containing more than ten pounds.

Between 10 and 25 lbs.

Between 60 and 80 lbs.

## Chap. 39.

*Tobacco and Cigar Regulations.*

coupons attached thereto it will correspond with the weight required; half pounds will not be allowed on packages containing twenty-five pounds and upwards;

Other packages.

(b.) All other packages of tobacco are to be covered by stamps of the denomination provided by law, and one stamp only is to be used on each package;

Cavendish, plug, twist.

(c.) Upon all descriptions of boxes and caddies of cavendish, plug, twist or other description of tobacco, the stamp shall be affixed over one corner or angle of the box or caddy, at equal distances from each end, attaching about equally to each side;

Fine cut chewing and snuff.

(d.) Upon all kegs, drums, pails or other packages containing five and ten pounds of fine-cut chewing, and five, ten and twenty pounds of snuff, as permitted by law, the stamp, being a strip stamp, shall be placed across the cover, so as to extend down each side of the package and to effectually seal it;

Strip stamps, how attached.

(e.) Strip stamps, whether used for packages containing smoking tobacco, fine-cut chewing, snuff or cigarettes, must be so attached as to effectually seal the package and render it impossible to open the same or remove the contents without destroying or breaking the stamp;

Strip stamps for cigar boxes.

(f.) Strip stamps, used for cigar boxes, must be so attached as to effectually seal the package;

Stamps to be affixed by adhesive material and varnished.

(g.) The stamps are to be affixed to the packages by using an adhesive material that will cause them to stick to the wood, paper or other package, securely and permanently: after the stamps on wooden packages have become dry and the cancellation has been made, as herein described, they must be varnished thoroughly but not so as to obscure or obliterate the impressions upon the stamps;

Tin-foil, how stamped.

(h.) Tobacco stamps will not adhere to tin-foil with ordinary gum or paste: the importer or owner of the goods must, therefore, either envelop the tin-foil in an outer wrapper of paper, or provide some kind of gum or paste by which the stamps may be so attached that they cannot be removed without destroying them.

Importer of tobacco to affix a label giving name of port, number of entry and notice.

Sec 125. The Inland Revenue Act, further provides that,—Every importer of tobacco shall, in addition to complying with all other requirements of this Act relating to imported tobacco, print on each package, or securely affix by pasting on each package containing tobacco, imported by or for him, a label, on which shall be printed the name of the

*Tobacco and Cigar Regulations.*

## Chap. 39.

port where, and the number of the entry under which, such tobacco is ex-warehoused for duty, and these words:—  
 “Notice: The importer of this tobacco has complied with all the requirements of the law: every person is directed to open this package in such a manner as to break the stamp, and is cautioned not to use either this package for tobacco again, or the stamp thereon, nor to remove the contents of this package, without destroying the said stamp, under the penalties provided by law in such cases.”

Form of notice.

Sec. 126. Every importer of cigars is also required to affix to each package of cigars imported by or for him, a label showing, in addition to the name of the port where, and the number of the entry under which such cigars were ex-warehoused for duty, these words:—“Notice: The importer of the cigars herein contained has complied with all the requirements of the law: every person is directed to open this package in such a manner as to break the stamp, and is cautioned not to use either this package for cigars again, or the stamp thereon, nor to remove the contents of this package, without destroying the stamp, under the penalties provided by law in such cases.”

Importer of cigars to affix a label giving name of port, number of entry and notice.

Form of notice.

Sec. 127. This caution notice, when used on boxes, caddies, kegs, pails, drums or other large packages of tobacco, is required to be not less than four nor more than six inches long, and not less than two and one-half inches in width, and must be affixed to the package in a conspicuous place, where it will be exposed as little as possible to be worn, or rubbed off, or broken, in opening the package, and in a manner so as not to be covered up or concealed by any other labels or marks and so as not to conceal by it any other marks or brands required by law to be placed upon the package.

Caution notice on tobacco boxes, &c.; its size; to be affixed in conspicuous place.

Sec. 128. The caution notice label, when used on boxes of cigars, is to be not less than three inches in length and two in width; or if made in circular or oval form, it shall cover not less than six square inches of paper, and is likewise to be affixed to the box or package, in a conspicuous place, and where it will not be covered up by the stamp, or otherwise obscured, or concealed, or broken, in opening the package.

Caution notice on cigars; its size; to be fixed in conspicuous place.

Sec. 129. If the importer desires to do so, he may increase the size of the paper on which the caution notice is printed, so as to allow the printing, *separate and distinct from the label*, of his name and trade-mark.

Size of caution notice may be increased.

## Chap. 39.

*Tobacco and Cigar Regulations.*

Separate and distinct label, when not required.

Sec. 130. A separate and distinct label will not be required on packages of imported tobacco containing one pound and under, nor on packages containing ten or twenty cigarettes each, provided the importer shall cause to be printed on each outer package, the caution notice as herein required, where it will not be covered up by the stamp or otherwise obscured or concealed: the name of the port and the number of the entry for duty, may be written in on the label or imprinted with a rubber stamp. The packing and stamping must be done in accordance with the provisions of the Inland Revenue Act,

Removal in bond under regulations.

Sec. 131. The Inland Revenue Act also provides that "tobacco and cigars intended for removal in bond to another port or place within the Dominion of Canada may be removed to such other port, under regulations to be established by the Governor in Council," which regulations are as follows:—

Consigned to order of collector.

(a.) That the tobacco or cigars must be consigned to the order of the Collector of Customs at the port to which the goods are bonded;

Removal bond to be taken.

(b.) A removal bond to be taken from the owner or importer by the Collector of Customs for double the Customs duty accruing on the goods so removed; and the bond shall be conditioned for the delivery of the goods into the possession of the Collector of Customs to whom consigned;

Bond, how cancelled.

(c.) This bond will be cancelled by the certificate of the Collector of Customs at the port to which the goods are consigned, certifying that they have been received by him and re-warehoused, and that a bond has been duly executed and that the goods shall be re-packed into packages similar to like articles when manufactured in Canada, and duly stamped or entered for exportation or destruction.

## ARTICLE 5.

## FOR SALE OF MANUFACTURED TOBACCO AND CIGARS.—SIZE AND FORM OF PACKAGES &amp;C.

Sale of tobacco in whole packages; stamping and branding.

Sec. 132. The sale of tobacco can only be made by manufacturers in whole packages,—each package bearing a stamp properly affixed and cancelled (or when entered for exportation, the packages containing the same, properly branded), and the package itself being according to the description and limitation prescribed in the Inland Revenue Act, and no other.



*Tobacco and Cigar Regulations.*

## Chap. 39.

Sec. 133. Dealers in manufactured tobacco must also sell whole packages, each package bearing the properly cancelled stamp, except that retail dealers are permitted to sell plug tobacco at retail, from half caddies, caddies, half boxes or boxes; fine-cut chewing tobacco, from five and ten pound packages; and snuff, from five, ten and twenty pound packages, legally stamped, marked and labelled and put up as prescribed by law: with the exception of snuff, which at times may require to be dampened, the dealers must not withdraw the goods from the stamped package until actually offered for sale.

Dealers must sell whole packages, except retail dealers.

Sec. 134. The stamp upon the package from which goods are being retailed is *prima facie* evidence that the duty on such goods has been paid: the absence of such stamp is *prima facie* evidence of the non-payment of the duty: dealers in manufactured tobacco will not be allowed to cut a package in two and to sell the divided portions of the package, nor to retail tobacco therefrom.

Stamp, how far evidence.

Sec. 135. The law provides that all cigars shall be packed in boxes not before used for that purpose, containing definite and limited numbers, and positively prohibits the sale, in any other form, except by retail dealers: retail dealers are allowed to retail cigars from boxes packed, stamped and branded in the manner prescribed by law; but this provision does not authorize or warrant the practice of retailing cigars from show cases: sales can legally be made only from the stamped package in which originally put up and excised.

Cigars not to be packed in boxes used before; except dealers retailing from show cases.

Sec. 136. Manufacturers of cigars shall only sell original and unbroken packages from their manufactory premises.

Sale from manufactory premises.

Sec. 137. Collectors of Inland Revenue are hereby instructed to divide their Divisions into surveys, under the charge of such officers as they, or the inspecting officer of Inland Revenue may designate. It shall be the duty of these surveying officers to visit all places where manufactured tobacco or cigars are stored or kept, or where it is exposed for sale, and ascertain if the law is being strictly complied with in respect of the stamping, branding, cancelling and sale of tobacco and cigars, and to take such action as the law directs in case of discovery of any infraction of the law.

Collectors of Inland Revenue are to divide their districts into surveys.

Duty of surveying officers.

## ARTICLE 6.

FOR USING WOOD, METAL, PAPER OR OTHER MATERIAL, FOR PACKING TOBACCO OR CIGARS.

Sec. 138. Any manufacturer of tobacco or cigars, wishing to avail himself of the privilege which the law author-

## Chap. 39.

*Tobacco and Cigar Regulations.*

Substitution of other material for wooden boxes now used.

izes, of substituting for the wooden box now used for packing cigars, or for packing fine-cut chewing, cavendish, plug, snuff or twist tobacco, packages made of other material, will be required to submit to the Commissioner of Inland Revenue samples of such packages, for his approval, and if the same are of such a character as to admit of the proper marks, brands, labels, &c., being applied to them, and the stamps to be securely and permanently attached, and properly cancelled, permission may be issued granting their use.

Sample packages to be accompanied by statement, giving particulars, &c.

Sec. **139.** All sample packages forwarded to the Commissioner for his approval must be accompanied by a statement, setting forth the materials of which the packages are made, the description of goods intended to be packed therein, and the capacity of the package, in pounds, if intended for tobacco, and if intended for cigars, the number of cigars to be packed in each, and showing also, by samples, the mode in which the marks, brands, labels and stamps may be put upon the packages, and the law in those respects fully complied with.

## ARTICLE 7.

A.—STAMPING TOBACCO OR CIGARS, ABANDONED, CONDEMNED OR FORFEITED, WHEN SOLD FOR THE BENEFIT OF THE DOMINION OF CANADA.

Tobacco and cigars sold by any officer of the Government.

Sec. **140.** All tobacco and cigars, whether imported or of domestic manufacture, sold by any officer of the Government for the benefit of the Dominion of Canada, must, before being delivered, have affixed to the packages containing the same, the proper Inland Revenue or Customs stamps, denoting the duty thereon; and such stamps shall only be used for this purpose upon the whole circumstances of the intended sale being reported to the proper department, and the necessary permission being obtained to use the same.

Abandoned, condemned or forfeited tobacco or cigars offered for sale.

Sec. **141.** When abandoned, condemned, or forfeited tobacco or cigars are offered for sale, if such goods will not bring a price equal to the duty thereon, then the law forbids the sale to be made for consumption in the Dominion of Canada; such goods may, however, be sold for immediate export to a foreign country, and be covered by the ordinary exportation brand.

B.—DESTRUCTION OF ABANDONED, CONDEMNED OR FORFEITED TOBACCO OR CIGARS.

Abandoned tobacco may be destroyed.

Sec. **142.** Abandoned, condemned or forfeited tobacco or cigars, may be destroyed by order of the Commissioner,

*Tobacco and Cigar Regulations.*

## Chap. 39.

whenever they will not sell for an amount equal to the duty due and payable thereon.

Sec. 143. Collectors of Inland Revenue or Customs having such goods in their custody which have been offered for sale, and upon which they have been unable to realize an amount equal to the duty thereon, and who desire permission to destroy the same, will make application therefor to the Commissioner.

Collectors having such goods which have been offered for sale.

Sec. 144. In making such application they will give a complete history of the goods, also the kind, quantity, their present condition, and what efforts have been made to sell them, and if it shall appear to the Commissioner to be to the interest of the Government that the goods shall be destroyed, he will give an order for such destruction.

Application to destroy abandoned goods; how made and what to state.

## ARTICLE 8.

## A.—FOR THE RE-WORKING OF TOBACCO.

Sec. 145. Before any tobacco can be re-worked twenty-four hours' notice must be given by the manufacturer to, and special permission must be obtained therefor from the Collector of Inland Revenue of the division where the manufactory is situated.

Notice to be given and permission obtained.

Sec. 146. The manufacturer, in making application for permission to re-work tobacco, must give full particulars as to the quantity and description of the tobacco to be re-worked, stating whether the tobacco is of his own manufacture or the product of another manufactory, and if the latter, the name of the manufacturer: he will also state the reason for desiring permission to re-work the tobacco in question.

Manufacturer in making application must give full particulars.

Sec. 147. The tobacco, when taken for re-working, shall be so credited on stock book No. 2 (and an entry ex-warehouse passed on the form provided for that purpose, when taken from the bonding warehouse), and the quantity carried to Dr. of daily record, and treated as raw material, the product of which will be accounted for as manufactured tobacco, in the usual manner, and stamped and treated as tobacco the original product of the leaf.

Tobacco for re-working, how credited, treated and accounted for.

Sec. 148. When the tobacco to be re-worked has paid duty, the stamps upon the packages must be destroyed in the presence of two officers of Inland Revenue, one of whom shall be the officer in charge of the manufactory, and the other an officer detailed therefor by the Collector of the

Officer in charge of manufactory must see that stamps are destroyed.

## Chap. 39.

*Tobacco and Cigar Regulations.*

Record to be kept and duplicate certificate to be furnished.

division, and these officers shall keep a record of, and shall furnish the Collector with a certificate, showing the numbers on each stamp, the weight of tobacco contained in each package covered thereby, and the registered number of the manufactory (or, if manufactured prior to the 1st day of July, 1883, the name or license number of the manufacturer), where manufactured or put up.

Bonded tobacco, stamped under the provisions of previous Acts.

Sec. 149. When the bonded tobacco to be re-worked has been stamped under the provisions of previous Acts, the stamps on the packages are to be removed and destroyed under the same regulations as are herein provided when the tobacco to be re-worked has paid duty.

Collector will compare numbers and weights of stamps with the record of stamps issued.

Sec. 150. The Collector of Inland Revenue will compare the numbers of these stamps and the weights thereon, with the record of stamps issued, kept in his office; and if the stamps have been issued in another division, shall forward to the Collector of that division a detailed statement of the number and weight on each stamp so destroyed, as well as the number of the manufactory where, (or the name of the manufacturer by whom) the tobacco was originally put up; the Collector so receiving the same shall compare this statement with his register of stamps issued to such manufacturer or manufacturers as are mentioned therein, and shall at once return said statement to the Collector from whom received, with a certificate as to its correctness or otherwise.

Packages to be destroyed and tobacco therein broken up.

Sec. 151. So soon as the stamps have been taken account of and destroyed, the packages, if they have been previously stamped or if the out-put of a factory other than that where the tobacco is to be re-worked, are to be also destroyed, and the tobacco contained therein broken up and steamed or treated in such a way that it cannot be removed from factory for sale without being re-worked.

No rebate will be allowed when stamps not taken account of and destroyed.

Sec. 152. No rebate will be allowed or paid when the stamps on the packages containing tobacco have not been taken an account of, and the said stamps destroyed in the presence of the officers herein mentioned, nor when the record of stamps destroyed does not accord with the stamp book of the Collector by whom issued.

Rebate of duty, less five cents per pound, when allowed to manufacturer

Sec. 153. When the tobacco to be re-worked has paid duty, a rebate of the duty paid, less five cents per pound to cover cost of supervision, stamps, &c., on the quantity of tobacco entered for re-manufacture, will be allowed to the

*Tobacco and Cigar Regulations.*

## Chap. 39

manufacturer and will be paid by the Department upon the receipt of a sworn statement from the manufacturer that the tobacco so taken has been re-worked and entered to the debit of stock book No. 2 as produced, accompanied by the certificate of the officer in charge of the manufactory that the stamps, and where necessary, the packages were destroyed in his presence, and that the tobacco was broken up and steamed or so treated that it could not be removed from the manufactory for sale without being re-worked, which certificate must be countersigned by the Collector of the division.

Receipt of sworn statement that tobacco has been re-worked, &c.

Sec. 154. No fee for supervision will be charged for bonded tobacco re-worked or where plug tobacco is merely taken from the caddy to rub or wipe the plugs. In the latter case, however, the operation must be carried on under the supervision of the officer in charge and to the satisfaction of the Collector.

Fee for supervision, when not to be charged.

Sec. 155. (a.) The re-working of the product of Canadian raw leaf tobacco is permitted, but no rebate of duty shall be allowed thereon.

Re-working raw leaf tobacco.

(b.) Imported tobacco shall only be reworked, duty paid.

Imported tobacco.

## B.—FOR THE RE-WORKING OF CIGARS.

Sec. 156. Before any cigars can be re-worked twenty-four hours' notice must be given by the manufacturer to, and special permission must be obtained therefor from, the Collector of Inland Revenue of the division where the manufactory is situated.

Notice, &c., necessary before cigars can be re-worked.

Sec. 157. The manufacturer, in making application for permission to re-work must give full particulars as to the quantity of cigars to be re-worked, stating that the cigars are of his own manufacture. He will also state the reason for desiring permission to re-work the cigars in question.

Manufacturer must give full particulars.

Sec. 158. The cigars when taken for re-working shall be so credited on stock-book No. 2 (and an entry ex-warehouse passed on the form provided for that purpose when taken from the bonding warehouse), the cigars weighed and the quantity carried to Dr. of daily record, and treated as raw material, the product of which will be accounted for as manufactured cigars, in the usual manner, and stamped and treated as cigars the original product of the leaf.

Cigars for re-working, how credited, weighed and accounted for.

Sec. 159. When the cigars to be re-worked have paid duty, the stamps upon the packages must be destroyed in

Stamps to be destroyed.

## Chap. 39.

*Tobacco and Cigar Regulations.*

In presence of two officers who shall keep a record of number, &c.

the presence of two officers of Inland Revenue, one of whom shall be the officer in charge of the manufactory, and the other an officer detailed therefor by the Collector of the division, and these officers shall keep a record of, and shall furnish the Collector with a certificate showing the numbers on each stamp, the number of cigars contained in each package covered thereby, and the registered number of the manufactory (or, if manufactured prior to the 1st day of July, 1883, the name or license number of the manufacturer), where manufactured or put up.

\*Cigars to be re-worked, having been stamped under previous Acts.

Sec. 160. When the bonded cigars to be re-worked have been stamped under the provisions of previous Acts, the stamps on the packages are to be removed and destroyed under the same regulations as are herein provided when the cigars to be re-worked have paid duty.

Collector shall compare numbers &c., of stamps.

Sec. 161. The Collector of Inland Revenue will compare the numbers of these stamps and the denominations thereof with the record of stamps issued, kept in his office.

Packages to be destroyed and wrappers removed.

Sec. 162. So soon as the stamps have been taken account of and destroyed, the packages are to be also destroyed, and the wrappers removed from the cigars contained therein or the cigars treated in such a way that they cannot be removed from factory for sale without being re-worked.

Rebate when not to be allowed.

Sec. 163. No rebate will be allowed or paid when the stamps on the packages containing cigars have not been taken an account of and the said stamps destroyed in the presence of the officers herein mentioned, nor when the record of stamps destroyed does not accord with the stamp book of the Collector by whom issued.

Rebate when to be allowed, amount thereof and provisions in reference thereto.

Sec. 164. When the cigars to be re-worked have paid duty, a rebate of the duty paid, less seventy-five cents per thousand to cover cost of supervision, stamps, &c., on the quantity of cigars entered for re-manufacture, will be allowed the manufacturer, and will be paid by the Department, upon receipt of a sworn statement from the manufacturer, that the cigars so taken have been re-worked and entered to the debit of stock book No. 2 as produced, accompanied by the certificate of the officer in charge of the manufactory, that the stamps and the packages were destroyed in his presence, and that the cigars were so treated that they could not be removed from the manufactory for sale without being re-worked, which certificate must be countersigned by the Collector of the division.

*Tobacco and Cigar Regulations.*

## Chap. 39.

Sec. 165. No fee for supervision will be charged when the bonded cigars re-worked are the product of the manufactory where the operation is to be carried on.

Fee for supervision, when not to be charged.

Sec. 166. The re-working of the product of one manufacturer by another will not be permitted unless under special permission obtained from the Department in each case.

Re-working by another manufacturer.

Sec. 167. The blank forms used when tobacco is taken for re-manufacture may also be used for cigars, the necessary alterations being made thereon.

Blank forms may be used for cigars.

## ARTICLE 9.

## A.—MARKING OR BRANDING CIGAR BOXES.

Sec. 168. (a.) The law provides that there shall be burned, stamped, indented or impressed into every box containing cigars, in a legible and durable manner, the registered number of the factory, the number of the Inland Revenue division in which the factory is situated and the number of cigars contained in each box: the number of cigars contained in each box may, however, if desired, be stencilled on the surface of the wood or other material of which the package is made; but the registered number of the factory, and the number of the Inland Revenue division, must be burned, stamped, indented or impressed into every box, as required by law;

Provisions as to working or branding cigar boxes; registered number of factory; number of division; number of cigars contained in each box may be stencilled.

(b.) Empty cigar boxes which may have become broken or otherwise rendered unfit for use, may be destroyed in the presence of the officer in charge of the manufactory and credit taken therefor in the Daily Record.

Empty cigar boxes may be destroyed.

## B.—CULL CIGARS.

Sec. 169. As in some cigar factories, manufacturers have more or less cigars made, which are unfit for packing, Collectors are hereby instructed that manufacturers may, upon application on the form C. 3, supplied by the Department, be permitted to take credit for such cigars when they are counted and broken up in the presence of the officer in charge. The credit entry will be made in column 9 of Daily Record, the entries being totalled to date and the proper deduction made. Every such entry must be initialled by the officer as an evidence of its correctness.

Credit for cigars when they are counted and broken up.

## C.—CIGAR SAMPLES.

Sec. 170. In addition to the provisions of the Act in respect of sample boxes of cigars, the following regulations are hereby prescribed:—

Additional regulations.

## Chap. 39.

*Tobacco and Cigar Regulations.*

- Manufacturer may take from warehouse one package of each brand for the purpose of exhibiting contents.
- (a.) A manufacturer of cigars may be permitted to take from the warehouse, under permit from the Collector in each case, one package containing not more than one hundred cigars of each brand manufactured by him,—these packages to remain on the factory premises unstamped, for the sole purpose of exhibiting the contents to his customers, and, when required for consumption, the regular ex-warehouse entry to be passed therefor, the duty paid and the packages stamped, as if just taken from the warehouse ;
- Removing packages without the ex-warehouse entry being passed, the duty paid and packages stamped, &c. Penalties in such case.
- (b.) A manufacturer removing any of these packages without the ex-warehouse entry being passed, the duty paid, and the packages regularly stamped, branded and labelled, will be deemed to have illegally abstracted the same from warehouse, and will render himself liable to the penalties imposed in the Act for such offence: the goods, although in the possession of the manufacturer, will be considered as still in the warehouse and treated as such until the ex-warehouse entry is passed: the officer delivering such packages of cigars on permit, will keep a record of the number and capacity of packages of cigars so delivered and will mark such packages so that they can afterwards be identified by him ;
- Abuse of privilege.
- (c.) Should any cigar manufacturer abuse the privilege hereby granted to him, by taking from the warehouse a greater number of packages than are deemed necessary by the inspector of tobacco, the Department reserves the right to withdraw from such manufacturer the privilege now granted to all.
- Conditions upon which duty paid boxes of cigars may remain open. Number not to exceed 3.
- Sec. 171. Duty-paid boxes of cigars may be permitted to remain open in any licensed cigar factory, upon the following,—and only upon the following conditions:—
- (a.) That the number of boxes thus remaining open in any factory premises shall not at any one time exceed three ;
- Stamps thereon shall be cut or broken.
- (b.) That the stamps thereon shall be cut or broken in the presence of an officer of Inland Revenue, unless the packages are taken from those which may have been brought in with cut stamps and placed in bonding warehouse as hereinafter provided ;
- Officer shall forthwith mark the package.
- (c.) That the officer shall forthwith so mark the package by writing date when opened and placing his signature thereon, that it can be hereafter identified by him ;
- Immediately package is emptied,
- (d.) Immediately every such package is emptied the manufacturer shall inform the officer of the fact, when said empty package and the stamp thereon shall be completely



*Tobacco and Cigar Regulations.*

## Chap. 39.

destroyed in the presence of said officer and a credit entry made in stock book No. 2 for the original contents thereof. officer shall be informed.

## D.—AS TO RETURN OF PACKAGES WITH CUT STAMPS.

Sec. 172. The stamps on cigar boxes which may have been cut after being removed from the manufactory, and which the manufacturer may in the course of business desire to have returned thereto, may be brought into the manufactory under the following conditions:— Conditions under which stamps cut, &c., may be brought into manufactory.

(a.) That they be brought into the manufactory only after notice in writing, of his intention to do so, has been served by the manufacturer on the Collector and at a time when an officer of Inland Revenue is present to take an account of the same; Notice how to be served on collector.

(b.) That the packages with cut stamps be at once placed in the bonding "cigar" or "raw leaf" warehouse and kept separate from all other goods therein, and that they shall remain in said warehouse until such time as the manufacturer may desire them for immediate removal from the manufactory or for use, as per Sections 168, 169 and 170 of these regulations; Packages with cut stamps to be placed in bonding warehouse and kept separate from all other goods.

(c.) That the regular entries be made in stock book No. 2 when the packages are brought into or removed from manufactory, in the same manner as for other duty paid cigars; and,— Regular entries to be made.

(d.) That any packages with cut stamps brought into manufactory without due notice being given, an account taken of them by an officer of this Department, and the packages and contents secured in bonding warehouse, or which may be found in any manufactory premises with stamps cut otherwise than as herein provided, shall render the manufacturer so offending liable to all penalties prescribed therefor under the Inland Revenue Act. Non-compliance with conditions to render manufacturer liable to penalties.

## E.—WAREHOUSING AND EX-WAREHOUSING OF CIGARS.

Sec. 173. The following provisions made by the Department of Inland Revenue in respect of the warehousing and ex-warehousing of cigars, are hereby established and confirmed, viz. :— Provisions made by Department confirmed.

(a.) Packages containing cigars when entered for warehouse need not be marked with the number of the entry under which warehoused, but only with the number of the month and year in addition to the specific information required by section 261 of "The Inland Revenue Act." Packages how to be marked.

## Chap. 39.

*Tobacco and Cigar Regulations.*

Manufacturer may take cigars from any lot. (b.) When ex-warehousing cigars, the manufacturer may take the cigars from any lot in warehouse, provided the number of packages and denomination are the same as those upon which he has paid duty.

Cigars, how to be stowed and arranged. (c.) Cigars, when placed in warehouse, shall be stowed and arranged in lots according to denomination of packages.

Collectors need open only a general account. (d.) Under this system it will not be necessary for Collectors to open an account with each warehouse entry, but only a general account with each individual. On the entry papers it will be unnecessary to show marks and numbers.

Subject to section 54 of Act. (e.) The above instructions are subject to the provisions of section 54 of "The Inland Revenue Act."

## ARTICLE 10.

## CUTTING MACHINES.

Persons not having license to manufacture, prohibited from having cutting machine; except retail dealers on signing declaration and receiving permit. Sec. 174. (a.) No person not having a license to manufacture tobacco or cigars shall be permitted to use, nor (without having notified the Collector of Inland Revenue thereof, in writing) to have in possession any machine for the purpose of cutting tobacco; except that persons dealing in manufactured tobacco at retail may, upon signing a declaration that such machine will be used solely for cutting duty paid "plug" or "cavendish" tobacco for immediate sale thereof to their customers, receive a permit to use the same during the pleasure of the Minister of Inland Revenue; but the said dealers will not be allowed to keep on hand any tobacco so cut, the cutting machine only to be used for cutting tobacco at the request of the customer, and for immediate delivery to him.

Persons having tobacco-cutting machine, to notify collector. (b.) All persons (other than those hereinbefore excepted) having in their possession any tobacco-cutting machines, are required to notify the Collector of Inland Revenue of the same, and it shall be the duty of the said Collector to cause the same to be so fastened or sealed as to render it incapable of being used without removal of the said seal, and any such machine found unsealed, whether such machine had been sealed by an officer of Inland Revenue or not, shall be seized and forfeited to the Crown.

Tobacco-cutting machines liable to forfeiture. (c.) All tobacco-cutting machines found in possession of any person other than those hereinbefore mentioned, or in the possession of other than a private individual not dealing in tobacco and using the same for cutting tobacco for his own use, (which machine must not be a rotary cutting

*Tobacco and Cigar Regulations.*

Chap. 39.

machine,) are forfeited and may be seized and removed by any officer of Inland Revenue.

## ARTICLE 11.—ASSESSMENT FOR DEFICIENCIES.

## TOBACCO.

Sec. 175. Section 268 of The Inland Revenue Act, provides that the deficiency in any tobacco manufactory shall not, at any time, exceed six per cent. Deficiency not to exceed 6 per cent.

## CIGARS.

Sec. 176. Section 269 of said Act directs that "there shall be produced from each and every twenty-five pounds of un-steamed raw leaf scraps, cuttings or other material taken for use in a cigar manufactory at least one thousand cigars, but if at any time the Department of Inland Revenue determines that the standard herein established exceeds or falls short of what is hereafter ascertained to be the true standard, the Governor in Council may amend or alter such standard by regulation to the extent of three pounds." Amendment of section 269 of the Inland Revenue Act allowed.

(a.) Under such direction the standard for the production of 1,000 cigars is reduced from 25 lbs. of raw leaf tobacco to 22 lbs., and such standard is made applicable to all transactions subsequent to the 1st day of July, 1884; Reduction of standard.

(b.) Allowance will be made for leaf tobacco sold or returned, or for cuttings and clippings when they are of such a character that they may be made into cigars, or are sold or removed for that purpose. Officers are, however, to understand that the scraps and cuttings, if, to be credited against the production account, must be free from dust, sand and tobacco-dust. No allowance will be made for stems, or for ordinary scraps and waste incidental to the business. In the making of finer grades of cigars, particularly of Havana tobacco, manufacturers often use only the best portion of the leaf and sell the balance to be used as filling for a lower or cheaper grade of cigars: in such cases an allowance will be made for such stock when sold or removed; Allowance for leaf tobacco, or for cuttings and clippings.

(c.) The annual stock statements have been prepared so that officers can readily understand the mode upon which the production is ascertained; No allowance for stems or ordinary scraps or waste.

(d.) The Commissioner of Inland Revenue is empowered by section 273 of the said Act to make an assessment, and to order the collection from the manufacturer of the duty at the highest rate chargeable on the tobacco or cigars produced in the manufactory where the deficiency is found to exist. Annual stock statements.

Commissioner empowered to make assessment.

## ARTICLE 12.

## ADDITIONAL FORFEITURE.

Packages, when liable to seizure and forfeiture. Sec. 177. Any package containing tobacco or cigars which is proven not to have been made by the manufacturer whose name or factory number is marked or branded thereon, shall, with the contents thereof, be seized, and shall be and remain forfeited to the Crown.

## ARTICLE 13.

## STOCK STATEMENTS.

Stemmed raw leaf tobacco, how to be treated. Sec. 178. In preparing statement B. of annual stock statement (G. 15), all stemmed raw leaf tobacco taken for use, and all stemmed raw leaf tobacco in process of manufacture at beginning and end of period, is to be treated as if resulting from raw leaf tobacco which contained twenty-five per cent. of stems, *i.e.*,  $\frac{1}{2}$  is to be added to the weight of stemmed leaf.

Unpacked cigars, how to be computed. Sec. 179. All unpacked cigars on hand at time of stock-taking are to be computed at a uniform rate of twenty-two (22) pounds per thousand.

Certificate of officer as to deficiency or surplus. Sec. 180. The Collector will attach to each cigar manufacturer's stock statement the certificate of the officer in charge as to any deficiency or surplus that may be found in the unpacked cigar account. When the account comes out correct, the officer's certificate must state so. All possible care must be used in stock-taking.

Duty to be collected upon the quantity of tobacco or cigars deficient. Sec. 181. Collectors, unless otherwise advised, will collect from the tobacco and cigar manufacturers of their respective divisions the duty upon the quantity of tobacco or cigars deficient of the standard established by law and also the duty on the quantity of cigars found deficient in unpacked cigar account as shown by stock statements each year.

Credit for quantity so deficient. Sec. 182. The manufacturer may then take credit in column 9 of his Daily Record for the quantity so deficient in unpacked cigar account in order to bring that book in accord with stock.

Surplus to be charged. Sec. 183. When a surplus is found it should be at once charged up in the same column.

Duties will be accounted for. Sec. 184. The duties under the foregoing instructions will be accounted for on the Form D. 11, which must contain full explanations of the source from which they are derived.

*Tobacco and Cigar Regulations.*

Chap. 39.

Sec. 185. All tobacco and cigar stock statements are to be forwarded to the Department in duplicate, one copy for the Inspector of tobacco factories and the other for the Department.

Statements to be forwarded to Department in duplicate.

## ARTICLE 14.

## REWARD FOR INFORMATION IN REGARD TO ILLICIT MANUFACTURE AND SALE OF TOBACCO OR CIGARS.

Sec. 186. (a.) For such information as will lead to the discovery and seizure of an illicit tobacco or cigar manufactory, or any illicit tobacco or cigars, one-half of the appraised value of the articles seized.

Information leading to discovery and seizure.

(b.) For such information as will lead to the conviction of the parties owning or working an illicit tobacco or cigar manufactory, one-half the amount of the penalties recovered, not exceeding \$200.

Information leading to conviction.

(c.) If the parties convicted are unable to pay the penalties imposed, and are committed to gaol for non-payment, the Department will make good to the informer one-fourth of the penalties imposed.

If parties convicted are unable to pay.

(d.) The names of the parties giving the information are not to be made known, unless by their own desire or consent.

Names not to be made known.

## ARTICLE 15.

## DRAWBACK.

Sec. 187. In accordance with the provisions of Section 259 of the Inland Revenue Act, as to drawback on cut tobacco and cigarettes in certain cases, the Department of Inland Revenue is authorized to pay over such drawback upon receiving the certificates of the Collectors of Inland Revenue, setting forth the number of stamps, of denominations applicable to packages mentioned in Section 259, aforesaid, delivered and paid for during the currency of each month, and entered upon the monthly return of the manufacturer, such payments to be treated as "Refunds of Excise Revenue."

In accordance with section 259 of the Act, Department is authorized to pay over drawback upon receiving certificates, &c.

## ARTICLE 16.

## DIRECTIONS FOR THE USE AND CARE OF CANCELLATION ROLLERS AND RUBBER STAMPS.

Sec 188. (a.) For roller stamps, put a few drops of ink on the roller pads with a small wedge shaped piece of soft wood and spread evenly.

For roller pads.

## Chap. 39.

*Tobacco and Cigar Regulations.*

- To clear the rollers. (b.) Take a few rough impressions to clear the rollers of surplus ink.
- For finger and hand stamps. (c.) For finger and hand stamps,—repeat the above directions in reference to inking, and spread the ink evenly on pad with distributer.
- To take an impression. (d.) To take an impression,—press the stamp on the pad and set down evenly on paper with a slight pressure and tremor of the hand. Do not strike the stamp.
- To clean. (e.) To clean,—use a tooth brush and water, nothing else, and dry the surface by applying the stamp on blotting paper.

## PORTS OF ENTRY FOR RAW LEAF TOBACCO.

Sec. 189. The following are constituted ports of entry at which raw leaf tobacco may be imported into Canada, in addition to those mentioned in Section 307 of "The Inland Revenue Act":—

- Yarmouth. Yarmouth, in the Province of Nova Scotia.  
O. C. March 5, 1877.
- Percé. The Village of Percé, in the Province of Quebec.  
O. C. Sep. 18, 1879.
- Three Rivers. The City of Three Rivers, in the Province of Quebec.  
O. C. April 19, 1884.
- Goderich. The Town of Goderich, in the Province of Ontario.  
O. C. July 10, 1884.
- Galt. The Town of Galt, in the Province of Ontario.  
O. C. March 23, 1885.
- Ottawa. The City of Ottawa, in the Province of Ontario.  
O. C. June 30, 1885.
- Listowel. The Town of Listowel, in the Province of Ontario.  
O. C. April 27, 1886.
- Tilsonburg. The Town of Tilsonburg, in the Province of Ontario.  
O. C. July 27, 1887.
- Walkerton. The Town of Walkerton, in the Province of Ontario.  
O. C. Jan. 9, 1889.

## CHAPTER 40.

### ANALYSTS UNDER "THE ADULTERATION ACT."

Government House, Ottawa,  
The 9th day of January, A.D. 1889.

On the recommendation of the Minister of Inland Revenue, and under the provisions of Chapter 107 of the Revised Statutes of Canada, intituled "The Adulteration Act,"

His Excellency in Council has been pleased to order, and it is hereby ordered, that the following regulations for carrying the said Act into effect be made and established:—

**Section 1.** The Districts for the purposes of this Act shall be coterminous with the inspection districts of Inland Revenue. [See *ante* Chapter 34, page 221.]  
O. C. Nov. 24, 1886.

Districts coterminous with inspection districts.

**Sec. 2.** Such Analysts may be remunerated as follows,—

(a.) By a retaining fee of \$200 per annum;

Remuneration of analysts.  
Retaining fee.

(b.) By an allowance for the first year of a sum not exceeding \$300 for the apparatus and material used in the laboratory;

Allowance for first year.

(c.) By an annual allowance of \$100 on account of such expenses as are necessarily incurred in providing material for analyzing samples submitted to them by duly authorized officers;

Annual allowance for expenses.

(d.) By an allowance of \$100 towards the rent of the place in which the laboratory may be established;

Allowance towards rent.

(e.) By payments equal to the amount of fees payable in each case in accordance with the scale hereinafter established, provided the aggregate sum paid shall not exceed the amount voted for such purpose by Parliament.

Payments equal to amount of fees.

**Sec. 3.** The following tariff of fees is hereby established:—

	Tariff of fees.
For analysis of milk.....	\$ 5 00
do do when six samples are submitted at one time.....	20 00
do bread, sweets and other articles unenumerated .....	5 00
do butter, cheese, malt liquors, cider, wines, alcoholic liquors, tinctures, liqueurs, condiments, spices, drugs, oils, proprietary infants' and invalids' foods, and fertilizers.....	8 00

## Chap. 40.

*Analysts under "The Adulteration Act."*

For analysis of tea, coffee, tobacco, cocoa or chocolate, and drugs for their alkaloids, as opium, barks, &c., pharmaceutical liquors, fluid extracts, &c., dispensed medicines and waters..... 10 00

Inland Revenue officer on obtaining sample, shall declare the object to the vendor and divide the sample into three parts and label them; one shall go to vendor, one to Minister and one to public analyst.

**Sec. 4.** Any Inland Revenue officer or other person authorized by the Act, on obtaining a sample from a vendor, and after the completion of his purchase of such samples, shall declare to the vendor the object for which he has made the purchase, and shall forthwith, in presence of the vendor, proceed to divide the sample into three equal parts, making the same up into three parcels of such description as the nature of the article may require, carefully wrapping each separately, attaching to it a label of such form as may be approved from time to time by the Minister of Inland Revenue, and sealing each parcel therewith in such a manner that the parcel cannot be opened without destroying the same. One parcel he shall offer to deliver to the vendor, the second shall be transmitted to the Minister of Inland Revenue, and the third shall be forwarded to the Public Analyst for the district within which the sample was taken.

Conduct of officer in case vendor refuses to show stock and to allow sample to be taken.

**Sec. 5.** If a vendor of an article (either wholesale or retail) refuses to give to an officer any sample of such article which the officer desires to procure under the provisions of the 7th section of the Act, after the officer has paid, or tendered, the value of such sample, the officer shall explain the object of his visit and the requirements of sections 7 and 8 of the Act, and shall thereupon demand to be shown the stock of such article and to be furnished with or permitted to take samples of the same. If the vendor still refuses the officer is to repeat the demand in the presence of a reliable witness.

Samples, how transmitted.

**Sec. 6.** When samples have been purchased at places distant from the residence of the Public Analyst of the district, the officer or Inspector shall transmit the respective portions of the samples to the Public Analyst and to the Minister of Inland Revenue respectively, by mail or express prepaid, and the cost of such transmission shall be deemed to be a portion of the cost of purchase.

Notice of intention to prosecute.

**Sec. 7.** When the Analyst's certificate declares an article to be adulterated within the meaning of the Act, the officer or Inspector shall be advised of such fact, and shall forthwith notify the vendor of intention to prosecute, if such



*Analysts under "The Adulteration Act."*

## Chap. 40.

course be determined by the Minister of Inland Revenue.

Sec. 8. The Analyst shall impartially perform the duties of his office and shall not communicate the result of his analysis to anyone, unless specially authorized or testifying before a court of law in conformity with his duties under the Act. Analyst not to communicate result of his analysis.

Sec. 9. The Analyst, on receipt of sample, shall proceed with all reasonable speed to make the analysis and forthwith forward his certificate of analysis to the Minister of Inland Revenue. Analyst to make analysis promptly.

Sec. 10. To any municipality appointing inspectors under the Act, a remission of one-half the fees shall be made by the Public Analyst, and the half so remitted shall be paid out of the grant made by Parliament for the purposes of this Act. Municipality appointing inspectors to receive half the fees

Sec. 11. But such Inspectors shall comply with all the requirements of the law and such instructions from the Minister of Inland Revenue, who shall in each case determine the maximum amount of fees that shall be remitted to a municipality in each fiscal year. Such inspectors to comply with law.

Sec. 12. The certificates and other forms used under the Adulteration Act, shall be approved by the Minister of Inland Revenue. Certificates and forms.

O.C. Jan. 13, 1886.

Sec. 13. Such employes of the Inland Revenue mentioned in section 5 of the Adulteration Act aforesaid as the Minister of Inland Revenue may select, shall be styled Food Inspectors, and for such extra services may be paid an additional remuneration, the gross salary not to exceed the sum of one thousand two hundred dollars (\$1,200) in any one year, as the Minister of Inland Revenue may decide, such extra remuneration to be paid out of the sum voted by Parliament for that purpose. Food inspectors and their remuneration

Sec. 14. Any manufacturer, importer, retailer or purchaser who desires to procure an analysis of any drug, food sample, &c., may obtain such from the Minister of Inland Revenue on payment of a fee of five dollars (\$5,00) for each sample so analyzed, such fees to be credited to the Adulteration of Food Grant. Fee for obtaining analysis of drug, food sample, &c

O.C. Feb. 27, 1883.

# CHAPTER 41.

## AGRICULTURAL FERTILIZERS.

Government House, Ottawa,  
The 9th day of January, A.D. 1889.

On the recommendation of the Minister of Inland Revenue, and under the provisions of Chapter 108 of the Revised Statutes of Canada, intituled "The Fertilizers Act,"

His Excellency in Council has been pleased to order, and it is hereby ordered, that the following regulations be made and established for the purpose of carrying into effect the said Act:—

Collectors of customs and of Inland Revenue to be Inspectors.

**Section 1.** All Collectors of Customs and Collectors of Inland Revenue are hereby appointed as Inspectors of Agricultural Fertilizers, under the said Act.

Duty of Inspector to ascertain that all importers or manufacturers have complied with provisions of Act by forwarding two-pound sample, &c.

**Sec. 2.** Every Inspector is hereby required, as soon as practicable after the first of January in each year, to ascertain that all importers or manufacturers of fertilizers (which are sold at more than ten dollars per ton, and which contain ammonia or its equivalent of nitrogen, or phosphoric acid) in his collection division, have complied with the provisions of the Act above cited, by forwarding to the Minister of Inland Revenue, at Ottawa, a two-pound sample, in a stoppered and sealed glass jar, of each of the fertilizers they propose to import or manufacture during the year, together with a certificate of analysis, stating the commercial name of the fertilizer, and an affidavit that such sample and certificate fairly represent the fertilizer they propose to import or manufacture.

Inspector at least once a year to procure sample and forward same to Minister.

**Sec. 3.** Every Inspector is hereby required to procure at least once in every year, from every importer or manufacturer of fertilizers within his collection division, a fair average sample of at least two pounds weight, drawn by himself or his deputy, from the bulk of each parcel imported, and of each batch manufactured and offered for sale, of such fertilizers, and forward the same to the Minister of Inland Revenue, for submission to the chief analyst for analysis and comparison with the certified analysis of the same fertilizer deposited and on record with the Minister of Inland Revenue.

Analyst to make analysis promptly.

**Sec. 4.** On receipt of such samples by the Chief Analyst, he is hereby required to have the same analyzed with all

*Agricultural Fertilizers.*

## Chap. 41.

convenient expedition, and to report the result of the same to the Minister of Inland Revenue in the form of Certificate A, hereinafter given. Result to be reported.

Sec. 5. After having taken the samples as above described, the Inspectors, or their deputies, are, if the fertilizer is put up in packages, to require that the manufacturer's certificate of analysis, bearing also the commercial name of the fertilizer in question, be placed upon and securely attached to each package by the manufacturer or importer as required by the Act. Commercial name of fertilizer to be attached to each package.

Sec. 6. If requested to do so by the manufacturer, or the person selling the fertilizer, the Inspector, or his deputy, is hereby authorized to cause to be applied, under his personal supervision, inspector's tags, one to each package, bag or barrel of fertilizer, before the same is offered for sale or distribution. These Inspector's tags are to be in the form B, and are to be numbered consecutively, and bear a *fac simile* of the signature of the Minister of Inland Revenue. Inspector's tag to be applied to each package on request.

Sec. 7. Inspectors are hereby authorized to demand and collect a fee (section 10 of said Act) for each inspection at the rate of (5) five cents per hundred pounds weight of the fertilizer inspected, and this fee shall be paid and the inspector's tag attached before the fertilizer may be removed from the mill, factory or storehouse, or out of the possession of the manufacturer's agent, or the person importing the same. Should the manufacturer, importer, or purchaser, desire to obtain from the chief analyst an analysis of any of the samples above referred to, or of any other he may provide, he shall be entitled to receive the same on payment of a fee of \$3 for each certificate. Inspector's fee to be paid and tag attached before fertilizer is removed from mill, factory or storehouse.

Sec. 8. Inspectors are not to furnish any tag to be attached to any package of fertilizer unless the manufacturer's certificate of analysis, bearing also the commercial name of the fertilizer, is plainly placed upon each parcel or package, claiming in the case of an ammoniated superphosphate that it contains at least (5) five per centum of soluble phosphoric acid, and (2) two per centum of ammonia; and, in the case of any acid phosphate or dissolved bones, that it contains at least (8) eight per centum of available phosphoric acid. Conditions upon which inspector's tag may be furnished; certificate of analysis.

Sec. 9. Nor shall any tag be furnished to be attached to any package of fertilizer, or bill of inspection be delivered in respect of any fertilizer, that is in a damaged or unmerchantable condition. Fertilizer in damaged or unmerchantable condition.

## A.

## CERTIFICATE OF ANALYSIS.

*Chemical Laboratory.*

INLAND REVENUE DEPARTMENT,  
OTTAWA, 18 .

I, \_\_\_\_\_, Chief Analyst for the Department of Inland Revenue, hereby certify that a sample of fertilizer, forwarded to the Minister of Inland Revenue by \_\_\_\_\_ described as \_\_\_\_\_ No. \_\_\_\_\_, manufactured or imported by \_\_\_\_\_ at \_\_\_\_\_ and drawn by \_\_\_\_\_ has been analyzed in this laboratory and found to contain:—

Soluble phosphoric acid.....	per cent.
Reverted do .....	do
Insoluble do .....	do
<hr/>	
Total.....	do
Ammonia .....	do

Moisture ..... do  
*Chief Analyst.*

## B.

## INSPECTOR'S TAG.

*The Fertilizers Act.*

Name. No. Inspected, 18 ,  
Canada.

(Signed,) \_\_\_\_\_  
*Minister of Inland Revenue.*

Notice in reference to tag.

NOTICE.—This tag is merely a guarantee that the manufacturer has complied with the requirements of the Act, and that a sample taken from the lot numbered \_\_\_\_\_ to \_\_\_\_\_ has been transmitted to the Minister of Inland Revenue for analysis. A departmental certificate of analysis may be obtained on application and upon payment of a fee of \$3.

Inspector  
Address

O. C. April 16, 1886.

## CHAPTER 42.

### WEIGHTS AND MEASURES,—REGULATIONS.

Government House, Ottawa,  
The 9th day of January, A.D. 1889.

On the recommendation of the Minister of Inland Revenue, and under the provisions of Chapter 104 of the Revised Statutes of Canada, intituled "The Weights and Measures Act,"

His Excellency in Council has been pleased to order, and it is hereby ordered, that the following regulations for the governance of the inspection of weights and measures be, and the same are hereby made and established :—

#### REGULATIONS RESPECTING WEIGHTS AND MEASURES.

Section 1. The following balances are to be admitted to verification :—

List of balances to be admitted to verification.

- A. Balances having equal arms, and on which :—  
suspended below the fulcrums.
- B. Balances commonly known as steelyards, or Roman balances, having unequal arms.
- C. Weigh-bridges.
- D. Balances with equal arms, and on which the load is placed above the fulcrums.
  - D 1. Hydrostatic balances for weighing coal.
  - D 2. Perfection scales.
  - D 3. Duplessis portable track scales.

Sec. 2. A. Balances with equal arms are only to be admitted to verification when :—

Balances with equal arms, when to be admitted to verification.

1. The beam shows no material difference as regards the form or magnitude of the two arms.

2. It is provided with a tongue pointing upwards or downwards from its centre, at right angles with a line joining the extreme bearings, or with some equivalent arrangement for indicating the position of the equilibrium.

3. It is in equilibrium when a line joining the extreme bearings is perfectly horizontal, and returns to that position after being put into vibration.

4. Its arms are equal within the specified limit of error.

5. The balance is sufficiently sensitive to be turned decidedly and promptly by the addition or withdrawal of so much of the load as represents the error tolerated by regulations in a commercial weight representing the load.

6. No balance balls or detached parts other than the pans and connections necessary for attaching them to the beam are used for adjusting the balance.

7. The balance, as a whole, is of sufficient strength, and on a sufficiently stable base, to secure it against change of form or position under the maximum load it is to carry.

8. The beam will carry its maximum load without deflection.

9. The maximum load for the weighing of which it is to be used is distinctly engraved or marked on the beam.

10. The knife edges are permanently fixed to the beam.

*Steelyards or Roman balances, having unequal arms, when to be admitted to verification.*

Sec. 3. B. Balances commonly known as *steelyards* or Roman balances, having unequal arms, are only to be admitted to verification when :—

1. There is sufficient room for oscillation, and the knife edges on which the beam oscillates are sufficiently fine to permit it to move freely.

2. The beam is sufficiently strong to carry its load without deflection.

3. The bottom of the notches by which the divisions of the long arm of the lever are indicated, and from which the weight is suspended, are in close approximation to a right line drawn through the knife-edges forming the points of suspension, and when such straight line passes near to and a little above the centre of gravity of the whole apparatus.

4. The divisions on the long arm of the lever are equal among themselves

5. The weight used with the lever—if it is changeable or can be readily detached therefrom—is some multiple or sub-multiple of the pound avoirdupois, and has distinctly marked on it its true weight.

6. The maximum weight intended to be weighed on it is either distinctly marked on the beam or indicated by its construction.

*Weigh-bridges, hay scales and platform scales, when to be admitted to verification.*

Sec. 4. C. Weigh-bridges, hay scales and platform scales will only be admitted to verification when :—

1. The foundation or supporting base is sufficiently firm, and capable of carrying without change of level or of form or other disturbance, the maximum load for which it is to be used.

2. If movable from place to place, some satisfactory arrangement, such as a level or plummet, is provided and permanently attached, for indicating whether the machine is perfectly level.

3. The platform is so arranged that any obstruction to its free movement can be easily detected.

4. All the beams, levers and other parts are of sufficient strength, to carry the maximum load to which they will be respectively subjected without deflection.

5. The knife edges are firmly and permanently fixed in the levers, have sufficient room to permit free oscillation, and are sufficiently firm.

6. The knife edges and fulcrums of each set of levers are in the same plane.

7. The oscillations are sufficiently evident.

8. The weights used with the instrument are equal to the avoirdupois pound or to multiples or authorized sub-multiples of the avoirdupois pound, or special weights for the barrel of flour or for the bushel of wheat, their actual weight and the weight or special quantity they are intended to indicate on the scale, being plainly marked thereon.

9. The weights used as above are a decimal sub-multiple as  $\frac{1}{10}$ ,  $\frac{1}{100}$ ,  $\frac{1}{1000}$ , or a binary sub-multiple, as  $\frac{1}{2}$ ,  $\frac{1}{4}$ ,  $\frac{1}{8}$ , &c., of the load indicated by them.

10. There are no detached parts for the adjustment of the balance accessible, or so placed that they can be used for fraudulent weighing.

11. The apparatus indicates the same weight, whether the load is placed in the centre of the platform, on one side of it, or at either corner.

12. The maximum load which the apparatus is intended to weigh and the maker's name and shop number are conspicuously marked on some essential part of it.

*Platform Scales, Weigh-Bridges and Balances with Unequal Arms.*

Sec. 5. All these weighing machines will be rejected:—

1. When with a full load and truly balanced, the movement of the lever-weight one "notch" or division on the graduated lever, in either direction, does not cause the lever to turn decidedly in accordance with such movement.

Weighing machines, when to be rejected.

2. When, with a full load, or with any less load, and with the balance in equilibrium, the addition or removal of one two-thousandth part of the load, to or from the load, does not turn the lever decidedly in accordance with such addition or removal.

3. When the maker's name, shop-number and maximum capacity are not legibly engraved or stamped on them. And when the knife-edges are not made of properly tempered steel, and the bearings of the same material or of chilled or case hardened malleable iron. (This clause applies as well to balances with equal arms.)

4. When unprovided with check-rods to hold the bearings in place.

NOTE.—Nothing in the above 4th sub-section shall apply to weighing machines constructed on the Howe principle,

nor to dormant scales, constructed on the principle of the "Wilson Improved Weigh-Bridge."

Balances with equal arms, on which the load is carried above the fulcrums, when to be admitted to verification.

Sec. 6. D. Balances with equal arms, and on which the load is carried above the fulcrums, will only be admitted to verification when :—

1. There is no material difference as to the magnitude or arrangement of the two arms.

2. Its arms are of equal length within a limit of error equivalent to that tolerated in commercial weights.

3. There are no balance balls, loose counterpoises or detached parts other than the pans necessary for carrying the load weighed, and the weights used for weighing it.

4. Its parallel rods, guides, levers and pivots, by which the adjustment of the scale is affected, are so constructed that they cannot be put out of adjustment without the use of violence, which may be readily detected on inspection.

5. The knife edges or fulcrums of each set of levers or guide-rods are in the same plane.

6. The balance is sufficiently sensitive to turn decidedly and promptly by the addition and withdrawal of so much of the load as is equivalent to the error tolerated in commercial weights.

7. When there is a tongue or pointer, or some equivalent arrangement for showing when the balance is in equilibrium.

-----

Balances that are to be verified and stamped.

Sec. 7. No balances other than such as will come within the conditions under one or other of the heads, A, B, C, D, D1, D2 or D3, are to be verified or stamped.

Hydrostatic balances.

Sec. 8. D1. Weighing machines known as "hydrostatic balances," being such as are commonly used for determining the weight of coals delivered at the pit mouth, may be verified for use for such purposes, and also for weighing coals as delivered from vessels and barges, provided they give true indications within one two-hundredth part of the load.

Perfection scales.

Sec. 9. D2. Weighing machines known as "perfection scales," when manufactured in accordance with specifications deposited in Patent Office at Ottawa, may be admitted to verification when found to weigh correctly.

Duplessis Portable Track Scales.

Sec. 10. D3. Weighing machines known as "Duplessis Portable Track Scales" used for determining the weight of cars on railway tracks may be admitted to verification for use for such purposes, provided they give indications within one four-hundredth part of the load.



*Weights and Measures,—Regulations.*

## Chap. 42.

Sec. 11. E. Verification and stamping of weights, measures and weighing machines on the premises of the manufacturer, and their removal therefrom.

1. The article shall bear the name of the maker, capacity and consecutive shop-number or other marks whereby it may be designated for identification, with the certificate of verification.

2. The verification and stamping must take place before the articles are packed for removal, and at that state of completion at which they are finally adjusted by the manufacturer.

3. For the first verification and stamping of weights, measures and weighing machines at the place where they are manufactured, the fees may be paid at once, or payment may be postponed for such period not exceeding three months as the Minister of Inland Revenue may authorize, sufficient security being taken for the payment thereof at the time stated in the Departmental Regulations under which the delay is granted.

Verification and stamping of weights, measures and weighing machines on the premises of the manufacturer and their removal therefrom.

Sec. 12. F. Weights, measures and weighing machines imported into Canada are to be dealt with as follows :—

1. The Collector of Customs at the port where such articles are imported will notify the nearest inspector or assistant inspector of weights and measures of the entry for consumption of any weights, measures or weighing machines at his port, which notice will state the number and description of such articles as are invoiced, and the names and residence of the parties to whom they are delivered.

2. So long as such articles remain in the original packages they may be removed from the Custom house or from a Customs warehouse to the premises of the importer without inspection.

Weights, measures and weighing machines imported into Canada, how to be dealt with.

Sec. 13. G. Nothing in these regulations, nor in any previous regulations is to be construed as preventing the importation, manufacture or removal of and setting up, before they are verified, of dormant scales or weigh-bridges of any description, coming within the requirements of the law, but which cannot be used nor properly verified until they are placed on a fixed foundation. But it shall be the invariable duty of the manufacturer or importer of such weighing machines to duly notify the inspector of weights and measures nearest to his place of business, of the shipment and destination of each of such articles ; and said manufacturer or importer shall be held responsible for its verification before being used for trade purposes.

Dormant scales or weigh-bridges which can not be used nor properly verified until they are placed on a fixed foundation.

Any trader not being a manufacturer of, or dealer in, such weighing machines, who imports such articles for his own use, shall be considered an importer, and therefore subject to the above regulation.

Iron weights of half a pound or under, when to be admitted to verification.

Sec. 14. H. 1. Iron weights of the denomination of half a pound or under may be admitted to verification, provided they are of such substance that a soft metal plug on which the stamp may be impressed, can be securely fixed therein, and when such soft metal plug is so fixed in them by the parties who present them for verification ; but,—

2. When any iron weight is presented for verification, or when any such weight is found in use from which a soft metal plug has been lost, it shall not be adjusted or re-stamped until the hole in which the plug was inserted has, in the presence of the Inspector, being enlarged at the bottom, so that the expansion of the lead used for adjusting it will prevent it subsequently falling out.

Grain testers, when to be admitted to verification.

Sec. 15. I. Grain testers shall only be admitted to verification when :—

1. The cup or vessel for containing the grain is cylindrical, the diameter being approximately equal to its depth, and its capacity some authorized sub-multiple of the gallon, not less than one quart.

2. There is marked on the cup in clearly legible characters its true capacity in standard measure.

3. The counterpoise is arranged so that it can be sealed or stamped in such manner as will prevent its being tampered with or removed from the instrument to which it belongs without destroying or breaking the seal or stamp.

4. It gives true indications of weight according to the purport of the figures and divisions marked on the beam.

5. The knife-edges and other working parts are in conformity with Section 3 of these regulations.

6. It is accompanied by a hopper or apparatus for automatically filling the weighing cup identical as to form and dimensions with the one deposited in the Standards Department at Ottawa, of which a sketch drawing with figured dimensions and instructions for use, will be given to each inspector of weights and measures.

7. The fee chargeable for verifying and stamping each grain tester shall be one dollar.

Salt carts, when to be admitted to verification.

Sec. 16. J. Salt carts, each to contain four imperial bushels, constructed, as to form and dimensions, in accordance with plan or drawing of the same to be attached to weights and measures regulations, shall be admitted to verification.

2. Salt carts made in any other form or according to other dimensions than the foregoing will not be admitted to

*Weights and Measures,—Regulations.*

Chap. 42.

verification, and consequently their use for trade purposes will be held to be illegal.

3. The fee chargeable for verifying and stamping each salt-cart shall be one dollar.

SCHEDULES A. and B.

Weights to be admitted to verification.

Sec. 17. OF Weights to be admitted to Verification.

SCHEDULE A—DENOMINATIONS.				SCHEDULE B—FORMS.	
DOMINION WEIGHTS.					
Avoirdupois Weights.			Troy or Bullion Weights.		
In Bronze or White Metal of equal hardness.	In Iron.	In Soft Metal Cased.	In Bronze only.		
60 lbs.	60 lbs.	60 lbs.	500	ozs.	
50 do	50 do	50 do	300	do	
30 do	30 do	30 do	200	do	
20 do	20 do	20 do	100	do	
10 do	10 do	10 do	50	do	
7 do	7 do	7 do	30	do	
5 do	5 do	5 do	20	do	
4 do	4 do	4 do	10	do	
3 do	3 do	3 do	5	do	
2 do	2 do	2 do	3	do	
1 do	1 do	1 do	2	do	
8 ozs.	8 ozs.	8 ozs.	1	do	
4 do	4 do	4 do	.5	do	
2 do	2 do	2 do	.3	do	
1 do	2 do	1 do	2	do	
8 drs.	1 do	8 drs.	.1	do	
4 do		4 do	.05	do	
2 do		2 do	.03	do	
1 do		1 do	.02	do	
$\frac{1}{2}$ do		$\frac{1}{2}$ do	.01	do	
1000 grs.			.005	do	
600 do			.003	do	
300 do			.002	do	
200 do			.001	do	
100 do					
60 do					
30 do					
20 do					
10 do					
6 do					
3 do					
2 do					
1 do					
6 do					
.3 do					
.2 do					
.1 do					
.06 do					
.03 do					
.02 do					
.01 do					

*Avoirdupois Weights.*

From 50 lbs. down to one pound, cylindrical, with knob.  
 The same with ring.  
 Rectangular block, with ring or handle cast solid.  
 Truncated square pyramid.  
 From 5 lbs. down to one-half dram. Any of the above forms: also flat discs in nests.  
 A 60 lb weight for the bushel of wheat, of some form sufficiently distinct from the forms herein described to prevent the one being mistaken for the other.

*Grain Weights.*

From 1,000 grains down to ten grains cylindrical, with a small rising stem and knob.  
 Six grains and under; bent platinum or aluminum wire so bent as to represent the number of grains or decimal parts of a grain.  
 In every case the denomination of the weights, when of sufficient size, must be cast, engraved, or stamped on them in bold, legible numerals, of a size duly proportioned to the size of the weight.

*Troy Weights.*

From 500 ounces down to one ounce, truncated cone, with knob.  
 From 5 ounces down to .001 ounce, flat square plates.  
 The denomination to be engraved or stamped on the top of the knob of each weight, in as large numerals as the size of the weight will admit; and, also, on face of the smaller weights.

Chap. 42.

Weights and Measures,—Regulations.

SCHEDULE C.

Fees for verification of weights. **Sec. 18.** Of Fees to be Collected for Verification of Weights.

DOMINION WEIGHTS.

Avoirdupois Weights.				Troy Weights.	
Denomination.	Verification Fees.			Denomination.	Verifi- cation.
	Bronze.	Iron.	Cased.		Bronze only.
	Cts.	Cts.	Cts.		Cts.
60 lbs .....	25	25	30	500 ozs .....	30
50 do .....	20	20	25	300 do .....	25
30 do .....	20	20	25	200 do .....	25
20 do .....	20	20	25	100 do .....	20
10 do .....	10	10	15	50 do .....	10
7 do .....	10	10	15	30 do .....	10
5 do .....	5	5	5	20 do .....	10
4 do .....	5	5	5	10 do .....	10
3 do .....	5	5	5	5 do .....	5
2 do .....	5	5	5	3 do .....	5
1 do .....	5	5	5	2 do .....	5
8 ozs .....	5	5	5	1 do .....	5
4 do .....	5	5	5	.5 .....	5
2 do .....	5	5	5	.3 .....	5
1 do .....	5	5	5	.2 .....	5
8 drams .....	5	5	5	.1 .....	5
4 do .....	5	Not Ad- mitted.	5	.05 .....	5
2 do .....	5		5	.03 .....	5
1 do .....	5		5	.02 .....	5
$\frac{1}{2}$ do .....	5		5	.01 .....	5
Set as above from 50 lbs. down to 1 lb.....	75		\$1 00	\$1 20	.005 .....
Set as above from 8 oz. to $\frac{1}{2}$ dram.....	30		30	.003 .....	5
Set of grain weights from 1,000 grains down to .01 of a grain, in authorized series	90			.002 .....	5
<i>Tolerated.</i>				.001 .....	5
56 lbs .....	30	30	35	Set as above from 500 ozs. to 1 oz.....	\$1 50
28 do .....	25	25	30	Set as above from 5 ozs. down to .001.....	\$1 75
14 do .....	20	20	25		

SCHEDULE D.

Sec. 19. Of the Dominion Measures of Capacity that may be admitted to Verification.

Dominion measures of capacity that may be admitted to verification.

Denomination.	Materials.
A.—BUSHEL. HALF-BUSHEL. PECK. GALLON.	May be made of— <ol style="list-style-type: none"> <li>1. Bronze or Brass, cast.</li> <li>2. Hammered Sheet Brass or Copper, strengthened by rims of similar metal, and upright straps.</li> <li>3. Sheet iron, when of sufficient strength to retain the form of the measure under ordinary usage, either with wood or iron bottoms.</li> <li>4. Wood of any suitable quality—with iron or hardwood rim. When of wood, the edge to be sufficiently thick to receive the brand.</li> </ol>
B.—GALLON. HALF-GALLON. QUART. PINT. HALF-PINT. GILL. HALF-GILL.	May be made of— <ol style="list-style-type: none"> <li>1. Bronze or Brass, cast.</li> <li>2. Hammered Sheet Brass or Copper, with suitable rim of similar metal.</li> <li>3. Hard Pewter.</li> <li>4. Stout tin plate as per the following descrip-</li> </ol>

The following descriptions of tin are the lightest that will be admitted to verification when manufactured into measures of capacity, viz., for the gallon and half gallon without top or bottom rims or bands, DXXX; for quart

Description of tin that will be admitted to verification.

## Chap. 42.

*Weights and Measures,—Regulations.*

and smaller measures without rims or bands, DXX; and for the gallon and half gallon with top and bottom rims or bands, IXX; for quart and smaller measures with top and bottom rims or bands, IX.

Measures of capacity, indented, battered, &c.

No measure of capacity, of which the sides or bottoms are indented, battered or knocked out of the regular form, will be admitted to verification nor any whose bottoms are not sufficiently strong to carry the contents without changing their form, nor any on which the maker's name and the capacity are not legibly and conspicuously marked.

Cylindrical.

The form of all measures of capacity must be cylindrical.

## SCHEDULE E.

Fees to be collected for verification of measures of capacity.

Sec 20. Of fees to be collected for Verification of Measures of capacity.

## DOMINION MEASURES.

Denominations.	Material.				
	Bronze Cast.	Sheet Brass or Copper.	Sheet Iron or Tin Plate.	Hard Pewter.	Wood.
	Cts.	Cts.	Cts.	Cts.	Cts.
Bushel.....	30	30	20	.....	10
$\frac{1}{2}$ Bushel.....	25	25	15	.....	7
Peck.....	20	20	15	.....	5
Gallon.....	15	10	10	15	5
$\frac{1}{2}$ Gallon.....	10	10	10	10	5
Quart.....	10	10	5	10	5
Pint.....	5	5	5	5	5
$\frac{1}{2}$ Pint.....	5	5	5	5	5
Gill.....	5	5	5	5	5
$\frac{1}{2}$ Gill.....	5	5	5	5	5
Set from bushel to gallon.....	75	75	50	.....	20
Set from gallon to $\frac{1}{2}$ gill.....	40	40	30	40	20
Victor molasses gate.....	.....	.....	25	.....	.....

Multiples of the bushel.

Multiples of the bushel shall in future be admitted to verification. The fee for verifying and stamping or branding such measures shall be the same as above for the first bushel, and 20 cents for each additional bushel.

Multiples of the gallon.

Multiples of the gallon, for liquid measures, may in future be admitted to verification. The fee for verifying such measures shall be the same as above for the first gallon, and 5 cents for each additional gallon.

*Weights and Measures,—Regulations,*

Chap. 42.

SCHEDULE F.

Sec. 21. Of fees to be charged for the Verification of Weigh-bridges, Platform Scales, Weighing Machines, Balances and Steelyards.

BALANCES WITH EQUAL ARMS, WHETHER THE LOAD IS CARRIED ABOVE OR BELOW THE FULCRUMS.

To weigh not more than	5 lbs. in each pan.....	\$0 20	Fees for verification of balances with equal arms.
"	from 5 lbs. to 50 lbs. " .....	0 30	
"	" 50 lbs to 100 lbs. " .....	0 50	
"	over 100 lbs.....	1 00	

Sec. 22. Of fees to be charged for the Verification of Weigh-bridges, &c.

STEELYARDS WITH DIVIDED ARM.

To weigh not more than	500 lbs..	\$0 50	} To be verified at the Inspector's office. If verified elsewhere cost of carriage of weights used for verification to be charged extra.	Fees for verification of steelyards &c.
"	" 1,000 " ..	0 75		
"	" 2,000 " ..	1 00		
"	over 2,000 lbs.....	1 50		

WEIGH-BRIDGES OR PLATFORM SCALES.

To weigh not more than	250 lbs..	\$0 50	} And in addition to these rates the cost of carting the weights used for verification.	Fees for verification of weigh-bridges, &c.
"	" 500 " ..	0 75		
"	" 2,000 " ..	1 00		
"	" 4,000 " ..	1 50		
"	" 6,000 " ..	2 00		
And for each additional ton.....		0 50		

RAILWAY TRACK SCALES.

Sec. 23. The fee chargeable for verifying and stamping railway track scales shall be 50 cents per ton for the first five tons, and twenty-five cents for each ton over five tons, provided always that the officials and employes of the railway company owning the scales render all reasonable assistance to the officer performing the work of inspection.

Same as above as to cost of carriage and cartage of weights required for verification.

## Chap. 42.

*Weights and Measures,—Regulations.*

## SCHEDULE G.

## Sec. 24. Of Lineal Measures that may be admitted to Verification.

	DENOMINATION.	MATERIAL.
Lineal measures that may be admitted to verification.	10 feet measures,	These measures may be made of any suitable metal or of straight grained wood. When of wood the ends must be protected by metal tips well secured.
	6 " "	
	5 " "	
	3 " " or yard	
	Half yard "	
	2 feet "	
	1 foot "	
	Half foot "	
	Chain or riband, 100 feet	The chains of iron or steel with solid joints.
	" " 50 " divided into feet.	
	Chain or riband, 66 "	The ribands may be of steel, or of metal wire, woven with other fibre.
	" " 33 " divided into links.	
	Common tape lines are not to be verified.	

## SCHEDULE H.

## Sec. 25. Of Fees to be charged for Verification of Lineal Measures.

		Of Metal.	Of Wood.
Fees for verification of lineal measures.	10 feet.....	25 cts.	20 cts.
	6 " .....	25	20
	5 " .....	25	20
	3 " or yard.....	8	5
	Half yard.....	8	5
	2 feet.....	2	2
	1 foot.....	2	2
Half foot.....	2	2	
	Chain or riband, 100 feet..\$1 50	The fees charged for the verification of any lineal measure shall include the charge for the verification of its sub-divisions.	
	" " 50 " .. 1 00		
	" " 66 " .. 1 00		
	" " 33 " .. 0 75		



*Weights and Measures,—Regulations.*

**Chap. 42.**

**SCHEDULE I.**  
**OF Remedy or Allowance for Error.**  
**Sec. 26. AVOIRDUPOIS WEIGHTS.**

STANDARDS.			TRADE WEIGHTS.		
Denomination of Weights.	Actual Allowance in excess.	Actual Allowance in deficiency.	Denomination of Weights.	Actual Allowance in excess.	Actual Allowance in deficiency.
Lbs.	Grains.	Grains.	Lbs.	Grains.	Grains.
50	5·0	2·5	50	50	20
30	"	"	30	30	10
20	"	"	20	20	8
10	2·0	1·0	10	10	5
5	"	"	5	5	3
3	"	"	3	3	1
2	0·25	0·125	2	2	1
1	"	"	1	2	1
8 oz.	"	"	8 oz.	1	1
4 "	"	"	4 "	1	1
2 "	"	"	2 "	1	0·5
1 "	0·05	0·025	1 "	1	"
8 drs.	"	"	8 drs.	0·5	"
4 "	"	"	4 "	"	"
2 "	"	"	2 "	"	"
1 "	"	"	1 "	0·25	0·25
$\frac{1}{2}$ "	"	"	$\frac{1}{2}$ "	"	"

**Sec. 27. BULLION WEIGHTS.**

STANDARDS.			TRADE WEIGHTS.		
Denomination of Weights,	Actual Allowance in excess.	Actual Allowance in deficiency.	Denomination of Weights.	Actual Allowance in excess.	Actual Allowance in deficiency.
Troy oz.	Grains.	Grains.	Troy oz.	Grains.	Grains.
500	1·0	0·5	500	1·0	0·5
300	"	"	300	"	"
200	"	"	200	"	"
100	0·25	0·125	100	0·25	0·125
50	"	"	50	"	"
30	"	"	30	"	"
20	"	"	20	"	"
10	0·025	0·0125	10	0·025	0·0125
5	"	"	5	"	"
3	"	"	3	"	"
2	"	"	2	"	"
1	0·005	0·0025	1	0·005	0·0025
0·5	"	"	0·5	"	"
0·3	"	"	0·3	"	"
0·2	"	"	0·2	"	"
0·1	"	"	0·1	"	"
0·05	"	"	0·05	"	"
0·03	"	"	0·03	"	"
0·02	"	"	0·02	"	"
0·01	"	"	0·01	"	"
0·005	"	"	0·005	"	"
0·003	"	"	0·003	"	"
0·002	"	"	0·002	"	"
0·001	"	"	0·001	"	"

Chap. 42.

*Weights and Measures,—Regulations.*

**Sec. 28. DECIMAL GRAIN WEIGHTS.**

STANDARDS			TRADE MEASURES.		
Denomination of Measures.	Actual Allowance in excess.	Actual Allowance in deficiency.	Denomination of Measures.	Actual Allowance in excess.	Actual Allowance in deficiency.
Grains.	Grains.	Grains.	Grains.	Grains.	Grains.
4000	0·05	0·025	4000	0·05	0·025
2000	"	"	2000	"	"
1000	"	"	1000	"	"
500	0·04	0·02	500	0·04	0·02
300	"	"	300	"	"
200	"	"	200	"	"
100	"	"	100	"	"
50	0·02	0·01	50	0·02	0·01
30	"	"	30	"	"
20	"	"	20	"	"
10	"	"	10	"	"
5	0·01	0·005	5	0·01	0·005
3	"	"	3	"	"
2	"	"	2	"	"
1	"	"	1	"	"
0·6	0·005	0·0025	0·6	0·005	0·0025
0·3	"	"	0·3	"	"
0·2	"	"	0·2	"	"
0·1	"	"	0·1	"	"
0·06	0·0025	0·00125	0·06	0·0025	0·00125
0·03	"	"	0·03	"	"
0·02	"	"	0·02	"	"
0·01	"	"	0·01	"	"

**Sec. 29. MEASURES OF LENGTH.**

10 feet.....	Inch. 0·05	Inch. 0·05	10 feet.....	Inch. 0·10	Inch. 0·05
6 ".....	"	"	6 ".....	"	"
3 ".....	"	"	3 ".....	0·05	"
2 ".....	"	"	2 ".....	"	"
1 ".....	0·005	0·005	1 ".....	"	"
1 inch.....	"	"	1 inch.....	"	"

**Sec. 30. MEASURES OF CAPACITY.**

	Grains weight of water.	Grains weight of water		
Bushel.....	280	280	Bushel.....	} In reference to these measures, the Inspector will reject them; when, upon ordinary test, the error is obvious to the eye.
Half-bushel.....	140	140	Half-bushel.....	
Peck.....	70	70	Peck.....	
Gallon.....	50	50	Gallon.....	
Half-gallon.....	25	25	Half-gallon.....	
Quart.....	10	10	Quart.....	
Pint.....	10	10	Pint.....	
Half-pint.....	8	8	Half-pint.....	
Gill.....	8	8	Gill.....	
Half-gill.....	4	4	Half-gill.....	
Quarter-gill.....	2	2	Quarter-gill.....	

*Weights and Measures,—Regulations.*

## Chap. 42.

## PLATFORM SCALES, WEIGH-BRIDGES AND BALANCES WITH UNEQUAL ARMS.

Sec. 31. All these weighing machines will be rejected:—

1. When, with a full load and truly balanced, the movement of the lever weight one "notch" or division on the graduated lever, in either direction, does not cause the lever to turn decidedly in accordance with such movement.

Weighing machines, when to be rejected.

2. When, with a full load, or with any less load, and with the balance in equilibrium, the addition or removal of one two-thousandth part of the load, to or from the load, does not turn the lever decidedly in accordance with such addition or removal.

O. C. July 22, 1886, *part.*

## WEIGHTS AND MEASURES, DIVISIONS.

## PROVINCE OF ONTARIO.

*Belleville,*

Sec. 32. To comprise the City of Belleville, and Counties of Durham, Hastings, Northumberland, Peterborough, Prince Edward and Victoria, and the Provisional County of Haliburton.

*Hamilton.*

Sec. 33. To comprise the City of Hamilton, and Counties of Haldimand, Halton, Lincoln, Waterloo, Welland, Wellington and Wentworth.

*Kingston.*

Sec. 34. To comprise the Towns of Brockville and Cornwall, City of Kingston, and Counties of Dundas, Frontenac, Glengarry, Leeds and Grenville, Lennox and Addington, and Stormont.

*London.*

Sec. 35. To comprise the City of London, and Counties of Brant, Elgin, Middlesex, Norfolk and Oxford.

*Orillia.*

Sec. 36. To comprise the Counties of Grey and Simcoe, and Districts of Parry Sound, Muskoka and Algoma as far west as the Pic River.

*Ottawa.*

Sec. 37. To comprise the City of Ottawa, and Counties of Carleton, Lanark, Prescott, Renfrew and Russell, and Dis-

Chap. 42.

*Weights and Measures, Divisions.*

trict of Nipissing, in the Province of Ontario, and the Counties of Ottawa and Pontiac, including City of Hull, in the Province of Quebec.

*Toronto.*

Sec **38.** To comprise the city of Toronto, and Counties of Dufferin, Ontario, Peel and York.

*Windsor.*

Sec. **39.** To comprise the Counties of Bruce, Essex, Huron, Kent, Lambton and Perth.

## PROVINCE OF QUEBEC.

*Montreal.*

Sec. **40.** To comprise the City of Montreal and Counties of Argenteuil, Bagot, Beauharnois, Chambly, Chateauguay, Hochelaga, Huntingdon, Jacques Cartier, Laprairie, Laval, Napierville, Rouville, Soulanges, St. Hyacinthe, St. John's, Terrebonne, Two Mountains, Vaudreuil and Verchères.

*Quebec.*

Sec. **41.** To comprise the City of Quebec and Counties of Beauce, Bellechasse, Bonaventure, Charlevoix, Chicoutimi, Dorchester, Gaspé, Kamouraska, Labrador and Magdalen Islands, Lévis, L'Islet, Lotbinière, Mégantic, Montmagny, Montmorency, Portneuf, Quebec, Rimouski, Saguenay, and Témiscouata.

*Sherbrooke.*

Sec. **42.** To comprise the Town of Sherbrooke, and Counties of Arthabaska, Brome, Compton, Drummond, Iberville, Missisquoi, Richmond, Shefford, Stanstead and Wolfe.

*Three Rivers.*

Sec. **43.** To comprise the City of Three Rivers, and Counties of Berthier, Champlain, Joliette, L'Assomption, Maskinongé, Montcalm, Nicolet, Richelieu, St. Maurice and Yamaska.

## PROVINCE OF NEW BRUNSWICK.

*St. John.*

Sec. **44.** To comprise the City of St. John, and Counties of Charlotte, Queens and St. John.

*Fredericton.*

Sec. **45.** To comprise the City of Fredericton, and Counties of Carleton, Madawaska, Sunbury, Victoria and York.

*Weights and Measures, Divisions.*

## Chap. 42.

*Kings.*

Sec. 46. To comprise the Counties of Albert, Gloucester, Kent, Kings, Northumberland, Restigouche and Westmorland.

## PROVINCE OF NOVA SCOTIA.

*Halifax.*

Sec. 47. To comprise the City of Halifax, and Counties of Halifax, Hants, Kings and Lunenburg.

*Pictou.*

Sec. 48. To comprise the Counties of Antigonish, Colchester, Cumberland, Guysborough and Pictou.

*Yarmouth.*

Sec. 49. To comprise the Town of Yarmouth, and Counties of Annapolis, Digby, Queens, Shelburne and Yarmouth.

*Cape Breton.*

Sec. 50. To comprise the whole Island of Cape Breton.

## PROVINCE OF PRINCE EDWARD ISLAND.

*Charlottetown.*

Sec. 51. To comprise the whole Island of Prince Edward.

## PROVINCE OF MANITOBA.

*Winnipeg.*

Sec. 52. To comprise the whole Province, the North-West Territories and that part of Ontario west of the Pic-River.

## PROVINCE OF BRITISH COLUMBIA.

*Victoria.*

Sec. 53. To comprise the whole Province.

O. C. July 22, 1886; Oct. 26, 1886; Feb. 3, 1887; Oct. 17, 1888.

## CHAPTER 43.

### WANY OR OCTAGONALLY SHAPED TIMBER, MODE OF MEASURING.

Government House, Ottawa,  
The 9th day of January, 1889.

On the recommendation of the Minister of Inland Revenue and under the provisions of Chapter 104 of the Revised Statutes of Canada, intituled "The Weights and Measures Act,"

His Excellency in Council has been pleased to order, and it is hereby ordered, that the following provisions for the measuring of wany or octagonally shaped timber be made and established :—

Mode of measurement to be adopted.

**Section 1.** The mode of measurement to be adopted :—The extreme breadth and thickness of each stick to be taken at the measuring point, measuring also the waness and making an average of them, the quantity represented by the four waness to be deducted from the gross contents (as computed from the extreme breadth and thickness and the length) in order to obtain the solid contents of the stick.

Tables to be adopted.

**Sec. 2.** The tables to be adopted are those compiled by Mr. John Quinn, which are computed to meet the above mode of measurement.

Measuring rod, described.

**Sec. 3.** The measuring rod to be 40 inches in length, having two arms of  $8\frac{1}{2}$  inches in length each, one at the end fixed, the other sliding, both arms as well as the rod itself to be graduated with inches and the sliding arm so arranged that it shall be always at right angles with the rod itself. This rod to be used in connection with the implements at present in use, or such other implements or rods, for small waness, as may be found necessary by the supervisor of cullers.

O. C. May 31, 1860.

## CHAPTER 44.

### INSPECTION OF STAPLE ARTICLES.

Government House, Ottawa,  
The 9th day of January, 1889.

On the recommendation of the Minister of Inland Revenue, and under the provisions of Chapter 99 of the Revised Statutes of Canada, intituled "The General Inspection Act."

His Excellency in Council has been pleased to order, and it is hereby ordered, as follows:—

#### INSPECTION DIVISIONS IN ONTARIO.

Section F. The following have been and are designated and established Inspection Divisions in the Province of Ontario for the inspection of the following articles, namely:

1. *Flour and meal, and wheat and other grain.*

Flour and  
meal, and  
wheat and  
other grain.

1. *Ottawa Division.*—Comprising all that portion of Ontario lying east of the Kingston and Pembroke Railway.

2. *Kingston Division.*—Comprising all that portion of Ontario lying west of the said Kingston and Pembroke Railway and east of the eastern boundaries of the Counties of Ontario, Muskoka and Parry Sound.

3. *Toronto Division.*—Beginning at the western boundary of the Kingston division, thence westerly along the north shore of Lake Ontario to Burlington, thence northerly along the route of the Hamilton and North-Western Railway to Georgetown, thence westerly to Guelph along the route of the Grand Trunk Railway, and thence north-westerly by the westernmost route of the Wellington, Grey and Bruce Railway to Kincardine. Excepting thereout all stations upon the line of the Grand Trunk and Georgian Bay extension which shall be deemed to be within the inspection division of Stratford.

4. *Stratford Division.*—Comprising all that territory lying north of the Grand Trunk Railway, between Guelph and Sarnia, and west of the said western boundary of the Toronto division as hereinbefore cited. Also all stations upon the line of the Grand Trunk and Georgian Bay extension between Stratford and Warton.

5. *London Division.*—All that territory lying south of the said line of the Grand Trunk Railway and west of the line of the Port Dover and Lake Huron railway.

6. *Hamilton Division.*—All that territory lying south of the main line of the Grand Trunk Railway (not hereinbe-

fore incorporated in the division of Toronto) and east of the Port Dover and Lake Huron Railway.

7. *Port Arthur Division.*—Comprising the town of Port Arthur and all the territory adjacent thereto within a radius of fifteen miles.

In cases in which lines of railway are designated as the common boundary or boundaries of any two inspection divisions, wheat and grain may be inspected at any stations upon such dividing lines by the inspector of either of the divisions of which said lines form the boundary.

O. C. Sep. 11, 1885 ; Nov. 10, 1885.

Beef and pork,  
pot ashes and  
pearl ashes,  
pickled fish  
and fish oils  
butter,  
leather and  
raw hides.

II. *Beef and pork, pot ashes and pearl ashes, pickled fish and fish oils, butter, leather and raw hides.*

1. The Counties of Essex, Kent and Lambton.
2. " " Middlesex, (excepting the city of London), and Elgin.
3. " " Oxford and Norfolk.
4. " " Perth and Huron.
5. " " Lincoln and Welland.
6. " " Brant and Haldimand.
7. " " Wellington and Waterloo.
8. " " Bruce and Grey.
9. " " Wentworth, (excepting the city of Hamilton), and Halton.
10. " " York and Peel, including the city of Toronto.
11. " " Simcoe and Algoma.
12. " " Ontario and Durham.
13. " " Northumberland and Hastings.
14. " " Peterborough and Victoria.
15. " " Lennox and Prince Edward.
16. " " Frontenac, (excepting the city of Kingston), Leeds and Addington.
17. " " Lanark and Renfrew.
18. " " Carleton), excepting the city of Ottawa), and Russell.
19. " " Grenville, Dundas and Stormont.
20. " " Glengarry and Prescott.

O. C. April 26, 1875 ; Sep. 27, 1883.

21. The City of Kingston.
22. " " Hamilton.
23. " " London.
24. " " Ottawa.

O. C. Aug. 29, 1873.

25. The Town of Port Arthur and all the territory adjacent thereto within a radius of fifteen miles.

O. C. Sep. 11, 1885.



*Inspection of Staple Articles.*

Chap. 44.

## INSPECTION DIVISIONS IN QUEBEC.

Sec. 2. The following have been and are designated and established inspection divisions in the Province of Quebec for the inspection of the following articles, namely:—

- I. *Flour and meal, wheat and other grain, beef and pork, pot ashes and pearl ashes, pickled fish and fish oils, butter, leather and raw hides.*
1. The City of Montreal.  
2. The City of Quebec.  
O.C. Aug. 29, 1873.  
3. The Counties of Temiscouata and Kamouraska.  
O.C. April 1, 1875.  
4. The Counties of Drummond and Arthabaska.  
O.C. Sep. 13, 1877.  
5. The Counties of Gaspé and Bonaventure and the Magdalen Islands to be designated "The Division of Gaspé."  
O.C. Oct. 19, 1877.  
6. The County of Ottawa, including the City of Hull.  
O.C. Feb. 5, 1884.

Flour and meal, wheat and other grain, beef and pork, pot ashes and pearl ashes, pickled fish and fish oils, butter, leather and raw hides.

II. *Pickled fish and fish oils.*

- The Counties of Quebec, Montmorency, Charlevoix, Saguenay and Chicoutimi (the same being attached to the inspection division of the City of Quebec).  
O.C. April 29, 1878.

Pickled fish and fish oils.

II. *Leather and raw hides.*

1. The Counties of Lotbinière, Lévis, Bellechasse and Dorchester.  
O.C. March 15, 1886.  
2. The County of Hochelaga.  
O.C. April 12, 1886.  
3. The Counties of Richmond, Shefford, Brome and Stanstead, including the Town of Sherbrooke.  
O.C. Oct. 31, 1887.

Leather and raw hides.

## INSPECTION DIVISIONS IN NEW BRUNSWICK.

Sec. 3. The following have been and are designated and established inspection divisions in the Province of New Brunswick for the inspection of the following articles, namely:—

- I. *Flour and meal, wheat and other grain, beef and pork, pot ashes and pearl ashes, pickled fish and fish oils, butter, leather and raw hides.*
1. The County of Northumberland.  
O.C. April 26, 1880.

Flour and meal, wheat and other grain, beef and pork, pot ashes, &c.

## Chap. 44.

*Inspection of Staple Articles.*

2. The County of Restigouche.

O.C. May 23, 1882.

3. The County of York.

O.C. Dec. 27, 1883.

4. The City of St. John and County of St. John (excepting, for the inspection of *pickled fish and fish oils*, that portion of the County of St. John including the Town of Carleton lying to the west of the St. John River).

O.C. Feb. 2, 1875; March 18, 1876.

Pickled fish and fish oils, excepted.

II. *Pickled fish and fish oils.*

1. That portion of the County of St. John, including the Town of Carleton, lying to the west of the St. John River.

O.C. March 18, 1876.

2. The County of Gloucester.

Pickled fish and fish oils.

## INSPECTION DIVISIONS IN NOVA SCOTIA.

Sec. 4. The following have been and are designated and established inspection divisions in the Province of Nova Scotia for the inspection of the following articles, namely:—

I. *Flour and meal, wheat and other grain, beef and pork, pot ashes and pearl ashes; pickled fish and fish oils, butter, leather and raw hides.*

1. The County of Halifax, including the City of Halifax.

O.C. Aug. 29, 1873; Oct. 16, 1873.

2. The County of Yarmouth (excepting for the inspection of *pickled fish and fish oils*, the Township of Argyle).

O.C. Oct. 16, 1873; April 25, 1879.

3. The County of Guysborough (excepting the District of St. Marys).

O.C. Oct. 16, 1873; March 18, 1875.

4. The County of Pictou.

O.C. Oct. 16, 1873.

5. The Township of Shelburne, in the County of Shelburne.

O.C. Oct. 16, 1873; April 20, 1876.

6. The County of Richmond (excepting for the inspection of *pickled fish and fish oils*, that portion of the county south of the Lennox Passage, including Ile Madame.)

O.C. Oct. 16, 1873; May 10, 1880.

7. The County of Antigonish.

8. " " Lunenburg.

9. " " Victoria.

O.C. Oct. 16, 1873.

10. The District of St. Marys, in the County of Guysborough.

O. C. March 18, 1875.

Flour and meal, wheat and other grain, beef and pork, pot ashes and pearl ashes, pickled fish and fish oils, butter, leather, and raw hides.

Pickled fish and fish oils excepted.

*Inspection of Staple Articles*

Chap. 44.

11. The Township of Barrington, in the County of Shelburne.

O. C. April 20, 1876.

12. The County of Annapolis.

O. C. June 25, 1877.

13. The County of Colchester.

O. C. April 9, 1879.

14. The County of Queens.

O. C. Feb. 28, 1881.

II. *Pickled fish and fish oils.*

Pickled fish  
and fish oils.

1. The Township of Argyle, in the County of Yarmouth.

O. C. April 25, 1879.

2. Ile Madame, in the County of Richmond and including that portion of the county south of Lennox Passage.

O. C. May 10, 1880.

3. The County of Cape Breton.

4. The County of Inverness

III. *Leather and raw hides.*

Leather and  
raw hides.

The Township of Windsor, in the County of Hants.

O. C. April 3, 1884.

INSPECTION DIVISIONS IN PRINCE EDWARD ISLAND.

Sec. 5. The following have been and are designated and established inspection divisions in the Province of Prince Edward Island for the inspection of the following articles, namely:—

I. *Flour and meal, wheat and other grain, beef and pork, pot ashes and pearl ashes, pickled fish and fish oils, butter, leather and raw hides.*

Flour and  
meal, &c., &c.

The City of Charlottetown.

O. C. Oct 23, 1885.

II. *Pickled fish and fish oils.*

Pickled fish,  
and fish oils.

The County of Prince.

O. C. June 19, 1886.

INSPECTION DIVISION IN MANITOBA.

Sec. 6. The following has been and is designated and established an inspection division in the Province of Manitoba for the inspection of the following articles, namely:—

*Flour and meal, wheat and other grain, beef and pork, pot ashes and pearl ashes, pickled fish and fish oils, butter, leather and raw hides.*

Flour and  
meal, and  
wheat and  
other grain,  
beef and pork,  
pot ashes, &c,  
&c.

The City of Winnipeg.

O. C. Aug. 10, 1884.

## Chap. 44.

*Inspection of Staple Articles.*

## BOARD OF EXAMINATION AND ARBITRATION.

- For the purposes set forth in the General Inspection Act. **Sec. 7.** For the purposes set forth in and under the provisions of the General Inspection Act aforesaid, there shall be a Board of Examiners and Arbitrators for the following purposes (three of whom shall form a quorum):—
- Inspectors of wheat, &c. (a.) To examine the fitness of candidates to become Inspectors of Wheat and other grains.
- Difference in cases of re-inspection (b.) To determine all cases of difference between Inspectors as to the true quality or grade of any grain inspected by one of them and re-inspected by another.
- Differences between two inspectors. (c.) Under the provisions of the General Inspection Act, to determine all differences between any two Inspectors of grain within the Dominion of Canada.
- Provisions in cases wherein the inspector for the Toronto division is a party. Provided that in cases wherein the Inspector for the Toronto Division is a party, the other Inspector with whom the difference arises, may call upon the President of any of the Boards of Trade for the cities hereinbefore cited, to nominate two members of such Board, engaged in or having a knowledge of grain and not being interested parties, and upon such parties presenting themselves at the usual place of meeting of the said Board of Arbitrators, such nominees shall, with the Chairman and such two other members of the Board, herein established, as the Chairman may elect, constitute a legal board for the determination of the matters in dispute.
- Acting chairman. (d.) In the absence of the Chairman, the Board shall select an Acting Chairman, and he shall have all the powers of the Chairman, as herein stated.
- Fee to be collected from each candidate. (e.) Under authority of Section 19 of the said Act, the Board of Examiners and Arbitrators so appointed shall be empowered to collect from each candidate coming before them for examination, before such examination is held, a fee not to exceed twenty dollars (\$20), to be distributed in such way as the said Board may direct.
- O. C. Nov. 10, 1885.
- Names of the board. (f) The appointment of the following persons as members, of the said Board of Examiners and Arbitrators is hereby confirmed, namely:—George A. Chapman, Chairman; W. D. Mathews, jr., Leonard A. Tilley, H. N. Baird, Thos. Flynn.
- Regulations for the guidance of the Board of Arbitrators. **Sec. 8.** The following regulations for the guidance of the said Board as a Board of Arbitrators mentioned and referred to in and by the next preceding section for the purpose of facilitating the adjustment of differences between Inspectors of Grain are hereby established and confirmed.

*Inspection of Staple Articles.*

Chap. 44.

(a.) The tariff for re-inspection shall be based upon the value of the grain re-inspected, as follows, viz. :— Tariff for re-inspection.

For each award under \$250. ....	\$ 6 00
“ “ from \$250 to \$500.....	10 00
“ “ “ \$500 to \$1,000....	12 00
“ “ “ \$1,000 to \$1,500..	18 00
“ “ “ \$1,500 to \$2,500...	25 00
“ “ upwards of \$2,500.....	50 00

(b.) For matters not involving pecuniary considerations, fees may be charged in proportion to the time and trouble involved, to be determined by the said Board, subject to an appeal to the Minister of Inland Revenue, if objected to ; and on cause being shown to the satisfaction of the Minister, the fees of the examiners may be increased, as may seem to him just and reasonable. Matters not involving pecuniary considerations.

(c.) The actual travelling expenses incurred by members of the said Board, Inspectors, or experts employed by the Board, to be a charge additional to the fees hereinbefore established. Travelling expenses.

(d.) The said Board may appoint a secretary to attend to the correspondence and routine business of the Board, and said secretary shall, upon receiving the award of the Arbitrators, notify the parties who may have a matter under arbitration of the amount of the fees, and on receipt of same the award shall be delivered to them. Appointment and duties of secretary.

(e.) Such fees shall be paid to the secretary for the benefit of the members sitting as arbitrators, and in addition the secretary shall be entitled to \$1 for each case submitted, if the values of the grain re-inspected be less than \$50, and \$2 if over such value. Secretary's fees.

(f.) The Minister may increase or diminish the amount so payable to the secretary if it be found that it is inadequate or excessive. Minister may alter fees.

O. C. Nov. 14, 1885.

REPORT OF INSPECTOR OF GRAIN FOR TORONTO.

Sec. 9. The inspector of grain at Toronto shall make a daily report to the secretary of the Board of Trade of Toronto of all grain inspected by him each day, by entering the same in such form as may be required by the council of the said Board of Trade—the forms for such daily entries to be provided by and at the expense of the said board. Report to secretary of Board of Trade of Toronto, how to be made.

In default of compliance with the terms of the foregoing regulation, the said inspector shall be liable to a penalty Penalty in default.

---

**Chap. 44.***Inspection of Staple Articles.*

---

Penalty,  
when not to  
be exacted.

of five dollars for each day's default, but the said penalty shall not be exacted save and until the form of return determined upon by the council of the said Board of Trade has been filed with and approved of by the Minister of Inland Revenue.

O. C. Aug. 22, 1875.

## CHAPTER 45.

### GRADES OF WHEAT AND OTHER GRAIN.

Government House, Ottawa,  
The 9th day of January, 1889.

On the recommendation of the Minister of Inland Revenue and under the provisions of Section 15 of Chapter 99 of the Revised Statutes of Canada, intituled "The General Inspection Act."

His Excellency in Council has been pleased to order, and it is hereby ordered that Section 44 of the said Act respecting the grades of wheat and other grain, be and the same is hereby cancelled and the following substituted in lieu thereof, viz. :—

#### *Spring Wheat.*

Section 1. (a.) Extra Manitoba hard wheat shall be sound and well cleaned, weighing not less than sixty-two pounds to the bushel, and shall be composed of at least eighty-five per cent of hard red Fyfe wheat, grown in Manitoba or the North-West Territories of Canada; Extra Manitoba hard wheat.

(b.) No. 1 Manitoba hard wheat shall be sound and well cleaned, weighing not less than sixty pounds to the bushel, and shall be composed of at least two-thirds of hard red Fyfe wheat, grown in Manitoba or the North-West Territories of Canada; No. 1 Manitoba hard wheat.

(c.) No. 2 Manitoba hard wheat shall be sound and reasonably clean, weighing not less than fifty-eight pounds to the bushel, and shall be composed of at least two-thirds of hard red Fyfe wheat, grown in Manitoba or the North-West Territories of Canada; No. 2 Manitoba hard wheat.

(d.) No. 1 hard white Fyfe wheat shall be sound and well cleaned, weighing not less than sixty pounds to the bushel, and shall be composed of not less than sixty per cent. of hard white Fyfe wheat, grown in Manitoba or the North-West Territories of Canada, and shall not contain more than twenty-five per cent. of soft wheat; No. 1 hard white Fyfe wheat.

(e.) No. 1 Manitoba northern wheat shall be sound and well cleaned, weighing not less than sixty pounds to the bushel, and shall be composed of at least fifty per cent. of hard red Fyfe wheat, grown in Manitoba or the North-West Territories of Canada; No. 1 Manitoba northern wheat.

## Chap. 45.

*Grades of Wheat and other Grain.*

- No. 2 Manitoba northern wheat. (f.) No. 2 Manitoba northern wheat shall be sound and reasonably clean, of good milling qualities, and fit for warehousing, weighing not less than fifty-eight pounds to the bushel, and shall be composed of at least fifty per cent. of hard red Fyfe wheat, grown in Manitoba or the North-West Territories of Canada;
- No. 1 spring wheat. (g.) No. 1 spring wheat shall be sound and well cleaned, weighing not less than sixty pounds to the bushel;
- No. 2 spring wheat. (h.) No. 2 spring wheat shall be sound and reasonably clean, weighing not less than fifty-eight pounds to the bushel;
- No. 3 spring wheat. (i.) No. 3 spring wheat shall comprise all wheat fit for warehousing, not good enough to be graded as No. 2, weighing not less than fifty-six pounds to the bushel;
- Rejected spring wheat. (k.) Rejected spring wheat shall comprise all wheat fit for warehousing, but too low in weight or otherwise unfit to be graded as No. 3;
- Goose wheat, No. 1. (l.) Goose wheat No. 1 shall be plump and well cleaned, weighing not less than sixty-one pounds to the bushel;
- Goose wheat, No. 2. (m.) Goose wheat No. 2 shall be plump and reasonably well cleaned, weighing not less than fifty-nine pounds to the bushel;
- Goose wheat, No. 3. (n.) Goose wheat No. 3 shall comprise such as is not good enough to be graded as No. 2, reasonably clean and weighing not less than fifty-five pounds to the bushel.

*Winter Wheat.*

- Extra white winter wheat. **Sec. 2.** (a.) Extra white winter wheat shall be pure white winter wheat, choice in color, sound, plump and well cleaned, weighing not less than sixty-two pounds to the bushel;
- No. 1 white winter wheat. (b.) No. 1 white winter wheat shall be pure white winter wheat, sound, plump and well cleaned, weighing not less than sixty pounds to the bushel;
- No. 2 white winter wheat. (c.) No. 2 white winter wheat shall be white winter wheat, sound and reasonably clean, weighing not less than fifty-eight pounds to the bushel;
- No. 1 red winter wheat. (d.) No. 1 red winter wheat shall be pure red winter wheat, sound, plump and well cleaned, weighing not less than sixty-two pounds to the bushel;



*Grades of Wheat and other Grain.*

Chap. 45

(e.) No. 2 red winter wheat shall be red winter wheat, sound and reasonably clean, weighing not less than sixty pounds to the bushel ; No. 2 red winter wheat

(f.) No. 1 mixed winter wheat shall be white and red winter wheat mixed, sound, plump and well cleaned, weighing not less than sixty-two pounds to the bushel ; No. 1 mixed winter wheat

(g.) No. 2 mixed winter wheat shall be white and red winter wheat mixed, sound and reasonably cleaned, weighing not less than fifty-nine pounds to the bushel ; No. 2 mixed winter wheat

(h.) No. 3 winter wheat shall include winter wheat not clean and plump enough to be graded as No. 2, weighing not less than fifty-seven pounds to be bushel ; No. 3 winter wheat.

(i.) Rejected winter wheat shall include winter wheat damp, musty, or from any cause so badly damaged as to render it unfit to be graded as No. 3 ; Rejected winter wheat.

(k.) All good wheat that is slightly damp shall be reported and entered on the inspector's books as "no grade" with the inspector's notations as to quality and condition ; "No grade" wheat.

(l.) All wheat that is in a heating condition, or too damp to be considered safe for warehousing or that has any considerable admixture of foreign grain or seeds, or is badly bin-burnt, whatsoever grade it might otherwise be, shall be reported and entered on the inspector's books as "condemned," with the inspector's notations as to quality and condition ; "Condemned" wheat.

(m.) Any material admixture of "rice wheat," otherwise known as "goose" or "California" wheat, or of red chaff wheat with other descriptions of wheat, shall exclude the parcel from regular inspection ; "Rice wheat," "goose" or "California" wheat.

(n.) All wheat shall be weighed, and the weight per bushel entered on the inspection book. All wheat be weighed.

*Indian Corn.*

Sec. 3. (a) No. 1 white corn shall be white, and in all other respects No. 1 corn ; No. 1 white corn.

(b.) No. 1 yellow corn shall be yellow, and in all other respects No. 1 corn ; No. 1 yellow corn.

(c.) No. 1 corn shall be sound, dry, plump and well cleaned, white and yellow ; No. 1 corn.

(d.) No 2 corn shall be dry, reasonably clean, but not plump enough to be graded as No. 1 ; No. 2 corn.

## Chap. 45.

*Grades of Wheat and other Grain.*

"Rejected" corn. (e.) All damp, dirty, or otherwise badly damaged corn, shall be graded as "rejected."

*Oats.*

No. 1 oats. Sec. 4. (a) No. 1 oats shall be sound, plump, clean and free from other grain ;

No. 2 oats. (b.) No. 2 oats shall be sound, reasonably clean, and reasonably free from other grain ;

No. 3 oats. (c.) No. 3 oats shall be sound but not clean enough to be graded No. 2.

"Rejected" oats. (d.) Rejected oats shall include such as are damp, unsound, dirty or from any cause unfit to be graded as No. 2.

*Rye.*

No. 1 rye. Sec. 5. (a) No. 1 rye shall be sound, plump and well cleaned ;

No. 2 rye (b.) No. 2 rye shall be sound, reasonably clean, and reasonably free from other grain ;

"Rejected" rye. (c.) All rye which is damp, musty or dirty, or which is from any cause unfit to be graded as No. 2 rye, shall be graded as "rejected."

*Barley.*

No. 1 barley. Sec. 6. (a) No. 1 barley shall be plump, bright, sound, clean and free from other grain ;

No. 2 barley. (b.) No. 2 barley shall be reasonably clean and sound, but not bright and plump enough to be graded as No. 1, and shall be reasonably free from other grain, and weigh not less than forty-eight pounds to the bushel ;

No. 3 extra barley. (c.) No. 3 extra barley shall be in all respects the same as No. 2 barley, except in color, weighing not less than forty-seven pounds to the bushel ;

No. 3 barley. (d.) No. 3 barley shall include shrunken, or otherwise slightly damaged barley, weighing not less than forty-five pounds to the bushel ;

No. 4 barley. (e.) No 4 barley shall include all barley equal to No. 3, weighing less than forty-five pounds to the bushel ;

"Rejected" barley. (f.) All barley which is damp, musty, or from any cause badly damaged or largely mixed with other grain, shall be graded as "rejected."

"Manitoba" barley. (g.) All barley grown in Manitoba or the North-West Territories of Canada shall be graded as above, but shall be distinctly classified by inspectors as "Manitoba" barley.

*Grades of Wheat and other Grain.*

Chap. 45.

*Peas.*

Sec. 6. (a.) No. 1 peas shall be white, clean, sound and not worm-eaten ; No. 1 peas.

(b.) No. 2 peas shall be moderately clean and sound ; No. 2 peas.

(c.) No. 3 peas shall be such as are too dirty to be graded as No. 2, or are worm-eaten ; No. 3 peas.

(d.) All peas which are damp, wormy or otherwise unfit to be graded as No. 3 peas shall be graded " rejected." "Rejected" peas.

*Provisions as to all Grain.*

Sec. 7. (a.) No grain that is warm, or is in a heating condition, shall be graded ; Warm or heating.

(b.) No wheat or other grain that has been subject to scouring or treatment, by use of lime or sulphur, shall be graded higher than No. 3 ; Scouring or treatment by lime, &c.

(c.) In the inspection of grain, the weight shall not alone determine the grade ; Weight alone not to decide.

(d.) All inspectors shall make their reasons for grading grain, when necessary, fully known by notation on their books ; Notation by inspectors.

(e.) Samples furnished to inspectors shall be made to conform, as strictly as possible, to the conditions and terms specified in the foregoing classification. Samples to inspectors.

O. C. Aug. 9, 1888.

## CHAPTER 46.

### GAS INSPECTION.

Government House, Ottawa,  
The 9th day of January, A.D. 1889.

On the recommendation of the Minister of Inland Revenue, and under the provisions of Chapter 101 of the Revised Statutes of Canada, intituled "The Gas Inspection Act,"

His Excellency in Council has been pleased to order, and it is hereby ordered, that the following regulations respecting the verification and testing of gas and gas meters under the said Act, be and the same are hereby made and established and also that the Gas Inspection Districts hereinafter named and specified be and the same are hereby established and confirmed :—

Copies of all models, deposited, legalized and verified, &c., to be known as "*Local Gas Standards.*"

**Section 1.** Copies of all models deposited in the Department of Inland Revenue and legalized by the Order in Council of 15th December, 1874, having been verified under the direction of the Minister of Inland Revenue, such copies shall hereafter be known as "*Local Gas Standards,*" and a sufficient set thereof shall be placed in such places as may be necessary for carrying out the provisions of the "*Gas Inspection Act,*" in suitable offices provided for that purpose.

"*Local Gas Standards,*" to be placed in custody of inspectors or deputies.

**Sec. 2.** The "*Local Gas Standards*" shall be placed in the custody of duly appointed inspectors or deputy inspectors, who shall be responsible for their safety and shall have sole possession of them ; and it shall not be lawful for any person—except such as are duly authorized thereto—to have access to or use any of the said "*Local Gas Standards.*"

Standards supposed to have become inaccurate, to be tested, or may be removed to Ottawa and verified by original models.

**Sec. 3.** Whenever there is reason for supposing that any of the said standards have become inaccurate—as to which the inspector of gas or some superior officer of the Inland Revenue Department shall be the sole judge—such standards shall be tested by such portable instruments as may be determined by departmental regulations ; or the standards supposed to be defective may, if deemed necessary by the Department of Inland Revenue, be removed to Ottawa and verified by the original models.

Gas meters, verified and found correct.

**Sec. 4.** When gas meters have been verified and found to be correct within the limit of error tolerated by the statute, the inspector or deputy inspector shall affix a seal thereto,

which seal shall be of wax bearing such device as may be directed by departmental regulations. Sealed with wax seal.

Sec 5. Under the authority of section 50 of said Act, it is hereby declared that sulphur in gas shall be considered as in excess, when found in greater quantity than thirty-five grains in one hundred cubic feet of gas, and that ammonia shall be considered as being in excess, when the quantity found is greater than four grains in one hundred cubic feet of gas. Sulphur and ammonia, when to be considered as in excess.

Sec. 6. The forms in Schedules A1, A2 and A3 shall be used for granting certificates respecting the verification of meters and the testing of gas, and no certificate shall be valid unless it is given on the form hereby authorized, nor unless stamps representing the authorized fees payable for such a certificate are attached thereto and cancelled in accordance with the departmental regulations then in force. Forms to be used for granting certificates of verification of meters and testing of gas.

Sec. 7. Schedule B attached hereto is a Schedule of fees which shall be paid for the verification of meters and for testing gas, and the fees made payable simply for testing or verifying meters shall be payable whether such meters are stamped or rejected. Fees established for verification and testing.

Sec. 8. Schedule C is a table of fees payable by gas companies for certificates to be delivered to them by Government inspectors, and made public by said companies as required by section 26, and sub-sections 2 and 3 of said section of the Gas Inspection Act. Fees established for certificates.

SCHEDULE A, 1.

GAS INSPECTOR'S OFFICE, 18 .

I hereby certify that I have tested the illuminating power of the gas furnished by Certificate of inspection of the illuminating power of gas.  
in accordance with the provisions of the Act to provide for the inspection of gas and gas meters, and that the illuminating power of the said gas was equal to that of  
[Attach stamps here] Standard Candles. The fees amounting to \$        have been paid and the stamps Nos.        representing said fees, are hereto attached.

*Inspector.*

*See particulars of experiments hereto attached.*

Chap. 46.

*Gas Inspection.*

## SCHEDULE A, 2.

GAS INSPECTOR'S OFFICE,

18 .

Certificate as to quantity of sulphur. I hereby certify that I have tested the purity of the gas furnished by the and after testing such gas in accordance with the provisions of the Act to provide for the inspection of gas and gas meters, I find the quantity of sulphur contained therein

Certificate as to quantity of ammonia. *[Attach stamps here.]* and the quantity of ammonia contained therein The fees amounting to \$ have been paid, and the stamps Nos. representing said fees are attached hereto.

*Inspector.**See particulars of experiments hereto attached.*

## SCHEDULE A, 3.

GAS INSPECTOR'S OFFICE,

18 .

Certificate of inspection of gas meters. I hereby certify that I have this day inspected the light meter No. manufactured by and found the same and found *[Attach stamps here]* The fees amounting to \$ have been paid and the stamps Nos representing said fees are attached hereto.

*Inspector.*

## SCHEDULE B.

VERIFICATION AND TESTING OF GAS AND GAS METERS.

Fee to be charged for the verification of gas meters and the testing of gas under the Gas Inspection Act:—

1st. *Verification of Meters.*

Fees for verification of meters.				\$	cts.
	5	lights and under	.....	0	50
	10	" "	.....	0	75
	20	" "	.....	1	00
	30	" "	.....	1	50
	50	" "	.....	2	00
	60	" "	.....	2	50
	80	" "	.....	3	50
	100	" "	.....	4	50

*Gas Inspection.*

Chap. 46.

and for every addition of twenty lights or under a charge of 80 cents.

2nd. *Inspection as to Illuminating Power.*

For every Certificate as to illuminating power,	\$3 00	Fees for inspection as to illuminating power.
For a Certificate as to average illuminating power during one week.....	6 00	
For a Certificate of illuminating power by inspection made at the request of, and in the presence of a consumer after due notification.	4 00	
For a Certificate as to the presence or absence of Sulphurated Hydrogen.....	1 50	
For a Certificate of an Analysis for quantity of Sulphur.....	4 00	
For a Certificate of an Analysis for quantity of Ammonia.....	3 00	
For a Certificate of Analysis, for average quantity of Sulphur and Ammonia during one month.	10 00	
For each requisition for Meter or Gas inspection with notice to opposite party.....	0 25	

O. C. Feb. 11, 1876.

SCHEDULE C.

CLASSIFICATION OF GAS COMPANIES.

CLASSIFICATION.	NUMBER OF CONSUMERS.
Class 1	Over 4,000.
do 2	do 2 000 and less than 4,000.
do 3	do 500 do 2,000.
do 4	Less than 500.

TABLE OF FEES payable by Gas Companies for certificates shall be delivered to them by Government Inspectors and made public by said Companies as required by Section 36 of The Gas Inspection Act. Such fees being in accordance with the second part of the Schedule to "The Gas Inspection Act," and establishing the number of tests upon which will be based the average result to be indicated in each certificate to be issued periodically as required by law.

Fees for certificates as required by Section 36 of Act.

Class of Company.	Illuminating Power, No. of Tests.	Sulph. Hydrogen. No. of Tests.	Total No. of Tests per Certificate.	Period embraced in each Certificate.	Cost per average Certificate.
1	2 per week.	2 per week.	5	1 week.	\$ 7 50
2	1 do	2 do	12	1 month.	10 00
3	1 per month.	2 per month.	9	3 months.	12 00
4	1 do	1 do	12	6 do	12 00

## Chap. 46.

*Gas Inspection.*TESTS FOR SULPHUR AND AMMONIA AS PER SUB-SECTION 2  
OF SECTION 28 OF THE SAID ACT.

Sulphur.	Ammonia.	Total No. of Tests.	Period embraced.	Cost per average Certificate.
2 per month.	2 per month.	12	3 months.	\$20 00

NOTE.—The above tests must be made on different days:—that is to say, not more than one test under each head shall be made on the same day.

## SCHEDULE D.

## ADDITIONAL REGULATION.

Gas Inspectors are to obtain the number of consumers in each city and town.

Gas inspectors are required to obtain from each gas company in their districts as soon as possible after the coming into force of the Gas Inspection Act, the number of consumers in each city and town as indicated in the book to be kept by each gas company, as provided in Section 35 of the said Act, and to advise the Department from time to time of the number of meters in use, so that a classification of companies may be established for putting into execution Section 36, and Sub-Sections 2 and 3 of Section 36 of the said Act.

## GAS INSPECTION DISTRICTS.

## PROVINCE OF ONTARIO.

*Belleville.*

Sec. 9. To comprise the city of Belleville and town of Deseronto.

*Hamilton.*

Sec. 10. To comprise the cities of Hamilton, Brantford, St. Catharines and Guelph and towns of Dundas, Galt and Berlin.

*Kingston.*

Sec. 11. To comprise the city of Kingston and towns of Cornwall and Napanee.

*London.*

Sec. 12. To comprise the city of London and towns of Chatham, Ingersoll, Stratford, St. Thomas, Windsor, Listowell and Sarnia.



*Gas Inspection.*

Chap. 46.

*Ottawa.*

Sec. 13. To comprise the city of Ottawa and town of Brockville and city of Hull, Province of Quebec.

*Peterborough.*

Sec. 14. To comprise the towns of Peterborough, Cobourg, Lindsay and Port Hope.

*Toronto.*

Sec. 15. To comprise the city of Toronto.

## PROVINCE OF QUEBEC.

*Montreal.*

Sec. 16. To comprise the city of Montreal.

*Sherbrooke.*

Sec. 17. To comprise the city of Sherbrooke.

*Three Rivers.*

Sec. 18. To comprise the city of Three Rivers.

*Quebec.*

Sec. 19. To comprise the city of Quebec.

## PROVINCE OF NEW BRUNSWICK.

*Moncton.*

Sec. 20. To comprise the towns of Moncton and Chatham.

*St. John.*

Sec. 21. To comprise the city of St. John.

*Fredericton.*

Sec. 22. To comprise the city of Fredericton.

## PROVINCE OF NOVA SCOTIA.

*Halifax.*

Sec. 23. To comprise the city of Halifax and towns of Pictou and Yarmouth.

## PROVINCE OF P. E. ISLAND.

*Charlottetown.*

Sec. 24. To comprise the city of Charlottetown.

## PROVINCE OF MANITOBA.

*Winnipeg.*

Sec. 25. To comprise the city of Winnipeg.

## PROVINCE OF BRITISH COLUMBIA.

*Victoria.*

Sec. 26. To comprise the city of Victoria.

# CHAPTER 47.

## PETROLEUM AND NAPHTHA.

Government House, Ottawa,  
The 9th day of January, 1889.

On the recommendation of the Minister of Inland Revenue, and under the provisions of Chapter 102 of the Revised Statutes of Canada, intituled "The Petroleum Inspection Act,"

His Excellency in Council has been pleased to order, and it is hereby ordered, that the following regulations respecting petroleum and naphtha be made and established:—

### STORAGE AND POSSESSION OF PETROLEUM.

Petroleum and naphtha may be stored in places conformable to municipal regulations, on payment of the fees.

**Section 1.** In cities and towns where there are municipal regulations or laws respecting the storage of petroleum and the products thereof, petroleum and naphtha which have been inspected as required by Act 44 Victoria, Chapter 23, or by "The Petroleum Inspection Act" aforesaid and the inspection fees paid, may be stored in any building or place which is in conformity with the municipal regulations in that behalf.

Directions for storing petroleum and naphtha where there are no municipal regulations relating thereto.

**Sec. 2.** In cities and towns where there are no such municipal laws or regulations, and in all villages and places other than cities or towns; petroleum and naphtha, if in quantities exceeding two barrels of refined petroleum or ten gallons of naphtha, shall be stored only in isolated buildings or premises which are at least 100 yards distant from the next nearest building not owned or in the occupation of the person to whom the petroleum or naphtha belongs: Provided always that a license to have in possession and to store naphtha shall in each case have been previously obtained from the Inland Revenue Department; and every such license shall be conditioned that such naphtha shall only be sold or used for the purposes mentioned in the Act above cited, namely:—

License to have in possession and store to be obtained and to be conditioned for the sale only for certain purposes.

Illuminating purposes.

(a.) For use for illuminating purposes:—

1st. In street lamps in which only the vapor is burned;  
2nd. In dwellings, factories and other places of business when vaporized in secure underground tanks outside the building in which the vapor so generated is used for lighting;

Mechanical purposes.

(b.) For use for mechanical or chemical purposes in buildings not inhabited as residences for family purposes.

O. C. Oct. 6, 1881.

*Petroleum and Naphtha.*

## Chap. 47.

## SEIZURE OF PETROLEUM.

*Regulations respecting the disposition of Petroleum and Naphtha seized as directed by Sections 13, 15, 24, or any other provision of "The Petroleum Inspection Act."*

Sec. 3. If the quantity seized exceeds ten barrels, if seized for a first offence, it shall be branded as naphtha, but it may then be returned to the person from whom seized, on payment of the money penalty mentioned in the Act, and on the further condition that he shall forthwith at his own cost forward it to some petroleum refinery, where it shall be so treated as to make it conform to the requirements of the law.

If quantity seized exceeds ten barrels, first offence.

If seized for a second or for any subsequent offence, it shall be branded as naphtha, and it shall be confiscated. The officer seizing it may then sell it at a fair value to any person, on condition that it shall be forthwith forwarded to a refinery to be treated as above provided.

If seized for second or subsequent offence.

Sec. 4. If the quantity seized is less than ten barrels, it may, if circumstances permit, be dealt with as directed in Section 3 hereof. But if the quantity is not sufficient to justify a sale for shipment to a refinery, or if there is any difficulty in the way of forwarding it to a refinery, it shall be branded as naphtha and sold, to be thereafter stored and dealt with as such, subject to the conditions and regulations then in force in that behalf.

If quantity seized is less than ten barrels.

Whether the petroleum so seized is forwarded to a refinery or stored as naphtha, its value may, when seized for a first offence, accrue to the benefit of the person from whom seized, provided he has paid the money penalty imposed by the Act, and conformed to the conditions herein mentioned, but for a second and for any subsequent offence, the petroleum seized shall be confiscated and sold either to be forwarded to a refinery for treatment, or to be stored and dealt with as naphtha.

Disposition of petroleum seized in cases of first, and second, and subsequent offences.

Sec. 5. Whenever any petroleum, which has been seized under the Act herein cited and has been released or sold to any person under the conditions herein mentioned—is again offered for sale in contravention of such conditions or any of them, it shall be again seized and dealt with in the same manner as if then first illegally sold or offered for sale.

Petroleum seized, and again offered for sale.

Sec. 6. Naphtha when seized for any contravention of the said Act may, when seized for a first offence, be restored to the person from whom seized, on payment of the money penalty mentioned in the said Act, and on the further con-

Naphtha when seized for contravention of Act, first offence,

## Chap. 47.

*Petroleum and Naphtha.*

dition that the requirements of the law, as to its inspection, branding of packages and storage, shall forthwith be complied with.

Second or  
subsequent  
offence.

But when seized for a second or any subsequent offence, it shall be confiscated and shall be sold on condition that the purchaser shall comply with the provisions of the law and with all regulations made thereunder.

O. C. May 27, 1880.

## CHAPTER 48.

### LICENSED MALTSTERS' REGULATIONS.

Government House, Ottawa,  
The 9th day of January, 1889.

On the recommendation of the Minister of Inland Revenue and under the provisions of Chapter 34 of the Revised Statutes of Canada, intituled "The Inland Revenue Act," and also of Chapter 29 of the said Revised Statutes, intituled "The Consolidated Revenue and Audit Act,"

His Excellency in Council has been pleased to order, and it is hereby ordered, that the following regulations respecting licensed maltsters be and the same are hereby approved and adopted:—

#### KILN DRYING OF DAMAGED GRAIN FREE OF MALT DUTY.

Section I. Licensed maltsters and others engaged in that pursuit shall be, and they are hereby permitted to kiln dry damaged grain of all kinds without payment of the duty of one cent per pound, on the following conditions:—

Conditions upon which maltsters, &c., may kiln dry damaged grain.

(a.) The period for drying damaged grain shall, in each case, be regulated by the Collector of Inland Revenue ;

Period for drying.

(b.) The drying shall be done under the personal inspection of the officer of Excise detailed for that purpose ;

Drying how done.

(c.) The owner of the grain or drying kiln shall pay to the collector of Inland Revenue such sum as shall be sufficient to cover the expenses incurred in the survey of drying damaged grain ;

Payment of expenses by owner.

(d.) It will be the duty of the officer to examine closely and ascertain whether the damaged grain is germinating, and if it be, to report the same to the collector forthwith.

Damaged grain to be reported.

O. C. June 25, 1869.

## CHAPTER 49.

### CULLERS' FEES.

Government House, Ottawa.  
The 9th day of January, A.D. 1889.

On the recommendation of the Minister of Inland Revenue, and under the provisions of Chapter 103 of the Revised Statutes of Canada, intituled "The Cullers' Act,"

His Excellency in Council has been pleased to order, and it is hereby ordered, that the following tariff of fees be established, to be levied and received by the supervisor of cullers:—

#### TARIFF.

#### Section 1. For measuring off or counting Lumber :

	Total Fees in Cents and Tenths of a Cent.		Office Fees in Cents and Tenths of a Cent.		Cullers' Fees in Cents and Tenths of a Cent.	
	Cents	Tenths	Cents	Tenths	Cents	Tenths
White Pine, Butternut or Basswood, per ton.....	5	0	1	0	4	0
Red Pine, per ton.....	6	6	2	6	4	0
Hard Wood, per ton.....	6	6	2	6	4	0
Deals, counted off, 100 standard.....	11	7	5	0	6	7
Waney timber, per ton.....	6	2	2	2	4	0
Do do string measurement, per ton	7	5	3	5	4	0
Hemlock, per ton.....	3	5	.....	.....	3	5

#### Sec. 2. For culling and measuring in a merchantable state or measuring in shipping order or counting off when not otherwise herein provided :

White Pine, Waney, string measurement, per ton.....	12	3	8	3	4	0
White Pine, Square and Waney, per ton...	9	3	5	3	4	0
Red Pine timber, per ton.....	10	8	6	8	4	0
Hard Wood, per ton.....	12	2	8	2	4	0
Deals, per 100 standard.....	60	0	10	0	50	0
Plank two inches thick and under, 100 pieces	50	0	15	0	35	0
Standard Staves, per mille.....	350	0	70	0	280	0
West India Staves, do .....	162	0	32	0	130	0
Barrel Staves, do .....	113	4	23	4	90	0
Onrs, counted off, 100 pieces.....	4	4	5	0	18	4
Handspikes, counted off, 100 pieces.....	23	23	5	0	18	4
Spars, from 12 to 19 inches, each.....	46	8	13	4	33	4
Masts and Bowsprits, 19 to 24 inches, each	73	4	23	4	50	0
Masts and Bowsprits 24 inches and upwards, each.....	85	1	23	4	61	7
Lathwood, per cord.....	38	4	10	0	28	4
Flatted and Round Timber, per 1,000 lineal feet.....	80	0	25	0	55	0
Boards, 100 pieces.....	40	0	5	0	35	0
Sawed Lumber, other than Deals for Exportation by Sea, 100 pieces.	5	0	0	0	5	0
Sleepers culling each piece.....	1	5	0	0	0	0

O. C. Feb. 23, 1871 ; June 18, 1877.

# CHAPTER 50.

## UPPER OTTAWA IMPROVEMENT COMPANY.

Government House, Ottawa,  
The 9th day of January, 1889.

On the recommendation of the Minister of Inland Revenue and under the provisions of Chapter 77 of the Acts 38 Victoria (1875), intituled "An Act relating to the Upper Ottawa Improvement Company,"

His Excellency in Council has approved the following rates of toll :—

Tariff of rates to be levied by the Upper Ottawa Improvement Company for the use of the undermentioned works :—

### Section 1.—*Through Des Joachims Boom.*

	Per piece. Cents.
Saw logs, 17 ft. and under.....	¼
Red and white pine, tamarac, spruce and hemlock, round or flatted, over 17 ft. and under 25 ft. long..	½
Red and white pine, tamarac, spruce and hemlock, round or flatted, 25 ft. to 35 ft. long.....	⅝
Red and white pine, tamarac, spruce and hemlock, round or flatted, 35 ft. and upwards in length.....	¾
Red and white pine, tamarac, spruce and hemlock, square.....	1
Oak, elm and other hardwood, square or flatted.....	1½

### Sec. 2.—*Through Fort William Boom.*

Saw logs, 17 ft. and under.....	10
Red and white pine, tamarac, spruce and hemlock, round or flatted, over 17 ft. and under 25 ft. long..	25
Red and white pine, tamarac, spruce and hemlock, round or flatted, 25 ft. to 35 ft. long.....	30
Red and white pine, tamarac, spruce and hemlock, round or flatted, 35 ft. and upwards in length.....	45
Red and white pine, tamarac, spruce and hemlock, square.....	60
Oak, elm and other hardwood, square or flatted.....	75

### Sec. 3.—*Passing Lapasse Boom.*

Saw logs, 17 ft. and under.....	10
Red and white pine, tamarac, spruce and hemlock, round or flatted, over 17 ft. and under 25 ft. long..	15
Red and white pine, tamarac, spruce and hemlock, round or flatted, 25 ft. to 35 ft. long.....	20

Chap. 50.

*Upper Ottawa Improvement Company.*

	Per piece. Cents.
Red and white pine, tamarac, spruce and hemlock, round or flatted, 35 ft. and upwards in length.....	$\frac{2}{15}$
Red and white pine, tamarac, spruce and hemlock, square.....	$\frac{1}{5}$
Oak, elm and other hardwood, square or flatted.....	$\frac{3}{10}$

Sec. 4.—*Through Improvements in Mississippi Chenail,  
Chats Rapids and Quion Boom or any of them.*

Saw logs, 17 ft. and under.....	$\frac{1}{5}$
Red and white pine, tamarac, spruce and hemlock, round or flatted, over 17 ft. and under 25 ft. long..	$\frac{1}{15}$
Red and white pine, tamarac, spruce and hemlock, round or flatted, 25 ft. to 35 ft. long.....	$\frac{1}{5}$
Red and white pine, tamarac, spruce and hemlock, round or flatted, 35 ft. and upwards in length.....	$\frac{2}{15}$
Red and white pine, tamarac, spruce and hemlock, square.....	$\frac{1}{5}$
Oak, elm and other hardwood, square or flatted.....	$1\frac{1}{5}$

Sec. 5.—*Through Improvements from Deschesne to  
Head of Hull Slide, North Side.*

Saw logs, 17 ft. and under.....	$\frac{1}{2}$
Red and white pine, tamarac, spruce and hemlock, round or flatted, over 17 ft. and under 25 ft. long..	$\frac{2}{5}$
Red and white pine, tamarac, spruce and hemlock, round or flatted, 25 ft. to 35 ft. long.....	$\frac{5}{8}$
Red and white pine, tamarac, spruce and hemlock, round or flatted, 35 ft. and upwards in length.....	$1\frac{1}{2}$
Red and white pine, tamarac, spruce and hemlock, square.....	2
Oak, elm and other hardwood, square or flatted.....	3

Sec. 6.—*Through Boom at outlet of Hull Slide.*

Saw logs, 17 feet and under.....	$\frac{1}{5}$
Red and white pine, tamarac, spruce and hemlock, round or flatted, over 17 ft. and under 25 ft. long..	$\frac{1}{15}$
Red and white pine, tamarac, spruce and hemlock, round or flatted, 25 ft. to 35 ft. long.....	$\frac{1}{5}$
Red and white pine, tamarac, spruce and hemlock, round or flatted, 32 ft. and upwards in length.....	$\frac{2}{15}$
Red and white pine, tamarac, spruce and hemlock, square.....	$\frac{1}{5}$
Oak, elm, and other hardwood, square or flatted.....	$1\frac{1}{5}$

Sec. 7.—*Through Improvements in Thompson's Bay  
and Lime Kiln Eddy.*

Saw logs, 17 ft. and under.....	$\frac{1}{2}$
---------------------------------	---------------



*Upper Ottawa Improvement Company.*

Chap 50.

	Per piece, Cents.
Red and white pine, tamarac, spruce and hemlock, round or flatted, over 17 ft. and under 25 ft. long..	2 $\frac{3}{4}$
Red and white pine, tamarac, spruce and hemlock, round or flatted, 25 to 35 ft. long.....	5 $\frac{5}{8}$
Red and white pine, tamarac, spruce and hemlock, round or flatted, 35 ft. and upwards in length.....	1 $\frac{1}{2}$
Red and white pine, tamarac, spruce and hemlock, square.....	2
Oak, elm and other hardwood, square or flatted.....	3

Sec. 8.—*Through Chaudière Assorting Boom.*

Saw logs, 17 ft. and under.....	1 $\frac{1}{8}$
Red and white pine, tamarac, spruce and hemlock, round or flatted, over 17 ft. and under 25 ft. long..	4 $\frac{1}{15}$
Red and white pine, tamarac, spruce and hemlock, round or flatted, 25 ft. to 35 ft. long.....	1 $\frac{1}{3}$
Red and white pine, tamarac, spruce and hemlock, round or flatted, 35 ft. and upwards in length.....	1 $\frac{2}{15}$
Red and white pine, tamarac, spruce and hemlock, square.....	4 $\frac{1}{4}$
Oak, elm, and other hardwood, square or flatted.....	1 $\frac{1}{2}$

WORKING EXPENSES RATES.

Sec. 9.—*Through Des Joachims Boom.*

Saw logs, 17 ft. and under.....	1 $\frac{1}{2}$
Red and white pine, tamarac, spruce and hemlock, round or flatted, over 17 ft. and under 25 ft long...	3 $\frac{3}{4}$
Red and white pine, tamarac, spruce and hemlock, round or flatted, 25 ft. to 35 ft. long.....	5 $\frac{5}{8}$
Red and white pine, tamarac, spruce and hemlock, round or flatted, 35 ft. and upwards in length.....	1 $\frac{1}{3}$
Red and white pine, tamarac, spruce and hemlock, square.....	2
Oak, elm and other hardwood, square or flatted.....	3

Sec. 10.—*Through Fort William Boom.*

Saw logs, 17 ft. and under.....	1 $\frac{1}{2}$
Red and white pine, tamarac, spruce and hemlock, round or flatted, over 17 ft. and under 25 ft. long..	3 $\frac{3}{8}$
Red and white pine, tamarac, spruce and hemlock, round or flatted, 25 ft. to 35 ft. long.....	5 $\frac{5}{16}$
Red and white pine, tamarac, spruce and hemlock, round or flatted, 35 ft. and upwards in length.....	1 $\frac{2}{3}$
Red and white pine, tamarac, spruce and hemlock, square.....	2
Oak, elm and other hardwood, square or flatted.....	3

Chap. 50.

*Upper Ottawa Improvement Company.*Per piece.  
Cents.Sec. 11.—*Through Allumette Boom.*

Saw logs, 17 ft. and under.....	1
Red and white pine, tamarac, spruce and hemlock, round or flatted, over 17 ft. and under 25 ft. long..	2
Red and white pine, tamarac, spruce and hemlock, round or flatted, 25 ft. to 35 ft. long.....	5
Red and white pine, tamarac, spruce and hemlock, round or flatted, 35 ft. and upwards in length....	11
Red and white pine, tamarac, spruce and hemlock, square.....	2
Oak, elm and other hardwood, square or flatted.....	3

Sec. 12.—*Through Melons Chenail Boom.*

Saw logs, 17 ft. and under.....	1
Red and white pine, tamarac, spruce and hemlock, round or flatted, over 17 ft. and under 25 ft. long..	2
Red and white pine, tamarac, spruce and hemlock, round or flatted, 25 ft. to 35 ft. long.....	5
Red and white pine, tamarac, spruce and hemlock, round or flatted, 35 ft. and upwards in length.....	11
Red and white pine, tamarac, spruce and hemlock, square.....	2
Oak, elm and other hardwood, square or flatted.....	3

Sec. 13.—*Through Improvements in Mississippi Chenail  
Chats Rapids and Quion Boom, or any of them.*

Saw logs, 17 ft. and under.....	1
Red and white pine, tamarac, spruce and hemlock, round or flatted, over 17 ft. and under 25 ft. long..	11
Red and white pine, tamarac, spruce and hemlock, round or flatted, 25 ft. to 35 ft. long.....	11
Red and white pine, tamarac, spruce and hemlock, round or flatted, 35 ft. and upwards in length.....	21
Red and white pine, tamarac, spruce and hemlock, square.....	4
Oak, elm and other hardwood, square or flatted.....	6

Sec. 14.—*Through Thompson's Bay Boom.*

Saw logs, 17 ft. and under.....	1
Red and white pine, tamarac, spruce and hemlock, round or flatted, over 17 ft. and under 25 ft. long..	1
Red and white pine, tamarac, spruce and hemlock, round or flatted, 25 ft. to 35 ft. long.....	11
Red and white pine, tamarac, spruce and hemlock, round or flatted, 35 ft. and upwards in length.....	2
Red and white pine, tamarac, spruce and hemlock, square.....	3
Oak, elm and other hardwood, square or flatted.....	4

*Upper Ottawa Improvement Company.*

Chap. 50.

Per piece.  
Cents.**Sec. 15.—***Through Chaudière Assorting Boom.*

Saw logs, 17 ft. and under.....	$\frac{3}{4}$
Red and white pine, tamarac, spruce and hemlock, round or flatted, over 17 ft. and under 25 ft. long..	1
Red and white pine, tamarac, spruce and hemlock, round or flatted, 25 ft. to 35 ft. long.....	$1\frac{1}{4}$
Red and white pine, tamarac, spruce and hemlock, round or flatted, 35 ft. and upwards in length.....	2
Red and white pine, tamarac, spruce and hemlock, square.....	3
Oak, elm and other hardwood, square or flatted .....	$4\frac{1}{2}$

O. C. Feb. 8, 1888.

## CHAPTER 51.

---

### LOWER OTTAWA BOOM COMPANY.

Government House, Ottawa,  
The 9th day of January, 1889.

On the recommendation of the Minister of Inland Revenue, and under the provisions of Chapter 92 of the Acts 38 Victoria, (1875), intituled "An Act to incorporate The Lower Ottawa Boom Company,"

His Excellency in Council has been pleased to order, and it is hereby ordered, that the Lower Ottawa Boom Company are authorized to collect the following rates of toll for the use of their works at Duck and Kettle Islands, that is to say:—

Saw logs, flat and round timber	
or cedars.....	30 cents per piece.
Square timber.....	40      "      "

O.C. Sep. 8, 1875.

## CHAPTER 52.

### ROUGE BOOM COMPANY.

Government House, Ottawa,  
The 9th day of January, 1889.

On the recommendation of the Minister of Inland Revenue, and under the provisions of Chapter 111 of the Acts 37 Victoria (1874), intituled "An Act to incorporate The Rouge Boom Company,"

His Excellency in Council has been pleased to approve of the following tariff of tolls to be charged by the Rouge Boom Company during the season of 1888:—

*Tariff of tolls to be charged by the Rouge Boom Company in 1888.*

Pine logs.....	3	cts. per piece.
Spruce logs.....	2	" "
Round timber .....	5	" "
Square timber .....	10	" "
Railway ties.....	1	" "

O. C. Jan. 24, 1888.

# CHAPTER 53.

## FERRY REGULATIONS.

Government House, Ottawa,  
The 9th day of January, 1889.

On the recommendation of the Minister of Inland Revenue, and under the provisions of Chapter 97 of the Revised Statutes of Canada, intituled "An Act respecting Ferries,"

His Excellency in Council has been pleased to order and it is hereby ordered, that the following ferry regulations be made, established and confirmed :—

*Buckingham and Cumberland Ferry.*

### BUCKINGHAM AND CUMBERLAND FERRY.

Across the Ottawa River between Buckingham, in the County of Ottawa, in the Province of Quebec, and Cumberland, in the County of Russell, in the Province of Ontario.

**Section 1.** Regulations for the ferry across the Ottawa River between *Buckingham* in the County of Ottawa in the Province of Quebec, and *Cumberland* in the County of Russell in the Province of Ontario.

#### *1st.—Limits.*

The limits of the ferry shall extend to a distance of one mile above and one mile below Buckingham wharf, in the county of Ottawa, in the Province of Quebec, and to a similar distance above and below Cumberland wharf, in the county of Russell, in the Province of Ontario.

#### *2nd.—Landing Stages.*

Suitable landing stages or wharves serviceable at all states of the water in the river must be constructed on both sides, subject to the approval of the Minister of Inland Revenue.

#### *3rd.—Ferry-Boat.*

During the first year after the execution of the lease, the lessee shall provide and maintain a vessel propelled either by steam, horse-power or by oars, suitable for the conveyance of passengers, horses, cattle and all ordinary vehicles with safety and reasonable despatch, and such vessel shall be subject to the approval of the Minister of Inland Revenue, and should the lessee decide to employ a steamboat he must obtain therefor and produce when required a certificate of fitness, safety and sufficiency from the Dominion Board of Steamboat Inspectors.

#### *4th.—Number of Trips.*

During the season of navigation the ferry-boat shall commence running daily, Sundays excepted, at 6 o'clock, a.m.,

*Ferry Regulations.*

Chap. 53.

and shall continue to cross, thereafter, as often as may be found necessary for the convenience of the public, the number of such crossings to be determined from time to time by the Minister of Inland Revenue. Until otherwise determined the lessee shall provide convenient and sufficient means of signalling and shall cross from side to side whenever signalled to do so.

*Buckingham and Cumberland Ferry, continued.*

*5th.—Tariff of Charges.*

	Cents.
For a two-horse cart or conveyance and driver, each way.....	30
For a one-horse cart or conveyance and driver, each way.....	25
For one horse.....	20
For each additional horse being the property of the same party.....	10
For one head of horned cattle.....	20
For each additional head of horned cattle, the property of the same party.....	10
For one swine or sheep.....	15
For each additional swine or sheep, the property of the same party.....	5
For each passenger (with baggage not exceeding 50 lbs).....	10
For each package of merchandize or goods, other than the above, under 100 lbs.....	5
Lots of freight weighing over 100 lbs. and under 1,000 lbs. (per hundred).....	5
Lots of freight over 1,000 lbs. (per hundred).....	3

*6th.—Equipment.*

[The ferry-boat shall be placed on the route fully completed and equipped, and the landing stages shall be fully constructed on or before the first day of May, 1886.]

*7th.—Length of Lease.*

The lease shall extend for a period of five years, from the first day of May, 1886.

*8th.—Sureties.*

The lessee is required to give two sureties satisfactory to the Minister of Inland Revenue, and the said sureties shall be held jointly and severally with the principal in the sum of \$400 for the full compliance by the lessee with the terms of the lease.

*9th.—Powers of Minister.*

The right is reserved to the Minister of Inland Revenue of rejecting the ferry-boat or landing stages, or either of

*Buckingham and Cumberland Ferry,*  
continued

them, should any of them be deemed unsuitable for the service or unsafe to the public or inadequate to meet the public wants. The right is also reserved to the Governor in Council to modify the maximum tariff, should it be found expedient in the public interest to do so ; and the Governor in Council may declare the lease forfeited and void, whenever it shall be satisfactorily shown that the lessee fails to comply with the conditions thereof.

10th.—*Notice.*

A notice of the rates of fares and tolls to be charged for ferriage shall be kept posted up in a conspicuous place near the ferry landing on either side, and also on board the ferry-boat employed.

O.C. Oct. 20, 1885.

*Dalhousie Ferry.*

DALHOUSIE FERRY.

Across the Restigouche River, between Florant's Point, in the Province of Quebec, and Dalhousie, in the Province of New Brunswick.

Sec. 2. Regulations for the ferry across the Restigouche River between Florant's Point, in the Province of Quebec, and *Dalhousie*, in the Province of New Brunswick.

1st.—*Limits.*

The limits of the ferry shall extend to a distance of three miles above and below the wharf at the town of Dalhousie, in New Brunswick, and to a similar distance above and below the usual ferry landing at Florant's Point, in the Province of Quebec.

2nd.—*Ferry-Boat.*

The lessee shall place on the ferry and maintain during the period of the lease a suitable vessel propelled by steam. Such vessel shall be of sufficient size for the safe conveyance of passengers, and shall be subject to the approval of the Minister of Inland Revenue, and the lessee must obtain therefor and produce when required a certificate of fitness, safety and efficiency from the Dominion Board of Steamboat Inspectors.

3rd.—*Number of Trips.*

During the season of navigation the ferry-boat shall commence running daily, Sundays excepted, at 6 o'clock, a.m., and shall continue to cross from each side every hour thereafter until 8 o'clock p.m.

4th.—*Tariff of Charges.*

The maximum charges for ferrying shall be as follows:—

	Cents.
For a two-horse cart or conveyance, with driver,	
each way.....	40



*Ferry Regulations.*

Chap. 53.

	Cents.	<i>Dalhousie Ferry, continued.</i>
For a one-horse cart or conveyance, with driver, each way.....	30	
For one horse, each way.....	10	
For each head of horned cattle, each way.....	10	
For each sheep or swine, each way.....	5	
For a passenger.....	10	
For every hundred pounds of freight.....	4	

*5th.—Equipment.*

[The ferry-boat shall be put on the route fully completed and equipped, and the landing stages shall be fully constructed on or before the 1st day of May, 1887.]

*6th.—Length of Lease.*

The lease shall extend for a period of five years from the 1st day of May, 1887.

*7th.—Sureties.*

The lessee is required to give two sureties satisfactory to the Minister of Inland Revenue, and the said sureties shall be held jointly and severally with the principal in the sum of \$500 for the full compliance by the lessee with the terms of the lease.

*8th.—Powers of Minister.*

The right is reserved to the Minister of Inland Revenue of rejecting the ferry-boat or landing stages, or either of them should any of them be deemed unsuitable for the service or unsafe to the public, or inadequate to meet the public wants. The right is also reserved to the Governor in Council to modify the maximum tariff should it be deemed expedient in the public interest to do so; and the Governor in Council may declare the lease forfeited and void whenever it shall be satisfactorily shown that the lessee fails to comply with the conditions thereof.

*9th.—Free Passages.*

The lessee of the ferry shall at all times during the continuance of the lease carry over and across the ferry without fee, toll or reward, militiamen, soldiers or sailors, when provided with proper passports or under the charge of their proper officer or officers, and it shall be lawful for the said lessee to commute the rate of passage fees.

*10th.—Notice.*

A notice of the rates of fares and tolls to be charged for ferriage shall be kept posted up in a conspicuous place near the ferry landing on either side, and also on board the steam ferry-boat employed.

O.C. April 25, 1887.

## Chap. 54.

*Ferry Regulations.*

*Fort Erie and Buffalo Ferry.*

Across the Niagara River, between Fort Erie and Buffalo, in the United States of America.

## FORT ERIE AND BUFFALO FERRY.

Sec. 3. Regulations for the ferry across the Niagara River between *Fort Erie* and *Buffalo*, in the United States of America:—

*1st.—Limits.*

The limits of the ferry shall be coterminous with the northerly and southerly limits respectively of the Village of Fort Erie, and a point in the City of Buffalo to be fixed by the municipal authorities of that place.

*2nd.—Landing Places.*

Suitable landing wharves or docks shall be secured and at all times maintained at some central point in said Village of Fort Erie, which must be safe and available at all states of the river and subject to the approval of the Department of Inland Revenue.

*3rd.—Size of Vessel.*

The vessel used shall be a substantial seaworthy steamer of not less than 100 feet keel and 24 feet beam, and having projecting guards so as to afford sufficient space for horses and carriages, and of a speed of not less than 12 miles per hour.

*4th.—Engine and Equipment.*

The engine shall be of not less than 100 horse power, high pressure, and shall be, as well as the vessel generally, subject to the inspection and approval of the Dominion Inspector of Steamboats.

The vessel shall be supplied with life-preservers and shall be in all respects fully equipped, having a respectable and efficient commander; and the Minister of Inland Revenue shall be at liberty to reject any steamer which may, at any time, be placed upon the said ferry, or the commander thereof, or the said dock or wharf, should he consider them or any of them respectively unsuitable to the service, or unsafe or inadequate to meet the wants of the public.

*5th.—Free Passages.*

The lessee of the ferry for the time being shall, at all times, during the continuance of the lease carry across on the said ferry, without fee, toll or reward, Her Majesty's mails, and upon requisition by the Postmaster General of Canada the mails of the United States of America.

*Ferry Regulations.*

Chap. 53.

*6th.—Contraband.*

The lessee shall not, at any time, carry or convey or permit or suffer to be carried or conveyed over said ferry any contraband articles whatsoever.

*Fort Erie and  
Buffalo  
Ferry,  
continued.*

*7th.—Customs Laws.*

The lessee shall observe all Customs and Revenue laws of the Dominion of Canada and of the United States of America.

*8th.—Number of Trips.*

During the period commencing on the 1st day of April, and ending on the 30th day of November in each and every year, the said ferry shall commence to ply at the hour of 6 o'clock in the morning, Sundays excepted, and shall continue to cross from each side at intervals of 20 minutes successively thereafter until the hour of 8 o'clock in the evening; and from the latter hour, until 11 o'clock p.m., shall cross from each side at intervals of one hour; and during the remainder of each and every year at 7 o'clock in the morning, Sundays excepted, and shall continue to cross from each side at intervals of 30 minutes successively thereafter until the hour of 7 o'clock in the evening; and from the latter hour, until 11 o'clock p.m., shall cross from each side at intervals of one hour, unless such crossing is rendered impossible by the floating ice of the river.

O.C. Aug. 21, 1884.

*9th.—Tariff of Charges.*

The charges for fares and tolls to be made on the said ferry shall not at any time exceed the following, that is to say:—

	Cents.
For foot passengers, each way.....	5
For children under 12 years.....	3
For horse and rider.....	10
For each head of cattle.....	10
For one-horse vehicle and driver, for pleasure...	15
For each additional passenger.....	5
For two-horse vehicle and driver, for pleasure..	25
For each additional passenger.....	5
For double teams loaded, 2 tons and under, each way.....	40
For double teams loaded, over 2 tons and under 2½ tons, each way.....	50
For double teams loaded, over 2½ tons and under 3 tons each way.....	60
For double teams loaded, over 3 tons and under 3½ tons, each way.....	70

## Chap. 53.

*Ferry Regulations.*

	Cents.
<i>Fort Erie and Buffalo Ferry,</i> continued.	
Single teams, other than pleasure, each way....	25
For vehicle without horse attached, each way..	10
For each sheep or swine, each way .....	3
For sheep or swine, in droves over 5, each way..	2
For freight in packages under 100 lbs.....	5
For freight over 100 lbs., per 100 lbs.....	5

O. C. March 17, 1885.

Single fare tickets, ten for twenty-five cents, to be sold to persons crossing every day or every other day.

O. C. June 5, 1885.

10th.—*Notice.*

Notice of the rates of fares and rates of tolls on the said ferry shall be kept posted up and exhibited at all times in a conspicuous place on or near the said dock or wharf, and also on the steamer employed from time to time on the said ferry.

11th.—*Powers of Governor in Council.*

The Governor in Council shall be at liberty to alter or modify the tariff of charges and tolls hereinbefore contained, should it be deemed expedient in the public interest. Notice of such alteration or modification shall be published in the *Canada Gazette*, as provided by the 6th section of the Act, respecting ferries, Chap. 97, Revised Statutes, of Canada, and the lessee shall be officially notified by the Department of Inland Revenue, and after such notification the lessee shall not take or receive any other or larger fares or tolls than those imposed in such modified tariff during the existence thereof.

12th.—*Forfeiture of Lease.*

The Governor in Council shall be at liberty at any time at which it may be shown that the lessee has failed to observe, perform, fulfil or keep any or either of the said provisos, restrictions or conditions hereinbefore contained and expressed, to declare the lease forfeited and void, whereupon the same shall become and be void to all intents and purposes, as if the same had never been granted, and without indemnification to the lessee.

13th.—*Infringement of Laws.*

The said lessee shall not, at any time during the existence of the lease, wilfully or knowingly infringe any of the laws or by-laws or of the regulations of the United States of America, or of the State of New York or the City of Buffalo, in reference to ferriage, which may be applicable to the said ferry or to such portion thereof as may be within the

*Ferry Regulations.*

Chap. 53.

jurisdiction of any of them, the United States of America, the State of New York or the City of Buffalo, or permit or suffer the same to be infringed by any officer, servant or employe of the said lessee. *Fort Erie and Buffalo Ferry, continued.*

*14th.—Claim for Compensation.*

Provided always that if the United States of America, or the State of New York, or the City of Buffalo, shall in the exercise of any authority in any of them existing at any time during the existence of the said lease, prevent or hinder ferriage at or upon the said ferry or such portion thereof as may be within the jurisdiction of such one of them, or put the lessee to any loss, expense, charge or damage in respect to the same, no claim or demand for compensation, or any right or title thereto, shall be made upon or against the Dominion of Canada.

*15th.—When to begin.*

[The ferry-boat shall be placed on the route immediately on the expiration of the present lease.]

*16th.—Length of Lease.*

The lease shall extend for a period of five years. The lessee is required to give two sureties, satisfactory to the Minister of Inland Revenue, and the said sureties shall be held jointly and severally with the principal in the sum of four thousand dollars (\$4,000), for the full compliance by the said lessee with the terms of the lease.

*17th.—Sub-letting.*

The lease shall not be sub-let or assigned.  
O. C. Aug. 21, 1884 ; Sep. 6, 1884.

**HULL FERRY.***Hull Ferry.*

**Sec. 4.** Regulations for the ferry across the Ottawa River between the City of Ottawa, in the Province of Ontario, and the City of *Hull*, in the Province of Quebec:—

*1st.—Limits.*

On the Ontario side of the river the limits shall be co-terminous with the limit of the city of Ottawa, as far east as the mouth of the Rideau river. On the Quebec side of the river the limits shall extend from the Union Suspension Bridge to the point known as Haycock's Point, and on which a saw mill has been recently erected by Messrs. Gil-mour & Co.

A cross the Ottawa River, between the City of Ottawa, in the Province of Ontario, and the City of Hull, in the Province of Quebec.

## Chap. 53.

*Ferry Regulations.**2nd—Landing Places.**Hull Ferry,*  
continued.

Suitable landing stages or wharves shall be constructed and maintained at the cost of the lessee, which must be safe and available at all states of the river and subject to the approval of the Minister of Inland Revenue.

*3rd.—Ferry-Boat.*

The vessel used shall be a substantial seaworthy steamer of sufficient size, and must have a Government certificate as to safety of boiler and engine.

The main deck must be suitably covered to protect passengers from the weather. Parties tendering are to specify the dimensions and character of the proposed boat, the power of the engines, and whether high or low pressure.

They must also state the proposed location of the landing stages, and the manner in which they propose to construct them.

*4th.—Number of Trips.*

From the opening to the close of navigation the ferry-boat shall commence running daily, Sundays excepted, at six o'clock a.m., and shall continue to cross from each side three times every hour thereafter until eight o'clock p.m. Earlier or later trips may be made at the option of the lessee, except from the 10th day of June to the 10th day of October, when four trips shall be made in each hour.

*5th.—Tariff of Charges.*

The maximum charge for ferrying shall be as follows:—

	Cents.
For a two-horse cart or waggon with driver and load, each way.....	30
For a one-horse cart or waggon with driver and load, each way.....	20
For one horse, each way.....	10
For each head of horned cattle, each way.....	15
For each sheep or swine, each way.....	5
For each passenger, each way.....	5
For every 100 lbs. freight, each way.....	1

*6th.—When to Begin.*

The ferry-boat shall be placed on the route fully completed and equipped and the landing stages so far completed as to be safe for use immediately on the expiration of the present lease, and the boat, as well as permanent landings, shall be ready on the opening of navigation each subsequent year during the continuance of the lease.

*Ferry Regulations.*

## Chap. 53.

*7th.—Length of Lease.**Hull Ferry,*  
continued.

The lease shall extend for a period of four years and eleven months from the first day of June, 1886.

*8th.—Sureties.*

The lessee is required to give two sureties satisfactory to the Minister of Inland Revenue, and the said sureties shall be held jointly and severally with the principal in the sum of \$1,000 for the full compliance by the lessee with the terms of the lease.

*9th.—Powers Reserved.*

The right is reserved by the Minister of Inland Revenue of rejecting the ferry-boat or landing wharves, should they or either of them be at any time deemed unsuitable to the service, unsafe or inadequate to meet the public wants, and to resume the ferry and re-let it.

The right is also reserved to the Governor in Council to modify the maximum tariff should it be deemed expedient in the public interest to do so, and the Governor in Council may declare the lease forfeited and void whenever it shall be satisfactorily shown that the lessee fails to comply with the conditions thereof.

*10th.—Free Passages.*

The lessee of the ferry shall, at all times during the continuance of the lease, carry over and across the ferry without fee, toll or reward all mail matter, militiamen, soldiers or sailors when provided with the proper passports or under the charge of the proper officer or officers, and it shall be lawful for the said lessee to commute the rate for passenger fees.

*11th.—Notices.*

A notice of the rates of fares and tolls to be charged for ferriage shall be kept posted up in a conspicuous place near the ferry landing on either side of the river, and also on board the steam ferry-boat employed.

*12th.—Contraband.*

The lessee shall not at any time during the term of his lease knowingly ferry, take or carry, or permit to be carried, taken or ferried over or across the said ferry any contraband articles whatsoever.

O. C. May 11, 1886.

## LAPASSE FERRY.

Sec. 5. Regulations for the ferry across the Ottawa River *Lapasse Ferry.* between *Lapasse*, in the Province of Quebec, and Gower Point, in the Province of Ontario:—

## Chap. 53.

*Ferry Regulations.**Lapasse  
Ferry.**1st.—Limits.*

Across the  
Ottawa  
River,  
between  
Lapasse, in  
the Province  
of Quebec,  
and Gower  
Point, in the  
Province of  
Ontario.

The limits of the ferry shall commence one mile above and one mile below the Village of Lapasse, in the Township of Mansfield, in the County of Pontiac, in the Province of Quebec, and a similar distance above and below Gower Point, in the Township of Westmeath, in the County of Renfrew, in the Province of Ontario.

*2nd.—Ferry-Boat.*

The lessee shall provide and maintain a suitable scow or ferry-boat propelled by oars or other suitable appliances, constructed and equipped to the satisfaction of the Minister of Inland Revenue, which shall be not less than 36 feet in length and 22 feet in width, and shall be capable of carrying conveniently and with safety one loaded team with twenty foot passengers at one time.

*3rd.—Landing Stages.*

The lessee shall construct on both sides of the river and maintain, during the term of the lease, suitable landing stages or wharves which shall be serviceable at all states of water in the river, with suitable mooring posts and other necessary appliances, so that passengers, teams and vehicles may be taken on board and landed conveniently, and without danger,—which landing stages and wharves shall be subject to the approval of the Minister of Inland Revenue.

*4th.—Number of Trips.*

The ferry-boat shall cross at such times as the public convenience may require, at any time between sunrise and sunset on every day, Sundays excepted, when hailed by intending passengers from either side of the river, and the Minister of Inland Revenue may at any time require the crossing to be made at regular specified hours as well as when hailed by passengers desirous of crossing.

*5th.—Tariff of Charges.*

The maximum tariff of charges shall be as follows:—

	Cents.
For a two-horse cart or conveyance and driver, each way, including horses.....	40
For a one-horse cart or conveyance and driver, including horse, each way.....	30
For one horse, each way.....	15
For each additional horse, the property of the same party.....	10
For one head of horned cattle, each way.....	15
For each additional head of horned cattle, the property of the same party, each way.....	10



*Ferry Regulations.*

Chap. 53.

	Cents.	<i>Lapsse Ferry, continued.</i>
For one swine or sheep.....	10	
For each additional swine or sheep the property of the same party.....	5	
For each passenger, with baggage not exceeding 50 lbs.....	5	
For each package of merchandise or goods other than the above, of 100 lbs.....	2	

*6th.—When to Begin.*

[The ferry-boat shall be placed on the route fully equipped and completed and the landing stages shall be fully constructed on or before the 1st day of May, 1887.]

*7th.—Length of Lease.*

The lease shall extend for a period of five years from the 1st day of May, 1887.

*8th.—Sureties.*

The lessee is required to give two sureties satisfactory to the Minister of Inland Revenue, and the said sureties shall be held jointly and severally with the principal in the sum of \$500 for the full compliance by the lessee with the terms of the lease.

*9th.—Powers Reserved.*

The right is reserved to the Minister of Inland Revenue of rejecting the ferry-boat or landing stages or either of them should any of them be deemed unsuitable for the service, or unsafe to the public, or inadequate to meet the public wants. The right is also reserved to the Governor in Council to modify the maximum tariff should it be deemed expedient in the public interest to do so, and the Governor in Council may declare the lease forfeited and void whenever it shall be satisfactorily shown that the lessee fails to comply with the conditions thereof.

*10th.—Free Passages.*

The lessee of the ferry shall at all times during the continuance of the lease carry over and across the ferry without fee, toll or reward; militiamen, soldiers or sailors when provided with proper passports or under the charge of the proper officer or officers, and it shall be lawful for the said lessee to commute the rate of passenger fees.

*11th.—Notice.*

A notice of rates of fees and tolls to be charged for ferrisage shall be kept posted up in a conspicuous place near the ferry landing on either side and also on board the ferry-boat employed.

O. C. Dec., 1886.

*Lochaber and Rockland Ferry.*

## LOCHABER AND ROCKLAND FERRY.

Across the Ottawa River, between the township of Lochaber, in the County of Ottawa, in the Province of Quebec, and the Village of Rockland, in the County of Russell, in the Province of Ontario.

Sec. 6. Regulations for the ferry across the Ottawa River, between the Township of *Lochaber*, in the County of Ottawa, in the Province of Quebec, and the Village of *Rockland*, in the County of Russell, in the Province of Ontario:—

*1st.—Limits.*

The limits of the ferry shall extend for one mile and a-half above, and a similar distance below, the wharf at the Village of Rockland, in the County of Russell, in the Province of Ontario, and for one mile and a half above, and a similar distance below, lots Nos. 21 and 22 in the second range of the Township of Lochaber, in the County of Ottawa, in the Province of Québec.

*2nd.—Landing Stages.*

Suitable landing stages or wharves serviceable at all states of the water in the river, shall be constructed and maintained on both sides of the river, and shall be subject to the approval of the Minister of Inland Revenue.

*3rd.—Ferry-Boat.*

The lessee shall provide and maintain a suitable vessel propelled by steam, oars or horse-power, for the conveyance of passengers, horses and cattle, and all ordinary vehicles, with safety and reasonable despatch; subject to the approval of the Minister of Inland Revenue.

*4th.—Number of Trips.*

The ferry-boat shall cross at such times as the public convenience may require at any time between sunrise and sunset on every day, Sundays excepted, when hailed by intending passengers from either side of the river, and the Minister of Inland Revenue may at any time require the crossing to be made at regular specified hours as well as when hailed by passengers desirous of crossing.

*5th —Tariff of Charges.*

	Cents.
For a two-horse cart or conveyance, and driver, each way, including horses.....	40
For a one-horse cart or conveyance, and driver, including horse, each way.....	30
For one horse, each way.....	25
For each additional horse, the property of the same party.....	15
For horned cattle, when only one, each way	25

*Ferry Regulations.*

Chap. 53.

	Cents.	
For each additional head of horned cattle, the property of the same party, each way	15	<i>Lochaber and Rockland Ferry, continued.</i>
For swine or sheep, when only one, each way	10	
For each additional swine or sheep, the property of the same party, each way...	5	
For each passenger, with baggage not exceeding 50 pounds, each way.....	15	
For each package of merchandise or goods, other than the above, per 100 lbs., each way	5	

*6th.—When to Begin.*

[The ferry boat shall be placed on the route fully completed and equipped, and the landing stages shall be fully constructed on or before the 1st day of May, 1887.]

*7th.—Length of Lease.*

The lease shall extend for a period of five years from the 1st day of May, 1887.

*8th.—Sureties.*

The lessee is required to give two sureties satisfactory to the Minister of Inland Revenue, and the said sureties shall be held jointly and severally with the principal in the sum of \$500, for the full compliance by the lessee with the terms of the lease.

*9th.—Powers Reserved.*

The right is reserved to the Minister of Inland Revenue of rejecting the ferry-boat or landing stages, or either of them, should any of them be deemed unsuitable for the service, or unsafe to the public, or inadequate to meet the public wants.

The right is also reserved to the Governor in Council to modify the maximum tariff should it be found expedient in the public interest to do so, and the Governor in Council may declare the lease forfeited and void whenever it shall be satisfactorily shown that the lessee fails to comply with the conditions thereof.

*10th.—Notice.*

A notice of the rates of fares and tolls to be charged shall be kept posted up in a conspicuous place near the ferry landing on either side, and also on board the ferry-boat employed.

O. C. May 17, 1887.

## Chap. 53.

*Ferry Regulations.**Montebello  
Ferry.*

## MONTEBELLO FERRY.

Between  
Montebello,  
in the County  
of Ottawa, in  
the Province  
of Quebec and  
St. Thomas  
d'Alfred, in  
the County of  
Russel, in the  
Province of  
Ontario.

Sec. 7. Regulations for ferry between *Montebello* in the county of Ottawa in the Province of Quebec and St. Thomas d'Alfred in the county of Russell in the Province of Ontario.

*1st.—Limits.*

The limits of the ferry shall extend to a distance of two miles above and two miles below Montebello Wharf, in the parish of Notre Dame de Bonsecours, in the county of Ottawa, in the Province of Quebec, and to a similar distance above and below McGovern's Point, in the township of d'Alfred, in the county of Prescott, in the Province of Ontario.

*2nd.—Landing Stages.*

Suitable landing stages or wharves serviceable at all states of the water in the river shall be constructed and maintained on both sides of the river, subject to the approval of the Minister of Inland Revenue.

*3rd.—Ferry-Boat.*

On the opening of navigation the lessee shall provide and maintain a vessel propelled by steam suitable for the conveyance of passengers, horses, cattle and all ordinary vehicles with safety and reasonable despatch, and such vessel shall be not less than 53 feet in length by 24 feet beam, and shall be subject to the approval of the Minister of Inland Revenue, and the lessee shall be required to produce a certificate of fitness, safety and sufficiency from the Dominion Board of Steamboat Inspectors for the said vessel.

*4th.—Number of Trips.*

During the season of navigation the ferry-boat shall commence running daily, Sundays excepted, at 6 o'clock, a.m., and shall continue to cross thereafter, as may be found necessary for the convenience of the public, the number of such crossings to be determined from time to time by the Minister of Inland Revenue. Until otherwise determined the lessee shall provide convenient and sufficient means of signalling and shall cross from side to side whenever signalled to do so.

*5th.—Tariff of Charges.*

From Montebello to McGovern's Point :

	Cents.
For a two-horse cart or conveyance, with driver, each way .....	40
For a two-horse cart or conveyance, with driver, to go and return.....	50

*Ferry Regulations.*

## Chap. 53.

	Cents.	<i>Montebello Ferry, continued.</i>
For a one-horse cart or conveyance, with driver, each way.....	20	
For a one-horse cart or conveyance, with driver, to go and return.....	25	
For one horse, each way.....	10	
For each head of horned cattle, each way.....	5	
For each sheep or swine, each way.....	5	
For each passenger, each way.....	10	
For every 100 lbs. of freight.....	1	

From Montebello to St. Thomas d'Alfred :

	Cen's.
For a two-horse cart or conveyance, with driver, each way.....	40
For a one-horse cart or conveyance, with driver, each way.....	25
For one horse, each way.....	10
For each head of horned cattle, each way.....	10
For each sheep or swine, each way.....	5
For each passenger, each way.....	10
For every 100 pounds of freight.....	5

*6th.—Equipment.*

The ferry-boat shall be placed on the route full completed and equipped, and the landing stages shall be fully constructed on or before the 1st day of May, 1889.

*7th.—Length of Lease.*

The lease shall extend for a period of five years from the first day of May, 1889.

*8th.—Sureties.*

The lessee is required to give two sureties satisfactory to the Minister of Inland Revenue, and the said sureties shall be held jointly and severally with the principal in the sum of \$600 for the full compliance of the lessee with the terms of the lease.

*9th —Powers Reserved.*

The right is reserved to the Minister of Inland Revenue of rejecting the ferry-boat or landing stages, or either of them, should any of them be deemed unsuitable for the service or unsafe to the public or inadequate to meet the public wants. The right is also reserved to the Governor in Council to modify the maximum tariff, should it be found expedient in the public interest to do so; and the Governor in Council may declare the lease forfeited and void whenever it shall be satisfactorily shown that the lessee fails to comply with the conditions thereof.

## Chap. 53.

*Ferry Regulations.*

*Montebello  
Ferry,*  
continued.

10th.—*Free Passages.*

The lessee of the ferry shall at all times during the continuance of the lease carry over and cross the ferry, without fee, toll or reward; militiamen, soldiers or sailors, when provided with proper passports or under the charge of their proper officer or officers, and it shall be lawful for the said lessee to commute the rate of passenger fees.

11th.—*Notice.*

A notice of the rates of fares and tolls to be charged for ferriage shall be kept posted up in a conspicuous place near the ferry landing on either side of the river, and also on board the ferry-boat employed.

O. C. Oct. 9, 1888.

*New Edinburgh  
Ferry.*

## NEW EDINBURGH FERRY.

Across the Ottawa River, between New Edinburgh, in the Province of Ontario, and Waterloo or Gatineau Point, in the Province of Quebec.

Sec. 8. Regulations for the ferry across the Ottawa River, between *New Edinburgh*, in the Province of Ontario, and Waterloo or Gatineau Point, in the Province of Quebec.

1st.—*Limits.*

On the Ontario side of the river, the limits shall extend from the mouth of the Rideau river to Rockliffe.

On the Quebec side of the river, the limits shall include both sides of the river Gatineau up to the Government booms, and shall also extend from the mouth of the Gatineau to the western or upper limit of the landing used by the old ferry from Rockliffe to Gatineau Point.

2nd.—*Landing Stages.*

Suitable landing stages or wharves shall be constructed and maintained at the cost of the lessee, which must be safe and available at all states of the river, and subject to the approval of the Minister of Inland Revenue.

3rd.—*Ferry-Boat.*

The ferry-boat shall be a substantial seaworthy steamer propelled by side wheels and a low pressure engine and must have a Government certificate as to the safety of the boiler and engine. The size of the hull shall not be less than 100 feet keel by 24 feet beam or sufficiently large to carry at one time with safety eight loaded teams and 120 passengers. The main deck must be suitably covered to protect the passengers from the weather. The engine to be of not less than thirty horse nominal power.

4th.—*Number of Trips, &c.*

From the opening of navigation to the 31st day of August the ferry-boat shall commence running daily, Sundays ex-

*Ferry Regulations.*

Chap. 53.

cepted, at six o'clock a.m. and shall continue to cross from each side three times every hour thereafter until six o'clock p.m. From the 1st day of September till the close of navigation the ferry-boat shall commence daily, Sundays excepted, at seven o'clock, a.m., and shall continue from each side every hour thereafter until six o'clock, p.m.

*New Edinburgh Ferry,*  
continued.

*5th.—Tariff of Charges.*

The maximum charges for ferrying shall be as follows:—

	Cents.
For a two-horse cart or waggon with driver, each way .....	30
For a one-horse cart or waggon with driver, each way.....	20
For one horse, each way.....	10
For each head of horned cattle, each way.....	15
For each sheep or swine “ .....	5
For each passenger “ .....	5
For every 100 lbs. of freight “ .....	1

*6th.—Equipment.*

The ferry-boat shall be placed on the route fully completed and equipped, and the landing stages fully constructed immediately upon the expiration of the present lease.

*7th.—Length of Lease.*

The lease shall extend for a period of four years and eleven months from the 1st day of June, 1886.

*8th.—Sureties.*

The lessee is required to give two sureties satisfactory to the Minister of Inland Revenue, and the said sureties shall be held jointly and severally with the principal in the sum of \$10,000 for the full compliance by the lessee with the terms of the lease.

*9th.—Powers reserved.*

The right is reserved to the Minister of Inland Revenue of rejecting the ferry-boat or landing wharves should they or either of them be, at any time, deemed unsuitable to the service, unsafe or inadequate to meet the public wants.

The right is also reserved to the Governor in Council to modify the maximum tariff, should it be deemed expedient in the public interest to do so, and the Governor in Council may declare the lease forfeited and void whenever it shall be satisfactorily shown that the lessee fails to comply with the conditions thereof.

## Chap. 53.

*Ferry Regulations.*

*New Edinburgh Ferry,*  
continued.

10th.—*Free Passages.*

The lessee of the ferry shall at all times during the continuance of the lease carry over and across the ferry, without fee, toll or reward; all mail matter, militiamen, soldiers or sailors, when provided with proper passports or under the charge of the proper officer or officers, and it shall be lawful for the said lessee to commute the rate for passenger fees.

11th.—*Notice.*

A notice of the rates of fares and tolls to be charged for ferriage shall be kept posted up in a conspicuous place near the ferry landing, on either side of the river, and also on board the steam ferry-boat employed.

12th.—*Contraband.*

The lessee shall not, at any time during the term of his lease, knowingly ferry, take or carry, or permit to be ferried, taken or carried over or across the said ferry, any contraband articles whatsoever.

O. C. April 27, 1886.

*Papineauville Ferry.*

## PAPINEAUVILLE FERRY.

Across the Ottawa River, between Papineauville Wharf, in the Parish of Ste. Angélique, in the County of Ottawa, in the Province of Quebec, and Brown's Wharf, in the Township of North Plantagenet in the County of Prescott, in the Province of Ontario.

Sec. 9. Regulations for the ferry across the Ottawa River between *Papineauville Wharf*, in the Parish of Ste. Angélique, in the County of Ottawa, in the Province of Quebec, and *Brown's Wharf*, in the Township of North Plantagenet, in the County of Prescott, in the Province of Ontario.

1st.—*Limits.*

The limits of the ferry shall extend to a distance of one mile above *Papineauville Wharf*, in the Parish of Ste. Angélique, in the County of Ottawa, in the Province of Quebec, to a similar distance below *Brown's Wharf*, in the Township of North Plantagenet, in the County of Prescott, in the Province of Ontario.

2nd.—*Landing Stages.*

Suitable landing stages or wharves, serviceable at all states of the water in the river, shall be constructed on both sides, subject to the approval of the Minister of Inland Revenue.

3rd.—*Ferry-Boat.*

During the first year after the execution of the lease, the lessee shall provide and maintain a vessel propelled either by steam, horse power or by oars, suitable for the conveyance of passengers, horses, cattle and all ordinary vehicles,



*Ferry Regulations.*

Chap. 53.

with safety and reasonable despatch, and such vessel shall be subject to the approval of the Minister of Inland Revenue, and should the lessee decide to employ a steam-boat he must obtain therefor, and produce when required, a certificate of fitness, safety and sufficiency from the Dominion Board of Steamboat Inspectors. *Papineauville Ferry,*  
continued.

*4th.—Number of Trips.*

During the season of navigation the ferry-boat shall commence running daily, Sundays excepted, at 6 o'clock, a.m., and shall continue to cross, thereafter, as often as may be found necessary for the convenience of the public, the number of such crossings to be determined from time to time by the Minister of Inland Revenue. Until otherwise determined the lessee shall provide convenient and sufficient means of signalling, and shall cross from side to side whenever signalled to do so.

*5th.—Tariff of Charges.*

The maximum charges for ferrying shall be as follows:—

	Cents.
For a two-horse cart or conveyance, with driver, each way.....	30
For a one-horse cart or conveyance, with driver, each way.....	25
One horse, each way.....	20
Each head of horned cattle, each way.....	20
Each sheep or swine ".....	10
Each passenger, each way.....	10
Every 100 lbs. of freight, each way.....	5

*6th.—Equipment.*

[The ferry-boat shall be placed on the route fully completed and equipped, and the landing stages shall be fully constructed on or before the first day of May, 1885.]

*7th.—Length of Lease.*

The lease shall extend for a period of five years, from the first day of May, 1885.

*8th.—Sureties.*

The lessee is required to give two sureties satisfactory to the Minister of Inland Revenue, and the said sureties shall be held jointly and severally in the sum of \$400 for the full compliance by the lessee with the terms of the lease.

*9.—Powers Reserved.*

The right is reserved to the Minister of Inland Revenue of rejecting the ferry-boat or landing stages, or either

*Papineauville Ferry,*  
continued.

of them, should any of them be deemed unsuitable for the service or unsafe to the public or inadequate to meet the public wants. The right is also reserved to the Governor in Council to modify the maximum tariff, should it be found expedient in the public interest to do so; and the Governor in Council may declare the lease forfeited and void whenever it shall be satisfactorily shown that the lessee fails to comply with the conditions thereof.

*10th.—Notice.*

A notice of the rates of fares and tolls to be charged for ferriage shall be kept posted up in a conspicuous place near the ferry landing on either side, and also on board the ferry-boat employed.

O. C. Feb. 20, 1885.

*Pembroke Ferry.*

PEMBROKE FERRY.

Across the Ottawa River between Pembroke, in the Province of Ontario, and Alouette Island, in the Province of Quebec.

Sec. 10. Regulations for ferry across the Ottawa River between *Pembroke*, in the Province of Ontario, and *Allouette Island*, in the Province of Quebec :—

*1st.—Limits.*

The limits of the ferry shall extend from the *Allouette Rapids*, below the Town of *Pembroke*, in the County of *Renfrew*, to the *Narrows* above the said town, a distance of about five miles on the *Ottawa River*.

*2nd.—Landing Stages.*

Suitable landing stages or wharves, serviceable at all states of the water in the river, shall be constructed on both sides; on North shore at either *Charles Warren's Wharf* or *Desjardin's Wharf*; on South shore either at *Supple's Wharf* or *Thistle's Wharf*, or some point between,—subject to the approval of the Minister of Inland Revenue.

*3rd.—Ferry-Boat.*

The lessee shall provide and maintain a vessel propelled by steam suitable for the conveyance of passengers, horses and cattle, and all ordinary vehicles, with safety and reasonable despatch, and such vessel shall not be less than 100 feet in length by 18 feet beam, must have a Government certificate as to the safety of the boiler and engine, and shall be subject to the approval of the Minister of Inland Revenue.

*4th.—Number of Trips.*

The ferry-boat shall make three round trips before noon and three after noon, daily as follows:—Leaving *Thistle's Wharf* on the west side of *Muskrat River*, it shall call at

*Ferry Regulations.*

Chap. 53.

the wharf on the east side of the said river known as *Pembroke Ferry,* and cross thence to Desjardin's Wharf on Allumette Island. Returning, it shall proceed from the said Island Wharf to Supple's Wharf and thence to Thistle's Wharf. Such trips to be made at fixed hours, of which notice shall be at all times kept posted up on the ferry-boat and at each landing. *continued.*

*5th.—Tariff of Charges*

Two horses with conveyance and driver and load of grain, hay or potatoes, one way and return.....	\$1 50
For a two-horse cart or conveyance, and driver each way, including horses.....	0 40
For one horse with conveyance, and driver and load of grain, hay or potatoes, one way and return.....	1 00
For a one-horse cart or conveyance and driver, including horse, each way....	0 80
For one horse, each way.....	0 25
For each additional horse, the property of the same party.....	0 15
For each head of horned cattle, when only one, each way.....	0 25
For each additional head of horned cattle, the property of the same party, each way.....	0 10
For each swine or sheep, when only one...	0 10
For each additional swine or sheep the property of the same party.....	0 05
For each passenger and baggage, not exceeding 50 pounds, each way.....	0 12½
For each package of merchandise or goods, other than the above, under 100 lbs.....	0 05
For oats, peas, rye, barley, potatoes and buckwheat, per 100 lbs.....	0 03
For pressed hay in bales, per 100 lbs.....	0 04
For lime in barrels, per bbl.....	0 10

*6th.—Equipment.*

[The ferry-boat shall be placed on the route fully completed and equipped, and the landing stages shall be fully constructed on or before the 1st day of May, 1887.]

*7th.—Length of Lease.*

The lease shall extend for a period of five years from the 1st day of May, 1887.

## Chap. 53.

*Ferry Regulations.**8th.—Sureties.*

*Pembroke  
Ferry,  
continued.*

The lessee is required to give two sureties satisfactory to the Minister of Inland Revenue, and the said sureties shall be held jointly and severally in the sum of \$1,000 for the full compliance by the lessee with the terms of the lease.

*9th.—Powers Reserved.*

The right is reserved to the Minister of Inland Revenue of rejecting the ferry-boat or landing stages or either of them, should any of them be deemed unsuitable for the service or unsafe to the public or inadequate to meet the public wants. The right is also reserved to the Governor in Council to modify the maximum tariff should it be found expedient in the public interest to do so; and the Governor in Council may declare the lease forfeited and void whenever it shall be satisfactorily shown that the lessee fails to comply with the conditions thereof.

*10th.—Notice.*

A notice of the rates of fares and tolls to be charged shall be kept posted up in a conspicuous place near the ferry landing on either side, and also on board of the ferry-boat employed.

O. C. May 6 1887.

## PRESCOTT AND OGDENSBURG FERRY.

*Prescott and  
Ogdensburg  
Ferry.*

Across the St. Lawrence River, between Prescott, in the Province of Ontario, and Ogdensburg, in the United States of America.

Sec. II. Regulations for the ferry across the St. Lawrence River between *Prescott*, in the Province of Ontario, and *Ogdensburg*, in the United States of America:—

*1st.—Limits.*

The limits of the ferry shall be coterminous with the easterly and westerly limits respectively of the Town of Prescott and a point in the City of Ogdensburg to be fixed by the municipal authorities of that place.

*2nd.—Landing Places.*

Suitable landing wharves or docks shall be secured and at all times maintained at some central point in the said Town of Prescott, which must be safe and available at all states of the river and subject to the approval of the Minister of Inland Revenue.

*3rd.—Size of Vessel.*

The vessel used shall be a substantial seaworthy steamer of not less than 85 feet keel and 18 feet beam and having projecting guards so as to afford sufficient spaces for horses

*Ferry Regulations.*

## Chap. 53.

and carriages, and of a speed of not less than eight miles per hour.

*Prescott and  
Ogdensburg  
Ferry,  
continued.*

*4th.—Equipment.*

The engine shall be of not less than 50-horse-power, high pressure, and shall be, as well as the vessel generally, subject to the inspection and approval of the Dominion Inspector of Steamboats. The vessel shall be supplied with life-preservers and be in all respects fully equipped, having a respectable and efficient commander; and the Minister of Inland Revenue shall be at liberty to reject any steamer which may, at any time, be placed upon the said ferry, or the commander thereof, or the said dock or wharf, should he consider them or any of them respectively unsuitable to the service, or unsafe or inadequate to meet the wants of the public.

*5th.—Free Carriage.*

The lessee of the ferry shall, at all times during the continuance of the lease, carry across on the said ferry, without fee, toll or reward, Her Majesty's mails and upon requisition by the Postmaster General of Canada the mails of the United States of America.

*6th.—Contraband.*

The lessee shall not at any time carry or convey, or permit or suffer to be carried or conveyed over the said ferry any contraband articles whatsoever.

*7th.—Customs Laws.*

The lessee shall observe all Customs and Revenue laws of the Dominion of Canada and of the United States of America.

*8th.—Number of Trips.*

During the period commencing on the 1st day of April and ending on the 30th day of November in each and every year, the said ferry shall commence to ply at the hour of seven o'clock in the morning, Sundays excepted, and shall continue to cross from each side at intervals of 45 minutes successively thereafter until the hour of seven o'clock at night, and during the residue of each and every such year the said ferry shall make not less than six trips per day, Sundays excepted, unless such crossing is rendered impossible by the freezing of the river.

*9th.—Tariff of Charges.*

The charges for fares and tolls to be made on the said ferry shall not at any time exceed the following, that is to say:—

## Chap. 53.

*Ferry Regulations.*

*Prescott and  
Ogdensburg  
Ferry,  
continued.*

	Cents.
For foot passengers, each way, adults.....	10
"                    "                    "                    children.....	5
For one horse or head of horned cattle.....	25
For double team waggon and load.....	50
For single team                    "                    "                    .....	37½
For stage coach and two horses.....	50
For two-wheeled carriage and 1 horse.....	37½
For sheep not exceeding 5, each.....	4
For sheep exceeding 5, each.....	2½
For swine not exceeding 5, each.....	5
For swine exceeding 5, each.....	4
For every 100 lbs. of freight.....	5
Winter rates for passengers, each.....	20
Or double the summer rates.	

*10th.—Notice.*

Notice of the rates of fares and rates of tolls on the said ferry shall be kept posted up, and exhibited at all times in a conspicuous place on or near the said dock or wharf, and also on the steamer employed from time to time on the said ferry.

*11th.—Powers Reserved.*

The Governor in Council shall be at liberty to alter and modify the tariff of charges and tolls hereinbefore contained, should it be deemed expedient in the public interests, and after such modification as aforesaid the lessee shall not take or receive any other or larger fares or tolls than those which shall be imposed in such modified tariff during the subsistence thereof.

*12th.—Forfeiture of Lease.*

The Governor in Council shall be at liberty at any time at which it may be shown that the lessee has failed to observe, perform, fulfil and keep any or other of the said provisos, restrictions or conditions hereinbefore contained and expressed, to declare the lease forfeited and void—whereupon the same shall become and be void to all intents and purposes as if the same had never been granted, without indemnification to the lessee.

*13th.—Infringement of Laws.*

The said lessee shall not at any time during the existence of the lease wilfully or knowingly infringe any of the laws or by-laws or of the regulations of the United States of America or of the State of New York, or the City of Ogdensburg, in reference to ferriage which may be applicable to the said ferry or such portion thereof as may be within the jurisdiction of any of them, the United States of America, State of New York or the City of Ogdensburg,

*Ferry Regulations.*

Chap. 53

nor permit or suffer the same to be infringed by any officer, servant or employé of the said lessee.

*Prescott and  
Ogdensburg  
Ferry,  
continued.*

*14th.—Claim for Compensation.*

Provided always that if the United States of America or the State of New York, or the City of Ogdensburg, shall, in the exercise of any authority in any of them existing, at any time during the existence of the said lease prevent or hinder ferriage at or upon the said ferry or such portion thereof as may be within the jurisdiction of such one of them, or put the lessee to any loss, expense, charge or damage in respect to the same, no claim or demand for compensation, or any right or title thereto shall be made upon or against the Dominion of Canada.

*15th.—When to begin.*

The ferry-boat shall be placed on the route immediately on the expiration of the present lease.

*16th.—Length of Lease.*

The lease shall extend for a period of five (5) years.

*17th.—Sureties.*

The lessee is required to give two sureties, satisfactory to the Minister of Inland Revenue, and the sureties shall be held jointly and severally with the principal in the sum of ten thousand dollars (\$10,000) for the full compliance by the said lessee with the terms of the lease.

*18th.—Sub-letting.*

The lease shall not be sub-let or assigned.

O.C. May 2, 1883.

## QUION FERRY.

*Quion Ferry*

Sec. 12. Regulations for the ferry across the Ottawa River, between the Township of Fitzroy, in the Province of Ontario, and Onslow, in the Province of Quebec:—

*Across the  
Ottawa  
River,  
between the  
Township of  
Fitzroy, in the  
Province of  
Ontario, and  
Onslow, in  
the Province  
of Quebec.*

*1st.—Limits.*

On the Ontario side of the river the limits shall extend  $1\frac{1}{2}$  mile above and  $2\frac{1}{2}$  miles below Mr. Mohr's Landing, in the Township of Fitzroy, on the Quebec side,  $1\frac{1}{2}$  mile above and 3 miles below the side line between Lots 10 and 11 in the Range 3 of the Township of Onslow.

*2nd.—Landing Stages.*

Suitable landing stages or wharves must be constructed and maintained at the cost of the lessee, which must be

## Chap. 53.

*Ferry Regulations.*

*Quion Ferry*, safe and available at all states of the river, and subject to continued. the approval of the Minister of Inland Revenue.

*3rd.—Ferry-Boat.*

The ferry-boat shall be a substantial and seaworthy vessel, propelled by steam, and with an engine of either high or low pressure, and must have a Government certificate as to safety of the boiler and engine. The size of the hull must be not less than 50 feet keel by 18 feet beam; depth of hold 3 feet, sufficiently large to carry at one time and with safety two loaded teams, and having cabin accommodation for at least 12 passengers. The main deck must be suitably covered to protect the passengers from the weather. The engine to be of not less than ten (10) horse nominal power.

O. C. Sep. 10, 1886; Feb. 3, 1887.

*4th.—Number of Trips.*

From the opening of navigation until the 1st day of October, the ferry-boat shall commence running daily, Sundays excepted, at six o'clock, a.m., till nine o'clock, p.m., and from the 1st day of October until the close of navigation at seven o'clock a.m., till eight o'clock, p.m., and shall cross whenever required by teams, and shall make not less than four round trips each day as shall be found necessary for the convenience of the public.

*5th.—Tariff of Charges.*

	Cents.
For a two-horse waggon or conveyance with driver, each way.....	50
For a one-horse waggon or conveyance with driver, each way.....	40
(Each vehicle being light or loaded with produce for home consumption.)	
Otherwise loaded, each way, extra.....	25
For one horse and driver, each way.....	25
For each additional horse, the property of the same party, each way.....	15
For each head of horned cattle, when only one, each way.....	25
For each additional head of horned cattle, the property of the same party, each way.....	15
For each swine or sheep, when only one, each way.....	10
For each additional swine or sheep, the property of the same party, each way.....	5
For each passenger with baggage not exceeding fifty pounds, each way.....	10



*Ferry Regulations.*

Chap. 53.

	Cents.	
For each package of merchandise or goods, other than the above, under 100 lbs.....	5	<i>Quion Ferry,</i> continued.
For lots of freight weighing over 100 lbs., to include storage, until 8 o'clock, p.m., of day of crossing, per 100 lbs.....	3	

*6th.—When to Begin.*

[The ferry-boat shall be placed on the route fully completed and equipped, and the landing stages shall be fully constructed on or before the 1st day of May, 1887.]

*7th.—Length of Lease.*

The lease shall extend for a period of five years from the 1st day of May, 1887.

*8th.—Sureties.*

The lessee is required to give two sureties satisfactory to the Minister of Inland Revenue, and the said sureties shall be held jointly and severally with the principal in the sum of \$500 for the full compliance by the lessee with the terms of the lease.

*9th.—Powers Reserved.*

The right will be reserved to the Minister of Inland Revenue of rejecting the ferry-boat or landing wharves should either of them be deemed unsuitable for the service, unsafe or inadequate to meet the public wants. The right is also reserved to the Governor in Council to modify the maximum tariff should it be deemed expedient in the public interest to do so, and the Governor in Council may declare the lease forfeited and void whenever it shall be satisfactorily shown that the lessee fails to comply with the conditions thereof.

*10th.—Free Passage.*

The lessee of the ferry shall at all times during the continuance of his lease carry over and across the ferry without fee, toll or reward, all militiamen, soldiers or sailors when provided with proper passports or under the charge of the proper officer or officers, and it shall be lawful for the said lessee to commute the rate for passenger fees.

*11th.—Notice.*

A notice of the rates of fares and tolls to be charged for ferriage shall be kept posted up in a conspicuous place near the ferry landing on either side and also on board the ferry-boat employed.

12th.—*Contraband.*

*Quion Ferry,*  
continued.

The lessee shall not at any time, during the term of his lease, knowingly ferry, carry or take or permit to be ferried carried or taken over or across the said ferry, any **contra-band** articles whatsoever.

O. C. Sep. 10, 1886.

*Restigouche Ferry.*

RESTIGOUCHE FERRY.

(*Cross Point to Campbellton.*)

Across the Restigouche River, between Cross Point, in the Province of Quebec, and Campbellton, in the Province of New Brunswick.

Sec. 13. Regulations for the ferry across the *Restigouche* River, between *Cross Point*, in the Province of Quebec, and *Campbellton*, in the Province of New Brunswick:—

1st.—*Limits.*

The limits of the ferry shall extend to a distance of three miles above and three miles below the wharf at the Village of *Campbellton*, in New Brunswick, and to a similar distance above and below the usual ferry landing at *Cross Point*, in the Province of Quebec.

2nd.—*Ferry-Boat.*

The lessee shall place on the ferry and maintain, during the period of the lease, a suitable vessel propelled by steam. Such vessel shall be of sufficient size for the safe conveyance of passengers, and shall be subject to the approval of the Minister of Inland Revenue, and the lessee must obtain therefor and produce, when required, a certificate of fitness, safety and efficiency from the Dominion Board of Steamboat Inspectors.

3rd.—*Number of Trips.*

During the season of navigation the ferry-boat shall commence running daily, Sundays excepted, at 6 o'clock, a.m., and shall continue to cross from each side every hour thereafter until 8 o'clock, p.m.

4th.—*Tariff of Charges.*

The maximum charges for ferrying shall be as follows:—

	Cents.
For a two-horse cart or conveyance, with driver each way.....	40
For a one-horse cart or conveyance, with driver, each way.....	30
For one horse, each way.....	10
For each head of horned cattle, each way.....	10
For each sheep or swine, each way.....	5
For a passenger.....	5
For every hundred pounds of freight.....	4

*Ferry Regulations.*

Chap. 53.

\* 5th.—*Equipment.*

[The ferry-boat shall be placed on the route fully completed and equipped, and the landing stages shall be fully constructed on or before the 1st day of May, 1887.] *Restigouche Ferry, continued.*

6th.—*Length of Lease.*

The lease shall extend for a period of five years from the 1st day of May, 1887.

7th.—*Sureties.*

The lessee is required to give two sureties satisfactory to the Minister of Inland Revenue, and the said sureties shall be held jointly and severally with the principal in the sum of \$500 for the full compliance by the lessee with the terms of the lease.

8th.—*Powers Reserved.*

The right is reserved to the Minister of Inland Revenue of rejecting the ferry-boat or landing stages, or either of them, should any of them be deemed unsuitable for the service or unsafe to the public, or inadequate to meet the public wants. The right is also reserved to the Governor in Council to modify the maximum tariff should it be deemed expedient in the public interest to do so; and the Governor in Council may declare the lease forfeited and void whenever it shall be satisfactorily shown that the lessee fails to comply with the conditions thereof.

9th.—*Free Passages.*

The lessee of the ferry shall at all times, during the continuance of the lease, carry over and across the ferry, without fee, toll or reward; militiamen, soldiers or sailors, when provided with proper passports or under the charge of their proper officer or officers, and it shall be lawful for the said lessee to commute the rate of passenger fees.

11th.—*Notice.*

A notice of the rates of fares and tolls to be charged for ferriage shall be kept posted up in a conspicuous place near the ferry landing on either side, and also on board the steam ferry-boat employed.

O.C. Aug. 25, 1887.

## ROCKLIFFE FERRY.

Sec. 14. Regulations for the ferry across the Ottawa *Rockliffe Ferry.* River, between *Rockliffe*, in the Province of Ontario, and the old ferry landing on the Gatineau Point, in the Province of Quebec.

*Rockliffe  
Ferry.*

Across the  
Ottawa River,  
between  
Rockliffe, in  
the Province  
of Ontario  
and the old  
ferry landing  
on the Gatineau Point, in  
the Province  
of Quebec.

*1st.—Limits.*

The limits of the ferry shall commence on either side of the river, at the eastern limit of the ferry established between New Edinburgh and Gatineau Point, and they shall extend half a mile eastward of the limit so determined.

*2nd.—Equipment.*

The lessee shall maintain a safe and suitable scow or ferry-boat propelled by oars or other suitable appliances, constructed and equipped to the satisfaction of the Minister of Inland Revenue, and capable of carrying conveniently and with safety one loaded team with twenty foot passengers at one time.

*3rd.—Number of Trips.*

The ferry-boat shall cross at such times as the public convenience may require at any time between sunrise and sunset on every day, Sundays, excepted when hailed by intending passengers from either side of the river, and the Minister of Inland Revenue may at any time require the crossing to be made at regular specified hours as well as when hailed by passengers desirous of crossing.

*4th.—Landing Places.*

The lessee shall construct and maintain a landing on either side of the river with suitable mooring posts and other necessary appliances, so that passengers, teams and vehicles may be taken on board and landed conveniently and without danger.

*5th.—Tariff of Charges.*

The maximum tariff of charges shall be as follows:—

	Cents.
For a two-horse cart or waggon with driver, each way.....	30
For a one-horse cart or waggon with driver, each way .....	20
For one horse, each way.....	10
For one head of horned cattle, each way.....	15
For one sheep or swine, each way.....	5
For one passenger, each way.....	5
For every 100 lbs. of freight, each way.....	1

*6th.—When to Begin.*

[The ferry-boat shall be placed on the route fully completed and equipped and the landing stages shall be fully constructed on or before the 1st day of August, 1886.]

*Ferry Regulations.*

Chap. 53.

*7th.—Length of Lease*

The lease shall extend for a period of four years and nine months from the first day of August, 1886.

*Rockliffe  
Ferry,  
continued.*

*8th.—Sureties.*

The lessee is required to give two sureties satisfactory to the Minister of Inland Revenue, who shall be held jointly and severally with the principal in the sum of \$500 for the full compliance by the lessee with the terms of the lease.

*9th.—Powers Reserved.*

The right is reserved to the Minister of Inland Revenue of rejecting the ferry-boat or landing stages or either of them should any of them be deemed unsuitable for the service, or unsafe to the public, or inadequate to meet the public wants. The right is also reserved to the Governor in Council to modify the maximum tariff should it be deemed expedient in the public interest to do so, and the Governor in Council may declare the lease forfeited and void whenever it shall be satisfactorily shown that the lessee fails to comply with the conditions thereof.

*10th.—Free Passages.*

The lessee of the ferry shall at all times during the continuance of the lease carry over and across the ferry without fee, toll or reward, all mail matter, militiamen, soldiers or sailors when provided with proper passports or under the charge of their proper officer or officers, and it shall be lawful for the said lessee to commute the rate of passenger fees.

*11th.—Notice.*

A notice of the rates of fares and tolls to be charged for ferriage shall be kept posted up in a conspicuous place near the ferry landing on either side and also on board the ferry-boat employed.

O. C. April 9, 1881.

## ST. BASIL FERRY.

Sec. 15. Regulations for the ferry across the St. John River between the ferry-landing at *St. Basil Church*, in the County of Madawaska, in the Province of New Brunswick, and a point immediately opposite, in the State of Maine, in the United States of America:—

*St. Basil  
Ferry.  
Across the St.  
John River.*

*1st.—Limits.*

The limits of the said ferry shall extend for three miles above and three miles below *St. Basil Church* on the

## Chap. 53.

*Ferry Regulations.**St. Basil Ferry.*

Across the St. John River, between the ferry-landing at St. Basil Church, in the County of Madawaska, in the Province of New Brunswick, and a point immediately opposite, in the State of Maine, in the United States of America.

Canada side of the river, and a corresponding distance above and below the point immediately opposite in the State of Maine.

O. C. Sep. 11, 1885.

*2nd.—Landing Stages.*

Suitable approaches or wharves, serviceable at all states of the water in the river, shall be constructed on both sides, subject to the approval of the Minister of Inland Revenue.

*3rd.—Ferry-Boat.*

The lessee shall provide and maintain a vessel not less than 35 feet keel and  $9\frac{1}{2}$  feet beam, propelled either by steam, horse-power, or by oars, suitable for the conveyance of passengers, horses, cattle and all ordinary vehicles with safety and reasonable despatch, and such vessel shall be subject to the approval of the Minister of Inland Revenue.

*4th.—Number of Trips.*

During the season of navigation the ferry-boat shall commence running daily, Sundays excepted, at 6 o'clock, a.m., and shall continue to cross, thereafter, as often as may be found necessary for the convenience of the public, the number of such crossings to be determined from time to time by the Minister of Inland Revenue. Until otherwise determined, the lessee shall provide convenient and sufficient means of signalling, and shall cross from side to side whenever signalled to do so.

*5th.—Tariff of Charges.*

	Cents.
For a two-horse cart or conveyance and driver, each way .....	50
For a one-horse cart or conveyance and driver, each way.....	30
For one horse, each way.....	25
For each additional horse, the property of the same party.....	10
For each head of horned cattle, each way.....	25
For each additional head of horned cattle, the property of the same party, each way.....	10
For each swine or sheep .....	10
For each additional swine or sheep, the pro- perty of the same party.....	5
For each passenger (with baggage not exceed- ing 50 lbs).....	15
For each package of merchandise or goods, other than the above, under 100 lbs.....	5

*Ferry Regulations.*

Chap. 53.

	Cents.	<i>St. Basil Ferry, continued.</i>
For lots of freight weighing over 100 lbs. and under 1,000 lbs., per 100 lbs.....	5	
For lots of freight weighing over 1,000 lbs., per 100 lbs.....	3	

*6th.—When to begin.*

[The ferry-boat shall be placed on the route fully completed and equipped, and the approaches shall be fully constructed on or before the first day of May, 1885.]

*7th.—Length of Lease.*

The lease shall extend for a period of five years from the first day of May, 1885.

*8th.—Sureties.*

The lessee is required to give two sureties satisfactory to the Minister of Inland Revenue, and the said sureties shall be held jointly and severally with the principal in the sum of \$200 for the full compliance by the lessee with the terms of the lease.

*9th.—Powers reserved.*

The right is reserved to the Minister of Inland Revenue of rejecting the ferry-boat or landing stages, or either of them, should any of them be deemed unsuitable for the service or unsafe to the public or inadequate to meet the public wants. The right is also reserved to the Governor in Council to modify the maximum tariff, should it be found expedient in the public interest to do so; and the Governor in Council may declare the lease forfeited and void whenever it shall be satisfactorily shown that the lessee fails to comply with the conditions thereof.

*10th.—Notice.*

A notice of the rates of fares and tolls to be charged for ferriage shall be kept posted up in a conspicuous place near the ferry landing on either side.

O. C. Jan. 28, 1885.

## THURSO AND CLARENCE FERRY.

*Thurso and  
Clarence  
Ferry.*

Sec 16. Regulations for the ferry across the Ottawa River between *Thurso*, in the Province of Quebec, and the Township of *Clarence*, in the Province of Ontario:—

Across the Ottawa River, between *Thurso*, in the Province of Quebec, and the Township of *Clarence*, in the Province of Ontario.

*1st.—Limits.*

The limits of the ferry shall extend to a distance of one mile above and one mile below the Village of *Thurso*, in the Province of Quebec, and to a similar distance above and

## Chap. 53.

*Ferry Regulations.*

*Thurso and  
Clarence  
Ferry,  
continued.*

below a point in the Township of Clarence, immediately opposite thereto, in the Province of Ontario.

*2nd.—Landing Stages.*

Suitable landing stages or wharves servicable at all states of the water in the river shall be constructed on both sides, subject to the approval of the Minister of Inland Revenue.

*3rd.—Ferry-Boat.*

The lessee shall provide and maintain a vessel, propelled by steam suitable for the conveyance of passengers, horses, and cattle and all ordinary vehicles, with safety and reasonable despatch, and such vessel shall be not less than 72 feet in length by 21 feet beam; must have a Government certificate as to safety of the boiler and engine and shall be subject to the approval of the Minister of Inland Revenue.

*4th.—Number of Trips.*

During the season of navigation the ferry-boat shall commence running daily, Sundays excepted, at 7.30 o'clock, a.m., and shall continue to cross thereafter as often as may be found necessary for the convenience of the public—the number of such crossings to be determined from time to time by the Minister of Inland Revenue: until otherwise determined, the lessee shall provide convenient and sufficient means of signalling, and shall cross from side to side whenever signalled to do so.

*5th.—Tariff of Charges.*

	Cents.
For a two-horse cart or conveyance and driver, each way.....	60
For a one-horse cart or conveyance and driver, each way.....	50
For one horse.....	40
For each additional horse, being the property of the same party.....	20
For each head of horned cattle, when only one..	40
For each additional head of horned cattle, the property of the same party.....	15
For each swine or sheep, when only one.....	15
For each additional swine or sheep the property of the same party.....	5
For each passenger, with baggage not exceeding 50 lbs.....	15
For each package of merchandise or goods, other than the above, under 100 lbs.....	5
Lots of freight, weighing over 100 lbs. and under 1,000 lbs. (per hundred).....	5
Lots of freight over 1,000 lbs. (per hundred).....	3



*Ferry Regulations.*

## Chap. 53.

*6th.—Time to begin.**Thurso and  
Clarence  
Ferry,  
continued.*

[The ferry-boat shall be placed on the route fully completed and equipped, and the landing stages shall be fully constructed on or before the 1st day of September, 1884.]

*7th.—Length of Lease.*

The lease shall extend for a period of five years, from the first day of August, 1884.

*8th.—Sureties.*

The lessee is required to give two sureties satisfactory to the Minister of Inland Revenue, and the said sureties shall be held jointly and severally with the principal in the sum of two hundred dollars for the full compliance by the lessee with the terms of the lease.

*9th.—Powers Reserved.*

The right is reserved to the Minister of Inland Revenue of rejecting the ferry boat or landing stages, or either of them, should any of them be deemed unsuitable for the service or unsafe to the public, or inadequate to meet the public wants. The right is also reserved to the Governor in Council to modify the maximum tariff should it be found expedient in the public interest to do so; and the Governor in Council may declare the lease forfeited and void whenever it shall be satisfactorily shown that the lessee fails to comply with the conditions thereof.

*10th.—Notice.*

A notice of the rates of fares and tolls to be charged for ferriage shall be kept posted up in a conspicuous place near the ferry landing on either side, and also on board the ferry-boat employed.

O. C. July 18, 1884.

## VICTORIA AND BLACK ROCK FERRY.

*Victoria and  
Black Rock  
Ferry.*

Sec. 17. Regulations for the ferry across the Niagara River, between *Victoria*, in the Township of Bertie, in the Province of Ontario, and *Black Rock*, in the State of New York:—

*Across the  
Niagara  
River, be-  
tween Vic-  
toria, in the  
Township of  
Bertie, in the  
Province of  
Ontario, and  
Black Rock,  
in the State of  
New York.**1st.—Limits.*

The limits of the ferry shall be at some point on the Niagara River in front of lots Nos. 7 or 8, in the first concession of the Township of Bertie, in the County of Welland, and a point in North Buffalo or Black Rock, to be fixed by the municipal authority of one or the other of those places.

## Chap. 53.

*Ferry Regulations.*

*Victoria and  
Black River  
Ferry,  
continued.*

*2nd.—Landing Places.*

Suitable landing wharves or docks shall be secured, and at all times maintained, which must be safe and available at all states of the river, and subject to the approval of the Minister of Inland Revenue.

*3rd.—Capacity of Vessel.*

The vessel used shall be a substantial, seaworthy steamer, of not less capacity or power than that of the steamer "Niagara," now or formerly running between Fort Erie and Buffalo, and having projecting guards, so as to afford sufficient spaces for horses and carriages.

*4th.—Equipment.*

The engine shall be, as well as the vessel generally, subject to the inspection and approval of the Dominion Inspector of Steamboats. The vessel shall be supplied with life-preservers, and be in all respects fully equipped, having a respectable and efficient commander; and the Minister of Inland Revenue shall be at liberty to reject any steamer which may, at any time, be placed upon the said ferry, or the commander thereof, or the said dock or wharf, should he consider them, or any of them, respectively, unsuitable to the service, or unsafe or inadequate to meet the wants of the public.

O. C. Aug. 21, 1884.

*5th.—Tug and Scow.*

It shall be optional with the lessee to employ for the ferry service a tug and scow in lieu of the steamer mentioned in the 3rd paragraph hereof; and such tug and scow, as well as the coupling to be used, shall be subject to the conditions as to inspection and approval set forth in the 4th paragraph hereof, and shall be of the following dimensions, viz. :—

(a.) The tug shall be a substantial sea-worthy vessel, of 50 feet keel by 13 feet beam, and have a sufficient cabin capacity to accommodate at least 20 passengers at a time.

(b.) The scow shall be a substantial sea-worthy vessel, 80 feet long by 16 feet wide, with guards  $4\frac{1}{2}$  feet high.

O. C. May 26, 1885.

*6th.—Free Passages.*

The lessee of the ferry for the time being shall, at all times during the continuance of the lease, carry across on the said ferry, without fee, toll or reward, Her Majesty's

*Ferry Regulations.*

Chap. 53.

mails, and upon requisition by the Postmaster General of Canada, the mails of the United States of America.

*Victoria and  
Black River  
Ferry,  
continued.*

*7th.—Contraband.*

The lessee shall not at any time carry or convey, or permit or suffer to be carried or conveyed, over the said ferry, any contraband article whatsoever.

*8th.—Customs Laws.*

The lessee shall observe all Customs and Revenue laws of the Dominion of Canada and of the United States of America.

*9th.—Number of Trips.*

During the period commencing on the first day of April and ending on the thirtieth day of November in each and every year, the said ferry shall commence to ply at the hour of six o'clock in the morning, Sundays excepted, and shall continue to cross from each side at intervals of forty-five minutes successively thereafter until the hour of nine o'clock at night, and during the residue of each and every such year the said ferry shall make not less than six trips per day, Sundays excepted, unless such crossing is rendered impossible by the freezing of the river, or the floating ice.

*10th.—Tariff of Charges.*

The charges for fares and tolls to be made on the said ferry shall not at any one time exceed the following, that is to say:—

	Cents.
For foot passengers, each way, adults.....	5
"                    "                    children.....	3
For one horse or head of horned cattle.....	20
For horses or horned cattle in droves of more than four.....	10
For double team, waggon and load .....	50
For single team                    "                    .....	30
For stage coach and two horses.....	50
For two-wheeled carriage and one horse.....	30
For sheep, not exceeding five, each.....	4
do          exceeding five, each.....	2½
For swine, not exceeding five, each.....	5
do          exceeding five, each.....	4
For every 100 lbs. of freight.....	5

*11th.—Notice.*

*Victoria and  
Black Rock  
Ferry,  
continued.*

Notices of the rates of fares and rates of tolls on the said ferry shall be kept posted up and exhibited at all times in a conspicuous place on or near the said dock or wharf and also on the steamer employed from time to time on the said ferry.

*12th.—Powers Reserved.*

The Governor in Council shall be at liberty to alter and modify the tariff of charges and tolls hereinbefore contained, should it be deemed expedient in the public interest, and after such modification as aforesaid, the lessee shall not take or receive any other or larger fares or tolls than those which shall be imposed in such modified tariff, during the subsistence thereof.

*13th.—Forfeiture.*

The Governor in Council shall be at liberty, at any time at which it may be shown that the lessee has failed to observe, perform, fulfil and keep any or either of the said provisos, restrictions and conditions hereinbefore contained and expressed, to declare the lease forfeited and void; whereupon the same shall become and be void, to all intents and purposes, as if the same had never been granted, without indemnification to the lessee.

*14th.—Infringement.*

The said lessee shall not, at any time during the existence of the lease, wilfully or knowingly infringe any of the laws or by-laws or of the regulations of the United States of America, or of the State of New York, or the city of Buffalo or Black Rock, in reference to ferriage, which may be applicable to the said ferry, or such portion thereof as may be within the jurisdiction of any of them, the United States of America, State of New York, or the city of Buffalo or Black Rock, or permit or suffer the same to be infringed by any officer, servant or employé of the said lessee.

*15th.—Claim for Compensation.*

Provided always, that if the United States of America, or the State of New York, or the city of Buffalo or Black Rock, shall, in the exercise of any authority in any of them existing at any time during the existence of the said lease, prevent or hinder ferriage at or upon the said ferry, or such portion thereof as may be within the jurisdiction of such one of them, or put the lessee to any loss, expense,

*Ferry Regulations.*

Chap. 53.

charge or damage in respect to the same, no claim or demand for compensation, or any right or title thereto, shall be made upon or against the Dominion of Canada.

*Victoria and  
Black Rock  
Ferry,*  
continued.

*16th.—When to Begin.*

[The ferry-boat shall be placed on the route immediately on the lease being granted.]

*17th.—Length of Lease.*

The lease shall extend for a period of five years, the rent being payable in advance.

*18th.—Sureties.*

The lessee is required to give two sureties, satisfactory to the Minister of Inland Revenue, and the said sureties shall be held, jointly and severally with the principal, in the sum of ten thousand dollars for the full compliance of the said lessee with the terms of the lease.

*19th.—Sub-letting.*

The lease shall not be sub-let or assigned without the consent of the Governor in Council, but in the event of the death of the lessee, the lease shall inure to the benefit of the lessee's personal representatives.

O. C. Aug. 21, 1884.

Sec. 18. Nothing in the foregoing regulations shall be held to alter the rights or responsibilities of any of the parties to leases now current.

Rights, &c.,  
of present  
lessees re-  
served.



*John Jackson  
+ Peter H. ...*

DEPARTMENT OF JUSTICE.

CHAPTER 54.

TARIFF OF FEES IN CROWN CASES IN THE NORTH-WEST TERRITORIES.

Government House, Ottawa,  
The 29th day of January, 1889.

On the recommendation of the Minister of Justice and under the provisions of the Revised Statutes of Canada,

His Excellency in Council has been pleased to order as follows:--authorizing the Minister of Justice from time to time, to make such arrangements as he deems most convenient for the payment of fees and expenses to Crown prosecutors, sheriffs, clerks of court, coroners, justices of the peace, witnesses, jurors, interpreters and stenographers, in the North-West Territories, according to the tariff prescribed in the annexed schedule.

SCHEDULE.

CROWN PROSECUTORS.

Section 1. Crown Prosecutors may, in addition to actual Fees to Crown and necessary expenses incurred and paid, be allowed the Prosecutors. following fees in full of all services in criminal cases:—

(a.) In cases tried in a summary manner :		In cases tried in a summary manner.
If undefended.....	\$ 10 00	
If defended.....	15 00	
In special cases the presiding judge may increase the latter fee to a sum not exceeding.....	80 00	

(b.) In other cases :		In other cases.
If undefended.....	10 00	
If defended.....	30 <sup>00</sup> 00	

(c.) In any case of special difficulty and importance, the Minister of Justice may allow such a fee as he deems an adequate compensation for the services rendered. In case of special difficulty.

(d.) In special cases where the payment of travelling expenses is authorized by the Minister of Justice the actual cost of the conveyance will be paid and an allowance of \$3.00 per day for subsistence. The travelling and subsistence accounts will have to be certified as correct by a judge before they are paid. Travelling and subsistence accounts.

---

**Chap. 54. Fees in Crown Cases in the North-West Territories.**

---

**SHERIFFS.**Fees to  
sheriffs.**Sec. 2.** Sheriffs may be allowed the following fees :—*In criminal cases.*In criminal  
cases.

For attending the sittings of the court in o <i>banc</i> at Regina while criminal appeals are being heard, per day.....	\$ 5 00
For summoning jury—each juror served....	0 50
For conveying prisoners convicted and sen- tenced to penitentiary (exclusive of dis- bursements), per day absent.....	4 00
Actual and necessary disbursements in taking care of, guarding and conveying such prisoners.	
For superintending execution in capital cases, each.....	20 00
Actual and necessary disbursements and expenses connected with the carrying out of such capital sentences.	
For executing every warrant.....	2 00
For levying fines or other moneys by distress warrants, the same percentage on the amounts realized as are allowed in civil matters.	

*For mileage.*

Mileage.

By railway, the actual amount necessarily  
disbursed.In other cases, for every mile necessarily  
travelled..... 0 15Fee to cover  
expenditure  
may be al-  
lowed by a  
judge.If in any case the latter fee does not cover the actual  
and necessary expenditure, a judge may allow such a sum  
as will cover such expenditure.**CLERKS OF THE SUPREME COURT.**Fees to clerks  
of Supreme  
Court.**Sec. 3.** In full for all services rendered for the Crown in  
criminal cases :—

For each day's attendance, in person or by  
deputy, at a court while actually en-  
gaged in trying criminal cases or at the  
hearing of criminal appeals before the  
court in *banc* at Regina..... \$5 00

**CORONERS.**Fees allowed  
to coroners.**Sec. 4.** Coroners may be allowed the following fees :—

Precept to summon jury.....	\$0 50
Empannelling a jury.....	1 00



*Fees in Crown Cases in the North-West Territories.*

**Chap. 54.**

Summons for witness, each.....	0 25
Information, deposition or examination of each witness.....	0 25
Taking every recognizance .....	0 25
Necessary travel to take an inquest, per mile each way .....	0 15
Taking inquisition and making return.....	5 00
Every warrant for arrest if necessary .....	1 00

**POST-MORTEM EXAMINATION.**

To the physician or surgeon for making the post-mortem examination if it is neces- sary and actually made.....	10 00	Post-mortem examination.
--	-------	-----------------------------

**JUSTICES OF THE PEACE.**

Sec. 5. For sitting with a judge in criminal cases tried before a jury, for each day actually engaged .....	5 00	Fees to Justices of the Peace.
---	------	--------------------------------------

**WITNESSES AND JURORS.**

Sec. 6. Witnesses and jurors may, in criminal cases and on inquests, be allowed the following fees :—		Fees to wit- nesses and jurors.
For every day necessarily absent from resi- dence, in going to, staying at, and returning from trial.....	\$1 00	
For every mile necessarily travelled by other means than railway.....	0 10	
When railway used, actual fare paid.		
Professional men when acting profession- ally, in addition to mileage as other witnesses, per day.....	5 00	

**INTERPRETERS.**

Sec. 7. Interpreters may, in criminal cases and on inquests, be allowed the same mileage as witnesses, and for each day actually engaged as interpreters.....	2 00	Mileage and fees to inter- preters.
--	------	---

**STENOGRAPHERS.**

Sec. 8. Stenographers when employed at the instance of a judge may, in criminal cases, be paid the following fees :—		Fees to steno- graphers.
For the first copy of evidence, per folio.....	\$0 10	
For additional copies when required.....	0 05	

**PRELIMINARY INVESTIGATIONS.**

Sec. 9. If any preliminary investigation before a magis- trate or justice of the peace is held at the instance of the Crown, the same fees and charges may be allowed as in other cases.		Fees in pre- liminary in- vestigations.
---	--	---

---

**Chap. 54.**     *Fees in Crown Cases in the North-West Territories.*

---

## ACCOUNTS.

Accounts in  
duplicate to  
be certified.

Sec. 10. No fee or charge payable by the Crown shall be paid until accounts in duplicate have been certified as correct by a judge and the Crown prosecutor if a Crown prosecutor is employed. All accounts shall be rendered in detail with the several items properly dated.

O.C. Feb. 18, 1887, *part.*

## CHAPTER 55.

### REGULATIONS FOR THE DOMINION POLICE.

Government House, Ottawa,  
The 29th day of January, 1889.

On the recommendation of the Minister of Justice and under the provisions of Chapter 184 of the Revised Statutes of Canada, intituled "An Act respecting the Police of Canada",

His Excellency in Council has been pleased to make and prescribe the following rules and regulations in respect to the order, management, disposition and remuneration of the Dominion Police Force:—

#### REGULATIONS.

Section 1. There shall be a superintendent of the police force who may also be the Commissioner of Police, and who shall be paid such salary as may, from time to time, be determined by Order in Council. Superintendent of Police.

Sec. 2. The remainder of the force shall be composed as follows, and shall be paid the following rates per day, viz:— Police force, how paid.

	Per day.
One inspector.....	\$2 25
Two sergeants, each.....	1 90
Constables for the first six months.....	1 25
do for the next two years and six months.....	1 50
do after three years.....	1 65

Such increase to be granted by the Minister of Justice on the recommendation of the commissioner of police that the constable having served six months or three years as aforesaid is efficient and deserving such increase; the Minister to have also the power, on the recommendation of the commissioner, to reduce to a lower grade, with corresponding reduction of pay, any constable who may be guilty of any offence against the rules or who may become inefficient. Increase, when and how to be granted.

O. C. Nov. 7, 1882; March 25, 1888.

The Minister of Justice is also authorized, in case of emergency, to direct the commissioner of police to appoint, from time to time, an additional number of sergeants and police constables so that the force does not exceed in all 50 men besides the superintendent; the services of the extra men so appointed, or of any of them, to be dispensed with at any time or times the Minister may see fit to direct the commissioner of police so to do; and as the men so to be em- Additional number of sergeants and police constables provided for.

## Chap. 55.

*Regulations for the Dominion Police.*

ployed may be selected in consequence of extra qualifications as detectives and police constables the pay and allowances to these men will exceed that of the men already permanently appointed.

O. C. May 1, 1883.

- Oath of allegiance and of office.** **Sec. 3.** The superintendent, if he be other than the commissioner of police, and the inspector, sergeants and men shall, upon their appointment, take the oath of allegiance and an oath of office in such form as the commissioner of police may prescribe, which oath of office the commissioner of police shall administer and keep on record.
- Member of force who has not taken oaths.** **Sec. 4.** Any member of the force as now existing, who has not taken an oath of allegiance and an oath of office, shall take them in the manner prescribed in the last preceding section.
- Conditions for appointment.** **Sec. 5.** No person will be appointed to serve as a police constable unless,—
- Subject of Her Majesty.** (a.) He is a subject of Her Majesty by birth or naturalization;
- Residence for one year.** (b.) He has been a resident of some part of Her Majesty's Dominion during one year prior to his application for appointment;
- Education.** (c.) He is able to read and write understandingly;
- Intelligence.** (d.) He is generally intelligent, according to the judgment of the superintendent;
- Age.** (e.) He is over twenty-one and under thirty-five years of age;
- Height.** (f.) He stands five feet ten inches without his shoes;
- Health.** (g.) He is in good health and of sound body and mind, and equal to the performance of police duty according to the opinion of the surgeon of the force.
- Character.** (h.) He is of good moral character and habits.
- Certificate required as to physical qualifications. By whom to be given.** **Sec. 6.** The surgeon of the police force being responsible according to his judgment for the physical qualifications required for the peculiar and arduous duties of the police, the certificate of any other surgeon cannot be received; and a candidate may be considered unfit for service and be rejected without any reason being assigned, and every candidate is to understand that he attends at his own risk as to trouble and expense connected with the medical examination.
- Expenses of same.**

*Regulations for the Dominion Police.*

## Chap. 55.

## SUPERINTENDENT.

Sec. 7. The superintendent, if he be other than the commissioner of police, shall receive his instructions direct from the commissioner, or, in the absence of the latter, from the Department of Justice, and shall have the general government of the force under his charge subject to the order of the commissioner.

Instructions of superintendent, from whom received.

Sec. 8. He shall in such case be held responsible to the commissioner for the general conduct, good order and discipline of the inspector, sergeants and men, and for their regularity and efficiency, and he shall give such personal attention and attendance as will secure this end.

Responsibility to commissioner.

Sec. 9. The superintendent shall instruct his officers in all the branches of their duty, and see that they give similar instructions to their men.

Instructions to officers.

Sec. 10. He must be particular that the standing orders and regulations, and all others, either emanating from himself or the commissioner, and given out from time to time, are strictly and promptly obeyed.

Standing orders and regulations.

Sec. 11. He may at discretion suspend from duty (immediately thereafter reporting to the commissioner, if not himself the commissioner) any member of the force against whom a complaint has been made, and the pay of such member shall not be allowed during the period between his suspension and re-instatement or discharge unless by order of the commissioner.

Suspending from duty any member of the force.

Sec. 12. When charges are preferred against constables he will investigate the same, and when of sufficient importance, submit the charge in writing, with the information, &c., to the commissioner, if not himself the commissioner, and the commissioner will require witnesses on both sides to attend, and will hear the evidence of the case.

Charges against constables, how to be dealt with.

Sec. 13. The superintendent shall keep a record of all offences registered against the officers and men under him, with the punishment awarded; such record to be termed the police defaulter's book.

Police defaulter's book to be kept.

Sec. 14. He shall also keep a nominal and descriptive roll of the officers and men of the force, with the dates of their enrolment.

Enrolment of force to be kept.

Sec. 15. He shall have general charge of the police department, and of all arms and ammunition, and property of

General charge.

## Chap. 55.

*Regulations for the Dominion Police.*

every description belonging to the Government in the possession of or under the charge of the force.

Head-  
quarters.

Sec. 16. His headquarters shall be at his office near the police station, and he shall require the officers to report thereat as often as he shall deem requisite, and shall then communicate to them such orders and instructions as he may deem necessary.

Account of  
duties per-  
formed.

Sec. 17. He shall keep an account of the duties performed by each member of the police and of all absentees from duty, and the cause of the same.

Pay lists,  
cheques and  
estimates.

Sec. 18. He shall make out the pay lists and cheques, prepare the estimates at the commencement of every year for the expenditure of the police department, for the examination and approval of the commissioner.

Expenses in-  
curred and  
moneys paid  
out.

Certifying of  
accounts.

Sec. 19. It is his duty to be thoroughly cognizant of all expenses incurred and moneys paid out in connection with the department; and no order on account is to be paid, however trivial, without his certifying to the same as correct, before the signature of the commissioner is attached, as an authority for the payment being charged to the police account.

Drill and  
discipline.

Sec. 20. He will see that the force is properly drilled, and that their discipline and efficiency as a military body (in case they should be required as such) could be depended upon in time of riot and peril.

Vacancies  
and appoint-  
ments

Sec. 21. It shall be his duty, when vacancies occur in the force, or when any new appointment thereto is authorized, to submit to the commissioner of police, if not himself commissioner, for approval and appointment, the names of persons qualified to act as police constables.

Duties herein,  
not to inter-  
fere with  
those already  
given.

Sec. 22. The duties herein assigned, and directions given to the superintendent, are in addition to, and are not in any manner to interfere with, those heretofore defined by Orders in Council, or the orders and directions already issued and given by the Departments of Justice and Public Works.

## INSPECTOR AND SERGEANTS.

Duties of in-  
spectors and  
sergeants, to  
be defined.

Sec. 23. Their diurnal duty shall be defined by the superintendent, to whom they shall be subordinate: they shall obey all his orders and cause the same to be observed by

*Regulations for the Dominion Police.*

## Chap. 55.

the members of the force under them; and shall set an example of sobriety, discretion, skill, industry and promptness to the constables under their command. They shall at all times appear neatly attired and clean in their person and equipments; and if absent from duty without leave, or refusing to obey orders, they shall be liable to the same penalties and subject to the same punishment, as in the case of other constables.

Sobriety, &amp;c.

Absence without leave.

Sec. 24. An inspector or a sergeant shall be constantly on duty at the station, and never leave without appointing the man most competent to act during his absence.

On duty at the station.

Sec. 25. He shall become acquainted with the working of the telephone or telegraph, as should also the men under his care.

Telephone or telegraph.

Sec. 26. He shall call the roll at such hours as may be appointed by the superintendent.

Calling of the roll.

Sec. 27. In turn he shall enter in the books or papers designated for the purpose, all and every the circumstances reported to him and transpiring during his watch.

Entry of circumstances reported.

Sec. 28. He shall see that each man has a book, and that it is regularly and properly kept.

Book to be kept.

Sec. 29. He shall, when on out duty or when there is no sergeant available for the station duty exclusively, patrol the whole territory covered by the constables on duty, seeing that each has been placed, as far as practicable, where he will be most useful and efficient, or where ordered to be placed.

Patrol when on duty.

Sec. 30. He shall cause all persons brought to the station to be first brought to the office. He shall enter in the book for the purpose, or on the police sheet, the name, nation, age, height, complexion, residence, and offence of the prisoner; and shall see that he is properly searched, if necessary, and that whatever is taken from him is properly entered on the book or sheet.

Prisoners to be brought to the office and entered in the book or on the police sheet.

Sec. 31. He shall receive all property coming into the possession of the men or station by virtue of their office. He shall mark and keep together the property taken from each person, and keep a record of the same. When delivered, upon proper authority, to the court or legal owner, he shall take a receipt therefor and file the same in the superintendent's office.

Property coming into possession of the men.

## Chap. 55.

*Regulations for the Dominion Police.*

Account of days of absence to be kept.

Sec. 32. He shall keep an accurate account of the number of days any of the constables may be absent, from sickness or any other cause.

Economy as to fuel and gas.

Sec. 33. He shall see that the strictest economy is exercised in the use of fuel and gas at the station, consistent with due regard to the comfort of the men, and that the furniture and other property of the Government are neither destroyed nor injured.

Responsibility, power and duties in absence of superintendent.

Sec. 34. In the absence of the superintendent the inspector or other officers on duty shall be responsible to the commissioner for the good government of the force, and shall have full power and direction of the force, and shall exercise the same authority in all respects as that which is vested in the superintendent. This rule shall apply to the officer or constable in charge for the time being of the station.

Inspection of constables.

Sec. 35. The sergeant or officer in charge, for the time being, of the station, shall inspect each constable before going on or coming off duty, and be particular in noting that their dress is clean, and emblems and devices are clean and in their proper places, and that the men are in every respect properly attired and fit for duty.

Attendance at drill.

Sec. 36. The inspector and sergeants shall attend drill regularly, and while so attending obey the orders and directions of the *drill instructor*.

## GENERAL DUTIES OF THE POLICE FORCE CONSTABLES.

Saluting.

Sec. 37. Constables, whether on duty or not, shall salute the Governor General and suite, the Premier, and Her Majesty's other Ministers of State, the Chief Justice and the judges of the Supreme Court, and Exchequer Court of Canada, the Speakers of the Senate and House of Commons, the Major-General commanding the militia of Canada, the Adjutant-General, Deputy Heads of Departments, and the Commissioner and superintendent of police.

Cleanliness.

Sec. 38. The men shall, under all circumstances, appear clean in uniform as well as person.

Day-duty men.

Sec. 39. Day-duty men or patrolmen shall remain clothed and booted, ready when called out.

Absence from station.

Sec. 40. No constable shall absent himself from the station under any circumstances without leave from the sergeant or other officer on duty.



*Regulations for the Dominion Police.*

## Chap. 55.

Sec. 41. Any constable desiring leave of absence shall apply in writing to the superintendent through the sergeant in charge, who shall report on and submit the same to the superintendent or other officer acting in his place. No leave of absence for a period greater than two weeks in one year shall be granted by the superintendent without authority from the commissioner or Department of Justice.

Leave of absence, how to be applied for.

Sec. 42. Constables shall not enter any of the offices in shirt sleeves or go out of the station without being in uniform.

Decorum.

Sec. 43. A constable is always on duty, whether in uniform or not, and should always assist citizens legally requiring his services; if not in uniform, show his badge or state that he is a constable.

Constable is always on duty.

Sec. 44. Constables are strictly forbidden to frequent any tavern or house of ill-fame, unless ordered to do so in discharge of their duty.

Taverns, &c.

## GENERAL REGULATIONS.

Sec. 45. A constable shall devote his whole time and attention to the police service, and shall follow no other occupation or calling, directly or indirectly.

Devoting time, &c., to police service.

Sec. 46. He shall promptly obey all lawful orders from his superior officers, and conform himself to all rules and regulations which may be made from time to time for the benefit of the service.

Obeying orders of superior officers.

Sec. 47. He shall at all times on duty appear in his complete police dress.

To appear in police dress.

Sec. 48. He shall clearly understand what powers are given to him by law and the department for the efficient discharge of his duties. For this purpose he is recommended to read carefully the instructions given to him respecting the general duties of a constable.

Understanding the powers and instructions given to him.

Sec. 49. He shall be able to see every part of his beat at least once in half an hour; and this he shall be expected to do, so that any person requiring assistance, remaining in the same spot for that length of time, may be able to meet a constable. However, he is permitted to remain at any particular place, if his presence there be necessary to watch the conduct of any suspected person, or for any other

Directions as to his beat.

When permitted to remain at any particular place.

## Chap. 55.

*Regulations for the Dominion Police.*

reason; but he shall satisfy the superior officer that there was sufficient cause for such apparent irregularity.

Civility and attentiveness.

Sec. 50. The constable must be civil and attentive to all persons, of every rank and class; insolence or incivility on his part will not be overlooked; and he must make himself acquainted with the names of the chief officers of each of the departments in order to give full directions to all parties making inquiries.

General conduct; caution, decision, boldness and command of temper.

Sec. 51. He must be particularly cautious not to interfere idly or unnecessarily. When required to act he will do so with decision and boldness. He must remember that there is no qualification more indispensable than a perfect command of temper; never allowing himself to be moved in the slightest degree by any language or threats that may be used. If he does his duty in a quiet and determined manner, such conduct will induce well disposed bystanders to assist him, should he require it.

Not to accept gratuity without consent of superintendent.

Sec. 52. Upon no occasion, and under no pretence whatever, shall any officer or man of the force accept any gratuity, present or reward from any person for services rendered by him in the discharge of his duties, without the express permission of the superintendent.

Notice to be given on quitting the force.

Sec. 53. No policeman shall quit the force without giving two weeks' notice, unless by consent of the superintendent. In case he quits without such consent or such notice, or be dismissed from the force, all arrears of pay then due shall be forfeited.

Delivering up of dress and appointments.

Sec. 54. Every officer and man who shall be dismissed or who shall resign his office, must forthwith, before he leaves the service, deliver up every article of dress and appointments supplied to him.

Untruthfulness.

Sec. 55. Untruthfulness is a grave disqualification. Members of the force must speak the truth at all times and under all circumstances, except in cases where they are not allowed by the rules of the service to divulge facts within their knowledge, in which event they must avoid saying anything.

Memorandum book to be kept.

Sec. 56. To enable him to speak quite confidently and to prevent the possibility of his evidence being shaken, he is to jot down at the time in his memorandum book, dates and other particulars respecting events, accidents or occurrences, to which he can always refer.

*Regulations for the Dominion Police.*

## Chap. 55.

Sec. 57. If a constable is called upon to act he must do so with energy, promptness and determination, for, if he wavers or doubts, the criminal may escape, or the opportunity to render assistance may be lost.

Energy, promptness, and determination.

Sec. 58. They must be civil and courteous to each other. *It is desirable to impress upon the minds of all the members of the force the necessity of courteous behavior to each other upon all occasions. A mutual good feeling ought to exist among all ranks; and the elder constables, by their tone and manner, should do everything in their power to encourage this unanimity, and abstain from everything that may approach ridicule or slight towards their younger or less experienced comrades.*

Courteous behavior and civility.

Mutual good feeling.

Sec. 59. Every man of the force will be liable to dismissal for the following offences:—

Dismissal.

Disobedience of orders, drunkenness, insolence in word or manner, violence, or coarse language or behavior.

Offences determining the same.

Neglect of duty.

Absence without leave

Immoral conduct.

Conduct unbecoming an officer or member of the police.

Conduct injurious to the public service or public welfare.

Incapacity—mental, physical or educational.

Contracting a debt under false or fraudulent pretences.

Entering houses of ill-fame or taverns, unless in regular discharge of duty, and various other offences unnecessary to class,—all violations of rules and regulations included under the general head of any breach of discipline.

Entering houses of ill-fame or taverns.

Sec. 60. The members of the force shall be regularly drilled in such evolutions and at such times as the superintendent may from time to time direct.

Drilling.

Sec. 61. In case of sickness, either in consequence of being hurt on duty or otherwise, a constable shall;—

Duty in case of sickness.

(a.) Send immediately to the officer on duty a report of his inability to perform duty, in which report he shall state whether or not he is able to wait upon the surgeon;

Report of his inability.

(b.) In case he is able so to do, attend at the police surgeon's consulting room on such days and hours as the surgeon shall designate, for the purpose of being seen and examined by the surgeon;

Attendance upon police surgeon.

(c.) When ordered by the surgeon to resume duty, forthwith report to the officer in charge, and resume duty whenever he is directed to do so.

Resuming duty.

## Chap. 55.

*Regulations for the Dominion Police.*

Stoppage of pay in case of absence through sickness or other cause.

Sec. 62. When absent from duty through sickness [or other cause, every officer and man will be liable to be placed under stoppage of pay as the commissioner on report from the superintendent, if not himself superintendent, shall deem expedient. The medical officer appointed to the force, or deputed to the duty, shall, when called upon as such to visit parties, ascertain the nature of the sickness, whether actual or feigned, and report to the superintendent. If caused by unusual exposure or exertions while in the discharge of his duty, full pay for lost time may be allowed.

Half-pay, when allowed.

Sec. 63. When on account of sickness or injury during the ordinary discharge of duty, and certified by the appointed physician, half-pay may be allowed. In either case, for such time only as may be deemed reasonable and proper.

Sickness or disability, when feigned or simulated.

Sec. 64. Sickness or disability, feigned or simulated, or when it arises from carelessness, excessive indulgence, or any improper or immoral practices, will be considered an offence, and will be punished accordingly. The fees of the physician shall be paid by the constable in all cases of feigned or simulated sickness.

Complaints for incurring debts, &c.

Sec. 65. Repeated complaints against any member of the force for incurring debts, and evidence of continued and persistent neglect or refusal to pay just debts, or to support his wife and family, shall be deemed unbecoming conduct, and will be cause for dismissal.

Offences against the provisions of the Act or regulations.

Sec. 66. For any offence against the provisions of the Act or regulations, or for any neglect of duty, the commissioner shall, on reports from the superintendent, if not himself superintendent, fine any officer or man of the force offending. The fine shall not exceed ten days' pay. Fines shall be deducted from the pay of offenders, and reprimands must be made verbally at roll call, or in general or special orders.

Places of residence to be reported.

Sec. 67. Members of the force will make return of their places of residence, and report any changes. A list of the members and their residences will be hung in the sergeant's and guard room.

Smoking.

Sec. 68. Smoking shall be allowed only in the room designated.

Coolness and firmness in cases of peril.

Sec. 69. Coolness and firmness will be expected in all cases, and in circumstances of peril all must be careful to act together and to protect each other in the restoration of

*Regulations for the Dominion Police.*

## Chap. 55.

peace and order. Whoever shrinks from danger or responsibility at such a moment is unworthy of a place in the service, and will be discharged at once.

Sec. 70. When upon duty, the extent of the constable's beat will be clearly pointed out to him by the officer in charge. He will then be responsible for the security of life and property within its limits, and for the preservation of the peace and general good order during the time he is on duty.

Responsibility of constable within the limits of his beat.

Sec. 71. Any instance of unnecessary violence in striking a party in charge will be severely punished. A constable must not use his baton because the party in his custody is violent in behavior or language. A constable is not to use language to persons to provoke or offend them. Such conduct creates resistance in the party and hostile feeling towards the constable among the bystanders. Every constable will recollect that in executing an arrest, he is not justified in doing more than is absolutely necessary for the safe custody of the person whilst he conveys him to the station.

Unnecessary violence forbidden and punishment therefor.

Sec. 72. Individual constables when walking the street or passages should not shoulder passengers, but give way in a mild and civil manner. The more respectful the police are when off duty, the more respected and supported they will be by the public in the proper execution of their duty.

When walking the street or passages, constable must give way in a civil manner.

Sec. 73. If, during the service, or upon dismissal or resignation from the force, it shall appear to the superintendent that any article of dress shall have been improperly used or damaged, a deduction from any pay due to the party will be made, sufficient to make good the damage or supply a new article.

Deduction from pay in case of damage to article of dress.

Sec. 74. During the time of his duty, if he observes anything to produce danger, public inconvenience or anything that appears to him irregular and offensive, the constable must report to the station.

Danger, public inconvenience, &c., to be reported by constable.

Sec. 75. Policemen are not to refuse to give their assistance for the protection of persons and property near their own-beats, if called upon in any case requiring immediate attention; but the constable is always bound to return as soon as possible to his own beat.

Protection of persons, &c., outside his beat.

Sec. 76. Members of the force are forbidden to smoke or drink, or carry sticks or umbrellas when on duty.

Smoking, &c., when on duty.

## Chap. 55.

*Regulations for the Dominion Police.*

- Drinking with person in custody. Sec. **77.** Members of the force are strictly forbidden to accept of any description of drink from any person while in custody, or after he shall have been discharged, or from any friend of the defendant or complainant.
- Conversation while on duty. Sec. **78.** Constables on duty are strictly forbidden to enter into conversation with any person whatever, excepting on matters relating to their duty.
- Secrecy to be observed. Sec. **79.** All matters relating to the police department shall be strictly kept secret, and no communication, whether in writing, verbally or otherwise, in any way connected with the force or its operation, shall be made or given to any one without permission, under penalty of dismissal.
- Cabals, conspiracies, &c., to be punished by instant dismissal. Sec. **80.** Cabals, conspiracies or reflections cast against the moral or official character of any officer of the force, without sufficient proof of the charges being made before the superintendent or commissioner, or other representative of the Department, will be punished by instant dismissal. The same rule shall apply as between any one member of the force and another.
- Appearing in full uniform. Sec. **81.** While on duty every member of the force shall be bound to appear in full uniform with his belt and baton.
- Intercourse with prisoners forbidden. Sec. **82.** Members of the force will upon no occasion whatever hold any intercourse with prisoners brought to the station, nor shall they laugh, jeer or joke at or with them.
- Men waiting to relieve must be in full dress. Sec. **83.** All men while waiting in the station to relieve those on duty, must be in full dress, ready to turn out at a moment's notice, and they are not permitted to lie down while on day duty.
- Relief to be inspected as to cleanliness, dress and equipment. Sec. **84.** Every relief before turning out for duty shall be closely inspected as to cleanliness, dress and equipment, and if found wanting in any of these respects, the constable or constables forming such relief shall be punished by stoppages of pay at discretion of the commissioner, upon a report from the superintendent.
- Nuisances to be reported. Sec. **85.** Nuisances of all kinds must be reported directly to the officer on duty as soon as the constable returns from his beat.
- Liability to be called on at all times. Sec. **86.** The men on and off duty are to consider themselves liable to be called on at all times, and will prepare themselves, when required, at the shortest notice.

*Regulations for the Dominion Police.*

## Chap. 55.

Sec. 87. All constables shall be fully instructed in their duty and its performances before being appointed to a beat. Instructions in duty.

Sec. 88. Every man joining the force must be possessed of a respectable suit of clothing, not uniform, in the event of his being detailed to any private or detective duty. Suit of clothing, not uniform.

Sec. 89. No member of the police force shall allow the use of his name at any fair, festival or exhibition, for the purpose of selling tickets, setting up or promoting any raffle or gift enterprise, or of having a present voted to him, or voted for in his name. Selling tickets at fair, festival, &c., not allowed.

Sec. 90. No member shall directly or indirectly, be concerned in making any compromise or arrangement between thieves or other criminals, and persons who have suffered by their acts, with a view to permitting the criminals to escape the penalties provided by law; and any officer or constable who has taken any part in such compromises or arrangements, or has any knowledge thereof and fails to give information to his superior officer, shall be subject to immediate dismissal. Compromises, &c., between criminals, to subject offender to immediate dismissal.

Sec. 91. Members of the force shall abstain from the expression of political or religious opinions which may in the slightest degree be calculated to give offence, and shall not, after appointment, connect themselves with or attend any secret society, or (except as a matter of police duty) any political meeting. Political or religious opinions and secret societies to be avoided.

Sec. 92. No certificate of character shall be granted by the superintendent,— Cases when certificate of character shall not be granted.

- (a.) If the constable is dismissed the service;
- (b.) If the constable has been repeatedly guilty of misconduct, although of a slight nature;
- (c.) If the constable has been guilty of any misconduct of a serious nature;
- (d.) If the constable leaves the service without giving due notice of his intention so to do.

## COMPLAINTS.

Sec. 93. The statement of any person making a complaint against the police at the station is to be taken down in writing, and submitted to the superintendent. The complainant must be requested to sign the statement, and the Complaints against police, how dealt with.

## Chap. 55.

*Regulations for the Dominion Police.*

officer taking down the complaint is to ascertain, from the person complaining, whether he is willing to make his charge before the commissioner, should it be deemed necessary to send it there.

Complaints by police, how submitted.

Sec. 94. Complaints by police against each other are to be made in writing and signed, and are to be submitted to the superintendent or the chief officer in charge.

Grievances or causes of complaint by police, how to be laid before the commissioner.

Sec. 95. Grievances or causes of complaint by police can at any time be laid before the commissioner through the superior officer in charge for the time being; and the constables are forbidden to make representations of their wants, complaints, &c., to the commissioner, except through the superior officer in charge, unless such officer refuses to forward such representations, complaints, &c., after being requested in writing by the complainant so to do.

O. C. Nov. 7, 1882.



## CHAPTER 56.

### PETITION OF RIGHT.

Government House, Ottawa,

The 29th day of January, 1889.

On the recommendation of the Minister of Justice, and under the provisions of the Revised Statutes of Canada,

His Excellency in Council has been pleased to order as follows:—

With reference to section 23 of 50-51 Victoria, Chapter 16, intituled: "An Act to amend the Supreme and Exchequer Courts Act, and to make better provision for the trial of claims against the Crown," which provides that "any claim against the Crown may be prosecuted by petition of right, or may be referred to the court by the head of the department in connection with the administration of which the claim arises and if any such claim is so referred no fiat shall be given on any petition of right in respect thereof," and in order to insure regularity in such references, and in order that the Minister of Justice may be kept informed of such references, with a view to advising against the granting of any fiat on a petition of right in respect of a claim so referred, all references to the court, under the authority of the section quoted, to be made by any head of a department, shall be so made through the Minister of Justice.

All references to the court under sec. 23 of 50-51 Vic., Chap. 16, made by any head of a department, shall be so made through the Minister of Justice.

O. C. Oct. 15, 1887.

# CHAPTER 57.

## THE NATURALIZATION ACT.

### REGULATIONS AND FORMS.

Government House, Ottawa,

The 29th day of January, 1889.

On the recommendation of the Minister of Justice, and under the provisions of Chapter 113 of the Revised Statutes of Canada, intituled "The Naturalization Act,"

His Excellency in Council has been pleased to make the following regulations:—

Time limited to five years immediately preceding the taking of oath.

**Section 1.** The time within which an alien's three years' residence or service must be had before taking the oaths or affirmations of residence and allegiance, and procuring the same to be filed of record as provided in the tenth section of the said Act is limited to five years, immediately preceding the taking of such oaths or affirmations.

Certificate in North-West Territories to be presented to a judge of the Supreme Court.

**Sec. 2.** In the North-West Territories the certificate mentioned in the twelfth section of the said Act shall be presented to a judge of the Supreme Court of the North-West Territories, who shall take such measures to satisfy himself that the facts stated in the certificate are true, as shall in each case appear to him to be necessary; and when satisfied that the facts stated in the certificate are true, he shall grant to the alien a certificate of naturalization, authenticated under his hand and the seal of the Court.

Record of certificates to be kept.

Each judge of the Supreme Court shall cause to be kept by the Clerk of the Court a record of the certificates presented to and filed with him; also a record of all certificates of naturalization granted by him, of which such judge or clerk is hereby authorized at any time to give a certified copy.

Forms of declarations of alienage.

**Sec. 3.** The forms of declarations of alienage made in pursuance of the said Act shall be respectively as follows:—

### THE NATURALIZATION ACT, CANADA.

#### *Declaration of Alienage by a Naturalized British Subject.*

I, A.B., of \_\_\_\_\_, having been naturalized as a British subject on the \_\_\_\_\_ of \_\_\_\_\_, 18 \_\_\_\_\_, do hereby under the provisions of the Order of the Governor General in Council of the \_\_\_\_\_, and of the treaty between

*The Naturalization Act.*

Chap. 57.

Great Britain and *C. D.*, renounce my naturalization as a British subject, and declare that it is my desire to resume my nationality as a subject [*or citizen*] of *C. D.*

(Signed) *A. B.*

Made and subscribed this day of 18 , before me.

(Signed) *E. F.*

Justice of the Peace,  
[*or other official title*].

THE NATURALIZATION ACT, CANADA,

*Declaration of Alienage by a Person born within British Dominions; but also a subject or citizen of a Foreign State by the law thereof.*

I, *A. B.*, of being held by the common law of Great Britain to be a natural-born subject of Her Britannic Majesty by reason of my having been born within Her Majesty's dominions, and being also held by the law of *C. D.*, to have been at my birth, and to be still, a subject [*or citizen*] of *C. D.*, hereby renounce my nationality as a British subject, and declare that it is my desire to be considered and treated as a subject [*or citizen*] of *C. D.*

(Signed) *A. B.*

Made and subscribed this day of 18 , before me.

(Signed) *E. F.*

Justice of the Peace,  
[*or other official title*].

THE NATURALIZATION ACT, CANADA.

*Declaration of Alienage by a person who is by origin a British Subject.*

I, *A. B.*, of , having been born out of Her Britannic Majesty's dominions of a father being a British subject, do hereby renounce my nationality as a British subject.

(Signed) *A. B.*

Made and subscribed this day of 18 before me.

(Signed) *G. H.*

Justice of the Peace,  
[*or other official title*].

THE NATURALIZATION ACT, CANADA.

*Declaration of British Nationality.*

I, *A. B.*, of , being a natural-born subject of Her Britannic Majesty, and having voluntarily become

## Chap. 57.

*The Naturalization Act.*

naturalized as a subject [or citizen] of C.D., on the  
of 18 , do hereby renounce such naturaliza-  
tion, and declare that it is my desire to be considered and  
treated as a British subject.

(Signed) A.B.

Made and subscribed this day of 18 , before  
me.

(Signed) E.F.

Justice of the Peace,  
[or other official title.]

NOTE.—The Act under which this declaration is made provides that the declarant "shall not within the limits of the Foreign State in which he was naturalized be deemed within Canada to be a British subject, unless he has ceased to be a subject of the State in pursuance of the laws thereof or in pursuance of a treaty to that effect."

Declaration to  
be deposited  
and registered  
with Secretary  
of State.

Sec. 4. Every declaration, whether of alienage or British nationality, made in pursuance of the said Act, shall be deposited and registered in the office of the Secretary of State of Canada.

Oaths to be  
filed with a  
clerk of the  
court.

Sec. 5. The oaths mentioned in sections 41 and 42 of the said Act shall, if the person taking them resides in the North-West Territories, be filed of record with a Clerk of the Supreme Court of the North-West Territories.

Who may  
give certified  
copies of such  
declarations.

Sec. 6. The Secretary of State of Canada, the Under Secretary of State, or the Deputy Registrar-General of Canada may give certified copies of any such declaration for the purposes mentioned in the said Act.

Imposition  
and applica-  
tion of fees.

Sec. 7. With the consent of the Treasury Board, the following provision is made in regard to the imposition and application of fees :—

Table of fees.	Matter in which a fee may be taken.	Amount of fee.	How to be applied.
		\$ cts.	
	For taking a declaration, whether of alienage or British naturalization...	0 40	To the justice or other official taking declaration.
	For administering the oath of allegiance.....	0 40	To the justice, commissioner, notary, stipendiary or other Magistrate administering the oath.
	For registration of declaration, with or without the oath of allegiance...	1 00	Consolidated Revenue of Canada.
	For certified copy of declaration, with or without an oath.....	1 00	Consolidated Revenue of Canada.

O. C. Dec. 19, 1883; Oct. 3, 1884; July 23, 1887.

## CHAPTER 58.

### FINES AND FORFEITURES.

Government House, Ottawa,  
The 29th day of January, 1889.

On the recommendation of the Minister of Justice and under the provisions of Chapter 180 of the Revised Statutes of Canada, intituled "An Act respecting Fines and Forfeitures,"

His Excellency in Council has been pleased to order as follows;—

#### UNDER THE CANADA TEMPERANCE ACT.

Section 1. All fines, penalties or forfeitures recovered or enforced under "The Canada Temperance Act," within any city or county or any incorporated town, separated, for municipal purposes, from the county, which would otherwise belong to the Crown for the public uses of Canada, shall be paid to the treasurer of the city, incorporated town or county, as the case may be, for the purposes of the said Act.

Fines, &c., to be paid to treasurer of city, incorporated town or county.

O. C. Nov. 15, 1886.

#### FINES AND PENALTIES IN THE NORTH-WEST TERRITORIES AND KEEWATIN—TO WHOM PAID.

Sec. 2. All justices of the peace and other persons in the North-West Territories who have collected or may collect any fines or penalties, under the criminal laws of Canada, in respect of which no provision to the contrary exists, are required to pay, every quarter, the amounts so collected to the Lieutenant-Governor of the North-West Territories, and similarly that all justices of the peace and other persons in the District of Keewatin so collecting fines or penalties shall pay the same, every quarter, to the Lieutenant Governor of Manitoba, in his capacity as Lieutenant Governor of Keewatin, and that, where possible, the parties collecting any money, as aforesaid, shall deposit the same to the credit of the Receiver General of Canada in some chartered bank, to be named by the said Lieutenant Governor for the purpose, forwarding the deposit receipts to the Lieutenant Governor in place of the money—and where such a course is impracticable, they shall forward a post office order for the amount in favor of the said Lieutenant Governor. And any moneys so received by the said Lieutenant Governors shall be by them deposited in the Bank of Montreal, Winnipeg; to the credit of the Receiver General of Canada.

Amounts collected as fines, &c., in North-West Territories to be paid to Lieutenant Governor of N. W. T., and when in District of Keewatin to Lieutenant Governor of Manitoba, to be deposited to credit of Receiver General of Canada.

O. C. June 29, 1884.

# CHAPTER 59.

## MARITIME COURT OF ONTARIO.

Government House, Ottawa,

The 14th day of February, 1889.

On the recommendation of the Minister of Justice and under the provisions of Chapter 137 of the Revised Statutes of Canada, intituled "The Maritime Court Act,"

His Excellency in Council has been pleased to order that the following rules and regulations made by the judge of the said court be and the same are hereby approved and adopted:—

### GENERAL RULES.

#### I.—*Interpretation.*

Interpreta-  
tion. †

Section 1. In these rules, together with the annexed schedules, the following words shall have the meanings hereby assigned to them, unless there be something in the subject matter or context repugnant to such construction, viz:—

Singular or  
plural num-  
ber.

(a.) Words importing the singular number shall include the plural, and words importing the plural number shall include the singular.

Masculine  
gender.

(b.) Words importing the masculine gender shall include females, and shall apply to bodies corporate as well as to individuals.

The Act.

(c.) "The Act" shall mean "The Maritime Court Act."

Court.

(d.) "Court" shall mean "The Maritime Court of Ontario."

Judge.

(e.) "Judge" shall mean the judge of the said court for the time being, or other person lawfully authorized to discharge the duties of the judge.

Surrogate.

(f.) "Surrogate" shall mean a surrogate judge appointed by the Governor in Council under the Act, or other person lawfully authorized to discharge the duties of the surrogate judge.

Registrar.

(g.) "Registrar" shall mean the registrar of the said court for the time being, or other person lawfully authorized to discharge the duties of the registrar.

Deputy  
registrar.

(h.) "Deputy registrar" shall mean a deputy registrar appointed by the Governor in Council at the city, town or place where a surrogate judge shall have been appointed;

*Maritime Court of Ontario.*

## Chap. 59.

or other person lawfully authorized to discharge the duties of the deputy registrar.

(j.) "Marshal" shall mean the marshal of the court for Marshal. the time being, or other person lawfully authorized to discharge the duties of the marshal.

(k.) "Deputy marshal" shall mean a deputy marshal <sup>Deputy marshal.</sup> appointed by the Governor in Council, at the city, town or place where a surrogate judge shall have been appointed; or other person lawfully authorized to discharge the duties of the deputy marshal.

(l.) "Examiner" shall mean an examiner appointed <sup>Examiner.</sup> under the Act by the Governor in Council.

(m.) "Action" shall mean any action, cause, suit or other <sup>Action.</sup> proceeding instituted in the court.

(n.) "Counsel" shall mean and include any barrister or <sup>Counsel.</sup> advocate entitled to plead in the court.

(o.) "Solicitor" shall mean and include any attorney, <sup>Solicitor.</sup> solicitor or proctor entitled to practice in the said court, or the party himself if conducting his cause in person.

(p.) "Party" or "person" shall include a corporation or <sup>Party or person.</sup> other public body.

(q.) "Oath," "affidavit" and "swear" shall respectively <sup>Oath.</sup> include affirmation, declaration, affirm and declare, in the case of persons allowed by law to affirm and declare instead of swearing.

(r.) "Ship" shall include every description of vessel used <sup>Ship.</sup> in navigation not propelled by oars only.

(s.) "Month" shall mean a calendar month. <sup>Month.</sup>

(t.) "Registry" shall mean the office of the registrar or <sup>Registry.</sup> of any deputy registrar.

## II.—Short Title.

Sec. 2. In referring to these rules it shall be a sufficient <sup>Short title.</sup> designation to use the expression "The Maritime Court Rules of Ontario."

## III.—Actions.

Sec. 3. Actions shall be of two kinds, actions *in rem* and <sup>Actions of two kinds.</sup> actions *in personam*.

## Chap. 59.

*Maritime Court of Ontario.*

Actions shall be numbered.

Sec. 4. All actions shall be numbered in the order in which they are instituted, and the number given to any action shall be the distinguishing number of the action, and shall be written or printed on all documents in the action as part of the title thereof. Forms of the title of an action will be found in schedule A hereto, Nos. 1 and 2.

IV.—*Writ of Summons.*

Writ to be indorsed with statement, &c.

Sec. 5. Every action shall be commenced by a writ of summons, which, before being issued, shall be indorsed with a statement of the nature of the claim, and of the relief or remedy required, and of the amount claimed, if any; such amount may include as part thereof the reasonable and probable amount of the costs to be incurred for the recovery of the claim. Forms of writ of summons and of the indorsements thereon will be found in schedule A hereto, Nos. 3, 4, 5 and 6.

When indorsement may include claim to have an account taken.

Sec. 6. In an action for seaman's or master's wages, or for master's wages and disbursements or for necessaries, or for bottomry, or in any mortgage action, or in any action in which the plaintiff desires an account, the indorsement on the writ of summons may include a claim to have an account taken.

Address for service to be indorsed.

Sec. 7. The writ of summons shall be indorsed with the name and address of the plaintiff, and of his solicitor, if any, and if he sues in person with an address, to be called *an address for service*, not more than three miles from the registry, at which it shall be sufficient to leave all documents required to be served upon him.

Preparation of writ and issue of writ.

Sec. 8. The writ of summons shall be prepared and indorsed by the plaintiff, and shall be issued under the seal of the court, and a copy of the writ and of all the indorsements thereon, signed by the plaintiff, shall be left in the registry at the time of sealing the writ.

Amendment of writ and indorsements.

Sec. 9. The judge or surrogate may allow the plaintiff to amend the writ of summons and the indorsements thereon in such manner and on such terms as to the judge or surrogate shall seem fit.

V.—*Service of Writ of Summons.*

Service in action *in rem*.

Sec. 10. In an action *in rem*, the writ of summons shall be served:—

Upon ship, or cargo &c. on board ship.

(a.) Upon ship, or upon cargo or other property, if the cargo or other property is on board a ship, by attaching



*Maritime Court of Ontario.*

## Chap. 59.

the writ for a short time to the main-mast or the single mast, or to some other conspicuous part of the ship, and by leaving a copy of the writ attached thereto.

(b.) Upon cargo, or other property, if the cargo or other property is not on board a ship, by attaching the writ for a short time to such cargo or property, and by leaving a copy of the writ attached thereto.

Upon cargo, &c., not on board ship.

(c.) Upon freight in the hands of any person, by showing the writ to him and by leaving with him a copy thereof.

Upon freight.

(d.) Upon proceeds in court, by showing the writ to the registrar and by leaving with him a copy thereof.

Upon proceeds in court.

Sec. 11. If access cannot be obtained to the property on which it is to be served, the writ may be served by showing it to any person appearing to be in charge of such property, and by leaving with him a copy of the writ.

If access can not be obtained.

Sec. 12. In an action *in personam*, the writ of summons shall be served by showing it to the defendant, and by leaving with him a copy of the writ.

Service in action *in personam*.

Sec. 13. A writ of summons against a firm may be served upon any member of the firm, or upon any person appearing at the time of service to have the management of the business of the firm.

Upon member or manager of a firm.

Sec. 14. A writ of summons against a corporation or a public company may be served in the mode, if any, provided by law for service of any other writ or legal process upon such corporation or company.

Against a corporation or public company.

Sec. 15. Where no such provision exists, a writ of summons against a corporation may be served upon the president, manager, or other head officer, or upon the cashier, clerk, treasurer, or secretary of the corporation at the head office or at any branch or agency in Ontario, or on any other person discharging the like duties, and a writ of summons against a public company may be served upon the secretary of the company, or may be left at the office of the company.

Service upon the president, manager, cashier, treasurer or secretary of corporation.

Sec. 16. If the person to be served is under disability, or if for any cause personal service can not, or can not promptly, be affected, or if in any action, whether *in rem* or *in personam*, there is any doubt or difficulty as to the person to be served, or as to the mode of service, the judge or surrogate may order upon whom, or in what manner-

If person to be served is under disability or prompt service can not be affected.

service is to be made, or may order notice to be given in lieu of service.

Writ may be served by plaintiff or his agent within 6 months.

**Sec. 17.** The writ of summons, whether *in rem* or *in personam*, may be served by the plaintiff or his agent within *six months* from the date thereof, and shall, after service, be filed with an affidavit of service indorsed thereon or attached thereto.

Affidavit of service.

**Sec. 18.** The affidavit shall state the date and mode of service, and shall be sworn to by the person who served the writ. A form of affidavit of service will be found in schedule A hereto, No. 7.

Proceedings *in rem* in registry outside Toronto, certificate to be forwarded to registrar, containing certain particulars.

**Sec. 19.** In all proceedings *in rem* in any registry outside Toronto it shall be the duty of the deputy registrar forthwith after the issuing of any writ of summons to forward to the registrar at Toronto a certificate of the fact of the issue of such writ, which certificate shall contain the number of the action, the names of the plaintiffs, the property proceeded against, the name of the owner, the amount of the claim, and whether a warrant has issued.

In case of decree and sale in an action instituted outside Toronto certificate to be forwarded to registrar containing particulars.

**Sec. 20.** In every action instituted in a registry outside Toronto under which a decree has been made and under which a sale of the vessel is effected, the deputy registrar shall forward to the registrar at Toronto a certificate of such fact: And the said certificate shall mention the number of the suit, the names of the plaintiffs and the owners, and the name of the vessel, together with the amount realized on the sale, and the name of the purchaser.

Upon receipt of the certificate registrar shall make entry of contents thereof.

**Sec. 21.** Upon the receipt of the certificate mentioned in the two next preceding sections the registrar shall enter in a book which he shall keep for the purpose the contents of the said certificate, duly indexing the same under the names of the plaintiff, owner, and the vessel. And the registrar shall enter in the same book similar particulars as to all actions commenced in his own office.

#### VI.—Appearance.

Appearance to be filed.

**Sec. 22.** A party appearing to a writ of summons shall file an appearance at the place directed in the writ.

Appearance on terms on expiry of time.

**Sec. 23.** A party not appearing within the time limited by the writ may, by consent of the other parties or by permission of the judge or surrogate appear at any time on such terms as the judge or surrogate shall order.

*Maritime Court of Ontario.*

## Chap. 59.

Sec. 24. If the party appearing has a set-off or counterclaim against the plaintiff, he may indorse on his appearance a statement of the nature thereof, and of the relief or remedy required, and of the amount, if any, of the set-off or counterclaim. But if in the opinion of the judge or surrogate such set-off or counterclaim cannot be conveniently disposed of in the action, the judge or surrogate may order it to be struck out.

Indorsement of set-off or counterclaim on appearance.

Sec. 25. The appearance shall be signed by the party appearing, and shall state his name and address, and those of his solicitor, if any, and if he appears in person also an address, to be called *an address for service* not more than three miles from the registry, at which it shall be sufficient to leave all documents required to be served upon him. Forms of appearance and of indorsement of set-off or counterclaim will be found in schedule A hereto, Nos. 8 and 9.

Address for service to be indorsed on appearance.

VII.—*Parties.*

Sec. 26. Any number of persons having interests of the same nature arising out of the same matter may be joined in the same action whether as plaintiffs or as defendants.

Number of persons may be joined.

Sec. 27. The judge or surrogate may order any person who is interested in the action, though not named in the writ of summons, to come in either as plaintiff or as defendant.

Adding a person interested.

Sec. 28. For the purposes of the last preceding section an underwriter or insurer or mortgagee shall be deemed to be a person interested in the action.

Who deemed a person interested.

Sec. 29. The judge or surrogate may order upon what terms any person shall come in, and what notices and documents, if any, shall be given to and served upon him, and may give such further directions in the matter as to him shall seem fit.

Terms upon which person may be made a party.

VIII.—*Consolidation of Actions.*

Sec. 30. Two or more actions in which the questions at issue are substantially the same, or for matters which might properly be combined in one action, may be consolidated by order of the judge or surrogate upon such terms as to him shall seem fit.

Action may be consolidated upon terms to be fixed by judge or surrogate.

Sec. 31. The judge or surrogate if he thinks fit, may order several actions to be tried at the same time, and on the same evidence, or the evidence in one action to be used

Several actions may be tried at same time.

## Chap. 59.

*Maritime Court of Ontario.*

Same evidence.  
Test action.

as evidence in another, or may order one of several actions to be tried as a test action, and the other actions to be stayed to abide the result.

Two or more actions brought against the same property, how consolidated and how dissevered.

**Sec. 32.** If two or more actions be brought against the same property the writs for which have been issued from the same office, the judge or surrogate as the case may be, may consolidate the same, and may afterwards if necessary dissever the actions; but an application for the consolidation of, or afterwards for the disseverance of two or more actions, wherein all the writs have not been issued from the same office, shall be made to the judge.

Action and cross action may be heard at the same time.

**Sec. 33.** Action and cross action of damage may be directed by the judge or surrogate, as the case may be, to be heard at the same time, and upon the same evidence, but if the actions be not commenced in the same office the order for the trial shall be made by the judge.

IX.—*Warrants.*

Warrant in an action *in rem*, how issued and what facts to state.

**Sec. 34.** In an action *in rem*, a warrant for the arrest of property may be issued by the registrar or deputy registrar at the time of, or at any time after the issue of the writ of summons, on an affidavit being filed, stating the facts as prescribed by the following sections. Forms of affidavit to lead warrant will be found in schedule A hereto, Nos. 10, 11 and 12.

Affidavit, what to state.

**Sec. 35.** The affidavit shall state the nature of the claim, and that the aid of the court is required.

**Sec. 36.** The affidavit shall also state:—

In action for wages, &c.

(a.) In an action for wages, the national character of the ship, and if the ship is foreign, that notice of the action has been served upon a consular officer of the State to which the ship belongs, if there is one resident at Toronto or in the place where the writ is issued;

In action for necessaries, or for building, &c.

(b.) In an action for necessaries, or for building, equipping, or repairing any ship, the national character of the ship, and that, to the best of the deponent's belief, no owner or part owner of the ship was domiciled in the Province of Ontario at the time when the necessaries were supplied or the work was done;

In action between co-owners.

(c.) In an action between co-owners relating to the ownership, possession, employment, or earnings of any ship registered in the Province of Ontario or the Province

*Maritime Court of Ontario.*

## Chap. 59.

of Quebec, the port at which the ship is registered and the number of shares in the ship owned by the party proceeding.

(d). In a mortgage action, the nationality of the mortgagee and verifying a copy of the mortgage annexed to the affidavit. In a mortgage action.

Sec. 37. In an action for bottomry, the bottomry bond in original, and, if it is in a foreign language, a translation thereof, shall be produced for the inspection and perusal of the registrar or deputy registrar, and a copy of the bond, or of the translation thereof, certified to be correct, shall be annexed to the affidavit. In an action for bottomry.

Sec. 38. The registrar, or deputy registrar, if he thinks fit, may issue a warrant, although the affidavit does not contain all the prescribed particulars, and, in an action for bottomry, although the bond has not been produced; or he may refuse to issue a warrant without the order of the judge or surrogate. Issue of warrant though affidavit does not contain all the prescribed particulars.

Sec. 39. The warrant shall be prepared in the registry, and shall be signed by the registrar, or deputy registrar, and issued under the seal of the court. A form of warrant will be found in schedule A hereto, No. 13. Warrant, where prepared and by whom signed.

Sec. 40. The warrant shall be addressed to the marshal and to each deputy marshal of the court and shall be delivered to such of them as the registrar or deputy registrar may, with a view of saving expense, think best, and shall be executed by him or his substitutes. Immediately after execution the warrant shall be returned by the marshal or deputy marshal and filed with the registrar or deputy registrar who issued the same, with a certificate of service indorsed thereon, and notice of the execution thereof shall be given by the marshal or deputy marshal to the solicitor who issued same. Warrant, to whom addressed and delivered. Execution and return, and filing of warrant with certificate of service and notice.

Sec. 41. The warrant shall be served by the marshal, deputy marshal or other officer in the manner prescribed by these rules for the service of a writ of summons in an action *in rem*, and thereupon the property shall be deemed to be arrested. Warrant to be served by marshal or deputy marshal.

Sec. 42. The warrant may be served on Sunday, Good Friday, Christmas Day or any public holiday as well as on any other day. Service on Sunday or holiday.

Certificate of service, what to state.

Sec. 43. The certificate shall state by whom the warrant has been served, and the date and mode of service, and shall be signed by the marshal or deputy marshal. A form of certificate of service will be found in schedule A hereto, No. 14.

Service when property to be arrested is distant from marshal or deputy marshal may be made by some literate person.

Sec. 44. Whenever the property to be arrested is at a distance from the marshal or any deputy marshal, the registrar or deputy registrar may, with the view of saving expense, address the warrant to some literate person in the neighborhood of the property, in which case such person shall, with respect to the warrant, perform the same duties and be entitled to the same fees as the marshal or deputy marshal would have performed and been entitled to had the warrant been executed by him.

Necessary instructions in such case.

Sec. 45. The registrar or deputy registrar shall wherever a warrant is addressed to a person other than the marshal or deputy marshal give to such person all necessary instructions as to the execution thereof.

*X.—Two or more Causes against the Same Property.*

Second or subsequent action against property under arrest.

Sec. 46. When the property is under arrest of the court, if there be a second or subsequent action against the same property, it shall not be necessary to take out a warrant for the further arrest thereof, but if in such second or subsequent action such requirements as would have entitled the plaintiff to a warrant had the property not been under arrest be complied with, the property shall be held as under arrest in such second or subsequent action also, and the registrar, or deputy registrar as the case may be, shall issue his certificate to that effect, and an office copy of such certificate shall be annexed to and served with the copy of the writ to be served.

Action against property under arrest commenced in another office; provisions and requirements in such case.

Sec. 47. If when any property is under arrest of the court, there be another action against the same property which has been commenced in another office, it shall not be necessary to take out a warrant for the further arrest thereof; but if in such other action such requirements as would have entitled the plaintiff to a warrant had the property not been under arrest be complied with, the registrar, or deputy registrar, as the case may be, shall issue his certificate to that effect, which certificate shall be filed with the registrar or deputy registrar who issued the warrant under which the property has been arrested, and thereupon the property shall be held as under arrest in such other action and shall only be released upon the certificate of the

registrar or deputy registrar with whom the other action has been instituted to the effect that the party seeking the release is entitled thereto. An office copy of the first mentioned certificate shall be annexed to and served with the copy of the writ to be served in such other cause.

If bail is to be given in such other action the proceedings relating thereto are to be taken in the office of the registrar or deputy registrar with whom the action is instituted. If bail is to be given in other action.

XI.—*Bail.*

Sec. 48. Whenever bail is required by these rules, it shall be given by filing one or more bail bonds, each of which shall be signed by two sureties, unless the judge or surrogate shall, on special cause shown, order that one surety shall suffice. If bail is to be given the bond may be in the form number 15 of schedule A hereto. Bail, how to be given.

Sec. 49. Such bond may be executed in the presence of one witness who must make an affidavit verifying the execution, the sureties must justify by affidavit, and the bail bond may be signed and the affidavits taken before any Commissioner of the Supreme Court of Judicature for the Province of Ontario. Form of affidavit of justification will be found in schedule A hereto No. 16. Execution of bail bond and affidavits of execution and justification.

Sec. 50. Upon the bond being so executed it may, with the affidavits of execution and justification, be filed with the registrar or deputy registrar, as the case may be, and an appointment may be obtained for its consideration before him. Bond and affidavits to be filed.

Twenty-four hours' notice of such appointment, together with the names and addresses of the sureties and the amount of the bond, shall be given to the plaintiff unless the judge or surrogate for special reasons allow a shorter notice to be given, and on the return of the appointment the registrar or deputy registrar may hear the parties and any evidence they may adduce regarding the sufficiency of the sureties and may allow or disallow the bond. He may adjourn the appointment from time to time if he thinks necessary, and shall himself make such inquiries respecting the sureties as he thinks fit. Notice of appointment for hearing parties relative to the sufficiency of the sureties, how to be given and what to contain.

XII.—*Releases.*

Sec. 51. A release for property arrested by warrant may be issued by order of the judge or surrogate. Release for property arrested.

Sec. 52. A release may also be issued by the registrar or deputy registrar, unless there is a *caveat* outstanding against the release of the property:— When it may be issued from registry.

## Chap. 59.

*Maritime Court of Ontario.*

- Payment into court. (a.) On payment into court of the amount claimed, or of the appraised value of the property arrested, or where cargo is arrested for freight only, of the amount of the freight verified by affidavit ;
- Bail bond being filed. (b.) On one or more bail bonds being filed for the amount claimed, or for the appraised value of the property arrested ; and on proof that *twenty-four hours'* notice of the names and addresses of the sureties has been previously served on the party at whose instance the property has been arrested ;
- Application of party. (c.) On the application of the party at whose instance the property has been arrested ;
- Consent in writing. (d.) On a consent in writing being filed signed by the party at whose instance the property has been arrested ;
- Discontinuance, &c. (e.) On discontinuance or dismissal of the action in which the property has been arrested.
- Property arrested for salvage. Sec. 53. Where property has been arrested for salvage, the release shall not be issued under the next foregoing section, except on discontinuance or dismissal of the action, until the value of the property arrested has been agreed upon between the parties or determined by the judge or surrogate.
- Registrar &c., may refuse. Sec. 54. The registrar or deputy registrar may refuse to issue a release without the order of the judge or surrogate.
- Preparation, signing and issue of release. Sec. 55. The release shall be prepared in the registry, and shall be signed by the registrar or deputy registrar, and issued under the seal of the court. A form of release will be found in schedule A hereto, No. 17.
- Release, how served. Sec. 56. The release shall be served on the marshal or deputy marshal, either personally or by leaving it at his office, by the party by whom it is taken out.
- Property free from arrest on service of release, &c. Sec. 57. On service of the release and on payment to the marshal or deputy marshal of all fees due to and charges incurred by him in respect of the arrest and custody of the property, the property shall be at once released from arrest.

XIII.—*Preliminary Acts.*

- Contents of preliminary act. Sec. 58. In an action for damage by collision, each party shall, within *one week* from an appearance being entered, file a *preliminary act*, sealed up, signed by the party and containing a statement of the following particulars :—



*Maritime Court of Ontario.*

Chap. 59.

- |  |                            |
|--|----------------------------|
| (a.) The names of the ships which came into collision, and the names of their masters ;                              | Names.                     |
| (b.) The time of the collision ;   | Time.                      |
| (c.) The place of the collision ;  | Place.                     |
| (d.) The direction and force of the wind ;   | Wind.                      |
| (e.) The state of the weather ;  | Weather.                   |
| (f.) The state and force of the tide (if the collision occurred in tidal waters) ;                                   | Tide.                      |
| (g.) The course and speed of the ship when the other was first seen ;  | Course and speed.          |
| (h.) The lights, if any, carried by her ;  | Lights.                    |
| (i.) The distance and bearing of the other ship when first seen ;  | Distance and bearing.      |
| (j.) The lights, if any, of the other ship which were first seen ;   | Lights first seen.         |
| (k.) The lights, if any, of the other ship, other than those first seen, which came into view before the collision ; | Other lights.              |
| (l.) The measures which were taken, and when, to avoid the collision ;   | Measures taken.            |
| (m.) The parts of each ship which first came into collision ;  | Parts first collided with. |
| (n.) What fault or default, if any, is attributed to the other ship.   | Fault or default.          |

XIV.—*Pleadings.*

Sec. 59. Every action shall be heard without pleadings, unless the judge or surrogate shall otherwise order. No pleadings, when.

Sec. 60. If an order is made for pleadings, the plaintiff shall, within *one week* from the date of the order, file his statement of claim ; and, within *one week* from the filing of the statement of claim, the defendant shall file his statement of defence ; and, within *one week* from the filing of the statement of defence, the plaintiff shall file his reply, if any ; and there shall be no pleading beyond the reply, except by permission of the judge or surrogate. Statement of claim, defence and reply to be filed within one week in each case.

Sec. 61. The defendant may, in his statement of defence, plead any set-off or counterclaim. But if, in the opinion What may be pleaded.

## Chap. 59.

*Maritime Court of Ontario.*

Set-off or counterclaim.

of the judge or surrogate, such set-off or counterclaim can not be conveniently disposed of in the action, the judge or surrogate may order it to be struck out.

Paragraphs to be numbered; and all pleadings filed in same office.

Sec. 62. Every pleading shall be divided into short paragraphs, numbered consecutively, which shall state concisely the facts on which the party relies; and all the pleadings in a cause must be filed at the same office.

Words of document, how set out.

Sec. 63. It shall not be necessary to set out in any pleading the words of any document referred to therein, except so far as the precise words of the document are material.

Rules of Supreme Court for Ontario and of British Vice-Admiralty Courts, how far applicable.

Sec. 64. The form of pleadings and the legal effect of the same and the practice in relation thereto shall, subject to the provisions of these rules, be the same as that directed by the rules of practice in force from time to time in the Supreme Court of Judicature for Ontario; or the forms of pleadings appended to the rules of the Vice-Admiralty Courts established by the Queen's Order in Council of the 23rd August, 1883, may be used.

Question of law or fact may be decided forthwith.

Sec. 65. Either party may apply to the judge or surrogate to decide forthwith any question of fact or of law raised by any pleading, and the judge or surrogate shall thereupon make such order as to him shall seem fit.

Amendment of pleading.

Sec. 66. Any pleading may at any time be amended, either by consent of the parties, or by order of the judge or surrogate.

Service of writs, pleadings, notices, &c., not requiring personal service, how made.

Sec. 67. All writs, pleadings, notices, orders, warrants and other documents and written communications which do not require personal service upon the party to be affected thereby, may be served upon his solicitor or upon the agent of such solicitor named in the "solicitor's and agent's book" provided for by section 265 of these rules, and kept in the office of the registrar or deputy registrar from which the writ issued. And if any such solicitor neglects to cause the name of his agent to be specified in such book, the posting up a copy of any such writ, pleading, notice, order, warrant or other document or written communication for the solicitor so neglecting as aforesaid, in the office of the registrar or deputy registrar, as the case may be, is to be deemed sufficient service.

Posting up copy in office of registry, when sufficient service.

### XV.—*Interrogatories.*

Leave to administer interrogatories.

Sec. 68. At any time before the action is set down for hearing any party desirous of obtaining the answers of the

*Maritime Court of Ontario.*

## Chap. 59.

adverse party on any matters material to the issue, may apply to the judge or surrogate for leave to administer interrogatories to the adverse party to be answered on oath, and the judge or surrogate may direct within what time and in what way they shall be answered, whether by affidavit or by oral examination.

When and how to be obtained.

Sec. 69. The judge or surrogate may order any interrogatory that he considers objectionable to be amended or struck out; and if the party interrogated omits to answer or answers insufficiently, the judge or surrogate may order him to answer, or to answer further, and either by affidavit or by oral examination. Forms of interrogatories and of answers will be found in schedule A hereto, Nos. 18 and 19.

Objectionable interrogatory may be amended or struck out.

*XVI.—Discovery and Inspection.*

Sec. 70. The judge or surrogate may order any party to an action to make discovery, on oath, of all documents which are in his possession or power relating to any matter in question therein.

Discovery on oath, how obtained.

Sec. 71. The affidavit of discovery shall specify which, if any, of the documents therein mentioned the party objects to produce.

Affidavit of discovery.

Sec. 72. Any party to an action may file a notice to any other party to produce, for inspection or transcription, any document in his possession or power relating to any matter in question in the action.

Notice for inspection or transcription.

Sec. 73. If the party served with notice to produce omits or refuses to do so within the time specified in the notice, the adverse party may apply to the judge or surrogate for an order to produce.

Order to produce, how obtained.

*XVII.—Examination of Parties.*

Sec. 74. Any party to an action may be examined by the party adverse in interest, and the practice thereon shall be the same as that directed by the rules and practice of the Supreme Court of Judicature of Ontario in that behalf.

Rules, &c. of Supreme Court of Ontario to apply.

*XVIII.—Admission of Documents and Facts.*

Sec. 75. Any party may file a notice to any other party to admit any document or fact (saving all just exceptions), and a party not admitting it after such notice shall be liable for the costs of proving the document or fact, what

Notice to admit document or fact may be filed.

## Chap. 59.

*Maritime Court of Ontario.*

ever the result of the action may be, unless the taxing officer is of opinion that there was sufficient reason for not admitting it.

No costs unless notice be given.

Sec. 76. No costs of proving any document shall be allowed, unless notice to admit shall have been previously given, or the taxing officer shall be of opinion that the omission to give such notice was reasonable and proper.

XIX.—*Special Case.*

Special case by agreement.

Sec. 77. Parties may agree to state the questions at issue for the opinion of the judge or surrogate in the form of a special case.

Question of law may be raised by order of judge or surrogate.

Sec. 78. If it appears to the judge or surrogate that there is in any action a question of law which it would be convenient to have decided in the first instance, he may direct that it shall be raised in a special case or in such other manner as he may deem expedient.

Special case, how divided and stated.

Sec. 79. Every special case shall be divided into paragraphs, numbered consecutively, and shall state concisely such facts and documents as may be necessary to enable the judge or surrogate to decide the question at issue.

Signed by parties.

Sec. 80. Every special case shall be signed by the parties, and may be filed by any party.

XX.—*Motions.*

Notice of motion.

Sec. 81. A party desiring to obtain an order from the judge or surrogate shall file a notice of motion with the affidavits, if any, on which he intends to rely.

What notice of motion shall state.

Sec. 82. The notice of motion shall state the nature of the order desired, the day on which the motion is to be made, and whether in court or in chambers.

When notice shall be filed.

Sec. 83. Except by consent of the adverse party, or by order of the judge or surrogate, the notice of motion shall be filed *twenty-four hours* at least before the time at which the motion is made.

When affidavits for notice must be filed.

Sec. 84. All the affidavits upon which a notice of motion is founded must be filed before the service of the notice of motion; and affidavits in answer must be filed not later than the day before that appointed for the hearing of the motion.

Sec. 85. No motion shall be made to the judge or surrogate in court save by counsel or by a party conducting his own cause in person. Solicitors may be heard on any motion before the judge or surrogate in chambers.

Motion in court.

Solicitors in chambers.

Sec. 86. Any notice of motion may be transferred from the chamber to the court list or *vice versa* as the judge or a surrogate may direct.

Notice of motion may be transferred.

Sec. 87. When the motion comes on for hearing, the judge or surrogate, after hearing the parties, or, in the absence of any of them, on proof that the notice of motion has been duly served, may make such order as to him shall seem fit.

Order may be made on proof of service of notice.

Sec. 88. The judge or surrogate may, on due cause shown, vary, or rescind any order previously made.

Power to vary or rescind.

Sec. 89. No proceeding shall be defeated by any formal objection.

Formal objection.

Sec. 90. All orders made by the judge or surrogate in chambers shall have the force and effect of orders of the court.

Effect of orders in chambers.

Sec. 91. When the writ has been issued by the registrar all applications in the cause to the court or in chambers shall be heard by the judge unless he direct the same to be heard before a surrogate.

Hearing of applications when writ issued by registrar.

When the writ has been issued by a deputy registrar all applications in the cause to the court or in chambers shall be heard by the surrogate residing nearest the place where such deputy registrar's office is, unless he direct the same to be heard before the judge or another surrogate.

Hearing of applications when writ issued by a deputy registrar.

XXI.—*Tenders.*

Sec. 92. A party desiring to make a tender in satisfaction of the whole or any part of the adverse party's claim, shall pay into court the amount tendered by him, and shall file a notice of the terms on which the tender is made. A party may make a tender notwithstanding he has pleaded other grounds of defence.

Payment into court and filing of notice in case of tender.

Sec. 93. Within a week from the filing of the notice of tender the adverse party shall file a notice, stating whether he accepts or rejects the tender, and if he shall not do so, he shall be held to have rejected it. Forms of notice of tender and of notice accepting or rejecting it will be found in schedule A hereto, Nos. 20 and 21.

Filing of notice by adverse party, accepting or rejecting.

## Chap. 59.

*Maritime Court of Ontario.*

Suspense of proceedings.      Sec. 94. Pending the acceptance or rejection of a tender, the proceedings shall be suspended.

XXII.—*Evidence.*

Statutes of Ontario to apply.      Sec. 95. The statutes respecting witnesses and evidence in force in the Province of Ontario, shall apply to trials and proceedings in the Maritime Court.

Modes of giving evidence.      Sec. 96. Evidence shall be given either by affidavit or by oral examination, or partly in one mode, and partly in another.

Evidence on motion and on hearing, subject to order of judge or a surrogate.      Sec. 97. Evidence on a motion shall in general be given by affidavit, and at the hearing by the oral examination of witnesses; but the mode or modes in which evidence shall be given, either on any motion or at the hearing, may be determined either by consent of the parties, or by order of the judge or surrogate.

Order to attend for cross-examination.      Sec. 98. The judge or surrogate may order any person who has made an affidavit in an action to attend for cross-examination thereon before the judge or surrogate, or the registrar or deputy registrar, or before an examiner named in the order.

The order and manner in which witnesses may be examined, &c.      Sec. 99. Witnesses examined orally before the judge, surrogate, registrar or deputy registrar or examiner, shall be examined, cross-examined, and re-examined in such order as the judge, surrogate, registrar or deputy registrar or examiner, may direct; and questions may be put to any witness by the judge, surrogate, registrar or deputy registrar or examiner, as the case may be.

Examination by interpretation.      Sec. 100. If any witness is examined by interpretation, such interpretation shall be made by a sworn interpreter of the court, or by a person previously sworn according to the form in schedule A hereto, No. 22.

Copies of examinations, how obtained.      Sec. 101. The parties to the action shall on payment of the regular fees be entitled to have from the examiner certified copies of such depositions or any part thereof immediately after they have been taken.

Examination *viva voce* may be ordered.      Sec. 102. Either solicitor in the action may apply to the judge or surrogate to order the attendance of any witness for examination *viva voce* at the hearing, although the witness may have already made an affidavit or been examined before the judge or surrogate, or an examiner or officer of the court.

XXIII.—*Oaths.*

Sec. 103. The judge or surrogate may appoint any person to administer oaths in any particular proceeding in the Maritime Court. A form of appointment to administer oaths will be found in schedule A hereto, No. 23.

Judge or surrogate may appoint.

XXIV.—*Affidavits.*

Sec. 104. Every affidavit shall be divided into short paragraphs numbered consecutively, and shall be in the first person; and the name, address and description of every person making an affidavit shall be inserted therein.

To be divided into paragraphs numbered.

Sec. 105. The names of all the persons making an affidavit, and the dates when, and the places where it is sworn, shall be inserted in the jurat.

Names, dates and places in jurat.

Sec. 106. When an affidavit is made by any person who is blind, or who from his signature or otherwise appears to be illiterate, the person before whom the affidavit is sworn shall certify that the affidavit was read over to the deponent, and that the deponent appeared to understand the same, and made his mark or wrote his signature thereto in the presence of the person before whom the affidavit was sworn.

Affidavit by person blind or illiterate to be read over and certified.

Sec. 107. When an affidavit is made by a person who does not speak the English language, the affidavit shall be taken down and read over to the deponent by interpretation either of a sworn interpreter of the court, or of a person previously sworn faithfully to interpret the affidavit. A form of jurat will be found in schedule A hereto, No. 24.

Affidavit by interpretation, how made.

Sec. 108. Affidavits may, by permission of the judge or surrogate be used as evidence in an action, saving all just exceptions:—

Affidavits, before whom to be sworn.

(a.) If sworn to, in the United Kingdom of Great Britain and Ireland, or in any British possession, before any person authorized to administer oaths in the said United Kingdom or in such possession respectively;

In British territory.

(b.) If sworn to, in any place not being a part of Her Majesty's dominions, before a British minister, consul, vice-consul, or notary public, or before a judge or magistrate, the signature of such judge or magistrate being authenticated by the official seal of the court to which he is attached.

In foreign territory.

When affidavit may be objected to.

Sec. 109. The reception of any affidavit as evidence may be objected to, if the affidavit has been sworn before the solicitor for the party on whose behalf it is offered, or before a partner or clerk of such solicitor.

XXV.—*Certificate of State of Action.*

Certificate of proceedings in office of registry.

Sec. 110. Upon the application of any person the registrar or deputy registrar is to certify, as shortly as he conveniently can, the several proceedings had in his office in any action or matter, and the dates thereof.

XXVI.—*Examination of Witnesses before Trial.*

Judge or surrogate may order examination of witnesses before trial under certain circumstances.

Sec. 111. The judge or surrogate may order that any witness, who cannot conveniently attend at the trial of the action or, if in the opinion of the judge or surrogate it may be impossible or very difficult to procure his attendance at the trial, shall be examined previously thereto, before either the judge or surrogate, or the registrar or deputy registrar, who shall have power to adjourn the examination from time to time, and from place to place, if he shall think necessary. A form of order for examination of witnesses will be found in schedule A hereto, No. 25.

Examination before special examiner or a commissioner.

Sec. 112. If the witness cannot be conveniently examined before the judge, surrogate or the registrar or deputy registrar, the judge or surrogate may order that he shall be examined before a special examiner, and if the witness is beyond the limits of the Province of Ontario, the judge or surrogate may order that he shall be examined before a commissioner specially appointed for the purpose.

Power to swear witnesses.

Sec. 113. The examiner or commissioner shall have power to swear any witnesses produced before him for examination, and to adjourn, if necessary, the examination from time to time, and from place to place. A form of commission to examine witnesses will be found in schedule A hereto, No. 26.

Counsel fee on examination.

Sec. 114. The parties, their counsel and solicitors, may attend the examination, but, if counsel attend, the fees of only one counsel on each side shall be allowed on taxation, except by order of the judge or surrogate.

Evidence to be taken in writing and certified.

Sec. 115. The evidence of every witness shall be taken down in writing, and shall be certified as correct by the judge, surrogate, registrar or deputy registrar, or by the examiner or commissioner, as the case may be.

Evidence to be lodged in registry.

Sec. 116. The certified evidence shall be lodged in the registry, or, if taken by commission, shall forthwith be



*Maritime Court of Ontario.*

## Chap. 59.

transmitted by the commissioner to the registry, together with his commission. A form of return to commission to examine witnesses will be found in schedule A hereto, No. 27. Transmitted to registry.

Sec. 117. As soon as the certified evidence has been received in the registry, it may be taken up and filed by either party, and may be used as evidence in the action, saving all just exceptions. Evidence may be filed by either party.

XXVII.—*Short-Hand.*

Sec. 118. In case of an examination before the trial or otherwise than at the trial of an action, if the examining party desires to have such examination taken in short-hand, he shall be entitled to have it so taken at the place of examination except when the judge or surrogate sees fit to order otherwise. Examination taken in short-hand.

Sec. 119. When an examination in an action or proceeding in court or otherwise is taken by an examiner or other duly authorized person in short-hand the examination may be taken down by question and answer; and in such case it shall not be necessary for the depositions to be read over to or be signed by the person examined unless the judge or surrogate so directs where the examination is taken before the judge or surrogate, or in other cases unless any of the parties so desires. Examination by question and answer, how to be taken.

Sec. 120. A copy of the depositions so taken, certified by the person taking the same as correct shall for all purposes have the same effect as the original depositions in ordinary cases. Copy of depositions so taken.

Sec. 121. Except in cases where the examiner himself takes the examination in short-hand, the short-hand writer employed shall be previously sworn faithfully to report the evidence. A form of oath to be administered to the short-hand writer will be found in schedule A hereto, No. 28. Short-hand writer to be sworn.

Sec. 122. The judge may from time to time appoint under the seal of the court an official reporter of the court, and it shall be his duty to attend all sittings of the court at Toronto, (or elsewhere if required by the judge), and report in short-hand the evidence and proceedings at trials at such sittings. Appointment of official reporter.

Sec. 123. The official reporter shall be entitled for his attendance at court and for copies of evidence when ordered Fees to official reporter.

by either party or by the judge or surrogate the fees set out in the table of fees in schedule B hereto.

Oath of office of official reporter.

Sec. **124.** Every official reporter shall before entering on the duties of his office, take the following oath before the judge, and the same shall be filed in the registrar's office:—

I, A. B., do solemnly and sincerely promise and swear that I will faithfully report the depositions and evidence and proceedings in any case in which it may be my duty to act as official reporter. So help me God.

Short-hand evidence at trial may be ordered.

Sec. **125.** The judge or surrogate may direct the evidence at any trial of an action to be taken in short-hand, and may make such order as to the costs of taking the same as to him shall seem just.

#### XXVIII.—*Printing.*

Printing of pleadings and written proofs.

Sec. **126.** The judge or surrogate may order that the whole of the pleadings and written proofs, or any part thereof, shall be printed before the trial; and the printing shall be in such form as the judge or surrogate shall order.

Preliminary acts.

Sec. **127.** Preliminary acts, if printed, shall be printed in parallel columns.

#### XXIX.—*Assessors.*

Appointment of assessors.

Sec. **128.** The judge or surrogate, on the application of any party, or without any such application, if he considers that the nature of the case requires it, may appoint one or more assessors to advise the court upon any matters requiring nautical or other professional knowledge.

Assessor duly summoned three clear days shall give his attendance and assistance.

Summons shall be sent in registered letter.

Assessor failing to attend subject to removal.

In case of absence or illness of assessor.

Sec. **129.** Each assessor named in the list of assessors prepared under the Act on being duly summoned three clear days before the day on which his attendance is required, shall give his attendance and assistance accordingly; such summons shall be sent by the registrar or deputy registrar in a registered letter directed to the assessor at his address as specified in the list, or such other address as shall on the application of the assessor be substituted therefor in a copy of the list to be kept in the registrar's or deputy registrar's office. If any assessor being duly summoned shall, without reasonable excuse, fail to attend or to give his assistance, the Minister of Justice, on the application of the judge, may remove his name from the list. The judge or surrogate shall have power, in case of the absence or illness of any assessor summoned, or for other

*Maritime Court of Ontario.*

## Chap. 59.

cause which shall appear to him sufficient, to pass over such assessor and cause another to be summoned in his stead.

Sec. 130. Each assessor shall be paid in each case the sum of six dollars for each day on which he shall attend in pursuance of any such summons for that purpose as aforesaid, and the fees of each assessor shall be costs in the cause; but shall in the first instance be paid by such of the parties to the action as the judge or surrogate may direct.

Assessors to be paid \$6 per day, and the fees to be costs in the cause.

Sec. 131. The assessors shall be selected from such list in rotation unless the judge or surrogate for any special reason shall otherwise direct.

Assessors to be selected in rotation.

XXX.—*Setting down for Trial.*

Sec. 132. An action shall be set down for trial by filing a notice of trial. A form of notice of trial will be found in schedule A hereto, No. 29.

Filing notice of trial.

Sec. 133. If there has not been any appearance, the plaintiff may set down the action for trial, on obtaining from the judge or surrogate leave to proceed *ex parte* ;—

If there has been no appearance.

(a.) In an action *in personam*, or an action against proceeds in court, after the expiration of *two weeks* from the service of the writ of summons;

In an action *in personam*.

(b.) In an action *in rem* (not being an action against proceeds in court), after the expiration of *two weeks* from the filing of the warrant.

In an action *in rem*.

Sec. 134. If there has been an appearance, either party may set down the action for trial ;—

If an appearance.

(a.) After the expiration of *one week* from the entry of the appearance, unless an order has been made for pleadings, or an application for such an order is pending ;

After expiration of one week.

(b.) If pleadings have been ordered, when the last pleading has been filed, or when the time allowed to the adverse party for filing any pleading has expired without such pleading having been filed.

If pleadings have been ordered.

In collision cases the preliminary acts may be opened as soon as the action has been set down for trial.

In collision cases.

Sec. 135. Where the writ of summons has been indorsed with a claim to have an account taken, or the liability has been admitted or determined, and the question is simply

Where claim to have account taken.

## Chap. 59.

*Maritime Court of Ontario.*

When liability admitted, &c.

Fixing a time for filing accounts, &c.

as to the amount due, the judge or surrogate may, on the application of either party, fix a time within which the accounts and vouchers, and the proofs in support thereof, shall be filed, and at the expiration of that time either party may have the matter sent down for trial.

XXXI.—*Trial.*

Time and place of trial.

Sec. 136. After the action has been set down for trial, any party may apply to the judge or surrogate, on notice to any other party appearing, for an order fixing the time and place of trial.

Judge or surrogate may order.

Sec. 137. The judge or surrogate may order such trial to take place before himself or before the judge or any surrogate.

Where trial is to be had in place other than that in which pleadings are filed.

Sec. 138. Where the trial is to be had in any town or place other than that in which the pleadings are filed, it shall be the duty of the party who obtains the order fixing the place of trial to deliver to the registrar or deputy registrar with whom the pleadings are filed, a sufficient time before the day fixed for hearing, a *præcipe* requiring him to transmit to the registrar or deputy registrar nearest the place where the trial is to be had, the pleadings and such other papers as may be specified in the *præcipe*, and at the same time to deposit with him a sufficient sum to cover the expense of transmitting and retransmitting such pleadings and papers, and thereupon it shall be the duty of the registrar or deputy registrar forthwith to transmit the pleadings and such other papers as may be specified accordingly.

Who shall begin.

Sec. 139. At the trial of a contested action the plaintiff shall in general begin; but if the burden of proof lies on the defendant, the judge or surrogate may direct the defendant to begin.

If several plaintiffs or defendants.

Sec. 140. If there are several plaintiffs or several defendants, the judge or surrogate may direct which plaintiff or which defendant shall begin.

Order of proceeding in the trial of an action.

Sec. 141. The party beginning shall first address the court, and then produce his witnesses, if any. The other party or parties shall then address the court, and produce their witnesses, if any, in such order as the judge or surrogate may direct, and shall have a right to sum up their evidence. In all cases the party beginning shall have the right to reply, but shall not produce further evidence, except by permission of the judge or surrogate.

*Maritime Court of Ontario.*

## Chap. 59.

Sec. 142. Only one counsel shall in general be heard on each side; but the judge or surrogate if he considers that the nature of the case requires it, may allow two counsel to be heard on each side. Counsel.

Sec. 143. If the action is uncontested, the judge or surrogate may, if he thinks fit, give judgment on the evidence adduced by the plaintiff. Uncontested action.

## XXXII.—References.

Sec. 144. The judge or surrogate may, if he thinks fit, refer the assessment of damages and the taking of any account to the registrar or deputy registrar either alone, or assisted by one or more merchants as assessors. Assessment of damages, when and to whom referred.

Sec. 145. The rules as to evidence, and as to the trial, shall apply, *mutatis mutandis*, to a reference to the registrar or deputy registrar, and the registrar or deputy registrar may adjourn the proceedings from time to time, and from place to place, if he shall think necessary. Rules of evidence in case of reference.

Sec. 146. The practice to be observed on references shall be the same as that prescribed by the rules of practice of the Supreme Court of Judicature for Ontario, for the regulation of references before the Master in Ordinary of the Supreme Court. Rules of practice of Supreme Court of Ontario to be observed.

Sec. 147. Counsel may attend the hearing of any reference, but the costs so incurred shall not be allowed on taxation unless the registrar or deputy registrar shall certify that the attendance of counsel was necessary. Counsel fees on reference.

Sec. 148. When a reference has been heard, the registrar or deputy registrar shall draw up a report in writing of the result, showing the amount, if any, found due, and to whom, together with any further particulars that may be necessary. A form of the report will be found in schedule A hereto, No. 80. Report in cases of reference.

Sec. 149. Where the registrar or deputy registrar is directed to appoint money to be paid at some time and place, he is to appoint the same to be paid into some incorporated bank at its head office, or at some branch or agency office of such bank in Ontario to the joint credit of the party to whom the same is made payable, and of the registrar or deputy registrar of the court; the party to whom the same is made payable to name the bank into which he desires the same to be paid, and the registrar or deputy registrar to name the place for such payment. Where registrar or deputy registrar is directed to appoint money to be paid.

## Chap. 59.

*Maritime Court of Ontario.*

Where money is paid into bank in pursuance of appointment.      **Sec. 150.** Where money is paid into a bank in pursuance of such appointment the party paying may pay the same either to the credit of the party to whom the same is made payable, or to the joint credit of the party and the registrar or deputy registrar, and if the same be paid to the sole credit of the party, such party shall be entitled to receive the same without an order.

Where default is made in payment.      **Sec. 151.** Where default is made in the payment of money appointed to be paid into a bank, the certificate of the cashier, manager or agent of the bank where the same is made payable, or of the like bank officer shall be sufficient evidence of default.

Notice of report being ready.      **Sec. 152.** When the report is ready, notice shall be sent to the parties, and either party may thereupon take up and file the report.

Notice of motion to vary report.      **Sec. 153.** Within *two weeks* from the filing of the registrar's or deputy registrar's report, either party may file a notice of motion to vary the report, specifying the items objected to.

Hearing of motion to vary.      **Sec. 154.** At the hearing of the motion the judge or surrogate may make such order thereon as to him shall seem fit, or may remit the matter to the registrar or deputy registrar for further inquiry or report.

When report shall stand confirmed.      **Sec. 155.** If no notice of motion to vary the report is filed within *two weeks* from filing the registrar's or deputy registrar's report, the report shall stand confirmed.

Proceedings on reference to be entered in cause book.      **Sec. 156.** The registrar or deputy registrar is to enter in the cause book from time to time the proceedings, taken before him, and the directions he gives in relation to the prosecution of the reference or otherwise.

XXXIII.—*Costs.*

To abide the event.      **Sec. 157.** In general costs shall abide the event; but the judge or surrogate may in any case make such order as to the costs as to him shall seem fit.

Lump sum.      **Sec. 158.** The judge or surrogate may direct payment of a lump sum in lieu of taxed costs.

Security for costs.      **Sec. 159.** If any plaintiff (other than a seaman suing for his wages or for the loss of his clothes and effects in a collision), or any defendant making a counterclaim is not resident in the Province of Ontario, the judge or surrogate

*Maritime Court of Ontario.*

## Chap. 59.

may, on the application of the adverse party, order him to give bail for costs.

Sec. 160. A party claiming an excessive amount, either by way of claim, or of set-off or counterclaim, may be condemned in all costs and damages thereby occasioned.

Party claiming an excessive amount.

Sec. 161. If a tender is rejected, but is afterwards accepted, or is held by the judge or surrogate to be sufficient, the party rejecting the tender shall, unless the judge or surrogate shall otherwise order, be condemned in the costs incurred after tender made.

Tender rejected but afterwards accepted.

Sec. 162. A party, who has not admitted any fact which in the opinion of the judge or surrogate he ought to have admitted, may be condemned in all costs occasioned by the non-admission.

Party not admitting fact.

Sec. 163. Any party pleading at unnecessary length or taking any unnecessary proceeding in an action may be condemned in all costs thereby occasioned.

Pleading at unnecessary length.

XXXIV.—*Taxation of Costs.*

Sec. 164. A party desiring to have a bill of costs taxed shall file the bill, and shall procure an appointment from the registrar or deputy registrar and shall serve the opposite party or parties with notice of the time at which the taxation will take place.

Bill of costs must be filed appointment and notice.

Sec. 165. The practice upon the taxation of costs shall be regulated, subject to the provisions of these rules, by the rules and practice in force in the Supreme Court of Judicature for Ontario.

Practice in Supreme Court of Ontario.

Sec. 166. At the time appointed, if either party is present the taxation shall be proceeded with.

Either party present.

Sec. 167. Within *one week* from the completion of the taxation application may be made to the judge or surrogate to review the taxation.

Review within one week.

Sec. 168. Costs may be taxed either by the judge, or a surrogate or by the registrar or a deputy registrar, and as well between solicitor and client, as between party and party, and upon any application to a surrogate to review the taxation of a deputy registrar, he may refer the matter to the registrar. Either party may appeal from the taxation of the registrar to the judge.

Who may tax costs; review of taxation.

Appeal from taxation.

## Chap. 59.

*Maritime Court of Ontario.*

Costs on reduction of bill.

Sec. 169. If in a taxation between solicitor and client more than *one sixth* of the bill is struck off, the solicitor, shall pay all the costs attending the taxation.

Certificate and order for payment of costs.

Sec. 170. When a bill of costs has been taxed by the registrar or deputy registrar he shall certify at the foot of the bill the amount at which he has taxed it, and the solicitor may then if necessary apply to the judge or surrogate for an order for the payment thereof.

XXXV.—*Appraisement and Sale, &c.*

Property under arrest may be ordered to be sold by auction or otherwise, notice to be given.

Sec. 171. The judge or surrogate may, either before or after final judgment, order any property under the arrest of the court to be appraised, or to be sold with or without appraisement, and either by public auction or by private contract and may direct what notice or notices by advertisement or otherwise shall be given or may dispense with the same.

Property deteriorating.

Sec. 172. If the property is deteriorating in value, the judge or surrogate may order it to be sold forthwith.

Property of small value.

Sec. 173. If the property to be sold is of small value, the judge or surrogate may, if he thinks fit, order it to be sold without a commission of sale being issued.

Removal of property under arrest.

Sec. 174. The judge or surrogate may, either before or after final judgment order any property under arrest of the court to be removed, or any cargo under arrest on board ship to be discharged.

Appraisement, sale and removal, how effected.

Sec. 175. The appraisement, sale and removal of property, and the discharge of cargo, shall be effected under the authority of a commission addressed to the marshal or to a deputy marshal. Forms of commissions of appraisement, sale, appraisement and sale, removal, and discharge of cargo, will be found in schedule A hereto, Nos. 31 to 35.

Commission, by whom executed.

Sec. 176. Every commission for the appraisement or sale of property under the decree of the court shall, unless the judge or surrogate otherwise order, be executed by the marshal or deputy marshal, or his substitutes.

Commission to be filed with a return.

Sec. 177. The commission shall, as soon as possible after its execution, be filed by the marshal or deputy marshal, with a return setting forth the manner in which it has been executed.



*Maritime Court of Ontario.*

## Chap. 59

Sec. 178. At the request of the purchaser the marshal or deputy marshal shall execute a bill of sale of any ship sold by him; such bill of sale to be prepared at the cost of the purchaser and tendered for execution to the marshal or deputy marshal; a copy of the decree or order for sale, authenticated by the seal of the court shall be attached to such bill of sale. A form of bill of sale will be found in schedule A hereto, No. 36.

Bill of sale, by whom executed; provisions respecting the same.

Sec. 179. As soon as possible after the execution of a commission of sale, the marshal or deputy marshal shall pay into court the gross proceeds of the sale, and shall with the commission file his accounts and vouchers in support thereof.

Payment of proceeds into court.

Sec. 180. The registrar or deputy registrar shall tax the marshal's or deputy marshal's account, and shall report the amount at which he considers it should be allowed; and any party who is interested in the proceeds may be heard before the registrar or deputy registrar on the taxation.

Marshal's or deputy marshal's account to be taxed.

Sec. 181. Application may be made to the judge or surrogate on motion to review the registrar's or deputy registrar's taxation under the next preceding section.

Review of such taxation.

Sec. 182. The judge or surrogate may, if he thinks fit, order any property under the arrest of the court to be inspected. A form of order or inspection will be found in schedule A hereto, No. 37.

Inspection of property under arrest.

Sec. 183. No order for advertising a notice of the action and intended sale in an action *in rem*, by default, shall be made unless upon the application for such order it is made to appear to the satisfaction of the judge or surrogate as the case may be;—

Order for advertising notice, &c., in an action *in rem*, when necessary.

(a.) That no owner or mortgagee of the property proceeded against resides in Canada; or—

Owner non-resident.

(b.) That the whereabouts of none of the owners or mortgagees in Canada can be ascertained after reasonable efforts in that behalf; or—

Whereabouts of owner unknown.

(c.) That the institution of the action has come to the knowledge of the owners or some of them, if in Canada,— or to the knowledge of the agent in Canada of the owners or some of them, and that the institution of the action has come to the knowledge of at least one of the mortgagees under each mortgage upon the property registered in Canada, or to the knowledge of his agent, if any, in Canada.

Knowledge of the institution of the action.

Order for sale in an action *in rem* when made.

Sec. 184. No order for the sale of the property proceeded against in an action, *in rem*, whether by default or otherwise, shall be made, unless upon the application for such order it is made to appear to the satisfaction of the judge or surrogate as the case may be;—

Knowledge to a mortgagee or his agent.

(a.) That the institution of the action has come to the knowledge of at least one of the mortgagees under each mortgage upon the property registered in Canada, or to the knowledge of his agent, if any, in Canada; or—

Whereabouts of mortgagee unknown.

(b.) That the whereabouts of none of the mortgagees in Canada can be ascertained after reasonable efforts in that behalf.

### XXXVI.—*Discontinuance.*

Discontinuance by filing notice; costs in such case.

Sec. 185. The plaintiff may, at any time, discontinue his action by filing a notice to that effect, and the defendant shall thereupon be entitled to have judgment entered for his costs of action on filing a notice to enter the same. The discontinuance of an action by the plaintiff shall not prejudice any action consolidated therewith or any counterclaim previously set up by the defendant. Forms of notice of discontinuance and of notice to enter judgment for costs will be found in schedule A hereto, Nos. 38 and 39.

Not to prejudice other parties.

### XXXVII.—*Consent.*

Consent in writing an order of court.

Sec. 186. Any consent in writing signed by the parties may, by permission of the registrar, or deputy registrar, be filed, and shall thereupon become an order of court.

### XXXVIII.—*Notice of Appeal.*

Fifteen days notice of intention to appeal.

Sec. 187. A party intending to appeal from a decision of the court to the Supreme Court of Canada must give notice of his intention to appeal to the opposite party within *fifteen days* from the time of the pronouncing of the decision appealed from, and otherwise the appeal shall be governed by the rules of the Supreme Court of Canada aforesaid. A form of notice of appeal will be found in schedule A hereto, No. 40.

Rules of Supreme Court of Canada to govern.

### XXXIX.—*Payment of Money into and out of Court.*

Canadian Bank of Commerce.

Sec. 188. A person desiring to pay money into court shall pay the same into the Canadian Bank of Commerce at Toronto or at some branch or agency thereof or as mentioned in the next following section, and in no other way.

*Maritime Court of Ontario.*

## Chap. 59.

Sec. 189. Money required to be paid into court in any of the following places (so long as the Canadian Bank of Commerce shall have no branch office thereat), shall be paid into the branch or agency office of the bank set opposite the said places respectively;—

At Cornwall	-	-	-	Bank of Montreal.
Kingston	-	-	-	Bank of Montreal.
Owen Sound	-	-	-	Merchants Bank.
Pictou	-	-	-	Bank of Montreal.
Port Arthur	-	-	-	Ontario Bank.

Sec. 190. The person paying money into court shall first obtain from the registrar or deputy registrar a direction to the bank to receive the money.

Direction to the bank.

Sec. 191. The person applying for the direction is to file a *praecipe* therefor and is to leave with the officer issuing the direction the judgment, order, writ or pleading, or copy thereof, under which the money is payable. And in case the direction is obtained elsewhere than in Toronto he shall also leave the necessary postage for the transmission of the document to the registrar and a further copy of the pleading for transmission.

Person applying for the direction is to file a *praecipe* therefor.

Sec. 192. When the direction is issued elsewhere than in Toronto the officer issuing the same shall forthwith transmit to the registrar by post the *praecipe* for such direction together with the papers left on the application therefor.

Direction issued elsewhere than in Toronto.

Sec. 193. A person paying money into court elsewhere than in Toronto shall be entitled to credit therefor as of the date on which the same was deposited in the bank, but the party entitled thereto shall not be entitled to receive bank interest thereon until the money shall have been received by the Canadian Bank of Commerce at Toronto.

When credit shall be given and when interest shall commence.

Sec. 194. The bank on receiving money to the credit of any action or matter is to give a receipt therefor in duplicate, and one copy shall be delivered to the party making the deposit, and the other shall be posted or delivered the same day to the registrar.

Bank to give receipt in duplicate.

Sec. 195. When a bank receipt for the amount shall be filed, the payment into court shall be deemed to be complete.

When payment deemed complete.

Sec. 196. Money shall be paid out of court upon the cheque of the judge or surrogate, countersigned by the registrar and not otherwise.

Money how paid out of court.

## Chap. 59.

## Maritime Court of Ontario.

Production of order and copy.

Sec. 197. The person entitled to the money shall produce to and leave with the registrar the order and a copy thereof entitling such person to the money.

Registrar shall countersign order if no caveat has been entered.

Sec. 198. The registrar after satisfying himself that no caveat against the payment of the money has been entered, or if entered that it has been set aside or withdrawn, shall countersign the order thus—"No caveat entered against payment of this money—registrar," and shall re-deliver the order to the person entitled thereto after making the necessary entries in his books respecting the same.

Bail for latent demands.

Sec. 199. Bail for latent demands shall not, unless the judge or surrogate shall otherwise order, be required on the payment of money out of court.

## XL.—Account Books.

Registrar shall keep books of account.

Sec. 200. The registrar shall keep such books of account and otherwise relating to money in court or invested under the authority of the court as the judge may from time to time think necessary to ensure safety and accuracy and ready reference.

Inspection of books and certificate.

Sec. 201. The books so kept shall be open to inspection, and the registrar shall give a certificate of the state of any account, or an extract therefrom at the desire of any party interested or his solicitor.

## XLI.—Caveats.

To prevent the arrest of property, notice may be filed and caveat entered.

Sec. 202. Any person desiring to prevent the arrest of any property may file a notice, undertaking within *three days* after being required to do so, to give bail to any action or counterclaim that may have been, or may be, brought against the property, and thereupon the registrar or deputy registrar shall enter a caveat in the "caveat warrant book" hereinafter mentioned. Forms of notice and of caveat warrant will be found in schedule A hereto, Nos. 41 and 42.

To prevent release of property under arrest.

Sec. 203. Any person desiring to prevent the release of any property under arrest, shall file a notice, and thereupon the registrar or deputy registrar shall enter a caveat in the "caveat release book" hereinafter mentioned. Forms of notice and of caveat release will be found in schedule A hereto, Nos. 43 and 44.

To prevent payment of money out of court.

Sec. 204. Any person desiring to prevent the payment of money out of court shall file a notice, and thereupon the registrar shall enter a caveat in the "caveat payment book"

*Maritime Court of Ontario.*

## Chap. 59.

hereinafter mentioned. Forms of notice and of *caveat* payment will be found in schedule A hereto, Nos. 45 and 46.

Sec. 205. If the person entering a *caveat* is not a party to the action, the notice shall state his name and address, and an address within three miles of the registry at which it shall be sufficient to leave all documents required to be served upon him. If person entering *caveat* is not a party.

Sec. 206. The entry of a *caveat* warrant shall not prevent the issue of a warrant, but a party at whose instance a warrant shall be issued for the arrest of any property in respect of which there is a *caveat* warrant outstanding, shall be condemned in all costs and damages occasioned thereby, unless he shall show to the satisfaction of the judge or surrogate good and sufficient reason to the contrary. Entry of *caveat* warrant shall not prevent issue of warrant.

Sec. 207. The party at whose instance a *caveat* release or *caveat* payment is entered, shall be condemned in all costs and damages occasioned thereby, unless he shall show to the satisfaction of the judge or surrogate good and sufficient reason to the contrary. Liability of party entering *caveat* release or *caveat* payment.

Sec. 208. If the *caveat* has not been entered in the office where the writ is issued, the registrar or any deputy registrar with whom a *caveat* has been entered, shall on the plaintiff's application transmit to the registrar or deputy registrar at whose office the writ is issued, a certified copy of the undertaking upon which the *caveat* was entered. If *caveat* not entered in office where writ issued.

Sec. 209. A *caveat* shall not remain in force for more than six months from the date of entering the same. Expiry of *caveat*.

Sec. 210. A *caveat* may at any time be withdrawn by the person at whose instance it has been entered, on his filing a notice withdrawing it. A form of notice of withdrawal will be found in schedule A hereto, No. 47. Withdrawal of *caveat*.

Sec. 211. The judge or surrogate may overrule any *caveat*. Overruling *caveat*.

Sec. 212. Application may be made in chambers to overrule any *caveat*. Application in chambers.

XLII.—*Subpœnas.*

Sec. 213. Any party desiring to compel the attendance of a witness shall serve him with a *subpœna*, which shall Attendance of witnesses.

## Chap. 59.

*Maritime Court of Ontario.*

be prepared by the party and issued under the seal of the court. Forms of *subpœnas* will be found in schedule A hereto, Nos. 48 and 49.

Any number  
of witnesses  
or in blank.

Sec. 214. A *subpœna* may contain the names of any number of witnesses, or may be issued with the names of the witnesses in blank.

Personal ser-  
vice.

Sec. 215. Service of the *subpœna* must be personal, and may be made by the party or his agent, and shall be proved by affidavit.

#### XLIII.—Orders for Payment.

Payment out  
of money in  
court.

Sec. 216. On application by a party to whom any sum has been found due, the judge or surrogate may order payment to be made out of any money in court applicable for the purpose.

Payment  
when no mon-  
ey in court  
or the amount  
is insufficient.

If there is no such money in court, or if it is insufficient, the judge or surrogate may order that the party liable shall pay the sum found due, or the balance thereof, as the case may be, within such time as to the judge or surrogate shall seem fit. The party to whom the sum is due may then obtain from the registry and serve upon the party liable an order for payment under seal of the court. A form of order for payment will be found in schedule A hereto, No. 50.

#### XLIV.—Attachments.

Contempt of  
court.

Sec. 217. If any person disobeys an order of the court, or commits a contempt of court, the judge or surrogate may order him to be attached. A form of such attachment will be found in schedule A hereto, No. 51.

Proceedings  
when person  
attached for  
disobedience  
or contempt.

Sec. 218. The person attached shall without delay be brought before the judge or surrogate, and if he persists in his disobedience or contempt, the judge or surrogate may order him to be committed. Forms of order for committal and of committal will be found in schedule A hereto, Nos. 52 and 53.

Order for  
committal.

The order for committal shall be executed by the marshal or deputy marshal.

#### XLV.—Amending Decree or Order.

Application  
to amend,  
&c., may be  
made in  
chambers.

Sec. 219. An application to amend an order, which has not been drawn up in conformity with the judgment pronounced, so as to make the same conformable thereto, and an application to correct any clerical mistake in an order or an error arising from an accidental slip or omission, may

*Maritime Court of Ontario.*

## Chap. 59.

be made in chambers, and the judge or surrogate may grant the same if under all circumstances he sees fit.

XLVI.—*Execution.*

Sec. 220. Any decree or order of the court may be enforced in the same manner as a decree or order of the Supreme Court of Judicature for the Province of Ontario may be enforced. A form of writ of execution (*Fieri Facias*), will be found in schedule A hereto, No. 54.

Enforcement of decree or order.  
Form of writ of execution.

XLVII.—*Instruments, &c.*

Sec. 221. Every warrant, release, execution, commission, attachment, and other instrument to be executed by any officer of, or commissioner acting under the authority of the court, shall be prepared in the registry and signed by the registrar or deputy registrar, and shall be issued under the seal of the court.

Warrant, release, execution, &c., to be prepared in registry.

Sec. 222. Every document issued under the seal of the court shall bear date on the day of sealing, and shall be deemed to be issued at the time of the sealing thereof.

When deemed to be issued.

Sec. 223. Every document requiring to be served shall be served within *six months* from the date thereof, otherwise the service shall not be valid.

Time for service, six months.

Sec. 224. Every instrument to be executed by the marshal or deputy marshal shall be left with the marshal or deputy marshal by the party at whose instance it is issued, with written instructions for the execution thereof.

Instrument to be executed shall be left with marshal or deputy.

XLVIII.—*Notices from the Registry.*

Sec. 225. Any notice from the registry may be either left at, or sent by post, by registered letter to, the address for service of the party to whom notice is to be given, and the day next after the day on which the notice is so posted shall be considered as the day of service thereof, and the posting thereof as aforesaid shall be a sufficient service.

Notice from registry may be served by post.

XLIX.—*Filing.*

Sec. 226. Documents shall be filed by leaving the same in the registry, with a *minute* stating the nature of the document, and the date of filing it. A form of *minute* on filing any document will be found in schedule A hereto, No. 55.

Mode of filing documents.

## Chap. 59.

*Maritime Court of Ontario.*

One *minute* sufficient.

Sec. 227. Any number of documents in the same action may be filed with one and the same *minute*.

Indorsement of certificate, when required.

Sec. 228. No document, except preliminary acts, bail bonds, documents issued from the registry, and minutes shall be filed without a certificate indorsed thereon, signed by the party filing the same, that a copy thereof has been served upon the adverse party, if any.

L.—*Time.*

Expiry of time on a Sunday, &c.

Sec. 229. If the time for doing any act or taking any proceeding in an action expires on a Sunday, or on any other day on which the registry is closed, and by reason thereof, such act or proceeding cannot be done or taken on that day, it may be done or taken on the next day on which the registry is open.

When time for doing any act shall commence.

Sec. 230. Where, by these rules or by any order made under them, any act or proceeding is ordered or allowed to be done within or after the expiration of a time limited from or after any date or event, such time, if not limited by hours, shall not include the day of such date or of the happening of such event, but shall commence on the next following day.

Time may be enlarged or abridged.

Sec. 231. The judge or surrogate may on the application of either party, enlarge or abridge the time prescribed by these rules or forms or by any order made under them for doing any act or taking any proceeding, upon such terms as to him shall seem fit, and any such enlargement may be ordered although the application for the same is not made until after the expiration of the time prescribed.

LI.—*Sittings of the Court.*

Sittings and adjournments.

Sec. 232. The judge or surrogate shall appoint proper and convenient times for sittings in court and in chambers, and may adjourn the proceedings from time to time and from place to place as to him shall seem fit.

LII.—*Office Hours.*

*Dies non.*

Sec. 233. The offices of the court shall be open on every day in the year except on Sundays, New Year's day, Good Friday, Easter Monday, Christmas day, and days appointed for the celebration of the birthday of Her Majesty and Her Royal successors, and any day appointed by proclamation for a general fast or thanksgiving.



*Maritime Court of Ontario.*

## Chap. 59.

LIII.—*Registrar.*

Sec. 234. The registrar shall attend all sittings of the court held in Toronto and also before the judge in chambers and shall make minutes of every act of the court or decree and enter the same in a proper book to be kept for the purpose, which is to form a record of the court, and shall do and perform all the other duties imposed upon him by these or any future rules, and by the practice of the court. If from illness or any other sufficient cause he should be unable to perform his duty, he may with the consent of the judge or the judge himself may appoint some other competent person to act as registrar on those occasions. He is prohibited from acting as either solicitor or advocate in any suit, matter or proceeding in the court.

Registrar shall attend all sittings of the court in Toronto and in chambers.

Absence of registrar provided for.

Shall not act as solicitor, &c.

LIV.—*Deputy Registrar.*

Sec. 235. The deputy registrar shall attend all sittings of the court held in the place where he keeps his office and also in chambers, before the surrogate residing nearest such place, and shall make minutes of every act of the court or decree and enter the same in a proper book to be kept for the purpose which is to form a record of the court; and shall do and perform all the other duties imposed upon him by these or any future rules, and by the practice of the court. If from illness or any other sufficient cause he should be unable to perform his duty, he may with the consent of the surrogate, or the surrogate himself may appoint some other competent person to act as deputy registrar on those occasions. He is prohibited from acting as either solicitor or advocate in any suit, matter or proceeding in the court.

Deputy registrar shall attend all sittings of the court in the place where he keeps his office and in chambers.

Absence of deputy registrar provided for.

Shall not act as solicitor, &c.

LV.—*Marshal.*

Sec. 236. The marshal shall attend the judge in court on all court days. He is to execute all such writs, warrants, decrees, monitions and instruments and orders as shall be issued from the court, and be directed to him, and he is to make due return thereof and to do and perform all other duties imposed on him by these or any future rules, or by the practice of the court.

Marshal shall attend judge, execute writs, &c., and make due return thereof.

LVI.—*Deputy Marshal.*

Sec. 237. The deputy marshal shall attend all sittings of the court on court days held in the place where he keeps his office. He is to execute all such warrants, decrees, monitions and instruments and orders as shall be issued

Deputy marshal shall attend sittings and execute warrants.

## Chap. 59.

*Maritime Court of Ontario.*

Shall make due return.

from the court and be directed to him, and he is to make due return thereof and to do and perform all other duties imposed on him by these or any future rules, or by the practice of the court.

In case of distance or other cause.

Sec. 238. Whenever, by reason of distance or other sufficient cause, the marshal or deputy marshal can not conveniently execute any instrument in person, he shall employ some competent person as his officer to execute the same.

LVII.—*Security of Marshal and Deputy Marshal.*

Judge or surrogate shall fix security.

Limit of time and the mode and terms relating to security to be given by marshals or deputy marshals.

Form of duplicate covenant.

Affidavit of justification.

Sec. 239. The judge or surrogate shall fix and determine the amount of security to be given by the marshal and each deputy marshal. Every marshal and deputy marshal shall, before he is sworn into office, and within *one month* after his appointment; or in the case of the marshal or deputy marshals already appointed within one month after notice to that effect from the judge or surrogate, execute and enter into a joint and several covenant in duplicate with two or more sureties of such amounts respectively as shall have been fixed by the judge or surrogate in that behalf as aforesaid for the due performance of the duties of his office, and the proper accounting for all moneys coming in or passing through his hands. Such duplicate covenant shall be in the form No. 56 of schedule A hereto, or to the like effect; and to each of the duplicate covenants respectively shall be attached an affidavit made by each of the covenantors therein named respectively in the form provided by No. 57 of schedule A hereto, or to the like effect.

The duplicate covenants and affidavits attached thereto shall be filed and submitted for approval, and transmitted to the Minister of Justice.

Sec. 240. The said duplicate covenants, with the affidavits thereto attached, shall within the periods hereinbefore limited respectively be filed with the registrar or deputy registrar of the said court; and the same shall be brought before the judge or surrogate by the said registrar or deputy registrar for approval; and when the same shall be indorsed by the said judge or surrogate as approved, one duplicate thereof shall be transmitted to the Minister of Justice at Ottawa for his approval. And in case the said Minister of Justice shall disapprove of the same he may forthwith give notice to the marshal or deputy marshal of such disapproval and in such case the marshal or deputy marshal shall within one month thereafter furnish another covenant in lieu of the covenant so disapproved of as aforesaid to the satisfaction of the said judge or surrogate and the Minister of Justice.

Sureties disapproved.

Sec. 241. The sureties named in any covenant so disapproved of as aforesaid shall not be discharged from lia-

*Maritime Court of Ontario.*

## Chap. 59.

bility by such disapproval, but shall be and continue liable for any defaults or misfeasances made, done or committed previous to the approval by the Minister of Justice of any securities that may be furnished in lieu of the same.

To continue liable.

Sec. 242. The judge or surrogate may at any time require the marshal or any deputy marshal to renew his covenants or securities or to furnish others in lieu of the same, as to the judge or surrogate may appear expedient for the protection of the interests of the Crown or of parties to legal proceedings, which new or substituted covenants or securities the marshal or any deputy marshal shall be bound to furnish in the same manner and subject to the same provisions as hereinbefore provided, within three months after notice from the judge or surrogate in that behalf.

Renewal or substitution of covenants may be required.

Sec. 243. Every renewed or substituted covenant or security shall be in the same form and executed and accompanied by the same formalities and affidavits, and subject to the same approval as the original covenant or security.

Form of renewed or substituted covenant.

Sec. 244. In case a new security is given or substituted as aforesaid the former sureties shall only be liable for or on account of defaults or misfeasances suffered or committed by the marshal or deputy marshal previous to the perfecting of the new security and the approval thereof by the judge or surrogate and the Minister of Justice; and not as to any subsequent default or misfeasance.

Liability of former sureties.

Sec. 245. In case of the default by the marshal or any deputy marshal to furnish such security as aforesaid within the time above limited it shall be the duty of the judge or surrogate to report the fact forthwith to the Minister of Justice.

Default in furnishing security.

LVIII—*Seal of the Court.*

Sec. 246. The judge shall cause a design for the seal of the court to be made. A seal shall be kept and used by the registrar and by each deputy registrar.

Judge shall cause design to be made.

Sec. 247. All instruments, orders and decrees of court, office copies and other documents issued by the registrar or deputy registrar shall be sealed with the seal of the court.

All instruments, &c., to be sealed.

LIX.—*Teste.*

Sec. 248. Monitions, warrants, attachments, subpoenas writs and other instruments and orders of the court run-

Monitions, &c.

## Chap. 59.

*Maritime Court of Ontario.*

Sealing and signing.

ning in the name of Her Majesty the Queen, shall be given under the seal of the court, and signed by the registrar or deputy registrar.

LX.—*Records of the Court.*Requisites and mode of keeping the *minute* book.

Sec. 249. There shall be kept in the registry a book, to be called the "*minute* book," in which the registrar or deputy registrar shall enter in order of date, under the head of each action, and on a page numbered with the number of the action, a record of the commencement of the action, of all appearances entered, all documents issued or filed, all acts done, and all orders and decrees of the court, whether made by the judge or surrogate, or by the registrar or deputy registrar, or by consent of the parties in the action. Forms of minute of order of court, of minute on examination of witnesses, of minute of decree, and of minutes in an action for damage by collision, will be found in schedule A hereto, Nos. 58 to 61.

Other books to be kept in registry.

Sec. 250. There shall be kept in the registry a "*caveat* warrant book," a "*caveat* release book," and a "*caveat* payment book," in which all such *caveats* respectively and the withdrawal thereof shall be entered by the registrar or deputy registrar.

Inspection of books.

Sec. 251. Any person may inspect the *minute* and *caveat* books, on payment of the proper fees.

LXI.—*Copies.*

Office copies may be obtained.

Sec. 252. Any person entitled to inspect any document in an action shall, on payment of the proper charges for the same, be entitled to an office copy thereof under seal of the court.

LXII.—*Forms.*

Forms of Supreme Court of Ontario, how far applicable.

Sec. 253. The forms hereto annexed shall be followed as nearly as the circumstances of the case will allow and in cases not provided for the forms in use in actions in the Supreme Court of Judicature for the Province of Ontario, *mutatis mutandis*, may be followed.

LXIII.—*Tariff of Fees.*

Fees in schedule B.

Sec. 254. The fees to be paid to the practitioners, officers and witnesses in causes in the court shall be as set forth in the *Tariff of Fees* in schedule B hereto.

*Maritime Court of Ontario.*

## Chap. 59.

Sec. 255. The fees and disbursements set forth in the said Tariff of Fees may be charged in respect of the services therein enumerated subject to the following rules. Fees subject to following rules.

Sec. 256. When the fee is per folio, the folio shall be counted at the rate of 100 words, and every numeral, whether contained in columns or otherwise written, shall be counted and charged for as a word. Folio.

Sec. 257. When the sum in dispute does not exceed \$200 or the value of the *res* does not exceed \$400, one-half only of the fees set forth in the said Tariff of Fees shall be charged and allowed; and if the judge or surrogate shall so order and direct the government fees in such cases may likewise be reduced to one half. This section is subject to the provisions of Chapter 75 of the Revised Statutes of Canada, intituled "The Inland Waters Seamen's Act." Half fees in certain cases.

Sec. 258. When costs are awarded to a plaintiff, the expression "sum in dispute" shall mean the sum recovered by him in addition to the sum, if any, counterclaimed from him by the defendant; and where "costs" are awarded to a defendant, it shall mean the sum claimed from him in addition to the sum, if any, recovered by him. "Sum in dispute."  
"Costs."

Sec. 259. Two or more persons having claims against the same property for wages or for necessaries may join against the same property in one writ, and unless the sum or sums adjudged to the claimant or claimants in a writ in an action of wages or of necessaries amount to the sum of one hundred dollars at least, no costs shall be allowed to the claimant or claimants, as the case may be, unless under all the circumstances the judge or surrogate thinks proper to allow a sum in gross not exceeding ten dollars in lieu of all costs. When two or more persons have claims against the same property for wages or necessaries amounting to \$100.

This section does not authorize the joining in one writ a claim for wages and a claim for necessaries. Non-joinder.

Sec. 260. The judge or surrogate may in any action order that half fees only shall be allowed, including the Government fees. Half fees in any action.

Sec. 261. Bonds executed upon an order for security for costs are to be given to the registrar or deputy registrar from whose office the writ issued; all the defendants are to be included in the same bond and the penal sum to be inserted therein is to be fixed upon the application for security, by the judge or surrogate who makes the order. Bonds for security for costs.

LXIV.—*Miscellaneous.*

The court may itself dispose of matters suitable for reference.

Sec. 262. In all cases where a reference to the registrar or deputy registrar may be directed the court may dispose of such matters itself if it thinks fit, and may direct the proceedings to be taken in full court or in chambers as it finds expedient.

Where documents filed with another officer are required, certificate required mode and expense of transmission.

Sec. 263. Where on a proceeding before an officer of the court pleadings or other documents filed with another officer of the court are required, the officer with whom the pleading or other documents are filed is upon production of a certificate signed by the officer requiring the pleadings or other documents, that the same are required for some proceedings before him, to transmit the pleadings or other documents mentioned in the certificate, but if they are to be sent by parcel post or by express, before they are sent the party requiring their transmission is to deposit a sufficient sum to cover the expense of transmission and of re-transmission to the office from which they are sent.

Re-transmission of document.

Sec. 264. As soon as the purpose for which any such documents are required is completed the officer to whom they have been sent is to re-transmit them to the office from which they were sent.

“The solicitor's and agent's book.”

Sec. 265. The registrar and each deputy registrar shall keep in his office a book to be called “the solicitor's and agent's book” in which each solicitor, residing elsewhere than in the place where such registrar's or deputy registrar's office may be, is to specify the name of an agent being a person entitled to act as a solicitor or attorney-at-law in Ontario, and having an office in such place, upon whom pleadings, writs, notices, orders, appointments, warrants and other documents and communications connected with any cause or matter in the office of such registrar or deputy registrar, as the case may be, may be served.

LXV.—*Repealing Clause.*

May 1, 1889.

Sec. 266. From and after the first day of May, 1889, except in regard to actions commenced before that day, the rules and regulations, together with all forms thereto annexed, and all tables of fees now in force in this court shall be repealed.

LXVI.—*Commencement of Rules.*

Rules, &c., in operation.

Sec. 267. These rules together with the following forms and tables of fees shall come into operation on the

first day of May, 1889, and shall apply to all actions commenced on or after that day. Actions commenced before that day may, by consent of the parties, and with the permission of the judge or surrogate, be continued under these rules on such terms as to the judge or surrogate shall seem fit. Actions pending.

[Made and signed by Joseph E. McDougall, the judge of the said court, January 31st, 1889.]

## SCHEDULE A.

### FORMS.

#### No. 1.

#### TITLE OF ACTION IN REM.

Section 4.

No. [Here insert the number of the action].

A.B., Plaintiff,  
against

- (a.) The Ship  
or (b.) The Ship and freight.  
or (c.) The Ship her cargo and freight.  
*or (if the action is against cargo only),*  
(d.) The cargo *ex* the Ship [state name of ship on board of which the cargo now is or lately was laden].  
*or (if the action is against the proceeds realised by the sale of the Ship or cargo),*  
(e.) The proceeds of the Ship  
or (f.) The proceeds of the cargo *ex* the Ship  
[or as the case may be.]

Action for [state nature of action, whether for damage by collision, wages, bottomry, &c., as the case may be].

#### No. 2.

#### TITLE OF ACTION IN PERSONAM.

Section 4.

No. [Here insert the number of the action].

A.B., Plaintiff,  
against

The Owners of the Ship , [or as the case may be].

Action for [state nature of action as in preceding form].

Chap. 59.

*Maritime Court of Ontario.*

No. 3.

Section 5.

## WRIT OF SUMMONS IN REM.

In the Maritime Court of Ontario.

(L.S.) [*Here insert title of action.*]

VICTORIA, by the grace of God, of the United Kingdom of Great Britain and Ireland, Queen, Defender of the Faith.

To the owners and all others interested in the Ship  
[her cargo and freight, &c., or as the case may be].

We command you that, within *one week* after the service of this writ, exclusive of the day of such service, you do cause an appearance to be entered for you in Our Maritime Court of Ontario in the above-named action; and take notice that in default of your so doing the said action may proceed, and judgment may be given in your absence.

Given at \_\_\_\_\_ in Our said Court, under the  
seal thereof, this \_\_\_\_\_ day of \_\_\_\_\_, 18 .

*Memorandum to be subscribed on the Writ.*

This writ may be served within *six months* from the date thereof, exclusive of the day of such date, but not afterwards.

The Defendant (or Defendants) may appear hereto by entering an appearance (or appearances) either personally or by solicitor at the registry of the said court situate at \_\_\_\_\_.

No. 4.

Section 5.

## WRIT OF SUMMONS IN PERSONAM.

In the Maritime Court of Ontario.

(L.S.) [*Here insert title of action.*]

VICTORIA, by the grace of God, &amp;c.

To C.D., of \_\_\_\_\_, and E.F., of \_\_\_\_\_

We command you that, within *one week* after the service of this writ, exclusive of the day of such service, you do cause an appearance to be entered for you in our Maritime Court of Ontario, in the above-named action; and take notice that in default of your so doing the said action may proceed, and judgment may be given in your absence.

Given at \_\_\_\_\_ in Our said Court, under the  
seal thereof, this \_\_\_\_\_ day of \_\_\_\_\_, 18 .



*Maritime Court of Ontario*

## Chap. 59.

*Memorandum to be subscribed on the Writ.*

Section 5.

This writ may be served within *six months* from the date thereof, exclusive of the day of such date, but not afterwards.

The Defendant (*or* Defendants) may appear hereto by entering an appearance (*or* appearances) either personally or by solicitor at the registry of the said court situate at

## No. 5.

## INDORSEMENTS TO BE MADE ON THE WRIT BEFORE ISSUE THEREOF. Section 5.

(1.) The Plaintiff claims [*insert description of claim as given in Form No. 6.*]

(2.) This writ was issued by the Plaintiff in person, who resides at [*state Plaintiff's place of residence, with name of street and number of house, if any.*]

<sup>(*or*,</sup>  
This writ was issued by C.D., of [*state place of business*] solicitor for the Plaintiff.

(3.) All documents required to be served upon the said Plaintiff in the action may be left for him at [*insert address for service within three miles of the registry.*]

<sup>*or*,</sup>  
*Where the action is in the name of the Crown.*

(1.) A.B., &c., claims [*insert description of claim as given in Form No. 6.*]

(2.) This writ was issued by A.B. [*state name and address of person prosecuting in the name of the Crown, or his solicitor, as the case may be.*]

(3.) All documents required to be served upon the Crown in this action may be left at [*insert address for service within three miles of the registry.*]

## No. 6.

## INDORSEMENTS OF CLAIM.

Section 5.

(1.) *Damage by collision :*

The Plaintiffs as owners of the Ship "Mary" [her cargo and freight, &c., *or as the case may be*] claim the sum of \$ \_\_\_\_\_ against the Ship "Jane" for damage occasioned by a collision which took place [*state where*] on the \_\_\_\_\_ day of \_\_\_\_\_ ; and for costs.

(2.) *Salvage :*

The Plaintiffs, as the owners, master, and crew of the Ship "Mary," claim the sum of \$ \_\_\_\_\_ for salvage services

## Chap. 59.

## Maritime Court of Ontario.

Section 5. rendered by them to the Ship "Jane" [her cargo and freight, &c., or as the case may be] on the day of 18, in or near [state where the services were rendered]; and for costs.

(3.) *Pilotage* :

The Plaintiff claims the sum of \$ for pilotage of the Ship "Jane" on the day of 18, from [state where pilotage commenced] to [state where pilotage ended] and for costs.

(4.) *Towage* :

The Plaintiffs, as owners of the Ship "Mary," claim the sum of \$ for towage services rendered by the said Ship to the Ship "Jane" [her cargo and freight, &c., or as the case may be], on the day of 18, at or near [state where the services were rendered]; and for costs.

(5.) *Master's wages and disbursements* :

The Plaintiff claims the sum of \$ for his wages and disbursements as master of the Ship "Mary," and to have an account taken thereof; and for costs.

(6.) *Seamen's wages* :

The Plaintiffs, as seamen on board the Ship "Mary," claim the sum of \$, for wages due to them, as follows; and for costs :

to A.B., the mate, \$ for two months wages from the day of

to C.D., able seaman, \$ &c., &c. ;

[and the Plaintiffs claim to have an account taken thereof.]

(7.) *Necessaries, repairs, &c.* :

The Plaintiffs claim the sum of \$, for necessaries supplied (or repairs done, &c., as the case may be) to the Ship "Mary" at the port of on the day of ; and for costs [and the Plaintiffs claim to have an account taken thereof].

(8.) *Possession* :

(a.) The Plaintiff, as sole owner of the Ship "Mary," of the port of, claims possession of the said Ship.

(b.) The Plaintiff, as owner of 48-64th shares of the Ship "Mary" of the port of, claims possession of the said Ship as against C.D., owner of 16-64th shares of the same Ship.

(9.) *Mortgage* :

The Plaintiff, under a mortgage dated the day of, claims against the proceeds of the Ship "Mary" the sum of \$, as the amount due to him for principal and interest, and for costs.

(10.) *Claims between Co-Owners* :

(a.) The Plaintiff, as part owner of the Ship "Mary," claims against C.D., part owner of the same Ship, the sum of \$ as part of the earnings of the said Ship due to the

*Maritime Court of Ontario.*

## Chap. 59•

Plaintiff, and for costs; and to have an account taken thereof. Section 5.

(b.) The Plaintiff, as owner of 24-64th shares of the Ship "Mary," being dissatisfied with the management of the said Ship by his co-owners, claims that his co-owners shall give bail in the sum of \$ \_\_\_\_\_, the value of his said shares, for the safe return of the Ship to this Province.

(11) *Bottomry* :

The Plaintiff, as assignee of a bottomry bond, dated the \_\_\_\_\_ day of \_\_\_\_\_, and granted by C.D., as master of the Ship "Mary" of \_\_\_\_\_, to A.B. at the port of \_\_\_\_\_, claims the sum of \$ \_\_\_\_\_ against the Ship "Mary" [her cargo and freight, &c., or as the case may be] as the amount due to him under the said bond, and for costs.

No. 7.

## AFFIDAVIT OF SERVICE OF WRIT OF SUMMONS.

Section 18.

In the Maritime Court of Ontario.

[Title of action.]

County of \_\_\_\_\_

I, A.B., of the [city, town, &c] of [name of place] [calling or occupation] make oath and say :

1. That I did on the \_\_\_\_\_ day of \_\_\_\_\_ 18 \_\_\_\_\_, serve the writ of summons herein by [here state particularly the mode in which service was effected and whether on the owner or on the ship, cargo, or freight, &c., as the case may be].

2. That I necessarily travelled \_\_\_\_\_ miles to effect said service.

Sworn before me, &c. }

A Commissioner, &c.

(Signed)

A.B..

No. 8.

## APPEARANCE.

Section 25.

(1.) *By Defendant in person.*

In the Maritime Court of Ontario.

[Title of Action.]

Take notice that I appear in this action.

Dated this \_\_\_\_\_ day of \_\_\_\_\_ 18 \_\_\_\_\_

(Signed) C. D., Defendant.

My address is \_\_\_\_\_

My address for service is \_\_\_\_\_



*Maritime Court of Ontario.*

## Chap. 59.

## No. 11.

AFFIDAVIT TO LEAD WARRANT IN A CAUSE OF RESTRAINT. Section 34.

In the Maritime Court of Ontario.

[*Title of Action.*]

I, A. B., of, &c., make  
oath and say as follows :

1. I am the lawful owner of [*state the number of shares*]  
sixty-fourth shares of the or vessel  
belonging to the port of  
and the value of my said shares amount to the sum of  
dollars or thereabout.

2. The said vessel is now lying at and is in  
the possession or under the control of  
the owner of [*state number*] sixty-fourth shares thereof,  
and is about to be despatched by him on a voyage to  
against my consent.

3. I am desirous that the said vessel be restrained from  
proceeding until security be given to the extent of my in-  
terest therein for her safe return to the said port of  
and the aid and process of the Maritime Court of  
Ontario are necessary in that behalf.

Sworn, &c. (Signed) A. B.  
the day of, &c.,

## No. 12.

AFFIDAVIT TO LEAD WARRANT IN A CAUSE OF POSSESSION. Section 34.

In the Maritime Court of Ontario.

[*Title of Action.*]

I, A. B., of, &c., make  
oath and say as follows :

1. I am the lawful owner of [*state the number of shares*]  
sixty-fourth shares of the or vessel  
belonging to the port of

2. That the said vessel is now lying at and is in  
the possession or under the control of [*state the name, address  
and description of the person retaining possession and state  
whether he is the master or part owner, and if owner of how  
many shares,*] and the said refuses to deliver  
up the same to me, and the certificate of registry of the said  
vessel is also unlawfully withheld from me by the said  
who is now in possession thereof.

## Chap. 59.

*Maritime Court of Ontario.*

3. The aid and process of the Maritime Court of Ontario are necessary to enable me to obtain possession of the said vessel and of the certificate of registry.

Sworn, &c.

(Signed) A. B.

\_\_\_\_\_  
No. 13.

Section 39.

WARRANT.

In the Maritime Court of Ontario.

(L.S.) [Title of Action.]

VICTORIA, &c.

To the marshal and to each deputy marshal of the Maritime Court of Ontario, and to all and singular the substitutes thereof,—Greeting.

We hereby command you to arrest the ship [her cargo and freight, &c., or as the case may be], and to keep the same under safe arrest, until you shall receive further orders from us.

Given at \_\_\_\_\_ in our said court, under the seal  
thereof, this \_\_\_\_\_ day of \_\_\_\_\_ 18  
Warrant;  
Taken out by \_\_\_\_\_

(Signed) E. F.,  
Registrar (or Deputy Registrar.)

\_\_\_\_\_  
No. 14.

Section 43.

CERTIFICATE OF SERVICE TO BE INDORSED ON THE WARRANT  
AFTER SERVICE THEREOF.

This warrant was served by [state by whom and in what mode service was effected] on \_\_\_\_\_ the  
day of \_\_\_\_\_ 18 .

(Signed) G. H.,  
Marshal (or Deputy Marshal).

\_\_\_\_\_  
No. 15.

Section 48.

BAIL BOND.

In the Maritime Court of Ontario.

[Title of Action.]

Know all men by these presents that we [insert names, addresses, and descriptions of the sureties in full] hereby jointly and severally submit ourselves to the jurisdiction of the said court, and consent that if the said [insert name of party



Chap. 59.

*Maritime Court of Ontario.*

you to arrest [*state name and nature of property arrested*] and to keep the same under safe arrest until you should receive further orders from us. We do hereby command you to release the said [*state name and nature of property to be released*] from the said arrest upon payment being made to you of all fees due to, and charges incurred by you in respect of the arrest and custody thereof.

Given at \_\_\_\_\_, in our said court, under the seal thereof, this \_\_\_\_\_ day of \_\_\_\_\_ 18 .

Release:

Taken out by

(Signed) \_\_\_\_\_ *E.F.*  
Registrar, (*or Deputy Registrar.*)

— — —  
No. 18.

Section 69.

## INTERROGATORIES.

In the Maritime Court of Ontario.

[*Title of Action.*]

Interrogatories on behalf of the Plaintiff *A.B.* [*or Defendant C.D.*] for the examination of the Defendants *C.D.* and *E.F.* [*or Plaintiff A.B., or as the case may be*].

1. Did not, &amp;c.

2. Have not, &amp;c.

The Defendant *C.D.* is required to answer the interrogatories numbered \_\_\_\_\_

The Defendant *E.F.* is required to answer the interrogatories numbered \_\_\_\_\_

Dated the \_\_\_\_\_ day of \_\_\_\_\_ 18 .

(Signed) *A.B.* [*or C.D., as the case may be*].

— — —  
No. 19.

Section 69.

## ANSWERS TO INTERROGATORIES.

In the Maritime Court of Ontario.

[*Title of Action.*]

The answers of the Defendant *C.D.* [*or Plaintiff A.B., &c.*] to the interrogatories filed for his examination by the Plaintiff *A.B.* [*or Defendant C.D., &c.*]





## Chap. 59.

*Maritime Court of Ontario.*

## No. 23.

## Section 103. APPOINTMENT TO ADMINISTER OATH IN ANY PARTICULAR PROCEEDING.

In the Maritime Court of Ontario.

(L.S.)

[*Title of Action.*]To [*state name and address of appointee*]I hereby authorize you to administer an oath [*or oaths as the case may be*] to [*state name of person or persons to whom, and proceeding in which the oath is to be administered or as the case may be*](Signed) A. B., Judge,  
(or C. D., Surrogate Judge.)

## No. 24.

## Section 107.

## FORM OF JURAT.

*(Where Deponent is sworn by Interpretation.)*On the                    day  
18   , the said A. B. was duly  
sworn to the truth of this affi-  
davit by the interpretation of  
C. D., who was previously sworn  
that he was well acquainted with  
the English and            languages,  
and that he would faithfully in-  
terpret the said affidavit, at  
Before me,  
E. F., &c.

(Signed) A. B.

## No. 25.

## Section 111.

## ORDER FOR EXAMINATION OF WITNESSES.

In the Maritime Court of Ontario.

[*Title of Action.*]On the                    day of            18  
Before                    judge [*or A.B., surrogate  
judge.*]It is ordered that [*state the names of the witnesses so far as it can be done*], witnesses for the Plaintiff [*or Defendant*], shall be examined before the judge [*or surrogate judge or registrar or deputy registrar, or special examiner as the case.*]

*Maritime Court of Ontario.*

Chap. 59.

may be], at [state place of examination], on [state day of week],  
 the day of instant [or as the case  
 may be], at o'clock in the noon.

(Signed) *E.F.*,  
 Registrar, (or Deputy Registrar.)

—  
 No. 26.

## COMMISSION TO EXAMINE WITNESSES.

Section 113.

In the Maritime Court of Ontario.

(L.S.) [Title of Action.]

VICTORIA, &c.

To [state name and address of commissioner] Greeting.

Whereas the judge [or A. B., surrogate judge] of our Maritime Court of Ontario has decreed that a commission shall be issued for the examination of witnesses in the above-named action. We, therefore, hereby authorize you, upon the day of 18 , at , in the presence of the parties, their counsel, and solicitors, or, in the absence of any of them, to swear the witnesses who shall be produced before you for examination in the said action, and cause them to be examined, and their evidence to be reduced into writing. We further authorize you to adjourn, if necessary, the said examination from time to time, and from place to place, as you may find expedient. And we command you, upon the examination being completed, to transmit the evidence duly certified, together with this commission, to the registry of our said court at

Given at in our said court, under the seal thereof, this day of 18 .

(Signed) *E.F.*,  
 Registrar, (or Deputy Registrar.)

Commission to examine witnesses :

Taken out by

—  
 No. 27.

## RETURN TO COMMISSION TO EXAMINE WITNESSES.

Section 116.

In the Maritime Court of Ontario.

[Title of Action.]

I, A.B., the commissioner named in the commission hereto annexed, bearing date the day of 18 , hereby certify as follows:

Chap. 59.

*Maritime Court of Ontario.*

Section 116.

(1.) On the \_\_\_\_\_ day of \_\_\_\_\_ 18 \_\_, I opened the said commission at \_\_\_\_\_, and in the presence of [*state who were present, whether both parties, their counsel, or solicitors, or as the case may be*], administered an oath to, and caused to be examined the under-named witnesses who were produced before me on behalf of the [*state whether Plaintiff or Defendant*] to give evidence in the above-named action; viz.:

[*Here state names of witnesses.*]

(2.) On the \_\_\_\_\_ day of \_\_\_\_\_ 18 \_\_, I proceeded with the examinations at the same place [*or, at some other place, as the case may be,*] and in the presence of [*state who were present, as above,*] administered an oath to and caused to be examined the under-named witnesses who were produced before me on behalf of [*state whether Plaintiff or Defendant*] to give evidence in the said action, viz.:

[*State names of witnesses.*]

(3.) Annexed hereto is the evidence of all the said witnesses certified by me to be correct.

Dated the \_\_\_\_\_ day of \_\_\_\_\_ 18 \_\_.  
 (Signed) *G.H.*,  
 Commissioner.

\_\_\_\_\_  
 No. 28.

Section 121.

## SHORTHAND WRITER'S OATH.

You swear that you will faithfully report the evidence of the witnesses to be produced in this action.

So help you God.

\_\_\_\_\_  
 No. 29.

Section 132.

## NOTICE FOR HEARING.

In the Maritime Court of Ontario.

[*Title of Action.*]

Take notice that I set down this action for hearing.

Dated the \_\_\_\_\_ day of \_\_\_\_\_ 18 \_\_.  
 (Signed) *A. B.*, Plaintiff  
 (*or C. D.*, Defendant.)



Section 148.

SCHEDULE annexed to the forgoing report.

No.		Claimed.		Allowed.	
		\$	cts.	\$	cts.
1	<p>[Here state as briefly as possible the several items of the claim with the amount claimed and allowed on each item in the columns for figures opposite the item.]</p>				
2					
3					
4					
5					
&c.]					
Total.....					

With interest thereon from the \_\_\_\_\_ day of \_\_\_\_\_ 18\_\_\_\_, at the rate of \_\_\_\_\_ per cent, per annum, until paid.

(Signed)

E. F.,  
Registrar,  
(or Deputy Registrar.)

No. 31.

Section 153

COMMISSION OF APPRAISEMENT.

In the Maritime Court of Ontario.

(L.S.)

[Title of Action.]

VICTORIA, &c.

To the marshal [or A.B., deputy marshal] of our Maritime Court of Ontario, Greeting.

Whereas the judge [or C.D., surrogate judge] of our said court has ordered that [state whether ship or cargo, and state name of the ship and, if part only of cargo, state what part] shall be appraised.

We, therefore, hereby command you to reduce into writing an inventory of the said [ship or cargo &c., as the case may be], and having chosen one or more experienced person or persons, to swear him or them to appraise the same accord-

*Maritime Court of Ontario.*

## Chap. 59.

ing to the true value thereof, and upon a certificate of such value having been reduced into writing, and signed by yourself and by the appraiser or appraisers, to file the same in the registry of our said court, together with this commission.

Given at \_\_\_\_\_, in our said court, under the seal  
thereof, this \_\_\_\_\_ day of \_\_\_\_\_ 18 \_\_\_\_\_  
(Signed) *E.F.*,

Commission of Appraisement : \_\_\_\_\_ Registrar,  
Taken out by \_\_\_\_\_ (or Deputy Registrar.)

\_\_\_\_\_  
No. 32.

## COMMISSION OF SALE.

Section 175.

In the Maritime Court of Ontario.

(L.S.) [Title of Action.]

VICTORIA, &c.

To the marshal [or *A.B.*, deputy marshal] of our Maritime Court of Ontario,—Greeting.

Whereas the judge [or *C.D.*, surrogate judge] of our said court, has ordered that [state whether ship or cargo and state name of ship, and if part only of cargo, what part] shall be sold. We, therefore, hereby command you to reduce into writing an inventory of the said [ship or cargo, &c., as the case may be], and to cause the said [ship or cargo, &c.], to be sold by public auction for the highest price that can be obtained for the same.

And we further command you, as soon as the sale has been completed, to pay the proceeds arising therefrom into our said court, and to file an account sale signed by you, together with this commission.

Given at \_\_\_\_\_, in our said court, under the seal  
thereof, this \_\_\_\_\_ day of \_\_\_\_\_ 18 \_\_\_\_\_  
(Signed) *E.F.*,

Commission of sale: \_\_\_\_\_ Registrar,  
Taken out by \_\_\_\_\_ (or Deputy Registrar.)

\_\_\_\_\_  
No. 33.

## COMMISSION OF APPRAISEMENT AND SALE.

Section 175.

In the Maritime Court of Ontario.

(L.S.) [Title of Action.]

VICTORIA, &c.

To the marshal [or *A.B.*, deputy marshal] of our Maritime Court of Ontario,—Greeting.

Whereas the judge [or *C.D.*, surrogate judge] of our said court, has ordered that [state whether ship or cargo, and state

*name of ship, and if part only of cargo, what part*] shall be appraised and sold. We, therefore, hereby command you to reduce into writing an inventory of the said [ship or cargo, &c., *as the case may be*], and having chosen one or more experienced person or persons to swear him or them to appraise the same according to the true value thereof, and when a certificate of such value has been reduced into writing and signed by yourself and by the appraiser or appraisers, to cause the said [ship or cargo, &c., *as the case may be*] to be sold by public auction for the highest price, not under the appraised value thereof, that can be obtained for the same.

And we further command you, as soon as the sale has been completed, to pay the proceeds arising therefrom into our said court, and to file the said certificate of appraisement and an account sale signed by you, together with this commission.

Given at \_\_\_\_\_, in our said court, under the seal  
thereof, this \_\_\_\_\_ day of \_\_\_\_\_ 18 .

(Signed) E.F.,

Commission of appraisement and sale : Registrar,  
Taken out by \_\_\_\_\_ (or Deputy Registrar.)

No. 34.

Section 175.

COMMISSION OF REMOVAL.

In the Maritime Court of Ontario.

(L.S.) [Title of Action.]

VICTORIA, &c.

To the marshal [or A.B. deputy marshal] of our Maritime Court of Ontario,—Greeting.

Whereas the judge, [or C.D. surrogate judge] of our said court, has ordered that the [*state name and description of ship*] shall be removed from \_\_\_\_\_ to \_\_\_\_\_ on a policy of insurance in the sum of \$ \_\_\_\_\_ being deposited in the registry of our said court; and whereas a policy of insurance for the said sum has been so deposited. We, therefore, hereby command you to cause the said ship to be removed accordingly. And we further command you, as soon as the removal has been completed, to file a certificate thereof, signed by you, in the said registry, together with this commission.

Given at \_\_\_\_\_, in our said court, under the seal  
thereof, this \_\_\_\_\_ day of \_\_\_\_\_ 18 .

(Signed) E.F.

Commission of removal : Registrar,  
Taken out by \_\_\_\_\_ (or Deputy Registrar.)





No. 36.  
BILL OF SALE.

Section 17b.

OFFICIAL NUMBER OF SHIP		NAME OF SHIP							
Port Number and Year of Registry.	Port of Registry...	How propelled...	Where built...						
Number of Decks.....	Build..... Galleries..... Head..... Framework.....	Length from forepart of Stem, under the bowsprit, to the aft side of the Head of the Stern-post..... Mainbreadth to outside of Plank..... Depth in Hold from Tonnage Deck to Ceiling at Midships..... Depth in Hold from Upper Deck to Ceiling at Midships in the case of three Decks and upwards..... Length of Engine Room, if any.....	When built.....						
Number of Masts.....									
Rigged.....									
Stern.....									
Particulars of Engines (if any):				No. of Engines.	Description.	Whether British or Foreign made.	When made.	Name and Address of Makers.	Diameter of Cylinders.
GROSS TONNAGE.		No. of Tons.		DEDUCTIONS ALLOWED.		No. of Tons.			
Under Tonnage Deck.....	On account of Space required for Propelling Power.....		On account of Space occupied by Seamen or Apprentices, appropriated to their use and kept free from Goods and Stores of every kind not being the personal property of the Crew. These spaces are the following, viz.: .....		Total Deductions .....				
Closed-in Spaces above Tonnage Deck, if any, Space or Spaces between Deck.....	Gross Tonnage.....		Deductions as per Contra.....		Registered Tonnage.....				
Poop.....	Registered Tonnage.....								
Forecastle.....									
Roundhouse.....									
Other Closed-in Spaces, if any, as follows.....									
<p>I,..... of the..... in the County of..... and Province of Ontario, Marshal* of the Maritime Court of Ontario, in consideration of the sum of..... whereof is hereby acknowledged, transfer..... Shares in the Ship above particularly described, and in her boats, guns, ammunition, small arms, and appurtenances, to the said..... who has purchased the same at a sale held by me as such Marshal, under and in pursuance of a commission of appraisement and sale, (or "commission of sale," or "order for sale," or as the case may be) to me directed by the said court, in a certain action therein pending at....., numbered†..... bearing date the..... day of..... A.D. 188 §</p> <p>In witness whereof I have hereunto subscribed my name and affixed the seal of said Court, this..... day of..... one thousand eight hundred and eighty..... in the presence of</p> <p>Executed by the above-named..... † Number of action. ‡ Style of action in which sale was held. § Date of commission or order for sale.</p> <p>* Or "Deputy Marshal."</p>									



Chap. 59.

*Maritime Court of Ontario.*

judge] of the said court made the                      day of                      18 ,  
to the Supreme Court of Canada.  
Dated the                      day of                      18 .  
(Signed)                      A.B., Plaintiff,  
(or Defendant.)

No. 41.

Section 202.

## NOTICE FOR CAVEAT WARRANT.

In the Maritime Court of Ontario.

Take notice that I, A.B. of                      apply for a  
caveat against the issue of any warrant for the arrest of [*state  
name and nature of property*], and I undertake, within *three  
days* after being required to do so, to give bail to any action  
or counterclaim that may have been or may be brought  
against the same in this court in a sum not exceeding [*state  
sum in letters*] dollars, or to pay such sum into court.

My address for service is

Dated the                      day of                      18 .  
(Signed)                      A.B.

No. 42.

Section 202.

## CAVEAT WARRANT.

In the Maritime Court of Ontario.

[*State Name of Ship, &c.*]

Caveat entered this                      day of                      18 ,  
against the issue of any warrant for the arrest of [*state name  
and nature of property*] without notice being first given to  
[*state name and address of person to whom, and address at  
which notice is to be given*], who has undertaken to give bail  
to any action or counterclaim that may have been or may  
be brought in the said court against the said [*state name and  
nature of property*].

On withdrawal of caveat add—

Caveat withdrawn the                      day of                      18 .

No. 43.

Section 203.

## NOTICE FOR CAVEAT RELEASE.

In the Maritime Court of Ontario.

[*Title of Action*]

Take notice that I, A.B., Plaintiff [or Defendant] in the  
above-named action, apply for a caveat against the release  
of [*state name and nature of property*].



Chap. 59.

*Maritime Court of Ontario.*

to [state name and address of person to whom, and address at which notice is to be given ]

On withdrawal of the caveat add—

Caveat withdrawn this \_\_\_\_\_ day of \_\_\_\_\_, 18 .

\_\_\_\_\_  
No. 47.

Section 210.

NOTICE FOR WITHDRAWAL OF CAVEAT.

In the Maritime Court of Ontario.

[Title of Action.]

Take notice that I withdraw the caveat [state whether caveat warrant, release or payment] entered by me in this action [or as the case may be].

Dated the \_\_\_\_\_ day of \_\_\_\_\_, 18 .  
(Signed) A. B.

\_\_\_\_\_  
No. 48.

Section 213.

SUBPŒNA.

In the Maritime Court of Ontario.

(L.S.) [Title of Action].

VICTORIA, &c.

To \_\_\_\_\_ Greeting.

We command you \_\_\_\_\_ that, all other things set aside, you appear in person before the judge [of surrogate judge or the registrar, or deputy registrar, or G.H., a commissioner appointed by an order of our said Court of A.B, an examiner] at \_\_\_\_\_ on \_\_\_\_\_ the \_\_\_\_\_ day of \_\_\_\_\_, 18 , o'clock in the \_\_\_\_\_ noon of the same day, and so from day to day as may be required, and give evidence in the above named action.

And herein fail not at your peril.

Given at \_\_\_\_\_, in our said court, under the seal thereof, this \_\_\_\_\_ day of \_\_\_\_\_, 18 .

Subpœna :

Taken out by \_\_\_\_\_

\_\_\_\_\_  
No. 49.

Section 213.

SUBPŒNA DUCES TECUM.

The same as the preceding form, adding before the words: "And herein fail not at your peril," the words "and that you bring with you for production before the said judge [or surrogate judge, registrar or deputy registrar or commissioner, or examiner as the case may be], the following documents, viz.,

[Here state the documents required to be produced.]



and secure arrest and bring him before our judge [or *A. B.*, our surrogate judge].

Given under the seal of our said Court at this            day of

Attachment :

Taken out by

(Signed)

By the Court.

E. F.,  
Registrar,  
(or Deputy Registrar),  
at

No. 52.

Section 218.

ORDER FOR COMMITTAL.

In the Maritime Court of Ontario.

(L.S.)

[*Title of Action.*]

On the

day of

18

Before

Judge [or *A. B.* Surrogate Judge].

Whereas *C. D.* [*state name and description of person to be committed*] has committed a contempt of court in that [*state in what the contempt consists*] and, having been this day brought before the judge [or *A. B.* surrogate judge] on attachment, persists in his said contempt, it is now ordered that he be committed to prison for the term of            from the date thereof, or until he shall clear himself from his said contempt.

(Signed)            E. F.,  
Registrar (or Deputy Registrar).

No. 53.

Section 218.

COMMITTAL.

To the Keepers of the common gaols.

In the Maritime Court of Ontario.

Receive into your custody the body [or bodies] of herewith sent to you, for the cause herein-under written; that is to say,—

For [*state briefly the ground of attachment*].

Dated the

day of

18

(Signed)

J. K.,  
Judge (or Surrogate Judge).

Witness,

E. F.,

Registrar (or Deputy Registrar.)



*Maritime Court of Ontario.*

## Chap. 59.

No. 54.

WRIT OF EXECUTION (FIERI FACIAS, GOODS OR LANDS.) Section 220.

In the Maritime Court of Ontario.

[L.S.] [Title of Action]

VICTORIA, by the Grace of God of the United Kingdom of Great Britain and Ireland, Queen, Defender of the Faith.

To the marshal and each deputy marshal of the Maritime Court of Ontario,— GREETING:

Whereas on the            day of           , 18   , obtained a decree [or order] of this court against            for the sum of            and costs, and it was thereupon ordered by the court that            should pay the same to            [on the            day of            or forthwith, as the case may be].

And whereas default has been in payment according to the said decree [or order.]

We therefore hereby command you, that you cause to be made of the goods and chattels of the said            wheresoever they may be found within the Province of Ontario, the sum of            being the amount due to            under the said decree [or order] including the costs of this writ and incidental thereto, or such part or so much thereof as may be sufficient to satisfy this writ and the costs of executing the same, together with interest at the rate of six per centum per annum on the said sum from the            day of            and to pay what you have so made to the [here designate the proper person entitled thereto, as the case may be] and make return of what you have done under this writ, immediately upon the execution thereof, and have there then this writ.

Given under the seal of our said Court at this day of            18   .

By the Court.

(Signed) A. B., Registrar (or Deputy Registrar.)

(a.) If writ be for non-payment of costs, or moneys ordered to be paid under a special order, as the case may be, the above form may be varied accordingly.

(b.) If writ be against lands, the words "goods and chattels" may be omitted and the words "lands and tenements" inserted.]

Issued from the office of the Registrar [or Deputy Registrar] of the Maritime Court of Ontario, at           , in the County of            Registrar [or Deputy Registrar.]

Chap. 59.

*Maritime Court of Ontario.*

No 55.

Section 226.

## MINUTE OF FILING ANY DOCUMENT.

In the Maritime Court of Ontario.

[*Title of Action.*]I, *A. B.*, [*state whether Plaintiff or Defendant*], file the following documents, viz. :[*Here describe the documents filed.*]Dated the                      day of                      18 .  
(Signed)                      *A. B.*

No. 56.

Section 239.

## FORM OF SECURITY, BY MARSHAL OR DEPUTY MARSHAL.

Know all men by these presents that we, *A. B.*, marshal [or deputy marshal] of the Maritime Court of Ontario; *C. D.*, of                      in the county of                      , and *E. F.*, of                      in the county of                      , do hereby jointly and severally for ourselves and each of our heirs, executors and administrators, covenant and promise that the said *A. B.*, as marshal [or deputy marshal] of the Maritime Court of Ontario shall well and duly pay over to the court all such moneys as he shall receive by virtue of his said office of marshal [or deputy marshal.]

And that he shall not wilfully misconduct himself in his said office to the damage of any person being a party in any proceeding in the said court.

Nevertheless it is hereby declared that no greater sum shall be recovered under this covenant against the said parties hereto than as follows, that is to say:—Against the said *A. B.* in the whole                      dollars. Against the said *C. D.*, in the whole                      dollars. Against the said *E. F.*, in the whole                      dollars.

In witness whereof we have to these presents set our hands and seals this                      day of                      , 18 .

Signed, sealed and delivered, }  
in presence of                      {

No. 57.

Section 239.

## AFFIDAVIT OF JUSTIFICATION.

In the Maritime Court of Ontario.

County of

I, *A. B.*, the principal covenantor in the annexed covenant named (or one of the sureties in the annexed covenant named) do make oath and say as follows:—

*Maritime Court of Ontario.*

## Chap. 59.

1. That I am seized and possessed to my own use of real estate in Ontario to the actual value of \_\_\_\_\_ dollars over and above all charges upon or encumbrances affecting the same.

2. The said real estate consists of (describe property.)

3. I am worth \_\_\_\_\_ dollars (the amount for which the parties become liable by the covenant) over and above my just debts.

4. My post office address is as follows:—

(Signed A. B.

Sworn before me at  
in the county of  
the \_\_\_\_\_ day of \_\_\_\_\_ 188 . }

A Commissioner, &c.

\_\_\_\_\_  
No. 58.

## MINUTE OF ORDER OF COURT.

Section 249.

In the Maritime Court of Ontario.

[*Title of Action.*]

On the \_\_\_\_\_ day of \_\_\_\_\_ 18 .

Before

Judge [*or A.B. Surrogate Judge.*]

The judge [*or A.B. surrogate judge*], on the application of [*state whether Plaintiff or Defendant*] ordered [*state purport of order*].

\_\_\_\_\_  
No. 59.

## MINUTE ON EXAMINATION OF WITNESSES.

Section 249.

In the Maritime Court of Ontario.

[*Title of Action.*]

On the \_\_\_\_\_ day of \_\_\_\_\_ 18 .

Before

Judge [*or Surrogate Judge.*]

A.B. [*state whether Plaintiff or Defendant*] produced as witnesses

[*Here state names of witnesses in full*]

who, having been sworn [*or as the case may be*], were examined orally [*if by interpretation, add by interpretation of*].

No. 60.

Section 249.

## MINUTE OF DECREE.

In the Maritime Court of Ontario.

[*Title of Action.*]

On the                      day of                      18 .

Before

Judge [ *or Surrogate Judge*].(1.) *Decree for an ascertained sum :*

The judge [or A.B., surrogate judge] having heard [state whether Plaintiff and Defendant, or their counsel or solicitors, or as the case may be], and having been assisted by [state names and descriptions of assessors, if any] pronounced the sum of [state sum in letters and figures] to be due to the Plaintiff [or Defendant], in respect of his claim [or counterclaim], together with costs [if the decree is for costs]. And he condemned—

- (a.) *in an Action in rem where Bail has not been given ;*  
           the ship                      [or cargo ex the ship                      , or  
           proceeds of the ship                      , or of the cargo ex  
           the ship                      or as the case may be] in the said  
           sum [and in costs].
- (b.) *in an Action in personam, or in rem where Bail has been given ;*  
           the Defendant [or Plaintiff] and his bail [if bail  
           has been given] in the said sum [and in costs].

(2.) *Decree for a sum not ascertained :*

The judge [or surrogate judge] having heard, &c. [as above] pronounced in favour of the Plaintiff's claim [or Defendant's counterclaim] and condemned the ship                      (or cargo, &c.,) or the Defendant [or Plaintiff] and his bail [if bail has been given] in the amount to be found due to the Plaintiff [or Defendant] [and in costs]. And he ordered that an account should be taken, and

- (a.) *if the amount is to be assessed by the judge [or surrogate judge],*  
           that all accounts and vouchers, with the proofs in support thereof, should be filed within  
           days [or as the case may be].
- (b.) *if the judge or surrogate judge refers the assessment to the registrar [or deputy registrar],*  
           referred the same to the registrar (or deputy registrar) [assisted by merchants], to report the amount due, and ordered that all accounts, &c. [as above].

*Maritime Court of Ontario.*

Chap. 59.

(3.) *Decree on dismissal of action :*

The judge [or surrogate judge] having heard, &c. [as above] dismissed the action [if with costs, add] and condemned the Plaintiff and his bail [if bail has been given] in costs.

No. 61.

MINUTES IN AN ACTION FOR DAMAGE BY COLLISION.

Section 249.

A.B., &amp;c.

No against

The Ship "Mary."

18 Jan. 3	A writ of summons [and a warrant] was [or were] issued to X.Y., on behalf of A.B., &c.. the owners of the ship "Jane" against the ship "Mary" [and freight, or as the case may be] in an action for damage by collision. Amount claimed \$5,000.
" 5	Y.Z. filed notice of appearance on behalf of C. D., &c., the owners of the ship "Mary."
" 6	X.Y. filed writ of summons.
" "	The marshal [or deputy marshal] filed warrant.
" 7	Y.Z. filed bailbond to answer judgment as against the Defendants [or as the case may be] in the sum of \$5,000, with affidavit of service of notice of bail.
" "	A release of the ship "Mary" was issued to Y.Z.
" 8	X.Y. filed preliminary act [and notice of motion for pleadings].
" "	Y.Z. filed preliminary act.
" 10	The judge [or surrogate judge] having heard solicitors on both sides [or as the case may be], ordered pleadings to be filed.
" 11	X. Y. filed petition.
" 14	Y. Z. filed answer [and counterclaim].
" 15	X. Y. filed reply.
" 16	The judge [or surrogate judge] having heard solicitors on both sides [or as the case may be] ordered both Plaintiffs and Defendants to file affidavits of discovery, and to produce, if required, for mutual inspection, the documents therein set forth within <i>three days</i> .

	18	
Jan.	18	X. Y. filed affidavit of discovery.
"	19	Y. Z. filed affidavit of discovery.
"	22	X. Y. filed notice of trial.
"	26	X. Y. produced as witnesses [ <i>state names of witnesses</i> ], who, having been sworn, were examined orally in court, the said [ <i>state names</i> ] having been sworn and examined by interpretation of [ <i>state name of interpreter</i> ] interpreter of the language. Present [ <i>state names of assessors present, if any</i> ] assessors.
		Y. Z. produced as witnesses, &c. [ <i>as above</i> ].
		The judge [ <i>or surrogate judge</i> ] having heard [ <i>state whether Plaintiffs and Defendants, or their counsel or solicitors, as the case may be</i> ], and having been assisted by [ <i>state names and descriptions of assessors, if any</i> ], pronounced in favor of the Plaintiffs [ <i>or Defendants</i> ] and condemned the Defendants [ <i>or Plaintiffs</i> ] and their bail [ <i>if bail has been given</i> ] in the amount to be found due to the Plaintiffs [ <i>or Defendants</i> ] [and in costs]. And he ordered that an account should be taken, and referred the same to the registrar [ <i>assisted by merchants</i> ] to report the amount due, and ordered that all accounts and vouchers, with the proofs in support thereof, should be filed within <i>days</i> [ <i>or as the case may be</i> ].
Feb.	5	X. Y. filed statement of claim, with accounts and vouchers in support thereof [numbered 1 to ], and affidavits of [ <i>state names of deponents, if any</i> ].
"	8	Y. Z. filed accounts and vouchers [numbered 1 to ] in answer to claim.
"	9	X. Y. filed notice for hearing of reference.
"	15	X. Y. [ <i>or Y. Z.</i> ] filed registrar's [ <i>or deputy registrar's</i> ] report, &c.

*Here insert address for service. | Here insert address for service  
of documents required to be | of documents required to be  
served on the Plaintiffs. | served on the Defendants.*

*Note.*—The above minutes are given as such as might ordinarily be required in an action *in rem* for damage by collision, where pleadings have been ordered. In some actions many of these minutes would be superfluous. In others additional minutes would be required.

SCHEDULE B.

TABLES OF FEES TO BE TAKEN BY SOLICITORS, COUNSEL, REGISTRAR AND DEPUTY REGISTRARS, SPECIAL OR OTHER EXAMINERS, OFFICIAL REPORTERS, MARSHALS AND DEPUTY MARSHALS, APPRAISERS, WITNESSES, AND GOVERNMENT FEE FUND. Section 254.

I.—BY THE SOLICITOR.

1. *Instructions.*

1. Instructions for suit or to defend.....	\$ 3 00
2. Instructions for suit or to defend when no warrant is issued.....	2 00
3. Instructions to counsel in special matters.....	1 00
4. Instructions to counsel in common matters.....	0 50
5. Instructions for special affidavit when allowed by taxing officer.....	1 00
6. Instructions for statement of claim or defence or counterclaim.....	1 50
7. Instructions to amend any pleading when amendment is proper.....	2 00
8. Instructions for special case in course of action to add parties by order of judge or surrogate.....	2 00
9. Instructions for brief.....	2 00
10. Instructions for adding parties in consequence of marriage, death, assignment, &c .....	1 00
11. Instructions to defend added parties.....	2 00
12. Instructions for such other important step or proceeding in the action as the taxing officer is satisfied warrants such a charge.....	2 00

2. *Writs.*

13. All writs (except writs of execution and concurrent writs) .....	1 00
14. Concurrent writ.....	0 75
15. Renewed writ (except writ of execution).....	1 00
16. On all writs for every folio over 4.....	0 20
17. Notice of writ under Sec. 16 (including copy)...	1 00
18. Special indorsement on writ of summons.....	0 50
19. { Writ of execution .....	4 00
{ Renewal of writ of execution.....	3 00
(In both cases to include placing the same in the marshal's or deputy marshal's hands, and all attendances, indorsements and letters in connection therewith.)	

3. *Copy and Service of Writs.*

20. For copy including copy of notices required to be indorsed.....	0 50
21. If over 4 folios, for each additional folio.....	0 10

22. Service of each copy (if not done by marshal or deputy marshal or substitute).....	1 00
23. Mileage, if over 2 miles, for each additional mile	0 13
24. For service of writ out of jurisdiction, such allowance as judge or surrogate shall think fit.	

#### 4. *Drawing Pleadings, &c.*

25. Statement of claim or defence or statement of defence and counterclaim not exceeding 10 folios (including copy to keep).....	2 00
26. For every additional folio.....	0 20
27. Other pleadings per folio.....	0 20
28. Special case per folio.....	0 20
29. Interrogatories, &c., per folio.....	0 20
(The above charges do not include engrossing, or copies to file or serve)	
30. { In collision cases preliminary acts not exceeding 10 folios.....	2 00
{ For every additional folio.....	0 20

#### 5. *Copies of Pleadings, &c.*

31. Pleadings, brief and other documents when no other provision is made; for copies properly allowable, per folio.....	0 10
32. Certified copies of pleadings, &c., for use of judge or surrogate. ....	2 00
33. For every folio over 20.....	0 10
34. Copies of orders or other documents for service or for filing, per folio.....	0 10
35. Observations and other original matter in brief, per folio.....	0 20
36. Notices, including one copy of appearance when duly entered and notice given on day of appearance, but not otherwise.....	0 50
37. To consul or officer under Sec. 36.....	0 50
38. If over 3 folios, each additional folio.....	0 20
39. Notice to admit and produce, not over 2 folios and one copy.....	0 50
40. For each additional folio.....	0 20
41. Other notices (common).....	0 50
42. Notice of setting down.....	0 50
43. Notice of motion in court or chambers and copy to serve, per folio, including engrossing.....	0 30
44. Each necessary additional copy of any of above notices for service, per folio .....	0 10
45. Notice of discontinuance and one copy.....	0 50



6. *Perusals.*

46.	Of statement of claim, defence, defence and counterclaim.....	1 00
47.	Of special case, except the one by whom prepared, when case is submitted in course of cause.....	2 00
48.	Interrogatories and cross interrogatories or interrogatories on commission..... (To be increased in discretion of taxing officer to \$5.00.)	1 00
49	{ Of affidavits of party adverse in interest filed or produced on any application, when perusal necessary, 20 folios or under.....	1 00
		{ Every folio over 20, per folio ..... (Not to exceed in any case \$5.00.)

7. *Attendances.*

50	{ Necessary attendances consequent upon service of notice to produce or to admit, or inspection of documents under order, including making admission.....	1 00
		{ To be increased by taxing officer in a case of special, difficult or important nature to.....
51	{ In chambers, on return of motion.....	1 00
		{ To be increased in discretion of judge or surrogate to a sum not exceeding.....
52	{ On counsel, consultation in special, important or difficult matter.....	2 00
		{ To be increased by judge or surrogate to a sum not exceeding..... (No special attendance to be allowed to solicitor on proceedings when he also acts as counsel.)
53	{ Solicitor attending court or trial of action, when not himself counsel or partner of the counsel.	2 00
	{ In special, important or difficult cases, each hour necessarily present at trial.....	1 50
	{ Not to exceed per day..... (Provided such attendance of solicitor and length of time be noted at the time in book of officer of court present at the time or be proved by affidavit)	10 00
54.	To hear judgment, when not given at close of argument or when judgment reserved, each attendance .....	2 00
55.	On taxation of costs, per hour.....	1 00
56.	On revision of costs, per hour.....	1 00
57.	To obtain or give undertaking to appear, when service accepted by solicitor.....	1 00

58.	Attendance to file or serve.....	0 50
59	{ Attendance on appointment of registrar, deputy registrar or examiner, per hour.....	1 00
	{ To be increased in discretion of surrogate or registrar to.....	2 00
60.	Every other necessary attendance .....	0 50
61.	On important points and matters requiring attendance of counsel the registrar, deputy registrar or examiner may certify amount of counsel fee proper to be allowed (to be noted at the time) for guidance of judge or surrogate who may allow same in lieu of fees for attendance..	

8. *Affidavits.*

62.	Drawing affidavits, per folio .....	0 20
63.	Common affidavits of service to include attendance to swear, and oath.....	1 00
64.	Engrossing affidavits to have sworn, per folio....	0 10
65.	Copies of affidavits when necessary, per folio....	0 10
66.	The solicitor for preparing each exhibit.....	0 10

9. *Briefs.*

67.	For drawing briefs, 5 folios or under.....	2 00
68.	For each folio above 5.....	0 10
69.	For drawing brief, per folio, for original and necessary matter.....	0 20
70.	Copy of documents other than pleadings, per folio	0 10
71.	Copy of brief for second counsel, when fee taxed to him, per folio.....	0 10
72	{ Appearance by defendant, including attending to enter same.....	1 00
	{ If over 5 folios, per folio.....	0 20
	{ For every additional defendant.....	0 20

10. *Judgments, or Orders.*

73.	Drawing minutes of judgment or order, per folio, when prepared by solicitor under directions of judge or surrogate, or registrar or deputy registrar .....	0 20
74.	Judgment for non-appearance on specially indorsed writs. ....	1 00
75.	Attending for appointment to settle or pass judgment, or order of court, copy and service.....	1 00
76.	When served on more than one party, the extra copies and services are to be allowed.	

*Maritime Court of Ontario.*

Chap. 59.

77	{	For every hour's attendance before proper officer on settling or passing minutes.....	1 00
		To be increased in the discretion of the taxing officer in special and difficult cases, when the solicitor attends personally, to a sum not exceeding altogether .....	5 00

11. *Letters.*

78.	Letter to each defendant before suit, only one letter to be allowed to any defendants who are in partnership and when subject of suit relates to the transactions of their partnership.....	0 50
79.	Common letters, including necessary agency letters .....	0 50
80.	With power to the registrar or deputy registrar as between solicitor and client, to increase the fee for special and important letters, to an amount not exceeding.....	2 00
81.	Postages—the amount actually disbursed.	

12. *Statements.*

82.	Statements of issues in registrar's or deputy registrar's office when required by them.....	2 00
83.	For each folio over 10.....	0 20

II.—COUNSEL FEES.

84.	On argument in chambers in cases proper for the attendance of counsel (to be increased in the discretion of the judge or surrogate to a sum not exceeding \$10.00 to be marked at the time)..	2 00
85.	Fee on settling pleadings, replications (when special) and advising whether cause should be set down for examination and hearing, and advising on evidence (to be increased in the discretion of the judge or surrogate to a sum not exceeding \$10.00).....	2 00
86.	On special applications to the court, (to be increased in the discretion of the judge or surrogate only) .....	5 00
87.	Fee to be allowed on settling special affidavits used in court (to be increased at the discretion of the registrar or deputy registrar to a sum not exceeding \$5.00).....	2 00
88.	On special and important points and matters requiring the attendance of counsel, the judge or surrogate, registrar or deputy registrar or special-examiner may, in lieu of the fees for attendance, allow a counsel fee when counsel attended the same, (to be noted at the time) not to exceed.....	5 00

89. Fee on consultation when necessary.....	5 00
90. Fee with brief at trial.....	10 00
(To be increased by judge or surrogate at his discretion.)	
91. To attend reference to registrar or deputy registrar, when counsel necessary.....	5 00
(To be increased in special and important matters requiring the attendance of counsel by the judge or surrogate upon notice to the opposite party.)	

---

### III.—MISCELLANEOUS.

92. When it has been satisfactorily proved that proceedings have been taken by solicitor out of court to expedite proceedings, save costs, or compromise suits, an allowance is to be made therefor in the discretion of the judge or surrogate.	
93. Drawing judge's or surrogate's appointment, and attendance for his signature and to serve.....	1 00
(When served on more than one party the extra copies and services shall be allowed.)	
94. Drawing bill of costs as between party and party for taxation, including engrossing and copy for taxing officer, per folio.....	0 30
95. Copy, per folio, to serve.....	0 10
96. The registrar or deputy registrar in taxing costs between solicitor and client or between party any party may allow for services rendered, not provided for by this tariff, a reasonable compensation as far as practicable analogous to its provisions, not in any case to exceed the fees allowed for similar services by the tariff of the Supreme Court of Judicature for Ontario, if therein provided for.	

---

### IV.—COURT FEES.

97. Fee on certified copy of pleading for judge or surrogate.....	1 00
98. Fee on every order or judgment to the party obtaining the same.....	1 00

---

*Maritime Court of Ontario.*

## Chap. 59.

## V.—DISBURSEMENTS.

1. *Fees to be taken by the Registrar or Deputy Registrar.*

99. Every writ of summons.....	0 50
100. Entering appearance and filing memorandum thereof.....	0 20
101. Filing statement of claim.....	0 20
102. Filing statement of defence or counterclaim.....	0 20
103. Entering and filing all other proceedings and affidavits on production, interrogatories and depositions or other evidence.....	0 20
104. Filing other papers.....	0 10
105. Every instrument under seal of court for which a fee is not specially named.....	1 00
106. Certificate of arrest.....	1 00
107. Amending every writ or other proceeding.....	0 30
108. Instructions under Sec. 45.....	0 50
109. Every attendance on warrant or appointment, not exceeding one hour.....	1 00
110. Every additional hour, or less.....	1 00
111. Filing preliminary acts.....	0 50
112. Filing special case.....	0 50
113. Certificates of not more than 2 folios, to include forwarding same under rules, except postage.....	0 50
114. For each additional folio.....	0 20
115. Notice to assessors, each.....	0 25
116. Setting down for trial.....	4 00
117. Forwarding papers from one office to that of another.....	0 50
(And postage or express charges.)	
118. Drawing report on reference or decree or court order when prepared by registrar or deputy registrar of not more than 3 folios.....	1 00
119. For each additional folio.....	0 20
120. Each notice from registry not otherwise provided for.....	0 25
121. Notice of sale, or notice of proceeding in cause of possession.....	0 75
122. Each direction to the bank to receive money....	0 50
123. Fee on filing receipt and papers from deputy registrar on payment into court.....	0 25
124. Deputy registrar forwarding receipt and papers as to payment to registrar.....	0 25
125. Subpœna, including præcipe.....	0 50
126. Fee to registrar entering institution of action in book whether at head office or deputy registrar's .....	0 60

*Maritime Court of Ontario.*

## Chap. 59.

4. *Fees to be taken by Official Reporter.*

Section 123.

155. For every day's attendance in court.....	5 00
156. For first copy of evidence if required by party, or by judge or surrogate, per folio.....	0 10
157. For each additional copy, per folio:.....	0 05

5. *Fees to be taken by the Marshal or Deputy Marshal.*

158. Receiving, filing, entering and indorsing every paper .....	0 25
159. Attendance to swear all necessary affidavits.....	0 50
160. On the execution of every warrant.....	2 00
161. Service of writ of summons <i>in personam</i> , each defendant.....	1 00
162. Serving subpoenas, rules, notices or other papers, (besides mileage).....	0 50
163. Actual and necessary mileage from the court house to the place where service of any process, paper or proceeding is made, per mile.....	0 13
164. On the execution of attachment for every person attached.....	2 00
165. On the execution of every decree or commission of un-livery, appraisement or sale.....	2 00
166. On the execution of every other instrument for which a fee is not specially provided.....	1 00
167. On attending, appointing and swearing appraisers, each.....	1 00
168. On delivering up ship, vessel, goods or property to the purchaser agreeably to the inventory.....	2 00
169. Fee on bill of sale of ship.....	1 00
170. On attending the un-livery of the cargo, or sale of ship, or vessel or goods, per day.....	2 00
{ On retaining possession of a ship or vessel, or of ship or vessel and goods, per day .....	0 50
171 { Exclusive of such reasonable disbursements actually incurred in the custody thereof as the registrar or deputy registrar may allow, not exceeding per day of 24 hours.....	2 00
(If the marshal or deputy marshal or any of his substitutes is required to go a greater distance than five miles from his office to perform any of the above duties, he will be entitled to his reasonable expenses for travelling, board and maintenance, as the registrar or deputy registrar may allow.)	
172. Poundage on the proceeds of any vessel, goods or property sold under the decree or order of the court if under \$250.00.....	1 00
173. If over \$250.00 and not exceeding \$500.00.....	2 00

Chap. 59.

*Maritime Court of Ontario.*

127. Fee to deputy registrar sending notice.....	0 25
128. Order in chambers, including entering.....	0 50
129. Entering decrees and other orders per folio.....	0 10
130. Copy of papers required to be given out, per folio.....	0 10
131. Searches within one year, each.....	0 10
132. Searches extending over one year and within two years.....	0 20
133. Searches extending over two years or a general search .....	0 50
134. Every affidavit, oath or affirmation taken.....	0 20
135. Marking each exhibit.....	0 20
136. Every appointment.....	0 50
137. Each attendance on reference or other special matter per hour, or enlargement thereof .....	1 00
138. Attending the opening of a commission.....	1 00
139. Every commission for examination of witnesses or parties.....	1 00
140. Each verdict taken, non suit, record withdrawn, or rule or order of reference at trial.....	1 00
141. Attending on inspection of documents produced with affidavit on production, per hour.....	1 00
142. Taxing costs, per hour.....	1 00

2. *Fees to be taken by the Registrar only.*

143. Countersigning cheque for payment of money out of court, if sum paid out does not exceed \$500.00.....	0 50
144. For every additional \$500.00.....	0 50

3. *Fees to be taken by a Special Examiner or Registrar or Deputy Registrar acting as Examiner.*

145. Every appointment.....	0 50
146. Every oath.....	0 20
147. Marking exhibit.....	0 20
148. Attendance, per hour.....	1 50
149. Fair copy for solicitor, per folio (when required). .....	0 10
150. Every certificate.....	0 50
151. Making up and forwarding answers, depositions &c.....	0 40
152. Every attendance out of office within 2 miles....	2 00
153. Every such attendance, over 2 miles, every extra mile.....	0 20
154. Every such attendance, when either solicitor or witness does not attend, and examiner not previously notified .....	1 00

## Chap. 59.

*Maritime Court of Ontario.*

174. For every additional \$500.00.....	0 50
175. Calling each cause at the hearing in court.....	1 00
176. Calling each witness.....	0 10

*6. Fees to be taken by Appraisers.*

177. Each, per appraisalment.....	2 50
(To be increased to a sum not exceeding \$5.00 in the discretion of the registrar or deputy registrar.)	

Section 130.

*7. Fees to be taken by Assessors.*

178. Each, per day (to be distributed rateably among the causes if more than one tried in a day).....	6 00
---	------

*8. Allowance to Witnesses.*

179. To witness residing not more than three miles from the place to which summoned, per day.	1 00
180. To witness residing over three miles from such place .....	1 25
181. Barristers and attorneys and solicitors, physicians and surgeons, when called upon to give evidence in consequence of any professional service rendered by them or to give opinions, per day.....	4 00
182. Engineers and surveyors, when called upon to give evidence of any professional service rendered by them, or to give evidence depending upon their skill or judgment, per day .....	4 00
183. If the witnesses attend in one cause only, they will be entitled to the full allowance.	
184. If they attend in more than one cause they will be entitled to a proportionate part in each cause only.	
185. The travelling expenses of witnesses over ten miles, shall be allowed according to the sums reasonably and actually paid, but in no case shall exceed twenty cents per mile one way.	

*9. Government Fee Fund.*

186. On every writ by which action is commenced ..	2 00
187. On every appearance and pleading filed.....	1 00
188. On every replication filed.....	1 00
189. On every order, decree, office copy and other document sealed with the seal of the court.....	0 50
190. On the hearing of every case.....	2 00
191. On the hearing of every appeal from the registrar or deputy registrar.....	2 00

When judge or surrogate on final disposition of action, orders only half costs under section 257, then one-half of fees to be allowed under this head.



## CHAPTER 60.

### PENITENTIARY REGULATIONS.

Government House, Ottawa,

The 29th day of January, 1889.

On the recommendation of the Minister of Justice and under the provisions of Chapter 182 of the Revised Statutes of Canada, intituled "The Penitentiary Act,"—

His Excellency in Council has been pleased to approve and does hereby approve of the following regulations made by the Inspector of penitentiaries for the government of the penitentiaries in Canada:—

#### WARDEN.

Section 1. The warden shall reside where the Minister of Justice may direct. His family and servants shall avoid intercourse with convicts. Residence of warden.

Sec. 2. During the visits of the Inspector, he shall give to that officer all necessary information and assistance in the execution of his duties. Information and assistance to Inspector.

Sec. 3. He shall promptly carry out all the orders made, and instructions given from time to time by the Inspector. Orders and instructions.

Sec. 4. He shall not absent himself from the prison for more than forty-eight hours, without obtaining leave. 48 hours' absence.

Sec. 5. He shall notify the deputy warden in writing, when he intends to be absent for more than twenty-four hours. When 24 hours absent.

Sec. 6. He should be careful to select as officers whom he is authorized to appoint, men of the best moral character, competent, physically fit, and not over forty-five years of age, and to retain in the service only those who are careful, vigilant, zealous and not inefficient from age or infirmity, in the performance of their duties. Selection of officers; 45 years of age.

Sec. 7. Whenever the warden appoints any officer he shall at once report the fact to the Inspector for the information of the Minister of Justice, and such appointment shall not be permanent until the Minister so directs. Appointment of officers, and report to Inspector.

Sec. 8. The warden may, upon any emergency, employ supernumerary guards, so long as required, a report of such employment to be made, immediately, to the Inspector. Supernumerary guards.

Responsibility of warden.

Sec. 9. He shall be responsible for the conduct and efficiency of every officer on the staff, and for the efficient administration of every department of the prison with the details of which he should be thoroughly conversant, and he shall at all times be prepared on the request of the Inspector to render him an account. It shall be his duty, without giving any encouragement to the degrading and demoralizing system of spying, to make himself acquainted with the conduct and general habits of every officer and servant of the institution; as it will be his duty to retain no man in the service, whose conduct is improper, or who is not zealous and competent.

His duty as regard conduct of officers and servants.

Power to fine for misconduct.

Sec. 10. He shall have power to impose a fine for misconduct, on the part of an officer, of a nature not to require dismissal, the amount of the fine to be retained out of the next payment of salary, until the approval or disapproval of the Minister has been signified by the Inspector, to whom he shall make a report of the penalty and its cause.

Letters and memoranda addressed to Inspector.

Sec. 11. He shall forward, at once, to the penitentiary branch, all letters, memoranda, &c., addressed to the Inspector and placed in his hands for that purpose, by either the officers or convicts, accompanying the same with such remarks as he may see fit.

Care in the administration of every department of the penitentiary.

Sec. 12. He shall take care that the administration of every department of the penitentiary be characterized by a sense of justice and morality; impressing upon every officer under his control the necessity of giving good example to one another and to the convicts, and of avoiding profane language or display of bad temper, especially in the presence of the prisoners.

Report on conduct and efficiency of staff.

Sec. 13. He shall report upon the conduct and efficiency of the staff to the Inspector during each of his periodic visits; and he shall also report immediately, by telegraph and by first mail, in writing, anything of an extraordinary or serious nature that may occur.

Returns and reports required by the Inspector.

Sec. 14. He shall make such returns and reports as the Inspector may from time to time require, and particularly at every stated visit, a report of the proceedings at the prison, from the date of the previous report, up to the day of the Inspector's arrival, and of the then actual condition of the penitentiary. He shall not enforce any new rule of his own making without first having reported the same to the Inspector and obtained the sanction of the proper authority, except when an emergency may arise, and in such case he shall forthwith report the same to the Inspector.

*Penitentiary Regulations.*

Chap. 60.

Sec. 15. He shall also, before the first day of September, render an annual report to the Inspector, giving a full statement of the condition and progress of the penitentiary, and of all the facts and affairs of interest affecting the prison which took place during the financial year, which expired on the previous 30th day of June. Annual report before the 1st of September, what to contain.

Sec. 16. The annual report of the warden shall be accompanied with the following reports and returns, in which, whenever necessary, male prisoners are to be distinguished from females :— Reports and returns to accompany annual report of warden.

- |  |   |  |  |
|--|---|--|--|
| <ul style="list-style-type: none"> <li>I. Reports of the Protestant and Roman Catholic chaplains.</li> <li>II. Report of the surgeon.</li> <li>III. Report of the matron.</li> <li>IV. Report of the schoolmaster.</li> <li>V. A list of convicts received into the penitentiary during the year, with statistical details from the register, as to crime, nationality, religion, &amp;c.</li> <li>VI. Statement of the movement of convicts during the year, distinguishing the number of insane.</li> <li>VII. Comparative movement for the previous ten years.</li> <li>VIII. List of convicts pardoned during the year, with the crime and place where convicted.</li> <li>IX. List of convicts who have become insane during the year, with their present state.</li> <li>X. List of convicts who have died, with crime and place of conviction.</li> <li>XI. List of convicts recommitted and number of recommitments.</li> <li>XII. Table of crimes and number of convicts guilty of each crime.</li> <li>XIII. Tabular statements showing length of sentences and number of convicts sentenced to each period.</li> <li>XIV. Ethnology of convicts.</li> <li>XV. Nationalities and number of convicts of each nationality.</li> <li>XVI. Ages.</li> <li>XVII. Religious belief.</li> <li>XVIII. State of education.</li> <li>XIX. Occupations.</li> <li>XX. Civil condition.</li> <li>XXI. Moral habits.</li> <li>XXII. Punishments.</li> <li>XXIII. Days of remission of sentence earned.</li> <li>XXIV. Employments.</li> <li>XXV. The work and the number of days work in each employment.</li> </ul> | } | These statistics are to include all convicts confined in the penitentiary. | <ul style="list-style-type: none"> <li>Reports of chaplains.</li> <li>Surgeon.</li> <li>Matron.</li> <li>Schoolmaster.</li> <li>List of convicts.</li> <li>Movement for the year.</li> <li>Previous ten years.</li> <li>Convicts pardoned.</li> <li>Convicts become insane.</li> <li>Convicts who have died.</li> <li>Recommitments.</li> <li>Table of crimes.</li> <li>Length of sentences.</li> <li>Ethnology.</li> <li>Nationality.</li> <li>Ages.</li> <li>Religion.</li> <li>Education.</li> <li>Occupations.</li> <li>Condition.</li> <li>Morals.</li> <li>Punishments.</li> <li>Remission.</li> <li>Employments.</li> <li>Work and number of days.</li> </ul> |
|--|---|--|--|

## Chap. 60.

*Penitentiary Regulations.*

Table of earnings.	XXVI. Table of the earnings of convicts in each description of labor.
Serious accidents.	XXVII. List of convicts to whom accidents of a serious nature have happened.
List of officers.	XXVIII. List of the officers, their salary, rank, nationality, religion, age and date of appointment.
Revenue and expenditure.	XXIX. Statement of revenue and expenditure, with the different heads of each.
Balance.	XXX. Balance sheet.
Statement of debts.	XXXI. Statement of debts due to the penitentiary, with the names of the debtors, the date when the debt was contracted, and the amount due opposite each name.
Statement of claims.	XXXII. Statement of claims outstanding against the institution, with the names of the claimants and the amounts claimed by each.
Statement of volumes in the several libraries.	XXXIII. Statement of the number of volumes in the general library and in the Protestant and Roman Catholic libraries respectively, showing the number of volumes added during the year and the total amount of outlay for each library, the number of convicts who have used books in each library, and the number of volumes issued during the year.
Valuators' inventory.	XXXIV. Copy of the inventory in detail made by the valuers.

Estimate of expenditure for the following year.

Expenditure outside of ordinary supplies, how provided for.

Sec. 17. The warden shall, when so instructed, furnish to the Department of Justice, an estimate of the expenditure for the following year for the ordinary expense of maintenance, under the different heads, and for extraordinary expenses separately. He shall make no expenditure outside of the ordinary supplies, without first having obtained the sanction of the Minister of Justice, even though provision for such expenditure be voted by Parliament.

Custody of books of the institution.

Sec. 18. The warden shall have the official custody of all the books of the institution, including the Inspector's minute book, with the contents of which he shall make himself acquainted, and shall, as occasion may require, take such action as may therein be ordered or intended. He shall not allow any of those books out of his possession, without the written authority of the Minister of Justice or the Inspector.

Personal inspection of books.

Sec. 19. He shall see, by personal inspection, that all books are properly and regularly kept by the respective officers.

*Penitentiary Regulations.*

## Chap. 60.

Sec. 20. Supplies for the prison shall be obtained by contract, wherever practicable. Supplies.

Sec. 21. The warden shall enter into no contract affecting the interests of the prison, without the sanction of the Minister of Justice. Contracts.

Sec. 22. No contract shall be entered into unless due notice shall have been given by public advertisement, or by circular as may be directed by the Minister of Justice. Public advertisement for contracts.

Sec. 23. The warden shall exact the faithful fulfilment of the contracts. Should there be any default on the part of a contractor in not furnishing an article or articles of supplies of the kind and quality contracted for, the warden shall (upon the refusal or neglect of the contractor to do so, after being duly notified) if they are required, purchase the article or articles, the price of which shall be charged in the accountant's books against the contractor. Fulfilment of contracts and directions in cases of default.

Sec. 24. He shall have charge of the health, conduct and safe-keeping of the prisoners, and shall examine into and promote the success of the religious, moral and industrial appliances provided for their reformation. Health, conduct and safe-keeping of prisoners.

Sec. 25. He shall, when not otherwise officially engaged, see every prisoner, not in hospital, at least, once every day, and be, at all times, responsible for the proper and judicious assignment of labor, and the place of labor to every convict. He shall make regular visits to every part of the prison, entering in the daily journal the particular portion inspected by him, each day, as also all occurrences and circumstances that he may deem it necessary to record. Visiting prisoners and prison and entry in daily journal.

Sec. 26. He shall satisfy himself, every evening, before leaving the prison, that all is safe, and enjoin upon his deputy or such officer as he or the deputy may appoint for the purpose, the duty of seeing that the keeper for the night is at his post and the night guards are on the alert. Safety of prison and oversight of keeper and night-guards.

Sec. 27. He shall be present in the dining hall, as frequently as possible, during the hours of meals, where meals are not taken in the cells. In both cases, he shall be present, at least three times a week, to see that the victuals at all meals are of good wholesome quality, sufficient in quantity, properly cooked and served. Presence at meals.

He shall deliver to convicts all letters which have been approved by him after reading them, and shall receive from Letters to convicts.

the convicts letters which they desire to transmit, and after reading them shall have them mailed if they meet with his approval.

Convict entering prison, conduct of warden in such case.

**Sec. 28.** When a convict is received into the prison the warden shall give a receipt for him to the person who delivers him, and shall direct the convict to be bathed and examined by the surgeon as soon as possible. The convict shall then be clothed in the prison dress, and the warden shall read or cause to be read, over to him the portion of the rules and regulations of the prison, which are usually kept in the cells of the prisoners, in English or French according to the language of the convict, and shall direct him if free from disease, to be sent to a solitary cell (where such cells have been constructed) for probationary treatment.

Convict, suffering from disease.

**Sec. 29.** Should the convict be suffering from any disease, the warden shall obtain from the surgeon a written statement of the fact, and shall dispose of him in such manner as the surgeon may direct.

Inventory to be entered in "The Prisoners' Effects Book."

**Sec. 30.** The warden, in obedience to the statute, shall at the time of a convict being received, cause a complete inventory to be made of every article found upon him, and a description thereof to be entered in a book to be kept for that purpose to be called "The Prisoners' Effects Book," and such articles shall be safely kept and returned to the convict, upon his release, unless otherwise disposed of with the convict's consent.

Convicts' money to be deposited in Government Savings Bank.

**Sec. 31.** Should any money be found upon a convict on his arrival, the warden shall deposit the same, in the Government Savings Bank in his corporate name, in trust for the convict; should he conceal any money at any time, it shall be forfeited and applied, by order of the inspector, to such purpose as the Minister of Justice may direct.

Report to chaplain of name, number, crime and period of sentence of each convict.

**Sec. 32.** The warden shall report without delay to the chaplain, under whose spiritual charge a convict is to be placed, his name, his number on the registrar, crime and period of sentence, and he shall afford any necessary aid and facility to the chaplains to perform their duties efficiently and well. The warden shall take due care that the religious opinions of convicts are not interfered with by any officer of the prison or by others.

Report to chaplain, of convict sent to hospital.

**Sec. 33.** He shall also report to the chaplain without delay, the name of any convict sent to hospital, or to a solitary cell, and, at least two days previously, the names of all convicts under his charge about to be discharged.

*Penitentiary Regulations.*

## Chap. 60.

Sec. 34. He shall place under the care of the schoolmaster every convict who requires instruction, unless the convict's conduct be such as to render him undeserving of that privilege. He shall from time to time designate the employment of every convict, having regard to his capacity, past pursuits and habits, and if it seem necessary, shall consult the surgeon thereon. In assigning employment to convicts there shall be no semblance of favoritism or prejudice.

Placing under care of schoolmaster convict requiring instruction.

Employment of convict.

Sec. 35. When convicts are congregated together in the workshops or other places of labor, the warden shall see that they observe the rule of silence and are kept as far apart and allowed as little intercourse as the nature of the different employments will admit.

Silence and non-intercourse to be observed.

Sec. 36. He shall see that there is an efficient superintendence of the convicts when attending Divine Service in chapel, and should there be service in both chapels at the same time, the warden or deputy warden shall be present in one chapel and the deputy warden or the chief keeper in the other, and in the case of the absence of the chief keeper some other superior officer named by the warden, shall take that duty.

Superintendence of convicts while attending Divine Service.

Sec. 37. The warden shall carefully inquire into every report made against a convict; the complainant and any other necessary witness shall be present, to give testimony, at the investigation, and the warden shall act in the matter according to the evidence. If the offence be proved, he shall award such punishment as it may justify, seeing that no unnecessary severity be used.

Report against convict to be carefully inquired into.

Sec. 38. Should it be necessary to inflict corporal punishment, the warden shall take evidence under oath, which he shall transmit, at once, to the Inspector, in order that the punishment be considered by the Minister. Should no order to the contrary be received by the warden, the punishment may be inflicted. He shall also notify the surgeon at once of the time thereof, but no corporal punishment shall be inflicted until, nor unless, the surgeon certify in writing upon the report book, opposite to the entry of the report, that the convict is "fit."

Corporal punishment.

Sec. 39. If the surgeon shall pronounce the convict "fit" the warden shall name the officers, who are to inflict the punishment, and the number of lashes to be given by each. The warden shall be present at the punishment himself, unless he be prevented by unavoidable absence,

Punishment, how inflicted and in whose presence.

## Chap. 60.

*Penitentiary Regulations.*

sickness or other disability, in which case the deputy shall be present in his stead.

Report in case of corporal punishment.

Sec. 40. The warden shall make a report to the Inspector in every case of corporal punishment, stating the nature of the offence and the evidence of the convict's guilt, taken under oath. He shall enter in the report and punishment book any change in the penalty recorded against a convict, and the reason for such change.

Two convicts shall not occupy the same bed or cell.

Sec. 41. He shall see that two convicts be never allowed to occupy the same bed, nor the same cell under any circumstances.

Discharge of convicts.

Sec. 42. In connection with the discharge of every convict the warden will comply with the provision made in section 63, clause 4 of "The Penitentiary Act."

New clothing, &c.

Sec. 43. The warden shall issue, in writing, all orders for new clothing or repairs.

Rules and orders to be reported.

Sec. 44. As occasion may arise, at the several penitentiaries, when it will be necessary for the warden to issue any important rules or orders, it shall be his duty to report such rules or orders immediately to the Inspector for the consideration of the Minister of Justice.

Order to deputy, &c., to be in writing.

Sec. 45. Every order issued by the warden to the deputy, chief keeper, and other officers, shall be in writing, of which a copy shall be kept in the proper book.

Reading of rules, &c., to officers.

Sec. 46. The warden shall, on the first Tuesday of every month, order a muster of the officers in their hall, for the purpose of reading over and explaining to them the rules and regulations. At St. Vincent de Paul Penitentiary the rules and regulations shall be read and explained in French and English.

## CHAPLAINS.

Religious instruction, &c.

Sec. 47. The chaplains shall give due attention to the religious instruction, and moral improvement, of the prisoners under their care.

Religious service.

Sec. 48. Religious service shall be performed in their respective chapels every morning at the opening of the prison, either by the chaplain or by an officer appointed for that purpose by the warden with the approval of the chaplain.



*Penitentiary Regulations.*

## Chap. 60.

Sec. 49. The Protestant chaplain shall, when practicable, as at Kingston and St. Vincent de Paul, celebrate divine service twice on Sundays, and days appointed to be celebrated as days of fast or thanksgiving, in the forenoon, between the hours of eight and eleven, and in the afternoon, between the hours of one and four.

Divine service, how often to be celebrated by Protestant chaplain.

Sec. 50. The Roman Catholic chaplains to the penitentiaries at Kingston and St. Vincent de Paul, shall celebrate divine service twice every Sunday, and at such other times as may be appointed by the Roman Catholic Bishop of the diocese, in which the penitentiary is situated, and which may be approved of by the Inspector, and the chaplains to the other penitentiaries shall officiate, on Sundays as regularly as possible.

Divine service how often to be celebrated by Roman Catholic chaplain.

Sec. 51. The Protestant chaplain shall see that every convict under his charge, who can read, be supplied with a copy of the authorized English version of the Bible without note or comment, and those who desire it with a copy of the Prayer Book of the Church of England.

Supplying Protestants with Bible and Prayer Book.

Sec. 52. The Roman Catholic chaplain shall see that convicts of that religious belief who can read, are supplied with such version of the Bible and Prayer Book as he may indicate.

Supplying Catholics with Bible, &c.

Sec. 53. The chaplains shall confine their religious instructions to those convicts only, whose names are transmitted to them respectively by the warden, as being placed under their charge, and they shall make no attempt directly or indirectly to proselytize any convict, nor endeavor to withdraw him from the care of the chaplain to whom he has been assigned.

Confining religious instruction to certain convicts.

Sec. 54. They shall be diligent in seeing and conversing with the convicts at all reasonable times, of which times the warden shall be the judge, in their cells or in the hospitals or chapels, and in imparting to them such instructions and ministrations as may be calculated to promote their spiritual welfare, their moral reformation and due obedience to the rules and authorities of the prison.

Seeing and conversing with convicts.

Sec. 55. When the chaplains impart religious instructions to the convicts collectively, on a week day, they shall attend during the dinner hour for that purpose, in order not to interfere with discipline or labor.

Religious instructions on week day.

## Chap. 60.

*Penitentiary Regulations.*

Visiting convicts sick, &c.

Sec. 56. They shall visit daily those convicts who are sick or under punishment, and, as soon as possible, every convict just received into prison.

Encouraging convicts to complain, to be guarded against.

Sec. 57. They shall guard themselves carefully against encouraging convicts to make complaints as to their treatment, or as to the officers of the prison. They shall not communicate to them without the consent of the warden, any information or knowledge of anything, which may have occurred without the precincts of the prison, or any intelligence whatever not in the strict line of their duty.

Communicating information.

When convict brought before executive, chaplain may submit facts of the case to Inspector in writing.

Sec. 58. In the case of any convict which, in the opinion of the chaplain, should be brought under the notice of the executive, the chaplains may submit, through the warden, the facts of such case to the Inspector in writing; but they shall not in any way interfere to procure the release of any convict, nor shall they give to any one any hope of a pardon, or promise of any aid in procuring it; but they shall on the contrary endeavor to convince him of the justice of his sentence, and enjoin upon him faithfully and zealously to endeavor to work out for himself the remission of a period of his imprisonment, as provided in the statute, by industry, by strict observance of the prison rules and by cheerful obedience to the officers of the prison.

Writing letters for convicts.

Sec. 59. They shall not write any letter for a convict, except with the permission of the warden.

Abuse, misconduct, &c.

Sec. 60. They shall communicate to the warden any abuse, misconduct, impropriety or irregularity which may at any time come to their knowledge in relation to the prison, or to any officer or convict therein.

Directing operations of the schools.

Sec. 61. It shall be the duty of the chaplains to direct the operations of the male and female schools, visit them frequently, see to their proper management and efficiency, note the system of education and its results, as shown by the progress of the convicts in learning, make report to the warden of anything which they or any one of them may see amiss in the schoolmaster or schoolmistress, or in any mode of teaching with such opinions or suggestions as he or they may think conducive to the educational interests of the convicts, or to the improvement of the schools.

Reporting religious and moral condition of convicts.

Sec. 62. Each chaplain shall make a report through the warden to the Inspector, at his periodic visits, and oftener should it be required, of the religious and moral condition

*Penitentiary Regulations.*

## Chap. 60.

of the convicts, and of such occurrences in the performances of his duties as he may consider of interest.

Sec. **63.** Each chaplain shall make to the Inspector, through the warden, before the first of September every year, a full report of his proceedings for the year, the progress of the convicts under his charge in morality and religion, the fruits of his labors among them, and such other information and remarks on the past year's experience as he may think useful.

Report of chaplain, every year, when to be made and what to specify.

Sec. **64.** When a chaplain of Kingston or St. Vincent de Paul Penitentiary desires to be absent for any time, not exceeding forty-eight hours, he shall notify the warden and report the name of the clergyman who shall take his place. For any longer period application must be made by him through the warden to the Inspector.

Absence of chaplain at Kingston or St. Vincent de Paul.

## ASSISTANT CHAPLAINS.

Sec. **65.** Where assistant chaplains are appointed, their duties shall be the same as those of the chaplains. The details as to time and place for performing them may be arranged between each chaplain and his assistant, or be fixed by the Inspector.

Same duties as chaplains.

## OTHER MINISTERS.

Sec. **66.** Ministers of any denomination of Christians, on the invitation of the chaplain, shall be allowed at times convenient, to be fixed by the warden, to visit the penitentiary for the religious instruction of such convicts as may be adherents of the same denomination as the ministers so visiting. Should a convict desire to be visited by any particular minister, the warden shall signify such wish to the minister named and he shall fix a time for the visit.

Ministers of any denomination may be allowed to visit penitentiaries.

## SURGEONS.

Sec. **67.** The surgeon shall have full control over the patients in hospital and in Kingston penitentiary over the criminal insane asylum, subject to the rules of the prison and instructions of the Inspector. He shall attend on all occasions, when necessary, to the wants of sick convicts, whether in their cells or in the hospital.

Control over patients; and in Kingston, over the criminal insane asylum.

Sec. **68.** He shall visit the prison every day, except on Sundays and holidays, between the hours of ten and twelve in the forenoon, and on Sundays and holidays between the hours of two and four, afternoon.

Hours of visiting prison.

## Chap. 60.

*Penitentiary Regulations.*

Other hours  
in special  
cases.

Sec. 69. When the state of a sick convict requires it, he shall visit at such other hours as he may think the case demands and if sent for at any time by the warden or deputy warden he shall immediately repair to the prison to the exclusion of all other engagements.

Examining  
prisoners in  
solitary cells.

Sec. 70. He shall from time to time examine prisoners in the solitary cells, and shall report to the warden any one whose health he thinks is suffering or endangered by a continuance of the labor he is employed at or from the confinement.

Ascertaining  
as to putrid,  
infectious or  
cutaneous  
diseases on  
the reception  
of a convict.

Sec. 71. Upon the reception of a convict into the penitentiary, the surgeon shall examine him to ascertain whether he is infected with any putrid, infectious or cutaneous disease, whether he labors under any bodily defect, or has any bodily deformity, and whether he has been vaccinated. He shall report the facts to the warden. Should the convict not have been vaccinated the surgeon shall vaccinate him as soon as possible.

Free of  
charge.

Sec. 72. He shall attend the officers and servants of the prison free of charge. This attendance does not extend to the families of the officers.

His duty in  
regard to the  
diet of prison  
and diet of  
patients  
under his  
charge.

Sec. 73. It shall be his duty to advise with the Inspector or warden as to the diet of the prison and he shall direct as to the diet of the patients under his charge. Should any neglect occur with respect to the diet of a patient, he shall at once make report thereof to the warden, and, if necessary, to the Inspector.

Power in case  
of epidemic.

Sec. 74. In times of present or of threatening epidemic, he shall have power to direct, after a written report to the warden, such changes in the general diet of the prisoners as he may consider advisable. He shall make report of the same to the Inspector also, at his next visit thereafter.

Duty and  
functions in  
case of cor-  
poral punish-  
ment.

Sec. 75. When a convict is ordered for corporal punishment, the surgeon shall state in writing over his signature, upon the punishment or report book, whether or not the convict is "fit" for the number of lashes ordered, or for any less number. He shall be present at the place and time of such punishment, of which he shall be duly notified by the warden, and shall remain while the punishment is being inflicted.

Hygiene and  
cleanliness of  
prison, &c.

Sec. 76. He shall give special attention to the hygiene and cleanliness of the prison and prisoners, ventilation of

*Penitentiary Regulations.*

## Chap. 60.

the dormitories, workshops and other chambers, and to the water supply and drainage. He shall report such improvements therein to the warden and Inspector as he may think beneficial.

Sec. 77. He shall keep such books, and in such form as from time to time may be indicated to him according to schedules ordered by the Inspector, all of which books shall be open at all times to the warden. Books to be kept.

Sec. 78. When the surgeon considers it necessary, or when required by the Inspector or the warden to make a *post mortem* examination of any deceased convict, he shall do so within thirty-six hours after the decease. He shall make such report as he may think necessary, of the examination to the warden, and of the conclusions he may have arrived at as to the cause of death. Post mortem examination.

Sec. 79. Whenever it is necessary for the surgeon to be absent for any time not exceeding twenty-four hours he shall notify the warden thereof, and if for a longer period, he shall apply through the warden to the Inspector for leave of absence. But the surgeon shall, at his own expense, provide a substitute to be approved of by the warden in the one case and by the Inspector in the other. Absence of surgeon.

Sec. 80. He shall enter, in the English language, day by day, in his journal, opposite the name of every sick prisoner, the name of the disease, the prescription of medicines, the diet, and any other treatment which he may order for such prisoner. Journal, what to contain.

Sec. 81. In case of any serious operation being required to be performed upon any prisoner (or when there is a question of a convict being insane) he shall have power to call in another medical practitioner for consultation. Consultation with another medical practitioner.

Sec. 82. Should the surgeon see fit in certain cases that the bathing of any convict or convicts should be more or less frequent than is provided by these rules he shall report his opinion to the warden, by whom the necessary orders shall be given accordingly. Bathing of convict.

Sec. 83. Should an epidemic be present in the penitentiary at any time he shall give his endeavor to ascertain the cause, and shall report his opinions to the warden, with such recommendations as he may consider necessary for its extirpation or mitigation. In cases of epidemic.

## DEPUTY WARDEN.

- His duties in the absence of the warden.      **Sec. 84.** The deputy warden, upon being notified in writing by the warden, at any time, of his intended absence, shall assume the duties of the warden, and exercise all the functions of that officer during the time of his absence, as provided by "The Penitentiary Act."
- Residence of deputy warden.      **Sec. 85.** He shall reside within the precincts of the prison, but he shall take every precaution to keep his family and servants apart from the convicts.
- When and where present.      **Sec. 86.** He shall be in the prison, night and day, during the absence of the warden. He shall be present at the opening and closing of the prison, at all meal times, during religious services, in the manner provided, and at the infliction of all corporal punishments. He shall not be absent from the prison without the warden's permission.
- Safety bell.      **Sec. 87.** He shall give the order for the safety bell to be rung at breakfast, dinner and locking up, but, before doing so, he shall be certain that all the convicts are accounted for, and on the closing of the prison at night, that all the keys are in the safety box.
- Inspection every evening and oversight of guards.      **Sec. 88.** Every evening after the safety bell has been rung, and before leaving the prison, he shall inspect the workshops, the storerooms, stables, drying kiln and other parts of the prison, and see that all is safe and in proper condition. He shall also see that the guards for the night are on duty.
- Visiting prison by surprise.      **Sec. 89.** He shall visit the prison in the night time at least once a week, at different hours, between 9 p. m. and 5 a. m., by surprise, and personally ascertain that the convicts are all secure, and that the officers are on the alert.
- Assigning duties to officers.      **Sec. 90.** Under instructions of the warden, he shall assign to every officer the duties to be performed by him for the day. He shall keep a roster, which shall remain of record in the prison, showing the post occupied by every officer and servant during every hour of every day and the order and time of night duty, taking care to apportion the weight of duty as equally as possible, among the officers, from day to day.
- Roster what to contain.      **Sec. 90.** Under instructions of the warden, he shall assign to every officer the duties to be performed by him for the day. He shall keep a roster, which shall remain of record in the prison, showing the post occupied by every officer and servant during every hour of every day and the order and time of night duty, taking care to apportion the weight of duty as equally as possible, among the officers, from day to day.
- Control of trade instructors, &c.      **Sec. 91.** Under the orders of the warden, he shall have special control and direction of the trade instructors, keepers, guards and other employés of the prison.

*Penitentiary Regulations.*

## Chap. 60.

- Sec. 92. He shall call the muster roll every morning, at the opening of the prison, before the convicts go to work, after dinner, in the evening after the closing of the prison, and at such other times as he may consider necessary, to see that all are present. Calling of muster roll, every morning.
- Sec. 93. He shall see that the arms and accoutrements are at all times in the best of order, and ready for service. Arms and accoutrements.
- Sec. 94. He shall see that all the officers of the prison are supplied with revolvers, and that guards on the walls and outside the prison are supplied with breech-loading rifles, in addition, and that they are practised at stated times in the use of these weapons, and in military and fire-drill exercises. Officers to be supplied with revolvers; guards with breech-loading rifles in addition.
- Sec. 95. He shall report to the warden the name of every officer coming upon duty in a slovenly or untidy manner, or without being in uniform. Officer, when to be reported.
- Sec. 96. He shall maintain generally the police and discipline of the prison with the strictest exactness, for which purpose he shall at least three times during the day visit the shops, yards, hospitals, kitchen, cells and other apartments of the prison, and the different places where work is in hand, taking every precaution for the security of the prison and prisoners, seeing that the officers are vigilant and attentive to their duties, and that they keep the prisoners under them diligently employed during their whole time. And it shall be his duty to report to the warden, in writing, strictly and promptly, every neglect of duty or of impropriety or misconduct on the part of any officer, and, verbally, whatever is not of importance. Police and discipline of prison, to be maintained by deputy warden.
- Sec. 97. He shall not permit any book, pamphlet or newspaper to be read by any officer while on duty in or about the prison. Directions as to his duty and routine.
- Sec. 98. He shall not permit any book, pamphlet or newspaper to be read by any officer while on duty in or about the prison. Books, pamphlets, &c.
- Sec. 99. He shall, twice a month, accompanied by the blacksmith, examine the locks, levers and gratings of the dormitories, towers and cellars, and the locks and fastenings on every door. On every examination he shall report in writing their condition to the warden. Locks, levers and gratings to be examined twice a month.
- Sec. 100. Once a week, at least, he shall examine the fire-arms and equipments of the officers and see that there is a proper supply of ammunition and everything ready for use at a moment's warning. He shall report to the warden their condition. Fire-arms and equipments to be examined once a week.

## Chap. 60.

*Penitentiary Regulations.*

Vigilance as to property of penitentiary. **Sec. 100.** He shall exercise due vigilance to see that there is no embezzlement of the property of the penitentiary, that not only no wilful waste, but that no want of economy in the necessary consumption or use of supplies takes place without making such known to the warden immediately.

Habits and conduct of subordinates. **Sec. 101.** He shall consider it his duty to make himself acquainted with the habits and conduct of every subordinate officer and servant employed about the prison, particularly when off duty.

Facilities for escape, to be carefully guarded against. **Sec. 102.** He shall see that nothing objectionable be allowed near the enclosing walls, and that nothing be accessible to convicts which can facilitate escape. He shall especially see that ladders be properly secured.

Earning a remission of sentence, how provided for, and duty of deputy warden in reference thereto. **Sec. 103.** As the Penitentiary Act affords to convicts the privilege of earning a remission of their sentences, it will be incumbent upon the deputy warden to satisfy himself as to the behavior of every prisoner, his industry, alacrity and zeal in the execution of his work, so that the deputy may be able to advise with the warden as to the remission of sentence to be made to the convict at the close of every month. And for this purpose he shall communicate freely with every officer in charge of a gang, when making his rounds.

Investigating reports of offences and awarding punishment. **Sec. 104.** In investigating reports of offences committed by convicts, during the absence of the warden, the deputy warden shall be careful in endeavoring to arrive at the truth, and, in awarding punishment, he shall be guided by the examples afforded him by the practice of the warden in similar cases.

Vigilance over persons having business about the prison. **Sec. 105.** The deputy warden shall have a vigilant eye over every person who may have business about the prison, to see that nothing is carried in or out for a convict, and, so far as he can, that no communication of any description is attempted by such person with any prisoner, except by authority and in the presence of an officer.

Precautionary measures to prevent escape of convicts. **Sec. 106.** He shall take every necessary precaution to prevent the escape of convicts employed outside as well as inside the walls. For this end he shall see that the prisoners are supplied with drinking water and accommodation for purposes of nature under the eye and convenient to the officer or officers in charge.



*Penitentiary Regulations.*

## Chap. 60.

## CHIEF KEEPER.

Sec. **107.** The chief keeper in a penitentiary where there is no deputy warden shall perform the duties of that officer in addition to his own as hereinafter defined. He shall report, in writing, to the warden any breach of rule or discipline that he may see on the part of officers or convicts at any time, during the discharge of his duties, and verbally, on the general affairs of the prison and whatever may not be important or noteworthy.

Duties of chief keeper where there is no deputy warden.

Breach of rule to be reported.

Sec. **108.** Where there is a deputy warden, the chief keeper shall, when not engaged in his own particular duties, arrange with that officer to assist him in the duty of general supervision, and in the maintenance of discipline, order and general good conduct among officers and convicts, in such a manner as not to clash or interfere with each other; but the responsibility of the deputy warden, as regards the performance of the duties incumbent upon him under the rules prescribing them, shall not in any way be lessened by the chief keeper sharing these duties. In other words he shall either perform them himself or have a certainty that they shall be performed by the chief keeper. The warden in all cases of doubt or difficulty is to be consulted and his decision followed, until the matter be disposed of by the Minister of Justice, should reference to him through the Inspector be deemed necessary.

Where there is a deputy warden, chief keeper shall arrange with that officer to assist.

Deputy warden's responsibility in such case.

Warden to be consulted in cases of doubt.

Sec. **109.** The chief keeper shall be responsible for the thorough cleanliness of the prison in every particular, and for the order and tidiness of everything connected therewith.

Cleanliness of prison, &c.

Sec. **110.** He shall see that the water supply and all the apparatus by which it is maintained, is kept constantly in efficient order, if there be no engineer appointed for this purpose, and that the drains are at all times clear of obstructions. He shall exercise special supervision over the fuel and its consumption. He shall report to the warden at once any defect as to water or drainage, and want of economy in the use of fuel.

Water supply and apparatus and drains.

Supervision over the fuel, &c.

Sec. **111.** He shall look to the cleanliness and good order of the stables and other outhouses within and without the walls.

Stables and other outhouses.

Sec. **112.** He shall take care that no garbage, filth or refuse of any kind be thrown down, or if thrown down be permitted to remain within the prison walls, but that it be

Garbage or refuse not to be allowed.

## Chap. 60.

*Penitentiary Regulations.*

deposited in proper receptacles in the yard, which shall be emptied every afternoon, between the hours of four and five o'clock in winter, and five and six o'clock in summer, or in the morning at the opening of the prison, and the contents carted away outside.

Receptacles,  
to be emptied.

Chimneys.

Sec. 113. He shall see that all the chimneys be swept at regular times.

Dormitory  
cells to be  
cleaned and  
bed clothes  
ventilated.

Sec 114. He shall have charge of the dormitory cells and shall see that every one be properly cleaned out every morning, and fresh water supplied every afternoon. He shall see that the bed clothes be suspended on hooks during the whole day for ventilation, that no article marked as belonging to one cell be allowed to be placed in another, that the cell be supplied with every article authorized by the rules, and that there be no article in any cell which is not allowed by the rules.

Bedding,  
clothing or  
furniture de-  
stroyed or  
missing.

Sec. 115. When in course of his daily inspection he shall discover that any bedding, clothing, furniture or any other article has been injured or destroyed, or that it is missing, he shall report the circumstance without delay to the warden.

Bathing.

Sec. 116. He shall see that the convicts are regularly bathed once a week in summer and once a fortnight in winter, unless otherwise ordered.

Changing of  
clothes, and  
of straw in  
beds.

Sec. 117. He shall assist the steward in seeing to the changing of the clothes of the convicts, and of the straw in the beds, when not upon any special duty otherwise.

Walls, floors,  
cell doors,  
&c., to be  
cleaned and  
kept in order.

Sec. 118. He shall take particular care that the walls of the cells, passages, corridors, &c., be whitewashed regularly, once every three months, that the floors of the cells and galleries leading thereto be scrubbed once a week, and that the cell doors, locks, railings, wood and iron work be varnished or painted whenever required.

Where there  
is no chief  
keeper.

Sec. 119. Where there is no chief keeper, the foregoing duties assigned to that officer shall be performed by the deputy warden.

## ACCOUNTANT.

Office hours of  
accountant.

Sec. 120. The accountant shall attend at his office from 9 a.m. until 5 p.m., and at such other hours as may be necessary for him to leave no arrears of work.

*Penitentiary Regulations.*

## Chap. 60.

Sec. **121.** For every article in every account presented for payment, he shall see that a requisition duly authenticated has been issued to the storekeeper, and that the storekeeper has accounted for the article in his stock book. He shall check the calculations and extensions, and shall certify by his initials that the whole account is correct.

Articles, to be supplied only on requisition.

Certificate of correctness of account.

Sec. **122.** All vouchers for payment of money shall be taken in triplicate and before payment of an account is made, he shall see that all requisition or orders for the goods are delivered up.

Vouchers for payment in triplicate.

Sec. **123.** He shall make an exact copy in the invoice book of every account paid by the penitentiary, and shall accurately analyze the same under the proper heads of service. He shall in the same way enter all articles sold for the benefit of the institution, as also articles manufactured within the prison for parties outside. He shall receive all moneys paid therefor, which he shall deposit to the credit of the Receiver General.

Accounts paid to be copied in the invoice book.

Articles sold or manufactured.

Moneys received.

Sec. **124.** He shall examine the time book of the trade instructors, keepers and guards weekly, to see that they be correctly kept, and shall charge in a book to be kept for the purpose the amount of convict labor expended upon any alteration, improvement, repair, or any addition to any of the buildings, works, machinery, drains or property of the penitentiary, or any labor expended on the farm, distinguishing capital from expense account, so that the precise value of convict labor used in every single undertaking may be ascertained and preserved.

Time book of the trade instructors, keepers and guards to be examined weekly.

Sec. **125.** Under the direction of the warden he shall be responsible for the safe keeping and orderly arrangement of all the accounts, vouchers, bills and other documents of every kind entrusted to him, as well as of all books of account and other books recording the money transactions of the prison.

He shall be responsible for the accounts, &c.

Sec. **126.** He shall make out all money statements and statements of account of every kind at such times as may be required by the warden or the accountant of penitentiaries.

Money statements and statements of account.

Sec. **127.** He shall be diligent in collecting all debts due to the penitentiary.

Collection of debts.

Sec. **128.** He shall make up before the 15th day of July in every year all statements relating to the finances of the penitentiary for the foregoing fiscal year.

Financial statement, yearly.

## Chap. 60.

*Penitentiary Regulations.*

Yearly estimate of expense.

Sec. **129.** He shall make up an estimate of the expense of the prison for the ensuing year under every head of expenditure separately.

## STORE-KEEPER.

Store-keeper shall attend at the prison.

Sec. **130.** The store-keeper shall attend at the prison from nine o'clock in the morning until five o'clock in the afternoon, unless he shall be on business of the penitentiary elsewhere, of which he shall notify the warden or deputy warden before leaving the prison.

Purchases of goods, wares and supplies.

Sec. **131.** He shall make such purchases of goods, wares and supplies required for the penitentiary as the warden may direct, and shall have the care, custody and protection of all such goods, wares and supplies until they be issued for actual consumption.

No article to be purchased without a requisition.

Sec. **132.** He shall purchase no article on account of the penitentiary except upon a requisition signed by the officer for whose department the article is required, and countersigned by the warden as approving.

Directions in order that a strict system of economy may be ensured.

Sec. **133.** In order that a strict system of economy may be ensured, and enforced in every branch of the penitentiary service, it shall be the duty of the store-keeper, before submitting any requisition to the warden for the purchase of any article mentioned in a requisition, to ascertain by inspection the balance in the hands of the officer making the requisition, and should he be of opinion that a fresh supply is not at the time needed, or that there has been an apparent want of economy in the use of what has been consumed, he shall make report thereof to the warden.

Receiving goods, &c., weighing, measuring, inspecting and certifying.

Sec. **134.** He shall receive all goods, materials and stores of every kind, including fuel. He shall weigh or measure the same as the case may require immediately on their being delivered; he shall inspect the quality and compare the items in the bills of parcels, without which no goods shall be received by him, check the calculations, and certify whether or not the items are correct, and whether they agree or not with the requisition on which they were purchased.

Articles manufactured in penitentiary to be entered in the stock book.

Sec. **135.** When articles are manufactured in the penitentiary they shall be entered in the stock book of the department manufacturing them, and then delivered to the store-keeper, who shall make a corresponding entry in the general stock book when he receives them into store,

*Penitentiary Regulations.*

Chap. 60.

and an account of them shall be kept on a distinct page the same as of articles purchased by him outside for penitentiary use.

Sec. 136. He shall without delay hand to the accountant every bill of parcels, after having checked it, and certified to its correctness. Bills of parcels.

## STEWARD.

Sec. 137. The steward shall have charge of the victualling department of the penitentiary, of the kitchen, the dining hall, the cellars and other places where provisions are kept, and all the passages leading thereto. Steward shall have charge of victualling department.

Sec. 138. If bread be baked within the prison he shall weigh what he receives from the bakery, as if it were supplied by a contractor. Weighing bread.

Sec. 139. He shall see that all provisions received by him be kept, until used, in such condition as to prevent their becoming injured in quality. He shall take care that no bad or unsound provisions be cooked or furnished to the prisoners. Care of provisions.

Sec. 140. Should provisions be delivered by a contractor, which are found by rigorous examination to be not according to contract, he shall refuse to receive the same, and shall at once report the fact to the warden, so that no delay may take place in obtaining a supply elsewhere, if the contractor should be unable or refuse to replace immediately what has been rejected. When provisions not according to contract.

Sec. 141. He shall be most careful that the articles of food supplied are of good quality, that the ration is sufficient and properly cooked, and it shall be his duty to report to the warden at once every instance of neglect in this respect. Food to be of good quality and properly cooked.

Sec. 142. He shall take special care, under direction of the warden, that the ventilation is perfect, and that the utmost cleanliness prevails in the kitchen, the cellars, and in every chamber and vessel in which provisions are kept, or from which they are eaten. Ventilation and cleanliness.

Sec. 143. Should he perceive any defect in the ventilation, he shall report it at once to the warden. Defect in ventilation.

Sec. 144. He shall see that the provisions at meal times are properly cooked, served and equally distributed, so Cooking and serving.

## Chap. 60.

*Penitentiary Regulations.*

that there be no occasion for complaint. He shall also see that no convict exchanges with or gives any portion of his mess to another convict, and shall take care that convicts on diet punishment are not surreptitiously supplied with any other than the diet ordered.

Straw in bed, to be changed every three months.

Sec. 145. He shall see that the straw in the bed is changed every three months, and for that purpose he shall so divide the whole number, that an equal proportion shall be attended to, in regular course, on some particular day to be fixed by the warden.

Facing convicts in the same direction.

Sec 146. He shall see that the convicts shall be all seated facing in the same direction, so that no opportunity shall be afforded them for communicating by sign or look.

Shaving and hair-cutting.

Sec. 147. The steward shall also superintend the shaving and hair cutting of the convicts, and the utensils shall be under his charge.

Washing, mending and changing of clothing, &c.

Sec. 148. He shall have charge of the washing and mending of the clothing and bedding of the convicts, and see that their underclothing is changed once a week, and their outer clothing when necessary.

Clothing and bedding of male convicts.

Sec. 149. He shall be responsible for all the clothing and bedding of the male convicts which have been served out to him by the store-keeper.

Hours, when he must be in prison.

Sec. 150. He shall be in the prison not later than at half-past six o'clock in the morning in winter, nor six o'clock in summer, to see to the preparation of breakfast. He shall be present at all meals.

Scrubbing and white-washing.

Sec. 151. He shall see that the cells are scrubbed out once a week, whitewashed once every three months, and the whole dormitory whitewashed at least twice a year.

Blocks of cells to be distinguished.

Sec. 152. The steward shall see that each of the blocks of cells is distinguished by a capital letter, viz. : A, B, C, D, E, &c., each of the ranges by the Roman numerals, I, II, III, IV, V, VI, &c., every cell by the figures, 1, 2, 3, 4, 5, &c.

Cleaning and clothing of convicts.

Sec. 153. When a convict is received into the prison the steward shall take charge of him and see that he is properly cleansed in bath, clothed in a prison suit and duly inspected by the surgeon.

*Penitentiary Regulations.*

## Chap. 60.

Sec. 154. He shall see that a description of everything found on a newly arrived convict is duly entered in "The Prisoners' Effects Book," and how it is disposed of; and that the convict be brought before the warden to be registered, &c. Should any money be found upon a convict the steward shall hand it to the warden after entry in "The Prisoners' Effects Book."

"Prisoners' Effects Book."

Sec. 155. He shall appoint the cell to be occupied by a convict, on entering the prison, but he shall not remove the convict from one cell to another without the permission of the warden.

Appointing cell to convict.

Sec. 156. He shall see that the clothing of convicts be properly cared for, that it be in good order and changed at proper times.

Care of convict's clothing.

Sec. 157. He shall see that every article supplied to a cell is marked with the appropriate letter, numeral and figure of the cell to which it belongs.

Article supplied to a cell.

Sec. 158. He shall see that every article for use or wear issued to a convict is marked with his prison number, number of his block, range and cell.

Article for use or wear.

Sec. 159. He shall see that in every cell there are furnished one stretcher, one bed, one pillow and pillow case, one pail, one piggin, one towel, one hair comb; that in summer the bed is furnished with two linen sheets, one blanket and one rug; and in winter with one blanket additional.

Furniture of cell.

Sec. 160. He shall see that there is a piece of soap in every cell.

Soap.

Sec. 161. He shall see that every convict is supplied with one jacket, one waistcoat, one pair of trousers, two pairs of drawers, two day shirts, two night shirts when ordered by the warden, two pairs of socks, one stock, one cap, one pair of strong shoes or brogans, one handkerchief.

Clothing of each convict.

Sec. 162. The dress of the male convicts, if of woollen cloth, shall be one half brown and one half yellow; if of cotton or linen, one half black and one half white.

Dress of male convicts.

Sec. 163. Every movable article, whether clothing, bedding, tool or other utensil, shall be marked with the initials of the institution to which it belongs.

Movable articles to be marked.

## Chap. 60.

*Penitentiary Regulations.*

Meals taken  
in the cells.

Sec. 164. In those penitentiaries, where the meals are taken in the cells, the steward shall take all due care to have the food served to the convicts with every possible regard to their comfort.

## CLERK.

Attendance of  
clerk.

Sec. 165. The clerk shall attend regularly at the prison, from 9 a.m. until 5 p.m., and for such longer time as the warden may, upon any occasion, require.

Clerk to the  
Inspector.

Sec. 166. He shall act as clerk to the Inspector during his visits to the penitentiary, as well as to the warden.

## SCHOOLMASTER.

Schoolmaster  
shall be under  
supervision of  
chaplains.

Sec. 167. The schoolmaster shall be under the immediate supervision of the chaplains, subject to the directions of the Inspector, who shall have power to fix from time to time the hours which he may consider most convenient for teaching the different classes, or to order that the convicts be instructed in their cells.

Instruction of  
convicts.

Sec. 168. He shall instruct such convicts as are ignorant and stand in need of teaching and as the warden may select, in reading, writing, and arithmetic, and in such other branches of secular knowledge as the warden may appoint, with the consent of the Inspector.

Assisting  
chaplain in  
Sunday  
school.

Sec. 169. He shall give his whole time and attention to his duties as schoolmaster, and shall assist in the Sunday school should the chaplain of his church desire it, during such hours as the warden shall appoint upon consultation with the chaplain.

Monthly  
report.

Sec. 170. At the end of every month he shall make a report to the warden of the conduct and proficiency of every convict in the school, in order that the remission for the month may be determined.

Books to be  
used.

Sec. 171. No books shall be used in the school except those provided by the chaplains with the approval of the Inspector.

Religious  
belief of con-  
vict.

Sec. 172. The schoolmaster shall not interfere with the religious belief of any of the convicts, nor hold any conversation with them except by way of instruction in learning.



*Penitentiary Regulations.*

## Chap. 60.

Sec. 173. He shall duly report to the warden any breach of the prison rules, or any instance of improper conduct on the part of a convict in school. In view of keeping proper discipline in the school, he shall have the power, pending a report to the warden, to order any convict creating disturbance, or causing interruption, to take a seat in any part of the school which he may consider best suited to prevent the convict's misconduct having a bad effect.

Report of breach of prison rules, or improper conduct.  
Power in case of convict creating disturbance.

Sec. 174. He shall assist in taking care of the general library in those penitentiaries where the schoolmaster has no other duties to perform than those of teaching.

Care of library.

## SCHOOLMISTRESS.

Sec. 175. The duties of the schoolmistress shall be the same, so far as applicable, as those of the schoolmaster.

Duties.

## TRADE INSTRUCTORS.

Sec. 176. Trade instructors shall observe the rules laid down for the guidance of officers in general, and obey all the orders of the warden, deputy warden and chief keeper in the management of the prison, but orders in relation to work in the clerk of works department, shall be signified to them through the clerk of works, whose instructions they shall follow. They shall see that the keepers, guards and other servants employed in the department over which they are respectively placed, carry out punctually and efficiently the directions they may give them respecting the work.

Duties and requirements of trade instructors.

Sec. 177. They shall be responsible for their subordinates in executing the work committed to them and for the efficiency of the work itself.

Responsibility for subordinates.

Sec. 178. They shall be held responsible for the proper use of the material given them to work up, and for any want of economy, which they may permit to take place, without reporting at once to the warden.

Responsibility for use of material.

Sec. 179. There shall be pains taken in instructing every convict placed under them in the trade, which they are appointed to teach; they shall point out the best mode of performing the different operations and shall use continual vigilance in watching the manner in which the convict manages his work, and whether he does so willingly, zealously and industriously, so as to produce the greatest results. They shall also note whether a convict is careful to economize, or inclined to waste the material on which he

Directions for the instruction of convicts.

is at work, and shall take such inclination into consideration in making their report in "The Conduct and Industry Book."

Report in case of inefficiency in performance of work.

**Sec. 180.** Should they find that the work of their department is not so quickly or so well performed, as they consider it ought to be, in consequence of the want of knowledge, the want of attention or of general inefficiency on the part of any officer or officers placed under them, they shall at once report such officer or officers to the warden.

Saving of labor or material, &c.

**Sec. 181.** It shall be the duty of a trade instructor to make special report to the warden of any ideas he may entertain, for the better saving of labor or of material, or for any improvement in the mode of executing, or of accounting for work in his department.

Dispensed from night and ordinary duties.

**Sec. 182.** Trade instructors are dispensed from night duty and from performing the ordinary duties of a guard or keeper, unless in cases of emergency, when their services can be called into requisition by the warden for any duty he may find it necessary to assign them.

Attendance.

**Sec. 183.** They shall be in attendance, in the morning and after dinner, at their various posts, in the prison, in time to receive the convicts when they go to work.

#### HOSPITAL OVERSEER.

Under direction of surgeon.

Hours of duty.

**Sec. 184.** The hospital overseer shall be under the immediate directions of the surgeon and shall obey his orders in all matters relating to his duties. He shall enter upon his duties at seven o'clock a.m. in summer, and eight o'clock a.m. in winter.

Responsibility.

**Sec. 185.** He shall be responsible for the officers, orderlies, and other servants, employed about the hospital.

Charge of hospital.

**Sec. 186.** He shall have charge of the hospital, and of the convalescent cells for the good order and cleanliness of which, and of all the approaches and surroundings he shall be responsible.

Sick and convalescent convicts.

**Sec. 187.** He shall have charge of all the sick in the hospital, and of the convalescent convicts, so long as they are receiving advice from the surgeon, and shall strictly attend to all instructions, that may be given him, as to their medicine, diet and treatment.

Complaining convicts.

**Sec. 188.** He shall attend also to all complaining convicts not in hospital, to whom medicine is administered. This shall be done in the hospital.

*Penitentiary Regulations.*

Chap. 60.

Sec. 189. He shall see that every chamber in the hospital is well ventilated, the bedding and clothing clean, and changed when necessary, the ceilings, walls and floors cleaned and purified by frequent scrubbing and white-washing, and that all impurities of every description are immediately removed.

Ventilation, &c., of chambers in hospital; cleaning and purifying.

Sec. 190. He shall attend the surgeon in his visits to the sick, make up all the prescriptions, compound all the medicines, and see that they are administered in the form, and at the times ordered by the surgeon.

Prescriptions and medicines.

Sec. 191. Should the symptoms of any patient appear to him to become aggravated he shall report at once to the warden, in order that if necessary the surgeon may be sent for, without loss of time. Should he observe that the death of a convict is approaching, he shall at once notify the warden, in order that information may be sent to the proper chaplain.

In case of aggravated symptoms or approaching death.

Sec. 192. It shall be his duty to make a tour of the wards of the hospital frequently during the day, and especially he shall do so, as his first duty in the morning, and last duty at night. If any instructions given to the officers, or assistants, or orderlies, have not been carried out, he shall at once report to the warden.

Visiting wards of hospital.

Sec. 193. He shall see that the bedclothes of patients, who are able to leave their beds, are well ventilated, while they are out of bed.

Bed clothes of patients.

Sec. 194. He shall see that the bed of a patient in hospital is not placed within six inches of the wall, and if the beds are in an open ward, one bed shall never stand within four feet of another. When a patient is discharged by the surgeon, the hospital overseer shall at once notify the warden.

Bed of patient in hospital, how to be placed.

Sec. 195. As the orderlies in the hospital will unavoidably have more freedom, than if employed in any other department of the prison it will be the duty of the hospital overseer to keep the stricter watch over them. He shall be vigilant to see that medical comforts, ordered for the sick, are not made use of, except for that purpose, that there is no waste nor misappropriation of tea, sugar, or other articles.

Strict watch to be kept over orderlies and medical comforts.

Sec. 196. He shall keep all medical comforts under lock, and be careful that no keys are left within reach of the convicts.

Custody of medical comforts.

## Chap. 60.

*Penitentiary Regulations.*

The term  
"hospital  
overseer."

**Sec. 197.** The term "hospital overseer" shall comprehend the person keeping and having the care of the hospital, by whatsoever name he may be designated.

## KEEPERS.

Keepers shall  
carry out  
orders of  
superior offi-  
cers and  
attend to con-  
victs at work.

**Sec. 198.** Keepers shall carefully carry out the orders of their superior officers, and see that the guards under their own orders are also vigilant. They shall give particular attention to the convicts at work, to see that they are diligent at their employment, to mark the degree of willingness and zeal with which they go about it, to note the carefulness and economy they evince, in working up the material confided to them, and to take care that neither material nor tools are negligently or maliciously injured.

Age of retir-  
ing.

Keepers shall be retired from the service upon attaining the age of sixty, unless specially qualified for their duties.

Searching  
convicts at  
night.

**Sec. 199.** It shall be the duty of the keepers, with sufficient assistance, at irregular but frequent times, to search the convicts at night, before leaving the workshops, to see that nothing is concealed about their persons, and also the work-benches, seats and drawers, in the shops, to see that nothing improper is hid therein.

Officer of the  
night.

**Sec. 200.** Every keeper in his turn shall be named as officer of the night, and shall go on duty when the safety bell is rung in the evening, and remain until relieved in the morning.

He shall have  
charge of the  
night watch.

**Sec. 201.** He shall have charge of all the night watch, and shall visit every post at least once every two hours. He shall make a tour of the dormitory wings every three hours, and shall see that the day clothes of the convicts are hanging upon the pegs in their cells, that the cell doors are properly fastened, and that everything is in a perfect state of security.

Visit to cham-  
bers where  
risk of fire.

**Sec. 202.** The keeper in charge of the night duty, shall especially see that the workshops and other buildings and chambers where there is risk of fire, or where there has been fire during the day, are visited regularly during the night, and that all is safe.

Ringing of  
bell.

**Sec. 203.** He shall cause the first bell in the morning to be rung five minutes before the prison is opened.

Noting ir-  
regularities  
during night.

**Sec. 204.** It shall be the duty of the keeper for the night to note everything which he finds irregular in the course of

*Penitentiary Regulations.*

## Chap. 60.

his rounds, and particularly he shall mark any want of vigilance on the part of any of the night guards, or anything which appears to him to be suspicious. He shall every morning make report of his watch to the warden in writing.

Report to warden.

## GUARDS.

Sec. 205. No one shall be eligible as a guard whose age exceeds forty-five; and no guard shall be retained in the service after having reached the age of sixty years, except he be reported by the warden as specially competent and active.

Eligibility, age and retirement of guard.

Sec. 206. Every candidate for this position must have a rudimentary education, that is, he must be able to read and write tolerably well.

Education.

Sec. 207. The appointment of every guard shall be probationary at first, for one month, upon the expiration of which period or any time before, the warden can dispense with his services should he see fit.

Appointment to be probationary at first.

Sec. 208. At the end of the term of probation the guard shall receive a Sunday suit of uniform and one suitable to the season, when he will have entered upon his duties.

Uniform at end of probation.

Sec. 209. Every man received upon the staff of the penitentiary as a guard, will bear constantly in mind the nature of the institution, in the service of which he enters, the peculiarity of the duties he will have to perform as an officer, and the moral obligations he is to assume, with reference to his own personal conduct, from the time he is engaged.

What a guard must bear in mind.

Sec. 210. He must understand that the penitentiary is not only designed as a prison, for the punishment of persons who have offended against the laws, but also as an institution which intends their reformation if possible.

What he must understand.

Sec. 211. Every guard, therefore, will not only feel it his duty to see that the rules of the prison are observed by the convicts placed under him; but also will understand that he must conduct himself when off duty, as well as when on duty, in such a way as to inspire sentiments of respect for his moral principles and character.

How he must conduct himself.

Sec. 212. He will accordingly be circumspect in his way of life, guarded as to the company he keeps, and the places he frequents.

Way of life and company.

## Chap. 60.

*Penitentiary Regulations.*

How guard shall be armed.

Sec. 213. Every guard on the walls, and on duty outside of the walls, shall be armed with a breech-loading rifle, in every chamber of which there shall be a ball cartridge; he shall also carry in addition, a revolver always loaded, the same as all officers within the walls.

Guard on night duty shall be vigilant.

Hours of duty in the yard.

Sec. 214. Guards for the night duty shall be vigilant on their posts, and shall carry out all special orders which may be given them from time to time by the warden, deputy warden, or chief keeper. Guards on duty, in the yard, shall make a full round of their prescribed duties once every two hours from the time they enter upon duty until they are relieved.

Time of entry upon night duty and their duties.

Sec. 215. The guards for the night shall enter on their duties at the ringing of the safety bell in the evening, and those for the dormitories shall at once carefully examine all the cell doors of the convicts and the doors of the wings, to see that all are perfectly secure. They shall also on their turns during the night see that the day clothes of the convicts are suspended on the pegs in the cells.

When convict taken ill in the night.

Sec. 216. Should a convict be taken ill in the night, the guard on night duty shall at once notify the night keeper, and if judged necessary, shall assist in removing the convict to the hospital.

Tour of dormitory wings.

Sec. 217. Guards for the night in the dormitory shall make a tour of the wings every hour.

Cell not to be opened during night.

Sec. 218. No cell is to be opened during the night, except in case of emergency, and then only in the presence of the keeper, and of one guard at least.

## GATE KEEPERS.

Admission of a stranger or discharged convict.

Sec. 219. The gate keeper shall not permit any stranger nor any discharged convict to enter the prison without the permission of the warden.

Person in liquor.

Sec. 220. He shall permit no person apparently in liquor to enter the prison.

"Visitors' Book."

Sec. 221. He shall cause every visitor to enter the name on the "Visitors' Book."

Look out from the guard room windows.

Sec. 222. He shall frequently look out from the guard room windows into the yard, and observe the conduct of all convicts within view. Should he notice anything

*Penitentiary Regulations.*

## Chap. 60.

wrong, the officer in charge of the convicts must be warned immediately and a written report sent to the warden as soon as convenient.

Sec. 223. He shall not allow convicts nor other persons to loiter about the gate, nor shall he permit officers, visitors or other persons to smoke in the guard room, or near the gate. Loitering or smoking not allowed.

Sec. 224. He shall permit no carriage to pass through the gate when convicts in the yard are near it. Carriages passing.

Sec. 225. One of the gate keepers where two are stationed at a gate shall attend visitors viewing the penitentiary. Should there be but one, he shall ring the guard room bell and detain the visitors until an officer comes to accompany them. Attendance upon visitors.

Sec. 226. An officer in charge of a gate must be ever vigilant in guarding against surprise or stratagem on the part of prisoners, and where there are two sets of gates he must never, if possible, permit the outer and inner ones to be open at the same time. He must never permit any person to go out by the gate he is in charge of, unless such person had entered by the same or is accompanied by an officer of the prison. Vigilance when in charge of gate.

Sec. 227. He shall permit no convict to pass out, unless he be in charge of an officer. Convict passing out.

Sec. 228. He shall permit no articles to be taken out without a pass authorizing it from the warden or deputy warden or accountant. Articles taken out.

Sec. 229. He shall be particular in examining all vehicles entering the yard to ascertain that nothing improper is carried therein, and equally particular on their departure to see that no convict is concealed therein, and that no article belonging to the prison is clandestinely carried out. Examining vehicles.

Sec. 230. As it has happened that strangers have been admitted on pretence of a simple visit, but actually for the purpose of communicating by sign with some particular convict, and have returned again in a short time to carry out the understanding so established with the convict, the gate keeper for the day shall scrutinize closely every person entering as a visitor, and if the gate keeper recognize him as having visited the prison before, he shall inform the warden. If, when a visitor passes through the establish- Gate keeper shall carefully scrutinize every person entering as a visitor.

## Chap. 60.

*Penitentiary Regulations.*

In case of a person having visited prison more than once on the same day.

ment, an officer shall recognize him as having visited the prison the same day, or a short time before, he shall quietly inform the officer who is conducting such visitor, and such conducting officer shall at once notify the nearest guard to detain at his post the companions of such visitor, while he himself shall re-conduct the visitor back to the guard room at the gate. Such occasions will be very rare, and will be managed with every possible politeness and quiteness, so as to give no unnecessary offence to those who may be in company with such visitor.

N.B.—The foregoing rules as to gate keepers apply also to the officer in charge of the main entrance door to any penitentiary.

## MATRON.

Residence and superintendence of matron.

Sec. 231. The matron shall reside in the prison and under the general direction of the warden and shall have the superintendence and control of the female convicts and officers of the female prison.

Responsibility and duty.

Sec. 232. Shall be responsible for all the details of the female department, shall see that economy, cleanliness, order and regularity prevail in every portion of the buildings belonging thereto, and on the part of every convict placed under her charge.

Reception of female convict.

Sec. 233. On the reception of a convict she shall see that she is thoroughly washed, examined by the surgeon, dressed in prison clothing and brought before the warden.

Prisoners' effects to be taken from her.

Sec. 234. Every article which a prisoner brings in with her shall be taken from her, and the same steps used with regard to her effects as is pointed out for those of male prisoners. She shall cause them to be entered in an "effects book," to be kept by her or the deputy matron, if there be one.

Oversight, management and instruction of female convicts.

Sec. 235. She shall be present with the convicts in the work room, see that they are diligent in their labor, economical in the use of material and infringe none of the prison rules, noting daily in the conduct and industry book the necessary particulars on which a remission of sentence is to be earned. She shall give the convicts all needful instruction in their work.

Change of employment.

Sec. 236. She shall not introduce any change in the nature of the employment of the convicts without the permission of the warden.



*Penitentiary Regulations.*

## Chap. 60.

Sec. 237. She shall allow no work to be done by the convicts, except for the prison, without the previous consent of the warden. Work done by convict.

Sec. 238. She shall be careful that no means of communication can be had between the female and the male convicts, nor with any except the female officers, nor with any portion of the prison other than the female department. Communication with male convicts to be guarded against.

Sec. 239. Should any such communication with male convicts or officers be held or attempted or suspected in any way, she shall at once give information to the warden. Report, when such communication held.

Sec. 240. She shall take care that all doors communicating with other parts of the prison are at all times securely locked. Doors to be locked.

Sec. 241. Cases of sickness are to be regularly reported by her to the surgeon through the warden. Cases of sickness.

Sec. 242. She shall take care that medicines prescribed by the surgeon, are administered as ordered, that the diet prescribed is given, and none other. Medicines and diet.

Sec. 243. On all days when there is Divine service, the matron, whether Protestant or Roman Catholic, shall be present thereat, with the Protestants at the hour set apart for them, and with the Roman Catholics at the hour set apart for them also. Should there be a matron and deputy matron, one officer shall be present in the one chapel, and the other in the other. Matron to be present at Divine service.

Sec. 244. In addition to the books to be kept by the matron, as the officer in charge of a department, she shall also keep or cause to be kept the following books : Books to be kept.

(a.) A *work book*, in which shall be entered the name and prison number of the convict and the daily labor performed by her; Work book.

(b.) A *convicts' report book*, similar to that for males and kept the same way. Convicts' report book.

Sec. 245. The matron shall see that the convicts under her charge are dressed in uniform as prescribed by the Inspector. Uniform.

Sec. 246. She shall pay particular attention to the conduct, industry and habits of each convict, in view of Remission time.

## Chap. 60.

*Penitentiary Regulations.*

**Instruction.** determining, every month, the amount of remission time to which she may be entitled. She shall see that an hour's instruction in reading, writing and arithmetic be given, daily to such of the convicts as require it.

## DEPUTY MATRON.

**Obedience to orders, performance of duties, &c.** **Sec. 247.** The deputy matron shall obey the orders of the matron, and shall do such duties in the female prison, as may from time to time be assigned to her by the matron or by the warden.

**Absence, &c., of matron.** **Sec. 248.** In case of the absence from sickness or other disability of the matron, the deputy matron shall take her place, and perform the duties of her office.

## ASSISTANT DEPUTY MATRON.

**Obedience to orders, performance of duties, &c.** **Sec. 249.** The assistant deputy matron shall obey the orders of her superior officers and perform such duties as may from time to time be assigned to her by the matron or warden.

**Absence, &c., of deputy matron.** **Sec. 250.** During the absence, sickness or other disability of the deputy matron, the assistant deputy matron shall take her place and perform her duties.

## DUTIES OF OFFICERS GENERALLY.

**Rules to apply to all officers.** **Sec. 251.** The following rules shall apply to all officers of the prison except where the rules for the special duties of the chaplains, the surgeon, the school master and the schoolmistress provide otherwise for those officers.

**Obedience to orders of superior.** **Sec. 252.** Every officer shall obey the orders of his superior, and carry them out with zeal and energy to the best of his ability.

**Wearing of uniform.** **Sec. 253.** Every officer when on duty shall wear his uniform and present a clean and orderly appearance; he shall reside as near as possible and if within hearing of the alarm bell, he shall immediately hasten to the prison when it is rung.

**Opening and closing of prison.** **Sec. 254.** Every officer, except the accountant, store-keeper, hospital keeper, and trade instructors, shall be present at the opening and closing of the prison, unless specially exempted by the warden. Officers for day duty shall, except during the time allowed for meals, be at the prison during the whole day, from 6 o'clock in the morning

**Day duty hours.**

*Penitentiary Regulations.*

Chap 60.

till 6 o'clock in the afternoon in summer, and from 6.30 o'clock in the morning till 5 o'clock in the afternoon in winter; but every day they shall remain until the safety bell has been rung.

Sec. 255. Should any officer or servant of the prison be taken with sickness he shall immediately send information thereof to the warden or deputy warden, so that another may be employed temporarily in his place if necessary. Such officer or servant shall also be required to furnish a certificate of his illness from the visiting surgeon, and, failing to do so shall be subject to a penalty.

Officer or servant taken with sickness.

Certificate from the surgeon required.

Sec. 256. No officer shall absent himself at any time, except from sickness, without having first obtained leave from the warden, to whom application in writing, recommended by the deputy warden, for such leave, must be made as many days before hand as possible.

Leave of absence.

Sec. 257. If any officer come to the prison under the influence of liquor, or shall fall asleep on duty; or have undue relations with any convict; or be guilty of a gross neglect of duty; or of immoral conduct; or frequenting taverns, or of associating with loose characters; or of doing anything unbecoming the character of an officer of the institution, he shall be dismissed.

Causes of dismissal.

Sec. 258. Every officer shall be at all times when on duty armed with a revolver fully loaded, but he shall not unnecessarily expose or use it.

Revolver to be loaded.

Sec. 259. No officer shall have any interview or conversation with any person not employed at the institution, while on duty in or about the prison.

Conversation forbidden.

Sec. 260. It shall be the duty of the warden, deputy warden and chief keeper to make themselves acquainted with the provisions of "The Penitentiary Act" and with all the rules and regulations of the prison; and it shall be the duty of all the other officers to make themselves acquainted with all the rules and regulations defining their respective duties and with all orders in the order book, and that may be placed from time to time on the bulletin board; and every officer shall readily obey all such rules and regulations in all points touching his own duty and shall enforce a strict obedience of them upon others under him in the discharge of their respective duties.

Acquaintance with provisions of Penitentiary Act, &c.

Officers to be acquainted with rules, &c., and to obey and enforce the same.

Sec. 261. Every officer and servant, of a penitentiary, must understand that the warden has the right to exact his

Right as to exacting services.

## Chap. 60.

*Penitentiary Regulations.*

services in any capacity for which he may consider such officer or servant qualified and without extra pay unless on the recommendation of the warden and the order of the Minister of Justice. Such services shall not be exacted in an arbitrary or capricious way, but only in cases of necessity.

Holding conversation.

Sec. 262. No officer shall hold any conversation with another officer in presence of a convict, except in relation to work then in hand.

Spying is forbidden.

Sec. 263. The demoralizing and base practice of spying is strictly prohibited as degrading to the character of an officer and to the institution. If an officer see or know anything wrong in the actions or conduct of another officer, it shall be his duty, should the offence be not of a grave character, to warn such officer against its repetition; but, should it be of a serious nature or a repeated breach of rule or discipline, the matter shall be reported in an open and manly way to the warden, so that he can take the necessary action.

In case of misconduct of officer, offender to be warned or reported.

Censuring officer not allowable in presence of convict.

Sec. 264. No officer shall speak to another officer, by way of censure or finding fault in the hearing of any convict, and if an officer shall see another guilty of any breach of the rules or of discipline, it shall be the duty of such officer to report the fact to the warden as soon as possible.

Reading and writing, when forbidden.

Sec. 265. No officer while on duty shall read any book or newspaper, nor shall he write, except necessary entries in the books under his charge.

Affairs of penitentiary not to be spoken of.

Sec. 266. Officers shall not make the affairs of the penitentiary the subject of conversation beyond the precincts of the prison, nor shall he make them known to any person whomsoever outside, under pain of suspension and even dismissal.

Examination by officer on taking charge.

Sec. 267. Every officer on taking charge of a post, or of a piece of work, shall make a thorough examination of everything placed under his charge. Should he perceive anything amiss or anything not in its proper place, he shall report the facts to the warden or deputy warden as soon as he is relieved. But should there be anything amiss which he can set right, and he shall not do so, it will be no excuse for him that he found it so. His duty will be to make it right and report the facts.

No officer shall leave his post.

Sec. 268. No officer shall leave his post, except by order of the warden or deputy warden, or chief keeper, who shall,

*Penitentiary Regulations.*

## Chap. 60.

before giving such order, take care that a relief is provided, to take the place of the officer relieved.

Sec. 269. At least fifteen minutes before quitting work for the day, the officer in charge of a workshop shall see that all lights and fires in the place are extinguished, and that all is safe and secure. Lights and fires.

Sec. 270. Whenever it may be necessary for a superior officer to countermand or disallow an order given by an inferior, notice of the countermand or disallowance shall be sent in writing by the superior officer to the officer who had given the order. Countermand of order, how effected.

Sec. 271. No officer shall take charge of another officer's gang or post, except by written order of the warden or deputy warden, or chief keeper, or except upon emergency, such as the escape or illness of a convict. Taking charge of another officer's gang.

Sec. 272. Every officer is enjoined to bear in mind that the affairs of the penitentiary can not be efficiently carried on by the warden, nor discipline properly maintained, if any officer be guilty of neglect or disregard of his duty, and it shall be incumbent upon every officer knowing of such neglect or disregard of duty on the part of another, to report the same to the warden, under his oath of office, without fear, favor or affection. Report of neglect or disregard of duty.

Sec. 273. Should any officer perceive any sign pass between a convict and a visitor, or see a visitor without permission speak or attempt to speak to, or to hand anything to a convict, or should a visitor be guilty of any conduct of an improper kind, the officer shall instantly bring the visitor before the warden. Cases when visitor may be brought before warden.

Sec. 274. Every officer shall see that the silent system is strictly carried out. He shall not permit one convict to speak to another on any pretence nor to himself upon any matter except the work at the moment in hand, and then only in the fewest words and in respectful terms, as enjoined by the Statute. Silence to be enjoined.

Sec. 275. An officer shall not have any familiarity with any convict, nor permit any to be used towards himself by any convict, to the slightest extent. Familiarity not permitted.

Sec. 276. Officers shall abstain from all hasty or opprobrious language towards convicts, as entirely unbecoming language. Unbecoming language.

## Chap. 60.

*Penitentiary Regulations.*

their position and character, under pain of severe punishment.

Striking a convict.

Sec. 277. No officer is permitted to strike a convict except in self defence, to suppress revolt, prevent escape, or as a punishment ordered by the warden after inquiry taken under oath.

Leaving or joining a gang.

Sec 278. No officer shall permit a convict placed under his charge to leave his gang, nor shall he permit a convict not placed in his charge to join his gang, without the written order of the warden or deputy warden, or chief keeper.

Convicts retiring for necessary purposes.

Sec. 279. When a convict is obliged to retire for necessary purposes, the officer in charge shall take care that the place is so conspicuous that the convict cannot leave it without being fully seen, that only one is permitted to be in the place at a time, and that he is absent for a reasonable time only. Any delay in such cases should arouse suspicion at once, and the officer must immediately make certain that all is right.

Statement of convict against another.

Sec. 280. No officer shall take the statement of one convict against another convict on which to make a report for punishment respecting the convict complained of, but shall report the fact nevertheless to the warden.

Convicts' complaint, how to be dealt with by officer.

Sec. 281. If a convict make complaint to an officer of any order given him or of any action towards him, by which he considers himself aggrieved, it shall be the duty of the officer to inform the warden thereof at the earliest moment convenient thereafter, and the warden will act in the matter as he may think reason and justice require; but the officer shall in the meantime see that the convict obey the order given him.

Report against convict to be entered.

Sec. 282. Every report against a convict shall be entered in the report book by the officer who makes it, or by the chief keeper or steward and signed by the officer reporting.

Religious belief not to be tampered with.

Sec. 283. No officer shall tamper with the religious belief of any convict, nor attempt to proselytize either by speech or by giving books or in any way whatever, under a pain of instant dismissal.

Officers, how to form opinions on convicts' work.

Sec. 284. In forming their opinions with respect to the industry of a convict, officers will bear in mind that as one convict may be able to do more work in a given time

*Penitentiary Regulations.*

## Chap. 60.

than another, so their reports on this head will have regard more to the continuous labor of the convict, the care bestowed upon it, and the evidence of his desire to do all he can, than upon the absolute quantity he does, as compared with others. An amount of work which may thus be insufficient for one man, may be quite sufficient for another, and the officer's report for the remission of sentence will be based accordingly.

Reporting on convicts work.

Sec. 285. In all their intercourse with the convicts, officers shall be careful to maintain a quiet firm demeanor under any provocation, recollecting that the convict, however disposed to be violent or abusive, is entirely in their power.

A quiet, firm demeanor to be observed.

Sec. 286. Should a convict be apparently attempting to escape, it shall be the duty of the officer observing him to order him to go to his work or other duty. Should the convict refuse, the officer will give the alarm by the readiest means, or if necessity require it, by firing his piece in the air, in a direction, however, in which he is sure the bullet can inflict no injury; and should the convict still endeavor to effect his escape, the officer shall aim at him, and fire so as to wound or disable the runaway, but not to kill, if possible. Officers will bear in mind that life is to be put in hazard only under circumstances of positive necessity, and that on none other shall they discharge their fire-arms at a convict, and that, therefore, firearms are not to be used if an escape can be prevented by any other means.

Convicts attempting to escape.

Use of fire-arms and general directions in such case.

Sec. 287. Every convict who attempts to escape, or who, having made his escape is afterwards arrested and returned to the penitentiary, shall be tried before the first court of competent jurisdiction. This shall also constitute a prison offence to be punished by the warden at his discretion.

Trial in case of escape or attempt.

Sec. 288. No officer shall recognize any convict after his discharge, nor make him known to others to his injury; but should a discharged convict fall again into improper courses, to the knowledge of an officer, this will not be understood to prevent the officer quietly warning any person, likely to suffer by the convict's acts, but on the contrary, it will be the duty of the officer to give such warning.

Discharged convict not to be recognized by an officer, but he may give warning.

Sec. 289. When a convict is taken ill at work, the officer in charge shall send him to the hospital in care of a guard, who will report the fact to the warden at the same time.

Convict taken ill at work.

## Chap. 60.

*Penitentiary Regulations.*

Convict sent  
on a message.

Sec. 290. When a convict is sent on a message from one part of the prison to the other, the officer sending him shall give him a pass stating the place from which, and the place to which, or person to whom he is sent. He shall take care that the pass is delivered up by the convict, immediately on his return and that he is not too long away.

Watching the  
convicts at  
work.

Sec. 291. It shall be the duty of every officer to keep constant watch over convicts in workshops to see that the convicts while pretending to be engaged on the work given them to do are not in reality at work at something else.

Manufacture  
of false keys  
to be guarded  
against.

Sec. 292. As models of false keys, and also false keys and burglarious implements have from time to time been discovered in the prison, which have been made by convicts, officers can not be too strict nor too sharply on the watch to prevent such manufacture and more particularly in those shops where tools are necessary in the hands of the convicts, which may be perverted to such purposes.

Educational  
qualifications  
of officers.

Sec. 293. No person shall be employed as an officer of the prison, who is not able to read and write with facility, or who can not readily use figures in the elementary rules of arithmetic.

Officers' annual  
report, how made  
and what to  
state.

Sec. 294. All officers whose duty it shall be to make an annual report to the warden for the Inspector, to be laid before Parliament, shall state in tabular form therein, all the information recorded in the several books kept in the department of such officer respectively, and also the progress of the department during the year, and its condition at the close of it. But no matter shall be introduced into any such report which has not been previously submitted to the Inspector.

## CONVICTS.

Supply of  
rations to  
convict.

Sec. 295. Every convict not under punishment shall receive the proper ration, but should there happen to be any irregularity in the division, or should a convict desire to have an additional quantity, he shall quietly stand up in his place, until a signal is made to him that he is observed, when he will receive a further supply or not as the warden or deputy warden may consider right.

Clothing to  
be numbered.

Sec. 296. Every convict shall see, when he receives any article of clothing that it bears the number which has been assigned to him, and if not he shall, at the earliest moment, return it to the officers dispensing the same.



*Penitentiary Regulations.*

## Chap. 60.

Sec. 297. Every convict shall be liable to punishment, upon whose person or in whose cell shall be found any article not marked with his number; should any such article be given to him by mistake, or should he find it in his cell he shall instantly inform the officer on duty.

Punishment for not having article marked.

Sec. 298. Every convict found in possession of more articles than he is authorized to have at any one time, even if marked with the numbers assigned him, shall be liable to punishment.

Having more articles than authorized to have.

Sec. 299. A convict is not allowed to have anything whatever in his possession, except what is allowed by the rules, without the permission of the warden or the deputy warden; nor to give anything to any person; nor to receive anything from any person except the officer in charge.

Not allowed to have, give or receive anything.

Sec. 300. If any money, book, or other article not the property of the institution be found in the possession of a convict, at any time after his reception, for which the consent of the warden has not been obtained, the same shall be forfeited, and the convict shall also be liable to punishment.

Money, book or other article found in possession of convict.

Sec. 301. No convict shall give or receive any article of provisions to or from another convict, except in the presence and with the knowledge and consent of an officer.

Giving to or receiving from another.

Sec. 302. A severe punishment shall especially be inflicted upon any convict who shall supply, or attempt to supply any convict under punishment with provisions or anything else.

Supplying convict while under punishment.

Sec. 303. Every convict shall keep his person and clothing as neat and clean as the character of his work will permit, and his cell also as cleanly as possible.

Cleanliness.

Sec. 304. Should any convict soil his clothing or cell, more than is unavoidable, he shall not only be liable to punishment, but should he make a practice of it, and should the warden see fit, he shall be made himself to clean them in addition to his daily work. Convicts who are filthy in their persons, practices or habits, shall also be made known to their fellows by a distinguishing mark, and shall not be permitted to eat at the same table.

Soiling clothing or cell.

Filthy convicts to have a distinguishing mark.

Sec. 305. When a convict enters his cell he shall pull in the door so as to be nearly shut, and stand close to it inside, until the appearance of the officer, locking the cells.

How convict must enter his cell.

- What officer shall do. He shall then close it fully, so that the lever shall catch the bolt. The officer having locked it, the convict shall remain standing until the checking officer shall have examined it, and satisfied himself that the door is securely locked.
- Rising from and going to bed. Sec. 306. Every convict shall rise from bed at the sound of the interior bell in the morning, and go to bed at the sound of the bell in the evening. On rising from bed he shall hang the bedclothes upon the pegs in his cell, and properly arrange the bed. He shall sweep out his cell, wash himself and comb his hair, and be prepared to carry out the cell utensils when the signal is given.
- Conduct of convict on rising. Sec. 307. Every convict shall approach the officers and servants of the penitentiary in respectful manner, and implicitly obey their orders.
- Approaching officers, &c.
- Not to leave the gang. Sec. 308. He shall not leave the gang to which he has been attached upon any pretence, without the permission of the officer in charge.
- Speaking to another convict or to an officer, &c. Sec. 309. No convict shall be permitted to speak to another convict upon any pretence whatever, nor to an officer, guard or any servant of the institution, except from necessity, or with respect to the work at which he is employed and then only in the fewest words, and in a respectful manner, nor shall he unless by permission speak to any visitor, nor look away from his work when a visitor is present.
- Writing, making sign, &c. Sec. 310. A convict shall not write to another convict, nor make any sign, motion nor communication to him, nor shall he give another convict any offence.
- Out of sight or hearing. Sec. 311. No two or more convicts shall be together out of the sight, or the easy hearing of an officer.
- Not to be in place without permission. Sec. 312. No convict shall at any time, be in any place where he has not received permission to go.
- Entering another's cell. Sec. 313. No convict, unless by permission of an officer shall enter the cell of any other convict.
- Convict shall be diligent to learn, careful and economical. Sec. 314. Every convict shall be diligent to learn the occupation to which he has been set, and faithful and industrious in his labor. He shall be careful not to injure any article of clothing, nor any materials nor tools with which he has been entrusted, but, on the contrary, he shall be economical in the use of everything, taking care that

*Penitentiary Regulations.*

## Chap. 60.

nothing is wasted, damaged or destroyed, and should any damage be done by any other he shall immediately notify an officer of the fact.

Sec. **315.** A convict is not allowed to look with curiosity nor forwardness around the room in which he is at work. He is expected to give his attention to his work, and to that only.

Not to look around room.

Sec. **316.** All whistling, shouting or making a noise of any kind; indecent behavior, or improper conduct, in chapel, school or elsewhere; breaking of windows, or injuring property in any way; idleness or negligence at work, or wilful mismanagement of it, will render the guilty convict liable to punishment.

Whistling, shouting, &c., and other improper conduct liable to incur punishment.

Sec. **317.** Every convict shall attend the services of the church of which he has declared himself to the warden to be an adherent, and he shall not be allowed to change from one church to another, without the special permission of the Inspector.

To attend services of his church.

Sec. **318.** Every convict shall more particularly conduct himself with propriety and decorum, when in chapel or in school; and as attendance at school is meant to be a privilege, the convict who misconducts himself while there, will be deprived of it as part of the punishment for the offence.

Conduct when in chapel or school.

Sec. **319.** Every convict shall take the greatest care of books received by him from the library; he shall take great care that they are not torn nor defaced, nor otherwise injured, while in his possession; he shall not be permitted to receive any book from another convict, nor to give a book to any other convict, but shall, when he has finished reading any book, return the same to the library on the first exchange day thereafter.

Books from library to be taken care of and not given to another convict.

Sec. **320.** All convicts who upon their reception into the penitentiary, declare themselves to belong to the Roman Catholic faith, shall be placed under the spiritual charge of the Roman Catholic chaplain; all others shall be placed under that of the Protestant Chaplain, and every convict shall be obliged to attend the services in one chapel or the other.

Spiritual charge of convicts

Compulsory attendance in chapel.

Sec. **321.** A convict who is sent on a message from one part of the prison to another, shall show his pass to every officer whom he meets or passes on the way should the officer require it. He shall deliver up the pass to the officer from whom he received it on his return.

Convict to show his pass when sent on a message.

## Chap. 60.

*Penitentiary Regulations.*

Away from work.

Sec. **322.** Should he be found away from his work without a pass, he will be liable to punishment.

When cell is changed.

Sec. **323.** When the cell of a convict is changed, the convict shall carry with him the bible, prayer book, and other books at the time in his possession.

Being within twenty feet of inclosure of prison.

Sec. **324.** Every convict who is seen within twenty feet of the inclosure of the prison grounds, unless he be in charge of an officer or be in such close proximity to the boundary, by permission, shall be liable to punishment.

Remission of sentence.

Sec. **325.** The remission of sentence authorized by the statute, shall for every month be such as the warden may determine according to the good conduct and industry of the convict. But no remission shall be allowed until after the expiry of the first six months of imprisonment.

Privilege of being visited.

Sec. **326.** A convict whose conduct is satisfactory shall have the privilege of being visited by his relatives once a month, and of writing to his family once a fortnight.

Permission to see Inspector.

Sec. **327.** He shall also, should he request it, receive permission to see the Inspector, in his office, during his periodic visits to the penitentiary.

To be under charge of officer.

Sec. **328.** Every convict shall be, at all times, under charge of an officer who shall be responsible for his safe keeping.

## VISITORS.

Speaking to convict.

Sec. **329.** No visitor is permitted to speak to any convict without the permission of the warden.

Communication with convict.

Sec. **330.** No visitor is permitted to make any sign to a convict, whether of recognition or otherwise, nor hold any communication with a convict of any kind or by any means.

Visitor infringing Penitentiary Act.

Sec. **331.** Should a visitor be detected in infringing the Penitentiary Act or any of the rules of the prison, he shall be immediately brought before the warden, to be dealt with according to law.

## SURVEY BOARD ON UNSERVICEABLE ARTICLES.

Of whom the board shall be composed.

Sec. **332.** The chief keeper, the storekeeper and the steward, or such three officers as the Inspector may name, shall form a board, whose duty it shall be to determine

*Penitentiary Regulations.*

Chap. 60.

whether an article which has been in use is unserviceable or not.

Sec. **333.** Officers in charge of departments shall be held responsible for every article given to them, until it shall have been condemned by the board as unserviceable. Officers responsible for articles given them.

Sec. **334.** When articles in use become unserviceable, they shall be sent to the storekeeper with a description thereof in writing by the proper officer, and the storekeeper shall notify the other members of the board of a day and hour convenient for them to assemble to pronounce their judgment thereupon. Articles becoming unserviceable to be sent to storekeeper.

Sec. **335.** The board shall determine whether the articles should be repaired, used for any other purpose, sold, or declared condemned, and lay their decision before the warden. What the board shall determine.

Sec. **336.** They shall keep a record of all articles submitted to them, and of their proceedings with regard to them. Record to be kept.

## BOOKS TO BE KEPT.

Sec. **337.** The following books shall be kept under the direction and control of the warden, and such other books as the Inspector may from time to time see fit to direct. Books to be kept by warden.

Sec. **338.** The Inspector may assign to any officer he may see fit, the duty of keeping any of the books hereinafter mentioned, or any other books ordered by him to be kept, the present regulations notwithstanding. Keeping of books by officer.

Sec. **339.** The warden shall keep a "daily journal," which shall be formally laid before the Inspector at his periodic visit, in which shall be entered:— "Daily journal," what to contain.

1. Every remarkable occurrence happening in the prison. Occurrences.
2. Every instance of negligence or misconduct on the part of any of the officers as reported to the warden as coming within his own knowledge. Negligence.
3. Every escape or attempt at escape on the part of a convict. Escape.
4. Every instance of bad or of insufficient food, of food not properly cooked, or not fairly distributed. Bad food.
5. Every complaint by a convict of cruel or unjust treatment by any officer or servant of the penitentiary. Complaint.

## Chap. 69.

*Penitentiary Regulations.*

Difficulty in carrying out rules.

6. Any difficulty experienced in carrying out any of the prison rules, or of any order of the Inspector. He shall also bring such difficulty under notice in his next report to the Inspector.

Other matters.

7. Such other matter or circumstance as may appear to the warden proper or beneficial to be mentioned.

“Convicts examination book.”

Sec. 310. He shall also examine the convicts at the time of their discharge, putting to them such questions as may from time to time be directed by the Inspector and shall enter the answers of the convicts in the “convicts’ examination book,” to be kept by him for that purpose.

Sec. 341. The deputy warden shall keep;—

“Roster.”

1. A “roster” on which shall be entered a record of every officer’s duty for the day and the post to which he is assigned.

“Officer’s report book.”

2. An “officer’s report book,” in which shall be entered the report of every officer coming off duty, of the state of his post, and of anything which he may desire to mention relating to it.

Chaplain to keep a “daily journal.”

Sec. 342. Each chaplain shall keep a “daily journal,” in which he shall record his visits to the prison, the time of his arrival and departure, the duty which he performs during the day, and any occurrence which he may think of importance. He shall lay the said journal before the Inspector as a matter of routine at every visit to the penitentiary, and before the warden at such times as he may desire.

He shall lay the same before the Inspector.

Chaplains shall keep “registers.”

Sec. 343. The chaplains shall keep “registers”, in which they shall enter the history of every convict under their charge, so far as they may be able to get knowledge of the same, the extent of his education, his habits and disposition, the places he has frequented, and the companions with whom he has associated; and register his moral and religious progress.

Books recording the money transactions to be kept by accountant.

Sec. 344. The books recording the money transactions of the penitentiary shall be kept by the accountant, and shall be as under:—

“Day book.”

1. A “day book,” on the left hand side of which shall be copied, item by item in detail, the particulars of every account or bill of parcels, and on the right hand side a “journal” double entry of the same and opposite thereto, naming the ledger account, or accounts with which the sum or sums comprising the bill are to be debited or credited.

“Journal.”

*Penitentiary Regulations.*

## Chap. 60.

2. A "ledger" containing the accounts to which the posting from the journal side of the day book shall be made. "Ledger."
3. An "official checks book" with counterfoil. Official checks only shall be used. All checks shall be signed by the warden and countersigned by the accountant. "Official checks book."
4. A "tenders book" into which shall be copied the calculations or the particulars of every tender for supplies sent to the warden. "Tenders book."
5. A "revenue and expenditure statements book" into which shall be copied every statement of revenue and expenditure transmitted to the auditor of accounts, and at the foot thereof the oath set forth in the eighth clause of "The Penitentiary Act." "Revenue and expenditure statements book."

Sec. 345. The following books shall be kept by the clerk:— Books kept by clerk.

1. The "Inspector's minute book" with the index thereto, and the latter shall be written up immediately after every visit of inspection. "Inspector's minute book."
2. A "register" in which the name of every convict shall be entered with a full detail of his civil and criminal state, a description of his person, the crime, the place where sentenced, the date of commitment, and the date of expiry of the sentence, with a column for remarks, and such other particulars as the Inspector may from time to time direct. When a convict is committed and again when discharged he shall be weighed in the presence of the clerk, and his weight shall be entered in the register. "Register," and what it shall contain.
3. An alphabetical "index" to the above. "Index."
4. A "discharge ledger" in which every month in every year in advance, shall have a page for itself, and when a convict is committed his prison number and name shall be entered in the page for the month and year in which according to his sentence he is to be discharged. "Discharge ledger."
5. A register of all official letters and documents received. Register.
6. A letter book, into which all official letters sent away shall be copied. Letter book.
7. An "orders book," in which all orders given by the Inspector for the guidance of the officers, and all orders given by the warden for the management or discipline of the prison shall be entered, and which shall be accessible at all times to the officers. "Orders book."

## Chap. 60.

*Penitentiary Regulations.*

"Officers default book."

8. An "officers default book," in which shall be entered the date of the reported default, the name of the officer or servant in default, a short statement of the circumstances of the default, and the acquittal, censure, reprimand, fine, suspension, or dismissal of the officer or servant, and whether such has been ordered by the Inspector or by the warden.

"Convict offenders book."

9. A "convict offenders book," in which shall be entered alphabetically, the number and name of every convict who has been punished for misconduct, with the date according to the report book, and the initial letters of the punishment ordered.

Chief keeper shall keep the "convicts report book" what to be entered therein.

Sec. 346. The chief keeper shall keep the "convicts report book," in which shall be entered every report of misconduct on the part of a convict, which shall be laid before the warden every day. Opposite to such report *the warden shall write the substance of the proof adduced*, and the punishment ordered by him to be inflicted, and shall affix his initials thereto.

"Convicts report book" for females.

Sec. 347. The "convicts report book" of the female department shall be kept by the matron.

"General stock book" to be kept by storekeeper, what to contain.

Sec. 348. There shall be a "general stock book" kept by the storekeeper, in which an account shall be opened for every article of whatever kind purchased for the use of the institution, or passing into his store, in which shall be entered the name of the party, the price of the article; daily quantity or number received, with the name of the party from whom received, the quantity or number issued with the name of the party to whom, and department to which issued, and the daily balance on hand.

Books to be kept by steward.

"Provision book."

Sec. 349. The steward shall keep the following books:—

1. A "provision book," in which shall be entered, with the name of the party from whom received, the amounts, and kinds of articles of food, each under its respective head, showing daily the quantity received, the quantity consumed and the balance on hand.

"Rations register."

2. A "rations register," showing the daily number of convicts in the penitentiary, the number on sick diet, the number on bread and water diet, and the number on full rations. According to the numbers he shall accurately weigh out and expend the stores necessary for consumption at every meal.

"Supplies in use book."

3. A "supplies in use book," showing the name and number of every convict in alphabetical order, the number of



*Penitentiary Regulations.*

## Chap. 60.

his cell, the number and description of every article served out to him, the date when served out and the date when returned as unserviceable.

4. A "prisoners effects book," in which shall be entered the date of the reception of every convict into the prison ; his number on the register, name, kind and number of articles taken from him, whether disposed of by the convict and how ; if not disposed of, whether ordered to be preserved or destroyed. The entry shall be signed by the officer making it and by the convict, if he can write, or by a witnessing officer also if the convict cannot write. Should any money be found upon him the warden shall deposit the same in Government Savings Bank, in his corporate name in trust for the convict until his discharge, or until disposal of the amount with the convict's consent. "Prisoners effects book."

Sec. 350. A "department stock book" shall be kept by every officer in charge of a department, in which shall be entered daily the quantity or number of each article received from the storekeeper, with the price, the quantity given out for consumption, and the balance on hand. "Department stock book."

Sec. 351. On the first day in every month, every officer in charge of a department shall leave at the accountant's office, the "department stock book," and it shall be the duty of the accountant and the storekeeper to check the same, the accountant checking the entries in the "general stock book" and the storekeeper those in the "department stock books," and both shall affix their initials on the line under the last entry, if the entries in both books be correct. Should there be any errors of any kind, the same shall be noted in a blotter, to be kept by the accountant for that purpose, and errors in calculation only may be corrected after being noted therein. Other discrepancies shall remain until the blotter shall have been laid before the warden, and his opinion as to their correction taken. The entries in the blotter shall be initialed by the accountant and storekeeper, and in cases brought to the notice of the warden, he shall state in writing on the blotter his decision as to the discrepancy. "Department stock book" to be checked every month.

Sec. 352. There shall be a "time book" kept by every officer in charge of work, in which shall be entered the prison number and name of every convict placed under his charge, and shall be noted every day, the kind of work performed by the convict, and, where practicable, the amount also, and the value. "Time book" what to contain.

“Conduct and industry book,” what to contain.

Sec. 353. There shall also be kept by the same officer a “conduct and industry book,” in which shall be kept a daily record of the conduct and industry of every convict under his charge, with the view to determining the amount of remission of sentence, to which such convict may be entitled, at the end of every month.

“Visitors’ book,” how to be kept.

Sec. 354. A “visitors’ book” shall be kept at the entrance lodge, in which every visitor shall enter his name, but he shall not be allowed to enter the prison without the consent of the warden, unless authorized by the 41st clause of the Penitentiary Act. Every visitor, or party of visitors, shall be accompanied by a guard.

“Requisition book,” how to be kept and by whom to be signed and countersigned.

Sec. 355. There shall be a “requisition book” with counterfoil, kept by every officer in charge of a department, in which shall be entered all articles required to be bought for the use of his department. The requisition shall be signed by the officer, and countersigned by the warden. And no article shall be purchased by the storekeeper, except upon an official requisition so authenticated.

Requisitions to be countersigned by warden.

Sec. 356. The warden shall in like manner countersign all requisitions made by the officer in charge of any department upon the storekeeper, for articles to be issued by him from store, for consumption. The storekeeper shall issue no goods from store, unless the requisition is so countersigned.

Books to be kept by hospital keeper.

Sec. 357. The hospital keeper under the direction of the surgeon, shall keep the following books in addition to those kept by him as head of a department:—

Register of sick convicts.

1. A register of all sick convicts admitted into hospital, in which shall be entered such statistical details as the Inspector may from time to time direct according to schedule.

Register of convicts receiving medicine.

2. A register of all convicts to whom medicine is administered, but who are not treated in hospital, in which shall be entered such statistical details as the Inspector may from time to time direct.

“Case book.”

3. A “case book,” which shall be kept according to a form from time to time to be given by the Inspector.

“Death book.”

4. A “death book,” in which shall be entered the prison number and the name of the deceased convict, his age, the length of time in prison and in hospital and the cause of death.

*Penitentiary Regulations.*

## Chap. 60.

5. A "hospital journal," in which shall be entered in the English or French language all prescriptions ordered for the sick under treatment. "Hospital journal."

6. A "conduct and industry book," in which shall be noted the conduct of every convict who is sick in hospital, and the conduct and industry of all convicts employed in or about it, under the charge of the hospital keeper. "Conduct and industry book."

## LIBRARIES.

Sec. 358. There shall be a Protestant library for which the books shall be of a religious character, and shall be selected by the Protestant chaplain; and a Roman Catholic library, for which the books shall be of a religious character, and selected by the Roman Catholic chaplain. Protestant library.  
Roman Catholic library.

Sec. 359. There shall be a general library for books of general literature to be used by the convicts in common, which shall be selected by the library board, to be composed of the warden and the two chaplains. Books of general literature.

Sec. 360. The library board, with the approval of the Inspector, shall give such instructions for the issue and return of books, and the recording thereof as he from time to time may see fit, as well as for the general management of the libraries and the preservation of the books. Instructions for issue and return of books to be given by library board.

Sec. 361. When new books are required for the general library, the library board shall prepare a list thereof, with an estimate of the cost, to be submitted to the Inspector, who may order such sum to be disbursed for the purpose as he may think necessary. When new books are required.

Sec. 362. In like manner when books are required for the Protestant or Roman Catholic library respectively, the chaplain requiring them shall transmit through the warden a list of the books required, with the probable cost, and the warden shall lay the same before the Inspector, for his action thereupon. Books required for Protestant or Roman Catholic library.

Sec. 363. No book of religious controversy, nor work tending to bring into contempt either the Protestant or the Roman Catholic faith, shall be permitted to be brought into the prison. Books of religious controversy forbidden.

## PUNISHMENTS.

Sec. 364. The punishment to be inflicted upon male convicts for any one prison offence shall not be other than the following:— Punishment of male convicts.

## Chap. 60.

*Penitentiary Regulations.*

- Diet. 1. Diet of bread and water not exceeding nine consecutive meals.
- Hard bed. 2. Hard bed, with or without a cover or covers, according to the season, not exceeding six consecutive nights.
- Diet and hard bed. 3. Diet of bread and water not exceeding nine consecutive meals, combined with hard bed not exceeding six consecutive nights, if approved by the surgeon.
- Ball and chain. 4. Ball and chain.
- Ball and chain, &c. 5. Ball and chain, combined with No. 1, or No. 2, or No. 3.
- Confinement and diet. 6. Confinement in the penal or separate cells, with such diet as the surgeon shall pronounce sufficient, respect being had to the constitution of the convict, and the length of the period during which he is to be confined.
- Penal or separate cell. 7. Penal or separate cell, combined with No. 1, No. 2 or No. 3.
- Flogging with cats. 8. Flogging with the cats, under the restrictions set forth in "The Penitentiary Act," and in these rules.
- Flogging with rods. 9. Flogging with rods of birch or other wood.
- Forfeiture of remission. 10. Forfeiture of the whole or a part of the remission of sentence earned by the convict.
- Other punishment. 11. Such other punishment as may be recommended by the warden, approved of by the Inspector and sanctioned by the Governor in Council, combined with any of the foregoing.
- Punishment of female convicts. **Sec. 365.** The punishment to be inflicted on female convicts shall not be other than the following for any single offence:—
- Diet. 1. Diet of bread and water not exceeding six consecutive meals.
- Hard bed. 2. Hard bed, with or without one or more covers, not exceeding six consecutive nights.
- Diet and hard bed. 3. Diet of bread and water not exceeding six consecutive meals, combined with hard bed, not exceeding six consecutive nights.
- Cutting hair. 4. Cutting the hair short.
- Cutting hair, &c. 5. Cutting the hair short, combined with No. 1, No. 2 or No. 3.

*Penitentiary Regulations.*

Chap. 60.

6. Penal or separate cell, with such diet as the surgeon shall declare sufficient; respect being had to the constitution of the convict, and to the period during which she is to be confined. Penal or separate cell with diet.

7. Penal or separate cell combined with any of the preceding. Penal or separate cell.

8. Forfeiture of days of remission of sentence earned by the convict. Forfeiture of remission.

## KEYS.

Sec. 366. All keys when not in actual use shall be deposited in a box or cupboard, at all times perfectly secure in the keepers' room, which shall, during the day, be under the special charge of the officer on duty in the hall; and at night under that of the officer of the night. Keys to be deposited in a box under charge of officer on duty.

## PRISON ROUTINE.

Sec. 367. When summer is mentioned in any rule, order, or writing, the period from the first day of March to the thirty-first day of October inclusive, shall be understood; and when winter is mentioned, the period from the first day of November to the last day of February inclusive, shall be understood. Summer months. Winter months.

Sec. 368. During summer the bell for opening the prison shall be rung, and the prison shall be opened every morning at six o'clock. The bell for closing the prison shall be rung, and the prison shall be closed at six o'clock in the evening in summer, and not later than six o'clock in winter. Hours for opening and closing of prison.

Sec. 369. The cell doors shall not be opened in the morning, nor the doors of the dormitory wings, until after the roll of officers shall have been called. Opening of the cell doors, &c.

Sec. 370. During summer the convicts shall have breakfast at twenty minutes past six o'clock in the morning; and in winter at seven; and shall have dinner at fifteen minutes past twelve o'clock noon; and they shall receive supper on going to their cells in the evening. Hours for meals.

Sec. 371. On Sundays they shall have dinner at one o'clock in the afternoon. Sunday's dinner.

Sec. 372. The bell for convicts going to bed shall be rung at nine o'clock, p. m., in summer and in winter, when the convicts shall undress and hang their day clothes upon the pegs in the cells. Hour for going to bed.

## Chap. 60.

*Penitentiary Regulations.*

Lamps for reading.

Sec. 373. The lamps allowed for enabling good conduct convicts to read, shall be extinguished on the ringing of the last bell.

## GATE MONEY AND FINES.

Moneys received from visitors or levied as fine, how to be used.

Sec. 374. All moneys received from visitors at the gate, or levied from officers as fines shall be deposited by the accountant monthly to the credit of the warden, to be disbursed for such purposes in connection with the penitentiary as the Minister of Justice may direct.

## DIETARY.

Penitentiary diet.

Sec. 375. The following is the penitentiary diet which may be altered from time to time, by the Inspector, upon consultation with the warden and surgeon:—

Breakfast.

*Breakfast.*

Cold meat, 4 ounces, without bone.  
Bread (white), 12 ounces.  
do (brown), 1 ounce.  
Coffee (peas), 1½ pints.  
Sugar, ½ ounce.

Dinner.

*Dinner.*

Meat, 7 ounces, without bone.  
Bread (white), 8 ounces.  
do (brown), 1 ounce.  
Potatoes, 16 ounces.  
Soup, 1½ pints.

Supper.

*Supper.*

Bread, 12 ounces.  
Tea, 1 pint.  
Sugar, ½ ounce.

Wardens and officers to obey rules.

Sec. 376. The wardens of the penitentiaries, and every other officer and servant employed in our about the same, shall be bound to obey the foregoing rules and regulations so far as they apply to each employé of a penitentiary.  
O.C. Jan. 16, 1888.

## INTERPRETATION.

Sec. 377. In these rules and the schedules thereto:—

“Minister.”

(a.) The expression “the Minister” means the Minister of Justice;

*Penitentiary Regulations.*

## Chap. 60.

(b.) The expression "the Inspector" means the Inspector of Penitentiaries; "Inspector."

(c.) The expression "the warden" means the warden of the penitentiary over which he presides; "Warden."

(d.) The expression "officer" means and includes any officer or employé of any of the classes mentioned in the schedule to an Act passed in the session held in 1887, intitled "An Act to amend the Penitentiary Act." "Officer."

(e.) The expression "trade instructors" includes bakers, blacksmiths, carpenters, masons, millers, shoemakers, stonecutters, tailors, and persons employed to direct and instruct convicts in any branch of labor. "Trade instructors."

## INCREASE OF SALARIES.

Sec. 378. Each warden shall, on or before the 1st day of June in each year, transmit to the Inspector, for the information of the Minister, a report showing the officers under him who are eligible for such yearly increases, and giving in each case his own opinion as to whether or not such increase should be given and the reasons therefor. Increase of officers' salaries on report of warden.

Sec. 379. The Inspector shall, on receipt of any such report, transmit the same to the Minister, with a memorandum showing whether he concurs or not in the recommendation of the warden. He shall also express his views as to whether or not the warden should be given any increase for which he is eligible. Inspector to transmit memorandum to Minister and express his own views.

## RESIDENCES AND GROUNDS.

Sec. 380. Any officer occupying any house or quarters, the property of and provided for him by Government, shall, during the will of the Minister, occupy the same with any grounds attached, free of rent. Officers' residences and grounds free of rent.

Sec. 381. No officer shall at any time have any claim to or be made any allowance in lieu of such free house or quarters. No allowance in lieu of rent.

Sec. 382. The Government will keep such houses and quarters in repair, but if at any time the need of such repairs shall be occasioned by the negligence or fault of the officer so occupying such house or quarters, or of any member of his family, the cost thereof may be charged to such officer and deducted from his salary. Houses, &c., to be kept in repair.

## Chap. 60.

*Penitentiary Regulations.*

Furnishing house for officer.

Sec. 383. The Government will not in future, in whole or in part, furnish any house or quarters for occupation by any officer.

Gas consumed by officer to be paid for.

Sec. 384. Any officer occupying any house or quarters lighted by gas from a supply common to the penitentiary shall pay for the gas consumed by him at a fair price to be fixed by the Minister, and a meter shall be used to indicate the quantity of gas so consumed by such officer.

Heating of house for paid for.

Sec. 385. Any officer occupying any house or quarters heated by a system common to the penitentiary, shall pay for such heating a fair price to be fixed by the Minister.

Grounds or gardens may be cultivated by convict labor.

Sec. 386. The grounds or gardens attached to the residence or quarters of a warden or deputy warden may be kept in order and cultivated by convict labor, but otherwise no convict labor shall be employed in keeping in order or cultivating any grounds occupied by any officer.

Products of grounds.

Sec. 387. Each officer shall be entitled to everything grown upon the grounds attached to his house or quarters.

## OFFICERS' UNIFORM CLOTHING.

Allowance to each officer.

Sec. 388. Each officer who wears uniform shall be allowed uniform clothing as follows:—

Fine blue dress suit.

(a.) One fine blue cloth dress suit every four years, consisting of fine blue cloth cap, frock coat, waistcoat and trousers ;

Winter suit.

(b.) One winter suit every year, consisting, of pilot cloth pea jacket, waiscoat and trousers ;

Summer suit.

(c.) One summer suit every year, consisting of blue serge or Halifax tweed, pea jacket, waistcoat and trousers ;

Overcoat.

(d.) A freize overcoat every three years ;

Winter and summer boots.

(e.) A pair of French kid boots for winter and a pair of shoes for summer, every year ;

Fur cap.

(f.) A fur cap every four years ;

Cloth cap.

(g.) A cloth cap every year ;

Suits allowed to officers retiring from the service.

Sec. 389. The warden may allow any officer whose conduct has been good and who is about to retire from the service, to take away his dress suit, if it has been in use eighteen months, and his winter or his summer suit, if it has been in use six months.



*Penitentiary Regulations.*

Chap. 60.

## SALE OF ARTICLES TO OFFICERS.

Sec. 390. The warden may, if he see fit so to do, sell at a fair price, to any officer for his own use only, any article manufactured in the penitentiary shops, or grown upon the penitentiary property, but not any other article the property of the penitentiary.

Articles, how to be sold to officers.

Sec. 391. The warden may, if he see fit so to do, allow any officer, for his own use only, at a fair value, to have any work done for him in the penitentiary shops.

Work done for officer in shops.

Sec. 392. Nothing shall be so sold, and no work shall be so done :—

Nothing shall be sold.

(a.) Without an application in writing by the officer, stating that the article sought to be purchased, or the work to be done, is for his own use only; and

Without an application.

(b.) Without a proper requisition, duly signed by the proper officers, according to the penitentiary rules in other cases in force.

Without a requisition.

Sec. 393. Subject to revision as hereinafter provided, the fair price or value of any article sold or work done for the warden shall be fixed by the deputy warden and accountant jointly, and in other cases by the warden.

Value to be fixed by deputy warden and accountant.

Sec. 394. Any officer signing a false application shall be dismissed.

False application.

Sec. 395. An accurate account shall be kept of all articles sold to any officer, or work done for him, and the price or value thereof, and a statement thereof, in such form and verified in such manner as the Minister from time to time prescribes, shall each month be sent to the accountant of penitentiaries, who may, under directions from the Minister, revise any such statement, and direct the warden to charge against and collect from any officer any amount short charged either by mistake or under-valuation.

Account to be kept of articles sold to officer and statement to be sent to accountant of penitentiaries.

Sec. 396. Any article so sold or work so done shall be paid for in cash on or before the last day of the month in which it is delivered or finished.

How and when to be paid for.

Sec. 397. No officer who is in arrears in respect of an article so sold to him or work so done for him, shall be paid his monthly salary until such arrears are discharged by him.

When officer in arrears for article sold him.

## GENERAL.

Officers shall not receive any additional salary or emolument for services at which he is employed.

Sec. 398. No officer shall, for any service or work in any manner or under any circumstances, done either under the direction of the Department of Justice, or the Department of Public Works, for or in respect of the penitentiary at which he is employed, be paid any salary or emolument in addition to that hereby prescribed, and for such salary the warden may exact any service for which by reason of his office or qualifications such officer is fitted.

O. C June 30, 1887.

## NOTE.

Salaries of officers regulated by statute.

[The salaries of the officers of the several penitentiaries of Canada are regulated by chapter 52 of the Acts of the Parliament of Canada, 50-51 Victoria, intituled "An Act to amend the Penitentiary Act." See section 10 of said amending Act, and the schedule thereto at pages 164, 165 and 166 of the "General Public Acts" of 1887.]

# POST OFFICE DEPARTMENT.

## CHAPTER 61.

### POST OFFICE SAVINGS BANKS.

Government House, Ottawa,  
The 30th day of May, 1889.

On the recommendation of the Postmaster General and under the provisions of Chapter 35 of the Revised Statutes of Canada, intituled "The Post Office Act,"

His Excellency in Council has been pleased to sanction and approve the following regulations made and prescribed by the Postmaster General for the conduct of post office savings banks.

Section 1. Every post office, being a money order office, at which the Postmaster General shall permit deposits to be received for remittance to the central savings bank in the Post Office Department at Ottawa, will be open for that purpose, and for the repayment of moneys withdrawn, during the hours appointed for the transaction of money order business at the said post office, and at such other hours as may from time to time be appointed in any case by the Postmaster General.

Hours to be the same as those for the transaction of money order business.

Sec. 2. (a.) Deposits of one dollar, or of any number of dollars, will be received from any depositor at the post office savings banks, provided the deposits made by such depositor in any year ending the 30th June do not exceed three hundred dollars, and provided the total amount standing in such depositor's name in his ordinary deposit account in the books of the Postmaster General do not exceed one thousand dollars, exclusive of interest.

Amount of deposits in one year \$300. Total amount in one name, \$1,000.

(b.) No interest will be allowed on any sum over and above one thousand dollars in an ordinary deposit account.

No interest on sum over \$1,000.

Sec. 3. (a.) Every depositor, on making a first deposit, shall be required to specify his christian name and surname, occupation and residence, to the postmaster or other officer of the Postmaster General receiving such deposit, and make and sign the following declaration, to be witnessed by the said postmaster or other officer receiving the deposit, or by some person known to him, or by a justice of the peace; and if such declaration, or any part thereof, shall not be true,

Name, occupation and residence of depositor to be furnished.

the depositor making the same shall forfeit and lose all right and title to his deposits.

Form of declaration by depositor making his first deposit.

Depositor's Book.

DECLARATION BY DEPOSITOR ON MAKING FIRST DEPOSIT.

Office

No.

I, ..... of ..... do hereby declare to the Postmaster General that I am desirous, on my own behalf, to become a depositor in the Post Office Savings Bank. I do further hereby declare that I am not directly or indirectly entitled to any sum or sums standing in my own name or in the name or names of any other person or persons in the books of the said Post Office Savings Bank; and I do hereby also testify my consent that my deposits in the said Post Office Savings Bank shall be managed according to the regulations thereof.

Witness my hand, this ..... day of ..... 18..... Signed by the said depositor, in the presence of me

..... } .....

Save and except such sum or sums as may be standing in my name as Trustee jointly with the name or names and on behalf of any other Depositor or Depositors.

NOTE.—When this Declaration is made on behalf of a minor under ten years of age, the age of such minor must be here stated after his name; and the minor's name at the foot must be followed by the signature of a parent or friend on his behalf.

Parents cannot obtain repayment of deposits made by them on behalf of minors under ten, and repayment will not be made to such minors until they reach the age of ten years.

Declaration that depositor understands what is required of him.

(b.) The following declaration must also be made and signed by the depositor.

I, the depositor named in the foregoing declaration, declare that I clearly understand that for every deposit I shall place in the hands of a Postmaster for transmission to the Post Office Savings Bank. I must see that I receive a direct receipt from the Postmaster General, and that the Postmaster's entry in the Pass Book is not sufficient without the further receipt from Ottawa.

Signed by the said depositor in the presence of me )

..... )

If depositor can not write.

If the Depositor can not write, the following certificate must be signed by two persons, both over the age of twenty-one years.

We, the undersigned, testify that the above declaration was read to the depositor named therein, in our presence and in our hearing, and that the depositor stated that he understood the same.

..... } Signature.

..... } Occupation.

..... } Signature.

..... } Occupation.

Copy of declarations.

(c.) A copy of the above declarations is printed within the cover of every depositor's book.

Attestation of signature.

(d.) On making the declarations aforesaid, and in all cases in which the signature of a depositor is required, if the depo-

*Post Office Savings Banks.*

Chap. 61

sitor can not write, his mark must be affixed in the presence of a witness, and attested by the signature of that witness.

Sec. 4. A depositor in any of the savings bank post offices may continue his deposits at any other of such offices, without notice or change of pass book, and can withdraw money at the savings bank office which is most convenient to him. For instance, if he makes his first deposit at the savings bank at Cobourg he may make further deposits at, or withdraw his money through the post office savings bank at Collingwood or Quebec, Sarnia, Brockville, or any place which may be convenient to him, whether he continues to reside at Cobourg, or removes to some other place.

Depositor in one office may continue his deposits, and withdraw moneys at any other office convenient to him.

Sec. 5. (a.) Every deposit received by a postmaster, or other officer of the Postmaster General appointed for that purpose, shall be entered by him at the time in a numbered book, and the entry shall be attested by him and by the dated stamp of his office, and the said book, with the entry so attested, shall be given to the depositor, and retained by him as primary evidence of the receipt of the deposit.

Deposits, how received, reported and acknowledged.

(b.) The depositor shall sign his name in a place to be provided for his signature in the depositor's book.

Depositor to sign his name.

(c.) The amount of each deposit so received, and the name, occupation and residence of the depositor, shall, upon the day of the receipt thereof, be reported to the Postmaster General, and the acknowledgment of the Postmaster General for the said deposit, signified by the officer whom he appoints for the purpose, shall be forthwith transmitted by post to the depositor as the conclusive evidence of his claim to the repayment of the deposit with the interest thereon, upon demand made by him on the Postmaster General.

Amount of each deposit, &c., shall be reported to and acknowledged by the Postmaster General.

(d.) If the depositor does not receive the said acknowledgment within ten days (or eighteen days if resident in British Columbia or the North West Territories) from the day on which he makes a deposit he must apply for the same to the Postmaster General, by letter, and if necessary renew his application to the Postmaster General, until he receives the said acknowledgment.

Time for the receipt of said acknowledgment.

Sec. 6. (a.) Interest calculated yearly, at a rate not exceeding four dollars per cent. per annum, is allowed on deposits, and shall be computed from the first day of the calendar month next following the day on which the deposit is made, up to the first day of the calendar month in which moneys are withdrawn.

Interest, how and from what day to be computed.

Chap. 61

Post Office Savings Banks.

Interest calculated to 30th day of June.

(b.) The interest will be calculated to the thirtieth day of June in every year, and will then be added to and become part of the principal money.

Deposits by a trustee, how to be made; and repayment of the same, how provided for.

Sec. 7. (a). Deposits may be made by a trustee on behalf of another person, in the joint names of such trustee and the person on whose account such money shall be so deposited; but repayment of the same, or any part thereof, shall not be made without the receipt and receipts of both the said parties, or the survivor or survivors, or the executors or administrators of such survivor, whose receipt and receipts, either personally or by agent appointed by power of attorney, which power of attorney, in the case of minors, may be executed by such minor if of or exceeding the age of fourteen years, shall alone be a valid discharge, except in case of insanity or imbecility of the party on whose behalf the deposits were made, when the Postmaster General may, on proof of the fact to his satisfaction, allow repayment to be made to the trustee alone.

Form of declaration by Trustee.

(b). The following declaration must be made in such cases:—

Depositor's Book.

Office.....

No.....

DECLARATION BY THE TRUSTEE OF A DEPOSITOR.

I.....(occupation) of.....(residence) do hereby declare to the Postmaster General that I am desirous of becoming a Depositor in the Post Office Savings Bank, as the Trustee of.....(occupation) of....., and I do further declare on behalf of myself, and also on behalf of the said.....that we are not either jointly or severally, directly or indirectly, entitled to any deposit or benefit from the funds of the Post Office Savings Bank, nor to any sum or sums standing in the name or names of any other person or persons in the Books of the said Savings Bank.

Witness my hand this.....day of.....18 .  
Signed by the said Trustee  
in the presence of me, .....  
..... }  
..... }

Save and except such sum or sums as may be standing in my name as a Depositor, on my own Account, or as Trustee jointly with the name or names, and on behalf of any other Depositor or Depositors.

NOTE.—This Declaration is to be signed by the Trustee alone—but the names of BOTH PERSONS must be written on the cover of the Pass Book, and the signatures of BOTH PERSONS will be required to a Notice of Withdrawal.

Declaration by Trustee that he understands what is required.

(c). The following declaration must also be made and signed by the Trustee:—

I, the Trustee above-named, declare that I clearly understand that for every deposit I shall place in the hands of a Postmaster for transmission to the Post

*Post Office Savings Banks.*

Chap. 61

Office Savings Bank, I must see that I receive a direct receipt from the Postmaster General, and that the Postmaster's entry in the Pass Book is not sufficient without the further receipt from Ottawa.

Signed by the said Trustee  
in the presence of me

.....  
.....  
.....

(d). If the Trustee can not write, the following certificate must be signed by *two persons, both over the age of twenty-one years* :—

If Trustee  
can not write.

We, the undersigned, testify that the above declaration was read to the Trustee referred to therein, in our presence and in our hearing, and that the said Trustee stated that he understood the same.

..... } Signature.  
..... } Occupation.  
..... } Signature.  
..... } Occupation.

(e). In case any such declaration shall not be true, the person making the same shall lose all right and title to his deposits.

Effect of false  
declaration.

Sec. 8. (a). Deposits may be made by or for the benefit of any person under twenty-one years of age.

Deposits for  
person under  
21 years.

(b). In case of minors under the age of ten years, the declaration must be made by one of the parents or by a friend on behalf of the minor.

Minors under  
10 years.

(c). Repayment to a minor over ten years of age shall be made in the same manner as if he were of full age.

Repayment  
to minor over  
10 years.

Sec. 9. Deposits may be made by married women, and deposits so made, or made by women who shall afterwards marry, will be repaid to any such women.

Married  
women.

Sec. 10. Every depositor shall, once in each year, on the anniversary of the day on which it issued, forward his book to the Postmaster General, in a cover to be obtained at any post office savings bank, in order that

Transmission  
of depositors  
books to  
Postmaster  
General

Chap. 61

*Post Office Savings Banks.*

the entries in the said book may be compared with the entries in the books of the Postmaster General, and that the interest due to the depositor on the preceding 30th June may be inserted in his book.

No charge to depositor for books supplied, except in case of loss.

Sec. **11.** No charge shall be made upon depositors for the books at first supplied to them, or for books issued in continuation thereof; but if any depositor shall lose his book, and shall desire a new book, application must be made by him to the Postmaster General, by letter, stating the circumstances, and enclosing postage stamps of the value of twenty cents to pay for the new book, and the Postmaster General shall then, as he thinks fit, issue a new book, or return the stamps to the applicant.

No charge to depositor for postage.

Sec. **12.** No charge for postage shall be made upon the depositors for the transmission of their books to the Postmaster General, or for the return thereof to them, or for any applications they may have to make for acknowledgments of deposits, or for any application or necessary letter of inquiry respecting the sums deposited by them, or for the replies thereto.

Application for withdrawal, how made.

Sec. **13. (a).** Any depositor wishing to withdraw the whole or part of the sum deposited by him must make application for the same to the Postmaster General, in the following form, a printed copy of which may be obtained at any Post Office Savings Bank.

Form of notice of withdrawal.

Depositor's Book. \_\_\_\_\_  
 The.....day of.....18 .  
 Office .....  
 To THE POSTMASTER GENERAL, OTTAWA.  
 No.....

I hereby give notice that I wish to withdraw the sum of.....dollars, from my Deposit Account, bearing the above Number in the Books of the Post Office Savings Bank, and I request that a Cheque may be issued for the above named sum, and made payable to me at the Post Office Savings Bank at.....

..... Signature }  
 ..... Address } of Depositor.  
 .....Occupation }

NOTE.—If the depositor cannot write, his mark must be affixed in the presence of a witness, and attested by the signature of that witness.

Minimum amount of withdrawal.

(b). No less amount than one dollar, or some number of dollars, shall be withdrawn, except when a depositor withdraws all the money, both principal and interest, due to him.



*Post Office Savings Banks.*

Chap. 61

(c). In the form for withdrawals the depositor must specify the number of his book, the name of the office at which his deposit book was issued, the sum which he wishes to withdraw, his occupation and residence, and the Savings Bank Post Office at which he wishes to receive his money. On receipt by the Postmaster General of such application, a cheque in the following form, for the amount required, payable at the office named, shall be sent to him by post :—

What depositor must specify in case of withdrawal.

Depositor's Book.	Cheque No.....
Office.....	POST OFFICE DEPARTMENT. SAVINGS BANK BRANCH, Ottawa..... 18 .
No.....	
To the Postmaster of.....	
Pay .....	the sum of..... dollars, on production of his Deposit Book, and on his satisfying you that he is the person entitled to the same, and charge the amount to this Department.
	Entered .....
S.....	.....Superintendent.

Form of cheque for payment in case of withdrawal.

DEPOSITOR'S RECEIPT.

Stamp of paying Post Office.

I hereby acknowledge the receipt of the above named sum.

.....(Signature of Depositor.)

NOTE.—If the Depositor cannot write, his mark must be affixed in the presence of a witness, and attested by the signature of that witness.

(d). This cheque must be presented by the depositor, with the least possible delay, at the Savings Bank Post Office named thereon, together with the depositor's book, in which the postmaster will enter the amount repaid, and attest the entry with his signature and the dated stamp of his office. The postmaster will take a receipt from the depositor on the cheque for the amount repaid to him.

Presentment of cheque by depositor, together with his book, must be made without delay.

(e). The Postmaster General will endeavor to prevent fraud, and to identify every depositor transacting business with the post office savings bank; but if any person shall fraudulently represent himself to be a depositor, and by forwarding the proper notice of withdrawal, and by presentation of the depositor's book, and compliance with the rules of the Department, shall obtain any sum of money belonging to that depositor, the Postmaster General will not be responsible for the loss thereof.

Postmaster General not responsible in case of fraud upon or impersonation of depositor.

Sec. 14. (a.) Payment of the Postmaster General's cheque for a withdrawal shall be made only to the depositor in person, or to the bearer of an order under his hand, signed in the

Payment of Postmaster General's cheque.

Chap. 61

Post Office Savings Banks.

Attestation of depositor's signature.

presence of a justice of the peace for the place in which the depositor resides,—or, in case of sickness, of the medical attendant. If the depositor be resident abroad, his signature must be verified by some constituted authority of the place in which he resides.

Form of order by a depositor or who can not personally present his cheque.

(b.) The following is the form of order to be signed by the depositor on such occasions, a copy of which may be obtained at the post office at which the cheque is made payable.

Depositor's Book.	ORDER BY A DEPOSITOR WHO HAVING RECEIVED A CHEQUE CAN NOT PERSONALLY PRESENT IT FOR PAYMENT	No. of Cheque.....
Office.....		Date of do.....
No.....		

To the Postmaster of .....

I, the undersigned, do hereby authorize and direct..... the Bearer of this Order, to receive on my Account the sum of..... due to me under the above described Cheque of the Post Office Savings Bank, for which sum the receipt of the above named person shall be a good and sufficient discharge.

As witness my hand, this..... day of..... 18 ..

.....Signature	} Of Witness.	.....Signature	} Of Depositor.
..... Address		..... Address	
..... Occupation		..... Occupation	

NOTE.—The possession of this order gives to the holder no property in the money represented by the cheque. He acts simply as agent of the depositor, and no claim by the holder, on the plea of value given therefor, will be recognized by the Postmaster General. The order is invalid unless it is filled up in every particular from the cheque, and unless the person presenting it, is also in possession of the cheque described in the order, and also the depositor's Pass Book.

Funds of deceased depositor when they do not exceed \$300.

Sec. 15. In case any depositor shall die, leaving a sum of money not exceeding \$300, exclusive of interest, deposited in the post office savings bank, and probate of his will, or letters of administration, or acte de curatelle or de tutelle, be not produced to the Postmaster General, or if notice in writing of the existence of a will, and intention to prove the same, or to take out letters of administration, or be appointed tutor or curator, be not given to the Postmaster General at the Post Office Department within the period of one month from the death of the depositor; or, if such notice be given, but such will be not proved, or letters of administration or acte de tutelle or de curatelle be not taken out, and the probate or letters of administration, acte de tutelle or de curatelle (as the case may be) produced to the Postmaster General within the period of two months from the death of the depositor; it shall be lawful for the Postmaster General, after such period of one or two months, as the case may be,

*Post Office Savings Banks.*

## Chap. 61

to pay and divide such funds at his discretion to or amongst the widow, or relatives of the deceased depositor, or any one or more of them; or, if he shall think proper, according to the provisions of law governing the distribution of property in all such cases.

Sec. 16. In case any depositor shall die leaving any sum of money in the post office savings bank, which (exclusive of interest) shall exceed the sum of \$300, the same shall only be paid to the executor or administrator, tutor or curator on the production of the probate of the will, acte de tutelle or de curatelle, or letters of administration of the estate or effects of the deceased depositor, to the Postmaster General.

Funds of deceased depositor when they exceed \$300.

Sec. 17. If any depositor, being illegitimate, shall die intestate, leaving any person or persons who, but for the illegitimacy of such depositor, and of such person or persons, would be entitled to the money due to such deceased depositor, it shall be lawful for the Postmaster General, with authority, in writing, of the Attorney General of Canada, to pay the money of such deceased depositor to any one or more of the persons who, in his opinion, would have been entitled to the same, according to law, if the said depositor, and such person or persons, had been legitimate.

Funds of a depositor who being illegitimate has died intestate.

Sec. 18. If any depositor shall become insane, or otherwise incapacitated to act, and the same shall be proved to the satisfaction of the Postmaster General, and he shall be satisfied of the urgency of the case, he may authorize payment, from time to time, out of the funds of such depositor to any person whom he shall judge proper, and the receipt of such person shall be a good discharge for the same.

Funds of a depositor becoming insane or otherwise incapacitated.

Sec. 19. If any dispute shall arise between the Postmaster General and any individual depositor, or any executor, administrator, tutor or curator, next of kin, or creditor, or assignee of a depositor who may become bankrupt or insolvent, or any person claiming to be such executor, administrator, tutor or curator, next of kin, creditor or assignee, or to be entitled to any money deposited in the post office savings bank, then, and in every such case, the matter in dispute shall be referred, in writing, to the Attorney General of Canada; and whatever award, order or determination shall be made by him, shall be binding and conclusive on all parties, and shall be final, to all intents and purposes, without any appeal.

In case of dispute the same to be submitted to the Attorney General of Canada, whose decision shall be final.

## Chap. 61

*Post Office Savings Banks.*

Information  
not to be dis-  
closed by  
postmasters  
or other  
officers.

Sec. **20.** The postmasters, and other officers of the post office, engaged in the receipt or payment of deposits, are forbidden to disclose the name of any depositor, or the amount deposited or withdrawn by him, except to the Postmaster General or to such of his officers as may be appointed to assist in carrying out the provisions of the Post Office Act in relation to post office savings banks.

Interpreta-  
tion.

Sec. **21.** In the construction of these regulations, unless there is something in the subject or context repugnant thereto, every word importing the singular number only shall mean and include several persons or things, as well as one person or thing, and the converse; and every word importing the masculine gender only shall mean and include a female as well as a male; and the word "month" shall refer to a calendar and not a lunar month.

O. C. March 2, 1868; *part.*

## CHAPTER 62

### POSTAL INSPECTION DIVISIONS.

Government House, Ottawa,  
The 30th day of May, 1889.

On the recommendation of the Postmaster General, and under the provisions of Chapter 35 of the Revised Statutes of Canada, intituled "The Post Office Act,"

His Excellency in Council has been pleased to make and prescribe the following Postal Inspection Divisions in the Dominion of Canada :—

#### POSTAL DIVISIONS UNDER THE CHARGE OF THE SEVERAL INSPECTORS.

The following are the Electoral Districts in the several Postal Divisions :—

##### *Nova Scotia Inspector's Division :*

Annapolis.  
Antigonishe.  
Cape Breton.  
Colchester.  
Cumberland.  
Digby.  
Guysborough.  
Halifax.  
Hants.  
Inverness.  
Kings.  
Lunenburg.  
Pictou.  
Queens.  
Richmond.  
Shelburne.  
Victoria.  
Yarmouth.

##### *New Brunswick Division :*

Albert.  
Carleton.  
Charlotte.  
Gloucester.  
Kent.  
Kings.  
Northumberland.  
Queens.  
Restigouche.  
St. John (city and county).  
St. John (city).  
Sunbury.  
Victoria.  
Westmoreland.  
York.

##### *Quebec Division (Province of Quebec) :*

Beauce.  
Bellechasse.  
Bonaventure.  
Charlevoix.  
Chicoutimi and Saguenay.  
Dorchester.  
Drummond (township of Kingsey only).  
Gaspé.  
Kamouraska.

*Quebec Division* (Province of Quebec)—Concluded.

Lévis.  
 L'Islet.  
 Mégantic.  
 Montmagny.  
 Montmorency.  
 Portneuf.  
 Quebec.  
 Quebec (city).  
 Richmond (townships of Cleveland and Shipton only).  
 Rimouski.  
 Temiscouata.  
 Wolfe.

*Three Rivers Division* (Province of Quebec):

Arthabaska.  
 Berthier.  
 Champlain.  
 Joliette.  
 L'Assomption.  
 Lotbinière.  
 Maskinongé.  
 Montcalm.  
 Nicolet.  
 St. Maurice.  
 Three Rivers (city).  
 Yamaska.

*Montreal Division* (Province of Quebec):

Argenteuil.  
 Bagot.  
 Beauharnois.  
 Brome.  
 Chambly.  
 Chateauguay.  
 Compton.  
 Drummond (except township of Kingsey).  
 Hochelaga.  
 Huntingdon.  
 Iberville.  
 Jacques Cartier.  
 Laprairie.  
 Laval.  
 Missisquoi.  
 Montreal (city).  
 Napierville.  
 Richelieu.  
 Richmond (except townships of Cleveland and Shipton).  
 Rouville.  
 St. Hyacinthe.  
 St. John.  
 Shefford.  
 Sherbrooke (town).  
 Soulanges.  
 Stanstead.  
 Terrebonne.  
 Two Mountains.  
 Vaudreuil.  
 Verchères.

*Ottawa Division* (Provinces of Ontario and Quebec):

Brockville (that portion of the county lying east of and including the Canadian Pacific Railway, and the town of Brockville).  
 Carleton.  
 Cornwall and Stormont.  
 Dundas.  
 Glengarry.  
 Grenville, South Riding.  
 Hastings, North Riding (townships of Jones, Robinson and Bangor only).  
 Lanark, North Riding.  
 Lanark, South Riding.  
 Leeds and Grenville, North Riding (that portion of the county lying east of and including the Canadian Pacific Railway, comprising the townships of Wolford, Oxford and South Gower).

*Postal Inspection Divisions.*

Chap. 62

*Ottawa Division* (Provinces of Ontario and Quebec)—Concluded.

Nipissing (district).  
 Ottawa (city).  
 Ottawa (county).  
 Pontiac.  
 Prescott.  
 Renfrew, North Riding.  
 Renfrew, South Riding.  
 Russell.  
 Stormont.

*Kingston Division* (Province of Ontario):

Addington.  
 Brockville (township of Kitley and that portion of Elizabethtown lying west of the Canadian Pacific Railway.)  
 Frontenac.  
 Hastings, North Riding (except the townships of Jones, Robinson and Bangor).  
 Hastings, East Riding.  
 Hastings, West Riding.  
 Kingston (city).  
 Leeds, South Riding.  
 Leeds and Grenville, North Riding (township of South Elmsley only).  
 Lennox  
 Northumberland, East Riding.  
 Northumberland, West Riding  
 Peterborough, East Riding  
 Peterborough, West Riding  
 Prince Edward.  
 Victoria, North Riding (townships of Galway, Snowdon, Minden, Stanhope, Sherborne and McClintock only).

*Barrie Division* (Province of Ontario):

Cardwell (townships of Mono and Adjala only).  
 Grey, East Riding.  
 Muskoka and Parry Sound.  
 Ontario, North Riding  
 Simcoe, East Riding  
 Simcoe, North Riding.  
 Simcoe, South Riding.  
 Victoria, North Riding (townships of Anson, Hindon, Bexley, Carden, Dalton, Digby, Eldon, Fenelon, Laxton, Oakley, Longford, Lutterworth and Somerville).  
 Victoria, South Riding.  
 York, North Riding (townships of East, West and North Gwillimbury and Georgina only).

*Toronto Division* (Province of Ontario):

Algora, with the exception of that portion of it lying between Port Arthur and the eastern boundary of Manitoba.  
 Brant, North Riding (township of Ancaster only).  
 Cardwell (townships of Albion and Caledon only).  
 Durham, East Riding.  
 Durham, West Riding.  
 Halton.  
 Hamilton (city).  
 Ontario, South Riding.  
 Ontario, West Riding.  
 Lincoln.  
 Monck (except township of South Cayuga).  
 Niagara (town).  
 Peel.  
 Toronto (city).  
 Welland.  
 Wentworth, North Riding.  
 Wentworth, South Riding.  
 York, East Riding.  
 York, West Riding.  
 York, North Riding (except townships of Georgina North, East and West Gwillimbury).

*Stratford Division* (Province of Ontario):

Bruce, East Riding.  
 Bruce, North Riding.  
 Bruce, West Riding.

*Kingston Division* (Province of Ontario)—Concluded.

Grey, North Riding.  
 Grey, South Riding.  
 Huron, East Riding.  
 Huron, South Riding.  
 Huron, West Riding.  
 Oxford, North Riding (townships of North and South Easthope only).  
 Perth, North Riding.  
 Perth, South Riding.  
 Waterloo, North Riding.  
 Waterloo, South Riding.  
 Wellington, Centre Riding.  
 Wellington, North Riding.  
 Wellington, South Riding.

*London Division* (Province of Ontario):

Bothwell.  
 Brant, North Riding (except township of Ancaster).  
 Brant, South Riding.  
 Elgin, East Riding.  
 Elgin, West Riding.  
 Essex, North Riding.  
 Essex, South Riding.  
 Haldimand.  
 Kent.  
 Lambton, East Riding.  
 Lambton, West Riding.  
 London (city).  
 Middlesex, East Riding.  
 Middlesex, West Riding.  
 Middlesex, South Riding.  
 Middlesex, North Riding.  
 Monck (township of South Cayuga).  
 Norfolk, North Riding.  
 Norfolk, South Riding.  
 Oxford, North Riding (except townships of North and South Easthope).  
 Oxford, South Riding.

*British Columbia Division.*

Cariboo.  
 New Westminster.  
 Victoria.  
 Vancouver.  
 Yale.

*Manitoba and North-West Territories Division:*

Province of Manitoba, District of Keewatin, and Territories of Alberta, Assiniboia and Saskatchewan, and that portion of the District of Algoma lying between the eastern boundary of Manitoba and Port Arthur.

*Prince Edward Island Division:*

The Province of Prince Edward Island



DEPARTMENT OF SECRETARY OF STATE.

CHAPTER 63.

REGULATIONS UNDER THE TRADE UNIONS ACT.

Government House Ottawa.

The 26th day of June, 1889.

On the recommendation of the Secretary of State, and under the provisions of Chapter 131 of the Revised Statutes of Canada, intituled "The Trade Unions Act,"

His Excellency in Council has been pleased to make the following regulations respecting Trade Unions:—

Section. 1. The registrar shall not register a trade union under a name identical with that of any other existing trade union known to him, whether registered or not registered, or so nearly resembling such name as to be likely to deceive the members or the public. Name to be different from that of any other trade union.

Sec. 2. Upon an application for the registration of a trade union which is already in operation, the registrar, if he has reason to believe that the applicants have not been duly authorized by such trade union to make the same, may for the purpose of ascertaining the fact, require from the applicants such evidence as may seem to him necessary. Registration of trade union already in operation.

Sec. 3. Application for registry shall be made in the form subjoined to these regulations. Application for registry.

Sec. 4. All documents transmitted to the registrar relating to any registered trade union shall be open to inspection of any person on payment of twenty-five cents. Documents open to inspection.

Sec. 5. The certificate of registry shall be delivered to the applicant on payment of five dollars. Certificate of registry.

Sec. 6.—FORM OF APPLICATION REFERRED TO IN THE FOREGOING REGULATIONS. Form of application.

(The Trade Unions Act.)

*Form of Application for Registry.*

1. This application is made by the seven persons whose names are subscribed at the foot hereof.

---

 Chap. 63 *Regulations under the Trade Unions Act.*

---

2. The name under which it is proposed that the trade union on behalf of which this application is made shall be registered is \_\_\_\_\_ as set forth in rule No. \_\_\_\_\_

To the best of our belief there is no other existing trade union, whether registered or not registered, the name of which is identical with the proposed name, or so nearly resembles the same as to cause confusion.

3. The place of meeting for the business of the (*name of the union*) and the office to which all communications and notices may be addressed is at \_\_\_\_\_, as set forth in rule No. \_\_\_\_\_

4. The (*name of the union*) was established on the \_\_\_\_\_ day of \_\_\_\_\_

5. The whole of the objects for which the (*name of the union*) is established, and the purposes for which the funds thereof are applicable, are set forth in rule No. \_\_\_\_\_

6. The conditions under which members may become entitled to benefits assured are set forth in rule No. \_\_\_\_\_

7. The fines and forfeitures to be imposed on members are set forth in rule No. \_\_\_\_\_

8. The manner of making, altering, amending and rescinding rules is set forth in rule No. \_\_\_\_\_

9. The provision for the appointment and removal of a general committee of management, of trustee or trustees, treasurer and other officers, is set forth in rule No. \_\_\_\_\_

10. The provision for the investment of funds and for the periodical audit of accounts is set forth in rule No. \_\_\_\_\_

11. The provision for the inspection of the books and names of the members by every person having an interest in the funds is set forth in rule No. \_\_\_\_\_

12. Accompanying this application are sent,—

(1.) Two printed copies, each marked A, of the rules.

(2.) A list, marked B, of the titles and names of the officers.

(3.) A general statement, marked C\* shewing—

(a.) The assets and liabilities of the † \_\_\_\_\_ at the date up to which the statement is made out.

(b.) The receipts and expenditure of † \_\_\_\_\_ during the year preceding the date ‡ up to which the statement is made out, such expenditure being set forth under separate heads corresponding to the several objects of the trade union.

13. We have been duly authorized by the trade union to make this application on its behalf, such authorization consisting of § \_\_\_\_\_

(Signed).

1. \_\_\_\_\_  
2. \_\_\_\_\_

*Regulations under the Trade Unions Act.*

Chap. 63

- 3. \_\_\_\_\_
- 4. \_\_\_\_\_
- 5. \_\_\_\_\_
- 6. \_\_\_\_\_
- 7. \_\_\_\_\_

day of 18

\* This will only be necessary in case the trade union has been in operation more than a year previous to the date of the application.

† Name of trade union.

‡ This date will be fixed by the registrar.

§ This will only be necessary where the trade union has been in operation before the date of the application.

¶ In paragraph 13 must be stated whether the authority to make this application was given by "a resolution of a general meeting of the trade union," or if not, in what other way it was given.

‡ The two copies of rules must be signed by seven members signing this application.

§ The application should be dated, and forwarded to "The Registrar General of Canada, Ottawa."

**Sec. 7. FORM OF ANNUAL RETURN OF ALTERATIONS OF RULES AND NEW RULES REQUIRED BY SEC. 17 OF THE ACT.**

Form of annual returns of alteration of rules and new rules.

(The Trade Unions Act.)

*Annual Return of alterations of Rules and New Rules for the Year ending 31st December, 18 .*

Date of Alteration or making of Rule.	Words of Rule previous to Alteration.	Words of Rule as altered, or of New Rule.

\_\_\_\_\_ } Trustees.

NOTE.—With the annual return must be furnished a copy of rules as they exist at the date of the return.

Chap. 63

Regulations under the Trade Unions Act.

SEC. 8. FORM OF ANNUAL RETURN OF RECEIPTS, &C., REQUIRED BY SEC. 17 OF THE ACT.  
(The Trade Unions Act.)

General Statement of the Receipts, Funds, Effects, and Expenditure of the Trade Union, held at  
in the County of \_\_\_\_\_ in the Province of \_\_\_\_\_ from 1st January to 31st December, 18 .

18 . 1st Jan. to 31st Dec.	RECEIPTS.	\$	c.	18 . 1st Jan. to 31st Dec.	EXPENDITURE.	\$	c.
	To Balance in Treasurer's hands on 1st January, 18 .....				By Stationery and printing.....		
	Fines.....				Salaries of paid officers (specifying them) .....		
	Entrance fees.....				Other necessary expenses of management.....		
	Contributions paid by Members for.....				Allowances for _____ to _____ members.....		
	(Here set forth each of the objects of the Trade Union severally.)				(Here set forth under the several heads of benefit assured by the Trade Union the number of claimants for each, and the amount paid.)		
	Contributions paid by members for expenses of management.....				Investments made during the year.....		
	Interest received during the year on the funds invested.....				Balance in Treasurer's hands on 31st December, 18 .....		
		\$				\$	

Reg. No. Dr. \_\_\_\_\_ Cr.

Statement of the Assets and Liabilities of the Trade Union.

18 . 1st Jan. to 31st Dec.	Dr.	\$	c.	18 . 1st Jan. to 31st Dec.	Cr.	\$	c.
	To Amount of money to pay members.....				By Money in public funds.....		
	(Here set forth separately the amount of each of the funds for benefits.)				Government securities.....		
	Amount of the management fund.....				Real securities.....		
		\$			Other investments (if any, specifying them).....		
						\$	

Auditors. \_\_\_\_\_  
Trustees. \_\_\_\_\_

*Regulations under the Trade Unions Act.*

Chap. 63

**Sec. 9.** FORM OF ANNUAL RETURN FOR CHANGE OF OFFICERS  
REQUIRED BY SEC. 17 OF THE ACT.

Form of annual return for change of officers.

(The Trade Unions Act.)

*Annual Return of Change of Officers for the year ending 31st December, 18 .*

Date of Change.	Title of Officer.	Name of Officer Retiring.	Cause of Retirement.	Name of Officer Appointed.

\_\_\_\_\_ } Trustees

**REGULATIONS RELATIVE TO THE REGISTRY OF ALTERATION OF RULES.**

(The Trade Unions Act.)

**Sec. 10.** An application may be made at any time on behalf of a trade union to the registrar for the registration of an alteration of rules.

Application may be made at any time.

**Sec. 11.** The alteration to be registered may be either—

(a.) A partial alteration, consisting of a new rule or rules to be added to the registered rules, or to be substituted for any of the registered rules; or—

Partial alteration.

(b.) A complete alteration, consisting of an entire set of rules to be substituted for the set of registered rules.

Complete alteration.

**Sec. 12.** An application for the registration of a partial alteration of rules must be in the Form M, annexed hereto, and must be accompanied—

Application, partial alteration.

(a.) By an affidavit or declaration, as the case may be, in Form Q (annexed hereto) of an officer of the trade union, to the effect that in making the alteration of rules submitted for registration, the rules of the trade union have been duly complied with: and (b) by two copies of the new rule or rules proposed to be added, or, as the case may

Affidavit or declaration of officer and two copies of new rules to accompany application.

Chap. 63

*Regulations under the Trade Unions Act.*

Each copy of new rules must be marked. be, by two copies of the new rule or rules proposed to be substituted, and two copies of the old rules in the place of which such substitution is to be made. Each copy of the new rules must be marked O, and signed by the applicants. The registrar, before registering the new rule or rules to be added or substituted, as the case may be, shall ascertain that the rules of the trade union, if altered in accordance with the proposed partial alteration, will provide for all the matters required by the above mentioned Act to be provided for by the rules of a registered trade union.

Certificate of registry of partial alteration. Sec. 13. The certificate of registry of a partial alteration shall be in Form N, annexed hereto, and shall be delivered to the applicants, attached to one of the copies of the new rule or rules, on payment of two dollars.

Application, complete alteration. Sec. 14. An application for the registration of a complete alteration of rules must be in the Form X, annexed hereto, and must be accompanied—

Affidavit or declaration of an officer to accompany. (a.) By an affidavit or declaration in Form Q, annexed hereto, of an officer of the trade union, to the effect that, in making the alteration of rules submitted for registration, the rules of the trade union have been duly complied with; and—

Two copies of new rules. (b.) By two copies of the new set of rules. Each copy of the rules must be printed, and be marked P, and signed by the applicants.

Duty of registrar before registering new set of rules. Sec. 15. The registrar, before registering the new set of rules, shall ascertain that the new set of rules provides for all the matters which, by the above mentioned Act, are to be provided for by the rules of a registered trade union.

Certificate of registry of complete alteration. Sec. 16. The certificate of registry of a complete alteration of rules shall be in the Form Y, annexed hereto, and shall be delivered to the applicants, attached to one of the copies of the new set of rules, on payment of two dollars.

Q.

Declaration by secretary of a trade union in applying for registry of alteration of rules. Sec. 17. *Declaration to be made by the Secretary of a Trade Union in applying for Registry of Alteration of Rules.*

(The Trade Unions Act.)

\_\_\_\_\_  
Trade Union. Register No. \_\_\_\_\_  
I, \_\_\_\_\_, of \_\_\_\_\_, the  
clerk (or secretary or one of the officers) of the above-men-

*Regulations under the Trade Unions Act.*

Chap. 63

tioned trade union, do swear (*or solemnly and sincerely declare*) that in making the alterations of the rules of the said trade union, the application for the registration of which is appended to this declaration, the rules of the said trade union have been duly complied with.

Sworn (*or declared*) before me, one of Her Majesty's justices of the peace for the county of \_\_\_\_\_ at \_\_\_\_\_ in the said county, this \_\_\_\_\_ day of \_\_\_\_\_

18 .

M.

Sec. 18. *Form of Application for Registry of Partial Alteration of Rules.*

Form of application for registry of partial alteration of rules.

\_\_\_\_\_ Trade Union. Register No. \_\_\_\_\_

1. This application is for the registry of a partial alteration of the rules of the \_\_\_\_\_ trade union, and is made by the seven persons whose names are subscribed at the foot hereof.

2. The partial alteration submitted for registration consists of the addition of the rule (*or rules*), two copies whereof accompany this application (each copy being marked O, and signed by the applicants), in addition to the rules already registered, or the substitution of the rule (*or rules*), two copies whereof accompany this application (each copy being marked O, and signed by the applicants), for No. \_\_\_\_\_ and No. \_\_\_\_\_ of the rules already registered.

3. This application is accompanied by a statutory declaration of \_\_\_\_\_, an officer of this trade union, to the effect that in making the alteration of rules now submitted for registration the rules of the trade union were duly complied with.

4. We have been duly authorized by the trade union to make this application on its behalf, such authorization consisting of a resolution passed at a general meeting on the \_\_\_\_\_ day of (*here insert the date, or if there was no such resolution, state in what other way the authorization was given*).

(Signed),

1. \_\_\_\_\_
2. \_\_\_\_\_
3. \_\_\_\_\_
4. \_\_\_\_\_
5. \_\_\_\_\_
6. \_\_\_\_\_
7. \_\_\_\_\_

day of

18 .

Form of application for registry of complete alteration of rules.

Sec. 19. *Form of an Application for Registry of Complete Alteration of Rules.*

\_\_\_\_\_ Trade Union. Register No. \_\_\_\_\_

1. This is an application for the registration of a complete alteration of the registered rules of the trade union, and is made by the seven persons whose names are subscribed at the foot hereof.

2. The complete alteration submitted for registration is the substitution of the set of rules, two printed copies of which (each copy marked P, and signed by the applicants) accompany this application, for the set of rules already registered.

3. The name under which it is proposed that the trade union, on behalf of which this application is made, shall be registered, is \_\_\_\_\_ set forth in rule No. \_\_\_\_\_

4. To the best of our belief, there is no other existing trade union, whether registered or not registered, the name of which is identical with the proposed name, or so nearly resembles the same as to cause confusion.

5. The place of meeting for the business of the \_\_\_\_\_ and the office to which all communications and notices may be addressed, is at \_\_\_\_\_, as set forth in rule No. \_\_\_\_\_

6. The (*here insert name of trade union*) was established on the \_\_\_\_\_ day of \_\_\_\_\_

7. The whole of the objects for which the (*here insert name of trade union*) is established, and the purpose for which the funds thereof are applicable, are set forth in rule No. \_\_\_\_\_

8. The conditions under which members may become entitled to benefit assured, are set forth in rule No. \_\_\_\_\_

9. The fines and forfeitures to be imposed on members, are set forth in rule No. \_\_\_\_\_

10. The manner of making, altering, amending, and rescinding rules, is set forth in rule No. \_\_\_\_\_

11. The provision for the appointment and removal of a general committee of management, of trustee or trustees, treasurer and other officers, is set forth in rule No. \_\_\_\_\_

12. The provision for the investment of funds and for the periodical audit of accounts, is set forth in rule No. \_\_\_\_\_

13. The provision for the inspection of books and names of the members, by every person having an interest in the funds, is set forth in rule No. \_\_\_\_\_

14. This application is accompanied by a statutory declaration of \_\_\_\_\_, an officer of the said trade union, to the effect that, in making the alteration of rules now submitted for registration, the rules of the trade union were duly complied with.



*Regulations under the Trade Unions Act.*

15. We have been duly authorized by the (*here insert name of trade union*) trade union to make this application on its behalf, such authorization consisting of a resolution passed at a general meeting held on the \_\_\_\_\_ day of (*here insert the date, or if there was no such resolution, state in what other way the authorization was given*).

- (Signed),
1. \_\_\_\_\_
  2. \_\_\_\_\_
  3. \_\_\_\_\_
  4. \_\_\_\_\_
  5. \_\_\_\_\_
  6. \_\_\_\_\_
  7. \_\_\_\_\_

\_\_\_\_\_ day of \_\_\_\_\_ 18 \_\_\_\_  
*The Registrar General of Canada, Ottawa.*

Sec. 20. FORMS OF CERTIFICATES.

Certificate of registry of partial alteration of rules.

N.

\_\_\_\_\_ Trade Union. Register No. \_\_\_\_\_

*Certificate of Registry of Partial Alteration of Rules.*

I hereby certify that the rules, copy whereof is appended hereto, have been registered under the above mentioned Act, in addition to the rules already registered (*or in substitution for No. \_\_\_\_\_ and No. \_\_\_\_\_ of the rules already registered*) for the (*here insert name of trade union*).

(Signed),

*Registrar General of Canada.*

\_\_\_\_\_ day of \_\_\_\_\_ 18 \_\_\_\_

Y.

\_\_\_\_\_ Trade Union. No. \_\_\_\_\_

*Certificate of Registry of Complete Alteration of Rules.*

I hereby certify that the set of rules, copy whereof is appended hereto, has been registered under the above mentioned Act in substitution for the set of rules already registered for the (*here insert name*) of trade union.

Certificate of registry of complete alteration of rules.

(Signed),

*Registrar General of Canada.*

\_\_\_\_\_ day of \_\_\_\_\_ 18 \_\_\_\_

O.C. Feb. 5, 1875.

## CHAPTER 64.

### INCORPORATION OF COMPANIES BY LETTERS PATENT.

Government House, Ottawa,  
The 26th day of June, 1889.

On the recommendation of the Secretary of State, and under the provisions of Chapter 119 of the Revised Statutes of Canada intituled "The Companies Act,"

His Excellency in Council has been pleased to make the following regulations and to establish the following tariff of fees for the incorporation of companies by Letters Patent:—

EXTRACTS from "The Companies Act," containing the forms of proceeding and record prescribed by the said Act in reference to the issuing of Letters Patent.

Notice to be given. Section 1. *Notice to be given in the "Canada Gazette," and what it shall contain.*

"The applicants for such letters patent shall give at least one month's previous notice in the *Canada Gazette* of their intention to apply for the same, stating therein,—

Proposed corporate name. "(a.) The proposed corporate name of the company, which shall not be that of any other known company, incorporated or unincorporated, or any name liable to be confounded therewith, or otherwise on public grounds objectionable;

Purposes. "(b.) The purposes for which its incorporation is sought;

Chief place. "(c.) The place within Canada which is to be its chief place of business;

Proposed amount of capital. "(d.) The proposed amount of its capital stock, which, in the case of a loan company, shall not be less than one hundred thousand dollars;

Shares. "(e.) The number of shares and the amount of each share;

Names, etc., of applicants. "(f.) The names in full and the address and calling of each of the applicants, with special mention of the names of not more than fifteen and not less than three of their number, who are to be the first or provisional directors of the company, and the majority of whom shall be residents of Canada."

[Section 4 of the Act.]

---

*Incorporation of Companies by Letters Patent.*      Chap. 64

---

**Sec. 2.** *Petition for Letters Patent.*

Petition for  
letters  
patent.

“ At any time, not more than one month after the last publication of such notice, the applicants may petition the Governor in Council, through the Secretary or State, for the issue of such letters patent ;

“ (2.) Such petition shall state the facts set forth in the notice, the amount of stock taken by each applicant, the amount paid in upon the stock of each applicant, and the manner in which the same has been paid in, and is held for the company ;

What it shall  
set forth.

“ (3.) The aggregate of the stock so taken shall be at least the one half of the total amount of the proposed capital stock of the company ;

Minimum  
of stock  
taken.

“ (4.) The aggregate so paid in thereon shall, if the company is not a loan company, be at least ten per cent. of the stock so taken ; if the company is a loan company the aggregate so paid in of the stock so taken shall be at least ten per cent. thereof, and shall not be less than one hundred thousand dollars.

Minimum of  
amount to  
be paid on  
stock.

“ (5.) Such aggregate shall be paid in to the credit of the company, or of trustees therefor, and shall be standing at such credit in some chartered bank or banks in Canada, unless the object of the company is one requiring that it should own real estate,—in which case any part not more than one half of such aggregate may be taken as being paid in, if it is *boná fide* invested in real estate suitable to such object which is duly held by trustees for the company, and is of the required value over and above all incumbrances thereon.

Disposal  
of amount  
paid in.

“ (6.) The petition may ask for the embodying in the letters patent of any provision which, under this Act, might be made by by-law of the company ; and such provision so embodied shall not, unless provision to the contrary is made in the letters patent, be subject to repeal or alteration by by-law.”

Certain provisions may  
be embodied.

[Section 5 of the Act.]

**Sec. 3.** *Preliminary conditions to be established.*

“ Before the letters patent are issued the applicants shall establish to the satisfaction of the Secretary of State, or of such other officer as is charged by the Governor

Applicants  
shall  
establish  
certain facts.

---

 Chap. 64 *Incorporation of Companies by Letters Patent.*

---

in Council to report thereon, the sufficiency of their notice and petition, and the truth and sufficiency of the facts therein set forth, and that the proposed name is not the name of any other known incorporated or unincorporated company; and for that purpose the Secretary of State, or such other officer, shall take and keep of record any requisite evidence in writing, by oath or affirmation or by solemn declaration."

[Section 6 of the Act.]

Fees must  
be prepared.

Sec. 4. *Fees must be paid before action taken.*

"No step shall be taken in any Department towards the issue of any letters patent or supplementary letters patent under this Act, until after all fees therefor are duly paid."

[Sub-section 3 of Section 84 of the Act.]

Notice to be  
given upon  
application  
for supple-  
mentary  
letters patent

Sec. 5. *Copies of certain notices to be published.*

"And notice thereof shall be forthwith given by the Secretary of State, in the *Canada Gazette*, in the Form B, in the schedule to this Act; and thereupon from the date of the supplementary letters patent, the undertaking of the company shall extend to and include the other purposes or objects set out in the supplementary letters patent, as fully as if such other purposes or objects were mentioned in the original letters patent, and a copy of every such notice shall forthwith, be, by the company to which the notice relates, inserted on four separate occasions in at least one newspaper in the county, city or place where the head office or chief agency is established."

[Section 16 of the Act, *in part*]

*Schedule of Fees.*

Schedule of  
fees payable  
under section  
84 of the Act.

Sec. 6. The following is the schedule of fees payable under the 84th section of the said Act:—

(a.) When the proposed capital stock of the company is \$500,000 or upwards, the fee to be \$200.

(b.) When the proposed capital stock is \$200,000 or upwards, and less than \$500,000, \$150.

(c.) When the proposed capital stock is \$100,000 or upwards, and less than \$200,000, \$100.

(d.) When the proposed capital stock is less than \$100,000, and is not \$40,000 or less than \$40,000, \$50

---

*Incorporation of Companies by Letters Patent.*      Chap. 64

---

(e.) When the proposed capital stock is \$40,000 or less than \$40,000, \$30.

Sec. 7. On application for supplementary letters patent, other than those for increase of capital stock, the fee shall be one half of that charged on the original letters patent. Fee for supplementary letters patent.

Sec. 8. When an increase of capital stock is applied for, the fee thereon shall be based upon the actual increase of the capital stock, and the fee payable shall be the same as is payable upon letters patent for the incorporation of a company whose capital stock is of the same amount as such increase. Fee on increase of capital stock.

Sec. 9. His Excellency in Council has also been pleased to order that the Department of the Secretary of State be and the same is designated as that through which the issue of letters patent or supplementary letters patent shall take place. Department through which issue of letters patent shall take place.

His Excellency in Council has also been further pleased to order that the forms of proceeding and record prescribed by the Act in reference to the issuing of letters patent be for the present adopted. Forms in the Act adopted.

O. C. Oct. 22, 1877; Feb. 25, 1889.

## CHAPTER 65.

### COMMISSIONS TO PUBLIC OFFICERS.

Government House, Ottawa,

The 26th day of June, 1889.

On the recommendation of the Secretary of State, and under the provisions of Chapter 19 of the Revised Statutes of Canada, intituled "An Act respecting Public Officers,"

His Excellency in Council has been pleased to make regulations declaring and determining that the following officers or classes of officers in the Civil Service now or hereafter to be appointed shall receive commissions under the Great Seal or under the Privy Seal, respectively:—

#### A.

Adjutant General of Militia.

Aides-de-Camp (Dominion).

Aide-de-Camp to General Officer Commanding the Militia.

Analyst, Chief, and Assistant Chief.

Analysts, Public.

Auditor General.

#### B.

Banks, Dominion Government Savings, Agents and Superintendents.

Board of Examiners, Civil Service.

do Militia Pensions.

do Masters and Mates, Chairman of.

do Customs, Chairman of.

do Steamboat Inspectors, Chairman of.

#### C.

Canals, Superintendents and Overseers of.

do Chief Engineer of.

Clerk of the Senate.

do House of Commons.

do Privy Council.

do Crown in Chancery.

do Legislative Assembly for the North-West Territories.

Clerks, Chief, of Departments.

Collectors of Inland Revenue.

do Canal Tolls.

Commandant of and officers of Royal Military College.

Commanders of Government vessels.

*Commissions to Public Officers.*

Chap. 65.

Commissioners of Police.

- do Census.
- do Dominion lands.
- do Escheats.
- do the Peace.
- do Pilots.
- do Railways.
- do Standards.

Commissioners appointed by Supreme Court.

Crown Timber Agents.

Cullers.

Cullers, Deputy Supervisors of.

- do Inspectors of.
- do Supervisors of.

Customs, Collectors, Assistant and Sub-collectors of.

- do Outport Collectors of.
- do Surveyors of and Assistant Surveyors of.
- do Landing Waiters and Searchers of.
- do Preventive Officers and Clerks of.
- do Gaugers.
- do Appraisers.

## D.

Deputy Registrar General of Canada.

- do do of Maritime Courts.

## E.

Emigration Agents.

## F.

Financial Inspector and Assistant.

Fish hatcheries, Officers in charge of.

Fish culture, Superintendents of.

Fishery Officers and Inspectors.

## G.

Gentleman Usher of the Black Rod.

Geological and Natural History Survey, Director and

Assistant Directors of.

Governor, Deputy.

Governors, Lieutenant.

## H.

Harbor Masters.

Harbor Commissioners.

High Commissioner for Canada in London.  
Humane establishments, Superintendents of.

## I.

Immigration agents.  
Indian agencies, Inspectors of.  
Indian Commissioners, Assistants and Superintendents.  
Inland Revenue, Accountants of.  
do Book-keepers of.  
do Chief Inspector of.  
do Excise Officers of.  
do Inspectors of.  
Inspectors of beef and pork.  
do boilers and engines.  
do bridges.  
do colonization societies.  
do distilleries.  
do flour and meal.  
do gas.  
do hospitals.  
do hulls and equipments.  
do leather and raw hides.  
do mines.  
do penitentiaries.  
do pickled fish and oil.  
do pot and pearl ashes.  
do ports.  
do standards (Chief).  
do tobacco factories.  
do weights and measures.  
do wheat and other grain.  
do land titles offices.  
Insurance, Superintendent of.

## J.

Judges of all courts, Assistant judges, Junior judges and  
Deputy judges.

## L.

Lands, Agents of Dominion.  
do Surveyor General of Dominion.  
do Registrar of Dominion.  
do Agents of Indian.  
Librarian of Parliament, Joint.  
Lights, Superintendents of.



*Commissions to Public Officers.*

## Chap. 65

## M.

Major General Commanding the Militia.  
 Marine mail clerks.  
 Marshals and Deputy marshals of the Maritime and Vice-Admiralty Courts.  
 Masters in chancery.  
 Medical examiners, Civil Service.  
 Medical superintendents at quarantine stations.  
 Measuring surveyors and clerks.  
 Militia staff, Officers of, paid.  
 Ministers and Deputy Ministers of the Crown.  
 Marine and Fisheries, Agents of.  
 Meteorological Service, Chief Officer of.  
 Mortuary Statistical officers.  
 Mounted Police, Comptroller of.  
     do Commissioners of.  
     do Assistant Commissioners of.  
     do Superintendents of.  
     do Surgeons of, and Veterinary Surgeons.  
     do Inspectors of, and Sub-inspectors of.  
     do Quartermasters of, and Paymasters of.

## O.

Officers representing Canada abroad and in other colonies.  
 Officers who have special professional or technical qualifications.  
 Official Referees.

## P.

Pilotage Commissioners.  
 Pilots, Superintendents of.  
 Police, Superintendent of Dominion.  
 Police, Chief of River.  
 Port physicians and visiting physicians.  
 Port wardens.  
 Postmasters of cities and towns.  
 Post office inspectors and assistants.  
 Preventive officers.

## Q.

Queen's Counsel.  
 Queen's Printer and Controller of Stationery.

## R.

Railways, Mechanical Superintendent of.  
     do Superintendent of Government.

Chap. 65

*Commissions to Public Officers.*

do Chief Engineer of Government.  
 Receiver General, Assistants.  
 Registrar and officers of N. W. T. Supreme Court.  
 do do of land titles in the North-West  
 Territories.  
 Registrar Supreme Court.  
 do Maritime Court.  
 Reporter to Supreme Court.  
 Revising Officers.

## S.

Sergeant-at-Arms of the House of Commons.  
 do do Senate.  
 Sheriffs of the North-West Territories.  
 Shipping masters.  
 Shipping, Surveyors of.  
 Stipendiary magistrates.

## T.

Telegraph and signal service, Manager of.  
 do do Superintendent of.  
 Tide surveyors and tide waiters.

## V.

Veterinary surgeons.

## W.

Wardens and chief officers of penitentiaries.  
 Wharfingers.

O. C. July 10, 1886; Oct. 30, 1886, *part.*

# CHAPTER 66.

## CANADA TEMPERANCE ACT.

Government House, Ottawa,  
The 26th day of June, 1889.

On the recommendation of the Secretary of State, and under the provisions of Chapter 106 of the Revised Statutes of Canada, intituled "The Canada Temperance Act,"

His Excellency in Council has been pleased to make the following regulations to be observed in dealing with petitions under the said Act:—

### *Respecting Petitions.*

Section 1. All petitions to the Governor General in Council under "The Canada Temperance Act," 1878, whether the same be for the bringing of the second part of the Act into force in any county or city in Canada; or for the revocation of any Order in Council bringing the second part of the Act into force as aforesaid, or for the repeal of a by-law passed by the Council of any county or city in Ontario or Quebec under the authority and for the enforcement of "The Temperance Act of 1864," are required to be executed and attested in the form following, or to the like effect, viz. :—

Petitions to the Governor General in Council.

### *Petition as per Schedule A, of Act.*

No.	Genuine Signature of Elector.	Name distinctly Written.	Description or addition of Elector.	Polling District or Division of Voters List where Name may be found.	Witness to Signature.

Form of petition.

It is particularly requested that the signatures to the petition be correctly and consecutively numbered.

Sec. 2. The evidence required under sections 6 and 7 of the Act for the satisfaction of the Governor General in Council shall be as follows or to the like effect:—

Evidence required under sections 6 and 7 of the Act.

*a.*

*Declaration by Witness to Signature. (Under Chap. 141, R. S. Canada.)*

I, \_\_\_\_\_ of \_\_\_\_\_, in the \_\_\_\_\_ of \_\_\_\_\_

Chap. 66

Canada Temperance Act.

Form of declaration by witness to signature.

did see , do solemnly declare that I was present and sign the { within or foregoing } petition, and that the signature appended to said petition, and numbered , is in the proper handwriting of the said

And I make this solemn declaration conscientiously believing the same to be true, and by virtue of the "Act respecting extra-judicial oaths."

A. B.

Declared before me at in the County of this day of 18 . C. D.

(Justice of the Peace or other functionary authorized by law to receive the solemn declaration of any person voluntarily making the same before him, under Chap. 141, R.S. Canada.)

N B.—Any number of signatures may be proved by the same declaration, making the change from singular to plural where necessary. When an elector is unable to sign, and makes his mark in the presence of a witness, the above declaration may be varied to suit the case.

b.

Form of declaration as to qualification of persons signing petition.

Declaration as to Qualification of Persons signing Petition. (Under Chap. 141, R. S. Canada.)

I, of the of , in the of do solemnly declare, That I have carefully compared the petition of certain electors of the of to His Excellency the Governor General in Council, praying that (here state the purport of the petition) with the last certified Voters List in force in the said of , and that from such comparison I find that the persons who have signed said petition are persons named in the said Voters List and as I verily believe qualified and competent to vote at the election of a Member of the House of Commons in the said of

And I make this solemn declaration, &c. (remainder as in form "a.")

*Canada Temperance Act.*

## Chap. 66

N.B.—The above declaration may relate to the whole or part of a petition. If it be made with respect to part of the petition only, it should be varied accordingly.

Where a difference in spelling or otherwise exists between the signature as on the petition, and the name as on the Voters Lists which it is desired to explain, a special declaration in explanation should be given.

*c.*

A declaration or certificate by the registrar, city or town clerk, clerk of the peace or other proper custodian of the Voters Lists, as to the number of electors in the county or city qualified and competent to vote at the election of a Member of the House of Commons at the time of the deposit of the petition with the sheriff or registrar of deeds. Declaration or certificate by the registrar.

*d.*

A copy of the revised Voters List in force in the county or city at the time of the deposit of the petition with the sheriff or registrar of deeds. Copy of voters list.

*e.*

A declaration or certificate by the sheriff or registrar of deeds of or in the county or city named in the petition as to the date of the deposit of the Petition and the time it remained in his office for public examination by any parties. Declaration by the sheriff or registrar of deeds.

*f.*

Two copies of two newspapers containing the notice previous to deposit, as required by section 6. Two copies of 2 newspapers.

O.C. Jan. 31, 1881.

## CHAPTER 67.

### CIVIL SERVICE EXAMINATIONS.

Government House, Ottawa,  
The 26th day of June, 1889.

On the recommendation of the Secretary of State, and under the provisions of Chapter 17 of the Revised Statutes of Canada, intituled "The Civil Service Act,"

His Excellency in Council has been pleased to make the following rules and regulations for the governance of the Board of Civil Service Examiners in holding examinations under the said Act.

#### *RULES to be observed by the Board of Civil Service Examiners.*

Chairman  
and secretary.

Section **1.** One of the members shall be chairman, and when present shall preside at the meetings of the Board, and one may be secretary, if appointed to that office by the Governor General in Council.

Two members  
of board may  
transact  
business.

Sec. **2.** In the absence of one of the members of the Board the other two shall be competent to transact business, and their decisions shall be as valid as if the three had been present.

Regular  
entrance ex-  
aminations.

Sec. **3.** Regular entrance examinations shall be held annually at as many of the places named in the Civil Service Act as the Governor General in Council may direct, and also at any other places similarly selected and designated to the Board. The examinations shall commence on the second Tuesday in the month of November, and shall be continued until completed.

Meetings of  
board.

Sec. **4.** The Board shall meet prior to the examination in sufficient time to make the preparations necessary for holding the said examination, and shall continue to meet until their work is finished.

Examina-  
tions to be  
held simul-  
taneously  
and in same  
manner.

Sec. **5.** The examination shall be held simultaneously, that is, on the same days and hours at the several places designated by the Council, and shall be conducted at every place precisely in the same manner, and by means of the same questions.

Answers in  
writing.

Sec. **6.** The answers of the Candidates shall be in writing, and on paper prepared and supplied by the Board.

*Civil Service Examinations.*

Chap. 67

Sec. 7. In the places at which the examiners cannot personally attend, sub-examiners shall be appointed to conduct the examinations according to the printed regulations supplied to them by the Board.

Sub-examiners to be appointed.

Sec. 8. At the close of the examination, it shall be the duty of the examiners in charge to collect and seal up the written papers of the candidates and to transmit the same, duly attested, to the secretary of the Board at Ottawa.

Written papers to be sealed up and transmitted to secretary.

Sec. 9. Every candidate for examination shall be required to satisfy the Board :—

Requirements of candidate.

1. If coming up for the Preliminary examination only, and if intending to serve in the Inside Departmental Division, that he is of the full age of fifteen years and not over thirty-five. If coming up for the Qualifying examination, that he is of the full age of eighteen years, and if for the Inside Departmental Division, not over thirty-five years old.

Preliminary examination, age.

Qualifying examination, age.

(NOTE.) The proof of age shall be by a properly certified extract from the birth registration, and should this not be procurable, then by such other evidence as may be satisfactory to the Board.

Proof of age.

2. That he is in sound health, and free from any defect or disease, mental or physical, which would be likely to interfere with the proper discharge of his duties.

Sound health.

(NOTE.) The proof of health shall be by the certificate of a practising physician.

Proof of health.

3. That his character is such as to qualify him for employment in the Civil Service.

Character.

(NOTE.) The proof of character shall be by the certificate of a minister of religion, mayor, or justice of the peace.

Proof as to character.

APPLICATIONS.

Sec. 10. The applications for admission to the examination shall be by means of forms which will be supplied to the candidates by the Board, and said forms correctly filled up shall be re-addressed to the secretary, at least one month before the day appointed for commencing the examination.

Applications for admission to examination, forms to be used.

Sec. 11. A fee of two dollars shall be paid by each candidate, and shall be collected on the first day of the examination as the Roll is being called. Should insuperable difficulties preclude the attendance of a candidate at the examination for admission to which he has sent the regular application and certificates, such candidate, on communicating the facts to the secretary, may be admitted at the

Fee of two dollars.

Admission to next ensuing examination.

next ensuing examination, by simply sending an application, without new certificates.

## EXAMINATIONS.

- Examinations, open.      **Sec. 12.** The examinations shall be open to all persons who shall have complied with the requirements of the Civil Service Act, as to proof of age, health and character, and in doing their examination work the candidates shall be at liberty to use either the English or French language.
- English or French language may be used.
- Notice of examination.      **Sec. 13.** Notice of every examination to be held under the Civil Service Act shall be published in the *Canada Gazette*, in the English and French languages, one month at least before the date fixed for the examinations and, shall state when and where it is to be held.
- Examinations how designated.      **Sec. 14.** The examinations shall be known as the Preliminary or Lower Grade, and the Qualifying or Higher Grade. In conjunction with the latter there will be certain optional subjects, any or all of which the candidates may take or decline to take as they may be minded.
- Optional subjects.
- Preliminary examination.      **Sec. 15.** The Preliminary examination will be in,—  
 1. Penmanship ;  
 2. Orthography ;  
 3. The first four rules of arithmetic ;  
 4. Reading print and manuscript.
- Maximum marks and minimum of average required.      **Sec. 16.** The maximum marks in each subject will be 60, and in order to pass, the candidate will require to make not less than 30 per cent., on any subject and an average of 50 per cent. of the combined value on all subjects, or 120 out of the 240.
- Appointments for which the preliminary examination will qualify.      **Sec. 17.** The Preliminary examination will qualify for the following appointments :—  
**Sec. 18.** Messengers in both Inside and Outside divisions, porters, sorters, packers, letter carriers, mail transfer clerks, box collectors, tide waiters, assistant inspectors of weights and measures and temporary copyists, and such other offices of the Lower Grades as may be determined by the Governor General in Council.
- Qualifying or higher grade examination.      **Sec. 19.** The Qualifying or Higher Grade examination shall be held immediately after the Preliminary, and shall be in,—



*Civil Service Examinations.*

## Chap. 67

- |   |  |
|---|--|
| <ol style="list-style-type: none"> <li>1. Penmanship ;</li> <li>2. Orthography ;</li> <li>3. Arithmetic, including interest, vulgar and decimal fractions ;</li> <li>4. Geography, chiefly of the Dominion of Canada ;</li> <li>5. History,—British, French and Canadian—chiefly the latter ;</li> <li>6. Grammar ;</li> <li>7. Composition ;</li> <li>8. Transcription.</li> </ol> | <p>List of subjects included in the examination.</p> |
|---|--|

Sec. 20. The same scale shall govern in this as in the Preliminary examination, viz., a minimum of not less than 30 per cent. on any one subject and an average on the whole of 50 per cent. As the subjects are valued at 100 marks each, the average required will be 400. This examination will qualify for the following appointments :—

- |   |   |
|---|---|
| <ol style="list-style-type: none"> <li>1. Third-class clerkships in the first division ;</li> <li>2. Third-class clerkships and the offices of landing waiters and lockers in the second division for Customs service ;</li> <li>3. Third-class clerkships and the office of exciseman in the second division for Inland Revenue service ;</li> <li>4. Third-class clerkships, railway and marine mail clerkships, and the offices in the second division for Post Office service.</li> </ol> | <p>Same scale shall govern as in the preliminary examination.</p> <p>Appointments for which the qualifying or higher grade examination shall qualify.</p> |
|---|---|

Sec. 21. Candidates who fail in one subject only at the Qualifying examination, but who make the required average (50 per cent., or 400 marks) will be allowed to come up at the next ensuing examination, and then only for that one subject, and if they secure the minimum will be held to have passed.

Sec. 22. Candidates who fail at the Qualifying examination, excepting those who fail in one subject only, will receive no advantage from the optional subjects they may have treated successfully, the failure in the Qualifying subjects neutralizing success in options.

Sec. 23. Candidates who may desire to be examined in Optional subjects must take them at the time of the Qualifying examination at which they present themselves, and will not be permitted to come up for that purpose at any subsequent examination.

Sec. 24. Candidates who pass in options will, in the event of appointment to office, be credited with the subjects in which they were successful up to four, but not in excess of four.

## Chap. 67

*Civil Service Examinations.*

List of  
optional  
subjects.

Sec. 25. The options are:—

1. Composition in French by candidates who have taken the Qualifying examination in English, and in English by those who have taken it in French ;
2. Translation from English into French by English candidates, and French into English by the French candidates ;
3. Précis-writing ;
4. Book-keeping—by double entry ;
5. Shorthand ;
6. Type-writing.

Minimum of  
marks in  
options.

Sec. 26. In order to pass in options the candidates will require to make at least 50 marks in each subject taken.

Option candi-  
dates will  
inform  
secretary.

Sec. 27. Candidates who intend taking Options will inform the Secretary of the Board.

## CERTIFICATES.

Certificate.

Sec. 28. Every candidate who passes the Preliminary or Qualifying examination successfully will receive a certificate to that effect, and in the cases of candidates who have gained Options, a certificate, "with honors," specifying the Options passed.

Options,  
"with  
honors."

## TIME TABLES.

Board will  
prepare time  
tables.

Sec. 29. The Board will prepare time tables for the several examinations, showing the order in which the subjects are to be taken up and the time allowed for each, which time shall be strictly observed by the examiners.

## FORMS.

Board will  
provide  
forms.

Sec. 30. The forms necessary for giving effect to the foregoing rules will be provided by the Board and on application to the Secretary not less than one month before the day of examination, will be forwarded to the candidates and others interested.

## REPORT.

When report  
shall be made  
by board,  
and what it  
shall  
embrace.

Sec. 31. Not later than the 31st day of January in each year the Board shall make a report to the Secretary of State of the proceedings for the year ended on the preceding 31st day of December, which report will embrace copies of the printed examination question papers used at the several examinations, the names of the successful candidates, and copies of any rules or regulations adopted during the year

*Civil Service Examinations.*

## Chap. 67

## STATIONERY.

Sec. **32.** The stationery and other requisites shall be provided by the Department of Public Printing and Stationery upon requisitions from the Board of Examiners approved by the Head of said Department. Stationery and other requisites.

*Regulations for Conducting the Civil Service Entrance Examinations*

Sec. **33.** The Board of Examiners shall prepare and cause to be printed (confidentially) the questions to be used at the Preliminary, Qualifying (including Options) and Promotion examinations, excepting always the Promotion papers on "Duties," which papers the Departments interested will supply. Preparation and printing of questions

Sec. **34.** The examiner will begin by calling the roll and marking, opposite to the names of the candidates in attendance, the word "present," and to these he will communicate the Number by which they are to be severally identified throughout the examinations. How examination shall be commenced.

Sec. **35.** Each subject for examination shall be dealt with in a separate paper, and sufficient time will be allowed the candidates to give their work a careful and intelligent treatment. Separate paper for each subject.

Sec. **36.** The examinations will commence each day at 9.30 a.m., continuing until noon, when a recess will be taken. They will recommence at 1.30 p.m., and continue day by day till 4 p.m., or to the time specified in the time table, till finished. Hours of examination.

Sec. **37.** Each candidate shall be designated by a Number, which he will place in plain figures at the head of each sheet of paper he may use, and also (together with the name of the subject treated) on the back of the outside sheet, which papers, at the expiration of the time allowed, he will hand to the examiner. Each candidate shall be designated by a number.

Sec. **38.** The questions will be numbered, and the number of marks assigned to each question will be shown in the margin of the printed question paper. Questions will be numbered.

Sec. **39.** The date and hour for the issue of each examination (question) paper, and the time allowed for its treatment, will be plainly stated at the head thereof. Date, hour and time to be stated.

## Chap. 67

*Civil Service Examinations.*

Examiners will exercise care.

Sec. 40. The examiners will exercise the greatest possible care in order to prevent the nature of the examination questions from becoming known before the time fixed for the issue of the papers has arrived.

Candidates guilty of misconduct by copying from each other, or improperly obtaining information, how to be dealt with.

Sec. 41. Should the Board have reason at any time to believe that candidates have been guilty of misconduct by copying from each other, or by improperly obtaining information relative to the subjects under treatment during the examination, they (the Board) will hold the results of the examination respecting such candidates in suspense, until they have thoroughly investigated the circumstances; and if such misconduct should be found to have occurred, the papers of such candidates will be cancelled and the offending persons will be disqualified from future examinations.

Irregularities to be reported to the board.

Sec. 42. Should the sub-examiners have cause to believe that the irregularities referred to in the preceding paragraph, or any others, have taken place among their candidates, they will faithfully report the facts to the Board.

Number of papers on each subject shall be sent to the examiners, and indorsed with the subject, etc.

Sec. 43. The number of examination (question) papers on each subject required at each place of examination will be sent to the examiners, enclosed in sealed envelopes, indorsed with the subject and the number of papers they contain, and said envelope shall only be opened when the time specified in the time table for doing so has arrived, and in the presence of the candidates.

Stationery will be supplied by the board.

Sec. 44. The stationery required for the examinations will be supplied by the Board, and the paper shall be written upon one side only. The margin must also be left blank, as it will be wanted for noting the valuations.

Who allowed in during examination.

Sec. 45. No persons other than the examiners, their assistants, and the candidates, shall be allowed within the rooms during the examinations.

Examiners not to communicate.

Sec. 46. The examiners shall refrain from communicating to anyone the results of the examinations until the same shall have been reported to the Secretary of State.

Position of candidates during examination.

Sec. 47. The candidates shall, if possible, be placed five feet apart during the examinations, and any attempt at holding communication with each other must be promptly and effectually checked by the examiners.

*Civil Service Examinations.*

## Chap. 67

Sec. 48. No books, notes, maps, or diagrams shall be permitted in the examination rooms. Books, etc., not permitted

Sec. 49. The candidates shall all be seated five minutes before the commencement of the examinations, and no candidate will be allowed to enter the rooms later than fifteen minutes after the time fixed for commencing the treatment of a subject. Nor shall any candidate be allowed to leave the rooms during the treatment of a subject—save in cases of extreme necessity—but so soon as any candidate shall have finished his paper he may hand it to the examiner, after which he will be at liberty to retire, but he will not, however, be allowed to re-enter until the time for the commencement of the next subject is called. Candidates shall be seated five minutes before the commencement of the examinations. Entering or leaving room.

Sec. 50. Perfect silence shall be observed during the time devoted to the treatment of the subjects. Perfect silence.

Sec. 51. Punctually at the expiration of the time allowed for the treatment of a subject the examiners in charge shall notify the candidates of the fact, and will collect the papers, whether finished or unfinished. At expiration of time examiner will collect papers.

Sec. 52. On receiving the papers the examiner in charge will check them with the list of candidates present, so as to satisfy himself that he has one from each person, and should he find any short he will at once proceed to inquire for them. If any candidate fails to put in a paper the examiner will state the fact and the reason for its having been withheld in the report of the secretary. After receiving and collecting the papers he will arrange them in numerical order and enclose them in an envelope with,— Examiner will check papers with list of candidates present. How papers are to be arranged and enclosed in envelope.

1. The place of examination ;
2. The subject of the paper ; and
3. The number of papers enclosed.
4. He will then seal and sign the cover.

Sec. 53. At the conclusion of the examination the examiners in charge will fill up a form certifying that the rules and regulations have been faithfully observed, and if anything requiring explanation has occurred they will state the facts to the Secretary of the Board. At close of examination examiner will fill up form.

*Promotion Examinations.*

Sec. 54. These examinations are held annually in the month of May, and are conducted in all respects like the examinations for entrance. (See the instructions relating to the latter). Time of holding promotion examination.

## Chap. 67

*Civil Service Examinations.*

Subjects designated as "obligatory" and "supplementary."

Sec. 55. The subjects in which the candidates are examined are known as "Obligatory" (from which there can be no deviation) and "Supplementary," or subjects which may be prescribed by the Deputy Heads of Departments.

List of "obligatory" subjects.

Sec. 56. The "Obligatory" subjects are:—

1. Penmanship.
2. Orthography.
3. Arithmetic (the nature of which is to be determined by the Deputy Head of the Department to which the candidate belongs, according to the requirements of the service the candidates are rendering or may be expected to render, if promoted to the higher classes they are aspiring to).
4. Composition.
5. Duties of office, or of the higher office sought.
6. Efficiency, by which is understood the value placed by the Deputy Heads upon the service rendered, or which is being rendered by the candidates.

List of "supplementary" subjects.

Sec. 57. The "Supplementary" subjects, any or all of which the Deputy Heads may prescribe, are:—

1. Translations (from English into French or French into English).
2. Geography.
3. Book-keeping.
4. Précis.
5. Constitution (The British North America Act).

"Obligatory" subjects; how rated.

Sec. 58. The "Obligatory" subjects, including "Efficiency," together with the "Supplementary" subjects, which the Deputy Heads of Departments may select from, are each rated at 100 marks.

Order of progress in the service.

Sec. 59. The order of progress in the service is from a lower to the next higher class, and as there are three degrees of advancement, the candidates at the examinations have to exhibit their eligibility for promotion according to the following scale:

Third-class men.

1. Third-class men must obtain not less than 30 marks in any one subject, and an average of 50 on all the subjects prescribed for their examination, so that if there are six subjects (Efficiency included) and there can not be less, they will require to make a total of not less than 300.

Second-class men.

2. Second-class men must make not less than 40 per cent., with an average of 60 per cent., and first-class men 50 and 70.

First-class Candidates on "duties of office."

3. Candidates examined on "Duties of Office" must obtain, if third-rate men, 50 marks; if second-class men, 60 marks; and if first-class men, 70 marks in their examination.

*Civil Service Examinations*

## Chap. 67

Sec. 60. If a candidate in any of the classes makes the average required, but falls below the minimum in one subject only, he will have the privilege of coming up at the next ensuing (annual) examination in that one subject, when the minimum of marks will pass him.

If a candidate makes the average required.

Sec. 61. The following penal clauses were added to the Civil Service Act by Chapter 12 of the Acts of Canada, 51 Victoria (1888), and are inserted here for convenience of reference :—

Penal clauses added to the Act.

"2. Whenever the Board are satisfied that any irregularity or fraudulent practice has obtained at any examination held by them, or by any person deputed by them to hold the same, they may summon before them, by an instrument signed by the chairman or acting chairman of the Board, and may examine under oath or affirmation, any person who in their opinion is in a position to give evidence in relation to any such irregularity or fraudulent practice; and if the person so summoned neglects or refuses to appear, or having appeared, refuses to be examined upon oath or affirmation concerning the premises, or refuses to take an oath or affirmation, or having taken the oath or affirmation, refuses to answer such questions concerning the premises as are then put to him, without offering any just and lawful excuse for his refusal, the chairman or acting chairman of the Board shall be vested with all the powers conferred, in like cases, upon a justice of a peace by section thirty-two of 'The Summary Convictions Act.'

Inquiry as to irregularities at examinations.

Penalty for neglecting or refusing to appear or to be examined on oath.

"3. Every oath or affirmation required for the purpose of such examination may be administered by any member of the Board :

Administration of oath.

"4. If any person is proved by such inquiry to have been concerned in any fraudulent practice, or to have been guilty of any breach of the regulations made in virtue of section thirty-one of this Act, the Board shall report the same to the Secretary of State, who may thereupon cause such person's name to be removed from the list of persons who are found qualified.

Name of person offending to be removed from the list.

"5. Every person who, at any examination held under this Act, personates any candidate, or employs, induces or allows any person to personate him, is guilty of an offence against this Act, and is liable, on summary conviction, to imprisonment for a term not exceeding six months, or to a fine not exceeding two hundred dollars, and if he is employed in the Civil Service, to be dismissed therefrom.

Penalty for personation of candidate.

## Chap. 67

*Civil Service Examinations.*

Penalty for wrongfully receiving or furnishing examination papers.

“ 6. Every person who surreptitiously procures from any printer, or other person, and every person who, without authority, furnishes to any other person any examination question paper or any other paper relating to any such examination as aforesaid, is guilty of an offence against this Act, and liable, under summary conviction, to imprisonment, with or without hard labor, for a term not exceeding six months, or to a fine not exceeding two hundred dollars, and if he is employed in the Civil Service, to be dismissed therefrom ; and no such person shall be allowed to present himself at any subsequent examination.”

Ninth section of Act added.

Sec. 62. The ninth section of “The Civil Service Act” is added hereto for convenience of reference, and is as follows :—

Who may be appointed assistants.

“The Board may obtain the assistance of persons who have had experience in the education of the youth of Canada, and with such assistance shall hold, or cause to be held, periodical examinations for admission to the Civil Service, in the cities of Halifax, St. John, N.B., Charlottetown, Quebec, Montreal, Ottawa, Toronto, Hamilton, London, Winnipeg, Victoria, and such other places as are determined by the Governor in Council ; it shall not be necessary to hold such examinations in all the said places, but the places at which the examinations shall be held shall be determined from time to time by the Governor in Council ; examinations shall, as far as possible, be in writing, and the cost thereof shall be defrayed out of moneys previously voted by Parliament for that purpose.”

Expenses ; how defrayed.

O.C. Oct. 22, 1888.



## CHAPTER 68.

### THE REVISED STATUTES OF CANADA.

LANSDOWNNE.

{L.S.]

#### CANADA.

VICTORIA, by the Grace of God, of the United Kingdom of Great Britain and Ireland, Queen, Defender of the Faith, &c., &c., &c.

To all to whom these presents shall come, or whom the same may in anywise concern,—Greeting :

#### A PROCLAMATION.

JNO. S. D. THOMPSON,

Attorney General, Canada.

WHEREAS, in and by an Act of the Parliament of Canada, passed in the Session thereof held in the forty-ninth year of Our reign, chaptered four, and intituled “An Act respecting the Revised Statutes of Canada,” after reciting that it has been found expedient to revise, classify and consolidate the Public General Statutes passed by the Parliament of the Dominion of Canada, and also certain Public General Statutes which were passed by the several Legislatures of the Provinces of Canada before they respectively became a part thereof, and which are still in force, and relate to matters within the legislative authority of the Parliament of Canada ; and that such revision, classification and consolidation have been made accordingly ; and that it is expedient to provide for the incorporation therewith of the Public General Statutes passed during the said Session, and for giving the force of law to the body of the Revised Statutes to result from such incorporation,—it is, amongst other things, in effect enacted :

That the printed Roll, marked A, of the Public General Statutes passed by the Parliament of the Dominion of Canada, and also certain Public General Statutes which were passed by the several Legislatures of the Provinces of Canada before they respectively became a part thereof, and which are still in force, and relate to matters within the legislative authority of the Parliament of Canada, attested under the signature of Our Governor General of Canada and that of the Clerk of the Parliaments as that of the said Statutes so revised, classified and consolidated as aforesaid, and which is deposited in the office of such clerk, shall be held to be the original thereof, and to embody the several Acts and parts of Acts mentioned as to be repealed in the Schedule A

annexed to the said Roll; but that the marginal notes thereon, and the references to former enactments at the foot of the several sections thereof, and the explanatory notes and tables inserted by the revisors, form no part of the Statutes, and shall be held to have been inserted for convenience of reference only, and may be omitted or corrected; and that any misprint or error, whether of commission or omission, or any contradiction or ambiguity in the said Roll, may also be corrected, but without changing the legal effect; and that such alterations in the language of the said Statutes as are requisite in order to preserve a uniform mode of expression, and do not alter the legal effect, may be made in the correct printed Roll hereinafter mentioned;

That Our said Governor General may select such Acts and parts of Acts passed during the said Session of the said Parliament of Canada as he deems it advisable to incorporate with the said Statutes contained in the said Roll marked A, and may cause them to be so incorporated therewith, adapting their form and language to those of the said Statutes, but without changing their effect, inserting them in their proper places in the said Statutes, striking out of the latter any enactments repealed by or inconsistent with those so incorporated, altering the numbering of the chapters and sections, if need be, and adding to the said Schedule A a list of the Acts and parts of Acts of the said Session so incorporated as aforesaid, and also amending the said Statutes in the particulars and to the extent in the Schedule to the said Act now in recital set forth;

That as soon as the said incorporation of such Acts and parts of Acts with the said Statutes, and the said addition to the said Schedule A and amendments have been completed, Our said Governor General may cause a correct printed Roll thereof, attested under his signature and countersigned by the Secretary of State, to be deposited in the office of the Clerk of the Parliaments, which roll shall be held to be the original thereof, and to embody the several Acts and parts of Acts mentioned as repealed in the amended Schedule A thereto annexed; but any marginal notes and references to former enactments which appear thereon shall be held to form no part of the said Statutes, but to be inserted for convenience or reference only;

That Our said Governor in Council, after such deposit of the said last mentioned Roll, may, by proclamation, declare the day on, from and after which the same shall come into force and have effect as law, by the designation of "The Revised Statutes of Canada;"

That on, from and after such day, the same shall accordingly come into force and effect as and by the designation of "The Revised Statutes of Canada," to all intents, as if

*The Revised Statutes of Canada.*

## Chap. 68

the same were expressly embodied in and enacted by the said Act, to come into force and have effect on, from and after such day ;

And that on, from and after such day, all the enactments in the several Acts and parts of Acts in such amended Schedule A mentioned shall, so far as the same are within the legislative authority of the Parliament of Canada, stand and be repealed to the extent mentioned in the third column of the said Schedule A ;

And whereas, Our said Governor General of Canada has, by two certain Orders in Council, bearing date respectively the fifth day of October, in the year of Our Lord one thousand eight hundred and eighty-six, and the twenty-fourth day of December in the same year, selected from the Acts passed during the Session of the said Parliament of Canada held in the forty-ninth year of Our reign the Acts and parts of Acts mentioned in the Schedule hereto annexed as those which he deems it advisable to incorporate with the Statutes contained in the said Roll marked A, and has caused them to be so incorporated therewith, adapting their form and language to those of the said Statutes, but without changing their effect, and inserting them in their proper places in the said Statutes, striking out of the latter any enactments repealed by or inconsistent with those so incorporated, altering the numbering of the chapters and sections, so far as was necessary, and adding to the said Schedule A a list of the Acts and parts of Acts so incorporated as aforesaid, and amending the said Statutes in the particulars and to the extent set forth in the Schedule to the said Act hereinbefore in part recited ; and the said incorporation of the said Acts and parts of Acts with the said Statutes, and the said additions to the said Schedule A, and the said amendments having been so completed as aforesaid, has caused a correct printed Roll thereof, attested under his signature and countersigned by the Secretary of State, to be deposited in the office of the Clerk of the Parliaments ;

And whereas the provisions contained in the first three sections of the said Act hereinbefore in part recited have been thus duly carried into effect ;

And whereas Our said Governor General, since such deposit of the said last mentioned Roll, by and with the advice of Our Privy Council for Canada, has declared the first day of March next as the day on, from and after which the same shall come into force and have effect as law, by the designation of "The Revised Statutes of Canada ;"

Now KNOW YE that, by and with the advice of Our Privy Council for Canada, We do, by this Our Royal Proclamation, declare that on, from and after the first day of March next, the said last mentioned Roll, attested under the signature

of Our said Governor General of Canada, countersigned by the Secretary of State and deposited in the office of the Clerk of the Parliaments, shall come into force and have effect as law, by the designation of "The Revised Statutes of Canada," to all intents as though the same were expressly embodied in and enacted by the said Act hereinbefore in part recited, to come into force and have effect on, from and after the said first day of March next.

Of all which Our loving subjects and all others whom these presents may concern are hereby required to take notice and to govern themselves accordingly.

IN TESTIMONY WHEREOF, We have caused these Our Letters to be made Patent, and the Great Seal of Canada to be hereunto affixed. WITNESS, Our Right Trusty and Entirely Beloved Cousin the Most Honourable Sir HENRY CHARLES KEITH PETTY-FITZMAURICE, Marquis of Lansdowne, in the County of Somerset, Earl of Wycombe, of Chipping Wycombe, in the County of Bucks, Viscount Calne and Calnstone, in the County of Wilts, and Lord Wycombe, Baron of Chipping Wycombe, in the County of Bucks, in the Peerage of Great Britain; Earl of Kerry and Earl of Shelburne, Viscount Clancourice and Fitzmaurice, Baron of Kerry, Lixnaw and Dunkerron, in the Peerage of Ireland; Knight Grand Cross of Our Most Distinguished Order of Saint Michael and Saint George; Governor General of Canada, and Vice Admiral of the same.

At Our Government House, in Our City of Ottawa, the Twenty-fourth day of January, in the year of Our Lord one thousand eight hundred and eighty-seven, and in the Fiftieth year of Our Reign.

By Command,

J. A. CHAPLEAU,

*Secretary of State.*

DEPARTMENT OF FISHERIES.

CHAPTER 69.

PROVINCE OF NOVA SCOTIA.

GENERAL FISHERY REGULATIONS.

Government House, Ottawa,  
The 18th day of July, 1889.

On the recommendation of the Minister of Marine and Fisheries, and under the provisions of Chapter 95 of the Revised Statutes of Canada, intituled "The Fisheries Act,"

His Excellency in Council has been pleased to make the following Fishery Regulations for the Province of Nova Scotia:—

*See Special Regulation O.C. 12 Sept 1889*

*Angling Permits (1)*  
Section 1.—BAIT. (2)

The Minister of Marine and Fisheries may authorize the issue of special permits to take bait for the *bona fide* purpose of deep-sea fishing, for any specified time during the Sunday close time prescribed by the fishery laws.

Special permits to take bait.

Sec. 2.—BASS. (3)

(a.) No person shall fish for, catch, kill, buy, sell or have in possession any Bass between the first day of March and the first day of October in each year, in the Province of Nova Scotia, nor at any time shall Bass of a less weight than two pounds be fished for, caught, killed, bought, sold or had in possession, and if caught by accident in nets or other fishing apparatus lawfully used for other fish, young Bass of less than two pounds weight shall be liberated alive at the cost and risk of the owner of the fishery, on whom in every case shall devolve the proof of such actual liberation: Provided, that nothing contained in this regulation shall prevent any person from fishing for, catching or killing Bass at all times by means of angling with a hook and line; but the possession, purchase or sale of Bass so caught shall impose on the possessor, purchaser or seller the burden of proving the lawful capture thereof.

Close season for bass, and the minimum weight thereof fixed at two pounds.

Angling for bass allowed.

(b.) In the Province of Nova Scotia Bass shall not be fished for, caught or killed by means of any kind of net having meshes of a less size than six inches, extension measure, nor by means of seines.

Size of meshes.

*4 Clauses see general regulations.*

Sec. 3.—COD. (5)

No person shall carry on Codfishing with seines at a less distance than one half mile from any fishing grounds where

Codfishing with seines.

Chap. 69

General Fishery Regulations, N.S.

fishing boats are anchored, and where fishermen are actually engaged fishing for Codfish with hooks and lines.

Sec. 4.—HERRINGS. (61)

Close season for herrings.

(a.) No seines shall be drawn nor any nets set within 600 feet of any place where Herrings resort to spawn between the 25th day of June and the 25th day of August in each year, under penalty provided by "The Fisheries Act."

Using seines or nets without license.

(b.) No seines shall be drawn nor any nets set within 600 feet of any weir under license on which license fees have been paid, under penalty provided by "The Fisheries Act."

"Driving" with torches, &c.

(c.) Fishing for herrings in the manner known as "driving" with torches, flambeaux or other artificial light, is prohibited, under penalty provided by "The Fisheries Act."

Sec. 5.—LOBSTERS. (7)

Close season for lobsters from Cape Canso westward to the United States.

(a.) On the part of the coast of the Atlantic Ocean extending from Cape Canso westward, and following the coast line of the Bay of Fundy to the United States' boundary line, it shall be unlawful to fish for, catch, kill, buy, sell or have in possession (without lawful excuse) any Lobsters between the 1st day of July and the 31st day of December in each year.

Close season in other waters.

(b.) In the remaining waters of the Province of Nova Scotia it shall be unlawful to fish for, catch, kill, buy, sell or have in possession (without lawful excuse) any Lobsters between the 15th day of July and the 31st day of December in each year.

Minimum length of lobsters fixed at nine and one half inches.

(c.) It shall be unlawful at any time to fish for, catch, kill, buy, sell, expose for sale, or have in possession, any berried or soft-shell Lobster or Lobsters, or any Lobster or Lobsters under nine and one half inches in length, measuring from head to tail, exclusive of claws or feelers, and when caught in fishing apparatus in legal use they shall be liberated alive by the proprietor, owner, agent, tenant, occupier, partner or person actually in charge either as occupant or servant, on each of whom shall devolve the proof of such actual liberation, and each of whom shall be deemed to be jointly and severally liable for any penalties or moneys recoverable under The Fisheries Act, or of any regulation made under the said Act.

Sec. 6.—OYSTERS. (8)

Close season.

Oysters shall not be fished for, caught, killed, bought,

*See former regulations for Oyster Fisheries*

General Fishery Regulations, N.S.

Chap. 69

sold or had in possession between the 1st day of June and the 15th day of September in each year, both days inclusive.

*See 9. July 1st to 15th*  
*Sec. 7.—SALMON. (10)*  
*15 to 23 inclusive*

See The Fisheries Act, section 8, and following sub-sections.

(a.) Salmon shall not be fished for, caught or killed between the 15th day of August and the 1st day of March in each year, in the Province of Nova Scotia; Provided always, that it shall be lawful to fish for, catch and kill Salmon with a rod and line, in the manner known as fly-surface fishing, between the 1st day of February and the 15th day of August, in each year.

Close season for salmon.  
*may be fished*  
*from 1st March to 15th Feb*

(b.) From the time of low water nearest six o'clock in the afternoon of every Saturday to the time of low water nearest six o'clock in the forenoon of every Monday, no one shall fish for, catch or kill Salmon in tidal waters.

Close time for salmon in tidal waters.

(c.) In non-tidal waters, frequented by Salmon, no one shall fish for, catch or kill Salmon or any other fish, between nine o'clock in the evening of every Saturday and six o'clock on the following Monday morning.

Close time for salmon in non-tidal waters.  
*in the Atlantic and waters of the Bay*

*in ponds, bays, creeks & rivers*  
Sec. 8.—SHAD AND GASPEREAUX. (11)

The close time for Shad and Gaspereaux shall extend from sunset on Friday evening to sunrise on Monday morning, in each week, during which time it shall be unlawful to fish for, catch or kill any Shad or Gaspereaux.

Close time for shad and gaspereaux.  
*the County of Sussex*

Sec. 9.—SMELTS. (12)

(a.) No one shall fish for, catch, kill, buy, sell or have in possession any Smelts, between the 1st day of April and the 1st day of July (both days inclusive) in each year.

Close season for smelts.

(b.) The use of Smelts for manure is prohibited.

(c.) The use of seines for the purpose of catching Smelts is prohibited.

Use of seines prohibited.

(d.) Smelts shall not be fished for, caught or killed by means of any kind of bag-nets having meshes of a less size than one inch and a quarter, extension measure.

Minimum size of meshes of bag-nets.

(e.) The use of bag-nets for the purpose of catching Smelts is prohibited, except under special license from the Minister of Marine and Fisheries, and then only between the 1st day of December and the 15th day of February in each year.

Special license to use bag-nets.

*The use of gill nets etc. - Sec 13 - Sturgeon*  
Sec. 10.—TROUT AND LAND-LOCKED SALMON. (14)

See The Fisheries Act, section 9.

Chap. 69

Special Fishery Regulations, N.S.

Close season for trout and land locked salmon.

*Salmon  
Grey head  
nose*

Angling with hook and line.

(a.) ~~In the Province of Nova Scotia~~ <sup>one</sup> no person shall fish for, catch, kill, buy, sell or have in possession any Speckled Trout (*Salvelinus fontinalis*), Lake Trout or Land Locked Salmon between the 1st day of October and the 1st day of April in each year, both days inclusive.

(b.) No one shall at any time fish for, catch or kill Trout by other means than angling with hook and line.

*See 15 - Ordinance between the*

Sec. 11.—EXPLOSIVES.

Use of explosives prohibited.

The use of explosive materials to catch or kill fish is prohibited.

*County*  
SPECIAL FISHERY REGULATIONS.

Sec. 12.—COUNTY OF ANNAPOLIS.

Owners of land in tidal waters to be allowed one stand for dipping salmon or alewives.

1. The owners of land in tidal waters along any salmon river in the County of Annapolis may be allowed one stand for dipping Salmon or Alewives, such stand to be selected by the owners and pointed out to the overseer, who shall determine what claims they are entitled to, and to hold the same under license from the Minister of Marine and Fisheries as their fishing privilege; but in no case shall any stand be less than two hundred yards from any mill-dam or fish-pass.

Brush weirs shall be provided with gates, placed in the hurdle or deepest place.

2. All brush weirs, of whatever description, shall be provided with gates, placed in the hurdle or deepest place; such gates to have an opening of at least eight feet in length by four feet in height, hinged at the top with iron straps, and provided with sufficient tackle attached to an upright timber, so that said gates may be raised at any time of tide. There shall be gates as above described for every one hundred and fifty feet of weir; but in every case these shall be placed as above directed in the deepest waters. These gates shall be opened at or before six o'clock on every Saturday night, and remain open until Monday morning at six o'clock.

To prevent the destruction of young fish, owner, shall enter his weir when the water is not less than six feet out.

3. To prevent the destruction of young fish, every owner, occupier or person in charge of a weir shall, either by himself, or by those employed under him, enter his weir in a boat when the water is not less than six feet out in the shallowest place along the other wing, ascertain the quality of fish taken, and if young, or small, shall immediately open the gates to permit such fish to escape.

Place and number of weirs and fisheries shall be fixed.

4. The place and number of all weirs or fisheries on public grounds in the County of Annapolis shall be fixed by the Fishery Overseer for said County, subject to the approval of the Inspector of Fisheries.



*Special Fishery Regulations, N.S.*

Chap. 69

5. All net fisheries for Herrings shall have a frontage of one hundred yards, said fisheries to be at right angles with the shore, as far as practicable. All such fisheries shall be described and numbered, and no person shall be allowed to set any net in front of, or in any way to interfere with, or encroach on any fishery held or occupied by any other person.

Net fisheries for herrings shall have a frontage of 100 yards.

6. Every net-buoy shall have the name of the owner, and the number of his fishery upon it, either in red letters or branded with hot iron; and every net shall have a tablet securely attached to it, with the name and number of its owner upon it, as above.

Every net-buoy and net to have a name and number.

7. All Lobster traps and buoys used in connection therewith shall have the name of the owner painted on them in red letters.

Lobster traps and buoys to have name.

8. All Lobster traps shall be set so as not to interfere with Herring nets, and at no less distance than sixty yards therefrom, or more, if necessary, in the opinion of the Overseer for the district wherein such traps may be used.

Lobster traps how to be set.

*17 County of Colchester*  
 Sec. 13.—COUNTY OF COLCHESTER.

1. The rivers and streams of the South District of Colchester shall be considered to extend (for fishing purposes) as follows:—

Extent and boundaries of the South District of Colchester.

(a.) *Shubenacadie River*, from Halifax County line to where it empties into the Bay of Fundy.

(b.) *Stewiacke River*, from its source to its junction with the Shubenacadie River.

(c.) *Green Creek*, from the source of the stream thus named, including lakes, to its connection with Shubenacadie River.

(d.) *Salmon and North Rivers*, from their respective sources to the bridge across the Bay of Fundy, known as "Board-landing Bridge."

2. Alewives or Gaspereaux shall not be taken in any of the streams or rivers in this County after the 1st day of June.

Alewives or Gaspereaux.

3. No person shall buy or sell any Alewives or Gaspereaux taken after the 1st day of June.

Buying or selling.

4. Every net shall have attached to it the name in full of the owner.

Name of owner.

5. No net shall be set nearer to the outlet of any lake than one hundred yards.

Proximity of net, 100 yards.

6. No fish shall be taken within the locks of the Shubenacadie Canal, nor within sixty yards therefrom.

Shubenacadie canal locks.

*18*  
 Sec. 14.—COUNTY OF CUMBERLAND. (119)

1. Low-water mark, or the boundary between fresh and low-water mark.

Low-water mark.

## Chap. 69

*Special Fishery Regulations, N.S.*

- Hannan's Falls. salt water, for the purpose of The Fisheries Act, shall be at the foot of Hannan's Falls, so called, on River Philip.
- Brush weirs. 2. Brush weirs, for the purpose of taking fish of any kind, shall not be allowed on any of the rivers of this County, nor within half a mile of the mouth thereof.
- Limits of shad nets. 3. Nets for taking Shad shall not exceed (except at Port Laurence) twelve fathoms in length, and the meshes of such nets shall in no case be less than four and one half inches, extension measure.
- Shad fishing. 4. Shad shall not be fished for in any of the rivers or bays of this County, by any mode of fishing, later than the 31st day of August.
- Each family. 5. Each family or householder shall have liberty to set fifty fathoms of net, and no more, in any one string or line of nets.
- Proximity of nets. 6. All nets shall be set in lines from the shore to the bank of the channel or bay, and no two lines of nets shall be set in the range of the tide or current nearer than five hundred yards of each other.
- Lines how to be laid off. 7. The Fishery Overseer shall lay off as many of these several lines as he may deem necessary for the accommodation of the inhabitants; each individual right in said lines to be twenty-five fathoms in any one line of nets, and no more, and each site or locality in the string to be determined by ballot.
- Notice by overseer. 8. The Overseer shall give six days' notice, by posting the same in three of the most public places in the district, of the time and place of laying off and balloting.
- The use of seines. 9. The use of seines for the purpose of taking Alewives is prohibited.
- Nets for taking alewives. 10. Nets for the purpose of taking Alewives shall not be set nearer than one quarter of a mile from Messrs. Rindress & Seaman's mill-dam, on Wallace River.

20

Sec. ~~15~~—COUNTY OF DIGBY.

- Net fisheries for herrings. 1. All net fisheries for Herrings shall have a frontage of one hundred yards; said fisheries to be divided by lines at right angles with the coast, as far as practicable. All such fisheries shall be described and numbered, and no person shall be allowed to set any net in front of, or in any way to interfere with, or encroach on any fishery held or occupied by any other person.
- Net-buoys and nets. 2. Every net-buoy shall have the name of the owner, and number of his fishery upon it, either in red letters or burned in with an iron; and every net shall have a tablet attached securely to it, containing name and number of its owner upon it, as above.

*Special Fishery Regulations, N.S.*

## Chap. 69

3. All brush weirs in tidal waters, or weirs of whatever description, shall be provided with gates, placed in the hurdle or deepest place; such gates to have an opening at least eight feet in length by four feet in height, hinged at the top with iron straps, and provided with sufficient tackle attached to an upright timber, so that said gates may be raised at any time of tide. There shall be gates as above described for every one hundred and fifty feet of weir; but in every case these shall be placed, as above directed, in the deepest waters. These gates shall be opened at or before six o'clock on every Saturday night, and remain open until Monday morning at six o'clock.

Weirs in tidal waters, their location, size and construction.

4. To prevent the destruction of young fish, every owner, occupier or person in charge of a weir shall, either by himself or by those employed under him, enter his weir in a boat before half tide ebb, ascertain the quality of the fish taken, and if young, or small, shall immediately open the gates to permit the fish to escape.

To prevent the destruction of young fish.

5. No weir shall be placed within one hundred yards from where some other weir has been, or is to be set or placed; and no person shall build in front of or below another weir.

Proximity of weirs.

6. The place and number of all weirs or fisheries on public ground, in the County of Digby, shall be fixed by the Fishery Overseer for said County, subject to the approval of the Inspector of Fisheries.

Place and number of weirs or fisheries.

7. No weir, net or other contrivance, except weirs for catching Eels, shall be placed or set in any river in the County of Digby visited by Salmon, nor nearer the mouth of any such river or stream than one fourth of a mile.

Weirs for catching eels.

8. No weir for catching Eels shall be nearer to another weir than one fourth of a mile.

Proximity of weirs.

9. No flume, eel-pot, box or other contrivance belonging to an eel-weir, shall be set with its mouth up stream on any river or branches thereof, for the purpose of taking Eels, if calculated to destroy young Alewives, from the 1st day of July until the 10th day of November.

Flume, eel pot, &c., how and when not to be set.

10. Owners of land along any falls in any of the rivers of the County of Digby shall be allowed one stand for dipping fish, to be selected by the owners and pointed out to the Overseer, who shall determine what claims they are entitled to, and to hold the same as their fishing privilege.

Owners of land along any falls.

11. When the width of any falls shall exceed twenty feet, any person, except the owner of a stand, may anchor a boat in said falls for the purpose of dipping fish; Provided that he does not interfere with the special privilege of owners of stands; and every boat so moored shall, after loading, make room and give place for others, by removing when requested to do so; and to prevent the intent of this clause from being

When width of any falls exceeds 20 feet.

Chap. 69

Special Fishery Regulations. N.S.

When the river is less than 20 feet wide.

Use of trawls in St. Mary's Bay.

defeated, no fish shall be salted in any such boat nor any fish shifted from one boat to another. When the river is less than twenty feet wide, no boat or craft of any kind shall be allowed to occupy any such public privilege in said river the second or any subsequent time until each man requesting the privilege shall have had his turn.

12. The use of trawls in St. Mary's Bay is prohibited from the 1st day of October to the 30th day of June, both days inclusive, in each year.

27

Sec. 16.—COUNTY OF GUYSBOROUGH.

Fishing berths, how acquired, and length of time same may be held.

1. No mooring or moorings, stake, pale or other contrivance shall hold or be allowed to hold a fishing berth for a longer period than forty-eight hours, unless the owner thereof shall set or cause to be set a net or nets thereto for the space of at least eight hours during the said forty-eight hours, to be so continued during the occupancy of such fishing berth, unless prevented by stress of weather or some other unavoidable cause

One fishing berth at one time.

2. No person shall occupy more than one fishing berth at one time, in any river, for the purpose of catching fish, if others are deprived of a berth on that account, should the latter wish to use it.

Weirs, nets &c., to extend only two thirds across channel.

3. All weirs, nets or other obstructions set or made for the purpose of catching fish while going up or down the rivers or streams of this County, shall extend only two thirds across the channel or deepest water of said river or stream.

Sketched out in 1851 12 Feb 1407 -

Protection of seine hauling grounds.

4. No one shall, on any of the seine hauling grounds, if a seine or seines be stationed there and prepared for taking fish, place moorings or set nets; nor shall any vessel, boat or material, sunken or floating, be anchored or moored within one hundred fathoms from the shore at low-water mark.

Removal of obstructions.

5. Any mooring, net, vessel, boat or material, if so placed, set, anchored or moored, shall be immediately removed by the owner or owners, master or masters thereof, upon request of the owner of the seine; or by direction of a Fishery Officer, unless prevented by stress of weather or other unavoidable cause.

Cost of removal of obstructions.

6. Failing which (if removal be practicable), the above obstructions or any of them may be removed by a Fishery Officer or the owner of a seine so stationed and prepared for taking fish, and the cost of such removal, in addition to any and all other penalties and expenses which may accrue, shall devolve upon the party or parties so placing, setting, anchoring or mooring the same; and the property shall be held until all fines and other expenses shall have been paid.

*Special Fishery Regulations, N.S.*

Chap. 69

- 6 A. Moorings for nets (excepting for Salmon) shall not be dropped or placed at a less distance from each other than seventy fathoms, unless the net or nets set thereto be moored at each end; then a distance of not less than sixty fathoms, and all moorings shall be of sufficient strength to hold a fleet or two nets in ordinary weather, and the buoys attached thereto shall be marked with the owners' names. Moorings for nets.
- 7 B. No one shall set more than two nets (Salmon nets excepted), not to exceed twenty fathoms each in length, to any mooring, nor shall any net be so set that one shall be on top or over the other, viz. (one sunken and one afloat), nor shall any net or nets exceed in depth an ordinary mackerel net. Number, size and location of nets.
- 8 C. When nets are set sunken or under the surface of the water their position shall be marked by not less than three floating buoys attached to each net, with the owners' name legibly marked thereon. Nets to be marked by buoys.
- 9 D. No net or nets (excepting Salmon nets) shall be allowed to remain set within any harbor or within one half mile of the entrance of the same, nor of any hauling ground where a seine is stationed and prepared for taking fish, from sunrise to one hour before sunset, unless prevented by some unavoidable cause. Nets not allowed to be set from sunrise to one hour before sunset.
- 10 E. No seine, trap-net, bag-net, fish-pound or other contrivance for taking fish shall be so set or allowed to remain set as to prevent fish from coming into or upon any of the hauling grounds within the said County, provided there is a seine stationed thereat. Protection of hauling grounds.
11. No person or persons shall sweep or haul with a seine, net or other appliances, any fish within the entrance or mouth of any fresh-water lake, river or stream, nor within one half mile of the entrance outside of the same on either shore. Entrance of fresh water lake not to be obstructed.

22  
Sec 17.—COUNTY OF HALIFAX.

1. No net or other apparatus for taking fish shall be set or used within the limits described in the following rivers, respectively:— Limits within which net or other apparatus may be used.
- (a.) *Ecum Secum River*.—Within two hundred and fifty yards on either side of the bridge on the main road, and within the same distance of Leslie's Mill.
- (b.) *Moser's River*.—Above the landing.
- (c.) *Salmon River, East*.—Above the north corner of the factory wharf.
- (d.) *Sheet Harbor Rivers*.—Within two hundred and fifty yards of West River Bridge, or Little River Bridge.
- (e.) *Tangier River*.—Above the north corner of George

Chap. 69

Special Fishery Regulations, N.S.

Ferguson's Wharf and west of same, nor in the small lake below Mooseland Mills.

(f.) *Ship Harbor River*.—Within two hundred and fifty yards of the artificial fishway and mouth of Newcomb's Brook.

(g.) *Musquodoboit River*.—Above Gardner's Line on the north side and White Rock on the south side.

(h.) *Petizwick River*.—Within two hundred and fifty yards of the bridge.

(i.) *Chezzeetcook River*.—Within two hundred and fifty yards of the large granite, called Boundary Rock.

(k.) *Porter's Lake Run and River*.—Within two hundred and fifty yards of the inside run, four hundred yards of the outside run, and two hundred and fifty yards of the mouth of East and West Rivers.

(L.) *Lawrencetown River*.—Within two hundred and fifty yards on either side of the dyke.

(M.) *Cole Harbor Dyke and River*.—No net or other apparatus for taking fish shall be set or used within Cole Harbor Dyke or the mouth of the river, and two hundred and fifty yards outside of the same.

(N.) *Cow Bay Run*.—Within two hundred and fifty yards on either side.

(O.) Provided always, that it shall be lawful to fish for Gaspereaux with dip-nets on Mondays, Tuesdays and Wednesdays in each week in all the above-mentioned streams, at a distance of not less than fifty feet from any fish-pass which may now be in operation or hereafter constructed, except in Ship Harbor River, where dip-net fishing shall be allowed on the north side of the stream only on Mondays, Tuesdays, Wednesdays and Thursdays in each week.

Provision as to fishing for Gaspereaux with dip-nets.

2. Each and every net shall have attached the name of the owner in full.

3. No fish shall be taken within the locks of the Shubenacadie Canal, nor within sixty yards therefrom.

23 County of Kings  
Sec. 18.—COUNTY OF KINGS.

1. Gaspereaux shall not be taken or caught in any part of the Gaspereau River above Fuller Bridge otherwise than in a square net; and drifting and dipping for Salmon and Gaspereaux is prohibited.

2. No square net shall be used in the Gaspereau River, or any branch or tributary thereof, of a greater size than twelve feet square, and the mesh of any seine used below Fuller Bridge shall be not less than two and a half inches.

3. Square nets, and fixtures connected therewith, shall not extend more than one third of the distance across any

Amended  
Oct 12<sup>th</sup> Sep 1907

(  
y  
K  
L  
m

When shall be

Name of owner.  
Shubenacadie canal locks.  
Gaspereaux and salmon regulations.  
Square net in Gaspereau River.  
Square nets and fixtures.  
PP 15, 16, 17, 18, 19, 20

above a line  
to Oct 12<sup>th</sup> 1907

Special Fishery Regulations, N.S.

Chap. 69

Pounds to take fish, and brush walls, their location, removal and general provisions concerning.

river from the bank in a line at right angles with the current, and such fixtures shall contain no waste-hole or fyke-gate; and all pounds to take fish, or brush walls, or other like contrivances to divert them from their natural course up or down stream, are hereby declared to be illegal, and shall be removed under the direction of the Overseer or his agent; and should the parties against whose land the same shall abut, neglect or refuse to remove the same within forty-eight hours after due notice by the Overseer or his agent, either written or verbal, then the party so offending shall forfeit the penalty of twenty dollars, as imposed by The Fisheries Act, together with the amount of costs incurred in the necessary removal of the said obstruction by the Overseer or his agent. And for the better protection of Fishery Officers, and the prevention of the evasion of the law, any fykes or nets illegally set, wall or walls, or fixture for the purpose of taking Salmon or Gaspereaux discovered upon the land or lands covered with water contiguous to, bordering upon, or beneath the surface of any river, shall be deemed to have been erected by, or on behalf of, or for the benefit of, and to be the property of the party or parties upon whose land, or land covered with water, they shall be so discovered, and shall be taken as prima facie evidence of his or their property and ownership therein.

Fykes or nets illegally set.

W. H. G. 107

Gaspereau River regulations.

4. No fishing shall be permitted in any brook appertaining to the Gaspereau River, nor shall any net or weir be set or placed within two hundred yards from the place where any other net or weir was first so set or placed, nor within a like distance of any brook or stream, nor within a like distance of any mill-dam erected across or partially across the said river, or any of its branches.

Eel-pots, mill owners, close season, &c.

5. No eel-pot shall be set in any river or stream between the 1st day of July and the 15th day of October; and every owner or occupier of a mill, when so directed by the Overseer, shall securely fasten to the mouth of every flume connected therewith a good and sufficient wire netting, and shall keep the same in good repair, so that young fish may be prevented from getting crushed by the wheel. And every such owner or occupier of a mill, when so directed by the Overseer, shall keep open the waste-way of such mill between the hours of 6 p.m. on Saturday and 6 a.m. on Monday, from the 15th day of May until the 15th day of October in each year.

Seines or nets in Gaspereau and Cornwallis rivers.

6. No seine or net shall be swept, drawn or used as a stake-net in any river, or any part of the Gaspereau River, or any branch thereof, except in that part of the river between Fuller Bridge and the Basin of Mines; but stake-nets may be set in the Annapolis River below Gates' Mill,

W. H. G. 107

the down line of the bed of the river of W. Stewart & Jack Leonard about 3/4 of a mile above Fuller bridge above Mines -

Chap. 69

*Special Fishery Regulations, N.S.*

- Stake-nets, how far to extend. and in the Cornwallis River, below the confluence of the Cornwallis and Brandywine. Such stake-nets shall in no case be so set as to extend over one third of the water of such rivers. They shall not be less than four hundred and forty yards distant from each other, and the mesh thereof shall be not less than five inches, and shall be legibly marked with the owner's name.
- Proximity of fisheries. 7. The distance between each fishery and that next adjoining it shall not be less than two hundred and fifty yards.
- Seine or weir setting. 8. No person or persons shall set any seine or weir between grounds already taken up and the shore.
- Shad in Scott's Bay. 9. No drifting for shad shall be allowed in Scott's Bay, inside of a straight line drawn from Cape Split to Stephen Bennet's Bay.
- Herring fishing, Medford and Pereaux, seines and weirs. 10. In the Herring fishery of Medford and Pereaux, each brush weir shall have at least two hundred feet of seine, of not less than two inches straight mesh in the "bunt," to allow the small fish to escape; and no seine or weir shall be so far finished as to catch fish before the 1st day of May in each year.
- Shore wing of weir. 11. The north or shore wing of each weir or seine shall not run nearer the shore than the Overseer shall prescribe.

23  
Sec. 19.—COUNTY OF HANTS.

- Close season for setting of flume, eel-box &c. 1. No flume, eel-box or any other contrivance shall be set with its mouth up stream, if calculated to destroy young Salmon or Alewives, from the 1st day of July until the 30th day of November.
2. No drifting for shad shall be allowed in the Avon River, inside of a straight line drawn from Avondale Landing to Young's Wharf, in Falmouth, and no drifting for shad shall be allowed above Salter's Head, in the Shubenacadie River, from the 1st day of June to the 30th day of September.
- Shubenacadie canal locks. 3. No fish shall be taken within the locks of the Shubenacadie Canal, nor within sixty yards therefrom.

25  
Sec. 20.—COUNTY OF LUNENBURG.

(Chester District.)

- Limits of mouths of certain rivers. 1. The mouths of *Gold, Martin's, Middle and East Rivers*, shall extend southerly in the harbor of Chester to an imaginary line commencing at Andrew's Point, and thence easterly to Deep Cove.
- Trap-nets, &c., prohibited. 2. No bag, stake, floor or trap-net, fish-pound or box shall be set or used for the capturing of Salmon within or north of the above named imaginary line.

*over the*  
*to the*  
*12/2/1907*  
*W. J. 7*



Special Fishery Regulations, N.S.

Chap. 69

3. *Gold River.*—(a.) No net or ~~other contrivance~~ <sup>net</sup> shall be set or placed for the capturing of Salmon in the fresh water above tide waters ; and in the tidal waters no net shall be set or placed north of Joseph Rafuse's south line, and from thence to one eighth of a mile below Swinehammer's Rock, no nets to be of greater length than ten fathoms ; and from the last mentioned bound to Oak Island no nets to be of greater length than twenty-eight fathoms and no nearer each other than ~~thirty rods~~. No net shall be set at the "Narrows," between Oak Island and the mainland ; from Oak Island to Martin's Point, no net to be of greater length than twenty-eight fathoms. And on the east side of said river no net shall be set nearer the head of the tide at low water than one eighth of a mile ; and between the last named bound and one eighth of a mile below Eisenhauer's Point, nets for the taking of Salmon to be of no greater length than ten fathoms ; and from the last mentioned bound eastward to Green Point, no net to be of any greater length than twenty-eight fathoms—all of which nets shall be set or placed at right angles from the shore.

Nets, their location, size, and description.

*Multi*  
*22*  
*17 Sep*  
*07*

Swinehammer's Rock.

Oak Island.

Eisenhauer's Point.

Green Point.

(b.) No dip-nets for any kind of fish are to be used from Mosher's Mill to Blackman's Point, excepting the branch, and none there within one hundred yards of the fish-pass, and in no part of the branch or main river from Thursday at sundown to Monday at sunrise in each week.

Dip-nets.

4. *Middle River.*—(a.) On the west side, in the tidal waters, no net for the taking of Salmon or Gaspereaux shall be set between the head of the tide and twenty rods west of the Bluff ; and from twenty rods west of the Bluff to Green Point no net of a greater length than twenty fathoms ; and from the east side, from the head of the tide to Nathan Eisenhauer's Wharf, no net of any description shall be set ; and from said Eisenhauer's Wharf, and around the north of Mosher's Island, and on the east of Mosher's Island, no net for the taking of Salmon of any greater length than eighteen fathoms, all at a right angle from the shore.

Nets for taking salmon or gaspereaux, their location.

(b.) No fish shall be taken at any time within one hundred yards of the fish-way in the Rolling dam, and in no part of the river, or its branches, between Thursday evening at sunset and Monday morning at sunrise in ~~each week~~.

Rolling dam.

5. *East River.*—In the tidal waters on the west side no net shall be set for Salmon nearer the river than Spruce Point, and on the east side no nearer the river than Prescott's Rock. No Gaspereaux shall be taken with dip-nets or otherwise within one hundred yards of East River Falls, and no Gaspereaux shall be taken in any part of the river excepting after sunrise on Monday till sundown on Wednesday.

Nets for taking salmon.

Nets for taking gaspereaux.

6. *Salmon Districts, East Chester.*—No. 1.—To begin at Lobster Point and extend east to Hume's Point.

Limits of districts.

*Mosher's Mill*  
*on*  
*at*  
*the*  
*fall*  
*17 Sep*  
*07*

*22*  
*17 Sep*  
*12*  
*107*

Chap. 69

*Special Fishery Regulations, N.S.*

5 No. 2.—To commence at and include Hume's Point to Spruce Point.

6 No. 3. To commence at Prescott's Rock and extend to Bohan's Island; and no salmon nets in any of the above named districts shall be of greater length than thirty-five fathoms.

Nets for gaspereaux, herrings or mackerel, from Misener's Wharf.

7. *Deep Cove*.—From Misener's Wharf to Bohan's Island no net for the taking of Gaspereaux, Herrings or Mackerel shall be set from sunrise until sunset in each day of the week: that is to say, all nets set in Deep Cove shall be taken up by sunrise in the morning, and not be set until sundown; and no net shall be set at any time in the "Narrows" at Deep Cove.

In line with channel.

8. All the nets set in the Cove for taking Herrings or Mackerel must be in a line with the channel.

Seines not allowed.

9. No seines shall be allowed to tend in the passes of said Cove.

Nets for gaspereaux, herrings or mackerel, from New Harbor Point.

10. From New Harbor Point to Lobster Point, no net for the taking of Gaspereaux, Herrings or Mackerel shall be set from sunrise till sunset in each day of the week within one hundred and fifty yards of the shore during the fishing season, except Salmon nets, setting in their berths in the different distances.

Limits within which fish are not to be taken.

11. *Town Brook*.—No fish shall be taken at any time between North Street and Mill Lake, nor between Mill Lake and Spectacle Lake, nor in any part of Swinehammer's Mill-race, so called.

From Westhaver's Point to New Harbor Point.

12. From Westhaver's Point to New Harbor Point no nets for the taking of Gaspereaux, Herrings or Mackerel shall be set from sunrise until sunset in each day of the week within two hundred and fifty yards of the shore during the fishing season, except Salmon nets in their respective and proper berths.

In Mahone Bay.

13. Seines shall not be trapped in the District of Chester.

14. *Mahone Bay and Mushamush River*.—In Mahone Bay, no net, seine or other contrivance for taking fish shall be set or placed above an imaginary line from John Zwicker's wharf, on the west side, to John Broom's Wharf, on the east side, as far up as Kedy's Bridge, at any time of the year.

Below the said line no net shall be set nearer to another than one hundred yards, and nets shall not be more than thirty fathoms in length.

No seine shall be shot, or placed, or drawn above Jacob Tanner's Wharf on the west side, or above Henry Acker's, on the east side, at any time of the year.

In Mushamush River.

15 In Mushamush River no fish shall be caught with dip-nets or otherwise—excepting surface fishing with hook and line—between low tide water mark on Mahone Bay and the head of Kedy's Mill-dam from sunset on Friday evening

Special Fishery Regulations, N.S.

Chap. 69

*End work*  
*Monday*  
until sunrise on ~~Monday~~ morning in each week; nor from the said head of Kedy's Mill-dam to the head of Roberts' lower Mill-dam from sunset on Saturday evening until sunrise on Tuesday morning in each week; nor from Roberts' lower Mill-dam upwards from Wednesday morning at sunrise until sunset on Friday evening in each week.

*ae*  
*12*  
*107*

Fish shall not at any time be caught in the little brook leading round the north side of said Kedy's Dam; nor in any of the small fish-brooks or passes leading from any dams situated on said Mushamush River or branches thereof.

The little brook north of Kedy's Dam.

Sec. <sup>26</sup>~~25~~—COUNTY OF LUNENBURG.

(Western District.)

1. Lunenburg Harbor.—No net shall be set or left in the water, within two hundred yards of the shore, from "Moser's Head" to "Fire Cove," between the 10th day of June and the 30th day of September in each year, during any part of the time between six o'clock in the morning and six o'clock in the evening of each day.

Close time for setting nets at Moser's Head and Fire Cove

2. Petite Rivière.—No Shad, Alewives or Gaspereaux shall be dipped for, taken or caught with dip-nets or otherwise, in Petite Rivière, above or below the bridges, between Friday morning at sunrise and Monday evening at sunset, surface or fly-fishing excepted; and in the said river, above the tide, no net or other contrivance for taking fish shall be set or placed on the western side, except on Monday and Tuesday; and not on the eastern side, except on Friday and Saturday in each week. No net shall extend more than one third part of the distance across the channel or part of the river made use of by fish in passing.

Shad, alewives and gaspereaux, dip-nets, &c.

Close time at Petite Rivière.

*Mutter in*  
*12 Sept*  
*107 Aug*

3. No net or seine shall be set or placed in Petite Rivière Harbor nearer any wharf than two rods, and any nets set or placed within the mouth of said river for the purpose of taking Shad or Alewives shall not be of a greater length than fifteen fathoms, and shall not be set nearer each other than one hundred yards.

Position and size of net or seine, Petite Rivière.

The mouth of the said river, for the purposes of "The Fisheries Act," shall be an imaginary line from Cherry Point west to Coot Rocks east.

Mouth of river defined.

4. No person or persons shall, in any manner whatever, drive or attempt to drive any Alewives, Gaspereaux or Salmon, up or down, in any run or stream in the County of Lunenburg at any time of the year.

Driving alewives, gaspereaux or salmon prohibited.

5. From Hann's Point, as far up as the tide rises, no net shall extend more than twelve fathoms in length, and no net shall be set nearer to Bridgewater Bridge than twenty rods.

Hann's Point and Bridgewater Bridge.

## Chap. 69

## Special Fishery Regulations, N.S.

Size and position of nets in rivers.

<sup>6u</sup> 6. Nets shall ~~not be set in any part of~~ <sup>6. 1/2</sup> said rivers, or branches thereof, to ~~extend more than one third of the distance across the river or channel, and~~ shall be set at right angles from the shore.

Net, weir, &c., above tide mark.

7. No net, weir or other contrivance for taking fish shall be set or placed in said rivers above the tide mark ~~on the western side, except on Mondays and Thursdays; nor on the eastern side, except on Thursdays and Fridays in each week.~~

Mouth of river defined.

~~R.S.~~ For the purpose of "The Fisheries Act," the mouth of the river shall be at an imaginary line extending from Gaff Point to Moser's Head.

Salmon, &c., in La Have River, Davidson's lower dam.

~~8.9~~ Neither Salmon, Alewives, Shad or Gaspereaux shall be caught or taken, or attempted to be caught or taken, with dip-nets or otherwise, in La Have River, within one hundred yards below Davidson's Lower Dam, surface fly-fishing with rod and line excepted.

Eisenhauer's wharf to Rolling dam.

10. From Eisenhauer's Wharf to Rolling Dam, and from said dam to Chester Grant Lake, no fish shall be taken in any manner whatever between Friday morning at sunrise and Monday morning at sunrise in each week. No fish shall be taken at any time within thirty yards of the fish-pass at said Rolling Dam; and in Middle River Branch no fish shall be taken from Thursday morning at sunrise until Monday morning at sunrise in each week.

Middle River branch.

## Sec. 22.—COUNTY OF QUEENS.

Sheer nets prohibited.

1. No sheer nets shall be set in any of the rivers, nor any nets with stakes in the form of a pound; but all nets shall be set straight.

Salmon net regulations.

2. No person shall be allowed to set in his own name, and in the name of another person, more than two Salmon nets, the second of which shall be actually owned by the person whose name is on the buoy. In order to prevent the evasion of this regulation, if a sworn Overseer of the river fisheries shall have any doubt of the ownership of any Salmon nets or net which must have the owner's name on the buoy, such Overseer is hereby authorized to seize such nets or net until the reported owner thereof or a credible person in his behalf, shall, within twenty-four hours after a notice of such seizure, make oath before the Overseer of the actual ownership thereof; and in default of such proof within the said twenty-four hours, such net or nets shall be forfeited and sold, and the proceeds thereof applied as "The Fisheries Act" directs.

Overseer may seize nets.

Length of Salmon nets and limits of river.

3. The length of the Salmon nets used in the river for fishing shall not exceed eighteen fathoms, nor be of less mesh than five inches, and the limits of the rivers for all purposes of these regulations shall be understood to mean:

*Special Fishery Regulations, N.S.*

## Chap. 69

at Liverpool, as far down the harbor as a line drawn from Eastern Head to Moose Harbor; at Port Medway, as far down as a line drawn from Western Head to Frying Pan Island; at Broad River, as far down as the mouth of said river; and at Port Mouton, from Bushen's Point to Broad River Head—within said boundaries to be considered Port Mouton.

Liverpool.  
Port Medway.  
Broad River.  
Port Mouton.

4. No dog fish, or offal of fish or gurry, shall be thrown into the harbor of Liverpool from Coffin's Island to Western Head, nor in Port Medway above a line from Western Head to Frying Pan, nor at Port Mouton within a line from Bushen's Point to Broad River Head, nor within Port Jollie Harbor from Port Jollie Head to Black Rock, nor west to the Western Head of Port La Bert.

Dog fish, offal or gurry, not to be thrown into waters.

5. No eel-pots shall be set at the tail of any mill in any part of Liverpool and Port Medway Rivers from the 1st day of April to the 1st day of October in every year.

Eel-pots, when forbidden.

6. Any person making cod-fishing his business shall be allowed to set one bait net during the week, excepting on Saturday night; and a permit for Sunday night may be given by the Inspector of Fisheries, countersigned by the Overseer, upon oath being made that bait is wanted for Monday's fishing.

Cod-fishing.

7. No net shall be set for the purpose of taking Salmon or Alewives, nor shall dipping for fish of any kind, nor fly fishing be allowed after the 1st day of July in each year, in the Liverpool River or waters tributary thereto.

Salmon or Alewife nets.

8. No net of any description shall be set at Port Jollie, across the little channel caused by the brook issuing from Robertson's Lake, but all nets shall be set in the main channel.

Nets at Port Jollie.

9. On Monday, Tuesday, Wednesday and Thursday in each week, from twelve o'clock noon to sunset of each of these days, the inhabitants of this County shall be allowed freely to dip fish in any of the rivers, streams and water-courses in this County; subject, however, to any regulations now in force, but not to dip within one hundred yards of any fish-ladder, fish-hole, or any other contrivance made for the protection of Salmon or Alewives.

Dipping for fish permitted on certain days and hours.

10. Indians shall be allowed to dip fish from their canoes, subject to the foregoing regulations, and the large rock at Bear Falls on the Port Medway River, shall be and is hereby reserved to the full free use of Indians for the purpose of fishing on each day that fish is allowed to be taken.

Indians' privileges at Bear Falls.

11. All stakes, moorings and kellocks used for Salmon and Alewife fishing shall be taken up by the person who put them down immediately at the close of the fishery season, on the 1st day of July, and not to be put down again before the 1st day of March the following year.

Stakes, moorings and kellocks, when to be taken up.

Chap. 69

Special Fishery Regulations, N.S.

Nets, &c., where not allowed.

12. No net or other appliance for taking fish shall be allowed to remain on or within one hundred yards of any of the fishery stages or places after the time specified by law for taking fish.

Sec. 23.—COUNTY OF SHELBURNE.

Jordan River.  
Green Harbor River.  
Sable River.  
Port Le Bert.  
Clyde River.  
Barrington River.

1. *Shelburne River* shall be considered to extend, for the purpose of fishing, from its source to the south side of Mc-Nutt's Island; *Jordan River* from its source to West Head, or the Headlands; *Green Harbor River* from its source to the south side of Headlands; *Sable River* from its source to the south side of Headlands; *Port Le Bert* from its source to the south side of Headlands; *Clyde River* from its source to the south side of Headlands; *Barrington River* from its source to the south side of Headlands.

*Minutes*  
*12/24/07*  
Location of nets in Shelburne River.

2. *Shelburne River* in tidal waters:—

No nets shall be set above John McGill's Point. No Salmon or Alewives shall be dipped for or taken within forty feet from any of the dams on or in any of the rivers, brooks or streams of the Township of Shelburne.

Dipping privileges at Morine's Falls, &c.

Dipping privileges at Morine's Falls and the saw-mill pitch on the Roseway River to be occupied by men living above said Falls, and to be subject to the dipping regulations.

Days for taking alewives.

Days allowed for taking Alewives will be Monday, Tuesday, Wednesday and Thursday in each week, and no nets shall be set before the 1st day of May in each year. Nets to be taken up each morning and not set until evening.

Location of nets in Jordan River.

3. *Jordan River* in tidal waters:—

No nets shall be set above the shipyard of Mr. Crow (so called).

Location of nets in Ogden's Brook.

4. *Ogden's Brook* in tidal waters:—

No net shall be set within one hundred yards of the bridge, and below that on one side only, and shall not extend over one third of the channel at low water.

*Minutes*  
*12/24/07*  
Location of nets in Ogden's Brook.

No alewives shall be taken in any manner in or about Lake Isabella, known as Hayden's Lake.

5. *Green Harbor* in tidal waters:—

Location of nets in Green Harbor.

No net shall be set within one hundred yards of the bridge, and below that on one side only, and shall not extend over one third of the channel at low water.

6. *Wall's Brook*:—

Close time, &c., at Wall's Brook.

No fish shall be taken after sunset on Thursday until sunrise on Monday in each week in any way, and a suitable passage shall be left always open from the 1st of April to the 1st of December, and two thirds of the channel shall be left open always, and no fish shall be taken in sluice-ways or weirs.

*Special Fishery Regulations, N.S.*

## Chap. 69

7. *Sable River* in tidal waters:—  
No fish shall be taken within two hundred yards of the post road. Where fish may be taken in Sable River.
8. *Port Le Bert* in tidal waters:—  
No net shall be set within two hundred yards of the post road. Where net may be set at Port Le Bert.
9. *Birch Town Brook* in tidal waters:—  
No net shall be set within two hundred yards of the post road, and below on one side of the brook only. Where net may be set in Birchtown Brook.
10. *Round Bay Brook*:—  
No fish shall be taken on Friday, Saturday or Sunday in any way or form. Close time in Round Bay Brook.
11. *Indian Brook*:—  
No fish shall be taken, in any way, from the setting of the sun on Saturday till sunrise on Monday, in each week. Close time in Indian Brook.
12. *Clyde River* in tidal waters:—  
Nets above Peter Sutherland's (so-called) to Thomas Coffin's shipyard, shall be set on one side of the river only. Where nets may be set in Clyde River.
13. *Barrington River* in tidal waters:—  
No net shall be set above Daniel Crowell's Point (so-called), to the south side of Hogg Island, thence to a rock on Josiah P. Doane's Point (so-called), nor within thirty feet of any dam on Barrington River. Where nets may be set in Barrington River.
14. No person shall set more than two nets, and no one boat shall take more than two persons. Each net shall have attached to it in full the name of the owner. Number of nets, name of owner.
15. No net shall be set or drawn across any stream, creek or brook where Salmon resort to spawn or rest above tidal waters. Salmon resorts protected.
16. No flume, eel-box or pot, or any other contrivance, shall be set with its mouth open up stream on any river or branches thereof, for the purpose of taking eels, if calculated to destroy young Alewives, from the 1st day of July until the 10th day of November. Flume, eel-box, &c., when not to be set with its mouth up stream.
17. No net shall be set nearer to the outlet of any lake or brook than one hundred yards. Outlets protected.
18. Owners of land along any falls in the County of Shelburne shall be allowed one stand for dipping Alewives, to be selected by owners, and pointed out to the Overseer, who shall determine what claim they are entitled to, and to hold the same as their fishing privileges. The said stands to be in front, adjoining land owned by the parties severally. Owners of land at falls allowed stands for dipping Alewives.
19. When the width of any falls shall exceed twenty feet, any person, except the owner of a stand, may anchor a boat or punt in said falls, for the purpose of dipping fish, provided that he does not interfere with the special privileges of owners of stands; and every boat or punt so moored shall, after loading, make room and give place to others by Regulation for dipping fish in the vicinity of falls.

## Chap. 69

*Special Fishery Regulations, N.S.*

When river is less than twenty feet wide.

removing, some other person requesting it. No fish shall be salted in such craft, nor any fish shifted from one boat to another. When the river is less than twenty feet wide no boat or craft of any kind shall be allowed to anchor or lie within said twenty feet for the purpose of taking fish. No person shall occupy any public privilege in said falls the second or any subsequent time until each man requesting the privilege shall have had his turn.

Nets, their number and size.

20. No person shall have, for the purpose of taking fish above tidal waters, more than one net for taking Alewives; those used above tidal waters not to exceed five fathoms and those used in tidal waters not to exceed thirty fathoms, each person not to set in tidal waters more than two Salmon nets and two for taking Alewives.

Dipping stands allowed to land owners.

21. Every landowner to whom a dipping stand is allowed shall confine himself to said stand for the purpose of taking Alewives, and shall be allowed to set one Salmon net in tidal waters, but such Salmon net shall not be set in any eddy in the river.

Catching eels.

22. Each family may set one flume, and no more, for the purpose of catching Eels, which must be set in the night only.

### Sec. 24.—COUNTY OF YARMOUTH.

Tusket River limits.

1. *Tusket River* shall be considered to extend (for the purpose of fishing) from its source to the south side of Fish Island, thence to the Wedge Point, including Goose Bay, and eastwardly to the south side of Sheep Island and to Indian Sluice Point.

Owners of land at falls allowed stands for dipping fish.

2. Owners of land along any falls in any of the rivers of Yarmouth County shall be allowed one stand for dipping fish, except Salmon, to be selected by the owners and pointed out to the Overseer, who shall determine what claim they are entitled to, and to hold the same as their fishing privilege; the said stands to be in front, adjoining land owned by the parties severally.

Falls, privilege at, defined.

3. Any person occupying a public privilege on the falls shall, after loading, make room and give place for others by removing if requested to, and shall not occupy said privilege the second or subsequent time until each person requesting the privilege shall have had his turn.

Dipping stands allowed to land owner.

4. Every land owner to whom a dipping stand is allowed shall confine himself to said stand for the purpose of taking Alewives, but shall be allowed to set one Salmon net in tidal waters.

Name of owner.

5. Each net shall have attached to it the name in full of the owner.



*Special Fishery Regulations, N.S.*

## Chap. 96

6. No flume, eel-box or pot, or any other contrivance, shall be set with its mouth up stream on any river or branch thereof, for the purpose of taking eels, if calculated to destroy young Alewives, from the 1st day of July until the 10th day of November.

Flume, eel-box, &c., when not to be set with its mouth up stream

7. No net shall be set nearer to the foot of any falls, rapids or brook than one hundred yards.

Net near falls, &c.

8. All mill-dams on the main river, as far up as the junction of Goldstream Branch, including said branch, and the Little River branching at the forks, shall, unless provided with fish-ladders to the satisfaction of the Overseer, be and remain open from the 1st day of April until the 1st day of November ensuing; and all mill-dams above said junction on the main river, and any branches or streams emptying into the same; and all mill-dams on Carleton River, or branches thereof, shall, unless provided with fish-ladders, be and remain open from the 1st day of April until the 1st day of November ensuing. The several mill-dams on the Salmon River, unless provided with fish-ladders to the satisfaction of the Overseer, shall be opened on the 1st day of April and shall remain open until the 1st day of November ensuing.

Mill-dams to be kept open from 1st of April to 1st of November

9. In *Tusket River* no net for the purpose of taking Shad shall be set nearer to nor within two hundred yards of the north-east side of Shad Island, in Lake Vaughan, and no net shall be set in or about Andrews' "Narrows" for that purpose.

Shad fishing in Tusket River.

10. *Little River* shall be kept open six feet wide, clear of all walls; no obstruction shall be placed in said river to prevent the free passage of fish; and no net shall be set nearer to the foot of Lake Dunn than two hundred yards.

Little River.

Lake Dunn.

11. *Eel Brook* shall be kept open nine feet wide, in the deepest water, during the year; no net to be set nearer to the foot or head of the falls of *Eel Brook* than two hundred yards; all nets set in the said *Eel Brook*, and lakes thereto belonging, to be set with the current, and not across it. No net, eel-pot or herring-pot shall be set nearer to the lower scooping place on *Herring Brook* than five hundred yards, and no fish shall be taken below the big maple tree; no fish shall be taken in any way or manner above the falls, or common scooping place of *Herring Brook*, and no net shall be set in Duck Lake, or brook near Paul Doucett's; all mill-dams on said brook or lake shall be and remain open from the 1st day of April until the 1st day of November, unless provided with fish-ladders to the satisfaction of the Overseer.

Eel Brook and other waters; regulations as to setting nets.

Herring Brook.

Duck Lake.

12. *Hobb's Falls*, and the falls above and below the mill-place, shall be kept open eight feet wide, and no eel-pot or

Hobb's Falls.

Chap. 69

Special Fishery Regulations, N.S.

other obstruction shall be put in the channel of said river, allowing eight feet for the channel, between Campbell's Falls and the mill place.

Pubnico River.

13. No net shall be set in *Pubnico River*, above a straight line extending from Walter Larkin's Wharf to the west point of Willet's Island. The "brook" shall be kept open six feet wide in the middle, for Herrings to go up and down. Each family may set one flume, and no more, for the purpose of catching eels.

Number and size of nets in tidal waters at Lower Narrows.

14. In tidal waters no one shall use more than four nets, three for the purpose of taking Alewives and one for taking Salmon; such nets shall not exceed forty fathoms each in length below Lower Narrows, and twenty-five fathoms each from Lower Narrows to the head of tidal waters

Sec. 25.—COUNTY OF YARMOUTH (*Argyle River*).

One net to each family; length of such net.

1. Each family may set one net and no more from Higgin's Island to Campbell's Falls; the length of such net to be not more than twenty-five fathoms.

Old Mill Place.

2. The stream at the Old Mill Place shall be kept open six feet wide in the deepest water; all stones and obstructions to be removed.

Guagus Falls.

3. The stream at the Guagus Falls shall be kept open six feet clear of all obstructions, in the deepest water.

Gill-nets.

4. No gill-nets shall be set or used in the stream, from Campbell's Falls to the Guagus Falls.

ISLAND OF CAPE BRETON.

Sec. 26.—GENERAL FISHERY REGULATIONS.

Name of owner.

1. Each net set for the purpose of taking fish shall have attached to it the name in full of the owner.

Close season for salmon.

2. No Salmon net shall be set, nor shall Salmon be taken with a dip-net, between the 15th day of August and the 1st day of March in each year.

Close season for alewives.

Alewives shall not be fished for, caught or killed in any river or stream after the 15th day of June in each year.

SPECIAL FISHERY REGULATIONS.

Sec. 27.—COUNTY OF VICTORIA.

Net not to be set within half a mile of the mouth of river.

No net of any description shall be set within half a mile of the mouth of any river or stream frequented by Salmon or Trout; nor shall any fish offal or debris of any kind, calculated to impede the passage of fish, or to injure the said fish, be thrown into any part of such river or stream.

Ans 5 6 7  
acted by  
12 Sept 1907

Dec 3  
Dec 12  
Dec 5  
15/

*Special Fishery Regulations, N.S.*

## Chap. 69

## Sec. 28.—COUNTY OF RICHMOND.

*Salmon*  
*in part* No net of any description shall be set within a quarter of a mile of the mouth of any river or stream frequented by fish; and no fish offal or debris of any kind, calculated to impede the passage of fish, or to injure the said fish, shall be thrown into any part of such river or stream.

Net not to be set within half a mile of the mouth of river.

## Sec. 29.—COUNTY OF CAPE BRETON.

1. No net, weir or other contrivance for taking fish shall be set or placed in any of the waters of this County, from Hearn's Point, at the south-west branch of Sydney River, to Blockett's Lake; nor for forty fathoms from where the lake runs into the brook; nor from the forks to the head-waters of the Salmon Hole Brook, including all the branches thereof.

Location of net, weir, &c., for taking fish.

2. From a line drawn from Cranberry Head to Low Point Light, no net shall be set or placed in the waters of Sydney Harbor between ten o'clock Saturday morning and four o'clock Monday evening.

From Cranberry Head to Low Point Light.

3. Within a quarter of a mile of the entrance to Little Bras d'Or Lake, and up to and including a quarter of a mile on the western side of Little Bras d'Or Bridge, no Herring net shall be allowed to remain set in the water, between ten o'clock in the morning and four o'clock in the afternoon of each day; and in these waters, including that portion of Little Bras d'Or Lake to the east end of Long Island, no Salmon or Herring net shall be allowed to remain in the water between ten o'clock on Saturday morning and four o'clock on Monday evening.

Within in quarter of a mile of the entrance to Little Bras d'Or Lake.

## Sec. 30.—COUNTY OF INVERNESS.

1. No flume, eel-box or pot, or any other contrivance for taking fish, shall be set with its mouth up stream on any river or branch thereof from the 1st day of July until the 10th day of November, if, in the opinion of the local Fishery Officer, such appliances are calculated to destroy young Alewives, Salmon or Trout.

Flume, eel-box, &c., when not to be set with its mouth up stream.

2. No net shall be set nearer the outlet of any lake than three hundred yards.

Proximity to outlet of lake.

3. No net shall be set for Salmon or Alewives nearer the mouth of any river than half a mile.

Proximity to mouth of river.

4. No net shall be placed lower down the Harbor of Margaree than within a direct line from McAllister's Well to Dead Man's Cape; nor outside the harbor within half a mile of the breakwater or its entrance; nor within one hundred and fifty yards of another net already set in the said harbor.

Location of net at Harbor of Margaree.

Chap. 69

Special Fishery Regulations, N.S.

Location of net at Harbor of Mabou.

5. No net shall be placed outside of the Harbor of Mabou within one quarter of a mile of the breakwater or the entrance of said harbor.

Length of net.

6. No net shall exceed thirty fathoms in length; nor shall any net take up more than one third of the channel at low water.

Size, location and proximity of weir, &c.

7. No weir or other contrivance for taking fish, set abreast of any island, shall take up in distance or extent more than one third of the stream on either side of such island; and no weir or other contrivance shall be placed within fifty yards either above or below such island.

From the upper line of the Indian lands at the Forks of Margaree.

8. From the upper line of the Indian lands at the Forks of Margaree to ten chains above it, only one weir shall be permitted to be set or placed, and such weir shall occupy no more than one fourth of the stream; and if such weir be set or placed at the point where the two rivers meet, only one sixth of the stream shall be occupied.

Position of weirs.

9. No person shall set or place a weir opposite another weir on any river, nor within sixty yards of another.

Length of weir.

10. No weir shall exceed in length thirty feet from the sluice, and no sluice shall exceed twenty feet in length.

No weir at Margaree.

11. No weir shall be placed by the side of any wharf or bulwark erected on any part of Margaree River.

Limits within which salmon and trout shall not be fished, &c.

12. Salmon or Trout shall not be fished for, caught or killed in any way, or at any season of the year, within the limits described in the following rivers, streams and waters, respectively:—

(a.) *North East Margaree*,—between the head of Big Intervale and the sources of the river.

(b.) *Little River* (Cheticamp),—from source to the settlement.

(c.) *Judique River* *Graham's Brook*, and *Long Point River*, between their sources and the line of the Main Post Road, between Port Hood and Port Hastings.

(d.) *River Inhabitants*,—between Long Stretch Bridge and its source.

(e.) *River Dennis*,—between Samuel McLean's Bridge and its source.

(f.) *Whycocomagh Bay*,—in any of the streams flowing thereinto, beyond two miles up such streams, from the point of entrance to Whycocomagh Bay, aforesaid.

(g.) *Mabou River* and its branches,—between Mabou Bridge and the source of the river; and the whole of the South-West River of Mabou.

Use of seine, bag-net, &c.

13. No seine, bag-net, trap-net, or fish-pound, or fish-box, shall be used in any stream, and no weir shall be turned upwards against the stream therein.

Owners of land.

14. Owners of land on any river shall be allowed one stand for dipping fish, except salmon, if above tidal waters,

omitted u  
12 Sept 1917  
WJ

*Special Fishery Regulations, N.S.*

## Chap. 69

to be selected by the owners and pointed out to the Fishery Overseer, who shall determine what claim they are entitled to, and to hold the same as their fishery privilege, the said lands to be in front, adjoining lands owned by the parties severally. Claims of owners of land, how determined.

15. The use of seines for the purpose of catching Herrings is prohibited in the waters of West Bay, Bras d'Or Lake. Seines prohibited in West Bay.

# CHAPTER 70.

## PROVINCE OF NEW BRUNSWICK.

### GENERAL FISHERY REGULATIONS.

Government House, Ottawa,

The 18th day of July, 1889.

On the recommendation of the Minister of Marine and Fisheries, and under the provisions of Chapter 95 of the Revised Statutes of Canada, intituled "The Fisheries Act."

His Excellency in Council has been pleased to make the following Fishery Regulations for the Province of New Brunswick:—

#### Section ~~1~~—BAIT.

*Section 1 is strike*  
*Western Permit*  
The Minister of Marine and Fisheries may authorize the issue of special permits to take bait for the *bona fide* purpose of deep-sea fishing, for any specified time during the Sunday close time prescribed by the fishery laws.

#### Sec ~~2~~—BASS.

Close season for bass, and minimum weight thereof fixed at two pounds.

(a.) No person shall fish for, catch, kill, buy, sell or have in possession any Bass between the 1st day of March and the 1st day of October in each year, ~~in the Province of New Brunswick~~, nor at any time shall Bass of a less weight than two pounds be fished for, caught, killed, bought, sold or had in possession; and if caught by accident in nets or other fishing apparatus lawfully used for other fish, young bass of less than two pounds weight shall be liberated alive at the cost and risk of the owner of the fishery, on whom in every case shall devolve the proof of such actual liberation: Provided, that nothing contained in this regulation shall prevent any person from fishing for, catching or killing Bass at all times by means of angling with a hook and line; but the possession, purchase or sale of Bass so caught shall impose on the possessor, purchaser or seller the burden of proving the lawful capture thereof.

Size of meshes.

(b.) In the Province of New Brunswick Bass shall not be fished for, caught or killed by means of any kind of net having meshes of a less size than five inches extension measure, nor by means of seines.

Owners of nets to obtain license.

(c.) The owner or owners of nets used for the purpose of taking Bass shall first obtain license therefor, and pay an annual license fee on each net legally in use of one dollar, which fee shall be paid, before any such net is used, to the local Fishery Overseer, for transmission to the Department of Fisheries.

*General Fishery Regulations, N.B.*

Chap. 70

(d.) All persons opening holes through the ice for the purpose of taking Bass shall cause the same to be marked with four evergreen bushes, each six feet in height.

Open holes in ice to be marked.

5 *Change 4*  
Sec. 3.—COD.

No person shall carry on codfishing with seines at a less distance than one half mile from any fishing grounds where fishing boats are anchored and fishermen are actually engaged fishing for Codfish with hooks and lines.

Cod fishing with seines.

6  
Sec. 4.—HERRINGS.

(a.) No net or nets shall be set or used within six hundred feet of any place where Herrings resort to spawn between the 25th day of June and the 25th day of August in each year; nor within six hundred feet of any weir under license on which license fees have been paid.

Proximity of nets and licensed weirs.

(b.) Fishing for *Herrings* in the manner known as "driving" with torches, flambeau or other artificial lights is prohibited.

"Driving" with torches, &c.

(c.) No weir, engine or barricade shall be built, set or used for the purpose of catching *Herrings*, except under the authority of an *annual license* from the Minister of Marine and Fisheries, or other person by him authorized to issue the same.

Annual license required.

7 *In Fisheries Act Cap 45 - 1 General regulations affecting British waters*  
Sec. 5.—LOBSTERS.

(a.) On the part of the coast of the Atlantic Ocean extending from Cape Canso westward, and following the coast line of the Bay of Fundy to the United States' boundary line, it shall be unlawful to fish for, catch, kill, buy, sell or have in possession (without lawful excuse) any Lobsters between the 1st day of July and the 31st day of December in each year.

Close season for lobsters from Cape Canso westward to the United States.

80  
12 Feb  
107

(b.) In the remaining waters of the Province of New Brunswick, it shall be unlawful to fish for, catch, kill, buy, sell or have in possession (without lawful excuse) any Lobsters between the 15th day of July and the 31st day of December in each year.

Close season in other waters.

(c.) It shall be unlawful at any time to fish for, catch, kill, buy, sell, expose for sale or have in possession any berried or soft-shell Lobster or Lobsters, or any Lobster or Lobsters under nine and one half inches in length, measuring from head to tail, exclusive of claws or feelers, and when caught in fishing apparatus in legal use they shall be liberated alive by the proprietor, owner, agent, tenant, occupier, partner or person actually in charge, either as occupant or servant, on each of whom shall devolve the proof of such

Minimum length of lobster fixed at nine and one half inches.

Chap. 70

General Fishery Regulations, N.B.

actual liberation, and each of whom shall be deemed to be jointly and severally liable for any penalties or moneys recoverable under The Fisheries Act, or of any regulation made under the said Act.

Sec. 6.—OYSTERS. *see 8*

Close season for oysters

Oysters shall not be fished for, caught, killed, bought, sold or had in possession between the 1st day of June and the 15th day of September in each year, both days inclusive.

*see para. 10, 11, 12, 13, 14, 15, 16, 17, 18, 19, 20, 21, 22, 23, 24, 25, 26, 27, 28, 29, 30, 31, 32, 33, 34, 35, 36, 37, 38, 39, 40, 41, 42, 43, 44, 45, 46, 47, 48, 49, 50, 51, 52, 53, 54, 55, 56, 57, 58, 59, 60, 61, 62, 63, 64, 65, 66, 67, 68, 69, 70, 71, 72, 73, 74, 75, 76, 77, 78, 79, 80, 81, 82, 83, 84, 85, 86, 87, 88, 89, 90, 91, 92, 93, 94, 95, 96, 97, 98, 99, 100*

*see 9 Amalgamated Fishermen's Association*  
Sec. 7.—SALMON.

Close season for salmon.

(a.) Salmon shall not be fished for, caught or killed, between the 15th day of August in each year and the 1st day of March ensuing, in the Province of New Brunswick: Provided always, that it shall be lawful to fish for, catch and kill Salmon with a rod and line, in the manner known as fly surface-fishing, between the 1st day of February and the 15th day of August.

*Amalgamated Fishermen's Association*  
*see 8*  
*see 9*  
*see 10*

Before any salmon net shall be used, the owner or person interested shall obtain a fishery license.

(b.) Before any Salmon net shall be used, the owner or person interested in such net shall cause a memorandum in writing, setting forth the name of the owner or person interested, the length of the net, and its intended location, to be filed with the local Fishery Overseer, who, if no valid objection exists, may, in accordance with instructions from the Minister of Marine and Fisheries, issue a fishery license for the same; and any net used before such license has been obtained, and any net used in excess or evasion of the description contained in such license, shall be deemed to be illegal, and liable to forfeiture, together with the fish caught therein, and the owner or person using the same shall also be subject to fine and costs under "The Fisheries Act."

11

License fee.

(c.) The owner or owners of any net or nets used for the purpose of taking Salmon shall, on receiving such license, pay an annual license fee of three cents for each fathom of net so licensed, which license fee shall be paid to the local Fishery Overseer, for transmission to the Department of Fisheries.

Salmon nets, how marked.

(d.) All Salmon nets shall have the name of the owner or owners legibly marked, on two pieces of wood or metal attached to the same; and such mark shall be preserved on such nets during the fishing season, in such manner as to be visible without taking up the net or nets; and any net used without such mark shall be liable to forfeiture.

Close time for salmon in tidal waters.

(e.) From the time of low water nearest six o'clock in the afternoon of every Saturday to the time of low water nearest six o'clock in the forenoon of every Monday, no one shall fish for, catch or kill Salmon in tidal waters.



General Fishery Regulations, N.B.

Chap. 70

(f.) In non-tidal waters frequented by Salmon no one shall fish for, catch or kill Salmon, or any other fish, between nine o'clock in the evening of every Saturday and six o'clock on the following Monday morning.

Close time for salmon in non-tidal waters.

Sec. 8.—SHAD AND GASPEREAUX.

(a.) The close time for Shad and Gaspereaux shall extend from sunset on Friday evening to sunrise on Monday morning, in each week, during which time it shall be unlawful to fish for, catch or kill any Shad or Gaspereaux. The fisheries within the harbor of St. John, New Brunswick, are, however, exempted from the foregoing provision of this section.

Close time for shad and gaspereaux.  
Harbor of St. John exempted.

(b.) The use of seines in the Province of New Brunswick, for the purpose of catching Shad and Gaspereaux, is prohibited.

Use of seines prohibited.

(c.) In the Province of New Brunswick no one shall fish for, catch or kill any Gaspereaux after the 30th day of June in each year.

Close season for gaspereaux.

Sec. 9.—SMELTS.

(a.) No one shall fish for, catch, kill, buy, sell, or have in possession any Smelts between the 1st day of March and the 30th day of June (both days inclusive) in each year.

Close season for smelts.

~~(b.) The use of Smelts for manure is prohibited.~~

(c.) The use of seines for the purpose of catching Smelts is prohibited.

Use of seines prohibited.

(d.) Smelts shall not be fished for, caught or killed by means of any kind of bag-nets having meshes of a less size than one inch and a quarter, extension measure.

Minimum size of meshes of bag-nets.

(e.) The use of bag-nets for the purpose of catching Smelts is prohibited, except under special license from the Minister of Marine and Fisheries, and then only between the 1st day of December and the 15th day of February in each year.

Special license to use bag-nets.

(f.) The use of electric or other lights in connection with bag-net fishing is prohibited.

Use of electric lights.

(g.) All persons opening holes through the ice for the purpose of taking Smelts shall cause the same to be marked with four evergreen bushes, six feet each in height.

Holes in ice to be marked.

Sec. 10.—STURGEON.

(a.) Sturgeon shall not be fished for, caught or killed between the 31st day of August and the 1st day of May following in each and every year, both days inclusive.

Close season for sturgeon.

(b.) Sturgeon nets shall not be less than thirteen inches in the mesh, extension measure, from knot to knot, when the net is dry.

Meshes of sturgeon nets.

Chap. 70

Special Fishery Regulations, N.B.

Sturgeon nets must be licensed.

(c.) No sturgeon net shall be used until a license has been obtained from the Minister of Marine and Fisheries, the fee for which shall be fifteen dollars for the season.

Sturgeon nets must be marked with owners name.

(d.) All sturgeon nets must be plainly marked with owner's name; non-compliance with this regulation will render the net liable to confiscation and the cancelling of its license.

*Account of Sturgeon  
with license  
See 50 17 12 1897  
cc.*

Sec. 11.—TROUT AND LAND-LOCKED SALMON.

Close season for trout and land-locked salmon.

(a.) In the Province of New Brunswick no person shall fish for, catch, kill, buy, sell or have in possession any Speckled Trout (*Salvelinus fontinalis*), Lake Trout or Land-locked Salmon, between the 15th day of September and the 1st day of May in each year, both days inclusive.

Angling with hook and line.

(b.) No one shall at any time fish for, catch or kill Trout by other means than angling with hook and line.

*see 14 - Trout & Land Locked Salmon*  
Sec. 12.—WHITEFISH.

*added by 0  
24/12 07*  
Close season for whitefish.

No one shall fish for, catch or kill any Whitefish between the 1st day of October and the 31st day of December in each year.

Sec. 13.—EXPLOSIVES.

The use of explosive materials to catch or kill fish is prohibited.

*Prohibited by  
07. Explosives prohibited.  
11/19*

SPECIAL FISHERY REGULATIONS.

Sec. 14.—COUNTY OF CHARLOTTE.

Herring Fishing.

Weir, engine or barricade in the Island of Grand Manan.

1. No weir, engine or barricade shall be set or placed on either side of Cow Passage or Cheney's Passage, in the Island of Grand Manan, without leaving a continuous clear passage or channel of the width of five hundred feet, following the deepest water of the same; and no wing belonging to or used therewith, or attached to any such weir, engine or barricade, shall extend beyond or into channels of the said passages, or either of them, so as to diminish the said width of five hundred feet.

Proximity of weirs, &c.

2. In no case shall weirs, engines or barricades be placed nearer each other than one thousand feet.

Weirs, &c destroyed by overseers when necessary.

3. The Fishery Overseers of the County, or either of them, as the case may be, are authorized and required, in the event of a violation of either of these regulations, in addition to the penalties imposed, when it is thought necessary by the

*Special Fishery Regulations, N.B.*

Chap. 70

said Overseers in their respective districts, to destroy the said weirs, engines or barricades, or wings belonging to them, or used therewith or attached to them, or each or any of them respectively, or such portions thereof as the said Overseers in their respective districts may deem necessary.

4. Herrings shall not be taken between the 15th day of July and the 15th day of October in any year, on the spawning ground at the Southern Head of Grand Manan, within the following limits, that is to say:—Commencing at Red Point, in the eastern part of Seal Cove; thence running southerly on a line with Gannet Rock Lighthouse, three miles; thence westerly, three miles from shore to a point three miles due west from a rock known as the Old Maid, near the southern head of Bradford's Cove; thence east to Old Maid Rock; thence following the shore back to Red Point, the place of beginning; said limits including the two wood islands and passing at the distance of six hundred feet around and from each of the weirs under license within said limits.

Herring fishing, close season and limits.

5. All nets or other fishing material, apparatus, tackle or gear used for catching Herrings on any part of the said ground during the period above described shall be seized and confiscated, and every person so using the same shall be subject to fine, as prescribed by "The Fisheries Act."

Seizure and confiscation of nets.

6. Herrings shall not be fished for, caught or killed by means of seines within three miles of shore.

Within three miles of shore.

*7 - fishing by means of seines 9 miles in the ...*  
Sec. 15.—COUNTY OF GLOUCESTER.

*see 12 646*  
*07.*

1. No net for the catch of any kind of fish shall be set at Tracadie South Gully, commonly called Young's Gully, below Daniel Cobb's lower line, towards Peter Ferguson's, at the opposite side; and no such net shall be set on the northern side of the same gully, below Thistle Point and John McLaughlin's shore, opposite his house on the other side.

Nets for catching fish at Young's Gully prohibited.

2. No net whatever shall be set, nor any seine or drift-net used in any way to impede or obstruct the free passage of fish into the Grand Lake, so called, at Shippegan Island.

Nets at Shippegan Island prohibited.

3. No net shall be set or seine used within two hundred yards on either side of the Little Tracadie River Bridges, or within two hundred yards on either side of the bridges over the South River of Pokemouche.

Nets at Little Tracadie River Bridge prohibited.

4. All nets shall be set from the shore or edge of the channel towards the thread of the river, and none shall be set upon any middle ground; and no net shall extend into any channel of the river in which it may be set further than one-third of the breadth of such channel.

Position of nets in river channels.

*0 miles in*  
*see 12*  
*sep 07*  
*Why*

## Chap. 70

*Special Fishery Regulations, N.B.*

Fish weir, traps, net, &c., may be destroyed, and penalty imposed for contravention of regulations.

5. When any fish weir, trap or other stationery device shall be erected contrary to any regulation, it shall be the duty of the Fishery Overseer or Warden to pull down and demolish such weir, trap or other stationery device; and the owner or party who erected the same shall be liable to a penalty, and also to the expense of pulling down and demolishing the same; and when any other infringement or violation of any of these regulations shall come to the knowledge of the Warden or Fishery Overseer it shall be his duty forthwith to prosecute the delinquent as the law directs, and it shall be also the duty of such Overseer or Warden to seize any net or nets found set or being contrary to these regulations, or any of them, and to set free any fish found therein, and remove such net to a place of safety, and advertise the same for the space of six days in three of the most public places in the parish, and then sell such net by public auction and remit the proceeds to the Inspector of Fisheries, for transmission to the Minister of Marine and Fisheries.

Nets for catching fish in the Big Nepisiguit River, &c.

6. No net shall be used for the catch of Salmon or any other fish in the Big Nepisiguit River, above John Swanton Bateman's Brook, or in any of the tributaries of the Big Nepisiguit River, or in the Tettagouche River, or in the Middle River, or in the Little River.

Nets within the Harbor of Bathurst.

7. No net shall be set within the Harbor of Bathurst, or on any middle ground, flat or channel between the forks of the Big River Channel and Allston and Carron Points, or within fifty fathoms on either side of the Big River Bridge.

*Gaspereau Fishing.*

Nets in the Rivers Pokemouche or Tracadie, regulations concerning their location.

8. All nets for the catch of Gaspereaux in the rivers of Pokemouche or Tracadie, and their several branches, shall be set with the stream up and down the river, and not at an angle with the stream; and if any net shall be set contrary to this regulation the owner or person using the same shall be liable to a penalty, and he shall be also liable to pay the charges and expenses of removing the same, which it shall be the duty of the Fishery Overseer or Warden forthwith to do; Provided, nevertheless, that from the 1st day of August until the 1st day of December, in each year, nets for the catch of Bass may be set at an angle with the stream or current of such rivers, ~~net, however, to extend into any channel more than one third the breadth of such channel.~~

No nets shall be set so as to impede fish going up the South River.

9. In the River Pokemouche no nets for the catch of Gaspereaux shall be set from Etienne Arseneau's shore to River's shore so as to impede the free course of fish going up the South River; and all nets set otherwise shall be deemed

*Special Fishery Regulations, N.B.*

Chap. 70

to be illegally set, and shall be liable to be seized and forfeited, and the owner or owners, or persons using the same, shall be liable to a penalty.

*Mullet in  
oe 12  
Bass or Gaspereaux in the River of Caraquet. Sep 10 1897*

10. Bass or Gaspereaux shall not be taken in the River of Caraquet, or in Saint Simon's Inlet, by seining; and no seine shall be used for the catch of Bass or Gaspereaux in the said river or inlet.

*Herring Fishing.*

11. Between the 1st day of July and the 1st day of November in each and every year no net for the catch of Herrings, or any other fish, shall be moored or anchored on any bank or shore, or any part of any bank or shore, in the Bay Chaleur, situate between Mizzonette Point and Point Miscou. All nets used upon these banks, or any part of them, shall be fastened to boats or other craft, and not otherwise, under a penalty as provided by "The Fisheries Act;" and all nets found moored or anchored contrary to this regulation shall be seized and removed, with all their contents, by the Warden of the fisheries, or the officer lawfully superintending the same; and such Warden or officer shall advertise the nets so seized for the space of six clear days in three or more public places in the Parish of Caraquet, in the County of Gloucester; and if the same are not claimed, and the penalty, costs and expenses paid before the expiration of that time, he shall sell the same by public auction to the highest bidder; and the proceeds arising from such sale shall be paid to the Minister of Marine and Fisheries through the Inspector of Fisheries.

Close season for herring fishing in the Bay Chaleur, between Mizzonette Point and Point Miscou.

Seizure, removal and sale of nets moored or anchored contrary to this regulation.

*re 17 2/24  
07*

Sec. 16.—COUNTY OF NORTHUMBERLAND.

1. No person or persons shall, under any pretence whatsoever, erect, build, make or set up, or make use of in the Bay, Harbor or River Miramichi, or any of its branches; or in any other river within the said districts, any brush or wooden weir or weirs, trap or traps, for the purpose of taking Gaspereaux, Shad, Salmon, Bass or other fish.

Weirs, traps, &c., for taking fish in Miramichi prohibited.

2. In all cases where any fish weir or weirs, trap or traps, shall be so erected contrary to the provisions of these regulations, it shall be the duty of Wardens and Overseers of the fisheries of the district in which such weir or weirs, trap or traps, shall so be erected, and all other persons are hereby fully authorized and empowered, immediately, or at any time thereafter, to pull down, remove and destroy such weir or weirs, trap or traps.

Weirs, &c., may be destroyed by warden or overseer when necessary.

3. No net whatever shall be set off Fox or Portage islands, except under special license from the Department

Regulations as to setting of nets.

## Chap. 70

*Special Fishery Regulations, N.B.*

Miramichi Bay, &c.	<p>of Fisheries, nor off any island, middle ground or shoal in the Bay, Harbor or River Miramichi and its branches, excepting as hereinafter permitted; no net shall be set from the western extremity of Huckleberry Island to the lot formerly owned by Thomas Ian, now or lately owned by the estate of Joseph Cunard; no net shall be set along the south shore, in the said space, to extend into the bay more than two hundred fathoms from three feet water, at low water. From the lower line of the Lacey lot, to the eastern line of the lot lately owned by John Mark Crank Delesdernier, at the mouth of Black River, no net shall extend into the bay more than two hundred fathoms; from thence to the Point aux Car no net shall extend into the bay more than two hundred fathoms; from Point aux Car to the lot owned by Alexander McDonald no net shall extend into the bay more than three hundred fathoms from low water; a base line to run from the said Alexander McDonald's lot to Point Cheval; no net shall extend into the bay more than three hundred fathoms from the said line; from Point Cheval to the upper extremity of the sand beach, in Napan Bay, no net shall extend into the bay more than two hundred and fifty fathoms from low water; no net shall be set off the inside of Bay du Vin Island to extend into the bay more than sixty-eight fathoms from low water, nor from the outside to extend into the river more than one hundred and fifty fathoms from low water; no net shall be set off the inside of Egg Island to extend into the bay more than sixty-eight fathoms from low water, nor from the outside to extend into the river more than one hundred fathoms from low water; a base line to run from the upper extremity of the sand beach in Napan Bay to the point commonly called Green Point, on the west side of a small creek at the end of George Murdoch's marsh; no net shall extend into the bay more than two hundred fathoms from the said line; and no net set from the said line to be nearer than one hundred fathoms to the said Green Point; from the said Green Point to within forty rods of the site of the fish shed, formerly occupied by James Anderson, and now or formerly occupied by Murdoch, no net shall be set to extend into the bay more than one hundred and fifty fathoms from low water; from thence to the lower extremity of East Point no net shall extend into the river more than eighty fathoms from low water; no net shall be set off East Point to extend into the river more than fifty fathoms from low water; no net shall be set off Sheldrake Island to extend into the river or bay more than sixty fathoms from low water; no net shall be set off Hay Island, opposite Neguac, to extend into the bay more</p>
Huckleberry Island.	
Mouth of Black River.	
Point aux Car.	
Point Cheval.	
Napan Bay.	
Bay du Vin Island.	
Egg Island	
Green Point.	
East Point.	
Sheldrake Island.	
Hay Island.	

*Special Fishery Regulations, N.B.*

Chap. 70

than two hundred fathoms from low water; from thence to lot No. 81, formerly owned by the late James Fraser, deceased, inclusive, no net to extend into the bay more than three hundred fathoms from low water; and no net shall be set in the said space more than two hundred fathoms in length; from thence to lot No. 76, formerly owned by James Thom, deceased, inclusive, no net shall extend into the bay more than two hundred and eight fathoms from low water; a base line to run from low water on lot No. 76 to the first point above the house owned by the late John English, deceased, opposite to the lower end of Sheldrake Island, no net shall extend into the bay more than two hundred and fifty fathoms from the said line; from thence to the lower line of lot No. 71 no net shall extend into the bay more than two hundred fathoms from low water; no net shall be set in front of lot No. 71 to extend into the river more than seventy fathoms beyond sixty fathoms from low water; a base line to commence at the upper line of lot No. 71, on Moody's Point, at low-water mark, and end at low water mark on lot No. 69, from thence to continue to low-water mark on lot No. 66, no net shall extend into the river more than sixty-five fathoms from low water; no net shall be set in front of the lots Nos. 65 and 66 to extend into the river more than sixty-five fathoms from the said line; no net shall be set in front of the lots Nos. 64 and 63 to extend into the river more than seventy fathoms from low water; no net shall be set in front of lot No. 64 to extend into the river more than sixty-five fathoms from low water; no net shall be set in front of lot No. 62 to extend into the river more than forty-five fathoms from low water; no net shall be set in front of lot No. 61 to extend into the river more than forty-five fathoms from low water; from lot No. 61 to lot No. 59, inclusive, no net shall extend into the river more than sixty-five fathoms from low water; no net shall be set in front of the lots Nos. 58, 57, 56, 55 and 54 to be longer than sixty-five fathoms beyond ~~forty~~ fathoms from low water; no net shall be set in front of the lots Nos. 53, 52 and 51, to be longer than sixty-five fathoms beyond fifty fathoms from low water; no net shall be set in front of lot No. 50 to extend into the river more than sixty-five fathoms from low water; from thence to lot No. 39, inclusive, no net shall extend into the river more than thirty-seven fathoms from low water; no net shall be set in front of lot No. 38 to extend into the river more than fifty fathoms from low water; no net shall be set in front of lots Nos. 37, 36, 35 and 34 to extend into the river more than sixty-eight fathoms from low water; from thence to the brook

Lot 81.

Lot 76.

Lot 71.

Moody's Point.

Lots 65 and 66.

Lot 64.

Lot 62.

Lot 61.

Lots 58 to 54.

Lots 53 to 51!

Lot 39.

Lot 38.

Lots 37 to 34.

1254  
126

## Chap. 70

*Special Fishery Regulations, N.B.*

Gilmour,  
Rankin &  
Co.'s wharf,  
Douglastown.

on the upper side of Gilmour, Rankin & Co.'s wharf, Douglastown, inclusive, no net shall extend into the river more than seventy fathoms from low water; from thence to

North-West  
Branch.

lot No. 14, inclusive, no net shall extend into the river more than fifty fathoms from low water; from thence to lot No. 5, inclusive, no net shall extend into the river more than forty-two fathoms from low water; from thence to lot No. 1, inclusive, no net shall extend into the river more than fifty-five fathoms from low water; from thence along the North Shore to Oxford's Cove, on the North-West Branch, no net shall extend more than thirty fathoms from low

Saw-mill  
Cove.

water; from thence to the Saw-mill Cove, inclusive, no net shall be set to extend into the river more than forty fathoms from low water, except in front of lots formerly occupied by James Oxford, Duncan McIntyre and George Hubbard, where the nets shall not extend into the river more than twenty fathoms from one foot of water at low water; from

Barr's Point.

the said Saw-mill Cove to the Cove below Barr's Point no net shall extend into the river more than eighty fathoms from low water; from thence to the upper Bass fishery no net shall extend into the river more than forty fathoms from low water; from thence to Dunbar's Point no net shall extend into the river more than sixty fathoms from low water, except in front of the lots formerly occupied by George Urquhart and Thomas Wright, where no net shall extend into the river more than 80 fathoms; from

Dunbar's  
Point.

William Mat-  
chett's upper  
line.

thence to William Matchett's upper line no net shall extend into the river more than thirty fathoms from low water; no net shall be set on the north side of the North-West Branch, or any of its tributaries, from the said William Matchett's upper line upwards, nor from the south side, from the mouth

Little South-  
West River.

of the Little South-West River upwards, to extend more than one third across the said branch or the channel thereof, or any of its tributaries; no net whatever shall be set off the south

James John-  
ston's lot.

side from the lower line of James Johnston's lot to the mouth of the Little South-West River; no net shall be set on either side of the Little South-West River to extend more than one third across the said river and its branches; and from the mouth of the Little South-West River down along the south or western shore to the lower line of the lot now occupied by

Widow Mc-  
Grath's lot.

the Widow McGrath, no net shall be set to extend into the river more than thirty fathoms from low water; and thence

Beauherbert's  
Point.

on the southern side downwards to Beauherbert's Point, inclusive, no net shall extend into the river more than forty fathoms from low-water mark, except in front of the lots occupied by Charles Stewart, Jared Tozer, Elson Tozer and William Taylor, where the nets shall not extend into the river more than thirty fathoms from one foot of water at low



*Special Fishery Regulations, N.B.*

## Chap. 70

water; no net whatever shall be set off Martin's Island, or off Martin's Island, or to any other island, middle ground or bar in the North-West Branch of the River Miramichi or its branches; a base line to run from east point to west point, no net shall extend into the river more than fifty fathoms from the said line; from low-water mark at west point, a base line to low-water mark at the lower point of lot No. 9, no net shall extend into the river more than sixty-five fathoms from the said line; from the said point of lot No. 9 to Terrill's Point no net shall extend into the river more than sixty-five fathoms from low water, except in front of lots Nos. 18 and 19, where the nets may extend sixty-five fathoms beyond twenty fathoms at low water; no net shall be set off Terrill's Point to extend into the river more than forty fathoms from low water; a base line to run from Terrill's Point to the lower end of Middle Island, no net shall be set to extend into the river more than forty-eight fathoms from the said line; no net shall be set from Middle Island towards the north shore to extend into the river more than fifty fathoms from low water; no net whatever shall be set from Middle Island to the south shore; no net shall be set from the south shore, opposite the upper end of Middle Island, to the lower line of lot No. 50, being the property lately occupied by Theophilus DesBrisay, to extend into the river more than fifty-two fathoms from low water, excepting in front of lots Nos. 28 and 29, which shall not exceed sixty fathoms from low water; and in front of lot No. 32 no net shall extend into the river more than thirty-eight fathoms from low water; no net shall be set in front of lot No. 33 to extend into the river more than fifty-five fathoms from low water; no net shall be set in front of lots Nos. 50, 51, 52, 53 and 54, inclusive, to extend into the river more than sixty fathoms from low water; from thence to lot No 58, inclusive, no net shall extend into the river more than sixty fathoms from low water; no net shall be set in front of lots Nos. 59, 60 and 61 to extend into the river more than fifty fathoms from low water; from thence to lot No. 41, in the grant of the late William Davidson, no net shall extend into the river more than forty fathoms from low water; no net shall be set in front of the lot now occupied by Peter Foley to extend into the river more than seventy fathoms from low water; no net shall be set from Beauherbert's Island to extend into the river more than thirty fathoms from low water; no net shall be set in the Tickle between Beauherbert's Island and Beauherbert's Point; no net shall be set in front of the burying ground on Beauherbert's Point, on either branch; no net shall be set from either side of the South-West Branch, from Beauherbert's Point, on the western shore, and Peter Foley's lot

Martin's Island.

Terrill's Point.

Middle Island, lower end.

Theophilus DesBrisay's property.

Lot 32.

Lot 33.

Lots 50 to 54

Lots 59 to 61.

Wm. Davidson's grant.

Peter Foley's lot.

The Tickle.

## Chap. 70

*Special Fishery Regulations, N.B.*

on the eastern shore, to the upper line of the lot occupied by James Carnahan, to extend into the river more than forty fathoms from low-water mark, excepting from the lot in possession of David Barron, on the north shore, towards the extremity of Barnaby's Island, where the nets shall not extend over thirty fathoms from low water; also, excepting the place known as Peter's Point, where the nets shall not extend into the river more than thirty fathoms from low water; and no net whatever shall be set from Barnaby's Island towards the north shore, nor from the lower extremity of Barnaby's Island towards the south shore, either from the said island or main land; and from thence upwards, to the lower line of the Barnaby River Mill Lot, no net shall be set on either side of the river, from Carnahan's upper line aforesaid to the mouth of Indian Town Brook to extend into the river more than thirty-five fathoms from low water; but in no case shall the nets extend more than one third across the main channel on the said South Branch; no net shall be set off the lots on the north shore, opposite Brown's Bar, or opposite the bar at Elm Tree, to extend into the river more than fifteen fathoms from low water; no net shall be set on either side of the said South-West Branch, or any of its branches, from the mouth of Indian Town Brook to the head of the Miramichi River and its branches, to extend more than one third part across the said river or its branches; no net shall be set off or from any island, middle ground or bar in the said South-West Branch of the River Miramichi and its branches; no net shall be set off the bar beginning at Knight's Cove and extending up stream; Provided always, that no net to be set in any of the branches of the River Miramichi, by virtue of these regulations, or in any other river within the said districts, not hereinbefore provided for, shall extend more than one third part across the said branch or river, anything herein contained to the contrary notwithstanding; and provided always, that where one third part shall include or take in more than one third of the main channel, or any of the said branches, or other rivers as aforesaid, no net whatever shall be set on the channel side of the river; and no nets whatever shall be set inside of any base lines allowed in the bay, harbor, river or branches of the Miramichi, excepting in front of lot formerly owned by Robert England, deceased, in Napan Bay, where the net may extend into the river in front of the said lot two hundred fathoms from low water, and the lot formerly owned by Richard Home, deceased, where the net may extend two hundred fathoms from low water. The violation of any of the provisions of this regulation shall subject the party offending to a penalty as provided by "The Fisheries Act."

James Carnahan's lot.

Barnaby's Island.

Peter's Point.

Barnaby River mill lot.

Indian Town Brook.

South Branch.

Brown's Bar, at the Elm Tree.

Knight's Cove.

Mapan Bay.

Richard Home's lot.

*Special Fishery Regulations, N.B.*

Chap. 70

4. No salmon of any description shall be taken or killed in any manner whatever in the bay, harbor or River Miramichi, below Beaubear's Island, or above Beaubear's Island in both branches, or in the Bartibogue, Tabusintac, Bay du Vin, Napan, or Black River, from the 15th day of August to the 1st day of March of the ensuing year; nor shall any person offer or expose for sale, nor shall any person purchase any fish so killed or taken; and no net shall be set or allowed to remain on any pickets in the said river or its branches after the times heretofore limited and appointed for fishing, and the owner or person using or fishing such set of nets shall, within forty-eight hours after the times limited as aforesaid, remove and pull up the pickets so used in fishing as aforesaid.

Salmon regulations and close season in River Miramichi, Bartibogue, Tabusintac, Bay du Vin, Napan, Black River.

5. No net or nets for the taking of Herrings shall be set or allowed to remain in the water, commencing three quarters of a mile to the westward of Lower Neguac Gully, and extending down three quarters of a mile to the eastward of Lower Neguac Gully, nor within three quarters of a mile from the shore within these points; no person shall be allowed to set any net or nets within twenty fathoms of another net for the taking of Herrings in Neguac Bay.

Nets for taking herrings, location and other provisions at Lower Neguac Gully.

**Sec. 17.—COUNTY OF RESTIGOUCHE.**

1. The extent, position and usage of Salmon nets set from middle grounds or islands in the River Restigouche, below Campbellton, shall be determined by the local fishery officers, in such manner as not to unduly interfere with or impede the running of Salmon.

Salmon nets in River Restigouche not to impede the running of salmon.

2. Sub-section 14 of section 14 of "The Fisheries Act" shall apply to angling as well as to net fishing for Salmon.

Angling

No Salmon fishing stand between Bontroming's Rocks and the first island above "Old Church Point," on the Restigouche River, shall exceed one hundred and fifty fathoms of bar-net, with wings not to extend more than twenty fathoms from the bar-net, and not more than one stand on every lot of land of sixty rods front, the same set within the western or upper boundary of the said lot of land, the meshes in the whole of said nets not to be less than five and one half inches, and at least fifty fathoms of channel shall be left open and unincumbered, to be determined by the Fishery Overseer.

Salmon fishing stand near Old Church Point, on the Restigouche River.

4. No fishing stand in any of the bays, coves and harbors, at and between Bontroming's Rocks and the eastern boundary line of the County of Restigouche, shall exceed two hundred fathoms of bar-net, nor have side-nets of greater length than twenty fathoms, nor more than one set on each and

Fishing stand between Bontroming's Rocks and eastern boundary line.

every lot of land of sixty rods front, the meshes in the whole of said nets not to be less than five and one half inches ; and if any pickets or nets shall be set or put to extend into the said bays, coves or harbors as aforesaid, further than is hereby directed, the owner or person using the same shall pay a fine, as provided by "The Fisheries Act."

Sec 18.—COUNTIES OF WESTMORELAND AND ALBERT.

*Shad Fishing.*

Size of meshes of nets for shad fishing.

1. All nets used for catching Shad shall be four and one half inches in the mesh, extension measure, and shall have the owner's name legibly marked, attached to them during the whole season, and shall not exceed two hundred and fifty fathoms in length ; each and every boat engaged in fishing for shad shall be entered with the local fishery officer, who will number the same on the bow or stern thereof, and the owner shall also mark such number on the sail, in legible characters.

Annual tax, shad weir.

2. Every weir used for taking shad shall pay an annual tax of one dollar.

Sec. 19.—COUNTIES OF ST. JOHN, KINGS, QUEENS, SUNBURY, YORK, CARLETON AND VICTORIA.

Length and extent of net.

1. No net shall exceed thirty fathoms in length and sixty meshes in depth, nor extend more than thirty fathoms into any river, cove or creek, nor more than one fourth part of the width of the water between the shore on either side of such river, cove or creek, and any island or sand bar in such river, cove or creek.

Width of rivers, &c., how computed

2. The width of all such rivers, coves or creeks, where there are any islands or sand bars, shall be computed from the opposite shore to the island or sand bar to where the waters surrounding the said islands or bars are three feet deep.

In case of shallow rivers.

3. In case of shallow rivers, where the water is not three feet deep or more, no net or other incumbrance shall extend more than one fourth of the width of such river or stream, such width to be computed from the one shore of such river or stream to the opposite shore.

*See 1/2 Sec 19*

*except 2c*

*4  
5  
Added by one  
12 or sup 07*

# CHAPTER 71.

## GENERAL FISHERY REGULATIONS.

### PROVINCE OF ONTARIO.

Government House, Ottawa,  
The 18th day of July, 1889.

On the recommendation of the Minister of Marine and Fisheries, and under the provisions of Chapter 95 of the Revised Statutes of Canada, intituled "The Fisheries Act;"

His Excellency in Council has been pleased to make the following Fishery Regulations for the Province of Ontario:—

#### Section 1.—PICKEREL.

No one shall fish for, catch, kill, buy, sell or possess any Pickerel (Doré) between the 15th day of April and the 15th day of May, both days inclusive, in each year. Close season for pickerel, (Doré).

#### Sec. 2.—BASS AND MASKINONGÉ.

No one shall fish for, catch, kill, buy, sell or possess any Bass or Maskinongé between the 15th day of April and the 15th day of June, both days inclusive, in each year. Close season for bass and maskinongé.

#### Sec. 3.—WHITEFISH AND SALMON-TROUT.

No one shall fish for, catch, kill, buy, sell or possess any Whitefish or Salmon-Trout between the 1st and 30th days of November, both days inclusive, in each year. Close season for whitefish and salmon-trout.

#### Sec. 4.—SPECKLED TROUT.

No one shall fish for, catch, kill, buy, sell or possess any Speckled Trout (*Salvelinus fontinalis*) between the 15th day of September and the 1st day of May, both days inclusive, in each year. Close season for speckled trout.

#### Sec. 5.—EXPLOSIVES.

The use of Explosive materials to catch or kill fish is prohibited. Explosives prohibited.

#### Sec. 6.—SNARES.

The use of Snares of any kind for the purpose of catching or killing fish is prohibited. Snares prohibited.

## Chap. 71

*General Fishery Regulations, Ontario.*

## Sec. 7.—LEASES AND LICENSES.

Fishing by means of nets, &c., without lease or license prohibited.

Fishing by means of nets or other apparatus without Leases or Licenses from the Minister of Marine and Fisheries, under the provisions of Chapter 95, Revised Statutes of Canada, and Section 4 thereof, is prohibited in the Province of Ontario.

## Sec. 8.—RESTRICTION, BAY OF QUINTE.

Fishing with nets, how far prohibited.

Fishing with nets of any kind in that portion of the waters of the Bay of Quinte in the Province of Ontario, lying westward of a line drawn between Green Point in the County of Prince Edward and the eastern limit of the town of Deseronto in the County of Hastings, shall be, and the same is hereby prohibited during the months of June, July and August in each year.

## CHAPTER 72.

### GENERAL FISHERY REGULATIONS.

#### PROVINCE OF QUEBEC.

Government House, Ottawa,  
The 18th day of July, 1889.

On the recommendation of the Minister of Marine and Fisheries, and under the provisions of Chapter 95 of the Revised Statutes of Canada, intituled "The Fisheries Act,"

His Excellency in Council has been pleased to make the following Fishery Regulations for the Province of Quebec:—

#### Sec. 1.—BAIT.

The Minister of Marine and Fisheries may authorize the issue of special permits to take Bait for the *bona fide* purpose of deep-sea fishing for any specified time during the Sunday close time prescribed by the fishery laws. Special permits to take bait.

#### Sec. 2.—COD.

No person shall carry on Cod-fishing with seines at a less distance than one half mile from any fishing grounds where fishing boats are anchored, and fishermen are actually engaged fishing for Codfish with hooks and lines. Limits within which cod-fishing with seines is prohibited.

#### Sec. 3.—EXPLOSIVES.

The use of Explosive materials to catch or kill fish is prohibited. Explosives prohibited.

#### Sec. 4.—WHALE FISHING.

Section 6 of "The Fisheries Act" is suspended, in so far as the same relates to the killing of Whales by explosive instruments. Section 6 of Act, how far suspended.

#### Sec. 5.—PICKEREL (DORÉ).

No one shall fish for, catch, kill, buy, sell or possess any Pickerel (Doré) between the 15th day of April and the 15th day of May, both days inclusive, in each year. Close season for pickerel, (Doré).

#### Sec. 6.—BASS AND MASKINONGÉ.

No one shall fish for, catch, kill, buy, sell or possess any Close season.

Bass or Maskinongé between the 15th day of April and the 15th day of June, both days inclusive, in each year.

### Sec. 7.—SALMON.

Close season for salmon.

(a.) Salmon shall not be fished for, caught or killed between the 31st day of July and the 1st day of May, in the Province of Quebec ; Provided always, that it shall be lawful to fish for, catch and kill Salmon with a rod and line in the manner known as fly-surface-fishing between the 1st day of February and the 15th day of August in each year.

Prohibited hours in tidal waters.

(b.) From the time of low water nearest six o'clock in the afternoon of every Saturday to the time of low water nearest six o'clock in the forenoon of every Monday no one shall fish for, catch or kill Salmon in tidal waters.

Prohibited hours in non-tidal waters.

(c.) In non-tidal waters, frequented by Salmon, no one shall fish for, catch or kill Salmon, or any other fish, between nine o'clock in the evening of every Saturday and six o'clock on the following Monday morning.

### Sec. 8.—SPECKLED TROUT.

Close season for speckled trout.

(a.) No person shall fish for, catch, kill, buy, sell or possess any Speckled Trout (*Salvelinus fontinalis*), between the 1st day of October and the 31st day of December, both days inclusive, in each year.

Fishing for trout by other means than angling.

(b.) Except in the tidal waters of the Province of Quebec, on the north bank of the River St. Lawrence, from the mouth of the River Saguenay to Blanc Sablon, no one shall at any time fish for, catch or kill Trout by other means than angling with hook and line.

### Sec. 9.—WHITEFISH.

Close season for whitefish.

No one shall fish for, catch, kill, buy sell or possess any Whitefish between the 10th day of November and the 1st day of December, both days inclusive, in each year.

### Sec. 10.—GREY TROUT OR LAKE TROUT, WININISH AND LAND-LOCKED SALMON.

Close season for grey trout, &c.

No one shall fish for, catch, kill, buy, sell or possess any Grey Trout or Lake Trout, Wininish and Land-Locked Salmon between the 15th day of October and the 1st day of December, both days inclusive, in each year.



*General Fishery Regulations. P.Q.*

## Chap. 72

**Sec. 11.—SMELTS.**

(a). No one shall fish for, catch, kill, buy, sell, or have in possession any Smelts between the 1st day of April and the 1st day of July, both days inclusive, in each year. Close season for smelts.

(b.) The use of Smelts for manure is prohibited.

(c.) The use of Seines for the purpose of catching Smelts is prohibited. Seines prohibited.

(d.) Smelts shall not be fished for, caught nor killed by means of any kind of Bag-Nets having meshes of a less size than one inch and a quarter, extension measure. Minimum size of meshes of bag-nets.

(e.) The use of Bag-Nets for the purpose of catching Smelts is prohibited, except under special license from the Minister of Marine and Fisheries, and then only between the 1st day of December and the 15th day of February in each year. Use of bag-nets prohibited, except under special license.

**Sec. 12.—LOBSTERS.**

(a). In the waters of the Province of Quebec (including the Magdalen Islands and Anticosti), it shall be unlawful to fish for, catch, kill, buy sell or have in possession (without lawful excuse) any Lobsters, between the 15th day of July and the 31st day of December in each year. Close season for lobsters.

(b). It shall be unlawful at any time to fish for, catch, kill, buy, sell, expose for sale or have in possession any berried or soft-shell Lobster or Lobsters, or any Lobster or Lobsters under nine and one half inches in length, measuring from head to tail, exclusive of claws or feelers, and when caught in fishing apparatus in legal use they shall be liberated alive by the proprietor, owner, agent, tenant, occupier, partner or person actually in charge, either as occupant or servant, on each of whom shall devolve the proof of such actual liberation, and each of whom shall be deemed to be jointly and severally liable for any penalties or moneys recoverable under the Fisheries Act, or of any regulation made under the said Act. Minimum length of lobsters fixed at nine and a half inches.

**Sec. 13.—OYSTERS.**

Oysters shall not be fished for, caught, killed, bought, sold or had in possession between the 1st day of June and the 15th day of September in each year, both days inclusive. Close season for oysters.

**Sec. 14.—DEEP SEA FISHERIES, MAGDALEN ISLANDS.**

(a.) It shall be deemed unlawful, during the season of Herring and Mackerel fishery in Pleasant Bay (Magdalen

## Chap. 72

*General Fishery Regulations, P.Q.*

No nets to be set opposite the entrance to Amherst Harbor from the 1st of May to the 15th of June.

No nets to be set in the middle of Sandy Hook Channel, nor along the northern and western shores of Entry Island, more than one mile from the beach.

Proximity of nets.

Stipendiary magistrate may remove nets set in contravention of these regulations.

Set-lines and bultow lines prohibited within Pleasant Bay.

Penalty, how recoverable.

Islands), from the 1st of May to the 15th of June, to set any net or nets opposite the entrance of Amherst Harbor, that is to say: eastward of a line drawn from the north-west end of the Cape bounding the mouth of said harbor to the east end of Cape Allright, as far as another line intersecting the same and bearing east south-east (magnetic) with the north Cape of Entry Island; and no person or persons shall be permitted at any time to set any net or nets in the middle of Sandy Hook Channel; nor shall any net or nets be set along the northern and western shores of Entry Island at more than one mile distant from the beach: Provided, however, that fishermen may lay their nets from Allright and Grindstone Islands towards Entry Island to within half a mile of those set upon the northern and western shores of said island, so as to leave always, for the purposes of navigation, a clear channel against the entrance into Amherst Harbor, and preserve free access to the bottom of Pleasant Bay for the schools of Herrings and Mackerel resorting thither to spawn.

(b.) No nets shall be set in the said bay nearer to each other than one hundred feet.

(c.) Whenever it shall be found impracticable to discover the owner or owners for the time being of any net or nets laid in contravention of these regulations, the stipendiary magistrate in charge of the Government vessel for the protection of fisheries may, upon sight, proceed to remove the same from the place of obstruction.

(d.) It shall not be lawful to use, in any manner whatsoever, for the purpose of taking Codfish or Halibut, set-lines or bultow lines, within Pleasant Bay, or at a less distance than three miles from any of the Magdalen Islands.

(e.) The penalty incurred for violation of either of the regulations hereinbefore made shall be as declared by the 18th section of "The Fisheries Act," and recoverable as by the said Act provided.

### Sec. 15.—LEASES AND LICENSES.

Fishing by means of nets, &c., without lease or license prohibited.

Fishing by means of nets or other apparatus without leases or licenses from the Minister of Marine and Fisheries, under the provisions of "The Fisheries Act" and Section 4 thereof, is prohibited in the Province of Quebec.

# CHAPTER 73.

## GENERAL FISHERY REGULATIONS.

### PRINCE EDWARD ISLAND.

Government House, Ottawa,  
The 18th day of July, 1889.

On the recommendation of the Minister of Marine and Fisheries, and under the provisions of Chapter 95 of the Revised Statutes of Canada, intituled "The Fisheries Act,"

His Excellency in Council has been pleased to make the following Fishery Regulations for the Province of Prince Edward Island : —

#### Section 1.—BAIT.

The Minister of Marine and Fisheries may authorize the issue of special permits to take bait for the *bona fide* purpose of deep-sea fishing, for any specified time during the Sunday close time prescribed by the fishery laws.

Special permits to take bait.

#### Sec. 2.—COD.

No person shall carry on Cod-fishing with seines at a less distance than one half mile from any fishing grounds where fishing boats are anchored and fishermen are actually engaged fishing for Codfish with hooks and lines.

Limits within which cod-fishing with seines is prohibited.

#### Sec. 3.—HERRINGS.

(a.) No seines shall be drawn nor any nets set within six hundred feet of any place where Herrings resort to spawn, between the 25th day of June and the 25th day of August in each year, under penalty provided by "The Fisheries Act."

Close season for herrings.

(b.) No seines shall be drawn or any nets set within six hundred feet of any weir under license on which license fees have been paid, under penalty provided by "The Fisheries Act."

Proximity of seines and nets to weirs.

(c.) Fishing for Herrings in the manner known as "driving" with torches, flambeaux or other artificial light is prohibited, under penalty provided by "The Fisheries Act."

"Driving" with torches, &c.

#### Sec. 4.—LOBSTERS.

(a.) In the Province of Prince Edward Island it shall be unlawful to fish for, catch, kill, buy, sell or have in

Close season for lobsters.

possession (without lawful excuse) any Lobsters between the 15th day of July and the 31st day of December in each year.

Minimum length of lobster fixed at nine and a half inches.

(b.) It shall be unlawful at any time to fish for, catch, kill, buy, sell, expose for sale or have in possession any berried or soft-shell Lobster or Lobsters, or any Lobster or Lobsters under nine and one half inches in length, measuring from head to tail, exclusive of claws or feelers, and when caught in fishing apparatus in legal use they shall be liberated alive by the proprietor, owner, agent, tenant, occupier, partner or person actually in charge, either as occupant or servant, on each of whom shall devolve the proof of such actual liberation, and each of whom shall be deemed to be jointly and severally liable for any penalties or moneys recoverable under "The Fisheries Act," or any regulation made under the said Act.

#### Sec. 5.—OYSTERS.

Close season for oysters.

Oysters shall not be fished for, caught, killed, bought, sold or had in possession between the 1st day of June and the 15th day of September in each year, both days inclusive.

#### Sec. 6.—SMELTS.

Close season for smelts.

(a.) No one shall fish for, catch, kill, buy, sell, or have in possession any Smelts between the 1st day of April and the 1st day of July, both days inclusive, in each year.

(b.) The use of Smelts for manure is prohibited.

Seines prohibited.

(c.) The use of Seines for the purpose of catching Smelts is prohibited.

Minimum size of meshes of bag-nets.

(d.) Smelts shall not be fished for, caught or killed by means of any kind of Bag-Nets having meshes of less size than one inch and a quarter, extension measure.

Use of bag-nets prohibited, except under special license.

(e.) The use of Bag-Nets for the purpose of catching Smelts is prohibited, except under special license from the Minister of Marine and Fisheries, and then only between the 1st day of December and the 15th day February in each year.

#### Sec. 7.—TROUT.

Close season for trout.

(a.) No person shall fish for, catch, kill, buy, sell, or possess any Trout between the 1st day of October and the 1st day of December, both days inclusive, in each year.

Fishing other than by angling.

(b.) No one shall at any time fish for, catch, or kill Trout by other means than angling with hook and line.

#### Sec. 8.—EXPLOSIVES.

Explosives prohibited.

The use of Explosive materials to catch or kill fish is prohibited.

## CHAPTER 74.

### GENERAL FISHERY REGULATIONS.

#### PROVINCE OF MANITOBA, AND NORTH-WEST TERRITORIES.

Government House, Ottawa,  
The 18th day of July, 1889.

On the recommendation of the Minister of Marine and Fisheries, and under the Provisions of Chapter 95 of the Revised Statutes of Canada, intituled "The Fisheries Act,"

His Excellency in Council has been pleased to make the following Fishery Regulations for the Province of Manitoba and the North-West Territories:—

#### Section 1.—PICKEREL.

No one shall fish for, catch, kill, buy, sell or possess any Pickerel (Doré) between the 15th day of April and the 15th day of May, both days inclusive, in each year. Close season for pickerel, (doré).

#### Sec. 2.—WHITEFISH.

(a.) Whitefish shall not be fished for, caught, killed or possessed between the 5th day of October and the 10th day of November in each year, both days inclusive. Close season for whitefish.

(b.) Whitefish shall not be taken for making oil or feeding domestic animals. For making oil, &c.

#### Sec. 3.—STURGEON.

Sturgeon shall not be fished for, caught, killed or possessed between the 1st day of May and the 15th day of June in each year, both days inclusive. Close season for sturgeon.

#### Sec. 4.—TROUT.

No one shall fish for, catch, kill or possess any Speckled Trout (*Salvelinus fontinalis*) between the 1st day of October and the 1st day of January in each year. Close season for trout.

#### Sec. 5.—PROVISO.

Provided always, that the Minister of Marine and Fisheries shall have power to set apart and license, without fee, for the exclusive use of Indians, such waters as he may deem necessary, and that the Indians shall, during the close seasons, have liberty to fish under license to themselves or to their bands, for the purpose of providing food for themselves, but not for sale, barter or traffic. Waters may be set apart for the exclusive use of Indians.

#### Sec. 6.—EXPLOSIVES.

The use of Explosive materials to catch or kill fish is prohibited. Explosives prohibited.

# CHAPTER 75.

## GENERAL FISHERY REGULATIONS.

### PROVINCE OF BRITISH COLUMBIA.

Government House, Ottawa,  
The 18th day of July, 1889.

On the recommendation of the Minister of Marine and Fisheries, and under the provisions of Chapter 95 of the Revised Statutes of Canada, intituled "The Fisheries Act,"

His Excellency in Council has been pleased to make the following Fishery Regulations for the Province of British Columbia:—

#### Section II.—SALMON.

- Fishing with nets, &c., without lease or license is prohibited.
1. Fishing by means of nets or other apparatus without leases or licenses from the Minister of Marine and Fisheries under the provisions of Chapter 95, Revised Statutes of Canada and section 4 thereof is prohibited in the Province of British Columbia.
- Indians may fish for food for themselves.
- Provided always, that Indians shall, at all times, have liberty to fish for the purpose of providing food for themselves, but not for sale, barter or traffic, by any means other than with drift nets, or spearing.
- Minimum size of meshes of nets.
2. Meshes of nets used for capturing Salmon shall be at least six inches extension measure, and nothing shall be done to practically diminish their size.
- Drifting confined to tidal waters.
3. (a). Drifting with Salmon nets shall be confined to tidal waters, and no Salmon net of any kind shall be used for Salmon in fresh waters.
- Extent of drift-net.
- (b). Drift-nets shall not be so used as to obstruct more than one third of any river.
- Close time for fishing for salmon.
- (c). Fishing for Salmon shall be discontinued from six o'clock a.m. on Saturday to six o'clock a.m. on the following Monday, and during such close time no nets or other fishing apparatus shall be set or used so as to impede the free course of fish, and all nets or other fishing apparatus set or used otherwise shall be deemed to be illegally set, and shall be liable to be seized and forfeited, and the owner or owners or persons using the same shall be liable to the penalties and costs imposed by The Fisheries Act.
- Before any salmon net, fishing boat, or other fishing apparatus shall be used.
4. (a). Before any Salmon net, fishing boat or other fishing apparatus shall be used, the owner or persons interested in such net, fishing boat or fishing apparatus shall cause a memorandum in writing, setting forth the name of the owner or person interested, the length of the net, boat or

*General Fishery Regulations, B.C.*

Chap. 75

other fishing apparatus and its intended location, to be filed with the Inspector of Fisheries, who, if no valid objection exists, may, in accordance with instructions from the Minister of Marine and Fisheries, issue a fishery license for the same, and any net, fishing boat or fishing apparatus used before such license has been obtained, and any net, fishing boat or fishing apparatus used in excess or evasion of the description contained in such license, shall be deemed to be illegal and liable to forfeiture, together with the fish caught therein; and the owner or person using the same shall be also subject to fine and costs under The Fisheries Act.

Owner or person interested shall obtain a fishery license.

(b.) All salmon nets and fishing boats shall have the name of the owner or owners legibly marked on two pieces of wood or metal attached to the same, and such mark shall be preserved on such nets or fishing boats during the fishing season, in such manner as to be visible without taking up the net or nets; and any net or fishing boat used without such mark shall be liable to forfeiture.

Salmon nets and fishing boats shall be marked with name of owner.

5. The Minister of Marine and Fisheries shall, from time to time, determine the number of boats, seines, or nets or other fishing apparatus to be used in any of the waters of British Columbia.

Number of boats, seines, nets, &c., to be determined by Minister.

## Sec 2.—TROUT.

No one shall fish for, catch or kill Trout from the 15th day of October to the 15th day of March, both days inclusive, in each year.

Close season for trout.

Provided always, that Indians may, at any time, catch or kill Trout for their own use only, but not for the purposes of sale or traffic.

Indians' use

## Sec. 3.—EXPLOSIVES.

The use of explosive materials to catch or kill fish is prohibited.

Explosives prohibited

## CHAPTER 76.

### PROTECTION OF NAVIGABLE WATERS.

Government House, Ottawa,  
The 18th day of July, 1889.

On the recommendation of the Minister of Marine and Fisheries, and under the provisions of Chapter 95 of the Revised Statutes of Canada, intituled "The Fisheries Act," and Chapter 91 of the Revised Statutes aforesaid, intituled "An Act respecting the Protection of Navigable Waters."

His Excellency in Council has been pleased to order, and it is hereby ordered that the following waters be and the same are exempted from the operations of the said Acts, so far as regards sawdust:—

Crooked  
Creek.

Section **1.** Crooked Creek, in the County of Albert, in the Province of New Brunswick.

Nashwaak  
River.

Sec. **2.** The Nashwaak River, in the Province of New Brunswick.

Beaver Creek.

Sec. **3.** Beaver Creek, in the Township of Waterloo, in the County of Waterloo, in the Province of Ontario.

St. Francis  
River.

Sec. **4.** That portion of St. Francis River, in the County of Richmond, in the Province of Quebec, called "Brompton Falls."

Part of  
Ottawa River.

Sec. **5.** All that part of the Ottawa River lying between the Chaudière Falls and Mackay's Bay, and also all that part of the Gatineau River from the Mill Pond above Gilmour & Co.'s mill at Chelsea to the mouth of the said Gatineau River.

Part of Gati-  
neau River.



# CHAPTER 77.

## PROPAGATION OF FISH.

Government House, Ottawa,  
The 2nd day of August, 1889.

On the recommendation of the Minister of Marine and Fisheries, and under the provisions of Chapter 95 of the Revised Statutes of Canada, intituled "The Fisheries Act,"

His Excellency in Council has been pleased to make the following Fishery Regulations.

### PROPAGATION OF FISH IN THE PROVINCE OF ONTARIO.

#### SALMON.

Section 1. The following waters in the Province of Ontario are set apart for the natural and artificial propagation of Salmon:—

(a.) The waters of the River Credit, in the Townships of Toronto, Esquesing, Chinquacousy and Caledon, in the Counties of Peel and Halton. River Credit.

(b.) The waters of Highland Creek, in the Township of Scarboro', in the County of York. Highland Creek.

(c.) The waters of Lyon's Creek, in the Township of Pickering, in the County of Ontario. Lyon's Creek.

(d.) The waters of Barber's Creek, in the Township of Darlington, in the County of Durham. Barber's Creek.

#### GENERAL.

Sec 2. The following waters in the Province of Ontario are set apart for the natural and artificial propagation of fish, as provided by the *twenty-first* section of "The Fisheries Act," namely:—

(a.) Certain waters situated on the north-east part of lot No. 2, in the 10th Concession of the Township of North Dumfries, in the County of Waterloo, on the west side of the Grand River, near the Town of Galt, used for the purposes of breeding fish therein. North Dumfries, on the west side of the Grand River.

(b.) The waters of the River Trent, situated within the Counties of Northumberland and Hastings. River Trent.

(c.) The waters of the stream called Grafton Creek, in the Township of Haldimand, in the County of Northumberland. Grafton Creek.

(d.) The waters of the stream called Baldwin's (or Wilmot's) Creek, in the Township of Clarke, in the County of Northumberland. Baldwin's (or Wilmot's) Creek.

## Chap. 77

*Propagation of Fish.*

- Duffin's Creek. (e.) The waters of the stream called Duffin's Creek, in the Township of Pickering, in the County of Ontario.
- River Rouge. (f.) The waters of the stream called River Rouge, in the Townships of Pickering, Scarboro' and Markham, in the Counties of Ontario and York.
- Kerr's Pond, Burlington Bay. (g.) The waters of that part of Burlington Bay, called "Kerr's Pond," situated in the Township of Nelson, in the County of Halton.
- Little Lake, off Mitchell's Bay. (h.) The place called Little Lake, off Mitchell's Bay, near the southern end of St. Ann's Island, in the Lake St. Clair, in the Province of Ontario.
- Clear Lake, Salmon-Trout Lake, Stony Lake, Jack and Eels Creek. (i.) Clear Lake, Salmon-Trout Lake, with tributary waters from Young's Point to Burleigh Falls, together with Stony Lake and Jack and Eels Creeks, up to the first falls on each, all within the County of Peterboro', in the Province of Ontario, are set apart for the natural propagation of fish.

PROPAGATION OF FISH IN THE PROVINCES OF  
ONTARIO AND QUEBEC.

Lake des Chats.

Sec. 3. Fishing with nets of any kind in the waters of the Lake des Chats, shall be and the same is hereby prohibited for a period of five years, computed from the 22nd day of May, 1889, and during such period, no mode of fishing in the said lake shall be permitted except angling with hook and line or with night lines.

PROPAGATION OF FISH IN THE PROVINCE OF QUEBEC.

Sec. 4. The following waters in the Province of Quebec are set apart for the natural and artificial propagation of fish:—

Ottawa River, Campbell's Bay and Fish Bay.

(a.) The waters of the Ottawa River, from opposite to the River Blanche, in the Township of Lochaber, to and opposite the River du Lièvre, in the Township of Buckingham, together with the waters of Campbell's Bay and Fish Bay, and their tributaries, in the Townships of Lochaber and Buckingham.

North River and Salmon River.

(b.) The streams known as North River, in the Counties of Argenteuil, Two Mountains and Terrebonne, and Salmon River, in the County of Huntingdon, with limits extending one half mile on either side of the mouth of each.

River Magog and Massawippi.

(c.) The Rivers Magog and Massawippi, in the Counties of Stanstead and Sherbrooke.

Brome Lake and inlets.

(d.) The waters of Brome Lake, and its inlets for a distance of one mile from said lake, are set apart for the natural and artificial propagation of fish, from the 1st day of March to the 1st day of June in each year, and no other mode of fishing

*Propagation of Fish.*

Chap. 77

is allowed during the open season than angling by hand with hook and line, or trolling with a spoon.

(e.) The waters in the County of Ottawa, commonly known as Dam Lake, Indian Lake, Long Lake, Forked Lake, Over-the-hill Lake, Mud Lake and Little Mud Lake, are respectively set apart from the 1st day of October in each year to the 1st day of May in each following year for the natural propagation of fish.

Dam Lake,  
Indian Lake,  
Long Lake,  
Forked Lake,  
Over-the-Hill  
Lake, Mud  
Lake and  
Little Mud  
Lake.

(f.) The waters of Rivière du Sud (South River) within the Parish of St. George de Henryville, in the County of Iberville, with limits extending one half mile on each side of the mouth of the said Rivière du Sud and to mid-channel of the Richelieu River, opposite the above stated reserve, at the mouth of said stream, are set apart for the natural propagation of fish.

Rivière du  
Sud, (South  
River.)

(g.) The River Escoumains and its tributaries, in the County of Saguenay, are set apart for the artificial propagation of fish.

River Escou-  
mains

PROPAGATION OF FISH IN THE PROVINCE OF NEW BRUNSWICK.

Sec. 5. The following waters in the Province of New Brunswick are set apart for the natural and artificial propagation of fish :—

(a.) The waters of the River Tomkedgewick, in the County of Restigouche.

River Tom-  
kedgewick.

(b.) The upper waters of the River Restigouche, from the River Tomkedgewick to its source in the Counties of Restigouche and Victoria.

River Resti-  
gouche.

(c.) The upper waters of the River Restigouche, extending from and including the place called "Jimmy's Hole" to and including the tributaries and sources of the same, in the Counties of Restigouche and Victoria.

"Jimmy's  
Hole."

(d.) The Jacquet River.

Jacquet  
River.

(e.) The River Charlo above the bridges on the (so called) Bathurst road.

River Charlo.

(f.) The River Upsalquitch above the Little Falls.

River  
Upsalquitch.

PROPAGATION OF FISH IN THE PROVINCES OF QUEBEC AND NEW BRUNSWICK.

Sec. 6. The Rivers Patapedia and Tomkedgewick, with their tributaries, in the Provinces of Quebec and New Brunswick, are set apart for the propagation of fish.

Rivers Pata-  
pedia and  
Tomkedgewick.

*See also  
6th April  
1908.  
River Resti-  
gouche.  
"Jimmy's  
Hole."  
see set  
apart*

---

Chap. 77*Propagation of Fish.*

---

PROPAGATION OF FISH IN THE PROVINCE OF PRINCE  
EDWARD ISLAND.Midgell,  
Morrel, Dunk  
and Winter  
Rivers.

Sec. 7. The Midgell, Morrel, Dunk and Winter Rivers, in the said Province, are set apart for the natural and artificial propagation of fish.

DEPARTMENT OF MARINE.

CHAPTER 78.

Cap 193 R.S.C.  
Sec 72  
77-78,

EXAMINATIONS AND CERTIFICATES OF MASTERS  
AND MATES.

Government House, Ottawa,  
The 12th day of June, 1889.

On the recommendation of the Minister of Marine and Fisheries and under the provisions of Chapter 78 of the Revised Statutes of Canada, intituled "An Act respecting Certificates to Masters and Mates of Ships,"—

His Excellency in Council has been pleased to order, and it is hereby ordered, that the following rules be and the same are hereby made and established for the conduct of examinations of candidates for certificates of competency and service to masters and mates and as to the qualification of applicants.

PART I.—SEA-GOING SHIPS.

*Certificates granted to Persons who pass Examinations.*

Section 1. Certificates of competency will be granted to those persons who pass the requisite examinations and otherwise comply with the requisite conditions. Certificates of competency.

Sec. 2. Examinations may be held at the ports of Quebec, St. John, Charlottetown, Yarmouth and Halifax, at such times as may be decided upon by the Minister of Marine and Fisheries. Ports where examinations may be held.

*Testimonials of Character, &c., required.*

Sec. 3. Testimonials of character and of sobriety, experience, ability and good conduct on board ship, for at least twelve months of service immediately preceding the date of application to be examined, will be required of all applicants, and without producing them no person will be examined. As such testimonials will have to be closely examined by the examiners for verification before any certificates can be granted, it is desirable that candidates should lodge them as early as possible. The testimonials of service of foreigners and British seamen serving in foreign vessels must be confirmed either by the consul of the country to which the ship in which the candidate served belonged, or by some other official authority of that country, Testimonials of character, and of sobriety, experience, ability and good conduct.  
Testimonials of service of foreigners and British seamen serving in foreign vessels.

## Chap. 78.

*Examination of Masters and Mates.*

or by the testimony of some credible person on the spot, having personal knowledge of the facts required to be established. The production however, of such proofs, will not of necessity be deemed sufficient. Each case will be decided on its own merits. Upon application to the Board of Examiners, candidates will be supplied with a form, which they will be required to fill up and lodge with their testimonials, in the hands of the examiners.

Each case decided on its own merits.

*Service in Coasting Trade.*

Service in the coasting trade allowed to count as service, in order to qualify for examination for a certificate of competency for foreign sea-going ships.

Sec. 4. Service in the coasting trade may be allowed to count as service, in order to qualify a candidate for examination for a certificate of competency for foreign sea-going ships—it being understood, however, that service in a lower grade than that of first or only mate in the coasting trade will not be recognized as officers' service. Two years' service as mate in the coasting trade, together with at least six months' service as master (computed as hereinafter mentioned), may be allowed to count as service for a master's certificate for foreign sea-going ships, provided the candidate's entire service at sea amounts to six years, and his services as mate and master in the coasting trade can be proved by the articles. As the service required by the regulations is service at sea, and as vessels engaged in the coasting trade must necessarily spend a large proportion of time in port, the whole or any part of the service of a candidate for a master's or mate's certificate of competency for foreign sea-going vessels, performed in the coasting trade, will only be accepted in the proportion of half as much again as that required by the regulations, *i. e.*, 18 months of such service will only be considered as equal to 12 months in the foreign trade.

*Certificates as to Age.*

Certificate of birth, when required.

Sec 5. Should any doubt exist as to the age of a candidate, he will be required to produce a certificate of birth.

*Foreigners to know English.*

Knowledge of English must be proved.

Sec. 6. Foreigners must prove to the satisfaction of the examiners that they can speak and write the English language sufficiently well to perform the duties required of them on board a British vessel.

*Service as Pilot's Apprentice.*

Half of service may count.

Sec. 7. Half the amount of service performed as an apprentice in a pilot ship propelled by sails may count as

*Examination of Masters and Mates.*

Chap. 78.

an actual sea service to qualify for examination for a certificate of competency.

*Service as First-Class Pilot.*

Sec. 8. A first-class pilot, with one year's sea service since he obtained a pilot's certificate, may also be examined for a first mate's certificate for foreign sea-going ships. One year's sea service.

*Service in capacities other than as an Apprentice or Seaman.*

Sec. 9. Candidates whose services have been in capacities other than apprentice, ordinary seaman or able seaman, *e. g.*, as cook, steward, carpenter, &c., will be required to satisfy the Board of Examiners that they have a good knowledge of seamanship. This may possibly be proved by the production of satisfactory certificates from masters with whom the applicants have served. Failing satisfactory evidence, the applicant may be required to perform additional service, which must be in the capacity of ordinary seaman or able seaman. Service as cook, steward, carpenter, &c.

*Foreign Sea-going Ships, higher Grade than that for Coasting.*

Sec. 10. Every certificate of competency or service for a foreign sea-going ship is to be deemed to be of a higher grade than the corresponding certificate for a coasting or inland ship, and will entitle the lawful holder to go to sea in the corresponding grade in such last mentioned ship, but no certificate for a coasting or inland vessel shall entitle the holder to go to sea as master or mate of a foreign sea-going ship. Certificate for foreign sea-going ship entitles holder to corresponding grade for coasting or inland ship.

*International Code of Signals.*

Sec. 11. All candidates for certificates of competency will be required to pass an examination in the use of the International Code of Signals. Failure in this branch will be considered as failure in navigation. Candidates must pass an examination.

*Certificates of Competency for Foreign Sea-going Ships, Color Tests.*

Sec. 12. Examination in Colors.—All candidates for certificates of competency must pass the examination in colors to test their ability to distinguish the following colors, *viz.*:—black, white, red, green, yellow and blue, but for the present the rejection of candidates is limited to such persons only who cannot distinguish red from green with ease. Examination in colors.

## Chap. 78

*Examination of Masters and Mates.*

Candidate who has obtained a certificate before the 19th Oct, 1884.

Statement required.

Age and term of service.

Requirements in navigation, &c.

Requirements in seamanship, &c.

**Sec. 13.** A candidate who has obtained a certificate before the regulations relative to the color test came into operation in Canada, or before the regulations herein mentioned first came into operation (namely, the 19th day of October, 1884,) and who, on presenting himself for examination for a certificate of a higher grade, is unable to pass the color test, will, notwithstanding, be permitted to proceed in the examination in navigation and seamanship for the certificate of the higher grade; but should he pass this examination, the following statement will be written on the face of the higher certificate which may be granted him, viz.:—"This officer has failed to pass the examination in colors," and should he fail to pass the examination in navigation and seamanship, a like statement relating to his being color blind, will be made on his inferior certificate before it is returned to him.

*Second Mate.*

**Sec. 14.** A second mate must be seventeen years of age, and must have been four years at sea. He must also prove that he has served at least one year in a square-rigged sailing vessel.

**Sec. 15.** In Navigation, &c.—He must write a legible hand, and will be required to give, in writing, definitions of various astronomical and other terms used in navigation. He must have a competent knowledge of the first five rules of arithmetic, and the use of logarithms. He must be able to work a day's work complete, correcting the course for deviation, leeway and variation. He will be required to find the latitude by meridian altitude of the sun, and the difference of longitude from a given departure by parallel sailing; also to find the course and distance from one position to another by Mercator's method. He will be required to find the time of high water at a given point, to observe and calculate the amplitude of the sun, and to find the error of the ship's compass therefrom, and also the deviation, the variation being given. He must be able to find the daily rate of the chronometer from error observed, and to find the longitude from altitude of the sun by the usual methods. He must understand the use of the sextant, with its adjustments, and be able to observe with it, find the index error by the horizon, and read off and on the arc.

**Sec. 16.** In Seamanship, &c.—He must give satisfactory answers as to the standing and running rigging of ships; as to bending, unbending, setting, reefing, taking in and



*Examination of Masters and Mates.*

Chap. 78.

furling sail ; as to sending masts and yards up and down, &c. ; as to the management of a ship when under canvas ; and as to dunnaging and stowing cargo, &c. He must have a thorough knowledge of the *rule of the road* as regards both steamers and sailing vessels, their regulation lights, and fog and sound signals, and be able to describe the signals of distress, and the signals to be made by ships wanting a pilot, and the liabilities and penalties incurred by the misuse of these signals. He must be able to mark and use the lead and log lines. He must also understand the use and management of the rocket apparatus in the event of his vessel being stranded, and other questions of a like nature, appertaining to the duties of the second mate of a ship which the examiner may think necessary to put to him.

Knowledge  
of the rule of  
the road re-  
quired.

*First Mate.*

Sec. 17. A first mate must be nineteen years of age, and have been five years at sea, of which one year must have been as second mate. He must also prove that he has served at least one year in a square-rigged sailing vessel.

Age and term  
of service.

Sec. 18. In Navigation, &c.—In addition to the qualifications required for a second mate, a mate must be able to find the true bearing of the sun and the error of the ship's compass from an observed azimuth of the sun, both from an altitude and also from the "Time Azimuth Tables," and with the variation given compute the deviation ; to find the latitude from a single altitude of the sun off the meridian, and to be able to use and adjust the sextant, and to find the index error by the sun ; and also to ascertain the true bearing of the sun, &c., and the ship's position by Sumner's method by projection. He must also be conversant with the use of Mercator's chart, and be able to find, on either a "true" or "magnetic" chart, the course to steer and the distance from one given position to another ; and find the ship's position on the chart from cross-bearings of two objects ; from two bearings of the same object, the course and distance between the bearings being given ; and also the distance of a ship from the object at the time of taking the second bearing. He must also understand how to keep a ship's log-book.

Requirements  
in navigation,  
&c.

Sec. 19. In Seamanship, &c.—In addition to the qualifications required for a second mate, a more extensive knowledge of seamanship will be required, as to shifting large spars, rigging sheers, taking lower masts in and out, how to moor and unmoor ship, and to keep a clear anchor ; to carry out

Requirements  
in seamanship,  
&c

## Chap. 78.

*Examination of Masters and Mates.*

Ventilation  
of holds and  
the stowage  
of explosives.

an anchor ; how to manage a ship in stormy weather ; how to cast a ship on a lee shore ; how to secure the masts in the event of accident to the bowsprit ; and how to rig purchases for getting heavy weights, anchors, machinery, &c., in and out. He must give satisfactory answers as to the ventilation of holds and the stowage of explosives. He must also know how to rig a sea anchor, and what means to apply to keep a vessel disabled or unmanageable out of the trough of the sea, and lessen her lee drift ; how to get a cast of deep sea lead in heavy weather, and must answer any other questions appertaining to the duties of a first mate of a ship which the examiner may think necessary to put to him.

*Master.*

Age and terms  
of service in  
different ca-  
pacities.

Sec. 20. A master must be twenty-one years of age, and have been six years at sea, of which one year must have been as first or only mate in a foreign sea-going ship, and one year as second or only mate, with an appropriate certificate in each grade, or he must have been six and a half years at sea, of which two and a half years must have been as second mate of a foreign sea-going ship. during the last twelve months of which service as second mate he must have been in possession of a first mate's certificate. He must also prove that he has served at least one year in a square-rigged sailing vessel in the capacity of either apprentice, seaman, mate or master.

Requirements  
in navigation,  
&c.

Sec. 21. In Navigation, &c.—In addition to the qualifications required for a second and first mate, he must be able to compute the latitude from the meridian altitude of a star, &c. He must be able to find the magnetic bearing from equidistant compass bearings of any fixed object when at sea, and compute the deviation therefrom. He must construct a deviation curve upon a "Napier's" diagram, which will be furnished by the examiner, and understand the practical application of the same, and give written answers to certain practical questions on the effect of the ship's iron upon the compasses, the method of determining the deviation, and compensating the same by magnets and soft iron. He will be required to find the course to steer by compass in order to counteract the effect of a given current, and find the distance the ship will make good towards a given point in a certain time, and to work out practically the correction to apply to soundings taken at a given time and place, to compare with the depth marked on the chart.

Requirements  
in seamanship,  
&c.

Sec. 22. In Seamanship, &c.—In addition to the qualifications required of a second and first mate, he must be

able to construct jury rudders for both wooden and iron vessels, and also rafts. He will be examined as to his resources for the preservation of the ship's crew in the event of wreck; as to the management of ships in heavy weather; as to rescuing the crew of a disabled ship; as to steps to be taken when a ship is on her beam ends, or in any danger or difficulty; or if disabled or unmanageable, and on a lee shore; heaving a keel out, &c. He must explain the mode of procedure when placing ship in dry dock, directing repairs, and if putting into port in distress, without damage to cargo and ship. He must possess a sufficient knowledge of what he is required to do by law, as to entry and discharge, and the management of his crew, and as to penalties and entries to be made in official log, and a knowledge of the measures for preventing and checking the outbreak of scurvy on board ship, and the law as to load line marks, and the entries and reports to be made respecting them. He will be questioned as to his knowledge of invoices, charter party, bills of lading, Lloyd's Agent, and as to the nature of bottomry,—also bills of exchange, surveys, averages, &c., and must answer any other questions of a like nature appertaining to the management of a ship, which the examiner may consider it necessary to touch upon.

Mode of procedure when placing ship in dry dock, &c.

### *Cyclones.*

Sec. 23. An applicant for a master's certificate for foreign sea-going vessels must answer, in writing, on paper supplied to him by the examiner, the following questions, numbering the answers to correspond with the questions.

Questions to be answered.

Question;—

(1.) The direction of the wind in a cyclone being \*———, state the probable bearing of its centre from the ship in the \*——— Hemisphere.

Direction of wind.

(2.) And suppose that the wind during the passage of the same cyclone were found to change toward the \*———, what would be the ship's position with reference to the line of progression of the centre of the cyclone, and what action would you take?

Ship's position.

(3.) Under what conditions would the change in the direction of the wind in the cyclone be the reverse of the above?

Change in direction of the wind.

(4.) What are the usual indications of a ship being on the line of progression of the centre of a cyclone?

Line of progression.

\* These spaces are to be filled in by the Examiners, and frequently varied.

## Chap. 78.

*Examination of Masters and Mates.*Approaching,  
receding.

(5.) What are the usual indications that a ship is (a) approaching the centre of a cyclone; (b) receding from it?

Track of cy-  
clone.

(6.) Describe the track usually taken by cyclone in the†———, and state the seasons of the year in which they most frequently occur in that region.

*Time allowed.*Additional  
time, to an-  
swer.

Sec. 24. Candidates will be allowed half an hour additional time to answer the questions contained in section 23.

*Fore-and-Aft-rigged Vessels.*Service in  
square-rigged  
sailing ves-  
sels.

Sec. 25. In cases where applicants for certificates of competency as master or mate have not complied with the regulation which requires them to have served at least one year in square-rigged sailing vessels, or who prove, in the course of examination, that they are ignorant of the management of square-rigged ships, they may obtain certificates on which the words "fore-and-aft rigged vessels only" will be written.

*Value of Fore-and-Aft Certificate.*Not entitled  
to act in  
square-rigged  
vessels.

Sec. 26. A certificate for fore-and-aft rigged vessels will not entitle the possessor to act in square-rigged vessels, amongst which are classed full-rigged ships, barks, brigs, barkantines, brigantines and steamships carrying square sails.

*Square-rigged Vessels.*Value of cer-  
tificate for  
fore-and-aft  
rigged ves-  
sels.

Sec. 27. A candidate possessing a certificate for fore-and-aft rigged vessels and desiring to obtain a certificate which will enable him to act as Master in square-rigged ships, must prove that he has served at sea at least one year in a square-rigged sailing vessel, and will be re-examined both in navigation and seamanship.

## PART II—PLEASURE YACHTS.

*Examination Voluntary.*Confined to  
persons who  
command  
their own  
pleasure  
yachts.

Sec. 28. The examination of candidates for certificates of competency or service as master or mates of pleasure yachts is purely voluntary, and is confined to persons who command their own pleasure yachts. A master of a yacht who is not also the owner, is not eligible for examination.

† The Examiners are to fill in whether North Atlantic, Bay of Bengal, China Seas, Indian Ocean, &amp;c.

*Examination of Masters and Mates.*

## Chap. 78.

*One description.*

Sec. 29. Only one description of certificate will be issued, which will entitle the holder to command his own yacht, whether foreign-going or only cruising within North American waters. The certificate will not entitle the holder to command any vessel except the pleasure yacht of which he is, at the time, owner.

Value of certificate, how limited.

*Specified time served not required.*

Sec. 30. Candidates are not required to have served any specified time afloat, as it is believed that their sea knowledge will be sufficiently tested by the examination they will have to pass in seamanship.

No specified time of service required.

Sec. 31. Testimonials of service need not be produced. Testimonials.

*Fee.*

Sec. 32. The fee of \$10, required for the examination of a master of a foreign sea-going ship, will be charged.

Fee of \$10.

*Regulations.*

Sec. 33. In other respects, the regulations framed for the conduct of the examination of masters ordinary will apply to these cases.

Ordinary regulations to apply.

Examination in colors.—He must pass the examination in colors.

Colors.

*Master.*

Sec. 34. In Navigation, &c.—He must understand the first five rules of arithmetic and the use of the logarithms. He must be able to work a day's work complete, including the bearings and distances from one port to another by Mercator's method; to correct the sun's declination for longitude, and find his latitude by meridian altitude of the sun. He must be able to observe and calculate the amplitude of the sun, and deduce the variations of the compass therefrom. He must know how to lay off the place of the ship on the chart, both by bearings of known objects and by latitude and longitude. He must be able to determine the error of a sextant and to adjust it; also to find the time of high water from the known time at full and change. He must be able to observe azimuths and compute the variation, to compare chronometers and keep their rates, and find the longitude by them from an observation of the sun; to work the latitude by single altitude of the sun off the meridian,

Requirements in navigation &c.

## Chap. 78.

*Examination of Masters and Mates.*

Nature of the effect of the ship's iron on the compass.

and to be able to use and adjust the sextant by the sun. He must be able to find the latitude by a star, &c. He will be required to answer, in writing, certain questions as to the nature of the effect of the ship's iron upon the compass, and as to the methods of determining any error arising therefrom. He will be examined in so much of the laws of the tides as is necessary to enable him to shape a course, and to compare his soundings with the depths marked on the charts. He must possess a sufficient knowledge of what he is required to do by the Merchant Shipping Acts, and to possess a knowledge of the measures for preventing and checking the outbreak of scurvy on board ship. He must be acquainted with the leading lights of the coast he has been accustomed to navigate, or which he is going to use.

Requirements in seamanship, &c.

Sec. 35. In Seamanship, &c.—He must understand the measurement of the log line, glass and lead line, and pass a satisfactory examination on the *rule of the road*, as regards both steamers and sailing vessels, and the lights and fog signals carried by them, and will also be examined as to his acquaintance with the "International Code of Signals for the use of all Nations." He must know how to moor and unmoor, and to keep a clear anchor, to carry out an anchor. He will also be questioned as to his knowledge of the use and management of the mortar and rocket lines in the case of the stranding of a vessel, as to managing a ship in stormy weather, taking in and making sail, casting a ship on a lee shore, and securing the masts in the event of accident to the bowsprit. He will be examined as to his competency to construct jury rudders and rafts, and as to his resources for the preservation of the ship's crew in the event of wreck.

Service in fore-and-aft rigged vessel.

Sec. 36. In cases where an applicant has only served in a fore-and-aft-rigged vessel, and is ignorant of the management of a square-rigged vessel, he will only obtain a certificate on which the words "fore-and-aft-rigged vessel" will be written. This certificate will not entitle him to command a square-rigged ship.

## PART III.—SPECIAL INSTRUCTIONS TO CANDIDATES.

*Punctuality of attendance.*

Punctuality.

Sec. 37. Candidates are required to appear at the examination room punctually at the time appointed.

Books or paper not allowed.

Sec. 38. Candidates are prohibited from bringing into the examination room, books or paper of any kind whatever.

*Examination of Masters and Mates.*

## Chap. 78.

The slightest infringement of this regulation will subject the offender to all the penalties of a failure.

*Injuring Examination Papers.*

Sec. 39. In the event of any candidate being detected in defacing, blotting, writing in, or otherwise injuring any book or books belonging to the Board, the papers of such candidate will be detained until the book or books so defaced be replaced by him. He will not, however, be at liberty to remove the damaged book, which will still remain the property of the Board.

Candidate detected in defacing or injuring books, &c.

*Discovered Copying, &c.*

Sec. 40. In the event of any candidate being discovered copying from another, or affording any assistance or giving any information to another, or communicating in any way with another during the time of examination, he will subject himself to a failure and its consequences.

Candidate discovered copying or affording assistance.

Sec. 41. No candidate will be allowed to work out his problems on a slate or on waste paper.

Slate or waste paper not allowed.

Sec. 42. No candidate will be permitted to leave the room until he has given up the paper on which he is engaged.

Permission to leave the room.

*Time allowed for Navigation Papers.*

Sec. 43. Candidates will be allowed to work out the various problems by the method and tables they have been accustomed to use, and will be allowed six hours to perform the work. At the expiration of six hours they will, if they have not finished, be declared to have failed, unless the Board of Examiners see fit to lengthen the period in any special case. If, however, the period is lengthened in any case, the special circumstances of that case and the reason for lengthening the period must be reported to the Minister of Marine and Fisheries by the Examiners at the time they send in the report.

Mode of, and time for, working out problems.

*Corrections by Inspection not allowed.*

Sec. 44. The corrections by inspection, from tables given in many works on navigation, will not be allowed (See Tables IX, XI and XXI, in Norie's Epitome, &c.); every correction must appear on the papers of the candidates.

Corrections from tables, not allowed.

## Chap. 78.

*Examination of Masters and Mates.*

Limit of accuracy required in answers.

Sec. 45. Candidates are expected to bring their answers to all problems within, or not to exceed, a margin of one mile of position from a correct result, with the exception of the ship's position by "Sumner's method," where a margin of  $2\frac{1}{2}$  miles may be allowed.

Longitude by chronometer.

Sec. 46. In finding the longitude by chronometer, the logarithms used in finding the hour-angle should be taken out for seconds of arc.

Degree of precision required from master.

Sec. 47. In all other problems the logarithms to the nearest minute will be sufficiently correct for all grades, except Master, from whom a degree of precision will be required, both in the work and in the results, beyond what is demanded from the inferior grade.

*Examination how to commence.*

Examination for master.

Sec. 48. In every case the examination for Master is to commence with the problems for Mate.

*Re-examination in case of failure.*

Re-examination *de novo*.

Sec. 49. In all cases of failure the candidates must be re-examined *de novo*. If a candidate fails in seamanship, he will not be re-examined until after a lapse of six months, to give him time to gain experience. If he fails three times in navigation, he will not be re-examined until after a lapse of three months.

*Knowledge of Commercial Code of Signals.*

Words to be inserted.

Sec. 50. The examiners are to insert in the report of examinations (under heading, Remarks) the word "passed," or "failed in commercial code of signals" (as the case may be).

*Correcting declination, &c.*

Declination, how to be corrected.

Sec. 51. Candidates will find it more convenient, both here and at sea, to correct the declination and other elements from the Nautical Almanac by the "hourly differences," which have been given in that work, in order to facilitate such calculations; they will thereby render themselves independent of any proportional or logarithmic table for such purpose.

*Standard of Examination may be raised.*

Minister may raise standard.

Sec. 52. As the examinations of masters and mates are made compulsory, the qualifications have been kept as low



*Examination of Masters and Mates.*

Chap. 78.

as possible, but it is distinctly to be understood that the Minister of Marine and Fisheries may raise the standard from time to time, whenever, as will no doubt be the case, the general attainments of officers in the merchant service shall render it possible to do so without inconvenience; and officers are strongly urged to employ their leisure hours, when in port, in the acquirement of the knowledge necessary to enable them to pass their examination; and masters will do well to permit apprentices and junior officers to attend schools of instruction and to afford them as much time for this purpose as possible.

Minister may raise the standard of examination from time to time.

*Color Test.*

Sec. 53. All candidates must pass the examination in colors.

Examination in colors.

*Evidence required.*

Sec. 54. A candidate for a certificate of service in a foreign sea-going ship will require to produce satisfactory evidence of sobriety, experience, ability and general good conduct, and will be required to furnish the name or names of vessels in which he served previous to 1870.

Certificate of service, evidence of character, and names of vessels served in before 1870.

Sec. 55. A candidate for a certificate of service in a foreign sea-going ship over one hundred tons and not over one hundred and fifty tons register will be required to pass the color test, to produce satisfactory evidence of sobriety, experience, ability and general good conduct, and will be required to furnish the name or names of vessels in which he served between the 1st day of January, 1870, and the 1st day of January, 1884.

Requisites for certificate of service in a foreign sea-going ship.

O. C. Oct. 19, 1884.

## PART IV.—COASTING OR INLAND VOYAGES.

Qualifications for certificates of competency for masters and mates engaged in the coasting trade or employed in navigating the inland waters of Canada.

*Coasting Trade from one port or place in Canada to another port or place in Canada; and between Canada and Newfoundland, or St. Pierre or Miquelon or any port or place in the United States of America or in Bermuda, or in any of the West Indies or on the east coast of South America or of Central America.*

Sec. 56. All candidates must pass the examination in colors.

Examination in colors.

## Chap. 78.

*Examination of Masters and Mates.**Mate.*

Age and term of service.      Sec. 57. A mate must be 19 years of age and have served at least two years at sea.

Requirements in navigation.      Sec. 58. In Navigation.—He must write legibly and be able to find his latitude by a meridian altitude of the sun, must be able to take a bearing by compass, and determine his position by cross-bearings on the chart, and to shape a course and determine the distance run from any given departure.

Requirements in seamanship.      Sec. 59. In Seamanship.—He must possess a thorough knowledge of the *rule of the road*, as regards both steamers and sailing vessels, their regulation lights, fog and sound signals; he must know the signals to be made if in distress, he must understand both the lead and the log, knotting and splicing rigging and stowing a cargo. He will be examined in seamanship generally, either for “square rig,” “fore-and aft” or “steamer,” as the case may be. If, in the last, he must have a knowledge of the fittings for fire purposes, the bulk-head sluices, if any, and the “engine room telegraph,” the securing and lowering of “life-boats” and “life-rafts.” The examiner will ask any other questions he may think fit relating to the duties of a mate.

*Master.*

Age and term of service.      Sec. 60. A master must be 21 years of age and have been at sea at least three years, one of which he must have been as mate.

Requirements in navigation.      Sec. 61. In Navigation.—In addition to the qualification for a mate, he will have to explain how he would shape a course to counteract the effect of a given current, and find the distance made good towards a given point in a certain time.

Requirements in seamanship.      Sec. 62. In Seamanship.—In addition to the qualifications for a mate, he must know the principal lights upon the coast, and be well acquainted with the tides and soundings. He will be required to explain how he would lay out an anchor in case of stranding, and be able to rig a temporary rudder should the steering apparatus become disabled. He will be questioned as to his knowledge of protests, invoices, charter-party, bottomry, bonds and bills of lading. The examiner will ask him any further questions he may think fit relating to the duties of a master.

*Examination of Masters and Mates.*

Chap. 78.

*For the great Inland Lakes of Canada.*

Sec. **63.** This certificate shall be valid for the inland lakes and rivers of Canada, including such great waters as Lake Huron and the Georgian Bay, Lake Superior, Lake Erie and Lake Ontario. Inland lakes specified.

Sec. **64.** All candidates must pass the examination in colors. Examination in colors.

*Mate.*

Sec. **65.** A mate must be 19 years of age and have served at least two years at sea, or on the inland waters. Age and term of service.

Sec. **66.** In Navigation.—He must write legibly, and be able to take a bearing by compass, and determine his position by cross-bearings on the chart. He must be able to shape a course, and determine the distance run from any given departure. Requirements in navigation.

Sec. **67.** In Seamanship.—He must possess a thorough knowledge of the *rule of the road* as regards both steamers and sailing vessels, their regulation lights, fog and sound signals; he must know the signals to be made if in distress; he must understand both the lead and the log, knotting and splicing, rigging and stowing a cargo. He will be examined in *steamship* generally, either for "square rig," "fore and aft" or "steamer," as the case may be. If in the last, he must have a knowledge of the fittings for fire purposes, the bulk-head sluices, if any, and the "engine room telegraph," the securing and lowering of "life-boats" and "life-rafts." The Examiner will ask any other questions he may think fit relating to the duties of a mate. Requirements in seamanship.

*Master.*

Sec. **68.** A master must be 21 years of age and must have been at sea or on the inland waters at least three years, one of which he must have been as mate. Age and term of service.

Sec. **69.** In Navigation: In addition to the qualifications for a mate, he will have to explain how he would shape a course to counteract the effect of a given current, and find the distance made good towards a certain point in a certain time. Requirements in navigation.

Sec. **70.** In Seamanship.—In addition to that required for a mate, he must know the principal lights upon the great inland waters; he will be required to explain how Requirements in seamanship.

## Chap. 78.

*Examination of Masters and Mates.*

he would lay out an anchor in case of stranding, and be able to rig a temporary rudder should the steering apparatus become disabled. He will be questioned as to his knowledge of protests, invoices, charter-party and bills of lading. The examiner will ask him any further questions he may think fit relating to the duties of a master.

*For the minor Lakes and Rivers of Canada, such as Lake Simcoe, Lake Memphremagog, the River St. Lawrence above Quebec, the Ottawa River, the River St. John and adjacent lakes, or any river or lake in British Columbia, or in Manitoba or the North-West Territories, or in the District of Keewatin:—*

*Mate.*

Age and term of service.      Sec. 71. A mate must be nineteen years of age, and have been at least two years afloat.

Must pass in colors.      Sec. 72. All candidates must pass in colors.

O. C. July 7, 1883.

Requirements in navigation.      Sec. 73. In Navigation.—He must be able to keep the run of the vessel.

Requirements in seaman-ship.      Sec. 74. In Seamanship—He must understand how to use the lead. He must possess a thorough knowledge of the *rule of the road*, both for sailing and steam vessels: he must be able to knot and splice, to fit, and rig a “fore and after.” He must understand the stowage of a cargo and the general management of a vessel in bad weather. If examined for a “steamship” he will not require to understand how to fit and rig a “fore and after,” but he must understand the use of springs on going to or leaving a wharf; he will have to explain the usual modes of extinguishing fire on board ship. He will have to explain the securing and lowering of “life boats.” The examiner will put any further questions he may think fit appertaining to the duties of a mate.

O. C. July 7, 1883; Aug. 14, 1886.

*Master.*

Age and term of service.      Sec. 75. A master must be twenty-one years of age, and have been at least three years afloat, one of which he must have served as mate.

Requirements in navigation.      Sec. 76. In Navigation.—In addition to the qualification for a mate, he must have a knowledge of the principal lights

*Examination of Masters and Mates.*

Chap. 78.

upon the lakes or rivers he is about to be employed upon; the principal dangers in that locality; and the courses and distances to be run to avoid them.

O. C. July 7, 1883.

Sec. 77. In Seamanship.—In addition to the qualifications of a mate, he will have to explain how he would lay out an anchor in case of his vessel becoming stranded. He will be examined as to his knowledge of bills of lading. The examiner will ask any further questions he may think fit relating to the duties of a master in the inland waters.

Requirements  
in seamanship.

O. C. July 7, 1883; Aug. 14, 1886.

*Service.*

Sec. 78. A candidate for a certificate of service will require to produce satisfactory evidence of sobriety, experience, ability and general good conduct, and furnish the names and class of vessels in which he served as master or mate, as the case may be, previous to the 1st day of January, 1883.

Evidence of  
good character  
and names  
of vessels  
served in prior  
to Jan. 1, 1883.

Sec. 79. All candidates must pass the examination in colors.

Examination  
in colors.

*Special Instructions.*

Sec. 80. Testimonials of character and of sobriety, experience, ability and good conduct on board ship, will be required of all applicants, and without producing them no person will be examined. As such testimonials will have to be closely examined by the examiners, for verification, before any certificates can be granted, candidates are to lodge them as early as possible. The testimonials of service of foreigners and British seamen serving in foreign vessels, must be confirmed either by the Consul of the country to which the ship in which the candidate served belonged, or by some other official authority of that country, or by testimony of some credible person on the spot, having personal knowledge of the facts required to be established. Upon application to one of the examiners, candidates will be supplied with a form, which they will be required to fill up and lodge with their testimonials in the hands of the examiner.

Testimonials  
of character,  
and of sobriety,  
experience,  
ability  
and good  
conduct.

Testimonials  
of service of  
foreigners  
and British  
seamen serving  
in foreign  
vessels.

Sec. 81. Candidates are required to appear at the examination room punctually at the time appointed.

Punctuality  
at examination.

## Chap. 78.

*Examination of Masters and Mates.*

Books or paper of any kind not allowed.

Sec. **82.** Candidates are prohibited from bringing into the examination room, books or paper of any kind whatever. The slightest infringement of this regulation will subject the offender to all the penalties of a failure.

*Candidates injuring Examination Papers.*

Candidate detected in defacing or injuring books, &c.

Sec. **83.** In the event of any candidate being detected in defacing, blotting, writing in or otherwise injuring any book or books belonging to the Board, the papers of such candidate shall be detained until the book or books so defaced be replaced by him. He will not, however, be at liberty to remove the damaged book, which will still remain the property of the Board.

*Discovered Copying, &c.*

Candidate discovered copying or affording assistance.

Sec. **84.** In the event of any candidate being discovered copying from another, or affording any assistance or giving any information to another, or communicating in any way with another during the time of examination, he will subject himself to a failure and its consequences.

Slate or waste paper not allowed.

Sec. **85.** No candidate will be allowed to work out his problems on a slate or on waste paper.

Permission to leave the room.

Sec. **86.** No candidate will be permitted to leave the room until he has given up the paper on which he is engaged.

*Time allowed for Navigation Papers.*

Mode of, and time for, working out problems.

Sec. **87.** Candidates will be allowed to work out the various problems by the method and tables they have been accustomed to use, and will be allowed six hours to perform the work. At the expiration of six hours they will, if they have not finished, be declared to have failed unless the Board of Examiners see fit to lengthen the period in any special case. If, however, the period is lengthened in any case, the special circumstances of that case and the reasons for lengthening the period must be reported to the Minister of Marine and Fisheries by the Examiners at the time they send in the report.

Limit of accuracy required in answers.

Sec. **88.** Candidates are expected to bring their answers to all problems within, or not to exceed, a margin of one mile of position from a correct result.

*Examination of Masters and Mates.*

Chap. 78.

Sec. 89. From Masters a degree of precision will be required, both in the work and in the results, beyond what is demanded from Mates. Degree of precision required from masters.

Sec. 90. In every case where problems are required to be worked out, the examination for Master is to commence with the problems for Mate. Examination for master, how to commence.

Sec. 91. In all cases of failure the candidate must be examined *de novo*. If a candidate fails, he will not be re-examined until after a lapse of six months' service afloat on the inland waters or sea coast, as the case may be, to give him time to gain experience. Examination *de novo*.

Sec. 92. Examinations relating to Coasting and Inland Voyages may be held at the following ports, viz.:—Toronto, Ottawa, Montreal, Quebec, St. John, N.B., Yarmouth, Halifax, Sydney, Charlottetown, Winnipeg and Victoria, for the purpose of examining candidates. Ports where examinations may be held.

*Note.*

Sec. 93. As the examination of masters and mates is made compulsory, the qualifications have been kept as low as possible, but it is distinctly to be understood that the Minister of Marine and Fisheries may raise the standard from time to time if deemed advisable. Standard of examinations may be raised by Minister.

O.C. July 7, 1883.

See cap 112  
 R S C. 1906  
 sec 554

## CHAPTER 79.

### HARBOR MASTERS.—REGULATIONS.

Government House, Ottawa,  
 The 12th day of June, 1889.

On the recommendation of the Minister of Marine and Fisheries and under the provisions of Chapter 86 of the Revised Statutes of Canada, intituled "The Harbor Masters' Act,"—

His Excellency in Council has been pleased to make the following general regulations defining the rights, powers, duties and obligations of Harbor Masters for ports within the application of said Act:—

#### GENERAL REGULATIONS.

*For the government of ports in the Provinces of Nova Scotia, New Brunswick, Quebec, Ontario, British Columbia and Prince Edward Island, to which the said Act applies and for the government of the office of Harbor Master for the said ports.*

The following regulations shall apply to each and every port which has been or hereafter may be proclaimed by an Order of the Governor in Council under the provisions of the above-named Act :

Harbor master or his deputy shall go on board of every ship or vessel within 12 hours of arrival.

**Section 1.** Within twelve hours after the arrival of any ship or vessel at any of the said ports, it shall be the duty of the Harbor Master in person, or by his deputy duly authorized, to go on board thereof; provided such ship or vessel, if in the port of Gaspé, Bridgewater or Lunenburg, be of the burthen of fifty tons (registered tonnage) or upwards, or if in any other of the said ports, of the burthen of twenty tons (registered tonnage) or upwards; to see that such ship or vessel is moored only in such a manner, or position as shall be assigned to her by the following regulations: And it shall be lawful for such Harbor Master to ask, demand and receive as compensation for his services, according to the following scale, and under the restrictions mentioned in the above-named Act :—

#### Scale of Fees.

Fees.	For every ship of 50 tons register or under..	\$0 50
	For every ship over 50 tons and not over 100 tons register.....	1 00
	For every ship over 100 tons and not over 200 tons register.....	1 50



*Harbor Masters—Regulations.*

Chap. 79.

For every ship over 200 tons and not over 300 tons register.....	\$2 00
For every ship over 300 tons and not over 400 tons register.....	2 50
For every ship over 400 tons and not over 500 tons register.....	3 00
For every ship over 500 tons and not over 700 tons register.....	4 00
For every ship over 700 tons register.....	5 00

[The foregoing scale of fees is fixed by Section 11 of The Harbor Masters' Act, and is inserted here for convenience of reference.]

Sec. 2. The said scale of fees shall not, nor shall any part of it apply to any ship or vessel belonging to or employed by Her Majesty, or by the Government of the Dominion of Canada; nor within the port of Goderich, Chatham, Newcastle, the Ledge of St. Stephens, Richibucto or Little Glace Bay, to any ship or vessel engaged in trading between ports and places in Canada, or in the fishing trade.

Ships and vessels to which the scale of fees shall not apply.

Sec. 3. All ships, vessels or rafts in any harbor or port, shall take their berth in such part of the harbor as the Harbor Master or his deputy may direct, and the master or other person in charge shall load or unload his vessel at such part of the harbor, and in such manner as the Harbor Master or his deputy may direct; and the master or other person in charge of any ship, vessel or raft shall cause the same to be removed whenever the Harbor Master or his deputy shall deem it necessary so to do, to any other station or berth within the harbor; and in the event of no person being found in charge of any ship, vessel or raft, or the person in charge refusing or neglecting to remove the same when directed so to do, then the Harbor Master or his deputy may remove such ship, vessel or raft to any station or berth within the harbor as in his opinion shall best promote the interests of those doing business in or about the harbor, and the expense of such removal shall be a lien against the ship, vessel or raft so removed; and such ship, vessel or raft may be detained by the Harbor Master or his deputy until all expenses incurred by such removal are paid and fully satisfied; and should it be necessary for vessels or floats to lie alongside of or moor or make fast to each other, it shall be lawful for the officers and crew of the outside vessel or float, and others having business with them, to work over the deck of the inside vessel or vessels in the loading or unloading thereof, without obstruction or interference from

Vessels or rafts shall take their berth in such part of the harbor as the harbor master or his deputy may direct, and if necessary the same may be removed at the expense of the owners thereof.

## Chap. 79.

*Harbor Masters—Regulations.*

the officers or crew of such inside vessel or vessels, provided the inside vessel or vessels shall not be injured or obstructed thereby.

Lower yards to be topped up or braced fore and aft, jib-booms, &c. to be rigged in and white light to be exhibited.

Sec. 4. The master or person in charge of a schooner, square-rigged vessel, scow or steamer lying in the harbor or at any of the piers, shall top up its lower yards or brace them fore and aft,—also rig in their jib-booms, davits, bowsprits and anchors; and all masters or persons in charge of ships, vessels or rafts shall elevate and exhibit a bright white light on a pole on the raft and in the rigging of the ship or vessel from sunset until sunrise, or in such other manner as the Harbor Master may direct; and any person or persons violating any of the provisions of this rule shall be liable to a fine as hereinafter provided, and accountable for any damage done to other vessels in consequence of neglecting to comply with the requirements of this Section and any damage he or they may sustain themselves in consequence of his or their own neglect of such regulation shall be at his or their own cost.

Fine and damages in case of non-compliance.

Watch to be kept during night.

Sec. 5. Any master or person in charge of any ship, vessel or raft having a fire on board during the day shall have a watch kept during the night, and in default of such watch being kept or if the watchman be found asleep, the master, owner or person in charge of such vessel or raft shall be liable to a fine as provided by Section 12 hereof.

Vessel shall not lie in front of any ferry, landing or other public slip.

Sec. 6. No vessel shall lie in front of any ferry, landing or other public slip, or use any rope, chain or shore-fast, extending over or across any ferry, landing or public slip, or the entrance thereto, or in any manner prevent the free ingress or egress thereto or therefrom, under the penalty of twenty dollars for each and every offence.

Vessel not to have tow-line, hawser, &c., made fast to wharf or shore.

Sec. 7. No vessel lying in the stream or harbor shall have any tow-line, hawser or other thing made fast to any wharf or to the shore except for the purpose of hauling in and out, without the permission of the Harbor Master.

Disputes between masters, owners or other persons to be settled by harbor master or his deputy.

Sec. 8. In case of any dispute arising between masters, owners or other persons engaged in hauling ships or vessels in or out of any of the docks or wharves, it shall be the duty of the Harbor Master, if called upon, to give such directions as he may think fit in respect of the same; and all masters, pilots or other persons having the charge or command of any ships or vessels shall comply with the directions of the Harbor Master or his deputy in these respects,

*Harbor Masters—Regulations.*

## Chap. 79.

under the penalty of twenty dollars for each and every neglect or refusal so to do. Penalty for non-compliance.

Sec. 9. If any ship or vessel arriving and anchoring, or being moored or fastened to any wharf or vessel in the port or harbor shall be so moored or placed as to be unsafe or dangerous to any other ship or vessel previously lying at anchor in the port or harbor, or moored or fastened as aforesaid, the Harbor Master or his deputy is hereby authorized and required to forthwith order and direct the situation of such ship or vessel so arriving and anchored, moored or fastened as aforesaid, to be altered in such a manner as to prevent such insecurity and danger; and the master, pilot or other person having charge of such ship or vessel shall comply with the orders and directions of the Harbor Master or his deputy in this respect, under the penalty of twenty dollars for each and every offence. Ship or vessel so moored or placed as to be unsafe or dangerous to any other ship or vessel, how to be dealt with.

Sec. 10. Any person or persons who may moor or fasten to, or in any manner injure, alter or change any of the public buoys, shall, on conviction, pay a penalty of twenty dollars besides being held liable for any damage sustained. Public buoys.

Sec. 11. Whenever it shall happen that any ship or vessel is short of hands, so that she can not be moved when ordered, it shall and may be lawful for the Harbor Master to employ a sufficient number of hands to effect such removal, and to remove or assist in removing such vessel as required or as may be necessary, and that, at the expense of such vessel. Removal of ship or vessel when short of hands.

Sec. 12. The Harbor Master shall have power to order the removal of any scow, boat or other vessel, loaded or unloaded, or anything calculated to interfere with the moving or mooring of vessels from any part of the port or harbor to any other part thereof; and the owner of such scow, boat, &c., or person in charge thereof, failing to make such removal in one hour after being notified so to do, shall forfeit and pay a sum not exceeding ten dollars nor less than five dollars, and after one hour shall have elapsed the Harbor Master shall have power to make the removal and charge the person notified for so doing. Removal of scow, boat or other vessel interfering with the moving or mooring of vessels.

Sec. 13. Whenever the Harbor Master shall find ships or vessels at the wharves with main-jib or spanker-booms rigged out so as to incommode other vessels, it shall be the duty of the Harbor Master to direct such to be rigged in, and the yards of all vessels shall be cockbilled or braced in, when the same shall be required by the Harbor Master, Main-jib, spanker-booms or yards, improperly rigged.

## Chap. 79.

*Harbor Masters—Regulations.*

and in the event of non-compliance, all accidents to the same shall be at the risk of the person or persons so offending, who shall also be liable for all injuries and damages caused thereby.

No vessel to be left without person in charge.]

Sec. 14. No vessel shall be left without some person to take care of her, by night and by day, when anchored in the stream or in the port or harbor, at all seasons of the year, except at the port of Lunenburg, at which port this section shall apply during the summer season only.

Light, when required.

Sec. 15. All vessels lying at anchor in the port or harbor shall keep a clear and bright light burning, at least six feet from the uppermost deck, from sunset until sunrise, at all seasons of the year, except at the port of Lunenburg, at which port this section shall apply during the summer season only.

Coal, ballast, &c., how to be discharged in the harbor.

Sec. 16. All ships or vessels loading or discharging in the port, harbor or stream; coal, ballast and such like materials, shall have a sufficient piece of canvas or tarpaulin so placed as to prevent any portion thereof from falling into the port harbor or stream, under the penalty of twenty dollars for each and every offence, to be paid by the owner, master or person in charge of such ship or vessel.

Unloading of ballast, stone, gravel, earth or rubbish, only in places set apart.

Sec. 17. No ballast, stone, gravel, earth or rubbish of any kind, shall be unladen, cast or emptied out of, or thrown overboard, from any ship or vessel whatever in the port or harbor, or at the entrance thereof, except in the places set apart for that purpose by the Harbor Master and under his direction, under the penalty of fifty dollars for each and every offence, to be paid by the owner, master or other person having the charge of any such ship or vessel.

Unloading of ballast, &c. at Hillsborough.

Sec. 18. At the port of *Hillsborough*, no ballast, stone, gravel, earth or rubbish of any kind, shall be unladen, cast or emptied out of, or thrown overboard, from any ship or vessel whatever in the harbor, or at the entrance thereof, from that part of the waters at the head of the bay above a direct line from the lighthouse on Grindstone Island, at the mouth of Shepody Bay or River, to the outer point of Cape Maranguin except in places set apart for that purpose by the Harbor Master and under his direction, under the penalty of fifty dollars for each and every offence, to be paid by the owner, master or other person having the charge of any such ship or vessel.

*Harbor Masters—Regulations.*

## Chap. 79.

Sec. 19. At the Ledge of *St. Stephens* no ballast, stone, gravel, earth or rubbish of any kind shall be unladen, cast or emptied out of, or thrown overboard, from any ship or vessel whatever in the harbor, or at the entrance thereof, except at a place near a buoy, one-half to three-quarters of a mile from Oak Point, with Oak Bay, Waweig River, and the River Ste. Croix open, under the penalty of fifty dollars for each and every offence, to be paid by the owner, master or other person having the charge of any such ship or vessel.

Unloading of ballast, &c., at ledge of *St. Stephens*.

Sec. 20. At the port of *Richibucto* no ballast, stone, gravel, earth or rubbish of any kind, shall be unladen, cast or emptied out of, or thrown overboard from any ship or vessel whatever in the harbor, or outside the bar, within three miles of the Big Buoy, in a south-easterly direction from the bar, and then only to enable such vessel to get over the bar, at high water except in places set apart for that purpose by the Harbor Master and under his direction, under the penalty of fifty dollars for each and every offence, to be paid by the owner, master or other person having the charge of any such ship or vessel.

Unloading of ballast, &c., at *Richibucto*.

Sec. 21. At the port of *Shediac* no ballast, stone, gravel, earth or rubbish of any kind shall be unladen, cast or emptied out of, or thrown overboard, from any ship or vessel whatever in the harbor, or within four miles easterly of the outside buoy, except in places set apart for that purpose by the Harbor Master and under his direction, under the penalty of fifty dollars for each and every offence, to be paid by the owner, master or other person having the charge of any such ship or vessel.

Unloading of ballast, &c., at *Shediac*.

Sec. 22. Any pilot sanctioning or allowing any ballast to be discharged from any vessel outside said harbor or port of *Shediac*, within four miles easterly of the outside buoy or knowing the same to be done and not forthwith reporting the same to the Harbor Master shall forfeit a sum not exceeding twenty dollars nor less than four dollars for each offence.

Penalty for pilot at *Shediac*, allowing ballast to be discharged at improper place.

Sec. 23. In places set apart by the Harbor Master for the deposit of ballast, or other material, it is hereby required that no ballast, stone, gravel, earth, or rubbish of any kind shall be unladen, discharged, deposited, thrown or laid, before sunrise or after sunset, under a penalty of forty dollars for each and every offence.

Time of day for unloading of ballast, &c.

## Chap. 79.

*Harbor Masters—Regulations.*

Ballast, &c., shall not be unladen below high-water mark.

Penalty for contravention.

Sec. 24. No ballast, stone, gravel, earth or rubbish of any kind shall be unladen, discharged, deposited, thrown, or laid, either from any vessel, boat, scow or other such craft, or in any other manner, or by any person, from any part of the beach or shore into any part of the port or harbor, or upon the beach or shore thereof, below high-water mark, under the penalty of forty dollars for each and every offence, to be paid by the owner or owners, master or person having charge of any vessel, boat or scow, or other craft from which such matter as aforesaid shall have been discharged, or by any other person or persons violating this law.

Discharging surplus ballast at Cow Bay.

Sec. 25. All vessels arriving at the port of Cow Bay, in ballast, are to discharge any surplus ballast at such places on the Government breakwater at Cow Bay, as the Harbor Master for the port may direct.

Penalty for throwing, or allowing to be thrown, any saw-dust, slabs, edgings, rinds, barks or chips from any of the mills on the Miramichi.

Sec. 26 (a.) In the case of any owner or occupier, or any servant or workman engaged in any mill or mills erected or that may be erected on or near any part of the banks or shores of the river or harbors of Miramichi, or of any bay, cove or creek in, or stream falling into the said river or harbors as far as the head of the tide on the north and south-west branches, for the manufacture of lumber of any description, who shall throw, or cause, suffer or permit to be thrown by any person or persons who may in any way be employed by him or them, any saw-dust, slabs, edgings, rinds, bark or chips made or cut at any such mill or mills, or shall suffer or permit the same or any part thereof to fall, roll or float into any part of the said river or harbors of Miramichi, or into any bay, cove or creek in, or stream falling into the said river or harbors as far as the head of the tide on the aforesaid branches, such person or any other person offending, whether interested in the manufacture of such lumber or otherwise, shall for each and every offence forfeit and pay the sum of forty dollars.

Penalty for hauling on the ice and depositing any prohibited rubbish from any of the mills on the Miramichi.

(b.) Any person or persons who shall haul on the ice and there deposit from any mill or mills, shipyard or from any other place whatever within the river or harbors of Miramichi aforesaid, any of the aforesaid prohibited rubbish referred to in the immediately foregoing clause, or any other rubbish whatever not particularly enumerated, shall forfeit and pay a fine of forty dollars for each and every offence.

(c.) Each and every vessel discharging ballast in the rivers or harbors of Miramichi aforesaid, shall haul in close

*Harbor Masters—Regulations.*

## Chap. 79.

alongside of a wharf to be provided for that purpose by the consignee or others interested in such vessel, and shall have a sufficient piece of canvas or tarpaulin reaching from the ballast port or gunwale of such vessel to such wharf, and shall discharge the ballast on or into such wharf, so that no part of such ballast shall be allowed to fall into the harbor, under a penalty of forty dollars for each and every offence.

Mode of discharging in the rivers or harbors of Miramichi.

**27 (a).** No gravel, earth or rubbish of any kind, stone excepted, shall be put into any wharf or pier that extends into the river, within the limits of the port of Getson's Cove, (stone breast works excepted,) under the penalty of forty dollars for each and every offence, to be paid by the owner or owners of any such wharf or pier, or by the contractor or contractors having the management of the construction of any such wharf or pier, in which such matter as aforesaid shall have been placed.

Depositing gravel, earth or rubbish of any kind at Getson's Cove.

**(b.)** No saw-dust, edgings or slabs, or mill-refuse of any kind, shall be unladen, discharged or deposited from any mill or other premises into the harbor within the limits of the port of Getson's Cove, or upon any part of the beach or shore thereof, under the penalty of forty dollars for each and every offence to be paid by the owner or owners, or any person or persons having charge of such mill or other premises from which such matter as aforesaid, shall have been discharged or by any other person or persons violating this regulation.

Penalty for improperly discharging saw-dust, edgings, &c., at Getson's Cove.

**(c.)** No fish refuse of any description shall be emptied out of, or thrown overboard from any vessel or boat whatever, nor from any wharf or stage, into the harbor of Getson's Cove, or at the entrance thereof, under the penalty of forty dollars for each and every offence, to be paid by the owner, master or other person having the charge of any such vessel, boat, wharf or stage.

Penalty for improperly depositing fish refuse at Getson's Cove.

**Sec. 28.** It shall be the duty of the Harbor Master at the port of *Bridgewater* to see that those persons engaged in lumbering and rafting logs, have their buoys, piers and booms so placed and arranged as to leave at all times a clear passage in main channel, of not less than two hundred feet for ships and vessels to navigate; and any buoys, piers and booms that are now obstructions to the navigation of the harbor shall be removed by the person or persons who placed or caused the same to be placed there, or by the representatives in

At the port of Bridgewater a clear channel of at least 200 feet shall be kept free from obstruction.

## Chap. 79.

*Harbor Masters—Regulations.*

Penalty for non-compliance.

ownership or possession of the property, on account of which such buoys, piers or booms were so placed, when requested to do so by the Harbor Master, under the penalty of fifty dollars for each and every neglect or refusal so to do. And in case of failure so to do, within fifteen days after notice given, it shall be the duty of the Harbor Master to effect such removal, at the expense of the person or persons who placed or caused the same to be placed there, or by the representative in ownership or possession of the property on account of which such buoys, piers and booms were so placed.

At the port of Lunenburg, vessels shall not be anchored, &c., within 200 yards of any wharf.

Sec. 29 (a.) No vessel within the limits of the port of Lunenburg shall be anchored, so as to swing at her anchors nearer to any wharf than two hundred yards, excepting for the purpose of coming to, or leaving a wharf or in removing from one wharf to another, and then not to remain any longer than necessary for such purpose unless from stress of weather or other unavoidable cause, to be judged of by the Harbor Master.

Vessels anchored on the western side of the harbor of Lunenburg.

(b.) All vessels anchored for the purpose of being laid up on the western side of the harbor of said port of Lunenburg must be so anchored as not to swing to the eastward of an imaginary line from the point of Selig's Head to the western corner of Lindsay's wharf, and all vessels anchored for the purpose of being laid up on the eastern side of the harbor must be so anchored, as not to swing to the westward of an imaginary line from the willow trees on Battery Point to the eastern corner of Finck's wharf.

Vessels at Nanaimo or Departure Bay, to keep light burning.

Sec. 30. All vessels at wharves or in docks, at the port of Nanaimo or Departure Bay, must keep a clear and bright light burning at the gangway from sunset until sunrise, at least four feet above the deck, and at all times be provided with a gangway with a side rail to it to prevent accidents.

Vessels at the port of Little Glace Bay.

Sec. 31. At the port of Little Glace Bay, vessels immediately on arriving in the harbor shall have both anchors hanging at the hawse-hole, and shall have the yards cock-billed.

Vessels at the Ledge of St. Stephens.

Sec. 32. All vessels are to be moored after casting anchor at the Ledge of St. Stephens within twelve hours off and on shore, as near as possible; and the Ledge of St. Stephens, for the purposes of these regulations, is and shall be deemed a port within the meaning of the Harbor Masters' Act.

Ledge deemed a port.



*Harbor Masters—Regulations.*

## Chap. 79.

Sec. 33. The Harbor Master is empowered to condemn any ballast wharf or wharves not sufficiently protected to prevent ballast falling into the harbors. Ballast wharf may be condemned.

Sec. 34. Any person or persons who shall or may hinder, oppose, molest or obstruct the Harbor Master, his deputy or any of his assistants in the discharge of his or their duty, shall, on conviction, pay a penalty of forty dollars for each and every offence. Penalty for obstructing harbor master or his deputy.

Sec. 35. The penalty for violation of, or not conforming to the provisions of the law, and for disobeying the lawful orders or directions of the Harbor Master or his deputy in respect to any provision for which no penalty is hereinbefore prescribed, shall be twenty dollars, to be imposed upon the owner or person in charge of the ship or vessel not conforming to the particular requirements, which penalties and all other penalties in these regulations contained may be recovered by the Harbor Master before any Police Magistrate, Stipendiary Magistrate, Justice of the Peace or County Court Judge having jurisdiction. Penalty for violation, when no other penalty prescribed, and before whom penalties may be recovered.

## CHAPTER 80.

### HARBOR MASTERS.—PORTS.

PORTS *designated and proclaimed by the Governor in Council to which "The Harbor Masters' Act" applies with the limits of said ports in so far as the same have been defined.*

#### Section 1. PROVINCE OF ONTARIO.

1. Collingwood. Proc. March 3, 1877.
2. Goderich. Proc. April 28, 1876.
3. Midland, and the limits of said port are declared to be from the concession line between the first and second concessions where it reaches the water upon the east and the line of intercession between Park Lots 78 and 79 on the west. Proc. July 22, 1882.
4. Parry Sound, and the limits of said port are declared to be and to comprise all the waters and coast line inside or to the eastward of a line drawn from Red Rock to Love Rock, the northern and southern limits being lines drawn due east from each of those and including all navigable waters between Parry Island and the mainland, as well as the whole of Parry Sound. Proc. March 19, 1883.
5. Penetanguishene. Proc. Feb. 2, 1877.
6. Port Arthur. Proc. May 12, 1884.
7. Rondeau. Proc. May 4, 1878.
8. Sarnia, and the limits of the said port are declared to extend from the south boundary of the Town of Sarnia, on the south, to a point on the beach five hundred yards north of the north wall of the Grand Trunk Railway passenger station, on the north including the whole of the bay. Proc. July 25, 1885.
9. Southampton. Proc. Sep. 23, 1875.

#### Sec. 2. PROVINCE OF QUEBEC.

1. Amherst Harbor. Proc. Sep. 5, 1878.
2. Carleton. Proc. Dec. 8, 1881.
3. Chicoutimi, and the limits of said port are declared to embrace that portion of the River Saguenay extending from the basin of the Chicoutimi River to a point five miles below Ha! Ha! Bay. Proc. May 23, 1882.
4. Gaspé. Proc. Sep. 25, 1874.
5. Lachine, in the Harbor of Montreal.  
Proc. April 19, 1880.
6. Matane, and the said port is declared to extend from the parish church situate in the village of Matane, a distance easterly of two miles, and a similar distance westerly from the same point. Proc. July 22, 1882.

7. Métis. Proc. Feb. 7, 1878.
8. New Richmond. Proc. April 3, 1882.
9. Oak Bay, on the River Restigouche, the limits of the said port to include the area from Cross Point to Garde Point and to extend one mile in a westerly direction, and comprising Mission or Indian Point on the said river. Proc. April 4, 1885.
10. Paspebiac. Proc. May 22, 1877.
11. Rimouski. Proc. March 5, 1877.
12. Rivière Ouelle, and the limits of said port are declared to be from Point Iroquois to Point St. Denis. Proc. July 22, 1882.
13. Sorel. Proc. July 15, 1874.
14. St. John's. Proc. July 15, 1874.
15. St. Thomas, in the County of Montmagny, and the northern boundary of the said port is defined as follows, viz. :—Beginning at a point on the south shore of Margaret Island due north, magnetically from Point St. Thomas, thence following the south shore of Margaret Island to its easterly extremity, thence following an imaginary line to the most westerly extremity of Crane Island, thence following the south coast of Crane Island to a point due north magnetically from Cap St. Ignace. Proc. May 3, 1886.

Sec. 3.—PROVINCE OF NEW BRUNSWICK.

1. Baie Verte. Proc. May 30, 1873.
2. Bathurst. Proc. April 12, 1880.
3. Black's Harbor and Beaver Harbor; beginning at a line running south from the headland between L'Etang Harbor and Black's Harbor, and extending eastwardly and northwardly to the western line of the district of Lepreaux Harbor. Proc. Sep. 22, 1883.
4. Buctouche. Proc. May 30, 1873.
5. Campbellton. Proc. May 30, 1873.
6. Campobello. Proc. May 30, 1873.
7. Caraquet. Proc. May 30, 1873.
8. Chatham, the limits of the said port to be on the west, a line stretching from the post known as the limit post above Morrison's Mill in the Parish of Chatham, and extending across the river to Douglastown in the Parish of Newcastle, and on the east a line extending from Point Escuminac to Tabusintac Gully, and to embrace that portion of the Miramichi River and Bay lying between the lines stated. Proc. May 28, 1883.
9. Cocagne. Proc. May 30, 1873.

10. Dalhousie. Proc. May 30, 1873.
11. Dorchester. Proc. May 30, 1873.
12. Elgin. Proc. Feb. 8, 1878.
13. Fredericton. Proc. May 30, 1873.
14. Grand Manan Harbor. Proc. Sep. 18, 1876.
15. Great Shemogue. Proc. May 17, 1875.
16. Harvey. Proc. April 10, 1875.
17. Hillsborough. Proc. May 30, 1873.
18. Ledge of St. Stephens. Proc. May 30, 1873.
19. La Tête, Back Bay and L'Etang, in the County of Charlotte, and the limits of the said port are declared to be as follows: Beginning at Clark's Point, in Passamaquoddy Bay, running west to the district of St. Andrew's Harbor Master; thence through La Tête Passage and channel or along the eastern and northern line of the district of the West Isles Harbor Master, and thence around the Bay easterly and northerly until it strikes a line running south from the most westerly point of the head of the entrance of L'Etang Harbor or to the headland between L'Etang Harbor and Black's Harbor. Proc. Sep. 17, 1883.
20. Little Shippegan and Miscou Gully, and the limits of the said port are declared to be as follows:—All the waters eastward of a line drawn south-west, magnetic, from Herring Point including Miscou Gully, and extending along the coast of the Gulf of St. Lawrence two miles north and south of the point on the north side of the entrance to the said Gully.  
Proc. April 19, 1886.
21. Moncton. Proc. May 30, 1873.
22. Musquash. Proc. March 26, 1874.
23. Newcastle. Proc. May 30, 1873.
24. North Joggins. Proc. May 30, 1873.
25. Port Elgin. Proc. Feb. 6, 1873.
26. Pokemouche and the limits of said port are declared to be from Tracadie on the south to Shippegan on the north. Proc. June 23, 1883.
27. Richibucto. Proc. May 30, 1873.
28. Rockland. Proc. May 30, 1873.
29. Sackville. Proc. May 30, 1873.
30. St. Andrews. Proc. May 30, 1873.
31. St. George. Proc. May 30, 1873.
32. St. Martins. Proc. May 14, 1874.
33. Shediac. Proc. May 17, 1875.
34. Shippegan. Proc. May 30, 1873.
35. Tracadie. Proc. July 16, 1875.
36. West Isles. Proc. Feb. 4, 1879.

## Sec. 4. PROVINCE OF NOVA SCOTIA.

1. Advocate. Proc. May 18, 1880.
2. Annapolis. Proc. March 12, 1875.
3. Apple River, the limits of said port to include all the waters inside of a line drawn from Lighthouse Point to Pudsey's Point. Proc. Aug. 5, 1886.
4. Arichat, in the County of Richmond and the limits of said port are declared to include the harbor of West Arichat and to be as follows:—1st. From an imaginary line drawn from Point Marache Lighthouse to a point touching the south-eastern part of Jerseyman Island, and to the south of the range beacon erected on the south-east part of the said Island;—2nd. From an imaginary line starting from Jerseyman Island Lighthouse to a point opposite, touching on its way the south-west part of Crid Island, which lies at the entrance of Crid Passage.  
Proc. Oct. 29, 1879.
5. Aspotogan Harbor, in the County of Lunenburg.  
Proc. Dec. 29, 1876.
6. Baddeck. Proc. Sep. 23, 1875.
7. Barrington, the limits of the said port to include all the space within and situated to the northward of a line drawn from Squaw Point, thence to south point of Stoddart's Island, thence to West Head on Cape Sable Island, but including all the shoals extending to the south-east from Stoddart's Island, thence from West Head across Cape Sable Island in the direction of, and to include the Bantam Rocks, and thence to Bacarro Point. Proc. July 10, 1882.
8. Bayfield. Proc. July 11, 1879.
9. Bay St. Lawrence. Proc. April 21, 1887.
10. Bear River. Proc. Sep. 25, 1874.
11. Beaver Harbor. Proc. July 5, 1880.
12. Big Harbor, Great Bras d'Or. Proc. May 28, 1883.
13. Bridgewater. Proc. May 6, 1874.
14. Bras d'Or, including New Campbelltown.  
Proc. May 6, 1874.
15. Bourgeois. See River Bourgeois.
16. Cape Canso. Proc. June 6, 1876.
17. Cape Negro. Proc. May 18, 1881.
18. Chester. Proc. Aug. 18, 1883.
19. Cheticamp. Proc. April 20, 1876.
20. Clarke's Harbor. Proc. June 1, 1881.
21. Clementsport. Proc. May 1, 1877.
22. Coleman's Cove, in the County of Lunenburg.  
Proc. Dec. 29, 1876.

23. County Line to Grand Narrows, in the County of Victoria. Proc. May 23, 1883.
24. Cow Bay, in the County of Cape Breton, the limits of said port to be as follows, to wit :—Within an imaginary straight line drawn from Magazine Point, on the north side of Cow Bay, to a point ten rods north-east of the South Head Shipping Pier, on the south side of Cow Bay. Proc. Nov. 15, 1879.
25. D'Escousse in the County of Richmond, and the limits of the said port are declared to be on the west, a line drawn due north from Glasgow Point Light ; on the east a line drawn due north from Cape la Round Light ; and on the north, mid, channel of Lennox Passage. Proc. Jan. 23, 1885.
26. Digby. Proc. Feb. 19, 1878.
27. East Bay. Proc. Aug. 18, 1883.
28. Gaberouse. Proc. March 3, 1879.
29. Getson's Cove, Lahave River, in the County of Lunenburg, and the limits of the said port are declared to extend up the Lahave River as far as the centre of Bear Hills, on the east side of the river, and to a point directly opposite on the west side of the river. Proc. March 12, 1875.
30. Glasgow and Cape Breton Pier, and the limits of said port are declared to be and include that portion of the Harbor of Sydney to the south of an imaginary straight line drawn from Battery Point to Amelia Point. Proc. Oct. 30, 1880.
31. Grand Narrows. See County Line, &c.
32. Greville. Proc. March 5, 1880.
33. Hantsport, and the limits of the said port are declared to embrace that portion of the Avon River extending from a line drawn between Horton Bluff and Indian Point to the upper waters of the Avon and St. Croix Rivers, such waters also to be included in the limits. Proc. June 27, 1884 ; Aug. 14, 1886.
34. Hawkesbury, the limits of the said port to be as follows :—All that portion of the Strait of Canso, extending from Wilson's line on the east shore to the centre of the Strait, thence proceeding on a southerly course to abreast on Madden's Point, also on the east shore, thence extending eastward so as to include Ship Harbor ; thence northwards, including Emery Pond, to the place of beginning at Wilson's line. Proc. July 12, 1881.
35. Indian Bay, in the County of Shelburne. Proc. Oct. 25, 1876.
36. Ingonish, North Bay of. Proc. March 22, 1881.

*Harbor Masters—Ports.*

## Chap. 80.

37. Ingonish, South Bay of. Proc. Oct. 9, 1884.
38. International Pier, within the Harbor of Sydney, and the limits of said port shall include that portion of the Harbor of Sydney aforesaid between an imaginary straight line drawn from Battery Point to Amelia Point and the southern boundary of the Harbor of North Sydney. Proc. Oct. 30, 1880.
39. Jordan Bay. Proc. Oct. 25, 1876.
40. L'Ardoise, Upper and Lower, the limits of said port to extend from land occupied by Felix Potty near the Roman Catholic Chapel to that of Thomas Clannon Red Point. Proc. Aug. 29, 1884.
41. Lingan. Proc. July 12, 1881.
42. Liscombe. Proc. May 18, 1881.
43. Little Bras d'Or Lake, extending from McKay's Point to Grand Narrows. Proc. April 25, 1884.
44. Little Bras d'Or Lake, extending from McKay's Point to Washabuck River. Proc. April 25, 1884.
45. Little Glace Bay Harbor, and the limits of said port shall include all the waters in the harbor proper, and to seaward from Table Head, N. E., three miles, and E. by N, five miles from the cove on the southern side of McPherson's Head; thence on a bearing of N. W.  $\frac{3}{4}$  N., four and a half miles to join first bearing (bearings are magnetic). Proc. Aug. 3, 1874.
46. Little Narrows to Cranberry Point.  
Proc. May 28, 1883.
47. Liverpool. Proc. Jan. 19, 1877.
48. Lockeport. Proc. May 18, 1881.
49. Louisburg. Proc. March 17, 1879.
50. Lunenburg. Proc. Dec. 3, 1875.
51. Mabou. Proc. June 23, 1880.
52. Mahone Bay. Proc. May 16, 1887.
53. McNair's Cove. Proc. March 12, 1875.
54. Main à Dieu to include all the waters in Main à Dieu Bay, north and west of Bar Reef and inside of Outer Rock on the north-west side of Main à Dieu Passage.  
Proc. July 21, 1886.
55. Maitland, in the County of Yarmouth, and the limits of the said port are declared to be as follows:—Commencing on the shore at a point five hundred feet south of the pier, running parallel with the pier to a point three hundred feet north-westerly outside of the end of pier, thence in a straight line to the shore north of the pier passing three hundred feet outside of the end. Proc. May 26, 1885.
56. Margaretville. Proc. March 26, 1873.
57. Margaret's Bay. Proc. July 16, 1875.

58. Margaree, in the County of Inverness, and the limits of said port are declared to extend from Chimney Corner to Friar's Head inclusive. Proc. June 5, 1886.
59. Merigomish. Proc. March 26, 1878.
60. Meteghan River, in the County of Digby, embracing the waters extending from a quarter of a mile north of Meteghan River to a quarter of a mile south of Meteghan Breakwater or Pier. Proc. Jan. 31, 1883.
61. Mill's Harbor. Proc. June 9, 1883.
62. Musquodoboit. Proc. May 19, 1882.
63. Neil's Harbor. Proc. May 28, 1883.
64. New Haven. Proc. May 28, 1883.
65. North Bay of Ingonish. Proc. March 22, 1871.
66. North Sydney. Proc. April 9, 1874.
67. Northport, the limits of said port to be from Aggre-more Point to the east of Goose River.  
Proc. June 27, 1882.
68. North-West Cove, in the County of Lunenburg.  
Proc. Dec. 29, 1876.
69. Parrsboro', the limits of said port to extend to Cape Sharp, so called, so as to include West Bay so called, and easterly to Moose Creek so called.  
Proc. Oct. 30, 1880.
70. Petite Rivière. Proc. June 23, 1883.
71. Plaster Harbor. Proc. May 6, 1874.
72. Port George. Proc. May 1, 1877.
73. Port Hawkesbury, the limits of said port to be as follows:—All that portion of the Strait of Canso extending from Wilson's Line on the east shore to the centre of the Strait, thence proceeding on a southerly course to abreast of Maddens Point, also on the east shore, thence extending eastward so as to include Ship Harbor, thence northwards including Emery Point to the place of beginning at Wilson's Line.  
Proc. July 12, 1881.
74. Port Hood. Proc. July 16, 1875.
75. Port LaTour. Proc. April 14, 1881.
76. Port Lorne (Bay Shore) in the County of Annapolis, and the limits of the said port are declared to extend as follows:—Two hundred yards from a point of the pier at Port Lorne, east to what is called East Point; and from a point of said pier west one hundred yards to what is called West Point, and from the head of the pier to low water mark.  
Proc. March 13, 1886.
77. Port Mulgrave. Proc. March 8, 1876.
78. Port Medway. Proc. June 25, 1879.
79. Pubnico. Proc. Sep. 27, 1882.



*Harbor Masters—Ports.*

Chap. 80.

80. Pugwash. Proc. Oct. 22, 1873.
81. Ritcey's Cove. Proc. Sep. 29, 1884.
82. River Bourgeois, in the County of Richmond, and the limits of the said port are declared to be as follows :—  
All the waters in the several branches of the harbor, and for the distance of three miles east and three miles west of the entrance, and half a mile south along the shore. Proc. April 19, 1886.
83. River John. Proc. March 26, 1878.
84. St. Ann's Harbor, including Fuches Cove, in the County of Victoria. Proc. April 20, 1881.
85. St. Mary's River. Proc. May 18, 1881.
86. St. Peter's, the limits of said port to be an imaginary straight line drawn from Sutherland Head to March Point in St. Peter's Bay. Proc. April 3, 1882.
87. Sambro. Proc. Dec. 23, 1879.
88. Sheet Harbor. Proc. May 14, 1874.
89. Shelburne, the limits of said port to include all the waters lying northward of an imaginary line drawn east and west, touching the north end of McNutt's Island. Proc. Aug. 27, 1877.
90. Ship Harbor, the limits of said port are declared to be as follows :—Embracing all the waters lying north and west of a line drawn from Wolf Point, Nichol Island to Carter Cove, Shoal Bay. Proc. June 2, 1884.
91. Smith's Mountain to Rockyside, including North River, North and South Gates, St. Ann's.  
Proc. May, 28, 1888.
92. South Bay, Ingonish, in the County of Victoria, and the limits of said port are said to be as follows :—All the waters inside a line drawn from the point which forms the southern extremity of Rocky Bay (which point is about due north magnetic from the East Rocks outside of Ingonish Island) to the outermost point of East Rocks, and thence to the extreme point of Cape Smoke. Proc. Oct. 9, 1884.
93. Tatamagouche. Proc. Feb. 27, 1878.
94. Tidnish, the limits of the said port to extend from Birch Head, running north north-east four miles, thence north-west by west to the New Brunswick line, including Tidnish River. Proc. July 5, 1882.
95. Torbay. Proc. May 18, 1881.
96. Tusket, to include that portion of Tusket River, between Tusket Bridge and Fish Island Light affected by the tide. Proc. March 18, 1875.
97. Victoria Pier, in the Harbor of Sydney, in the County of Cape Breton, and the limits of the said port are declared to include that portion of the Harbor of

Sydney aforesaid, lying between an imaginary straight line drawn from Nunn's Wharf, on the eastern side of said Harbor, to Flag Staff Point, on the western side, which line shall be the southern boundary of said port and a line drawn from the point of the South Bar to Point Edward, which line shall constitute its northern boundary, the boundaries of the Ports of International Pier and North Sydney being amended accordingly.

Proc. July 25, 1884.

98. Wallace. Proc. Oct. 22, 1873.

99. Westport. Proc. March 8, 1887.

100. West Bay. Proc. May 8, 1884.

101. Whitehaven. Proc. May 18, 1881.

102. Whycocomagh. Proc. Oct. 29, 1875.

103. Windsor, in the County of Hants, to include in addition to the Harbor of Windsor, that portion of the River Avon, extending from Windsor to an imaginary line drawn from Cheverie Point to Boot Island which shall be considered a portion of the Harbor of Windsor for the purposes of the Act; and the Harbor Master shall have jurisdiction so that ballast may not be discharged in the waters to the detriment of the channel and anchorage grounds lying near Horton Bluff. Proc. Sep. 24, 1874; May 9, 1878.
104. Yarmouth, the limits of said port to include all waters within the harbor affected by the tide from Milton to a line drawn from Cat Rock to Sandy Point. Proc. March 18, 1875.

#### SEC. 5. THE PROVINCE OF PRINCE EDWARD ISLAND.

1. Alberton. Proc. July 15, 1874.
2. Bay Fortune. Proc. April 10, 1875.
3. Cape Traverse, and the limits of said port are declared to be as follows:—Extending from Wright's Point, Tryon (being the western boundary of Crapaud District), to Carleton Point. Proc. May 23, 1884.
4. Cardigan River, including Cardigan Bridge. Proc. Aug. 9, 1878.
5. Cardigan River, from head of river to north bank Mitchell River. Proc. July 2, 1878.
6. Cascumpec. Proc. July 15, 1874.
7. Cove Head. Proc. May 15, 1880.
8. Charlottetown. Proc. July 15, 1874.
9. Crapaud. Proc. July 15, 1874.
10. Egmont Bay. Proc. July 15, 1874.
11. Georgetown. Proc. July 15, 1874.

*Harbor Masters—Ports.*

## Chap. 80.

12. Grand River. Proc. April 10, 1875.
13. Grand River, down to and including Poplar Point and Chapel Wharf. Proc. April 10, 1875.
14. Hillsborough River. Proc. March 24, 1881.
15. Malpeque. Proc. July 10, 1874.
16. Miminegash, the limits of said port to extend from Black Pond on the north to Campbellton on the west. Proc. April 17, 1880.
17. Montague Bridge. Proc. July 15, 1874.
18. Murray River. Proc. May 16, 1879.
19. Murray Harbor. Proc. July 15, 1874.
20. New London. Proc. July 15, 1874.
21. North Pinette. Proc. July 15, 1874.
22. Port Hill. Proc. July 15, 1874.
23. Pownal. Proc. July 10, 1879.
24. Rollo Bay. Proc. April 10, 1875.
25. Rustico. Proc. May 17, 1875.
26. St. Peter's Bay. Proc. April 10, 1875.
27. Souris. Proc. April 10, 1875.
28. Summerside. Proc. July 15, 1874.
29. Tracadie. Proc. May 17, 1875.
30. Tryon. Proc. April 12, 1877.
31. Vernon River. Proc. July 15, 1874.
32. West River. Proc. May 17, 1875.

## SEC. 6. PROVINCE OF BRITISH COLUMBIA.

1. Burrard Inlet. Proc. Dec. 4, 1876.
2. Departure Bay. Proc. Jan. 24, 1882.
3. Esquimalt. Proc. March 20, 1875.
4. Nanaimo. Proc. April 10, 1875.
5. New Westminster, the limits of the said port to extend from an imaginary line drawn north and south (true) across Point Sébastien, the eastern end of Manson or Douglas Island, situated in the river at the mouth of the Pitt River to either shore of the Fraser River, thence down stream through all its channels to lines drawn across the points of land forming the mouths of its outlets emptying into the Gulf of Georgia. Proc. Jan. 23, 1880.
6. Quadra, Bayne's Sound. Proc. April 17, 1877.
7. Victoria. Proc. March 20, 1875.

## CHAPTER 81

### HARBOR MASTER FOR THE PORT OF HALIFAX.

Government House, Ottawa,  
The 12th day of June, 1889.

On the recommendation of the Minister of Marine and Fisheries, and under the provisions of Chapter 42 of the Acts 35 Victoria, intituled "An Act to provide for the appointment of a Harbor Master for the Port of Halifax," and the Acts in amendment thereof.

His Excellency in Council has been pleased to make the following rules and regulations defining the rights, powers, duties and obligations of the Harbor Master for said port.

*Rules for the government of the Port of Halifax, in the County of Halifax, in the Province of Nova Scotia, and for the government of the office of Harbor Master for the said Port.*

#### VESSELS MOORED OR AT ANCHOR.

Harbor master shall go on board of every ship or vessel.

**Section 1.** It shall be the duty of the Harbor Master of the said port of Halifax in person, at such times and on such occasions as he shall think it necessary, to go on board of every ship or vessel which shall arrive within the port of Halifax, to see that she is moored only in such a manner or position as shall be assigned to her by the following regulations.

Disputes between masters, owners, or other persons, to be settled by harbor master

**Sec. 2.** In case of any dispute arising between masters, owners or persons engaged in hauling ships or vessels in or out of any of the docks or wharves, it shall be the duty of the Harbor Master, if called upon, to give such directions in respect to the same as he may think fit, and all masters, pilots and other persons having the charge or command of any ships or vessels shall comply with the directions of the said Harbor Master, in these respects, under a penalty of fifty dollars for each and every neglect or refusal so to do.

Penalty for non-compliance.

Ship or vessel so moored or placed as to be unsafe, or dangerous, how to be dealt with,

**Sec. 3.** If any ship or vessel arriving and anchoring, or being moored or fastened to any wharf, or vessel in the said harbor, shall be so moored or placed as to be unsafe and dangerous to any other ship or vessel previously lying at anchor in the said harbor, or moored or fastened as aforesaid, the said Harbor Master is hereby authorized and required to forthwith order and direct the situation of such ship or vessel so arriving and anchored, moored or fastened as aforesaid, to be altered in such a manner as to prevent such insecurity and danger; and the master, pilot or other

*Harbor Master for Port of Halifax.*

## Chap. 81.

person having charge of such ship or vessel, shall comply with the orders and directions of the said Harbor Master, in this respect, under a penalty of fifty dollars for each and every offence.

Penalty for non-compliance.

Sec. 4. It shall be the duty of the Harbor Master to see that a track be kept open for the ferry steamers between the city of Halifax and Dartmouth, and that a space of two hundred fathoms easterly from the line of wharves be reserved as a passage for the Royal Mail and other steamers.

Harbor master to see that track is kept open for ferry steamers.

Sec. 5. If any ship or vessel is moored or anchored in the stream in such a position as to obstruct or prevent the docking or undocking of any other ship or vessel, or in any way impeding the navigation of the harbor, the Harbor Master is hereby authorized and required to forthwith order and direct the removal of such ship or vessel so moored or anchored as aforesaid; and the master, pilot or other person having charge of such ship or vessel shall comply with the orders and directions of the Harbor Master in this respect, under a penalty of fifty dollars for each and every offence.

Removal of ship or vessel, when obstructing the docking of vessel, &c.

Penalty for non-compliance.

## RATE OF SPEED.

Sec. 6. No steamer entering or leaving Halifax Harbor (those of Her Majesty and the Government of the Dominion of Canada excepted), shall, while inside of George's Island, proceed at more than half her usual speed, under a penalty of one hundred dollars, to be paid by the owner, master or agent of the vessel violating the law.

Speed of steamer entering or leaving Halifax Harbor.

Penalty for contravention.

## REMOVAL OF VESSELS.

Sec. 7. Whenever it shall happen that any ship or vessel is short of hands, so that she can not be moved when ordered under the provisions of these rules, it shall and may be lawful for the Harbor Master to employ a sufficient number of hands to effect such removal or assist in removing such vessel as required or as may necessary, and that, at the expense of such vessel.

Removal of ship or vessel, when short of hands.

Sec. 8. The Harbor Master shall have power to order the removal of any scow, boat or other vessel, loaded or unloaded, or anything calculated to interfere with the mooring or moving of vessels from any part of the harbor to any other part thereof; and the owner or person in charge of such scow, boat, vessel or other obstruction failing to make such removal in one hour after having been notified so to

Removal of scow, boat or other vessel interfering with the moving or mooring of vessels.

## Chap. 81.

*Harbor Master for Port of Halifax.*

do by the Harbor Master, shall forfeit and pay a sum not exceeding twenty-five dollars; and after one hour shall have elapsed the Harbor Master shall have power to remove the same, and that at the expense of the owner or person in charge thereof.

Docks, water privileges, &c. to be kept open and free from obstructions.

**Sec. 9.** It shall be the duty of the Harbor Master to see that the docks, water privileges and landing places belonging to or owned by the city of Halifax or known as the "Water property of the city of Halifax," and fronting on the harbor, be kept open and free from all obstructions. Any person or persons failing to comply with the orders and directions of the Harbor Master in this respect, shall be liable to a penalty of fifty dollars for each and every offence.

## VESSELS LOADING OR DISCHARGING.

Coal, ballast, etc., how to be discharged in the harbor.

**Sec. 10.** All ships or vessels loading or discharging, in the stream, coal, ballast and such like materials, shall have a sufficient piece of canvas or tarpaulin so placed as to prevent any portion thereof from falling into the harbor, under the penalty of fifty dollars for each and every offence, to be paid by the owner, master or person in charge of such ship or vessel.

Main-jib or spanker-booms to be rigged in.

**Sec. 11.** It shall be the duty of the masters or persons in charge of ships or vessels lying at the wharves, with their main-jib or spanker-booms projecting beyond the end of the wharves, to have the same rigged in, and in the event of non-compliance, all accidents to the same shall be at the risk of the person so offending.

Main-jib or spanker-booms improperly rigged.

**Sec. 12.** Whenever the Harbor Master shall find ships or vessels at the wharves or in the stream with main jib or spanker booms rigged out or yards braced so as to incommode other vessels, it shall be the duty of the Harbor Master to direct such booms to be rigged in, and such yards to be braced by or cock-billed; and the masters, pilots or other persons in charge of such ships or vessels shall comply with the directions of the Harbor Master in this respect, under a penalty of fifty dollars for each and every offence.

## CAUTIONARY DIRECTIONS.

No vessel to be left without person in charge.

**Sec. 13.** No vessel shall be left without some person to take care of her, by night and by day, when anchored in the stream.

*Harbor Master for Port of Halifax.*

## Chap. 81.

Sec. 14. All vessels lying at anchor in the harbor shall keep a clear and bright light burning, at least twelve feet from the uppermost deck, from sunset until sunrise. Light, when required.

Sec. 15. No vessel lying in the stream shall have any tow-line, hawser, or other thing made fast to any wharf or to the shore, except for the purpose of hauling in or out. Tow-line, hawser, &c.

Sec. 16. No boat or vessel which may come into any of the slips, or to any pier or wharf in the said city, laden or partly laden with hay or straw, shall have any fire on board the same, under the penalty of fifty dollars, to be paid by the owner, master or other person having charge of such boat or vessel. Boat laden with hay or straw, to have no fire on board.

## BALLAST, &amp;C.

Sec. 17. No ballast, stone, gravel, earth or rubbish of any kind, shall be unladen, cast or emptied out of, or thrown overboard, from any ship or vessel whatever in the harbor of Halifax, or at the entrance thereof (except in places set apart for that purpose by the Harbor Master), under the penalty of one hundred dollars for each and every offence, to be paid by the owner, master or other person having the charge of any such ship or vessel. Unloading of ballast, stone, gravel or rubbish only in places set apart.

Sec. 18. No ballast, stone, gravel, earth or rubbish of any kind shall be unladen, discharged, deposited, thrown or laid, either from any vessel, boat, scow or other such craft, or in any other manner, or by any person, from any part of the beach or shore of the city, into any part of the harbor, or upon the beach and shore thereof, either below low-water mark or between high-water and low-water mark, under the penalty of one hundred dollars for each and every offence, to be paid by the owners, master or person having charge of any vessel, boat, scow, or other craft from which such matter as aforesaid shall have been discharged, or by any other person or persons violating these rules. Ballast, etc., shall not be unladen below high-water mark. -  
Penalty for contravention.

## PENALTIES.

Sec. 19. No cast off wharf piles, saw logs, log ends, refuse timber or rubbish of a like nature shall be thrown into the water or allowed to go adrift into the Harbor of Halifax, under a penalty of fifty dollars for each and every offence, to be paid by the person or persons violating this rule. Wharf piles, saw logs, log ends, refuse timber, &c.

## Chap. 81.

*Harbor Master for Port of Halifax.*

Explosive material, &c., not to be landed in city of Halifax.

Sec. 20. No explosive material, such as nitro-glycerine, or compounds of the same, gun cotton or petroleum, shall be landed in the City of Halifax (except in such quantities as shall be stated in writing by the Harbor Master), under a penalty of one hundred dollars for each and every offence, to be paid by the owners, master or person having charge of the ship or vessel from which such explosive material has been landed.

## GUNPOWDER.

Gunpowder exceeding in quantity 25 lbs. shall be unladen within 48 hours of arrival of ship and before touching wharf. Her Majesty's and Government ships excepted; penalty for contravention.

Sec. 21. If any ship or vessel arriving and coming into the harbor of the said city (those belonging to or employed by Her Majesty and the Government of the Dominion of Canada excepted), shall have any gunpowder on board exceeding the quantity of twenty-five pounds, such gunpowder exceeding that quantity shall be unladen and discharged from such ship or vessel within forty-eight hours after her arrival, and before such ship or vessel shall be brought alongside of any pier or wharf in the said city, under the pain of forfeiture of such gunpowder, and under the penalty of one hundred dollars for each and every offence, to be paid by the owner or owners of such ship or vessel, or by the master or person having charge or command thereof; and whenever any gunpowder is discharged from any ship or vessel in the said harbor, the same shall be conveyed by water, in a boat or boats, to some safe and secure place for the deposit of gunpowder without the limits of the said city, during which conveyance such gunpowder shall be covered with a tarpaulin or other secure covering, under the penalty of fifty dollars for each and every offence, to be paid by the owner or owners of such gunpowder, or the person having charge or direction of such conveyance.

Gunpowder so unladen shall be conveyed in boats to safe place outside limits of city, under penalty of \$50.

Gunpowder not to be laden at wharf nor until ship cleared and ready for sea, without permission of harbormaster. Her Majesty's and Government ships excepted; forfeiture and penalty for contravention.

Sec. 22. No gunpowder shall be taken or received on board of any ship or vessel bound to sea (those belonging to or employed by Her Majesty and the Government of the Dominion of Canada excepted), while such ship or vessel shall be and remain at any pier or wharf in the said city and until such ship or vessel shall be cleared at the Custom House and ready for sea, except with the knowledge and sanction of the Harbor Master,—in which case, as soon as the gunpowder is on board, the vessel shall be removed to the stream (wind and weather permitting), under the pain of forfeiture of such gunpowder, and the further penalty of one hundred dollars for each and every offence, to be paid by the owner or owners of any such ship or vessel into which such gunpowder may be so received, contrary to the true intent and meaning hereof, or by the person having charge or command



*Harbor Master for Port of Halifax.*

Chap. 81.

of such ship or vessel; and when it is intended to take or load any gunpowder on board of any ship or vessel lying in the said harbor, the same shall be conveyed by water to such ship or vessel, during all which conveyance such gunpowder shall be covered in the manner hereinbefore mentioned, under the penalty of fifty dollars for each and every offence, to be paid by the owner or owners of such gunpowder, or the person having charge or direction of such conveyance.

Gunpowder to be so laden, shall be conveyed by water and covered, under penalty of \$50.

Sec. 23. All gunpowder forfeited under and by virtue of this law shall and may be seized by the Harbor Master, or person deputed by him, and when seized shall be conveyed to and deposited in some secure place without the limits of the said city, and, upon conviction of the offender, the said Harbor Master shall and may, and he is hereby authorized and empowered, within three days after such conviction, to sell such gunpowder at public auction, by sample, in the said city, and the proceeds of such sale, after deducting the necessary costs and charges of prosecution and sale, shall be paid by the said Harbor Master to the credit of the Receiver General of the Dominion of Canada.

Gunpowder forfeited may be seized by harbor master conveyed to safe place outside the city and sold.

## OBSTRUCTING OR DISOBEYING OFFICER.

Sec. 24. Any person or persons who shall or may hinder, oppose, molest or obstruct the Harbor Master in the discharge of his duty shall, on conviction, pay a penalty of fifty dollars for each and every offence.

Obstructing harbor master. Penalty.

Sec. 25. The penalty for violation of, or not conforming to the provisions of the law, and for disobeying the lawful orders or directions of the Harbor Master in respect to any provisions for which no penalty is hereinbefore prescribed shall be fifty dollars, to be imposed upon the owner or person in charge of the ship or vessel not conforming to the particular requirements.

Penalty for violation of law or disobeying orders.

O.C. Aug. 18, 1883.

Copy 112  
 R. S. C.  
 sec 7  
 June 1889  
 Dec 19

## CHAPTER 82.

### HARBORS, PIERS AND BREAKWATERS.

Government House, Ottawa,

The 12th day of June, 1889.

On the recommendation of the Minister of Marine and Fisheries, and under the provisions of Chapter 84 of the Revised Statutes of Canada, intituled "An Act respecting the Government Harbors, Piers and Breakwaters,"

His Excellency in Council has been pleased to make and approve the following regulations for the use and management of the harbors, wharves, piers and breakwaters, being the property of Canada; and the tariff of tolls and dues hereinafter mentioned, to be paid for the use of the same; and the said regulations, and the said tariff apply and shall hereafter apply to all harbors, wharves, piers and breakwaters now or hereafter the property of Canada, and which shall come under the provisions of the said Act; until and unless other and special regulations and tariffs shall hereafter be made and approved for the use and management of the same.

*Regulations for the government of Breakwaters, Piers and Wharves in Canada the property of the Dominion Government, with Tariff of Tolls and Dues leviable on vessels and merchandise thereat.*

#### REGULATIONS.

Driving vehicles.

**Section 1.** No waggon or other vehicle shall be driven along any breakwater, pier or wharf, unless employed in the loading or unloading of vessels, or carting ballast.

Not faster than a walk.

**Sec. 2.** No person shall ride or drive a horse or horses faster than a walk on any of the breakwaters, piers or wharves.

Piling lumber, laths, &c.

**Sec. 3.** No lumber, laths or other material shall be piled in or near the snubbing-posts, in such a manner that a vessel can not be made fast.

Master or others in charge, shall report cargo to wharfinger.

**Sec. 4.** Masters of vessels, or other persons in charge of vessels or rafts, shall make a faithful report of the cargo, as to the quantity and description, to the wharfinger, at his office; and any master or person in charge of any vessel or raft, who neglects to report and to pay the tolls and dues, (except by permission of the wharfinger), shall be liable to have the vessel or raft of which he may be in charge, or of which he is the master, seized and detained, then or at any

Liability and penalty in case of non-compliance.

*Harbors, Piers and Breakwaters.*

## Chap. 82.

future time, until such dues and tolls are paid; and the master, owner or person in charge shall also be liable to the penalty provided by law.

Sec. 5. Any master or person in charge of any vessel or raft, making a false report of cargo, shall be liable to a fine of twenty dollars, with or without imprisonment, for each and every false report, and the vessel or raft shall be liable to detention then, or at any future time, until such dues are paid or satisfied; and if any master or person in charge of any vessel neglects to report her cargo, such vessel, or the owner thereof, shall be liable for the tolls on such cargo at any future time, and the master thereof shall be liable to a fine of twenty dollars for each and every offence. The master or person in charge of any vessel shall report and pay the tolls to the wharfinger, at his office.

In case of false report, fine and imprisonment to be incurred.

Sec. 6. No person, without the permission of the wharfinger, shall remove any goods, chattels, merchandise or material of any description, from any breakwater, pier or wharf, on which the tolls and dues have not been paid.

Goods not to be removed till tolls are paid.

Sec. 7. All goods, chattels, merchandise or material of any kind whatever, having been landed, piled or placed on any breakwater, pier or wharf, for shipment, shall be liable to tolls, as per schedule annexed, whether afterwards shipped or not, and shall likewise be liable to all the regulations as to removal and ground rent and sale, and the fact of any of the said articles having been landed, piled or placed on any part of the harbor property shall be presumptive evidence that the owner intended to ship the same, and said lumber, timber, salt, and other articles, shall in consequence be liable to pay the usual tolls, although afterwards removed by teams or otherwise.

Goods having been landed shall be liable to tolls, whether shipped or not.

Sec. 8. All tolls and dues shall become due and payable at once upon the goods, chattels, merchandise or other material being landed, piled or placed on any breakwater, pier or wharf.

Tolls payable as soon as goods landed.

Sec. 9. No goods, chattels, merchandise or materials of any kind, shall be landed or placed in or upon any breakwater, pier or wharf, unless by permission of the wharfinger, and then only on such portions of the breakwater, pier or wharf as may be allowed to them for the time being, and shall be so landed and placed in such a manner as the wharfinger may direct; and goods, chattels, merchandise or other material landed or placed on any breakwater, pier or

Goods, &c., shall not be landed, except by permission of wharfinger, and only in such places and in such manner as he may direct.

wharf, shall be shipped or removed within forty-eight hours, and in default of so shipping or removing said goods, chattels, merchandise or other material, it may be removed at the direction of the wharfinger, and the expense of such removal shall be a lien upon such property so removed; it shall also pay a rental of not more than one dollar for every succeeding forty-eight hours for each and every twelve feet square of any breakwater, pier or wharf so occupied thereby. In case the owner or agent of such goods, chattels, merchandise or other material refuses or neglects to ship or remove the same from any breakwater, pier or wharf, after the expiration of twenty-eight days from the time of their being placed there, the proceedings provided for by the statute in that behalf may be taken, and the said goods, chattels, merchandise or other material may be sold to pay the sums due with costs.

Removal within 48 hours and rental after that time.

Slaughter-house, fish-stall, &c., not to be erected without permission of Minister.

**Sec. 10.** No slaughter-house, fish-stall or other structure shall be erected upon any breakwater, pier or wharf, without the permission of the Minister of Marine and Fisheries; and any such structure shall pay ground rent to be determined by the said Minister; provision to be made for the removal of such structure by his direction.

No goods shall be landed in, or shipped from slaughter-house, fish-stall, &c., without permission of wharfinger.

**Sec. 11.** No goods, chattels, merchandise or any other material shall be landed in or on, or shipped from off such slaughter-house, fish-stall or other structure without the permission of the wharfinger, and all such goods, chattels, merchandise or other material landed in or on, or placed for shipment from off such structure, shall be liable for the tolls and dues as if landed on any other part of the breakwater, pier or wharf.

Vessels not entitled to any berth, without permission first obtained from wharfinger.

**Sec. 12.** Vessels will not be entitled to any berth, although they may have been hauled in and made fast to the same, unless permission shall have been first obtained from the wharfinger, and such vessels are in all cases to be removed at his request; and in case the owner or person in charge such vessel shall refuse or neglect to remove the same they shall be removed at the risk and expense of the owner.

Precedence of vessels.

**Sec. 13.** Vessels to discharge cargo will take precedence over vessels to load.

Rates on lumber discharged overboard.

**Sec. 14.** Lumber or merchandise of any description discharged overboard, to be rafted, will be charged half rates, but full rates if discharged into lighters, scows or other vessels.

*Harbors, Piers and Breakwaters.*

## Chap. 82.

Sec. 13. Goods discharged from one vessel to another vessel will be charged half the specified rates for goods landed upon any breakwater, pier or wharf; and in all cases said charge is to be paid by the inside vessel.

Rates on goods discharged from one vessel to another.

Sec. 16. All goods, chattels, merchandise or material of any description, shipped from any breakwater, pier or wharf, will be charged the same rates as for landing, except in the case of goods, chattels, merchandise, &c., landed and directly re-shipped,—which shall be charged one rate only.

Rates on goods shipped from wharf, how regulated.

Sec. 17. No person shall obstruct any wharfinger in the performance of his duties.

Obstructing wharfinger.

Sec. 18. The tolls and dues specified in the accompanying schedule shall be, and they are hereby imposed and authorised to be levied and collected by the wharfinger on the vessels and articles enumerated in said schedule, making use of any of the breakwaters, piers or wharves belonging to Canada; except goods, wares and merchandise belonging to the Government of Canada, which are and shall be free of all tolls.

Tolls prescribed by schedule.

Excepted goods, &c.

Sec. 19. The tolls payable upon such vessels or upon goods, chattels, merchandise or other material being landed, piled or placed on any breakwater, pier or wharf, are hereby imposed upon, and may be collected and recovered from the owner of the same.

Tolls may be recovered from owner.

Sec. 20. No dirt, sand, gravel or other ballast will be allowed to be put upon any breakwater, pier or wharf, unless with the approbation and under the inspection of the wharfinger; neither will dirt, sweepings of the hold or any articles whatsoever, under any pretence, be permitted to be thrown into the docks. Coal, limestone or any article which either through carelessness or otherwise in discharging or loading shall fall into the docks, shall be removed by the master of the vessel, or by the wharfinger at the expense of the master.

No dirt, sand, gravel, or other ballast allowed to be put in any breakwater, &c., unless with approbation of wharfinger.

Sec. 21. Wharfage will be charged on all ballast put on board or taken from any vessel at any breakwater, pier or wharf.

Wharfage on ballast.

Sec. 22. All goods, chattels, merchandise or material of any description on any breakwater, pier or wharf, will be at the sole risk of the owner.

Goods, &c., at risk of owner.

## Chap. 22.

*Harbors, Piers and Breakwaters.*

- Penalty for violation of law.**      **Sec. 23.** The penalty for violation of the law or any rule or regulation made thereunder, shall not exceed one hundred dollars, and punishment by imprisonment shall not exceed thirty days.
- Cattle not allowed on wharf except by permission.**      **Sec. 24.** No cattle shall be allowed to remain on any breakwater, pier or wharf after orders have been given by the wharfinger for their removal, under a penalty of twenty cents per head.
- Lying at wharf during winter.**      **Sec. 25.** Special arrangements may be made with the wharfinger for vessels lying at the wharf during the winter season.
- Lying with moorings attached.**      **Sec. 26.** Vessels lying with moorings attached for shelter and a harbor, shall pay  $\frac{1}{2}$  cent per registered ton for every twenty-four hours or portion thereof.
- Limit of time for goods on wharf.**      **Sec. 27.** No goods shall remain on the wharf longer than seven days unless by special permission of and agreement with the wharfinger.
- The ton weight.**      **Sec. 28.** The ton weight mentioned shall be 2,000 pounds.
- Tolls upon vessel recoverable from master, owner or person in charge; those payable upon other articles, how recoverable.**      **Sec. 29.** The tolls payable upon any steam-boat or other vessel are hereby imposed upon and may be collected and recovered from the master or owner or person in charge of such vessel; those payable upon any other articles are imposed upon and may be collected and recovered from the owner or person in charge thereof; and those payable upon any articles shipped or landed at the wharf off any vessel, are imposed upon and may be levied and collected on and from such vessel and on and from the master or owner or person in charge thereof.
- Vessel not to make fast to fenders.**      **Sec. 30.** No vessel shall be allowed to make fast to any of the fenders on any breakwater, pier or wharf, without the permission of the wharfinger.
- Tariff of  $\frac{1}{4}$  of 1 per cent. to be paid on articles of unknown value.**      **Sec. 31.** On all goods, wares and merchandise whatsoever, the quality of which by right measurement or other mode of estimate provided for in the Tariff, can not be conveniently ascertained, it shall be lawful for the wharfinger to levy a rate of one quarter of one per cent. on the value thereof.
- Goods not under any class in tariff.**      **Sec. 32.** Goods not coming under any class enumerated in the Tariff shall be charged at the same rate as the class to which they are most nearly assimilated.

*Harbors, Piers and Breakwaters.*

Chap. 82.

- Sec. 33. Each entry shall pay not less than five cents. Each entry 5 cents.
- Sec. 34. All property landed on a breakwater, pier or wharf for re-shipment shall only pay one wharfage. Only one wharfage.
- Sec. 35. Tonnage dues at the rate of six cents per ton of the registered measurement are hereby imposed and authorized to be levied on and collected from each and every vessel entering the port or harbor at Cow Bay, in the County of Cape Breton, as provided by the 3rd section of the Act 37 Victoria, Chapter 18, and the said dues are hereby imposed upon and may be collected from the master or owner, or the person in charge of such vessel, but such dues shall not apply to vessels entering said port of Cow Bay, which merely seek freight and are obliged to leave the said port in ballast and do not use the breakwater for shelter, while in port. Tonnage dues at Cow Bay in the County of Cape Breton, how imposed and collected.
- Sec. 36. The limits of the harbor or port of Cow Bay aforesaid, for the levying and collection, under the provisions of the Act 37 Vict., Chap. 18, of the tonnage dues on vessels entering that harbor or port, are defined as within an imaginary straight line drawn from Magazine Point, on the north side of Cow Bay, to a point ten rods north-east of the South Head Shipping Pier, on the south side of Cow Bay. Limits of harbor of Cow Bay.
- Sec. 37. Any of the tolls payable upon any vessel under the tariffs herein mentioned may be recovered with costs in the manner provided by the 30th Section of Chapter 36, Revised Statutes of Canada, from the owner or master or person in charge of such vessel. Tolls on vessels, recoverable from owner, master or person in charge.
- Sec. 38. The tolls payable under the said tariff upon any goods, are hereby imposed also upon the vessels or other crafts upon or from off which such goods may be shipped or landed, and the payment of such tolls may be enforced, and there shall be the same remedy for their non-payment as if they had been expressly imposed upon such vessels or crafts, by the said tariff. Tolls on goods imposed also on vessels or crafts.
- Sec. 39. The tolls payable upon any goods may also be recovered with costs in the manner provided by the said 30th section, from the owner or consignee, or person in charge of such goods. Tolls on goods recoverable from owner, consignee or person in charge.

SCHEDULE:—GENERAL TARIFF OF TOLLS AND DUES.

*Goods.*

	Cents.
Animals, undescribed.....	3
Apples, per barrel.....	1

	Cents.
Apples, per pushel or per bag .....	½
Bacon, per 100 pounds.....	3
Bark, per cord .....	5
Barrels, each .....	2
Barrels, empty, per 100 .....	25
Beef and pork, per barrel .....	3
Beef and pork, per half barrel.....	2
Beef and pork, per quarter barrel.....	1
Beer, ale and porter, per barrel .....	4
Beer, ale and porter, per half barrel .....	2
Beer, ale and porter, per quarter barrel .....	1
Boilers, per ton .....	25
Bricks, per thousand .....	20
Brooms, per dozen .....	3
Buckets, per dozen .....	3
Building stone, per cord .....	10
Butter, per 100 pounds .....	2
Calves, each .....	3
Carriages, waggons and carts of all kinds, each.....	10
Cases, bales, and other similar goods, per ton of 40 cubic feet.....	4
Casks, empty, each.....	2
Cattle and horses, per head.....	10
Cedar posts, per 100 .....	20
Cement, per barrel .....	1
Chains and anchors, per ton.....	10
Cheese, per 100 pounds .....	2
Cider, per barrel .....	3
Clover seed, per bushel.....	2
Coal, iron, building stone and the like material, per ton .....	5
Colts and fillies, each.....	7
Cordage and ropes, per ton.....	40
Cordwood and bark, per cord.....	3
Corn meal, Indian, per barrel.....	2
Cranberries, per barrel.....	5
Crockery, including china and glass ware, per crate..	10
Cultivators, each.....	8
Dry goods, not elsewhere specified, per ton .....	50
Earthenware, coarse, per crate.....	10
Eggs, per barrel or box of 72 dozen.....	5
Fanning mills, each.....	15
Fish, fresh.....	Free
Fish, pickled, per barrel .....	2
Fish, pickled, per half barrel .....	1
Fish, dry, per 100 pounds.....	1
Flour, per barrel .....	2



*Harbors, Piers and Breakwaters.*

Chap. 82.

	Cents.
Flour, per 100 pounds .....	1
Fruit, not otherwise provided for, per 100 pounds ...	5
Furniture, per ton measurement .....	30
Grain of all kinds, except oats per bushel.....	$\frac{1}{8}$
Grain of all kinds, except oats, per bushel passing through Grand Trunk elevator at Goderich.....	$\frac{1}{8}$
Grain, oats, per bushel.....	$\frac{1}{8}$
Grain, oats, per bushel passing through Grand Trunk elevator at Goderich.....	$\frac{1}{8}$
Gravel, for use of roads.....	Free.
Grind stones, per ton.....	15
Gunpowder, per ton.....	50
Gypsum, per ton.....	3
Hams, per 100 pounds .....	2
Hardware, per ton .....	25
Hay, per ton .....	10
Headings, barrel, per 1,000.....	25
Hides and skins, per 100 pounds.....	1
Hogsheads, and puncheons, each.....	5
Hoops, per 1,000 .....	2
Hops, per 100 pounds .....	5
Horse racks, each.....	5
Iron, bar, per ton .....	5
Iron, pig, per ton.....	8
Iron, scrap, per ton.....	15
Lard, per barrel .....	5
Lard, per half barrel.....	$2\frac{1}{2}$
Laths, per 1,000 pieces.....	$\frac{1}{2}$
Leather, per 100 pounds .....	3
Lime, per barrel.....	2
Lime, in bulk, per ton.....	5
Lumber sawn or square, per 1,000 feet board measure	5
Machinery, engines, &c., per ton.....	25
Machines, reaping and mowing, each.....	50
Machines, threshing, each .....	75
Marble, per ton .....	25
Matches, per 10 gross.....	3
Mattresses, each.....	4
Merchandize, dry goods, per ton.....	50
Millstones, per pair.....	30
Molasses, per puncheon or hogshead.....	8
Musical instruments, such as pianos, organs and melodians, each.....	5
Nails, per keg .....	2
Nails and spikes, per ton.....	25
Nursery produce, per ton .....	80
Oakum, per 100 pounds .....	2

	Cents.
Oatmeal, per ton.....	2
Oils, per barrel .....	2
Paints, per ton.....	5
Pearl ashes and potashes, per barrel.....	8
Pickets, per 1,000 .....	3
Plaster, calcined, per barrel .....	4
Plaster, land, per barrel.....	2
Plaster, rough from quarry, per ton .....	2
Ploughs, each.....	3
Poles, telegraph, each.....	$\frac{1}{2}$
Potatoes and roots, per bushel.....	$\frac{1}{2}$
Rags, per ton.....	15
Rakes (hay), snaths and forks, per dozen .....	1
Rakes, horse, each .....	5
Rice, per bag .....	4
Root slicers, each .....	5
Salt, per barrel.....	$\frac{1}{2}$
Salt, per ton.....	$1\frac{1}{2}$
Sand, per ton .....	$11\frac{1}{2}$
Saw logs, per 1,000 feet board measure .....	1
Sewing machines, each.....	10
Sheep, per head.....	2
Shingles per 1,000.....	$\frac{1}{2}$
Shingles or stave bolts, per cord .....	3
Shovels per dozen.....	3
Slate per 10 feet square .....	3
Soap per 100 pounds box.....	1
Spirits of all kinds and wines, per barrel .....	10
Spirits of all kinds and wines, per half barrel .....	5
Spirits of all kinds and wines, per keg or quarter barrel .....	$2\frac{1}{2}$
Spirits of all kinds and wines, per dozen bottles ....	2
Staves, fish, flour and salt, per 1,000 .....	2
Staves, pipe, per 1,000 .....	20
Staves, West India, per 1,000.....	15
Stone, block, in the rough, per ton.....	15
Stone, cut, per ton .....	20
Stone or gravel or earth ballast for shipping, per ton..	2
Stoves, per ton .....	20
Straw cutters and hay cutters, each.....	5
Sugar, per hogshead.....	10
Swine, each.....	2
Teas, per chest.....	2
Ties, railroad, each.....	$\frac{1}{2}$
Timber, per 1,000 feet.....	5
Timothy seed, per bushel.....	2
Tobacco, per 100 pounds .....	2

*Harbors, Piers and Breakwater.*

Chap. 82.

	Cents.
Unenumerated articles, per ton .....	4
Vehicles undescribed, each.....	10
Vinegar, per barrel.....	4
Wood, per cord .....	3
Wool, per ton.....	£0

*Steamboats and Sailing Vessels.*

The following dues shall be charged on each steamboat and sailing vessel for each day or fraction of a day they make use of any of the said wharves, piers or breakwaters:—

On each steamboat.....	\$1 00
On each sailing vessel, under 50 tons.....	10
of 50 tons and under 100 tons.....	15
100       “       200   “ .....	20
200       “       300   “ .....	30
300       “       500   “ .....	50
500       “       800   “ .....	75
800       “       1,200 “ .....	1 00
1,200       “       1,600 “ .....	1 25
above 1,600 “ .....	1 50

Rev Stat Can Chap 113 VHTT  
Shipping  
Sec 404 - 410 cc

## CHAPTER 83.

### PILOTAGE DISTRICTS.

Government House, Ottawa,  
The 12th day of June, 1889.

On the recommendation of the Minister of Marine and Fisheries, and under the provisions of Chapter 80 of the Revised Statutes of Canada, intituled "The Pilotage Act,"

His Excellency in Council has been pleased to order and it is hereby ordered that the following Pilotage Districts be and the same are hereby constituted and established and the limits thereof fixed and determined as hereinafter mentioned.

#### ANNAPOLIS, N.S.

- Limits of district.** Section 1. A pilotage district for the County of Annapolis, in the Province of Nova Scotia, the limits of which district shall embrace all the bays, rivers and coasts of the said County :
- Dues.** The payment of pilotage dues to be *non-compulsory* within the limits of the said district.
- O.C. April 30, 1874 ; July 11, 1888.

#### ANTIGONISH, N.S.

- Limits of district.** Sec. 2. A pilotage district for the Port of Antigonish, in the County of Antigonish, in the Province of Nova Scotia, such district to extend to and comprise all the waters of Antigonish Bay, between the entrance of Antigonish Harbor and an imaginary straight line drawn from Cape Jack to Cape George Lighthouse, together with all the waters of Antigonish Harbour :
- Dues.** The payment of pilotage dues to be *compulsory* within the limits of the said district.
- O.C. May 16, 1879.

#### BATHURST, N.B.

- Limits of district.** Sec. 3. A pilotage district in the County of Gloucester and in the waters adjacent in the Province of New Brunswick, to be known as the Bathurst Pilotage District, the limits of which district shall extend from the county line near the Belledune River, to an imaginary line drawn from the site of the Roman Catholic Church at Grand Anse :
- Dues.** The payment of pilotage dues to be *compulsory* within the limits of the said district.
- O.C. April 9, 1878, *part.*

*Pilotage Districts.*

## Chap. 83.

## BAY VERTE AND PORT ELGIN, N.B.

Sec. 4. A pilotage district for Bay Verte and Port Elgin, Limits of district. in the County of Westmoreland, in the Province of New Brunswick, the limits of which district shall extend from the Province line, on the east, to Jourmain Island, on the west :

The payment of pilotage dues to be *compulsory* within the Dues. limits of the said district.

O.C. May 30, 1883.

## BONAVENTURE, P.Q.

Sec. 5. A pilotage district for the County of Bonaventure, Limits of district. in the Province of Quebec, to extend from Point Macquereau to the Head of the Tide at Bourdon, in the Restigouche River.

The payment of pilotage dues to be *non compulsory* within Dues. the limits of the said district.

O.C. April 3, 1889. [June 15, 1889.]

## BRAS D'OR LAKE AND GREAT AND LITTLE BRAS D'OR, N.S.

Sec. 6. A pilotage district embracing the ports, harbors Limits of district. and bays in Bras d'Or Lake, and Great and Little Bras d'Or, within the County of Victoria, Nova Scotia.

The payment of pilotage dues to be *compulsory* within the Dues. limits of the said district.

O.C. May 4, 1863.

## BUCTOUCHE, N.B.

Sec. 7. A pilotage district for the Port of Buctouche, in Limits of District. the County of Kent, in the Province of New Brunswick, the limits of which district shall extend north to Richibucto Head, and south to Cocagne Head, and to comprehend the waters between New Brunswick and Prince Edward Island, or adjacent thereto :

The payment of pilotage dues to be *compulsory* within Dues. the limits of the said district.

O. C. April 28, 1887.

## CARAQUET, N.B.

Sec. 8. A pilotage district to be known as the Caraquet Limits of district. District, to extend from an imaginary line drawn from the site of the Roman Catholic Church at Grand Anse to Point Miscou, and from Point Miscou to the boundary line of the Counties of Gloucester and Northumberland :

The payment of pilotage dues to be *compulsory* within the Dues. limits of the said district.

O. C. April 9, 1878.

## Chap. 83.

*Pilotage Districts.*

## CHARLOTTE, N.B.

Limits of district. Sec. 9. A pilotage district for the County of Charlotte in the Province of New Brunswick, which district shall embrace all the bays, rivers and coasts of the said County of Charlotte :

Dues. The payment of pilotage dues to be *compulsory* within the limits of said district.

O. C. April 2, 1874.

## COCAGNE, N.B.

Limits of district. Sec. 10. A pilotage district for the Port of Cocagne, in the County of Kent, in the Province of New Brunswick, the limits of which district shall extend north to Dixon's Point, Buctouche, and south to Casey's Point, Shediac, and to comprehend the waters between New Brunswick and Prince Edward Island, or adjacent thereto :

Dues. The payment of pilotage dues to be *compulsory* within the limits of the said district.

O. C. April 23, 1877.

## CRAPAUD, P.E.I.

Limits of district. Sec. 11. A pilotage district for Crapaud Harbor, in the County of Queens, in the Province of Prince Edward Island, such district to extend from Brokleby's Head at De Sable, on the east side, to Birch Point, at Tryon, on the west side of Crapaud Harbor aforesaid :

Dues. The payment of pilotage dues to be *compulsory* within the limits of the said district.

O. C. March 22, 1878.

## ECONOMY, N.S.

Limits of district. (No dues.) Sec. 12. A pilotage district for the Port of Economy in the County of Colchester, Province of Nova Scotia, the limits of such district to extend from Harrington's River to Bass River.

O. C. July 10, 1886.

## GLACE BAY, N.S.

Limits of district. Sec. 13. A pilotage district to embrace all the ports, bays and harbors situated between Low Point on the southern side of Sydney Harbor and the south head of Cow Bay in the County of Cape Breton :

Dues. The payment of pilotage dues to be *compulsory* within the limits of the said district.

O. C. June 19, 1885.

*Pilotage Districts.*

## Chap. 88.

## HALIFAX, N.S.

Sec. 14. The Halifax Pilot Commissioners, as already constituted, consisting of three persons appointed by the Governor in Council, two persons elected by the City Council for the City of Halifax, and two persons elected by the executive committee of the Chamber of Commerce of the City of Halifax, shall be the pilotage authority of the pilotage district of Halifax, the limits of which shall be fixed by an Order in Council.

Pilot Commissioners, how appointed and elected.

The limits of the pilotage district for the County of Halifax shall embrace all the ports, bays, rivers and coasts of the said County.

Limits of district of County of Halifax.

O. C. June 6, 1874.

Rev. Stat. Can.; Chap. 80, Sec. 6.

The limits of the pilotage district for the Port of Halifax shall extend in a north-east line from Chebucto Head Light to Devil's Island Light, thence to extend seawards in a radius of fifteen miles.

Limits of district of Port of Halifax.

O. C. June 25, 1875.

The coasting steamships "Edgar Stuart," "M. A. Starr" and "George Shattuck" all being under 250 tons register tonnage are relieved from compulsory pilotage dues under the provisions of Chapter 80 of the Revised Statutes of Canada, intituled "The Pilotage Act."

Coasting steamships exempted from dues.

O. C. July 28, 1876.

## HANTS, N.S.

Sec. 15. A pilotage district for the County of Hants, in the Province of Nova Scotia, the limits of which district shall embrace Cobequid Bay, the Basin of Minas, Minas Channel, and extend down the Bay of Fundy until they strike a line drawn from Cape Chignecto, in the County of Cumberland, to a point in the County of Kings, where the division line between the Counties of Kings and Annapolis strikes the Bay of Fundy, such limits also to include the several ports, rivers and creeks in the County of Hants:

Limits of district.

The payment of pilotage dues in the said pilotage district of Hants to be compulsory and the pilots appointed by the pilotage authority of that district are alone entitled to pilot ships to ports and places in the county of Hants aforesaid.

Dues.

O. C. May 4, 1878; March 17, 1879.

## Chap. 83.

*Pilotage Districts.*

## LOUISBURG, N.S.

Limits of district. Sec. 16. A pilotage district for Louisburg, in the County of Cape Breton, in the Province of Nova Scotia, to include Main-à-Dieu and Gabarouse in said county :

Dues. The payment of pilotage dues to be *compulsory* within the limits of the said district.

O. C. Feb. 28, 1881.

## MIRAMICHI, N.B.

Limits of district. Sec. 17. A pilotage district for Miramichi, in the Province of New Brunswick, the limits of the said pilotage district to be as follows, that is to say,—extending on the east as far as Entry Island (Magdalens) ; on the north to Point Miscou, in the County of Gloucester ; and on the south to Kouchibouguac River, in the County of Kent :

Dues. The payment of pilotage dues to be *compulsory* within the limits of the said district.

O. C. May 7, 1874.

## MONCTON, N.B.

Limits of district. Sec. 18. A pilotage district for the port of Moncton, in the County of Westmoreland, in the Province of New Brunswick, which district shall commence at the town of Moncton and following the eastern shore of Petitcodiac River southerly to the wharf at Boudreau's quarries, thence across the Petitcodiac River to the western side to a place called Stewart's wharf, nearly opposite Boudreau's quarries, thence along the western shore of the Petitcodiac River to the Petitcodiac bridge, thence across the said bridge to the town of Moncton aforesaid :

Dues. The payment of pilotage dues to be *compulsory* within the limits of the said district.

O. C. June 3, 1881.

## NANAIMO, B.C.

Limits of district. Sec. 19. A pilotage district for the Port of Nanaimo, and all the other ports in the Island of Vancouver, in British Columbia, excepting Victoria and Esquimalt :

Dues. The payment of pilotage dues to be *compulsory* within the limits of the said district.

O. C. Oct. 2, 1879.

## NEW LONDON, P.E.I.

Limits of district. Sec. 20. A pilotage district for the Harbor of New London, Queens County, in the Province of Prince Edward



*Pilotage Districts.*

Chap. 88.

Island, the limits of such pilotage district to extend from Cavendish Capes, east, to Third Ponds west of New London Harbor :

The payment of pilotage dues to be *compulsory* within the Dues. limits of the said district.

O. C. April 16, 1878.

## PARRSBORO', N.S.

Sec. 21. A pilotage district for the Port of Parrsboro', in the County of Cumberland, in the Province of Nova Scotia, <sup>Limits of dis-</sup> <sup>trict.</sup> the limits of such district to extend from Harrington's River on the east, to Isle Haute on the west :

The payment of pilotage dues to be *compulsory* within the Dues. limits of the said district.

O. C. Jan. 24, 1881.

## PART OF PRINCE COUNTY, P.E.I.

Sec. 22. A pilotage district for a portion of Prince County, <sup>Limits of dis-</sup> <sup>trict.</sup> in the Province of Prince Edward Island, such district to extend from Cape Egmont to Lennox Island, in Richmond Bay, and to embrace the ports and harbors along the coast line of that district :

The payment of pilotage dues to be *compulsory* within Dues. the limits of the said district.

O. C. June 8, 1877.

## PICTOU, N.S.

Sec. 23. A pilotage district for the port of Pictou, in the County of Pictou in the Province of Nova Scotia, <sup>Limits of dis-</sup> <sup>trict.</sup> the limits of which district are fixed as follows, that is to say:—Extending from the most easterly point of Pictou Island, on a line running thence south-east, until it strikes the gulf shore at Arisaig Pier, and bounded on the west by a line drawn from Amet Island to Rocky Point at the County line, and embracing all the navigable waters in the County of Pictou :

The payment of pilotage dues to be *compulsory* within Dues. the limits of the said district.

O. C. March 23, 1874.

## PUGWASH, N.S.

Sec. 24. A pilotage district for Pugwash, in the County of Cumberland, in the Province of Nova Scotia, <sup>Limits of dis-</sup> <sup>trict.</sup> the said district to be bounded on the east by Cape Cliff, and on the

## Chap. 83.

*Pilotage Districts.*

west or north-west by Lewis Head, both in the County of Cumberland aforesaid :

The limits of said district to extend from Cape Cliff aforesaid on the east, thence running westerly until it strikes the provincial division line in the waters between Nova Scotia and New Brunswick, to embrace all the navigable waters, harbors, bays, rivers, or loading places, within the said district :

Dues. The payment of pilotage dues to be *compulsory* within the limits of the said district.

O. C. Feb. 2, 1877.

## RESTIGOUCHE, N. B.

Limits of district. Sec. 25. A pilotage district for Restigouche, in the Province of New Brunswick, the limits of which district shall comprehend all the ports and outports within the County of Restigouche :

Dues. The payment of pilotage dues to be *compulsory* within the limits of the said district.

O. C. July 21, 1876.

## RICHIBUCTO, N. B.

Limits of district. Sec. 26. A pilotage district for the port of Richibucto, in the County of Kent, in the Province of New Brunswick, the limits of which district shall extend from Point Escuminac, on the north, to Cassey Cape, on the south, and as far as North Point, Prince Edward Island, on the east :

Dues. The payment of pilotage dues to be *compulsory* within the limits of said district.

O. C. April 21, 1875.

## RICHMOND COUNTY, N. S.

Limits of Western district. Sec. 27. (a) A pilotage district in Richmond County, in Province of Nova Scotia, the limits of said district to extend from Point Tupper, in the Strait of Canso, to Cape Canso, and from Cape Canso to Cape Forchu, and to embrace all the rivers, navigable waters, harbors, bays, and lakes in the said district :

Dues. The payment of pilotage dues to be *compulsory* within the limits of the said district.

O. C. April 8, 1875 ; June 11, 1879.

Limits of Eastern district. (No dues.) (b.) A pilotage district in the County of Richmond, aforesaid, the limits thereof to include St. Peter's Bay, Lennox Passage, St. Peter's Canal, and the southern portion of Bras d'Or Lake.

O. C. May 11, 1889.

*Pilotage Districts.*

Chap. 88.

## SACKVILLE, N. B.

Sec. 28. A pilotage district for the port of Sackville, in the County of Westmoreland, in the Province of New Brunswick, the limits of which district shall commence at Cape Maranquin and comprise the headwaters of the Bay of Fundy (so-called) southwardly and eastwardly of said Cape, and include all the navigable rivers emptying therein:

The payment of pilotage dues to be *compulsory* within the limits of the said district.

O. C. July 12, 1877.

## ST. JOHN, N. B.

Sec. 29. The St. John Pilot Commissioners, already constituted, consisting of the three persons appointed by the Governor in Council, two persons elected by the Mayor, Aldermen and Commonalty of the City of St. John, and two persons elected by the Council of the St. John Board of Trade, shall be the pilotage authority of the pilotage district of St. John,—the limits of which shall be fixed by Order in Council.

Rev. Stat. Can., Chap. 80, Sec. 9.

A pilotage district for St. John, in the Province of New Brunswick, the limits of which district shall embrace the harbor of St. John, and extend to a bound ranging with Mount Desert and Cape Sable, Seal Islands, bearing north-west and south-east:

The said pilotage district of St. John also to include the harbor of Musquash, in the County of St. John, in the said Province:

The payment of pilotage dues to be *compulsory* within the limits of the district above defined.

O. C. June 16, 1874; March 1, 1875.

## ST. MARYS AND LISCOMB, N. S.

Sec. 30. A pilotage district for the harbor of St. Marys and Liscomb, in the County of Guysboro', in the Province of Nova Scotia:

The payment of pilotage dues to be *compulsory* within the limits of the said district.

O. C. June 10, 1880.

## ST. MARY'S BAY, N. S.

Sec. 31. A pilotage district for St. Mary's Bay, in the County of Digby, in the Province of Nova Scotia, the limits

of which district shall embrace the whole of St. Mary's Bay, and such ports and harbors therein, as belong to the County of Digby, inside of an imaginary line drawn between Whipple Point and Cape St. Mary's, such district to include also Grand and Petit Passages.

O. C. July 11, 1888.

#### SHEDIAC, N. B.

Limits of district. Sec. 32. A pilotage district for Shediac, in the County of Westmoreland, in the Province of New Brunswick, the boundaries of which district shall extend from the point known as Shediac Point, southerly to Cape Bald, comprehending the waters lying westerly of a straight line between those points:

Dues. The payment of pilotage dues to be *compulsory* within the limits of the said district.

O. C. May 19, 1876; June 1, 1876.

#### SUMMERSIDE, P. E. I.

Limits of district. Sec. 33. A pilotage district for the port of Summerside, in the Province of Prince Edward Island, the said district to embrace the waters of the Northumberland Straits, extending from Egmont Cape to Paul's Bluff, both in Prince County, in said Province:

Dues. The payment of pilotage dues to be *compulsory* within the limits of the said district.

O. C. June 9, 1877.

#### SYDNEY AND NORTH SYDNEY, N. S.

Limits of district. Sec. 34. A pilotage district for the ports of Sydney and North Sydney in the Province of Nova Scotia, the limits of which district shall comprise all ports, bays, and harbors within an imaginary line drawn between Cranberry Head, on the northern side of Sydney Harbor, and Low Point on the southern side of the said harbor:

Dues. The payment of pilotage dues to be *compulsory* within the limits of the said district.

O. C. June 19, 1885.

#### TATAMAGOUCHE AND BRULÉ, N. S.

Limits of district. Sec. 35. A pilotage district for the ports of Tatamagouche and Brulé, in the County of Colchester, in the Province of Nova Scotia, the limits of said pilotage district to extend along a line running from Amet Island in a southerly

*Pilotage Districts.*

Chap. 83.

direction until it strikes Rocky Point in Brulé to Pictou County line, and from Amet Island until it strikes Malligash Point, in Cumberland County, in a westerly direction and to include Brulé Harbor and Tatamagouche Harbor :

The payment of pilotage dues to be *compulsory* within Dues. the limits of the said district.

O. C. April 12, 1880.

## TIDNISH, COUNTY OF CUMBERLAND, N. S.

Sec. 36. A pilotage district for Tidnish, in the County of Cumberland, in the Province of Nova Scotia, the limits of such district to extend from Lewis Head to the division line between the Provinces of Nova Scotia and New Brunswick comprising and including the district of Tidnish : <sup>Limits of district.</sup>

The payment of pilotage dues to be *compulsory* within the Dues. limits of the said district.

O. C. May 30, 1883.

## VICTORIA AND ESQUIMALT, B. C.

Sec. 37. A pilotage district for the ports of Victoria and Esquimalt, in the Province of British Columbia, the limits of which district shall extend from the shores of Washington Territory to the northern boundary of the Province of British Columbia, and include the entire coast of the said Province with its rivers and harbors, saving and excluding from the limits of such district : <sup>Limits of district.</sup>

1. The port of Nanaimo and all the other ports in the Island of Vancouver, with the exception of Victoria and Esquimalt ; and— <sup>Nanaimo excepted.</sup>

2. All the ports, harbors and rivers within the limits of the electoral districts of Yale and New Westminster as said electoral districts were established on the 5th day of May, 1879 : <sup>Yale and New Westminster excepted.</sup>

The payment of pilotage dues to be *compulsory* within Dues. the limits of said pilotage district of Victoria and Esquimalt.

O. C. May 5, 1875 ; April 15, 1879.

## WALLACE, N.S.

Sec. 38. A pilotage district for the port of Wallace, in the County of Cumberland, in the Province of Nova Scotia, such district to extend westerly by the eastern limits of the Pugwash pilotage district, and easterly by a line drawn from <sup>Limits of district.</sup>

Chap. 83.

*Pilotage Districts.*

Malagash Point to Amet Island, and including all navigable waters within such limits :

Dues.

The payment of pilotage dues to be *non-compulsory* within the limits of the said district.

O. C. June 11, 1879.

## YALE AND NEW WESTMINSTER, B.C.

Limits of district.

Sec. 39. A pilotage district for the electoral districts of Yale and New Westminster, in the Province of British Columbia, to embrace all the ports, harbors and rivers within the limits of such electoral districts :

Dues, to what vessels to extend.

The payment of pilotage dues to be *compulsory* within the limits of the said district,—the same to extend as well to vessels coming to any of the said ports from the Pacific Ocean as to vessels leaving any such ports for the ocean.

O. C. April 15, 1879.

Cap 113. R.S.O. Section 869 of Act -

see Sec 900 as to Rules & Regulations for

part of the  
Act in  
the  
Annex  
to the  
Act

**CHAPTER 84.**

**PORT WARDENS.**

Government House, Ottawa,

The 12th day of June, 1889.

On the recommendation of the Minister of Marine and Fisheries and under the provisions of Chapter 85 of the Revised Statutes of Canada intituled "The Port Wardens' Act,"

His Excellency in Council has been pleased to order and determine the following ports to be ports at and for which Port Wardens may be appointed and to sanction and approve the following several Tariffs of Fees, together with the Rules and Fees for ports in the Province of Prince Edward Island.

**ANNAPOLIS, N. S.**

**Section 1.** Port Warden for Annapolis, in the County of Annapolis, in the Province of Nova Scotia.

Port established May 16, 1887.

**Sec. 2.** For Tariff of Fees to be paid to the Port Warden for said port of Annapolis, See "The Port Wardens' Act," section 30, sub-sections (a), (b) and (c). For tariff of fees, See Act.

**CHATHAM, N.B.**

**Sec. 3.** Port Warden for Chatham, in the County of Northumberland, in the Province of New Brunswick.

Port established Oct. 24, 1881.

**Sec. 4.** For Tariff of Fees to be paid to the Port Warden for said port of Chatham, See "The Port Wardens' Act," section 30, sub-sections (a), (b) and (c). For tariff of fees, See Act.

**COW BAY, N.S.**

**Sec. 5.** Port Warden for Cow Bay, in the County of Cape Breton, in the Province of Nova Scotia.

Port established April 15, 1879.

**Sec. 6.** *Tariff of Fees to be paid to the Port Warden for the said port of Cow Bay.* Tariff of fees.

First survey of hatches, and certificate .....	\$3 00	Every survey of damaged goods on the wharf or in store, value \$500 and over, and certificate...	5 00
Every subsequent survey of cargo, and certificate.....	2 00	Survey of vessel damaged or arriving in distress, and certificate	8 00
Survey of cargo when hatches have not been previously surveyed, and certificate.....	5 00	Every subsequent survey and certificate.....	5 00
Every survey of damaged goods on the wharf or in store, value under \$200, and certificate.....	3 00	Valuation of a vessel for average, under 200 tons, and certificate...	5 00
Every survey of damaged goods on the wharf or in store, value \$200 and under \$500, and certificate.....	4 00	Valuation of a vessel for average, of 200 tons and under 500 tons, and certificate.....	7 50
		Valuation of a vessel for average, of 500 tons and upwards, and certificate.....	10 00

## Chap. 84.

## Port Wardens.

Survey of cargo reported to have shifted, and certificate.....	5 00	Filing auctioneer's papers.....	0 25
All extra copies of certificate when required.....	0 50	<i>Vessels putting in in distress from any port, as under:—</i>	
Certificate under seal.....	1 00	For every 1,000 bushels of wheat and peas.....	0 15
Hearing and settling disputes between master and consignee of ships and owners of cargo.—\$200 value, \$2; \$200 to \$500, \$3; \$500 and over, \$5.		For every 1,000 bushels of wheat and barley.....	0 12
General superintendence of a vessel loading, and certificate.....	5 00	For every 1,000 bushels of wheat and oats.....	0 10
Ascertaining if vessel is seaworthy, and certificate.....	8 00	For every 1,000 bushels of wheat and corn.....	0 10
Survey that repairs ordered if not seaworthy have been made, and certificate.....	5 00	For every 1,000 barrels of flour....	0 75
		Coal oil, per barrel.....	0 01
		Ores and mineral, per ton.....	0 04
		Lumber and all other description of timber, per ton weight.....	0 02

O. C. March 15, 1881.

HALIFAX, N.S.

Sec. 7. Port Warden for the Harbor of Halifax, in the County of Halifax, in the Province of Nova Scotia.  
Port established March 29, 1875.

Tariff of fees.

Sec. 8. *Tariff of Fees to be paid to the Port Warden for the Harbor of Halifax, as made by the Chamber of Commerce of that City under the provisions of "The Port Wardens' Act".—*

First survey of hatches and certificate.....	2 50	All extra copies of certificates when required.....	0 50
Every subsequent survey of cargo and certificate.....	2 00	Certificate under seal.....	1 00
Survey of cargo where hatches have not been previously surveyed, and certificate.....	5 00	Hearing and settling disputes between master and consignee of ship and owners of cargo; \$200 value, \$2 00; \$200 to \$500, \$3.00; \$500 to \$1,000, \$4.00; \$1,000 and over, \$5.00	
Every survey of damaged goods on the wharf or in store, value under \$200, and certificate.....	3 00	Filing papers of auctioneers, &c....	0 25
Every survey of damaged goods on the wharf or in store, value \$200 and under \$500, and certificate..	4 00	Ascertaining if vessel is seaworthy, and certificate.....	8 00
Every survey of damaged goods on the wharf or in store, value \$500 and over, and certificate.....	5 00	Survey that repairs ordered if not seaworthy have been made, and certificate, 200 tons and under, \$3.00, all over 200 tons, \$5 00.	
Survey of vessel damaged or arriving in distress, and certificate...	8 00	General superintendence of a vessel loading, and certificate.....	5 00
Every subsequent survey, and certificate.....	5 00	<i>Vessels putting in in distress from Foreign ports, as under:—</i>	
Valuation of a vessel for average, under 200 tons, and certificate...	5 00	For every 1,000 bushels of wheat and peas.....	0 15
Valuation of a vessel for average, of 200 tons and under 500 tons, and certificate.....	7 50	For every 1,000 bushels of barley...	0 12
Valuation of a vessel for average, of 500 tons and upwards, and certificate.....	10 00	do do do oats....	0 10
Survey of cargo reported to have shifted, and certificate.....	5 00	do do do corn...	0 10
		do do barrels flour.....	0 75
		Coal oil, per barrel.....	0 00½
		Ores and minerals per ton, ballast excepted.....	0 04
		Lumber and all other descriptions of timber per ton weight.....	0 02

O. C. June 14, 1875.



*Port Wardens.*

Chap. 84.

HOPEWELL CAPE, N.B.

Sec. 9. Port Warden for Hopewell Cape, in the County of Albert, in the Province of New Brunswick.  
Port established Aug. 9, 1887.

Sec. 10. For Tariff of Fees to be paid to the Port Warden For tariff of for said port of Hopewell Cape, See "The Port Wardens' Act," fees, See Act. section 30, sub-sections (a), (b) and (c).

INTERNATIONAL PIER, SYDNEY, N.S.

Sec. 11. Port Warden for International Pier, Sydney Harbor, in the County of Cape Breton, in the Province of Nova Scotia.  
Port established May 16, 1887.

Sec. 12. For Tariff of Fees to be paid to the Port Warden For tariff of for the said port of International Pier, See "The Port Wardens' Act," section 30, sub-sections (a), (b) and (c).

LOUISBURG, N.S.

Sec. 13. Port Warden for Louisburg, in the County of Cape Breton, in the Province of Nova Scotia.  
Port established Dec. 14, 1877.

Sec. 14. For Tariff of Fees to be paid to the Port Warden For tariff of for the said port of Louisburg, See "The Port Wardens' fees, See Act. Act," section 30, sub-sections (a), (b), and (c).

MONCTON, N. B.

Sec. 15. Port Warden for Moncton, in the County of Westmoreland, in the Province of New Brunswick.  
Port established April 25, 1881.

Sec. 16. *Tariff of Fees to be paid to the Port Warden for* Tariff of fees. *the said port of Moncton.*

First survey of hatches, and certificate .....	\$2 50	Survey of vessel damaged on arriving in distress, and certificate .....	8 00
Every subsequent survey of cargo, and certificate.....	2 00	Every subsequent survey and certificate.....	5 00
Survey of cargo when hatches have not been previously surveyed, and certificate.....	5 00	Valuation of a vessel for average, under 200 tons, and certificate...	5 00
Every survey of damaged goods on wharf or in store, value under \$200, and certificate.....	3 00	Valuation of a vessel for average, over 200 tons, and under 500 tons, and certificate.....	7 50
Every survey of damaged goods on wharf or in store, value \$200 and under \$500, and certificate..	4 00	Valuation of a vessel for average, of 500 tons and upwards, and certificate.....	10 00
Every survey of damaged goods on wharf or in store, value \$500 and over, and certificate.....	5 00	Survey of cargo reported to have shifted, and certificate.....	5 00

Chap. 84.

Port Wardens.

All extra copies of certificates when required.....	0 50	Filing papers of auctioneers, &c.	0 25
For certificate, under seal.....	1 00	Ascertaining if vessel is seaworthy, and certificate.....	8 00
Hearing and settling disputes between master and consignee of ship, and owners of cargo, \$200 value, \$2.00; \$300 to \$500, \$3.00; \$500 to \$1,000, \$4.00; \$1,000 and over, \$5.00.		Survey that repairs ordered, if not seaworthy have been made, and certificate, 200 tons and under, \$3.00; all over 200 tons, \$5.00.	
		General superintendence of a vessel loading.....	5 00

O. C. June 25, 1881.

NANAIMO AND DEPARTURE BAY, B. C.

Sec. 17. Port Warden for Nanaimo and Departure Bay, in the Province of British Columbia.

Port established Oct. 24, 1884.

For tariff of fees, See Act.

Sec. 18. For Tariff of Fees to be paid to the Port Warden of said port of Nanaimo and Departure Bay, See "The Port Wardens' Act," section 30, sub-sections (a), (b), and (c).

NEWCASTLE, N. B.

Sec. 19. Port Warden for Newcastle, in the County of Northumberland, in the Province of New Brunswick.

Port established Oct. 24, 1881.

For tariff of fees, See Act.

Sec. 20. For Tariff of Fees to be paid to the Port Warden for said port of Newcastle, See "The Port Wardens' Act," section 30, sub-sections (a), (b), and (c).

NORTH SYDNEY, N. S.

Sec. 21. Port Warden for North Sydney, in the County of Cape Breton, in the Province of Nova Scotia.

Port established Feb. 19, 1877.

Tariff of fees.

Sec. 22. Tariff of Fees to be paid to the Port Warden for the said port of North Sydney, the same as those established for the Port Warden for the Harbor of Halifax, Section 8 of this Chapter.

O. C. May 11, 1881.

PICTOU, N. S.

Sec. 23. Port Warden for the Harbor of Pictou, in the County of Pictou, in the Province of Nova Scotia.

Port established April 12, 1878.

Tariff of fees.

Sec. 24. Tariff of Fees to be paid to the Port Warden for the said port and harbor of Pictou, the same as those established for the Port Warden for the Harbor of Halifax, Section 8 of this Chapter.

O. C. Jan. 24, 1881.

*Port Wardens.*

Chap. 84.

PORT HASTINGS, N.S.

Sec. 25. Port Warden for Port Hastings in the County of Inverness in the Province of Nova Scotia.

Port established May 16, 1835.

Sec. 26. For Tariff of Fees to be paid to the Port Warden for said port of Hastings, See "The Port Warden' Act," section 30, sub-sections (a), (b) and (c). For tariff of fees, See Act.

PORT HAWKESBURY, N. S.

Sec. 27. Port Warden for Port Hawkesbury, in the County of Inverness, in the Province of Nova Scotia.

Port established July 28, 1875.

Sec. 28. Tariff of Fees to be paid to the Port Warden for the said port of Hawkesbury, the same as those established for the Port Warden for the Harbor of Halifax, Section 8 of this Chapter. Tariff of fees.

O. C. Jan. 4, 1881.

PORT MULGRAVE, N. S.

Sec 29. Port Warden, for Port Mulgrave, in the County of Guysborough, in the Province of Nova Scotia.

Port established July 22, 1875.

Sec. 30. *Tariff of Fees to be paid to the Port Warden for the said port of Port Mulgrave.* Tariff of fees.

First survey of hatches, and certificate .....	\$3 00	Survey of cargo reported to have shifted, and certificate .....	\$5 00
Each subsequent survey and certificate .....	2 50	All extra copies of certificates when required .....	0 50
Survey of cargo when hatches have not been previously surveyed, and certificate .....	5 00	Hearing and settling disputes between master and consignee of ships and owners of cargo \$200 value, \$2.00; \$200 to \$500, \$3.00; \$500 to \$1 000, \$4.00; \$1,000 and over, \$5.00.	
Each survey of damaged goods on the wharf or in store, value under \$200, and certificate .....	3 00	Filing papers of auctioneer, &c... ..	0 50
Each survey of damaged goods on the wharf or in store, value \$200 and under \$500, and certificate..	4 00	Ascertaining if vessel is seaworthy, and certificate .....	8 00
Each survey of damaged goods on the wharf or in store, value \$500 and over, and certificate .....	5 00	<i>Vessels putting in in distress, from foreign ports, as under :-</i>	
Survey of vessels damaged or arriving in distress, and certificate	8 00	For every 1,000 bushels of wheat and peas .....	0 15
Each subsequent survey, and certificate .....	5 00	For every 1000 bushels of barley..	0 12
Valuation of a vessel for average, under 200 tons, and certificate..	5 00	For every 1,000 bushels of oats...	0 10
Valuation of a vessel for average, of 200 tons and under 500 tons, and certificate .....	7 50	For every 1,000 bushels of corn...	0 10
Valuation of a vessel for average, of 500 tons and upwards, and certificate .....	10 00	For every 1,000 barrels of flour...	1 00
		Coal oil, per barrel .....	0 01
		Ores and minerals, per ton, ballast excepted.....	0 04
		Lumber and all descriptions of timber, per ton weight.....	0 02

O. C. July 12, 1881.

## Chap. 84.

## Port Wardens.

## PRINCE EDWARD ISLAND.

Regulations  
and fees.

Sec. 31. *Regulations and Fees made and established for the Port Wardens for all ports in the Province of Prince Edward Island.*

Ports established May 13, 1880.

Master of ves-  
sel on arriv-  
ing shall  
make report  
to port war-  
den.

Sec. 32. Rules and By-laws.

1. Every master of a vessel on arriving in port from any place not within the limits of inland navigation, shall (in order to enable the Port Warden to grant the necessary certificate for the vessel's clearance at the Custom house) proceed to the Port Warden's office, and make a report of his vessel and cargo, and receive a copy of these rules and by-laws.

Records of  
proceedings  
to be kept by  
port warden.

2. The Port Warden shall keep in his office, records in full of all his proceedings, together with statements of the results of all examinations and inquiries made by him; which records may be inspected during business hours by any parties interested: he shall keep on record all certificates granted by him and shall furnish duplicates of the same as hereinafter provided on payment of the regular fee.

Notifications  
and requests.

3. All notifications and requests to the Port Warden must be made at his office in writing and duly entered by him in a book to be kept for that purpose.

Directions as  
to loading  
with oats and  
other grain.

4. Great care must be taken to thoroughly fill the vessel with bulk grain under the decks, and it is advisable when vessels are filling up that no more grain should be put on board than the number of laborers employed are able to trim and properly stow. Oats may be carried in bulk to any extent irrespective of the tonnage of the ship, but subject to such regulations with reference to dunnage lining and shifting boards as the Port Warden, or his deputy, may prescribe.

By whom fees  
shall be paid.

5. The fees mentioned in the tariff of fees embodied in these rules as applicable shall be payable to the Port Warden by the parties employing him, but in case of a survey of cargo alleged to be improperly stowed, the party in the wrong shall pay the fee.

Shifting  
boards, stan-  
chions and  
shores.

6. All shifting boards shall be well secured and fastened to each side of the stanchions, and the stanchions shall be properly secured to the keelson and beams, and shall be sufficiently shored,—the shores to be not less than 6 inches by 3 inches.

Port Wardens.

Chap. 84.

7. All lumber used for dunnage, shifting boards and shores shall be free from rents and shakes, and the work shall be done in a workmanlike manner to the satisfaction of the Port Warden or his deputy. Lumber used for dunnage, &c
8. All air-streaks and openings shall be closed and made grain-tight. Air-streaks and openings.
9. The limber boards shall be taken up and thoroughly cleaned out if required by the Port Warden or his deputy. Limber boards.
10. The pump-well and chain-locker and water-tanks shall be cased and made grain-tight. Pump-well, chain-locker and water-tanks.
11. Should any shores or braces be removed by stevedores or others, the same shall be replaced before clearance certificate is granted. Removal of shores or braces.
12. Vessels loading grain in bulk shall have dunnage ten inches clear of ceiling in bottom of ship and extending to first futtock heads, and shall have shifting boards of 3 inch material from keels on to main deck extending the full length of vessel. Vessels loading grain in bulk; dunnage and shifting boards.
13. Vessels shall be ballasted according to the discretion of the Port Warden or his deputy. Ballast.

Sec. 33. *Tariff of Fees to be paid to the Port Warden in the Province of Prince Edward Island.* Tariff of fees.

First survey of hatches and certificate.....	\$3 00	seaworthy have been made, and certificate.....	4 00
Each subsequent survey of cargo, and certificate.....	2 00	General superintending of a ship loading and certificate, under 100 tons register.....	5 00
Survey of cargo when hatches have not been previously surveyed, and certificate.....	5 00	100 tons and under 150 tons register... gister...	6 00
Every survey of damaged goods on the wharf or in store, value under \$200, and certificate .....	3 00	150 do do 200 do ...	7 00
Each subsequent survey, from \$200 to \$500.....	4 00	200 do do 300 do ...	8 00
Survey of vessel damaged or arriving in distress, and certificate.....	8 00	300 do do 400 do ...	9 00
Survey of cargo reported to have shifted, and certificate.....	5 00	400 do and upwards do ...	10 00
Extra copies of certificate and seal	1 00	<i>Vessels putting in in distress from any port other than a port in Prince Edward Island, as under—</i>	
Hearing and settling disputes between master and consignee of ship and owners of cargo \$200 value .....	2 00	Cents.	
From \$200 to \$1,000.....	3 00	For every 1,000 bushels wheat and	
Filing papers of auctioneers.....	0 25	do do peas...	10
Ascertaining if vessel is seaworthy, and certificate .....	8 00	do do barley	8
Survey that repairs ordered if not		do do oats...	13
		do do corn...	5
		For every 1,000 barrels flour.....	70
		Coal oil per barrel.....	$\frac{1}{2}$
		Ores and minerals per ton.....	2
		Lumber and all other descriptions of timber per ton weight	2

O. C. March 14, 1882.

## Chap. 84.

*Port Wardens.*

## RIMOUSKI, P.Q.

Sec. **34.** Port Warden for Rimouski in the County of Rimouski, in the Province of Quebec.

Port established Nov. 15, 1882.

For tariff of fees, *See Act.* Sec. **35.** For Tariff of Fees to be paid to the Port Warden of said Port of Rimouski, *See* "The Port Wardens' Act," section 30, sub-sections (a), (b) and (c).

## SHEDIAC, N.B.

Sec. **36.** Port Warden for Shediac in the County of Westmoreland in the Province of New Brunswick.

Port established Oct. 15, 1887.

For tariff of fees, *See Act.* Sec. **37.** For Tariff of Fees to be paid to the Port Warden for said port of Shediac, *See* "The Port Wardens' Act," section 3, sub-sections (a), (b) and (c).

## ST. ANDREWS, N.B.

Sec. **38.** Port Warden for St. Andrews, in the County of Charlotte, in the Province of New Brunswick.

Port established June 18, 1881.

Tariff of fees, same as for Halifax. Sec. **39.** Tariff of Fees to be paid to the Port Warden for the said Port of St. Andrews, the same as those established for the Port Warden for the Harbor of Halifax, Section 8 of this Chapter.

O. C. Oct. 28, 1881.

## SYDNEY, N.S.

Sec. **40.** Port Warden for Sydney in the County of Cape Breton, in the Province of Nova Scotia.

Port established Jan. 11, 1878.

Tariff of fees, same as for Halifax. Sec. **41.** Tariff of Fees to be paid to the Port Warden for the said port of Sydney, the same as those established for the Port Warden for the Harbor of Halifax, Section 8 of this Chapter.

O. C. May 16, 1881.

## VICTORIA PIER, N.S.

Sec. **42.** Port Warden for Victoria Pier or South Bar of Sydney Harbor in the County of Cape Breton, in the Province of Nova Scotia.

Port established May 16, 1887.

Sec. 43. For Tariff of Fees to be paid to the Port Warden for the said Port of Victoria Pier or South Bar of Sydney Harbor, *See* "The Port Wardens' Act," section 30, sub-sections (a), (b) and (c). For tariff of fees, *See Act.*

YARMOUTH, N.S.

Sec. 44. Port Warden for Yarmouth, in the County of Yarmouth, in the Province of Nova Scotia.  
Port established Oct. 27, 1882.

Sec. 45. Tariff of Fees to be paid to the Port Warden for the said port of Yarmouth, the same as those established for Port Warden for the Harbor of Halifax, Section 8 of this Chapter. Tariff of fees, same as for Halifax.

O. C. Jan. 29, 1883.

VANCOUVER AND BURRARD INLET, B.C.

Sec. 46. Port Warden for Vancouver and Burrard Inlet, in the Province of British Columbia.  
Port established April 25, 1887.

Sec. 47. For Tariff of Fees to be paid to the Port Warden of said Port of Vancouver and Burrard Inlet, *See* "The Port Warden's Act," section 30, sub-sections (a), (b) and (c). For tariff of fees, *See Act.*

VICTORIA AND ESQUIMALT, B.C.

Sec. 48. Port Warden for Victoria and Esquimalt, in the Province of British Columbia.  
Port established March 8, 1875.

Sec 49. *Tariff of Fees to be paid to the Port Warden for the said ports of Victoria and Esquimalt.* Tariff of Fees.

First survey of hatches, with certificate under seal.....	\$5 00	Survey of vessel damaged or arriving in distress, including certificate under seal.....	10 00
Every subsequent survey of cargo, with certificate under seal.....	2 00	Every subsequent survey, with certificate under seal.....	5 00
Survey of cargo when hatches have not been previously surveyed, including certificate under seal.....	5 00	Valuation of a vessel for average, under 200 tons register, including certificate under seal...	5 00
Every survey of damaged goods on the wharf or in store, value under \$200, and certificate under seal.....	3 00	Valuation of a vessel for average of 200 tons and under 500 tons, with certificate under seal	7 50
Every survey of damaged goods on wharf or in store, value \$200, and under \$500, with certificate under seal.....	4 00	Valuation of vessel for average of 500 tons and upwards, with certificate under seal.....	10 00
Every survey of damaged goods on the wharf or in store, value \$500, and over, with certificate under seal.....	5 00	Survey of cargo reported to have shifted, including certificate under seal.....	5 00
		Extra copy of certificate when required, under seal.....	1 00

## Chap. 84.

*Port Wardens.*

Hearing and settling disputes between master and consignee of ship and owner of cargo, the Port Warden shall be entitled to demand and receive:—		Survey, that repairs ordered, if not seaworthy, have been made, inclusive of certificate under seal:—	
Value of cargo under \$200.....	\$2 00	200 tons and under.....	3 00
do do \$200 to \$500.....	3 00	Over 200 tons and not exceeding 500 tons.....	4 00
do do \$500 to \$1,000.....	4 00	Over 500 tons.....	5 00
do do \$1,000 and over.....	5 00	General superintendence of a vessel loading, with certificate under seal.....	5 00
Filing papers of auctioneers, &c, each.....	0 25		
Ascertaining if vessel is seaworthy, with certificate under seal.....	10 00		

O. C. Jan. 10, 1880.

Defined by  
the Act.

## DUTIES AND POWERS OF PORT WARDEN.

When not otherwise established by Order in Council, the duties and powers of the Port Warden are defined by the provisions of the Port Wardens' Act, Chapter 85, R. S. Canada, commencing at page 1,219.



## CHAPTER 85.

### PORT WARDEN, MONTREAL.

Government House, Ottawa,

The 12th day of June, 1889.

On the recommendation of the Minister of Marine and Fisheries, and under the provisions of Chapter 45 of the Acts 45 Victoria, intituled "An Act to amend and consolidate the Acts relating to the office of Port Warden for the Harbor of Montreal,"

His Excellency in Council has been pleased to approve the following Tariff of Fees established by the Council of the Board of Trade for the city of Montreal to be paid to the Port Warden for services performed in pursuance of said Act :

#### TARIFF OF FEES.

First survey of hatches and (or) cargo, including certificate.....	\$1 00	Extra copies of certificate, when required.....	\$0 25
Every subsequent survey.....	0 50	For inspection of the lining of a vessel intending to load grain—	
Every survey of damaged goods on wharf or in store with certificate, value \$200 and under.....	1 00	200 tons and under 400.....	3 00
Over that value.....	2 00	400 " " 600.....	4 00
Survey of hull and (or) sails, spars and rigging of any vessel damaged or arriving in port in distress.....	5 00	600 " " 800.....	5 00
Every subsequent survey.....	1 00	800 " upwards.....	6 00
Survey to ascertain if ship is seaworthy, with certificate.....	2 50	General superintendence of loading on vessels which do not pay fees otherwise.....	5 00
Survey that repairs ordered, if not seaworthy, have been made, with certificate.....	2 00	Certificate of general loading where fees have not otherwise been paid to the amount of \$3 00	1 00
Valuation of a vessel for average, under 500 tons.....	5 00	Settling disputes between master and consignee of ship and owners of cargo.....	2 50
500 to 1,000 tons, \$1 00 per 100 tons, but not to exceed.....	7 50	For certificate under seal or copy of record or document.....	1 00
Survey of cargo reported to have shifted, with certificate.....	4 00	Every extra copy of every certificate.....	0 25
Measurement of a vessel's beam for towage.....	1 00	For the appeal of any case from the Port Warden to the Board of Examiners, payable by the party against whom the decision is given, in no case more than.....	20 00

*Export Fees to be collected on shipments by sea-going vessels loaded for Ports other than those in British North America.*

ON GRAIN.		
Wheat, peas, barley, malt, oats, Indian corn.....	Free.	Sheep and hogs, per head..... \$0 00½
ON FLOUR AND MEAL.		On other articles not herein enumerated, being natural production, per ton..... 0 02
On every 1,000 barrels, and proportionate charge for every fractional quantity thereof.....	\$0 75	On other articles not herein enumerated, and shipped from this port, being manufactured in whole or in part, per ton weight or measurement..... 0 06
Ashes per barrel.....	0 02	And the same on all quantities or parcels of such other goods exceeding in the whole shipment half a ton, though not amounting to one ton weight or measurement; but no fee to be charged in respect to such other articles for any shipment not amounting to half a ton, or any fractional part of a ton, in any shipment exceeding one or more tons.
Apples per barrel.....	0 00½	
Coal oil per barrel.....	0 00½	
Ores and minerals per ton (ballast excepted).....	0 02	
Oil cake per ton.....	0 03	
Phosphates per ton.....	0 01	
Sawn lumber per 1,000 feet.....	0 00½	
Deals, per Petersburg std. hundred.....	0 02	
Staves, puncheon, per mile.....	0 08	
Staves, pipe, ".....	0 30	
Staves, West India, ".....	0 08	
Oxen and horses, per head.....	0 01½	

## CHAPTER 86.

### PORT WARDEN, QUEBEC.

Government House, Ottawa,  
The 12th day of June, 1889.

On the recommendation of the Minister of Marine and Fisheries, and under the provisions of Chapter 33 of the Acts 34 Victoria, intituled "An Act to provide for the appointment of a Port Warden for the Harbor of Quebec," and the Act in amendment thereof,

His Excellency in Council has been pleased to approve the following Tariff of Fees, established by the Council of the Board of Trade for the city of Quebec, to be paid to the Port Warden for services performed in pursuance of said Acts.

#### TARIFF OF FEES.

<p>First survey of hatches and cargo including certificate for vessels of 400 tons and under ..... \$2 50</p> <p style="padding-left: 20px;">do 400 do to 700 tons 3 50</p> <p style="padding-left: 20px;">do 700 do and upwards ..... 5 00</p> <p>Every subsequent survey on cargo on board of the ship..... 1 00</p> <p>Every copy of certificate when required..... 0 50</p> <p>For certificate under seal of copy of record or document..... 1 50</p> <p>Every copy of certificate when required..... 1 00</p> <p>Every survey of damaged goods on wharf or in store, with certificate value \$200 or under.... 2 50</p> <p>Over \$200 in value..... 5 00</p> <p>Survey on hulls, sails, spars and rigging of any vessel damaged or arriving in port in distress for the first survey..... 8 00</p> <p>Every subsequent survey..... 5 00</p> <p>Certificate of survey, repairs and seaworthiness..... 1 00</p> <p>Survey to know if ship is seaworthy, with a certificate ..... 2 50</p> <p>Survey that repairs ordered have been made or cause of unseaworthiness removed, with certificate..... 2 50</p> <p>Valuation of vessels for average, under 500 tons..... 5 00</p> <p>500 to 1,000 tons, \$1 00 per 100 tons but not to exceed ..... 7 50</p>	<p>Measurement of a vessel's beam for towage..... \$ 1 00</p> <p>Certificate when required..... 0 25</p> <p>For inspection of a vessel intending to load with certificate (and payable by the vessel) all the surveys..... 5 00</p> <p>For hearing and settling disputes on matters of which the Port Warden is authorized to take cognizance, a sum to be graduated according to the value of the thing or amount in dispute, from \$1 00 to..... 20 00</p> <p>For certificate under seal or copy of record or document..... 0 50</p> <p>Every copy of certificate if required..... 0 25</p> <p>For estimating cost of repairs to a damaged vessel, to be graduated according to the extent of damage, from \$2.50 to..... 20 00</p> <p>For the appeal of any case from the Port Warden to the Board of Examiners, payable by the party against whom the decision is given, in no case more than..... 20 00</p> <p>Port Warden's expenses to be paid when his services are required outside of the limits (viz.) the Commissioner's Wharf to the East, and the Montreal Ocean S.S. Co's Wharf to the West.....</p>
---	---

O.C. July 29, 1871.

See Vol. 113 RSC  
III vol. - p 1 of 104  
(see 1881)

## CHAPTER 87.

### REGISTRATION OF SHIPPING,—PORTS.

Government House, Ottawa,  
The 12th day of June, 1889.

On the recommendation of the Minister of Marine and Fisheries, and under the provisions of Chapter 72, of the Revised Statutes of Canada, intituled "An Act respecting the Registration and Classification of Ships,"

His Excellency in Council has been pleased to constitute and appoint the following ports in the Dominion of Canada, as ports for the registration of shipping, and such ports are hereby constituted and appointed accordingly, that is to say:—

Province of  
Ontario.

**Section 1. In the Province of Ontario.**

Amherstburg, O. C.	March 26,	1874.
Brockville	do	do
Belleville	do	do
Chatham	do	do
Collingwood	do	do
Cornwall	do	do
Dover	do	do
Goderich	do	do
Hamilton	do	do
Hope	do	do
Kingston	do	do
Owen Sound	do	do
Ottawa	do	do
Picton	do	do
Sarnia	do	do
Sault Ste. Marie	do	do
Stanley	do	do
Toronto	do	do
Windsor	do	do
Cobourg	April	2, 1874.
Burwell	April	29, 1874.
Darlington	May	21, 1874.
Whitby	do	do
St. Catharines	June	3, 1874.
Port Rowan	Sep.	22, 1874.
Wallaceburg	March	8, 1875.
Prescott	Feb.	7, 1880.
Desoronto	May	19, 1882.
Port Arthur	March	23, 1885.
Peterboro'	[June	15, 1889.]
Saugeen	[July	16, 1889.]

*Registration of Shipping Ports.*

Chap. 87.

<b>Sec. 2. <i>Province of Quebec.</i></b>			Province of Quebec.
Gaspé, O. C.	March 26,	1874.	
Montreal	do	do	
Magdalen Islands	do	do	
New Carlisle	do	do	
Quebec	do	do	
St. Johns	do	do	
<b>Sec. 3. <i>Province of New Brunswick.</i></b>			New Brun- swick.
Chatham, O.C.	March 26,	1874.	
Dorchester	do	do	
Richibucto	do	do	
Sackville	do	do	
St. Andrews	do	do	
St. John	do	do	
Moncton	July 6,	1878.	
<b>Sec. 4. <i>Province of Nova Scotia.</i></b>			Nova Scotia.
Amherst, O.C.	March 23,	1874.	
Annapolis	do	do	
Arichat	do	do	
Barrington	do	do	
Digby	do	do	
Guysborough	do	do	
Halifax	do	do	
Liverpool	do	do	
Lunenburg	do	do	
Parrsborough	do	do	
Pictou	do	do	
Port Hawkesbury	do	do	
Shelburne	do	do	
Sydney	do	do	
Weymouth	do	do	
Windsor	do	do	
Yarmouth	do	do	
Port Medway	do	do	
Maitland, Hants Co.	July 23,	1874.	
Port Hawkesbury	June 14,	1875.	
Truro	July 9,	1875.	
<b>Sec. 5. <i>Province of Prince Edward Island.</i></b>			Prince Ed- ward Island.
Charlottetown, [O.C. July 16, 1889.]			
<b>Sec. 6. <i>Province of Manitoba.</i></b>			Manitoba.
Winnipeg, O.C. July 9, 1875.			
<b>Sec. 7. <i>Province of British Columbia.</i></b>			British Col- umbia.
New Westminster, O.C. March 5, 1880.			
Victoria, [O.C. July 16, 1889.]			

## SURVEYORS OF SHIPPING.

On the recommendation aforesaid and under the provisions aforesaid.

Fees for the measurement of vessels about to be registered.

Sec. 8. His Excellency in Council has been pleased to order, and it is hereby ordered, that Surveyors of Shipping shall be entitled to the following mentioned fees for the measurement of vessels about to be registered for the first time under the said Act, or requiring measurement for the purposes of registry, that is to say :—

For vessels under 100 tons register.....	\$2 00
“ of 100 tons, and not exceeding 200 tons.	3 00
“ over 200 tons, and not exceeding 400 tons.....	4 00
“ over 400 tons, and not exceeding 1,000 tons .....	5 00
“ over 1,000 tons.....	6 00

Travelling fees of surveyors of shipping.

Sec. 9. His Excellency, on the authority aforesaid, has further been pleased to order, and it is hereby ordered, that every Surveyor of Shipping shall, when required to travel for the purpose of making any such measurement, be entitled to demand and receive from the person or persons requiring his services the sum of ten cents for every mile actually and necessarily travelled by him for the purpose of making such measurement.

O. C. March 26, 1874; June 28, 1888.

## CHAPTER 88.

### SHIPPING OFFICES.

Government House, Ottawa,  
The 12th day of June, 1889.

On the recommendation of the Minister of Marine and Fisheries, and under the provisions of Chapter 74 of the Revised Statutes of Canada intituled "The Seamen's Act."

His Excellency in Council has been pleased to order, and it is hereby ordered as follows, that is to say.

**Section. 1.** At any place in either of the Provinces of Quebec, Nova Scotia, New Brunswick, British Columbia or Prince Edward Island in which no separate Shipping Office has been established, the business of the Shipping Office shall be conducted at the Custom House, and in respect of such business, such Custom House shall be for all purposes deemed a Shipping Office, and the Chief Officer of the Customs at any such place shall be a Shipping Master, and shall be held and deemed to have been appointed as such within the meaning of the said Act.

Custom House to be shipping office in place where no separate shipping office has been established.

O. C. April 21, 1874.

His Excellency in Council has also been pleased to establish a Shipping Office at each of the following ports and to appoint superintendents of said offices to be called Shipping Masters under the provisions of said Act.

**Sec. 2.** *In the Province of Quebec.*

Province of Quebec.

The Port of Gaspé,

" Montreal, O.C. Oct., 7, 1878.

" Quebec.

**Sec 3.** *In the Province of Nova Scotia.*

Nova Scotia.

The Port of Arichat, in the County of Richmond.

" O. C. May 7, 1874.

" Bear River, in the County of Annapolis.

O. C. June 29, 1880.

" Caledonia, in the County of Cape Breton.

O. C. March 18, 1880.

" Cape Sable Island, in the County of Shelburne. O. C. April 1, 1831.

" Cow Bay, in the County of Cape Breton. O. C. April 9, 1874.

## Chap. 88.

*Shipping Offices.*

- The Port of Glace Bay, in the County of Cape Breton.  
O. C., April 23, 1874.
- “ Halifax, in the County of Halifax.  
O. C. Oct. 12, 1872.
- “ Lahave, in the County of Lunenburg.  
O. C. Oct. 20, 1873.
- “ Lingan, in the County of Cape Breton.  
O. C. April 23, 1874.
- “ Liverpool, in the County of Queens.  
O. C. May 15, 1873.
- “ Louisburg, in the County of Cape Breton.  
O. C. April 23, 1874.
- “ Lunenburg, in the County of Lunenburg,  
O. C. Oct. 22, 1873.
- “ North Sydney, in the County of Cape  
Breton. O. C. April 9, 1874.
- “ Pictou, in the County of Pictou.  
O. C. May 15, 1873.
- “ Port Hawkesbury, in the County of In-  
verness. O. C. July 28, 1875.
- “ Sydney, in the County of Cape Breton.  
O. C. April 9, 1874.
- “ Yarmouth, in the County of Yarmouth.  
O. C. Jan. 19, 1876.

New Bruns-  
wick.Sec. 4. *In the Province of New Brunswick.*

- The Port of Chatham, in the County of Northumberland.  
O. C. May 19, 1876.
- “ St. Andrew's, in the County of Charlotte.  
O. C. July 8, 1874.
- “ St. John in the County of St. John.

Prince Ed-  
ward Island.Sec. 5. *In the Province of Prince Edward Island.*

- The Port of Charlottetown, in the County of Kings.  
O. C. July 22, 1875.
- “ Summerside, in the County of Prince.  
O. C. May 10, 1880.



See Copy 113 R.S. C Vol III  
see sec 734.

CHAPTER 89.

As 1881  
2049

WRECKS AND SALVAGE.

Government House, Ottawa,  
The 12th day of June, 1889.

On the recommendation of the Minister of Marine and Fisheries and under the provisions of Chapter 81 of the Revised Statutes of Canada, intituled "The Wrecks and Salvage Act,"

His Excellency in Council has been pleased to constitute and establish the following districts for all the purposes of said Act:—

*In the Province of Prince Edward Island.*

Section 1. Two districts in Kings County:—

Kings County  
P.E.I.

(a.) One district to be for the North Coast of Kings County, and to extend from East Point to the line of division between Kings and Queens Counties;

North Coast.

(b.) And the other district to be for the South Shore of said county, and to extend from East Point to the line of division between Kings and Queens Counties.

South Shore.

O. C. May 7, 1877.

Sec. 2. A district to extend from County line, between Kings and Queens Counties, in the Province of Prince Edward Island, at Little Sands to Trout Point, in Hillsborough Bay, in the County of Kings, including Governor's Island.

Little Sands  
to Trout Point

O. C. May 13, 1880.

Sec. 3. Two districts in Prince County:—

Prince County.

(a.) One district to comprise all that portion of Prince County, lying north of a line commencing on the east side of the island at or near Kildare Creek, on the division line between lots number 3 and number 4, and following said line to the west side of the island, at or near Little Miminigash.

Northern district.

O. C. May 23, 1884.

## Chap. 89.

*Wrecks and Salvage.*

- Eastern district. (b.) And the other district to comprise the eastern portion of said county, embracing lots 16, 17, 18, 19, 25, 26, 27, and 28.  
O. C. Oct. 3, 1837.
- In the Province of Nova Scotia.*
- Richmond. Sec. 4. The County of Richmond.  
O. C. May 14, 1874.
- Shelburne. Sec. 5. The County of Shelburne.  
O. C. June 3, 1874.
- Smoky Cape to Cow Bay, C.B. Sec. 6. A district extending from Smoky Cape, in the County of Victoria to Southern Head of Cow Bay in the County of Cape Breton.  
O. C. June 3, 1874.
- Ingonish to Bay St. Lawrence. Sec. 7. A district extending from Ingonish, in the County of Victoria, in the Island of Cape Breton, to Bay St. Lawrence, in the same County, and including the Island of St. Pauls.  
O. C. Aug. 10, 1874.
- Digby County. Sec. 8. A district in the County of Digby, comprising Brier Island, Long Island and Petit Passage.  
O. C. Dec. 22, 1874.
- Yarmouth. Sec. 9. The County of Yarmouth.  
O. C. April 7, 1875.
- Inverness, Southern district. Sec. 10. A district in the County of Inverness to be called the Southern District of the County and to extend from the County line of Inverness, on the Strait of Canso to Mabou Harbor.  
O. C. June 14, 1875.
- Inverness, Northern district. Sec. 11. A District in the said County of Inverness to be called the Northern District, and to extend from Mabou Harbor to the County line of Inverness aforesaid at Cape North.  
O. C. June 14, 1875.
- Guysborough District. Sec. 12. A district in the County of Guysborough to be known as the District of Guysborough, and to include the

*Wrecks and Salvage.*

Chap. 89.

coast line from Auld's Cove, at Antigonish County line, to the east side of Becherton Harbor, in the County of Guysboro.

O. C. Jan. 6, 1877.

Sec. 13. A district, in the said County of Guysborough, to be known as St. Mary's District, and to include the coast line from the east side of Beherton Harbor to Ecumsecum, at Halifax County line.

St. Mary's  
District.

O. C. Jan. 6, 1887.

Sec. 14. A district in the County of Cape Breton to extend from Point Cape Breton to the northern head of Gabarous Bay.

Point Cape  
Breton to  
Gabarous  
Bay.

O. C. April 23, 1877.

Sec. 15. The County of Pictou.

Pictou.

O. C. June 15, 1877.

Sec. 16. The County of Lunenburg.

Lunenburg.

O. C. Sep. 25, 1885.

Sec. 17. A district in the County of Halifax, to extend from the dividing line between Halifax and Guysboro Counties to Pope Head, in the County of Halifax, and to include Spry Bay and all other bays and harbors between these limits.

Halifax Dis-  
trict.

O. C. March 21, 1889.

*In the Province of New Brunswick.*

Sec. 18. A district to be known as the Caraquet District, and to extend from an imaginary line drawn from the Roman Catholic Church at Grand Anse to Point Miscou, and from Point Miscou to the boundary line of the Counties of Gloucester and Northumberland.

Caraquet Dis-  
trict.

O. C. April 26, 1878.

Sec. 19. Districts in the County of Charlotte :—

Charlotte,  
N.B.

(a.) The River St. Croix and the inner Passamaquoddy Bay ;

River St.  
Croix.

(b) The districts lying between the extension eastward of the County line between the Counties of Charlotte and Saint John, and a line running eastwardly from inner Passamaquoddy Bay through the middle of La Tête Passage and midway between Bliss Island and the White Horse Island, and to the southward of the Wolves' Island ;

Passama-  
quoddy Bay,  
La Tête Pas-  
sage, &c.

## Chap 89.

*Wrecks and Salvage.*

- Campobello and West Isles. (c.) All the parish of Campobello, and the parish of West Isles, except that part thereof that is bounded by inner Passamaquoddy Bay;
- Grand Manan. (d.) The parish of Grand Manan.  
O. C., April 8, 1886.
- In the Province of Quebec.*
- Rimouski. Sec. **20.** The County of Rimouski.  
O. C. April 30, 1874.
- Magdalen Islands. Sec. **21.** The Magdalen Islands in the Gulf of St. Lawrence.  
O. C. May 14, 1874.
- Kamouraska. Sec. **22.** The County of Kamouraska.  
O. C. June 17, 1874.
- Gaspé. Sec. **23.** A district extending from Fox Point to Maquereau Point in the County of Gaspé.  
O. C. June 17, 1874.
- Temiscouata. Sec. **24.** The County of Temiscouata and the adjacent islands belonging to that county.  
O. C. June 19, 1874.
- L'Islet. Sec. **25.** The County of L'Islet.  
O. C. Nov. 6, 1874.
- Bellechasse. Sec. **26.** The County of Bellechasse.  
O. C. Nov. 6, 1874.
- Fox Point. Sec. **27.** A district to extend from Fox Point in the County of Gaspé to the boundary line between the Counties of Gaspé and Rimouski.  
O. C. Nov. 23, 1875.
- Saguenay. Sec. **28.** A district to include that part of the north shore coast of the River St. Lawrence, comprised in the County of Saguenay.  
O. C. March, 13, 1879.
- Chicot River to Otter River. Sec. **29.** A district to extend from the east side of Chicot River to the west side of Otter River, on the Island of Anticosti, in the Gulf of St. Lawrence.  
O. C. April 8, 1882.

*Wrecks and Salvage.*

Chap. 89.

Sec. 30. A district to extend from the east side of Otter River easterly to Charleston Point, on the north side of the Island of Anticosti, in the Gulf of St. Lawrence. Otter River to Charleston Point.

O. C. April 8, 1882.

Sec. 31. A district to extend from Charleston Point, on the north side westerly to west side of Becsic River, on the Island of Anticosti, in the Gulf of St. Lawrence. Charleston Point to Becsic River.

O. C. April 8, 1882.

Sec. 32. A district to extend from the east side of Becsic River to the west side of Chicot River, on the Island of Anticosti, in the Gulf of St. Lawrence. Becsic River to Chicot River.

O. C. April 8, 1882.

*In the Province of Ontario.*

Sec. 33. A district extending from Point Traverse to Petticoat Point, in the County of Prince Edward. Point Traverse to Petticoat Point.

O. C. Nov. 12, 1874.

Sec. 34. A district extending from Petticoat Point to West Point, in the same County. Petticoat Point to West Point.

O. C. Nov. 12, 1874.

Sec. 35. A district extending from West Point to Con-  
secon, in the same County. West Point to Conseccon.

O. C. Nov. 12, 1874.

Sec. 36. The County of Welland.

Welland.

O. C. March 25, 1878.

*In the Province of British Columbia.*

BRITISH COLUMBIA.

Sec. 37. The whole Province except the two districts next hereinafter described. The Province except, &c.

O. C. April 27, 1874.

Sec. 38. Vancouver's Island exclusive of the Ports of Victoria and Esquimalt. Vancouver's Island except, &c.

O. C., April 12, 1880.

Sec. 39. The Ports of Victoria and Esquimalt.

Victoria and Esquimalt.

O. C. Sep. 17, 1883.

Copy 113 R.S. 0  
Case  
20 565-4000  
577 hull  
576

Vol III  
p 2570

576  
by J.C. [unclear]  
[unclear]

## CHAPTER 90.

### INSPECTION OF BOILERS OF STEAM-BOATS.

Government House, Ottawa,  
The 17th day of September, 1889.

On the recommendation of the Minister of Marine and Fisheries and under the provisions of Chapter 23 of the Acts 52 Victoria (1889), intituled "An Act further to amend The Steam-boat Inspection Act, Chapter 78 of the Revised Statutes."

His Excellency in Council has been pleased to order and it is hereby ordered that the following Regulations be made respecting the testing of boilers of Steam-boats and matters connected with the construction and working of such boilers.

#### PART ONE.

##### *Mode of Inspection.*

The boiler of every steam-boat shall be subjected to a test by hydrostatic pressure at least once a year.

Owner shall provide necessary apparatus and help.

Certificate shall not be granted till boiler tested.

Before boiler is tested it shall be opened up for inspection.

Section 1. Any Inspector may, whenever he deems it necessary so to do, and one Inspector shall, at least once in every year, subject the boiler of every steam-boat to a test by hydrostatic pressure, in the ratio of one hundred and fifty pounds to one hundred pounds allowable as a working pressure, using the water in such test at a temperature not exceeding sixty degrees Fahrenheit, and shall satisfy himself by examination and experimental trials that such boiler is well made of good and suitable materials. For the purposes of such test the owner of the steam-boat shall provide the necessary hand-pump, and apparatus, the same to be worked by the crew of the vessel; and no Inspector of boilers and machinery shall make or deliver to the owner or master of any steam-boat any certificate, unless he has first subjected the boiler or boilers of such steam-boat to such test by hydrostatic pressure and examination as herein prescribed.

Sec. 2. Before a boiler is subjected to a test by hydrostatic pressure, it shall be opened up for inspection, the man-hole and mud-plate doors removed, and the outside and inside of the boiler cleaned, the furnace grates removed and the furnace swept out clean, so that satisfactory and efficient inspection may be made; when bulkheads are so placed as to prevent a close examination of the plate of the boiler, they shall be removed; and the owner or master of the steam-boat shall see that the foregoing requirements are complied with before applying for inspection.

*Inspection of Boilers of Steam-boats.*

## Chap. 90.

**Sec. 3.** In any case in which the test is not satisfactory, the defects shall be made good and the boiler re-tested satisfactorily, before a certificate is granted.

When boiler shall be re-tested.

**Sec. 4.** Inspectors are to fix the working pressure of boilers by a series of calculations of the strength of the various parts, and according to the workmanship and material of which they are composed.

Inspectors are to fix the working pressure of boilers.

**Sec. 5.** Before testing a boiler the Inspectors should examine it, take the necessary measurements and calculate what the working pressure should be, in accordance with these regulations; these instructions apply to super-heaters, steam-chests, and water-jackets, as well as boilers.

Before testing the Inspector should examine, &c., in accordance with these regulations.

**Sec. 6.** If a boiler is too hot for an Inspector to examine it efficiently with safety and convenience, he should decline to do so, and absolutely refuse to grant a certificate until he can make a satisfactory examination.

If a boiler is too hot.

**Sec. 7.** In order to satisfy himself as to strength and internal condition of a boiler, the Inspector may, should he deem it necessary, order holes to be cut in it, and may also demand that such information by drawings and specifications of the several parts be furnished him of the construction, as will enable him to determine, by calculation and examination, their strength.

Inspector may order holes to be cut in boiler for purpose of examination.

**Sec. 8.** During the construction of every boiler made in Canada, the maker of such boiler shall notify the Inspector of the District in which it is being made, that it is open to his inspection, and shall, at all times during such construction allow the Inspector free access to it.

During construction of boiler notice to be given to Inspector.

**Sec. 9.** To prevent questions arising after a boiler is commenced, particulars of its construction by drawing and specification should be furnished the Inspector by the maker or contractor, for his approval; the Inspector having received such plans or tracings and approved of them, will be careful to see that they are followed in construction. This regulation will also apply to boilers undergoing alterations.

Maker or contractor to furnish particulars of construction to Inspector.

**Sec. 10.** No boiler shall be made of boiler plate, whether iron or steel, which has not been stamped with the name or mark of the maker thereof; and no certificate shall be granted with respect to any boiler made wholly or in part of plate not so marked; and before a certificate shall be granted with respect to any boiler, a declaration on oath by

No boiler to be made of boiler plate not stamped with name or mark of the maker thereof.

Chap. 90.

Inspection of Boilers of Steam-boats.

Declaration required before granting certificate.

the maker of the boiler, stating the name of the maker of the plates, their quality and the quality of all materials used in the construction of the boiler, shall be furnished the Inspector; such oath may be taken before any Justice of the Peace in Canada, or before a Notary Public and certified under his official seal, if taken out of Canada: Provided always, that in any case where such declaration on oath by the maker of the boiler cannot be obtained owing to the death of the maker, or from other causes deemed sufficient by the Inspector, the affidavit of two practical boiler makers who have examined the boiler and reported upon the quality of the materials in it and its workmanship and strength, shall, if satisfactory to the Inspector, be deemed sufficient in lieu of such declaration by the maker of the boiler.

Boiler, when not to be approved.

Sec. 11. No boiler or pipe in connection therewith shall be approved which is made in whole or in part of bad material or workmanship, or is unsafe in its form, or from age, use or any other cause.

Manner of testing, by hydraulic pressure, new boilers and boilers under repair.

Sec. 12. Inspectors should see all new boilers, and boilers that have been taken out of a ship for thorough repair, tested by hydraulic pressure up to at least one and one half the working pressure that will be allowed, previous to the boiler being placed in the vessel, to test the workmanship, etc., but the working pressure is to be determined by the stay power, the thickness of the plate, strength of riveting, etc., and not by the hydraulic test.

Hydraulic test, how to be applied.

Sec. 13. The hydraulic test should in no case exceed the ratio of one and one half the working pressure allowed, and it is never to be applied until the boiler has been opened up for examination and until the strength of all the parts have been calculated from the necessary measurements taken from the boiler itself.

When boiler is partially inspected by one Inspector and inspection completed and certificate granted by another.

Sec. 14. When a boiler is partially inspected by one Inspector, and the inspection is completed and the certificate granted by another Inspector, if the Inspector who witnesses the test of the boiler by the hydraulic pressure has an opportunity of examining the boiler inside and outside after the test, such Inspector shall determine the pressure to be allowed on the boiler, taking care to inform the owners, makers or agents, and the Inspector, who is ultimately to grant the certificate, what pressure should in his opinion be allowed.

*Amended by the Inspectors of the Province of Ontario, 1887.*



*Inspection of Boilers of Steamboats.*

## Chap. 90.

Sec. 15. Cast iron must not be used for stays in boilers ; Cast iron, for what uses not to be allowed.  
 Inspectors should also discourage the use of cast iron for chocks and saddles for boilers ; particular attention should be paid to chocking and fastening boilers to the vessels to guard against shifting or breaking loose.

Sec. 16. A pressure once allowed on a boiler is not, under any circumstances whatever, to be increased, unless the Inspector has previously written for and obtained the sanction of the Chairman of the "Board of Steam-boat Inspection". In cases where an Inspector is of opinion that an increased pressure may with safety be allowed, he should communicate with the Inspector who last inspected the boiler, and if, on learning the reason why the existing pressure was formerly allowed, the Inspector is still of opinion that it may be increased, he should communicate all the facts of the case to the Chairman ; but, as above stated, the pressure should not, in any case, be increased until the question has been decided by the Chairman. A pressure once allowed not to be increased without the sanction of the Board of Steamboat Inspection.

Sec. 17. In the event of any novelty in construction of a boiler, or of any departure from the practice of staying and strengthening as prescribed in these rules and regulations, the Inspector shall report full particulars to the Chairman before fixing the working pressure. In the event of any novelty in construction of a boiler.

Sec. 18. An Inspector shall not declare a boiler safe unless he is fully informed as to its construction, material and workmanship. He should, therefore, be very careful how he ventures to give a certificate for a boiler that he is not called in to inspect until after it is completed and fixed in the ship. Special care to be exercised in the inspection of a boiler after it is completed.

Sec. 19. In the case of new boilers, the Inspector may allow a stress not exceeding 7,000 pounds per square inch of net section on solid iron screw stays supporting flat surfaces, but the stress should not exceed 6,000 pounds when the stays have been welded or worked in the fire. Stress to be allowed in the case of new boilers.

Sec. 20. (a.) The pressure on plate forming flat surfaces is found by the following formula :— Pressure on plate forming flat surfaces, how ascertained.

$$\frac{C \times (T + 1)^2}{S - 6} = \text{Working Pressure.}$$

T = Thickness of plate in inches.

S = Surface supported in square inches.

C = Constant according to the following circumstances :—

C = 100 when the plates are not exposed to the impact of heat or flame, and the stays are fitted with nuts and

washers, the latter being at least three times the diameter of the stay and two thirds the thickness of the plate they cover.

C = 90 when the plates are not exposed to the impact of heat or flame, and the stays are fitted with nuts only.

C = 60 when the plates are exposed to the impact of heat or flame, and the steam in contact with the plates, and the stays fitted with nuts and washers, the latter being at least three times the diameter of the stay, and two thirds the thickness of the plates they cover.

C = 54 when the plates are exposed to the impact of heat or flame, and steam in contact with the plates, and the stays fitted with nuts only.

(b.) If the diameter of riveted washers be at least two thirds the pitch of the stays, and the thickness not less than the plates they cover, the constants may be increased to 150.

(c.) When doubling plates are fitted of the same thickness of the plates they cover, and not less in width than two thirds the pitch of the stays, the constants may be increased to 160. ~~150~~

(d.) When doubling plates cover the whole of the flat surfaces, the constant may be increased to 200. ~~160~~

C = 80 when the plates are exposed to the impact of heat or flame, with water in contact with the plates, and the stays screwed into the plates and fitted with nuts.

C = 60 when the plates are exposed to the impact of heat or flame, with water in contact with the plates, and the stays screwed into the plates, having the ends riveted over to form substantial heads.

C = 36 when the plates are exposed to the impact of heat or flame, and steam in contact with the plates, with the stays screwed into the plates, and having the ends riveted over to form substantial heads.

(e.) In cases where plates are stiffened by T or L irons, and a greater pressure is required for the plate than is allowed by the use of the above constants, the case should be submitted for the consideration of the Chairman.

(f.) When the riveted ends of the screw stays are much worn, or when the nuts are burned, the constants should be reduced, but the Inspector must act according to the circumstances that present themselves at the time of the inspection, and it is expected that in cases where the riveted ends of screw stays in the combustion boxes and furnaces are found in this state it will be often necessary to reduce the constant from 60 to 36.

alteration  
in rules, 1904

567

*Inspection of Boilers of Steam-boats.*

## Chap. 90.

Sec. 21. Inspectors should not in any case allow a greater compressive stress on the tube plates than 7,500 pounds, which is that used in the following formula;—

$$\frac{(D-d)T \times 15,000}{W \times D} = \text{Working Pressure.}$$

*after  
Julius 16/11/11*

D = Least horizontal distance between centres of tubes in inches.

d = Inside diameter of ordinary tube in inches.

T = Thickness of tube plate in inches.

W = Extreme width of combustion box in inches from front of tube plate to back of fire box, or distance between combustion box tube plates when boiler is double ended and the box common to the furnaces at both ends.

Sec. 22. When stays prevent an Inspector from getting inside a boiler, he must order their removal, and he must see them properly replaced before granting a certificate.

Removal and replacing of stays.

Sec. 23. In the case of zig-zag riveting through the plate diagonally between the rivets is equal to that horizontally between the rivets, when the diagonal pitch equals six tenths the horizontal pitch plus four tenths the diameter of the rivet.

In the case of zig-zag riveting.

Sec. 24. When the outside of the bottom of a boiler can not be otherwise perfectly inspected, the boiler should be lifted once at least in every four years.

When boiler should be lifted.

*Construction of Boilers.*

Sec. 25. (a.) When cylindrical boilers or the cylindrical parts of boilers composed of iron plates are made of the best material with all the rivet holes drilled in place and all the seams fitted with double butt straps, each of at least five eighths the thickness of the plates they cover, and all the seams at least double riveted with rivets having an allowance of not more than 75 per cent. over the single shear, and provided that the boilers have been open to inspection, then 5 may be used as the factor of safety. The tensile strength of the material is to be taken as equal to 47,000 lbs. per square inch with the grain, and 40,000 lbs. across the grain. When the above conditions are not complied with, the addition, in the following scale, must be added to the factor, according to the circumstances of each case:—

When 5 may be used as the factor of safety in cylindrical boilers composed of iron plates made of the best material, &c.

The tensile strength of the material, how computed.

A 15—To be added when all the holes are fair and good in the longitudinal seams, but drilled out of place after bending.

## Chap. 90.

*Inspection of Boilers of Steam-boats.*

Additions to be made to the factor when the above conditions are not complied with.

- B·3—To be added when all the holes are fair and good in the longitudinal seams, but drilled out of place before bending.
- C·3—To be added when all the holes are fair and good in the longitudinal seams, but punched after bending instead of drilled.
- D·5—To be added when all the holes are fair and good in the longitudinal seams, but punched before bending.
- E\*·75—To be added when all the holes are not fair and good in the longitudinal seams.
- F·1—To be added if the holes are all fair and good in the circumferential seams, but drilled out of place after bending.
- G·15—To be added if the holes are fair and good in the circumferential seams, but drilled before bending.
- H·15—To be added if the holes are fair and good in the circumferential seams, but punched after bending.
- I·2—To be added if the holes are fair and good in the circumferential seams, but punched before bending.
- J\*·2—To be added if the holes are not fair and good in the circumferential seams.
- K·2—To be added if double butt straps are not fitted to the longitudinal seams, and the said seams are lapped and double riveted.
- L·1—To be added if double butt straps are not fitted to the longitudinal seams, and the said seams are lapped and treble riveted.
- M·3—To be added if only single butt straps are fitted to the longitudinal seams, and the said seams are double riveted.
- N·15—To be added if only single butt straps are fitted to the longitudinal seams, and the said seams are treble riveted.
- O 1.—To be added when any description of joint in the longitudinal seams is single riveted.
- P‡·1—To be added if the circumferential seams are fitted with single butt straps and are double riveted.
- Q‡·2—To be added if the circumferential seams are fitted with single butt straps and are single riveted.
- R‡·1—To be added if the circumferential seams are fitted with double butt straps and are single riveted.
- S‡·1—To be added if the circumferential seams are lapped joints and are double riveted.
- T·2—To be added if the circumferential seams are lapped joints and are single riveted.
- U·25—To be added when the circumferential seams are lapped, and the strakes of plates are not entirely under or over.

For the maximum factor 1 rule on sec 43

*Inspection of Boilers of Steam-boats.*

Chap. 90.

V·3—To be added when the boiler is of such a length as to fire from both ends, or is of unusual length, such as flue boilers; and the circumferential seams are fitted as described opposite P., R. and S., but of course when the circumferential seams are as described opposite Q. and T., V·3 will become V·4.

W\*·4—To be added if the seams are not properly crossed.

X\*·4—To be added when the iron is in any way doubtful, and the Inspector is not satisfied that it is of the best quality.

Y†1·65—To be added if the boiler is not open to inspection during the whole period of its construction.

(b.) The strength of the joints is found by the following method :— Strength of joints, how found.

$$\frac{(\text{Pitch} - \text{Diameter of rivets}) \times 100}{\text{Pitch}} = \text{Percentage of strength of plate at joint as compared with the solid plate.}^{**}$$

$$\frac{(\text{Area of rivets} \times \text{No. of row of rivets}) \times 100}{\text{Pitch} \times \text{thickness of plate.}} = \text{Percentage of strength of rivets as compared with the solid plate.}^{\dagger\dagger}$$

(c.) Where marked \* the allowance may be increased still further if the workmanship or material is very doubtful or unsatisfactory. When allowance may be increased.

\*\* The maximum pitch of the rivets should not exceed  $\frac{1}{2}$  inches, and if in any case the Inspector finds the pitch in excess of this, he should report to the Chairman.

†† If the rivets are exposed to double shear, multiply the percentage as found by 1·75.

† When inspecting boilers that have not been open to inspection during construction the case should be submitted to the Chairman as to the factors to be used.

‡ P†1, Q†2, R†1, S†1, shall not apply to the end or circumferential seams, if such seams are sufficiently stayed by through bolts; nor to the seams between the square and round part of shell, in cylindrical boilers with square furnaces, when such seams are double riveted.

(d.) Then take iron as equal in tensile strength to 47,000 pounds per square inch and use the smallest of the two percentages as the strength of the joint, and adopt the factor of safety as found from the preceding scale :— Mode of finding pressure to be allowed on safety-valves.

$$\frac{47,000 \times \text{percentage of strength of joint} \times \text{twice the thickness of the plate in inches.}}{\text{Inside diameter of boiler in inches} \times \text{factor of safety.}} = \text{Pressure to be allowed per square inch on the safety-valves.}$$

(e.) Plates that are drilled in place must be taken apart and the burr taken off and the holes slightly countersunk from the outside. Plates drilled in place.

(f.) Butt straps must be cut from plates and not from bars, and must be of as good quality as the shell plate, and for the longitudinal seams must be cut across the fibre. Butt straps must be cut from plates.

## Chap. 90.

## Inspection of Boilers of Steam-boats.

Rivet holes.

(g.) The rivet holes may be punched or drilled when the plates are punched or drilled out of place, but when drilled in place, must be taken apart and the burr taken off and slightly countersunk from the outside.

Single butt straps.

(h.) When single butt straps are used and the rivet holes in them punched, they must be one eighth thicker than the plates they cover.

Diameter of rivets.

(i.) The diameter of rivets must not be less than the thickness of the plate of which the shell is made, but it will be found when the plates are thin, or when lap joints or single butt straps are adopted, that the diameter of the rivets should be in excess of the thickness of the plate.

Distance of rivet holes from edge.

(j.) The distance of the rivet holes from the end or edge of the plates shall not be less than the diameter of the rivets.

Dished ends, not hemispherical.

(k.) Dished ends that are not truly hemispherical must be stayed; if they are not theoretically equal in strength to the pressure needed they must be stayed as flat surfaces, but if they are theoretically equal in strength to the pressure needed the stays may have a strain of 10,000 lbs. per effective square inch of sectional area. *p. I have always been*

Strength of a sphere.

(l.) Inspectors will remember that the strength of a sphere to resist internal pressure is double that of a cylinder of the same diameter and thickness.

Neutral parts of boiler shells.

Sec. 26. (a.) The neutral parts of boiler shells under steam domes must be sufficiently stiffened and stayed.

Sides of boilers having square furnaces and half round tops.

(b.) The sides of boilers having square furnaces and half round tops must be stayed from side to side of the shell, over the furnace, one or more rows of these stays to be placed well above the centre of the cylindrical part.

Screw stays.

(c.) Screw stays are not to be used when supporting flat surfaces at any angle but a right angle to the surface supported, their diameter to be measured inside the thread.

Longitudinal seams.

(d.) The longitudinal seams in the cylindrical shell of boilers should be as far as possible from the bottom.

The inside diameter.

(e.) The inside diameter of the outside strake or course in the cylindrical shell of a boiler is to be taken as the measure of its diameter.

In cylindrical super-heaters the strength of joints and factor of safety, how found.

Sec. 27. (a.) In cylindrical super-heaters the strength of the joints and the factor of safety is found in a similar manner as for cylindrical boilers and steam receivers, but instead of using 47,000 pounds as the tensile strength of iron, 24,000 pounds is adopted, unless where the heat of flame impinges at or nearly at right angles to the plate, then 18,000 pounds is substituted.

Internal steam-pipes, how fitted.

(b.) In all cases the internal steam pipes should be so fitted that the steam in flowing to them will pass over all the plates exposed to the impact of heat or flame.

(c.) Super-heaters or water jackets should, as regards inspection, be deemed to be the most important part of the boilers, and must be inspected inside and outside; those that can not be entered, (on account of their size), must have a sufficient number of doors through which a thorough inspection of the whole of the interior can be made.

Super-heaters or water jackets must be inspected inside and outside.

(d.) Special attention should be paid to the inspection of super-heaters, as with high pressure the plates may become dangerously weak and not give any sound to indicate their state when tested with the hammer; the plate should, therefore, be occasionally drilled. Drain pipes must be in all cases fitted to super-heaters in which a collection of water in the bottom is possible.

Special attention to be given to the inspection of super-heaters.

(e.) Super-heaters that can be shut off from the main boiler must be fitted with a Government lock-up safety valve of sufficient size, but the least size passed shall not be less than two inches diameter.

Super-heaters to be fitted with lock-up safety valve.

Sec. 28. The areas of diagonal stays are found in the following way:—

Areas of diagonal stays, how found.

Find the area of a direct stay needed to support the surface, multiply this area by the length of the diagonal stay and divide the product by the length of a line drawn at right angles to the surface supported to the end of the diagonal stay, the quotient will be the area of the diagonal stay required.

Sec. 29. (a.) When the tops of combustion boxes or other parts of a boiler are supported by solid rectangular girders, the following formula, which is used by the Imperial Board of Trade, will be useful for finding the working pressure to be allowed on the girders, assuming that they are not subjected to a greater temperature than the ordinary heat of steam, and the ends fitted to the edges of the tube plate and the back plate of the combustion box:

When the tops of combustion boxes or other parts of a boiler are supported by solid rectangular girders, working pressure, how found.

$$\frac{C \times d^2 \times T}{(W-P) D \times L} = \text{Working Pressure.}$$

Formula.

W=Width of combustion box in inches.

P=Pitch of supporting bolts in inches.

D=Distance between the girders from centre to centre in inches.

L=Length of girder in feet.

d=Depth of girder in inches.

T=Thickness of girder in inches.

C=500 when the girder is fitted with one supporting bolt.

C=750 when the girder is fitted with two or three supporting bolts.

*See page 14  
rule 1909*

## Chap. 90.

*Inspection of Boilers of Steam-boats.*

C=850 when the girder is fitted with four supporting bolts.

Working pressure for supporting bolts.

(b.) The working pressure for the supporting bolts, and for the plate between them, shall be determined by the rule for ordinary stays.

Flat ends of boilers, &c., how to be fitted.

Sec. 30. The flat ends of all boilers, as far as the steam space extends, and the ends of super-heaters should be fitted with shield, or baffle plates, where exposed to the hot gases of the uptake, as all the plates subjected to the direct impact of heat or flame are liable to injury, unless covered with water.

Donkey boilers, to be inspected and fitted same as main boilers.

Sec. 31. Donkey boilers that are in any way attached to, or connected with the main boilers, or with the machinery used for propelling the ship, must be inspected and fitted the same way as the main boilers, and must have a water and steam gauge, and all other fittings complete, and as regards safety-valves must comply with the same regulations as the main boilers, and no safety-valve shall be passed less than two inches in diameter.

Escape of steam through safety-valve.

Sec. 32. (a.) No boiler or steam chamber is to be so constructed, fitted or arranged as that the escape of steam from it through the safety-valve can be wholly or partially intercepted by the action of any other valve.

Stop valve.

(b.) A stop valve must always be fitted between the boiler and the steam pipe, and (when two or more boilers are connected with a steam receiver or super-heater), between each boiler and super-heater or steam receiver. The object of this is obvious, viz., to avoid the failure of all the boilers through the failure of one. The necks of stop valves should be as short as practicable.

Each boiler must have its fittings complete.

Sec. 33. (a.) Each boiler must be fitted with glass water gauge, at least two test cocks, and steam gauge, that is to say, each boiler must be fitted with all the fittings as complete as if there was only one boiler.

Boilers that fire at both ends or are of unusual width.

(b.) Boilers that fire at both ends, and those of unusual width, must have water gauges and test cocks at each end or side, as the case may be. When a steamer has more than one boiler, and those boilers are fitted with stop valves, each boiler must be treated as a separate one, and have all the requisite fittings.

Inspectors, when not to sanction any new construction of marine steam-boilers.

Sec. 34. Inspectors shall be most careful not to give any official sanction to any new arrangement or construction of marine steam boilers, without first obtaining the permission of the Chairman in writing, nor shall they give any



written approval of any invention or arrangement unless by direction of the Chairman, and whenever they know that any invention or new arrangement is to be fitted to a vessel that is intended to have a passenger certificate, they shall as soon as possible obtain plans and specifications and submit the same to the Chairman.

Sec. 35. When the longitudinal seams in cylindrical furnaces are not welded or made with a butt strap, the following constants will be substituted for 90,000 :

- (a.) Furnaces with butt joints and drilled rivet holes. { 90,000 where the longitudinal seams are double riveted and fitted with single butt straps ; 80,000 where the longitudinal seams are single riveted and fitted with single butt straps ; 90,000 where the longitudinal seams are single riveted and fitted with double butt straps.
- (b.) Furnaces with butt joints and punched rivet holes. { 85,000 where the longitudinal seams are double riveted and fitted with single butt straps ; 75,000 where the longitudinal seams are single riveted and fitted with single butt straps ; 85,000 where the longitudinal seams are single riveted and fitted with double butt straps.
- (c.) Furnaces with lapped joints and drilled rivet holes. { 80,000 where the longitudinal seams are double riveted and bevelled ; 75,000 where the longitudinal seams are double riveted and not bevelled ; 70,000 where the longitudinal seams are single riveted and bevelled ; 65,000 where the longitudinal seams are single riveted and not bevelled.
- (d.) Furnaces with lapped joints and punched rivet holes. { 75,000 where the longitudinal seams are double riveted and bevelled ; 70,000 where the longitudinal seams are double riveted and not bevelled ; 65,000 where the longitudinal seams are single riveted and bevelled ; 60,000 where the longitudinal seams are single riveted and not bevelled.

Constants to be substituted for 90,000 when the longitudinal seams in cylindrical furnaces are not welded or made with a butt strap.

*all in*  
*rule*  
*35-1904*

*Steel Boilers.*

Sec. 36. (a.) The following rules should guide Inspectors when the general quality of the steel has been found suitable for marine boilers:—

Rules for the guidance of inspectors.

(b.) The steel makers or boiler makers should test one or more strips or pieces cut from each plate and bar for tensile strength and elongation, and stamp both results on each plate or bar. When practicable the plates or bars should be so stamped that the marks can be easily seen when the boiler is constructed.

One or more strips or pieces cut from each plate and bar should be tested.

## Chap. 90.

*Inspection of Boilers of Steam-boats.*

Inspector not obliged to witness test. (c.) An Inspector is not obliged to witness the foregoing test, but he should see that all the plates and bars are properly stamped.

Inspector may select any plates or bars in the boiler shop and require specimens to be tested. (d.) From the plates and bars, the tests of which have been stated to have been made by the steel maker, and not witnessed by the Inspector, the Inspector may, if he thinks it advisable, select any plates or bars after they are in the boiler shop and require specimens to be cut off and tested. If the results are not satisfactory, the whole of the plates, except those which were tested and found satisfactory by the Inspector, may be liable to be rejected.

25 per cent. of rivet bars should be tested. (e.) Twenty-five per cent. of the rivet bars should be tested for tensile strength and elongation, the tensile strength should be from 28 to 30 tons gross or 58,000 to 67,000 lbs. to the square inch, and the elongation in ten inches should not be less than 25 per cent.

Inspector may select a few rivets and see them tested. (f.) The Inspector may not in every case see some of the rivets tested, but he should occasionally select a few, and after they are prepared, see them tested. The tensile stress should be from 27 to 32 tons gross, or 62,000 to 72,000 lbs. to the square inch, with a contraction of area of 60 per cent. The elongation should when practicable be taken in length equal to two and a half times the diameter of the prepared part.

25 per cent. of the bars for stays of each size should be tested. (g.) Twenty-five per cent. of the bars for stays of each size should be tested, solid steel screw stays which have not been welded or otherwise worked after heating, may be allowed a working stress of 9,000 pounds to the square inch of net section, provided the tensile stress is from 27 to 32 tons gross, or 62,000 to 72,000 lbs. to the square inch, and the elongation in ten inches about 25 per cent, and not less than 20 per cent.

Steel stays welded in the fire. (h.) Steel stays which have been welded or worked in the fire have been found to be unreliable, therefore they should not be passed.

Original size of bars, how to be reduced. (i.) If the original size of the bars for rivets or stays be reduced before testing it should be done in the lathe or by a machine; test pieces of any kind should not be prepared by heating and drawing down.

When tests for tensile stress and elongation should be made. (j.) If for the plates from which the Inspectors select the above proportion, a greater stress is wished than is allowed for iron, tests for tensile stress and elongation should be made, also a few tempering and bending tests, and those for which no reduction of thickness is asked may be tested for resistance to bending and tempering only, if preferred in the latter case, the stress and elongation stamped on each plate should be reported by the Inspector to the Chairman, along with the result of the bending and tempering test.

*Inspection of Boilers of Steamboats.*

Chap. 90.

(k) The breadth of test strips for tensile stress should be about two inches, and the elongation, taken in the length of ten inches should be about 25 per cent., and not less than 20 per cent. The strips must be carefully prepared and measured, and they should be cut from the plate by a planing or shaping machine. The skin of the test pieces should not be removed by planing, shaping or otherwise, the edges only being planed or shaped, and in no case should the test pieces be prepared or reduced in size by hammering or otherwise working on the anvil, and they must not be annealed previous to being tested, neither must the plates or bars be annealed before the test pieces are cut from them.

Breadth of test strips for tensile stress.

Preparation, measurement and cutting of test strips

*W. H. P.*

(l.) The bending tests for plates not exposed to flame should be made with strips in their normal condition, and occasionally also some tempering test. Strips cut from furnaces, combustion boxes, &c., should be heated to a cherry red, then plunged into water of about 80 degrees and kept there until of the same temperature as the water and then bent. The bending and tempering strips should not be less than two inches broad and ten inches long, and they should be bent until they break, or until the sides are parallel at a distance from each other of not more than (3) three times the thickness of plate.

Bending tests for plates not exposed to flame, how to be made.

(m.) When full allowance over iron is wished, the tensile stress of the plates not exposed to flame should be not less than 27 tons gross or 62,000 lbs., and should not exceed 32 tons gross or 72,000 lbs., per square inch of section, and 27 tons gross, or 65,000 lbs. should be the stress used in the calculation for cylindrical shells, if the plates comply with all the conditions as stated herein; but when the minimum tensile strength of shell plate is not less than 28 tons gross or 63,000 lbs., and allowance is wished for the excess, then the case should be specially submitted for the consideration of the Chairman as to whether the stress in the calculation may be increased to 30 tons gross or to 67,000 lbs., the tensile strength of furnace, flanging, and combustion box plates may range from 26 tons gross or 58,000 lbs. to 30 tons gross or 67,000 lbs., to the square inch.

When full allowance over iron is wished, minimum of tensile strength not exposed to flame.

*W. H. P.*

(n) All plates that are punched, flanged or locally heated must be carefully annealed after being so treated.

Plates to be annealed.

(o.) The rivet holes in the furnaces and longitudinal seams of cylindrical shells should be drilled, but if it is wished to punch them and afterwards bore or anneal the plates in a proper furnace, the particulars of the punching and boring or annealing should be submitted to the Chairman for consideration before being done, but all punched holes should be made after bending.

Rivet holes to be drilled.

(p.) In all cases where assent has been given by the Chairman for plates to be punched after bending, and then

Plates to be punched must be stamped.

annealed, the maker of the boiler should stamp the plates with the words "punched after bending and then annealed," and in all cases where assent has been given for punching and afterwards boring plates the words "punched and then bored" should be stamped on the plates.

Rules for increasing the constants relating to flanging plates, &c.

(q.) If the flanging plates and those exposed to flame comply with the foregoing conditions, the constants in these rules for iron boilers may be increased as follows:—

1. The constants for flat surfaces, when they are supported by stays screwed into the plates and riveted, 10 per cent.

2. The constants for flat surfaces, when they are supported by stays screwed into the plates and nuted, or when the stays are nuted in the steam space, 25 per cent. This is also applicable to the constants for flat surfaces stiffened by riveted washers or doubling strips and supported by nuted stays.

3. The constants for combustion box girders, 10 per cent.

When the furnaces are new, corrugated and machine made and practically true circles, working pressure, how formed.

(r.) When the furnaces are new, corrugated and machine made and practically true circles, the working pressure is found by the following formula, provided that the plain parts at the ends do not exceed 6 inches in length and the plates are not less than  $\frac{5}{16}$  inch thick.

$$\frac{12,500 \times T}{D} = \text{Working pressure.}$$

T=Thickness in inches.

D=Mean diameter in inches.

(If the furnace is riveted in two or more lengths, the case should be submitted to the Chairman).

Maximum of compressive stress.

(s.) A greater compressive stress should not be allowed on tube plates than 10,000 lbs. to the square inch, which is that used in the following formula:—

$$\frac{(D-d) T \times 20,000}{W \times D} = \text{Working pressure.}$$

D=Least horizontal distance between centres of tubes in inches.

d=Inside diameter of ordinary tubes in inches.

T=Thickness of tube plate in inches.

W=Extreme width of combustion box in inches from front of tube plate to back of fire box, or distance between combustion box tube plates when boiler is double ended and the box common to the furnaces at both ends.

Minimum of rivet section, if of iron.

(t.) The rivet section, if of iron, in the horizontal seams of cylindrical shells, where lapped and at least double riveted, should not be less than  $\frac{1}{8}$  time the net plate section; but if steel rivets are used, their section should be at least  $\frac{2}{3}$  of the net section of the plate if the tensile stress of the rivet is not less than 27 tons gross or 62,000 lbs., or not

Minimum of rivet section, if of steel.

more than 32 tons gross or 72,000 lbs. per square inch. Therefore, in calculating the working pressure, the percentage strength of the rivet may be found in the usual way by the rules, but in the case of iron rivets the percentages found should be divided by  $\frac{1}{8}$ , and in the case of steel rivets by  $\frac{2}{3}$ , the result being the percentages required. If the percentage strength of the rivets by calculation is less than the calculated percentage strength of the plate, calculate the working pressure by both percentages. When using the percentage strength of the plate, use the nominal factor of safety suitable for the method of construction as by the rules for iron boilers, but when using the percentage strength of the rivets, use 5 as the factor of safety. The less of the two pressures so found is the working pressure to be allowed for the cylindrical portion of the shell, or otherwise in accordance with the formulæ in appendix.

Mode of calculating the working pressure.

(u.) Local heating of the plates should be avoided, as many plates have failed from being so treated.

Local heating of plates.

(v.) Steel plates which have been welded should not be passed if subject to a tensile stress, and those welded and subject to a compressive stress should be sufficiently annealed. In other respects the boiler should comply with the rules for iron boilers.

Welded steel plates, when not to be passed.

Sec. 37. In no case shall a certificate be granted for a boiler, when drift pins have been used in bringing the holes in the sheets together.

No certificate when drift pins used.

Sec. 38. Man-hole openings must be stiffened with compensating plates or rings of at least the same effective sectional area as the plate cut out, and in no case shall such plates or rings be of less thickness than the plate to which they are attached, nor the attachment of less strength than the plate or ring. All openings in the shells of boilers must have their short axes placed longitudinally.

Man-hole openings must be stiffened with compensating plates or rings.

Sec. 39. Every boiler, made after the coming into force of these Regulations, shall be stamped with the initial letters of the Inspector's name, who inspected and tested it, the year it was made and the pressure under which it was tested, also the actual working pressure allowed upon it.

Every boiler must be stamped with initials of Inspector's name, &c.

#### *Furnaces and Flues.*

Sec. 40. (a) The external working pressure to be allowed on plane circular steel furnaces and flues, when subjected to such pressure when the longitudinal joints are welded or made with a butt strap, shall be determined by the following formulæ:—

External working pressure, how determined.

$$o c - 50\frac{1}{2}$$

*alt*  
*1954*

(b.) The product of 90,000 multiplied by the square of the thickness of the plate in inches, divided by the length of the flue, or furnace, in feet, plus *one* multiplied by the diameter in inches, will be the allowable working pressure per square inch in pounds; provided it does not exceed that found by the following formula:—

(c.) The product of 10,000 multiplied by the thickness of the plate in inches, divided by the diameter (outside) of the flue or furnace, in inches, will be the allowable working pressure per square inch in pounds.

#### *Corrugated Steel Furnaces and Flues.*

*alt*

Working pressure in steel flue furnaces when new, corrugated and machine made, and practically true circles, show found.

Sec. 41. (a) In steel flue furnaces when new, corrugated, and machine made, and practically true circles, the working pressure is found by the following formula, provided that the plane parts at the ends do not exceed 6 inches in length and the plates are not less than  $\frac{5}{16}$  inch thick.

$$\frac{12,500 \times \text{thickness in inches}}{\text{Mean diameter in inches}} = \text{Working pressure per square inch.}$$

(b) When the furnaces are riveted in two or more lengths the case should be submitted to the Chairman for consideration, as it may be necessary to make a reduction.

#### *Corrugated Iron Furnaces.*

Working pressure for corrugated iron furnaces practically circular and machine made.

Sec. 42. The working pressure for corrugated iron furnaces practically circular and machine made, provided the plane parts at the ends do not exceed 6 inches in length and the plates are not less than  $\frac{5}{16}$  inch thick, should not be greater than that found by the following formula:—

$$\frac{10,000 \times \text{thickness in inches}}{\text{Mean diameter in inches}} = \text{Working pressure.}$$

#### *Cylindrical Boiler Shells.*

### APPENDIX.

#### JOINTS WITH DRILLED HOLES.

Ordinary chain riveted and ordinary zig-zag riveted joints.

Sec. 43. Formulæ for ordinary chain riveted and ordinary zig-zag riveted joints, and for joints of these descriptions, when every alternate rivet in the outer or in the outer and inner rows have been omitted:—

Let E = distance from edge of plate to centre of rivet in inches.

V = distance between rows of rivets in inches.

V<sub>1</sub> = distance between inner and middle row of rivets in inches for joint J.

- B = boiler pressure in lbs. per square inch.  
 C = 1 for lap or single butt joints.  
     = 1.75 for double butt joints.  
 d = diameter of rivets in inches.  
 D = inside diameter of boiler in inches.  
 F = factor of safety for shell plates, as by section 25 of these regulations.  
 n = number of rivets in one pitch.  
 p<sub>d</sub> = diagonal pitch in inches.  
 P<sub>d</sub> = diagonal pitch in inches between inner and middle rows of rivets in inches for joint J.  
 p = greatest pitch of rivets in inches.  
 r = percentage of plate left between holes in greatest pitch.  
 R = percentage of rivet section.  
 R<sub>1</sub> = percentage of combined plate and rivet section.  
 S = tensile strength of material in lbs. per square inch of section.  
 T = thickness of plate in inches.  
 T<sub>1</sub> = thickness of each butt strap in inches.  
 o<sub>10</sub> = least value of r, R, R<sub>1</sub>, as the case may be, divided by 100.

When joints are used in boiler construction other than those shown in the attached sketches, or when any of the rivets are less than two diameters apart, the particulars of such joints should be submitted for the consideration of the Board.

ORDINARY CHAIN AND ZIG-ZAG RIVETED JOINTS.

Iron plates and iron rivets or steel plates and steel rivets:—

$$\frac{100(p-d)}{p} = r.$$

Iron plates and iron rivets:—

$$\frac{100 \times d^2 \times .7854 \times n \times C}{p \times T} = R.$$

Steel plates and steel rivets:—

$$\frac{100 \times 23 \times d^2 \times .7854 \times n \times C \times F}{5 \times 28 \times p \times T} = R.$$

GIVEN C, d, F, n, T, TO FIND p, SO THAT r AND R ARE EQUAL.

Iron plates and iron rivets:—

$$\frac{d^2 \times .7854 \times n \times C}{T} + d = p.$$

Steel plates and steel rivets:—

$$\frac{23 \times d^2 \times .7854 \times n \times C \times F}{5 \times 28 \times T} + d = p.$$

GIVEN C, F,  $n$ , T,  $r$ , TO FIND  $p$  AND  $d$ .

Iron plates and iron rivets :—

$$\frac{r \times T}{(100 - r) \times .7854 \times n \times C} = d.$$

$$\frac{100 \times r \times T}{(100 - r)^2 \times .7854 \times n \times C} = p.$$

Steel plates and steel rivets :—

$$\frac{5 \times 28 \times r \times T}{23 \times (100 - r) \times .7854 \times n \times C \times F} = d.$$

$$\frac{100 \times 5 \times 28 \times r \times T}{23 \times (100 - r)^2 \times .7854 \times n \times C \times F} = p.$$

Iron plates and iron rivets or steel plates and steel rivets when  $d$  is found first, then :—

$$\frac{100 d}{100 - r} = p$$

Iron plates and iron butt straps or steel plates and steel butt straps :—

Double butt straps :—

$$\frac{5 \times T}{8} = T_1.$$

Single butt straps :—

$$\frac{9 \times T}{8} = T_1.$$

FOR DISTANCE BETWEEN ROWS OF RIVETS, &c.

Iron and steel :—

$$\frac{3 \times d}{2} = E.$$

Chain riveted joints not less than :—

$$2 \times d = V.$$

(See NOTE (a), below)

Zig-zag riveted joints :—

$$\frac{\sqrt{(11p + 4d)(p + 4d)}}{10} = V.$$

Diagonal pitch :—

$$\frac{6p + 4d}{10} = p_p.$$

TO DETERMINE THE WORKING PRESSURE.

$$\frac{S \times .10 \times 2 T}{F \times D} = B.$$



## ORDINARY CHAIN AND ZIG-ZAG RIVETED JOINTS

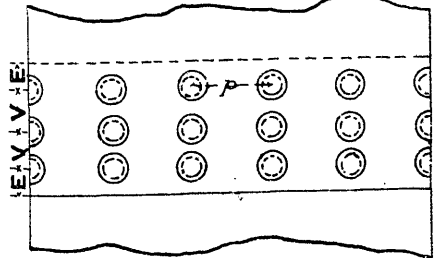
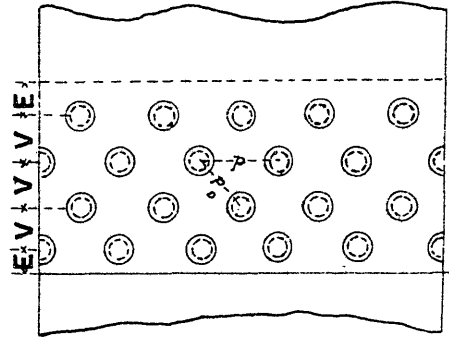
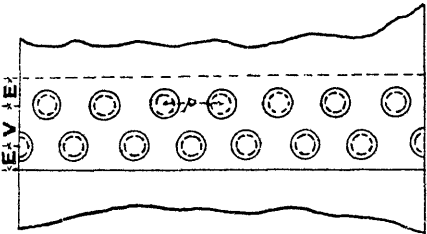
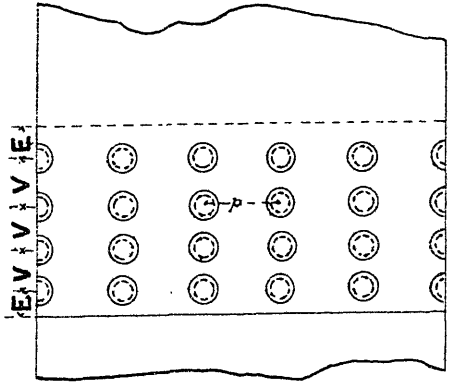
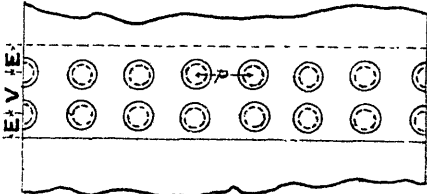
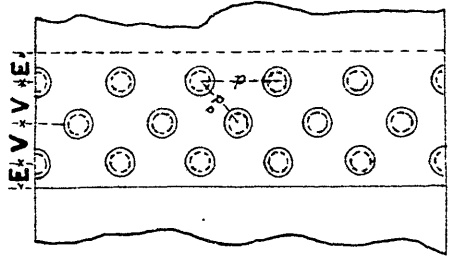
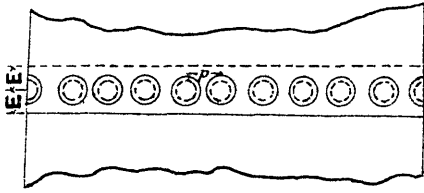

*ORDINARY CHAIN AND ZIG-ZAG RIVETED JOINTS - Continued.*

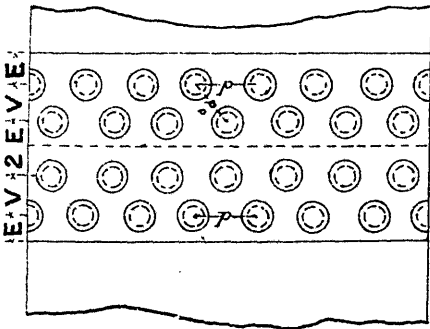
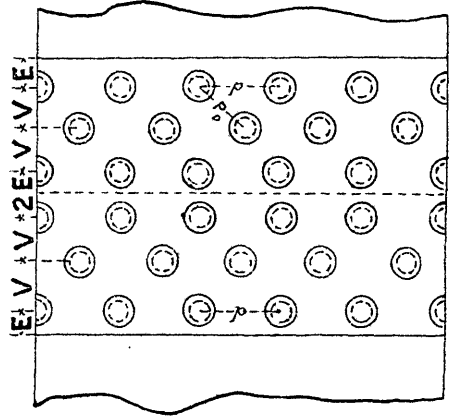
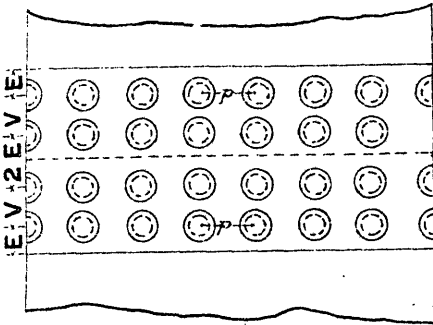
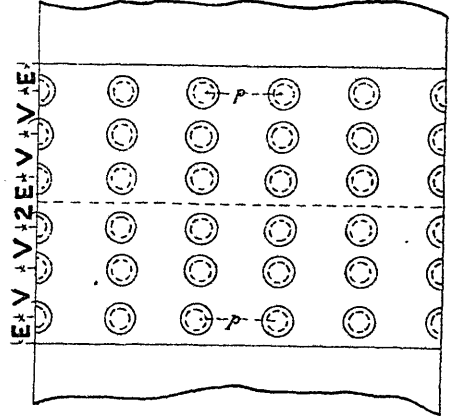
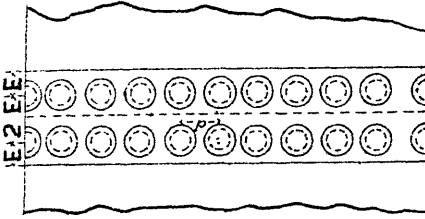

CHAIN AND ZIG-ZAG RIVETED JOINTS IN WHICH EVERY ALTERNATE RIVET HAS BEEN OMITTED IN THE OUTER ROW, OR IN THE OUTER AND THE INNER ROWS SUCH AS ARE SHOWN BY THE FOLLOWING SKETCHES.

Iron plates and iron rivets or steel plates and steel rivets;—

$$\frac{100(p-d)}{p} = r$$

Iron plates and iron rivets:—

$$\frac{100 \times d^2 \times .7854 \times n \times C}{\times T} = R.$$

Steel plates and steel rivets:—

$$\frac{100 \times 23 \times d^2 \times .7854 \times n \times C \times F}{5 \times 28 \times p \times T} = R.$$

Iron plates and iron rivets or steel plates and steel rivets:—

$$\frac{100(p-2d)}{p} + \frac{R}{n} = R_1.$$

For iron lap joints of this description the diameter of the rivet should not be less than:—

$$\frac{T}{.7854} = d.$$

For steel lap joints of this description the diameter of the rivet should not be less than:—

$$\frac{T \times 28 \times 5}{.7854 \times 23 \times F} = d.$$

*all*

**JOINTS FITTED WITH SINGLE OR DOUBLE BUTT STRAPS.**

Where the number of rivets in the inner row is double the number in the outer row.

Iron plates and iron butt-straps or steel plates and steel butt-straps.

Double butt-straps:—

$$\frac{5 \times T(p-d)}{8 \times (p-2d)} = T_1.$$

Single butt-straps —

$$\frac{9 \times T(p-d)}{8 \times (p-2d)} = T_1.$$

When the number of rivets in the inner row is the same as in the outer row.

Double butt-straps:—

$$\frac{5 \times T}{8} = T_1.$$

Single butt-straps:—

$$\frac{9 \times T}{8} = T_1.$$

## FOR DISTANCE BETWEEN ROWS OF RIVETS, &amp;c.

Iron and steel :—

$$\frac{3 \times d}{2} = E.$$

Chain riveted joints :—

$$\sqrt{\frac{(11p + 4d)(p + 4d)}{10}} = V \quad \left. \begin{array}{l} \text{The greater of these} \\ \text{two values of } V \text{ to} \\ \text{be used, (See NOTE} \\ \text{(a), below)} \end{array} \right\}$$

or  $2 \times d = V.$

For joint K.:—

$$2 \times d = V_1. \quad (\text{See NOTE (a), below.})$$

Zig-zag riveted joints :—

$$\sqrt{\left(\frac{11}{2}p + d\right)\left(\frac{1}{2}p + d\right)} = V.$$

Diagonal pitch :—

$$\frac{3}{10}p + d = p_D.$$

For joint J.:—

$$\frac{\sqrt{(11p + 8d)(p + 8d)}}{20} = V_1.$$

Diagonal pitch :—

$$\frac{3p + 4d}{10} = P_D.$$

## TO DETERMINE THE WORKING PRESSURE.

$$\frac{S \times \frac{1}{2} \times 2T}{F \times D} = B.$$

NOTE(a).—The minimum value of  $V$  or  $V_1$  for chain riveted joints is given as  $2d$ ,

$$\text{but } \frac{4d + 1}{2}, \text{ is more desirable.}$$

*Inspection of Boilers of Steam-boats.*

Chap. 90.

*Safety-Valves.*

*See page 58*  
*Chap. 90*

Sec. 44. (a) The boiler of every steamboat shall be fitted with one, or more, locked-up safety-valves, the area of which, or the joint area, shall not be less than half a square inch for each square foot of grate surface in or under the boiler. In all cases the safety-valves should be upon the boiler, or as near as possible to it.

The boiler of every steam-boat shall be fitted with locked up safety valves.

(b.) Safety-valves should not be passed less than two inches in diameter; except in the case of small boilers when the area of grate surface is less than six square feet, when safety-valves of less diameter may be used; but in no case shall their diameter be less than one inch; and provided the above proportion of area of safety-valve to area of grate be complied with.

Diameter of safety-valves.

Sec. 45. (a.) Inspectors are instructed that in all new boilers and whenever alterations can be easily made the valve chest should be placed directly on the boiler, and the neck or part between the chest and the flange which bolts on to the boiler should be as short as possible, and be cast in one with the chest.

Position and construction of valve chest.

(b.) In any case in which an inspector is of opinion that it is positively dangerous to have a length of pipe between the boilers and the safety-valve chest, he shall at once insist on the requisite alterations being made before granting a certificate.

Pipe between boiler and safety-valve chest.

(c.) Inspectors shall fix the limit of the weight to be placed on the safety-valves, and shall satisfy themselves that the boilers are in their judgment sufficient with the weight so placed.

Limit of weight on safety-valves

(d.) Care should be taken that the safety-valves have a lift equal to at least one fourth their diameter, that the area of the inlet and outlet openings for the passage of steam be not less than the area of the valve; where lever valves are used the distance between the centre of the valve and the centre of the fulcrum should not be less than the diameter of the valve.

Lift of safety-valves and area of openings for passage of steam.

(e.) The size of the steel of which the spring is made in spring safety-valves is found from the following formula taken from the Imperial Board of Trade Rules:—

Size of steel in spring safety-valves.

$$3\sqrt{\frac{S \times D}{c}} = d$$

c = 8,000 for round steel.

c = 11,000 for square steel.

S = the load on the spring in pounds.

D = the diameter of the spring. (from centre to centre of wire in inches).

*Duties and Liabilities of Engineers.*

## RULES.

Engineers to report to owner and to Inspector, any defects of boilers and machinery. Report to Inspector, of accident happening. Accountability of chief engineer of a steamer. Engineer of steamer, at least once a year, shall satisfy himself that boiler connections are in proper condition. Engineer to exhibit certificate with copy of rules.

Sec. **46.** (a.) Engineers when laying up a steamer in the autumn, or when finally leaving her, are required to report to the owner, and also to the Inspector of the nearest district, any defects of, or injury to, the boilers and machinery by which the safety of the same may be endangered. They shall also report to the Inspector of the district at which the steamer next arrives, any accident happening to the boilers or machinery during the trip, and in case of omission to make such report, the license of the engineer so omitting shall be revoked.

(b.) The chief engineer of a steamer will be held accountable by the Department of Marine for the proper care and management of the boilers and machinery under his charge. He is, therefore, in no case to absent himself from the vessel while on her regular trips, unless a competent substitute be provided to fill his place during his absence.

(c.) Engineers on first taking charge of a steamer, and at least once a year thereafter, shall satisfy themselves by close examination that the braces, stays and pins of the boiler are in good order, and sufficient for the strain to which they may be subjected; they shall also satisfy themselves that the safety-valves are in good working order and sufficient for the requirements of clause (a) of section 44.

(d.) Engineers are to exhibit their certificates in the engine room along with a copy of these rules, that is to say, sections 46 and 47, when required to do so.

*Management of Boilers.*

Getting up steam. Sec. **47.** (a.) Getting up steam.—Warm the boiler gradually. Steam should not be raised from cold water in less than four hours. If practicable light the fires over night. By getting up steam too quickly the boiler will soon be destroyed.

Firing. (b.) Firing.—Fire regularly. Keep the sides up, and use the slice gently and as seldom as possible.

Feed water. (c.) Feed water.—Let the feed be regular and constant.

Glass gauge and try cocks. (d.) Glass gauge and try cocks.—Keep the glass free and try the gauge cocks every fifteen minutes.

## PART TWO.

Regulations governing the inspection and testing of boilers now in existence and of boilers now or hereafter to be manufactured, in Canada, for the use of steam-boats, whenever in the opinion of the Inspector the regulations contained in Part One of this order are, on account of the make of such boilers, or for some other reason, not capable of application in the testing thereof; pro-

vided that in every such case the Inspector shall issue his certificate, in which he shall state that his inspection has been made under Part Two of this order.

*Mode of Inspection.*

Sec. 48. Any inspector may, whenever he deems it necessary so to do, and one Inspector shall, at least once in every year, subject the boiler of every steam-boat to a test by hydrostatic pressure, and shall satisfy himself by examination and experimental trials that such boiler is well made of good and suitable materials; the limit of such pressure shall be in the ratio of one hundred and fifty pounds to one hundred pounds allowable as a working pressure; for the purposes of such test the owner of the steam-boat shall provide the necessary hand-pump and apparatus, and the same shall be worked by the crew of the steam-boat: and no Inspector shall make or deliver to the owner or master of any steam-boat, any certificate unless he has first subjected the boiler of such steam-boat to such test by hydrostatic pressure.

The boiler of every steam-boat shall be subjected to a test by hydrostatic pressure at least once a year.

Owner shall provide necessary apparatus and help.

Certificate shall not be granted till boiler tested.

*20 pages  
32 1904*

*2c  
44.*

Sec. 49. Before a boiler is subjected to a test by hydrostatic pressure, it shall be opened up for inspection, the man-hole doors and mud-plates removed, and the outside and inside of the boiler cleaned, the furnace grates removed and the furnace swept out clean, so that satisfactory and efficient inspection may be made; when bulkheads are so placed as to prevent a close examination of the plates of the boiler, they shall be removed; and the owner or master of the steam-boat shall see that the foregoing requirements are complied with before applying for inspection.

Before boiler is tested it shall be opened up for inspection.

*45*

Sec. 50. In any case in which the test is not satisfactory, the defects shall be made good and the boiler re-tested satisfactorily before a certificate is granted.

When boiler shall be re-tested.

*46*

Sec. 51. When the outside of the bottom of a boiler cannot be otherwise perfectly inspected, the boiler shall be lifted for inspection once at least in every four years.

When boiler shall be lifted for inspection.

*47*

Sec. 52. In subjecting boilers made of iron plates to the hydrostatic test aforesaid, the Inspector shall assume one hundred pounds to the square inch as the maximum pressure allowable as a working power for a new boiler forty-two inches in diameter, made of the best refined iron, at least one quarter of an inch thick, in the best manner and of the quality herein required,—and shall rate the working pressure of all iron boilers, whether of greater or less diameter, according to their strength compared with this standard; and in all such cases the test applied shall exceed

In subjecting boilers made of iron plates to the hydrostatic test, Inspector shall assume 100 lbs to the square inch as the maximum pressure.

*48*

## Chap. 90.

*Inspection of Boilers of Steam-boats.*

the working pressure allowed, in the ratio of one hundred and fifty pounds to one hundred, using the water in such tests at a temperature not exceeding sixty degrees Fahrenheit.

In subjecting boilers made of steel to the hydrostatic test, Inspector shall assume 125 lbs. as the maximum pressure.

Sec. 53. In subjecting boilers made of steel to the hydrostatic test aforesaid, the Inspector shall assume one hundred and twenty-five pounds as the maximum pressure allowable as a working power for a new boiler forty-two inches in diameter, made in the best manner of the best quality of steel plates, at least one quarter of an inch thick, with all the rivet holes drilled in place, the plates being then taken apart and the burrs removed, the longitudinal seams in the shell being fitted with double butt steel straps cut across the grain of the plate, and each of five eighths the thickness of the plates they cover, and all the seams being at least double riveted and having at least seventy per cent. of the strength of the solid plate, and all the flat surfaces stayed in the best manner and all the seams double riveted,—and they shall rate the working pressure of all steel boilers so made, whether of greater or less diameter, according to their strength compared with this standard; and in all such cases the test applied shall exceed the working pressure allowed for such boilers in the ratio of one hundred and eighty-seven and a half pounds to one hundred and twenty-five pounds, using the water in such tests at a temperature not exceeding sixty degrees Fahrenheit.

Inspector may, for certain reasons, to be stated in his certificate, fix the working pressure at two thirds of the test pressure.

Sec. 54. If the Inspector is of opinion that any boiler, whether made of iron or steel plates, by reason of its construction or material, will not safely allow so high a working pressure as that hereinbefore specified for each such description of boiler respectively, he may, for reasons to be stated specifically in his certificate, fix the working pressure of such boiler at less than two thirds of the test pressure.

Discretion allowed to Inspector as to working pressure.

Sec. 55. The foregoing rules shall be observed in all cases, unless the proportion between such boilers and the cylinders, or some other cause, renders it manifest that their application would be unjust,—in which case the Inspector may depart from the said rules if it can be done with safety; but in no case shall the working pressure allowed exceed the proportion hereinbefore mentioned, as compared with the hydrostatic test.

External working pressure on flues, &c., how determined.

Sec. 56 (a.) The external working pressure to be allowed on plane circular iron furnaces and flues subjected to such pressure, when the longitudinal joints are welded or made with a butt strap, shall be determined by the following formula:—



*Inspection of Boilers of Steam-boats.*

Chap. 90.

(b.) The product of 99,000 multiplied by the square of the thickness of the plate in inches,—divided by the length of the flue or furnace in feet plus 1, multiplied by the diameter in inches,—shall be the allowable working pressure per square inch in pounds,—provided it does not exceed that found by the following formula :—

Formula.

(c.) The product of 8,000 multiplied by the thickness of the plate in inches, divided by the diameter of the furnace or flue in inches, shall be allowable working pressure per square inch in pounds,—

Formula..

(d.) The length of the furnace to be used in the first formula being the distance between the rings, if the furnace is made with rings; and that one of the two formulae which gives the lowest pressure being the one by which the Inspector shall be guided.

Length of furnace, how understood.

Sec. 57. On flat surfaces the allowable working pressure shall not exceed six thousand pounds to each effective square inch of sectional area of the stays supporting it; the pressure to be allowed on plates forming flat surfaces shall be that found by the following formula :—

Allowable working pressure on flat surfaces.

1904  
S-S

$$\frac{C \times (T + 1)^2}{S - 6} = \text{Working pressure in pounds per square inch, where—}$$

Formula.

- T=Thickness of plate in sixteenths of an inch ;
- S=Surface supported in square inches ;
- C=100; but when the plates are exposed to the impact of heat or flame, and steam only is in contact with the plates on the opposite side, C is to be reduced to 50.

alt?  
S-S  
65

Sec. 58. In order to satisfy himself as to the strength and condition of a boiler, the Inspector may, if he deems it necessary, order holes to be cut in it, and may also demand that such information shall be furnished him in respect to the interior construction of the boiler as will enable him to judge correctly of its strength.

Interior condition of boiler, how to be ascertained.

S-4

Sec. 59. In no case shall a certificate be granted for a boiler when drift pins have been used in bringing the holes in the sheets together.

Drift pins not to be used.

S-5

Sec. 60. Man-hole openings shall be stiffened with compensating rings of at least the same effective sectional area as the plate cut out, and in no case shall such rings be of less thickness than the plates to which they are attached; all openings in the shells of cylindrical boilers shall have their short axes placed longitudinally.

Man-hole openings.

Openings in shells.

S-6

## Chap. 90.

*Inspection of Boilers of Steam-boats.*

Hanging stays to crown sheet of boilers.

57

Sec. 61. When bars or angle irons are used for sustaining the crown sheet of the furnace of a boiler, three fifths of the working pressure allowable upon the crown sheet shall be sustained by hanging stays from the shell of the boiler attached to the crown sheet.

Donkey boilers.

58

Sec. 62. Donkey boilers on steam-boats shall be provided with a safety-valve, which may be locked up.

Reduction in the working pressure for single rivetted shells.

59

Sec. 63. Boilers in which the longitudinal seams in the cylindrical shell are single riveted, in place of being double riveted, shall be subject to a reduction in the working pressure allowable for a boiler made in the best manner (as prescribed by sections 52 and 53 of these regulations and the limit of pressure in boilers so made shall not exceed eighty pounds to the square inch in place of one hundred pounds or one hundred and twenty-five pounds, as mentioned in the said sections.

Mark or name of maker of plates to be stamped thereon.

60

Maker and quality of plates to be sworn to.

In case of decrease of maker or other cause.

Sec. 64. No boiler made and placed on board shall be made of boiler plate, whether iron or steel, which has not been stamped with the mark or name of the maker thereof; and no certificate shall be granted with respect to any boiler made wholly or in part of plate not so marked; and before a certificate shall be granted with respect to any boiler, a declaration on oath by the maker of the boiler, stating the name of the maker of the plates, their quality, and the quality of all materials used in the construction thereof, shall be furnished to the Inspector; such oath may be taken before any justice of the peace in Canada, or before a notary public, and certified under his official seal, if taken out of Canada: Provided always, that in any case where such declaration on oath by the maker of the boiler cannot be obtained owing to the death of the maker, or from other cause deemed sufficient by the Inspector, the affidavit of two practical boiler makers who have examined the boiler and reported upon the quality of the materials in it and its workmanship and strength, shall, if satisfactory to the Inspector, be deemed sufficient in lieu of such declaration by the maker of the boiler.

During construction of boiler, Inspector to be notified.

61

Sec. 65. During the construction of every boiler made in Canada, the maker of such boiler shall notify the Inspector of the district in which it is being made, that it is open to his inspection, and shall, at all times during such construction, allow the Inspector access to such boiler.

Sec. 66. No boiler or pipe shall be approved which is made in whole or in part of bad material, or is unsafe in its form, or dangerous from defective workmanship, age, use or any other cause.

When boiler or pipe shall not be approved.

62

*Construction of Boilers.*

Sec. 67. (a.) When cylindrical boilers or the cylindrical parts of boilers composed of iron plates are made of the best material with all the rivet holes drilled in place and all the seams fitted with double butt straps, each of at least five eighths the thickness of the plates they cover, and all the seams at least double riveted with rivets having an allowance of not more than 75 per cent. over the single shear, and provided that the boilers have been open to inspection during the whole period of construction, then 4 may be used as the factor of safety. The tensile strength of the material is to be taken as equal to 48,000 lbs. per square inch with the grain, and 42,000 lbs. across the grain. When the above conditions are not complied with, the addition, in the following scale, must be added to the factor according to the circumstances of each case.

When 4 may be used as the factor of safety in cylindrical boilers or parts of boilers composed of iron plates made of the best materials &c.

The tensile strength of the material, how computed.

63

See Rules 1904

- A·15—To be added when all the holes are fair and good in the longitudinal seams, but drilled out of place after bending.
- B·3—To be added when all the holes are fair and good in the longitudinal seams, but drilled out of place before bending.
- C·3—To be added when all the holes are fair and good in the longitudinal seams, but punched after bending instead of drilled.
- D·5—To be added when all the holes are fair and good in the longitudinal seams, but punched before bending.
- E\*·75—To be added when all the holes are not fair and good in the longitudinal seams.
- F·1—To be added if the holes are all fair and good in the circumferential seams, but drilled out of place after bending.
- G·15—To be added if the holes are fair and good in the circumferential seams, but drilled before bending.
- H·15—To be added if the holes are fair and good in the circumferential seams, but punched after bending.
- I·2—To be added if the holes are fair and good in the circumferential seams, but punched before bending.
- J\*·2—To be added if the holes are not fair and good in the circumferential seams.
- K·2—To be added if double butt straps are not fitted to the longitudinal seams, and the said seams are lap and double riveted.

Additions to be made to the factor when the above conditions are not complied with.

- L·1—To be added if double butt straps are not fitted to the longitudinal seams, and the said seams are lap and treble riveted.
- M·3—To be added if only single butt straps are fitted to the longitudinal seams and the said seams are double riveted.
- N·15—To be added if only single butt straps are fitted to the longitudinal seams, and the said seams are treble riveted.
- O 1—To be added when any description of joint in the longitudinal seams is single riveted.
- P†·1—To be added if the circumferential seams are fitted with single butt straps and are double riveted.
- Q†·2—To be added if the circumferential seams are fitted with single butt straps and are single riveted.
- R†·1—To be added if the circumferential seams are fitted with double butt straps and are single riveted.
- S†·1—To be added if the circumferential seams are lap joints and are double riveted.
- T·2—To be added if the circumferential seams are lap joints and are single riveted.
- U·25—To be added when the circumferential seams are lap, and the strakes of plates are not entirely under or over.
- V·3—To be added when the boiler is of such a length as to fire from both ends, or is of unusual length, such as flue boilers; and the circumferential seams are fitted as described opposite P., R. and S., but of course when the circumferential seams are as described opposite Q. and T., V·3 will become V·4.
- W\*·4—To be added if the seams are not properly crossed.
- X\*·4—To be added when the iron is in any way doubtful, and the Inspector is not satisfied that it is of the best quality.
- Y† 1—To be added if the boiler is not open to inspection during the whole period of its construction.

(b.) The strength of the joints is found by the following method :--

$$\frac{(\text{Pitch} - \text{Diameter of rivets}) \times 100}{\text{Pitch}} = \text{Percentage of strength of plate at joint as compared with the solid plate.}$$

$$\frac{(\text{Area of rivets} \times \text{No. of rows of rivets}) \times 100}{\text{Pitch} \times \text{thickness of plate.}} = \text{Percentage of strength of rivets as compared with the solid plate. ††}$$

(c.) Where marked \* the allowance may be increased still further if the workmanship or material is very doubtful or unsatisfactory.

†† If the rivets are exposed to double shear multiply the percentage as found by 1·75.

† When surveying boilers that have not been open to inspection during construction the case should be submitted to the Chairman as to the factors to be used.

Strength of joints, how found.

When allowance may be increased.

¶1, Q† 2, R† 1, S† 1, shall not apply to the end or circumferential seams, if such seams are sufficiently stayed by through bolts; nor to the seams between the square and round part of shell, in cylindrical boilers with square furnaces, when such seams are double riveted.

(d.) Then take iron as equal in tensile strength to 48,000 lbs. per square inch and use the smallest of the two percentages as the strength of the joint, and adopt the factor of safety as found from the preceding scale :

$$\frac{(48,000 \times \text{percentage of strength of joint}) \times \text{twice the thickness of the plate in inches}}{\text{Inside diameter of boiler in inches} \times \text{factor of safety.}}$$

= Pressure to be allowed per square inch on the safety-valves.

(e.) For steel plates of the best quality the tensile strength may be taken as equal to 60,000 lbs. per square inch, using the same factor of safety.

(f.) Plates that are drilled in place must be taken apart and the burr taken off and the holes slightly countersunk from the outside.

(g.) Butt straps must be cut from plates and not from bars, and must be of as good quality as the shell plates, and for the longitudinal seams must be cut across the fibre.

(h.) The rivet holes may be punched or drilled when the plates are punched or drilled out of place, but when drilled in place must be taken apart and the burr taken off and slightly countersunk from the outside.

(i.) When single butt straps are used and the rivet holes in them punched they must be one eighth thicker than the plates they cover.

(j.) The diameter of rivets must not be less than the thickness of the plates of which the shell is made, but it will be found when the plates are thin, or when lap joints or single butt straps are adopted that the diameter of the rivets should be in excess of the thickness of the plates.

(k.) The distance of the rivet holes from the ends or edge of the plates shall not be less than the diameter of the rivet.

(l.) Dished ends that are not truly hemispherical must be stayed; if they are not theoretically equal in strength to the pressure needed they must be stayed as flat surfaces, but if they are theoretically equal in strength to the pressure needed the stays may have a strain of 10,000 lbs. per effective square inch of sectional area.

(m.) Inspectors will remember that the strength of a sphere to resist internal pressure is double that of a cylinder of the same diameter and thickness.

Sec. 68. (a.) The neutral parts of boiler shells under steam domes must be sufficiently stiffened and stayed.

(b.) The sides of boilers having square furnaces and half round tops must be stayed from side to side of the shell,

64

## Chap. 90.

*Inspection of Boilers of Steam-boats.*

- over the furnace, one or more rows of these stays to be placed well above the centre of the cylindrical part.
- Screw stays. (c.) Screw stays are not to be used when supporting flat surfaces at any angle but a right angle to the surface supported, their diameter to be measured inside the thread.
- Longitudinal seams. (d.) The longitudinal seams in the cylindrical shell of boilers should be as far as possible from the bottom.
- The inside diameter. (e.) The inside diameter of the outside strake or course in the cylindrical shell of a boiler is to be taken as the measure of its diameter.
- 65 In cylindrical super-heaters, the strength of joints and factor of safety, how found. Sec. 69. (a.) In cylindrical super-heaters the strength of the joints and the factor of safety is found in a similar manner as for cylindrical boilers and steam receivers, but instead of using 48,000 lbs. as the tensile strength of iron 24,000 lbs. is adopted unless where the heat or flame impinges at or nearly at right angles to the plate, then 18,000 lbs. is substituted.
- Internal steam pipes, how fitted. (b.) In all cases the internal steam pipes should be so fitted that the steam in flowing to them will pass over all the plates exposed to the impact of heat or flame.
- Super-heaters or water jackets must be inspected inside and outside. (c.) Super-heaters or water jackets should, as regards inspection, be deemed to be the most important part of the boilers and must be inspected inside and outside; those that cannot be entered (on account of their size) must have a sufficient number of doors through which a thorough inspection of the whole of the interior can be made.
- Special attention to be given to the inspection of super-heaters. (d.) Special attention should be paid to the inspection of super-heaters, as with high pressure the plates may become dangerously weak and not give any sound to indicate their state when tested with the hammer; the plate should therefore be occasionally drilled. Drain pipes must be in all cases fitted to super-heaters in which a collection of water in the bottom is possible.
- Super-heaters to be fitted with lock-up safety valve. (e.) Super-heaters that can be shut off from the main boilers must be fitted with a Government lock-up safety valve of sufficient size, but the least size passed shall not be less than 3 inches diameter.

Areas of diagonal stays, how found.

Sec. 70. The areas of diagonal stays are found in the following way:

66 Find the area of a direct stay needed to support the surface, multiply this area by the length of the diagonal stay and divide the product by the length of a line drawn at right angles to the surface supported to the end of the diagonal stay, the quotient will be the area of the diagonal stay required.

67 Sec. 71. (a.) When the tops of combustion boxes or other parts of a boiler are supported by solid rectangular

girders, the following formula, which is used by the Imperial Board of Trade, will be useful for finding the working pressure to be allowed on the girders, assuming that they are not subjected to a greater temperature than the ordinary heat of steam, and in case of combustion chambers, that the ends are fitted to the edges of the tube plate and the back plate of the combustion box :

$$\frac{C \times d^2 \times T}{(W-P) D \times L} = \text{Working pressure.} \quad \text{Formula.}$$

W=Width of combustion box in inches.

P=Pitch of supporting bolts in inches.

D=Distance between the girders from centre to centre in inches.

L=Length of girder in feet.

d=Depth of girder in inches.

T=Thickness of girder in inches.

C=500 when the girder is fitted with one supporting bolt.

C=750 when the girder is fitted with two or three supporting bolts.

C=850 when the girder is fitted with four supporting bolts.

(b.) The working pressure for the supporting bolts and for the plate between them, shall be determined by the rule for ordinary stays.

Working pressure for supporting bolts.

Sec. 72. The flat ends of all boilers, as far as the steam space extends, and the ends of superheaters should be fitted with shield, or baffle plates, where exposed to the hot gases of the uptake, as all the plates subjected to the direct impact of heat or flame are liable to get injured unless covered with water.

Flat ends of boilers, &c., how to be fitted.

68

Sec. 73. Donkey boilers that are in any way attached to, or connected with the main boilers, or with the machinery used for propelling the ship, must be inspected and fitted the same way as the main boilers, and have a water and steam gauge, and all other fittings complete, and as regards safety-valves must comply with the same regulations as the main boilers, and no safety-valve shall be passed less than two inches diameter.

Donkey boilers, to be inspected and fitted the same way as main boilers.

64

Sec. 74. (a.) No boiler or steam-chamber is to be so constructed, fitted or arranged as that the escape of steam from it through the safety-valve can be wholly or partially intercepted by the action of any other valve.

Escape of steam through safety-valve.

90

Chap. 90.

Inspection of Boilers of Steam-boats

Stop valve must be fitted between boiler and steam pipe.

(b.) A stop valve must always be fitted between the boiler and the steam pipe, and when two or more boilers are connected with a steam receiver or superheater, between each boiler and superheater or steam receiver. The object of this is obvious, viz., to avoid the failure of all the boilers through the failure of one. The necks of stop valves should be as short as practicable.

Each boiler must have its fittings complete.

Sec 75. (a.) Each boiler must be fitted with glass water-gauge, at least two test cocks, and steam gauge, that is to say, each boiler must be fitted with all the fittings as complete as if there were only one boiler.

Boilers that fire at both ends or are of unusual width.

(b.) Boilers that fire at both ends and those of unusual width, must have water gauges and test cocks at each end or side, as the case may be. When a steamer has more than one boiler, and those boilers are fitted with stop valves each boiler must be treated as a separate one and have all the requisite fittings.

Inspectors not to sanction any new arrangement or construction of marine steam boilers without permission of the Chairman.

Sec. 76. Inspectors are to be most careful not to give any official sanction to any new arrangement or construction of marine steam boilers, without first obtaining the permission of the Chairman in writing, nor are they allowed to give any written approval of any invention, or arrangement unless by direction of the Board, and whenever they know that any invention or new arrangement is to be fitted to a vessel that is intended to have a passenger certificate, they should as soon as possible obtain plans and submit the same to the Chairman.

Constants to be substituted for 90,000 when the longitudinal seams in cylindrical furnaces are not welded or made with a butt strap.

Sec. 77. When the longitudinal seams in cylindrical furnaces are not welded or made with a butt strap as provided in section 56 of these regulations the following constants will be substituted for 90,000:

(a.) Furnaces with butt joints and drilled rivet holes. { 90,000 where the longitudinal seams are double riveted and fitted with single butt straps; 80,000 where the longitudinal seams are single riveted and fitted with single butt straps; 90,000 where the longitudinal seams are single riveted and fitted with double butt straps.

(b.) Furnaces with butt joints and punched rivet holes. { 85,000 where the longitudinal seams are double riveted and fitted with single butt straps; 75,000 where the longitudinal seams are single riveted and fitted with single butt straps; 85,000 where the longitudinal seams are single riveted and fitted with double butt straps.

71

72

73



- |   |   |  |
|---|---|--|
| (c.) Furnaces with lap joints and drilled rivet holes.    | } | 80,000 where the longitudinal seams are double riveted and bevelled; 75,000 where the longitudinal seams are double riveted and not bevelled; 70,000 where the longitudinal seams are single riveted and bevelled; 65,090 where the longitudinal seams are single riveted and not bevelled.          |
| (d.) Furnaces with lapped joints and punched rivet holes. | } | 75 000 where the longitudinal seams are double riveted and bevelled.<br>70,000 where the longitudinal seams are double riveted and not bevelled.<br>65,000 where the longitudinal seams are single riveted and bevelled.<br>60,000 where the longitudinal seams are single riveted and not bevelled. |

*Furnaces and Flues.*

Sec. 78. (a.) The external working pressure to be allowed on plane circular steel furnaces and flues when subjected to such pressure, when the longitudinal joints are welded or made with a butt strap, shall be determined by the following formulæ:—

External working pressure to be allowed when the longitudinal joints are welded or made with a butt strap.  
Formula.

76

(b.) The product of 90,000 multiplied by the square of the thickness of the plate in inches, divided by the length of the flue, or furnace, in feet, plus 1, multiplied by the diameter in inches, will be the allowable working pressure per square inch in pounds; provided it does not exceed that found by the following formula:—

all

(c.) The product of 10,000 multiplied by the thickness of the plate in inches, divided by the diameter (outside) of the flue or furnace, in inches, will be the allowable working pressure per square inch in pounds.

Formula.

*Corrugated Steel Furnaces and Flues.*

Sec. 79. (a.) Steel flue furnaces when new, corrugated, and machine made, and practically true circles, the working pressure is found by the following formula, provided that the plane parts at the ends do not exceed six inches in length, and the plates are not less than  $\frac{1}{8}$  inch thick.

Formula for finding the working pressure.

75- all

$$\frac{12,500 \times \text{thickness in inches}}{\text{Mean diameter in inches}} = \text{Working pressure per square inch.}$$

(b.) When the furnaces are riveted in two or more lengths the case should be submitted to the Chairman for consideration, as it may be necessary to make a reduction.

When the furnaces are riveted.

*Corrugated Iron Furnaces.*

Sec. 80. The working pressure for corrugated iron furnaces practically circular, and machine made, provided the

Formula for working pressure.

76

## Chap. 90.

*Inspection of Boilers of Steam-boats.*

plane parts at the ends do not exceed six inches in length and the plates are not less than  $\frac{5}{16}$  inch thick, should not be greater than that found by the following formula:—

$$\frac{10,000 \times \text{thickness in inches}}{\text{Mean diameter in inches}} \quad \text{Working pressure per square inch.}$$

*Duties of Inspectors.*

77  
Working pressure, how calculated.

Sec. **81.** Inspectors are to fix the working pressure of boilers by a series of calculations of the strength of the various parts, and according to the workmanship and material.

78  
Examination of boiler by Inspector before testing.

Sec. **82.** Before testing a boiler the Inspector should examine it, take the necessary measurements and calculate what the working pressure should be, in accordance with these regulations. If the test is not satisfactory the defects must be made good and the boiler re-tested. This instruction applies to superheaters, steam chests and water jackets as well as boilers.

79  
If the boiler is too hot.

Sec. **83.** If the boiler is too hot for the Inspector to examine it efficiently with safety and convenience he should decline to examine it and absolutely refuse to grant a certificate until he can make an efficient examination.

80  
New boilers and boilers under repair to be tested by a hydraulic pressure.

Sec. **84.** Inspectors should see all new boilers and boilers that have been taken out of a ship for a thorough repair, tested by a hydraulic pressure up to at least one and one half the working pressure that will be allowed previous to the boilers being placed in the vessel to test the workmanship, &c., but the working pressure is to be determined by the stay power, thickness of plates and strength of riveting, &c., and not by the hydraulic test.

Working pressure, how determined.

81  
Maximum of hydraulic test.

Sec. **85.** The hydraulic test should in no case exceed that provided by section 48 of these regulations, and it is never to be applied until the boiler has been opened up for examination and until the strength has been calculated from the necessary measurements taken from the boiler itself.

Mode of applying test.

82  
When boiler is partially inspected by one Inspector and inspection completed by another.

Sec **86.** When a boiler is partially inspected by one Inspector and the inspection is completed and the certificate granted by another, if the Inspector who witnesses the test of the boilers by the hydraulic pressure has an opportunity of examining them inside and outside after the test, such Inspector shall determine the pressure to be allowed on the boilers in question, taking care to inform the owners,

*Inspection of Boilers of Steam-boats.*

## Chap. 90.

makers or agents, and the Inspector who is ultimately to grant a certificate, what pressure should in his opinion be allowed on them.

Sec 87. Cast iron must not be used for stays, and Inspectors should also discourage the use of cast iron for chocks and saddles for boilers. Particular attention should be paid to chocking and fastening boilers to the vessel.

Cast iron not to be used for stays.

83

Sec. 88. A pressure once allowed on a boiler of a passenger steamer is not, under any circumstances whatever, to be increased, unless the Inspector has previously written for and obtained the sanction of the Chairman. In cases where an Inspector is of opinion that an increased pressure may with safety be allowed he should communicate with the Inspector who last inspected the boiler, and if on learning the reason why the existing pressure was formerly allowed, the Inspector is still of opinion that it may be increased, he should communicate all the facts of the case to the Chairman, but as above stated the pressure should not in any case be increased until the question has been decided by the Chairman.

Pressure on boiler of passenger steamer not to be increased by Inspector without sanction of Chairman.

84

Sec. 89. In fixing the maximum working pressure on steam-boat boilers, Inspectors are to assume one hundred and twenty-five pounds to the square inch as the limit allowable for a new steel boiler forty-two inches in diameter, made in the best manner, of the best quality of steel plates, at least one quarter of an inch thick, with all the rivet holes drilled in place, the plates being then taken apart and the burrs removed, the longitudinal seams in the shell being fitted with double butt steel straps cut across the grain of the plate and each of at least five eighths the thickness of the plates they cover, and all the seams being at least double riveted and having at least seventy per cent of the strength of the solid plate, and all the flat surfaces stayed in the best manner and all the seams double riveted, and they shall rate the working pressure of all steel boilers so made, whether of greater or less diameter according to their strength compared with this standard, and in all such cases the test applied shall exceed the working pressure allowed for such boilers in the ratio of one hundred and fifty pounds to one hundred pounds, using the water in such tests at a temperature not exceeding sixty degrees Fahrenheit, and all percentages added to the factor of safety for inferior workmanship or material, are to be deducted from that pressure.

Maximum working pressure on steam-boat boilers, how reckoned, and fixed.

85-

## Chap. 90.

*Inspection of Boilers of Steam-boats.*

Standard for determining the maximum working pressure on steam-boat boilers.

86

**Sec. 90.** In fixing the maximum working pressure on steam-boat boilers, Inspectors are to assume one hundred pounds to the square inch, as the limit allowable for a new boiler forty-two inches in diameter, made of the best refined iron, at least one quarter of an inch thick, in the best manner and of the quality herein required, and shall rate the working pressure of all iron boilers, whether of greater or less diameter, according to their strength compared with this standard, and in all such cases the test applied shall exceed the working pressure allowed, in the ratio of one hundred and fifty pounds to one hundred, using the water in such tests at a temperature not exceeding sixty degrees Fahrenheit, and all percentages added to the factor of safety, for inferior workmanship or material, are to be deducted from that pressure.

In the case of zig-zag riveting.

87

**Sec. 91.** In the case of zigzag riveting the strength through the plate diagonally between the rivets is equal to that horizontally between the rivets, when diagonal pitch =  $\frac{1}{2}$  horizontal pitch +  $\frac{1}{2}$  diameter of rivet.

*P-III 1904 Rules for Inspectors of Water-Tube Boilers Safety-Valves.*

The area and position of locked safety-valve.

*See 58*

**Sec. 92.** Section 21 of the Steam-boat Inspection Act provides that the boiler of every steam-boat shall be fitted with one or more locked-up safety-valves. Section 22 further provides that the area of any locked safety-valve or the joint areas of any locked safety-valve to any boiler made or placed on board after the 17th day of May, 1882, shall not be less than half a square inch for each square foot of grate surface in or under the boiler. In all cases the safety-valves should be upon the boiler or as near as possible to it.

Valve chest to be placed directly on the boiler.

**Sec. 93.** Inspectors are instructed that in all new boilers and whenever alterations can be easily made the valve chest should be placed directly on the boiler, and the neck or part between the chest and the flange which bolts on to the boiler should be as short as possible and be cast in one with the chest.

Pipe between boiler and safety-valve chest, when not allowed.

**Sec. 94.** In any case in which an Inspector is of opinion that it is positively dangerous to have a length of pipe between the boilers and the safety-valve chest, it is his duty at once to insist on the requisite alterations being made before granting a certificate.

Limit of weight on safety-valves.

**Sec. 95.** Inspectors are to fix the limit of the weight to be placed on the safety-valves and are to satisfy themselves that the boilers are in their judgment sufficient with the weight so placed.

*Inspection of Boilers of Steam-boats.*

## Chap. 90.

Sec. 96. In new vessels no safety-valves should be passed less than two and one half inches in diameter, and for donkey boilers and boilers having less than six square feet of grate surface, not less than one inch in diameter.

Minimum diameter of safety-valve.

Sec. 97. Care should be taken that the safety-valves have a lift equal to at least one fourth their diameter, that the area of the inlet and outlet openings for the passage of steam be not less than the area of the valve; where lever valves are used the distance between the centre of the valve and the centre of the fulcrum should not be less than the diameter of the valve.

Safety-valves to have a lift equal to one fourth their diameter.

Sec. 98. The size of the steel of which the spring is made in spring safety-valves is found from the following formula taken from the Imperial Board of Trade Rules :

Formula for finding size of steel of which spring of safety-valve is found.

$$\sqrt[3]{\frac{S \times D}{c}} = d$$

S = the load on the spring in pounds.

D = the diameter of the spring (from centre to centre of wire) in inches.

d = the diameter of side of square of the wire in inches.

c = 8,000 for round steel.

c = 10,000 for square steel.

The spring should be protected from the steam and impurities issuing from the boiler, and in case of the spring breaking means provided to keep it in position on the valve.

Sec. 99. A standard spring if made of the best square cast steel contains .25 of a square inch, the inside diameter is two inches, and the outside diameter three inches, it has thirteen complete coils with the ends and is  $11\frac{1}{2}$  inches long. The working load is assumed at 600 pounds, one sixth of its breaking load when hardened to a temper, just sufficient to break it, at which load it should deflect just one inch.

Standard spring, how to be made.

Sec. 100. To find the sectional area for any other spring the pressure on the valve being given:

Formula for finding sectional area of any other spring.

600 : : 700 : .25 : .29 = sectional area of spring at 700 lbs. load.

Suppose the pressure on the valve be 1,344 lbs. then 600 : 1,344 : : .25 : .56 equal to a  $\frac{3}{4}$  inch square bar; the other dimensions of the spring would be in like proportion.

Sec. 101. The following conditions should apply to all safety-valves :—

## Chap. 90.

*Inspection of Boilers of Steam-boats.*

Conditions which apply to all safety-valves.

(a.) Under no consideration whatever should the pressure rise in the boiler above the load placed on the safety-valve.

(b.) The relieving power of the safety-valve or safety-valves should be twice the generating power of the boiler under full fires.

(c.) No disk or "pop safety-valve" liable to open the full area of the valve suddenly, should be passed over four inches in diameter. When a larger area of safety-valve is required, two or more valves may be used; but in all cases lifting gear must be provided for raising them singly or together.

Location of safety-valves.

Sec. 102. Safety valves must be placed in convenient and accessible places, that their adjustment and examination may be readily and efficiently made.

*Duties and Liabilities of Engineers.*

Engineers upon stopping of engine to open safety-valves, shall open doors or close dampers and put out fires.

Sec. 103. (a.) Engineers are required in all cases upon stopping of the engine to open the safety-valves, so as to keep the steam in the boiler below the limit allowed by the Inspector's certificate as prescribed by law, to open the doors or close the dampers, and when from accident or other cause, the water in the boiler has fallen below the point of safety, to put out the fires immediately.

Fire pumps, hose, &c., to be kept in perfect condition ready for use.

(b.) Engineers shall keep the fire pumps and hose and their connections in perfect condition ready for immediate use, and when found unfit for use from age or other cause, shall report their condition to the Inspector of Hulls by whom the steamer was last inspected.

Engineers to report to owner and to Inspector any injury to boilers and machinery.

(c.) Engineers when laying up a steamer in the fall, or when finally leaving her, are required to report to the owner and also to the Inspector of the nearest district any defects of, or injury to, the boilers and machinery by which the safety of the same may be endangered. They shall also report to the Inspector of the district at which the steamer next arrives, any accident happening to the boilers or machinery during the trip, and in case of omission to make such report, the license of the engineer so omitting shall be revoked.

Report to Inspector of accident.

Accountability of chief Engineer of a steamer.

(d.) The Chief Engineer of a steamer is held accountable by the Department of Marine for the proper care and management of the boilers and machinery under his charge. He is, therefore, in no case to absent himself from the vessel while on her regular trips, unless a competent substitute be provided to fill his place during his absence.

Duty of engineer at least once a year.

(e.) Engineers on first taking charge of a steamer, and at least once a year thereafter, shall satisfy themselves by close examination that the braces, stays and pins of the

*Inspection of Boilers of Steam-boats.*

Chap. 90

boiler are in good order, and sufficient for the strain to which they may be subjected; they shall also satisfy themselves that the safety-valves are in good working order and sufficient for the requirements of section 67 of these regulations. Boiler connections to be kept in proper condition.

(f.) Engineers are to exhibit their certificates in the Engine room along with a copy of these regulations when required to do so. Engineer to exhibit certificate.

*Management of Boilers.*

Sec. 104. (a.) Getting up steam.—Warm the boiler gradually. Steam should not be raised from cold water in less than four hours. If practicable, light the fires over night. By getting up steam too quickly, the boiler will soon be destroyed. Getting up steam.

*See 113*

(b.) Firing.—Fire regularly. Keep the sides up, and use the slice gently and as seldom as possible. Firing.

*1204*

(c.) Feed water.—Let the feed be regular and constant. Feed water.

(d.) Glass gauge and try cocks.—Keep the glass free and try the gauge cocks every fifteen minutes. Glass gauge and try cocks

(e.) Safety valves.—Lift each safety valve at least once a day and always before getting up steam. Safety-valves

(f.) Low water.—Put out the fires by drawing them or throwing ashes on them. Never use water. Low water should never occur. Low water.

(g.) Blowing off the Boiler.—Do not blow off by steam pressure; let the water run off if possible. See that the fires are all out. Blowing off boiler.

(h.) Boiler Purgers.—Never use any compositions to keep down incrustation, or oil or other impurities to remove it without the approval of the Chairman. Boiler purgers.

(i.) General Rules.—Keep the boiler clean inside and outside and free from leak. Never throw water in the furnace. Under high pressure, raise the safety-valve gently. Lower the fires, or, if necessary stop the engine when foaming to find the water level. General rules

~~P. 68~~ P. 66 Regulations 1889  
Regulations regarding  
Seymour

P. 66  
9 Regulations  
1884

CHAPTER 91.

INSPECTION OF HULLS OF STEAM-BOATS.

Government House, Ottawa,  
The 17th day of September, 1889.

On the recommendation of the Minister of Marine and Fisheries, and under the provisions of Chapter 78 of the Revised Statutes of Canada, intituled "The Steam-boat Inspection Act,"

His Excellency in Council has been pleased to approve the following regulations made by the Board of Steam-Boat Inspection for the uniform inspection of Steam-Boats, and for such other purposes as are necessary under the said Act:—

*Inspection of Hulls and Equipment of Steam-boats Carrying Passengers.*

Inspectors must be satisfied that particulars have been complied with.  
Hull sufficient and in good condition.  
Boats, &c., in good condition.  
Time for which hull sufficient.  
Limits beyond which vessel not fit to ply.  
Number of passengers vessel may carry.

Section. 1. Inspectors of Hulls, before granting a passenger certificate, must be satisfied that the following particulars have been complied with, in accordance with the requirements of the Act relating to steam-boat inspection.

- (a.) That the hull of the vessel is sufficient for the service intended, and in good condition.
- (b.) That the boats, life-preservers, buoys, lights, signals and compasses are in good condition, and the certificates of the master and mate, or mates, engineer or engineers, are such as are required by the said Act.
- (c.) The time (if less than 12 months) for which the said hull will be deemed sufficient.
- (d.) The limits (if any) beyond which, as regards the hull and equipments, the vessel is, in the Inspector's judgment, not fit to ply.
- (e.) The number of passengers besides the crew, the vessel is allowed to carry, distinguishing, if necessary, between the respective numbers to be carried on the main deck and upper deck.

Inspection to be made, if possible, when owner or master and engineer present.

Sec. 2. (a.) Inspectors shall make their inspections when the owner, or master, and engineer of the vessel are present, if possible. Repairs can then be required, and defects can be pointed out to the proper persons, without incurring delay. If these persons are not present, the Inspectors will make their inspection without them.

Written statement of defects or alterations.

(b.) In order to prevent any mistakes as to the nature and extent of repairs required by the Inspectors, whenever they can not give a certificate until the repairs are effected or



*Inspection of Hulls of Steam-boats.*

## Chap. 91.

alterations made, a written statement of the defects to be remedied or alterations required, shall, in all cases, be handed to the owner or master of the vessel, whether such statement is applied for by him or not, a copy of which should be always taken and transferred to the office press letter book.

To be furnished to owner or master.

(c.) If any difference of opinion arises between the Inspector and the owner or master, the facts should at once be submitted to the Chairman of the Board of Steam-Boat Inspection for consideration, and for reference to the Minister of Marine and Fisheries, when necessary.

Submission to Chairman of Board in case of difference of opinion.

Sec. 3. If a vessel usually plying in one district, is taken to another district to be inspected, the Inspector in the latter district shall not give a certificate without first communicating with the Inspector for the former district; nor, if there is any difference of opinion, without referring the question to the Chairman aforesaid for decision.

Vessel usually plying in one district taken to another district to be inspected.

Sec. 4. It is the duty of the Inspector of Hulls to satisfy himself personally upon every detail of the inspection of a vessel, and not to trust to any certificate, or other document given by any person not responsible to his department, who will hold him responsible to the fullest extent for the performance of the duty entrusted to him, and will support him in any reasonable step he may think necessary, in order to the fullest performance of his duty.

Inspector of Hulls to satisfy himself upon every detail of the inspection.

Sec. 5. In case the Inspector has reason to believe that the hull or equipment is not fit for so long a time as twelve months, he is to grant his certificate for such shorter period as he may deem proper, informing the owners of his reasons for so doing.

Inspector may grant certificate for shorter period than 12 months.

Sec. 6. It is most desirable that an Inspector should complete the inspection of a vessel in every detail when he has commenced it; and, if possible, arrangements should always be made with the owners to secure this. Delays and inconveniences may be prevented, if notice is given by owners when the vessel is ready for inspection, and her equipment in place on board. An Inspector should not sign a certificate for any detail which he has not inspected, and for which he is not prepared to hold himself personally responsible.

Inspector, having commenced inspection, should complete it without delay.

Sec. 7. Every person who knowingly and wilfully makes or assists in making, or procures to be made, a false or fraudulent certificate with respect to any steam-boat, or who forges or assists in forging, or procures to be forged, fraudulently, alters, or assists in fraudulently altering any certificate

Person making or procuring false or fraudulent certificate.

## Chap. 91.

*Inspection of Hulls of Steam-boats.*

When guilty of a misdemeanor.

required by The Steam-boat Inspection Act, or any words, figures in any such certificate or any signatures thereto, is guilty of a misdemeanor.

Certificate for 12 months not to be granted in case of doubt.

**Sec. 8.** A certificate for twelve months shall not be granted, whenever the Inspector has any doubts whatever, as to the efficiency of any part of the vessel or equipment for such period.

Inspectors shall determine the condition of hulls of passenger steamers and examine same once a year.

**Sec. 9.** Inspectors shall determine whether hulls of passenger steamers are in good condition and fit for the service for which they are intended; and shall examine the hulls outside and inside, once a year, if possible, or oftener, and at such time as is most convenient to the owner.

New steam-boats should be inspected before painting or completion.

**Sec. 10.** New steam-boats should be inspected before painting or completion, but any such inspection is not to interfere with the complete inspection of hull and equipment, after completion, the object being to form an opinion of the workmanship, material and construction.

When steam-boat not in every respect in good condition, though practically fit for service, Inspector should report defects to Chairman.

**Sec. 11.** When a steam-boat which has been inspected for a passenger certificate, is not in every respect in good condition, although the defects may not be sufficient to warrant the withholding the certificate, and although the vessel may be practically fit for the service intended, the Inspector should, when he grants the certificate, forward to the Chairman aforesaid a report showing the nature of the defects in question.

O. C. July 6, 1886.

Parts of ceiling may be removed for purpose of examination.

**Sec. 12.** For examining the internal parts of a passenger steam-boat, the Inspector shall, if he considers it necessary, have parts of the ceiling removed, in order that he may ascertain the condition of the hull, frames, floors, &c., particularly in the engine room and boiler space, and also in the coal bunkers, they being empty.

O. C. April 7, 1887.

Date of last inspection to be entered in an office inspection book with particulars.

**Sec. 13.** The date of the last inspection shall be entered in an office inspection book with particulars of the condition of the hull at that time, with approximate sketches of the midship section, showing the form, build, and dimensions of the vessel, and parts, sufficiently to judge of her shape and strength. Any question or doubt as to the strength of the vessel for the route on which she is placed, should be referred to the Chairman aforesaid.

*Inspection of Hulls of Steam-boats.*

## Chap. 91.

Sec. 14. The height of the combings round all openings in main deck, and the means provided for securely protecting or fastening down all sky lights, bunker openings, &c., are important items to be noticed by the Inspector in steam-boats subject to heavy seas. All gangways and openings, on, or below weather deck, should be fitted with covers in such a manner that they can be quickly and efficiently secured. Hatch covers should be provided with means for effectually securing them down. Grating and hatch covers must be kept and secured in a suitable place, at all times accessible, and near to the openings for which they are intended.

Important items to be noticed by Inspector in steam-boats subject to heavy seas.

O. C. July 6, 1886.

Sec. 15. All boats should be hung on davits and kept ready for service at any moment. Inspectors should see that in all boats the full complement of oars is provided, that each boat has two plugs to each plug hole, attached with lanyards or chains, and one set and a half of thole pins or crutches attached to the boat by sound lanyards, a bailer, a rudder and tiller or yoke and yoke lines; a painter of sufficient length and a boat hook. The rudder and painter shall be attached to the boats by sufficient long lanyards and ready for use; means for speedily detaching the boats from the lower blocks of the davit tackles should be insisted upon. An ordinary fixed hook in the lower block shipping into fixed eye in the boat should not be allowed.

Boats should be hung on davits and kept ready for service.

Other special directions relating to boats.

Sec. 16. Inspectors should see that the davits are strong enough, that they are so spaced that the boat can be swung out without unnecessary labor; that the boat chocks can be expeditiously removed, and that the boats will not foul the ship's sides, when lowering, when the ship has no list. The whole of the tackling, including davits, equipment and crew, falls, blocks, eye bolts and rings, &c., shall be of sufficient strength to lower the boat with its full equipment and crew on board. The davit tackle falls must be long enough to lower the boat into the water, when the vessel is light. Life lines should be fitted to the davits long enough to reach the water when the vessel is light, and allowance made for the extreme roll of the vessel.

Directions relating to davits, boat chocks, tackling, life lines, &c., &c.

Sec. 17. Inspectors will refuse a certificate in cases in which these instructions are not carried out, but it is to be left to the owners of passenger steam-boats to furnish such methods as they please for lowering boats so long as the intention of the Act is complied with. Any unusual or doubtful method of lowering boats must be submitted to

Methods for lowering boats to be left to owners, provided intention of the Act is complied with.

## Chap. 91.

*Inspection of Hulls of Steam-boats.*

the Board of Steam-boat Inspection for its consideration and approval before it is passed. All boats should be lowered into the water at every inspection.

O. C. April 7, 1887.

Life-buoys with lines attached, how secured.

Examination of life-buoys, &c., when inspecting vessel.

**Sec. 18.** Life-buoys with lines attached should be secured by a toggle or becket, or any other similar method, so that they may be quickly released. They must not be lashed or seized to the rail or any other part of the vessel, but must be kept so as to be ready for use at a moment's notice in case of emergency. Life-buoys and jackets shall be carefully examined when inspecting the vessel to see that the materials of which they are composed have not become sodden and that the lines attached to them are of sufficient length, serviceable and in good order.

O. C. July 6, 1886.

*Masts and Sails and Gangboards.*

Steam-boats above 60 tons register, to be provided with masts and sails.

**Sec. 19.** Section 54 of "The Steam-boat Inspection Act" empowers the Minister of Marine and Fisheries to require steam-ships above sixty tons registered tonnage, carrying passengers on the sea coasts of the Dominion or on any, or on all the waters of the Dominion, with certain exceptions, to be provided with a mast or masts and sail or sails, suitable for such steam-boat; and to prescribe the dimensions of such mast or masts, and sail or sails respectively.

Inspectors of Hulls of passenger steam-boats are to see that they have sufficient sail power.

**Sec. 20.** Inspectors of Hulls when inspecting passenger steam-boats employed on the sea coast, or on the great lakes of the Dominion, are to see that they are fitted with sufficient sail power to enable them to steer in the event of their machinery becoming disabled. All such sails must be examined by the Inspector, who must be assured of their efficiency, as also with that of the standing and running gear at every inspection, and in any case of doubt to apply to the Chairman.

Suitable and safe gang-boards.

**Sec. 21.** Inspectors shall see that suitable and safe gang-boards are provided with means for securing them safely at both ends.

Compasses to be properly adjusted, and certificate to that effect granted by Inspector.

**Sec. 22.** In the first inspection of a steam-boat employed on the sea coast or on the great lakes of the Dominion, whether built of iron or wood, the Inspector shall require the compasses to be properly adjusted or verified by a competent person, selected by the owner, whereupon the inspector shall grant a certificate to the owner to the effect that the compasses of the ship (if an iron ship) are properly

*Inspection of Hulls of Steam-boats.*

Chap. 91.

adjusted, and a table of errors shall be furnished, and handed by the owners to the Inspector before he gives the certificate.

O. C. April 7, 1887.

Sec. 23. Inspectors of Hulls shall see that the deck pumps, whether worked by hand or steam, are properly placed, sufficient in number, and that provision is made to get at the end of the suction pipes in case of fouling. No deck pump shall be passed which requires charging by hand before taking suction. When such is found to be the case, the Inspector shall insist upon proper provision being made to made the pump efficient at all times. Fire hose should be stretched to their length and thoroughly examined and tried under pressure from the pumps at least once a year, and at any other time the Inspector may deem necessary. The hose should be connected with the pumps for immediate use.

Deck pumps to be properly placed.

Fire hose to be stretched full length, and examined and tried.

Sec. 24. A spare tiller shall be provided, with relieving tackles, to be kept near the after steering gear, ready for immediate use on all sea-going steamers and steamers on the great lakes. The steering gear shall be inspected and thoroughly examined at least once a year.

Spare tiller to be provided.

Steering gear to be inspected.

Sec. 25. Inspectors of Hulls must be careful to see that every sea-going steamer, subject to the Act, and every steamer employed on the great lakes, is provided with suitable chain cables, anchors and ground tackle, in good condition sufficient for the service in which the vessel is employed, and that the cable be removed from the lockers at least once in a year and cleaned, if necessary, and the pins knocked out of the shackles.

Steamer to be provided with suitable chain cables, anchors and ground tackle.

O. C. July 6, 1886.

Sec. 26. (a) Inspectors of Hulls shall keep an office register book for new steamers, in which they shall enter particulars of their registration, official number, name, port of registry, dimensions, tonnage, ownership, names of master and engineers; also a general description of build, showing a sketch of the midship section, giving sizes of frames, planking, deck beams, clamps, knees, covering boards and fastenings, as the case may be, sufficient to judge of the vessel and the fitness for the route on which it is to be placed. A description of the upper works on passenger steamers shall also be given stating how the same are secured to the hull, and what provision is made against rolling in a heavy sea.

Office register book for new steamers to be kept by Inspectors of Hulls; what it shall contain.

## Chap. 91.

*Inspection of Hulls of Steam-boats.*

Trim of the vessel.

(b.) The trim of the vessel, light and loaded, shall be shown on the sketch of midship section.

Fitness of the boats and other equipments for saving life.

(c.) The fitness of the boats and other equipments for saving life, whether sufficient for the number of passengers the steamer is allowed to carry, together with the crew on the route she is to be placed shall also be given in the said particulars. A copy of these particulars in full made out neatly on foolscap paper shall be sent to the Chairman of The Board of Steam-boat Inspection and shall be filed for reference in the office for the information of the Department of Marine.

O. C., April 7, 1887.

Office docking book to be kept by Inspector of Hulls; what it shall contain.

Sec. 27. (a.) Each Inspector of Hulls will also keep an office docking book, in which he shall enter the date of last docking of each steamer inspected by him, with particulars of repairs made upon her; also memoranda of her last inspection, as made by him; the condition in which he then found the hull and equipment; with copy of any correspondence between the owner and master, relating to any repairs, fittings, equipment, or other things which may require proof, in the event of their not having been complied with.

Duties of Inspectors of Hulls to apply to all steam-boats, subject to the Act, and coming within their district.

(b.) Inspectors of Hulls shall not consider their duty as finished, in respect to a steam-boat for which they have granted a certificate for a year or any shorter period, but are expected by the Department to have supervision over all steam-boats, subject to the Act, within, or coming within their district. Should any infractions of the law on the part of an owner or master of steam-boats come to the knowledge of an Inspector, whereby the safety of life or property is endangered, it will be his duty at once, to cause steps to prevent such occurrence by reporting the case to the Department of Marine with the grounds of the complaint.

*Passengers.*

Number of passengers allowed on passenger steamers, how ascertained.

Sec. 28. (a.) The number of passengers allowed on passenger steamers may be found by multiplying the length by the breadth of the vessel at the water line, and dividing the product by a factor of safety, according to the class of vessel, thus:—

For ocean steamers the factor shall be..	10
For ocean coasting steamers.....	10
For steamers navigating in the great lakes.....	9
For lake coasting, harbor, river, ferry and excursion steamers.....	6

*Inspection of Hulls of Steam-boats.*

## Chap. 91.

(b.) No deviation shall be made from this regulation unless with the consent of the Chairman of the Board of Steam-boat Inspection and with the approval of the Minister of Marine and Fisheries. Rule not to be deviated from, unless, &c.

(c.) In excursion steamers carrying passengers within the hold of the vessel, the limit shall be at the discretion of the Inspector, but in no case shall exceed as many as can find accommodation. Excursion steamers carrying passengers.

(d.) These factors may be increased to a further limit, if from age or unfitness, the vessel is not considered safe for the carriage of so many passengers. If vessel not considered safe.

Sec. 29. The carrying capacity in the number of persons of yawl boats shall be determined as follows, viz. :— Carrying capacity of yawl boats, how determined.

By multiplying the length of the keel by the breadth and by the depth from top of keel to gunwale in feet, and then dividing the product by 10, the quotient will be the number of persons allowed to each boat.

*Life-boats and their Equipments.*

Sec. 30. (a.) Life-boats shall be built whale-boat fashion; they should have a sheer of about  $\frac{3}{4}$  inch to a foot, rising equally from amidship to the stem and stern, and to have sufficient strong serviceable air-tight compartments so constructed, fitted and arranged that water can not find its way into them. Life-boats shall be built whale-boat fashion.

(b.) The life-boat must be substantially constructed of galvanized iron of not less than No. 18 wire guage in thickness. Galvanized iron required.

(c.) Zinc shall not to be used in the construction of a life-boat or in her air-casings. Zinc not to be used.

(d.) The air-tight compartments must be so distributed as to give the boat good buoyancy and stability. Whether a part of the air-case should be under thwarts, or whether they should be in the ends and along the sides, will be, so long as an efficient life-boat is obtained, left to the option of the owner. Air-tight compartments.

(e.) Spaces filled with or containing any material are not to be deemed air spaces. Air spaces.

(f.) A square stern boat is not to be passed as a life-boat. Square stern.

(g.) Life-lines shall be suitably attached to the gunwale of the life-boat. Life lines.

(h.) The life-boat must be provided with the full complement of oars properly secured; two plugs for each plug-hole, attached with lanyards or chains, a bailer, rudder and tiller, also attached to the boat by lanyards; a hatchet, attached with a lanyard, shall be kept in each end of the boat, and a painter and a boat hook. Equipment of life-boat.

## Chap. 91.

*Inspection of Hulls of Steam-boats.*

Means for detaching speedily the life-boat from the lower blocks of the davit tackles.

(i) Means for detaching speedily the life-boat from the lower blocks of the davit tackles must be provided. An ordinary fixed hook in the lower block should not be allowed. The boat's davits must be strong enough and so spaced that the boat can be swung out without unnecessary labor, so that the boat chocks can be expeditiously removed, and that the boat will not foul the ship's sides in lowering when the ship has no list; and that the whole of the tackling davits, falls, blocks, eye-bolts, and rings, &c., are of sufficient strength to lower the boat with its full complement on board.

O. C. April 7, 1887.

*Rate or Duty.*

Rate or duty to be paid by owner or master of steam-boat.

Sec. 31. The following rate or duty shall be paid by the owner or master of every steam-boat in Canada, under the provisions of the 46th Section of Chapter 78 of the Revised Statutes of Canada:

The rate or duty to be paid yearly by owners or masters of steam-boats, shall be eight cents for every ton gross, each steam-boat measures, on and after the 1st day of October, 1889.

Rules of the Road for the great  
Lakes - adopted by me, 20 April  
1905.

"International Rules of the Road"  
issued by the Dept. of Marine Affairs -  
under the provisions of the Canadian  
Shipping Act Cap 113 R.S.C. 1906 -



# DEPARTMENT OF PUBLIC WORKS.

## CHAPTER 92.

### SLIDES AND BOOMS.

Government House, Ottawa,

The 19th day of August, 1889.

On the recommendation of the Minister of Public Works, and under the provisions of Chapter 36 of the Revised Statutes of Canada, intituled "The Public Works Act,"

His Excellency in Council has been pleased to order, and it is hereby ordered that the following regulations for the management, maintenance, proper use and protection of the Slides and Booms and public works connected therewith and hereinafter mentioned, and for the collection of the Tolls and Dues thereon be and the same are hereby made and established; and that the Tolls and Dues hereinafter mentioned be and the same are hereby imposed, authorized and established.

#### GENERAL REGULATIONS.

**Section 1.** The Government Slides, Booms and other works connected therewith in each of the several districts shall be under the control and management of the Superintendent of the Works for that district, or in case there should be no Superintendent, or in the absence of such an officer, under the control and management of the Slide Master, Deputy Slide Master or other officer duly appointed by the Minister of Public Works; and these officers, and no others, shall have the power of regulating the supply of water required for the passage of timber, of allotting the space for rafting or mooring timber, of determining the quantity of timber that may pass daily through the slide or booms, of collecting the slidage dues, of awarding the amount that may be due by the owner or owners of timber or persons in charge thereof for damages that may have been done to any of the works, of imposing fines or penalties for any violation of the Slide Regulations, of seizing the timber, and of detaining or selling the same at public auction, as hereinafter provided, and of recovering the said dues, penalties or damages, when the owners of timber or persons in charge thereof refuse or neglect to pay the same; and the orders of the said Superintendent of the Works, Slide Master, Deputy Slide Master, or other officer duly appointed as aforesaid,

Works shall be under the control and management of the Superintendent, or the Slide Master or Deputy, or other officer appointed by Minister of Public Works.

Powers and duties of such officer.

## Chap. 92

*Slides and Booms.*

must in all cases be obeyed by the owners of timber or their employés, who, in case of refusal or neglect to obey such orders, shall be subject to the fines or penalties hereinafter imposed, as the case may be.

Notice to be given to, and permission obtained from such officer, before using Government Slide.

Penalty for contravention.

Sec. 2. No raft or parcel of timber shall be permitted to enter any Government Slide, for the purpose of passing through, without the owner or person in charge of such raft or parcel of timber first giving notice thereof to and obtaining permission from the Superintendent, Slide Master, Deputy Slide Master, or other officer as the case may be, duly appointed as aforesaid, under a penalty of not less than four dollars and not more than twenty dollars.

Owner or person in charge of raft, before using Slide, shall make report containing particulars in detail.

Penalty for contravention.

Sec. 3. The owner or person in charge of any raft or parcel of timber, previous to entering any of the Government crib Slides, for the purpose of passing such raft or parcel of timber through the same, shall make a full and complete report of such raft or parcel of timber, containing an account of the number of cribs and the description of timber composing the raft or parcel of timber, the name and designation of the owner or owners and of the supplier or furnisher thereof, together with marks and all other particulars relating thereto, under a penalty of not less than twenty dollars and not more than two hundred dollars, for refusing or neglecting to make such report.

On arrival of timber at Slides, &c., the owner or person in charge shall immediately send a sufficient number of men to pass said timber through, and shall not allow the timber to accumulate or to obstruct.

In case of neglect, Slide Master may cause timber to be removed at expense of owner, who shall be liable for all damages and to penalty.

Sec. 4. On the arrival of any description of timber at or near any of the Government Slides, Booms or works, the owner thereof or person in charge of the same shall immediately send a sufficient number of men to pass said timber through the said slides, booms or works, and shall not allow the timber to accumulate at the head of the said slides, booms or works, or to obstruct the passage of other timber to or from the said slides, booms or works; and if a "jam" of any description of timber takes place in any of the said slides, booms or works, or near the same, the owner or person in charge shall at once remove the "jam" or obstruction, under the direction of the Slide Master or officer acting in that capacity; and in case the owner or person in charge of said timber should refuse or neglect to remove the same within forty-eight hours, the said Slide Master or officer, or person by him authorised in that behalf, shall have the power of removing the same at the proper costs, risks and expenses of the owners thereof, who shall be subject to a penalty of not less than fifty dollars and not more than one hundred dollars for every day during which their timber shall obstruct the passage of other timber, over and above

*Slides and Booms.*

## Chap. 92

the amount that may be awarded by the Slide Master, or Superintendent of the work, as well for the expenses of removing the same as for any damage that may have been done in consequence of such refusal or neglect.

Sec. 5. No raft or parcel of timber shall be moored or banded up nearer to the entrance to or the outlet of any of the Government Slides, Booms or works than the berths pointed out by the Slide Master or officer acting in that capacity; and when permission shall be granted to the owners or persons in charge of any raft or parcel of timber to place any pocket boom, raft or timber in or near the said slides, booms or works, the owners or persons in charge of such raft, timber or pocket boom shall not in any case take any more or other space or place than the berth or berths allotted by the said Slide Master, or other officer in charge of the works, and shall at any time, when directed so to do, move the said rafts, timber or pocket booms from place to place, or remove the same entirely, as soon as required so to do by the said Slide Master or other officer in charge of the works, under a penalty of not less than twenty dollars and not more than fifty dollars in case of refusal or neglect on the part of the said owners or persons in charge of timber, rafts or pocket booms to comply with the requirements of this section.

Timber shall not be moored or banded nearer the entrance or outlet of Slides, &c., than the berths pointed out.

Pocket boom, raft or timber, regulations in relation thereto.

Penalty for contravention.

Sec. 6. The owner or owners, or person in charge of any raft or parcel of timber shall, before removing the same from any Slide, Boom or public work connected therewith, subscribe and deliver to the said Superintendent, Slide Master, Deputy Slide Master, or other officer, as the case may be, duly appointed as aforesaid, an acknowledgement in duplicate, certifying the number and description of cribs or of timber so passed, and shall pay the slide dues, or secure the same to the satisfaction of the Collector of Slide Dues, under a penalty of not less than twenty dollars and not more than two hundred dollars, and shall further pay double the amount of dues which would otherwise be payable, on any raft or parcel of timber passing such slide without such acknowledgement.

Owner, &c., before removing timber from Slide, &c., shall subscribe and furnish an acknowledgement in duplicate certifying the number and description of cribs or of timber so passed.

Sec. 7. The Collector of Slide Dues, or any person or persons duly authorised by him in that behalf, shall, at all hours during the day, have free access, and full power and permission to enter and remain as long as he or they may see fit upon any raft or parcel of timber, for the purpose of examining the same, and every facility shall be afforded him or them for ascertaining the number of cribs or the number

Collector of Slide Dues, or person authorized by him, shall have free access to examine raft or parcel of timber.

## Chap. 92

*Slides and Booms.*

Penalty for obstructing Collector in the execution of his duty.

of pieces and description of timber of which the same is composed, and any person obstructing the Collector of Slide Dues, Slide Master, or other persons duly authorized as aforesaid, in the execution of his or their duty, shall incur a penalty of not less than fifty dollars and not more than two hundred dollars.

Owner, &c., responsible for injury or damage done the Slides or other works by parties in his employ. Slide Master may seize and detain raft, &c., until injury be repaired or security given.

**Sec. 8.** The owner, as well as the person in charge of any raft or parcel of timber, shall be held responsible for any injury or damage done to the Slides, Booms, Piers, or other works connected therewith, by any of the parties in their employment; and it shall and may be lawful for the Slide Master, or officer acting in that behalf, to seize and detain such raft or parcel of timber until the injury so done shall be repaired, or until security to his satisfaction shall have been given for such amount as shall be awarded on account of such damage; and any and every person interfering with the management or supply of water, or with any of the duties of the said Slide Masters or officers acting in that capacity, without having been duly authorized by them so to do, and any and every person doing injury or damage, as aforesaid, to any of the Government Slides, or to the booms, slides, gates or piers connected therewith, or aiding or assisting in doing such injury or damage, shall, for the first offence, incur a penalty of not less than twenty dollars and not more than one hundred dollars, over and above payment of the amount which may be awarded for such damages; and, for the second and every subsequent offence, shall incur a penalty of not less than one hundred dollars and not more than two hundred dollars, over and above payment of such damage, the amount of which damage shall, in each case, be ascertained and determined by the Slide Master or officer in charge of the slide, boom or work.

Penalties imposed and damages incurred under this section; how ascertained.

Collector of Slide Dues or person authorized may enter upon, seize and detain any raft or parcel of timber removed without payment of dues, damages, fines or penalties.

**Sec. 9.** It shall be competent for the Collector of Slide Dues, his deputy or deputies, assistant or assistants, or persons duly authorized by him, to enter upon, seize and detain, at the risk, costs and charges of the owner or owners thereof, any raft or parcel of timber which shall have been moved away from any of the Government Slides, booms or works, without the slide dues thereof, the amount awarded for damages, or the fines or penalties, if any, being first paid or secured to his satisfaction, and any and every person obstructing the Collector of Slide Dues, or other person or persons duly authorized, as aforesaid, in the execution of his or their duty, shall incur a penalty of not less than twenty dollars and not more than two hundred dollars.

Penalty for obstructing officer.

*Slides and Booms.*

## Chap. 92

Sec. 10. Rafts, cribs, and every description of timber shall be held liable for the dues, damages and penalties imposed under these Regulations; and the Slide Master or other duly appointed officer is hereby authorized and required to seize and detain any such raft, crib or parcel of timber until payment of such dues, damages and penalties is made, or until the owner or person in charge shall have given satisfactory security for the payment thereof, within thirty days after the same shall have been declared to be incurred or shall have been demanded; and, in default of such payment being made within the said term of thirty days, then the said Slide Master, or officer, may proceed to sell by public auction any such raft, crib or parcel of timber; but at least two weeks' notice of the day of the intended sale by auction shall, in the mean time, have been given, and have been duly inserted in one or more of the public newspapers published at the nearest place from the said works, and a copy of such notice shall also have been placarded during the same time (two weeks before the intended sale) in a public and conspicuous place at or near the said works where the raft, crib or timber is lying; and if the costs attendant on such auction sale, as well as all other costs, damages and penalties imposed or awarded, cannot be realized from the timber so seized and sold, the same shall be recoverable from the owner of said raft, crib or parcel of timber.

Rafts, cribs, and every description of timber shall be liable for all dues, damages and penalties imposed.

Mode of procedure prescribed for the collection and enforcement of dues, damages and penalties by seizure and sale at public auction.

O.C. May 17, 1865.

## SAGUENAY DISTRICT.

## REGULATIONS.

Sec. 11. All person or persons in charge of lumber that is to pass through the Saguenay Slide must notify the resident Slide Master when they will be ready to commence.

Notice to Slide Master.

Sec. 12. All person or persons in charge of lumber at the head of the Slide shall send eight men to assist the Slide Master in the discharge of his duties during the passage of their timber: four of these men to be placed at the head of the Slide to feed it, and the other four stationed along the side of the Slide, as the Slide Master may direct; these eight men shall be under the orders and control of the person in charge of the Slide while their employer's timber is being passed.

Person in charge of lumber, shall send eight men to assist Slide Master.

Sec. 13. As it would be difficult for the Slide Master to count the number of logs, etc., in the Boom at the head of the Slide, all person or persons lumbering above the Public

Persons proposing to use the Works.

## Chap. 92

*Slides and Booms.*

Required to furnish statement of quantity of timber.

Works on the River Saguenay, who propose passing their timber through the Government Works, are required to furnish to the Slide Master or person in charge of the Slide at the time, when called upon, a statement of the exact quantity of timber by them manufactured in the woods.

O.C. Sep. 28, 1860.

## TOLLS.

Rates of toll at the Saguenay Slides and Works.

Sec. 14. The following rates of toll shall be levied and collected at the Saguenay Slides and Works, that is to say:

*(a). On Tamarac Timber.*

Flatted or sided, not exceeding 20 feet in length, 3 cents each.

Flatted or sided, exceeding 20 feet, but not over 40 feet, 6 cents each.

Flatted or sided, exceeding 40 feet, 9 cents each.

O.C. Oct. 9, 1874.

*(b). At the Chicoutimi Booms and Slides.*

On yellow and white pine logs, 3 cents each.

On red pine and spruce logs, tamarac, futtocks and knees, 2 cents each.

On red, yellow and white pine timber, per stick, 5 cents each.

On masts, 20 cents each.

On spars, 8 cents each.

O.C. April 13, 1865.

## ST. MAURICE DISTRICT.

## REGULATIONS.

Notice to be given for eight full days by person proposing to use the Works.

Sec. 15. The owner of every parcel of squared timber, saw-logs or other timber proposed to be passed down the River St. Maurice through any of the works constructed thereon shall give notice in writing to the Superintendent of Public Works on the said river, eight full days at least before the period appointed for driving the same, specifying the section or sections of the river, such timber is to be driven from, whether or not it is to be driven to the mouth of the river, and if not, where it is intended to be stopped, under a penalty, in default of giving such notice, of not less than four dollars and not exceeding twenty dollars.

*Slides and Booms.*

## Chap. 92

**Sec. 16.** The owner or person in charge of every such lot of squared timber, saw-logs or other timber, shall, when the same reaches its destination on the St. Maurice, or before, subscribe and deliver to the said Superintendent, or to such person as he may authorize in that behalf, an acknowledgment in duplicate, certifying the number and description of sticks or logs passed or driven through any of the said works, and specifying the name and designation of the owner thereof, and of the person or firm supplying or furnishing such owner, together with the marks distinguishing such timber, and such other particulars as may be required for the identification thereof; and any person who, having passed or driven any parcel of timber through any of the said works, shall refuse or neglect so to give such acknowledgment, or who, in giving the same, shall make a false statement, either as to the number or description of the timber so passed or driven, or as to the place of its departure or destination, shall incur a penalty of not less than twenty dollars and not exceeding two hundred dollars; and shall further pay, on every parcel of timber so passed or driven without such acknowledgment, or in relation to which any such false statement is made, double the amount of Dues which would otherwise have been payable thereon.

Owner or person in charge of timber, before using the works, shall subscribe and furnish an acknowledgment in duplicate, certifying the number and description of sticks, &c., with marks and other particulars.

**Sec. 17.** The Collector of Dues on the said River St. Maurice, or such person or persons as may be in that behalf duly authorized by him, shall, at all hours of the day, have free access to and full power and permission to enter and remain as long as he or they may see fit upon any such parcel of timber, for the purpose of examining the same, and of ascertaining the number of pieces and the description of timber of which the same is composed.

Collector of Dues, or person authorized by him, shall have free access to examine timber.

**Sec. 18.** The dues leviable on all parcels of square timber, saw-logs or other timber passing down the said river, according to the schedule of rates hereunto annexed, shall be payable immediately on the arrival of such timber or saw-logs at the booms at the mouth of the River St. Maurice, or at such intermediate place as they may be destined for, and no person shall remove any such parcel of timber until such dues have been paid or secured to the satisfaction of the Collector, under a penalty of not less than forty dollars and not exceeding two hundred dollars.

Dues to be paid immediately on arrival of timber at the booms.

Penalty for neglect.

**Sec. 19.** The owner, as well as the person in charge of any parcel of timber, shall be held jointly and severally responsible for any injury or damage done to any of the Slides, Dams, Booms, Piers or other Public Works on the

Owner, &c., responsible for injury by persons in his employ.

## Chap. 92

*Slides and Booms.*

Superintendent may seize and detain timber until injury be repaired or security given.

said River St. Maurice, by any of the parties in the employment of such owner or person in charge, and it shall and may be lawful for the said Superintendent, or other person acting for him, to seize and detain such parcel of timber until the injury so done shall be repaired, or until satisfactory security shall have been given for the payment of the amount at which injury or damage shall be estimated by the Superintendent.

Wilful injury to the works, how punished.

**Sec. 20.** Every person who shall wilfully do any injury or damage to any of the Slides, or to any of the Booms, Dams, Piers or other Public Works on the said River St. Maurice, and every person who shall aid or assist in so doing any such injury or damage, shall, for every such offence, incur a penalty of not less than one hundred dollars and not exceeding two hundred dollars, over and above the amount at which such injury or damage shall be estimated by the Superintendent, as hereinbefore provided.

Penalty incurred, and damage how ascertained.

Owner of timber shall keep a sufficient number of men stationed to prevent damage by accumulation of logs or timber.

**Sec. 21.** The owner of any parcel of squared timber, saw-logs, or other timber conveyed down the River St. Maurice, shall, during the passage thereof, keep a sufficient number of men stationed at every Slide and Boom and also at every other point which the said Superintendent may indicate, to prevent all such damage to the works or obstruction in the river as might arise from the accumulation of logs or other timber against the Booms, or in the channels or bends of the river, or from logs or other pieces of timber escaping under the Booms or going over them.

Number of men to be regulated by Superintendent.

**Sec. 22.** The number of men required at each station shall be regulated by the said Superintendent, and any owner or person in charge of such logs who shall neglect or refuse to comply with this regulation shall incur a penalty of not less than twenty dollars and not exceeding two hundred dollars, over and above the payment of the amount at which any injury or damage so done to the works may be estimated by the Superintendent.

Penalty for non-compliance.

Payment of damages.

Person in charge of timber in the retaining Boom at Shawenegan Bay shall be under the direction of the Superintendent.

**Sec. 23.** No person in charge of timber held in the retaining Boom at Shawenegan Bay shall allow the same to be put or passed out of the Boom, except under the direction of the said Superintendent, or of such person as he may authorize in that behalf, who shall regulate the descent of timber and the time of passing it out; and any person in charge of such timber who shall refuse or neglect to stop the running out of logs at the Boom at Shawenegan Bay, when directed to do so by any such officer, shall incur



*Slides and Booms.*

## Chap. 92

a penalty of not less than twenty dollars and not exceeding two hundred dollars, in addition to the amount at which any injury or damage done to the works, by reason of such neglect or refusal, shall have been estimated by the Superintendent. Penalty for contravention.

Sec. 24. The owner or person in charge of any squared timber, saw-logs, or other timber passing down the St. Maurice, shall, from the time when the same shall approach the Main Booms at the mouth of the said River, until all such timber shall have been passed through the said Main Booms, keep a sufficient number of men stationed at such Booms to prevent any obstruction or damage to the works, which might arise from any undue accumulation of such timber against the Booms or in the gates thereof; and every owner or person in charge of such timber shall furnish at least the number of men required by the Superintendent or person duly authorized by him in that behalf, and shall pass out such timber at the places, at the time and in the manner directed by such Superintendent or person duly authorized by him as aforesaid; and any owner or person in charge of such timber, who shall neglect or refuse to comply with this regulation, shall incur a penalty of not less than twenty dollars and not exceeding two hundred dollars, over and above the amount at which any damage done to the works, by reason of such neglect or refusal, shall be estimated by the said Superintendent. Owner or person in charge of timber passing down the St. Maurice, shall keep a sufficient number of men stationed to prevent obstruction or damage. Number of men shall be prescribed by Superintendent. Penalty for refusal or neglect. Damages incurred.

Sec. 25. Any person who shall tie or fasten, or cause to be tied or fastened, any raft or crib to any of the said Booms at the mouth of the said River St. Maurice, or who shall make or cause to be made any crib frames, or who shall cut or chop, or cause to be cut or chopped, any timber or wood on any of the said Booms, shall incur a penalty of not less than twenty dollars, and not exceeding two hundred dollars. Penalty for tying or fastening raft or crib to any of the said Booms.

Sec. 26. Any person who shall oppose, hinder or obstruct, or who shall aid or assist any other person in opposing, hindering or obstructing any Superintendent of Public Works, Collector of Dues, Boom Keeper, or other officer or person duly authorized by any such officer, in the execution of his duty, shall incur a penalty of not less than twenty dollars and not exceeding two hundred dollars. Penalty for obstructing Superintendent or other officer in the performance of his duty.

O.C. April 29, 1854.

TOLLS.

Tolls on squared timber, saw-logs, &c.

Sec. 27. The following Tolls shall be and are hereby imposed, and shall be payable on squared timber, saw-logs or other timber passing through the Public Works, or parts of the same, on the river St. Maurice :

From Falls of *Grande Mère* to mouth of River.

(a.) From above the Falls of the *Grande Mère* to the mouth of the River St. Maurice—

Squared or Flatted Timber, per 100 pieces..... \$10.00  
Saw Logs, per 100 pieces..... 2.00

From below *Grande Mère* and above Shawenegan.

(b.) From below the *Grande Mère*, and above the Shawenegan Falls to the mouth of the river St. Maurice—

Squared or Flatted Timber, per 100 pieces..... \$7.50  
Saw Logs, per 100 pieces..... 2.00

From below Shawenegan and above Grès Falls.

(c.) From below Shawenegan, and above the Grès Falls to the mouth of the river St. Maurice—

Squared or Flatted Timber, per 100 pieces..... \$5.00  
Saw Logs, per 100 pieces..... 2.00

From above *Grande Mère* to Grès Falls.

(d.) From above the *Grande Mère* to the Grès Falls, or any place intermediate—

Saw Logs, per 100 Pieces..... \$2.00

From below Shawenegan to Grès Falls.

(e.) From below Shawenegan to Grès Falls, or any intermediate place—

Saw Logs, per 100 pieces..... \$1.50

The same to be charged on saw logs taken down the Shawenegan River only when their owners actually use the Public Works, and when the Slide and Boom Masters report that they do so.

Quantities less than one hundred pieces to pay the above rate in proportion.

The said tolls "From below Shawenegan to Grès Falls, or any intermediate place" are to be levied and collected for the use of the booms at Shawenegan and Grès Falls, comprised in the St. Maurice works in the Province of Quebec.

From above Grand Piles.

(f.) From above the Grand Piles to the mouth of the river St. Maurice—

Saw Logs, per 100 pieces..... \$2.50

Saw-log established as the standard of measurement.

(g.) The saw-log is established as the standard of measurement for wood passing through the St. Maurice Slides and Booms ; and the undermentioned items, not provided for in the present tariff of tolls, shall henceforth be calculated and charged for in the following relative proportions :—

Railway ties, Telegraph poles.

Four railway ties as equal to one saw-log.  
Two telegraph poles as equal to one saw-log.

*Slides and Booms.*

Chap. 92

Two other logs or poles for posts or fence-rails as equal to one saw-log.	Other logs or poles.
One pile as equal to one saw-log.	Pile.
One hundred fence-rails as equal to five saw-logs.	Fence-rails.
One cord firewood as equal to three saw-logs.	Firewood.
One cord spool wood as equal to four saw-logs.	Spool wood.
One cord other wood, for manufacturing purposes, as equal to four saw-logs.	Other wood.

O.C. April 29, 1854; Nov. 12, 1874; April 16, 1878; Sep. 2, 1878; Aug. 10, 1884; Jan. 28, 1885.

OTTAWA DISTRICT.

REGULATIONS, CHAUDIÈRE FALLS.

The Timber Slide situated in the vicinity of Chaudière Falls, on the south side of the Ottawa River, in the Ottawa District, shall be subject to the following Regulations.

Sec. 28. (a.) No rafts of round, square or flatted timber, or saw logs, shall be allowed to be banded up within the sheet of water bounded by the "Ottawa Slide", south shore of Victoria Island to the eastern extremity of the same, and extending easterly to a mark on the south side of Pine Tree Island, thence in a southerly direction to a mark at the water's edge of the River Ottawa, opposite the centre of Kent street, in the city of Ottawa; thence along the south shore of the river to the foot of the slide aforesaid.

No rafts of timber, or saw logs shall be banded up within the limits prescribed.

(b.) But in case of cribs of timber or saw logs being damaged or broken up in passing the Slide they may be repaired or re-rafterd within the aforesaid limits, if, in the opinion of the Superintendent of the works, such repairing or re-raftering be necessary. But in no case shall they be allowed to remain within the said limits longer than forty-eight hours after passing the Slide.

Cribs damaged or broken up may be repaired or re-rafterd within the said limits on certain conditions.

(c.) Every violation of this provision, or encroachment on said limits, shall subject the owner, person or persons in charge of such raft to a penalty of not less than twenty-five dollars and not exceeding fifty dollars.

Penalty for violation.

Sec. 29. No steam-boat, barge or other craft, during the season of running timber, shall be allowed to moor within the said limits in a position that obstructs a free outlet from the slide; and in all cases vessels loading or unloading, must be brought to the wharves or landing places and lie parallel with the current, but in no case shall there be more than two vessels abreast of each other, under a penalty, for every offence, of not less than fifteen dollars nor more than fifty dollars.

Steam-boat, barge or other craft, not allowed to moor within said limits, so as to cause obstruction.

Penalty for contravention.

## Chap. 92

*Slides and Booms.*

Rafts, vessels, or other craft, liable for penalty; and Superintendent may seize and detain until penalty paid or security given.

Mode of procedure to enforce penalty.

Sec. 30. Rafts, vessels or other craft, as aforesaid, shall be held liable for the penalty imposed under these regulations; and the Superintendent of the works is authorized and required to seize and detain any such raft, vessel, barge or boat, until payment of such penalty, or until the owner or person in charge shall give satisfactory security for the payment thereof, within thirty days after such penalty shall have been declared or demanded; and in default of such payment being made within such specified time, then the Superintendent may proceed to sell by public auction any such raft, vessel or boat, after having first given two weeks' notice of the day of such intended sale; such notice to be inserted in one or more of the public newspapers published in the city of Ottawa, at least two clear weeks prior to the day of sale, levying the cost attendant thereon, as well as the fine so imposed, upon the owner or person claiming such property.

O.C. June 8, 1860.

## REGULATIONS, GATINEAU RIVER.

Persons engaged in "driving" timber down the River shall not deposit any saw-logs or square timber until the ice has left the pond.

The main guide boom in the southern channel shall be kept clear of logs and timber.

Not more than 15,000 pieces of saw-logs or square timber allowed to accumulate in the main guide boom at one time.

Sec. 31. Persons engaged in "driving" timber down the Gatineau River, in the Ottawa District aforesaid, shall not deposit on the banks of the main stream, or any of its tributaries, any saw-logs or square timber, within reach of the spring floods, nor float any timber down the rivers aforesaid until the ice has left the pond near the mouth of the Gatineau, the said pond being a receptacle for lumber, and connected with the main boom on said Gatineau River by a creek; and whereas during the season of the low water, steamers, barges, or other river craft, or rafts of square timber or sawed lumber, can not pass through the "trip" boom forming the upper portion of the Gatineau boom in the north channel of the Gatineau River, but have to be passed through the main guide boom in that river by a more southerly channel, the said boom shall be kept clear of logs and timber, and the owners or persons having any logs or timber obstructing the said boom, during the said season of low water, when steamers, barges or other river craft or rafts of square timber or sawed lumber cannot pass through the "trip" boom aforesaid, shall be held liable for all damages that may be caused to the owners or persons in charge of steamers or other river craft, or rafts of any description of timber, on account of detention, or otherwise, by such obstruction, over and above the penalty hereinafter mentioned; and during the season of high water in the said river the owners or persons in charge of rafts or timber shall not allow more than fifteen thousand pieces of saw logs or square timber to

*Slides and Booms.*

## Chap. 92

accumulate or be in the main guide boom leading to the canal at the same time; every violation of this regulation shall subject the owners or persons in charge of such timber to a penalty of not less than twenty-five dollars and not more than fifty dollars, for each and every day during which the present regulation shall be violated, over and above the amount that may be awarded by the Superintendent of the Ottawa works, for any damage that may be done to the booms or works in consequence of such violation.

Penalty for contravention and damages how awarded.

O.C. May, 17, 1865.

## REGULATIONS, GATINEAU BOOMS.

Sec. 32. (a.) The Gaps at the Upper and Lower Boom of the Gatineau during the season for running timber and logs, shall be opened at five o'clock in the morning and closed at seven o'clock in the evening, or at an earlier or later hour, if found necessary by the Boom Master or person in charge of the said Gaps.

Gaps, hours of day to be left open.

(b.) The said Gaps shall be kept continually open for running between the hours named in the next preceding sub-section with the exception of two hours for meals.

Two hours for meals allowed.

(c.) When any timber, logs or other lumber arrive at the Sorting Gaps on the Gatineau aforesaid, the owner of such timber, logs or lumber shall at once cause the removal thereof. In the case of neglect or delay on the part of the owner thereof to comply with this regulation, whereby the passage of the timber, logs or other lumber of other owners might or should be impeded, the Boom Master, or his assistant at the Gatineau Boom or Upper Gap, or the person appointed to carry out these regulations at the outlet of the Gatineau Pond, in the Ottawa River or Lower Gap, respectively, is hereby empowered to turn adrift the timber causing the impediment and the loss resulting therefrom shall fall upon its owner.

Timber, logs or lumber arriving at the Sorting Gaps, to be removed at once.

In case of neglect or delay, Boom Master may turn adrift the timber causing impediment.

(d.) The officers above mentioned shall have full power to enforce these regulations at their respective stations; and the Superintendent of the Ottawa River Works, or his assistant, in any case of damages on account of breakages or over-crowding the timber of any description, shall determine what damages shall be paid on account thereof, and in what proportions such damages shall be paid at either the Upper or Lower Gap.

Officers shall have full powers to enforce regulations, and Superintendent shall determine respecting damages.

O.C. May, 21, 1874.

## REGULATIONS, MADAWASKA RIVER.

Deputy Slide Master shall determine the quantity of timber allowed to pass the Chain Rapids Boom each day.

Owner or person in charge shall send a sufficient number of men to keep Boom clear and prevent obstruction.

Penalty and damages.

Penalty and damages incurred by owner or person in charge of timber for interference with Deputy Slide Master at Arnprior station.

Sec. 33 (a.) In order to prevent an over-pressure of timber being brought on the Guide Boom at the High Falls station, on the Madawaska River, in the Ottawa District aforesaid, the Deputy Slide Master at that station shall determine the quantity of timber that shall be allowed to pass the Chain Rapids Boom each day, and the owners or persons in charge of timber shall send a sufficient number of men to the High Falls Guide Boom for the purpose of keeping it clear and preventing an accumulation of timber at that place; and every violation of this regulation by such owners or persons in charge of timber shall subject them to a penalty of not less than fifty dollars and not more than one hundred dollars, over and above the amount that may be awarded by the Superintendent of the Ottawa Works for any damage that may be done to the works in consequence of such violation.

(b.) Any interference on the parts of owners or persons in charge of timber with the Works between Springtown and the mouth of the Madawaska River (including the retaining boom near McCrea's house, at Springtown, and the retaining boom in the Chats Lake), which are both under the control and management of the acting Deputy Slide Master at Arnprior station, or any interference with the duties of that officer, as already provided, shall subject the owners or parties so interfering, without being thereto duly authorized, to a penalty of not less than one hundred dollars and not more than two hundred dollars, over and above the amount that may be awarded by the Superintendent of Ottawa Works in consequence of any damage that may arise from such interference or violation of this regulation.

O.C. May 17, 1865.

Slides and Booms.

TARIFF OF TOLLS ON THE OTTAWA WORKS.

Sec. 33. TARIFF OF TOLLS to be levied on Timber, Saw-logs, &c., passing through the Government Slides and Works upon the Ottawa and its Tributaries.

Name of River.	Name of Slide or other Improvement.	PER SLIDE OR IMPROVEMENT.			RATE TO CLEAR.		Special Rates.
		Red and White Pine or Hardwood.			To Ottawa, per Saw-log.	To foot of Chaudière, per Crib of Square Timber.	
		Per Crib of Square Timber.	Per Stick of Square Timber.	Per Saw-log.			
		\$ cts.	cts.	cts.	cts.	\$ cts.	
Ottawa	For passing through—						
do	Slides at Roche Capitaine.....	1 00				4 50	
do	do St. Joachim Rapids.....	1 00				3 50	
do	do Calumet and Mountain Rapids.....	1 00				2 50	
do	do Portage du Fort.....	0 50				1 75	
do	do Chats.....	1 00				1 50	
do	do Chaudière.....	1 00		1		1 00	
do	Cheneaux Boom.....		2				
do	Chaudière do.....			1			
do	Dams, piers and booms between Cedar Lake and Memo Rapids.....			1			
Petawawa		0 75					
do	Trout Lake & slide above Lake Traverse.....	1 00					
do	Lake Traverse slides.....	0 50		1			
do	Crooked Chute.....	1 25		1 1/2			
do	Bois Dur to River Ottawa.....					3c. per stick and \$0.	
do	Ragged Chute and High Falls slide and improvements.....	1 50		2		3c. per stick and \$0.25.	
Madawaska	Improvements below High Falls to Arnprior.....	0 50		1		4 25	
do	From High Falls to above Arnprior slide.....	1 75		2		3 75	
do	Slide at Arnprior.....	0 50		3 1/2		3 50	
		1 75		1 1/2		3 00	
		0 50		1/2		1 75	
				1/2			

Boom at mouth of Madawaska to be charged additional when used.

## TARIFF OF TOLLS ON THE OTTAWA WORKS.

## TARIFF OF TOLLS to be levied on Timber, Saw-logs, &amp;c.—Continued.

Name of River.	Name of Slide or other Improvement.	PER SLIDE OR IMPROVEMENT.				RATE TO CLEAR.		Special Rates.
		Red and White Pine or Hardwood.				To River Ottawa, per Saw-log	To foot of Chaudière, per Crib of Square Timber.	
		Per Crib of Square Timber.	Per Stick of Square Timber.	Per Saw-log.				
\$ cts.	\$ cts.	\$ cts.	\$ cts.	cts.	\$ cts.			
Madawaska..	For Retaining booms and piers in Chats Lake at mouth of river.....	0 25	15	1	14	15c. perstick and \$3.50.		
Dumoine ..	High Falls slide to River Ottawa .....							
do	Below High Falls, lower improvement..	0 75						
Coulonge....	Slide at High Falls.....	1 50		2	2	4 00		
Black River.	Slides at Black River.....	1 00		2	2	3 50		
Gatineau ..	Booms.....		6	2	2			

Ordinary cribs of sawn lumber 50 per cent. additional on square timber rates.

Small flattened timber at half the rate of square timber.

Eight railway ties to be charged as equivalent to one ordinary piece of flattened timber at half the rate of square timber.

Round, flattened and dimension timber exceeding 15 inches in mean diameter to be charged as square timber; and not exceeding 15 inches in mean diameter to be charged half the rate of square timber on all works used; in each case when the timber is loose 30 pieces to be treated as equivalent to one crib of square timber.

O.C. Jan. 9, 1889.



*Slides and Booms.*

Chap. 92

## NEWCASTLE DISTRICT.

## REGULATIONS, FENELON RIVER.

Sec. 35. Regulations for the running of timber of any description down the Fenelon River, from Cameron's Lake to Sturgeon Lake, in the Newcastle District, in the Province of Ontario :—

(a.) The owner or person in charge of any raft or parcel of timber, previous to entering the Fenelon River for the purpose of passing such raft or parcel of timber down the channel allotted for the same, viz., the eastern channel formed by the Government Boom, shall attach a boom to the snubbing post on the west bank of the river, and to the up-stream pier of the aforesaid Government Boom, so as to prevent any of the said timber entering the channel set apart for vessels, that is to say, the channel on the west side of the Government Boom. Every violation of this regulation shall subject the owner or person in charge of such timber to a penalty of not less than fifty dollars and not more than two hundred dollars.

Owner or person in charge of timber shall attach a boom to the snubbing post on the west bank of the river and to the up-stream pier.

Penalty for violation.

(b.) No raft or parcel of timber of any description whatever shall be permitted to enter the Fenelon River through the slide at the Falls without the owner or person in charge of such raft or parcel of timber first giving notice thereof to, and obtaining permission from, the Superintendent or officer appointed to regulate the running of timber down the river, under a penalty of not less than fifty dollars and not more than two hundred dollars.

Notice to be given to, and permission obtained from Superintendent or other officer before entering the slide.

(c.) Parties engaged in running timber of any description whatever down the Fenelon River are hereby prohibited from allowing the said timber to enter the river through the slide at the Falls at a faster rate or in greater quantities than that directed by the Superintendent or officer duly appointed to regulate the running of timber down the river, under a penalty of not less than fifty dollars and not more than two hundred dollars.

Superintendent to regulate how fast and in what quantities timber may run. Penalty for non-compliance.

O.C. Aug. 10, 1874.

## TOLLS IN THE NEWCASTLE DISTRICT.

Sec. 36. Tariff of Tolls authorized to be levied and collected on all logs, timber, square and round, pine, cedar, railway ties, etc., etc., passing down and running into the Boom erected across the River Trent, in the Village of Trenton.

Tariff of tolls on logs, &c., across the River Trent.

## Chap. 92

*Slides and Booms.*

For every saw-log coming into the said boom....	$\frac{1}{2}$	cent.
“ piece of square timber, mast or spar....	5	“
“ Railway tie, allowing 8 feet for each....	$\frac{1}{4}$	“
“ Float .....	2	“
“ Board, plank or deal, and all kinds of lumber, per M. feet board measure...	15	“
“ piece of round Cedar.....	2	“
“ “ Ash or other round wood	2	“
“ Telegraph pole.....	$\frac{1}{2}$	“
“ Crib or dram of boards, plank, railway ties, hop poles, States-bound, or square timber, deal or other lumber of any kind that may come into the boom, also cribs made or rafted within the corporation boom and not passing directly out .....	\$1.00	

O.C. May 26, 1871.

Tariff of tolls  
on logs, &c.,  
passing  
through the  
slides.

Sec. 37. Tariff of Tolls authorized to be levied and collected on logs, etc., passing through the slides:—

(a.) *At Heely's Falls.*

On each saw-log passing through the slide....	$\frac{1}{4}$	cent.
On each float or boom stick.....	$\frac{1}{2}$	“
On each stick of square timber .....	1	“
On each railway tie, cedar post, bolt, barrel heading, telegraph pole and stave.....	$\frac{1}{8}$	“

(b.) *At Middle Falls.*

Same as Heely's Falls.

(c.) *At Chisholm's Rapids.*

Same as Heely's Falls.

O.C. Nov. 13, 1884.

All over in Council - passed  
 Oct. 1879 - will be found with  
 19 of 1879 *1879* *1879*  
 CHAPTER 93.

TRANSFER AND ABANDONMENT OF PUBLIC  
 WORKS.

PUBLIC BUILDINGS TRANSFERRED TO THE GOVERNMENT OF  
 QUEBEC.

Section 1. Whereas by the "British North America Act, 1867" certain public buildings became the property of Canada, and by 31 Vic., Chap. 12, intituled "An Act respecting the Public Works of Canada," which has been since superseded by "The Public Works Act," Chap. 36 of the Revised Statutes of Canada, the same were placed under the control and management of the Minister of Public Works;—

And Whereas amongst such Buildings were the several Court Houses and Gaols hereinafter mentioned, situate in the Province of Quebec; and whereas the Government of the Province of Quebec did apply for the transfer to that Province of the Public Buildings in question;—

His Excellency in Council, on the recommendation of the Minister of Public Works, and under the authority aforesaid, was thereupon pleased to order and it was thereby ordered, that all and singular the several Court Houses and Gaols, hereinafter mentioned, situate in the Province of Quebec, should be, and they were thereby granted and transferred to the Government of the said Province of Quebec, that is to say:

Court Houses  
 and Gaols in  
 the Province  
 of Quebec  
 transferred to  
 the Govern-  
 ment of said  
 Province.

Name of Building.	District.	Chief Place.
Court House and Gaol	Arthabaska	St. Christophe.
Do	Beauce	St. Joseph.
Do	Beauharnois	Beauharnois.
Do	Bedford	Sweetsburg.
Do	Chicoutimi	Chicoutimi.
Do	Gaspé	Percé.
Do	Gaspé	New Carlisle.
Do	Iberville	St. Johns.
Do	Joliette	Joliette.
Do	Magdalen Islands	Amherst.
Do	Montmagny	Montmagny
Do	Richelieu	Sorel.
Do	Rimouski	St. Germain.
Do	Saguenay	St. Etienne de la Malbaie.
Do	St. Hyacinthe	St. Hyacinthe.
Do	Terrebonne	Ste. Scholastique.

---

**Chap. 93**      *Transfer and Abandonment of Public Works.*

---

Name of Building.	District.	Chief place.
Court House	Quebec	Quebec.
Do	Three Rivers	Three Rivers.
Gaol	Montreal	Montreal.
Do	Three Rivers	Three Rivers.

Upon the terms and conditions following, that is to say :

To be held  
with all the  
privileges and  
encumbrances.

(a.) That the same, and every part thereof, respectively, should be held and taken by the Government of Quebec, with all the privileges and encumbrances therewith, and so that no liability should exist in the Government of Canada in respect to the same or any incumbrances thereon.

To be taken in  
their then  
condition.

(b.) That the several buildings be taken, by the Government of Quebec in the state of repair and condition in which they might respectively be at the date of the Order in Council.

O. C. Noy. 19, 1869.

**PUBLIC BUILDINGS TRANSFERRED TO THE GOVERNMENT  
OF ONTARIO.**

Sec. 2. Whereas, by the "British North America Act, 1867" certain public buildings became the property of Canada, and by 31 Vict., Chap. 12, intituled "An Act respecting the Public Works of Canada," the same were placed under the control and management of the Minister of Public Works;—

And whereas amongst such buildings were the Asylums at Toronto and Orillia, the Reformatory at Penetanguishene and the Gaol and Court House at Sault Ste. Marie, situate in the Province of Ontario; and whereas the Government of the Province of Ontario applied for the transfer to that Province of the Public Buildings in question;

Buildings  
transferred to  
and appropri-  
ated for the  
use of the Leg-  
islature and  
Government  
of Ontario.

His Excellency in Council, on the recommendation of the Minister of Public Works, and under the authority of the 108th section of the first mentioned Act, and the 8th item of the third schedule attached thereto, was thereupon pleased to order, and it was thereby ordered, that all and singular the several public buildings hereinafter mentioned, situate in the Province of Ontario, should be, and they were thereby transferred to and appropriated for the use of the Legislature and Government of the Province of Ontario, that is to say :

1. The Asylums at Toronto and Orillia.
2. The Reformatory at Penetanguishene.
3. The Gaol and Court House at Sault Ste. Marie.

O. C. Jan. 6, 1877.

*Transfer and Abandonment of Public Works.*

Chap. 93

PUBLIC BUILDINGS, TRANSFERRED TO THE GOVERNMENT  
OF NEW BRUNSWICK.

Sec. 3. Upon the report of the Minister of Public Works, that the properties in the Town of Fredericton, in the Province of New Brunswick, known as the "Government House," and the "Provincial Buildings," and more particularly described in the schedule hereunto annexed, and forming part of this order, were not required for the use of the Dominion of Canada; His Excellency, on the recommendation of the Minister of Justice, and under the provision of the 108th Section of "The British North America Act, 1867," and the 8th item of the third schedule attached thereto, was pleased to order, and it was thereby ordered, that the said properties should be, and they were thereby appropriated to the use of the Government and Legislature of the Province of New Brunswick.

Properties appropriated to the use of the Government and Legislature of New Brunswick.

*Schedule.*

Two tracts of land in the Parish of Fredericton, in the County of York, Province of New Brunswick, and bounded as follows, to wit:—

1st. The first tract being that on which the Government House and out-houses are erected, bounded north-easterly by the River St. John; south-easterly by Smyth Street, in the Town Plot of Fredericton; south-westerly by the Great Road from Fredericton to Woodstock; and north-westerly by the Lane leading from the said Great Road to the River St. John, at the distance of forty-three chains, of four poles each, and fifty links (measured along the said Great Road) from Smyth Street, and containing fifty acres, more or less: The said tract being that which was conveyed by Lieutenant Governor Carleton to His late Majesty George the Third, on the Seventh day of March, A.D. 1816, and recorded in pages 89, 90 and 91, No. 1609, of Book E, of the records of the said County of York.

That on which the Government House and out-houses are erected.

2nd. The second tract being that on which the Legislative and other Public Buildings are erected in the aforesaid Town Plot of Fredericton, bounded north-westerly by St. John Street, south-westerly by King Street, south-easterly by Secretary's Lane, and north-easterly by Queen Street, and containing two acres and two roods, more or less.

That on which the Legislative and other Public Buildings are erected.

O.C. Feb. 11, 1870.

---

 Chap. 93      *Transfer and Abandonment of Public Works.*

---

 GOVERNMENT HOUSE AT CHARLOTTETOWN, TRANSFERRED  
 TO THE GOVERNMENT OF PRINCE EDWARD ISLAND.

Sec. 4. On the recommendation of the Minister of Public Works, and under the provisions of the 108th section of "The British North America Act, 1867," and the 8th item of the third schedule attached thereto ;

Government House, grounds, premises and farm attached and held therewith.

His Excellency in Council, was pleased to order and it was thereby ordered that the Government House at Charlottetown, in the Province of Prince Edward Island, its grounds and premises, together with the farm thereunto attached and held therewith, should be transferred to the use of the Government and Legislature of the said Province of Prince Edward Island.

O. C. June 10, 1874.

---

 PUBLIC PROPERTY TRANSFERRED TO BRITISH COLUMBIA.

Sec. 5. On the recommendation of the Minister of Public Works, and under the 108th section of "The British North America Act, 1867," and the 8th item of the third schedule attached thereto ;

Properties transferred to and appropriated for the use of the Legislature and Government of B.C.

His Excellency in Council was pleased to order and it was thereby ordered that the following properties, situate in the localities hereinafter mentioned, in the Province of British Columbia, be transferred to and appropriated for the use of the Legislature and Government of the said Province of British Columbia, that is to say :—

The lots and buildings marked B, C, and E.

1st. The Lots and Buildings marked B, C and E, on plan No. 1, signed by the Hon. Henry Holbrook, Chief Commissioner of Lands and Works, and being ;—

Lot B, the Government Buildings,

Lot C, a School House and Reserve, and

Lot E, the Police Barracks, all in Victoria.

Lieutenant Governor's residence.

2nd. The Lot and Building represented on plan No. 6, signed as above, and being the Lieutenant-Governor's residence at Victoria.

School House and reserve, Victoria District.

3rd. The public building and land represented on plan No. 8, signed as above, and being a School House and reserve in Victoria District.

Court House and Gaol, &c., at New Westminster.

4th. The lots and buildings indicated on plan No. 10 by the letters C, E and F., and signed as above, being Lot C, the Court House and Gaol ; Lot E, a Public School House, and Lot F, a Public Hospital, all at New Westminster.

Court House and Gaol at Nanaimo.

5th. The public buildings and lands indicated on plan No. 16, signed as above, being the Court House and Gaol at Nanaimo.

6th. The public buildings and lands indicated on plan No. 17 by letter A, and signed as above, being the Court House and Gaol at Hope. Court House and Gaol at Hope.

7th. The public buildings and lands indicated on plan No. 19 by letter A, signed as above being the Gaol at Yale. Gaol at Yale.

8th. The public buildings and lands indicated by letters A and B on plan No. 22, signed as above, being the Court House and Gaol at Lytton. Court House and Gaol at Lytton.

9th. The public buildings and lands indicated by letters A and B on plan 25, signed as above, being Lot A, a Court House, and Lot B, a Gaol, at Lillooet. Court House and Gaol at Lillooet.

10th. The public buildings and lands represented on plan No. 28, signed as above, being the Gaol at Quesnel. Gaol at Quesnel.

11th. The public buildings and lands represented on plan No. 30, signed as above, and marked respectively "Court House," "Jail," and "Police Barracks," at Richfield. "Court House," "Jail," &c., at Richfield.

12th. The public buildings and lands indicated on plan No. 31, signed as above, and marked "Assay Office," and "Approximate site of Jail," at Barkerville. "Assay Office" &c., at Barkerville.

13th. The public building indicated on plan No. 32, signed as above, and marked "Lock-up," at Van Winkle. "Lock-up" at Van Winkle.

14th. The public buildings and lands indicated on plan No. 33, and marked "Court House," "Jail," "Police Barracks," "Church and Parsonage," at Langley; all of which plans are authenticated by the signature of the Minister of Public Works, and remain of record in his Department. "Court House," "Jail," &c., at Langley.

And it was further ordered that the said enumerated properties be and the were thereby transferred to the said Province of British Columbia in their then present state, and subject to any condition in the original grant or reservation, and to any trust, rent, claim, servitude or other incumbrance whatsoever. Transferred in their then condition.

O.C. May 26, 1876.

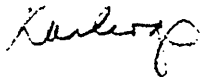

DESJARDINS CANAL TRANSFERRED TO THE TOWN OF DUNDAS.

Sec. 6. On the recommendation of the Minister of Public Works, and under the provisions of the 54th, 56th and 57th sections of the Act passed in the Session of the Parliament of Canada, held in the 31st year of Her Majesty's reign, chaptered 12, and intituled "An Act respecting the Public Works of Canada," and of the Act passed in the Session of the Parliament of Canada held in the 39th year of Her Majesty's reign, chaptered 17, and intituled "An Act respecting the Desjardins Canal," His Excellency in Council was pleased to order, and it was thereby ordered, that the Public Work known as the "Desjardins Canal," together The Public Work known as the "Desjardins Canal" with its appurtenances, transferred to the Corporation of the Town of Dundas and their successors.

with all its appurtenances, be granted, transferred and conveyed to the Corporation of the Town of Dundas and their successors; To have and to hold the same to the said Corporation and their successors forever, subject to the provisions of the said Act 39 Victoria, Chapter 17, and subject also to the following conditions:—

Said work to be kept in thorough repair by the said Corporation.

1st. That the said work and its appurtenances shall at all times hereafter be kept in thorough repair by the said Corporation and their successors,—the sufficiency of such repair to be ascertained and decided upon by such Engineer as shall be appointed to examine the same by the Minister of Public Works for the time being; and that the decision and report of the said Engineer as to the sufficiency of such repair shall be final and conclusive.

Upon failure of performance of preceding condition, property to revert to Her Majesty.

2nd. That upon failure of performance of the preceding condition, or of any part thereof, and notwithstanding the waiver of any previous similar breach or default, Her Majesty, Her heirs or successors, may enter into and upon the said Canal and its appurtenances, or may obtain possession of the same under a warrant, as hereinafter mentioned.

Proceedings prescribed for obtaining possession on behalf of Her Majesty, in case of forfeiture and reversion.

3rd. That, whenever, by any default or breach of condition under the foregoing provisions, Her Majesty, Her heirs or successors, shall have the right to enter into or upon the said Canal, it shall be lawful for Her Majesty, Her heirs or successors, or for such person or persons as His Excellency the Governor General, or the person administering the Government of Canada shall authorize or appoint for that purpose on behalf of Her Majesty, Her heirs or successors, into and upon the said Canal, or into and upon any part thereof, in the name of the whole to re-enter, and the said Corporation, or their successors, and their servants, and all other persons occupying the said Canal, or any part thereof, thereout and thence utterly to expel, put out and remove; or, a warrant directed to the Sheriff of the County in which the said Canal shall be situate, may be issued under the Privy Seal of His Excellency the Governor General, or the person administering the Government of Canada, reciting such default and commanding such Sheriff forthwith to deliver to a public officer to be named in the said warrant for and in the name of Her Majesty, Her heirs or successors, the said Canal and its appurtenances; and the said Sheriff and his officers and assistants shall have full power and authority under such warrant to enter into and upon the said Canal, and every part thereof, or upon any part thereof in the name of the whole, and the said Corporation, or its successors, and their servants and all other persons, occupying the said Canal, or any part thereof, thereout and thence



*Transfer and Abandonment of Public Works.*

Chap: 93

utterly, to expel, put out and remove, and to deliver the same and the possession thereof to the said public officer of Her Majesty, Her heirs or successors. And upon entry being made by or on behalf of Her Majesty, Her heirs or successors, or upon possession being delivered by any Sheriff as aforesaid, the grant of the said Canal, and every matter and thing herein contained, shall thenceforth become and be utterly null and void; and Her Majesty, Her heirs or successors, shall thenceforth stand and be absolutely seized and possessed of the said Canal and its appurtenances, and every part thereof as of Her Majesty's original estate therein.

O.C. Oct. 26, 1877.

PORT DOVER HARBOR WORKS TRANSFERRED TO "THE PORT DOVER AND LAKE HURON RAILWAY COMPANY."

Sec. 7. By Order in Council of the 1st day of May, 1877, and under the provisions of Section 54 of Chapter 12 of the Acts 31 Victoria, superseded by Section 17 of Chapter 36 of the Revised Statutes of Canada, intituled "The Public Works Act," His Excellency the Governor General in Council directed that the Port Dover Harbor, situate at the mouth of Patterson's Creek, in the County of Norfolk, in the Province of Ontario, in the Dominion of Canada; with the piers, approaches and other works vested in Her Majesty, connected with and forming the said harbor, and the appurtenances thereunto belonging, and the tolls of and arising from the said harbor, be granted, transferred and conveyed to the Company called "The Port Dover and Lake Huron Railway Company," and their successors and assigns, to hold to them, their successors and assigns, upon and subject to the terms, provisions and conditions following, that is to say:—

1st. That the said Company, their successors and assigns, do and shall keep the said harbor, and the entrance to the same, free and clear of all obstructions, and the said harbor, piers and all others the works and premises thereunto appertaining, in thorough repair; and for all the purposes of this order and conveyance, the sufficiency and insufficiency of such repairs and state of repair shall be ascertained and decided on by the Engineer who shall be appointed to examine the same by the Honorable the Minister of Public Works of Canada, and his decision and report as to the sufficiency or insufficiency of such repairs and state of repair shall be final and conclusive.

2nd. That upon any breach or default in the performance of any of the preceding conditions, or any part thereof, and notwithstanding the waiver or supposed waiver of any previous similar breach or default, and in addition to any other

Port Dover Harbor, with the piers, approaches and other works, and the appurtenances; and the tolls arising therefrom transferred to "The Port Dover and Lake Huron Railway Company."

Company to keep the harbor and entrance free of obstructions, and the premises in thorough repair.

Upon failure to perform conditions, property to revert to Her Majesty.

forfeiture incurred thereby, Her Majesty, Her heirs and successors may enter into, and upon the Public Works aforesaid, or may obtain possession of the same under a warrant or warrants, as hereinafter provided, in which case the purchase money paid by the Company will be forfeited, and the Company will be held liable for any damage caused by any such breach or default.

Harbor shall be a public harbor, subject to payment of the lawful tolls and to general regulations.

3rd. That the said harbor shall, at all times hereafter, be a public harbor, which all vessels and persons shall have a right to enter, and the said harbor and piers shall be kept and may be used for the accommodation and convenience of vessels entering into and lying, loading and unloading within the same, subject to the payment of the harbor tolls legally imposed thereon, and also to all general regulations made or to be made for the regulation and management, proper using and protection of the said harbor and piers.

Tolls not to exceed those mentioned in Order in Council of 21st May, 1872.

4th. That the tolls to be collected or received for the use of the said harbor shall not in any case exceed the terms or rates of toll mentioned and established by His Excellency the Governor General in Council, by Order, dated at Ottawa the twenty-first day of May in the year of Our Lord one thousand eight hundred and seventy-two, and published in the *Canada Gazette* of the same year at page 1094, and that no toll shall be charged or taken for passengers embarked or disembarked at the said harbor.

Subject to restrictions and conditions specified, all rights and powers vested in the Governor General in Council which can be granted to the said Company under the Act 31 Vic., Chap. 12, are granted and transferred to said Company.

5th. That subject to the restrictions and conditions hereinbefore contained, all rights and powers which, at or before making of this Order, were vested in His Excellency the Governor General of Canada in Council, and which, under the said Act 31 Victoria, Chapter 12, can be granted to the said Company of enacting regulations for the regulation and management, proper using and protection of the said harbor and piers, or for fixing or varying the tolls of the said harbor, or for the collection of the said tolls, and by such regulations to impose fines for enforcing the same, and to provide for the non-passing or detention, at the risk of the owner, of vessels or goods on which tolls are not paid, or in respect of which any such regulations are not complied with, or any injury done to the said harbor, piers or other works, or any fine which may have been incurred and remain unpaid, shall be and the same are subject to the restrictions and conditions herein contained, are hereby granted, transferred and conveyed to and invested in the said Company and their successors; Provided, however, that all regulations of His Excellency the Governor General in Council heretofore legally enacted for any of the purposes aforesaid, relating to the said harbor and piers, shall, except so far as they are inconsistent with the provisions herein contained, continue

Provisions for continuing existing regulations.

*Transfer and Abandonment of Public Works.*

Chap. 93

in force until otherwise ordered or enacted by any order or regulation of the said Company, and all the rights and powers by such regulations vested in Her Majesty or Her servants with regard to the said harbor and piers shall be and the same are hereby granted to and vested in the said Company, and their successors and servants, respectively, and that all fines and penalties imposed by the said regulations, applying to the said harbor, piers and other works, shall belong to the said Company; but no fines to be imposed by any order or regulation enacted by the said Company, under the powers hereby granted, shall exceed the sum of ten dollars; and provided, further, that no regulations to be enacted by the Directors of the said Company, under the powers granted by this section, shall be valid and effectual until approved by His Excellency the Governor General in Council, but regulations by which tolls or penalties are reduced in amount may be made by the said Company, without such approval being had or obtained.

Fines limited to ten dollars.

Regulations to be enacted shall be approved by Governor in Council.

6th. That Her Majesty, Her heirs or successors, may, at any time after the expiration of ten years from the tenth day of October, one thousand eight hundred and seventy-three, resume the said Public Works hereby granted, together with any additions, improvements or acquirements therein made by the said Company, upon paying to the said Company or their successors or assigns the then cash value of the said works; Provided, the Honorable the Minister of Public Works of Canada, or other officer authorized in that behalf by His Excellency the Governor General or person administering the Government of Canada, shall have previously given to the said Company, their successors or assigns, at least six calendar months' notice in writing of the intention to resume the said works, and of the day on which the same will be resumed. And the said the Honorable the Minister of Public Works, or other officer authorized as aforesaid, and the said Company or their assigns, shall agree upon and fix the value of the said works within two calendar months from the time of giving such notice; and in default thereof the said the Honorable the Minister of Public Works, or other officer authorized as aforesaid, shall select one Arbitrator on behalf of Her Majesty, Her heirs or successors, and the said Company or their assigns shall select another Arbitrator; and in default of the said Company or their assigns making such selection and notifying the said the Honorable the Minister of Public Works, or other officer thereof, and of the person selected, within ten days after being required, in writing, by the said the Honorable the Minister of Public Works, or other officer, so to do, the said the Honorable the Minister of Public Works or

Her Majesty may at any time after expiration of ten years from the 10th October, 1873, resume the said Public Works, with additions and improvements.

Minister of Public Works to give the said Company at least six months notice.

The value of the said works to be settled by arbitration in case the Minister and the Company do not come to an agreement thereon.

Procedure prescribed for the selection of arbitrators and their adjudication upon the matters to be submitted to them.

other officer may name an Arbitrator on behalf of said Company or their assigns, and the said two Arbitrators shall appoint a third Arbitrator within ten days after the appointment of the Arbitrator on behalf of the said Company or their assigns, and in default thereof a third Arbitrator shall be appointed by the Judge or Senior Judge for the time being of the County Court of the County in which the said works shall lie; and in case there shall not be a Judge of such County Court, then by the Chancellor of Ontario for the time being. And the said Arbitrators shall receive evidence and inquire into and ascertain the value of the said works, having previously given to the said the Honorable the Minister of Public Works or other officer, and to the said Company or their assigns, eight days' notice in writing of the time and place of their sittings; and the award in writing of the said Arbitrators, or of any two of them, under the hands and seals of any two or more of them, fixing the value of the said works, additions and acquirements, and made at least one week previous to the day mentioned in the aforesaid notice for resuming the said works, additions and acquirements, shall be final, and the amount so fixed shall be taken to be the cash value of the said works, additions and acquirements: Provided, that in case no award shall be made by the said Arbitrators, or any two of them, within the time hereinbefore mentioned, the said the Honorable the Minister of Public Works, or other officer, may again give six calendar months' notice of the intention to resume the said works, and of the day on which the said works shall be resumed, and the like proceedings in every respect may be thereafter taken under the foregoing provisions, as if no other notice had been given by the said the Honorable the Minister of Public Works, or other officer, and as if no Arbitrators had been previously chosen. That upon payment or tender to the said Company or their assigns of the value of the said works, additions and acquirements, so agreed upon as aforesaid, or upon a warrant for the payment of the same to the said Company or their assigns, being issued and deposited with the Honorable the Receiver, General of Canada, the said Company and their assigns, and all persons claiming any estate or interest in the said works, additions and acquirements, or any part thereof under them, shall, on the day mentioned in the notice aforesaid for resuming the said works, by a good and sufficient deed, convey and surrender to Her Majesty, Her heirs, and successors forever, wholly free from any incumbrance whatsoever, the said works, additions and acquirements, and every part thereof, and all right, interest and title therein or thereto acquired by the said Company or their assigns under this

Provisions for obtaining possession on behalf of the Government after the determination of proceedings fixing the value

order or otherwise ; and in default of so doing, Her Majesty, Her heirs and successors, may enter into and upon the said works, additions and acquirements, or a warrant or warrants may at any time thereafter issue for obtaining possession of the said works, additions and acquirements, as hereinafter provided, and that all notices or papers for the said Company may be served on the President, Secretary, Treasurer, or any Director or other officer of the said Company, which shall, for all purposes, be considered a sufficient service on the Company.

7th. That whenever, by reason of any default, breach of condition or otherwise, under the foregoing provisions, Her Majesty, Her heirs or successors, shall have the right to enter into or upon the said works, additions or acquirements, it shall be lawful for Her Majesty, Her heirs or successors, or for such person or persons as His Excellency the Governor General, or person administering the Government of Canada shall authorize or appoint for that purpose on behalf of Her Majesty, Her heirs or successors, into and upon the said tolls, public works and premises, with the additions and acquirements, and with the appurtenances hereby transferred or otherwise acquired, or into or upon any part thereof in the name of the whole, to re-enter ; and the said Company, their successors and assigns, and their servants, and all collectors, receivers and occupiers of the said premises, thereout and from thence utterly to expel, put out and remove ; or a warrant or warrants directed to the Sheriff of the County in which the said works shall be situated may be issued, under the hand and seal of His Excellency the Governor General, or the person administering the Government of Canada, reciting such default and commanding such Sheriff forthwith to deliver to a public officer to be named in said warrant or warrants, for Her Majesty, Her heirs and successors, the said public works and premises hereby transferred, with the appurtenances, together with the additions and the acquirements made thereto ; and the said Sheriff and his officers and assistants shall have full power under such warrant or warrants to enter into and upon the same and every part thereof, and the said Company and their assigns, and their servants and all collectors, receivers and occupiers of the said premises, thereout and from thence, utterly to expel, put out and remove, and to deliver the same and the possession thereof to the said public officer of Her Majesty, Her heirs or successors : and that upon any entry being made by or on behalf of Her Majesty, Her heirs or successors, or on possession being delivered by any Sheriff or Sheriffs, as aforesaid, this order and every matter and thing therein contained shall thenceforth become and be vacated and

In case of default or breach of condition, Her Majesty or such person as the Government of Canada shall authorize may re-enter and take possession of said tolls, public works and premises.

Warrant may be issued to expel and remove the said Company, their servants and collectors.

---

 Chap. 93      *Transfer and Abandonment of Public Works.*

---

determined, and Her Majesty, Her heirs or successors, shall thenceforth stand and be absolutely seized and possessed of the said works, and every part thereof, and of Her and their original estate therein, and also of all additions and acquisitions made thereto.

Persons desirous of building pier or wharf within the limits of said harbor shall be at liberty to do so on obtaining permission from the Minister of Public Works.

8th. That any person or persons, or any other body or bodies corporate, now or hereafter holding any lands in freehold or for a term of years, desirous of building any pier or wharf within the limits of the said harbor, which, in the opinion of the Honorable the Minister of Public Works of Canada, will not obstruct the proper using of the said harbor and piers, shall have the right to build such pier or wharf into the waters of the said harbor in front of such land, having first obtained the authority in writing of the said the Honorable the Minister of Public Works so to do, which authority shall be valid and effectual against the said Company; their successors and assigns, to all intents, as if the right to build such wharf or pier, and the water or land covered with water to be occupied by such pier or wharf had been granted in fee to such person or persons, body or bodies corporate, by Her Majesty previously to the making of this Order: Provided, always, that any such person or persons body or bodies corporate, shall have given to the said Company one month's notice in writing of their application in that behalf, and of the time and place at which such application shall be made, together with a copy of their petition or written application to that effect; and it shall be competent to the said Company to make such representations in relation to such application as they deem proper; provided, however, that no such right or permission so given to such person, body or bodies corporate, shall exempt him or them from the payment of the harbor dues legally leviable as aforesaid.

Such person shall give one month's notice to the said Company.

Right to build shall not exempt from payment of harbor dues.

[See *Canada Gazette*, vol. 10, p. 1506.]

OAKVILLE HARBOR, ONTARIO.

Harbor of Oakville, with appurtenances vested in the Corporation of the Town of Oakville.

Sec. 8. By Order in Council of the 5th day of November 1874, the Harbor of Oakville, together with the appurtenances as vested in the Crown, and all tolls arising from the same, in the Township of Trafalgar, in the County of Holton, in the Province of Ontario, was declared no longer a public work, and was vested in the Corporation of the Town of Oakville, and certain regulations concerning its management and tolls were approved.

[See *Canada Gazette*, vol. 8, p. 472.]

*Transfer and Abandonment of Public Works.*

## Chap. 93

## KETTLE CREEK BRIDGE, ONTARIO.

Sec. 9. By a Proclamation dated the 26th day of February, 1868, His Excellency, in Her Majesty's name, declared that upon and after that day the swing bridge erected and built at the expense of the late Province of Canada over and across a certain stream, called Kettle Creek, and being adjacent to the harbor of Port Stanley, in the County of Elgin in the Province of Ontario, should be no longer under the control of the Minister of Public Works for Canada.

Swing bridge across Kettle Creek, adjacent to the harbor of Port Stanley, no longer a public work.

[See *Canada Gazette*, vol. 1, page 274.]

## METAPEDIA ROAD, P.Q.

Sec. 10. By a Proclamation dated the 4th day of September, 1868, His Excellency, in Her Majesty's name, declared that upon and after the 28th day of September aforesaid those two several portions of that certain one of the Public Works, in the Province of Quebec, in our Dominion of Canada, which in known as the "Metapedia Road," and which extends from the River St. Lawrence, in the Parish of Ste. Flavie, in the County of Rimouski, to "Cross Point Ferry," in the Baie des Chaleurs, in the Township of Mann, in the County of Bonaventure, namely:— First. That certain portion thereof which passes through the Seigniory of Lepage and Thivièrge, and through portions of the Township of Fleuriau and of the Fief of Pachot all in the said County of Rimouski, running between the said River St. Lawrence, in the said Parish of Ste. Flavie, and the residence of one Pierre Ouellette, in the said Fief of Pachot, (on the fourteenth mile of the said "Metapedia Road"); such above-described portion of the said road extending and being about fourteen miles in length; And second, all that certain other portion of the said "Metapedia Road" commencing at and extending from the residence of one Daniel Frazer (on the ninety-sixth mile thereof), in the Township of Restigouche, in the said County of Bonaventure, to "Cross Point Ferry," in the said "Baie des Chaleurs," on the one hundred and eleventh mile thereof; such last described portion of the said "Metapedia Road," extending and being about thirteen miles and one half of a mile in length, should cease to be under the management and control of the Minister of Public Works.

"Metapedia Road" extending from the River St. Lawrence, in the Parish of Ste. Flavie, in the County of Rimouski, to "Cross Point Ferry" in the Baie des Chaleurs, in the Township of Mann, in the County of Bonaventure, no longer a public work.

[See *Canada Gazette*, vol. 2, p. 141.]

---

 Chap. 93      *Transfer and Abandonment of Public Works.*

---

## BATISCAN BRIDGE, P.Q.

"The Batiscan Bridge" in the County of Champlain, no longer a public work.

Sec. 11. By a Proclamation dated the 19th day of March, 1869, His Excellency, in Her Majesty's name, declared that upon and after that date the public bridge, called and known as "The Batiscan Bridge," erected and built over the River Batiscan, in the Seigniorship of Batiscan, in the County of Champlain, in the District of Three Rivers, in the Province of Quebec, should cease to be under the management and control of the Minister of Public Works.

[See *Canada Gazette*, vol. 2, page 643.]

## L'ASSOMPTION DE BERTHIER ROAD, P.Q.

Road in the Parish of L'Assomption de Berthier, in the County of Bellechasse, from the main road up to the high-water mark of the River St. Lawrence, to be no longer a public work.

Sec. 12. By a Proclamation dated the 10th day of February, 1870, His Excellency, in Her Majesty's name, declared that on and after the 28th day of February, aforesaid, all that certain public road heretofore acquired and maintained at the expense of the late Province of Canada, and built or constructed upon the following lot, tract or parcel of ground, or any portion or portions thereof, that is to say: upon a certain lot, tract or parcel of ground, situate, lying and being in the Parish of L'Assomption de Berthier, in the County of Bellechasse, in the District of Quebec, in that part of the late Province of Canada called Lower Canada, and now known as the Province of Quebec, containing thirty-three feet in front (French measure) by about fifteen arpents and a half, more or less, from the main road up to the high-water mark of the River St. Lawrence, bounded in front towards the south by the main road, and in the rear towards the north by the said high-water mark, on one side towards the south-west partly by Toussaint Bilo-deau, and partly by one Charles Fague, and on the other side towards the north-east by the said Charles Fague, as described in a certain deed of assignment thereof from Charles Fague therein named to Us, Our heirs and successors, which said deed was passed before Joseph Petitclerc and his colleague, Notaries Public, at the City of Quebec, on the thirtieth day of April, in the year of Our Lord one thousand eight hundred and fifty-two, upon certain terms and conditions in the said deed contained, should cease to be under the management and control of the Minister of Public Works.

[See *Canada Gazette*, vol 3, page 589.]



*Transfer and Abandonment of Public Works.* Chap. 93

## CALEDONIA BRIDGE, ONTARIO.

Sec. 13. By a Proclamation dated the 19th day of June, 1874, His Excellency, in Her Majesty's name, declared that upon and after that day the public toll bridge situate in the Village of Caledonia, in the County of Haldimand, in the Province of Ontario, and known as the "Caledonia Bridge," and the planked and macadamized toll road commencing at the City of Hamilton and running southerly to the Village of Port Dover, in the County of Norfolk, including the swing bridge and its abutments on the line of the said road over the stream called Patterson's Creek, in the said village, being composed of all that part of the public toll road known as the Hamilton and Port Dover Road, lying between the southern limit of the City of Hamilton, and the south-western extremity of the south-western abutment of the said bridge, over the said creek, at the Village of Port Dover, aforesaid, together with all bridges on the said road under the management and control of the Minister of Public Works, should be no longer under his control.

Public Toll Bridge in the Village of Caledonia, in the County of Haldimand, known as the "Caledonia Bridge" and the toll road from Hamilton to Port Dover, including the swing bridge, no longer a public work.

[See *Canada Gazette*, vol. 8, p. 2.]

## HUNTINGTON AND LAKE ST. FRANCIS ROAD, P. Q.

Sec. 14. By a Proclamation dated the 8th day of January, 1875, His Excellency, in Her Majesty's name, declared that upon and after that day the Public Work known as the Huntington and Lake St. Francis Road, in the Province of Quebec, and which, by Proclamation dated the 30th day of May, 1869, was acquired and made a Public Work of Canada, under the management and control of the Minister of Public Works, should be no longer under his control.

Huntington and Lake St. Francis Road, no longer a public work.

[See *Canada Gazette*, vol. 8, p. 846.]

## L'ISLET PIËR, P. Q.

Sec. 15. By a Proclamation dated the 8th day of January, 1875, His Excellency, in Her Majesty's name, declared that upon and after that day the Public Work known as the Government Pier at L'Islet, in the Province of Quebec, under the management and control of the Minister of Public Works, should be no longer under his control.

L'Islet Pier no longer a public work.

[See *Canada Gazette*, vol. 8, p. 846.]

Chap. 93      *Transfer and Abandonment of Public Works.*

BRANTFORD BRIDGE, ONTARIO.

Toll Bridge in the Town of Brantford, in the County of Wentworth known as the "Brantford Bridge," and the Toll Road running from the City of Hamilton to the westerly boundary line of the County of Wentworth together with the bridge thereon and the toll-gates, toll-bars and toll-houses, to be no longer under the control and management of the Minister of Public Works.

Sec. 16. By a Proclamation dated the 5th day November, 1874, His Excellency, in Her Majesty's name, declared that upon and after the seventh day of November then instant, the Public Works formerly known as the Public Toll Bridge, situate in the Town of Brantford, in the County of Wentworth, as it stood on the eleventh day of April, in the year of Our Lord one thousand eight hundred and fifty-one, known as the "Brantford Bridge," and the macadamized, planked and gravelled Toll Road situate in the said County, commencing at the City of Hamilton, and thence running westerly to the westerly boundary line of the said County of Wentworth, being composed of all those parts of the Public Toll Roads known as the Hamilton and Brantford Road and the Brantford and London Road, lying between the western limits of the City of Hamilton and the western limits of the County of Wentworth (excepting such parts thereof as lie within the limits of the said Town of Brantford), and now known and described as the Public Toll Bridge, situate in the Town of Brantford, in the County of Brant, known as the "Brantford Bridge," and the macadamized, planked and gravelled Toll Road running through the Township of Brantford, in the County of Brant, aforesaid, and the Township of Ancaster and Barton, in the County of Wentworth, commencing at the western boundary line of the County of Wentworth, as it stood on the eleventh day of April, in the year of Our Lord one thousand eight hundred and fifty-one, thence easterly through the Town and Township of Brantford, and the Townships of Ancaster and Barton aforesaid, to the City of Hamilton, in the said County of Wentworth, being composed of all those parts of the Public Roads formerly known as the Hamilton and Brantford Road and the Brantford and London Road, lying between the said western boundary line of the County of Wentworth, as it stood on the said eleventh day of April, in the year of Our Lord one thousand eight hundred and fifty-one, and the western limits of the said City of Hamilton (excepting such parts of the said road as lie within the limits of the said Town of Brantford), together with all the bridges thereon, and all toll-gates, toll-bars and toll-houses on the said road, then under the management and control of the Minister of Public Works, should be no longer under his control.

[See *Canada Gazette*, vol. 8, p. 468.]

PORTAGE DU FORT BRIDGE, P. Q.

Sec. 17. By a Proclamation dated the 30th day of July, 1875, His Excellency, in Her Majesty's name, declared that

*Transfer and Abandonment of Public Works.* Chap. 93

upon and after that day the Public Bridge situate in the Village of Portage du Fort, in the County of Pontiac, in the Province of Quebec, and known as the "Portage du Fort Bridge," then under the management and control of the Minister of Public Works, should be no longer under his control.

"Portage du Fort Bridge," no longer a public work.

[See *Canada Gazette*, vol. 9, p. 166.]

## PUBLIC BRIDGE OVER OTTAWA RIVER.

Sec. 18. By a Proclamation dated the 19th day of May, 1876, His Excellency, in Her Majesty's name, proclaimed and declared that upon and after the twentieth day of May then instant the Public Bridge extending over the Timber Slides and Buchanan Channels of the Ottawa River, the same being within the City of Ottawa, in the Province of Ontario, and its approaches, then under the management and control of the Minister of Public Works, should be no longer under his control.

Bridge extending over the Timber Slides and Buchanan Channels of the Ottawa River, no longer a public work.

[See *Canada Gazette*, vol. 9, p. 1536.]

## MUD FLAT, B. C.

Sec. 19. By a Proclamation dated the 23rd day of April, 1886, that piece of Crown land in the Province of British Columbia, from time to time covered by tide-water, situated to the east of James' Bay Bridge, Victoria Harbor, commonly known as the "Mud Flat," was abandoned and left to the control of the City of Victoria, in the Province of British Columbia, under and by virtue of the authority vested in Her Majesty by the Act passed in the thirty-first year of Her Majesty's reign, chaptered twelve, and intituled "An Act respecting the Public Works of Canada."

"Mud Flat," situate to the east of James' Bay Bridge, Victoria Harbor, abandoned and left to the control of the City of Victoria.

[See *Canada Gazette*, vol. 19, p. 1569.]

*Incorporated in  
Yorkon System*

**CHAPTER 94.**

**TELEGRAPH LINES, BRITISH COLUMBIA.**

Government House, Ottawa,

The 19th day of August, 1889.

On the recommendation of the Minister of Public Works, and under the provisions of Chapter 36 of the Revised Statutes of Canada, intituled "The Public Works Act,"

His Excellency in Council has been pleased to impose and authorize the following:—

TARIFF OF RATES TO BE CHARGED FOR MESSAGES OVER DOMINION TELEGRAPH LINES IN BRITISH COLUMBIA.

	Barkville.	Stanley.	Quesnelle.	Soda Creek.	Stables.	Bridge Creek.	Mount Begbie.	Clinton.	Caché Creek.	Spence's Bridge.	Lytton.	Yale.	Hope.	Vista.	Chilweack.	Matsqui.	Langley.	New Westminster.	Burrard Inlet.	Nootsack.	Schome.	Samish.	La Conner.	Victoria.
Barkville .....	0,25	25	25	50	50	50	75	75	75	75	75	75	\$1	\$1	\$1	\$1	\$1	\$1	\$1	\$1	\$1	\$1	\$1	\$1
Stanley .....		25	50	50	50	50	50	50	50	50	50	50	75	75	75	75	75	75	75	75	75	75	75	75
Quesnelle .....			25	50	50	50	50	50	50	50	50	50	75	75	75	75	75	75	75	75	75	75	75	75
Soda Creek .....				25	25	25	25	25	25	25	25	25	25	25	25	25	25	25	25	25	25	25	25	25
Stables .....					25	25	25	25	25	25	25	25	25	25	25	25	25	25	25	25	25	25	25	25
Bridge Creek .....						25	25	25	25	25	25	25	25	25	25	25	25	25	25	25	25	25	25	25
Mount Begbie .....							25	25	25	25	25	25	25	25	25	25	25	25	25	25	25	25	25	25
Clinton .....								25	25	25	25	25	25	25	25	25	25	25	25	25	25	25	25	25
Caché Creek .....									25	25	25	25	25	25	25	25	25	25	25	25	25	25	25	25
Spence's Bridge .....										25	25	25	25	25	25	25	25	25	25	25	25	25	25	25
Lytton .....											25	25	25	25	25	25	25	25	25	25	25	25	25	25
Yale .....												25	25	25	25	25	25	25	25	25	25	25	25	25
Hope .....													25	25	25	25	25	25	25	25	25	25	25	25
Vista .....														25	25	25	25	25	25	25	25	25	25	25
Chilweack .....															25	25	25	25	25	25	25	25	25	25
Matsqui .....																25	25	25	25	25	25	25	25	25
Langley .....																	25	25	25	25	25	25	25	25
New Westminster .....																		25	25	25	25	25	25	25
Burrard Inlet .....																			50	50	50	50	50	50
Nootsack .....																				25	25	25	25	25
Schome .....																					25	25	25	25
Samish .....																						25	25	25
La Conner .....																							25	25
Victoria .....																								0

The above Tariff is for messages of 10 words or under.

Where the charge for 10 words is 25c., each additional word will be 2	Cents.
“ “ “ 50c., “ “ “ 4	4
“ “ “ 75c., “ “ “ 5	5
“ “ “ \$1.00 “ “ “ 6	6

The word *collect* in collect messages is counted as one word.

O.C. Dec. 22, 1879.

## CHAPTER 95.

---

### SOUTH WEST BOOM COMPANY.

MIRAMICHI, NEW BRUNSWICK.

Government House, Ottawa,

The 19th day of August, 1889.

On the recommendation of the Minister of Public Works, and under the provisions of Chapter 92 of the Revised Statutes of Canada intituled "An Act respecting certain Works constructed in or over Navigable Waters,"

His Excellency in Council has been pleased to make the following regulation :—

REGULATION for the government of the Boom of the South-West Boom Company, Miramichi, in New Brunswick.

That portion of the boom of the South-West Boom Company, the plan of which was approved by Order in Council of the 19th December, 1883, extending from block number 82 to block number 83, shall be a swing boom, and for the purpose of free navigation shall, at all times, be kept open, except when it is necessary to close the same for the purpose of protecting and collecting logs or timber passing down the River Miramichi ; and when the same is so closed, the company shall, at all times, keep a person in attendance to open the same and admit of the passage through it of rafts, scows, steamers, boats or other craft navigating the river.

O.C. April 12, 1884.

## CHAPTER 96.

### CLASSIFICATION OF BRIDGES.

Government House, Ottawa,

The 19th day of August, 1889.

On the recommendation of the Minister of Public Works, and under the provisions of Chapter 36 of the Revised Statutes of Canada, intituled "The Public Works Act,"

His Excellency in Council has been pleased to make and prescribe the following classification for all public bridges throughout the Dominion of Canada:—

#### *Class One.*

Bridges maintained solely by Dominion Government.

Section 1. Bridges built and maintained by the Dominion Government solely, including;—

- (a.) Bridges on Government railways,
- (b.) Bridges over Dominion public works, when such bridges have been built by Government as public improvements,
- (c.) The Union Suspension Bridge at Ottawa, and other bridges built by Government as public works, and not transferred to local authority.

#### *Class Two.*

Bridges maintained partly by Dominion Government.

Sec. 2. Bridges built or maintained partly by the Dominion Government and partly by local authority, including;—

- (a.) Bridges over Dominion rivers.
- (b.) Bridges over public works, whenever the cost of any such bridge is increased by the existence of any such public work.

#### *Class Three.*

Bridges in which Dominion has no interest.

Sec. 3. Bridges in which the Dominion has no interest, and should not contribute to, including all bridges other than those comprised in classes One and Two above mentioned, and which are therefore strictly local in character and purpose.

O.C. Feb. 11, 1871.

Look for this in Railways  
Manuals as Dept. works  
done in Oct 1879—

# DEPARTMENT OF INTERIOR.

## CHAPTER 97.

### REGULATIONS AFFECTING DOMINION LANDS IN THE PROVINCE OF MANITOBA AND THE NORTH-WEST TERRITORIES.

Government House, Ottawa,  
The 1<sup>st</sup>/th day of September, 1889.

On the recommendation of the Minister of the Interior, and under the provisions of Chapter 54 of the Revised Statutes of Canada, intituled "The Dominion Lands Act,"

His Excellency in Council has been pleased to order, and it is hereby ordered, that the following regulations for the sale, settlement, use and occupation of Dominion lands in the Province of Manitoba and the North-West Territories be approved and adopted :—

31	32	33	34	35	36
30	29	28	27	26	25
19	20	21	22	23	24
18	17	16	15	14	13
7	8	9	10	11	12
6	5	4	3	2	1

Diagram showing the division of a township into sections. Each section—a square mile—is sub-divided into quarter-sections of 160 acres. Those designated by even numbers (excepting sections 8 and 26 and) which are shaded green on the original regulations, are reserved for free grant homesteads and their attached pre-emptions. Sections numbered 11 and 29 are designated "School Lands," those numbered 8 and 26 "H. B. Co's Lands."

#### SALE OF DOMINION LANDS.

Section 1. The surveyed lands in Manitoba and the North-West Territories shall, for the purposes of these regulations, be classified as follows :—

Surveyed lands classified.

CLASS A.—All lands east of the second Initial Meridian and all lands within and south of the C. P. R. Belt west of the said Meridian.

CLASS B—All lands not included in Class A.

Sec. 2. The even numbered sections at the disposal of the Crown in Classes A and B are to be held exclusively for homestead and pre-emption entry, unless in special cases

Even numbered sections in classes A and B.

## Chap 97.

*Regulations affecting Dominion Lands.*

otherwise ordered by the Minister of the Interior, or exempted under the operations of the Dominion Lands Act. [See Sub-Section 4, Section 32, Chapter 54 of the Revised Statutes of Canada.]

Odd numbered sections in classes A and B.

**Sec. 3.** The odd numbered sections at the disposal of the Crown in Classes A and B and not reserved for or granted to any Railway Company, are to be held exclusively for sale, unless in special cases otherwise ordered by the Minister of the Interior.

Price of pre-emption and odd numbered sections.

**Sec. 4.** The price of pre-emptions and of odd numbered sections in Class A shall be \$2.50 per acre, and the price of pre-emptions and of odd numbered sections in Class B shall be \$2.00 per acre.

Reservation of lands for intending settlers.

**Sec. 5.** The Minister of the Interior or the Land Board or the Commissioner of Dominion Lands may in special cases order the reservation of lands for intending settlers on receiving satisfactory assurance that the application for such reservation made by or on behalf of the intending entrant has been made in good faith and with the purpose of actual residence upon the land applied for.

False statement in application of settler, to involve forfeiture.

**Sec. 6.** In case it is proved to the satisfaction of the Minister of the Interior that a settler has made any false statement in the affidavit in support of his application for entry, his right to the land shall be forfeited and his entry therefor shall be cancelled.

Free grant of land to religious denomination.

**Sec. 7.** The Minister of the Interior may make a free grant of land, not exceeding 40 acres in area, to any religious denomination in Manitoba or the North-West Territories applying therefor in connection with any of their mission stations, provided the land which is the subject of the application is at the disposal of the Government, and is not within any town-site or other reserve.

Patents for lands shall reserve to Her Majesty all mines and minerals, and right to enter and work the same.

**Sec. 8.** All patents from the Crown for lands in Manitoba and the North-West Territories, shall reserve to Her Majesty, Her Successors and Assigns forever, all mines and minerals which may be found to exist within, upon, or under such lands, together with full power to work the same, and for this purpose to enter upon, and use and occupy the said lands or so much thereof and to such an extent as may be necessary for the effectual working of the said minerals, or the mines, pits, seams and veins containing the same; except in the case of patents for lands which have already been sold or disposed of for valuable consideration, or for lands which



*Regulations affecting Dominion Lands.*

## Chap. 97.

have been entered as homesteads before the date upon which these regulations come into force.

Sec. 9. The Minister of the Interior may direct the reservation of odd or even numbered sections or of any portions thereof as timber lands or hay lands for the common use of settlers under lease or permit, and may, under the provisions of the Dominion Lands Act and these Regulations, grant licenses to cut timber upon Dominion Lands.

Reservation of timber lands or hay lands: licenses to cut timber.

Sec. 10. The Minister of the Interior may direct the reservation of lands being either odd numbered or even numbered sections or portions thereof, and may order the sale thereof as wood lots containing not more than 20 acres and not less than 10 acres each, which shall be paid for at the price of \$5.00 per acre in cash, or in scrip receivable as cash, at the time of sale.

Reservation of lands as wood lots.

Price \$5.00 per acre.

## LEASES OF GRAZING LANDS.

Sec. 11. Leases of grazing lands in Manitoba and the North-West Territories, and within the railway belt in the Province of British Columbia, may be granted only after public competition, except in the case of an actual settler, to whom may be leased, without public competition, a tract of land not to exceed four sections in area and to be in the vicinity of the settler's residence. Leases shall be for a period of not exceeding twenty-one years, and no single lease shall cover a greater area than 100,000 acres.

Leases to be granted only after public competition.

Actual settlers excepted.

Period and area of leases.

Sec. 12. Parties tendering will be required to state the sum or bonus per acre which they will pay in addition to the ground rent; and each tender must be forwarded in a sealed envelope and be accompanied by an accepted cheque for the amount of such bonus, payable to the order of the Deputy of the Minister of the Interior. No tender by telegraph will be accepted. The lease will be awarded to the party offering the highest bonus therefor.

Tender, how to be made.

To be accompanied by accepted cheque.

Sec. 13. In surveyed territory, the land embraced by the lease shall be described in townships and sections. In unsurveyed territory, if required by the Minister of the Interior the party to whom the lease may be promised shall, before the issue of the lease, cause a survey of the tract to be made at his own expense, by a Dominion Land Surveyor, under instructions from the Surveyor General, and the plan and field notes of such survey shall be deposited on record in the Department of the Interior.

Description of land.

In unsurveyed territory, survey may be required, and plans and field notes deposited.

## Chap. 97.

*Regulations affecting Dominion Lands.*

Lessee shall pay annual rental of \$20.00 for every 1,000 acres.  
Amount of stock required to be kept.

**Sec. 14.** (a) The lessee shall pay an annual rental at the rate of \$20.00 for every 1,000 acres covered by his lease, and shall within each of the three years from the date of the Order in Council granting the lease, place upon the tract of land leased not less than one third of the whole amount of the stock which is required to be placed upon the said tract, namely, one head of cattle for every twenty acres of land covered by the lease, but not to exceed that number, and shall during the rest of its term maintain cattle thereon in that proportion.

Returns of amount of stock.

(b) And he shall from time to time, as required by the Minister of the Interior, furnish returns of the amount of stock owned by him.

Lessee may purchase a reasonable area for a farm and corral.

**Sec. 15.** After placing the prescribed number of cattle upon the tract leased, the lessee may purchase a reasonable area of land within his leasehold for a home farm and corral, paying therefor at the price per acre in cash obtaining in the class in which the lands so purchased may be situated. This shall not affect the rights of lessees acquired prior to the date hereof, to purchase the said home farm and corral at a less price per acre.

Lands authorized to be leased subsequently to the 12th day of January, 1886.

**Sec. 16.** The whole or any part of any lands authorized to be leased subsequently to the 12th day of January, 1886, unless otherwise provided in any lease thereof, shall be open to homestead and pre-emption entry, or to be purchased from the Government at the price obtaining in the class in which the lands are situate, upon application being made therefor, and as entries are granted or purchases effected, the lease shall become void in respect of the land so entered or purchased.

Permission to homestead lands.

**Sec. 17.** A lessee of grazing lands shall not be permitted to homestead lands within any tract leased to another for grazing purposes.

Failure to fulfil conditions.

**Sec. 18.** Failure to fulfil any of the conditions of his lease shall subject the lessee to the forfeiture thereof.

No one allowed to place sheep on Dominion lands without permission in writing.

No person to graze stock on the public domain without consent.

**Sec. 19.** Whether he be a lessee or not a lessee, no person shall be allowed to place sheep upon Dominion lands in Manitoba and the North-West Territories without permission in writing being first had and obtained from the Minister of the Interior. No person shall be allowed to graze stock of any kind on the public domain, without the consent of the Minister of the Interior being first obtained. The grazing of same will render them liable to seizure and forfeiture by the owner.

*Regulations affecting Dominion Lands.*

## Chap 97.

## FORM OF LEASE OF GRAZING LANDS.

Sec. 20. The following is the form of lease to be used in respect of grazing lands:—

THIS INDENTURE, made in duplicate this \_\_\_\_\_ day of \_\_\_\_\_

in the year of Our Lord one thousand eight hundred and \_\_\_\_\_

By and between Her Majesty Queen Victoria, represented herein by the Honorable the Minister of the Interior of Canada, of the first part, and \_\_\_\_\_

hereinafter called the lessee of the second part.

WHEREAS the lands hereinafter described are "Dominion Lands," within the meaning of the "Dominion Lands Act."

And whereas the said Act provides, among other things, as follows:—"The Governor in Council may, from time to time, grant leases of unoccupied Dominion Lands for grazing purposes to any person or persons for such term of years, and at such rent in each case, as may be deemed expedient; and every such lease shall contain a condition by which the Governor in Council may authorize the Minister of the Interior, at any time during the term of the lease, to give the lessee notice of cancellation thereof; and at the end of two years from the service of such notice, such lease shall cease and determine."

And whereas the said lessee, alleging that such lands are unoccupied, has applied for a lease thereof for grazing purposes;

And whereas the Governor in Council has granted such application upon the conditions herein contained;

Now therefore this indenture witnesseth that in consideration of, and subject to, the rents, stipulations, provisos and conditions hereinafter reserved and contained, Her Majesty doth hereby demise and lease unto the lessee, all and singular the following lands and premises, viz.:—

Save and except such lands in each now surveyed township, forming part of the above described lands, as under the provisions of the said Dominion Lands Act are known and designated as the lands of the Hudson's Bay Company, and also such lands as under the provisions of said Act are set apart as an endowment for purposes of education; save and except also all trails, public roads and highways, by land or water, which may be upon the said lands, save and except also such lands as may, under the provisions and conditions of these presents, be or become hereafter withdrawn from the operation hereof, and save and except such land as may be now used or may be required in the future for the use of the Mounted Police Force;

To have and to hold unto the lessee \_\_\_\_\_, subject, as aforesaid, for and during the term of \_\_\_\_\_ years, computed from the \_\_\_\_\_ day of \_\_\_\_\_ one thousand eight hundred and \_\_\_\_\_, and thenceforth next ensuing, and fully to be complete and ended, yielding and paying therefor yearly and every year during the said term unto Her Majesty, her successors and assigns, the clear rent of \_\_\_\_\_ dollars per year, to be payable in equal sums half yearly on the \_\_\_\_\_ day, of \_\_\_\_\_ and \_\_\_\_\_ each year, the first payment to become due and be made on the \_\_\_\_\_ day of \_\_\_\_\_, subject, however, to reduction of the said rent as hereinafter provided.

These presents are made and issued subject to the following provisos, terms and conditions, viz.:—

1. That the lessee will abide by, perform, fulfil and keep all the provisos, terms and conditions hereof, and that upon the breach of any of the provisos, terms or conditions herein contained, whether negative or positive in form, the term hereby granted shall, at the option of the Governor in Council, cease and determine, and Her Majesty, her successors and assigns, may thereupon re-enter upon the demised premises, and hold, possess and enjoy the same as if these presents had never been made.

2. That no waiver on behalf of Her Majesty, her successors or assigns, of any such breach shall take place or be binding upon her or them, unless the same be expressed in writing, under the authority of the Governor in Council; and any waiver so expressed shall extend only to the particular breach so waived, and shall not limit or affect her or their rights with respect to any other or future breach.

3. That the lessee pay to the Minister of the Interior, or other person duly authorized by Her Majesty, her successors and assigns, in that behalf, the yearly rent hereby reserved, as and when the same becomes due and payable.

4. That the lessee will not, without the consent in writing of the Governor in Council, make any transfer or assignment of these presents, or of interest or any part of \_\_\_\_\_ interest under these presents, or any sub-lease for the whole or part of the term hereby granted of the lands or any part of the lands hereby leased.

## Chap. 97.

*Regulations affecting Dominion Lands.*

5. That if any such transfer, assignment or sub-lease be so assented to, all the provisos and conditions herein contained shall extend to and be binding upon the transferee, assignee or sub-lessee, as well as the lessee hereunder, and any breach thereof by such transferee, assignee or sub-lessee shall have the same effect as if such breach were made by the said lessee during continuance as such lessee

6. That the lessee shall within each of the three years from the date of the Order in Council authorizing the issue of the lease, place upon the tract of land hereby demised not less than one third of the whole amount of the stock which required to place upon the said tract, namely, one head of live cattle for every twenty acres of land covered by these presents, but not to exceed that number, and shall during the rest of the term hereby granted maintain live cattle thereon in that proportion.

The word "cattle" in this clause means bulls, oxen, cows, and horses at least one year old. Cattle now upon the said land, which may have been placed there by the lessee before the date hereof, are to be counted as placed in compliance with this clause.

7. That the lessee will not, during the said term, use or allow to be used any part of the lands and premises hereby demised for any purpose other than grazing purposes within the true intent and meaning of the Dominion Lands Act and of these presents, and will not, during the said term, allow sheep to graze or to be kept upon any part of the said tract, without the consent in writing in that behalf of the Minister of the Interior, and will not, during the said term, cut or destroy, or allow to be cut or destroyed, any timber or timber trees without the consent in writing in that behalf of the Minister of the Interior, and then only in accordance with such terms, conditions and regulations as may be made or established in that behalf.

8. That the whole or any part of the lands hereby demised shall be open to homestead and pre-emption entry, or to be purchased from the Government at the cash price of not less than the price obtaining in the class in which the lands may be situate, upon application being made therefor; and that as entries are granted or sales effected the lease shall become void in respect of the lands so entered or purchased. And should the Governor in Council at any time during the term hereby granted, think it to be in the public interest to terminate these presents for any reason, the Minister of the Interior of Canada may, on giving the lessee two years' notice, cancel these presents at any time during the time hereby demised.

9. That should the Minister of the Interior at any time, or from time to time during the term hereby granted, think it to be in the public interest to cause any unsurveyed part or parts of the lands hereby demised to be surveyed, the surveyors appointed to make the surveys may, with their assistants, servants, horses and other things required in that behalf, enter upon the land and make the surveys.

10. That so soon as a survey of a township has been made and confirmed, such lands therein, as under the provisions of the said Dominion Lands Act are known and designated as the lands of the Hudson's Bay Company, and also such lands as under the provisions of the said Act are set apart as an endowment for purposes of education, shall thereupon become withdrawn from the operation of these presents, and the term hereby created shall thereupon cease and determine with respect thereto; but the lessee shall not become entitled to any reduction or abatement of the rent hereby reserved unless and until the said lands have been taken actual possession of by some person under proper authority in that behalf. And in case of such actual possession the lessee shall become entitled to a reduction of the rent hereby reserved, equal to two dollars for every one hundred acres so taken possession of, but shall have no further or other claim or be entitled to any other compensation for or on account of such withdrawal.

11. That should any portion or portions of the land hereby demised be now occupied by any person or persons who may have settled thereon, such persons and those claiming through them shall not be disturbed in their possession by the lessee, unless with the consent in writing of the Minister of the Interior; and the Minister of the Interior may, if he think it expedient so to do, from time to time, give to the lessee written notice that the lands in possession of such persons respectively, and such adjoining lands as he may think proper (but not exceeding in the whole three hundred and twenty acres for each separate settler), are withdrawn from the operation of these presents, and thereupon such lands shall become withdrawn, and the term hereby created shall thereupon cease and determine with respect thereto, and thereupon the lessee shall become entitled to a reduction of the rent hereby reserved, equal to two dollars for every one hundred acres so withdrawn, but shall have no further or other claim, or be entitled to any other compensation for or on account of such withdrawal.

12. That should any portions of the lands hereby demised be thought to contain gold, silver, copper, coal or other minerals, building stone or marble, the Governor in Council may grant licenses to any person or corporation to explore and search for the same subject to such conditions for the protection of the interests of the lessee

*Regulations affecting Dominion Lands.*

## Chap. 97.

as the Governor in Council may think proper. And should any portions of the lands hereby demised contain gold, silver, copper, coal or other minerals, building stone or marble, or water power capable of being used to drive machinery, the Governor in Council may, from time to time cause written notice to be given to the lessee that the same and such adjoining lands as may be thought proper are withdrawn from the operation of these presents; and thereupon such lands shall become withdrawn, and the term hereby created shall thereupon cease and determine with respect thereto, and thereupon the lessee shall become entitled to a reduction of the rent hereby reserved, equal to two dollars for every one hundred acres so withdrawn, but shall have no further or other claim to be entitled to any other compensation, for or on account of such withdrawal.

13. That should any portions of the lands hereby demised contain timber, the Governor in Council may, subject to such conditions for the protection of the interests of the lessee as the Governor in Council may think proper, grant to any person or corporation, under the provisions of the said Dominion Lands Act, the right under license or permit to enter upon the lands and cut and remove such timber.

14. That should the Canadian Pacific Railway Company or any other Railway Company become entitled to a grant from Her Majesty or her successors of any portion of the lands hereby demised, whether as part of their land subsidy provided for by the Statutes of Canada, or for the road-bed of the railway, or its branches, or for stations, station grounds, workshops, dock ground and water frontage on navigable waters, buildings, yards and other appurtenances required for the convenient and effectual construction and working of the railway and its branches, and should any other railway company, pursuant to any legal contract or statute in that behalf, become entitled to a grant from Her Majesty or her successors of any portion of the lands hereby demised, for road-bed and stations, and if Her Majesty or her successors grant the same, the land so granted shall thereupon become withdrawn from the operation of these presents; and the term hereby created shall thereupon cease and determine with respect thereto, but the lessee shall not become entitled to any reduction or abatement of the rent hereby reserved unless and until the lands so granted have been taken actual possession of by some person under proper authority in that behalf; and in case of such actual possession the lessee shall become entitled to a reduction of the rent hereby reserved, equal to two dollars for every one hundred acres so taken possession of, but shall have no further or other claim, or be entitled to any other compensation for or on account of such withdrawal.

15. That the word "lessee" in these presents includes the lessee or lessees, as the case may be, and his or their executors, administrators and assigns, and in the case of an incorporated company, their successors and assigns.

16. That no implied covenant or liability of any kind on Her Majesty's part is created by the use of the words "demise and lease" herein, or by the use of any other word or words herein.

17. That any notice, demand, or other communication which Her Majesty or the Minister of the Interior may require or desire to give or serve upon the lessee may be validly given and served by the Secretary or the Assistant Secretary of the Department of the Interior.

In witness whereof the Deputy of the Minister of the Interior, and the lessee, have hereunto set their hands and seals the day and year first above written.

Signed, sealed and delivered,  
in the presence of }

*Deputy Minister of the Interior.*

## PERMITS TO CUT HAY.

Sec. 21. Permits to cut hay may be granted by any Agent of Dominion Lands or other officer appointed for the purpose by the Minister of the Interior, upon any Dominion or School Lands at the disposal of the Crown, and permits thus granted shall vest in the permittee exclusive rights of ownership as to the hay upon such lands.

Permits to cut hay may be granted by any Agent of Dominion Lands.

Sec. 22. (a.) Applications for permits to cut hay may be received after the 1st of January, and permits may be issued on and after the 1st day of April in each year. If before the 1st day of April, more than one permit is applied for,

Application for permits to cut hay when received and when issued.

## Chap. 97.

*Regulations affecting Dominion Lands.*

When several applicants, how regulated.

covering any section or sections of land or any portion of any section, the Agent, if he can not arrange a division of the land to suit the several applicants, may post a notice in his office calling for tenders for the purchase of the hay upon such lands, and shall issue a permit to the person who may offer the highest cash bonus over and above the regular rates.

Date to be fixed each year.

(b.) No hay shall be cut on Dominion lands prior to a date to be fixed each year by the Minister of the Interior, which date may vary according to whether the season be early or late.

Office fee to be paid.

Sec. 23. The applicant will require to pay an office fee of 50 cents before he can obtain a permit.

Rates chargeable for permits.

Sec. 24. The rates chargeable for permits shall be, to actual settlers who require the hay for their own use, 10 cents per acre or 10 cents per ton, and to all other persons the rate shall be \$1.00 per acre or \$1.00 per ton, to be paid in full at the time of application.

Permit for specified area or quantity.

Sec. 25. The Agent may, in his discretion, issue a permit covering a specified area of land or a specified quantity of hay as the circumstances of the case may, in his opinion, render advisable.

## LEASES TO CUT HAY.

Leases of school lands in the North-West Territories for the purpose of cutting hay thereon may be issued for a term of five years; provided, &c.

Sec. 26. Leases of School Lands in the North-West Territories for the purpose of cutting hay thereon, may be issued for a term not exceeding five years; provided that a lease shall not issue to any person for more than a section, or less than a quarter-section, and that such lease shall be revocable at any time it may be deemed advisable by the Minister of the Interior to offer the land so leased for sale by public auction in the interest of the School Endowment, or for any other reason, and that in such case the lessee shall receive one year's notice of the intention of the Minister to terminate the lease, but shall not be entitled to compensation for any improvements made by him; and further, that in case of there being only one applicant for the lease of a School Section, or any part thereof, the rental shall be at the rate of 25 cents per acre per annum, but where there is more than one applicant for such lease, it shall be put up for tender at an upset rental of 25 cents per acre per annum, which would be the product of a minimum price of \$5.00 per acre, provided the money were invested at 5 per cent. per annum.

Rental when only one applicant.

Tender when more than one applicant.

*Regulations affecting Dominion Lands.*

## Chap. 97.

Sec. 27. A settler in the vicinity of unoccupied hay lands may obtain a lease for an area thereof not exceeding one fourth of a quarter-section, or forty acres, for such term and at such rent as the Minister deems expedient; but such lease shall not operate to prevent, at any time during its term, the sale or settlement of the land; and in the case of such sale or settlement, the lessee shall be paid by the purchaser or settler, for fencing or other improvement made, such sum as the local agent determines; and the lessee shall be allowed to remove any hay he has cut.

Settler in the vicinity of unoccupied hay lands.

## CUTTING HAY WITHOUT AUTHORITY.

Sec. 28. The permit or lease shall describe the lands upon which the hay may be cut, and shall during its continuance vest in the permittee or lessee the exclusive right of ownership to the hay upon such lands, whether such hay is cut by his authority or by any person without his authority, and such permit or lease shall entitle the permittee or lessee to seize in replevin, revendication, or otherwise, as his property, such hay where the same is found in the possession of any unauthorized person, and also to bring any suit or action against any person unlawfully in possession of such hay, and to prosecute all persons cutting hay in trespass upon the land covered by the permit or lease to conviction and punishment and to recover damages, if any, and all proceedings pending at the expiration of any such permit or lease may be continued and completed, as if the permit or lease had not expired.

Permit or lease shall describe the lands, and vest in permittee or lessee the exclusive right of ownership to the hay upon such lands.

Permittee or lessee may prosecute trespasser.

Sec. 29. If any person without authority, cuts or employs or induces any other person to cut or assist in cutting any hay or grass of any kind on Dominion Lands, or removes or carries away, or employs or induces or assists any other person to remove or carry away, any hay or grass of any kind so cut, he shall not acquire any right to such hay or grass or any claim for remuneration for cutting the same, preparing the same for market, or conveying the same to or towards market, and when the hay has been removed out of reach of the Dominion Lands Agent, or it is otherwise found impossible to seize it, he shall, in addition to the loss of his labor and disbursements (and in addition to the value of the hay so cut by him) incur a penalty not exceeding one hundred dollars, and not less than ten dollars for every such offence, which shall be recoverable with costs in a summary manner before a Judge of the Supreme Court of the North-West Territories, a Stipendiary Magistrate, Commissioner of Police, or any two Justices of the Peace under "The Summary Convictions Act," and in default of immedi-

Person cutting hay or grass without authority shall not acquire any right to such hay or grass, but shall incur a penalty, and in default of payment may be imprisoned.

## Chap. 97.

*Regulations affecting Dominion Lands.*

ate payment of such penalty and the costs of prosecution, the offender may be imprisoned for any term not exceeding three months.

Person cutting or taking hay without authority, to be made liable on the averment of the person prosecuting.

**Sec. 30.** In such cases it shall be incumbent on the party to prove his right or authority to cut and take the hay or grass in question, and the averment of the person seizing or prosecuting that he is duly authorized so to do (or that he is duly empowered under the authority of the Dominion Lands Act) shall be sufficient proof thereof, unless the Defendant proves the contrary.

Hay or grass cut without authority may be seized in Her Majesty's name and placed in proper custody.

**Sec. 31.** Whenever any Dominion Lands Agent, Crown Timber Agent or other officer receives satisfactory information, supported by affidavit, made before any Justice of the Peace or before any other competent officer or person, that any grass or hay has been cut without authority on Dominion Lands or if such Dominion Lands Agent, Crown Timber Agent or officer from other sources of information or his own knowledge, is aware that any hay or grass has been cut without authority, on any such lands, he may seize or cause to be seized in Her Majesty's name, the hay or grass so reported or known to be cut, and place the same under proper custody, until the matter is decided by competent authority.

Moneys and fines, to whom paid.

**Sec. 32.** Moneys and fines collected under these Regulations shall be paid over to the credit of the Receiver General, and form part of the Consolidated Revenue Fund of Canada.

Person seizing hay may call in assistance.

**Sec. 33.** Any officer or person seizing hay in the discharge of his duty under these Regulations, may, in the name of the Crown, call in any assistance necessary for securing and protecting the hay so seized.

DISPOSAL OF COAL LANDS, THE PROPERTY OF THE DOMINION GOVERNMENT, IN MANITOBA, THE NORTH-WEST TERRITORIES AND BRITISH COLUMBIA.

Anthracite coal lands, price.

Other coal lands, price.

Maximum area to one applicant.

When more than one applicant for same location.

**Sec. 34.** (a) Lands containing anthracite coal may be sold, at an upset price of \$20.00 per acre, cash, and coal other than anthracite, at an upset price of \$10.00 per acre, cash, or may be sold by public competition if the Minister of the Interior shall so decide.

(b) Not more than three hundred and twenty acres shall be sold to one applicant.

**Sec. 35.** When there is more than one applicant for the same coal location, the Minister of the Interior may invite competition between the several applicants, or offer the land



*Regulations affecting Dominion Lands.*

Chap. 97.

for sale at public competition by tender or by auction as he may think expedient at the upset price of coal lands.

Sec. 36. In cases where the Minister of the Interior satisfies himself that companies, or persons, have expended considerable sums of money in exploring for coal on lands for which they may have applied under the Regulations of the 17th of December, 1881, the said lands may be sold to such companies or persons at the upset price fixed for such lands.

Companies or persons having applied under the Regulations of 17th December, 1881.

Sec. 37. The boundaries beneath the surface of coal mining locations shall be the vertical planes or lines in which their surface boundaries lie.

Boundaries beneath the surface.

Sec. 38. The rights of lessees, and of persons in favor of whom Orders in Council authorizing leases have been passed, shall not be affected by these Regulations.

Rights of present lessees.

Sec. 39. The Minister of the Interior may upon application, grant permission to prospect for coal for a period of sixty days, and such permission may cover any single tract of land not exceeding three hundred and twenty acres in extent.

Permission to prospect for coal.

Sec. 40. If the land sought for be not included in any surveyed township, the applicant shall stake out the same, by placing at each angle or corner thereof a stake or post at least four inches square, and standing not less than four feet above the surface of the ground; and upon each post he shall inscribe his name and the angle represented thereby thus: "A. B's. N. E. Corner," (meaning North-East Corner) or as the case may be; except such posts are so planted before an application for permission to prospect is made, all the proceedings taken by the applicant shall be void; also with his application he shall forward to the Minister of the Interior a map or sketch of the land as staked out, specifying metes and bounds, and showing thereon the best information in his power respecting the same, and all boundaries so staked out shall be due north and south, and east and west lines, and the length thereof shall not exceed twice the breadth; if, however, the land has already been included in any general survey then the official number of the section or sections, parts or legal sub-divisions of a section shall be given.

If the land sought for be not in any surveyed township; proceedings by the applicant in such case.

Sec. 41. The party or parties to whom permission to prospect may be given, shall, within one month from the date of such permission, commence operations and carry on

Parties permitted to prospect.

Chap. 97

Regulations affecting Dominion Lands.

Commencement and continuance of operations. Amount to be expended. the same continuously throughout the remainder of the period covered thereby; and shall expend in such prospecting a sum at the rate of not less than \$2.00 per day from the time of commencement of the same; and the permission so given shall become void if the said operations cease for one week during the remainder of the period for which such permission is given.

Time covered by permission to prospect may be extended. Sec. 42. On application to the Minister of the Interior, the time covered by permission to prospect, may be extended, if the applicant has complied with the above requirements, and provided there are no other applicants for the lands comprised therein; should there be others, however, it will be necessary that the right to prospect be acquired by competition amongst the applicants.

Operations to be carried on continuously. Sec. 43. If the time covered by permission to prospect be extended it will be necessary that prospecting operations be carried on continuously from the date of such extension.

LANDS PATENTED OR ENTERED, ON WHICH THE MINING RIGHTS HAVE BEEN RESERVED.

Application for permission to prospect when mining rights are reserved. Sec. 44. (a) Any person or persons desirous of obtaining permission to prospect for minerals on lands that have been patented or entered and on which the mining rights have been reserved, shall make application therefor to the Minister of the Interior.

Shall be in writing. (b) Such application shall be in writing, defining clearly the area applied for, which area must not exceed 320 acres.

Permission to prospect for 60 days. (c) If the Minister of the Interior sees no objection to the application being granted, the applicant will be given permission to prospect for a period of sixty days, upon furnishing the Minister with proof that he has complied with the provisions of the following sub-section

Bond for damages to lands. (d) The applicant shall enter into a bond, with two sureties to the satisfaction of the Superintendent of Mines, to recompense the owner or occupant of the soil for damages that may be done to his lands.

Proprietor of lands entered shall, within two months, make his claim in writing against prospector. Arbitration provided for. (e) If the proprietor of lands so entered upon shall seek damages, he shall before the end of two months after the expiration of the permission given, make his claims in writing against the prospector, detailing the particulars and amount of claim; and if the claim is not adjusted by agreement between the parties within one month after notice thereof as aforesaid, it shall be settled by arbitration in the manner prescribed in sections 50 and 51 of these regulations.

Conditions of permission. Sec. 45. (a) The permission given to prospect shall be subject to the conditions of section 41 of these regulations.

*Regulations affecting Dominion Lands.*

## Chap. 97.

(b) A renewal for a further period of sixty days may be granted provided that the conditions of these regulations have been complied with, but should there be other applicants for the lands over which permission to prospect has been given, competition amongst the same will be invited.

Renewal for further period of 60 days.

Sec. 46. No permission to prospect shall authorize entry upon any buildings, or the curtilage appertaining to any house, store, barn or building, or upon any garden, orchard, or grounds reserved for ornament, or under cultivation by growing crops, and enclosed; except with the consent of the occupier or permission from the Minister of the Interior upon special application setting forth the circumstances under which the same is applied for, and on such terms as the case may require.

Permission to prospect shall not authorize entry upon any buildings curtilage, garden, orchard, &c.

Sec. 47. If, at the expiration of the period for which permission has been given to prospect on lands, it be desired to acquire the mining rights thereunder, they will be sold at the rate and on the terms prescribed by the mining regulations, less the price ruling for surface rights in the class in which the lands may be situated.

Mining rights, the rate and terms of sale.

Sec. 48. Before a patent of the mining rights of any lands can be issued, it will be necessary for the party obtaining the same, to furnish proof to the Minister of the Interior that he has acquired the surface rights of the lands from the owner or agent or occupier of such lands.

Surface rights must precede patent of mining rights.

Sec. 49. If the occupier of the lands has not received a patent therefor, the purchase money of the surface rights must be paid to the Crown, and a patent of the surface rights will issue to the party who acquired the mining rights. The money so collected will either be refunded to the occupier of the land, when he is entitled to a patent therefor, or will be credited to him on account of payment for land.

Purchase money of surface rights must be paid to the Crown, when.

Sec. 50. When the party obtaining the mining rights to lands can not make an arrangement with the owner or his agent or the occupant thereof for the acquisition of the surface rights, it shall be lawful for him to give notice to the owner or his agent or the occupant to appoint an arbitrator to act with another arbitrator named by him, in order to award the amount of compensation to which the owner or occupant shall be entitled. The notice mentioned in this Section shall be according to a form to be obtained upon application from the Agent of Dominion Lands for the District in which the lands in question lie, and

When party obtaining mining rights cannot arrange with owner for surface rights.

Notice to appoint an arbitrator.

## Chap. 97.

*Regulations affecting Dominion Lands.*

Length of service of notice.

If proprietor refuses to appoint, the Agent of Dominion Lands may appoint an arbitrator on his behalf.

Arbitrators to be sworn and proceed to business forthwith.

Value of land, how to be estimated.

In case arbitrators can not agree.

Award of two final. Award to be filed.

shall, when practicable, be personally served on such owner, or his agent if known, or occupant; and after reasonable efforts have been made to effect personal service, without success, then such notice shall be served by leaving it at, or sending by registered letter to the last place of abode of the owner, agent or occupant. Such notice shall be served if the owner or agent resides in the District in which the land is situated, ten days; if out of the District and within the Province, twenty days, and if out of the Province, thirty days, before the expiration of the time limited in such notice. If the proprietor refuses or declines to appoint an arbitrator, or when for any other reason, no arbitrator is appointed by the proprietor in the time limited therefor in the notice provided for by this Section, the Agent of Dominion Lands for the District in which the lands in question lie, shall, on being satisfied by affidavit that such notice has come to the knowledge of such owner, agent or occupant, or that such owner, agent or occupant wilfully evades the service of such notice, or can not be found, and that reasonable efforts have been made to effect such service, and that the notice was left at the last place of abode of such owner, agent or occupant, appoint an arbitrator on his behalf.

Sec. 51. (a) All the arbitrators appointed under the authority of these regulations shall be sworn before a Justice of the Peace to the impartial discharge of the duties assigned to them, and they shall forthwith proceed to estimate the reasonable damages which the owners or occupants of such lands, according to their several interests therein, shall sustain by reason of such prospecting operations.

(b) In estimating such damages, the arbitrators shall determine the value of the land irrespectively of any enhancement thereof from the existence of minerals therein.

(c) In case such arbitrators cannot agree, they may select a third arbitrator; and when the two arbitrators cannot agree upon a third arbitrator, the Agent of Dominion Lands for the District in which the lands in question lie, shall select such third arbitrator.

(d) The award of any two such arbitrators made in writing shall be final, and shall be filed with the Agent of Dominion Lands for the District in which the lands lie.

## CHAPTER 98.

### REGULATIONS AFFECTING TIMBER ON DOMINION LANDS.

Government House, Ottawa,  
The 17th day of September, 1889.

On the recommendation of the Minister of the Interior and under the provisions of Chapters 54 and 56 of the Revised Statutes of Canada, intituled respectively, "The Dominion Lands Act" and "An Act respecting certain Public Lands in British Columbia,"

His Excellency in Council has been pleased to make the following regulations:—

*Governing the granting of yearly licenses and permits to cut timber on Dominion Lands in Manitoba, the North-West Territories, and within twenty miles on either side of the Canadian Pacific Railway in the Province of British Columbia.*

#### TIMBER LICENSES.

Section 1. (a) All licenses to cut timber shall be disposed of by public competition. Public competition.

(b) Parties tendering will be required to state the sum or bonus per square mile which they will pay in addition to the ground rent and royalty; and each tender must be forwarded in a sealed envelope and be accompanied by an accepted cheque payable to the order of the Deputy Minister of the Interior for the amount of such bonus. No tender by telegraph will be accepted. The limit will be awarded to the party offering the highest bonus therefor. Parties tendering must state bonus per square mile. Tender must be in sealed envelope, with accepted cheque.

(c) The foregoing clauses of this Section shall not apply to any person who on or prior to the 1st day of April, 1889, has applied for, staked out the land sought for, and published notice of application for license to cut timber west of Eagle Pass in the Railway Belt in the Province of British Columbia. Applications prior to April 1, 1889.

(d) The length of any berth covered by a license shall in no case exceed three times the breadth thereof. Length of berth.

Sec. 2. (a) The licensee shall pay a ground rent of five dollars per square mile, except for lands situated west of Eagle Pass, in the Province of British Columbia, in which case the ground rent shall be five cents an acre. Ground rent.

## Chap. 98.

*Regulations affecting Timber on Dominion Lands.*

Rent for the year to be paid in advance.

(b) Within a month after the date of the Order in Council granting a timber berth, the party in whose favor it is passed shall pay the rent for the year in advance, and if not then paid the said rent shall bear interest at the rate of six per cent. per annum from that date until the same is paid.

Licensee shall pay royalty.

(c) The licensee shall pay a royalty of five per cent. on the amount of the sales of all products of the berth. Saw logs and other timber for manufacture taken from the berth must be manufactured at the saw mill of the licensee to be operated in connection with the berth as prescribed in clause (f) of this Section.

Timber for manufacture.

Licensees of timber berths shall furnish a statement in writing in detail, upon oath.

(d) On the first day of May in each year all licensees of timber berths shall furnish through themselves, their scalers and foremen to the Crown Timber Agent, having jurisdiction in the matter, or such officer as the Minister of the Interior may appoint for that purpose, a statement in writing in detail, upon oath, setting forth the number of pieces of timber, saw logs and other lumber, and the correct contents in board measure of the same as scaled by Scribner's log rule, cut under his or their license during the twelve months immediately prior to making said statement. Should it so result from any cause whatsoever that the amount of lumber accounted for in the return of sales of the products of the berth, should fall short of the amount shown to have been cut or taken from the timber berth, the holder of such license shall account to the Minister of the Interior for such discrepancy and pay for said deficiency a royalty of five per cent. upon the value thereof, the value being calculated upon the average price of his or their sales of lumber for the six months prior to making the return as aforesaid.

A royalty of five per cent. shall be paid for deficiency.

Licensees shall furnish proof upon oath as to locality where timber is cut.

(e) It is also required that all licensees through themselves, their scalers and foremen, shall furnish satisfactory proof upon oath on the said first day of May of each year as to the exact locality, by a ground sketch, where all timber, saw logs or other lumber cut by themselves and others, to their knowledge, upon the timber berth held or occupied by him or them respectfully have been cut.

Licensee shall keep in operation six months in each year, a saw mill in connection with his berth.

(f) The licensee shall have in operation within a year from a date to be fixed in the license, and keep in operation for at least six months of each year of his holding, a saw mill in connection with his berth capable of cutting in twenty-four hours a thousand feet board measure for every two and a half square miles of the area licensed, or shall establish such other manufactory of wood goods as the Minister accepts as equivalent thereto.

Right not to be transferred without consent.

(g) Any right to a timber berth, acquired under an Order in Council, can not be assigned or transferred without the consent of the Minister of the Interior.

*Regulations affecting Timber on Dominion Lands.*

## Chap. 98.

Sec. 3. The licensee of a timber berth shall not be held to have any claim whatever to a renewal of his license, unless such renewal is provided for in the Order in Council, under which it was obtained, but when a licensee has fully complied with all the conditions herein set forth, and where no portion of the timber berth is required for settlement or other public purpose, of which the Minister of the Interior is to be the judge, the license may be renewed for another year subject to such revision of the annual rental and royalty to be paid therefor as may be fixed by the Governor in Council

Conditions for renewal of license of timber berth.

Sec. 4. (a) In unsurveyed territory the party to whom a license shall be promised shall, before the issue of said license and before the said party shall cut any timber, cause to be made at his own expense under the instruction of the Surveyor General, a survey of his timber berth by a duly qualified Dominion Land Surveyor, and the plan and field notes of such survey shall be deposited on record in the Department of the Interior, but he shall be held liable for the dues upon timber that may be cut by any one on the berth subsequent to ten days from the date upon which he is notified that the berth has been awarded to him. The dues upon such timber to be fixed by the Minister of the Interior.

In unsurveyed territory party to whom license is promised shall cause to be made a survey of his timber berth by a duly qualified Dominion Land Surveyor.

(b) In surveyed territory, berths shall consist of Township Sections, their legal sub-divisions, or fractions thereof.

In surveyed territory.

Sec. 5. If in consequence of any incorrectness in survey or other error or cause whatsoever, a timber berth is found to comprise lands included in another berth awarded at a prior date, or any lands sold, granted, leased or lawfully set apart for any other purpose under these regulations or the Dominion Lands Act, the later berth shall be void in so far as it interferes with any previous sale, grant or setting apart.

Later berth shall be void in so far as it may comprise lands included in prior berth.

Sec. 6. All ground rents, royalties or other dues on timber cut within the boundaries of any timber berth, which are not paid at the time when they become due, shall bear interest at the rate of six per cent. per annum until paid, and shall be a lien on any timber cut within such limits; and in case of such non-payment—whether, in consequence thereof, the license of the berth has or has not been cancelled—the Crown Timber Agent or other person authorized thereto may, with the sanction of the Minister, seize so much of the timber cut on such berth as will, in his opinion, be sufficient to secure the payment of such rent or royalty and all interest and expenses of seizure and sale, and may detain the same as security for the payment thereof; and if payment is not made within three months after such seizure, he may, with

Ground rents, royalties or other dues, not paid when due, shall bear interest at 6 per cent.

In case of non-payment, the Crown Timber Agent may seize timber to secure payment of rent or royalty and interest and expenses.

---

**Chap. 98.      *Regulations affecting Timber on Dominion Lands.***

---

Such timber may be sold at public auction.      the sanction of the Minister, sell such timber by public auction, and after deducting the sum due to the Crown, the interest thereon and expenses aforesaid, he shall pay over the balance, if any, to the licensee, if the timber was in his possession at the time of seizure, or if it was not, to the person who had possession thereof at the time.

Timber liable for payment of Crown dues wherever found and whether manufactured or not.      **Sec. 7.** All timber cut under license shall be liable for the payment of the Crown dues thereon, whenever and wherever the said timber, or any part of it, is found, whether it is or is not converted into deals, boards or any other manufacture of wood; and all officers or agents employed in the collection of such dues may follow all such timber and may seize and detain the same wherever it is found, until the dues thereon are paid or secured, as provided in the next preceding clause.

If payment of Crown dues evaded by removal of timber out of Canada, the amount of dues and expenses may be collected out of other timber belonging to the same licensee.      **Sec. 8.** If the payment of the Crown dues on any timber has been evaded by any licensee or other person, by the removal of such timber or products out of Canada, or otherwise, the amount of dues so evaded and any expenses incurred by the Crown in enforcing payment of the said dues under the Dominion Lands Act, may be added to the dues remaining to be collected on any other timber cut on any timber berth by the licensee or by his authority, and may be levied and collected or secured on such timber, together with such last mentioned dues, in the manner hereinbefore provided; or the amount due to the Crown, of which payment has been evaded, may be recovered by action or suit in the name of the Minister or his agent, in any court of competent jurisdiction.

Minister may take bonds or promissory notes for money due the Crown.      **Sec. 9.** The Minister may take or authorize the taking of bonds or promissory notes for any money due to the Crown, as aforesaid, or in his discretion, for double the amount of any dues, penalties and costs incurred or to be incurred, and may, if it is under seizure, then release any timber upon which the same would be leviable; but the taking of such bonds or notes shall not affect the right of the Crown to enforce payment of such money, and the debt shall be a lien on any timber cut on the same or on any other berth, by the licensee or by his authority, if the sums for which such bonds or notes are given are not paid when due.

The taking of such bonds or notes shall not affect the right of lien or any other mode of enforcing payment.

**FORM OF TIMBER LICENSE.**

License to be used in respect of timber lands.      **Sec. 10.** The following is the form of license to be used in respect of timber lands:



*Regulations affecting Timber on Dominion Lands.*

Chap. 98.

KNOW ALL MEN BY THESE PRESENTS, that by virtue of the authority vested in me by the *Dominion Lands Act*, and by an order of His Excellency the Governor General in Council of the \_\_\_\_\_ day of \_\_\_\_\_ 18\_\_\_\_ I,

the Minister of the Interior of Canada, do hereby, in consideration of the sum of \_\_\_\_\_, ground rent now paid to me for the use of Her Majesty, and in consideration of the royalty hereinafter mentioned, give unto hereinafter called the licensee

executors and administrators, full right, power and license, subject to the conditions and restrictions hereinafter mentioned and contained, to cut timber on the following tract of land (hereinafter called the "berth" or "berths"), that is to say:— \_\_\_\_\_ and to take and keep exclusive possession of the said lands, except as hereinafter mentioned for and during the period of one year from the \_\_\_\_\_ day of \_\_\_\_\_ 18\_\_\_\_, to the \_\_\_\_\_ day of \_\_\_\_\_ 18\_\_\_\_, and no longer.

This license shall vest in the licensee, subject to the conditions hereinafter mentioned, all right of property whatsoever in all trees, timber, lumber, and other products of timber cut within the "berths" during the continuance thereof, whether such trees, timber and lumber or products be cut by authority of the licensee or by any other person, with or without \_\_\_\_\_ consent; and shall entitle the licensee to seize in replevin, revendication or otherwise, as \_\_\_\_\_ property, such timber where the same is found in the possession of any unauthorized person, and also to bring any action or suit, at law or in equity, against any party unlawfully in possession of any such timber, or of any land so leased, and to prosecute all trespassers thereon and other such offenders as aforesaid, to conviction and punishment, and to recover damages, if any; and all proceedings pending at the expiration of this license may be continued and completed as if the same had not expired.

But this license is subject to the following conditions, viz:—

1. That the licensee shall not have the right thereunder to cut timber of a less diameter than ten (10) inches, except such as may be actually necessary for the construction of roads, &c, to facilitate the taking out of merchantable timber.

2. That this license shall not be allowed to interfere with the settlement of any lands within the "berths" which may be desirable for settlement, the Minister of the Interior to be the judge of the fact, and the only recourse of the licensee against the ruling of the Minister in favor of permitting settlement within such "berths" to be that \_\_\_\_\_ (the licensee) may within sixty days after receiving notice to the above effect from the Local Agent of Dominion Lands, remove all timber on such lands which may be over ten inches in diameter.

Further that this license shall not prevent individual Homestead Settlers holding *free permits* heretofore or hereafter given under the Order in Council, dated the \_\_\_\_\_ day of \_\_\_\_\_ 18\_\_\_\_, or under any subsequent Order in Council passed in such behalf, from cutting and removing from the land covered by this license such quantity of building timber, fence rails, or firewood, as such permit may set forth; and the Government may, notwithstanding this license give such permit to individual Homestead Settlers from time to time under said Order in Council or any subsequent Order in Council.

3. That the licensee shall take from every tree \_\_\_\_\_ cut down all the timber fit for use, and manufacture the same into sawn lumber or some other saleable product.

4. That the licensee shall prevent all unnecessary destruction of growing timber on the part of \_\_\_\_\_ men, and exercise strict and constant supervision to prevent the origin or spread of fires.

5. That the licensee shall make returns to the Government monthly, or at such other periods as may be required by the Minister of the Interior, or by regulations under the said Act, sworn to by \_\_\_\_\_ or by \_\_\_\_\_ agent or employe, cognizant of the facts, declaring the quantities sold or disposed of, of all sawn lumber, timber, railway car stuff, ship timbers and knees, shingles, laths, cordwood, or bark, or any other product of timber from the berth, in whatever form the same may be sold or otherwise disposed of by \_\_\_\_\_ during such month or other period, and the price or value thereof.

6. That the licensee shall pay, in addition to the said ground rent, a royalty of five per cent. on his monthly account of sales as above.

7. That the licensee shall keep correct books of such kind and in such form as may be provided by regulation under the said Act, and submit the same for the inspection of the collector of dues whenever required, for the purpose of verifying returns aforesaid.

8. This license shall be subject to the right of the Crown to deal, in accordance with the provisions of the said Act and the regulations made under it by the Governor in Council, with any and all stone, coal and other minerals found within the limits of the berth licensed; and the Crown shall have the right in dealing, as above provided, with any stone, coal or other minerals in lands licensed as timber limits, to authorize the persons to whom such stone, coal or other minerals are

Chap. 98. *Regulations affecting Timber on Dominion Lands.*

granted, to take possession of and occupy such extent of the land so licensed as is necessary to work such stone, coal or other minerals, and to open necessary roads through any such timber berth, paying the licensee of the berth the value of any and all timber necessarily cut in making such roads or in working the quarries or mines; and the provisions of this clause shall operate retrospectively, that is to say:—They shall apply to all licenses of timber berths heretofore granted under any Act respecting Dominion Lands, as if they had been contained in such Act when it was passed.

9. This license shall be subject to forfeiture for infraction of any one of the conditions to which it is subject, or for any fraudulent return; and in such case the Minister of the Interior shall have the right without any suit or other proceeding at law or in equity, or compensation to the licensee to cancel the same, and to make a new license or disposition of the said "berth" to any other party, at any time during the term hereby granted. Provided, that the Minister of the Interior, if he sees fit, may refrain from forfeiting such license for non-payment of dues, and may enforce payment of such dues in the manner provided by the said Act:

Provided, that if during the said term of one year any actual waiver on the part of the Minister of the Interior, or of any one on his behalf, of the benefit of any condition in this license shall take place in any one particular instance, such actual waiver shall not be assumed or deemed to extend to any instance or any branch of such condition, other than that to which such waiver shall specially relate, nor to be a general waiver of the benefit of such condition. Provided, that whenever in the above conditions the word "licensee" occurs, it is to be taken to extend to and include the executors, administrators and assigns of the "licensee":

Provided further, that the Minister of the Interior shall be the sole judge of the fact in regard to infraction, or alleged infraction, of any one of the conditions of this license, and that his decision in relation thereto shall be binding and conclusive.

10. If upon the final location of the Canadian Pacific Railway the whole or part of the lands described in this license, should be found to fall within twenty-four miles of the said line on either side thereof, or if the whole or part of the said lands form part of any tract which may be granted to the said Company as a portion of the land subsidy to which they are entitled under their charter, the sections in the whole or part of such lands, as the case may be, bearing uneven numbers will thereby, after such final location, and as soon as due notice thereof in writing has been served upon the licensee or legal representatives, be withdrawn from the operation of this license, but the licensee or legal representatives shall be at liberty to remove all timber then cut and all other property belonging to them on the lands thereby withdrawn from the operation of this license.

11. This license can not be assigned or transferred without the consent of the Minister of the Interior.

12. The licensee shall have in operation within one year from the day of 18 , and keep in operation for at least six months of each year of his holding, a saw-mill in connection with the berth herein described, capable of cutting in twenty-four hours a thousand feet board measure for every two and a half square miles of the area licensed.

Dated at Ottawa this }  
                                   day }  
 of                               , one }  
 thousand eight hundred }  
 and

*Deputy of the Minister of the Interior..*

accept this license and agree to all the terms and conditions thereof.

*Licensee.*

TIMBER PERMITS AND DUES.

Permits, by public competition except in the case of an actual settler.

Sec. 11. Permits to cut timber on available Dominion Lands, subject to the payment of the dues hereinafter specified, are granted by public competition, except in the case of an actual settler to whom may be granted a permit to cut timber for his own use, without public competition.

*Regulations affecting Timber on Dominion Lands.*

Chap. 98.

(a) Cordwood.....	25 cents per cord.
Cordwood of dry or fallen timber, over seven inches in diameter, when cut by actual settlers for their own use on their farms.....	10 cents per cord.
Fence posts 7 ft. long, and not exceeding 5 in. at the small end.....	1 cent each.
Fence rails of poplar not exceeding 5 in. at the but-end.....	\$2 per thousand.
Rails of any other wood not exceeding 3 in. at the but-end .....	$\frac{1}{2}$ cent each.
Building logs of poplar when not exceeding 12 in. at the but-end .....	$\frac{1}{2}$ cent per lineal ft.
Building logs of pine, spruce, tamarac and any other wood unenumerated when not exceeding 12 in. at the but-end .....	1 cent per lineal ft.
Building logs of oak, elm, ash, or maple when not exceeding 12 in. at the but-end.....	$1\frac{1}{2}$ ct. per lineal ft.
Shingles.....	40 cts. per thousand.
Telegraph poles 22 ft. long.....	5 cents each.
Telegraph poles, each lineal foot over 22 feet.....	1 cent per ft.
Railway ties 8 ft. long .....	3 cents each.
Square timber and sawlogs of poplar..	\$2 per M. ft. B. M.
Square timber and saw logs of pine, cedar, spruce, tamarac and other woods unenumerated .....	\$2.50 per M. ft. B. M.
Square timber and saw logs of oak, elm, ash or maple.....	\$3 per M. ft. B. M.
Returns of board measure to be made by "Scribner's" log rule.	

(b) All other products of the forest, not enumerated, 10 per cent. *ad valorem*.

Sec. 12. The dues on burnt timber to be manufactured into lumber, ties, &c., are five per cent. royalty upon the sales, and fifty cents per thousand in lieu of rent of the berth covered by the permit. Dues on burnt timber.

Sec. 13. An office fee of twenty-five cents shall be charged for each permit. Office fee.

Sec. 14. Issuers of permits will be instructed by the Minister of the Interior as to the quantity of timber that will be granted, and also what proportion of dues shall be deposited on issue of permit as a guarantee on the part of those obtaining the same. Instructions as to quantity of timber and proportion of dues.

## Chap. 98.

*Regulations affecting Timber on Dominion Lands.*

Grantees to pay additional sum to meet expense of survey, &c.

Sec. 15. Besides the dues above specified, grantees of permits may be called upon to pay such additional sum as the Minister may judge necessary to meet their proportion of any expense incurred or that may be incurred by the Department in making a survey or other demarcation on the ground of the boundaries within which such permits are to be operative.

What permits shall set forth.

Sec. 16. Permits shall set forth that those obtaining them must conform to the conditions, terms and requirements specified in the same, and carefully restrict their cutting to the limits described therein, and any breach thereof will subject the offender to all the pains and penalties in that behalf prescribed by the Dominion Lands Act.

Permittee shall cut up the whole of the trees.

Sec. 17. The permittee shall cut up the whole of the trees felled in such a way that there shall be no waste, and to prevent the spread of prairie or bush fires, the refuse (*i. e.* the tops and branches unfit either for rails or firewood) shall be piled together in a heap and not left scattered through the bush.

## TIMBER PERMITS ON SCHOOL LANDS.

Conditions upon which permits may be granted.

Sec. 18. Permits to cut timber upon school lands may be granted in the discretion of the Minister of the Interior, who, before authorizing the issue of permits to cut upon any section or portion thereof, shall cause the same to be carefully examined, and shall satisfy himself that the removal of the timber will not impair the value of the land when offered for sale.

## PERSONS EXEMPTED FROM DUES.

Exemption from dues.

Sec. 19. No dues are to be exacted from the following classes of persons for timber cut for their own use upon undisposed of Dominion lands; that is to say:—

- (a) Miners engaged in prospecting;
- (b) Travellers;
- (c) Persons engaged in merely scientific pursuits or exploring.

## DRAW-BACK OR REBATE.

Draw-back on piles, spars, &c., manufactured in British Columbia.

Sec. 20. The Governor in Council may allow on exportation beyond the limits of Canada, of any piles or spars, or any timber manufactured at any mill in British Columbia, upon which the royalty imposed by these regulations has been paid, a draw-back or rebate equal to one half the royalty upon such timber.

## TIMBER FOR HOMESTEADERS.

Sec. 21. Any occupant of a homestead quarter-section having no timber of his own may, upon application, obtain a permit to cut such quantity of building timber, fencing timber or fuel as he may require for use on his homestead, not exceeding the following:—

(a) 1,800 lineal feet of building timber, no log to be over 12 inches at the but-end ;

(b) 400 roof poles ;

(c) 2,000 poplar fence-rails, no rail to exceed 5 inches at the but-end ;

(d) 30 cords of dry wood ;

(e) Burnt or fallen timber of a diameter up to seven inches inclusive, for fuel or fencing.

Building timber, fencing timber and fuel required for use on homestead may be cut by occupant.

Sec. 22. Should the house timber be sawn at a mill, payment for sawing must not be made by way of toll as the full quantity of lumber cut from the logs must be used on the permit-holder's homestead.

Payment for sawing-not to be made by way of toll.

Sec. 23. In order that mill owners may be able to give satisfactory evidence that saw logs or lumber found in their possession have been lawfully cut, they should require from settlers bringing timber to be sawn, proof that the same has not been cut on Dominion lands, or that it has been cut under a permit, which the settler should produce in order that its number, its date, and the name of the permittee may be noted by the mill owner. The latter should also record the quantity of such timber sawn by him, so that he may be in a position to duly protect himself should an account or return thereof be demanded by agents of the Department.

To enable mill owners to give satisfactory evidence that saw logs, &c., have been lawfully cut, they should require proof from settlers.

Sec. 24. The applicant will require to pay an office fee of twenty-five cents before he can obtain a permit, but no dues will be charged for the timber or wood cut under and in accordance therewith.

Fee of 25 cents.

Sec. 25. Homesteaders whose farms may have thereon a supply of timber, or who are in possession of wood lots or other timbered lands, will not be granted a free permit.

Homesteaders having supply.

## CHAPTER 99.

### REGULATIONS GOVERNING THE DISPOSAL OF DOMINION LANDS CONTAINING MINERALS.

Government House, Ottawa,  
The 9th day of November, 1889.

On the recommendation of the Minister of the Interior and under the provisions of Chapter 54 of the Revised Statutes of Canada, intituled "The Dominion Lands Act,"

His Excellency in Council has been pleased to order that the following regulations governing the disposal of Dominion Lands containing minerals other than coal in Manitoba and the North-West Territories, and of such mineral lands in British Columbia as are the property of the Government of Canada, except lands containing gold or silver, be approved and adopted:—

Gold, cinnabar, lead, tin, copper, petroleum, iron, &c.

**Section 1.** These regulations may be cited as "The Dominion Mining Regulations," and shall be applicable to all Dominion lands containing gold, silver, cinnabar, lead, tin, copper, petroleum, iron, or other mineral deposit of economic value, with the exception of coal, and in British Columbia with the exception of gold and silver.

Persons may explore vacant Dominion lands for mineral deposits with a view to obtaining mining location.

**Sec. 2.** Any person or persons may explore vacant Dominion lands not appropriated or reserved by Government for other purposes, and may search therein, either by surface or subterranean prospecting, for mineral deposits, with a view to obtaining under these regulations a mining location for the same; but no mining location or mining claim shall be granted until actual discovery has been made of the vein, lode, or deposit of mineral or metal within the limits of the location or claim.

#### QUARTZ MINING.

Dimensions of a location for mining.

**Sec. 3.** A location for mining, except for iron or petroleum, on veins, lodes, or ledges of quartz or other rock in place, shall not exceed the following dimensions: Its length shall not be more than 1,500 feet, its breadth not more than 600 feet; its surface boundaries shall be four straight lines, and the side lines and end lines shall be parallel lines, except where prior locations may prevent, in which case it may be of such shape as may be approved by the Superintendent of Mines. Its length shall not be more than three times its breadth. Its boundaries beneath the surface shall be the vertical planes in which its surface boundaries lie.

*Dominion Mining Regulations.*

## Chap. 99.

Sec. 4. Any person having discovered a mineral deposit may obtain a mining location therefor, under these regulations, in the following manner :—

(a.) He shall mark the location on the ground by placing at each of its four corners a wooden post, not less than four inches square, driven not less than eighteen inches into the ground, and showing that length above it. If the ground be too rocky to admit of so driving such posts, he shall build about each of them, to support it and keep it in place, a cairn or mound of stones, at least three feet in diameter at the base, and eighteen inches high. If the location be timbered, a line shall be run and well blazed joining the said posts. If it be not so timbered, and the ground is of such a nature that any one post cannot be seen from the ends of either of the lines, which form the angle at which the said post is placed, posts flattened on two sides (such flattened portions facing the directions of the line) shall be planted or mounded along the side lines wherever necessary, so that no difficulty may be experienced by a subsequent prospector or explorer in discovering or following the boundaries of any location. If the location be laid out with its boundaries due north and south and east and west, then he shall mark on the post designating the north-east angle of the location, legibly, with a cutting instrument, or with colored chalk, his name in full, the date of such marking, and the letters M. L., No. 1, to indicate that the post is Mining Location post No. 1. Proceeding next to the south-easterly angle of the location he shall mark the post planted there with the letters M. L. No. 2, and his initials; next to the south-westerly angle of the location, the post planted at which he shall mark with the letters M. L. No. 3, and his initials; and lastly to the north-westerly angle of the location, the post planted at which he shall mark with the letters M. L. No. 4, and his initials. If the location be laid out by other than due north and south and east and west lines, the first mentioned post shall be the one at the northerly angle; the second the one at the easterly angle; the third the one at the southerly angle; and the fourth the one at the westerly angle. Furthermore, on the face of each post, which face shall in the planting thereof be turned towards the post which next follows it in the order in which they are here named and numbered, there shall be marked in figures the number of yards distant to the next following post. If means of measurement are not available, the distance to be so marked on each of the posts may be that estimated. If the corner of a location falls in a ravine, bed of a stream, or any other situation where the character of the locality may render the planting of a post impossible, the said corner may be indicated by the erection at the nearest suitable point

Person having discovered a mineral deposit may obtain mining location.

Mode of marking, laying out and establishing boundaries of mining location.

Location laid out with its boundaries due north and south, and east and west.

Location laid out by other than due north and south, and east and west lines.

If corner of location falls in a ravine, &c.

of a witness post, which in that case shall contain the same marks as those prescribed in this clause in regard to corner posts, together with the letters W. P., and an indication of the bearing and distance of the site of the true corner from such witness post.

(In this manner any subsequent prospector, informed of these regulations, will, on finding any one of the posts or mounds, be enabled to follow them all round, from one to another, and avoid encroachment, either in search of or in marking out another location in the vicinity for himself);

Claimant shall file declaration under oath setting forth particulars, and shall pay fee of \$5.00.

(b.) Having so marked out on the ground the location he desires, the claimant shall, within sixty days thereafter, file with the Agent in the Dominion lands office for the district in which the location is situated, a declaration under oath, according to Form A in the Schedule to these regulations (which may be sworn to before the said agent, or may have been previously sworn to before a justice of the peace or commissioner), setting forth the circumstances of his discovery, and describing as nearly as may be, the locality and dimensions of the location marked out by him as aforesaid; and shall, along with such declaration, pay to the said agent an entry fee of five dollars.

Agent shall grant receipt, which shall authorize claimant to enter into possession for the term of five years.

(c.) The Agent upon such payment being made shall grant a receipt according to the Form B in the Schedule to these regulations. This receipt shall authorize the claimant, his legal representatives or assignees, to enter into possession of the location applied for, and subject to its renewal from year to year as hereinafter provided, during the term of five years from its date, to take therefrom and dispose of any mineral deposit contained within its boundaries, provided that during each of the said five years after the date of such receipt he or they shall expend in actual mining operations on the claim at least one hundred dollars, and furnish to the agent of Dominion lands within each and every year a full detailed statement of such expenditure, which evidence shall be in the form of an affidavit corroborated by two reliable and disinterested witnesses; and the agent shall thereupon, subject to the payment by the claimant of a fee of five dollars, issue a receipt in the Form C in the Schedule hereto, which shall entitle the claimant to hold the location for another year;

Party of miners, not exceeding four, may make expenditure on adjoining locations.

(d.) Any party of miners, not exceeding four, whose claims are adjoining, and each of which has been entered within three months of the other, may, for the better development of their locations, and upon being authorized to do so by the agent, make upon any one of such locations, during the first and second years after entry, but not subsequently, the expenditure required by these regulations to be made upon each of the said locations. The authority herein provided for



*Dominion Mining Regulations.*

## Chap. 99.

shall be in the Form D in the Schedule hereto, and shall be granted by the agent upon application made in writing to that effect by each of the claimants interested, and payment of a fee of five dollars, upon which payment the agent shall also grant a receipt in the Form E in the Schedule hereto: Provided, however, that the expenditure made upon any one location shall not be applicable in any manner or for any purpose to any other location.

Sec. 5. At any time before the expiry of five years from the date of his entry for his mining location, the claimant shall be entitled to purchase the said location upon filing with the agent proof that he has expended not less than five hundred dollars in actual mining operations on the same, and that he has in every other respect complied with the requirements of these regulations.

Claimant entitled to purchase within five years.

Sec. 6. The price to be paid for a mining location shall be at the rate of five dollars per acre, cash.

Price, \$5.00 per acre.

Sec. 7. On making the application to purchase a mining location, and paying the price therefor, as hereinbefore provided, the claimant shall also deposit with the agent the sum of fifty dollars, which shall be deemed payment by him to the Government for the survey of his location; and upon the receipt of the plans and field notes, and the approval thereof by the Surveyor General, a patent shall issue to the claimant in the Form F in the Schedule hereto. If, on account of its remoteness or other cause, a mining location cannot, at the time of the deposit of fifty dollars by the applicant for the purpose, be surveyed by the Government for that sum, he shall be subject to the alternative of waiting until the employment of a surveyor by the Government on other work in the vicinity of the claim renders it convenient to have the survey made at a cost not exceeding fifty dollars, or of sooner procuring, at his own cost, its survey by a duly commissioned surveyor of Dominion lands, under instructions from the Surveyor General; in the latter case, on receipt of the plans and field notes of the survey and approval thereof by the Surveyor General, as hereinbefore provided, the claimant shall be entitled to receive his patent, and to have returned to him the fifty dollars deposited by him to defray the cost of survey.

Claimant shall also deposit with the Agent \$50.00, whereupon patent shall issue.

Alternative in case of remoteness or other cause.

Sec. 8. Should the claimant, or his legal representatives as aforesaid, fail to prove within each year the expenditure prescribed, or, having proved such expenditure, fail within the prescribed time to pay in full, and in cash, to the agent, the price hereinbefore fixed for such mining location,

Should the claimant fail to prove within each year the expenditure prescribed.

## Chap. 99.

*Dominion Mining Regulations.*

When claimant's right shall lapse.

and also to pay the sum of fifty dollars hereinbefore prescribed for the survey of his location,—then any right on the part of the claimant or of his legal representatives in the location, or claim on his or their part to acquire it, shall lapse, and the location shall thereupon revert to the Crown, and shall be held, along with any immovable improvements thereon, for disposal, under these regulations, to any other person, or as the Minister of the Interior may direct :

Applications must conform to the regular system of surveys.

(a.) In cases where applications for mining locations are made in respect of lands within surveyed townships, they must conform to the regular system of surveys ; that is, the location shall be either legal sub-divisions or regular sub-divisions thereof ; and prior to the application being granted it shall be necessary to stake out the location, at least approximately, on the ground, and it shall be surveyed by a Dominion land surveyor, acting under instructions from the Surveyor General, within one year thereafter :

Applications made within a township of which at least one boundary has been surveyed.

(b.) If applications for mining locations are made within a township of which at least one boundary has been surveyed, to protect himself the discoverer may stake out his claim in conformity with these regulations ; but, before the issue of the patent, the claim shall, if required by the Minister of the Interior, be described by legal sub-divisions or fractional portions thereof, upon a survey made by a Dominion land surveyor acting under instructions from the Surveyor General.

Where two or more lay claim to same mining location.

Sec. 9. Where two or more persons lay claim to the same mining location, the right to acquire it shall be in him who can prove he was the first to discover the mineral deposit involved and to take possession, by demarcation in the manner prescribed in these regulations, of the location covering it.

Priority alone shall not give right ; other conditions which may govern.

Sec. 10. Priority of discovery alone shall not give the right to acquire ; but a person subsequently and independently discovering, who has complied with the other conditions prescribed in these regulations, shall take precedence of the first discoverer if the latter has failed to comply with the said other conditions : Provided, however, that in any case where it is proved that a claimant has, in bad faith, used the prior discovery of another, and fraudulently affirms that he made independent discovery and demarcation, he shall, apart from any other legal consequences, have no claim, and shall forfeit the deposit made with his application, and shall be absolutely debarred from obtaining another mining location.

*Dominion Mining Regulations.*

## Chap: 99.

**Sec. 11.** Not more than one mining location shall be granted to any individual claimant upon the same lode or vein.

Upon the same lode or vein.

**Sec. 12.** Where land is used or occupied for milling purposes, reduction works, or other purposes incidental to mining operations, either by the proprietor of a mining location or other person, such land may be applied for and patented, either in connection with or separate from a mining location, in the manner hereinbefore provided for the application for and the patenting of mining locations, and may be held in addition to any such mining location; but such additional land shall in no case exceed five acres in extent, and shall be paid for at the same rate as a mining location.

Land used for purposes incidental to mining, how applied for and patented.

**Sec. 13.** The Minister of the Interior may grant a location for the mining of iron or petroleum not exceeding 100 acres in area, which shall be bounded by due north and south and east and west lines, and its breadth and length shall be equal: Provided, that should any person making an application purporting to be for the purpose of mining either iron or petroleum thus obtain, whether in good faith or fraudulently, possession of a valuable mineral deposit other than iron or petroleum, his right in such deposit shall be restricted to the area hereinbefore prescribed for other minerals, and the rest of the location shall thereupon revert to the Crown for such disposition as the Minister may direct.

Minister may grant location for mining iron or petroleum, not exceeding 160 acres.

**Sec. 14.** When there are two or more applicants for any mining location, no one of whom is the original discoverer or his assignee, the Minister of the Interior, if he sees fit to dispose of the location, shall invite their competitive tenders, or shall put it up to public tender or auction as he may deem expedient.

Two or more applicants, no one of whom is the original discoverer.

**Sec. 15.** An assignment of the right to purchase a mining location shall be indorsed on the back of the receipt or certificate of assignment (Forms B and G, in the Schedule hereto), and the execution thereof shall be attested by two disinterested witnesses; upon the deposit of the receipt or certificate with such assignment executed and attested as herein provided, in the office of the Agent, accompanied by a registration fee of two dollars, the Agent shall give to the assignee a receipt in the Form G in the Schedule hereto, which certificate shall entitle the assignee to all the rights and privileges of the original discoverer in respect of the claim assigned; and the said assignment shall be forwarded to the Minister of the Interior by the Agent, at the same

Assignment of right to purchase a mining location, how made.

Full directions and regulations in reference thereto.

time and in like manner as his other returns respecting Dominion lands, and shall be registered in the Department of the Interior; and no assignment of the right to purchase a mining location which is not unconditional and in all respects in accordance with the provisions of this clause, and accompanied by the registration fee herein provided for, shall be recognized by the agent or registered in the Department of the Interior.

Application by assignee of the right to purchase.

**Sec. 16.** If application be made under the next preceding clause by the assignee of the right to purchase a mining location, and such claim is duly recognized and registered, as hereinbefore provided, such assignee shall, by complying with these regulations, become entitled to purchase the location for the price and on the terms prescribed thereby.

#### PLACER MINING.

Regulations hereinbefore laid down, how far applicable.

**Sec. 17.** The regulations hereinbefore laid down in respect of quartz mining shall be applicable to placer mining so far as they relate to entries, entry fees, assignments, marking of locations, agents' receipts, and generally where they can be applied, save and except as otherwise herein provided.

#### *Nature and size of Claims.*

Size of claim.

**Sec. 18.** The size of claims shall be as follows:—

"Bar diggings."

(a.) For "bar diggings," a strip of land 100 feet wide at high water mark, and thence extending into the river to its lowest water level;

"Dry diggings."

(b.) For "dry diggings," 100 feet square;

"Creek and river claims."

(c.) "Creek and river claims" shall be 100 feet long, measured in the direction of the general course of the stream, and shall extend in width from base to base of the hill or bench on each side, but when the hills or benches are less than 100 feet apart the claim shall be 100 feet square; Provided, however, that in any case where the distance from base to base of the hill or bench exceeds ten chains, such claims shall be laid out in areas of ten acres each, the boundaries of such areas to be due north and south and east and west lines, and if within surveyed territory the said area of ten acres shall consist of one-fourth of a legal sub-division, and shall be marked on the ground in the manner prescribed by these regulations for marking quartz mining locations: Provided further, that any such claim intersected by a creek or river, shall, in addition to the stakes at the four corners thereof, have the points at which its boundaries may be intersected by the high water mark of the creek or river on both sides of the creek or river designated by posts of the

*Dominion Mining Regulations.*

Chap. 99.

same size which shall be driven into the ground the same depth and showing the same length above it as the posts prescribed by these regulations in respect of quartz mining locations, and the said posts shall have marked upon them legibly, with a cutting instrument or with colored chalk, the name of the claimant in full and the date of such marking;

(d.) "Bench claims" shall be 100 feet square.

"Bench claims."

(e.) Every claim on the face of any hill, and fronting on any natural stream or ravine, shall have a frontage of 100 feet, drawn parallel to the main direction thereof, and shall be laid out, as nearly as possible, in the manner prescribed by Section 4 of these regulations;

Claim on face of hill, frontage.

(f.) If any person or persons shall discover a new mine, and such discovery shall be established to the satisfaction of the agent, claims of the following size, in dry, bar, bench, creek or hill diggings, shall be allowed:

If any person or persons shall discover a new mine.

To one discoverer.....	300 feet in length.
To a party of two.....	600 do do
To do three.....	800 do do
To do four.....	1,000 do do

and to each member of a party beyond four in number, a claim of the ordinary size only.

A new stratum of auriferous earth or gravel, situated in a locality where the claims are abandoned, shall, for this purpose, be deemed a new mine, although the same locality shall have been previously worked at a different level; and dry diggings discovered in the vicinity of bar diggings shall be deemed a new mine, and *vice versa*.

A new stratum of auriferous earth or gravel to be deemed a new mine.

*Rights and Duties of Miners.*

Sec. 19. The forms of application for a grant for placer mining, and the grant of the same, shall be those contained in Forms H and I in the Schedule hereto.

Application and grant.

Sec. 20. The entry of every holder of a grant for placer mining must be renewed and his receipt relinquished and replaced every year, the entry fee being paid each time.

Renewal of entry, &c.

Sec. 21. No miner shall receive a grant of more than one mining claim in the same locality, but the same miner may hold any number of claims by purchase, and any number of miners may unite to work their claims in common upon such terms as they may arrange, provided such agreement be registered with the Agent, and a fee of five dollars paid for each registration.

No miner shall receive a grant of more than one claim in same locality.

Sec. 22. Any miner or miners may sell, mortgage, or dispose of his or their claims, provided such disposal be re-

Miner may sell or mortgage.

## Chap. 99.

*Dominion Mining Regulations.*

gistered with, and a fee of two dollars paid, to the agent, who shall thereupon give the assignee a certificate in Form J in the Schedule hereto.

Miner to have exclusive right of entry; but no surface rights.

Sec. 23. Every miner shall, during the continuance of his grant, have the exclusive right of entry upon his own claim, for the miner-like working thereof, and the construction of a residence thereon, and shall be entitled exclusively to all the proceeds realized therefrom; but he shall have no surface rights therein; and the Superintendent of Mines may grant to the holders of adjacent claims such right of entry thereon as may be absolutely necessary for the working of their claims, upon such terms as may to him seem reasonable.

Miner to have use of water naturally flowing.

Sec. 24. Every miner shall be entitled to the use of so much of the water naturally flowing through or past his claim, and not already lawfully appropriated, as shall, in the opinion of the Superintendent of Mines, be necessary for the due working thereof; and shall be entitled to drain his own claim free of charge.

Claim, when deemed to be abandoned.

Sec. 25. A claim shall be deemed to be abandoned and open to occupation and entry by any person when the same shall have remained unworked on working days by the grantee thereof for the space of seventy-two hours, unless sickness or other reasonable cause be shown, or unless the grantee is absent on leave.

Claim to be continuously worked.

Sec. 26. A claim granted under these regulations shall be continuously, and in good faith, worked, except as otherwise provided, by the grantee thereof or by some person on his behalf.

Tunnelling under hills.

Sec. 27. In tunnelling under hills, on the frontage of which angles occur, or which may be of an oblong or elliptical form, no party shall be allowed to tunnel from any of the said angles, or from either end of such hills, so as to interfere with parties tunnelling from the main frontage.

Tunnels and shafts belonging to claim.

Sec. 28. Tunnels and shafts shall be considered as belonging to the claim for the use of which they are constructed, and as abandoned or forfeited by the abandonment or forfeiture of the claim itself.

Tunnels in working of back claims on benches or slopes.

Sec. 29. For the more convenient working of back claims on benches or slopes, the Superintendent of Mines may permit the owners thereof to drive a tunnel through the claims fronting on any creek, ravine or water-course, upon such terms as he may deem expedient.

*Dominion Mining Regulations.*

## Chap. 99.

*Administration.*

Sec. 30. In case of the death of any miner while entered as the holder of any mining claim, the provisions as to abandonment shall not apply either during his last illness or after his decease. In last illness or decease, abandonment not to apply.

Sec. 31. The Minister of the Interior shall take possession of the mining property of the deceased, and may cause such mining property to be duly worked, or dispense therewith, at his option; and he shall sell the property by private sale, or, after ten days' notice thereof, by public auction, upon such terms as he shall deem just, and out of the proceeds pay all costs and charges incurred thereby, and pay the balance, if any, to the legal representatives of the said deceased miner. Minister to take possession of mining property of deceased and cause same to be worked; and to sell it upon notice.

Sec. 32. The Minister of the Interior, or any person authorized by him, shall take charge of all the property of deceased miners until the issue of letters of administration. Minister to take charge, pending administration.

## BED-ROCK FLUMES.

Sec. 33. It shall be lawful for the Minister of the Interior, upon the application hereinafter mentioned, to grant to any bed-rock flume company, for any term not exceeding five years, exclusive rights of way through and entry upon any mining ground for the purposes of constructing, laying and maintaining bed-rock flumes. Minister may grant exclusive right of way to flume company..

Sec. 34. Three or more persons may constitute themselves into a bed-rock flume company; and every application by them for such grant shall state the names of the applicants and the nature and extent of the privileges sought to be acquired. Ten full days' notice thereof shall be given between the months of June and November, and between the months of November and June one month's notice shall be given, by affixing the same to a post planted in some conspicuous part of the ground or to the face of the rock, and a copy thereof conspicuously upon the inner walls of the Land Office of the district. Prior to such application, the ground included therein shall be marked out in the manner prescribed in sub-section (a) of Section 4 of these Regulations. It shall be competent for any person to protest before the Agent within the times hereinbefore prescribed for the notice of such application, but not afterwards, against such application being granted. Every application for a grant shall be accompanied by a deposit of \$100, which shall be returned if the application be refused, but not otherwise. Three or more persons may constitute themselves into a bed-rock flume company.

Manner of marking out ground.

## Chap. 99.

*Dominion Mining Regulations.*

Grant to be in writing.      **Sec. 35.** Every such grant shall be in writing, in the Form K in the Schedule hereto.

Holders of claims may put in bed-rock flume.      **Sec. 36.** The holders of claims through which the line of the company's flume is to run may put in a bed-rock flume in their claims to connect with the company's flume, upon giving the company ten days' notice in writing to that effect; but they shall maintain the like grade, and build their flume as thoroughly, and of as strong materials, as that built by such company.

Number of feet to be laid by company.      **Sec. 37.** Every bed-rock flume company shall lay at least fifty feet of flume during the first year and one hundred feet annually thereafter, until completion of the flume.

Miners may tail their sluices, &c., into such flume.      **Sec. 38.** Any miners lawfully working any claims where a bed-rock flume exists, shall be entitled to tail their sluices, hydraulics and ground sluices into such flume, but so as not to obstruct the free working of such flume, by rocks, stones, boulders or otherwise.

Registration, fee and annual rent.      **Sec. 39.** Upon a grant being made to any bed-rock flume company, the agent shall register the same, and the company shall pay for such registration a fee of \$10. They shall also pay, in advance, an annual rent of \$10 for each quarter of a mile of right of way legally held by them.

## DRAINAGE OF MINES.

Minister may grant permission to run drain or tunnel through occupied mining land.      **Sec. 40.** The Minister of the Interior may grant to any person or persons permission to run a drain or tunnel for drainage purposes through any occupied mining land, and may give such persons exclusive rights of way through and entry upon any mining ground for any term not exceeding five years, for the purpose of constructing a drain or drains for the drainage thereof.

Grantee shall compensate owners for damage in construction of drain or tunnel.      **Sec. 41.** The grantee shall compensate the owners of lands or holders of claims entered upon by him for any damage they may sustain by the construction of such tunnel or drain, and such compensation if not agreed upon shall be settled by the Superintendent of Mines and be paid before such drain or tunnel is constructed.

Ownership of drain or tunnel.      **Sec. 42.** Such drain or tunnel, when constructed, shall be deemed to be the property of the person or persons by whom it shall have been so constructed.

**Sec. 43.** Every application for a grant shall state the names of the applicants, the nature and extent of the pro-



*Dominion Mining Regulations.*

## Chap. 99.

posed drain or drains, the amount of toll (if any) to be charged, and the privileges sought to be acquired, and shall, save where the drain is intended only for the drainage of the claim of the person constructing the same, be accompanied by a deposit of \$25, which shall be refunded in case the application is refused, but not otherwise. Notice of the application shall be given and protests may be made in the same manner as provided in regard to bed-rock flumes.

Application for grant for right to make drain, how made; deposit to accompany application.

Sec. 44. The grant of the right of way to construct drains or tunnels shall be made in the Form L in the Schedule hereto. The grant shall be registered by the grantee in the office of the Agent, to whom he shall at the time pay a registration fee of \$5, or, if the grant gives power to collect tolls, a fee of \$10. An annual rent of \$10 shall be paid, in advance, by the said grantee for each quarter of a mile of right of way legally held by him, save where the drain shall be for the purpose of draining only the claim of the person constructing the same.

Form of grant; registration, fee and annual rent.

## DITCHES.

Sec. 45. The Minister of the Interior may, upon application hereinafter mentioned, grant to any person or persons, for any term not exceeding five years, or in special cases for such length of time as he may determine, the right to divert and use the water from any stream or lake, at any particular part thereof, and the right of way through and entry upon any mining ground, for the purpose of constructing ditches and flumes to convey such water; provided always, that every such grant shall be deemed as appurtenant to the mining claim in respect of which it has been obtained, or is required in connection with reduction works, sampling works, stamp mills, concentrating works, or other works connected with mining operations, and, whenever the claim shall have been worked out or abandoned, or whenever the occasion for the use of such water upon the claim or in connection with such works shall have permanently ceased, the grant shall cease and determine.

Minister may grant, for term of five years, right to divert and use water from any stream or lake.

Sec. 46. Twenty days' notice of the application shall be given, in accordance with Form M in the Schedule to these regulations, by affixing the same to a post planted in some conspicuous part of the ground, and a copy thereof conspicuously posted upon the inner walls of the land office for the district, and any person may protest within such twenty days, but not afterwards, against such application being wholly or partially granted.

Twenty days notice to be given.

## Chap. 99.

*Dominion Mining Regulations.*

Deposit to accompany application.

Sec. 47. Every application for a grant of water exceeding 200 inches shall be accompanied by a deposit of \$25, which shall be refunded in case the application is refused, but not otherwise.

Application shall state names of applicants and other particulars.

Sec. 48. Every such application shall state the names of the applicants, the name or description of the stream or lake to be diverted, the quantity of water to be taken, the locality for its distribution, the price (if any) to be charged for the use of such water, and the time necessary for the completion of the ditch. The grant shall be in the form N in the Schedule hereto.

Grant of water privilege on occupied creeks.

Sec. 49. Every grant of a water privilege on occupied creeks shall be subject to the rights of such miners as shall, at the time of such grant, be working on the stream above or below the ditch head, and of any other persons lawfully using such water for any purpose whatsoever.

If, after grant has been made, miner locate and work below ditch head.

Sec. 50. If, after the grant has been made, any miner or miners locate and *bona fide* work any mining claim below the ditch head, on any stream so diverted, he or they collectively shall be entitled to 40 inches of water if 200 inches be diverted, and 60 inches if 300 inches be diverted, and no more, except upon paying to the owner of the ditch, and all other persons interested therein, compensation equal to the amount of damage sustained by the diversion of such extra quantity of water as may be required; and, in computing such damage, the loss sustained by any claims using water therefrom, and all other reasonable losses, shall be considered.

No person entitled to grant for the purpose of selling water.

Sec. 51. No person shall be entitled to a grant of the water of any stream for the purpose of selling the water to present or future claim holders on any part of such stream. The Minister of the Interior may, however, grant such privileges as he may deem just, when such ditch is intended to work bench or hill claims fronting on any such stream, provided that the rights of miners then using the water so applied for be protected.

Enlargement or alteration of ditch.

Sec. 52. The Minister of the Interior may, on the report of the Superintendent of Mines that such action is desirable, order the enlargement or alteration of any ditch, and fix the compensation (if any) to be paid by parties to be benefited thereby.

Waste of water to work forfeiture.

Sec. 53. Every owner of a ditch or water privilege shall take all reasonable means for utilizing the water granted to him; and, if he wilfully take and waste any unreasonable

*Dominion Mining Regulations.*

## Chap 99.

quantity of water, the Minister may, if such offence be persisted in, declare all rights to the water forfeited.

Sec. 54. The owner of any ditch or water privilege may distribute the water to such persons and on such terms as he may deem advisable, within the limits mentioned in this grant; provided always that such owner shall be bound to supply water to all miners who make application therefor in a fair proportion, and shall not demand more from one person than from another, except where the difficulty of supply is enhanced.

Owner of ditch or water privilege may distribute water, provided he shall do so proportionately.

Sec. 55. Any person desiring to bridge any stream, claim or other place, for any purpose, or to mine under or through any ditch or flume, or to carry water through or over any land already occupied, may, in proper cases, do so with the written sanction of the Superintendent of Mines. In all such cases the right of the party first in possession shall prevail, so as to entitle him to compensation if the same be just.

Any person desiring to bridge stream claim or other place.

Sec. 56. In measuring water in any ditch or sluice, the following rules shall be observed: The water taken into a ditch or sluice shall be measured at the ditch or sluice head: no water shall be taken into a ditch or sluice except in a trough placed horizontally at the place at which the water enters it, which trough shall be extended two feet beyond the orifice for the discharge of the water: one inch of water shall mean the quantity that will pass through a rectangular orifice two inches high by half an inch wide, with a constant head of seven inches above the upper side of the orifice.

Rules to be observed in measuring water in any ditch or sluice.

Sec. 57. Whenever it shall be intended, in forming or upholding any ditch, to enter upon and occupy any part of an entered claim, or to dig or loosen any earth or rock, within four feet of any ditch not belonging solely to the registered owner of such claim, three days' notice, in writing, of such intention shall be given, before entering or approaching within four feet of such other property.

Intention to occupy entered claim or to dig within four feet of any ditch not belonging to claimant.

Sec. 58. Any person engaged in the construction of any road or work may, with the sanction of the Minister of the Interior, cross, divert or otherwise interfere with any ditch, water privilege or other mining rights whatsoever, for such period as the Minister shall approve.

Right to cross divert or otherwise interfere with ditch, &c.

Sec. 59. The Minister shall order what compensation for every such damage or interference shall be paid, and when, and to whom, and whether any and what works, damaged or affected by such interference as aforesaid, shall be replaced

Compensation for damages.

## Chap. 99.

*Dominion Mining Regulations.*

by flumes or otherwise repaired by the person or persons causing any such damage.

Owners of ditch, &c., at their own expense to construct, maintain, &c., culverts.

**Sec. 60.** The owners of any ditch, water privilege, or mining right, shall, at their own expense, construct, secure, and maintain, all culverts, necessary for the passage of waste and superfluous water flowing through or over any such ditch, water privilege or right.

Owners of ditch, &c., shall keep same in repair.

**Sec. 61.** The owners of any ditch or water privilege shall construct and secure the same in a proper and substantial manner, and maintain the same in good repair to the satisfaction of the Superintendent of Mines, so that no damage shall occur to any road or work in its vicinity from any part of the works of such ditch, water privilege, or right.

Owners of ditch, &c., shall make good damages.

**Sec. 62.** The owners of any ditch, water privilege or right, shall be liable, and shall make good, in such manner as the Superintendent of Mines shall determine, all damages which may be occasioned by or through any part of the works of such ditch, water privilege or right, breaking or being imperfect.

Right of the Lieutenant Governor of the North-West Territories in Council.

**Sec. 63.** Nothing herein contained shall be construed to limit the right of the Lieutenant Governor of the North-West Territories in Council, or of the proper authority in any Province containing Dominion lands to lay out, from time to time, public roads across, through, along, or under any ditch, water privilege or mining right, without compensation.

## GENERAL PROVISIONS.

*Interpretation.*

Meaning of expressions.

**Sec. 64.** In these regulations the following expressions shall have the following meanings respectively, unless inconsistent with the context:—

Minister.

(a.) "Minister" shall mean the Minister of the Interior.

Agent.

(b.) "Agent" or "local agent" shall mean the agent of Dominion lands for the district, or other officer appointed by the Government for the particular purpose referred to.

Mineral.

(c.) "Mineral" shall include all minerals whatsoever other than coal.

Close season.

(d.) "Close season" shall mean the period of the year during which placer mining is generally suspended.

Miner.

(e.) "Miner" shall mean a person holding a mining location or a grant for placer mining.

*Dominion Mining Regulations.*

## Chap. 99.

- (f.) "Claim" shall mean the personal right of property in a placer mine or diggings during the time for which the grant of such mine or diggings is made. Claim.
- (g.) "Claimant" shall mean a person who has obtained an entry for a mining location with a view to patent. Claimant.
- (h.) "Bar diggings" shall mean a mine over which a river extends when in its flooded state. Bar diggings.
- (j.) "Dry diggings" shall mean any mine over which a river never extends. Dry diggings.
- (k.) The mines on benches shall be known as "bench diggings," and shall, for the purpose of defining the size of such claims, be excepted from "dry diggings." Bench diggings.
- (l.) "Streams and ravines" shall include water-courses whether usually containing water or not, and all rivers, creeks and gulches. Streams and ravines.
- (m.) "Ditch" shall include a flume or race, or other artificial means for conducting water by its own weight, to be used for mining purposes. Ditch.
- (n.) "Ditch head" shall mean the point in a natural water-course or lake where water is first taken into a ditch. Ditch head.
- (o.) "Placer mining" shall mean the working of all forms of deposits, excepting veins of quartz or other rock in place. Placer mining.
- (p.) "Quartz mining" shall mean the working of veins of quartz or other rock in place. Quartz mining.
- (q.) "Location" shall mean the land entered by, or patented to, any person for the purpose of quartz mining. Location.

*Hearing and Decision of Disputes.*

Sec. 65. The Superintendent of Mines shall have power to hear and determine all disputes in regard to mining property arising within his district, subject to appeal by either of the parties to the Commissioner of Dominion Lands. Determination of disputes.

Sec. 66. No particular forms of procedure shall be necessary, but the matter complained of must be properly expressed in writing, and a copy of the complaint shall be served on the opposite party not less than seven days before the hearing of the said complaint. No particular forms of procedure necessary.  
Copy to be served.

Sec. 67. The complaint may, by leave of the Superintendent of Mines, be amended at any time before or during the proceedings. Amendment of complaint.

Sec. 68. The complainant shall, at the time of filing his complaint, deposit therewith a bond fee of \$20, which shall be returned to him if the complaint proves to have been well founded, and not otherwise, except for special cause, by direction of the Minister. Complainant shall deposit bond fee.

## Chap. 99.

*Dominion Mining Regulations.*

Directions in case of appeal.

Sec. 69. In the event of the decision of the Superintendent of Mines being made the subject of an appeal to the Commissioner of Dominion Lands, the appellant shall, at the time of lodging the appeal, deposit with the Agent a bond fee of \$20, which shall be returned to the said appellant if his appeal proves to have been well founded, and not otherwise, except for special cause by direction of the Minister.

Deposit in such case.

Appeal must be lodged within three days.

Sec. 70. The appeal must be in writing and must be lodged with the Superintendent of Mines not more than three days after his decision has been communicated in writing to all the parties interested, and must state the grounds upon which the said decision is appealed from.

In case of disputed measurements or boundaries; expenses of survey by whom to be borne.

Sec. 71. If the Commissioner of Dominion Lands decides that it is necessary, to a proper decision of the matter in issue to have an investigation on the ground, or, in case of disputed boundaries or measurements, to employ a surveyor to measure or survey the land in question, the expense of the inspection or re-measurement or re-survey, as the case may be, shall be borne by the litigants, who shall pay into the hands of the said Commissioner, in equal parts, such sum as he may think sufficient for the same, before it takes place; otherwise it shall not proceed, and the party who refuses to pay such sum shall be adjudged in default. The said Commissioner shall subsequently decide in what proportion the said expense should be borne by the parties respectively, and the surplusage, if any, shall then be returned to the parties as he may order.

Bond-fees forfeited, how disposed of.

Sec. 72. All bond-fees adjudged as forfeited and all payments retained under the last preceding Section, shall, as soon as decision has been rendered, and all entry and other fees or moneys shall, as soon as they have been received by him, be paid by the said Agent or Commissioner to the credit of the Receiver General in the same manner as other moneys received by him on account of Dominion lands.

*Leave of Absence,*

Declaring close season.

Sec. 73. The Agent in each district shall, under instructions from the Minister of the Interior, declare the close season in his district.

Absence during close season.

Sec. 74. Each holder of a mining location or of a grant for placer mining shall be entitled to be absent from his mining location or diggings and to suspend work thereon during the close season.

*Dominion Mining Regulations.*

## Chap. 99.

Sec. 75. The Agent shall have power to grant leave of absence to the holder of a mining location or grant for placer mining pending the decision of any dispute in which he is concerned under these regulations.

Agent may grant leave of absence.

Sec. 76. In cases where water is necessary to the continuance of mining operations, and the supply of water is insufficient, the Superintendent of Mines shall have power to grant leave of absence to the holder of the grant during such insufficiency, but no longer, except by permission of the Minister of the Interior.

Leave of absence in case of insufficiency of water supply.

Sec. 77. Any miner or miners shall be entitled to leave of absence for one year from his or their diggings, upon proving to the satisfaction of the Superintendent of Mines that he or they have expended on such diggings, in cash, labor or machinery, an amount of not less than \$200 on each of such diggings without any return of gold or other minerals in reasonable quantities for such expenditure.

Leave of absence for one year may be granted on proof of expenditure of \$200.

Sec. 78. The time reasonably occupied by the locator of a claim in going to, and returning from, the office of the Agent or Superintendent of Mines to enter his claim, or for other purposes prescribed by these regulations, shall not be counted against him, but he shall, in such cases, be deemed to be absent on leave.

Time going and coming, not to count.

*Miscellaneous.*

Sec. 79. The Minister of the Interior shall, from time to time, as he may think fit, declare the boundaries of mineral and mining districts, and shall cause a description of the same to be published in the *Canada Gazette*.

Minister may declare boundaries.

Sec. 80. The Minister of the Interior may direct mineral and mining locations to be laid out within such districts wherever, from report of the Director of the Geological Survey, or from other information, he has reason to believe there are mineral deposits of economic value, and may sell the same to applicants therefor, who, in his opinion, are able and intend in good faith to work the same; or he may, from time to time, cause the said locations to be sold by public auction or tender. Such sales shall be for cash, and at prices in no case lower than those prescribed for locations sold to original discoverers, and shall otherwise be subject to all the provisions of these regulations.

Minister may direct locations to be laid out where he has reason to believe there are mineral deposits of economic value.

Sec. 81. The Minister of the Interior may grant to any person or persons who have a mining location and are

## Chap. 99.

*Dominion Mining Regulations.*

Minister may grant additional location when vein or lode likely to extend beyond vertical lines.

actively developing the same, an additional location adjacent to and not exceeding it in area, provided the person or persons holding such location shall show to the satisfaction of the Minister that the vein or lode being developed on the location will probably extend outside of either of the vertical lines forming the side boundaries of the location before it has reached the depth at which it cannot be profitably mined.

Persons desiring to obtain quarries for stone on vacant Dominion lands.

Sec. 82. Persons desirous of obtaining quarries for stone on vacant Dominion lands may do so under these regulations; but the Minister may require the payment of a royalty not exceeding five per cent. on account of the sales of the product of such quarries, or the land may be sold not subject to such royalty at such price as may be determined.

Returns to be made monthly, and sworn to.

Sec. 83. Returns shall be made by the grantee, sworn to by him, or by his agent or other employé in charge of the mine, at monthly or other such intervals as may be required by the Minister, of all products of his mining location and of the price or amount he received for the same.

Mining works not to interfere with public work or highway, &c.

Sec. 84. The Minister of the Interior shall have the power to summarily order any mining works to be so carried on as not to interfere with or endanger the safety of the public, any public work or highway, or any mining property, mineral lands, mining claims, bed-rock drains or flumes; and any abandoned works may, by his order, be either filled up or guarded to his satisfaction, at the cost of the parties who may have constructed the same, or in their absence upon such terms as he shall think fit.

Space of ground for deposits of leavings and deads.

Sec. 85. The Superintendent of Mines, acting under instructions to be from time to time issued by the Minister shall cause to be laid out, at the expense of the person or persons applying for the same, a space of ground for deposits of leavings and deads from any tunnel, claim or mining ground.

*Forfeiture.*

Breach of these regulations to work forfeiture.

Sec. 86. In the event of the breach of these regulations, or any of them, by any person holding a grant for quartz or placer mining from the Crown other than Crown patents, or from the Minister of the Interior, or from any duly authorized officer of Dominion lands, such right or grant shall be absolutely forfeited *ipso facto*, and the person so offending shall be incapable thereafter of acquiring any such right or grant, unless for special cause it is otherwise decided by the Minister of the Interior.



*Dominion Mining Regulations.*

Chap. 99.

## SCHEDULE TO MINING REGULATIONS.

## FORM A.

APPLICATION AND AFFIDAVIT OF DISCOVERER OF QUARTZ  
MINE.

I (*or we*) (A.B.) of hereby apply under the Dominion Mining Regulations, for a mining location in (*here give general description of locality*) for the purpose of mining for (*here name the metal or mineral*) and I (*or we*) hereby solemnly swear:—

1. That I (*or we*) have discovered therein a deposit of (*here name the metal or mineral*).
2. That I (*or we*) am (*or are*) to the best of my (*or our*) knowledge and belief, the first discoverer of the said deposit.
3. That I (*or we*) am (*or are*) unaware that the land is other than vacant Dominion land.
4. That I (*or we*) did, on the day of mark out on the ground, in accordance in every particular with the provisions of sub-section (*a*) of section 4 of the said mining regulations, the location for which I (*or we*) make this application, and that in so doing I (*or we*) did not encroach on any mining location previously laid out by any other person.
5. That the said mining location contains, as nearly as I (*or we*) could measure or estimate, an area of acres, and that the description (and sketch, *if any*), of this date hereto attached, signed by me (*or us*), set forth in detail to the best of my (*or our*) knowledge and ability its position, form and dimensions.
6. That I (*or we*) make this application in good faith to acquire the land for the sole purpose of mining to be prosecuted by myself (*or us*) or by myself and associates, or by my (*or our*) assigns.

Sworn before me at  
this day of } (*Signature.*)  
18 .

NOTE.—In case of abandoned ground it may be necessary to omit No. 2.

Chap. 99.

*Dominion Mining Regulations.*

## FORM B.

## RECEIPT FOR FEE PAID BY APPLICANT FOR MINING LOCATION.

No.....

DEPARTMENT OF THE INTERIOR,  
 Dominion Lands Office,  
 Agency, 18 .

Received from (A.B.) of five dollars, being the fee required by sub-section *b*, of section 4 of the Dominion Mining Regulations, accompanying his (*or their*) application No. , dated 18 , for a mining location in *(insert general description of locality)*.

This receipt authorizes the said (A.B.) his (*or their*) legal representatives or assigns, to enter into possession of the said mining location, and, subject to the payment of a fee of five dollars and the renewal of this form of receipt on or before the beginning of each year, during the term of five years from this date, to take therefrom and dispose of any mineral deposit contained within its boundaries, and, on due compliance at any time within that period with the several requirements in that behalf of the said mining regulations, entitles him or them to purchase the said location which, provisionally, and until survey thereof, may be known and described as follows: *(insert description in detail)*.

If the said (A.B.) or his (*or their*) legal representatives or assigns, fail to comply, as aforesaid, with the conditions that would entitle him or them to purchase within five years from this date, or, having so complied, do not within that time make payment in full for the land, and also pay the sum of fifty dollars prescribed in the said regulations for the survey of the location, then the right to purchase shall lapse and the mining location shall revert to the Crown, to be otherwise disposed of as may be directed by the Minister of the Interior.

*Agent of Dominion Lands.*

*Dominion Mining Regulations.*

Chap. 99.

## FORM C.

## RECEIPT FOR ANNUAL FEE FOR RENEWAL OF LOCATION CERTIFICATE.

No.....

DEPARTMENT OF THE INTERIOR,  
 Dominion Lands Office,  
 Agency , 18 .

Received from (A.B.) of , five dollars, being the fee required by sub-section (c) section 4 of the Dominion Mining Regulations, accompanying his (or their) application No. , dated 18 , respecting the mining location described as follows: (*insert description in detail*) for which he (or they) obtained entry No. on the 18 .

From evidence furnished in support of the said application No. it would appear that (A.B.) his (or their) legal representatives or assigns, are entitled to continue in possession of the said mining location, and during the term of year from the 18 , to take therefrom or dispose of any mineral deposit contained within its boundaries, and, on due compliance at any time within that period with the several requirements in that behalf of the said mining regulations, to purchase the said location which, provisionally, and until survey thereof, may be known and described as above.

If the said (A.B.) or his (or their) legal representatives or assigns, fail to comply, as aforesaid, with the conditions that would entitle him or them to purchase within year from this date, or having so complied, do not within that time make payment in full for the land, and also pay the sum of fifty dollars prescribed in the said regulations for the survey of the location, then the right to purchase shall lapse, and the mining location shall revert to the Crown, to be otherwise disposed of as may be directed by the Minister of the Interior.

*Agent of Dominion Lands.*

Chap. 99.

*Dominion Mining Regulations.*

## FORM D.

CERTIFICATE IN CASES OF PARTNERSHIP THAT ANNUAL EXPENDITURE MAY FOR FIRST TWO YEARS AFTER RECORDING CLAIMS BE MADE ON ANY ONE OF THE CLAIMS AFFECTED BY SUCH PARTNERSHIP.

No.....

DEPARTMENT OF THE INTERIOR,  
Dominion Lands Office,  
Agency, 18

This is to certify that in accordance with the provisions of sub-section (d) of section 4 of the Dominion Mining Regulations (A.B) of , who obtained entry No. for the mining location described as follows :

on the day of 18 , and (C.D.) of who obtained entry No. for the mining location described as follows :

on the day of 18 , and (E.F.) of who obtained entry No. for the mining location described as follows :

on the day of 18 , and (G.H.) of who obtained entry No. for the mining location described as follows :

on the day of 18 , having complied with the conditions required by said sub-section (d) in so far that they have filed a certificate of a partnership entered into at dated the day of 18 , and all their claims having been entered within three months of each other, and numbered in this office as Nos. (or if incorporated have filed the documents required) may make within one year from this date the annual expenditure required by each on any one of the mining locations aforementioned, amounting to dollars, this being the amount under said regulations required to be expended within the first and second years after said claims were located.

*Agent of Dominion Lands.*

*Dominion Mining Regulations.*

Chap. 99.

## FORM E.

RECEIPT TO BE GIVEN FOR FEE PAID IN CASE OF PARTNERSHIP.

No.....

DEPARTMENT OF THE INTERIOR,  
 Dominion Lands Office,  
 Agency, 18 ,

Received from (A.B.) of five dollars being the fee required by sub-section (d) of section 4, of the Dominion Mining Regulations accompanying his (or their) application No. dated 18 , respecting the mining location described as follows: (*insert description in detail*) for which he (or they) obtained entry No. , on the day of 18 .

From evidence furnished by the said application No. it would appear that (A.B.) his (or their) legal representatives or assigns are entitled to continue in possession of the said mining location, and, during the term of year from the 18 , to take therefrom and dispose of any mineral deposit contained within its boundaries, and, on due compliance at any time within that period with the several requirements in that behalf of the said mining regulations, are entitled to purchase the said location which, provisionally and until survey thereof, may be known and described as above.

If the said (A.B.) or his (or their) legal representatives or assigns, fail to comply, as aforesaid, with the conditions that would entitle him or them to purchase within year from this date, or, having so complied, do not within that time make payment in full for the land, and also pay the sum of fifty dollars prescribed in the said regulations for the survey of the location, then the right to purchase shall lapse, and the mining location shall revert to the Crown, to be otherwise disposed of as may be directed by the Minister of the Interior.

The said (A.B.) and the foregoing mining location are those recited in No. Form D, dated at the day of , 18 .

*Agent of Dominion Lands.*



*Dominion Mining Regulations.*

Chap. 99.

This certificate entitles the said (B.C.), or his (*or their*) legal representatives or assigns, to all the rights and privileges of the said (A.B.), in respect of the claim assigned and hereinafter described; that is to say, to enter into possession of the said mining location, and during the term of year from the date of the receipt No. , granted to the said (A.B.), dated the day of 18 , to take therefrom and dispose of any mineral deposit contained within its boundaries, and on due compliance at any time within that period with the several requirements in that behalf of the Dominion Mining Regulations, entitles him or them to purchase the said location, which, provisionally, and until survey thereof, may be known and described as follows:—(*Insert description in detail*).

If the said (B.C.), or his (*or their*) legal representatives or assigns, fail to comply as aforesaid with the conditions that would entitle him (*or them*) to purchase within year of the date of the receipt granted to (A.B.), and now deposited with me, or having so complied, do not within that time make payment in full for the land, and also pay the sum of fifty dollars prescribed in the said regulations for the survey of the location, then the right to purchase shall lapse, and the mining location shall revert to the Crown, to be otherwise disposed of as may be directed by the Minister of the Interior.

*Agent of Dominion Lands.*

## FORM H.

## APPLICATION FOR GRANT FOR PLACER MINING AND AFFIDAVIT OF APPLICANT.

I (*or we*) of , hereby apply, under the Dominion Mining Regulations, for a grant of a claim for placer mining, as defined in the said regulations, in (*here describe locality*)

and I (*or we*) solemnly swear:

1. That I (*or we*) have discovered therein a deposit of (*here name the metal or mineral*).

2. That I (*or we*) am (*or are*) to the best of my (*or our*) knowledge and belief, the first discoverer of the said deposits; or—

3. That the said claim was previously granted to (*here name the last grantee*), but has remained unworked by the said grantee for not less than

4. That I (*or we*) am (*or are*) unaware that the land is other than vacant Dominion land.

5. That I (*or we*) did, on the \_\_\_\_\_ day of \_\_\_\_\_, mark out on the ground, in accordance, in every particular, with the provisions of sub-section (*e*) of section 18 of the said mining regulations, the claim for which I (*or we*) make this application, and that in so doing I (*or we*) did not encroach on any other claim or mining location previously laid out by any other person.

6 That the said claim contains, as nearly as I (*or we*) could measure or estimate, an area of \_\_\_\_\_ square feet, and that the description (and sketch, *if any*) of this date hereto attached, signed by me (*or us*), sets (*or set*) forth in detail, to the best of my (*or our*) knowledge and ability, its position, form and dimensions.

7. That I (*or we*) make this application in good faith to acquire the claim for the sole purpose of mining to be prosecuted by myself (*or us*), or by myself and associates, or by my (*or our*) assigns.

Sworn before me at  
this \_\_\_\_\_ day of \_\_\_\_\_  
18 \_\_\_\_\_

} (Signature.)

FORM I.

GRANT FOR PLACER MINING.

No.....

DEPARTMENT OF THE INTERIOR,  
Dominion Lands Office,  
Agency, \_\_\_\_\_ 18 \_\_\_\_\_

In consideration of the payment of five dollars, being the fee required by the provisions of the Dominion Mining Regulations, sections 4 and 20, by (A.B.) of \_\_\_\_\_, accompanying his (*or their*) application No. \_\_\_\_\_, dated \_\_\_\_\_, 18 \_\_\_\_\_, for a mining claim in (*here insert description of locality.*)

The Minister of the Interior hereby grants to the said (A.B.) \_\_\_\_\_, for the term of one year from the date hereof, the exclusive right of entry upon the claim (*here describe in detail the claim granted*)

for the miner-like working thereof and the construction of a residence thereon, and the exclusive right to all the proceeds realized therefrom.

The said (A. B.) \_\_\_\_\_ shall be entitled to the use of so much of the water naturally flowing through or past his (*or their*) claim, and not already lawfully appro-



*Dominion Mining Regulations*

Chap. 99

riated, as shall be necessary for the due working thereof, and to drain his (or their) claim free of charge.

This grant does not convey to the said (A. B.) any surface rights in the said claim, or any right of ownership in the soil covered by the said claim; and the said grant shall lapse and be forfeited unless the claim is continuously and in good faith worked by the said (A. B.) or his (or their) associates.

The rights hereby granted are those laid down in the aforesaid mining regulations, and no more, and are subject to all the provisions of the said regulations, whether the same are expressed herein or not.

*Agent of Dominion Lands.*

## FORM J.

## CERTIFICATE OF THE ASSIGNMENT OF A PLACER MINING CLAIM.

No.....

DEPARTMENT OF THE INTERIOR,  
Dominion Lands Office,

This is to certify that Agency, 18 (B. C.) of , has (or have) filed an assignment in due form, dated 18 , and accompanied by a registration fee of two dollars, of the grant to (A. B.) of of the right to mine in (insert description of claim) for one year from the , 18 .

This certificate entitles the said (B.C.) to all the rights and privileges of the said (A.B.) in respect of the claim assigned, that is to say, to the exclusive right of entry upon the said claim for the miner-like working thereof, and the construction of a residence thereon, and the exclusive right to all the proceeds realized therefrom, for the remaining portion of the year for which the said claim was granted to the said (A.B.) , that is to say, until the day of , 18 .

The said (B.C.) shall be entitled to the use of so much of the water naturally flowing through or past his (or their) claim and not already lawfully appropriated as shall be necessary for the due working thereof, and to drain the claim free of charge.

This grant does not convey to the said (B.C.) any surface rights in the said claim, or any right of owner-

ship in the soil covered by the said claim; and the said grant shall lapse and be forfeited unless the claim is continuously and in good faith worked by the said (B.C.) or his (or their) associates.

The rights hereby granted are those laid down in the Dominion Mining Regulations, and no more, and are subject to all the provisions of the said regulations, whether the same are expressed herein or not.

*Agent of Dominion Lands*

FORM K.

GRANT TO A BED-ROCK FLUME COMPANY.

No.....

DEPARTMENT OF THE INTERIOR,  
Dominion Lands Office,  
Agency, 18 .

In consideration of the payment of a deposit of one hundred dollars, required by section 34 of the Dominion Mining Regulations to be made with the application of a Bed-Rock Flume Company, and of the further sum of ten dollars, being the fee for registration of this grant required by section 39 of the said regulations;

The Minister of the Interior hereby grants to (*names of members of company*) forming together a Bed-Rock Flume Company [known as the (*title of company*) ], the following rights and privileges, that is to say:—

(a.) The rights of way through and entry upon any new and unworked river, creek, gulch or ravine, and the exclusive right to locate and work a strip of ground one hundred feet wide and two hundred feet long in the bed thereof to each individual of the company;

(b.) The rights of way through and entry upon any river, creek, gulch or ravine worked by miners for any period longer than two years prior to such entry, and already wholly or partially abandoned, and the exclusive right to stake out and work both the unworked and abandoned portions thereof, one hundred feet in width, and one quarter of a mile in length for each individual of the company;

(c.) The rights of way through and entry upon all claims which, at the time of the notice of application, are in good faith being worked, for the purpose of cutting a channel and laying their flume therein, with such reasonable space for constructing, maintaining and repairing the flume as may be necessary;

*Dominion Mining Regulations.*

Chap. 99.

(d.) The use of so much of the unappropriated water of the stream on which they may be located, and of other adjacent streams, as may be necessary for the use of their flumes, hydraulic power, and machinery to carry on their operations and the right of way for ditches and flumes to convey the necessary water to their works, subject to the payment of any damage which may be done to other parties by running such ditch or flume through or over their ground ;

Provided, that the rights herein granted shall apply only to such claims and streams as are here specified :

(*insert description of claims and streams*) and such other claims and streams as may after due notice and application, be subsequently added to the above list by the Minister of the Interior, under the hand of the local Agent ;

Provided also, that the said company shall pay to the local Agent, in advance, an annual rent of ten dollars for each quarter of a mile of right of way legally held by them ;

Provided, further, that this grant is subject to all the provisions of the Dominion Mining Regulations in that behalf, whether the same are expressed herein or not.

This grant shall cease and determine at the expiration of years from the date hereof.

*Agent of Dominion Lands.*

## FORM L.

## GRANT FOR DRAINAGE.

No.....

DEPARTMENT OF THE INTERIOR,  
Dominion Lands Office,  
Agency, , 18 .

In consideration of the payment of a deposit of twenty-five dollars required by section 43 of the Dominion Mining Regulations to be made with the application for a grant of right of way to construct drains, and of the further sum of dollars, being the fee for the registration of this grant required by section 44 of the said regulations :

The Minister of the Interior hereby grants to  
(*name or names of grantee or grantees*) the right to run a drain or tunnel for drainage purposes through the occupied mining lands here specified (*here describe mining lands*) and further, for a term of

from the date hereof, exclusive rights of way through and entry upon the following mining grounds: *(here insert description)* for the purpose of constructing a drain or drains for the drainage thereof; and the right to charge the following tolls for the use thereof: *(insert tariff of tolls)*;

Provided, that the grantee *(or grantees)* shall construct such drain or drains of sufficient size to meet all requirements within from the date hereof, and keep the same in thorough working order and repair, and free from all obstructions; and shall, within a reasonable time, construct proper tap drains from or into any adjacent claims, upon being requested by the owners thereof, and in default thereof shall permit such parties themselves to make them, in which case such parties shall only be chargeable with one half the rates of drainage toll herein authorized;

Provided, also, that the said grantee *(or grantees)* shall compensate the owners of lands or holders of claims entered upon by for any damage they may sustain by the construction of such tunnel or drain;

Provided, further, that the said grantee *(or grantees)* shall pay to the local agent, in advance, an annual rent of ten dollars for each quarter of a mile of right of way legally held by ;

Provided, further, that this grant is subject to all the provisions of the Dominion Mining Regulations in that behalf, whether the same are expressed herein or not.

*Agent of Dominion Lands.*

#### FORM M.

#### NOTICE OF APPLICATION TO USE AND DIVERT WATER.

Notice is hereby given, in pursuance of the provisions of the Dominion Mining Regulations, that I *(or we)* of at the expiration of twenty days from the date hereof, intend to apply to the Minister of the Interior of Canada, for authority to take, carry away, and divert to my *(or our)* mining claim or from its natural channel, inches of the unentered and unappropriated water of the *(stream or lake)* known as for purposes, during the term of years from the date of entry, with the object of

Such diversion will be made at a point situate on the end or side of the said *(stream or lake)*, marked on the ground by a conspicuous post; and it is intended that such water shall be carried in and through a *(ditch, or flume, or both)*,

*Dominion Mining Regulations.*

Chap. 99.

in a direction over the lands of  
as indicated by like conspicuous posts  
planted about every quarter of a mile along the proposed  
location of the (*ditch, or flume, or both*).

(Signed)

Post Office Address.

Dated the day of , 18 ,  
at

FORM N.

GRANT OF RIGHT TO DIVERT WATER AND CONSTRUCT  
DITCHES.

No.....

DEPARTMENT OF THE INTERIOR,  
Dominion Lands Office,  
Agency, 18 .

In consideration of the payment of a deposit of twenty  
five dollars, required by Section 47 of the Dominion  
Mining Regulations to be made with the application for the  
right to divert water and construct ditches :

The Minister of the Interior hereby grants to  
(A.B.) , for the term of years  
from the date hereof, the right to divert and use the water  
from (*specify stream or lake*) to the  
extent of inches, and no more, to be distributed as  
follows :— (*describe locality of distribution*)  
together with the right to charge the following rates for the  
use of the said water :— (*insert rates to be charged*)  
and the rights of way through and entry upon the  
following mining grounds (*insert description*)  
for the purpose of constructing ditches and  
flumes to convey such water, provided such ditches and  
flumes are constructed and in working order within  
from the date hereof;

Provided that this grant shall be deemed to be appurte-  
nant to mining claim No. , and shall cease and deter-  
mine whenever the said claim shall have been worked out  
or abandoned, or the occasion for the use of such water  
upon the said claim shall have permanently ceased.

Provided, also, that this grant is subject to all the pro-  
visions of the Dominion Mining Regulations in that behalf,  
whether the same are expressed herein or not.

*Agent of Dominion Lands.*

O. C. Oct. 5, 1887.

## CHAPTER 100.

### REGULATIONS AFFECTING DOMINION LANDS IN RAILWAY BELT IN BRITISH COLUMBIA.

Government House, Ottawa,  
The 17th day of September, 1889.

On the recommendation of the Minister of the Interior and under the provisions of Chapter 56 of the Revised Statutes of Canada, intituled "An Act respecting certain public lands in British Columbia,"

His Excellency in Council has been pleased to order, and it is hereby ordered, that the following regulations for the survey, administration, disposal and management of Dominion lands within the forty mile railway belt, in the Province of British Columbia, be approved and adopted :

#### REGULATIONS FOR THE DISPOSAL OF DOMINION LANDS WITHIN THE RAILWAY BELT IN THE PROVINCE OF BRITISH COLUMBIA.

##### *Interpretation.*

*Dominion Lands*

Section 1. These regulations shall apply exclusively to the public lands of the Dominion, within what is known as the railway belt, in the Province of British Columbia, which lands shall be styled and known as *Dominion Lands*; and the following terms and expressions therein shall be held to have the meaning hereinafter assigned them, unless such meaning be repugnant to the subject or inconsistent with the context; that is to say:—

Meaning of terms and expressions.

Minister of the Interior.

(a.) The term *Minister of the Interior* means the Minister of the Interior of Canada :

Surveyor General.

(b.) The term *Surveyor-General* means the officer of the Department of the Interior bearing that designation, or the chief clerk performing his duties for the time being :

Agent or Officer.

(c.) The term *Agent or Officer* means any person or officer employed in connection with the administration and management, sale or settlement of Dominion lands; and the term

Local Agent.

*Local Agent* means the agent for Dominion lands employed as aforesaid, with respect to the lands in question; and the term *Land Office* means the office of any such agent :

Land Office.

Dominion Land Surveyor.

(d.) The term *Dominion Land Surveyor* means a surveyor duly authorized under the provisions of the Dominion Lands Act, to survey Dominion lands :

Crown Timber Agent.

(e.) The term *Crown Timber Agent* means the local officer appointed to collect dues and to perform such other duties

as may be assigned to such officer, in respect to the timber on Dominion lands:

(f.) The term *Canada Gazette* means the official Gazette of the Government, published at Ottawa: Canada Gazette.

(g.) The term *British Columbia Gazette* means the official Gazette of the Government of British Columbia, published at Victoria. British Columbia Gazette.

*Department of the Interior.*

Sec. 2. The Department of the Minister of the Interior shall be charged with the administration and management of the Dominion lands: Administration and management

(a.) Under the authority of Chapter 56 of the Revised Statutes of Canada, intituled "An Act respecting certain Public Lands in British Columbia," the powers and authorities of the Dominion Lands Board and of the officers thereof are hereby extended to the public lands of Canada in British Columbia:

(b.) The provisions of section 7 with the sub-section thereof, and sections 52, 53, 54, 55, 56, 57, 58, 78, 93 and 94 of Chapter 54 of the Revised Statutes of Canada, intituled: "The Dominion Lands Act," shall apply to the public lands of Canada in British Columbia.

*Surveys.*

Sec. 3. The Dominion lands in British Columbia shall be laid off, so far as practicable, in quadrilateral townships, each containing thirty-six sections of as nearly one mile square as the convergence of meridians permits, together with an allowance of twelve acres in each section for road purposes: Dominion lands, how laid off.

The sections shall be bounded and numbered as shown by the following diagram:—

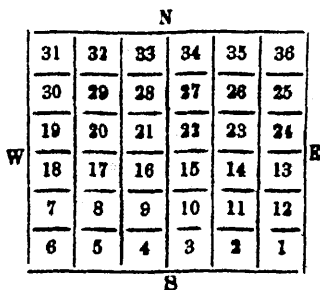

Sec. 4. The lines bounding sections on the east and west sides shall be meridians; and those on the north and south sides shall be chords to parallels of latitude. Bounding lines.

## Chap. 100.

*Dominion Lands in Railway Belt in B. C.*

Division of section into quarter sections.

**Sec. 5.** Each section shall be divided into quarter-sections of one hundred and sixty acres, more or less, together with an allowance for roads of three acres in each, subject to the provisions hereinafter made.

Deficiency or surplus resulting from convergence of meridians, how divided.

**Sec. 6.** In the survey of a township, the deficiency or surplus resulting from convergence of meridians shall be divided equally between all the quarter-sections involved, and the north and south error in closing on the correction lines from the north or south shall be allowed in the ranges of quarter-sections adjoining, and north or south respectively of the said correction lines; excepting in the case of the north and south closings in those townships between the first correction line and the International boundary or first base line, which error is to be left in the last quarter-section adjoining the said first base line.

Irregular quarter-sections.

**Sec. 7.** The dimensions and areas of irregular quarter-sections shall in all cases be returned by the surveyor at their actual measurements and contents.

Every section, shall be supposed to be divided into quarter-quarter-sections of 40 $\frac{1}{4}$  acres.

**Sec. 8.** To facilitate the description for letters patent of less than a quarter-section, every section shall be supposed to be divided into quarter-quarter-sections, of forty and three-quarters acres, and such quarter-quarter-sections shall be numbered as shown in the following diagram, which is intended to show such sub-divisions of a section, which shall be styled legal sub-divisions:—

				N.								
				13	14	15	16					
				12	11	10	9					
W.					5	6	7	8	E.			
				4	3	2	1					
				S.								

The area of any legal sub-division, as above set forth, shall, in letters patent, be held to be more or less, and shall in each case be represented by the exact quantity as given to such sub-division in the original survey.

Survey of public highways.

**Sec. 9.** The Governor in Council may order the survey by a Dominion Land Surveyor of such public highways as he may deem expedient, through any lands subject to these regulations:

(a.) On the approval of the survey of a public highway, the fact shall be notified to the Lieutenant Governor of British Columbia by the Minister of the Interior, and, by



*Dominion Lands in Railway Belt in B. C.*

## Chap. 100.

virtue of such notification, such public highway shall become the property of the said Province, the legal title thereto remaining in the Crown for the public use of the Province; but no such road shall be closed up or its direction varied, or any part of the land occupied by it sold or otherwise alienated, without the consent of the Governor General in Council :

On approval of survey, &c., such public highway shall become the property of the Province.

(b.) The Governor in Council may authorize any person to locate and build public highways or to build public highways located in accordance with the provisions of this section (9) of these regulations :

Governor in Council may authorize to build highways.

(c.) In the meantime, and until any such road shall have been located and constructed, a convenient right of way not exceeding 66 feet in width over any such land is hereby reserved for the use and convenience of settlers and landholders in passing, from time to time, to and from their locations or lands to and from any now existing public road or trail: Provided always that such settler or landowner, making use of the aforesaid privilege shall not damage the fences or crops of the occupier of any such located, sold or leased land :

Right of way for use of settlers not exceeding 66 feet in width.

(d.) Every patent issued for lands subject to these regulations shall contain a provision reserving to the Governor in Council the power to order the survey through such lands by a Dominion Land Surveyor of such public highways as he may deem expedient, and for that purpose to take any existing road, and any requisite area of land, whether the area of the roads and lands so taken be or be not in excess of the allowance for roads in any section, quarter-section or legal sub-division; also to enter upon such lands and take therefrom any gravel, stone, timber, or other material required for the construction of such highway or any bridge connected therewith; and also to enter upon any such land for the purpose of cutting any drains necessary for the building of such highway.

Patent for lands shall contain a provision reserving the power to order survey of public highway; also to take gravel, stone, timber, &c.

*Ordinary Sale of Lands.*

Sec. 10. Dominion lands, as the surveys thereof are duly made and confirmed, shall, except as otherwise hereinafter provided, be open for homesteading and purchase at such prices and on such terms and conditions as may be fixed from time to time by the Governor in Council: Provided, that no purchase shall be permitted at a less price than five dollars per acre: Provided also, that, except in special cases where otherwise ordered by the Governor in Council, no sale to one person shall exceed a section, or six hundred and forty acres :

Dominion lands to be open for homesteading and purchase at prices to be fixed by the Governor in Council.

No sale to exceed a section or 640 acres.

## Chap. 100.

*Dominion Lands in Railway Belt in B. C.*

When lands may be withdrawn from ordinary sale and settlement.

(a.) And provided also, that, whenever so ordered by the Minister, such unoccupied lands as may be deemed by him expedient, from time to time, may be withdrawn from ordinary sale and settlement, and sold at public auction or tender to the highest bidder—an upset price being fixed for the same :

Lands which may be deemed of special value.

(b.) Provided further, that any legal sub-division or other portion of Dominion lands which may be deemed by the Minister of the Interior of special value, may be reserved from ordinary sale and be disposed of in such manner and on such terms and conditions as may be fixed by the Governor in Council on the report of the Minister of the Interior.

*Town Plots, &c.*

Withdrawal for town or village lots.

Sec. 11. The Minister of the Interior shall have power to withdraw from sale or homestead entry any tract or tracts of land, and to lay the same out into town or village lots, the lots so laid out to be sold, either by private sale and for such price as he may see fit, or at a public auction or tender, an upset price being fixed for the same :

Dominion lands for market places, gaols, court houses, places of public worship, burying grounds, schools, &c.

The Governor in Council may set apart and appropriate such Dominion lands as he may deem expedient for the sites of market places, gaols, court houses, places of public worship, burying grounds, schools, benevolent institutions, squares, and for other like public purposes, and at any time before the issue of letters patent therefor may alter or revoke, such appropriation, as he deems expedient ; and he may make free grants for the purposes aforesaid of the lands so appropriated—the trusts and uses to which they are to be subject being expressed in the letters patent.

Lands settled upon after Jan. 1, 1891.

Sec. 12. The provisions of Sections numbered 13 to 29 of these regulations, both inclusive, shall not apply to lands settled upon after the first day of January, one thousand eight hundred and ninety-one.

*Homestead Rights.*

Sole head of family or male 18 years old who has not had homestead on Dominion lands, &c., may obtain homestead entry not exceeding one quarter-section.

Sec. 13. Any person, male or female, who is the sole head of a family, or any male who has attained the age of eighteen years, who has not heretofore had a homestead on Dominion lands in British Columbia, Manitoba or the North-West Territories, or does not hold or own by pre-emption record or otherwise, under the laws of the Province of British Columbia, more than one hundred and sixty acres of land within the railway belt in the said Province, shall, on making application in the form A in the Schedule to this Order, be entitled to obtain homestead entry for any

quantity of land not exceeding one quarter-section, and being of the class of land open under the provisions of these regulations to homestead entry :

(a.) The entry for a homestead shall entitle the recipient to take, occupy and cultivate the land entered for, and hold possession of the same to the exclusion of any other person or persons whomsoever, and to bring and maintain actions for trespass committed on the said land, the same as if a patent therefor had issued in his favor; the title to the land shall remain in the Crown until the issue of the patent therefor, and the said land shall not be liable to be taken in execution before the issue of patent :

Entry shall entitle to take, occupy and cultivate the land, and to hold possession thereof.

(b.) The privilege of homestead entry shall only apply to surveyed agricultural lands; no person shall be entitled to such entry for land valuable for its timber, or for hay land, or for land on which there is a stone or marble quarry, or coal or other mineral having commercial value, or whereon there is any water power which may serve to drive machinery, or for land which by reason of its position, such as being the shore of an important harbor, bridge site or canal site, or being either an actual or prospective railway terminus or station, it will be in the public interest to withhold from such entry.

Privilege of homestead entry shall apply only to surveyed agricultural lands.

*Homestead Entries and Sales Affecting Timbered Lands.*

Sec. 14. All merchantable timber growing or being upon any land entered or sold within the limits of Dominion lands in British Columbia, and all gold, silver, copper, lead, iron, petroleum, coal or other mines or minerals shall be considered as reserved from the said land, and shall be the property of Her Majesty, except that the homesteader or purchaser, or those claiming under him, may cut and use such merchantable timber as may be necessary for the purpose of building, fencing or road-making, on the land so entered or sold, and may also, under the authority of the Crown timber agent, cut and dispose of all timber required to be removed in the actual clearing of the said land for cultivation; but no merchantable timber (except for the necessary building, fencing or road-making as aforesaid) shall be cut beyond the limit of such actual clearing; and all merchantable timber cut in the process of clearing, and disposed of, shall be subject to the payment of the same dues as are at the time payable by the holders of licenses to cut timber.

All merchantable timber, and all gold, silver, copper, lead, iron, petroleum, coal, or other mines or minerals, shall be considered as reserved from the said land; except timber for building, fencing or road making.

Sec. 15. The patents for all lands, hereafter entered or sold as aforesaid, shall contain a reservation of all merchantable timber growing or being on the said lands, which

The patents for all lands shall contain reservation.

## Chap. 100.

*Dominion Lands in Railway Belt in B. C.*

Person holding licenses to cut timber may remove, &c., such as is necessary.

Patentees may cut and use timber for building, fencing or road making, and for the purpose of clearing land for cultivation.

Holders of timber licenses may haul their timber over uncleared lands, and make necessary roads, &c.

Merchantable timber to be subject to timber license.

Person having *bona fide* settled and made improvements before survey to have prior right.

merchantable timber shall continue to be the property of Her Majesty; and any person or persons now or hereafter holding a license to cut timber on such land, may, at all times during the continuance of such license, enter upon the uncleared portion of such lands, and cut and remove such timber, and make all necessary roads or water-ways for that purpose, and for the purpose of hauling in supplies, doing no unnecessary damage thereby; but the patentees or those claiming under them may cut and use such timber as may be necessary for the purpose of building, fencing or road-making on the lands so patented, and may also, under the authority of the Crown Timber agent, cut and dispose of such timber required to be removed in actually clearing the said land for cultivation, but no merchantable timber (except for the necessary building, fencing or road-making as aforesaid) shall be cut beyond the limit of such actual clearing; and all merchantable timber so cut and disposed of shall be subject to the payment of the same dues as are at the time payable by the holders of licenses to cut timber.

**Sec. 16.** Holders of timber licenses, their servants and agents, shall have the right to haul their timber over the uncleared portion of any land entered as a homestead or purchased as hereinbefore provided, and to make such roads or water-ways thereon as may be necessary for that purpose, doing no unnecessary damage, and to use all slides, portages, roads, water-ways, or other works previously constructed or existing on any land so entered, sold or leased, and the right of access to, and free use of all streams and lakes heretofore used, or that may be necessary for the passage of timber; and all land necessary for such work is hereby reserved.

**Sec. 17.** All merchantable timber growing or being upon any land hereafter entered as a homestead or sold under these regulations, shall be subject to any timber license in force at the time of such entry or sale, and may, at any time during the currency of any such license or of any license which may be subsequently issued, be cut and removed under the authority thereof.

**Sec. 18.** Whenever the survey of any township has been finally confirmed and such township opened for homestead entry, any person who has *bona fide* settled and made improvements before such confirmed survey on land in such township, shall have a prior right to obtain homestead entry for the land so settled on, provided such right be exercised within three months after the land is opened for settlement; and provided that such land has not been re-

*Dominion Lands in Railway Belt in B. C.*

## Chap. 100.

served or the right to homestead entry is not excepted under the provisions of these regulations; no homestead entry shall be granted to any other person in respect of such land until three months after notice in writing shall have been given by the local agent to such *bona fide* settler that such land is open for settlement.

**Sec. 19.** Every person applying for homestead entry shall appear and make affidavit before the local agent or, in his absence, the senior clerk performing his duties, according to the Form B, C or D, in the Schedule to this Order, as the circumstances require; and upon filing such affidavit with the said local agent or senior clerk, and on payment to him of an office fee of ten dollars, such person shall receive a receipt from the said local agent or senior clerk according to the Form J in the Schedule to this Order; and such receipt shall be a certificate of entry, and shall be authority to the person obtaining it to take possession of the land described in it:

(a.) The Minister of the Interior or the Dominion Lands Board, upon requisition, may authorize any person named therein to make a homestead entry on behalf of any person signing such requisition and desiring to obtain such entry:

(b.) The person so authorized shall, in order to obtain such entry, make application in the Form E in the Schedule to this Order, on behalf of each of those whom he represents, and shall make an affidavit before the local agent or, in his absence, the senior clerk performing his duties, according to Form F, G, or H, in the Schedule to this Order, as the circumstances of the case require, and shall pay for each homestead entry the office fee of ten dollars, hereinafter prescribed for such entry, and shall receive for each fee so paid a receipt in the Form J in the Schedule hereto:

(c.) Persons occupying land owned by them may obtain homestead entry for any contiguous land open to the same; but the whole extent of land, including that previously owned and occupied, must not exceed one quarter-section:

(d.) A person applying for such entry for contiguous land must, when making the affidavit prescribed for homestead entry, also describe therein the tract he owns and lives upon; and his residence upon and cultivation of the whole shall thereafter be of the kind and for the term required by the provisions of these regulations, in the case of ordinary homestead entry, before he shall be entitled to patent for the part so entered for: Provided, that such residence and cultivation may be upon either the land originally occupied by him or that for which homestead entry has been obtained, or both.

Person applying for homestead entry shall appear and make and file affidavit.

Payment of office fee.

Obtaining receipt.

Certificate of entry.

Minister may authorize homestead entry.

Person authorized shall make formal application, make affidavit and pay office fee of \$10.

Homestead entry for contiguous land.

Application for entry for contiguous land, how made.

## Chap. 100.

*Dominion Lands in Railway Belt in B. C.*

Cases of dispute, how settled.

**Sec. 20.** In case a dispute arises between persons claiming the right to homestead entry for the same land, the local agent, or senior clerk, or any person thereto authorized by the Minister of the Interior, shall make investigation and obtain evidence respecting the facts, and his report thereon, together with the evidence taken, shall be referred to the Minister of the Interior for decision, or to the Dominion Lands Board, Commissioner of Dominion Lands, or such person as may be appointed by the Governor in Council to consider and decide in cases of such disputes :

Prior right of person who has first settled.

(a.) Provided that when two or more persons have settled upon and seek to obtain homestead entry for the same land, the one who settled first thereon and has continued to reside upon and cultivate the land for which homestead entry is sought shall be entitled to such entry if the land be of the class open to homestead entry, and if it be not in the opinion of the Minister of the Interior otherwise inexpedient, in the public interest, to entertain any application therefor :

Where contending parties have valuable improvements, division may be made.

(b.) Provided further, that where contending parties have valuable improvements on the lands in dispute, the Minister of the Interior, if the application to acquire the land by homestead entry is entertained by him, may order a division thereof in such a manner as shall preserve to each of them, as far as practicable, his improvements; and the Minister may, at his discretion, direct that what the land so allotted to each of them may be deficient of a quarter-section shall be made up from unoccupied land adjoining, if there be any such of the class open to homestead entry.

Six months allowed to perfect entry.

**Sec. 21.** Any person who has obtained a homestead entry shall be allowed a period of six months from its date within which to perfect the entry, by taking in his own person possession of the land and beginning continuous residence thereon and cultivation thereof; and if the entry be not perfected within that period it shall be void, and the land shall be open to entry by another person, or to other disposition under these regulations by the Minister of the Interior :

Provision in case of immigrants.

Provided further, that in the case of immigrants from elsewhere than the North American Continent, the Governor in Council may extend the time for the perfecting of entry to twelve months from the date thereof.

At expiration of three years, settler shall be entitled to patent for the land.

**Sec. 22.** (a.) At the expiration of three years from the date of his perfecting his homestead entry, the settler, or in case of his death, his legal representatives, upon proving to the satisfaction of the local agent that he, or they, or some of them, have resided upon and cultivated the land during the

said term of three years, shall be entitled to a patent for the land, provided such proof is accepted by the Commissioner of Dominion Lands, or in his absence by a member of the Land Board, and on payment of one dollar per acre for the land : Provided also, that the patent therefor shall not issue to any person not then a subject of Her Majesty by birth or naturalization :

(b). Provided, that in case of a settler who may have obtained homestead entry for land occupied by him previous to survey thereof, in manner hereinbefore mentioned, residence upon and cultivation of the land for three years next preceding the application for patent shall, for the purpose of the issue of patent, be held to be equivalent to that prescribed in the foregoing sub-clause of this section, if such residence and cultivation be otherwise in conformity with the provisions of these regulations :

Homestead entry for land occupied previous to survey.

**Sec. 23.** Any person proving that he has resided on the land for which he has homestead entry for twelve months from the date of his perfecting his entry therefor, and that he has brought under cultivation at least thirty acres thereof, may, before the expiration of the three years defined in subsection (b) of Section 22, obtain a patent by paying two dollars and fifty cents per acre for the land :

Person having resided on land for 12 months and cultivated 30 acres may obtain patent before expiry of 3 years.

**Sec. 24.** Any person claiming a patent under a homestead entry shall also be entitled thereto upon making payment therefor at the rate of one dollar per acre and proving to the satisfaction of the Commissioner of Dominion Lands or the Dominion Lands Board,—

Payment at the rate of one dollar per acre.

(a.) That he perfected his homestead entry by commencing the cultivation of the homestead within six months from the date of his homestead entry ;

That he perfected his homestead entry.

(b.) That within the first year after the date of his homestead entry he broke and prepared for crop not less than five acres of his homestead quarter-section ; or if the land affected by his homestead entry be timber land, then in lieu of breaking and preparing for crop five acres he may substitute therefor the clearing and fencing of three acres ;

That within the first year he broke and prepared for crop not less than 5 acres of his homestead.

(c.) That within the second year he cropped the said five acres, and broke and prepared for crop not less than ten acres in addition, making not less than fifteen acres in all ; or if the land affected by his homestead entry be timber land, in lieu of cropping five acres and breaking and preparing for crop ten acres additional, he may substitute therefor cropping the three acres broken the previous year and clearing and fencing five acres in addition, making in all eight acres cleared and fenced, three of which shall also be cropped ;

That within the second year he broke and prepared 10 acres in addition.

## Chap. 100

*Dominion Lands in Railway Belt in B. C.*

That he has erected a habitable house.

(d.) That he has erected a habitable house upon his homestead before the expiration of the second year after his homestead entry, and has *bona fide* resided therein and has cultivated the land for three years next prior to the date of his application for his patent;

That he has commenced the residence.

(e.) That at the commencement of the third year after the date of his homestead entry, or previously, he commenced the residence on his homestead required by the next preceding paragraph of this Section :

Proof of the residence and improvements, how made and substantiated.

(f.) Proof of the residence and improvements required by this Section shall be made by the claimant by affidavit, and shall be corroborated by the evidence on oath of two disinterested witnesses, resident in the vicinity of the land affected by their evidence, and accepted as sufficient by the Commissioner of Dominion Lands or in his absence by a member of the Land Board; such affidavit shall be sworn and such testimony given before the local agent or, in his absence, the senior clerk performing his duties, or some other person named for that purpose by the Minister of the Interior.

Six months notice to be given to the Agent of Dominion Lands.

Sec. 25. Every person who has obtained a homestead entry, and who proposes to apply for a patent for such homestead, shall give six months' notice in writing to the agent of Dominion lands of his intention to make such application, and shall produce evidence to the officer who is authorized to receive the application that such notice has been duly given.

In case it is proved to the satisfaction of Minister that settler has not complied with the foregoing conditions, the right to the land shall be forfeited.

Sec. 26. (a) In case it is proved to the satisfaction of the Minister of the Interior that a settler has not resided upon and cultivated his homestead, except as herein provided, for at least six months in any one year, or has failed to cultivate and crop the said land during the first two years after obtaining entry therefor, or to erect a habitable house before the expiration of the second year after such entry, and to *bona fide* reside therein and cultivate the land for three years next prior to the date of his application for patent, or has made any false statement in the affidavit in support of his application for entry, or if he fails, within the time provided for in these regulations, to apply for a patent for his homestead, and to pay for the said homestead the price specified in these regulations, the right to the land shall be forfeited and the entry therefor shall be cancelled, and the settler so forfeiting his entry shall not be eligible to obtain another entry, except in special cases in the discretion of the Minister of the Interior :

Provido, in case of illness.

(b) Provided, that in case of illness, vouched for by sufficient evidence, or in the case of immigrants requiring to



*Dominion Lands in Railway Belt in B. C.*

Chap. 100.

return to their native land to bring out their families to their homesteads, or in other special cases, the Minister of the Interior may, in his discretion, grant an extension of time, during which a settler may be absent from his homestead without prejudice to his right therein; but the extension of time so granted shall not count as residence.

Sec. 27. A homestead, the entry of which has been cancelled, may, at the discretion of the Minister, be held for homestead entry by another person, on such terms and conditions as the Minister of the Interior may prescribe, or for sale of the land with the improvements if any, or of the improvements alone in connection with homestead entry thereof, to another person.

Homestead, the entry of which has been cancelled.

Sec. 28. Any assignment or transfer of homestead right or any part thereof and any agreement to assign or transfer any homestead right or any part thereof after patent shall have been obtained, made or entered into before the issue of the patent, shall be null and void; and the person so assigning or transferring or making an agreement to assign or transfer shall forfeit his homestead right and shall not be permitted to make another homestead entry: Provided, that a person whose homestead may have been recommended for patent by the local agent or senior clerk and who has received from such agent or clerk a certificate to that effect in the Form K, in the Schedule to this Order, countersigned by the Commissioner of Crown lands, or in his absence by any member of the Dominion Lands Board may legally dispose of and convey, assign or transfer his right and title therein.

Assignment or transfer of homestead right, &c., made before issue of patent shall be null and void.

*Fruit Culture.*

Sec. 29. Any person eligible under these regulations to obtain a homestead entry may, for fruit-growing purposes, upon payment of a fee of ten dollars, and upon making application therefor to the local agent in the Form L in the Schedule hereto, obtain entry for any area not in excess of one quarter-section of Dominion lands of the class open for homestead entry under these regulations, upon the following terms and conditions:—

Person eligible to obtain homestead entry may, for fruit-growing purposes, obtain entry of quarter-section.

(a.) For each legal sub-division included in the land entered, the applicant shall, during the first year after the date of entry, clear at least four acres and plant the same in fruit trees, bushes, plants or vines, to the number prescribed in these regulations;

During first year to clear &c., 4 acres.

(b.) During the second year he shall clear and plant three acres additional; and any trees, plants or vines

2d year to clear 3 additional acres..

## Chap. 100.

*Dominion Lands in Railway Belt in B. C.*

planted the preceding year which may have died shall be replaced ;

During third year to clear, &c., 3 additional acres.

(c.) During the third year he shall clear three acres additional, planting the same as in the first and second years, and replacing any trees, shrubs, plants or vines planted during the first and second years which may have died ;

At end of 3d year to have 10 acres cleared.

(d.) At the end of the third year he shall have ten acres cleared and planted with fruit trees, bushes or vines ;

Clearing, &c. may be on any part.

(e.) Provided that the clearing and planting herein provided for may be made upon any portion of the land entered for :

Fruit trees, bushes or vines to be planted in the proportion set forth in table.

(f.) The fruit trees, bushes or vines to be planted by the applicant as herein provided, shall be in the proportion set forth in the following table, according to the variety or varieties planted :—

Kind.	Distance apart.	No. per Acre.
Apple trees, standards.....	33 feet.	40
Pear " " .....	20 "	110
Peach " " .....	15 "	200
Plum " " .....	15 "	200
Cherry " " .....	20 "	110
Currant bushes.....	4 " x 6 feet,	1,815
Gooseberry bushes.....	4 " x 6 "	1,815
Grapes.....	10 " x 12 "	864
Raspberries.....	3 " x 6 "	2,425
Strawberries.....	1 " x 4 "	10,900

At the expiry of 5 years, applicant shall be entitled to patent on payment of one dollar per acre.

(g.) At the expiration of five years from the date of his entry, the applicant, or in case of his death his legal representative, upon proving to the satisfaction of the local agent, or in his absence the senior clerk performing his duties, that there are then growing upon the land and in healthy condition, the number of trees, bushes, plants or vines, as the case may be, prescribed by these regulations, shall be entitled to a patent for the land upon payment therefor at the rate of one dollar per acre, provided such proof is accepted by the Commissioner of Dominion Lands, or in his absence by a member of the Land Board ; but such patent shall not issue to any person who is not a subject of Her Majesty by birth or naturalization ;

Failure to comply with conditions shall work forfeiture.

(h.) If any person having an entry for land for purposes of fruit culture fails to comply with any of the conditions in respect thereof prescribed by these regulations, his entry therefor shall be forfeited and cancelled, and he shall have no claim to the land whatever, except in special cases, in the discretion of the Minister of the Interior.

*Grazing Lands.*

Sec. 30. The Governor in Council may, from time to time, grant leases of unoccupied Dominion lands for grazing purposes to any person or persons, for such term of years and at such rent in each case, as may be deemed expedient; and every such lease shall contain a condition by which the Governor in Council may authorize the Minister of the Interior, at any time during the term of the lease, to give the lessee notice of cancellation thereof; and at the end of two years from the service of such notice such lease shall cease and determine.

Leases of unoccupied Dominion lands for grazing purposes may be granted.

*Mining and Mining Lands.*

Sec. 31. Lands containing coal or other minerals, whether in surveyed or unsurveyed territory, may be disposed of in such manner and on such terms and conditions as may, from time to time, be fixed by the Governor in Council by regulations to be made in that behalf.

Lands containing coal or other minerals how to be disposed of.

Sec. 32. It is hereby declared that no grant from the Crown of lands in freehold, or for any less estate, has operated or will operate as a conveyance of the minerals therein, unless the same are expressly conveyed in such grant.

Minerals not granted unless expressly conveyed.

*Ditches.*

Sec. 33. The provisions of "The Dominion Mining Regulations" having reference to the diversion and use of the water from any stream or lake, and the rights of way necessary for the construction of flumes and ditches to convey such water, shall apply to the diversion and use of the water from any stream or lake, and the rights of way necessary to the conveyance thereof in respect of the irrigation of agricultural lands: Provided however, that the Forms M. N. and O. in the Schedule to this Order shall be used.

Provisions of Dominion Mining Regulations as to diversion of water to apply to agricultural lands.

O.C. Sep. 17, 1887; March 18, 1889.

*Timber Slides, &c.*

Sec. 34. No sale or grant of any Dominion lands shall give or convey any right or title to any slide, dam, water-way, pier or boom, or other work previously constructed on such land, or any stream passing through or along it, for the purpose of facilitating the descent of timber or saw logs, unless it be expressly mentioned in the letters patent or other documents establishing such sale or grant that such slide, dam, water-way, pier or boom, or other work, is intended to be thereby sold or granted:

Sale or grant shall not give title to any slide, dam, water-way, pier or boom.

## Chap. 100.

*Dominion Lands in Railway Belt in B. C.*

Free use of slide, dam, water-way, &c., not to be obstructed.

The free use of any slide, dam, water-way, pier, boom or other work on streams, to facilitate the descent of lumber and saw logs, and the right of access thereto for the purpose of using the same and keeping the same in repair, shall not in any way be interrupted or obstructed by or in virtue of any sale or grant of Dominion lands made subsequent to the construction of any such work.

Free use of stream or lake and the right of passing and re-passing along the land on either side, &c., shall continue uninterrupted.

**Sec 35.** The free use for the floating of saw logs or other timber, of any stream or lake that may be necessary for the descent thereof from Dominion lands, and the right of access to such stream or lake, and of passing and re-passing on or along the land on either side, and wherever necessary for such use thereof, and over any existing or necessary portage road past any rapid or fall, or connecting such stream or lake, and over such road as, owing to natural obstacles, may be necessary for taking out timber from Dominion lands, and the right of constructing any slide or water-way where necessary, shall continue uninterrupted, and shall not be affected or obstructed by or in virtue of any sale or grant of such lands.

*Assignments.*

Registration of assignments.

**Sec. 36.** The Minister of the Interior shall cause to be kept in his Department, books for registering, at the option of the parties interested, assignments of any right to Dominion lands which is assignable under these regulations, upon proof to his satisfaction that such assignment is in conformity with these regulations; and every assignment so registered shall be valid against any other assignment unregistered or subsequently registered; but any assignment to be registered must be unconditional, and all conditions on which the right depends must have been performed or dispensed with by the Minister of the Interior before the assignment is registered.

*Township Plans and Patent Lists.*

Certified copy of map to be transmitted to Registrar General of British Columbia.

**Sec. 37.** The Minister of the Interior shall transmit to the Registrar General of British Columbia, or his deputy or deputies, as early as possible in each year, a certified copy of the map of each township in such district or division, surveyed in the year next preceding, together with a certified list of the lands in such district or division patented during such year.

*General Provisions Relating to the Railway Belt in British Columbia.*

Powers delegated to Governor in Council.

**Sec. 38.** The following powers are hereby delegated to the Governor in Council, to be exercised, from time to time,

by special Orders in Council, upon the recommendation of the Minister of the Interior :—

(a.) To withdraw from the operation of these regulations, subject to existing rights as defined or created under the same, such lands as have been or may be reserved for Indians ;

To withdraw lands reserved for Indians.

(b.) To encourage works undertaken, with a view of draining and reclaiming swamp lands, by granting to the promoters of such works remuneration in the way of grants of the lands so reclaimed, or of such portions thereof, or any other land, as may be deemed fair and reasonable ;

To encourage drainage and reclaiming swamp lands.

(c.) To make such orders as may be deemed necessary, from time to time, to carry out the provisions of these regulations, according to their true intent, or to meet any cases which may arise and for which no provision is made in these regulations ; and further to make and declare any regulations which may be considered necessary to give the provisions in this clause contained full effect ; and from time to time alter or revoke any order or orders or any regulations made in respect of the said provisions, and make others in their stead :

To make orders for carrying into effect the provisions of these regulations.

(d.) Every order or regulation made by the Governor in Council, in virtue of the provisions of this section, or of any other section of these regulations, shall, unless otherwise specially provided in these regulations, have force and effect only after the same has been published for four successive weeks in the *Canada Gazette* and *British Columbia Gazette* ; and all such orders or regulations shall be laid before both Houses of Parliament, within the first fifteen days of the Session next after the date thereof.

Publication of order or regulation.

Sec. 39. All affidavits, oaths, solemn declarations or affirmations required to be taken or made under these regulations except as otherwise herein provided, may be taken before a registrar of the Supreme Court of British Columbia, or the judge or registrar of any County Court, or any justice of the peace, or any commissioner for taking affidavits, or notary public, or any Dominion lands agent or officer, or any person specially authorized to take such affidavits by these regulations or by the Minister of the Interior.

Officials before whom affidavits, oaths, solemn declarations or affirmations may be taken.

Sec. 40. The Dominion Lands Board, or any member thereof, the Crown timber agent, or any person specially authorized to that effect by the Governor in Council, shall have power to summon before them, or him, any person, by subpœna issued by them or him, to examine such person under oath and to compel the production of papers and writings before them or him—and such subpœna may be in the Form P in the Schedule to this Order—and, if

Dominion Lands Board, any member thereof, the Crown timber agent or person specially authorized may issue subpœna.

## Chap. 100.

*Dominion Lands in Railway Belt in B. C.*

In case of non-attendance, warrant may issue.

any person duly summoned neglects or refuses to appear at the time and place specified in the subpoena upon him legally served, or refuses to give evidence or to produce the papers or writings demanded of him; may, by warrant under their or his hands or hand, cause such person so neglecting or refusing, to be taken into custody and to be imprisoned in the nearest common gaol, as for contempt of court, for a period not exceeding fourteen days.

Solemn affirmation instead of oath.

Sec. 41. In any case where an affidavit or oath is required by these regulations, a solemn affirmation may be administered and made, instead of an oath, by any person who is by law permitted in civil cases to make a solemn affirmation instead of taking an oath.

Receipt or certificate of entry shall entitle person to maintain suit.

Sec. 42. Every receipt or certificate of entry or sale issued by an agent of Dominion lands shall, unless such entry or sale shall have been revoked or cancelled by the Minister of the Interior, entitle the person to whom the same was granted to maintain suits at law or in equity against any wrong-doer or trespasser on the lands to which such receipt or certificate relates, as effectually as he could do under a patent of such land from the Crown.

*Who shall be competent to survey Dominion Lands.*

Sections 99 to 139 of Act extended to British Columbia.

Sec. 43. Sections 99 to 139 inclusive of Chapter 54 of the Revised Statutes of Canada, are hereby extended to the public lands of Canada in the Province of British Columbia.

*Tariff of Fees.*

Governor in Council may establish Tariff of Fees.

Sec. 44. The Governor in Council may establish a tariff of fees to be charged by the Minister of the Interior for all copies of maps, township plans, field notes and other records, and also for registering assignments; and all fees received under such tariff shall form part of revenue from Dominion lands.

SCHEDULE.

FORM A.

Application for a Homestead Entry.

I, \_\_\_\_\_, of \_\_\_\_\_, do hereby apply for a homestead entry, under the provisions of the Regulations for the disposal of Dominion lands within the railway belt

*Dominion Lands in Railway Belt in B. C.*

Chap. 100.

in the Province of British Columbia approved by Order in Council of the \_\_\_\_\_, 188\_\_\_\_, for the \_\_\_\_\_ quarter-section of section number \_\_\_\_\_ of the \_\_\_\_\_ township, in the \_\_\_\_\_ range \_\_\_\_\_ of the \_\_\_\_\_ meridian.

## FORM B.

Affidavit in support of a claim for Homestead Entry by a person who has *bona fide* settled and made improvements upon land in advance of survey.

I, A. B., do solemnly swear (or affirm, as the case may be) that I am over eighteen years of age; that to the best of my knowledge and belief the land in respect of which my application is made is surveyed agricultural land; it is not chiefly valuable for its timber, or for hay land, nor is there upon it any stone or marble quarry, or coal or other mineral having commercial value; there is not upon it any water-power which may serve to drive machinery, nor is it specially valuable by reason of its position, such as being the shore of an important harbor, bridge site or canal site, or being either an actual or prospective railway terminus or station; that I became resident upon and began to cultivate the said land on the \_\_\_\_\_ day of \_\_\_\_\_, 18\_\_\_\_, before the same was surveyed; that I have resided upon and cultivated the said land continuously ever since; that there is no other person residing or having improvements upon it, and that this application is made for my exclusive use and benefit, with the intention of residing upon and cultivating the said land, and not directly or indirectly for the use or benefit of any other person or persons whomsoever; and that I have not heretofore obtained an entry for a homestead on Dominion lands, nor do I own more than one hundred and sixty acres of land within the tract known as the railway belt in British Columbia.

Subscribed and sworn to, this \_\_\_\_\_ day of \_\_\_\_\_, 18\_\_\_\_, } (Signature)  
before me.

*Local Agent.*

## FORM C.

Affidavit in support of a claim for Homestead Entry by a person who has not previously obtained Homestead Entry.

I, A. B., do solemnly swear (or affirm, as the case may be) that I am over eighteen years of age; that to the best of my knowledge and belief the land in respect of which my





*Dominion Lands in Railway Belt in B. C.*

Chap. 100.

been permitted to make application for and to receive another homestead entry ; that this application is made for my exclusive use and benefit, with the intention of residing upon and cultivating the land applied for, and not, directly or indirectly, for the use or benefit of any other person or persons whomsoever, and I neither own nor have I a homestead entry for any other land within the tract known as the railway belt in British Columbia.

Subscribed and sworn to, this }  
 day of 18 , } (Signature)  
 before me.

*Local Agent.*

## FORM E.

Application for a Homestead Entry by an Agent.

I, A. B., do hereby apply on behalf of  
 of , for homestead entry under the  
 provisions of the Regulations for the disposal of Dominion  
 lands within the Railway Belt in the Province of British  
 Columbia as approved by Order in Council, of the  
 188 , for the quarter-section of  
 section number of the township, in the  
 range of the meridian.

## FORM F.

Affidavit by an Agent in support of a claim for Homestead  
 Entry on behalf of a person who has *bona fide* settled and  
 made improvements upon land in advance of survey.

I, A.B., do solemnly swear (*or affirm, as the case may be*)  
 that for whom I am acting herein as agent, is over  
 eighteen years of age ; that to the best of my knowledge and  
 belief the land in respect of which the application is made  
 is surveyed agricultural land ; it is not chiefly valuable for  
 its timber, or for hay land, nor is there upon it any stone or  
 marble quarry, or coal or other mineral having commercial  
 value ; there is not upon it any water power which may  
 serve to drive machinery, nor is it specially valuable by  
 reason of its position, such as being the shore of an impor-  
 tant harbor, bridge site or canal site, or being either an  
 actual or prospective railway terminus or station ; that the  
 said became resident upon and  
 began to cultivate the said land on the  
 day of 18 , before the same was surveyed ;

that he has resided upon and cultivated the said land in conformity with the requirements of the homestead provisions of the Dominion lands regulations in British Columbia ever since; that there is no other person residing on, or claiming, or having improvements upon it, and that this application is made for his exclusive use and benefit, with the intention of his residing upon and cultivating the said land, and not directly or indirectly for the use or benefit of any other person or persons whomsoever, and that he has not heretofore obtained an entry for a homestead on Dominion lands, nor does he own any land within the tract known as the railway belt in British Columbia.

Subscribed and sworn to, this }  
                   day of            18 , } (Signature)  
 before me.

*Local Agent.*

FORM G.

Affidavit by an Agent in support of a claim for Homestead Entry on behalf of a person who has not previously obtained Homestead Entry.

I, A.B., do solemnly swear (*or affirm, as the case may be*) that \_\_\_\_\_, of \_\_\_\_\_, for whom I am acting herein as agent, is over eighteen years of age; that to the best of my knowledge and belief the land in respect of which the application is made is surveyed agricultural land; it is not chiefly valuable for its timber, or for hay land, nor is there upon it any stone or marble quarry, or coal or other mineral having commercial value; there is not upon it any water power which may serve to drive machinery, nor is it specially valuable by reason of its position, such as being the shore of an important harbor, bridge site or canal site, or being either an actual or prospective railway terminus or station; that there is no person residing upon the said land, nor are there any improvements thereon, and that this application is made for the exclusive use and benefit of the said \_\_\_\_\_, with the intention of his residing upon and cultivating the said land, and not directly or indirectly for the use or benefit of any other person or persons whomsoever, and that he has not heretofore obtained an entry for a homestead on Dominion lands, nor does he own any lands within the tract known as the railway belt in British Columbia.

Subscribed and sworn to, this }  
                   day of            18 , } (Signature)  
 before me.

*Local Agent.*

## FORM H.

Affidavit by an Agent in support of a claim for Homestead Entry on behalf of a person who has previously obtained and has forfeited his Homestead Entry, but is permitted by the Minister of the Interior to obtain another Homestead Entry.

I, A. B., do solemnly swear (or affirm as the case may be) that for whom I am acting herein as agent, is over eighteen years of age; and to the best of my knowledge and belief the land in respect of which application is made is surveyed agricultural land; it is not chiefly valuable for its timber, or for hay land, nor is there upon it any stone or marble quarry, or coal or other mineral having commercial value; there is not upon it any water power which may serve to drive machinery, nor is it specially valuable by reason of its position, such as being the shore of an important harbor, bridge site or canal site, or being either an actual or prospective railway terminus or station; that there is no person residing on the said land, nor are there any improvements thereon; that he obtained homestead entry on the            day of            , 18    , for the            quarter-section of section            township            range            of the            meridian, but forfeited the same; that by an order of the Minister of the Interior, which I now produce, he has been permitted to make application for and receive another homestead entry, and that this application is made for his exclusive use and benefit, with the intention of his residing upon and cultivating the land applied for, and not directly or indirectly for the use or benefit of any other person or persons whomsoever, and that he neither owns nor has he a homestead entry for any other land within the tract known as the railway belt in British Columbia.

Subscribed and sworn to, this }  
                   day of            18    , } (Signature.)  
 before me.

*Local Agent.*

## FORM J.

## Receipt and Certificate of Entry.

I certify that I have received from            the sum of ten dollars, being the office fee for homestead entry for (describe the land), and that the said            is, in consequence of such entry and payment, vested with the rights

Chap. 100.

*Dominion Lands in Railway Belt in B. C.*

conferred in such cases by the provisions of the Regulations for the disposal of Dominion lands within the Railway Belt in the Province of British Columbia as approved by Order in Council, of the 188 , respecting homestead rights.

*Local Agent.**(Place—Date).*

## FORM K.

## Certificate of Recommendation for Patent.

I certify that \_\_\_\_\_ who is the holder of a homestead entry for (*describe the land*) has complied with the provisions of the law required to be conformed to, in order to entitle him to receive a patent for such land, and that I have recommended the issue of such patent.

*Local Agent.**(Place—Date).*

Countersigned :

*Commissioner of Dominion Lands.*

## FORM L.

## Application for Fruit Culture Entry.

I, A. B., do hereby apply for entry under the Regulations, 188 , for the disposal of Dominion Lands for fruit culture within the Railway Belt in the Province of British Columbia, as approved by Order in Council of the \_\_\_\_\_ day of \_\_\_\_\_, 188 , for legal sub-division (number) \_\_\_\_\_, of section number \_\_\_\_\_, of the \_\_\_\_\_ township in the \_\_\_\_\_ range west of the \_\_\_\_\_ meridian.

And I, A. B., do solemnly swear (*or affirm, as the case may be*) that I am over eighteen years of age; that to the best of my knowledge and belief the land in respect of which this application is made is of the class open for homestead entry; that there is no person residing upon the said land, nor are there any improvements thereon; and that I have not heretofore obtained a fruit culture or other entry for Dominion Lands.

Sworn before me, this \_\_\_\_\_ day }  
of \_\_\_\_\_ A. D. 18 \_\_\_\_\_ } (*Signature*)  
at \_\_\_\_\_ }

*Local Agent.*

FORM M.

Notice of Application for Right to Divert Water.

Notice is hereby given in pursuance of the provisions of the Regulations for the disposal of Dominion lands within the railway belt in the Province of British Columbia, that I, \_\_\_\_\_ of \_\_\_\_\_ at the expiration of 20 days from the date hereof intend to apply to the Local Agent of Dominion lands at \_\_\_\_\_, in the Province of British Columbia, for authority to take, carry away and divert to my (farm or mining claim) from its natural channel \_\_\_\_\_ inches of the unentered and unappropriated water of the (stream or lake) known as \_\_\_\_\_ for purposes during the term of \_\_\_\_\_ years from the date of record with the object of (irrigating or sluicing) my said (farm or mining claim); such diversion will be made at a point situated on the (north, east, south, or west, end or side) of the said (stream or lake) marked on the ground by a conspicuous post, and it is intended that such water shall be carried in and through a (ditch or flume or both) in a direction over the lands of \_\_\_\_\_, as indicated by like posts planted, where practicable, every quarter of a mile along the proposed line of the (ditch or flume or both).

(Signature)

Dated this \_\_\_\_\_ day of \_\_\_\_\_, 18 \_\_\_\_\_, at \_\_\_\_\_

FORM N.

Affidavit in support of Application for Right to Divert Water.

Province of British Columbia, }  
To Wit :

I, \_\_\_\_\_ of \_\_\_\_\_, make oath and say:—

1st. That the document hereunto annexed and marked with the letter "A" is a true copy of a notice given by me, \_\_\_\_\_, in pursuance of the provisions of the Regulations for the disposal of the Dominion lands within the railway belt in the Province of British Columbia, and posted up by me on the day of the date thereof at the point of diversion therein named.

2nd. That on the \_\_\_\_\_ day of \_\_\_\_\_, A.D. 18 \_\_\_\_\_, I also posted up a like copy of such notice in a conspicuous place on the lands of each of the following persons, viz.:

Chap. 166.

*Dominion Lands in Railway Belt in B. C.*

3rd. That the lands of the said several persons named in the last above paragraph, and of no others, will be affected by the proposed diversion in the said notice mentioned.

4th. That I am lawfully entitled to hold land under the said regulations, and I am lawfully occupying (and *bona fide* cultivating or working, as the case may be), the (land or mineral claim) to which the said water is intended to be diverted.

5th. That I have planted posts in accordance with the terms of, and along the proposed line of \_\_\_\_\_, as indicated in the said notice, and I believe that I have performed all conditions precedent necessary to entitle me to a record of the water privilege in the said notice mentioned or referred to.

Sworn before me, this \_\_\_\_\_ day }  
 of \_\_\_\_\_ A.D. 18 \_\_\_\_\_, at \_\_\_\_\_ } (Signature)  
 in the said Province.

*Local Agent.*

FORM O.

Grant of the Right to Divert Water.

To all whom it may concern—GREETING :

Know ye, that \_\_\_\_\_, of \_\_\_\_\_, having complied with the provisions of the Regulations for the disposal of Dominion lands within the railway belt in the Province of British Columbia, as appears by affidavit of himself with notice annexed filed with the undersigned on the \_\_\_\_\_ day of \_\_\_\_\_ 18 \_\_\_\_\_, is hereby authorized to divert for his own use for a period of \_\_\_\_\_ years from the date hereof, \_\_\_\_\_ inches of unrecorded and unappropriated water of \_\_\_\_\_, or so much of that quantity as may be lawfully diverted and used by him under and in accordance with the provisions of the said regulations, and the said \_\_\_\_\_ is entitled to all the rights conferred by the said regulations upon the recorded owner of a water privilege.

Given the \_\_\_\_\_ day of \_\_\_\_\_ 18 \_\_\_\_\_, at \_\_\_\_\_ in the Province of British Columbia.

*Local Agent.*

---

*Dominion Lands in Railway Belt in B. C.*

---

Chap. 100.

FORM P.

Subpœna.

To

GREETING :

You are hereby commanded that all things set aside and ceasing every excuse, you be and appear in your proper person before me the under-signed, at \_\_\_\_\_ on the \_\_\_\_\_ day of \_\_\_\_\_ 18\_\_\_\_, by \_\_\_\_\_ o'clock in the \_\_\_\_\_ noon, and so on from day to day, to be then and there examined upon oath touching your knowledge of

And you are to bring with you and produce all papers and writings in your custody, power or control, in any wise relating to the said matters; and take notice that if you neglect or refuse to appear at the time or place aforesaid you will be liable to be taken into custody and to be imprisoned in the nearest common gaol, as for contempt of court, for a period not exceeding fourteen days.

Given under my hand and seal, this \_\_\_\_\_ day of \_\_\_\_\_ 18\_\_\_\_, at \_\_\_\_\_

*(Signature of Officer)*

[L. S.]

O.C. Sep. 17, 1887.

# CHAPTER 101.

## TRAILS ORDERED TO BE SURVEYED IN THE NORTH-WEST TERRITORIES.

Government House, Ottawa.

The 17th day of September, 1889.

On the recommendation of the Minister of the Interior, and under the provisions of Chapter 50 of the Revised Statutes of Canada, intituled "The North-West Territories Act",

His Excellency in Council has been pleased to order and direct the following trails to be surveyed by a Dominion lands surveyor as provided for in Section 108 of the said Act:—

*17*  
*Dumfries*  
The Saskat-  
chewan Forks  
and Carlton  
Trail.

**Section 1.** The Saskatchewan Forks and Carlton trail (*via* Prince Albert town), from east line of Township 48, Range 24, west of 2nd Initial Meridian, to north line of Township 45, Range 1, West of 3rd Initial Meridian.

*3*  
Trails from  
Prince Albert  
to South  
Branch of the  
Saskatche-  
wan.

**Sec. 2.** The trails from Prince Albert to South Branch of the Saskatchewan, as follows:—

- (a.) Trail from Prince Albert to Halcro Settlement (*via* Red Deer Hill).
- (b.) South Branch Road to Prince Albert (*via* Island Lake), through south-west  $\frac{1}{2}$  of Muskoday's Indian Reserve.
- (c.) From South Branch Road, through north-east  $\frac{1}{4}$  of Muskoday's Indian Reserve to Prince Albert.
- (d.) From South Branch Road to Road B, *via* Island Lake.

*4*  
Halcro Settle-  
ment to Mus-  
koday's.

**Sec. 3.** South Branch Road from westerly boundary of Halcro Settlement to northerly limit of Muskoday's Indian Reserve.

Carlton  
Forks to  
Fisher's or  
Batoche's.

**Sec. 4.** Trail from Carlton Forks, Section 24, Township 46, Range 1, West of 3rd Initial Meridian, to Fisher's or Batoche's Crossing, South Branch of Saskatchewan River.

St. Laurent  
Mission to  
Duck Lake.

**Sec. 5.** Trail from near the north limit of St. Laurent Mission to Duck Lake.

Fisher's to  
Gabriel's  
Crossing.

**Sec. 6.** From Fisher's or Batoche's Landing to Gabriel's Crossing.

From Duck  
Lake.

**Sec. 7.** Trail from Duck Lake to Gabriel's Crossing.  
O. C. Dec. 17, 1885.



Trails to be surveyed in the North-West Territories.

Chap. 101.

<sup>10</sup> Sec. 8. The old trails crossing and in the Qu'Appelle Valley. Qu'Appelle Valley.

<sup>11</sup> Sec. 9. The old trail from Troy to Prince Albert. Troy to Prince Albert.

<sup>12</sup> Sec. 10. The old trail from Swift Current to Battleford. Swift Current.

<sup>13</sup> Sec. 11. The old trail from Calgary to Edmonton. Edmonton.

<sup>14</sup> Sec. 12. The old trail from Calgary to Fort McLeod. Fort McLeod.

<sup>15</sup> Sec. 13. The old trail from Blackfoot Crossing to Fort McLeod. Blackfoot Crossing.

O. C. Sep. 11, 1885.

<sup>16</sup> Sec. 14. The Indian trail from Moosomin to a point five miles south-west of the post office at Moose Mountain. Moosomin to Moose Mountain.

<sup>17</sup> Sec. 15. So much of the trail known as the Fort Walsh Trail from Medicine Hat as lies between Medicine Hat and Dunmore. Medicine Hat and Dunmore.

Sec. 16. The trail from Blackfoot Crossing to Calgary, north of Bow River. Blackfoot Crossing to Calgary.

Sec. 17. The trail from Calgary to Morleyville, north of the Bow River. Calgary to Morleyville.

Sec. 18. The trail from Calgary to Morleyville, south of the Bow River and near the Elbow River. Near Elbow River.

O. C. Sep. 17, 1887.

<sup>19</sup> Sec. 19. The Wood Mountain and Qu'Appelle trail. Wood Mountain.

<sup>20</sup> Sec. 20. The Bow River trail running along the Bow Bottom near Calgary. Bow Bottom near Calgary.

O.C. May 24, 1887.

19 - not included here

O.C. 17. 24/87

20 " " " "

21 " " " "

22 " " " "

17 Sep 1889

## CHAPTER 102.

---

### TRAILS ORDERED TO BE SURVEYED IN MANITOBA.

Government House, Ottawa,  
The 17th day of September, 1889.

On the recommendation of the Minister of the Interior and under the provisions of Chapter 49 of the Revised Statutes of Canada, intituled "An Act respecting Road and Road Allowance in the Province of Manitoba,"

Trail from  
Pembina to  
Lake Winni-  
peg on the  
west side of  
Red River.

His Excellency in Council has been pleased to order and direct that the portion of the trail from Pembina to Lake Winnipeg on the west side of the Red River, within the limits of the city of Winnipeg, commencing at the Assiniboine River where the survey made by C.J. Chapman, D.L.S., in 1878 terminated, to the point where the survey made by Edgar Bray in 1877 commenced, be surveyed by a Dominion land surveyor as provided for in section 3 of said Act.

O.C. Sep. 17, 1887.

---

## CHAPTER 103.

---

### TRAILS LEADING TO MINNEDOSA ESTABLISHED AS PUBLIC HIGH-WAYS.

Government House, Ottawa,  
The 17th day of September, 1889.

On the recommendation of the Minister of the Interior and under the provisions of Chapter 54 of the Revised Statutes of Canada, intituled "The Dominion Lands Act",

His Excellency in Council has been pleased to order that the following described trails be and the same are established as public high-ways and set apart for the public use :—

Section 1. The main north trail to Fort Ellice which has been diverted and runs out of the valley in which the town of Minnedosa is situated, in a north-westerly direction across the north half of section 10, in Township 15, Range 18, west of the 1st Initial Meridian, following the course of a ravine. The main north trail to Fort Ellice.

Sec. 2. The trail which was opened by a number of settlers north of the town of Minnedosa following the course of a ravine running in a north-westerly direction across the easterly part of section 11 of said Township 15. The trail opened north of the town of Minnedosa.

O.C. April 20, 1885.

## CHAPTER 104.

### TRAILS TRANSFERRED TO NORTH-WEST TERRITORIES.

Government House, Ottawa.

The 17th day of September, 1889.

On the recommendation of the Minister of the Interior and under the provisions of Chapter 50 of the Revised Statutes of Canada, intituled "The North-West Territories Act",

His Excellency in Council has been pleased to order, and it is hereby ordered, that the following trails, having been duly surveyed in accordance with the provisions of the said Act, be and the same are hereby transferred to the Lieutenant-Governor of the North-West Territories for the public use of the Territories :—

The Saskatchewan Forks and Carlton Trail from east line of Township 48.

**Section 1.** The Saskatchewan Forks and Carlton Trail from the east line of Township 48, Range 24, west of the 2nd Initial Meridian, to the easterly boundary of the municipal corporation of the town of Prince Albert

The Saskatchewan Forks and Carlton Trail from Prince Albert.

**Sec. 2.** The Saskatchewan Forks and Carlton Trail from the westerly boundary of the Municipal Corporation of the town of Prince Albert to the north line of Township 45, Range 1, west of the 3rd Meridian.

Trails from Prince Albert to South Branch of the Saskatchewan.

**Sec. 3.** The trails from Prince Albert to South Branch of the Saskatchewan, as follows :—

(a.) Trail from Prince Albert to Halcrow Settlement (*via* Red Deer Hill).

(b.) South Branch Road to Prince Albert (*via* Island Lake) through south-west quarter of Muskoday's Indian Reserve.

(c.) From South Branch Road, through north-east quarter of Muskoday's Indian Reserve, to Prince Albert.

(d.) From South Branch Road to Road (b.) (*via* Island Lake).

Halcro's Settlement to Muskoday's.

**Sec. 4.** South Branch Road from westerly boundary of Halcro Settlement to northerly limit of Muskoday's Indian Reserve.

Carlton Forks to Fisher's or Batoche's.

**Sec. 5.** Trail from Carlton Forks, Section 24, Township 46, Range 1, west of the 3rd Initial Meridian, to Fisher's or Batoche's Crossing, South Branch of Saskatchewan River.

St. Laurent Mission to Duck Lake.

**Sec. 6.** Trail from near the north limit of St. Laurent Mission to Duck Lake.

*Trails transferred to North-West Territories.*

Chap. 104.

- Sec. 7. From Fisher's or Batoche's Landing to Gabriel's Crossing. Fisher's to Gabriel's Crossing.
- Sec. 8. Trail from Duck Lake to Gabriel's Crossing. From Duck Lake.  
O. C. April 23, 1886.
- Sec. 9. The Indian trail from Moosomin to a point five miles south-west of the post office at Moose Mountain. Moosomin to Moose Mountain.
- Sec. 10. The old trails crossing and in the Qu'Appelle Valley. Qu'Appelle Valley.
- Sec. 11. The old trail from Troy to Prince Albert. Troy to Prince Albert.
- Sec. 12. The old trail from Swift Current to Battleford. Swift Current.
- Sec. 13. The old trail from Calgary to Edmonton. Edmonton.
- Sec. 14. The old trail from Calgary to Fort McLeod. Calgary to Fort McLeod.
- Sec. 15. The old trail from Blackfoot Crossing to Fort McLeod. Blackfoot Crossing to Fort McLeod.
- Sec. 16. The trail known as the Wood Mountain and Qu'Appelle trail running from the town site of Qu'Appelle Station on the line of the Canadian Pacific Railway to the point of intersection of said trail with the road allowance between Ranges 16 and 17 in Township 16, west of the 2nd Initial Meridian. Wood Mountain and Qu'Appelle.
- Sec. 17. So much of the Fort Walsh trail from Medicine Hat as lies between Medicine Hat and Dunmore, both stations on the line of the Canadian Pacific Railway. Medicine Hat and Dunmore.
- Sec. 18. That part of "the Bow River trail running along the Bow Bottom near Calgary," from Dunbow at the mouth of High River to the north-east corner of Section 35 of Township 23, Range 1, west of the 5th Initial Meridian. Bow Bottom near Calgary.
- Sec. 19. That part of the trail along the south shore of the North Saskatchewan, from the Forks of the Saskatchewan, as far as the east boundary of Section 35, Township 48, Range 24, west of the 2nd Meridian, also that part of said trail from the west limit of River Lot No. 31, of Prince Albert Settlement, to the 3rd Initial Meridian. From the forks of the Saskatchewan along the south shore of the North Saskatchewan.
- Sec. 20. The part of trail from Carlton to Prince Albert lying to the west of the north boundary of Section 34, Carlton to Prince Albert.

Chap. 104.

*Trails transferred to North-West Territories.*

Township 45, Range 1, west of the 3rd Initial Meridian as far as Carlton.

Carlton to  
Duck Lake.

Sec. **21**. The part of trail from Carlton to Duck Lake lying north-west of the east limit of Beardy's Indian Reserve, as far as Carlton.

Halcrow  
Settlement to  
Forks of the  
Saskatche-  
wan.

Sec. **22**. The part of trail from Halcrow Settlement to the Forks of the Saskatchewan, lying north-east of the north limit of Muskoday's Indian Reserve, in Township 47, Range 24, west of the 2nd Initial Meridian, as far as said Forks.

O. C. May 10, 1888.

## CHAPTER 105.

### BOUNDARIES OF PROVISIONAL DISTRICTS IN THE NORTH-WEST TERRITORIES.

Government House, Ottawa.

The 17th day of September, 1889.

On the recommendation of the Minister of the Interior and under the provisions of Chapter 7 of the Revised Statutes of Canada, intituled "The North-West Territories Representation Act,"—

His Excellency in Council has been pleased to order, and it is hereby ordered, that the boundaries of the provisional districts mentioned in said Act be as follows:—

#### *Assiniboia.*

Section 1. The District of Assiniboia, about 95,000 square miles in extent, to be bounded on the south by the international boundary line, the 49th parallel; on the east by the western boundary of Manitoba; and on the north by the 9th correction line of the Dominion lands system of survey into townships, which is near to the 52nd parallel of latitude; on the west by the line dividing the 10 and 11th ranges of townships numbered from the 4th Initial meridian of the Dominion lands system aforesaid.

District of Assiniboia.

#### *Saskatchewan.*

Sec. 2. The District of Saskatchewan, about 114,000 square miles in extent, to be bounded on the south by the District of Assiniboia and Manitoba; on the east by Lake Winnipeg and the Nelson River flowing therefrom into Hudson's Bay; on the north by the 18th correction line of the Dominion lands survey system; and on the west by the line of that system dividing the 10th and 11th ranges of townships numbered from the 4th Initial meridian.

District of Saskatchewan.

#### *Alberta.*

Sec. 3. The District of Alberta, about 100,000 square miles in extent, to be bounded on the south by the international boundary; on the east by the Districts of Assiniboia and Saskatchewan; on the west by the Province of British Columbia; and on the north by the 18th correction line before mentioned, which is near the 55th parallel of latitude.

District of Alberta.

---

**Chap. 105.      *Boundaries of Provisional Districts in the N.-W. T.***

---

*Athabasca.*

District of  
Athabasca.

Sec. 4. The District of Athabasca, about 122,000 square miles in extent, to be bounded on the south by the District of Alberta; on the east by the line between the 10 and 11th ranges of Dominion lands townships before mentioned, until in proceeding northward that line intersects the Athabasca River; then by that river and the Athabaska Lake, and Slave River, to the intersection of the last with the northern boundary of the district, which is to be the 32nd correction line of the Dominion lands townships system, and is very nearly on the 60th parallel of north latitude; westward by the Province of British Columbia.

O.C. May 8, 1882.



## CHAPTER 106.

### REGISTRATION FEES IN THE NORTH-WEST TERRITORIES.

Government House, Ottawa,  
The 17th day of September, 1889.

On the recommendation of the Minister of the Interior and under the provisions of Chapter 51 of the Revised Statutes of Canada, intituled "The Territories Real Property Act," as amended:

His Excellency in Council has been pleased to order, and it is hereby ordered, that the following tariff of fees be fixed and settled as the fees which shall be demanded by, paid to and received by the several registrars of land registration districts in the North-West Territories under and by virtue of the said Act.

#### Section 1. *Tariff of Registrar's Fees.*

1. Each certificate of ownership for lands granted since the 1st day of January, 1887, shall be issued and delivered or mailed to the person entitled thereto, free of charge, if at the time of the issue of such certificate, the patent or notification mentioned in section 9 of 51 Victoria, chapter 20, is the only instrument, in the hands of the Registrar, affecting the land.
  2. Each certificate of ownership issued in accordance with an application made under the provisions of section 45 of chapter 51 of the Revised Statutes of Canada, where at the time of the issue of such certificate the patent is the only instrument, in the hands of the Registrar, affecting the land, shall be issued and delivered or mailed to the person entitled thereto, for a fee of..... \$1 00
  3. For each certificate of ownership which does not fall within one of the two classes above mentioned ..... 2 00
- In addition to the fee of \$2.00 for the certificate in such cases the percentage fee provided by section 20 of 51 Victoria, chapter 20, and other necessary fees for registrations, abstracts, &c., which are provided for by this Tariff must also be paid.
4. For filing and registering any transfer, mortgage, encumbrance, charge or surrender, or any assignment or discharge wholly or partially, of a mortgage, encumbrance or charge, or a satis-

Certificate of ownership for lands, when issued free of charge.

## Chap. 106.

*Registration Fees in the North-West Territories.*

	fraction of an annuity or any other instrument affecting land other than those hereinafter particularly specified .....	1 00
5.	For each Memorial endorsed on a certificate of ownership.....	0 50
6.	For registering proprietor of any freehold estate on a transmission.....	2 00
7.	For each registration abstract including all charges for searches and certificates from 1 to 5 entries, inclusive.....	0 50
	And for each additional entry over five .....	0 10
8.	For filing each caveat, and for preparing and mailing from 1 to 4 notices in connection therewith.....	2 00
	And for each additional notice, over four ....	0 25
9.	For entering withdrawal of caveat.....	1 00
10.	For entry of foreclosure.....	1 00
11.	For each search.....	0 25
12.	For each map deposited.....	1 00
13.	For registering recovery of possession by legal proceedings, or registering a lessor as surrenderee..	2 00
14.	For vesting of lease in mortgagee on refusal of assignee to accept the same.....	2 00
15.	For entering notice of marriage or death.....	0 50
16.	For entering notice of writ of <i>feri facias</i> , or of any order, certificate or decree of a court or judge.	1 00
17.	For entering satisfaction of any writ, or entering notice setting aside writ, order, certificate or decree .....	0 50
18.	For production of each instrument, filed or registered except such instrument is required in connection with an application for a certificate of ownership, in which case it is to be produced free of charge.....	0 10
19.	For returning the documents of title deposited in support of an application for withdrawal or rejection of any application for certificate of ownership .....	1 00
20.	For inspecting each material instrument of title to land for which certificate of ownership is asked to be granted .....	0 10
21.	For copy of, or extract from any registered instrument or instrument otherwise in the custody of the Registrar, per folio of one hundred words.	0 10
22. (a)	For copy of every map or tracing attached to or endorsed on any document.....	2 00
(b)	For copy of each map or plan deposited in office, for each lot plotted thereon up to and inclusive of 100 lots.....	0 03

*Registration Fees in the North-West Territories.*

Chap. 106.

And for each additional lot over 100.....	0 02
(c) And for copy or tracing shewing one block of lots or of one or more lots in one block on any such map or plan.....	2 00
23. For each certificate that copy or extract is correct, signed by Registrar and authenticated by his official seal .....	0 25
24. For taking each affidavit or statutory declaration.	0 20
25. For each special commission issued by a court or judge.....	3 00
26. For each summons.....	0 50
27. For examination thereunder per hour. ....	1 00
28. For entering executor, administrator, curator or guardian or an assignee of an insolvent, as transferee or proprietor. ....	1 00
29. For entering husband as joint proprietor.....	1 00
30. For entering survivor, or other person as proprietor, in the case of a joint proprietorship.....	1 00
31. For each certificate to court .....	2 00
32. For filing and entering adverse claim with statement and affidavit.....	2 00
33. For a new certificate issued to replace worn out, filled up, destroyed, or lost certificate.....	2 00
34. For consolidating two or more certificates.....	2 00

O. C. Nov. 23, 1888.

*Disposal of Registrar's fees.*

Sec. 2. On the first day of each month or on the second day of the month when the first day is a statutory holiday or falls upon Sunday, each of such registrars shall deposit to the credit of the Minister of Finance and Receiver General, on account of "The Territories Real Property Act," at the agency of the Bank of Montreal which is nearest to the town in which his office is situated, or at such other bank as may be named to him in writing by the Deputy Minister of Finance, all fees which have been received by him under the provisions of the said Act during the month which ended on the day immediately preceding the month on the first or second day of which the deposit is so to be made.

On the first day of each month the Registrar shall deposit to credit of Minister of Finance all fees received by him.

Sec. 3. On the days upon which the deposits are so respectively to be made each registrar shall forward to the Auditor General and the Secretary of the Department of the Interior, at Ottawa, a copy of a return to be prepared on a form similar in effect to that which is printed in Schedule "A," in which return shall be set forth, under the respective headings in the form in question, full particulars of each of the registrations, searches or other services which

Return setting forth full particulars of registrations, searches and other services to be furnished by registrar.



## CHAPTER 107.

---

### PAYMENT OF FINES FOR VIOLATION OF "AN ACT RESPECTING THE NORTH-WEST TERRITORIES" PROHIBITING THE INTRODUCTION OF INTOXICANTS.

Government House, Ottawa,  
The 17th day of September, 1889.

On the recommendation of the Minister of the Interior, and under the provisions of the 3rd section of Chapter 180 of the Revised Statutes of Canada, intituled "An Act respecting Fines and Forfeitures,"—

His Excellency in Council has been pleased to order and direct, and does hereby order and direct, that all fines collected for violations of that portion of Chapter 50 of the Revised Statutes of Canada, intituled "An Act respecting the North-West Territories," which prohibits the introduction of intoxicants into the Territories, and that would otherwise belong to the Crown for the public uses of Canada, be paid over to the general revenue fund of the North-West Territories, until other provisions are made.

O. C. Oct. 5, 1887.

# CHAPTER 108.

---

## JUDICIAL DISTRICTS IN THE NORTH-WEST TERRITORIES.

Government House, Ottawa,  
The 17th day of September, 1889.

On the recommendation of the Minister of the Interior and under the provisions of Chapter 50, of the Revised Statutes of Canada, intituled "The North-West Territories,"

His Excellency in Council has been pleased to order it is hereby ordered that the North-West Territories be and the same are hereby divided into five judicial districts, named and bounded as follows :—

### *Eastern Assiniboia.*

Judicial District of Eastern Assiniboia.

Section 1. The Judicial District of Eastern Assiniboia, comprising that part of Assiniboia eastward of the eleventh range of townships west of the second meridian.

### *Western Assiniboia.*

Judicial District of Western Assiniboia.

Sec. 2. The Judicial District of Western Assiniboia, comprising that part of Assiniboia west of the Judicial District of Eastern Assiniboia and east of the west line of the twenty-third range of townships west of the third meridian.

### *Southern Alberta.*

Judicial District of Southern Assiniboia.

Sec. 3. The Judicial District of Southern Alberta, comprising the remainder of Assiniboia, with that portion of Alberta, south of townships seventeen.

### *Northern Alberta.*

Judicial District of Northern Alberta.

Sec. 4. The Judicial District of Northern Alberta, comprising that part of Alberta north of townships sixteen, including the country lying north of Alberta.

### *Saskatchewan.*

Judicial District of Saskatchewan.

Sec. 5. The Judicial District of Saskatchewan, comprising Saskatchewan, including the country to its north.

O. C. Feb. 18, 1887.

## CHAPTER 109.

### THE WESTERLY AND SOUTH-WESTERLY BOUNDARY OF MANITOBA ESTABLISHED.

Government House, Ottawa.  
The 17th day of September, 1889.

On the recommendation of the Minister of the Interior and under the provisions of Chapter 53 of the Revised Statutes of Canada, intituled "The Keewatin Act,"

His Excellency in Council has been pleased to order, and it is hereby ordered, that the following described territory shall be and the same is hereby detached from the said District of Keewatin and re-annexed to that part of the North-West Territories not included in the said district:—

Commencing at the point of intersection of the easterly shore line of Lake Winnipegosis with the northern boundary of the Province of Manitoba, thence in a north-westerly direction along the said easterly shore of Lake Winnipegosis to the southerly end of the portage leading from the head of the said lake into Cedar Lake, known as the Cedar or Mossy Portage, thence northerly, following the trail of the said portage to the northerly end of the same on the shore of Cedar Lake, thence due north to the northerly boundary of the District of Saskatchewan, thence east along the northerly boundary of the said District of Saskatchewan to the point of its intersection with the westerly shore of the Nelson River, thence southerly, following the western shore of the Nelson River and Lake Winnipeg to its intersection with the northern boundary of the Province of Manitoba, thence due west along the said northern boundary of the said Province to the place of beginning.

Commencing at the point or intersection of the easterly shore line of Lake Winnipegosis with the northern boundary of the Province of Manitoba.

Proc. May 7, 1886.

## CHAPTER 110.

---

### KEEWATIN. POWERS OF LIEUTENANT GOVERNOR AND COUNCIL TO MAKE ORDINANCES.

Government House, Ottawa,  
The 17th day of September, 1889.

On the recommendation of the Minister of the Interior and under the provisions of Chapter 53 of the Revised Statutes of Canada, intituled "The Keewatin Act,"

His Excellency in Council has been pleased to order that the Lieutenant Governor of the District of Keewatin be and he is hereby empowered, by and with the advice and consent of the Council appointed to aid him under Section 5 of the said Act, to make provision for the administration of justice in the said district, and generally to make, ordain and establish all such laws, institutions and ordinances as he may deem necessary for the peace, order and good government of Her Majesty's subjects and others therein: Provided, first, that no such ordinances shall deal with or affect any subjects which are beyond the jurisdiction of a Provincial Legislature under "The British North America Act, 1867,"—and provided, second, that all such ordinances shall be made to come into force only after they have been approved by the Governor General in Council, unless in case of urgency, and in that case the urgency shall be stated on the face of the ordinance.

O.C. Nov. 25, 1876.



# DEPARTMENT OF RAILWAYS AND CANALS.

## CHAPTER III.

### GENERAL REGULATIONS FOR GOVERNMENT RAILWAYS.

Government House, Ottawa,  
The 26th day of October, 1889.

On the recommendation of the Minister of Railways and Canals, and under the provisions of Chapter 38 of the Revised Statutes of Canada, intituled "The Government Railways Act,"

His Excellency in Council has been pleased to order, and it is hereby ordered, that the following rules and regulations respecting the Government Railways of Canada be and the same are hereby approved and adopted:—

#### *Rules to be observed by the staff generally.*

Section 1. A copy of these Rules and Regulations shall be given to each employé engaged on the line; and a copy, printed on a sheet and framed, will be hung up in every station conductor's room, engine house, repair shop, &c., where it will be open for inspection by every employé of the railway, and no plea or excuse, for ignorance of the rules and regulations, will be admitted, should any employé not have received a copy.

Copy of these Rules to be given to each employé, and copy to be hung up for inspection.

Sec. 2. When a special, written, or telegraphic order is given by the general superintendent, or superintendent, to suspend or alter any of the following rules and regulations, such special order shall be instantly obeyed.

Special order to be instantly obeyed.

Sec. 3. Every employé shall make himself thoroughly acquainted with the rules and regulations of the railway, including those contained in the working time-table of the district in which he is employed; and he shall keep a copy of the same in his possession, under a penalty of one dollar for not doing so.

Employé to make himself acquainted with the rules, &c.

Sec. 4. When an alteration takes place in the running of trains in the district in which he is employed he shall take care to provide himself with a copy of the altered time-table.

Copy of altered time-table.

## Chap. 111

*General Railway Regulations.*

- Regulations regarding the running of trains.      **Sec. 5.** The regulations regarding the running of trains, which are printed on the time-tables, are to be read and considered as part of the rules and regulations of the railway.
- Service and residence.      **Sec. 6.** Each person is to devote himself exclusively to the service of the railway, residing where he may be required.
- Obedience and conformance to regulations.      **Sec. 7.** He shall obey promptly all instructions he may receive from persons placed in authority over him, and conform to all the regulations of the railway.
- Appearance on duty.      **Sec. 8.** All employés of the railway must appear on duty clean and neat.
- Fee or reward forbidden.      **Sec. 9.** No employé shall receive fee or reward from any person on any consideration.
- Smoking not allowed.      **Sec. 10.** Employés must not smoke when on duty, on or about the railway premises.
- Dismissal for intoxication.      **Sec. 11.** Any employé intoxicated when on duty will be at once dismissed.
- Absence from duty, notice in case of illness.      **Sec. 12.** No employé is allowed, under any circumstances, to absent himself from duty, without the permission of his superior officer, except in case of illness; and then notice must be immediately sent to his superior officer, so that a substitute may be found in season.
- Employé not to receive money unless, &c.      **Sec. 13.** No employé, unless appointed to do so, shall receive money on any occasion, or under any pretence, from any person on account of the railway.
- Bonds for faithful performance on receipt of money.      **Sec. 14.** Employés authorized to receive money on account of the railway, must, when required, enter into bonds for the faithful performance of their duty in this respect.
- Misconduct or negligence to be reported.      **Sec. 15.** All persons in places of trust in the railway service must, immediately report any misconduct or negligence affecting the interests or safety of the road, or failure to comply with these rules and regulations, which may come under their notice. Their withholding such information will be considered a proof of neglect and indifference on their part.

*General Railway Regulations.*

## Chap. 111

Sec. 16. All officers concerned will be held responsible for regulating their time-pieces, in accordance with the times observed on the various divisions of the railway, as stated in the time-table. Time-pieces, responsibility in reference to.

Sec. 17. The employés of the railway are to exercise great care and watchfulness in order to prevent injury to persons, or damage to property, and where a doubt may exist as to the proper course to pursue *they must take the safe side, and not run unnecessary risk.* Prevention of injury or damage.

Sec. 18. Employés subject themselves to criminal prosecution for disobedience or neglect of orders, and to fine, suspension or dismissal for misconduct, incompetency, wrangling, or using improper language while on duty. Liability to criminal prosecution.

Sec. 19. The railway authorities shall have the right to deduct from the pay of any employé such sums as may be awarded against him by the general superintendent for damage to property entrusted to his care, or as fines, for misconduct or neglect of duty. Deduction from pay in case of fines.

Sec. 20. The pay of every man absent, or suspended from duty, will be stopped. Pay when stopped.

Sec. 21. No person shall quit the railway service without giving fourteen days' previous notice; and in case he leaves without such notice all pay then due will be forfeited. Notice of intention to leave service.

Sec. 22. Any person leaving the railway service must deliver up to his superior all property belonging to the railway under his charge.

## SIGNALS.

Sec. 23. RED is a signal of DANGER : STOP.

GREEN—CAUTION : PROCEED SLOWLY.

WHITE—ALL RIGHT : GO ON.

Sec. 24. These signals will be made by FLAGS in the day time, and by LAMPS at night. Signals, how made.

Sec. 25. In addition to this, any signal waved violently, or a man standing with both arms raised above his head, denotes danger, and the necessity of stopping immediately. Signal for stopping immediately.

Sec. 26. The absence of a signal at a point, where one is usually displayed is to be taken as denoting danger. Absence of signal.

## WHISTLING SIGNALS.

- Sec. 27. TO PUT ON BRAKES—*One short, sharp* whistle.  
 TO START OR TAKE OFF BRAKES—*Two short, sharp* whistles.  
 TO BACK—*Three short, sharp* whistles.  
 TO TURN SWITCH—*Four short, sharp* whistles.  
 DANGER—*A repetition of short, sharp* whistles.

On approaching level crossings of public roads and curves—*One long* whistle.

On approaching stations—*One long continuous* whistle.

Train, &c.,  
moving after  
sunset.

Sec. 28. Every train or empty engine, moving on the line after *sunset*, must display one *Red* tail light, as well as one *White* light, in front of the engine.

Extra train  
or engine fol-  
lowing.

Sec. 29. A *red* flag carried upon the head of an engine and tail of the train, by day, or a *red* light by night (in addition to the usual *white* light upon the head of the engine and *red* light upon the tail of the train), denotes that an extra engine or train is *following, having right of track over all other trains*.

Train to come  
in *opposite*  
direction.

Sec. 30. A *Red* signal, with a *Green* one carried in the manner above described, denotes that an extra engine or train, having right over all others, will come in an *opposite* direction.

Extra train  
following will  
keep clear.

Sec. 31. *White* signals, carried in like manner, denote that an extra train is following, but will *keep clear* of all regular trains.

Extra train  
coming will  
keep clear.

Sec. 32. *Green* signals carried in the same way denote that an extra train or engine will come in an *opposite* direction, but will *keep clear* of all regular trains.

Signal cords.

Sec. 33. *Signal cords* must be used on all trains, to extend from the rear car to the whistle or alarm bell on the engine.

Danger or cau-  
tion signal.

Sec. 34. A *danger or caution* signal must be observed without cavil, the person giving it being responsible for its necessity.

Where dis-  
tance and  
semaphore  
signals exist.

Sec. 35. Where distance and semaphore signals exist, the following regulations respecting them must be observed :—

All right.

(a.) The *All right* signal is shown during daylight by the arm being within the post, and by a *green* light on the top of

*General Railway Regulations.*

## Chap. 111

the post at night, which also means caution—"To come on slowly."

(b.) The *caution* signal to slacken speed is shown during daylight by the semaphore arm being raised to an angle, or by a *green* light at night. *Caution.*

(c.) The *danger* signal—*always to stop*—is shown during the daylight by the arm being raised to the horizontal position, or by a *red* light at night. *Danger.*

(d.) At *draw-bridges, crossings of other railways, and junctions*, the semaphore arm for *day*, and the lamps for *night* signals are always to be set at *Danger*; and every engine and train must come to a stand before reaching the signal, and not proceed until the signal to "*come on*" is shown, and the man in charge must not alter the signal until trains or engines have been brought to a stand. *Draw-bridges, &c.*

(e.) All signal lamps must be lighted at least half an hour before dark. They must be kept burning brightly all night, and extinguished half an hour after daylight. *Signal lamps, when to be lighted.*

## DIRECTIONS FOR THE USE OF TORPEDOES (FOG SIGNALS).

Sec. 36. During foggy weather, snow storms, or at any time when the ordinary signals cannot be seen, torpedoes are to be placed on the rails (label upwards) and bending the lead clip round the upper flange of the rail, to prevent their falling off. When the engine passes over the signal it explodes with a loud report, and the driver is instantly to stop. *During foggy weather, snow storms, &c., torpedoes to be placed on the rails.*

Sec. 37. Torpedoes are to be used in addition to the regular day and night signals, *which must first be exhibited.* *Regular signals to be exhibited first.*

Sec. 38. Each and every conductor, switchman, engine driver, and foreman of trackmen, must provide himself with twelve torpedoes, which he must always have ready for use while on duty; and every station master must provide himself with the same number, which are to be kept in an unlocked drawer or on a shelf, in order that they may at all times be easy of access, and every person connected with the station shall be made acquainted with the place where they are deposited. *Conductor, switchman, engine driver, foreman and station master must provide himself with twelve torpedoes.*

Sec. 39. All the above-mentioned persons are responsible for having on hand the proper number of torpedoes, and when the stock is diminished, by one or more, it is their duty immediately to apply for others. *Officials responsible.*

## Chap. 111

*General Railway Regulations.*

Whenever an accident occurs to a train or a train is stopped on the line at any place other than a station.

**Sec. 40.** Whenever an accident occurs to a train, or a train is stopped on the line at any place other than a station, in consequence of which the line is obstructed, the brakemen must be sent each way at least 800 yards (or sixteen telegraph poles), or more if at or near a steep grade or curve, to stop an approaching engine or train; and as the men proceed they must place on the rails, at a distance of every 200 yards, one of these torpedo signals; and on arriving at the end of the above mentioned distance they are to place two such signals on the line of rail.

In case of engine passing over one of these signals.

**Sec. 41.** In case of an engine passing over one of these signals the train must be immediately stopped, and measures must at once be taken by the conductor for protecting his train from any following train, by sending men back with torpedoes, which must be placed on the line every 200 yards to a distance of a quarter of a mile, the train afterwards proceeding slowly and cautiously to the place of the obstruction.

When driver of an engine shall use these signals.

**Sec. 42.** Every driver of an engine not accompanied by a conductor must also use these signals in case of accident or obstruction, in the manner before mentioned.

Removal of signals.

**Sec. 43.** When the line is again clear the conductor or engine driver, as the case may be, must, before proceeding, remove all the signals from the rails.

Foreman of works, or other servant.

**Sec. 44.** In any of the above circumstances, and in the absence of either of the officers above mentioned, any foreman of works, or other servant of the railway, is to observe the same rules to guard against danger.

O.C. Aug. 16, 1876.

## PASSENGER AND STATION REGULATIONS.

Passengers who have not procured their tickets before entering the car.

**Sec. 45.** Passengers who have not procured their tickets before entering the car shall pay to the conductor an additional sum of ten cents each, and the conductors shall issue to each of such passengers a "duplex ticket," showing the names of the stations from and to which the passenger is travelling, the date and the class (first or second, as the case may be) being punched out. This ticket, if properly punched, shall, on presentation by the holder at any ticket office of the line, entitle him to a refund of ten cents if a whole fare has been paid, and of five cents if a half fare.

O.C. May 5, 1884.

*General Railway Regulations.*

## Chap. 111

Sec. 46. Passengers should provide themselves with tickets at least five minutes before the advertised time for departure of the train. Tickets, Time for procuring.

Sec. 47. Express proprietors, dealers, agents and messengers holding season tickets, shall not carry with them baggage or parcels for the purpose of their business, unless the freight for the same be prepaid at double first-class freight rates. In case of violation of this rule the ticket shall be forfeited. Express proprietors, dealers, agents and messengers.

Sec. 48. No person shall be allowed to get into or upon or quit any car after the train has been put in motion, or until it stops. Any person doing so, or attempting to do so, has no recourse upon the Railway Department for any accident which may take place in consequence of such conduct. No person to get into car in motion.

Sec. 49. Persons drunk, and unable to take care of themselves, shall not be furnished with tickets, or be allowed to enter the cars or station premises; and if found in the cars or station premises may be removed. Persons drunk and unable to take care of themselves.

Sec. 50. Passengers are required to produce and deliver up their railway tickets to the conductor, or other person in charge of the train, whenever requested so to do by such officer. Should they refuse to do this, and to pay the proper fare, they may be removed from the train at or near a station. Passenger to deliver up ticket. Removal from train.

Sec. 51. Passengers are not entitled to occupy more than one sitting in a passenger car for each ticket. One sitting for each ticket.

Sec. 52. Passengers, before they can have their baggage checked, must show their tickets to the station baggage master. To avoid mistakes, they must attend personally to the checking and marking of their baggage. Checking and marking of baggage.

Sec. 53. Passengers can only have their baggage checked to the stations to which they hold tickets. Check to correspond with ticket.

Sec. 54. Passengers, on arrival at their destination, must produce their duplicate check before their baggage can be delivered to them. Duplicate check to be produced.

Sec. 55. Coachmen, hackmen, carters, porters and runners for railroads, boats, stage lines and hotels, will not be allowed to solicit customers or passengers upon any of the Coachmen, &c., when not allowed to solicit custom.

## Chap. 111

*General Railway Regulations.*

trains,—nor will they be allowed to enter the stations, nor come upon the platforms on the arrival of the passenger trains, to solicit or influence passengers, but they shall stand in such places as directed by the station master, agent or policeman. Cattle dealers, butchers and market men will not be allowed in the cars, station or freight houses, or upon the platforms, on the arrival of the trains, for the purpose of trading; nor will hucksters, or vendors of newspapers, books, fruit, flowers, confectionery, and other such articles, be allowed in the cars, or upon the train, nor to enter the stations, or come upon the platform for the purpose of disposing of the same, except by permission of the station master or conductor, under the authority of the superintendent.

Cattle dealers,  
hucksters, &c.,  
Restrictions  
relating to.

Coachmen,  
&c., holding  
checks.

Sec. 56. Coachmen, hackmen and porters holding checks will be admitted into the stations for the purpose of obtaining baggage,—they will also be admitted when taking baggage to the trains.

Private car-  
riages, hacks,  
and baggage  
waggons,  
Position of.

Sec. 57. Private carriages, hacks and baggage waggons, while waiting at the station the arrival of trains, are required to stand at, in or near the station premises, as directed by the station master or policeman. Unnecessary noise, and obscene and abusive language, are strictly prohibited.

Walking upon  
the track,  
forbidden.

Sec. 58. All persons are strictly forbidden to walk upon the track of the railway, or trespass upon the railway premises.

O.C. Aug. 16, 1876.

Fine for con-  
travention of  
rules num-  
bered 48, 49,  
51, 55, 57 and  
58.

Sec. 59. Any person or persons who shall be guilty of any contravention or infraction of the foregoing rules and regulations numbered respectively forty-eight, forty-nine, fifty-one, fifty-five, fifty-seven and fifty-eight, shall, in addition to any forfeiture or penalty thereby imposed, be liable to be brought before a Magistrate or Justice of the Peace, in the district, county or place in which the offence may have been committed, and to be fined a sum of not less than two dollars, nor more than twenty dollars for each separate offence, by virtue of "The Government Railways Act."

O.C. May 5, 1884.



*General Railway Regulations.***Chap. 111****STATION MASTERS.**

Sec. **60.** Every station master must be able to write a good hand, to spell correctly, and to write grammatically; he must also be conversant with the elementary rules of arithmetic, and be able to keep books neatly; at stations where there are no clerks kept he must properly understand telegraphing, and in all cases the station master, or one of his clerks, must be an operator. The station master is also responsible for the efficient discharge of the duties devolving upon all the employés at the station.

Literary qualifications of station master.

Sec. **61.** He shall see that all general and other orders are duly executed, and entered in a book to be kept for the purpose.

Shall see that orders are duly executed.

Sec. **62.** He must at all times enforce the observance of cleanliness and neatness by the employés at his station. He must immediately report every instance of neglect of duty on their part, and see that their conduct is respectful and civil to the public. Should any man be complained of, he must investigate the matter and communicate the particulars as soon as possible to the superintendent.

Duties of station master as to cleanliness, &c.

Sec. **63.** He is responsible for the efficient protection and safety of the station, office, buildings, and other property connected therewith, and must daily inspect the same as well as the station grounds, and see that they are kept clean and in good order.

Responsibility for safety of buildings, &c.

Sec. **64.** He shall see that all station and signal lamps belonging to his station are trimmed, and that signals of every kind are in good order and ready for instant use.

Station and signal lamps.

Sec. **65.** He must see that the time of arrival and departure of every stopping train, and the time of passing of all other trains or engines, with the number of cars in each case, are accurately entered in the train book.

Time of arrival and departure of trains to be entered.

Sec. **66.** He must report immediately whenever any train leaves or passes his station before the time prescribed in the time-table.

Report.

Sec. **67.** He is to direct the conductor of a train when to start, and he must use every exertion to ensure punctuality.

Direct when to start.

Sec. **68.** He must not permit any engine or train to leave or pass his station within fifteen minutes of another going in the same direction.

Proximity of engine or train.

## Chap. 111.

*General Railway Regulations.*

Look out for  
train signals.

Sec. **69.** He must keep a sharp look-out for train signals, and be careful to notify conductors of the same, and of any orders or arrangements that may exist in any way affecting the trains.

Main line to  
be kept clear.

Sec. **70.** He must see that no engines or cars are left upon the main line, and no cars are, under any circumstances, to be loaded on main line, without direct authority from the superintendent, after which they must be placed as quickly as possible in a siding clear of the main line, with the wheels securely scotched.

Engine or car  
shunting.

Sec. **71.** He must not allow an engine or car to cross or shunt on the main line within ten minutes of a train being due at his station.

Switches to be  
kept in good  
order.

Sec. **72.** He must see that all switches at his station are in good order, proper position, and carefully attended to at all times, and especially before and after the arrival and departure of trains, and keep the main line clear for special trains duly signalled. Where there is no switchman he must himself perform the switchman's duty.

Unusual  
occurrences.

Sec. **73.** He shall forthwith communicate to the superintendent all unusual occurrences which may happen in connection with the railway.

In case of any  
obstructions  
on the line,  
station master  
must tele-  
graph.

Sec. **74.** In case of any obstructions on the line, or slips, or other casualties, the station master at the nearest station to the scene of the accident must immediately give notice of the same, by telegraph or otherwise, to the superintendent and the nearest foreman of the permanent way.

Tickets, where  
not to be sold.

Sec. **75.** Tickets must not be sold for any station at which the train does not stop. Ticket agents must consult the working time-table, so as to avoid mistakes.

Books and  
returns.

Sec. **76.** The station master shall see that all books and returns are regularly written up and neatly kept.

Responsibility  
for money  
received.

Sec. **77.** He shall be responsible for all money received at his station on account of the railway, and will be required to make good any deficiency of cash, whether arising from bad money or errors. He must make up and balance his accounts daily in the form prescribed, and remit his cash, as called for by special instructions.

*General Railway Regulations.*

## Chap. 111

Sec. 78. Any station master who shall render a statement of account which contains errors plainly traceable to his cash not having been properly counted and balanced, or to any want of care in taking an inventory of the freight in store, or shall enter remittances not actually made at the time indicated, is open to the serious charge of knowingly falsifying his accounts. Statement of account containing errors.

Sec. 79. All goods or articles, without exception, received for transportation, must be properly entered on way-bills to accompany the same. Way-bills.

Sec. 80. He is held personally responsible for the safe keeping and proper delivery of all goods received by him, and for all charges due thereon, and all articles entered on the way-bills will be considered as having reached his station in good order, unless it is otherwise stated on the face of the way-bill. Safe keeping and delivery of goods.

Sec. 81. He shall see that all full-loaded box cars of freight, not required to be opened until their destination is reached, are sealed. Sealing full-loaded box cars.

Sec. 82. Station masters shall not permit freight cars to be over or improperly laden. If a doubt exists they shall take the safe course, by consulting the freight tariff as to estimated weights and measurements. Over loading freight cars, not allowed.

Sec. 83. Station masters must not offer for transportation an improperly laden car. Improperly laden car.

Sec. 84. To avoid misunderstanding and delay, a requisition for freight cars must be made upon the form provided for the purpose, and handed to the conductor. If previously telegraphed for, the fact must be stated on the requisition. Requisition for freight cars.

Sec. 85. Freight and cattle cars must be thoroughly cleansed on being discharged. The station master shall immediately report every instance in which a car, bearing evidence of not having been cleansed by the sending station, arrives at his station. Freight and cattle cars to be cleansed.

Sec. 86. He must be careful that all stores supplied for the station are economically used, and that there is no waste of any kind. Waste to be avoided.

Sec. 87. He must not supply or lend, under any circumstances, stores or other articles belonging to the railway. Stores, &c., not to be loaned.

## STATION BAGGAGE MASTERS.

- Badge; and time of attendance.      **Sec. 88.** Station baggage masters shall wear a badge denoting their office, and be in attendance at least forty-five minutes before the advertised departure of the train.
- To compare checks.      **Sec. 89.** They must compare baggage checks with the duplicates, and see that they correspond.
- Checks on hand.      **Sec. 90.** They must not keep more checks on hand than are necessary.
- Checks not in use.      **Sec. 91.** Checks, when not in use, must be kept under lock and key.
- Amount of baggage.      **Sec. 92.** A passenger is allowed 100 lbs. of personal baggage. Any quantity exceeding that weight must be charged double first-class freight rates, and must be prepaid.
- Baggage, when to be checked.      **Sec. 93.** Station baggage masters must not check baggage until a short time previous to the departure of the train.
- Tickets to be exhibited.      **Sec. 94.** They are to request passengers to exhibit their tickets before checking their baggage, and to check the baggage accordingly.
- Effacement of previous numbers.      **Sec. 95.** All previous station numbers on baggage must be effaced.
- Checks, to whom given.      **Sec. 96.** Checks must only be given to passengers, and not to cabmen, or others, on their behalf.
- Baggage to be guarded.      **Sec. 97.** Baggage, while in charge of the railway officers, must be well guarded, or left in a secure place.
- Record of baggage received to be kept.      **Sec. 98.** A record must be kept at stations of all baggage received from passengers and forwarded by train, giving the date, number of check, train and destination, in every case.
- Record of baggage delivered to be kept.      **Sec. 99.** A record must also be kept of all baggage received by trains and delivered to passengers, showing date, train, and number of check, in the same way.
- Baggage for flag stations.      **Sec. 100.** Baggage for flag stations must be numbered, but not checked.

*General Railway Regulations.***Chap. 111**

**Sec. 101.** On no account are passengers to be allowed to take checked baggage out of the possession of baggage masters, unless properly claimed. Baggage must be properly claimed.

**Sec. 102.** Special care must be taken not to deliver baggage without first removing the checks, and obtaining the duplicates from the passengers. Removing the checks.

**Sec. 103.** A report must be sent to the general baggage agent, Moncton, of all baggage received, the checks and duplicates of which do not tally. The report must show the time of arrival, number of train, and the name of the station whence received. Report to the general baggage agent.

**Sec. 104.** When a passenger has lost his duplicate check the baggage must not be given up unless he can describe the contents of such baggage, and pays 25 cents for the lost check. When duplicate check is lost.

**Sec. 105.** A receipt must be taken from the owner for all baggage so delivered without the duplicate check being presented, as also for all baggage mischecked. Receipt from owner.

**Sec. 106.** Station baggage masters, or station masters, will report immediately to the general baggage agent, Moncton, any baggage missing at their station, and will also report any baggage that may have remained unclaimed one week. Report of baggage missing or unclaimed.

**Sec. 107.** All lost or unclaimed baggage must be sent, properly labelled, to Moncton monthly. Lost or unclaimed baggage.

**Sec. 108.** No baggage shall be opened, except in the presence of the owner. Baggage not to be opened.

**Sec. 109.** Reports must be made periodically to the general baggage agent of all inward and outward baggage. Reports periodically.

**SWITCHMEN.**

**Sec. 110.** Men in charge of switches are required to exercise great care and vigilance, as the slightest neglect on their part may cause an accident. Care and vigilance.

**Sec. 111.** They must be very careful to keep their switches in good working order and in proper position, and must immediately report all defects to the station master, who will advise the superintendent and the nearest station foreman. Switches to be kept in good order; and defects to be reported.

## Chap. 111

*General Railway Regulations.*

Personal inspection of switches.

**Sec. 112.** Before leaving his work he must satisfy himself, by personal inspection, that the switches are properly set and locked for the main line, and that the signals are right. He must also carefully examine the switches and stationary signals every time he returns to work after being off duty.

Articles with which switchman must be furnished.

**Sec. 113.** He must be furnished, when on duty, with the following articles :—

- 1 Hand Lamp, having three colors.
- 4 Flags,—two red, one white and one green.
- 12 Fog Signals (torpedoes).

Engines or cars passing on to or crossing the main line.

**Sec. 114.** Switchmen shall not, within fifteen minutes of a train being due, allow any engines or cars to pass on to or cross the main line, without the express order of the station master ; and then he shall not open the switch until the proper danger signal is shown. He must not allow an engine to pass from one line to another without first ascertaining that it is safe to do so.

Responsibility of conductors and other officials using switches.

**Sec. 115.** Conductors engine-drivers, track-masters and others who may have occasion to use switches, shall be held responsible for leaving them locked in their proper position, but nothing in this rule shall relieve the station master of his responsibility in regard to switches.

## CONDUCTORS.

Qualification of conductor.

**Sec. 116.** Conductors must be able to write a good, legible hand, to spell correctly, and be conversant with the elementary rules of arithmetic.

Badge.

**Sec. 117.** They shall wear a badge denoting their office.

Attendance and duty.

**Sec. 118.** They must be at the station from which they are about to start at least half an hour before the appointed time for departure, and must see that the baggage master and brakemen are also on duty at the proper time.

Articles with which train shall be furnished.

**Sec. 119.** The conductor shall see that he has on his train the following articles :—

- |                  |                                   |
|------------------|-----------------------------------|
| 1 axe,           | 1 whisk.                          |
| 1 saw,           | 2 red, 2 green and 2 white flags, |
| 1 hammer,        | 3 red lamps,                      |
| 1 oil filler,    | 2 white lamps,                    |
| 1 pair scissors, | 1 green lamp,                     |

*General Railway Regulations.*

## Chap. 111

1 case containing 12 torpedoes,	1 signal lamp,
2 brooms,	1 conductor's lamp,
Alarm cords and couplings,	2 tail lamps,
1 tail rope,	4 brass brushes,
2 water pails,	4 axle-box wedges,
1 chain, 12 feet long, with hooks attached,	1 pair trimmers,
1 lb. sulphur,	1 oil pail and packing iron,
6 links and 6 pins,	1 water crock,
2 dippers,	1 water can,
1 pinch bar,	3 oil cans,
2 shovels,	1 scrub brush,
1 chamois skin,	3 ice picks,
	1 mop,
	1 monkey wrench,
	1 duster.

Sec. 120. Until the train has started the conductor shall be under the direction of the station master. Before leaving the station he shall see that the cars are properly coupled; that there are proper brakes, and a sufficient number of brakemen on the train; that the signal lamps are properly trimmed and attached to the car, and, if required, lighted; that he has a proper supply of stores on board; that the alarm cord is properly secured and extended from the engine to the rear of the train; that the cars are in a proper state of cleanliness; and, if it be winter, that the stoves have been properly attended to, and the cars ventilated and properly warmed. If the cars are found to be in a dirty condition he must report the fact to the superintendent.

Duties of conductor before leaving station.

Sec. 121. In forming a train, baggage, freight or lumber cars shall not be placed in rear of the passenger cars.

Forming a train.

Sec. 122. The rear car of every train must be a brake car, and a man must, when the train is in motion, always be stationed on that car.

Rear car of train.

Sec. 123. Conductors shall strictly obey all signals and special orders which they may receive from the officers in charge of stations.

Obedience to officers in charge.

Sec. 124. They must not give the signal to start while passengers are getting on board, and should, when making it, stand near the front end of the first passenger car. They should afterwards pass to the platform of the last car, and look out for any signal that may be given them.

Signal to start.

## Chap. 111

*General Railway Regulations.*

Conductor to have absolute control of train after it has started.

Sec. **125.** After the train has started it shall be under the conductor's entire charge and control. He is responsible for the safety of the train and all on board of it. He must see that the rules and regulations of the railway, as well as any special regulations that may be issued, are strictly observed by both passengers and employes, and shall report any violations of them, and must himself take care to observe all such rules and regulations.

Backing a train.

Sec. **126.** When backing a train, there must always be a man specially stationed upon the rear part of it to give due warning and prevent accident.

Conductor may check engine driver if train running at unsafe speed.

Sec. **127.** It shall be the conductor's duty to check the engine driver should the train be running at an unsafe speed, and to direct that the regular rate or speed prescribed in the time-table, or a slower rate if the track be in bad order, be observed, as the case may require. Negligence or recklessness on the part of the engine-driver will be taken as proof of the inefficiency of the conductor, unless such conduct has been duly and distinctly reported on every occasion of its taking place. He shall at the same time treat the engine-driver with that consideration which is due to his very responsible duties, and will always advise with him in cases of difficulty.

In very extreme cases only can a train which has once left a station be allowed to return.

Sec. **128.** In very extreme cases only can a train which has once left a station be allowed to return: and this proceeding must be accompanied with the greatest possible degree of caution. Before anything else is done, two men with red flags or lights must be sent fully half a mile in advance of the rear end of the train, to give warning to any train or trains that may be approaching from that direction, in order to guard against the possibility of collision. The train must not move until these two men have proceeded at least half a mile. Every other available measure must also be taken to notify trackmen and to stop any approaching engine. The officers of a train so situated are to assume in every case that a train is approaching, and act accordingly. Conductors or other officers in charge of any trains that may receive such warning are responsible for protecting their own trains in the same manner.

Directions in such case.

When a train breaks down or is stopped or seriously delayed on the road.

Sec. **129.** When a train breaks down or is stopped or seriously delayed on the road similar precautions must be taken, should the case require it; to guard against being run into by any other train, proper use must be made of red flags, or lanterns and torpedoes. When assistance is required,



*General Railway Regulations.*

## Chap. 111

or when the circumstances require it, messengers must be sent to the station master on either side, and the conductor must communicate direct, or through those officers, with the superintendent.

Sec. **130.** The conductor shall see that the brakemen and other train employés are kept at their posts so as to be ready for any emergency, that they are cleanly and attentive to their duties, and that their signals are ready for instant use.

Conductor's oversight of brakemen, &c.

Sec. **131.** The conductor shall, from time to time, during the journey, examine the wheels, brakes, springs, trucks and journals of the cars, and must see that they are kept in proper order.

Conductor shall examine wheels, &c.

Sec. **132.** The tail signal must also be examined at every station, and in the event of a train being brought to a stand on the main track the conductor must take care that no person obstructs the rear view of it.

Examination of tail signal.

Sec. **133.** Whenever telegraphic despatches are sent, directing the movements of trains, they must be repeated back by the receiving office to the sending office, and acknowledged by the persons to whom they may be addressed. Such acknowledgment shall always show how the message is understood by the parties receiving it, and such persons shall not start the train until they have found their construction of the message to be the true one. *If doubt should arise they must take the safe course.*

Telegraphic messages to be repeated and acknowledged.

Sec. **134.** Verbal messages which in any way affect the movement of engines or trains must not under any circumstances be received through a third person, whatever confidence may be placed in the veracity of such person. All instructions not communicated personally or by telegraph to the individual for whom they are intended *must be in writing.* The responsibility of accident resulting from a misunderstanding of this sort will rest upon the person acting without the proper authority.

Instructions not communicated personally or by telegraph *must be in writing.*

Sec. **135.** The conductor must not allow persons to ride on the platform or outside of the cars, or in the baggage car, and must use all possible means to prevent passengers exposing themselves to danger.

Passengers not to ride on platform, &c.

Sec. **136.** In the event of any passenger being drunk or disorderly, to the annoyance of others, he must use all gentle means to stop the nuisance; failing which, he must

Passenger, drunk or disorderly.

exercise his authority, and restrain, or keep him in a separate place until his arrival at the next station, or at a station near to a police office or lock-up, where the passenger must be left and may be, if considered expedient, delivered to the police and charged with the offence in the usual way.

Fare collected  
in the cars.

Sec. **137.** Whenever a fare is collected in the cars the conductor must at once issue a ticket to the passenger, and enter the amount in his book. No excuse will be admitted for any departure from this rule.

Delivery of  
letters, &c.

Sec. **138.** Conductors must promptly deliver all letters, way-bills and despatches entrusted to their care.

Sale of books,  
&c., in the  
cars.

Sec. **139.** They must not allow the sale of books, papers, refreshments, &c., in the cars, without permission from the superintendent.

Freight trains  
must always  
keep out of  
the way of pas-  
senger trains.

Sec. **140.** Freight trains must always keep out of the way of passenger trains. If from unavoidable circumstances the conductors of freight trains find themselves running within ten minutes of the running time of a passenger train following them, they must use all proper means to inform such passenger train of their position and prevent its running into them. If practicable, conductors of such freight trains must direct trackmen to put out signals and notify the passenger train conductor that a freight train is immediately ahead.

Conductors of  
freight cars.

Sec. **141.** Conductors of freight trains must not take loaded cars without way-bills, nor way-bills without the proper cars.

Cars, where  
not to be  
taken.

Sec. **142.** Cars must not be taken beyond stations to which their contents may be destined, unless needed, as they may have to be brought back empty.

Car loaded for  
several way-  
stations.

Sec. **143.** At stations where freight for several way stations is loaded into one car, particular attention should be given to have that loaded for the farthest station put in the car first, and so on in succession, until the freight for the nearest station to the point where it is being loaded is next the door of the car.

Responsibility  
of conductor  
for goods, &c.,  
entrusted to  
him.

Sec. **144.** Conductors will be held personally responsible for the proper care of all goods or property entrusted to them, and will be careful to see that the same are delivered to the station masters according to the way-bills.

*General Railway Regulations.*

## Chap. 111

Sec. 145. A conductor shall not permit live stock to be carried in closed cars. When there are horses on a train, unless the owner has sent a person in charge of them, the conductor will see that they are carefully watered and moderately fed on the road; and the expense thus incurred shall be paid him at the end of his journey by the station master, who shall be reimbursed by the consignor or consignee, or owner, as the case may require.

Live stock, how to be carried and taken care of.

Sec. 146. Every conductor shall make himself acquainted, as far as practicable, with the condition of the goods conveyed on his train; and when they are stowed so as to be liable to damage, he shall stow them differently, or, if that be not possible, shall leave them, if necessary, at a station, to be more securely stowed and sent on by another opportunity, reporting the same to the superintendent. He shall see that no pilfering of the contents of the car takes place, and that the doors of loaded cars are sealed, and empty ones closed.

Conductor to become acquainted with condition of goods and the manner of their stowage.

Sec. 147. If from any cause it becomes necessary to leave freight where it does not belong, the conductor shall note the fact on the way-bill, and give notice in writing to the superintendent. He shall take all proper means to have the same forwarded to its destination without delay.

Leaving freight where it does not belong.

Sec. 148. Irregular trains must be on a siding at least fifteen minutes before the regular trains are due, and wait till they have passed, unless otherwise ordered.

Irregular trains.

Sec. 149. Conductors will duly call the attention of the repairer of cars—or, in his absence, that of the station master—to any repairs required, or damage that may have been sustained by the cars, and in the latter case report the particulars to the superintendent.

Repairs required, damages sustained.

Sec. 150. They must be careful, also, to report to the nearest station master and to the division superintendent any defect they may observe on the line.

Defect on line to be reported.

Sec. 151. Conductors must keep a diary of their proceedings, which must be ready for inspection at all times; and they shall make daily returns upon the proper form to be supplied them.

Conductor must keep a diary.

Sec. 152. Where a conductor may have had charge of a train for only part of a trip he must insert in his return, upon the proper form and over his own signature, the particulars of the same, which, with any money he may have

Where conductor has charge of train for only part of a trip.

## Chap. 111

*General Railway Regulations.*

collected, he will hand over to the officer relieving him, who will complete and forward the return, also signing it.

Entries in  
conductor's  
diary.

Sec. **153.** The conductor shall enter in his diary all delays, casualties or unusual occurrences, and report the facts to the superintendent. He will also make a note of them in his return.

## TRAIN BAGGAGE MASTERS.

Badge and  
duty.

Sec. **154.** Train baggage masters shall wear their proper badge of office, and must report any baggage they receive not properly marked and checked; they must be particular to see that the number of the station for which the baggage is intended is distinctly marked.

Checks, &c., to  
be compared.

Sec. **155.** All checks and duplicates in charge of train baggage masters must be compared by them before being used.

Checks to be  
kept in a box.

Sec. **156.** Checks must not be carried loose in the baggage car, but shall be kept in a box supplied for that purpose.

Baggage for  
flag stations.

Sec. **157.** Baggage for flag stations shall be numbered, but not checked.

Proper ac-  
count to be  
kept.

Sec. **158.** Train baggage masters shall keep a proper account, in books provided for the purpose, of all baggage checked or unchecked, showing stations at which the baggage is received and delivered.

Riding in  
baggage car,  
not allowed.

Sec. **159.** They shall not allow persons, except those working the train, to ride in the baggage car, unless by direction of the conductor.

Not to leave  
station till  
baggage  
claimed.

Sec. **160.** They shall not leave the station, at the end of the journey, until the baggage has been claimed or properly disposed of.

Shall obey  
instructions.

Sec. **161.** They shall obey such other instructions in regard to baggage, and perform such other duty, as may be required of them.

## BRAKESMEN.

Badge and  
duty.

Sec. **162.** Brakesmen must wear their proper badge of office, and while the train is in motion must be near their brakes, which, when necessary, they will skilfully apply.

*General Railway Regulations.*

Chap. 111

Sec. 163. Passenger car brakes must always be eased off, and not permitted suddenly to escape, so that no disagreeable jarring may be felt by the passengers. Passenger car brakes must be eased off.

Sec. 164. The alarm cord must not on any account be removed at the end of a journey until the train has been brought to a stand. Alarm cord.

Sec. 165. Brakesmen shall perform such other duties as may be required of them. Other duties

Sec. 166. Freight conductors and train baggage masters shall act as brakesmen when not engaged with their other duties. Who shall act as brakesmen.

ENGINE DRIVERS.

Sec. 167. *Table showing the speed of an Engine at a given rate per hour.*

Speed per hour.	Time of performing $\frac{1}{4}$ mile.	Time of performing $\frac{1}{2}$ mile.	Time of performing 1 mile.	Speed per hour.	Time of performing $\frac{1}{4}$ mile.	Time of performing $\frac{1}{2}$ mile.	Time of performing 1 mile.
Miles.	M. S.	M. S.	M. S.	Miles.	M. S.	M. S.	M. S.
5	3 0	6 0	12 0	33	0 27	0 54	1 49
6	2 30	5 0	10 0	34	0 26	0 53	1 46
7	2 6	4 17	8 34	35	0 25	0 51	1 43
8	1 52	3 45	7 30	36	0 25	0 50	1 40
9	1 40	3 20	6 40	37	0 24	0 48	1 37
10	1 30	3 0	6 0	38	0 23	0 47	1 34
11	1 21	2 43	5 27	39	0 23	0 46	1 32
12	1 15	2 30	5 0	40	0 22	0 45	1 30
13	1 9	2 18	4 37	41	0 21	0 43	1 27
14	1 4	2 8	4 17	42	0 21	0 42	1 25
15	1 0	2 0	4 0	43	0 20	0 41	1 23
16	0 56	1 52	3 45	44	0 20	0 40	1 21
17	0 52	1 46	3 31	45	0 20	0 40	1 20
18	0 50	1 40	3 20	46	0 19	0 39	1 18
19	0 47	1 34	3 9	47	0 19	0 38	1 16
20	0 45	1 30	3 0	48	0 18	0 37	1 15
21	0 42	1 25	2 51	49	0 18	0 36	1 13
22	0 40	1 21	2 43	50	0 18	0 36	1 12
23	0 39	1 18	2 36	51	0 17	0 35	1 10
24	0 37	1 15	2 30	52	0 17	0 34	1 9
25	0 36	1 12	2 24	53	0 17	0 34	1 7
26	0 34	1 9	2 18	54	0 16	0 33	1 6
27	0 33	1 6	2 13	55	0 16	0 32	1 5
28	0 32	1 4	2 8	56	0 16	0 32	1 4
29	0 31	1 2	2 4	57	0 15	0 31	1 3
30	0 30	1 0	2 0	58	0 15	0 31	1 2
31	0 29	0 58	1 56	59	0 15	0 30	1 1
32	0 28	0 56	1 52	60	0 15	0 30	1 0

## Chap. 111

*General Railway Regulations.*

- When subject to station master. Sec. **168.** The engine driver, when at a station, shall be subject to the orders of the station master.
- When subject to conductor. Sec. **169.** He shall be guided by instructions from the conductor as to when to start and stop the train.
- Proper lights after sunset. Sec. **170.** He must not proceed after sunset, unless the proper lights are exhibited on his engine.
- Special train. Sec. **171.** No special train or engine shall leave any station without the authority of the superintendent.
- Time-keeping. Sec. **172.** Every engine driver and fireman must provide himself with a good watch, and compare the time with conductors and drivers of other trains they meet, as well as with station clocks, reporting all differences to the superintendent.
- Signals. Sec. **173.** They must pay immediate attention to all signals, whether the cause for giving them be known or not.
- Duties of driver specified. Sec. **174.** The driver must be in attendance at the station at least half an hour, and the fireman at least forty-five minutes, before the appointed time for starting the train. He must see that the engine is coupled at least ten minutes before the time for starting—that it is in proper working order, sufficiently supplied with fuel and water, and properly oiled—that the alarm cord is attached to the gong or whistle, and that the lamps and signals are in a fit state for use. Before taking charge of the engine he and the fireman must sign their names in the appearance book, kept by the locomotive foreman.
- Responsibility of conductors and drivers. Sec. **175.** Conductors and drivers of trains supplied with air brakes are responsible for seeing that such are in perfect working order before starting from terminal stations: this also applies to the ordinary brakes and running gear on all cars.
- Articles with which engine driver shall be furnished. Sec. **176.** Every engine driver shall have with him, at all times, the following tools:—
- 2 jack screws
  - 1 set hand wrenches.
  - 3 oil cans (a full set).
  - 1 large monkey wrench.
  - 1 small monkey wrench.

- 3 cold chisels.
- 1 hand hammer.
- 1 copper hammer.
- 1 pinch bar.
- 2 fire buckets.
- 2 sets signals (flags).
- 1 engineer's lamp.
- 1 red tail lamp.
- 1 signal lamp.
- 1 green lamp.
- 1 head light.
- 1 hand saw.
- 1 tallow kettle.
- 6 iron plugs, for tubes.
- 2 large boxes, or chests.
- 2 small chests.
- 5 chains, with rings and hooks attached.
- 1 narrow axe.
- 1 switch rope (30 feet).
- 1 plug iron.
- 1 scraper, for ash pan.
- 1 picker, for fire.
- 1 case, containing 12 torpedoes.
- A quantity of flax and twine.

for which he shall be held responsible, and any party found guilty of destroying them shall be fined or dismissed.

**Sec. 177.** The engine driver shall not allow any person, Riding on engine or tender. except the superintendents and trackmasters, to ride on his engine or tender without due authority.

**Sec. 178.** He must not start his train until the bell be rung, and he receive the signal from the conductor; he must, invariably, start carefully, without jerking, and see that he has the whole of his train; he must run the train as nearly to time as possible, arriving at the stations neither too late nor too soon. He must not shut off steam suddenly, so as to cause concussion of the cars, unless in case of danger. When and how to start the train. Directions as to running train.

**Sec. 179.** If a train becomes separated when in motion care must be taken not to stop the portion in front before the after-part has stopped, and the men on such detached part must apply their brakes in time to prevent collision with the cars in front. If train becomes separated.

**Sec. 180.** No engine shall run tender or train foremost, unless from unavoidable necessity, or by order of the superintendent. Not to run tender or train foremost.

## Chap. 111

*General Railway Regulations.*

Position of driver and fireman.

Sec. **181.** The driver shall stand by the hand-gear, and keep a good look-out. The fireman also must be on the look-out when not engaged in other duties.

Targets to be correctly set.

Sec. **182.** Before passing switches, the driver must be careful to see that the targets are correctly set.

Obligations and requirements of engine driver on leaving duty.

Sec. **183.** An engine driver on duty must not leave his engine except in cases of great necessity, on which occasions he must place it in charge of the fireman, and notify the nearest locomotive foreman of the fact, in order that a competent person may be sent to take his place. On no account shall both leave it until it is given in charge to the party authorized to receive it.

Rough or bad tracks, curves or through cuttings; rates of speed.

Sec. **184.** Engine drivers are required to run slowly and carefully over rough or bad tracks, and round curves, or through cuttings. The track-masters are authorized, when it is found necessary, to prescribe rates of speed, faster than which an engine must not be driven over the parts of the roads indicated, and they shall report violations of their instructions in this respect.

Running behind another train.

Sec. **185.** In running behind another train, the driver must so run as to allow the leading train to be not less than two miles in advance, and, on approaching a station, and entering, or running round curves, he must exercise great caution, so as to avoid the possibility of a collision. No excuse as to being deceived about the distance will be received for neglect of this rule. The responsibility of a collision will rest upon the conductor and engine driver of the rear train.

Approaching stations, crossings, &c.

Sec. **186.** When approaching stations, crossings, bridges and viaducts, and when passing wood piles, all trains are required to run at reduced speed and with extreme caution, the dampers of the engines being closed.

Trains passing each other.

Sec. **187.** When trains have to pass each other, the train having the right to the road shall occupy the main track.

Sounding whistle and ringing bell.

Sec. **188.** Engine drivers are to take care that the whistle be sounded 800 yards before reaching every level crossing of a public road, and that the bell be rung 600 yards before reaching such crossing, and until the crossing be passed. The bell, and whistle, are also to be sounded, when approaching a cutting, station or junction. During foggy weather, also, the bell must be sounded at proper intervals.



*General Railway Regulations.*

## Chap. 111

Sec. 189. They must never allow themselves to be governed by any information they may receive as to where the train ahead will stop for fuel or other cause, but must always be prepared to stop short of the station. They should invariably run on the supposition that a train may be found out of place at a station.

Must always be prepared to stop short of the station.

Sec. 190. In bringing up his train the driver must pay particular attention to the state of the weather, and the condition of the rails, as well as to the length of the train, and these circumstances must have due weight in determining him when to shut off the steam. Stations must not be entered so rapidly as to require a violent application of the brakes, or to render necessary the sounding of the signal whistle. He must report every instance of overshooting a station to the superintendent.

Manner of bringing up train and of entering station.

Sec. 191. Unless the driver is himself in the cab of the engine at the time, and directing its movements, he must not allow the fireman to shunt cars or move the engine; cars must not be shunted at so great a speed as to endanger the lives of men employed in coupling, or in any way injure the property of the railway.

Shunting cars.

Sec. 192. An engine or train shall not pass from a branch on to the main line until the proper signals are given.

Passing to main line.

Sec. 193. No engine driver, when acting without a conductor, shall, without the express permission of the station master, move his engine, on any pretence, from any siding on to the main line.

Moving from siding on to the main line.

Sec. 194. When there is an unavoidable necessity, from an accident or other special cause, for an engine to stop on the main line, the engine driver must send a man each way with signals, to the distance of 800 yards (or sixteen telegraph poles), or more, if at or near a steep grade or curve, in order to protect the train or engine.

Stopping on the main line, directions in such case.

Sec. 195. Engine drivers shall not, except in case of accident or sudden illness, change engines on the journey without permission.

Engines not to be changed on the journey.

Sec. 196. They must not allow fuel or waste to be thrown from the engine or tender while in motion.

Throwing out fuel or waste.

Sec. 197. Engine drivers must guard against killing cattle. Should any animal be injured by the engine, the engine

Report in case of injury to animals.

## Chap. 111

*General Railway Regulations.*

driver must report the same in writing to the superintendent, stating the facts of the case. Any engine driver who neglects to make such report immediately will be held responsible for all damages.

Should fire occur on train, directions in such case.

Sec. 198. Should a fire occur on a train it must be immediately stopped, and the proper measures at once be taken for protecting the train. The burning car or cars must be detached with as little delay as possible. No attempt must be made to run to a tank, if it be more than three hundred yards distant, as such a proceeding is likely to cause the fire to spread.

Consultation in cases of doubt or difficulty.

Sec. 199. In case of doubt or difficulty, engine drivers and conductors must consult and advise with each other, as they will be held equally responsible for any violation of the rules, through forgetfulness, negligence, misapprehension, or any other cause. In all cases of doubt the safe side must be taken, *safety being the first consideration.*

Should conductor become disabled, engine driver to have full charge.

Sec. 200. Should a conductor be disabled the engine driver will have full charge of and be held responsible for the safety of the train until another officer takes charge. In such case, he shall observe the rules laid down for the guidance of conductors.

Engine drivers, when on the line, will obey the direct orders of the superintendent.

Sec. 201. Engine drivers, when on the line, will obey the direct orders of the superintendent, whether the same be communicated verbally, by telegraph, or in writing; and in all cases where a message directing the train or engine to proceed cautiously, or at a given rate of speed, over any part of the railway, or any bridge or viaduct, is given to the conductor of any train, he shall at once hand the same to the engine driver, and call his attention to the contents thereof; and the engine driver shall retain it in his possession. If any engine driver shall, after the receipt of such message, incautiously, or at a greater rate of speed than that named, drive his engine over the portion of the railway, bridge or viaduct named, he shall at once be dismissed from the service; and any conductor failing to obey the requirements of this order will receive like punishment.

Engine to be carefully examined after each journey.

Sec. 202. Every engine driver must carefully examine his engine after each journey, and he must immediately report to the locomotive foreman, and enter in the book that is kept for that purpose, any defect or deficiency in his engine. He must also report to the superintendent, and to the

*General Railway Regulations.*

## Chap. 111

station master at the nearest station, any accident, neglect, or irregularity that may have occurred on the journey.

Sec. 203. Engine drivers must keep diaries, and make returns to the locomotive department, as may be required. Diary to be kept.

## FIREMEN.

Sec. 204. Firemen are subject to the orders of the engine drivers while on their engines. Subject to engine driver.

Sec. 205. They will keep the engine cleaned and properly oiled, and assist the engine driver, as may be required. Duties of fireman.

## MAINTENANCE OF WAY DEPARTMENT.

Sec. 206. The track-master, under the direction of the Engineer, who shall be responsible to the General Superintendent, shall have the charge and supervision of all repairmen in his division, and be held responsible for the faithful performance by them of their duty. Track-master to have supervision of all repairmen.

Sec. 207. When materials are wanted for repairs the track-master, on receiving a requisition from the foreman, properly filled in, will countersign it if the materials are known to be required, and forward it to the engineer. Materials wanted for repairs.

Sec. 208. Before any foreman or laborer is engaged by the track-master he must be made to understand that the wilful transgression of any of these rules—insubordination, drunkenness, being found off his work during working hours, or the commission or omission of any act whereby the passage of trains or engines is endangered—will be punished by dismissal. Grounds for dismissal of foreman or laborer.

Sec. 209. In every gang of track-laborers there must be a foreman; and the track-master will be held responsible that every foreman is provided with a copy of the regulations, a copy of the current time table, and the proper signal flags and lamps, and twelve torpedoes or fog signals; also, that each foreman is furnished with an accurate gauge for gauging the line of track, and with all other necessary materials and implements. Foreman of gang of track-laborers. Responsibility and duties of track-master.

Sec. 210. Each foreman shall constantly carry with him a copy of these rules and regulations while on duty, and must read and explain them to every man engaged under him, and must produce them, when required to do so by Duties and responsibility of foreman.

any of the principal officers of the railway. He shall be responsible for the men under his charge, and for the proper execution of the work assigned to them, and shall have a list of the names and places of abode of all men employed under him, so that in case of accident or other emergency he may be enabled to summon them immediately.

Foreman must walk over his section every morning.

Sec. 211. Each foreman or other employé, selected by the track-master, must walk over his section every morning, and oftener should it be necessary for him to do so, as in the case of violent storms. Foremen must see that all joints are properly spiked and bolted, and the joint-ties well packed up, and all other things appertaining to the road secured before the passage of the first train.

During heavy storms, Duty of foreman.

Sec. 212. During heavy storms of rain, snow or hail, whereby the works may be liable to sudden injury, foremen must be on duty, and immediately after the abatement of the storm, or, if necessary, during its continuance, they are required to go over their sections with danger signals, to ascertain if the track is safe for the passage of trains.

Track-repairers, Duties of.

Sec. 213. Track-repairers must be particular in watching each train as it passes, to see whether any notices are dropped off the train, or flags or lamps are exhibited upon the engine and rear of the train, giving notice of an extra train.

Green signal.

Sec. 214. The *green* signal indicates caution, and is to be used when it is necessary to slacken the speed of an approaching train; the *red* signal indicates danger.

Red signal.

and is to be used when necessary to stop the train, and such signals must be sent back for a distance of twenty (20) telegraph poles from the place they are meant to protect, and must be waved across the track.

Use of signals when it is necessary to displace any part of the track.

Sec. 215. Whenever it is necessary to displace any part of the track, or in case of any slip or failure of any portion of the works, or in the event of any car being required for temporary use on the line, or if, from any other cause, the track is not safe, the *red* signal must be conspicuously exhibited at a distance of not less than twenty (20) telegraph poles each way, even if no train or engine is expected, and a torpedo must be placed outside the *red* signal a further distance of two (2) telegraph poles. No hand-car or lorry must be used on the track, or work done, to impede the transit of trains during a fog or snow-storm, or within fifteen minutes of the time of a train being due.

*General Railway Regulations.*

## Chap. 111

Sec. 216. When any part of the track is out of repair, so as to make it necessary for a train to proceed cautiously, a signal must be sent twenty (20) telegraph poles in the direction whence a train is expected, and kept there until it passes, or until the track is made safe.

Signal when any part of track is out of repair.

Sec. 217. The track must not, in any case, be displaced for the purpose of putting in cattle-guards, cross-drains or culverts, unless by express order of the track-master. The track must not be rendered unsafe by any operation, during the day or night, or upon Sunday until notice shall have been given by the track-master to the superintendent, and permission obtained to use the track.

Displacement of track for purpose of putting in cattle-guards &c.

Sec. 218. No rails must be taken up, nor must the track be otherwise disturbed, in such a manner as to render it unsafe, within twenty minutes of the time of a train being due, nor until it has passed. All such work must be done between the regular running hours.

When track must not be taken up or disturbed.

Sec. 219. In raising the track and packing the ballast no lift must be greater than two inches in twenty-four feet and both rails must be raised equally and at the same time; and in all cases, when practicable, the lift must be made in the direction in which the first train due approaches.

Directions in raising the track and packing the ballast.

Sec. 220. The track-master must see that safety blocks are put down on all sidings diverging from the main track, at a proper distance therefrom.

Safety blocks.

Sec. 221. The foreman of each section, under the direction of the track-master, is held responsible for the safe keeping of all sleepers, rails, chairs, plates, bolts, tools and implements of every kind pertaining to the track not in special charge of the store-keeper, and the track-master must immediately report to the engineer any losses or destruction of such property.

Safe keeping of sleepers, rails, chairs, plates, bolts, tools, &c.

Sec. 222. The foreman must report, in writing, to the trackmaster, every case in which any of the signals are disregarded by an engine driver.

Report of foreman.

Sec. 223. All persons walking along the line, who are not in the railway service, must be warned off; and, in case of non-compliance, their names ascertained and reported to the trackmaster, or they must be placed under arrest, as the exigencies of the case seem to require.

Persons walking along the line must be warned off.

## Chap. 111

*General Railway Regulations.*

Animals found straying within the railway fence; gates, and private crossings.

Sec. 224. Animals found straying within the railway fence must be immediately driven off. Section men will close all gates found open. Owners and occupiers of property adjacent to the railway must keep properly shut all gates at private crossings; in case of accident through negligence on their part, or on the part of their servants, in leaving them open, they will be held liable for the consequences.

Lorries or hand-cars.

Sec. 225. When the lorries or hand-cars are not in use they must be lifted off the track, and the wheels secured by a chain and lock. Track lorries must only be used to convey materials for the line; they must never be attached to a train.

Surface crossings.

Sec. 226. All surface crossings must be closely looked after, and foremen must see that the planking is securely spiked down. Any temporary injury to any of the telegraph poles or wires shall be repaired as far as practicable, and intelligence of the damage immediately conveyed to the nearest station master. If not a telegraph station, the agent shall write to the telegraph station, giving particulars.

Injury to telegraph poles and wires.

Sec. 227. Track foremen must be particular in cutting down trees which are too near the telegraph wires, and when the wires are touching each other, separate them, fix them up and keep them from wet.

Cutting down trees.

Sec. 228. In case of the water supply at any station being short, or the frog of a siding being out of repair, or any other matter affecting the movement of traffic, foremen must report by telegraph, at once, to the bulletin boards on their divisions, and to the track-master as well.

Water supply.

Sec. 229. All articles found on the track must be promptly sent to the station-master of the nearest station.

Articles found on track.

O.C. Aug. 16, 1876.

Exemptions from Sec. 14, Chap. 38, R. S. Canada.

Sec. 230. The following works are exempted from the operation of Section 14 of Chapter 38 of the Revised Statutes of Canada relating to the height of existing bridge structures or tunnels on the line of the Intercolonial Railway, namely:—

- (a.) The Campbell Road Bridge at Halifax.
- (b.) Morrissey's Rock Tunnel, near Campbellton.
- (c.) The Mill Sluice, near Etchemin.

O. C. July 26, 1881.

---

*General Railway Regulations.*

---

Chap. 111

Sec. **231.** The tunnel under the Welland Canal, through which the trains of the Great Western Railway pass, are under the provisions of Section 47 of Chapter 109 of the Revised Statutes of Canada, relating to the height of clear and open headway to be maintained between the undermost parts of bridges, tunnels, &c., and the tops of the highest cars of a railway, exempted from the operation of said section.

The tunnel  
under the Wel-  
land Canal.

O. C. Jan. 26, 1882.

## CHAPTER 112.

### THE INTERCOLONIAL RAILWAY.

Government House, Ottawa,

The 26th day of October, 1889.

On the recommendation of the Minister of Railways and Canals, and under the provisions of Chapter 38 of the Revised Statutes of Canada, intituled "The Government Railways Act,"

His Excellency in Council has been pleased to order, and it is hereby ordered, that the following rules and regulations for the carriage of freight on the Intercolonial Railway and classification thereof, together with the following general tariff of rates to be imposed and collected thereon, be and the same are hereby adopted and established.

#### GENERAL CONDITIONS OF CARRIAGE APPLICABLE TO LIVE STOCK AND OTHER FREIGHT FORMING PART OF THE FREIGHT TARIFF

Accountability for live stock, &c.

**Section 1.** The Intercolonial Railway will not be accountable for any live stock or any article or thing unless the same be signed for as received by a duly authorized agent.

Responsibility for loss of or damage to money, bills, promissory notes, jewellery, gold or silver, clocks, matches, writings, prints, paintings, china, glass, wearing apparel, musical instruments, &c.

**Sec. 2.** Nor will it be responsible for the loss of, or damage done to money, cash, bills, promissory notes or securities for money, jewellery, trinkets, rings, precious stones, gold or silver, manufactured or unmanufactured, gold or silver plate or plated articles, clocks, watches, time-pieces, marble, lace, furs, silks in manufactured or unmanufactured state, and whether wrought up or not wrought up with other materials; writings, title deeds, prints, maps, paintings, engravings, pictures, stamps or other valuables; nor for damage done to china, glass, eggs, wearing apparel, musical instruments, furniture, toys, stoves, cast-iron work, grindstones, tombstones, slate, or any other such hazardous or brittle articles, in packages or otherwise.

Delays from storms, &c., damages from the weather, fire, heat, frost, &c.

**Sec. 3.** Nor will it be responsible for delays from storms or accidents, or damages from the weather, fire, heat, frost or delay of perishable articles, or from civil commotion; nor will it, under any circumstances, be liable for loss of market or other claim arising from delay or detention of any train, whether in starting or at any of the stations, or in course of



*Intercolonial Railway Regulations.*

## Chap. 112

the journey. The railway does not undertake to send goods by any particular train, notwithstanding the goods may have been taken to the station before the hour appointed by the railway.

Sec. 4. Nor will it be responsible for the loss or damage of any packages insufficiently or improperly marked, packed, directed or described, or containing a variety of articles, liable by breaking to damage each other or other articles ; nor for leakage arising from bad casks, or bad cooperage, or from fermentation or any other cause beyond the control of the railway.

Goods improperly marked, packed, &c. ; leakage, cooperage, fermentation, &c.

Sec. 5. Nor will it be responsible for the loss or damage of any goods put into returned wrappers or boxes, or packages described as "Empties ;" nor for any goods directed "to be left until called for," or "to order," warehoused for the convenience of the parties to whom they belong, or by or to whom they are consigned ; nor will it, under any circumstances, be accountable for the loss or damage of goods that are not taken away immediately after advice of their arrival has been sent or posted.

Goods put into returned wrappers. Empties.

Goods not taken away immediately.

Sec. 6. Nor will it be responsible for any injury to grain by heating, nor for any deficiency in weight or measure of grain, &c., in bags or in bulk, nor for any deficiency in weight, number or measure, of lumber, coal or iron, carried by the car load, nor for shrinkage or short weight or short measure of goods of any kind, unless a damage to the package can be shown to have happened whilst in the possession of the railway.

Injury to grain by heating, &c.

Sec. 7. No agent or other employé of this railway is authorized to take charge of bank notes, money or valuable papers.

Bank notes, &c.

Sec. 8. The railway will not, under any circumstances, receive or carry gun cotton, dualine, dynamite, nitro-glycerine, or any of its compounds, giant powder, hercules powder, rend-rock or like explosives.

Gun cotton, dualine, dynamite, &c.

Sec. 9. The railway will not undertake the transport of aquafortis or nitric acid, acetic acid, oil of vitrol or sulphuric acid, friction matches, gunpowder, or other dangerous articles, except at the convenience of the railway, and by special arrangement.

Aquafortis nitric acid, gunpowder, &c.

## Chap. 112.

*Intercolonial Railway Regulations.*

Senders of dangerous articles, when held accountable for damage.

**Sec. 10.** Senders of dangerous articles will be held accountable for any damage arising therefrom, unless the nature of the contents is distinctly marked on the outside of the package containing the same, and unless notice in writing is also given to the station-master or freight agent, that due care may be observed in loading and transporting it. In no case will the railway be liable for the loss of or damage to any such article.

Refusal to take goods of a dangerous nature.

**Sec. 11.** Any officer, employé or servant of the railway may refuse to take any package or parcel which he suspects to contain goods of a dangerous nature, or may require the same to be opened to ascertain the fact.

Lien for freight and charges, and directions for enforcing the same.

**Sec. 12.** (a.) The railway shall have a lien on all goods transported over it for the freight and charges thereon, as well as for any balance previously due for freight or otherwise by the owner or consignee, and the said goods shall be liable to be sold by public auction for the payment of the charges thereon, and other balances due, and if the owner or his agent does not, within ten days after the arrival of the goods at the place of destination, pay the freight and other charges due thereon, or payable in respect thereof, and take possession of and remove such goods from the railway premises, the superintendent may sell the same at public auction, after giving ten days public notice of such sale, to defray the railway claims and all expenses incurred in respect thereof, and in the mean time the said goods shall be at the risk of the owner thereof.

Goods of a perishable nature.

(b.) Should the said goods be of a perishable nature the superintendent may sell the same at public auction, after giving the consignee or his agent one day's notice, and the proceeds of such sale shall be used to defray the railway claims and all expenses incurred in respect thereof.

Risk in case of perishable articles.

**Sec. 13.** Fresh fish, fruit, fresh meat, poultry, oysters and other perishable articles are conveyed only at the owner's risk, and the freight must be prepaid.

Articles directed to be left where no buildings for storage of freight.

**Sec. 14.** All articles directed to be left at any way-station or flag-station or platform, where the railway has no buildings for the storage of freight, or where there is no resident agent, must be prepaid, and will be at the risk of the owner, whenever they are landed at such station or platform, and all articles brought there for conveyance will also be at the owner's risk until taken into the cars.

*Intercolonial Railway Regulations.*

Chap. 111

Sec. 15. (a.) In respect of all goods addressed to consignees at points beyond the places at which the railway has stations, and respecting which goods no directions to the contrary have been received at these stations, the railway reserves the right to forward such goods to their destination by public carrier or otherwise, as opportunity may offer; or to allow them to remain on the railway premises, or to send them to any public or private warehouse, pending communication with the consignees.

(Goods directed to consignees at points beyond where the railway has stations.)

(b.) The railway will not be responsible for any delay to such goods.

Responsibility for delay.

(c.) The delivery of the goods by the railway will be considered as complete, and the responsibility of the railway will be considered to have ceased, when such carriers shall have received notice that the railway is prepared to deliver them the goods for further conveyance.

When responsibility of railway shall cease.

(d.) And the railway will not be responsible for any loss of or any damage or detention that may happen to goods so sent by them, if such loss, damage or detention occur after the said notice or beyond the limits of the railway.

Loss after notice given.

(e.) If the goods are allowed to remain on the railway premises or are sent to any public or private warehouse they shall be at the risk of the owners for any damage arising from any cause whatever.

Goods allowed to remain on railway premises.

Sec. 16. All goods contracted for at a through rate or otherwise, to or from places beyond the line of the Intercolonial Railway, if shipped by water shall, while not on the railway or in its sheds or warehouses, be entirely at the owner's risk; and in cases of loss or damage to any goods for which this railway or connecting lines may be liable, it is agreed and understood that they shall have the benefit of any insurance effected by or for account of the owner of the said goods, before any demand shall be made.

Goods, if shipped by water, when at owner's risk.

Benefit of insurance.

Sec. 17. Storage will be charged at the rates named in the storage tariff on all goods remaining on the premises of the railway over forty-eight hours after their arrival.

Storage over 48 hours.

Sec. 18. The time allowed by the railway for the purpose of loading or unloading cars is forty-eight hours, exclusive of Sundays; after the expiration of that time demurrage at the rate of two dollars per car per day will be charged. This applies as well to cars that are not promptly loaded after being placed in position as to cars that are not unloaded after arrival. The railway reserves the right to discharge cars that are liable to be unloaded by consignee or owner, and at his expense, unless the above rules are complied with.

Time allowed for loading and unloading cars.

## Chap. 112

*Intercolonial Railway Regulations.*

Goods not delivered till charges paid.

Sec. 19. No goods will be delivered until all charges against them are paid, and the railway will not be accountable for the correctness of any "back charges" on goods, &c., by other roads, companies, conveyances or individuals, and when consigned to order, bills of lading must be indorsed and surrendered before delivery.

Notice in writing in case of claim.

Sec. 20. No claim whatever, for loss or damage (for which the railway may otherwise be liable), will be allowed, unless notice in writing is given to the station agent before the goods are removed.

Minimum charge, 25 cents.

Sec. 21. No charge less than twenty-five cents will be made for any single package or consignment.

Vehicles.

Sec. 22. Vehicles are carried only at the owner's risk of damage from fire, weather, and all other contingencies

Long or bulky machines and articles.

Sec. 23. Machines or articles very long or bulky, which require one or more cars to be taken especially to convey them, will be charged at full car rates.

Articles which must be loaded and unloaded by the owner thereof or at his expense.

Sec. 24. Barley, bones in bulk, chalk in bulk, corn, clay, coals, coke, hay and straw, oats, oysters, potatoes, rye, salt, wheat, dry fish in bulk, bricks, grindstones, mill-stones and burr-stones, manures, limestone, ores, slate, sand, gravel and stones, chains and chain cables, pig iron and scrap iron, lumber of all kinds, tan bark, gypsum and plaster in bulk, ice, rails and railway chairs, ships' knees (iron), lime, minerals in rough state, ships' rigging, fitted or unfitted, drain pipes, extract of barks, sugar and molasses, hides, leather, tanning materials, grease, tallow, resin, C soda, paper, leather-board, chemicals, shoe pegs, clothes pegs, earthenware, oil, empty barrels, soap, manganese, and all articles of a similar character in car loads, must be loaded and unloaded by the owner thereof, or at his expense.

Wharfage.

Sec. 25. Wharfage at the rates named in the wharfage tariff will be charged on all goods landed on or passing over the railway wharves, except in cases where the goods are received or forwarded over this railway without being taken off the railway premises, and are not delayed at the instance of the owner, consignor or consignee.

Car loads of not less than 20,000 lbs.

Sec. 26. Car loads of not less twenty thousand pounds each, of any or all descriptions of goods, except gunpowder and other hazardous articles, if consigned to one address and

*Intercolonial Railway Regulations.*

## Chap. 112

all belonging to and addressed to the consignee, may be rated and charged fifth class.

Sec. 27. All live stock conveyed over the railway are to be loaded and discharged by the owner or his agent, and he undertakes all risk of loss, injury, damage and other contingencies, in loading, unloading, transportation, conveyance and otherwise, no matter how caused; and the stock must be fed at his expense. Halters are to be provided by him when necessary, or when the stock is carried in less quantities than car loads. One drover will be carried free (second-class) when accompanying his stock, for the purpose of taking care of it, and paying the full price of a car load. Cars can not be hired to load cattle, or goods of any kind, with the privilege of "loading up" from different stations; and in no case can drovers be permitted to go free, except when they have at least one full car load from one station, and then only from that station.

Conveyance of live stock.

Sec. 28. Hay and straw will only be conveyed in box freight cars, and at owner's risk of fire.

Hay and straw.

Sec. 29. Pine, hemlock, cedar and spruce will be reckoned as *soft*, and all other kinds of wood as *hard*. The quantities mentioned as being the load for one car will not be considered as applicable to lumber, which, by reason of its length, requires for its conveyance two or more cars. Scantling, sawn or hewn, and ship plank or deck plank, or other long lumber, must not be piled higher than the tariff quantity of the same description of goods would reach, if upon one car; owners to produce survey bill when required by the station-master, or other duly authorized agent; and in case of dispute as to the quantities, the lumber may be re-surveyed at the expense of the party proved to be in error.

Pine, hemlock, cedar and spruce.

Scantling, ship plank or deck plank or other long lumber.

Sec. 30. Lumber will be taken to mean timber, deals, boards, planks, ship stuff, cordwood, tamarack fence poles, hoop poles or hop poles, box shooks, clapboards, staves, logs, laths, shingles, railway ties, spars, and all other similar products of the forest. It must in all cases be properly and safely laden upon the cars, and must not project over the ends of the cars, nor shall cross-grained wood be used for stakes. In the event of the owner neglecting or refusing to obey the directions of the station master, or other person authorized by the superintendent in relation thereto, the load will be reduced, if necessary, to bring it within the quantity prescribed for a car load, and afterwards so secured as to make it entirely safe for transportation, the expense of doing this being charged against the goods.

Lumber, meaning of,

Manner of loading lumber.

## Chap. 112

*Intercolonial Railway Regulations.*

Stakes to be used.

Sec. 31. When lumber is put upon one car, care must be taken to have a stake placed near the centre of the length in addition to the others, so as to prevent its being dependent on only two stakes; and when the load is of logs or small round timber, or such description of lumber as tends to settle, and thus produce increased strain upon the stakes, chains or ropes must be used about one third of the height from the top of the load to bind it; and where entire safety cannot be otherwise secured, skids to separate the tiers must also be used.

Manner of loading logs or small round timber.

Sec. 31. When lumber is put upon one car, care must be taken to have a stake placed near the centre of the length in addition to the others, so as to prevent its being dependent on only two stakes; and when the load is of logs or small round timber, or such description of lumber as tends to settle, and thus produce increased strain upon the stakes, chains or ropes must be used about one third of the height from the top of the load to bind it; and where entire safety cannot be otherwise secured, skids to separate the tiers must also be used.

Manner of binding long lumber.

Sec. 32. Long lumber extending over two or more cars must be bound by chains or large ropes. It must not be "bound" by the stakes, but loaded on "bunks," that it may "play" or "swivel" freely.

Risk in carrying lumber.

Sec. 33. Lumber will be carried only at the convenience of the railway, and at the risk of the owner.

Cars laden with lumber.

Sec. 34. Cars laden with lumber will not be allowed to stand over to give owners or consignees choice of positions at the receiving stations when other berths are unoccupied.

Loading cordwood.

Sec. 35. In loading cordwood, sticks must be placed at the edges of the car for the outer ends of the wood to rest upon, that it may tend, when piled, towards the centre. The stakes must be green spruce or straight hardwood of sufficient thickness.

Yardage and charge therefor.

Sec. 36. (a.) Yardage at the rate 10 cents per ton per day will be charged on all lumber or other materials left upon the wharves, or other premises of the railway. This charge will commence 48 hours after the lumber or other materials have been placed on the railway premises.

(b.) This charge will not apply to materials which are in sheds or warehouses, or which are in or on cars.

Goods and live stock, where received.

Sec. 37. Goods and live stock will only be received for transportation at the stations designated from time to time, by the superintendent, for the purpose.

Lumber received at sidings, when.

Sec. 38. (a.) Lumber will only be received for transportation at sidings, unless by previous arrangement it is shown, to the satisfaction of the superintendent, that sufficient for a full train load of twelve cars is so placed that it can readily be laden with the assistance of an engine.

*Intercolonial Railway Regulations.*

## Chap. 112

(b.) A charge of \$2.50 per hour will be made, in addition to the rate per car, when the engine is detained more than five hours. Charge per hour.

Sec. 39. To avoid errors in way-billing loaded cars at sidings, owners should fasten a ticket upon the side of the car stating to whom the load belongs and to whom and where it is to be consigned. Ticket on side of car.

Sec. 40. When goods are required to be loaded by the owner or his agent, or at his expense, all fittings (such as stakes, bunks, skids, chains, ropes, &c., for lumber, and sideboards for sand, bricks, clay, stone, manganese, or articles of a similar character), must be provided by him, or will be charged to him if furnished by the railway. Such fittings will be transported back free, if necessary, but at the owner's risk. Fittings, &c., must be provided by owner.

Sec. 41. When cars, liable to be laden or unladen by the owner or consignee of the goods have been once placed, and for the convenience of the owner, or at his request, are shifted to another berth in the same station yard, a charge of one dollar per car will be made for such service. Car shifted to another berth.

Sec. 42. Cars left at stations or sidings to fill requisitions will be subject to demurrage after twenty-four hours (exclusive of Sunday); they may be handed over or removed to fill other requisitions. Demurrage.

Sec. 43. All cars with lumber should be loaded to their full capacity, as marked upon them, at car load rates per 100 pounds. Cars without capacity marked upon them should only be loaded with 20,000 pounds. In all cases, the actual quantity loaded on the cars is to be charged for at car load rates. The minimum load for a car shall be 20,000 pounds. Cars with lumber should be loaded to their full capacity.

Sec. 44. All regulations previously enacted for the conveyance of live stock, goods or merchandise over this railway, inconsistent with the foregoing are cancelled. Previous regulations cancelled.

O.C. Feb. 25, 1889.

## INTERCOLONIAL RAILWAY TARIFF.

## Freight.

Sec. 15. His Excellency in Council has been pleased to authorize and impose the collection of the following tolls and dues for the carriage of freight upon the Intercolonial Railway, the same being in accordance with a maximum mileage freight tariff submitted by the Minister of Railways and Canals, based on the Canadian Joint Freight Classification, No. 6 taking effect April 15, 1889, and also for storage and wharfage in connection with the said railway.

MAXIMUM General Freight Tariff, governed by the Canadian Joint Freight Classification, and subject to conditions of carriage.

DISTANCES.	CLASSES IN CENTS PER 100 POUNDS.									
	1st.	2nd.	3rd.	4th.	5th.	6th.	7th.	8th.	9th.	10th.
Not exceeding 5 miles.....	7	6	5	4	3½	3½	3	3½	3½	2
Over 5 not over 10 ".....	9	7	6	5	4	4	3	4	4	2½
10 15 ".....	11	8	7	6	4½	4	3½	4½	4½	2½
15 20 ".....	12	9	7	6	5	4½	4	5	5	2½
20 25 ".....	13	10	8	7	6	5	4½	5½	5½	3
25 30 ".....	14	11	9	7	6	5½	4½	6	6	3½
30 35 ".....	15	12	10	8	7	6	5	6½	6½	4
35 40 ".....	16	13	11	8	7	6	5	6½	6½	4
40 45 ".....	17	14	12	9	8	6½	5½	7	7	4½
45 50 ".....	18	15	13	9	8	7	6	7½	7½	4½
50 55 ".....	19	16	14	10	9	8	6½	8	8	5
55 60 ".....	20	17	14	10	9	8	6½	8½	8½	5
60 65 ".....	21	18	14	11	10	9	7	9	9	5½
65 70 ".....	22	19	14	11	10	9	7	9	9	5½
70 75 ".....	23	20	15	11	10	9	7½	9½	9½	6
75 80 ".....	24	21	15	11	10	9	7½	9½	9½	6
80 85 ".....	25	22	15	12	11	10	8	10	10	6½
85 90 ".....	26	23	16	12	11	10	8	10	10	6½
90 95 ".....	27	24	16	12	11	10	8	10	10	7
95 100 ".....	28	24	17	12	11	10	8½	10½	10½	7
100 105 ".....	29	25	17	12	11	10	9	10½	10½	7½
105 110 ".....	30	25	17	12	11	10	9	11	11	7½
110 115 ".....	30	26	18	12	11	10	9	11	11	7½
115 120 ".....	31	26	18	12	11	10	9	11	11½	8
120 125 ".....	31	26	18	12	11	10	9	11	11½	8
125 130 ".....	32	27	18	12	11	10	9	11½	12	8½
130 135 ".....	32	27	19	12	11	10	9	11½	12	8½
135 140 ".....	32	27	19	13	12	11	9½	11½	12½	9
140 145 ".....	33	28	19	13	12	11	10	11½	12½	9½
145 150 ".....	33	28	19	13	12	11	10	11½	12½	9½
150 155 ".....	33	28	20	13	12	11	10	12	13	10
155 160 ".....	34	29	20	14	13	12	11	12	13	10
160 165 ".....	34	29	20	14	13	12	11	12½	13½	10½
165 170 ".....	34	29	20	14	13	12	11	12½	13½	10½
170 175 ".....	35	29	21	14	13	12	11	12½	13½	10½
175 180 ".....	35	30	21	15	14	13	12	12½	13½	11
180 185 ".....	35	30	21	15	14	13	12	13	14	11½
185 190 ".....	35	30	21	15	14	13	12	13	14	11½
190 195 ".....	36	30	22	15	14	13	12½	13	14	12



*Intercolonial Railway Regulations*

INTERCOLONIAL RAILWAY—Continued.

MAXIMUM GENERAL FREIGHT TARIFF—Concluded.

DISTANCES.	CLASSES IN CENTS PER 100 POUNDS.									
	1st.	2nd.	3rd.	4th.	5th.	6th.	7th.	8th.	9th.	10th.
Over 195 not over 200 miles.	36	31	22	16	15	14	12½	13	14	12
200 210	36	31	22	16	15	14	12½	13	14½	12
210 220	36	31	22	16	15	14	12½	13	14½	12
220 230	37	32	23	16	15	14	13	13½	14½	12½
230 240	37	32	23	17	16	15	13	13½	15	12½
240 250	37	32	23	17	16	15	13½	13½	15	13
250 260	38	32	23	17	16	15	13½	13½	15	13
260 270	38	33	24	17	16	15	13½	14	15½	13½
270 280	38	33	24	18	17	16	14½	14½	16	14
280 290	39	33	24	18	17	16	14½	14½	16	14
290 300	39	34	25	18	17	15	14½	15	16	14½
300 310	40	34	25	19	18	17	15	15½	16	14½
310 320	40	34	25	19	18	17	15	15½	16½	14½
320 330	41	35	26	20	19	18	15½	16	17	14½
330 340	41	35	26	20	19	18	15½	16	17	15
340 350	42	36	26	20	19	18	15½	16	17	15
350 360	42	37	27	20	19	18	16	16½	17½	15
360 370	43	37	27	21	20	19	16½	17	17½	15
370 380	43	37	27	21	20	19	16½	17	17½	15½
380 390	44	38	28	22	21	19	16½	17	17½	15½
390 400	44	38	28	22	21	19	16½	17	18	15½
400 420	44	38	28	22	21	19	16½	17	18	15½
420 440	44	38	29	22	21	19	16½	17	18	16
440 460	44	38	29	22	21	19	17	17½	18½	16
460 480	45	39	29	22	21	19	17	17½	18½	16
480 500	45	39	30	23	22	20	17½	18	19	16½
500 520	46	39	30	23	22	20	17½	18	19	16½
520 540	46	39	30	23	22	20	17½	18	19	16½
540 560	47	40	31	23	22	20	18	18½	19½	17
560 580	47	40	31	23	22	21	18½	19	20	17
580 600	48	40	31	24	23	22	18½	19	20	17
600 625	49	41	32	24	23	22	19	19½	20½	17
625 650	50	42	33	25	24	23	19	19½	20½	17
650 675	51	43	33	25	24	23	19½	20	21	17½
675 700	52	44	34	26	25	24	20	21	22½	17½

SMALLS.—No single shipment of freight from one consignor to one consignee will be charged less than for 100 lbs. at 1st-class rate.

Minimum charge, 25 cents.

The above rates cancel all previous tariffs and special rates.

## INTERCOLONIAL RAILWAY OF CANADA.

## MAXIMUM LOCAL HAY AND STRAW TARIFF.

DISTANCES.		Small Lots.	Car Loads
		L. C. L.	Minimum Weight, 20,000 lbs.
		Cents per 100 lbs.	Cents per 100 lbs.
Not exceeding 5 miles	.....	5	3½
Over 5 not over 10	.....	6	4
10	15	7	4½
15	20	7	5
20	25	8	5½
25	30	9	6
30	35	10	6½
35	40	11	6½
40	45	12	7
45	50	13	7½
50	55	14	8
55	60	14	8½
60	65	14	9
65	70	14	9
70	75	15	9½
75	80	15	9½
80	85	15	10
85	90	16	10
90	95	16	10
95	100	17	10½
100	105	17	10½
105	110	17	11
110	115	18	11
115	120	18	11½
120	125	18	11½
125	130	18	12
130	135	19	12
135	140	19	12½
140	145	19	12½
145	150	19	12½
150	155	20	13
155	160	20	13
160	165	20	13½
165	170	20	13½
170	175	21	13½
175	180	21	13½
180	185	21	14
185	190	21	14
190	195	22	14
195	200	22	14
200	210	22	14½
210	220	22	14½
220	230	23	14½
230	240	23	15
240	250	23	15
250	260	23	15
260	270	24	15½
270	280	24	16
280	290	24	16
290	300	25	16
300	310	25	16
310	320	25	16½
320	330	26	17
330	340	26	17
340	350	26	17

*Intercolonial Railway Regulations.*

**Chap. 112**

INTERCOLONIAL RAILWAY—*Concluded.*

DISTANCES.	Small Lots. L. C. L.	Car Loads Minimum Weight, 20,000 lbs.
	Cents per 100 lbs.	Cents per 100 lbs.
Over 350 not over 360 miles.....	27	17½
360 370 “.....	27	17½
370 380 “.....	27	17½
380 390 “.....	28	17½
390 400 “.....	28	18
400 420 “.....	28	18
420 440 “.....	29	18
440 460 “.....	29	18½
460 480 “.....	29	18½
480 500 “.....	30	19
500 520 “.....	30	19
520 540 “.....	30	19
540 560 “.....	31	19½
560 580 “.....	31	20
580 600 “.....	31	20
600 625 “.....	32	20½
625 650 “.....	33	20½
650 675 “.....	33	21
675 700 “.....	34	22½

When shipments are made in car loads, the loading and unloading shall be performed by owners, or at their expense. Hay or straw, loosely pressed, and occupying a whole car, minimum weight of 20,000 lbs. to be charged for.

The above rates cancel all previous tariffs and special rates.

## INTERCOLONIAL RAILWAY.

*Wharfage.*

Sec. 46. The following rates of wharfage are to be charged vessels using the railway wharves, except in cases where the vessel is lying to unload goods to be carried by the railway, or where the vessel may be receiving articles directly from the railway. Vessels in all cases to lie where directed by the agent or wharfinger for the time being:—For every decked vessel or wood-boat of the burden of 40 tons or under, 30 cents per day; above 40 tons and under 50 tons, 35 cents; above 50 and under 60, 40 cents; above 60 and under 70, 45 cents; above 70 and under 80, 50 cents; above 80 and under 90, 55 cents; above 90 and under 100, 60 cents; above 100 and under 120, 70 cents; above 120 and under 150, 80 cents; above 150 and under 180, 90 cents; above 180 and under 200, \$1.00; above 200 and under 220, \$1.10; above 220 and under 240, \$1.20; above 240 and under 260, \$1.30; above 260 and under 280, \$1.40; above 280 and under 300, \$1.50; above 300 and under 320, \$1.60; above 320 and under 340, \$1.70; above 340 and under 360, \$1.80; above 360 and under 380, \$1.90; above 380 and under 400, \$2.00; above 400 and under 450, \$2.25; above 450 and under 500, \$2.50; and 25 cents for each additional 50 tons.

## TOP WHARFAGE.

Articles.	Rate.	Cents.
A.		
Acids.....	Per Carboy.....	2
Ale, porter, beer.....	Cask.....	4
Almonds.....	Brl. or Bag.....	1
Antimony.....	Brl.....	1
Anchors.....	Ton 2,000 lbs.....	20
Animals.....	Each.....	10
Anvils.....	Each.....	1
Apples.....	Per Brl.....	1
Ashes (pot and pearl).....	Brl.....	1
Asphalt.....	Brl.....	2
Axes.....	Dozen.....	1
Axles.....	Sett.....	1
B.		
Bacon.....	Per Brl.....	1
do.....	Cask.....	2
Bags.....	Bale.....	2
Barley.....	Brl.....	1
Bath tubs.....	Each.....	4
Bark (tan).....	Per Cord.....	5
Bark (extract).....	Cask.....	2
Baskets.....	Dozen.....	2

*Intercolonial Railway Regulations.*

Chap. 112

TOP WHARFAGE—*Continued.*

Articles.	Rate.	cts.
<b>B</b>		
Batting.....	Per Bale.....	3
Ballast.....	Ton 2,000 lbs.....	10
Bales and boxes (merchandise).....	Each.....	7
Bedsteads.....	Each.....	2
Belting (all kinds).....	Per Roll.....	1
Beef.....	Brl.....	2
Beans.....	Brl.....	1
Biscuits.....	Brl.....	1
Block tin.....	Ton 2,000 lbs.....	20
Boilers, for machines.....	do.....	20
Boiler flues.....	do.....	20
do plates.....	do.....	20
do (farmers).....	Each.....	2
Bones.....	Per Ton 2,000 lbs.....	20
Bone dust.....	Brl.....	1
Boats.....	Each.....	15
Bottles (crates).....	Each.....	2
Bows (carriage).....	Per Bdl.....	1
Boxes (waggon).....	Sett.....	1
Bran and shorts.....	Ton 2,000 lbs.....	20
Brick machines.....	Each.....	2
do.....	Per M.....	20
Brooms.....	Dozen.....	1
Broom corn (in bales).....	Each.....	3
Broom handles.....	Per Bdl.....	1
Buffalo robes.....	Per Bale.....	2
Buckets or pails.....	Dozen.....	1
Building stone.....	Ton 2,000 lbs.....	20
Boards.....	M.....	5
Boxes, not less than 112 lbs.....	Each.....	1
Burr, block and mill stones.....	Each.....	10
Butter (Firkins).....	Each.....	1
Burial cases.....	Each.....	2
<b>C.</b>		
Chains and cables.....	Per Ton 2,000 lbs.....	20
Camphene.....	Brl.....	2
Candles.....	Box.....	1
Canada plates.....	Box.....	2
Capstans.....	Each.....	5
Carriages (all kinds).....	Each.....	10
Castings (all kinds).....	Per Ton 2,000 lbs.....	20
China (Crates).....	Each.....	5
Cement.....	Per Brl.....	1
Chair stuff.....	Bdl.....	1
Cider.....	Brl.....	1
Clay, fire and brick.....	Ton 2,000 lbs.....	20
Clapboards.....	M.....	10
Cotton warps.....	Bale.....	2
do waste.....	Bale.....	2
Coal.....	Ton 2,000 lbs.....	5
Composition bars, bolts, sheets, &c.....	do.....	20
Coal facings.....	Brl.....	1
Codfish.....	Bdl.....	1
do.....	Box.....	1
Cornmeal.....	Brl.....	1
Crockery.....	Cask.....	2
do.....	Crate.....	5
Cranberries.....	Brl.....	1
Calves.....	Each.....	1

TOP WHARFAGE—Continued.

Articles.	Rate.	cts.
<b>D.</b>		
Demijohns or jars.....	Each.....	2
do (empty).....	Each.....	1
Drugs.....	Per Brl.....	1
do.....	Case.....	1
Duck.....	Bale.....	2
<b>E.</b>		
Earth paints.....	Per Brl.....	1
Engines (steam).....	Ton 2,000 lbs.....	20
Excelsior.....	Bale.....	3
<b>F.</b>		
Fence, wire.....	Per Roll.....	1
Felt.....	Roll.....	1
Fish.....	Brl.....	2
do dry.....	Bdl.....	1
Flax seed.....	Brl.....	1
Flock.....	Bale.....	4
Flour.....	Brl.....	1
do.....	Bag.....	1
Friction matches.....	Case.....	3
Fruit.....	Brl.....	1
do.....	Box.....	1
Furniture.....	Ton 2,000 lbs.....	30
<b>G.</b>		
Glue.....	Per Brl.....	1
do.....	Case.....	1
Glassware.....	Brl.....	1
do.....	Crate.....	5
Glass (window).....	100 ft.....	1
Grates.....	Each.....	1
Gravel.....	Per Ton 2,000 lbs.....	20
Grindstones.....	do.....	20
Grease.....	Brl.....	1
Groceries, not otherwise mentioned.....	Brl.....	1
	Box.....	1
	Case.....	2
	Ton 2,000 lbs.....	20
Gypsum.....	Keg.....	1
Gunpowder.....	100 Bushels.....	20
Grain (all kinds).....		
<b>H.</b>		
Haberdashery.....	Per Bale.....	2
	Case.....	2
Hay cutters.....	Each.....	1
Hardware.....	Per Brl.....	1
	Case.....	2
Hay and straw.....	Ton 2,000 lbs.....	20
Hides.....	Green, Each.....	1
	Green in bales.....	10
Hollowware.....	Per Brl.....	1
	Ton 2,000 lbs.....	20
do.....		
Hose, rubber, &c.....	Bdl.....	1
Hoops.....	Bdl.....	1
Herring (smoked).....	Box.....	1

*Intercolonial Railway Regulations.*

Chap. 112

TOP WHARFAGE—Continued.

Articles.	Rate.	
I.		
Ice .....	Per Ton 2,000 lbs. ....	20 cts.
Iron and brass, bars .....	do .....	20
do bundles .....	do .....	20
do scrap .....	do .....	20
J.		
Junk .....	Per Ton 2,000 lbs. ....	20
K.		
Kettles .....	Per Brl. ....	1
L.		
Lemons .....	Per Box .....	1
Lead pipe .....	Bdl. ....	1
do .....	Ton 2,000 lbs. ....	20
Lignunvite .....	do .....	20
Liquors .....	Cask .....	3
do .....	Puncheon .....	7
do .....	Can. ....	1
Lime .....	Cask .....	6
do in Bulk .....	Ton 2,000 lbs. ....	20
Lumber .....	M. ....	10
M.		
Meal, all kinds .....	Per Bbl or Bag .....	1
Machinery .....	Ton 2,000 lbs. ....	20
Machines, Planing, &c. ....	do .....	20
Manures, all kinds .....	do .....	20
Manganese .....	do .....	20
Mattresses .....	Bales. ....	5
Marble .....	Ton 2,000 lbs. ....	20
Melodeons .....	Each .....	5
Minerals .....	Per Ton 2,000 lbs. ....	20
Molasses .....	Puncheon .....	7
do .....	Tierce .....	5
N.		
Nails .....	Per Keg. ....	1
Nuts, of all kinds .....	Bag or Brl. ....	1
O.		
Oars .....	Per 100 .....	10
Oakum .....	Bdl. ....	1
Oil .....	Cask .....	2
Oil .....	Brl. ....	1
Onions .....	Brl. ....	1
P.		
Paints .....	Per Keg. ....	1
do .....	Ton 2,000 lbs. ....	20
Paper hangings .....	Bale .....	1
do (printing and wrapping) ..	Bdl. ....	1
Peas .....	Brl. ....	1
Pelts .....	Bdl. ....	1

TOP WHARFAGE—*Concluded.*

Articles.	Rate.	cta.
P		
Pipes (stove).....	Per 100 lbs.....	1
Plaster.....	Brl.....	1
Potatoes.....	Brl.....	1
Pork.....	Brl.....	2
Pumps.....	Each.....	2
Puncheons, all kinds, not otherwise provided for.....		7
Q.		
Quartz.....	Per Ton 2,000 lbs.....	20
R.		
Raisins.....	Per Box.....	1
Rags.....	Ton 2,000 lbs.....	20
Rice.....	Bag.....	1
do.....	Tierce.....	3
Rigging.....	Ton 2,000 lbs.....	20
Rope.....	do.....	20
Roofing composition.....	Brl.....	2
S.		
Sails.....	Per Ton 2,000 lbs.....	20
Salt.....	Bag.....	1
Salt.....	Ton 2,000 lbs.....	10
Sand and slate.....	do.....	20
Sewing machines.....	Each.....	2
Shrubbery.....	Per case.....	5
Shovels and spades.....	Per Bdl.....	1
Ship blocks.....	Bdl.....	1
Spring beds.....	Bdl.....	2
Spirits (all kinds).....	Brl.....	2
Stoves.....	Each.....	2
Stone.....	Per Ton 2,000 lbs.....	20
Sugar.....	Hhds.....	7
do (bags or barrels).....	Ton 2,000 lbs.....	10
Syrups.....	Brl.....	2
Sleepers (railway).....	M.....	25
Sheep.....	Each.....	2
Soap.....	Per box.....	1
T.		
Tar.....	Per Brl.....	1
Tallow.....	Brl.....	1
Tea.....	Box.....	1
Tobacco.....	Box.....	1
Trunks.....	Each.....	1
Turpentine.....	Per Brl.....	2
Tubs (in nests).....		2
Tubs.....	Per 100 cubic feet.....	25
V.		
Vehicles (undescribed).....	Each.....	5
Vinegar.....	Per Brl.....	2
W.		
Waggons, buggies, gigs.....	Each.....	5
Wood (fire).....	Per cord.....	5



*Intercolonial Railway Regulations.*

Chap. 112

Goods not coming under any class enumerated in the Tariff shall be charged the same rate as the class to which they are most nearly assimilated

Each entry shall pay not less than 5 cents.

All empty packages to pay half the rate of full packages.

### Sec. 47. STORAGE TARIFF ON THE INTERCOLONIAL RAILWAY.

(a.) *Flour and Meal in Barrels and Bags—*

	Per Brl.	Per 100 Lbs.
For 48 hours after arrival of cars.....	Free.	Free.
After 48 hours, and for 10 days thereafter.....	2 cents.	1 cent.
If allowed to remain more than 10 days, for each 10 days or part thereof.....	2½ cents.	1¼ cents.

(b.) *Grain, Feed, etc., in Bags—*

For 48 hours after arrival.....	Free	
After 48 hours, and for ten days thereafter.....		1 cent.
For each succeeding 10 days or part thereof.....		1½ cent.

(c.) *Grain, Feed, etc., in Bulk (to be unloaded by owner)—*

For 48 hours after arrival.....	Demurrage.
For each day thereafter.....	Free.
	\$1 per car.

(d.) Shipments of flour and meal, *via* I. C. R. from Ontario or United States, for re-shipment to Europe or shore ports from Richmond wharf, will be allowed free storage for first twenty days; after that time to be charged at above rates.

(e.) *Goods and Merchandise of all kinds—*

For 48 hours after arrival.....	Free.
After 48 hours, and for 10 days thereafter.....	1 cent per 100 lbs.
For each succeeding 10 days or part thereof.....	1¼ do
Consignments of all kinds in car loads (except grain and feed) will be charged demurrage.....	\$2.00 per car per day.

Goods and Merchandise remaining in the railway warehouses or in the cars will be entirely at the owner's risk for any damage arising from any source whatever.

No charge less for any consignment than twenty-five (25) cents.

*Canadian Joint Freight Classification.***CANADIAN JOINT FREIGHT CLASSIFICATION.**

No. 6.

*TAKING EFFECT APRIL 15th, 1889.*

## ADOPTED BY

CANADIAN PACIFIC RAILWAY.  
 CANADA ATLANTIC RAILWAY.  
 CENTRAL ONTARIO RAILWAY.  
 CENTRAL VERMONT RAILROAD (in Canada).  
 CUMBERLAND RAILWAY & COAL CO.  
 ERIE & HURON RAILWAY.  
 GRAND TRUNK RAILWAY.  
 INTERCOLONIAL RAILWAY (Through Canadian Traffic).  
 KINGSTON & PEMBROKE RAILWAY.  
 LAKE ERIE, ESSEX & DETROIT RIVER R'Y.

MANITOBA & NORTH-WESTERN RAILWAY.  
 MICHIGAN CENTRAL RAILROAD (Canada Division).  
 NIAGARA CENTRAL RAILWAY.  
 PONTIAC PACIFIC JUNCTION RAILWAY.  
 QUEBEC CENTRAL RAILWAY.  
 QUEBEC & LAKE ST. JOHN RAILWAY.  
 { BAY OF QUINTE RAILWAY & NAV. CO.  
 { NAPANEE, TAMWORTH & QUEBEC R'Y.  
 { THOUSAND ISLANDS RAILWAY.  
 TEMISCOUATA RAILWAY.

**Explanation of Terms and Characters used.**

The number of the Class is given opposite each article:—1, 2, 3, 4, 5, 6, 7, 8, 9, 10, stand for first, second, third, fourth, fifth, sixth, seventh, eighth, ninth and tenth Classes respectively; 1½ stands for once and a-half first class; D-1 for double first class; 3-1 for three times first class; 4-1 for four times first class; C.L. stands for carload; L.C.L. for less than carload; O.R. stands for owners' risk; K.D. stands for knocked down; S.D. stands for single deck; D.D. for double deck.

Articles not enumerated should be classed with similar or analogous goods.

For Tables of Estimated Weights, etc., see pages 44-47.

**Special Regulations and Conditions.**

1. The minimum weight for carloads of 1st, 2nd, 3rd, 4th, 5th, 6th and 9th Class Freights is 20,000 lbs. per car; and for 7th, 8th and 10th Class Freights 24,000 lbs. per car, unless otherwise specially stated. Carloads to be entitled to C.L. rate must be from one Shipper to one Consignee. All cars may be loaded up to their full capacity at L.C.L. or C.L. rates, as the case may be. Refrigerator cars, when supplied for perishable or other freight, will be charged ordinary rates for 1st, 2nd, 3rd, 4th, 5th or 6th Class traffic, but if traffic lower than 6th Class be loaded the minimum charge will be C.L. at 6th Class rate.

2. Mixed freight will not be taken at C.L. rate, but each description must be weighed, and charged as per classification, except as provided for in rules 3 and 4. and as otherwise provided for in this classification.

3. When a number of different articles of the same class in carloads embraced in one line of trade are shipped at one time by one Shipper to one Consignee at one point of delivery, in full carloads, they shall be taken at the rate per hundred pounds for such class in C.L. This rule will not apply on mixed shipments of Groceries, Hardware, Dry Goods, Iron, etc., but only to different articles of one straight line of trade.

4. When the minimum carload weight or more of one article is shipped in one day by one Consignor to one Consignee the established rate for a carload should apply on the entire lot, although it may be less than two full carloads; the actual weight of the balance to be charged for at the C.L. rate, reference being made on the way-bill for the balance of the lot to the way-bill for the full carload or loads.

This, however, will not apply on shipments of Agricultural Implements, Machinery, Live Stock, Vehicles, Furniture, Woodenware, Baskets, Empty Barrels, Casks or Boxes, Flour, Hay, Coal, Scrap Iron, and all bulk freights commonly carried in C. L. lots, as Grain, Mill Feed, Lumber and other rough forest products, Joiner's Work, Lime, Brick, etc.; also all light or bulky goods which will not load 20,000 lbs. per car. In all such cases excess lots, for which an extra car is necessary, will be charged at the L.C.L. rates.

5. Freight from one Shipper to one Consignee should not be charged more for a smaller than for a greater quantity, where varying quantities of the same description of goods are classed differently. For instance: 4 bbls. of ale, etc., should not be charged more than for 5 bbls.; 49 bbls. of apples and under should not be charged more than for 50 bbls.; 129 bbls. or under should not be charged more than for 130 bbls.; 120 bbls. flour should not be charged more than for 125 bbls.; nor should an L.C.L. weight at a higher class be charged more than the sum for a C.L., where C.L. classification of the same freight is given.

6. Where C.L. is not quoted the classification given is to apply, irrespective of quantity.

7. All articles, except as otherwise specified, will be taken at actual gross weight; provided, however, that any article not otherwise provided for herein, requiring a whole car for carriage (whether full capacity of car be occupied, or otherwise), if 10,000 lbs. weight or under, will be charged a minimum of 20,000 lbs. at 7th Class, and if over 10,000 lbs. a minimum of 20,000 lbs. at 6th Class. These minimums will not apply in cases where the actual gross weight as per Classification would give a higher charge.





Canadian Joint Freight Classification.

	L.C.L.	C.L.		L.C.L.	C.L.
Balusters—See Joiners' Work.			Birds, Stuffed—See Stuffed Birds, etc.		
Band Boxes, not boxed or crated, O.R.	4	1	Biscuits, in boxes or barrels	2	4
"    nested and crated, O.R.	3	1	Bitters—Same as Liquors.		
"    nested and boxed, O.R.	D	1	Blacking	2	4
Barilla	2	4	Black Lead	2	4
Bark, Extract of, in casks, O.R.	1	4	Blankets, in bales	1	
"    Tanners, box cars 30 feet or under,			Bleaching Salts	4	5
minimum 20,000 lbs., flat cars and			Blinds, Wooden—See Joiners' Work.		
box cars over 30 feet, 24,000 lbs.	7		Block Shells	3	5
"    Ground, in barrels, casks or sacks	3	5	Blocks, Butchers'	3	
"    Slippery Elm, in boxes, barrels or			"    Pulley or Tackle	3	5
bundles	1		Blowers, Iron Rotary	2	
Barley, Pearl, Pot and Common—See Grain.			Blue Stone or Vitriol, in kegs or boxes	2	4
Barrels, Empty—Flour, Sugar and Apple,			Bluing, Liquid, Cake or Ball	1	
prepaid	D	1	Boats, Racing—Taken by special contract		
"    Ale, Oil, and other iron			only.		
hooped barrels and casks			Boats, Steam Yachts or Launches, O.R.,		
prepaid	1½		released, 30 feet long or under, requir-		
"    all kinds, C. L. 20,000			ing a flat car for carriage, if 10,000		
"    lbs., prepaid	10		lbs. or under, to be charged 20,000 lbs.		7
"    returned—See Empties			If over 10,000 lbs., to be charged C.L.		6
Returned.			Canoes, 20 feet and under, estimated		
Barrel Covers	1	7	weight 700 lbs. each, O.R., released	1	
Barytes	3	5	Canoes, nested and crated, actual weight	1½	
Baskets, Wicker or Willow	4	1	Boats, Skiffs and Pleasure Boats, 15 feet		
"    "    nested	3	1	and under, estimated weight 800		
"    Stave and Splint, nested	D	1	lbs. each, O.R., released	1	
"    Flag, for mechanics' tools, nested	D	1	"    20 feet and under, estimated weight		
"    all kinds, nested, crated or boxed	D	1	1,200 lbs. each, O.R., released	1	
"    all kinds, C.L. 20,000 lbs.	10		"    30 feet and under, estimated weight		
Bath Brick, in barrels or boxes	3		2,000 lbs. each, O.R., released	1	
Bath Tubs, wood, tin or copper	D	1	"    over 30 feet long. Taken by special		
"    wood, tin or copper, nested or			contract only.		
boxed	1	6	"    under 30 feet long, C.L., 20,000 lbs.,		
Batting, in bundles, O.R.	D	1	O.R., released		6
"    pressed, in bales or cases	1		"    or Sleds, for hauling stone or clay	3	6
Baseball Bats, in bundles	2		"    Lumbermen's, and Batteaux, 30 feet		
"    in boxes	3		and under, estimated weight 2,000		
Bay Rum, in glass or stone, packed in			lbs. each, O.R., released	1	
wood, O.R.	1		"    Lumbermen's, and Batteaux, C.L.,		
Bay Rum, in wood	2		20,000 lbs., O.R., released	10	
Beans—See Grain.			Bobbins—Same as Spools.		
Bedding—See Household Goods.			Boilers (and fixtures, shipped together), 28		
Bedsteads, Iron—See Iron.			feet and under, loaded and		
"    Wood—See Furniture.			unloaded by owners	1	6
Bee Hives, set up	D	1	"    over 28 feet long. Taken by		
"    nested	1	4	special contract only.		
"    K.D., in bundles, or packed in			"    requiring a whole car for carriage		
boxes or hives	3	5	(whether full capacity of car be		
Bees, in Hives, O.R., released	3	1	occupied or otherwise), if 10,000		
Owners to load and unload. Man in			lbs. or under, to be charged		
charge of carload lots passed free.			20,000 lbs.		7
Bees' Wax	1		"    if over 10,000 lbs., to be charged		
Beer—See Ale.			C.L.		6
Beets—See Vegetables.			Boiler Compound, in kegs or barrels	3	5
Bellows, O.R., released	1		"    Flues or Tubes	2	4
Bells, O.R.	1		"    Plates—See Iron.		
"    Small, in cases—See Hardware.			Bolster Plates—See Iron.		
Belting, Leather or Rubber, O.R.	2	4	Bolsters—Feather, Hair, etc.	D	1
Bent Stuff—See Carriage Goods.			Bone Black	3	5
Benzine or Benzole, in wood—Same as			"    Dust, in barrels or casks	1	5
Coal Oil.			Bones, in sacks or casks, less than 10,000		
Must not be taken for shipment by water.			"    "    "    lbs.	3	
Berries—See Fruit.			"    "    "    10,000 lbs. and		
Bicycles—See Vehicles.			over	4	
Billiard Tables and Fittings, K.D., boxed,			"    in sacks, casks or bulk, C.L.		10
O.R.	1		Bonnets—See Millinery.		
Billiard Tables, not boxed. NOT TAKEN.			Books, in boxes or cases	1	
Binders' Boards, O.R.	3	5	Boots and Shoes, in trunks, O.R.	1½	4
Bird Cages, in boxes, O.R.	D	1	"    "    in cases	1	4

Canadian Joint Freight Classification.

		L.C.L.	C.L.			L.C.L.	C.L.
Boot Crimps.....		1		Butter in tubs and firkins, nested, covers in		2	6
Boralumine .....		3	5	"    Workers, set up.....		1½	
Borax.....		3		Buttons, in cases or boxes.....		1	
Bottles—See Glassware.				C			
Bows—See Carriage Goods.				Cabbage—See Vegetables.			
Boxes, Wooden, Empty, prepaid.....	D	1		Cables, Chain—See Chain.			
"    "    "    nested, or with				Calamine, in packages.....		3	
"    "    "    inside divisions				Caloric Engines.....		1	
"    "    "    for bottles.....		1		Camphene, in wood only, O.R.....		1	
"    "    "    C.L., 20,000 lbs....			10	This Freight must not be taken for ship-			
"    Butter, Cheese, Grease, Fig, Spice		1		ment by water, except by special			
"    or Bail, in crates, boxes or cases..		1		contract.			
"    Paper, Empty, not boxed, O.R.....	4-1	6		Camphor Gum.....		1	
"    "    "    nested and crated,			5	Canada Plate.....		3	5
"    "    "    O.R.D.....		1		Candied Peel, in boxes or barrels.....		1	
"    "    "    nested and boxed,			6	Candles, Tallow.....		3	5
"    "    "    O.R.D.....		1		"    Wax and Paraffine.....		2	4
Box Stuff, in bundles or shooks.....		3		Canes, Walking, in bundles.....	D	1	
Brackets—See Furniture.				"    "    in boxes.....		1	
Bran.....		4	8	Cane Splints, in bundles.....		1	
Brandy—See Liquors.				Canned Goods—Fish, Vegetables, Berries,			
Brass, Car Brasses or Bearings.....		2	5	Fruit and Potted Meats.....		3	5
"    manufactured, not otherwise speci-		1	4	Cannon, and Cannon Balls. Taken by			
"    in Sheets, Rolls, Rivets or Tubing..		2	4	special contract only.			
Brass, Scrap.....		3	6	Cant Hooks and Peaveys.....		2	
Bread, prepaid, O.R.....		1		Canvas, in rolls.....		1	
Brewers Finings (liquid), in casks or bbls.		2	4	"    in bales.....		2	
Bricks, Common.....		4	4	Capstans.....		2	
"    Fire.....		3	7	Carbon Points (Electric Light).....		1	
"    for stove lining, loose, O.R.....		1	7	Carboys, empty, O.R.....		1	6
"    "    "    in boxes or bar-			7	Car Brasses—See Brass.			
"    "    "    rels, O.R.....		3	7	Cardboard, in cases.....		2	
Brimstone, in packages.....		2	4	Cards, in cases—Same as Stationery.			
Bristles, in packages.....		1		Carpenters' Tools, in chests.....		1	
Britannia Ware, boxed.....		1	4	Carpets and Carpeting, in bales, O.R. of			
Bromide of Ammonia, in boxes or barrels.		2	4	"    chafing.....		1	3
"    Potash.....		2	4	Carpet Lining and Stair Pads.....		1	3
"    Soda.....		2	4	Carpet Seepers, loose, O.R.....	D	1	
"    in iron drums.....		3	4	"    boxed.....		1	
Bromine, in glass, packed in wood.....		1		Carriages—See Vehicles.			
Brooms, in bales, bundles or racks.....		1	5	Carriage Goods, as follows:—			
"    boxed, handles detached.....		2	5	Bows, in bundles.....		1	
Broom Corn, pressed, in bales, O.R.....		1	5	Carriage Stuff, not otherwise specified..		2	
"    Handles—See Handles.				Hubs.....		3	
"    Racks, Wooden.....		1	6	Hub-Blocks.....		4	10
Bronze Powder, in cases.....		1		Rims or Felloes.....		3	
Bronzeware, in boxes or cases.....		1		Running Gear, wheels off.....		1	
Brush Backs, Wooden, in boxes.....		3	5	Shafts, Unfinished, in bdls., Tongues and			
Brushes, in boxes.....		2	4	"    Poles.....		3	
Buckets, Iron—See Iron.				Spokes, in bundles.....		3	
"    Wooden—See Woodenware.				Thills, Finished.....	D	1	
Backwheat—See Grain.				"    Unfinished, in bundles.....		3	
"    Meal—See Flour and Meal.				Thimble Skeins—See Iron.			
Buffalo Robes, in bales, O.R.....		1	3	Wheels, Finished, without tires.....		1½	
Buggies—See Vehicles.				"    Finished, with tires.....		1	
Bulbs and Roots, in packages, prepaid, O.R.		1		"    Unfinished, in white, without			
Bungs, Wooden, in bags.....		2	4	"    tires.....		1	
"    in boxes or barrels.....		3	4	"    Unfinished, in white, with tires		2	
Burial Cases, Wooden or Metallic, O.R.,				Whiffletrees, Unfinished, in bundles.....		3	
released.....	1½	4		Carriage Goods and Bent Stuff (except			
"    "    Wooden or Metallic, nested,				Hub-Blocks).....			6
"    "    O.R., released.....		1	4	Cars, Railway, on own wheels, O.R			
Burlaps.....		3	5	released:—			
Burr Stones or Blocks.....		3	5	Sleeping Cars.....each, 15c. per mile.			
Butter, in crocks, jars, baskets or pails,				Passenger Cars.....    "    12c.    "			
O.R.....		1	3	Mail, Baggage or Express			
"    in tubs, firkins, kegs, boxes or				Cars.....    "    10c.    "			
"    barrels, O.R.....		2	3				
"    Tubs and Firkins.....		1	6				

*Canadian Joint Freight Classification.*

	L.C.L.	C.L.		L.C.L.	C.L.
Cars, Railway, &c.					
Freight Box Cars.....each	8c.	per mile.			
Platform and Coal Cars " "	6c.	"			
4-Wheel Box. Platform or Coal Cars..... " "	5c	"			
Minimum charge \$6.00.					
Railway cars requiring transportation on other cars taken by special contract only.					
Cars, Street, 1-Horse, estimated weight 6,000 lbs.....	1	4			
" " 2-Horse, estimated weight 8,000 lbs.....	1	4			
" Hand, Push or Logging, set up.....	1	6			
" " " " R.D.....	5	6			
Car Pushers.....	3				
Car Springs, Rubber, Spiral or Elliptic.....	3	5			
Car Wheels and Axles.....	4	7			
Cartridge Shells or Cases, empty.....	1				
Cartridges, Metallic (when authorized to be taken), closely and securely boxed	1				
Carts—See Vehicles.					
Cassia, in bales or boxes.....	1				
Castor Oil, in tin or glass, boxed.....	1	4			
" " in casks, O.R. of leakage.....	2	4			
Catsup, in glass, boxed, O.R.....	1				
" " in kegs or casks, O.R.....	3				
Cattle Food, Patent or Concentrated, in boxes, barrels or bags.....	3	5			
" " Chopped Straw, Hay, Versilage, and similar common Cattle Food.....	4	8			
Cattle Tails.....	2				
Cedar Posts and Ties. Taken by special contract only.	1				
Celluloid, in bundles.....	1				
" " in boxes.....	2	5			
" " Goods, in boxes.....	1				
Cement, in sacks or barrels.....	4	10			
Cereals, not otherwise specified, rolled, pressed, cracked, dried or desiccated, in boxes.....	3	5			
" " Same in bags or barrels.....	4	5			
Chain, other than Cable, loose.....	2	4			
" " in boxes or barrels.....	3	5			
" " Cable, half inch and over.....	3	4			
Chalk, in boxes.....	2				
" " in barrels or casks.....	4				
Charcoal, in sacks or barrels.....	2				
Cheese, in boxes or casks, O.R. from weather Presses—See Machinery	3	4			
" Safes, loose or in bundles.....	4-1				
" " crated.....	3-1				
" " boxed.....	D1				
" " Setters.....	1				
" " Vats, set up.....	D1				
" " requiring a whole car for carriage (whether full capacity of car be occupied or otherwise), if 10,000 lbs. or under, to be charged 20,000 lbs.....		7			
" " if over 10,000 lbs., to be charged C.L.....		6			
" " Box Stock.....	3	6			
Chicken Coops, prepaid.....	D1				
Chicory, in cases.....	2				
" " in bags or barrels.....	3	5			
Children's Carriages, Sleds, etc.—See Vehicles					
Chimney Pots, Zinc.....	D1				
Chimney Pots, Earthenware.....	2	4			
Chlorate of Potash, in kegs.....	3	5			
Chloride of Lime, in boxes.....	3	5			
" " in casks or barrels.....	4	5			
" " of Calcium, in boxes or barrels.....	1				
" " in drums.....	3				
Chocolate, in boxes.....	1				
Churns, loose.....	D1	6			
" " boxed or racked.....	1	6			
Cider. Same rates and conditions as Ale.					
Cider Mills and Presses.—See Machinery.					
Cigars and Cigarettes, in cases, securely strapped.....	1½				
" " not strapped, nor TAKEN.					
Cinnamon—See Spices.					
Cisterns, Wooden, set up.....	D1				
" " " " K.D.....	3	5			
" " " " requiring a whole car for carriage (whether full capacity of car be occupied or otherwise), to be charged 20,000 lbs.....		10			
Clams—See Oysters.					
Clay, Fire Pottery, etc.....	4	10			
Clay Birds or Balls—See Balls.					
Clocks and Weights, boxed, O.R.....	1				
Clothes Lines—See Cordage.					
Clothes Frames or Horses.....	1				
Clothes Pins, less than 50 boxes.....	2				
" " 50 boxes and over.....	3	5			
Clothes Wringers and Washers, not boxed	1½				
" " boxed.....	2				
Clothing (not personal effects) in trunks.....	D1				
" " " " boxed.....	1				
Clover Seed—See Seed.					
Cloves—See Spices.					
Coal, Mineral and Coke.....	4	10			
Coal Facings.....	3	5			
Coal Hods or Scuttles, O.R.....	1				
Coal Oil—See Oils.					
Cocoa, in boxes.....	1				
Cocoanuts, in bags.....	1	4			
" " in boxes, barrels or casks.....	2	4			
" " (desiccated), in boxes.....	1	4			
" " " " in barrels.....	2	4			
Cocoa Matting—See Matting.					
Coffee, Essence or Extract, in cases.....	1				
" " Roasted, Ground or Unground, in sacks, boxes, barrels or tins, crated	3	5			
" " in tins, not crated or boxed, O.R.....	1				
" " Green, in sacks or barrels.....	4	5			
Coffee Mills.....	1				
Coffins—See Burial Cases.					
Cogs, Wooden, in boxes or barrels.....	3				
Combs in cases.....	1				
Concentrated Lye.....	2				
Confectionery, O.R.....	1	4			
Contractor's Plant, consisting of vehicles, derricks, tools and dredges.....		6			
Cooper's Flags.....	1				
Copperas, in boxes or kegs.....	2	5			
" " in bbls. or casks.....	3	5			
Copperine.....	3	5			
Copper Stills and Worms.....	D1				
" " Bottoms, Bolts, Nails, Sheets, Rod, Wire and Ingots.....	2	4			
" " Vessels, very large. Taken by special contract only.					

Canadian Joint Freight Classification.

	L.C.L.	C.L.		L.C.L.	C.L.
Copper, Scrap and Pig.....	3	6	Cutch .....	3	5
Ore.....	4	10	Cutlery—See Hardware.		
Oxide.....	3				
Manufactured, not otherwise specified.....	1		<b>D</b>		
Copying Presses.....	1		Dates—See Fruits.		
Cordwood. Taken by special contract only.			Deck, Vault or Floor Lights—See Glass.		
Cordage, Rope and Rigging.....	3	5	Deer, in carcass, O.R.....	D 1	
Clothes Lines, Small Cord and Twine.....	2	4	Dental Goods.....	1	
Binding Cord for Harvesters, in bales or boxes.....	3	5	Demijohns, Empty, O.R.....	D 1	4
Lath Yarn.....	3	5	in casks or cases, O.R.....	1	4
Corks and Corkwood.....	1	4	Derricks, too large to go into an ordinary box car, and necessitating a platform car for carriage, if 10,000 lbs. or under, to be charged 20,000 lbs.....		7
Cork, Ground, compressed in packages....	3	5	if over 10,000 lbs. to be charged C.L.....		6
Cornices, Metallic, in frame or open box.....	3-1		Desks—See Furniture.		
" K.D., well boxed.....	1	6	Dirt Scrapers.....	1	
Cornices, Wooden.....	1	6	Dowel Rods or Pins.....	3	6
Cornice Poles, in bundles or cases.....	1		Dressed Hogs, O.R. of weather.....	3	5
Corn—See Grain.			Drugs and Medicines, not otherwise specified, in boxes, barrels or casks.....	1	
Corn Cakes, in cases.....	1		Drums, in cases.....	4-1	
Corn Meal. Same as Flour and Meal.			Dry Goods, in trunks, O.R.....	D 1	
Corn, Pop Corn.....	2		in bales, O.R. of chafing.....	1	
parched or popped.....	1		in boxes.....	1	
Sweet, dried.....	2		Dualine. NOT TAKEN.		
Cobs, C.L. 20,000 lbs.....	10		Duck, in bales.....	2	
Husks. Same as Husks.			Dumb-Bells, in boxes.....	3	
Poppers—See Hardware.			Dye Stuff, not otherwise specified.....	1	
Corsets, in cases.....	1		in sticks or bundles.....	2	4
Cotton, not pressed, in bags or sacks, O.R. of fire.....	1	4	in boxes, barrels or bags.....	3	5
Raw, pressed in bales, O.R. of fire.....	3	5	Dye, Liquid, in boxes or barrels, O.R.....	1	4
" in cans, crated or boxed.....	3	5	Dynamite. NOT TAKEN.		
Cottons, Domestic, in cases.....	1	3			
in bales.....	2	4	<b>E</b>		
in cases and bales, mixed.....	3	3	Earth Closets, loose.....	1½	
Cotton Goods.....	1		racked.....	1	
Seed Meal.....	4		Earthenware, in boxes, barrels or casks, O.R.....	2	5
Waste, not pressed, in bags or sacks, O.R. of fire.....	1	4	in crates or hdds., O.R.....	3	5
" pressed in bales, O.R. of fire.....	3	5	Loose, O.R., taken in C.L. only; loaded and unloaded by owners.....	6	
Crackers, in boxes or bbls.....	2	4	Drain or Sewer Pipe.....	4	10
Cracklings.....	4	7	Eavetroughs, Metallic, loose.....	3-1	6
Cranberries—See Fruits.			" nested, in bdl.....	D 1	5
Creamers, set up.....	D 1	6	" crated.....	1½	5
K.D., and boxed.....	1	6	" boxed.....	1	5
Cricket Bats, Wickets, etc., in boxes.....	1		Wooden.....	2	7
Crowbars—See Hardware.			Edge-Tools—See Hardware.		
Crayons, in boxes or barrels, O.R.....	1		Eggs, in baskets or pails, O.R.....	D 1	
Cream Tartar.....	1		in boxes or barrels, O.R.....	2	4
Crockery and Stoneware, in boxes, barrels or casks, O.R.....	2	5	in patent carriers, O.R.....	2	4
" in crates or hdds., O.R.....	3	5	Egg Cases and Carriers.....	D 1	
Cross Arms—See Telegraph Supplies.			C.L., 20,000 lbs.....		10
Croquet Sets.....	1		Elbows, Corrugated—See Stove Pipe.		
Crucibles, O.R.....	1		Electrotype Plates, boxed, O.R., released.	1	
in boxes or casks.....	3		Elevator Buckets, Tin or Iron, in bundles, crated or boxed.....	1	
Cultivator Teeth, in bundles.....	2	4	Elevators, for buildings.....	1	6
in boxes or casks.....	3	4	Emery, in cases.....	2	
Curling Stones, O.R.....	1		Emigrants' Movables—See Household Goods.		
Currants—See Fruit.			Etiapies, not otherwise specified, prepaid.....	D 1	
Curtain Fixtures, boxed or crated.....	1		not otherwise specified, prepaid, C.L., 20,000 lbs.....		10
Rollers and Slats, in bundles or boxes.....	2				
Cushions, Carriage or Sleigh, boxed.....	D 1				
These articles must not be received for as part of any vehicle forwarded by railway.					



Canadian Joint Freight Classification.

L.C.L. C.L	L.C.L. C.L
Empties, returned from original consignee to original shipper, every package to be fully marked or addressed, any quantity prepaid.. 4	Fire Kindlers, Wood, boxed..... 3 6
“ not fully marked or addressed. NOT TAKEN.	Fish, Fresh or Frozen, in packages or fish safes on wheels, prepaid or guaranteed, O.R. .... 1
Engines, Locomotive and Tenders, on their own wheels, actual weight—Shippers must declare weight—O.R. released... 6	“ Fresh, in packages or frozen in bulk, prepaid or guaranteed, O.R..... 4
Locomotive Engines must be accompanied by a person fully competent to take charge of and travel with them, who will be passed free under the same conditions and regulations as in case of man travelling in charge of live stock.	“ in fish safes on wheels, prepaid or guaranteed, O.R. .... 6
Engines, Portable or Stationery—See Machinery.	Fish in bulk or in fish safes on wheels to be loaded and unloaded by owners.
Engravings—See Pictures.	Fish, Salted, Dried or Smoked, in hampers, O.R. .... 1 4
Epsom or Glauber Salts—See Salts.	“ Salted, Dried or Smoked, in bundles, boxes or barrels, O.R..... 2 4
Essences and Extracts, in packages, not otherwise specified ..... 1	“ Pickled, in pails, casks or barrels..... 4 5
Evaporators.....D 1	Fish, Canned—See Canned Goods.
Excelsior, in bales..... 1 4	Fishing Nets, in bales, O.R. of chafing..... 1
This Freight must not be taken for shipment by water.	“ in boxes ..... 1
F	Fishing Rods, in bundles or cases.....D 1
Fancy Goods, not otherwise specified, in trunks, O.R., released.....D 1	Flax, in boxes, O.R..... 2
Fancy Goods, not otherwise specified, in cases..... 1	“ in hales, O.R..... 3 5
Fans, Palm Leaf, in cases..... 1 3	Flax Seed—See Seeds.
Farina, in cases..... 2	Flax Seed Meal, in bags or barrels..... 4 8
“ in bags or barrels ..... 3	Flocks, in sacks or boxes, O.R..... 1
Faucets, Wooden, in barrels or boxes..... 2	“ Hard Pressed, in bales..... 3 5
Feathers, in boxes.....4-1	Flour and Meal, in boxes and paper sacks, O.R. released..... 3 8
“ in sacks.....D 1	Flour and Meal, in bags or barrels, estimated weight 200 lbs. per bbl., lots under 5,000 lbs..... 4
Feather Dusters, in boxes.....D 1	Flour and Meal, Lots 5,000 lbs. and over... 5 8
Feed Steamers and Evaporators, O.R.....D 1	“ mixed in paper sacks, sifting, bags or bbls..... 8
Feldspar..... 3 6	Fluor Spar, in packages. .... 3 6
Felt Clippings, in boxes, barrels or bags... 3	Fluters—See Hardware.
“ for underlying carpet..... 3 5	Fly Traps, in boxes.....D 1
“ for roofing..... 4 5	“ nested and boxed..... 1
“ boiler and pipe covering ..... 2 4	Foots..... 4 5
Fence Posts and Rails. Taken by special contract only.	Forges, Portable, O.R..... 2
Fenders and Fire Irons, in boxes..... 2	Forks, Hay and Manure, in bundles, O.R. .. 2 5
Fertilizers, in bags or barrels..... 4 7	“ Wooden, in bundles, O.R..... 1 5
Figs—See Fruit.	Fountains and Fixtures, Soda, boxed, O.R.D 1
Files—See Hardware.	Fowls—See Poultry.
Filters, O.R..... 1	Frames, Picture or Looking Glass, in bundles, O.R. ....D 1
Findings, Shoe and Leather, in cases..... 1	Frames, Picture or Looking Glass, in crates, O.R..... 1 3
Fire Arms, in boxes (not Government property)..... 1	Frames, Picture or Looking Glass, in boxes ..... 1
Fire Crackers and Fire Works, securely boxed, and marked to show contents, O.R. ....D 1	Freezers, Ice Cream..... 1 2
Fire Engines, Hand-brake, estimated weight 4,000 lbs., O.R..... 1 6	Fruits :—
Fire Engines, Steam, estimated weight 8,000 lbs., O.R. .... 1 6	Apple Cores or Parings, in boxes or barrels..... 4 7
Fire Extinguishers, Chemical, set up.....D 1	Apple or Fruit Butter or Sauce in glass or stone, O.R..... 1 4
“ in boxes, O.R. 1	Apple or Fruit Butter or Sauce, in cans or wood, O.R..... 2 4
“ 2-wheel, estimated weight 2,000 lbs., O.R..... 1 6	Apples, Evaporated or Dried, in bags... 1 4
Fire Extinguishers, Chemical, 4-wheel estimated weight 6,000 lbs., O.R..... 1 6	Apples, Evaporated or dried, in boxes or barrels..... 5 5
Fire Extinguishers, Hand Grenades, boxed. 3 5	Apples, Green, only carried at owner's risk of freezing ; must be prepaid and released between the 1st of November and 30th April, as follows, in bags or boxes..... 1
Fire Kindlers, Composition..... 1	Apples in bbls. to be taken at actual weight, but not less than 150 lbs per bbl., as follows :—
	Apples, under 50 barrels..... 2
	“ 50 and under 100 barrels..... 3







Canadian Joint Freight Classification.

Hardware—	L.C.L.	C.L.	Hardware—	L.C.L.	C.L.
Grates and Fronts, O.R.....	1	4	Vices.....	3	5
“ “ K.D., and boxed.....	2	4	Wagon Boxes, or Thimble Skeins, loose		
Hoops.....	3	5	or in bundles.....	2	5
Horse Shoes.....	4	5	Water Wheels.....	2	5
Horse Shoes and Nails, in boxes or kegs,			Iron, for Railway Supplies, viz :—		
in mixed cars.....	4	5	Fish Plates, Spikes, Bolts.....	4	7
Lath, in crates or boxes.....	4	5	Frogs and Crossings.....	4	7
Lead, White or Red, in tins, loose.....	2	4	Chairs, Tyres.....	4	7
Mantels and Fronts, set up, O.R.....	1	4	Wheels, Axles, Rails.....	4	7
“ “ K.D., and boxed.....	2	4	Isinglass, in cases.....	1	
Metallic Shingles, in packages.....	4	6	Ivory and Ivory Black, in packages.....	1	
Ore.....	4	10	Ivory Nuts, or Blocks, in packages.....	3	4
Pig and Speigle.....	4	10			
Pipe (Gas and Water, light).....	3	5	J.		
Pipe, 5 in. diameter and over.....	4	7	Jacks, Hand, loose.....	2	
“ (Hot Air, Steam or Water-Coil)—			“ “ boxed or crated.....	3	
Same as Radiators.....			Japanware—Same as Tinware.....		
Pipe Fittings, in boxes, kegs or bbls.....	3	5	Japanese Goods—Same as Fancy Goods..		
Pots, Pans and Stove Furniture.....	1		Japonica.....	3	5
Pulleys.....	2	4	Jellies—See Preserves.....		
Pumps.....	1		Jewellers' Scrap or Sweepings.....	1	
Rings, or 5th Wheels, Carriage or Wag-			Joiners' Work (subject to Note at foot of		
gon, in bundles.....	1	5	this article), as follows :—		
“ “ Carriage or Waggon,			Blinds, Inside—Door and Window.....	1	
in packages.....	2	5	“ Outside, with Slats, racked, O.R.....	2	
Rolls, loose.....	1	5	Balusters and Turned Work, O.R.....	2	
“ boxed.....	3	5	Counters, if in box cars, O.R.....	1	
Roofing.....	3	5	Door Frames, O.R.....	1	
Russia (Sheet), O.R.....	1	4	Doors, loose and racked, O.R.....	2	
Safes, 10,000 lbs. each, or over, O.R.....	2	4	Mantles, O.R.....	1	
“ under 10,000 lbs. each, O.R.....	3	4	Mouldings in White, in bundles, O.R....	1	
Safes of 1,000 lbs each, or over, to be			“ in boxes or crates.....	2	
loaded and unloaded by owners.....			Panelled Work, O.R.....	2	
Sash—Shutters.....	2	5	Planed and Moulded Boards, O.R.....	3	
Scrap, including old rails, old wheels,			Shelving, Base-boards, etc., O.R.....	3	
etc.....	4	10	Sashes, Glazed, O.R.....	D 1	
Shafting—Wheels and pulleys attached..	1	6	“ Unglazed, O.R.....	1	
“ “ detached.....	2	6	Shutters, Close, O.R.....	2	
“ requiring a whole car for carriage			Joiners' Work, not otherwise specified.....	1	
(whether full capacity of car be			Note.—Joiner's work requiring a		
occupied or otherwise), if 10,000			whole car for carriage (whether full		
lbs. or under, to be charged			capacity of car be occupied or other-		
20,000 lbs.....			wise), if 10,000 lbs. or under, to be		
“ If over 10,000 lbs. to be charged			charged 20,000 lbs.....		7
C.L.....			“ If over 10,000 lbs., to be charged		
Sheet, Sheet Galvanized, Sheet Tinned..	3	5	C.L.....		6
Ship Knees.....	3	5	Junk.....	3	5
Sinks.....	1		Jute.....	3	5
Sinks, nested.....	2				
Sleigh and Cutter Gear, K.D., in bundles	1	5	K		
Smoke Stacks.....	3-1		Kaoline—Same as Clay.....		
“ requiring a whole car for carriage			Kalsomine—Same as Paints.....		
(whether full capacity of car be occupied			Knees, Ship—See Lumber.....		
or otherwise), if 10,000 lbs. or			“ Iron—See Iron.....		
under, to be charged			Knitting Machines, Hand, in boxes.....	14	
20,000 lbs.....			“ Power—See Machinery.....		
“ If over 10,000 lbs., to be					
charged C.L.....			L		
Spring Clips, Carriage or Waggon, in			Lacrosses, in bundles.....	D 1	
packages.....	3	5	“ in boxes.....	1	
Stable Fittings, Feed Boxes, Hay Racks,			Ladders.....	D 1	6
Stall Posts, etc.....	2		“ Step.....	1	6
Statuary and Ornamental Figures, O.R..	1		Lamp Black.....	1	
Stills and Worms.....	D 1		Lamps and Lanterns, well packed, O.R....	1	
Stretchers, for wire fencing, in boxes or			Lard.....	3	5
kegs.....	3	5	Lasts, tied in bundles or sacks.....	3	5
Tyres, other than R.R. Supplies.....	3	5	“ in boxes.....	2	5
Vault and Prison Work.....	3	5			
Vases.....	1	4			

Canadian Joint Freight Classification.

	L.C.L.	C.L.		L.C.L.	C.L.
Last Blocks.....		10	Live Stock, &c.--		
Laths--See Lumber.			4, 5 or 6 cars.....	two persons.	
Lawn Tennis Sets, in boxes.....	1		7, 8, 9 or 10 cars.....	three "	
Lead, White or Red, in Tins, loose.....	2	4	Over 10 cars in one lot.....	four "	
" " " packed in wood	3	5	Return Passes will not be given.		
" " " in kegs, casks, drums	3	5	IN LESS THAN CARLOADS, AS FOLLOWS:--		
" " " or irons.....	3	5	Bulls, under one year old, 1,000 lbs. each	1	
" Bar, Pig, Sheet and Pipe.....	3	5	" one year and under two years old,		
" Scrap.....	4	7	3,000 lbs. each.....	1	
Leather, loose.....	1	4	" over two years old, 4,000 lbs. each	1	
" in bundles, rolls, boxes or bales...	3	5	Cattle or Horned Animals:--		
Leather Board.....	3	5	One animal, 2,000 lbs.....	1	
Leather, Patent, in boxes.....	1		Two animals, 3,500 lbs.....	1	
Leather Scraps.....	3	5	Three animals, 5,000 lbs.....	1	
Leather Belting--See Belting.			Each additional animal in same car,		
Lemons--See Fruit.			car, 1,000 lbs.....	1	
Lemon Syrup, in glass, packed in wood...	1		Calves, under six months old, 500 lbs.		
" " in wood.....	2		each.....	1	
Liciorc--Stick, Root or Mass.....	1		" over six months and under one		
" Mass or Paste, in boxes.....	2		year, 1,000 lbs. each.....	1	
" Powdered, in barrels.....	3		Cow and Calf, together, 2,500 lbs.....	1	
Lightning Rods, in bundles.....	1		Colts under six months old, each, 1,000		
Lightning Rods, in boxes.....	3	4	lbs.....	1	
Lime, Common.....	4	10	Hogs, Goats, Sheep and Lambs, not		
Linseed--See Seed.			crated, not taken except by special		
Linseed Meal--See Flaxseed Meal.			authority.		
Liquors, in demijohns or baskets, O.R.....	D 1		Hogs, Sheep, Lambs and other small		
Foreign Wines, Spirits and Cordials, in			animals, in boxes or crates, actual		
glass, tins or jugs, securely			weight.....	D 1	
packed in boxes or barrels,			Horses, Mules, etc.--1 animal, 2,000 lbs...	1	
O.R.....	1	3	" " 2 animals, 3,500 lbs.	1	
" Wines, Spirits and Cordials, in			" " 3 animals, 5,000 lbs..	1	
wood, less than 2,000 lbs.,			" each additional animal in same		
O.R.....	1		car, 1,250 lbs.....	1	
" Wines, Spirits and Cordials, in			Mare and Foal, together, 2,500 lbs.....	1	
wood, 2,000 lbs. and over, O.R.	2	4	Stallions and Jacks, 4,000 lbs. each.....	1	
Native Wines, Spirits and Cordials, in			Minimum charge for any one animal		
glass, tins or jugs, securely			\$1.00.		
packed in boxes or barrels, O.R.	1	4	Above weights and rates are based		
" Wines, Spirits and Cordials, in			upon, and intended for animals of		
wood, less than 2,000 lbs., O.R.	2		ordinary value only.		
" Wines, Spirits and Cordials, in			Race Horses and other valuable		
wood, 2,000 lbs. and over, O.R..	3	5	animals will be carried at the same		
Litharge--Same as Lead. Red.			weights and rates, on condition that		
Lithographic Stones, in boxes. O.R.....	1		the owners sign a written agreement,		
Live Stock will only be carried at owner's			as follows:--		
risk, to be loaded, unloaded, and fed			" At owner's risk of loss or damage		
by owners or at their expense, as			arising from any cause whatever."		
follows:--			This must be written on the face of		
In carloads, at not less than the follow-			the consignment note and receipt.		
ing minimum weights:--			Lobsters, Fresh, in casks or boxes, O.R.....	1	
Horses, 20,000 lbs.....	9		" in tins--See Canned Goods.		
Cattle, 20,000 lbs.....	9		Logwood and Logwood Extract--Same as		
Hogs, S. D., 20,000 lbs.....	9		Dye Stuff.		
" D.D., 25,000 lbs.....	9		Looking Glasses--See Glass Mirrors.		
Sheep, S.D., 18,000 lbs.....	9		Lumber, Common, and other, to be loaded		
" D.D., 24,000 lbs.....	9		and unloaded by owners, will only be		
Hogs, Sheep, Calves or Small Cattle must			carried at the convenience of the		
not be loaded under larger cattle in same			Company, and at the risk of the		
car.			owners, shippers furnishing their own		
When small and large animals are			stakes. Lumber, Common, to include:		
shipped together in same car they must			Ash, Birch, Beech, Cherry, Cedar, Chest-		
be kept separate by a partition; this rule,			nut, Elm, Hemlock, Hickory, Larch,		
however, will not apply to Milch Cows			Maple, Oak, Pine, Poplar, Spruce,		
with their Calves.			Sycamore, Tamarack, Willow, Staves,		
The owners or drivers may be taken			Laths, Shingles, Clapboards, Bolts,		
free on the same train with their			Edgings, Slabs, Shooks, Heads, Hoops,		
Live Stock, under the following			Hoop and Hop Poles, Ship Knees,		
regulations:--			Blocks, Raftsmen's Floats, Oars, Tra-		
1, 2 or 3 cars.....		one person.	verses, Toggles and Withes, Pegwood,		
			Poplar and Pulp Wood.....	4	10

Canadian Joint Freight Classification.

	L.C.L.	O.L.	Machinery, &c.	L.C.L.	O.L.
Lumber, Common, planed, tongued and grooved.....	4	10	Tenoning Machines.....		1
Rails, Fence Posts, Telegraph Poles and Ties of all descriptions. will only be taken by special contract.			Machinery, not otherwise specified, in frame, O.R.....	1½	
Mahogany, Rosewood, Walnut, Lignum Vitæ, and other valuable Hardwoods.	3	7	" not otherwise specified, closely boxed, O.R.....	1	
Note.—All cars with Lumber should be loaded to their full capacity, as marked upon them at C.L. rate per 100 lbs. Cars without capacity marked upon them should only be loaded with 24,000 lbs. All excess over the capacity of cars up to 2,000 lbs. each shall be charged proportionate C.L. rate, but if the excess be over 2,000 lbs. the whole excess over the capacity of the car shall be charged L.C.L. rate, as above; and the Companies reserve the right to remove all the excess at the expense of the owner, and forward the same on another car.			" Heavy, K.D., not otherwise specified, 1,000 lbs. per piece or over, with connections and detachable parts removed and boxed, O.R.....	2	
			" all kinds.....		6
			Note.—Engines or machinery requiring a whole car for carriage (whether full capacity of car be occupied or otherwise), if 10,000 lbs. or under, to be charged 20,000 lbs.....		7
			If over 10,000 lbs., to be charged C.L. Engines or machinery over 1,000 lbs. per piece, to be loaded and unloaded by owners		6
			Machines, Sewing, set up, not boxed or racked, O.R.....	3-1	2
			Machines, Sewing, set up, boxed or racked, O.R.....	1	4
			Machines, Sewing, K.D. and boxed, O.R....	2	4
			" " Stands, K.D., in bundles	1	4
			Madder, in cases.....		2
			" in barrels or casks.....		3
			Magazines, returned empty, used in transporting gunpowder.....		4
			Majolica Ware—Same as Crockery.		
			Malt—See Grain.		
			Mangles, set up, not boxed.....	1½	6
			" " crated.....	1	6
			" " K.D., and boxed.....	2	6
			Manilla, in bales, O.R.....	3	5
			Manure, Stable, in cattle cars only.....		10
			Maple Sugar—See Sugar.		
			Maple Syrup—See Syrup.		
			Marble, Polished, Carved or Lettered, not boxed—NOT TAKEN.		
			Marble, Polished, Carved or Lettered, boxed, O.R., prepaid.....	1	3
			Marble Slabs, Blocks or Spires, Polished, not Carved or Lettered, boxed, O.R....	2	5
			Marble Slabs, Blocks or Spires, Unwrought	4	7
			" Tile, O.R.....	4	7
			" Dust, in barrels.....	4	7
			" Blocks, Rough from Quarry.....		10
			Marbles, in boxes or casks.....	2	
			Mats. Taken by special contract only.		
			Matches, completely covered in paper or wooden boxes and securely packed in cases, less than 2,000 lbs., O.R.....	D	1
			Matches, packed as above, lots of 2,000 lbs. and over, O.R.....	1	5
			Matches, loose in cases—NOT TAKEN.		
			Match Splints.....	9	3
			Mattresses—See Furniture.		
			Mats and Rugs.....	1	
			Mattling—Cocoa, Hemp, etc.....	1	4
			Meal—See Flour and Meal.		
			Measures, loose.....	D	1
			" nested.....	1	1
			Meats, Fresh, prepaid, O.R.....	1	4
			" Mince and Sausage, prepaid, O.R....	1	4
			" Mince, in paper packages, packed in boxes, O.R., prepaid.....	2	5

M

Macaroni.....	1	
Machine or Cattle Cards.....	1	
Machinery (subject to note at foot of this article), at O.R. in each case, as follows:—		
Band Saws.....	1	
Bark Mills.....	1	
Bolt Cutters.....	1	
Bran Dusters.....	D	1
Brick Machines, set up.....	1	6
" " K.D.....	3	6
Cards, Cotton or Woollen.....	D	1
Cob Mills.....	1	
Cotton Presses.....	1	
Cider Mill Presses.....	1	
Cheese Presses.....	1	
Ditching Machines.....	1	
Drag Saws, with horse-power, Sweep.....	1½	
Engines, Portable or Stationary.....	1	
Hemp Machines.....	1	
Horse-Powers, Sweep.....	1½	
" Trend—See Agricultural Implements.		
Knitting Machines, Power.....	1½	
Laths, wood or iron.....	1	
Looms.....	1½	
Meat Choppers, in frame.....	1	
Mortice Machines.....	1	
Moulding Machines.....	1	
Nail Machines.....	3	
Planing Machines and Jointers.....	1	
Printing Presses.....	1	
Purifiers, set up.....	D	1
" " K.D. and boxed.....	1	
Re-Sawing Machines.....	1	
Road Scrapers.....	1	
Saw Mills, Portable.....	1	
Sawing Machines.....	4-1	
Saw Tables.....	1	
Shearing Machines.....	1½	
Shingle Machines.....	1	
Smut Machines.....	1½	
Stumping Machines, K.D., detachable parts removed.....	2	

Canadian Joint Freight Classification.

		L.C.L.	C.L.			L.C.L.	C.L.	
Ments, Salted, Smoked or Dried, loose or in bags.....	2	4	Notions, not otherwise specified, in boxes, O.R.....	1				
" Salted, Smoked or Dried, in boxes, barrels or casks.....	3	5	Nutmegs.....	1				
Mechanics' Tools, in boxes.....	1		Nuts, Edible, in bags, O.R.....	1				
Medicines—See Drugs.			" in boxes or barrels.....	2	4			
Melons, prepaid O.R.....	1	6	<b>O.</b>					
Merchandise—Shippers are required to give full description of contents of packages; all articles described as merchandise will be charged.....	D	1	Oakum.....	2	4			
Merchandise, in trunks, contents described, O.R., released.....	D	1	Oars, Boat.....	1	6			
Metallic Packing, in packages.....	3	4	Oats—See Grain.					
" Shingles—See Iron.			Oatmeal—See Flour and Meal.					
Methylated Spirits—Same as Liquors (Native).			Ochre, in cans, kegs or boxes.....	2				
Mica, Manufactured, in packages.....	1	4	" in barrels or casks.....	3	5			
Milk. Taken by special contract only.			Oil Cans, Glass, in tin jackets, crated or boxed, O.R.....	2	6			
" Condensed—Same as Canned Goods.			Oils, except Coal or Mineral, in glass or stone, well packed, O.R.....	1				
Mill Boards—Same as Binder's Boards			" except Coal or Mineral, in kegs or cans, securely boxed, O.R.....	2	4			
Millet—See Seeds.			" except Coal or Mineral, in wood, O.R.....	3	5			
Mill Dogs.....	1		" Coal or Mineral, in cans, securely boxed, O.R.....	2	4			
Mill Feed—Same as Flour and Meal.			" " in wood, less than 10 bbls., O.R.....	2				
Mill-Stones—See Stones.			" " in wood, 10 bbls. and over, O.R.....	3	5			
Millinery Goods, in cases.....	D	1	" " for machines or lubricating purposes, in wood, O.R.....	3	5			
Mineral Waters—Same as Ale.			Coal or Mineral Oil must not be taken for shipment by water.					
Moccasins—Same as boots and shoes.			Oil Cake.....	4	8			
Models for Statuary and Stucco Work.....	D	1	Oilcloth, in rolls, O.R.....	1				
Molasses, in Wood, O.R. of leakage.....	3	5	" in boxes.....	2				
Mops and Mop Sticks, in bundles.....	1		" requiring a whole car for carriage (whether full capacity of car be occupied or otherwise), if 10,000 lbs. or under, to be charged 20,000 lbs.....	7				
" " in boxes.....	2		" if over 10,000 lbs., to be charged C.L.....	6				
Moss, in sacks.....	D	1	Onions—See Vegetables.					
" in bales.....	1		Opticians' Instruments, O.R.....	1				
Mouldings—Gilt or Finished, in bundles.....	D	1	Oranges—See Fruits.					
" " crated.....	1	1/2	Ore.....	4	10			
" " boxed.....	1		Organs—See Musical Instruments.					
" Common Building—See Joiners' Work.			Ornaments—See Plaster of Paris.					
Mucilage, in glass, packed in boxes or barrels.....	1		Oxide of Iron—Same as Earth Paints.					
Mucilage, in tins, packed in boxes or barrels.....	2		Ox Yokes.....	2				
Mucilage, dry, in boxes.....	2		Oysters and Clams, Fresh, in cans or kegs, O.R.....	1	3			
Musical Instruments, not boxed—NOT TAKEN.			" " Shell, in bags or barrels, O.R.....	2	4			
Musical Instruments, Pianos and Organs, boxed and released, O.R.....	1	4	" " Pickled—See Pickles.					
Musical Instruments, Church Organs, K.D., loaded and unloaded by owners, O.R.....	D	1	Oziers (Willow Reeds), in boxes, bales or bundles.....	2	6			
Musical Instruments, boxed, not otherwise specified, O.R.....	D	1						
Mustard, in jars or tins, loose, O.R.....	1		<b>P</b>					
" " packed in boxes.....	2		Pails—See Woodenware.					
Mustard Seed.....	2		Paintings and Engravings, contents not to exceed \$50 in value, boxed and released.....	2-1				
<b>N.</b>								
Nails and Spikes, in bags.....	2	5	" over \$50, not exceeding \$200 in value, boxed and released.....	4-1				
" " in kegs, boxes or cases.....	4	5	" over \$200. Taken by special contract only. Shippers must declare value.					
Nails and Horse Shoes, in boxes or kegs, in mixed cars.....								
Naphtha—Same as Coal Oil. Must not be taken for shipment by water.								
Neck Yokes.....	2							
Nitro Glycerine—NOT TAKEN.								
Nitrate of Soda—See Soda.								
Notions, not otherwise specified, in trunks, O.R.....	D	1						





Canadian Joint Freight Classification.

S		L.C.L. C.L.	L.C.L. C.L.
Saddlery—			Shoes—See Boots and Shoes.
Saddles and Harness, loose or in bundles.	D 1		Shoe Findings..... 1
"    "    in trunks.....	1 1/2		Shoe Pegs, in boxes..... 1 5
"    "    in boxes.....	1		"    in barrels or casks..... 2 5
Saddle-trees and Swent Pads.....	1		Shooks—See Lumber.
Hames, in bundles.....	1		Shorts—See Bran.
"    in boxes or casks.....	2		Shot—See Hardware
Horse Collars, in sacks or bundles.....	D 1		Shower Baths..... D 1
"    in boxes or barrels.....	1		Show Cases, O.R., released..... 3-1
Saddlery Hardware, in boxes or barrels..	2		Shrubbyery, loose, prepaid, O.R..... D 1
Saddlery and Harness.....	4		"    in bundles, prepaid..... 1 5
Safes, Bread, Meat, Milk or Cheese.....	4-1		"    in boxes, O.R., prepaid..... 3 5
"    Iron—See Iron.			Sieves..... D 1
Sago.....	1		"    nested and boxed..... 1
Saleratus in boxes or bbls.....	2		Sign Boards—Same as Advertising Boards.
Salt, in small bags or boxes.....	3		Sisal, in bales..... 3 5
"    in sacks or barrels (or C.L. in bulk)..	4 10		Sizing, in sacks or barrels..... 2
Salt, in glass, boxed.....	2		Slag, Mill, and Cinders, prepaid..... 10
Salts, Epsom.....	1		Slate, Floor, in barrels, casks or boxes..... 4 5
"    Glauber, in boxes or barrels.....	3 5		"    School, in boxes..... 2 4
Saltpetre, in boxes.....	2 5		"    Roofing, O.R..... 3 10
"    in barrels.....	3 5		"    Manufactured and Marbleized, well boxed, O.R..... 1 4
Samples, in trunks, O.R., released.....	D 1		"    Slab, Manufactured, not Marbleized, well boxed, O.R..... 4 5
Sand in packages.....	4		"    Slab, Manufactured, not Marbleized, not boxed..... 5
Sand.....	10		"    Wash Tubs, Sinks and Tanks, loose, O.R..... 2 4
Sandpaper.....	2 5		"    Wash Tubs, Sinks and Tanks, nested, crated or boxed..... 3 5
Sand Screens.....	D 1		Sleds and Sleighs, Children's or Hand—See Vehicles.
Sardines. Same as Canned Goods.			Sleigh Stuff—See Carriage Goods.
Sashes—See Joiners' Work.			"    Shoes, Iron and Steel..... 3 5
Sash-weights, in boxes.....	2		Smoke Stacks—See Iron.
Sauces. Same as Preserves.			Snowshoes, in bundles..... D 1
Saur Kraut. Same as Pickles.			"    in boxes..... 1
Sausage Casings, in barrels or kegs.....	2 5		Snow Shovels, Wooden, in bundles..... 1
Sausages—See Meats.			Snuff, in jars or bladders..... 1 1/2
Sawdust and Shavings.....	3		"    in boxes, barrels, casks or kegs..... 1
Sawbucks, Wooden, packed in bundles....	2		Soap, Fancy, in boxes..... 1
Saws, loose or on boards.....	1		"    Common, in boxes..... 4
"    boxed.....	2		"    Oil or Soft, in barrels..... 4 5
"    Buck, in bundles.....	1		Soapstone, Crude..... 4 10
Sawing Machines—See Machinery.			"    Slabs and Manufactured Articles, O.R..... 1
Saw Mills, Portable—See Machinery.			"    Dust..... 4 7
Scales and Scale Beams, not boxed.....	1 4		Soda, Bi-Carbonate, in boxes, kegs or barrels..... 3 5
"    boxed.....	2 4		"    Ash or Sal Soda, in boxes, barrels or casks..... 4 5
Scale Boards.....	2 5		"    Caustic, in iron drums..... 4 5
"    Weights, Metal.....	3 6		"    Nitrate, in iron drums..... 3 5
Scoops, Spades and Shovels—See Hardware.			"    Salt Cake, in casks..... 4 5
Screws, Wooden.....	2		"    Silicite, in glass..... 1
Scripture, prepaid, O.R., released.....	D 1		"    in wood..... 4 5
Scythe Smiths—See Hardware.			Water—See Mineral Water.
Scythe Stones, in boxes.....	3 5		Pearline and other Washing Powders..... 3 5
Sea-grass, pressed, in bales.....	3 7		Solder, in packages..... 2
Seed, Bird, in packages, O.R.....	1		Spark Arresters..... D 1
"    Garden, in boxes, O.R.....	1 4		Spars. Taken by special contract only.
"    Blue Grass or Orchard, in bags or barrels, O.R.....	1		Spelter..... 3 5
"    Clover, Timothy or Red Top, O.R....	3 5		Spices—Cloves, Cinnamon, Pepper, Allspice, Nutmegs, etc..... 1 3
"    Flax or Hemp.....	3 8		Spinning Wheels..... 1
"    Field, not otherwise specified, in bags, boxes or barrels.....	2		"    "    Heads..... D 1
"    Tares.....	3		Spirits—See Liquors.
"    Hungarian and Millet, O.R.....	3		
Sewing Machines—See Machinery.			
Shavings, Brewers', in bales.....	2		
Shellac, Gum, in boxes or barrels.....	1		
Shells, Sea, in packages, O.R.....	1		
Shingles, Metallic, in packages.....	4 6		
Shoddy.....	2		



Canadian Joint Freight Classification.

	L.C.L.	C.L.		L.C.L.	C.L.
Theatrical Scenery, O.R.....	D	1	4		
Thimble Skeins—See Iron.					
Thread, in boxes.....		1			
Tierces, Empty—See Empties.					
Ties—See Lumber.					
Tiles, Drain or Sewer.....		4	10		
" Roofing.....		3	7		
" Encaustic or Enamelled, for floor, O.R.....		1	4		
Tile Machines—Same as Brick Machines.					
Timber and Logs, under 28 feet long— Same as Lumber.					
" " over 28 feet long, taken by special contract only.					
Tin Foil.....		1			
Tin, Pig or Plate.....		3	5		
Tin Troughs—Same as Eave-troughs.					
Tinware, loose, O.R.....	D	1	6		
" nested, O.R.....		1½			
" in crates, O.R.....		1½			
" in boxes or barrels.....		1	4		
Tobacco, Unmanufactured, in bales.....		1	5		
" " in hogsheads and cases.....		3	5		
" Cut, in pails, loose or tied to- gether.....	D	1	4		
" " " two or more, strapped together with metal or wood.....		1	4		
" " in boxes or barrels.....		1	5		
" " repacked in cases..		2	5		
" Plug, in caddies, loose or tied together.....	D	1	4		
" " " two or three, strapped together with metal or wood, or firmly tied together with cord of not less than ½-inch diameter....		1			
" " " four or more, strapped together with metal or wood, or firmly tied together with cord of not less than ½-inch diameter.....		3	5		
" " in boxes or barrels.....		3	5		
" " in caddies, crated.....		3	5		
" Stems, in cases or hogsheads....		3	5		
Toboggans, loose.....	3	1	6		
" tied in bundles.....	D	1	6		
Tooth Picks, in boxes.....		1			
Top Pins—See Telegraph Supplies.					
Tow, in boxes, O.R.....		2			
" pressed in bales.....		3	5		
Toys, loose or in bundles, O.R.....	4	1			
" in Trunks or crates, O.R.....	D	1			
" in boxes, O.R.....		1			
Trays, in racks or cases.....		1			
Trees—See Shrubbery.					
Tricycles—See Velocipedes.					
Tripe, salted or pickled.....		3	5		
Tripoli.....		2			
Trunks, empty, O.R.....	D	1	4		
" filled with Valises and Satchels, O.R.....		1½	4		
Trunks containing wearing apparel and personal effects will not be taken as freight unless with ship-					
ment of household goods. When they are offered for shipment, Agents will refer parties to Express Com- panies.					
Tubs in nests—See Woodenware.					
Turned Stuff—See Joiners' Work.					
Turnips—See Vegetables.					
Turpentine—See Spirits of Turpentine.					
Twine—See Cordage.					
Type, in boxes.....		2	5		
Type Writers or Caligraphs, boxed or crated, O.R. released.....	D	1			
U					
Umbrellas, in boxes.....		1			
V					
Valises, loose, O.R.....	D	1			
" in trunks, O.R....		1½	4		
" in cases.....		1	4		
Varnish, in cans when boxed, O.R.....		1			
" in wood, O.R. of leakage.....		2	4		
This freight must not be taken for shipment by water.					
Vaseline, in glass, O.R.....		1			
" in cans, boxed.....		2			
Vats, Empty—Same as Cheese Vats.					
Vegetables, Evaporated—Same as Fruits (Apples), Evaporated.					
" Green, O.R. prepaid—Beans, Beets, Cabbages, Car- rots, Cauliflowers, Cucumbers, Onions, Parsnips, Peas, Turnips and Tomatoes, in bags or crates.....		1			
" " in boxes or barrels.....		3			
" " in packages or bulk.....		1	8		
" " not otherwise specified....		1	8		
Vehicles—At O.R. of chafing and breakage in each case, and subject to Note at foot of this article:—					
Omnibuses, Stage Coaches, 5,000 lbs. each		1			
Hearses, Waggon and Sleighs, extra large, 5,000 lbs. each.....		1			
2-Horse Buggies, Carriages, Hacks, Sleighs, Waggon, Expresses and Peddlers' Waggon, 3,000 lbs. each....		1			
1-Horse Buggy or Carriage with covered top, 3,000 lbs. each.....		1			
1-Horse Carriage, Buggy, Chaise, Wag- gon, Express or Peddlers' Waggon, Cab, Gig, Phaeton, or Sleigh, 2,000 lbs. each.....		1			
1-Horse Carole, Calache or Cutter, 1,000 lbs. each.....		1			
1-Horse Carts, 2-wheels, 1,000 lbs. each.		1			
1-Horse Sulkies, set up, 800 lbs. each....		1			
Sulkies, wheels off, not crated or boxed		3	1		
Sulkies and Road Carts, K.D., crated or boxed.....	D	1			
Democrat Waggon, 2-horse, set up, 3,000 lbs.....		1			
" " 1-horse, set up, 2,000 lbs.....		1			
" " crated or boxed, wheels, shafts, etc., removed and shipped separate..	D	1			



Canadian Joint Freight Classification.

		L.C.L.	C.L.			L.C.L.	C.L.	
Wire, Picket Fencing (with wooden pickets).....	2	5	Woodenware, Wooden or Fibre Buckets or Tubs, nested.....	1	6			
" Picket Fencing (with iron pickets). for Fencing—Cut in lengths and rolled in bundles.....	3	5	" " not otherwise specified.....	1	6			
" Netting or Fencing, rolled in bbls..."	2	5	Wool, Domestic, in sacks, any quantity....	1				
" Rope, in coil....."	3	5	" Foreign Compressed, in bales.....	3	5			
" Truss Hooping, in coil....."	3	5	Woollen Goods.....	1				
" Woven Door Mats, in bundles, crates or cases.....	2	4	Wool Waste—Same as Cotton Waste.....					
Wire-work, not otherwise specified.....	D	1	Y					
Wood Board.....	3	5	Yarn, in bundles or boxes.....	1	4			
Wood Cuts, in boxes, O.R.....	1		" pressed in bales.....	3	5			
Wood Pulp.....	4	10	Yeast, Liquid, in kegs or barrels.....	1				
Wood Spirits or Alcohol—Same as Liquors Wood, Turned—See Joiners' Work.			" Powder and Cakes, in boxes or bbls.	2				
Woodenware, Buckets, Pails and Tubs, nested.....	1	6	Z					
Woodenware, Wooden Buckets, crated.....	2	6	Zinc, in Sheet or Rolls, in bundles.....	2	5			
" " Butter Plates, nested and crated.....	2	6	" " in casks.....	3	5			
			" Slabs or Pigs.....	3	5			
			" Scrap.....	4	10			

TABLE OF ESTIMATED WEIGHTS ONLY TO BE USED WHEN ACTUAL WEIGHTS CANNOT BE ASCERTAINED.

	Lbs.
Alcohol, per bbl.....	420
Ale, Beer and Porter, per Imperial gallon	10·60
" " per wine "	8·85
Lager Beer, per Imperial gallon.....	10·50
" per wine "	8·75
(Weights of barrels to be added).	
Apples, Green, per bushel.....	56
" " per bbl.....	150
Barrels, empty—Ale, beer & porter, per hhd.	125
" " " " " bbl....	75
" " " " " $\frac{1}{2}$ bbl....	50
" " " " " $\frac{1}{3}$ bbl....	35
" " Lager Beer, per bbl.....	85
" " " " " $\frac{1}{2}$ bbl....	52
" " " " " $\frac{1}{3}$ bbl....	32
" " " " " $\frac{1}{4}$ bbl....	20
" " " " " $\frac{1}{16}$ bbl....	12
Beef, per bbl.....	330
" per tierce.....	480
Brick, Common, each.....	4 $\frac{1}{2}$
" Pressed ".....	7
" Fire ".....	7
Charcoal, per bushel.....	22
Cider, per bbl.....	400
Clay, per cubic yard.....	3,000
Coal. Anthracite:—	
Nut, per cubic foot.....	50
Stove " ".....	53
Egg " ".....	55
Bituminous:—	
Blossburg, per cubic foot.....	53
Cumberland, per cubic foot.....	53
Pittsburg ".....	46
Clover Hill ".....	45
Pictou ".....	49
Coke, per bushel.....	40
Fish, Salted or Pickled, per bbl.....	300
" " " per half bbl.....	160
" " " per quarter bbl....	80
" " " per kit.....	40
Grain:—	
Barley, per bushel.....	48
Beans ".....	60
" per bbl.....	280
Buckwheat, per bushel.....	48

	Lbs.
Grain—	
Corn (shelled), per bushel.....	56
" (in ear) ".....	70
Malt, per bushel.....	38
Oats ".....	34
Peas ".....	60
" (whole), per bbl.....	260
" (split) ".....	240
Rye, per bushel.....	56
Wheat, per bushel.....	60
Gravel, per cubic yard.....	3,500
High Wines, per bbl.....	420
Ice, per cubic foot.....	57
Lime, per bushel.....	75
Nails, per keg.....	106
Oils, per bbl.....	400
Oil, Petroleum, in bulk, in tank cars, per Imperial gallon.....	8
Onions, per bushel.....	56
" per bbl.....	170
Pitch, per bbl.....	400
Pork, per bbl.....	320
Potatoes, Common, per bbl.....	180
" " per bushel.....	60
Resin, per bbl.....	280
Salt, per bushel.....	60
" per bbl.....	300
Sand, per cubic yard.....	3,000
Seed, Blue Grass, per bushel.....	14
" Clover ".....	60
" Flax ".....	56
" Hemp ".....	44
" Hungarian ".....	45
" Millet ".....	45
" Timothy ".....	45
Stone, Cobble or Rubble, per cord of 128 feet.....	13,000
" Cobble or Rubble, per toise of 216 ft	22,000
" Granite, dressed, per cubic foot....	166
" Limestone ".....	170
" Marble ".....	170
" Sand, or Free ".....	150
" Slate ".....	170
" Quartz, per cubic foot.....	166
Tar, per bbl.....	400
Turnips, per bushel.....	56
Vinegar, per bbl.....	400
Whiskey.....	450

Canadian Joint Freight Classification.

CORDWOOD.

	Green.	Dry.
	Lbs.	Lbs.
Hickory per cord of 128 ft...	5,000	4,000
Beech and Maple " " ...	4,500	3,750
Pine and Hemlock " " ...	3,500	2,500
Poplar " " ...	5,000	4,000

STAVE BOLTS.

	Green.	Partly Seasoned.	Dry.
	Lbs.	Lbs.	Lbs.
Oak, green, per cord.....	5,300		
Ash and Elm " " .....	4,600		
Maple " " .....	4,500		

"Dry" Cordwood should be cut and piled at least six months.

To ascertain contents of a car of Cordwood or Stave Bolts:—Multiply the length, breadth and height (in feet) together, and dividé by 128.

Thus:—Car 30 ft. long, 3 ft. 6 in. high, 8 ft. wide:—

$$30 \text{ ft.} \times 3 \text{ ft. 6 in.} \times 8 \text{ ft.} = 840 \div 128 = 6.56 \text{ cords.}$$

LUMBER, Etc.

	Green.	Partly Seasoned.	Dry.
	Lbs.	Lbs.	Lbs.
White Pine, White Wood Basswood, per 1,000 feet.	3,500	3,000	2,700
Butternut, Chestnut, Red Pine, Norway or Yellow Pine, Hemlock, Spruce, per 1,000 feet.....	4,000	3,500	3,000
Ash, Elm, Maple, Cherry, per 1,000 feet.....	4,500	4,000	3,500
Oak, Walnut Hickory, Birch, Beech, per 1,000 ft.	5,000	4,500	4,000
Shingles (18-inch), per 1,000	375	350	325
" (16-inch), per 1,000	350	325	300
Lath, per 1,000.....	600	525	450
Bark, per cord.....	3,500	3,000	2,400
Staves, finished, for Oil, Pork and Beef Barrels, per 1,000.....	3,750	3,375	3,000
Staves, sawed, unfinished, for Oil, Pork and Beef Barrels, per 1,000.....	4,375	3,925	3,500
Staves, rough, for Oil, Pork and Beef Barrels, per 1,000.....	5,000	4,500	4,000
Staves, manufactured, for Flour Barrels, per 1,000..	1,250	1,125	1,000
Cedar Posts, or Bolts, for Block Paving, per cord..	3,500	3,000	2,500
Shingle Bolts, per cord....	3,500	3,000	2,500
Stabs—Hardwood, per cord	5,000	4,000	3,000
Stabs—Pine, Spruce and Hemlock, per cord.....	4,000	3,000	2,400
Telegraph Poles, per cord.	4,000	3,500	3,000
Ties—Hemlock, Pine, Spruce, Tamarac, each about.....	160	150	130
Ties—Cedar, Sawn Pine, each about.....	140	120	100
Hoops, Hoop Poles, Hop Poles, per cord.....	3,500	3,250	3,000

Above estimates are for "Dry Lumber," cut and piled 4 months or over; "Partly Seasoned," cut and piled at least 2 months, and all under 2 months cut is "Green."

To find contents in inch measure of a car of Lumber, multiply the length in feet, the width in feet, and the height in inches together; the product will give the number of feet, inch measure.

Thus:—Car 14 ft. long, 8 ft. wide, 60 in. high:—  
 $14 \times 8 \times 60 = 6,720$  feet.

Allowance should be made for waste space (if any) between the boards.

CEDAR POSTS.

The following quantities of cedar posts, 9 feet long, are estimated to weigh 24,000 lbs.:

28 feet car .....	4 ft.	9 in.	high
30 " " .....	4 ft.	6 in.	"
32 " " .....	4 ft.	3 in.	"
33 " " .....	4 ft.	0 in.	"
34 " " .....	3 ft.	10 in.	"

GRAIN IN BULK

The quantity in a car can be ascertained, with sufficient accuracy, by multiplying the internal length and breadth of the car together, and then by the height of the grain. Multiply this product by 1,728 (number of inches in a square foot), and divide by 2,150 (number of square inches in a bushel)

Thus:—Car 27 ft. 6 in.  $\times$  8 ft. 7 1/2 in.  $\times$  2 ft. 1 in. = 494 ft. 1 in. 8 pts. Multiply by 1,728, and  $\div$  2,150 = 400 nearly.

ROUND TIMBER

1st. When all the sixes are in feet, multiply the length by the square of one quarter of the mean girth, and the product will give the volume in cubic feet.

2nd. When the length is in feet and the girth is in inches, multiply as above, and divide by 144.

3rd. When all the dimensions are in inches, multiply as above, and divide by 1,728.

Thus:—50 ft long—girths 31.5 and 62.9 inches.

$$50 \times \left( \frac{31.5 + 62.9}{2} \div 4 \right)^2 = 50 \times 11.8^2 = 6,962, \text{ and}$$

$$\frac{6,962}{144} = 48.347 \text{ feet.}$$

$$50 \times \frac{31.5 + 62.9 \div 2^2}{16} \div 144 = \frac{111,392}{16} \div 144$$

$$= 48.347 \text{ feet.}$$

The mean girth of Round Timber may be obtained by taking the circumference at both ends and in the centre, adding them together, and dividing by 3.

The girth of Spars should be arrived at by taking their diameter at one third of their length from the butt or large end.

SQUARE TIMBER.

1st. When all the dimensions are in feet, multiply the product of the breadth by the depth, by the length, and the product will give the volume in cubic feet.

2nd. When one of the dimensions is in inches and the other dimensions are in feet, multiply as above and divide by 12.

3rd. When two of the dimensions are in inches and the other dimension in feet, multiply as above and divide by 144.

Thus: 20 ft. long and 15 in. square:— $15 \times 15 \times 20 = 4,500$ , and  $4,500 \div 144 = 31.25$  cubic feet.

The following are found to be average weights of Round and Square Timber:—

White Pine.....	48 lbs.	per cubic foot.
Hemlock, Spruce, Red Pine.	55	" "
Ash, Elm, Maple, Cherry,	"	" "
Birch, Beech.....	60	" "
Oak, Hickory.....	65	" "

## INTERCOLONIAL RAILWAY—PASSENGER TARIFF.

MILES.	CLASS.		MILES.	CLASS.		MILES.	CLASS.		MILES.	CLASS.	
	First.	Second.		First	Second.		First.	Second.		First.	Second.
1	3	2	51	1 53	1 02	101	3 00	2 00	151	4 04	2 69
2	6	4	52	1 56	1 04	102	3 00	2 00	152	4 06	2 71
3	9	6	53	1 59	1 06	103	3 00	2 00	153	4 07	2 72
4	12	8	54	1 62	1 08	104	3 00	2 00	154	4 09	2 73
5	15	10	55	1 65	1 10	105	3 00	2 00	155	4 11	2 74
6	18	12	56	1 68	1 12	106	3 00	2 00	156	4 12	2 75
7	21	14	57	1 71	1 14	107	3 00	2 00	157	4 14	2 76
8	24	16	58	1 74	1 16	108	3 00	2 00	158	4 15	2 77
9	27	18	59	1 77	1 18	109	3 03	2 02	159	4 17	2 78
10	30	20	60	1 80	1 20	110	3 06	2 04	160	4 18	2 79
11	33	22	61	1 83	1 22	111	3 09	2 06	161	4 20	2 80
12	36	24	62	1 86	1 24	112	3 12	2 08	162	4 21	2 81
13	39	26	62	1 89	1 26	113	3 15	2 10	163	4 22	2 82
14	42	28	64	1 92	1 28	114	3 18	2 12	164	4 23	2 82
15	45	30	65	1 95	1 30	115	3 21	2 14	165	4 24	2 83
16	48	32	66	1 98	1 32	116	3 24	2 16	166	4 25	2 84
17	51	34	67	2 01	1 34	117	3 27	2 18	167	4 27	2 85
18	54	36	68	2 04	1 36	118	3 30	2 20	168	4 28	2 86
19	57	38	69	2 07	1 38	119	3 33	2 22	169	4 30	2 87
20	60	40	70	2 10	1 40	120	3 36	2 24	170	4 32	2 88
21	63	42	71	2 13	1 42	121	3 39	2 26	171	4 34	2 90
22	66	44	72	2 16	1 44	122	3 42	2 28	172	4 36	2 91
23	69	46	73	2 19	1 46	123	3 45	2 30	173	4 37	2 92
24	72	48	74	2 22	1 48	124	3 48	2 32	174	4 38	2 92
25	75	50	75	2 25	1 50	125	3 51	2 34	175	4 39	2 93
26	78	52	76	2 28	1 52	126	3 54	2 36	176	4 40	2 94
27	81	54	77	2 31	1 54	127	3 56	2 38	177	4 41	2 94
28	84	56	78	2 34	1 56	128	3 58	2 39	178	4 43	2 95
29	87	58	79	2 37	1 58	129	3 60	2 40	179	4 44	2 96
30	90	60	80	2 40	1 60	130	3 62	2 42	180	4 45	2 97
31	93	62	81	2 43	1 62	131	3 64	2 43	181	4 46	2 98
32	96	64	82	2 46	1 64	132	3 66	2 44	182	4 47	2 98
33	99	66	83	2 49	1 66	133	3 68	2 45	183	4 49	3 00
34	1 02	68	84	2 52	1 68	134	3 70	2 47	184	4 51	3 01
35	1 05	70	85	2 55	1 70	135	3 72	2 48	185	4 52	3 02
36	1 08	72	86	2 58	1 72	136	3 74	2 50	186	4 53	3 02
37	1 11	74	87	2 61	1 74	137	3 76	2 51	187	4 54	3 03
38	1 14	76	88	2 64	1 76	138	3 78	2 52	188	4 55	3 03
39	1 17	78	89	2 67	1 78	139	3 80	2 53	189	4 56	3 04
40	1 20	80	90	2 70	1 80	140	3 82	2 55	190	4 58	3 05
41	1 23	82	91	2 73	1 82	141	3 84	2 56	191	4 60	3 07
42	1 26	84	92	2 76	1 84	142	3 86	2 57	192	4 62	3 08
43	1 29	86	93	2 79	1 86	143	3 88	2 59	193	4 64	3 09
44	1 32	88	94	2 82	1 88	144	3 90	2 60	194	4 66	3 11
45	1 35	90	95	2 85	1 90	145	3 92	2 61	195	4 68	3 12
46	1 38	92	96	2 88	1 92	146	3 94	2 63	196	4 70	3 13
47	1 41	94	97	2 91	1 94	147	3 96	2 64	197	4 72	3 15
48	1 44	96	98	2 94	1 96	148	3 98	2 66	198	4 74	3 16
49	1 47	98	99	2 97	1 98	149	4 00	2 67	199	4 76	3 18
50	1 50	1 00	100	3 00	2 00	150	4 02	2 68	200	4 78	3 19



INTERCOLONIAL RAILWAY—PASSENGER TARIFF—*Concluded.*

MILES.	CLASS.		MILES.	CLASS.		MILES.	CLASS.		MILES.	CLASS.	
	First.	Second.		First.	Second.		First.	Second.		First.	Second.
201	4 80	3 20	251	5 63	3 75	301	6 45	4 30	351	7 30	4 87
202	4 82	3 21	252	5 64	3 76	302	6 47	4 31	352	7 31	4 87
203	4 84	3 23	253	5 65	3 77	303	6 48	4 32	353	7 32	4 88
204	4 86	3 24	254	5 66	3 78	304	6 49	4 33	354	7 34	4 89
205	4 88	3 25	255	5 68	3 79	305	6 50	4 33	355	7 36	4 91
206	4 90	3 27	256	5 70	3 80	306	6 51	4 34	356	7 38	4 92
207	4 91	3 27	257	5 72	3 81	307	6 52	4 35	357	7 40	4 93
208	4 92	3 28	258	5 74	3 82	308	6 54	4 36	358	7 42	4 95
209	4 93	3 29	259	5 76	3 84	309	6 55	4 37	359	7 44	4 96
210	4 94	3 30	260	5 78	3 85	310	6 58	4 39	360	7 46	4 97
211	4 96	3 31	261	5 80	3 87	311	6 60	4 40	361	7 48	4 99
212	4 98	3 32	262	5 81	3 87	312	6 62	4 41	362	7 50	5 00
213	5 00	3 33	263	5 82	3 88	313	6 64	4 43	363	7 52	5 01
214	5 02	3 35	264	5 83	3 89	314	6 66	4 44	364	7 54	5 03
215	5 04	3 36	265	5 84	3 90	315	6 68	4 45	365	7 55	5 04
216	5 06	3 37	266	5 86	3 91	316	6 70	4 47	366	7 56	5 04
217	5 08	3 39	267	5 88	3 92	317	6 72	4 48	367	7 59	5 06
218	5 10	3 40	268	5 90	3 93	318	6 73	4 49	368	7 60	5 07
219	5 11	3 41	269	5 92	3 95	319	6 74	4 49	369	7 61	5 08
220	5 12	3 41	270	5 94	3 96	320	6 75	4 50	370	7 63	5 09
221	5 13	3 42	271	5 95	3 97	321	6 77	4 51	371	7 65	5 10
222	5 15	3 43	272	5 96	3 97	322	6 78	4 52	372	7 67	5 11
223	5 17	3 45	273	5 97	3 98	323	6 79	4 53	373	7 68	5 12
224	5 19	3 46	274	5 98	3 99	324	6 81	4 54	374	7 69	5 13
225	5 21	3 47	275	5 99	4 00	325	6 83	4 55	375	7 70	5 13
226	5 23	3 49	276	6 00	4 00	326	6 84	4 56	376	7 71	5 14
227	5 25	3 50	277	6 02	4 01	327	6 86	4 57	377	7 72	5 15
228	5 27	3 52	278	6 04	4 02	328	6 88	4 59	378	7 73	5 15
229	5 28	3 52	279	6 06	4 04	329	6 90	4 60	379	7 74	5 16
230	5 29	3 53	280	6 08	4 05	330	6 92	4 61	380	7 75	5 17
231	5 30	3 53	281	6 10	4 07	331	6 94	4 63	381	7 76	5 18
232	5 31	3 54	282	6 12	4 08	332	6 96	4 64	382	7 78	5 19
233	5 33	3 55	283	6 14	4 09	333	6 98	4 65	383	7 79	5 20
234	5 35	3 57	284	6 16	4 11	334	7 00	4 66	384	7 80	5 20
235	5 37	3 58	285	6 18	4 12	335	7 01	4 67	385	7 82	5 21
236	5 39	3 60	286	6 20	4 13	336	7 02	4 68	386	7 83	5 22
237	5 41	3 61	287	6 22	4 15	337	7 03	4 69	387	7 85	5 23
238	5 43	3 62	288	6 23	4 15	338	7 04	4 70	388	7 87	5 24
239	5 45	3 63	289	6 24	4 16	339	7 06	4 71	389	7 89	5 26
240	5 46	3 64	290	6 25	4 17	340	7 08	4 72	390	7 90	5 27
241	5 47	3 65	291	6 26	4 17	341	7 10	4 73	391	7 91	5 27
242	5 48	3 65	292	6 27	4 18	342	7 12	4 75	392	7 92	5 29
243	5 49	3 66	293	6 29	4 19	343	7 14	4 76	393	7 93	5 29
244	5 51	3 67	294	6 31	4 20	344	7 16	4 77	394	7 94	5 30
245	5 53	3 69	295	6 33	4 22	345	7 18	4 79	395	7 95	5 30
246	5 55	3 70	296	6 35	4 23	346	7 20	4 80	396	7 96	5 31
247	5 57	3 72	297	6 37	4 25	347	7 22	4 81	397	7 97	5 32
248	5 59	3 73	298	6 39	4 26	348	7 24	4 83	398	7 98	5 32
249	5 61	3 74	299	6 41	4 27	349	7 26	4 84	399	7 99	5 33
250	5 62	3 75	300	6 43	4 20	350	7 28	4 85	400	8 00	5 34

## CHAPTER 113.

### WINDSOR BRANCH OF THE INTERCOLONIAL RAILWAY.

Government House, Ottawa,

The 26th day of October, 1889.

On the recommendation of the Minister of Railways and Canals, and under the provisions of Chapter 38 of the Revised Statutes of Canada, intituled "The Government Railways Act,"

His Excellency in Council has been pleased to order, and it is hereby ordered, that the following Regulations and Tariff of Rates on the Windsor Branch of the Intercolonial Railway be and the same are hereby established.

#### REGULATIONS.

Passengers  
to purchase  
tickets before  
entering cars.

**Section 1.** Passengers at ticket stations are required to purchase their tickets before entering the cars, otherwise they must pay the conductor an additional charge of twelve cents. They should provide themselves with tickets at least five minutes before the advertised time for departure of the train.

Children.

**Sec. 2.** Children not exceeding four years of age, under the care of their parents or friends, will be taken free; those over that age, and under twelve, will pay half fare.

Family  
tickets.

**Sec. 3.** Family tickets will be sold at ticket stations at a reduced rate from first-class fares, upon the express condition that the purchaser shall not sell or transfer them, or allow them to be used, except by himself or his wife and children residing with him. Season tickets will also be issued, allowing persons whose names have been inserted on them to ride between the stations to be indicated on any regular passenger train. If any such family tickets or season tickets should be presented or used by any person or persons other than those mentioned, the conductor shall take up the ticket and collect the fare—the ticket to be forfeited and the owner to be refused any further supply.

Season  
tickets.

Express pro-  
prietors, &c.,  
holding sea-  
son tickets.

**Sec. 4.** Express proprietors, dealers, agents and messengers holding season tickets shall not carry with them baggage or parcels for the purposes of their business, unless

the freight for the same be prepaid at double first-class freight rates. In case of violation of this rule the ticket shall be forfeited.

Sec. 5. Excursion return tickets at a single first-class fare will be issued at ticket offices to parties of five or more going and returning together by any passenger train to and from any given station within three days—it being distinctly understood that unless these conditions are complied with the tickets will be void and of no effect.

Excursion  
return tickets.

Sec. 6. Persons drunk and unable to take care of themselves shall not be furnished with tickets or be allowed to enter the cars or station premises, and if found on the cars or station premises may be removed.

Persons drunk  
and unable to  
take care of  
themselves.

Sec. 7. Passengers are required to produce and deliver up their railway tickets to the conductor or other person in charge of the train whenever requested to do so by such officer. Should they refuse to do this, and to pay the proper fare, they may be removed from the train at or near a station.

Passengers  
to deliver up  
tickets.

Removal in  
case of refusal.

Sec. 8. Passengers are required to conduct themselves with propriety, and to obey the reasonable requests of the station master, conductor or other officer in charge, with a view to promote the general comfort and convenience, and to maintain order and decorum.

Passengers,  
Duties of.

Sec. 9. Passengers are not entitled to occupy more than one sitting in a passenger car for each ticket.

One sitting.

Sec. 10. Persons are not allowed to get into, or upon, or to quit a car while the train is in motion.

Entering and  
quitting car.

Sec. 11. Passengers, before they can have their baggage checked, must show their tickets to the station baggage master. To avoid mistakes, they must attend personally to the checking and marking of their baggage.

Must show  
tickets before  
baggage  
checked.

Sec. 12. Passengers can only have their baggage checked to the station to which they hold tickets.

Checks must  
correspond  
with tickets.

Sec. 13. Passengers are allowed 100 lbs. of baggage; any quantity exceeding that weight must be charged double first-class freight rates, which must be prepaid.

Amount of  
baggage  
allowed.

Sec. 14. Baggage shall not be understood to include money, merchandise or any articles other than those for personal use.

Baggage not  
to include  
money, &c.

Limit of responsibility of railway.

**Sec. 15.** The railway will not be responsible for any baggage, or article, nor properly given in charge to an officer authorized to receive the same. The railway shall not be accountable for the baggage of any passenger beyond the value of fifty dollars.

Production of check.

**Sec. 16.** Passengers, on arrival at their destination, must produce their duplicate check before their baggage can be delivered to them.

**Sec. 17. PASSENGER TARIFF—BETWEEN HALIFAX AND WINDSOR.**

Miles.	CLASS.		Miles.	CLASS.		Miles.	CLASS.		Miles.	CLASS.		Miles.	CLASS.	
	1st.	2nd.		1st.	2nd.		1st.	2nd.		1st.	2nd.		1st.	2nd.
1	3	2	10	30	20	19	57	38	28	84	56	37	111	74
2	6	4	11	33	22	20	60	40	29	87	58	38	114	76
3	9	6	12	36	24	21	63	42	30	90	60	39	115	78
4	12	8	13	39	26	22	66	44	31	93	62	40	120	80
5	15	10	14	42	28	23	69	46	32	96	64	41	123	82
6	18	12	15	45	30	24	72	48	33	100	66	42	126	84
7	21	14	16	48	32	25	75	50	34	102	68	43	129	86
8	24	16	17	51	34	26	78	52	35	105	70	44	132	88
9	27	18	18	54	36	27	81	54	36	108	72	45	135	90



Chap. 113

Windsor Branch of the I. C. R.

Sec. 19.—SPECIAL FREIGHT RATES.

ARTICLES.	FROM.	To	Miles.	FOR ACCOUNT OF.	AUTHORIZED RATE.	REMARKS.						
Sawn Lumber.....	St. Croix Mills.....	Richmond.....	31	St. Croix Mills.....	\$6 75 per car.....	<i>Hay and Straw.—Third-class rates. Horses.—Estimated at 1,000 lbs. and charged three cents per mile each; no less charge than 45 cts. Cattle.—Estimated at 900 lbs. and charged Third-class rates</i>						
"	Stillwater Mills ..	"	33	Stillwater " .....	6 00 " .....							
Coals.....	Acadia Mines.....	Windsor.....	120	Public.....	1 80 per ton.....							
Rough Plaster.....	Pellows Siding.....	"	4	Pellow.....	0 17. " .....	<i>Sheep and Lambs.—Estimated at 100 lbs. each and charged Third-class rates.</i>						
"	Newport.....	"	6	Public.....	0 17 " .....	<i>Between Richmond (Hatifax) and St. John.</i>						
"	Wilkins Siding.....	"	2	Public.....	0 12½ " .....	<i>Railway Proportion of Rates To or From Windsor.</i>						
"	Windsor or.....	Richmond.....	45	Wilkins.....	0 70 " .....	<i>Passengers—1st class each, \$1 00. cts.</i>						
"	Ballast-pit Siding..	Richmond.....	45	Public.....	0 70 " .....	<table border="0"> <tr> <td>1st class Goods per 100 lbs.</td> <td>13</td> </tr> <tr> <td>2nd " " "</td> <td>10</td> </tr> <tr> <td>3rd and 4th class " " " " " "</td> <td>8</td> </tr> </table> <p>Freight Not to include Side Stock or Carriages.</p>	1st class Goods per 100 lbs.	13	2nd " " "	10	3rd and 4th class " " " " " "	8
1st class Goods per 100 lbs.	13											
2nd " " "	10											
3rd and 4th class " " " " " "	8											
"	Newport.....	"	39	Public.....	0 65 " .....							

Full Car-loads of 18,000 lbs. of any and all descriptions of goods, except Gunpowder and other hazardous articles, to one address, will be carried at Fourth class rates.

The above rates are subject to the conditions and classification of General Freight Tariff.

O. C. Feb. 23, 1874.

# CHAPTER 114.

## PRINCE EDWARD ISLAND RAILWAY.

Government House, Ottawa,

The 15th day of October, 1889.

On the recommendation of the Minister of Railways and Canals, and under the provisions of Chapter 38 of the Revised Statutes of Canada, intituled "The Government Railways Act,"

His Excellency in Council has been pleased to authorize and impose the collection of the tolls and dues for the carriage of freight upon the Prince Edward Island Railway, set forth in the maximum general freight tariff hereunto annexed, such tariff being governed by the Canadian Joint Freight Classification (See pages 994 to 1015 hereof), and being subject to the conditions of carriage.

His Excellency in Council was also pleased to establish tariffs for side and top wharfage to be levied at railway wharves, and for storage in connection with the said railway.

### PRINCE EDWARD ISLAND RAILWAY.

Maximum General Freight Tariff governed by the Canadian Joint Freight Classification and subject to the conditions of carriage.

Distances.	Classes in cents per 100 lbs.										Distances.	Classes in cents per 100 lbs.										
	1st.	2nd.	3rd.	4th.	5th.	6th.	7th.	8th.	9th.	10th.		1st.	2nd.	3rd.	4th.	5th.	6th.	7th.	8th.	9th.	10th.	
Not exceeding 5 m	7	6	5	4	3½	3	3½	3½	3½	2	Over 90 not over 95 m	27	24	16	12	11	10	8	10	10	7	
Over 5 not over 10	9	7	6	5	4	4	3	4	4	2	95	100	28	24	17	12	11	10	8½	10½	10½	7
10	15	11	8	7	6	4½	4	3½	4½	2½	100	105	29	25	17	12	11	10	9	10½	10½	7½
15	20	12	9	7	6	5	4½	4	5	2½	105	110	30	25	17	12	11	10	9	11	11	7½
20	25	13	10	8	7	6	5	4½	5½	3	110	115	30	26	18	12	11	10	9	11	11	7½
25	30	14	11	9	7	6	5	4½	6	3½	115	120	31	26	18	12	11	10	9	11	11½	8
30	35	15	12	10	8	7	6	5	6½	4	120	125	31	26	18	12	11	10	9	11	11½	8½
35	40	16	13	11	8	7	6	5	6½	4	125	130	32	27	18	12	11	10	9	11½	12	8½
40	45	17	14	12	9	8	6½	5½	7	4½	130	135	32	27	19	12	11	10	9	11½	12	8½
45	50	18	15	13	9	8	7	6	7½	4½	135	140	32	27	19	13	12	11	9½	11½	12½	9
50	55	19	16	14	10	9	8	6½	8	5	140	145	33	28	19	13	12	11	10	11½	12½	9½
55	60	20	17	14	10	9	8	6½	8½	5	145	150	33	28	19	13	12	11	10	11½	12½	9½
60	65	21	18	14	11	10	9	7	9	5½	150	155	33	28	20	13	12	11	10	12	13	10
65	70	22	19	14	11	10	9	7	9	5½	155	160	34	29	20	14	13	12	11	12	13	10
70	75	23	20	15	11	10	9	7½	9½	6	160	165	34	29	20	14	13	12	11	12½	13½	10½
75	80	24	21	15	11	10	9	7½	9½	6	165	170	34	29	20	14	13	12	11	12½	13½	10½
80	85	25	22	15	12	11	10	8	10	6½	170	175	35	29	21	14	13	12	11	12½	13½	10½
85	90	26	23	16	12	11	10	8	10	6½												

**SMALLS**—No single shipment of freight from one consignor to one consignee will be charged less than for 100 lbs. at 1st Class rate.  
 Minimum charge, 25 cents.  
 The above rates cancel all previous tariffs and special rates.  
 For side and top wharfage and storage see pages 988 to 993, hereof, substituting Prince Edward Island Railway for Intercolonial Railway, and omitting sub-section (d) of Section 47.

## CHAPTER 115.

### CANALS—REGULATIONS AND TOLLS.

Government House, Ottawa,

The 26th day of October, 1889.

On the recommendation of the Minister of Railways and Canals, and under the provisions of Chapter 37 of the Revised Statutes of Canada, intituled "An Act respecting the Department of Railways and Canals,"

His Excellency in Council has been pleased to make the following regulations for the management, maintenance, proper use and protection of the canals of the Dominion of Canada, and to impose and authorize the following tariffs of tolls and dues upon said canals, and the same are hereby made, imposed and authorized.

#### REGULATIONS:—

For the management, maintenance, proper use and protection of the Canals of the Dominion of Canada, under the control of the Federal Government.

Clearance to be obtained and exhibited at the first lock after departing from the collector's office.

Section II. The master or person in charge of any vessel, steam-boat, boat or raft, navigating any of the canals, shall, immediately upon or before entering any of these canals, obtain a clearance for such vessel, boat or raft, as aforesaid, at the first or nearest collector's office, which clearance shall be exhibited at the first lock after departing from the collector's office to the lock-master, superintendent or any officer duly appointed, and the same shall be exhibited at any other lock whenever and as often as shall be required by any such officers, and in default thereof the lock-master shall not permit such vessel, boat or raft to pass through the lock, and the owner or master in charge thereof shall be subject to a fine not exceeding twenty dollars; and any superintendent, collector, wharfinger, lock-master or other officer duly appointed shall have the right at any time to board any vessel, boat or scow when necessary, in order to check or verify any pass or manifest of such vessel, boat or scow, and any master or person in charge of any such vessel, boat or scow, who shall obstruct and prevent any officer in such discharge of his duty, shall be subject to a penalty not less than forty dollars.



*Canal Regulations.*

## Chap. 115.

Sec. 2. Every vessel or boat navigating any of the canals shall be correctly and distinctly marked and gauged in feet and inches at the bow amidships and stern, showing the exact draft of water drawn by each portion of the vessel or boat, neither of which will be allowed to enter the Welland Canal drawing more than fourteen feet of water, or any of the St. Lawrence Canals drawing more than nine feet in any part or portion of the said vessel or boat, and the master or person in charge of the same who shall proceed into either of the said Welland or St. Lawrence Canals in violation of this regulation shall be subject to a fine not exceeding one hundred dollars, and to detention until the said fine is paid, and the vessel properly lightened. They shall also be supplied with a horn, bell or steam-whistle, which it shall be the duty of the person in charge to sound or cause to be sounded at least one quarter of a mile or fifteen minutes before entering any lock, or passing any swing-bridge, under a penalty of not less than two dollars and not exceeding twenty dollars.

Vessel or boat to be marked and gauged, showing the exact draft of water, &c.

Horn, bell or whistle to be sounded before entering lock or passing swing-bridge.

Sec 3. Every vessel or boat navigating any of the canals, or any navigable channel between any of the canals, whether under way or at anchor, or passing through any lock, or lying moored in any canal, shall, during the night, show a conspicuous light at the bow and stern; a light shall also be exhibited at each end of every raft passing through or lying in any navigable channel or canal at night, and the person in charge of any such vessel, boat or raft, who shall neglect to cause such lights to be shown, or the owner of any such vessel, boat or raft, shall incur a penalty of not less than four dollars and not exceeding forty dollars.

Light to be shown at night.

Sec. 4. No steam-vessel shall be permitted to pass any of the canals, or into or out of the harbors, at either end of the Welland Canal, which shall not have fixed at the top of each of her chimneys or smoke-pipes a wire screen, through which the smoke from the fires of the said steam-vessel is to pass, with meshes or interstices not more than one quarter of an inch in width, the screen to be so placed as to be perfectly visible when closed, and any lock-keeper who shall permit the passage of any steam-vessel or craft propelled by steam without such wire-screen closed on each of the chimneys or smoke-pipes shall be subject to a fine of twenty dollars for each offence; and every master or person in charge of any such steam-vessel or other craft propelled by steam, who shall proceed with a vessel under his charge into or through any part of the said canal or harbors without having such wire-screen closed over each of the chimneys of the vessel or craft, shall be subject

Steam-vessels to have chimney screens.

Penalties for contravention of this regulation.

## Chap. 115.

*Canal Regulations.*

to a like fine of twenty dollars for each offence, and for all damages ensuing therefrom as estimated by the canal superintendent.

Lock or bridge to be approached carefully and with speed slackened.

Sec. 5. It shall be the duty of all masters or persons in charge of any steam-boat or other vessel, or of any raft, on approaching any lock or bridge to ascertain for themselves, by careful observation, whether the lock or bridge is prepared and ready to receive them, or allow them to pass through, and to be careful to stop the speed of any such steam-boat or other vessel or raft in sufficient time to avoid a collision with the lock or its gates, or the bridges, or other works of the canal or harbors, and should such collision take place the owner, owners or master of such steam-boat, other vessel or raft, shall be subject to such fine as the superintendent may impose, not exceeding eighty dollars, and shall also be held liable for any damage to the lock, bridges or other works of the canal that may ensue from such collision; such damage to be estimated by the superintendent of the canal, and at once paid over to the collector, paymaster or person appointed to receive it.

Penalty for injuries to lock, bridges or other works of canal.

Vessel, &c., to be moved promptly on demand of superintendent or other officer.

Sec. 6. The owner, master or person in charge of any vessel, boat or raft as aforesaid, shall, when required to do so by the superintendent of the canal, wharfinger or other officer duly authorized on that behalf, promptly and with all diligence move such vessel, boat or raft as aforesaid, to any place where the superintendent or other officer shall direct, as it may appear to him to be necessary for the purpose of repairing a breach, or for preserving the free and uninterrupted navigation of the canal, or harbors, or for the maintenance of order and regularity at the locks, wharves and landing places, or elsewhere, under a penalty not exceeding forty dollars.

Interference with machinery or water or works of canal, forbidden.

Sec. 7. No person shall open or shut any of the gates or sluices of any of the locks or waste-weirs, or draw down the level by any means whatever, for the supply of machinery, or for any other object, nor shall he in any manner interfere with any of the locks, bridges, waste-weirs or other works of the canal, unless by consent, and under the direction of the officer or person in charge of the same, and any person (not coming within the meaning and provision of Section 18 of this order), who shall commit a breach of this regulation, or interfere with or obstruct the superintendent, lock-master, or other person employed under him, in the execution or performance of his duties, shall incur a penalty not exceeding forty dollars for each and every offence.

Penalty for breach of this regulation.

*Canal Regulations.*

## Chap. 115

**Sec. 8.** All sailing vessels, or other vessels navigating any canal or harbor, shall have their yards topped or braced up, so as not to extend athwart-ships further than the side of the vessel; they shall also have their booms, bowsprits and jib-booms and all out-riggers, rigged in or topped up, and their anchors secured, so as to avoid doing damage to any of the lock-gates, piers, bridges or other works, or vessels, under a penalty against the owner, master or person in charge, not exceeding forty dollars currency for any and every neglect of this regulation.\*

Vessels navigating canal or harbor, how to be trimmed.

**Sec. 9.** No master or person in charge of any vessel, boat or raft, navigating any canal or harbor, shall cast anchor in the same, or in the channel leading thereto, nor fasten, nor moor any such vessel, boat or raft whilst in the canal or harbor, or channel leading thereto, nor discharge any part of their cargo, or take in any lading or wood without the express permission of the superintendent, wharfinger, harbor-master, or lock-master, under a penalty of not less than four dollars, nor exceeding forty dollars, for each and every offence.

Casting anchor, mooring vessel, discharging cargo, or taking in wood, &c., without permission, forbidden.

**Sec. 10.** No person shall build or repair vessels, boats, or barges on any canal ground, unless with the permission of and at such places as the superintendent may point out, under a penalty of not less than four dollars nor more than eighty dollars, and the master of any vessel, or person whatsoever, who shall boil or heat tar, pitch, turpentine, resin or grease, for graving or paving a vessel, or for any other purposes, on any canal ground, except with the permission of and at such places as the superintendent may point out, shall incur a like penalty of not less than four dollars nor exceeding twenty dollars.

No building or repairs to be done or materials prepared without permission.

**Sec. 11.** Any person or persons who shall throw into the harbor or canal, or any lock, feeder, basin or waste-weir connected therewith, or into the channel, or within two hundred yards of the entrance thereof, any carcass or dead animal, or putrid substance of any kind, or stones, ballast, timbers; brush or other rubbish; or in any manner obstruct any canal or harbor, or channel thereto, shall incur a penalty of not less than two dollars and not exceeding two hundred dollars.

Throwing refuse into canal, &c., forbidden.

**Sec. 12.** No pike-poles, or other instruments shod with iron, shall be used in or about the locks or in the canals, under a penalty of four dollars against the person offending.

Pike-poles, &c., not to be used.

\*See Note page 1060.

## Chap. 115.

*Canal Regulations.*

Wood, timber, &c., not to be piled upon or drawer over banks of canal.

**Sec. 13.** No person or persons shall pile wood, or place timber, logs, stones or other materials upon the towing-path, bermbank or any other bank of any canal or basin, or upon any canal ground or harbor, without the permission in writing of the superintendent, and no person shall roll or draw from or into any of the canals, harbors or over the side of any lock or aqueduct, or over the side of any embankment, any log, timber or other material, and every violation of this regulation shall subject every person so offending to a penalty not exceeding forty dollars.

Rafts not allowed without permission.

**Sec. 14.** Timber, cordwood, staves, saw-logs and spars shall not be allowed to pass into or through any of the canals in raft, without permission from the superintendent, and every person offending against this regulation shall be subject to a fine of twenty dollars. In case rafts be admitted into the canal with the permission of the superintendent, they shall be governed by the following regulations:—

Size of raft or tow of timber passing through the Welland Canal.

**Sec. 15.** No raft or tow of timber passing through the Welland Canal shall exceed 25 feet in width; or through the other canals of the Dominion, except those hereunder mentioned, 12 feet in width. Between Allanburg and Lake Erie, such raft or tow shall not exceed 560 feet in length, nor half that length between Allanburg and Lake Ontario. On the St. Lawrence Canals the width of the rafts shall not exceed 25 feet, and the length 720 feet. On the Chambly Canal the width shall not exceed 23 feet and the length 400 feet:

Proximity of rafts to each other.

(a.) No such raft or tow of timber shall approach any other raft or tow of timber nearer than one eighth part of a mile, unless for the purpose of passing, or to be moored nearer than one eighth part of a mile to any other raft or tow of timber which shall be first moored.

Traverses in cribs.

(b.) No traverse in any crib of timber shall extend within one inch of the outer edge of the outside piece of such crib of timber.

Raft to have clearance.

(c.) Every separate raft or tow of timber shall be provided with a clearance, and shall lie over on the off side when passing any vessel in the canal.

Directions as to mooring and conducting rafts.

(d.) No raft shall be allowed to lie unmoored in any canal, or be moored or allowed to lie in any manner across the channel to obstruct the navigation; and every raft or tow of timber shall be conducted through the canal without any unnecessary delay, at such time only, and with such number of men and horses, and under such further regu-

*Canal Regulations.*

## Chap. 115

lations as shall be appointed by the superintendent of the canal.

(e.) Every raft or tow of timber of the full length hereinbefore mentioned, when passing through the canal, shall have at least three men in charge thereof, and shall be towed by two or more horses. Every shorter raft shall have at least two men and one or more horses.

Number of men and horses required.

(f.) In all cases of vessels, boats or scows loaded with lumber, it shall be so stowed as not to project beyond the gunwale of the vessel, boat or scow.

Mode of stowing lumber.

(g.) Every violation of any of the provisions of this section shall subject the owner, person or persons in charge of such tow or raft, or last mentioned vessel, boat or scow, to a penalty of not less than ten dollars, and not exceeding forty dollars.

Penalty for contravention of this section.

Sec. 16. Should any vessel, boat, scow, raft, piece of timber or other matter be left abandoned in any canal or basin, harbor, stream or channel leading to or from the same, or in connection therewith, or in or near the entrance thereof, floating or sunken, or in any measure incommode or likely, in the opinion of the superintendent, to incommode the navigation, or to interfere with the improvements or works of the canal, or harbor, or should any articles be found upon the bank of the canal, or harbor, not under the charge of any person, the owner thereof shall be subject to a fine of not less than four dollars, nor exceeding eighty dollars; which fine shall be held against the property so found, and the superintendent of the canal or harbor-master may seize and remove any such unclaimed or abandoned property, and may afterwards sell the same at public auction, on giving two weeks' written or printed notice, at two public places nearest the place where such property may be found, and shall pay the proceeds of the sale into the hands of the nearest collector of tolls, or of the paymaster or person appointed to receive it; or the superintendent or harbor-master may cause such property to be removed, levying the cost attendant thereon, as well as the fine so imposed, upon the owner or person claiming such property. Provided, also, that upon suspicion that the captain or master intends to abandon such wreck, &c., the canal superintendent or harbor-master is hereby authorized to seize the same, as well as all the contents of said vessel, and to deal with the same as hereinbefore provided in cases of sunken or abandoned property. And provided, also, that before removing any vessel, boat, scow or raft wrecked or sunken, or any part thereof, or the contents thereof, in the canal or harbor, or any property left

Proceedings in case of sunken or abandoned property likely to incommode navigation or to interfere with improvements or works.

## Chap. 115.

*Canal Regulations.*

on the bank of any canal or harbor, connected therewith, the person or persons claiming such vessel, boat, scow or raft, or any portion thereof, or the contents thereof, or such property, shall give security for the payment of all costs and expenses that may be incurred by or for the removal of such wrecked or abandoned property, or any part thereof; such security to be approved of by the superintendent of the canal or by the harbor-master, unless such person or persons shall have obtained leave from that officer to remove the same.

Provision in case owner appears and pays fine and expenses.

Sec. 17. If the owner or owners of any property so seized shall appear and claim the same before the time of sale, and pay the fine, the cost of seizure and expense of removal, no sale shall take place.

Instructions to owners of mills.

Sec. 18. All owners of mills, or those in charge of them, shall stop or shut down their gates when so directed by the superintendent, or person in charge of that part of the canal on which they are situated, and shall not at any time draw down the level below high-water mark, under a penalty of twenty dollars.

O. C. May 31, 1873.

Priority of passage, two classes of vessels.

Sec. 19. As regards priority of passage through the canals or locks of the Dominion, with the exception of the Weland Canal, for which special provision is made, there shall be only two recognized classes of vessels, namely,—

First class.

(a.) First Class—Composed of steamers whose machinery is described in the certificate of the Steamboat Inspector as suitable to be employed “in the carriage of passengers,” in distinction to steamers whose machinery, &c., is described in such certificate as suitable to be employed “in the carriage of freight and passengers,” also market steamers.

Second class.

(b.) Second Class—Composed of all other vessels, of what kind soever they may be.

First class to have priority over second class.

(c.) Of these two classes of vessels, those of the first class shall have priority of passage over those of the second class; provided, that Mail Steamers navigating the canals or passing through any of the locks of Canada shall always have priority of passage over all other vessels whatsoever; and any violation of this clause shall subject the offending party to a penalty of not less than four dollars and not exceeding twenty dollars.

Steamers carrying Her Majesty's mails.

O.C. July 10, 1879; June 17, 1881.

*Canal Regulations.*

## Chap. 115

(d.) When several boats or vessels are lying by, or are waiting to enter any lock or canal, they shall lie in single tier, and at a distance of not less than 300 feet from such lock or entrance, and each boat or vessel, for the purpose of passing through, shall advance in the order in which it may be lying in such tier, except in the case of vessels of the first class, to which priority of passage is granted as above.

Boats waiting must lie in single tier and not less than 300 feet from entrance.

(e.) Should, however, any first class vessel, for which, at a certain fixed hour, any lock is kept clear, not then enter such lock, vessels of the second class, which may be in waiting, shall immediately have the use of the lock, and continue so to use it until the delayed first class vessel arrives.

If first class vessel does not enter, second class vessel to have use of lock.

O. C. June 17, 1881.

(f.) Provided, also, that priority of passage in the Welland Canal will at all times be given over all others to steamers freighted with goods or produce, in being passed through the entrance locks at ports Dalhousie, Colborne and Maitland, and the locks at Allanburgh; and that further priority will at all times be given to steamers freighted with passengers and goods or produce, in being passed through locks Nos. 2 and 25, and the guard gates at Thorold. Any violation of the foregoing provisions of this Section shall subject the offending party to a penalty of not less than four dollars and not exceeding forty dollars.

Priority of passage in the Welland Canal, how regulated.

Sec. 20. All vessels and boats approaching a lock, while any other vessel, going in the contrary direction, is in or about to enter the same, shall be stopped and made fast to the posts placed for that purpose on the off side from the trackway, and remain there until the vessel going through the lock shall have passed, under a penalty, for every such offence, of not less than four dollars and not exceeding twenty dollars.

Vessels, &c., approaching a lock while other vessel is going in contrary direction.

O. C. May 31, 1873.

Sec. 21. In all cases of vessels or boats meeting in any of the canals, the vessels descending the canal shall keep the tow-path, the ascending vessels passing to the off-side; and when any vessel, navigating any canal, shall overtake another vessel which shall not be moving at the same rate of speed; the vessel so overtaken shall bring up and lie to on the off side, at the first convenient place, in order to allow the faster vessel to pass by, unless within 300 yards of the wall of the lock towards which the vessels are progressing, in

Directions in case of vessels, &c., ascending and descending or overtaking another vessel.

which case the faster vessel shall not attempt to pass; under a penalty of not less than two dollars and not exceeding twenty dollars for every offence against this section.

O.C. May 31, 1873; June 17, 1881.

Vessel, &c.,  
not to pass  
through canal  
in less than a  
given time.

Sec. 22. No vessel or boat shall be permitted to pass through any canal in a less time or at a greater speed, than that fixed by the superintendent or other officer in charge thereof (the particulars of which may be ascertained at the first lock on entering such canal); under a penalty, for every such offence, of not less than twenty dollars, and subject, further, to be detained at the last lock until the time limited for passing such canal shall have expired. (See form of notice.)

Directions for  
boats or scows  
built with  
square heads.

Sec. 23. The corners of all boats or scows built with square heads shall be rounded off to a radius of not less than three feet. All such boats or scows shall also have their owners' names or numbers prominently painted on the sides or stern, and they shall also be provided with two iron stakes with rings, to which to make fast when not moored to snubbing posts; and in the case of boats or scows taking in gravel, clay or stones, it shall be only at such places on the canal as the superintendent shall permit, and they must have such guards or trip-boards on the sides, to prevent such materials falling into the canal, as the superintendent may require; under a penalty not exceeding forty dollars.

Rudder, how  
to be con-  
structed.

Sec. 24. Every vessel, boat or barge navigating any canal shall have its rudder so constructed as not to catch or cut the tow-rope of any other vessel, boat or barge; under a penalty not exceeding twenty dollars, to be incurred by the owner, master or person in charge.

Vessel, &c.,  
shall be con-  
ducted into,  
through and  
out of lock in  
a careful  
manner.

Sec. 25. Every vessel, boat and raft as aforesaid, shall be conducted into, through and out of every lock in a careful manner, so as to do no injury to such lock; and for every neglect of this regulation the owner or master shall pay a fine not exceeding twenty dollars, in addition to the cost of repairing any injury that may be done to the lock, or its gates, or other works of the canals of Canada or harbors of the Welland Canal.

Vessel, &c., to  
be provided  
with hawsers  
or check-  
ropes.

Sec. 26. Every vessel, boat or craft navigating the canals shall be provided with at least two good and sufficient hawsers or check-ropes, one at the bow and one at the quarter, which, on passing or entering any lock, shall be made fast to the snubbing posts on the bank of the canal and lock, and



*Canal Regulations.*

## Chap. 115

each rope shall be attended by one of the boat's crew, to check the speed of the vessel while entering the lock, and to prevent it striking against the gates or other parts of the lock, and to keep it from moving about in the lock, while the lock is being filled or emptied; and the master or owner of any vessel or boat who shall neglect to comply with this section shall be liable to a fine not exceeding forty dollars, and the vessel or boat shall not be permitted to pass if in the opinion of the superintendent or other officer duly appointed the lines are considered insufficient.

Sec. 27. Whenever any vessel, boat or other craft shall be passing through any lock or bridge, the master or person in charge shall furnish two, at least, of his boat's crew to assist in working the lock or bridge, to pass his own vessel through it; and the refusal or neglect of such master or person in charge to furnish such assistance shall subject the said master or person in charge to a fine of not less than two dollars, nor more than forty dollars.

Master or owner to furnish two men to assist if required.

Sec. 28. It shall be the duty of the wharfinger, or harbor-master, or if there be no wharfinger present, of the superintendent, collector or lock-tender (whenever in his opinion it shall be necessary), to assign berths for all vessels, boats or rafts when loading, unloading or stopping at any basin, harbor or landing place, or approach, in, or to any canal; and any master, owner or person having charge of any vessel, boat or raft, who shall refuse or neglect promptly to comply with such directions as shall be given by the wharfinger, harbor-master, superintendent, collector or lock-tender, or any person who shall forcibly remove, or attempt to remove, any vessel, boat or raft from the berth assigned to it by the said officer, without his permission, shall be subject to a fine not exceeding twenty dollars.

Berths to be assigned.

Penalty for non-compliance with regulations relating to berths.

Sec. 29. All vessels, boats and rafts as aforesaid, shall be held liable for any injury or damage they may do to any lock, bridge, boat or machinery used in making repairs or in executing works upon any canal or harbor, or to any building adjoining any canal or harbor, whether the same arise from the fault, neglect or mismanagement of the master or person in charge, or from his inattention to the canal regulations, or from accident, and every penalty which may be duly imposed, under these regulations, by any collector of tolls, harbor-master or canal superintendent, and declared in these regulations as against the owner, master, navigator or person in charge of any vessel, boat or raft as aforesaid, whether the same be for non-payment of

Vessels, &c., liable for damage done to locks, bridges, machinery, &c.

tolls, or for any fine duly imposed, or for any sum demanded by the superintendent, engineer or person in charge of any canal, as compensation for any injury done, shall be chargeable upon such vessel, boat or raft as aforesaid; and the superintendent of the canal is authorized and required to seize and detain any such raft, vessel or boat as aforesaid, with her cargo and appurtenances, at the risk of the owner or owners, until payment of such tolls, penalty or compensation as aforesaid, and in default of such payment thereof the superintendent or person in charge of the canal may proceed to sell by public auction any such vessel, boat or raft, after having first given two weeks notice of the day of such intended sale, such notice to be inserted in one or more of the public newspapers, published in or near the place where such seizure shall have been made, at least two clear weeks prior to the day of sale.

Mode of enforcing payment of penalty or damages.

Fine incurred on one canal may be levied on vessel, &c., on another canal.

Sec. 30. Any vessel or boat that shall incur any fine, or do any injury upon any one of the canals or harbors, may be stopped and detained upon any other of the canals or harbors until the fine or compensation for injury done shall be paid, or until security be given for the payment thereof, in the manner above mentioned.

Canal officials not to have an interest in any canal work without permission.

Sec. 31. No overseer or foreman, or other person employed to take charge of any work on the canals, shall, without written permission from the Department of Railways and Canals, or the chief officer having the supervision of the canal, furnish any teams, boats, carriages, materials or other things for the use of the public or of any canal, or employ or contract for the same when owned by any member of his family, or by any foreman or lock-master, or employ any member of his family on the canal, or employ any team, carriage, boat, material or other thing belonging to the public, for any private use or purpose. And no officer on the canals, or person holding any appointment under the Department of Railways and Canals, shall either directly or indirectly be interested in any contract for labor, materials, or other things connected with the canals, and shall not, either directly or indirectly, derive any benefit from the annual expenditures on the canals, beyond his established compensation, nor shall he be in any way interested in boarding any lock-tender, foreman or laborer on the canal, nor shall he sell any articles or property of any kind whatsoever.

Lock-tender not to keep tavern, &c.

Sec. 32. No lock-tender or other officer on the canals shall keep, or in any way be interested in any inn, tavern or grocery, nor shall he sell, or be interested in the sale of any

*Canal Regulations.*

Chap. 115

articles or property whatsoever, to any person navigating or travelling on the canals, nor shall he be directly or indirectly concerned in the sale of fuel, or in the hiring of horses for towage.

Sec. 33. These regulations shall also extend and apply to the several canals and public works hereinafter mentioned, for their management, maintenance, proper use and protection, that is to say:—The Rideau Canal, including the Rideau River and the Lakes through which the Navigation passes, the Navigation between Lachine and Ottawa City, including the Carillon, Chute à Blondeau and Grenville Canals and the Feeder from the North River; the Navigation from Scugog Lake to the Buckhorn Dam, including Scugog Lake and River, the Lock and Dam at Lindsay, Sturgeon Lake, Bobcaygeon Canal, Lock and Dam, Pigeon and Mud Lakes and the Dam at Buckhorn.

Canals to which these regulations shall apply.

Sec. 34. No raft of timber shall be allowed to be moored along the line of the Welland or St. Lawrence Canals unless it be placed under the immediate charge of one or more men (according to the quantity of timber it may contain) under a penalty of not less than ten dollars and not exceeding forty dollars, and the superintendent is hereby authorized to place in charge of such raft or tow of timber one or more men, as may seem to him necessary, and may seize and detain such raft or tow of timber until the expense incurred thereby as well as the fine be paid.

Timber moored along Welland or St. Lawrence Canals to be placed in charge of one or more men.

O.C. May 31, 1873.

Sec. 35. All vessels owned or chartered by persons having contracts for the enlargement or repair of any of the canals, and employed by them in removing earth or carrying materials necessary for the prosecution of such works, shall be entitled to pass through such canals free of tolls upon such vessel and cargo.

Vessels owned or chartered by persons having contracts for repairing canals

O.C. April 22, 1884.

## MAKING REPORTS.

Sec. 36. Every owner, master or person in charge of any vessel, boat, barge or raft about to enter any canal shall, before entering, make to the nearest collector of canal tolls or other proper officer a full and complete report setting forth in detail:—

Full and complete report to nearest collector.

(a.) The quantity and description of the cargo contained in such vessel, boat or barge;

Quantity and description.

## Chap. 115

## Canal Regulations.

Registered  
tonnage.

(b.) The registered tonnage of the vessel, boat or barge,—  
or ;

Number of  
pieces and  
cubic feet.

(c.) In the case of rafts, the number of pieces of timber or  
logs, and with reference to rafts of square timber, the num-  
ber of cubic feet contained therein ; and

Other infor-  
mation.

(d.) Generally such other information as may be necessary  
for computing the tolls to which the vessel, boat, barge  
with the cargo contained therein, or the raft, as the case  
may be, is liable to pay.

Report to be  
signed.

(e.) Every such report shall be signed by the person  
making it, and its correctness shall be declared to before the  
collector of tolls or other officer in charge.

Manifests,  
clearances,  
bills of lading,  
&c., may be  
required of  
owner, master,  
&c.

Sec. 37. The collector of tolls or other officer in charge is  
hereby authorized to require of any owner, master or other  
person in charge of any vessel, boat barge or raft entering  
any canal ; communication of all manifests, clearances, bills  
of lading, specifications, certificates, measurements and all  
other papers relating to the vessels and their cargoes, or to  
rafts, and to enter upon and to examine any such vessel,  
boat, barge or raft, and take account of the cargoes or quan-  
tities they contain.

Owner, &c.,  
neglecting or  
refusing to  
give correct  
information.

Sec. 38. Any owner, master or other person having  
charge of any vessel, boat barge or raft entering any canal,  
who—

(a.) Neglects or refuses to make such reports as herein  
provided,—or,

(b.) Who refuses to produce papers or to give any informa-  
tion such as is herein required,—or,

(c.) Who impedes or prevents any collector of tolls or other  
officer in the performance of his duties,—or,

(d.) Who gives any false information in relation to any  
matter herein referred to,—

Penalty.

Shall, for each and every such offence, incur a penalty of  
not less than five dollars nor more than twenty dollars, and  
shall, in addition thereto, pay double tolls on all articles  
wholly or in part omitted from any report made by him in  
pursuance of these regulations.

O.C. Oct. 6, 1881.

RIDEAU CANAL BASIN, OTTAWA.

The following Sections of these Regulations to the end of  
Section 63 shall apply to the management, proper use and

*Canal Regulations.*

## Chap. 115

protection of the wharves around the Rideau Canal Basin and the approaches thereto in the City of Ottawa, embracing that portion of the canal from and including the first Lock to the bridge known as the Maria Street Bridge.

Sec. 39. The wharfinger shall, according to his discretion, assign to each vessel, steamer or barge the berth it shall occupy, giving precedence, when practicable, to a vessel or barge with cargo over a vessel or barge taking in cargo, and he shall have power to change such berth from time to time as he may see fit; and such assignment of a berth may be made by verbal notice to the master or person in charge of such vessel or barge, either on each trip or for the whole business season, and no vessel or barge shall take up or occupy any berth in the said basin or the approaches thereto unless such berth shall have been assigned to her by the wharfinger; provided always that the wharfinger assigns a berth within twelve hours after her arrival; but if the wharves are full such vessel shall lie where indicated until a berth has been assigned by the wharfinger.

Wharfinger shall assign berth to vessel.

Vessel not to occupy berth unless assigned.

Proviso.

Sec. 40. All vessels or barges in the said canal basin and its approaches shall be under the control of the wharfinger, so far as regards their position, mooring, fastening, removal and the extent of accommodation, which the masters or persons in charge thereof may require from each other; and no other person on board or in charge of any vessel or barge in said basin shall disregard or disobey the orders of the wharfinger in such respect; and in the event of such refusal or disregard of the orders of the wharfinger it shall be lawful for such wharfinger to cast off or cut away the hawsers or other fastenings of such vessels or barges, or cut away any ring or post to which such hawsers or other fastenings may be attached; and in such event, in addition to the penalty hereinafter provided for, the masters or persons in charge of each vessel shall be bound to pay to the Department of Railways and Canals of Canada the damage (if any) caused to the wharf by the cutting away of such ring or post; and the wharfinger shall have power to hold any vessel disobeying his order, and causing damages, until such damages be paid.

Vessels, &c., under control of wharfinger.

Refusal to obey; liability for damages.

Sec. 41. In the event of the resistance of any person or persons on board of any vessel to the orders of the wharfinger, to remove the same under the powers conferred upon him by the last preceding section, whether such resistance be active or passive, it shall be lawful for the wharfinger to take possession of such vessel or barge, and to remove the

Resistance to orders.

Wharfinger may remove vessel.

same, and he shall have the power of employing a sufficient number of men for that purpose, at the expense of the master, owner or person in charge of such vessel, to aid him in forcing such removal, and have the right to move, anchor, or make fast such vessel at such point as he shall see fit.

Raft, crib, &c., not to be attached to any wharf without permission.

Sec. 42. No raft, crib, floats or floating timber shall be or remain attached, or secured to any wharf in said basin or its approaches, without the express permission of the wharfinger, and irrespective of the penalty hereinafter provided for; and the wharfinger shall have the power, without any notice to any person whomsoever, to cut adrift any raft, crib or timber, or hire tugs to remove, or may otherwise remove the same, when so attached or secured without his permission; and such raft, crib or timber, so cut adrift or towed out, shall thereafter continue to be and remain at the risk of the owner thereof, and the owner shall be liable for all costs connected with towing or cutting adrift or otherwise removing such raft, crib or timber, and no raft shall enter the Deep Cut without the permission of the wharfinger being first had; and no vessel or barge shall lie within the limits of said basin or its approaches in such a place or position as to prevent a free and unobstructed passage for all other vessels or barges in the said basin to any wharf in the said basin.

No raft to enter Deep Cut without permission.

Lessees to have first privilege.

Sec. 43. Lessees of lots facing the basin shall, (subject to the disallowance of the wharfinger,) have the first privilege of unloading or loading vessels or barges opposite their respective lots; but the wharfinger may, if he sees fit, allow any vessel or barge to discharge on the wharves although fronting on private lots.

Raft, vessel, &c., assigned a berth, to commence unloading immediately.

Sec. 44. Rafts or cribs, floats, barges or vessels loaded with cordwood, boards, lumber, ties, brick, cedar posts, stone or other freight, shall not be permitted to remain in the berths assigned to them, unless the unloading of the cargo thereof be commenced immediately and diligently and continually proceeded with, and except when unloading firewood alongside any wharf at the rate of not less than twenty-five cords a day; and all cordwood, lumber, ties, posts, bricks, stone or other freight must be carted clear of the canal lands, unless special permission to deposit the same on the canal lands be given beforehand by the wharfinger.

Time allowed for unloading.

Sec. 45. Vessels or barges arriving in the canal basin or its approaches shall be allowed as follows:—

*For Unloading.*—Two working days for 50 tons of cargo, or less than 50 tons; three working days for over 50 tons

*Canal Regulations.*

## Chap. 115

and not exceeding 100 tons, and one working day for every 50 tons of cargo exceeding 100 tons. Cordwood not less than 25 cords per day.

*For Loading.*—One working day for 50 tons or under, and two working days for 50 tons and under 100 tons; one working day additional for every 50 tons of cargo exceeding 100 tons: Provided always that vessels or barges that shall be discharged or loaded in a shorter time, or that shall have ceased discharging or loading from any cause, shall not be entitled to retain their berths should the wharfinger see fit to order them to remove; and provided also that on application to that effect the wharfinger shall have the power, if he sees fit, to extend such time for a further period, and every such working day shall consist of ten hours.

Sec. 46. No goods, coal, firewood or cargo of any kind landed from any vessel, barge or raft, and placed upon any wharf or the canal lands, shall remain for a longer period than twenty-four hours (Sundays excepted) after being landed or placed there, before the owners, the master or person in charge shall commence removing the same off the wharves or canal lands at the rate specified by the next preceding Section and a like penalty to that hereinafter provided shall be incurred for every twenty-four hours of working days during which such goods shall remain upon such wharf or canal lands without being removed.

Sec. 47. No goods placed on the wharves or the canal lands for shipment on any vessel or barge shall be allowed to remain on the wharves or canal lands for a longer period than twenty-four hours, unless under special permission from the wharfinger, and a like penalty to that hereinafter provided shall be incurred for every twenty-four hours of working days during which such goods shall remain upon such wharf or canal lands until shipped.

Sec. 48. No goods shall be placed on the wharves in said basin or the canal lands so as to obstruct the thoroughfare therein under the penalty provided for the breach of any by-law, and if so placed shall be removed forthwith by the owner or person in charge thereof upon the orders of the wharfinger to that effect, under a further like penalty.

Sec. 49. In the event of the breach of either of the last three foregoing Sections, or any part of them, it shall be lawful for the wharfinger to remove or cause to be removed any goods, coal, wood, lumber or other thing which shall

For loading.

Goods or cargo landed not to be allowed to remain on wharf more than 24 hours.

Goods for shipment, how long allowed to remain.

Goods not allowed to obstruct the thoroughfare.

On breach of the last three sections, wharfinger may remove goods.

remain on the wharf or canal lands longer than it or they are permitted to do by the last three foregoing Sections; or by any of them, and such removal shall be made at the cost and charges of the owner or consignee of such goods, or of the master or person in charge of said vessel or barge from which they are landed, or shipped at the option of the Minister of Railways and Canals, and such costs and charges, and any further or other reasonable costs and charges in respect thereof, and of the custody and safe-keeping of the same, and all penalties incurred in respect thereof, shall be a lien upon such goods, which shall not be delivered to any person whomsoever until all such costs, charges and penalties be paid, and notwithstanding such removal such goods, shall continue to be at the risk of the owners thereof; and if the costs and charges thereon, and all penalties due in respect thereof, be not paid, and such goods, taken away by the owners thereof or their representatives within thirty days after their removal, such goods, may be sold by public auction for the benefit of whom it may concern, and the Minister of Railways and Canals shall only be accountable in respect of such goods, for the net proceeds of such sale, less all such costs, charges and penalties.

Costs to be a  
lien on the  
goods.

Goods at  
owners' risk.

Effects may  
be sold.

Repairs.

**Sec. 50.** No person shall make or dress any timbers or do any repairs on any of the wharves or canal lands, except with the express permission of the wharfinger previously obtained, and at such places as he shall have designated.

No rubbish to  
be thrown into  
canal.

**Sec. 51.** No rubbish or thing whatsoever shall be thrown from any vessel, barge, raft, or from the wharves into the water of the canal basin, and no person shall place, pile or deposit any dirt, rubbish, snow, ice or other thing upon said wharves.

Lease of piling  
ground.

**Sec. 52.** The wharfinger shall have power, under the direction of the superintendent, to allot, let or lease any space or vacant ground adjoining the canal basin for piling thereon cordwood, lumber, &c., subject to such rate of charges and for such time and times as from time to time may be fixed by the Minister of Railways and Canals.

Penalty for  
violation of  
regulations.

**Sec. 53.** Every person, in whatsoever capacity he may be acting, who shall violate or infringe any of the regulations hereinbefore contained, shall be subject to a fine of five dollars.

Penalty for  
disobedience.

**Sec. 54.** Every person, in whatsoever capacity he may be acting, who shall fail or neglect to obey any one of the afore-



*Canal Regulations.*

Chap. 115

said regulations, or any portion of one of them, shall be subject to a penalty of five dollars.

Sec. 55. The master or person in charge of any vessel or barge who shall violate or infringe, or fail or neglect to obey any one of the aforesaid regulations; or any part of any one of them, and the master or person in charge of any vessel or barge in the conduct and management of which any one of the said regulations, or any part of any one of them, shall be violated, infringed or destroyed, shall be subject to a penalty of five dollars.

Master, &c., violating or neglecting to obey, to be subject to fine.

Sec. 56. The owner of any cargo, lumber or effects, or of any matters or things whatsoever landed from any barge in respect to which cargo, lumber or effects, matters or things, there shall be any violation or infringement of or disobedience to, any one of the aforesaid regulations or any part of any one of them, shall be subject to a penalty of five dollars.

Owner of cargo landed, liable.

Sec. 57. The owner or person in charge of any goods, lumber or other effects deposited for shipment on any wharf or elsewhere on the said basin, or its approaches, in respect of which goods, lumber or effects there shall be any violation or infringement of, or disobedience to, any one of the aforesaid regulations, or any part of any one of them, shall be subject to a penalty of five dollars.

Owner of cargo for shipment, liable.

INTERPRETATION.

Sec. 58. The word "Vessel," when made use of in the foregoing regulations, is to be understood as comprehending and including vessels, boats and barges, whether propelled by steam or otherwise, scows, pontoons or other floating conveyances of freight, or for the purposes of transport. The word "Raft," when made use of in the foregoing regulations, is to be taken as including rafts or cribs of timber of every description, whether manufactured or unmanufactured, lumber, logs, floating timber, rafting materials, ties and wood, or of material used for conveyance of freight or for purposes of transport. The words "Working days" are to be understood as comprehending and meaning days on which work can be legally performed. The word "Owner" shall comprehend or mean a part owner or owners. The word "Wharfinger" shall comprehend the person appointed to act as such by the Minister of Railways and Canals of Canada. The word "Goods" shall be understood as comprehending coal, ore and other mineral products, lumber, fire-

Vessel.

Raft.

Working days.

Owner.

Wharfinger.

Goods.

wood, cordwood, ties, staves, laths, brick, stone, sand or earth. or any goods, wares or merchandise of any description or nature whatsoever. When more persons than one are hereinbefore made subject to a penalty, the Minister of Railways and Canals shall have the option of proceeding for such penalty against any one or more of such persons as he may see fit.

O.C. May 14, 1875.

REGULATIONS FOR LANDING FIREWOOD ON THE LINE OF THE  
RIDEAU CANAL.

Sapper's  
Bridge to  
Little Sus-  
sex St.

Sec. **59.** No firewood shall be landed on the easterly side of the basin from Sapper's Bridge to the line of Little Sussex Street.

Between the  
line of Little  
Sussex St. and  
the by-wash or  
waste weir.

Sec. **60.** Firewood may be landed between the line of Little Sussex Street and the by-wash or waste weir, but must be removed within twenty-four hours after having been placed there; a fine of three cents per cord will be charged for every day the wood remains on the wharf after such notice has been given.

Around the  
basin on Gov-  
ernment land.

Sec. **61.** Firewood may be landed and piled around the basin on Government land within forty feet of the water, leaving a roadway of at least fifteen feet between every four piles of firewood, which roadway must be as near as practicable at right angles to the margin of the canal; this wood must also be removed within twenty-four hours after the owner or person in charge has been notified to that effect, and in default a fine of three cents per cord will be levied upon it for every day it remains thereafter.

Wharfage on  
Government  
Canal Re-  
serve.

Sec. **62.** Two cents per cord will be charged as wharfage or ground rent upon firewood placed on any part of the Government Canal Reserve.

Permit to land  
firewood.

Sec. **63.** No firewood shall be landed without a permit having been first obtained from the lock-master or collector, and the let-pass must be given up to this officer before the wood is unloaded, under a penalty of forty dollars.

O.C. June 2, 1860.

CANAL AND LOCK AT BOBCAYGEON.

Limit of  
regulations.

Sec. **64.** This, and the three sections next following, in addition to the Regulations above mentioned, shall, for the further management, maintenance, proper use and pro-

*Canal Regulations.*

## Chap. 115

tection of the same, apply to the canal and lock at Bobcaygeon.

Sec. 65. No scow, barge, or other vessel, shall be allowed to take on or deliver freight, while in either the lock or canal, under a penalty of five dollars for each offence; except that passenger steamers may have the privilege of taking in fuel, landing or taking in freight, when in the canal; provided, that no longer time is occupied in so doing than one half hour, and no detention is caused thereby to any other vessel.

Not allowed to take or deliver freight in lock or canal.

Exception.

Sec. 66. In case of two vessels approaching from opposite directions, about the same time, the one ascending shall stop, or tie up opposite a fixed point (to be designated by the lockmaster), and there remain until the other shall have passed through, under a penalty of five dollars for each offence against this regulation.

Two vessels approaching from opposite directions.

Sec. 67. In any case where logs are taken down to the sawmill in operation on the north side of the lock, the rafts of which they form a part must be separated in the bay above the entrance; and no more than two logs abreast of each other shall be sent down or allowed to accumulate in any part of the canal at one time; neither shall there be in the whole canal at any one time more logs than the basin built for their reception can accommodate, and no "floats," "traverses," or "withs," shall be allowed to enter the canal, whether separated from or connected with the logs intended for the saw-mill; and any bark, slabs, edgings or other obstructions found in the lock or approaches to it, known to have emanated from the mill or the handling of the logs for it, shall be removed at the mill-owner's expense, who shall, in addition, be fined the sum of five dollars for each time such occurrence takes place.

Logs taken down to the saw mill on the north side of the lock.

Directions as to the accumulation of logs and obstructions to the locks.

O.C. May 31, 1873.

## STURGEON LAKE TO PIGEON LAKE.

Sec. 68. This, and the six sections next following, shall apply to the passing of logs and timber of any description through the lock at Bobcaygeon downwards from Sturgeon Lake to Pigeon Lake, or upwards from Pigeon Lake to Sturgeon Lake, in the Province of Ontario, in addition to the general regulations for the management and protection of the canals and harbors of the Dominion of Canada.

Limit of regulations.

Sec. 69. The owner or person in charge of any raft or parcel of timber, logs or other description of timber (which shall

Owner or person in charge.

be in cribs of suitable size to pass through the lock); previous to entering into the Canal Race above the lock, and at the mouth of the river in Pigeon Lake for the passing of such raft or parcel of timber through the same, shall make a full and complete report of such raft or parcel of timber, containing an account of the number of cribs, the number of pieces, description of timber, the name and designation of the owner or owners, and of the supplier or furnisher thereof, together with marks and other particulars relating thereto; and upon failure to comply with this regulation such owner or person in charge shall incur a penalty of not less than twenty dollars and not more than two hundred dollars.

Shall make full and complete report.

Penalty for non-compliance.

Permission to use berths.

**Sec. 70.** No raft or parcel of timber, logs or any description of timber in rafts or parcels, shall be moored or banded up nearer to the upper Canal Race or to the outlet of the river in Pigeon Lake than the berths pointed out by the lock-master or officer acting in that capacity; and when permission shall be granted to the owners or persons in charge of any raft to place any raft or parcel of timber of any description, such raft or parcel of timber shall not, in any case, take more or other space or place than the berths allotted by the said lock-master or other officer in charge of the works; and they shall, at any time when directed so to do, move the said raft or parcel of timber from place to place, or remove the same entirely as soon as required so to do by the lock-master or other officer in charge of the works; and in case of refusal or neglect on the part of the said owners or persons in charge of timber or rafts of any description to comply with the requirements of this section they shall incur a penalty of not less than twenty dollars and not more than fifty dollars.

Report showing number of pieces and payment of lock dues.

**Sec. 71.** The owner or owners or persons in charge of any raft or parcel of timber of any description shall, before removing the same from the mouth of the river in Pigeon Lake or the bay above the Lock in Sturgeon Lake, subscribe and deliver to the lock-master or other officer duly appointed, as the case may be, a report in duplicate, showing the number of pieces of each description of timber, saw-logs or any other description of timber so passed, and shall pay the lock dues thereon (the same being assessed in conformity with the schedule hereunder written), or secure the same to the satisfaction of the lock-master or other person appointed to collect dues; on failure to comply with this regulation such owner or person in charge shall incur a penalty of not less than twenty dollars and not more than two hundred dollars, in addition to double the amount of dues which would other-

*Canal Regulations.*

## Chap. 115

wise be payable on any raft or parcel of timber of any description passing such lock without such acknowledgment.

**Sec. 72.** The collector of lock dues, or any person or persons duly authorized by him in that behalf, shall, at all hours during the day, have free access and full power and permission to enter and remain as long as he or they may see fit upon any raft or parcel of timber, for the purpose of examining the same, and every facility shall be afforded him or them for ascertaining the number of cribs or the number of pieces of any description of timber of which the same is composed; and any person obstructing the collector of lock dues, lock-master or other person duly authorized as aforesaid, in the execution of his duty, shall incur a penalty of not less than fifty dollars and not more than two hundred dollars.

Collector of lock dues to have free access and full power to enter and remain on raft, &c.

**Sec. 73.** It shall be competent for the collector of lock dues, his deputy or deputies, assistant or assistants, or persons duly authorized by him, to enter upon, seize and detain, at the risk, costs and charges of the owner or owners thereof, any raft or parcel of timber which shall have been moved away from the bay above the Canal Race in Sturgeon Lake, or the mouth of the river in Pigeon Lake, without the lock dues therefor, the amount awarded for damages, or the fines and penalties, if any, being first paid or secured to his or their satisfaction; and any and every person obstructing the collector of lock dues, or other person or persons duly authorized as aforesaid, in the execution of his or their duty, shall incur a penalty of not less than twenty dollars and not more than two hundred dollars.

Collector may seize and detain raft, &c., moved away without payment of lock dues.

**Sec. 74.** Rafts, cribs and every description of timber shall be held liable for the dues, damages and penalties imposed under these regulations; and the lock-master, or other duly appointed officer, is hereby authorized and required to seize and detain any such raft, crib or parcel of timber, until payment of such dues, damages or penalties is made, or until the owner or person or persons in charge shall have given satisfactory security for the payment thereof, within thirty days after the same shall have been declared to be incurred or shall have been demanded; and, in default of such payment being made within the said term of thirty days, then the said lock-master or officer may proceed to sell by public auction any such raft, crib or parcel of timber,—of which sale at least two weeks' notice shall, in the mean time, have been given in one or more of the public newspapers pub-

Rafts, cribs, &c., to be held liable for dues damages and penalties.

Mode of procedure to enforce payment of dues, &c.

Chap. 115.

*Canal Regulations.*

lished at the nearest place from the said works, and placarded in a public and conspicuous place at or near the said works where the raft, crib or timber is lying; and if the cost attendant on such auction sale, as well as all other costs, damages and penalties imposed or awarded, can not be realized from the timber so seized and sold, the same shall be recoverable from the owner of said raft, crib or parcel of timber.

O.C. Aug. 10, 1874.

*Saml A. Mann*

*Se*

Canal Regulations.

Sec. 75.—DOMINION CANALS.

RATES OF TOLLS.

The Rates of Tolls are divided into Six Classes, as under, and are per Ton, unless otherwise specified,	Welland Canal, westward only.	Welland Canal, eastward only.	Lake Erie to Montreal.	St. Lawrence Canals, each way.	Chambly Canal and St. Ours Lock, each way.	Rideau Canal, each way.	Ottawa Canals and St. Ann's Lock, each way.	Ottawa to St. John's, each way.
	\$ cts.	\$ cts.	\$ cts.	\$ cts.	\$ cts.	\$ cts.	\$ cts.	\$ cts.
<i>Class No. 1.</i>								
Vessels, steam, per ton.....	0 01½	0 01½	0 02½	0 00¾	0 00¾	0 01½	0 00½	0 01½
“ sail and other, per ton.....	0 02½	0 02½	0 03¾	0 01½	0 01½	0 02½	0 01	0 02¾
<i>Class No. 2.</i>								
Passengers, 21 years of age and upwards, each..	0 10	0 10	0 20	0 10	0 05	0 08	0 02½	0 09½
“ under 21 years, each.....	0 05	0 05	0 10	0 05	0 02	0 04	0 01½	0 04½
<i>Class No. 3.</i>								
Bricks, cement and water lime.....	} 15	} 0 20	} 0 20	} 0 15	} 0 10	} 0 07	} 0 06	} 0 19½
Clay, lime and sand.....								
Brimstone.....								
Corn.....								
Flour.....								
Iron, railway.....								
“ pig.....								
“ all other, including steel (O. C., Feb. 1, '88)								
Plaster, gypsum.....								
Salt.....								
Salt meats or fish, in barrels or otherwise.....								
Agricultural products, vegetable, not enumerated	} 0 15	} 0 20	} 0 20	} 0 15	} 0 10	} 0 07	} 0 06	} 0 19½
“ animal.....								
Stone, for cutting.....	} 0 15	} 0 20	} 0 20	} 0 15	} 0 10	} 0 07	} 0 06	} 0 19½
Wheat.....								
<i>Class No. 4.</i>								
All other articles, not enumerated.....	0 15	0 20	0 20	0 20	0 10	0 26	0 14	0 29
<i>Class No. 5.</i>								
Bark.....	0 20	0 20	0 20	0 15	0 10	0 07	0 06	0 19½
Barrels, empty, each.....	0 02	0 02	0 02	0 02	0 02	0 02	0 01	0 03½
Boat knees, each.....	0 05	0 05	0 05	0 02	0 02	0 02	0 01	0 03½
Floats, per 1,000 lineal feet.....	1 40	1 40	1 40	1 40	1 20	1 05	0 50	2 05
Firewood, per cord, in vessels.....	0 20	0 20	0 20	0 20	0 10	0 15	0 08	0 23
“ “ rafts.....	0 25	0 25	0 25	0 25	0 15	0 19	0 09	0 30½
Hoops.....	0 25	0 25	0 25	0 20	0 15	0 15	0 10	0 30
Masts and spars, telegraph poles, per ton of 40 cubic feet, in vessels.....	0 15	0 15	0 15	0 05	0 05	0 08	0 07	0 13½
Masts and spars, telegraph poles, per ton of 40 cubic feet, in rafts.....	0 20	0 20	0 20	0 10	0 10	0 15	0 10	0 22½
Railway ties, in vessels, each.....	0 01	0 01	0 01	0 00½	0 00½	0 00½	0 00½	0 01½
“ “ rafts, “.....	0 02	0 02	0 02	0 01	0 01	0 02	0 01	0 02½
Sawed stuff, boards, plank, scantling and sawed timber, per M feet, board measure, in vessels	0 30	0 30	0 30	0 15	0 10	0 11½	0 06½	0 20

Chap. 115

Canal Regulations.

RATES OF TOLLS—*Concluded.*

The Rates of Tolls are divided into Six Classes, as under, and are per Ton, unless otherwise specified.	Welland Canal, westward only.	Welland Canal, eastward only.	Lake Erie to Montreal.	St. Lawrence Canals, each way.	Chambly Canal and St. Ours Lock, each way.	Rideau Canal, each way.	Ottawa Canals and St. Ann's Lock, each way.	Ottawa to St. John's, each way.
	\$ cts.	\$ cts.	\$ cts.	\$ cts.	\$ cts.	\$ cts.	\$ cts.	\$ cts.
<i>Class No. 5—Continued.</i>								
Sawed stuff, boards, plank, scantling and sawed timber, per M feet, board measure, in rafts...	0 60	0 60	0 60	0 30	0 20	0 19	0 09	0 36½
Square timber, per M cubic feet, in vessels.....	3 00	3 00	3 00	1 00	1 00	0 56	0 44	1 69
“ “ “ rafts.....	4 50	4 50	4 50	2 00	2 00	1 12	0 63	3 13
Waggon stuff, woodenware and wood, partly manufactured, per ton of 40 cubic feet.....	0 40	0 40	0 40	0 40	0 25	0 30	0 20	0 55
Shingles, per M.....	0 06	0 06	0 06	0 06	0 04	0 04½	0 02½	0 08
Split posts and fence rails, per M, in vessels.....	0 40	0 40	0 04	0 40	0 20	0 23	0 12	0 42
“ “ “ rafts.....	0 80	0 80	0 80	0 80	0 40	0 38	0 17	0 77
Sawlogs, each standard log.....	0 08	0 08	0 08	0 08	0 05	0 06	0 06	0 13
Staves and headings, barrel, per M.....	0 40	0 40	0 40	0 20	0 15	0 15	0 10	0 30
“ “ pipe “.....	1 50	1 50	1 50	1 00	1 00	0 75	0 50	1 75
“ “ West India, per M.....	0 75	0 75	0 75	0 60	0 25	0 45	0 25	0 65
“ “ salt barrel, sawn or cut, per M.....	0 08	0 08	0 08	0 04	0 03	0 03	0 02	0 06
Traverses, per 100 pieces.....	0 50	0 50	0 50	0 50	0 40	0 38	0 15	0 67½
Hop poles, per 1,000 pieces.....	2 00	2 00	2 00	2 00	1 50	1 50	0 65	2 65
<i>Class No. 6.</i>								
Gypsum, crude (per O. C., 28th October, 1882)...	0 15	0 05	.....	0 05	Westward	.....	.....	.....
Coal.....	0 20	0 20	0 20	0 15	0 10	0 08	0 05	0 17½
Stone, unwrought, corded, and not suitable for cutting, per cord.....	0 75	0 75	0 75	0 60	0 37½	0 28	0 24	0 77½
Iron ore, kryolite or chemical ore.....	0 05	0 05	0 05	0 05	0 05	0 05	0 05	0 05
Ice.....	0 05	0 05	0 05	.....	.....	.....	.....	.....

O.C. April 18, 1873.



*Canal Regulations.*

Chap. 115

**Sec. 76.**—STANDARD FOR ESTIMATING WEIGHTS, FOR CANAL TOLLS.

	Tons.		Tons.
2,000 lbs avoirdupois.....	1	Stone, 1 cord.....	7½
Per M. is per thousand feet.....		Whiskey, 4 barrels or 215 gallons	1
Per Mille is per thousand pieces.....		Empty barrels, 10.....	1
Green fruit, 9 barrels are.....	1	Barrel hoops, 10 Mille.....	1
Ashes, 3 barrels are.....	1	Board and other sawed lumber,	
Bark, 4 cords.....	1	600 feet board measure.....	1
Beef, 7 barrels.....	1	Boat knees, 4.....	1
Biscuit and crackers, 9 barrels.....	1	Firewood, 1 cord.....	3
Bricks, common, 1,000.....	2	Hop poles, 60 or 40 cubic feet.....	1
Butter, 22 kegs or 7 barrels.....	1	Shingles, 12 M. or bundles.....	1
Cattle, 3.....	1	Split posts and fence rails, 1 Mille	1
Cement and water lime, 7 barrels..	1	Staves & headings, Pipe, 1 Mille..	8
Fire bricks, 1,000.....	3	do W. India, 1 Mille	4
Fish, 7 barrels.....	1	do Barrel, 1 Mille...	2½
Flour, 9 barrels.....	1	do Salt barrel, 1	
Gypsum and manganese, 6 barrels	1	Mille.....	½
Horses, 2.....	1	Sawlogs, standard, 1.....	½
Lard and tallow, 7 brls. or 22 kegs	1	Square timber, 50 cubic feet.....	1
Liquors and spirits, 215 gallons....	1	Telegraph poles, 10, or 40 cubic ft	1
Liquors, all others, 215 gallons....	1	Masts and spars, 40 cubic feet....	1
Nuts, 9 barrels.....	1	Railroad ties, 16 or 50 cubic feet	1
Oysters, 6 barrels.....	1	All other woodenware, or partly	
Pork, 7 barrels.....	1	manufactured wood, 40 cubic	
Salt, 7 barrels.....	1	feet, as per tariff.....	1
Seeds, 9 barrels.....	1	Traverses, 40 cubic feet, or 5 pieces,	1
Sheep, 20.....	1	Floats, 50 lineal feet.....	1
Stone, 12 cubic feet.....	1		

NOTE.—By the Weights and Measures Act, Chapter 104 of the Revised Statutes of Canada, Section 14, all the above named articles are to be estimated by the cental of 100 lbs.

O.C. June 23, 1883.

WAY RATES.

Sec. 77. The following way rates are to be levied on vessels and property passing the several sub-divisions of the canals :—

*Welland Canal.*

	Rate.
1. From Port Maitland, Dunnville and Port Colborne to Port Robinson or Allanburg, not passing the lock, each way.....	½
2. From Chippawa Cut, or any part thereof, to Dunnville, Port Maitland or Port Colborne.....	¾
3. From Dunnville to Port Colborne.....	½
4. From Thorold to St. Catharines or Port Dalhousie	½
5. From Maitland, Dunville, Colborne or Port Robinson to Marshville and intermediate places.....	¾

## Chap. 115

## Canal Regulations.

	Rate.
6. From Marshville or intermediate places to Port Maitland, Dunville, Port Colborne and Port Robinson .....	2/8
7. From Port Robinson to Allanburg or Thorold.....	3/8
8. From Port Robinson to St. Catharines or Port Dalhousie .....	1/2
9. From St. Catharines to Port Dalhousie.....	1/8
10. From Dunnville to Maitland.....	1/4
11. From Port Robinson through the Lock and Chippawa Cut.....	1/4
12. From Port Colborne to Port Maitland.....	1/2
13. From Chippawa Cut through Lock to Port Robinson.....	1/4
14. From Colborne, Dunnville, Maitland and Marshville to Thorold.....	5/8
15. From Colborne, Dunnville, Maitland and Marshville to St. Catharines.....	7/8
16. Through the Chippawa Cut only.....	1/8
17. Through the Port Robinson Lock only.....	1/8

*St. Lawrence Canals.*

Navigation  
divided into  
four sections.

Sec. 78. The navigation is divided into four sections, viz., Cardinal, Cornwall, Beauharnois and Lachine. Tolls are to be levied on all vessels and property in proportion to the number of sections passed through.

*Chambly Canal.*

Sorel to  
Chambly.

Sec. 79. Vessels and property passing from Sorel to Chambly, to pay .....

Rate.

1/3

Chambly to  
St. John's.

Vessels and property passing from Chambly to St. John's, to pay.....

2/3

*Ottawa Canals.*

Navigation  
divided into  
three sections.

Sec. 80. The navigation is divided into three sections, viz., Grenville, Carillon and St. Ann's. Tolls are to be levied on all vessels and property in proportion to the number of sections passed through.

*Rideau Canals.*

Navigation  
divided into  
three sections.

Sec. 81. The navigation of this canal is divided into three sections, viz., Ottawa, Smith's Falls and Kingston Mills. Vessels and freight passing one section are to be charged one third; two sections, two thirds.

## Canal Regulations.

## Chap. 115

*General.*

Sec. 82. (a.)—Any fraction of a ton freight is to be charged one ton, and portions of sections are to be charged as a whole section on all the above canals. <sup>Fraction of a ton.</sup>

(b.)—The passing of sawlogs or other lumber through any of the canals, or sections thereof, shall be at all times governed by the regulations for their management. <sup>Passing of saw logs.</sup>

## SPECIAL REGULATIONS RELATING TO TOLLS ON SOME OF THE CANALS.

Sec. 83. Coal may pass up all canals, except the Welland Canal, free of toll. <sup>Coals.</sup>

O.C. June 7, 1869.

Sec. 84. Logs, lumber or other produce may pass free of toll down the Chippewa Creek, between the Aqueduct and Port Robinson. <sup>Logs, &c. Chippewa Creek.</sup>

O.C. May 18, 1863.

Sec. 85. Iron ore, kryolite or chemical ore, may pass through one section, or through all the canal sections aforesaid, for 5 cents per ton. <sup>Iron ore, &c.</sup>

Sec. 86. (a). All goods having paid full toll through the whole line of the St. Lawrence Canals, or through the Lachine Canal, St. Ann's Lock, or Ottawa and Rideau Canals, shall be allowed to pass free through the Welland Canal; and if tolls have been paid at the Chambly Canal such tolls shall be refunded at Montreal or Kingston Mills; and having paid full tolls through the Welland Canal, they shall be allowed to pass free through the St. Lawrence Canals, or through the Ottawa and Rideau Canals, St. Ann's Lock, the Lachine Canal and the Chambly Canal; provided always:—That the articles to be entitled to the above exemptions shall go downwards through the whole length of the Canal to Montreal, or pass upward from Montreal through the whole length of the St. Lawrence Canals, or the Ottawa and Rideau Canal, to Lake Ontario. <sup>Goods having paid full toll through the St. Lawrence Canals, &c.</sup>

(b). All articles, goods or merchandise not enumerated above, shall be charged to Class No. 4. <sup>Class No. 4.</sup>

(c). No let-passes shall be issued to steam tugs or other small vessels for less than 25 cents, as a minimum charge; but such vessels, not carrying freight or passengers, can obtain, on payment of \$30, a season "Let-Pass," which will pass them up and down the canals as often as desired. <sup>Let-passes.</sup>

O.C. April 18, 1873.

## Chap. 115

## Canal Regulations.

Goods shipped to any port west of the St. Lawrence Canals.

Sec. 87. Goods shipped to any port west of the St. Lawrence Canals, tolls upon which have already been paid for passage through such Canals, may be re-shipped from such ports and be passed through the Welland Canal free of tolls, in the same way as if they had been shipped through direct in the first instance; and goods going eastward, having paid Welland Canal tolls, may be transhipped at any port on Lake Ontario, and thereafter pass free through the St. Lawrence Canals, as if they had been shipped through direct in the first instance.

O.C. June 23, 1883.

During the season of navigation for 1889, the rate of toll for the passage of wheat, &c.

Sec. 88. During the season of navigation for 1889, the rate of toll for the passage of wheat, Indian corn, pease, barley and rye, when shipped for Montreal or for any port east of Montreal shall be two cents per ton, such toll covering the Welland and the St. Lawrence Canals; and during the said period if the ordinary full tolls for passage of the said food products through the Welland Canal have been paid the said products shall be exempted from payment of any further toll for passage through any portion of the St. Lawrence Canal system, though not traversing the whole distance to Montreal.

O.C. March 18, 1889.

## HARBOR DUES.

When free from harbor dues.

Sec. 89. Vessels receiving or discharging freight at the premises of the Welland Railway, at Ports Colborne or Dalhousie, are to be free from harbor dues; but all other vessels discharging or receiving cargo at Port Dalhousie, Port Colborne or Port Maitland, shall pay on every ton of freight so received or discharged, two cents.

## TOLLS AT SHEDS AT LACHINE CANAL BASIN.

Tolls to be levied.

Sec. 90. The following Tolls shall be levied upon property stored at the Sheds at the Lachine Canal Basin:—

	Cents.
Wheat and other grain, per week, per bushel.....	1
Meal do per barrel.....	4
Pork, beef, butter and lard do do .....	5
Muscovado sugar do per hhd., 10 cents per brl. 5	5
Liquors } do per pipe, 15 " per pun.....	12
do } do per hhd., 10 " per qtr. cask	7
Iron (bars) do per ton.....	24
Iron pig do do .....	12
Salt except at the St. Gabriel Sheds do per 100 minots.....	36

Canal Regulations.

Chap. 115

Salt at	el Sheds		Cents.
Montreal, after the first			
48 hours	do	per bag.....	½
Bales, crates, cases, &c.	do	per ton weight or meas- urement.....	24
Coals	do	per chaldron.....	12

Sec. 91. (a). No charge shall be made for property stored in the Sheds at the Lachine Canal basin for the first forty-eight hours, after which period, except in the case of flour, the foregoing rate of storage for the use of the sheds are to be raised, levied and collected. No charge for first 48 hours.

(b). Articles unenumerated are to be charged according to the above rates as nearly as the same can be computed. Articles un-enumerated.

(c). All property stored in the sheds remaining after the first forty-eight hours will be liable to one week's storage, although it should only have been stored for a portion of the same, and so on for each succeeding week. Property stored remaining after the first 48 hours.

(d). The labor of receiving property into the sheds and delivering the same shall be at the expense of and be furnished by the owners of the property or their agents. Labor of receiving and delivering.

(e). All property stored in these sheds shall be at the risk of the proprietor from damage by fire or otherwise. Risk.

(f). All dues for storage shall be paid before the removal of the property. Dues.

O.C. Aug. 21, 1846; Oct. 28, 1846.

Flour.

Sec. 92. (a). Flour shall be allowed to remain in the sheds for two whole days free of charge. Two days free of charge.

(b). If kept there beyond two days or 48 hours, such flour shall be liable to a charge of one cent per day per barrel for the first four days after the expiration of the 48 hours of exemption. Charge after two days.

(c). Should the flour be kept in the sheds beyond four days at one cent per day per barrel, it shall be liable to pay two cents per day per barrel for every day subsequent to the expiration of such four days. Charge after four days.

(d). Any part of a day shall be considered as one day. Part of day.

O.C. May. 31, 1856.

TOLLS ON VESSELS TRADING TO LOWER PORTS AND ENTERING THE LACHINE CANAL AT MONTREAL HARBOR.

Rates of tolls to be levied.

Sec. 93. The following rates of toll shall be levied upon vessels trading to lower ports, and entering the Lachine Canal from the Harbor of Montreal, and on certain goods herein mentioned; said vessels to be allowed forty-eight hours for discharge of cargo before the following be incurred; and said discharge to be made below the St. Gabriel Lock.

Steam-boats measuring 50 tons or upwards, per ton register, per day of 24 hours.....	Mills. 8
All other vessels measuring 50 tons or upwards, per ton register, per day of 24 hours.....	4
Steam-boats measuring under 50 tons register, each day of 24 hours.....	Cents. 40
All other vessels measuring from 25 to 50 tons register, per day of 24 hours.....	20
All vessels measuring less than 25 tons register, per day of 24 hours.....	10
Coal, per chaldron.....	10
Salt, per 100 minots.....	15
Iron of all kinds, per ton weight.....	15
Merchandise as in class No. 6 of the tariff of tolls on Dominion Canals.....	10

Proviso.

Provided always that the above tolls be levied only on goods for consumption in Montreal, and on vessels trading with that port.

O. C. June 8, 1860.

CHARGES FOR WHARFAGE ON FIREWOOD ON WHARVES AND BANKS OF LACHINE CANAL.

Rates of tolls to be collected.

Sec. 94. The following rates of tolls shall be collected as herein mentioned, that is to say:—

Firewood.

(a). Firewood landed on wharves or banks of the Lachine Canal, or in boats, barges or other crafts occupying any of basins between Wellington Street Bridge and Lock No. 3, four cents per cord, and for every day the wood is allowed to remain in either the Canal or basin, or on the wharves or banks after the first five days, an additional charge of four cents per cord.

O. C. Aug. 7, 1860.

Banks and grounds at Côte St. Paul

(b). The clause next preceding shall not only apply to the rates of toll to be collected on firewood on wharves at

*Canal Regulations.*

## Chap. 115

Lachine and the Lachine Canal and Basin, but are also extended and made applicable to the banks and grounds at Côte St. Paul and at Lachine. and at Lachine.

O.C. Jan. 27, 1862.

## CANAL BASINS IN MONTREAL PART OF MONTREAL HARBOR.

Sec. 95. Whereas under existing regulations for the collection of Canal tolls, Eastern bound vessels having paid the charges one way in full through the Welland Canal are chargeable one Section Canal Toll if re-entering the Lachine Canal ; Lachine Canal basins within Montreal city limits, to be considered as part of Montreal Harbor for certain purposes.

And whereas Vessels loaded with grain destined for the Montreal harbor frequently unload only part of their cargoes on board sea-going vessels in that harbor, and re-enter the Lachine Canal for the purpose of unloading the balance of their cargoes either in elevators or mills located along the Canal basins ;

It is ordered, that the Lachine Canal basins within the Montreal City limits be considered as part of the Montreal Harbor, in so far only as regards the collection of tolls on the class of vessels above referred to, which re-enter that portion of the canal for the purpose of unloading the balance of their cargoes. but that the same shall not apply any further, as in the event of vessels returning to the harbor to take cargo, in which case the usual toll shall be charged against them on passing out of the canal a second time into the harbor.

O.C. Aug. 8, 1878.

## PHOSPHATES.

Sec. 96. Whereas vessels laden with grain for delivery in Montreal Harbor frequently carry also deck loads of phosphates, and being compelled to proceed at once to the harbor for the discharge of the grain, they pay tolls through to that point, subsequently re-entering the Lachine Canal for the storage of the phosphates, and in accordance with the existing regulations, paying canal dues a second time for such re-entry ; Lachine Canal basins within the Montreal city limits, to be considered as part of Montreal Harbor for the unloading of phosphates.

It is ordered, that the Lachine Canal basins within the Montreal City limits, be considered as part of the Montreal Harbor, for the purposes of the unloading of phosphates carried by vessels in addition to their grain cargoes as described in this section ; it being however provided that in the event of their returning to the harbor to take cargo,

the usual tolls shall be charged against such vessels on their passing out of the canal a second time.

O.C. July 12, 1881.

CHARGES ON VESSELS WINTERING IN LACHINE CANAL.

Rates per ton for wintering vessels.

Sec. 97. The following rates per ton shall be charged for wintering vessels in the Lachine Canal, viz.:—

For each boat, barge, scow or other vessels of ten tons measurement or under, seventy cents per vessel for the entire winter; and every ten tons above the first ten, an additional rate of eight cents.

O.C. Aug. 22, 1879.

DUES ON VESSELS IN THE NEW BASIN, LACHINE CANAL.

Rates in the new basins the same as those levied in respect of the old basin.

Sec. 98. The Montreal Harbor Commissioners shall be allowed to retain the right of levying dues in respect of the old lower basin of the Lachine Canal, but the Government shall retain full control of the new works and basins of said canal and of the revenue that may be derived from their use, and the rates shall be levied by the Government on vessels loading or unloading in the new basins equal and similar to those levied by the Commissioners in respect of the old basin.

O.C. Jan. 26, 1883.

DUES IN THE HARBOR OF MONTREAL UNDER ACTS 40 VIC., CHAP. 53, AND 42 VIC., CHAP. 28.

Sec. 99.—*Tonnage Dues.*

Tonnage dues on steam-boats.

On steam-boats, for each day of twenty-four hours, or part of a day they remain in the harbor, reckoned from the hour of their arrival to that of their departure .....

Per ton register.  
1 cent

Other vessels.

On all other vessels, per day, as aforesaid

$\frac{1}{2}$  do

Sec. 100.—*Wharfage Dues.*

Wharfage dues.

All goods, wares and merchandise, not elsewhere specified.....

Per ton.  
25 cents

Hay, straw, pig and scrap iron, pot and pearl ashes.....

20 do



*Canal Regulations*

Chap. 115

Apples, crates and their contents, flour and meal, fish, meats, pitch, potatoes, tar, horses, neat cattle, sheep, swine.....	Per ton. 15 cents.
Ballast, clay, fire-bricks, gypsum, lime, marble, phosphates, sand, salt.....	10 do 7½ do
Coal and coke, grain and seeds of all kinds....	
Special.—Bricks, 10 cents per 1,000 ; cordwood, 5 cents per cord ; lumber, 10 cents per 1,000 feet, board measure.....	
Bullion, specie.....	Free.

*Note.*

Sec. 101. (a). On all goods, wares and merchandise whatsoever, the quantity of which by weight, measurement or other mode of estimate provided for in the tariff of the next preceding section can not be conveniently ascertained, it shall be lawful for the Harbor Commissioners to levy a rate of  $\frac{1}{4}$  of 1 per cent. on the value thereof.

When quantity can not be conveniently ascertained.

(b). Each entry shall pay not less than 5 cents. Each entry.

(c). All property landed on the wharves for re-shipment shall only pay one wharfage. Re-shipment.

(d). The ton mentioned in the tariff of wharfage dues shall be 2,000 lbs. weight, or 40 cubic feet measurement, according to the bill of lading. The ton.

Sec. 102.—*Standard for Estimating Weights.*

Ashes, pot or pearl.....	3 brls. to 1 ton.	Standard for estimating weights.
Apples, flour, meal, potatoes.....	9 do 1 do	
Fish, meats, pitch, tar.....	7 do 1 do	
Horses.....	2 to 1 ton.	
Neat cattle.....	3 to 1 do	
Sheep.....	15 to 1 do	
Swine.....	10 to 1 do	

O. C. April 1, 1881.

TOLLS ON FLOATED TIMBER, &C., ENTERING THE BASIN AT LACHINE.

Rates of  
tolls to be  
collected.

Sec. 103. The following rates of tolls shall be collected on floated timber, lumber and firewood entering the basin at Lachine and Lachine Canal:—

Kinds of Timber.	For receiving Timber, &c., to include use of Basin and Wharf for one Month.	For each succeeding Month during the Season of Navigation.	For Wintering in Basin or on Wharf.
	Cents.	Cents.	Cents.
Timber, square or round, of all kinds, above 12x12, per M. cubic feet.....	25	20	35
Timber, round or flatted, of all kinds, under 12x12, per M. lineal feet .....	20	15	30
Planks and boards to include all kinds of sawed lumber in rafts, per M. feet, board measure.....	3	2	3
Saw-logs, 12 feet long, if longer in same proportion per log.....	1	1	2
Floats, per 100.....	10	5	10
Traverses, per 100.....	10	5	10
Fence posts and rails, per M.....	10	5	10
Staves, Barrel, per M.....	8	4	8
do Pipe do .....	8	4	8
do West India, per M.....	8	4	8
Firewood on bank of Canal between Lock No. 3 and lock No. 5, and also on wharves in canal basin at Lachine.....	3	3	3

*Note.*

No fractional allowance.

Sec. 104. (a). No allowance shall be made for fractional parts of a month or winter season.

Firewood, how to be corded.

(b). The firewood shall be corded across the bank while being delivered from the boat in such manner and at such points as the superintendent may direct.

Rates, when to take effect.

(c). The rates on timber to take effect upon the completion of the booms in Lachine Canal.

O.C. June 8, 1860.

CHARGES FOR WINTERING VESSELS IN RIDEAU CANAL.

Winterage dues.

Sec. 105. The winterage dues for vessels wintering in the Canal Basin, at Ottawa, or other points along the line of the Rideau Canal, shall be as follows:—

*Canal Regulations.*

Chap. 115

In Canal Basin, Ottawa, Steamers, per season...	\$ 8 00	In canal basin.
“ “ “ Barges “ ...	4 00	
Inside Locks “ Steamers “ ...	50 00	Inside locks.
“ other stations “ “ ...	15 00	

If the Minister of Railways and Canals deems it advisable, he is authorized to take security from parties wintering their vessels in locks against damage to Government property by fire. Security may be taken.

O.C. March 19, 1887.

CHARGES FOR REPAIRING VESSELS ON THE BANKS OF CANALS.

Sec. 106. (a). Persons using the banks of the Lachine Canal as a site for the repair of their vessels shall be subject to a charge of four dollars, payable in advance, for each vessel; the period during which such site may be occupied under any one payment being limited to six months, and permission for repairing being first obtained from the proper officer, in conformity with the existing Canal Regulations. Persons using the banks of the Lachine Canal for the repair of their vessels.

(b). In the event of failure to remove vessels so occupying the banks at the expiration of the period named, no fresh permits having been obtained, such vessels may be sold under the 16th Section of the Canal Regulations. In the event of failure to remove vessels occupying banks.

O.C. March 5, 1880.

Sec. 107. Rules with respect to the repairing of Vessels on the banks of the Lachine Canal, the Beauharnois and the Chambly:— Rules with respect to repairing.

(a). Repairs shall only be executed at such points as may be indicated and approved by the superintendent. Repairs at certain points only.

(b). For each vessel hauled up or beached for repairs, a charge of one dollar, over and above all other charges, shall be made, carrying the privilege of remaining for one month, a further sum of one dollar being charged for each additional month or fraction of a month the vessel may remain. Charges.

(c). In cases, however, where a vessel hauled up for repairs upon the canal bank remains there throughout the winter, a charge of four dollars only shall be made (in addition to the ordinary winterage dues), the period covered being from the 1st of November to the 1st of June, inclusive. Charge to cover the winter.

(d). Any vessel remaining on the canal bank after having wintered thereon shall be charged at the rate of one dollar a month or fraction of a month of her subsequent stay. Charge for subsequent stay

## Chap. 115

*Canal Regulations.*

Vessel remaining more than one year. (e). Any vessel remaining more than one year on the bank of the canal shall for such time as she may remain in excess of that period pay at the rate of two dollars a month or fraction of a month throughout the whole year.

Charges where and when payable. (f). All charges shall be payable at the collector's office in advance on the first day of each month.

Application of these rules. (g). These rules shall be understood as applying to all cases where the canal bank is used in any manner for the repairs of vessels, whether such vessels are actually hauled up or not.

O. C. Aug. 6, 1881.

MASTS AND FLAG POLES TO CLEAR THE ATLANTIC AND  
NORTH-WEST RAILWAY COMPANY'S BRIDGE OVER  
THE LACHINE CANAL.

*Note.*

[In the case of all barges or other vessels using the Lachine Canal with the exception of those larger craft whose size as at present requires, as shall be shown by the certificate either of the Superintending Engineer or of the Superintendent of the canal, the opening of the draw; no mast, flag pole or other erection shall be permitted of a greater height than will admit of safe passage under the said Atlantic and North-West Railway Company's draw-bridge over the said canal, unless such mast, flag pole or other erection is furnished with an appliance for lowering in order to such passage, under a penalty against the owner, master or person in charge, not exceeding forty dollars currency for any and every neglect of this Regulation.]

O. C. June 15, 1889.

Canal Regulations.

Chap. 115

Sec. 108.—TRENT VALLEY CANAL.

The Rates of Tolls are divided into Six Classes, as under and are per Ton, unless otherwise specified.	1ST SECTION	2ND SECTION	3RD SECTION	4TH SECTION	THROUGH.	Whitlaw's to Hastings.
	Fenelon Falls to Bobcaygeon	Bobcaygeon to Buckhorn.	Buckhorn to Burleigh.	Burleigh to Lakefield.	Fenelon Falls to Lakefield.	
	Tolls Chargeable at Fenelon Falls.	Tolls Chargeable at Bobcaygeon	Tolls Chargeable at Buckhorn.	Tolls Chargeable at Burleigh.	Tolls Chargeable at Fenelon Falls.	Tolls Chargeable at Whitlaw's.
<i>Class No. 1.</i>	\$ cts.	\$ cts.	\$ cts.	\$ cts.	\$ cts.	\$ cts.
Vessels, steam..... per ton	0 00 <sup>3</sup> / <sub>4</sub>	0 00 <sup>3</sup> / <sub>4</sub>	0 00 <sup>3</sup> / <sub>4</sub>	0 00 <sup>3</sup> / <sub>4</sub>	0 00 <sup>3</sup> / <sub>4</sub>	0 00 <sup>3</sup> / <sub>4</sub>
“ sail and other.....	0 00 <sup>1</sup> / <sub>4</sub>	0 00 <sup>1</sup> / <sub>4</sub>	0 00 <sup>1</sup> / <sub>4</sub>	0 00 <sup>1</sup> / <sub>4</sub>	0 01	0 00 <sup>1</sup> / <sub>4</sub>
<i>Class No. 2.</i>						
Passengers, 21 years of age and upwards.....	0 01	0 01	0 01	0 01	0 04	0 01
Passengers, under 21 years, each....	0 00 <sup>1</sup> / <sub>2</sub>	0 00 <sup>1</sup> / <sub>2</sub>	0 00 <sup>1</sup> / <sub>2</sub>	0 00 <sup>1</sup> / <sub>2</sub>	0 02	0 00 <sup>1</sup> / <sub>2</sub>
<i>Class No. 3.</i>						
Bricks, cement and water lime.....	0 01	0 01	0 01	0 01	0 04	0 01
Clay, lime and sand.....						
Brimstone.....						
Corn.....						
Flour.....						
Iron, railway.....						
“ pig.....						
“ all other (including steel).....						
Plaster, gypsum.....						
Salt.....						
Salt meats or fish, in barrels or otherwise.....						
Agricultural products, vegetable, not enumerated.....						
Agricultural products, animal, not enumerated.....						
Stone, for cutting.....						
Wheat.....						
<i>Class No. 4.</i>						
All other articles, not enumerated....	0 03	0 03	0 03	0 03	0 12	0 03
<i>Class No. 5.</i>						
Bark.....	0 01	0 01	0 01	0 01	0 04	0 01
Barrels, empty, each.....	0 00 <sup>1</sup> / <sub>2</sub>	0 00 <sup>1</sup> / <sub>2</sub>	0 00 <sup>1</sup> / <sub>2</sub>	0 00 <sup>1</sup> / <sub>2</sub>	0 01	0 00 <sup>1</sup> / <sub>2</sub>
Boat knees, each.....	0 00 <sup>1</sup> / <sub>2</sub>	0 00 <sup>1</sup> / <sub>2</sub>	0 00 <sup>1</sup> / <sub>2</sub>	0 00 <sup>1</sup> / <sub>2</sub>	0 01	0 00 <sup>1</sup> / <sub>2</sub>
Floats per, 1,000 lineal feet.....	0 13	0 13	0 13	0 13	0 52	0 13
Firewood, per cord, in vessels.....	0 03	0 03	0 03	0 03	0 10	0 03
“ “ rafts.....	0 04	0 04	0 04	0 04	0 14	0 04
Hoops.....	0 02	0 02	0 02	0 02	0 08	0 02
Masts and spars, telegraph poles, per ton of 40 cubic feet, in vessels.....	0 02	0 02	0 02	0 02	0 08	0 02
Masts and spars, telegraph poles, per ton of 40 cubic feet, in rafts.....	0 01	0 01	0 01	0 01	0 04	0 01
Railway ties, in vessels, each.....	0 00 <sup>1</sup> / <sub>2</sub>	0 00 <sup>1</sup> / <sub>2</sub>	0 00 <sup>1</sup> / <sub>2</sub>	0 00 <sup>1</sup> / <sub>2</sub>	0 00 <sup>1</sup> / <sub>2</sub>	0 00 <sup>1</sup> / <sub>2</sub>
“ “ rafts, each.....	0 00 <sup>1</sup> / <sub>4</sub>	0 00 <sup>1</sup> / <sub>4</sub>	0 00 <sup>1</sup> / <sub>4</sub>	0 00 <sup>1</sup> / <sub>4</sub>	0 01	0 00 <sup>1</sup> / <sub>4</sub>

## Chap. 115

## Canal Regulations.

## Sec. 108.—TRENT VALLEY CANAL.

The Rates of Tolls are divided into Six Classes, as under and are per Ton, unless other- wise specified.	1ST SECTION	2ND SECTION	3RD SECTION	4TH SECTION	THROUGH.	Whitlaw's to Hastings.
	Fenelon Falls to Bobcaygeon	Bobcaygeon to Buckhorn.	Buckhorn to Burleigh.	Burleigh to Lakefield.	Fenelon Falls to Lakefield.	
	Tolls Chargeable at Fenelon Falls.	Tolls Chargeable at Bobcaygeon	Tolls Chargeable at Buckhorn.	Tolls Chargeable at Burleigh.	Tolls Chargeable at Fenelon Falls.	Tolls Chargeable at Whitlaw's.
	\$ cts.	\$ cts.	\$ cts.	\$ cts.	\$ cts.	\$ cts.
<i>Class No. 5.—Concluded.</i>						
Sawed stuff, boards, planks, scantling and sawed timber, per M. feet board measure, in vessels.....	0 03	0 03	0 03	0 03	0 10	0 03
Sawed stuff, boards, plank, scantling and sawed timber, per M. feet board measure, in rafts.....	0 04	0 04	0 04	0 04	0 14	0 04
Square timber, per M. cubic feet, in vessels.....	0 07	0 07	0 07	0 07	0 28	0 07
Square timber, per M. cubic feet, in rafts.....	0 14	0 14	0 14	0 14	0 56	0 14
Wagon stuff, woodenware and wood, partly manufactured, per ton of 40 cubic feet.....	0 04	0 04	0 04	0 04	0 16	0 04
Shingles, per M.....	0 00 $\frac{3}{4}$	0 00 $\frac{3}{4}$	0 00 $\frac{3}{4}$	0 00 $\frac{3}{4}$	0 03	0 00 $\frac{3}{4}$
Split posts and fence rails, per M., in vessels.....	0 03	0 03	0 03	0 03	0 12	0 03
Split posts and fence rails, per M., in rafts.....	0 05	0 05	0 05	0 05	0 20	0 05
Sawlogs, each standard log.....	0 00 $\frac{3}{4}$	0 00 $\frac{3}{4}$	0 00 $\frac{3}{4}$	0 00 $\frac{3}{4}$	0 03	0 00 $\frac{3}{4}$
Staves and headings, barrel, per M.....	0 02	0 02	0 02	0 02	0 08	0 02
“ pipe “ “ ..	0 10	0 10	0 10	0 10	0 40	0 10
“ West India “ “ ..	0 05 $\frac{1}{2}$	0 05 $\frac{1}{2}$	0 05 $\frac{1}{2}$	0 05 $\frac{1}{2}$	0 22	0 05 $\frac{1}{2}$
“ salt barrel, sawn or cut, per M.....	0 00 $\frac{1}{2}$	0 00 $\frac{1}{2}$	0 00 $\frac{1}{2}$	0 00 $\frac{1}{2}$	0 02	0 00 $\frac{1}{2}$
Traverses, per 100 pieces.....	0 05	0 05	0 05	0 05	0 20	0 05
Hop poles, per 1,000 pieces.....	0 20	0 20	0 20	0 20	0 80	0 20
<i>Class No. 6.</i>						
Gypsum, crude (per O. C., 28th Oct., 1882).....	Free	Free	Free	Free	Free	Free
Coal.....	0 01	0 01	0 01	0 01	0 04	0 01
Stone, unwrought, corded, and not suitable for cutting, per cord.....	0 03 $\frac{1}{2}$	0 03 $\frac{1}{2}$	0 03 $\frac{1}{2}$	0 03 $\frac{1}{2}$	0 14	0 03 $\frac{1}{2}$
Kryolite, iron ore or chemical ore... Ice.....	0 00 $\frac{1}{4}$ Free	0 00 $\frac{1}{4}$ Free	0 00 $\frac{1}{4}$ Free	0 00 $\frac{1}{4}$ Free	0 03 Free	0 00 $\frac{1}{4}$ Free

O. C. July 25, 1888.

## ST. PETER'S CANAL.

Sec. 109. On each and every vessel passing through the said canal, two cents per ton on the vessel and one cent per ton on the freight, each way.

O. C. June 23, 1883.

# SUPPLEMENT.

## ADDENDA AND CORRIGENDA.

(Made up to December 20, 1889.)

### *Department of Agriculture.*

Page.

- 11—Sec. 20. Omit marginal note.  
28—Form 22, should be 24.  
    Form 23, should be 25.  
29—Form 24, should be 26.  
55—Sec. 25, last clause. Read “questions” instead of “question.”

### *Department of Customs.*

- 91—Sec. 11. Omit all after the words “contained in” to the end of the page, and read instead thereof the words “section 12, next page.”
- 95—Sec. 20. The reference should be O.C. April 29, 1879.
- 102—Sec. 3. The reference should be O.C. May 19, 1881.
- 109—Sec. 1. Omit “and” from the first line.
- “ Chap. 13. Special Regulations. Add “Lithographic Printing Presses are not printing presses within the terms of Item 122 of the Tariff Act of 1887, but come under Item 89 of said Tariff Act.” O.C. June 4, 1889. Special Regulations.  
Lithographic Printing Press.
- “ Chap. 13. Special Regulations. Add “Tariff on Ferro-Manganese, Ferro-Silicon, Spiegel, Steel Bloom Ends and Cross Ends of Steel Rails, when not for the manufacture of steel shall be rated for duty under Item 41 of Act 50-51 Vic. (1887), Chap. 39, at the rate of \$4.00 per ton.” O.C. June 26, 1889. Ferro-Manganese, Ferro-Silicon, Spiegel, &c.
- “ Chap. 13. Special Regulations. Add “Spruce Logs and Pine Logs found to measure inside the bark at the but end thereof eleven inches or less in diameter, irrespective of the length of such logs, shall not when exported for piling purposes or as piling be subject to any export duty.” Proc. May 22, 1889. Spruce Logs and Pine Logs for piling purposes.
- 118—Chap 15. Free list. Add “When wheat or grain grown in Canada is taken to the United States to be ground and the produce thereof in flour or meal returned to Free list.  
Wheat or grain grown in Canada.

*Supplement.*

	Page.	
Taken to the United States to be ground, &c.	118	Canada, such produce may be returned free of Customs duty, provided the owner thereof resides near the frontier and more than five miles from any Canadian Grist Mill at which such wheat or grain could be ground, and that he observes and complies with the following Rules:—
Report to nearest Customs officer.		1st. He shall report to the nearest Customs officer, the exact quantity of wheat or grain which he is taking out, and such officer shall enter in a book to be kept for that purpose the name of the owner, the date of the transaction, the quantity in bushels and fractions or bushels, so to be taken out, and the name and location of the mill and the proprietor thereof where the grinding is to be performed.
Report inwards of exact quantity of flour, &c.		2nd. He shall report inwards in like manner the exact quantity of flour or meal and other product of said wheat or grain when he returns the same to Canada, and make a solemn declaration to the effect that such flour or meal and other product is the actual produce of the wheat or grain taken from Canada and no other.
Officer shall verify truth of report.		3rd. The officer receiving such reports shall verify the truth thereof to the best of his ability and enter the particulars in the aforesaid book, and shall require the owner to append his signature to such entries in attestation of the correctness of the same.
Fraudulent Act to involve seizure and forfeiture.		4th. If it be found that any additional quantity of product has been returned more than that which the quantity of wheat or grain should properly produce, or if it be ascertained that any change has been made therein by the substitution in whole or in part of foreign wheat or grain or the product thereof for the Canadian wheat or grain represented to have been taken out to be so ground, or if any other fraudulent act has been done in reference thereto then the product or the alleged product so returned shall be seized and forfeited." O.C. Jan. 12, 1889.
Felloes of hickory wood.	118—	Chap. 15. Free list. Add "Felloes of hickory wood, sawn to shape only, and not smoothed or otherwise manufactured, imported for use in the manufacture of carriage and cart wheels." O.C. Nov. 16, 1888.
Homo Spring Steel Wire.	"	Chap. 15. Free list. Add "Homo Spring Steel Wire coppered or tinned smaller than No. 9, and not smaller than No. 15 wire gauge, when imported by manufacturers of mattresses for use in their own factories." O.C. Dec. 6, 1888.
Second process molasses.	"	Chap. 15. Free list. Add "Second process molasses, testing by polariscope less than 35 deg. when imported



*Supplement.*

Page.

118

by manufacturers of blacking for use in their own factories in the manufacture of blacking, shall be, and the same is hereby added to the list of articles that may be imported into Canada free of Customs duty, conditional that the importers shall, in addition to making oath at the time of entry that such molasses is imported for such use and will not be used for any other purpose, cause such molasses to be at once mixed in a proper tank made for the purpose with at least one third of the quantity thereof of cod oil, whereby such molasses may be rendered unfit for any other use, such mixing to be done in the presence of a Customs officer at the expense of the importer, and under such further regulations as may from time to time be considered necessary in the interest and protection of the revenue, and that until such mixing is done and duly certified on the face of the entry thereof by such Customs officer, the entry shall be held to be incomplete and the molasses subject to the usual rate of duty as when imported for any other purpose." O.C. May 14, 1889.

Manufacturers of blacking.

" Chap. 15. Free list. Add "Sulphate of alumina, alum cake, used as a substitute for alum by paper makers." O.C. May 22, 1889.

Sulphate of alumina, &amp;c.

" Chap. 15. Free list. Add "Sumac, when imported to be used for dyeing or tanning purposes, *i.e.*, manufacturing purposes, not further manufactured than crushed or ground." O.C. June 4, 1889.

Sumac for dyeing or tanning.

123—Chap. 17. Directions respecting Duties. Add "Musical instruments being the property of companies of musicians entering Canada for the purpose of giving public concerts, shall in all cases be entered for duty in accordance with law, and the Minister of Customs may grant a refund of ninety per cent. of the duty so paid on being fully satisfied that the said instruments have been duly re-exported, provided that such re-exportation takes place within one month of the date of such import entry, and that the said instruments have been duly identified at the time of making export entry of the same by an officer of Customs.

Musical instruments of musicians entering Canada for the purpose of giving public concerts.

Any Collector of Customs may permit any musical instrument to be imported and used on not more than two occasions, within the limits of his own port, under such precautions or provisions as he may consider necessary to secure the due exportation thereof immediately after such use, but no instrument or instruments so admitted shall be allowed to be removed to any other port, unless the above conditions have been complied with." O.C. Dec. 16, 1888.

## Supplement.

	Page.	
Directions respecting Duties. Articles won as prizes by citizens of Canada.	123	—Chap. 17. Directions respecting Duties. Add "Articles won as prizes by citizens of Canada in any regatta or other public competition in a foreign country, to be held by the winners thereof for a limited period, may, on receipt of the same in Canada, be entered for warehouse and be considered as constructively warehoused and may be left in possession of the winner during the time for which he is authorized to retain the same, then to be entered for exportation exwarehouse and must be actually exported under surveillance of an officer of Customs in the usual manner and the duty thereon remitted." O.C. Jan. 12, 1889.
Sapolio and Silver Soap.	"	Chap. 17. Directions respecting Duties. Add "Sapolio and Silver Soap; ruled, the rate of duty thereon to be the same rate as that payable on soap powders, namely three cents per pound." O.C. April 4, 1889.
Vermouth Bitters, &c.	"	Chap. 17. Directions respecting Duties. Add "Vermouth Bitters or Vermouth Wine are dutiable as bitters or cordial under Item 394 of the Tariff (Chap. 33, R.S., Can.) at \$1.90 per Imperial gallon." O.C. Aug. 25, 1888.
Veneers of wood shaved or cut with a knife, etc.	"	Chap. 17. Directions respecting Duties. Add "Veneers of wood shaved or cut with a knife direct from the logs, not planed or otherwise smoothed, or manufactured in any way, shall be and the same are hereby classed and rated for duty, and such duty shall be levied and collected under item No. 153 of the Schedule of Customs duties imposed by the Act 50-51 Victoria (1887), Chap. 39, at the rate of ten per cent. <i>ad valorem</i> ." O.C. May 14, 1889.
	132	—Sec. 2. The reference should be "O.C. Aug. 13, 1873."
Values of Foreign Currencies.	144	—Chap. 23. Values of Foreign Currencies. Cancelled and superseded by O.C. May 14, 1889. These values are liable to be changed from time to time.
Ports of Entry. Penetanguishene.	147	—Ports of Entry, Ontario. Omit "Penetanguishene." O. C. Jan. 16, 1889.
Kincardine, Saugeen.	"	"Kincardine" and "Saugeen." O. C. July 10, 1889.
Caraquette, Shippegan.	148	—Ports of Entry. New Brunswick. Omit "Caraquette" and "Shippegan." O. C. June 10, 1889.
Londonderry.	"	Ports of Entry, Nova Scotia. Omit "Londonderry." O. C. Oct. 9, 1888.
Emerson.	"	Ports of Entry. Manitoba. Omit "Emerson." O.C. Aug. 12, 1889.
Outports. Penetanguishene.	149	—Outports, Ontario. Add "Penetanguishene under the survey of Toronto." O. C. Jan. 16, 1889.
Campbellford.	"	"Campbellford under the survey of Belleville." O. C. Feb. 16, 1889.

*Supplement.*

- Page.  
 149—Outports, Ontario. Add “Orillia under the survey of Orillia. Toronto.” O. C. April 18, 1889.  
 “Kincardine and Saugeen under the survey of Kincardine, Goderich.” O. C. July 10, 1889. Saugeen.  
 “Smith’s Falls under the survey of Brockville.” O. C. Smith’s Falls. July 16, 1889.  
 “Orangeville under the survey of Toronto.” O. C. Nov. Orangeville. 14, 1889.
- 150—Outports, Ontario. Instead of “Midland” under the Midland. survey of “Penetanguishene” for “Penatanguishene” read “Toronto.” O. C. Jan. 16, 1889.
- 151—Outports, Ontario. Instead of “Wingham” under the Wingham. survey of “Kincardine” for “Kincardine” read “Goderich.” O. C. July 10, 1889.
- 152—Outports, New Brunswick. Add “Caraquette and Caraquette, Shippegan under the survey of Bathurst.” O. C. Shippegan. June 10, 1889.  
 “Omit “Grand Manan” and read “North Head” in place North Head. thereof. O. C. Sep. 9, 1889.  
 “Instead of “Tracadie” under the survey of “Caraquette” Tracadie. for “Caraquette” read “Bathurst.” O. C. June 10, 1889.
- 153—Outports, Nova Scotia. Instead of “Cornwallis” read Canning. “Canning.” O. C. Dec. 16, 1888.  
 “Instead of “Economy” under the survey of “London- Economy. derry,” for “Londonderry” read “Truro.” O. C. Oct. 9, 1889.  
 “Instead of “Five Islands under the survey of London- Five Islands. derry” for “Londonderry” read Parsboro.” O. C. Oct. 9, 1889.
- 154—Outports, Nova Scotia. Add “Londonderry under the Londonderry. survey of Truro.” O.C. Oct. 9, 1888.  
 ““Springhill under the survey of Amherst.” O. C. May Springhill. 14, 1889.  
 ““Mabou under the survey of Port Hood.” O. C. Aug. Mabou. 2, 1889.
- 156—Outports, Manitoba and North-West Territories. Add Deloraine. “Deloraine under the survey of Winnipeg.” O. C. April 18, 1889.  
 “Killarney under the survey of Winnipeg.” O. C. Killarney. June 26, 1889.  
 “Emerson under the survey of Winnipeg.” O. C. Emerson. Aug. 12, 1889.  
 Instead of “Gretna” under the survey of “Emerson” Gretna. for “Emerson” read “Winnipeg.” O. C. June 10, 1889.  
 “Outports, British Columbia. Omit “Port Simpson” Port Simpson. O. C. Nov. 4, 1889.

*Supplement.*

	Page.	
Warehousing Ports, Ontario.	157—	Add "Campbellford." O. C. Feb. 16, 1889.
Campbellford.		"Orillia." O. C. April 18, 1889.
Orillia.		"Smith's Falls." O. C. July 16, 1889.
Smith's Falls.		"Orangeville." O. C. Nov. 14, 1889.
Orangeville.	160—	Warehousing Ports Nova Scotia. Add "Springhill." O.C. May 14, 1889.
Springhill.	161—	Warehousing Ports Manitoba. Add "Deloraine." O.C. April 18, 1889.
Deloraine.		"Killarney." O. C. June 26, 1889.
Killarney.		

*Department of Indian Affairs.*

Reserves in Manitoba and N. W. T. confirmed.	165—	Add "Reserves of lands in Manitoba and the North-West Territories confirmed to the Indians." O. C. May 17, 1889. [See <i>Canada Gazette</i> , Vol. 23, pages 78 and 79.]
	168—	Chap. 29, Section 9 sub-section (b). Insert the word "not" between the words "must" and "exceed" in the last line but one.
Cutting, &c., sugar maple on Parry Island.	170—	Chap. 30. Add "The cutting, carrying away, or removing of any hard or sugar maple or sapling from Parry Island by the licensees of the timber on that Island, or by any other party or parties is prohibited under pain of the penalties in the <i>said</i> section mentioned, [See Sec. 32, Chap. 43, R. S. Can.] O.C. Nov. 26, 1888.
	178—	Chap. 30. Insert the words "on Indian" in the title at the top of pages 178, 179, 180 and 181.
Price of Mining Location, ten dollars.	185.—	Chap. 31. Instead of Section 6, read "The price to be paid for mining location shall be ten dollars per acre, cash." O. C. Dec. 2, 1889.
Sections 81 and 82 repealed.	199.—	Chap. 31. Strike out Sections "81 and 82," the same being repealed. O. C., Dec. 2, 1889.
Amendments to apply to lands patented or applied for previously to Oct. 1, 1887.	203.—	Chap. 31, Form D. Strike out the clause regarding "royalty." O. C. Dec. 2, 1889. Add to Chapter 31 as follows,— "The foregoing amendments, so far as royalty is concerned, also apply to any mineral lands which may have been patented or applied for since the first of October, 1887, being the date of the Order in Council establishing the first Indian Lands Mining Regulations; provided an amount be paid in cash to make the difference between the price already paid and the price hereby fixed for mining lands." O. C. Dec. 2, 1889.

*Department of Finance.*

218—Chap 33. Government Savings Banks Regulations. Omit all the words from section 22 after the word "receives" in the fifth line thereof.

---

*Supplement.*

---

- Page. *Department of Inland Revenue.*
- 222—Sec. 4. Inland Revenue Districts, &c. Strike out “Beauharnois” from the first column and “Orms-  
harnois” from the second column, and read “Beauharnois, Chateauguay, Huntington” in the third column as being attached to the Inland Revenue Division of Montreal. O. C. March 18, 1889. Strike out  
Beauharnois  
and Orms-  
town.
- 222—Sec. 4. Strike out “Iberville” from the first and second columns and read “St. Johns.” O.C. Sept. 14, 1889. Iberville.
- 222—Chap. 34. Add “West Assiniboia” and “Alberta” to Inspection Districts. O.C. Feb. 26, 1889. West Assini-  
boia, Alberta.
- Amend Section 8 of Chapter 34 as follows “For Excise purposes Rat Portage is detached from the Inland Revenue Division of Port Arthur and attached to the Inland Revenue Division of Winnipeg.” O. C. Nov. 21, 1889. Rat Portage  
attached to  
Winnipeg.
- 248—Chap. 38. Read “reputed” instead of “reported” in the 8th line of Section 19.
- 250—Chap. 38. Read “applications” instead of “application” in the 10th line of Section 29.
- 252—Chap. 58. Read “Fusel Oil” instead of “Fusil Oil” where the words occur in this and subsequent pages. Fusel Oil.
- 311—Chap. 42. Add to Section 1 “The Spafford Improved Standard Platform Counter Scale.” O.C. Oct. 15, 1889. Spafford  
Counter Scale.
- 325—Chap. 42. Weights and Measures Divisions made coterminous with the Inspection Districts of Inland Revenue, as vacancies occur. [See pages 221 and 222.] O. C. Feb. 11, 1889. Inspection  
Districts to be  
adopted.
- 341.—Chap. 45. Grades of Wheat and other grain. Add “No. 2 Quebec Peas shall be moderately clean and sound and grown in the Province of Quebec.” O. C. Nov. 21, 1889. No. 2 Quebec  
Peas.
- 365—Chap. 53. Ferry Regulations, Fort Erie and Buffalo Ferry. Tariff of Charges amended. O.C. Sep. 3, 1889. Fort Erie and  
Buffalo Ferry.
- 374—Chap. 53. Ferry Regulations, Montebello Ferry. Tariff of Charges amended. O. C. March 18, 1889. Montebello  
Ferry.
- 386—Chap. 53. Ferry Regulations Quion Ferry. Fourth clause amended by inserting “September” for “October.” In the last line of page 386 read “15” for “10.” O.C. Aug. 2, 1889. Quion Ferry.
- 399—Chap. 53. Add “Ferry Regulations across the Ottawa River from Ross’ Point in the township of *Bristol*, in the County of Pontiac, in the Province of Quebec, to a point immediately opposite in the Township of McNab, in the County of Renfrew, in the Province of Ontario.” O. C. March 18, 1889; April 8, 1889. Bristol Ferry.

*Supplement.*

	Page.	
Youngstown Ferry.	399	Add "Ferry Regulations across the Niagara River from Niagara in the Province of Ontario to Youngstown in the State of New York in the United States of America." O. C. June 4, 1889.

*Department of Justice.*

<i>Penitentiary Regulations amended.</i>	451—	Chap. 59. In the third line of Section 182 read "for inspection, instead of "or inspection."
Section 67.	517—	Chap. 60. Penitentiary Regulations. For Section 67 read "The surgeon shall have full control over the patients in hospital, and in Kingston Penitentiary, over the Criminal Insane Asylum, subject to the rules of the prison, and instructions of the Inspector. He shall attend all sick inmates of the institution, whether in their cells or in the hospital."
Section 72.	518—	For Section 72 read "He shall attend the officers and servants of the prison, free of charge, also the families of the officers when such families are resident on the penitentiary property, or in quarters provided by the Government, or convenient to the penitentiary. O. C. Nov. 4, 1889.

*Post Office Department.*

578—Chap. 62. Postal Inspection Divisions. First line of page 578 read "Stratford" instead of "Kingston."

*Department of Fisheries.*

Propagation of Fish.	641—	Chap. 70. In Section 4, Sub-section (a.) Instead of "six hundred" in both places where these words occur read "one thousand." O. C. Nov. 9, 1889.
Fishing for Bass in the waters of Mi- ramichi prohi- bited for three years.	669—	Chap. 77, Propagation of Fish. Add to Section 5 as follows :—"Fishing for Bass in any manner whatsoever shall be and the same is hereby prohibited during a period of three years from the first day of December, A. D. 1889, in the water of Miramichi River and its tributaries as well as the waters of Miramichi Bay and all rivers emptying therein in the Province of New Brunswick." O. C. Nov. 16, 1889.

*Department of Marine.*

<i>Wrecks and Salvage Dis- tricts.</i>	759—	Chap. 89. Wrecks and Salvage Districts in Ontario. Add:
Goderich.		"1. Goderich District, extending from the village of Bayfield to the Northern Line or Boundary of the Township of Ashfield, including about 35 miles.

---

*Supplement.*

---

2. Kincardine District extending from the North- Kincardine.  
ern Boundary of the Township of Ashfield to the  
Northern Boundary of the Township of Bruce, also  
including a distance of about 35 miles.

3. Southampton District extending from the Southampton.  
Northern Boundary of the Township of Bruce to  
Cape Hurd, and including a distance of about 35  
miles." O. C. Nov. 4, 1889.





# INDEX.

## A

	PAGE.
Abandonment of Public Works.....	827
Addenda and Corrigenda. <i>See</i> Supplement.....	1063
Adulteration Act, Analysts under.....	305
Agricultural Fertilizers.....	308
Agriculture, Department of.....	1 to 88
Analysis. <i>See</i> Adulteration Act.....	305
Animals, Contagious Diseases among.....	71
Animals, Conveyance and shipment of.....	75
Animals, Transit of, in Bond.....	73

## B

Banks, Government Savings.....	212
Banks, Post Office Savings.....	565
Balances known as <i>steel yards</i> .....	312
Balances to be admitted to verification.....	311
Balances with equal arms.....	311, 314
Balances with unequal arms.....	312, 313
Batiscan Bridge, no longer a public work.....	840
Bed-rock Flumes.....	879
Berries free of duty. <i>See</i> Fruits, &c.....	122
Board of Health.....	1, 2
Bobcaygeon, Canal and Lock at.....	1042
Boilers of Steam-boats. <i>See</i> Inspection of boilers of steam-boats.....	760
Bonded Manufactories, Inland Revenue.....	231
Acetic Acid, Percentage of.....	233
Closed pipes.....	236
Collectors and Officers, Duties of.....	232
Duty paid spirits.....	235
Instructions to be given.....	237
Liability of Manufacturer.....	232
Licenses to manufacture.....	231
Samples, Officers may take.....	233
Spirits, &c., how to be removed.....	233, 234
Stock books.....	235
Tests to be provided.....	237
Vinegar and crude fulminate in the form of paste.....	231
Vinegar running from germinators.....	236
Weighing, testing and locking up spirits.....	234
Bonding Warehouse, Excise.....	239
Booms. <i>See</i> Slides and Booms.....	809
Boundaries of Provisional Districts in the North-West Territories.....	935
Bounty on Pig Iron.....	126
Brantford Bridge, no longer a public work.....	842
Breakwaters. <i>See</i> Harbors, Piers, &c.....	716
Breeding purposes, Importation of swine for.....	99
Bridges, Classification of.....	846
British and Foreign Manufactures, Drawback on.....	102
British Columbia. <i>See</i> Dominion Lands in Railway Belt in B. C.....	902
British Columbia, Coal Lands. <i>See</i> Disposal of Coal Lands, &c.....	856

*Index.*

	PAGE.
<b>B</b>	
British Columbia, Fishery regulations.....	664
British Columbia, Inspection and Quarantine of animals.....	82
British Columbia, Mineral Lands. <i>See</i> Dominion Mining Regulations.....	870
British Columbia, Public property transferred to.....	830
British Columbia, Telegraph Lines.....	844
British Columbia, Timber. <i>See</i> Timber on Dominion Lands.....	861
British Copyright Works, Foreign reprints of.....	109
<b>C</b>	
Caledonia Bridge, no longer a public work.....	841
Canada Temperance Act.....	597
Declaration as to qualification.....	598
Declaration by witness to signature.....	597
Evidence.....	597
Form of petition.....	597
Petitions, respecting.....	597
Qualification, Declarations as to.....	598
Canadian Joint Freight Classification.....	994 to 1015
Canadian Railway Company to enter into bond before manifesting goods.....	139
Canals, Regulations and Tolls.....	1024 to 1062
Bobcaygeon, Canal and Lock at.....	1042
Canals to which regulations extend.....	1035
Chambly Canal.....	1050
Collector of tolls.....	1036
Dimensions of raft, &c.....	1028
Firewood on Lachine Canal, Wharfage on.....	1054
Firewood on Rideau Canal.....	1042
Flag poles and masts.....	1060
Flour at Lachine Basin.....	1053
General Regulations.....	1024
Harbor dues.....	1052
Interpretation.....	1041
Lachine Canal, Dues on vessels in the new basin at.....	1056
Mail Steamers.....	1030
Montreal, Canal Basins in.....	1055
Montreal Harbor, Dues in.....	1056
Ottawa Canals.....	1050
Phosphates.....	1055
Pigeon Lake.....	1043
Priority of passage.....	1030, 1031
Repairing of vessels, Charges.....	1059
Reports, Who shall make.....	1035
Rideau Canal basin.....	1035
Rideau Canals.....	1050
Sheds at Lachine Basin, Tolls at.....	1052
Special regulations relating to Tolls.....	1051
St. Lawrence Canals.....	1050
St. Peter's Canal, Tolls.....	1062
Standard for estimating weights.....	1049
Sturgeon Lake to Pigeon Lake.....	1043
Tolls, Rates of, on Dominion Canals.....	1047
Trent Valley Canal, Tolls.....	1061
Welland Canal, Tolls.....	1049
Wharfage dues, Montreal harbor.....	1056
Wintering at Lachine Canal, Charges for.....	1056
Wintering vessels in Rideau Canal, Charges for.....	1058

*Index.*

C

	PAGE.
Canals, Special regulations.....	1051
Cape Breton, Fishery regulations for.....	636
Carriage by Railway through Canada.....	137
Carriage by Railway through the United States.....	149
Cattle Quarantine Stations—	
Partridge Island.....	78
Point Edward.....	79
Red River.....	78
Certificate of Analysis. <i>See</i> Agricultural Fertilizers.....	310
Certificates of Masters and Mates. <i>See</i> Examinations and Certificates of Masters and Mates.....	671
Chambly Canal.....	1050
Chaudière Falls. <i>See</i> Slides and Booms.....	819
Chicoutimi, Slides and Booms.....	814
Chief Analyst. <i>See</i> Agricultural Fertilizers.....	308
Chisholm's Rapids, Tariff of Tolls at.....	826
Cigar Regulations. <i>See</i> Tobacco and Cigar Regulations.....	255
Cinnabar. <i>See</i> Dominion Mining Regulations.....	870
Civil Service Examinations.....	600
Admission to next ensuing Examination.....	601
Application for Examination.....	601
Appointments for which the higher grade will qualify.....	603
Board, Rules to be observed by.....	600
Candidates failing.....	603
Candidates guilty of misconduct.....	606
Candidates, Requirements of.....	601
Certificates.....	604
Entrance Examinations.....	600
Examinations.....	602
Fee to be paid.....	601
Forms.....	604
Higher Grade Examination.....	602
Irregularities to be reported.....	606
Meetings of Board.....	600
Notice of Examination.....	602
Obligatory subjects.....	608
Options, Candidates who pass in.....	603
Options, specified.....	604
Papers, how to be arranged.....	607
Penal clauses, from the Civil Service Act.....	600, 610
Preliminary Examinations.....	601, 602
Promotion Examinations.....	607
Qualifying Examinations.....	602
Regulations for conducting entrance examinations.....	605
Report, Annual.....	604
Rules to be observed by Board.....	600
Scale of Higher Grade.....	603
Stationary.....	605
Sub-examiners.....	601
Subsequent examinations in options.....	603
Supplementary subjects.....	608
Time tables.....	604
Translations.....	608
Classification, Canadian Joint Freight.....	994 to 1015
Classification for Inland Revenue.....	223
Classification of Bridges.....	846

*Index.*

	PAGE.
<b>Coal Lands</b> , the property of the Government, &c. <i>See Disposal of Coal Lands, &amp;c.</i>	856
<b>Coal Lands</b> within Indian Reserves in Manitoba and North-West Territories.	210
<b>Coal</b> , Warehousing of	94
<b>Coasting Trade</b> , Foreign vessels	132
Vessels of Argentine Republic	134
Vessels of Austro-Hungary	133
Vessels of Belgium	134
Vessels of Denmark	133
Vessels of Germany	132
Vessels of Italy	132
Vessels of Netherlands	133
Vessels of Sweden and Norway	133
<b>Coasting Trade</b> , General Regulations under the Customs Act	127
British Columbia, How far Regulations are to apply to	131
British registered vessels	127
Coasting Regulations	127
Report inwards	128
Report outwards	129
<b>Commissions to Public Officers</b>	592
<b>Companies</b> . <i>See Incorporation of Companies by Letters Patent.</i>	588
<b>Contagious Diseases among Animals</b>	71
Alberta. <i>See Provisional Districts, &amp;c.</i>	86
American Cattle and Swine. <i>See Transit of Animals in Bond.</i>	73
Assiniboia. <i>See Provisional Districts, &amp;c.</i>	86
British Columbia, Importation of animals into	88
British Columbia, Inspection and Quarantine of Animals in	82
Carriage of diseased animals	75
Cattle Quarantine Station at Partridge Island	78
Point Edward	77
Red River	78
Conveyance and Shipment of Animals	75
Foot and mouth disease	82
General Disposition	77
Head Ropes	77
Horses, Mules, Sheep and Swine, Importation of, into Provisional Districts	88
Horses and Mules, Importation of, into British Columbia	88
Infected places	75
Infected vessels	82
Inspection of cattle and swine	74
Lyn. <i>See Infected places.</i>	75
Manitoba, Fees for Inspection of horses and mules	85
Manitoba, Fees for Inspection of neat cattle	84
Manitoba, Fees for Inspection of sheep	85
Manitoba, Fees for Inspection of swine	86
Manitoba, Importation of horses and mules	85
Manitoba, Importation of neat cattle	82
Manitoba, Importation of sheep	85
Manitoba, Importation of swine	85
Manitoba, the North-West Territories and British Columbia, Regulations respecting the Inspection and Quarantine of Animals in	82
North-West Territories, Inspection and Quarantine of Animals	82
Partridge Island, Cattle Quarantine Station at	78
Pleuro-Pneumonia	82
Point Edward, Cattle Quarantine Station at	77
Prohibition	71
Provisional Districts of Assiniboia, Saskatchewan and Alberta	83

Index.

*Contagious Diseases Act - 50th Anniversary P.M.C. Reg. 20*

**Contagious Diseases amongst Animals—Continued.**

*Sec 12*  
PAGE

Quarantine.....	71
Red River, Cattle Quarantine Station at.....	78
Resting place at Lyn.....	75
River St. Clair. <i>See</i> Point Edward, &c.....	77
Sarnia. <i>See</i> Infected places.....	75
Saskatchewan. <i>See</i> Provisional Districts, &c.....	86
Sheep and swine, Importation of, into British Columbia.....	88
Sheep Scab, The Disease of.....	79
Shipment of Animals.....	75
Transit of animals in Bond.....	73
Transit of animals, Regulations relating to.....	74
United Kingdom, Cattle coming from.....	78
Vessels, Infected.....	82
Western United States, Cattle coming from.....	77
<b>Copper.</b> <i>See</i> Dominion Mining Regulations.....	870
<b>Copyright, Appendix of Forms.....</b>	32
Registration of Copyright.....	32
Application for, by agent of proprietor.....	33
Application for, by proprietor himself.....	32
Registration of Interim Copyright.....	34
Application for, by agent of proprietor.....	34
Application for, by proprietor himself.....	34
Registration of Temporary Copyright.....	35
Application for, by agent of proprietor.....	36
Application for, by proprietor himself.....	35
<b>Copyright, General Rules.....</b>	31
<b>Copyright Works, Foreign reprints of British.....</b>	100
<b>Corn used in the manufacture of distilled spirits, Drawback on.....</b>	108
<b>Court of Ontario, Maritime. <i>See</i> Maritime Court of Ontario.....</b>	424
<b>Criminal Statistics, Forms of Returns.....</b>	5
Convictions.....	7
Persons tried.....	5
Prerogative of mercy exercised.....	6
Prisoners convicted.....	6
<b>Cullers Fees.....</b>	352
<b>Currencies, Values of Foreign.....</b>	144
<b>Customs House, when a Shipping Office. <i>See</i> Shipping Offices.....</b>	753
<b>Customs, Department of.....</b>	89 to 162
<b>Customs Duties, Directions respecting.....</b>	123
<b>Customs, Free list.....</b>	118 to 121
<i>See also</i> Supplement.....	1063 to 1065
<b>Customs: Directions respecting duties.....</b>	123
Animals for the improvement of stock.....	125
Blood horses, Regulations relating to.....	125
Cattle, Regulations relating to.....	125
Fish-hooks, nets and seines, lines and twines.....	123
Glove leather.....	124
Horses, mules, &c., from the United States.....	123
Improvement of stock.....	125
Leather for gloves.....	124
Lines and twines. <i>See</i> Fish-hooks, &c.....	123
Models of invention.....	124
Mules. <i>See</i> Horses, mules, &c.....	123
Musical instruments. <i>See</i> Supplement.....	1065
Nets and seines. <i>See</i> Fish-hooks, &c.....	123

*Index.*

	PAGE.
<b>Customs: Directions respecting duties—Continued.</b>	
Prizes, Articles won as. <i>See</i> Supplement.....	1066
Sapolid or silver soap. <i>See</i> Supplement.....	1066
Regulations relating to blood horses, short horn cattle, &c.....	125
Rigging. <i>See</i> Wire rope, &c.....	124
Seines. <i>See</i> Fish-hooks, &c.....	123
Ships' rigging. <i>See</i> Wire rope, &c.....	124
Stock, Animals for the improvement of.....	125
Twines. <i>See</i> Fish-hooks, &c.....	123
United States, Horses, &c., from.....	123
Veneers of wood shaved or cut, &c. <i>See</i> Supplement.....	1066
Vermouth bitters and Vermouth wine. <i>See</i> Supplement.....	1066
Water hog leather.....	124
Wire rope for ships' rigging.....	124
<b>Customs: Forms of oath, &amp;c.</b>	113
Agent or Attorney.....	114
Consignee.....	113
Declaration by other than Owner, Consignee or Importer.....	114
Foreign owner.....	116
Goods entered at a lower rate than would otherwise be chargeable.....	115
Goods entered without invoice.....	115
Goods transferred on a removal entry.....	116
Importer.....	113
Owner, Consignee or Importer.....	113
Settlers effects.....	117
<b>Customs: Special regulations.</b>	109
Carboys and Demijohns.....	109
Celluloid.....	110
Coal dust.....	109
Duty on Sugar and Melado.....	109
Expenses of gauging and testing spirits, wines and malt liquors.....	111
Ferro-Manganese, Ferro-Silicon, Spiegel, &c. <i>See</i> Supplement.....	1063
Fur skins.....	110
Importation of spirits.....	112
Lithographic printing presses. <i>See</i> Supplement.....	1063
Polariscopic test.....	112
Refund on re-exported goods.....	111
Spirits, Importation of.....	112
Spruce and Pine logs. <i>See</i> Supplement.....	1063
Tare and draft upon packages containing imported sugars.....	110
Vinegar, The standard for.....	110
<b>Customs Warehouses.</b>	89
Applications for establishment of Warehouses.....	90
Class Five, Warehouses for refining Sugar.....	91
Class Four.....	91
Class One.....	89
Class Six, Sufferance Warehouses.....	91, 92
Class Three.....	90
Class Two.....	89
Classification of Warehouses.....	89
Coal, Warehousing of.....	94
General provisions.....	93
General regulations.....	89
Grain, Regulations respecting the Grinding and Packing of Wheat, Maize and other Grain in bond.....	94

*Index.*

O

Customs Warehouses—Continued.

	PAGE.
Grinding and Packing of Wheat, &c., in bond	94
Maize, Grinding and Packing, &c., in bond	94
Molasses for Refining	95
Sufferance Wharves and Warehouses	91, 92
Sugar and Molasses for Refining	95
Warehouses for refining Sugar	91
Wheat, Grinding and Packing, &c., in bond	94
Cutting hay without authority	855
<i>Relief of Licensees of Beer &amp; Wine Licenses, Sec 93, 1903</i>	
Damaged Grain. See Licensed malsters	351
Death Certificate, Form of	4
Deep-Sea Fisheries, Vessels engaged in, not included in the rules governing foreign trading vessels	136
Department of Agriculture	1 to 88
Department of Customs	89 to 162
Department of Finance	212 to 220
Department of Fisheries	615 to 670
Department of Indian Affairs	163 to 211
Department of Inland Revenue	221 to 399
Department of Interior	847 to 944
Department of Justice	401 to 564
Department of Marine	671 to 808
Department of Public Works	809 to 846
Department of Railways and Canals	945 to 1062
Department of Secretary of State	579 to 614
Department, Post Office	565 to 578
Designs. See Trade Marks and Designs, &c	37
Desjardins Canal, transferred to the town of Dundas	831
Diseases Among Animals	71
Disposal of Coal Lands, the property of the Dominion Government in Manitoba, the North-West Territories and British Columbia	856
Disposal of Indian Lands	166
Distilled Spirits, Drawback on corn used in the manufacture of	108
Districts and Divisions, Inland Revenue	221
Districts under The Adulteration Act	305
Dominion Lands in Railway Belt in British Columbia	902
Administration and management	903
Assignment or transfer of homestead right	913
Assignments, Registration of	916
Commissioner of Dominion Lands	910, 911, 912, 914
Conditions on which claimant may become entitled to a patent under a homestead entry	911
Crown Timber Agent	902, 907, 908, 917
Disputes, how settled	910
Ditches	915
Dominion Land Surveyor	902, 904, 905,
Dominion Lands Board	918, 911, 912, 917
Dominion Mining Regulations, Application of	915
Fees, Tariff of	918
Forms	918 to 927
Fruit culture	913
General Provisions relating to the Railway Belt in British Columbia	916
Governor in Council, Powers delegated to	916
Grazing lands	915

*See  
Col 22  
P. 2.*

*Relief of Licensees  
of Beer & Wine*

## Index.

## D

<b>Dominion Lands in Railway Belt in B. C.—Continued.</b>	<b>Page.</b>
Homestead entries and sales effecting Timbered lands.....	907
Homestead entry, how made.....	909
Homestead Rights.....	906
Immigrants, Provision in case of.....	910
Interior Department of.....	903
Interpretation.....	902
Lands Board.....	910, 911, 912, 914
Legal sub-divisions.....	904
Meaning of terms.....	902
Mining and mining lands.....	915
Officials before whom affidavits, &c., may be made.....	917
Ordinary sale of lands.....	905
Patent lists.....	916
Powers delegated to the Governor in Council.....	916
Proportion in which fruit trees, &c., are to be planted.....	914
Public highways.....	904
Publication of regulations.....	917
Quarter quarter-sections.....	904
Registrar General of British Columbia.....	916
Registration of assignments.....	916
Roads, Public.....	904
Sale of Lands.....	905
Schedule of Forms.....	918 to 927
Sections, Diagram of.....	903
Settler, when entitled to patent.....	910
Six months' notice to be given.....	912
Subpenas.....	917
Survey of Dominion Lands.....	918
Surveys.....	903
Tariff of Fees.....	918
Timber Licenses.....	908
Timber Slides, &c.....	915
Timbered lands, Homestead entries and sales affecting.....	907
Town Plots, &c.....	906
Township plans and Patent lists.....	916
<b>Dominion Lands in Railway Belt in B. C. Schedule of Forms</b> .....	<b>918</b>
Affidavit by an Agent in support of a claim for Homestead Entry on behalf of a person who has <i>bona fide</i> settled and made improvements upon land in advance of survey.....	921
Affidavit by an Agent in support of a claim for Homestead Entry on behalf of a person who has not previously obtained Homestead Entry.....	922
Affidavit by an Agent in support of a claim for Homestead Entry on behalf of a person who has previously obtained and has forfeited his Homestead Entry, but is permitted by the Minister of the Interior to obtain another Homestead Entry.....	923
Affidavit in support of a claim for Homestead Entry by a person who has <i>bona fide</i> settled and made improvements upon land in advance of survey.....	919
Affidavit in support of a claim for Homestead Entry by a person who has not previously obtained Homestead Entry.....	919
Affidavit in support of a claim for Homestead Entry by a person who has previously obtained and has forfeited his Homestead Entry, but is permitted by the Minister of the Interior to obtain another Homestead Entry.....	920
Affidavit in support of application for right to divert water.....	925
Application for a Homestead Entry.....	918
Application for a Homestead Entry by an Agent.....	921
Application for Fruit culture entry.....	924



*Index.*

**D**

	PAGE.
<b>Dominion Lands in Railway Belt in B. C. Schedule of Forms—Continued.</b>	
Certificate of recommendation for patent.....	924
Grant of the right to divert water.....	926
Notice of application for right to divert water.....	925
Receipt and certificate of entry.....	923
Subpcena.....	927
<b>Dominion Lands Regulations.....</b>	<b>847</b>
Arbitration.....	859, 860
Classification of lands.....	847
Coal lands, Disposal of.....	856
Cutting hay without authority.....	855
Grass. <i>See</i> Cutting hay, &c.....	855
Grazing lands, Form of lease of.....	851
Grazing lands, Leases of.....	849
Hay lands, Reservation of.....	849
Hay, Leases to cut.....	854
Hay, Permits to cut.....	853
Homestead and pre-emption.....	847
Lands patented or entered on which the mining rights have been reserved.....	858
Leases of grazing lands.....	849
Leases to cut hay.....	854
Mines and minerals reserved.....	848
Mining rights reserved.....	858
Permits to cut hay.....	853
Pre-emptions.....	847
Prospecting for coal.....	857
Religious denomination, Free grant to.....	848
Sale of Dominion lands.....	847
Sections, Diagram of.....	847
Surveyed lands, classified.....	847
Timber lands, Reservation of.....	849
Township, Division of, into sections.....	847
Wood lots, Reservation of.....	849
<b>Dominion lands, Sale of.....</b>	<b>847</b>
<b>Dominion lands, Timber on. <i>See</i> Timber on Dominion lands.....</b>	<b>861</b>
<b>Dominion Mining Regulations.....</b>	<b>870</b>
Administration.....	879
Applications, how made.....	874
Assignment of right to purchase.....	875
Bed-rock flumes.....	879
Bond fees.....	886
Claimant, Rights of.....	873
Death of miner.....	879
Declaration under oath.....	872
Disputes, how settled.....	885
Ditches.....	881
Diversion of water.....	883
Drainage of mines.....	880
Forfeiture.....	888
General provisions.....	884
Hearing and decision of disputes.....	885
Interpretation.....	884
Leave of absence.....	886
Mining location, Regulations for.....	371
Miscellaneous.....	887
Nature and size of claims.....	876

*Index.*

## D

	PAGE.
<b>Dominion Mining Regulations—Continued.</b>	
Placer mining.....	876
Quartz mining.....	870
Rights and duties of miners.....	877
Size of claims.....	876
Tunnelling.....	878
Waste of water.....	882
Water privilege.....	882
<b>Dominion Mining Regulations, Forms</b> .....	889
Application and affidavit of discoverer of Quartz mine.....	889
Application for grant for Placer mining and affidavit of applicant.....	895
Certificate in cases of Partnership, &c.....	892
Certificate of the assignment of a Mining Location.....	894
Certificate of the assignment of a Placer Mining claim.....	897
Grant for Drainage.....	899
Grant for Placer Mining.....	896
Grant of right to Divert Water and construct Ditches.....	901
Grant to a Bed-rock Flume Company.....	898
Notice of application to use and divert water.....	900
Patent of a Mining Location.....	894
Receipt for annual fee for renewal of location certificate.....	891
Receipt for fee paid by applicant for mining location.....	890
Receipt to be given for fee paid in case of Partnership.....	893
<b>Dominion Police Regulations</b> .....	405
Character, Certificate of.....	417
Commissioner of Police.....	405
Complaints against Police.....	417
Constables, Pay of.....	405
Constables, Qualifications of.....	406
Dismissal, Grounds for.....	413
Drill Instructor.....	410
Duties of Constables, General.....	410
Full dress.....	416
General regulations.....	411
Inspector and Sergeants, Duties of.....	408
Pay of Inspector, Sergeants and Constables.....	405
Saluting.....	410
Sergeants, Duties of.....	408
Sergeants, Pay of.....	405
Sickness, Duty in case of.....	413
Superintendent, Duties of.....	407
Superintendent of Police.....	405
Uniform, Appearing in full.....	416
<b>Dormant Scales or Weigh-bridges</b> .....	315
<b>Drainage of Mines</b> .....	880
<b>Drawback on British and Foreign Manufactures</b> .....	102
<b>Drawback on corn</b> used in the manufacture of distilled spirits.....	108
<b>Drawback on goods</b> exported to Newfoundland.....	103
<b>Drawbacks.</b>	
Boxes, barrels and crates.....	106
Common cut nails.....	106
Corn for starch.....	104
Corn used in the manufacture of distilled spirits.....	108
Cotton coverings for cheese.....	105
Cotton used in packing bacon and hams.....	104
Crates. <i>See</i> Boxes, &c.....	106

*Done in M.C.  
and wife  
27/11/11*

*Index.*

## D

	PAGE.
<b>Drawbacks—Continued.</b>	
Horse-shoe nails .....	105
Nails .....	105, 106
Ships' Materials .....	105
<b>Drawbacks</b> on exportation of imported goods .....	101
General regulations .....	101
Section 247 of the Customs Act .....	101
<b>Dues</b> on Timber cut under license on Indian Lands .....	169
<b>Dundas, Desjardins</b> Canal transferred to the town of .....	831
<b>Duplessis</b> Portable Track Scales .....	314
<b>Duties, Directions</b> respecting Customs .....	123
<i>Division of Customs, see Stat Can 192 P. 25</i>	
<b>Enfranchisement</b> of Indians .....	165
<b>Entry</b> of goods ex-warehouse for consumption .....	244
<b>Entry</b> of goods ex-warehouse for exportation .....	240
<b>Entry</b> of goods for removal—ex-warehouse in bond .....	242
<b>Entry, Outports</b> of .....	149
<b>Entry, Ports</b> of .....	147
<b>Examinations and Certificates</b> of Masters and Mates .....	671
Age, Certificate as to .....	672
Apprentice or Seaman, Service other than as .....	673
Candidate who has obtained a certificate before the 19th October, 1884 .....	674
Candidates injuring examination papers .....	688
Certificates of competency .....	671
Character, Testimonials of .....	671
Coasting Trade .....	683
Master .....	684
Mate .....	684
Coasting trade, Service in .....	672
Color, Examination in .....	673
Competency, Certificates of .....	671
Cyclones, Questions relating to .....	677
Discovered copying, &c. .....	688
First Mate of Sea-going Ship .....	675
Fore-and-aft-rigged vessels, Service in .....	678
Foreign Sea-going Ships, higher grade than that for coasting .....	673
Foreigners to know English .....	672
Great Inland Waters of Canada .....	685
Georgian Bay .....	685
Lake Erie .....	685
Lake Huron .....	685
Lake Ontario .....	685
Lake Superior .....	685
Master, Qualifications of .....	685
Mate, Qualifications of .....	685
Inland Voyages, Coasting or .....	683
International Code of Signals .....	673
Master of Sea-going Ship .....	676
Master of Yacht .....	679
Minor Waters of Canada .....	686
Master, Qualifications of .....	686
Mate, Qualifications of .....	686
Service prior to Jan. 1st, 1883 .....	687
Special Instructions .....	687

*Index.*

<b>E</b>	
<b>Examinations and Certificates of Masters and Mates—Continued.</b>	<b>PAGE.</b>
Pleasure Yachts .....	678
Ports where examinations may be held .....	
For Coasting Vessels, &c. ....	689
For Sea-going Ships .....	671
Sea-going Ships .....	671
Second Mate of Sea-going Ship .....	674
Service as First-class Pilot .....	673
Service as Pilot's Apprentice .....	672
Service in capacities other than as an Apprentice or Seaman .....	673
Service in Coasting trade .....	672
Service, Testimonials of .....	671
Square-rigged vessels .....	678
Special Instructions .....	688
Special Instructions to Candidates .....	680
Color test .....	683
Correcting declination, &c. ....	682
Corrections by Inspection not allowed .....	681
Discovered copying, &c. ....	681
Evidence required .....	683
Examination how to commence .....	682
Injuring examination papers .....	681
Knowledge of Commercial Code of Signals .....	682
Punctuality of attendance .....	680
Re-examination in case of failure .....	682
Standard of examination may be raised .....	682
Time allowed for Navigation papers .....	681
Standard may be raised .....	689
Testimonials of Character and of Service .....	671
Time allowed at examinations .....	678
Time allowed for navigation papers .....	688
Value of Fore-and-aft certificate .....	678
Yachts, Examination voluntary .....	678
Yachts, Regulations .....	678, 679
<b>Examinations, Civil service .....</b>	<b>690</b>
<b>Excise duties, Goods subject to and exported, allowed to be re-imported free of duty ..</b>	<b>245</b>
<b>Excise, Warehousing Regulations .....</b>	<b>238</b>
<b>Exemption from Dues on Timber Lands .....</b>	<b>868</b>
<b>Export Bond, Excise .....</b>	<b>241</b>
<i>Empire Steamboat Assn's as to by and</i> <i>20. Rules 79 &amp; 4 &amp; 65</i>	
<b>Fenelon River. See Slides and Booms .....</b>	<b>825</b>
<b>Fertilizers, Agricultural .....</b>	<b>398</b>
<b>Ferry Regulations .....</b>	<b>360</b>
Allumette Island. See Pembroke .....	380
Bertie, Township of. See Victoria and Black Rock .....	395
Black Rock. See Victoria and Black Rock .....	395
Brown's Wharf. See Papineauville .....	378
Buckingham and Cumberland .....	360
Buffalo. See Fort Erie and Buffalo .....	364
Buffalo. See Victoria and Black Rock .....	398
Campbellton. See Cross Point to Campbellton .....	388
Clarence. See Thurso and Clarence .....	393
Cross Point to Campbellton .....	388
Cumberlaud. See Buckingham and Cumberland .....	360

*Index.*

F

	PAGE.
<b>Ferry Regulations—Continued.</b>	
Dalhousie.....	362
Fitzroy, Township of. <i>See</i> Quion.....	385
Florant's Point. <i>See</i> Dalhousie.....	362
Fort Erie and Buffalo.....	364, 1069
Gatineau Point. <i>See</i> New Edinburgh.....	376
Gatineau Point. <i>See</i> Rockliffe.....	389
Gower Point. <i>See</i> Lapasse.....	369
Hull.....	367
Lapasse.....	369
Lessees, Rights of, reserved.....	399
Lochaber and Rockland.....	372
Madawaska, County of. <i>See</i> St. Basil.....	391
Maine, State of. <i>See</i> St. Basil.....	391
Montebello.....	374, 1069
New Edinburgh.....	376
New York, State of. <i>See</i> Victoria and Black Rock.....	395
North Buffalo. <i>See</i> Victoria and Black Rock.....	395
North Plantaganet. <i>See</i> Papineauville.....	378
Ogdensburg. <i>See</i> Prescott and Ogdensburg.....	382
Onslow. <i>See</i> Quion.....	385
Ottawa, City of. <i>See</i> Hull.....	367
Ottawa River. <i>See</i> Lapasse.....	369
Ottawa River. <i>See</i> Lochaber and Rockland.....	372
Ottawa River. <i>See</i> New Edinburgh.....	376
Ottawa River. <i>See</i> Papineauville.....	378
Ottawa River. <i>See</i> Pembroke.....	380
Ottawa River. <i>See</i> Rockliffe.....	389
Ottawa River. <i>See</i> Thurso and Clarence.....	393
Papineauville.....	378
Pembroke.....	380
Prescott and Ogdensburg.....	382
Quion.....	385, 1069
Restigouche River. <i>See</i> Cross Point to Campbellton.....	388
Restigouche River. <i>See</i> Dalhousie.....	362
Rockland. <i>See</i> Lochaber and Rockland.....	372
St. Angelique. <i>See</i> Papineauville.....	378
St. Basil.....	391
St. John River. <i>See</i> St. Basil.....	391
St. Lawrence River. <i>See</i> Prescott and Ogdensburg.....	382
St. Thomas d'Alfred. <i>See</i> Montebello.....	374
Rockliffe.....	389
Thurso and Clarence.....	393
Victoria and Black Rock.....	395
Waterloo. <i>See</i> New Edinburgh.....	376
<i>See also Supplement.</i> .....	1069, 1070
<b>Fines and Forfeitures in the N. W. T. and Keowatin.</b> .....	423
<b>Fines, Payment of, in N. W. T.</b> <i>See</i> Intoxicants, &c.....	941
<b>Finance, Department of.</b> .....	212
<b>Fish, Propagation of.</b> <i>See</i> Propagation of Fish.....	667
<b>Fisheries, Department of.</b> .....	615 to 670
<b>Fishery Regulations, British Columbia.</b> .....	664
Explosives.....	665
Salmon.....	664
Trout.....	665

*Index.*

<b>F</b>	<b>PAGE.</b>
<b>Fishery Regulations, General for New Brunswick</b> .....	640
Bait.....	640
Bass. (See also Supplement, page 1070).....	640
Cod.....	640
Explosives.....	644
Gaspercaux.....	643
Herrings. (See also Supplement, page 1070).....	641
Land-locked Salmon.....	644
Lobsters.....	641
Oysters.....	642
Salmon.....	642
Shad and Gaspercaux.....	643
Smelts.....	643
Sturgeon.....	643
Trout and Land-locked Salmon.....	644
Whitefish.....	644
<b>Fishery Regulations, General for Nova Scotia</b> .....	615
Bait.....	615
Bass.....	615
Cod.....	615
Explosives.....	618
Gaspercaux.....	617
Herrings.....	616
Land-locked Salmon.....	617
Lobsters.....	616
Oysters.....	616
Salmon.....	617
Shad and Gaspercaux.....	617
Smelts.....	617
Trout and Land-locked Salmon.....	617
<b>Fishery Regulations, Island of Cape Breton</b> .....	636
<b>Fishery Regulations, Manitoba and North-West Territories</b> .....	663
Explosives.....	663
Pickarel.....	663
Proviso.....	663
Sturgeon.....	663
Trout.....	663
Whitefish.....	663
<b>Fishery Regulations, Ontario</b> .....	655
Bass and Maskinongé.....	655
Explosives.....	655
Leases and licenses.....	656
Maskinongé.....	655
Pickarel.....	655
Quinté, Bay of.....	656
Salmon-Trout.....	655
Snares.....	655
Speckled Trout.....	655
Whitefish.....	655
<b>Fishery Regulations, Prince Edward Island</b> .....	661
Bait.....	661
Cod.....	661
Explosives.....	662
Herrings.....	661
Lobsters.....	661
Oysters.....	662
Smelts.....	662
Trout.....	662

*Index.*

	PAGE.
<b>F</b>	
<b>Fishery Regulations, Province of Quebec.....</b>	<b>657</b>
Bait.....	657
Bass and Maskinongé.....	657
Cod.....	657
Deep sea Fisheries.....	659
Explosives.....	657
Grey trout.....	658
Lake trout.....	658
Land-locked Salmon.....	658
Leases and licenses.....	660
Lobsters.....	659
Magdalen Islands.....	659
Maskinongé.....	657
Oysters.....	659
Pickarel.....	657
Salmon.....	658
Smelts.....	659
Speckled trout.....	658
Whale fishing.....	657
Whitefish.....	658
Wininish.....	658
<b>Fishery Regulations, Specic' for New Brunswick.....</b>	<b>644</b>
County of Albert.....	654
Carleton.....	654
Charlotte.....	644
Gloucester.....	645
Kings.....	654
Northumberland.....	647
Queens.....	654
Restigouche.....	653
St. John.....	654
Sunbury.....	654
Victoria.....	654
Westmoreland.....	654
York.....	654
<b>Fishery Regulations, Special for Nova Scotia.....</b>	<b>618</b>
County of Annapolis.....	618
Cape Breton.....	637
Colchester.....	619
Cumberland.....	619
Digby.....	620
Guysborough.....	622
Halifax.....	623
Hants.....	626
Inverness.....	637
Kings.....	624
Lunenburg (Chester District).....	626
Lunenburg (Western District).....	629
Queens.....	630
Richmond.....	637
Shelburne.....	632
Victoria.....	636
Yarmouth.....	634
Yarmouth (Argyle River).....	636
<b>Foreign Currencies, Values of.....</b>	<b>144</b>
<b>Foreign Manufactures, Drawback on.....</b>	<b>102</b>

*Index.*

	PAGE.
Foreign reprints of British copy-right works.....	100
Foreign Trading Vessels.....	185
Foreign Vessels, Coasting Trade.....	182
Free List, Customs.....	118 to 121
<i>See also Supplement</i> .....	1063 to 1065
Freight Classification.....	994 to 1015
Fruits, Berries, seeds, trees, plants, vegetables, imported into Canada free of duty.....	122

## G

Gas Inspection.....	342
Gas Inspection Districts.....	346
Belleville.....	346
British Columbia, Province of.....	347
Charlottetown.....	347
Fredericton.....	347
Halifax.....	347
Hamilton.....	346
Kingston.....	346
London.....	346
Manitoba, Province of.....	347
Moncton.....	347
Montreal.....	347
New Brunswick, Province of.....	347
Nova Scotia, Province of.....	347
Ontario, Province of.....	346
Ottawa.....	347
Prince Edward Island, Province of.....	347
Peterborough.....	347
Quebec (City).....	347
Quebec, Province of.....	347
Sherbrooke.....	347
St. John.....	347
Three Rivers.....	347
Toronto.....	347
Victoria, B.C.....	347
Winnipeg.....	347
Gas Inspection, Schedule of Forms.....	343
Certificate as to quantity of ammonia.....	344
Certificate as to quantity of sulphur.....	344
Certificate, illuminating power.....	343
Certificate of inspection of meters.....	344
Classification of Gas Companies.....	345
Fees for certificates.....	345
Fees for inspection.....	345
Fees for testing of meters.....	344
Fees for verification, &c.....	344
Number of consumers.....	346
Number of meters.....	346
Tests for sulphur and ammonia.....	346
Gatineau Booms. <i>See Slides and Booms</i> .....	821
Gatineau River. <i>See Slides and Booms</i> .....	820
General Warehousing Regulations, Excise.....	238
Government House at Charlottetown transferred to Government of Prince Edward Island.....	830
Grès Falls. <i>See Slides and Booms</i> .....	818



Index.

*Contingency Act*  
*Government Savings Banks Cap 20 R.S.C. 720*

Gold. See Dominion Mining Regulations.....	PAGE
Government Savings Banks.....	870
Grades of Wheat and other grain.....	212
Barley.....	337
Indian corn.....	340
Oats.....	339
Peas.....	340
Provisions as to other grain.....	341
Quebec Peas. See Supplement.....	341
Rye.....	1069
Spring wheat.....	340
Winter wheat.....	337
Grain, Grinding, &c., in bond.....	338
Grain Testers. See Weights and Measures.....	94
Grand Mère. See Slides and Booms.....	316
Grazing Lands, Form of lease of.....	818
Grazing Lands, Leases of.....	851
	849

*Page 314*  
*314*  
*1. 8*  
*Cap 20*  
*Sec 12*

H

Halifax, Harbor Master for.....	710
Halifax, Pilotage.....	729
Halifax, Port Warden.....	738
Harbor Master for the Port of Halifax.....	710
Ballast &c.....	713
Cautionary Directions.....	712
Gunpowder.....	714
Obstructing or disobeying officer.....	715
Penalties.....	713
Rate of speed.....	711
Removal of vessels.....	711
Vessels loading or discharging.....	712
Vessels moored or at anchor.....	710
Harbor Masters, Ports.....	700
British Columbia.....	709
New Brunswick.....	701
Nova Scotia.....	703
Ontario.....	700
Prince Edward Island.....	708
Quebec.....	700
Harbor Masters, Regulations.....	690
Anchors, Position of.....	692
Ballast &c.....	694 to 696
Ballast wharf may be condemned.....	699
Boarding vessel.....	690
Bow sprits, Position of.....	692
Bridgewater, Persons lumbering at.....	697
Buoys.....	693
Coal, ballast &c. how and where to be discharged.....	694
Cow Bay, Ballast &c., at.....	696
Davits, Position of.....	692
Departure Bay.....	698
Directions of Harbor Master to be complied with.....	692
Disputes between masters, owners and others.....	692
Fees, Scale of.....	690
Ferry, landing place, &c.....	692
Getson's Cove, Deposits at.....	697

*Index.*

<b>H</b>	
<b>Harbor Masters, Regulations—Continued.</b>	<b>PAGE.</b>
High-water mark, Ballast not to be unladen below.....	696
Hillsborough, Ballast &c., at.....	694
Jib-booms, Position of.....	692
Ledge of St. Stephens.....	698
Light to be exhibited.....	692, 694
Little Glace Bay.....	698
Locating of vessels and rafts by Harbor Master.....	691
Lower yards, Position of.....	692
Lunenburg.....	698
Main-jib, &c., improperly rigged.....	693
Miramichi, Saw-dust, &c., at.....	696
Mooring of vessel, &c.....	690, 691
Nanaimo or Departure Bay.....	698
Penalties, &c.....	699
Person in charge.....	694
Removal of scow, &c., interfering with moving or mooring of vessels.....	693
Removal of ship or vessel when short of hands.....	693
Removal of vessel, &c., by Harbor Master.....	691
Richibucto, Ballast, &c., at.....	695
Saw-dust, &c., Miramichi.....	696
Shediac, Ballast, &c., at.....	695
Shediac, Pilot at.....	695
Ships and vessels exempted from fees.....	691
Spanker-boom, &c., improperly rigged.....	693
St. Stephens Ledge, Ballast, &c. at.....	695
Time of day for unloading ballast, &c.....	695
Tow-line, hawser, &c.....	692
Unsafe or dangerous location of vessel, &c.....	693
Watch to be kept.....	692
<b>Harbors, Piers and Breakwaters.....</b>	<b>716</b>
Berth to be obtained from wharfing.....	718
Cattle on wharf.....	720
Cow Bay, Tonnage at, and limits of harbor.....	721
Dirt, sand, gravel, &c.....	719
Driving and riding.....	716
Dues. <i>See</i> Tolls, &c.....	721, 725
Dues on steamboats and sailing vessels.....	725
Excepted goods from tolls.....	719
False report punishable.....	717
Goods, &c., discharged from one vessel to another, Rates.....	719
Landing of goods, &c.....	717
Limit of time.....	720
Lumber discharged overboard, Rates.....	718
Lumber, laths, &c.....	716
Lying at wharf during winter.....	720
Lying with moorings attached.....	720
Obstructing wharfing.....	719
Only one wharfage.....	721
Penalty.....	720
Precedence of vessels.....	718
Rates, how regulated.....	719
Removal of goods, &c.....	718
Report of cargo.....	716
Risk of owner.....	719
Sailing vessels, Dues on.....	725

*Index.*

<b>H</b>	
<b>Harbors, Piers and Breakwaters—Continued.</b>	<b>PAGE.</b>
Slaughter-house, fish stall, &c. ....	718
Steamboats and sailing vessels, Dues on .....	725
Tariff of Tolls and Dues. ....	722
Tariff on goods not under any class. ....	730
Tariff on unknown articles. ....	720
Tolls and Dues are payable as soon as goods landed .....	717
Tolls and Dues, General Tariff. ....	721
Tolls and Dues on Goods .....	721 to 725
Tolls and Dues prescribed. ....	719
Tolls, how recoverable. ....	719
Tolls on goods, how recoverable. ....	720
Tolls on goods recoverable from owner &c. ....	721
Tolls on goods recoverable from vessel. ....	721
Tolls on vessels, how recoverable. ....	720
Tolls recoverable from master. ....	721
Ton weight .....	720
Vessels, Dues on .....	725
Vessels not to be made fast to fenders. ....	720
Wharfage on ballast. ....	719
<b>Hay, Cutting without authority. ....</b>	<b>855</b>
<b>Hay, Leases to cut. ....</b>	<b>854</b>
<b>Hay, Permits to cut. ....</b>	<b>853</b>
<b>Hay scales. See Weigh-bridges, &amp;c. ....</b>	<b>312</b>
<b>Health, Board of. ....</b>	<b>1, 2</b>
<b>Health Districts under "The Act respecting Statistics" .....</b>	<b>4</b>
<b>Health of Animals order. ....</b>	<b>71</b>
<b>Heeley's Falls, Tariff of tolls at. ....</b>	<b>826</b>
<b>Highways, Minnedosa. See Trails leading to Minnedosa. ....</b>	<b>931</b>
<b>Howe principle. See Weights and Measures. ....</b>	<b>313</b>
<b>Hulls of Steamboats, Inspection of. ....</b>	<b>800</b>
<b>Huntington and Lake St. Francis Road, no longer a public work. ....</b>	<b>841</b>
<b>Hydrostatic balances. ....</b>	<b>314</b>

**I**

<b>Importation of swine for breeding purposes. ....</b>	<b>99</b>
<b>Incorporation of Companies by Letters Patent. ....</b>	<b>588</b>
Copies of notices to be published. ....	590
Fees must be paid. ....	590
Fees, Schedule of .....	590
Notice to be given. ....	588
Petition for Letters Patent. ....	589
Preliminary conditions. ....	589
Schedule of fees. ....	590
<b>Indian Affairs, Department of. ....</b>	<b>163 to 211</b>
<b>Indian Bands enfranchised. ....</b>	<b>165</b>
<b>Indian Lands, Dues on timber cut under license on. ....</b>	<b>169</b>
<b>Indian Lands in Ontario and Quebec, Sale of timber on. ....</b>	<b>170</b>
Arbitration, Reference to. ....	171
Cancellation of licenses. ....	171
Crown dues on timber. ....	173
Duties, how estimated and how levied. ....	174
Expiry and renewal of licenses. ....	172
Forfeited timber berths .....	170
Form of License .....	177

*Index.*

	PAGE.
<b>Indian Lands in Ontario and Quebec, Sale of timber on—Continued.</b>	
Ground rent for timber berths .....	172
License suspended .....	172
License to cut timber on Indian Lands, Form .....	177
Licenses or occupants to furnish proof, &c .....	174
Licenses to be in triplicate .....	177
Maple and swamp elm, Dues on .....	174
Maple or sappling, Parry Sound. <i>See</i> Supplement .....	1068
Matters in dispute .....	171
Offences and trespasses .....	179
Penalties .....	179
Pine trees .....	179
Purchasers, who have not completed conditions of sale .....	172, 176
Rafts or parcels of timber, &c .....	175, 176
Register or plan .....	171
Renewal of licenses .....	171
Renewal, when not granted .....	172
Statement by licensee, Form .....	178
Surveys .....	180
Tariff of dues .....	173
Timber berths .....	170
Timber berths, how described .....	171
Transfers .....	171, 179
<b>Indian Lands, Mining regulations.</b> .....	182
<b>Indian Lands, Regulations for the disposal of surrendered.</b> .....	166
Pine and spruce timber .....	167
Pine and spruce trees on timber licenses .....	167
<b>Indian Lands, Regulations to actual settlers on.</b> .....	168
<b>Indian Reserves in Manitoba and North-West Territories, Coal lands</b> within .....	210
<b>Indian Reserves, Protection of.</b> .....	163
Cutting maple trees .....	163
Grain and other produce, Selling .....	163
Maple trees, Cutting .....	163
Selling grain and other produce .....	163
<b>Indians, Enfranchisement of.</b> .....	165
<b>Infected Vessels.</b> .....	82
<b>Inland Revenue, Bonded manufactories.</b> <i>See</i> Bonded manufactories, Inland Revenue	231
<b>Inland Revenue, Classification.</b> .....	223
Accountants or Book-keepers .....	225
Collectors, Classification of .....	224
Conduct record .....	229
Deputy Collectors .....	225
District Inspector .....	230
Examinations, Excise promotion .....	226
Excisemen .....	225
Excisemen, Salaries of .....	227
General provisions .....	230
Promotion .....	229
Re-classification .....	223
Salaries of Collectors .....	224
Salaries of Excisemen .....	227
Special class .....	227
Special class examinations .....	228
Subjects and values .....	228
<b>Inland Revenue, Department of.</b> .....	221 to 399

*Index.*

	PAGE.
<b>Inland Revenue, Districts and Divisions.</b> .....	221
British Columbia.....	223
Kingston, Ontario.....	221
Manitoba.....	222
Montreal.....	222
New Brunswick.....	222
Nova Scotia and P.E.I.....	222
Ontario, Province of.....	221
Prince Edward Island.....	222
Quebec District.....	222
Quebec, Province of.....	222
Toronto, Ontario.....	221
Windsor, Ontario.....	221
<b>Inland Revenue, Warehousing Regulations.</b> .....	238
<b>Inspection and Quarantine of Animals in Manitoba, North-West Territories and British Columbia.</b> .....	82
<b>Inspection Divisions.</b> <i>See</i> Postal Inspection Divisions.....	585
<b>Inspection Divisions in Manitoba.</b> <i>See</i> Inspection of Staple articles.....	333
<b>Inspection Divisions in New Brunswick.</b> <i>See</i> Inspection of Staple articles.....	331
<b>Inspection Divisions in Nova Scotia.</b> <i>See</i> Inspection of Staple articles.....	332
<b>Inspection Divisions in Ontario.</b> <i>See</i> Inspection of Staple articles.....	329
Hamilton.....	329
Kingston.....	329
London.....	329
Ottawa.....	329
Port Arthur.....	330
Toronto.....	329
<b>Inspection Divisions in Prince Edward Island.</b> <i>See</i> Inspection of Staple articles.....	333
<b>Inspection Divisions in Quebec Province.</b> <i>See</i> Inspection of Staple articles.....	331
<b>Inspection of Gas</b> .....	342
<b>Inspection of Grain for Toronto</b> .....	335
<b>Inspection of Boilers of Steam-boats</b> .....	760
Allowance, when it may be increased.....	767, 788
Appendix.....	776 to 780
Chain and zig-zag riveted joints.....	779
For distance between rows of rivets.....	778
Joints fitted with single or double butt straps.....	779
Joints with drilled holes.....	776
Ordinary chain and zig-zag riveted joints.....	777
To determine the working pressure.....	780
Boilers now in existence (Part Two).....	782
Boilers now or hereafter to be manufactured in Canada (Part Two).....	782
Butt straps.....	767, 789
Cast iron, when not allowed.....	763
Certificate and Declaration.....	761
Chief Engineer of a steamer.....	782, 798
Constants to be substituted.....	771, 792
Construction of boilers.....	765, 787
Corrugated Iron Furnaces.....	776, 793
Corrugated Steel Furnaces and Flues.....	776, 793
Cylindrical Boiler Shells.....	776
Cylindrical Boilers, composed of iron plates.....	765, 787
Cylindrical Super-heaters.....	768, 790
Diagonal stays.....	769, 790
Dished ends.....	768, 789

*Index.*

## I

**Inspection of Boilers of Steam-boats—Continued.**

	PAGE.
Donkey boilers.....	770, 786
Duties and Liabilities of Engineers.....	782, 798
Duties of Inspector.....	794
Engineers, Duties and liabilities of.....	782, 798
Escape of Steam.....	770
Examination before testing.....	794
Examination by Inspector.....	761
External working pressure on flues.....	784
Factor of safety.....	765
Factor of safety, Additions to.....	765 to 767
Fittings of boilers.....	770
Flat ends of boilers, &c.....	770, 791
For distance between rows of rivets, &c.....	780
Formulae. See Appendix.....	776
Furnaces and Flues.....	775, 793
Hydraulic pressure.....	762
Hydraulic test.....	762
Hydrostatic pressure.....	760, 783
Hydrostatic test, maximum pressure, iron boilers.....	783
Hydrostatic test, maximum pressure, steel boilers.....	784
Inspection after completion of boiler.....	763
Inspector's certificate under Part Two.....	783
Inspector's duties.....	794
Joints with Drilled Holes.....	776
Lifting boiler.....	765
Management of boilers.....	782, 799
Man-hole openings.....	775, 785
Maximum of hydraulic test.....	794
Maximum working pressure on steam-boat boilers.....	795, 796
Minimum diameter of safety-valve.....	797
Mode of inspection.....	760, 783
Neutral parts of boiler shells.....	768, 789
New construction.....	770, 792
Notice to Inspector.....	761
Novelty of construction.....	763
Opening up for inspection.....	760, 783
Part One.....	760 to 782
Part Two.....	782 to 799
Partially inspected.....	762
Particulars of construction.....	761
Plates drilled in place.....	767, 789
Pressure on boiler of passenger steam-boat.....	795
Pressure once allowed.....	763
Re-testing.....	761, 783
Rivet holes.....	768, 789
Safety-valve chest.....	781
Safety-valves.....	781, 796
Safety-valves, Pressure allowed on.....	767, 789
Screw stays.....	768, 790
Single butt straps.....	768, 789
Spring safety-valves, Size of steel in, Formula.....	781, 797
Stamp of maker on boiler plate.....	761
Stamp with initials of Inspector.....	775
Stays, Removal and replacing of.....	765
Steel boilers.....	771 to 775

*Index.*

## I

	Page.
<b>Inspection of Boilers of Steam-boats—Continued.</b>	
Stop valve.....	770, 792
Strength of joints, how found.....	767, 788
Stress in case of new boilers.....	763
Super-heaters.....	769, 790
Tensile strength.....	765
Test strips.....	773
Testing steel boilers.....	771, 775
Valve chest.....	781
Valve chest, where to be placed.....	796
Welded steel plates.....	775
Working pressure.....	761, 784
Working pressure for girders, Formula.....	769, 791
Working pressure for steel boilers, Formula.....	774
Working pressure for supporting bolts.....	770
Working pressure, how calculated.....	794
Working pressure, Mode of calculating.....	775
Working pressure on flat surfaces, Formula.....	785
Working pressure on plane circular iron furnaces, &c., Formula.....	785
Working pressure, on plate forming flat surfaces, Formula.....	763, 764
Working pressure on tube plates, Formula.....	765
Zig-Zag riveting.....	765, 796
<b>Inspection of Hulls of Steam-boats.....</b>	<b>800</b>
Anchors.....	805
Annual inspection.....	802
Boats, Directions as to.....	803
Ceiling, Removal of parts of.....	802
Certificate for twelve months.....	802
Certificate, when to be granted.....	800
Chain cables.....	805
Compasses, Certificate as to.....	804
Date of last inspection.....	802
Davits, &c., Directions as to.....	803
Deck pumps.....	805
Duties of Inspectors of Hulls.....	806
Excursion steamers.....	807
Fire hose.....	805
Fraudulent certificate.....	801
Gangboards.....	804
Ground tackle.....	805
Important items to be noticed by Inspector.....	803
Inspection book, entry therein.....	802
Inspection, when to be made.....	800
Inspector of hulls.....	801
Inspector to complete inspection.....	801
Inspector's certificate.....	801
Life-boats and their equipments.....	807
Life buoys.....	804
Lowering boats, Directions as to.....	803
Masts, sails and gangboards.....	804
New steamboats.....	802
Office docking book.....	806
Office register book for new steamers.....	805
Passenger Steam-boats, Sail power on.....	804
Passengers, Number allowed.....	806
Rate or Duty.....	806

*Index.*

## I

	PAGE
<b>Inspection of Hulls of Steam-boats—Continued.</b>	
Report of defects to Chairman.....	802
Sail power on passenger steam-boats .....	804
Sails.....	804
Saving life, Equipments for.....	806
Spare tiller.....	805
Statement of defects, &c. ....	800
Steam-boats above 60 tons.....	804
Steering gear.....	805
Submission to Chairman.....	801
Supervision of all steam-boats.....	806
Vessel examined in another district.....	801
Yawls boats.....	807
<b>Inspection of staple articles.....</b>	<b>329</b>
Beef and pork, pot ashes and pearl ashes, pickled fish and fish oils, butter, leather and raw hides.....	330, 331, 332, 333
Butter.....	330, 331, 332, 333
Fish and fish oils.....	330, 331, 332, 333
Flour and meal and wheat and other grain.....	329, 331, 332, 333
Grain &c.....	329, 331, 332, 333
Hides. <i>See</i> Raw hides.....	330, 331, 332, 333
Leather.....	330, 331, 332, 333
Meal &c.....	329, 331, 332, 333
Oils. <i>See</i> Fish and fish oils.....	330, 331, 332, 333
Pearl ashes.....	330, 331, 332, 333
Pickled fish and fish oils.....	330, 331, 332, 333
Pork &c. <i>See</i> Beef and pork &c.....	330, 331, 332, 333
Pot ashes and pearl ashes.....	330, 331, 332, 333
Raw hides.....	330, 331, 332, 333
Wheat &c.....	329, 331, 332, 333
<i>See also</i> Inspection Divisions &c.....	329 to 333
<b>Inspection of staple articles, Board of examination and arbitration.....</b>	<b>334</b>
<b>Inspection of staple articles, Divisions.....</b>	<b>329</b>
<b>Inspection of wheat &amp;c. <i>See</i> Grades of wheat &amp;c.....</b>	<b>337</b>
<b>Inspectors tag. <i>See</i> Agricultural Fertilizers.....</b>	<b>310</b>
<b>Intercolonial Railway.....</b>	<b>976</b>
Canadian Joint Freight Classification.....	994
Freight, Carriage of.....	976
Freight Classification.....	994
Freight Tariff.....	984
General conditions of carriage.....	976
Hay and straw tariff.....	986
Joint Freight Classification.....	994
Live Stock, Carriage of.....	976
Responsibility of Railway.....	976
Storage tariff.....	993
Tariff for freight.....	984
Top wharfage.....	988
Wharfage.....	988
<b>Intercolonial Railway, Passenger Tariff.....</b>	<b>1016, 1017</b>
<b>Interior, Department of.....</b>	<b>847 to 944</b>
<b>Intoxicants, Payment of Fines for violation of "An Act respecting the North-West Territories" prohibiting the introduction of.....</b>	<b>941</b>
<b>Invention, Patents of. <i>See</i> Patents of Invention.....</b>	<b>8</b>
<b>Iron. <i>See</i> Dominion Mining Regulations.....</b>	<b>870</b>
<b>Iron Weights. <i>See</i> Weights and Measures.....</b>	<b>316</b>

*Alleged to be act 988, p 3, sec 11, 12 - su -*  
*Insurance case 34 R.S.C. 1906*



*Index.*

<b>J</b>		PAGE.
<b>Joint Freight Classification</b> .....	994 to 1015	
<b>Joint Stock Companies.</b> <i>See</i> Incorporation of Companies by Letters Patent.....	588	
<b>Justice, Department of</b> .....	401 to 564	
Court of Ontario, Maritime.....	424 to 506	
Crown cases, Fees, in N.W.T.....	401	
Dominion Police Regulations.....	405 to 418	
Fees in Crown cases in N.W.T.....	401	
Fines and Forfeitures.....	423	
Maritime Court of Ontario.....	424 to 506	
Naturalization Act.....	420 to 422	
North-West Territories, Fees in Crown cases in.....	401	
Ontario, Maritime Court of.....	424 to 506	
Penitentiary Regulations.....	507 to 564	
Petition of Right.....	419	
Police, Dominion, Regulations.....	405 to 418	
Right, Petition of.....	419	
<b>K</b>		
<b>Keewatin, Powers of Lieutenant Governor and Council to make Ordinances</b> .....	944	
<b>Kettle Creek Bridge, no longer a public work</b> .....	839	
<b>Kiln drying of damaged grain free of malt duty</b> .....	351	
<b>L</b>		
<b>Lachine Canal</b> .....	1054, 1056	
<b>Lands patented or entered, on which the mining rights have been reserved</b> ...	858	
<b>Lands, Regulations.</b> <i>See</i> Regulations affecting Dominion Lands.....	847	
<b>Lands, Timber.</b> <i>See</i> Timber on Dominion Lands.....	861	
<b>L'Assomption de Berthier road, no longer a public work</b> .....	840	
<b>Lead.</b> <i>See</i> Dominion Mining Regulations.....	870	
<b>Letters Patent, Incorporation of Companies by</b> .....	588	
<b>Licensed malsters</b> .....	351	
<b>L'Islet Pier, no longer a public work</b> .....	841	
<b>Lower Ottawa Boom Company</b> .....	358	
<b>M</b>		
<b>Madawaska River.</b> <i>See</i> Slides and booms.....	822	
<b>Malsters Regulations</b> .....	351	
<b>Malt duty.</b> <i>See</i> Licensed malsters.....	351	
<b>Malt warehoused under "The Inland Revenue Act"</b> .....	244	
<b>Manitoba, Coal Lands.</b> <i>See</i> Disposal of Coal Lands, &c.....	856	
<b>Manitoba, Dominion Lands in.</b> <i>See</i> Regulations affecting Dominion Lands.....	846	
<b>Manitoba, Fishery regulations</b> .....	663	
<b>Manitoba, Inspection and Quarantine of animals</b> .....	82	
<b>Manitoba, Mineral Lands.</b> <i>See</i> Dominion Mining Regulations.....	870	
<b>Manitoba, Timber.</b> <i>See</i> Timber on Dominion Lands.....	861	
<b>Manitoba, Trails ordered to be surveyed in</b> .....	930	
<b>Masters and Mates.</b> <i>See</i> Examinations and certificates of masters and mates.....	671	
<b>Marine, Department of</b> .....	671, 808	
<b>Maritime Court of Ontario</b> .....	424	
Account Books.....	454	
Actions.....	426	
Actions, Consolidation of.....	420	
Actions pending.....	405	
Admission of Documents and Facts.....	437	

*Index.*

<b>M</b>	
<b>Maritime Court of Ontario—Continued.</b>	<b>PAGE.</b>
Affidavits, before whom sworn.....	441
Affidavit of justification, Form of.....	433
Affidavit of service, Form of.....	428
Affidavit to lead warrant, Form of.....	430
Amending decree or order.....	456
Amendment.....	436
Appeal, Form of notice of.....	452
Appearance.....	428
Appearance and indorsement, Forms of.....	429
Appraisement and sale.....	450
Appraisements &c., Forms of commissions of.....	450
Arrest, Form of order for inspection of property under.....	451
Assessors.....	444
Attachments.....	456
Attachments, Form of.....	456
Bail bond, Form of.....	433
Bail, how to be given.....	433
Banks. <i>See</i> Payment of money, &c.....	453
Begin, Who shall.....	446
Bill of sale, Form of.....	451
Books of Account.....	454
British Vice-Admiralty Courts, Forms of, when to be used.....	436
Caveat, Form of withdrawal of.....	455
Caveat payment book.....	454
Caveat payment, Forms of.....	455
Caveat release book.....	454
Caveat release, Forms of.....	454
Caveat Warrant book.....	454
Caveat Warrant, Forms of.....	454
Caveats.....	454
Certificate of service of warrant, Form of.....	432
Certificate of State of Action.....	442
Commencement of Rules.....	464
Commission of appraisement, &c., Form of.....	450
Commission to examine, Form of.....	442
Committal, Forms relating to.....	456
Consent.....	452
Consolidation of actions.....	429
Contempt of Court. <i>See</i> Attachments.....	456
Copies.....	462
Costs.....	448, 449
Costs. <i>See</i> Tariff of Fees.....	402, 463
Counsel.....	447
Counterclaim.....	435
Court, Records of.....	462
Court, Seal of.....	461
Court, Sittings of.....	458
Deputy Marshal.....	459
Deputy Marshal, Security by.....	460
Deputy Registrar.....	459
<i>Dies non</i> .....	458
Discontinuance, Form of notice of.....	452
Discovery and Inspection.....	437
Documents and Facts, Admission of.....	437
Evidence.....	44

*Index.*

<b>M</b>	
<b>Maritime Court of Ontario—Continued.</b>	<b>PAGE.</b>
Examination, Form of .....	442
Examination of parties .....	437
Examination of witnesses before trial .....	442
Execution .....	457
Execution, Form of writ of .....	457
Facts, Admission of .....	437
Fees .....	462
<i>Fieri Facias</i> .....	457
Filing documents .....	457
Forms of Supreme Court of Ontario, when to be followed .....	462
General Rules .....	424
Holidays .....	458
Hours. <i>See</i> Office hours .....	458
Inspection, Discovery and .....	437
Inspection of books .....	462
Interpretation or meaning of words .....	424
Interpretation, witness ; Form to be used .....	440
Interrogatories and answers, Forms of .....	437
Interrogatories, witnesses .....	436
Issue of documents. <i>See</i> Tests .....	461
Justification of bail .....	433
Marshal .....	459
Marshal and Deputy Marshal, Form of security by .....	460
Marshal, Deputy .....	459
Marshal, Security by .....	460
Minute. <i>See</i> Filing .....	457, 458
Minute book .....	462
Minute, Form of .....	457
Minute of order of Court, &c., Form of .....	462
Miscellaneous .....	404
Money, Payment of .....	462
Monitions, &c., how issued. <i>See</i> Tests .....	401
Motions .....	438
Notice of Appeal .....	452
Notice of Motion .....	438, 439
Notice of Trial, Form of .....	445
Notices from the Registry .....	457
Oaths, by whom administered .....	441
Office hours .....	458
Official Reporter .....	443, 444
Orders for Payment .....	456
Parties, Examination of .....	437
Payment, Form of order for .....	456
Payment of money into and out of Court .....	452
Pending actions .....	465
Pleadings .....	435
Posting up of copy .....	436
Preliminary Acts .....	434
Printing .....	444
Records of the Court .....	462
References, Form of report .....	447
References may be decided by Court .....	464
References .....	447
Registrar .....	459
Registrar, Deputy .....	459

## Index.

## M

	PAGE.
<b>Maritime Court of Ontario—Continued.</b>	
Registry, Notices from .....	457
Release for property arrested.....	433
Release, Form of.....	434
Repealing clause.....	464
Reply.....	435
Reporter. <i>See</i> Short-hand.....	443
Re-transmission of documents.....	464
Rules, Commencement of.....	464
Sale. <i>See</i> Appraisalment and sale.....	450
Seal of Court.....	461
Security for Costs.....	463
Security of Marshal and Deputy Marshal.....	460
Service, Affidavit of.....	428
Service of pleadings, &c.....	436
Service of writ of summons.....	426
Setting down for Trial.....	445
Set-off.....	435
Short-hand.....	443
Short title.....	425
Sittings of Court.....	463
Solicitor's and Agent's book.....	404
Special case.....	438
State of Action.....	442
Statement of claim.....	435
Statement of defence.....	435
Subpoena, Form of.....	456
Subpoenas.....	455
Summons, Service of writ of.....	426
Summons, Writ of.....	426
Tariff of Fees.....	462
Taxation of costs.....	449
Tender, Form of notice of.....	439
Tenders.....	439
Teste.....	461
Time.....	468
Title of an Action, Forms of.....	426
Transmission of documents.....	464
Trial, Notice of.....	445
Trial, Setting down for.....	445
Trial, Time and place of, how fixed.....	446
Two or more causes against the same property.....	432
Uncontested action.....	447
Warrant, Affidavit to lead.....	430
Warrant, Certificate of service of.....	432
Warrant, Form of.....	431
Warrant in an action <i>in rem</i> .....	430
Withdrawal of caveat.....	455
Witnesses, Attendance of. <i>See</i> Subpoenas.....	455
Witnesses, Examination of, before trial.....	442
Writ of Summons, Forms of.....	426
Writ of Summons, Service of.....	426
<b>Maritime Court of Ontario, Schedule of Forms.....</b>	<b>465</b>
Affidavit of Justification.....	473
Affidavit of Justification (Marshal or Deputy Marshal's security).....	492
Affidavit of Service of Writ of Summons.....	460

*Index.*

<b>M</b>	
<b>Maritime Court of Ontario, Schedule of Forms—Continued.</b>	<b>PAGE.</b>
Affidavit to lead Warrant, General.....	470
Affidavit to lead Warrant in a cause of Possession.....	471
Affidavit to lead Warrant in a cause of Restraint.....	471
Answers to Interrogatories.....	474
Appearance, by Defendant in person.....	469
Appearance, by Solicitor for Defendant.....	470
Appointment to Administer Oath, &c.....	476
Attachment (for Contempt).....	489
Bail Bond.....	472
Bill of Sale.....	484
Caveat Payment.....	487
Caveat Release.....	487
Caveat Warrant.....	486
Certificate of Service to be indorsed on the Warrant, of the Service thereof.....	472
Commission for Discharge of Cargo.....	483
Commission of Appraisement.....	480
Commission of Appraisement and Sale.....	481
Commission of Removal.....	482
Commission of Sale.....	481
Commission to Examine Witness.....	477
Committal.....	490
Execution, Writ of.....	491
Fees, Tables of.....	497
<i>Fieri Facias</i> , Goods or Lands.....	491
Indorsement of Claim.....	467
Indorsement of Set-off or Counter-claim.....	470
Indorsements to be made on the Writ before Issue thereof.....	467
Interpreter's Oath.....	475
Interrogatories.....	474
Jurat, Form of.....	470
Marshal or Deputy Marshal, Form of Security by.....	452
Memorandum to be subscribed on the Writ.....	467
Minute of Decree.....	494
Minute of Filing any Document.....	492
Minute of Order of Court.....	493
Minute on Examination of Witnesses.....	493
Minutes in an Action for Damage by Collision.....	495
Notice Accepting or Rejecting Tender.....	475
Notice for Caveat Payment.....	487
Notice for Caveat Release.....	486
Notice for Caveat Warrant.....	486
Notice for Hearing.....	478
Notice for Withdrawal of Caveat.....	488
Notice of Appeal.....	485
Notice of Discontinuance.....	485
Notice of Tender.....	475
Notice to enter Judgment for Costs.....	485
Order for Committal.....	490
Order for Examination of Witnesses.....	476
Order for Inspection.....	485
Order for Payment.....	489
Registrar's or Deputy Registrar's Report.....	479
Schedule thereto.....	480
Release.....	473
Return to commission to examine witness.....	477

*Index.*

## M

	PAGE.
<b>Maritime Court of Ontario, Schedule of Forms—Continued.</b>	
Shorthand writer's oath .....	478
Subpoena .....	488
Subpoena <i>Duces Tecum</i> .....	488
Title of Action in <i>Personam</i> .....	465
Title of Action in <i>Rem</i> .....	465
Warrant .....	472
Writ of Execution .....	491
Writ of Summons in <i>Personam</i> .....	466
Writ of Summons in <i>Rem</i> .....	466
<b>Maritime Court of Ontario, Tables of Fees</b> .....	497
Affidavits .....	500
Allowance to witnesses .....	506
Appraisers, Fees to be taken by .....	506
Assessors, Fees to be taken by .....	506
Attendances .....	499
Briefs .....	500
Copies of Pleadings, &c. ....	498
Copy and Service of Writs .....	497
Counsel fees .....	501
Deputy Marshal. <i>See</i> Marshal, &c. ....	505
Disbursements .....	503
Drawing pleadings, &c. ....	499
Examiner. <i>See</i> Special Examiner, &c. ....	504
Government fee fund .....	506
Instructions .....	497
Judgments or Orders .....	500
Letters .....	501
Marshal or Deputy Marshal, Fees to be taken by .....	505
Miscellaneous .....	502
Official Reporter, Fees to be taken by .....	505
Perjura .....	499
Registrar only, Fees to be taken by .....	504
Registrar or Deputy Registrar, Fees to be taken by .....	503
Reporter. <i>See</i> Official Reporter .....	505
Solicitor .....	497
Special Examiner or Registrar, or Deputy Registrar acting as Examiner .....	504
Statements .....	501
Supreme Court of Ontario, Fees when to apply .....	502
Witnesses, Allowance to .....	500
Writs .....	497
• <b>Masters and Mates, <i>See</i> Examinations and certificates of masters and mates.</b> .....	671
<b>Measures, <i>See</i> Weights and Measures.</b> .....	311
<b>Metapedia Road, no longer a public work.</b> .....	839
<b>Medical officer, Sanitary.</b> .....	1, 2
<b>Middle Falls, Tariff of Tolls at.</b> .....	826
<b>Mineral deposits of economic value, <i>See</i> Dominion Mining Regulations.</b> .....	870
<b>Minerals other than Coal. <i>See</i> Dominion Mining Regulations.</b> .....	870
<b>Mining Regulations, Forms.</b> .....	889
<b>Mining Regulations, for the disposal of Mineral Lands other than Coal Lands, (Indian Lands)</b> .....	182
Absence, Leave of .....	190, 198
Bed-rock flumes .....	191
Boundaries of mineral and mining districts .....	109
Disputes, Hearing and decision of .....	197
Ditches .....	193

*Index.*

## M

	PAGE.
<b>Mining Regulations, for the disposal of Mineral Lands, &amp;c.—Continued.</b>	
Director of Geological Survey, Report of .....	199
Drainage of mines .....	192
Forfeiture .....	200
General provisions .....	196
Hearing and decision of disputes .....	197
Interpretation .....	196
Leave of absence .....	190, 198
Limit lines .....	170
Mineral and mining locations, how to be laid out .....	199
Miscellaneous .....	199
Placer Mining .....	188
Absence, Leave of .....	190
Administration .....	191
Areas of claims .....	188
Bar diggings .....	188
Bench claims .....	188
Claim on face of hill .....	188
Creek and river claims .....	188
Dry diggings .....	188
Leave of absence .....	190
Nature and size of claims .....	188
New stratum .....	189
Rights and duties of miners .....	189
Quartz mining .....	182
Algoma, District of, excepted .....	185
Assignment of right to purchase .....	187
Deposit to be made by claimant .....	185
Iron, Location for the mining of .....	187
Lapse of claimant's right .....	186
Limit of time for claimant to purchase .....	184
Location for the mining of iron .....	187
Milling purposes, Land used for .....	186
Mineral deposit .....	183
Mining location .....	183
Surrender .....	184
Royalty .....	190
See also Supplement .....	1068
<b>Mining Regulations, Indian Lands, Schedule of Forms .....</b>	<b>200</b>
Application and affidavit of discoverer of Quartz mine .....	200
Application for Grant for Placer Mining and Affidavit of Applicant .....	201
Certificate of assignment of Mining Location .....	203
Certificate of assignment of Placer Mining claim .....	201
Grant for drainage .....	208
Grant for Placer Mining .....	205
Grant of right to divert water and construct ditches .....	209
Grant to a Bed-rock Flume Co. ....	206
Patent of a Mining Location .....	203
Receipt for fee on extension of time for purchase .....	203
Receipt for fee paid by applicant for Mining Location .....	201
<b>Minnedosa, Trails leading to .....</b>	<b>931</b>
<b>Miramichi. See South West Boom Company .....</b>	<b>845</b>
<b>Montreal, Port Warden .....</b>	<b>747</b>
<b>Mortuary Statistics .....</b>	<b>1</b>
<b>Mud Flat, no longer a public work .....</b>	<b>843</b>

*Index.*

	PAGE.
<b>Naphtha.</b> <i>See</i> Petroleum and Naphtha.....	848
<b>Naturalization Act, Declarations under</b> .....	420
Alienage by a naturalized British subject.....	420
Alienage by a person born within British dominions, but also a subject or citizen of a foreign state by the law thereof.....	421
Alienage by a person who is by origin a British subject.....	421
British nationality.....	421
Certified copies.....	422
Declaration to be deposited.....	422
Fees.....	422
Oaths to be filed.....	422
<b>Naturalization, Regulations and Forms</b> .....	420
<b>Navigable Waters, Protection of</b> .....	666
<b>New Brunswick Fishery regulations, General</b> .....	640 to 644
Special.....	644 to 654
<b>New Brunswick, Public buildings transferred to Government of</b> .....	825
<b>Newcastle District, Slides and booms</b> .....	825
<b>Newcastle District, Tariff of tolls</b> .....	825, 826
<b>Newfoundland, Drawback on goods exported to</b> .....	103
<b>North-West Territories, Boundaries of provisional districts in</b> .....	936
<b>North-West Territories, Coal Lands.</b> <i>See</i> Disposal of Coal Lands, &c.....	856
<b>North-West Territories, Fees, &amp;c., in</b> .....	401
Accounts.....	404
Clerks of Supreme Court.....	402
Coroners.....	402
Crown Prosecutors and others.....	401
Interpreters.....	403
Jurors.....	403
Justices of the Peace.....	403
Post mortem examination.....	403
Preliminary investigations.....	403
Prosecutors, Crown.....	401
Sheriffs.....	402
Stenographers.....	403
Supreme Court, Clerks of.....	402
Witnesses.....	403
<b>North-West Territories, Fishery Regulations</b> .....	663
<b>North-West Territories, Inspection and quarantine of animals</b> .....	82
<b>North-West Territories, Judicial Districts in</b> .....	942
Eastern Assiniboia.....	942
Northern Alberta.....	942
Saskatchewan.....	942
Southern Alberta.....	942
<b>North-West Territories, Lands in.</b> <i>See</i> Regulations affecting Dominion lands.....	847
<b>North-West Territories, Mineral lands.</b> <i>See</i> Dominion Mining Regulations.....	870
<b>North-West Territories, Payment of fines in.</b> <i>See</i> Intoxicants, &c.....	941
<b>North-West Territories, Registration fees in</b> .....	937
<b>North-West Territories, Timber.</b> <i>See</i> Timber on Dominion lands.....	861
<b>North-West Territories, Trails ordered to be surveyed in</b> .....	923, 929
<b>North-West Territories, Trails transferred to Lieutenant Governor of</b> .....	932 to 934
<b>Nova Scotia, Fishery regulations, General</b> .....	615 to 618
Special.....	618 to 639



*Index.*

	PAGE.
<b>Oakville Harbor</b> , no longer a public work.....	838
<b>Octagonally shaped timber</b> .....	328
<b>Officers, Commissions</b> .....	502
<b>Ontario and Quebec</b> , Sale of timber on Indian Lands in.....	170
<b>Ontario</b> , Fishery regulations.....	635, 636
<b>Ontario</b> , Maritime Court of. <i>See</i> Maritime Court of Ontario.....	424
<b>Ontario</b> , Public buildings transferred to Government of.....	828
<b>Ottawa Canals</b> .....	1060
<b>Ottawa District</b> , <i>See</i> Slides and booms.....	819
<b>Ottawa Slide</b> . <i>See</i> Slides and booms.....	819
<b>Ottawa Works</b> , Tariff of Tolls on.....	823, 824
<b>Outports for Customs</b> .....	149
British Columbia.....	155
Manitoba and North-West Territories....	156
New Brunswick.....	151
North-West Territories.....	156
Nova Scotia.....	153
Ontario.....	149
Prince Edward Island.....	156
Quebec.....	151
<i>See also</i> Supplement.....	1066, 1067

**P**

<b>Passenger Steam-boats</b> . <i>See</i> Inspection of Hulls, &c.....	800
<b>Patents of Invention</b> .....	8
Assignments of Patents.....	11
Caveat.....	9
Commissioner of Patents.....	8
Deputy Commissioner.....	8
Drawings.....	10
Fees, how transmitted.....	9
Forms of proceedings.....	8
General Rules.....	8
Intricate and multifarious proceedings.....	11
Models.....	8
Oaths.....	23
Papers and drawings.....	11
Protest, Filing of.....	9
Re-issue under Section 23 of the Act.....	10
Samples.....	9
Transactions to be in writing.....	11
<b>Patents of Invention, Assignments</b> .....	20
Of an entire interest.....	28
Of an entire interest, or an undivided one-half interest, before the issue of patent.....	28
<b>Patents of Invention, Form of Oaths</b> .....	24
Caveat, In support of.....	28
Joint Inventors.....	24
Re-issue, Assignee of the entire interest.....	27
Re-issue, Inventor.....	26
Sole Inventor for Assignee only.....	26
Sole Inventor for himself.....	24
Sole Inventor for himself and Assignee.....	25
<b>Patents of Invention, Forms of Petition</b> .....	12
Administrator or Executor.....	14
Assignee, Inventor and.....	13

*Index.*

## P

	PAGE.
<b>Patents of Invention, Forms of Petition—Continued.</b>	
Assignee or Legatee.....	13
Certificate of payment of Fee for further term, Assignee.....	17
Certificate of payment of Fee for further term, Inventor.....	17
Executor, Administrator or.....	14
Inventor and Assignee.....	13
Joint Inventors.....	12
Legatee.....	13
Sole Inventor.....	12
Re-issue, by Assignee.....	15
Re-issue by Inventor.....	15
<b>Patents of Invention, General Forms.....</b>	<b>16</b>
Art or Process, For an.....	21
Caveat.....	27
Composition of Matters.....	22
Disclaimer.....	29
Drawings.....	21
Machine, Specifications for a.....	19
Power of Attorney.....	18
Process, For an Art or.....	21
Revocation of Power of Attorney.....	18
Specifications.....	19
Surrender on the original Patent.....	16
<b>Payment of Fines in N.W.T. See Intoxicants, &amp;c.....</b>	<b>941</b>
<b>Penitentiary Regulations.....</b>	<b>507</b>
Absence of surgeon.....	519
Accountant.....	524
Accountant, Books to be kept by.....	552, 553
Amendments to sections 67 and 72. See Supplement.....	1070
Annual report of warden.....	509
Approaching officers, &c.....	548
Arms and accoutrements.....	521
Assistant Chaplain.....	517
Assistant deputy matron.....	540
Bathing of convicts.....	519, 524
Bed clothes.....	524
Bed clothes of patients to be ventilated.....	533
Bed of patient in hospital.....	533
Bible and Prayer Book.....	515
Bills of parcels.....	527
Books, Custody of, by warden.....	510
Books, Personal inspection of.....	510
Books to be kept by—	
Accountant.....	552
Chaplain.....	552
Chief Keeper.....	554
Clerk.....	553
Deputy Warden.....	552
Hospital Keeper.....	556
Matron.....	539, 554
Officers in charge.....	555
Steward.....	554
Warden.....	551

*Index.*

## P

## Penitentiary Regulations—Continued.

	PAGE
Breakfast .....	560
Breech-loading rifles .....	521
Care of provisions .....	527
Case book .....	556
Causes for dismissal of officers .....	541
Chapel, Compulsory attendance .....	549
Chapel, Conduct of convict in .....	549
Chaplain, Absence of. ....	517
Chaplain, Report of. ....	516, 517
Chaplains .....	514
Chief Keeper .....	523
Chief Keeper, Book to be kept by. ....	554
Chief Keeper, When there is none, Deputy Warden shall perform duties. ....	524
Chimneys to be swept .....	524
Cleaning and clothing of convicts .....	528
Cleanliness of convict .....	547
Cleanliness of prison .....	523
Clerk .....	530
Clerk, Books to be kept by .....	553
Clothing and bedding .....	528
Clothing of Officers .....	562
Clothing to be numbered .....	546
Conduct and industry book .....	556, 557
Contracts .....	511
Convict, entering prison .....	512
Convict offenders book .....	554
Convict requiring instruction .....	513
Convict sent to hospital .....	512
Convict suffering from disease .....	512
Convict taken ill at work .....	545
Convicts complaint .....	544
Convicts examination book .....	552
Convicts money .....	512
Convicts, Rations to .....	546
Convicts report book .....	539, 554
Convicts report book of female apartment .....	554
Cooking and sewing .....	527
Corporal punishment .....	513, 518
Criminal insane asylum, Kingston. <i>See</i> Surgeons .....	517
Custody of books .....	510
Custody of medical comforts .....	533
Daily journal to be kept by Chaplain .....	552
Daily journal, what to contain .....	551
Day book by accountant .....	552
Death book .....	556
Department stock book .....	555
Deputy matron .....	540
Deputy warden .....	520
Deputy warden, Books to be kept by .....	552
Diet of patients .....	518
Dietary .....	560
Dinner .....	560
Discharge ledger by Clerk .....	553
Discharge of convicts .....	514

*Index.*

## P

**Penitentiary Regulations—Continued.**

PAGE.

Divine service, Attendance . . . . .	513, 515
Divine service, Every convict shall attend . . . . .	549
Dormitory cells . . . . .	524
Dress of male convicts. . . . .	529
Duties of officers generally. . . . .	540
Earning remission of sentence . . . . .	522
Entering cell by convict. . . . .	547
Epidemic, Power of Surgeon in such case. . . . .	518.
Escape, Convict attempting . . . . .	545.
Escape to be guarded against . . . . .	522.
Examination by officer on taking charge. . . . .	542.
Examining prisoners in solitary cells . . . . .	517
Examining vehicles . . . . .	537
Expenditure, Estimate of. . . . .	510
Female convicts, Management, oversight and instruction of . . . . .	538
Fines. . . . .	560
Filthy convicts to be marked . . . . .	547
Financial statement, Yearly. . . . .	525.
Fire-arms and equipment. . . . .	521
Fire-arms, Use of, &c . . . . .	545
Food. <i>See</i> Steward . . . . .	527.
Fuel, Supervision over. . . . .	523.
Gate keepers. . . . .	536.
Gate money and Fines. . . . .	560
General directions as to officers salary. . . . .	564
General stock book. . . . .	554
Guard, how to be armed. . . . .	536
Guards . . . . .	535
Grounds, Residence and . . . . .	561
Hair-cutting . . . . .	523
Hospital, Care of . . . . .	532 to 534
Hospital journal . . . . .	557
Hospital keeper, Books to be kept by . . . . .	556
Hospital Overseer. . . . .	532
Hour for going to bed . . . . .	559
Hours for meals . . . . .	559
Hours for opening and closing prison . . . . .	559
Hygiene and cleanliness. . . . .	518
Increase of Salaries . . . . .	561
Index to be kept by Clerk . . . . .	553
Infectious disease . . . . .	518
Inspector's minute book, by Clerk . . . . .	553
Instruction of convicts. . . . .	531
Instructors. <i>See</i> Trade Instructors. . . . .	531
Interpretation . . . . .	560
Investigating reports of offences . . . . .	522
Invoice Book. . . . .	524
Journal by Accountant. . . . .	552
Journal by Surgeon. . . . .	519
Keepers . . . . .	534
Keys . . . . .	559
Leave of absence of officers. . . . .	541
Ledger by Accountant. . . . .	553
Letter book. . . . .	553
Letters to convicts . . . . .	511

*Index.*

P		PAGE.
<b>Penitentiary Regulations—Continued.</b>		
Libraries .....		537
Library, Books from .....		549
Library, Care of .....		531
Lights and fires in workshops.....		543
Locks, levers and gratings to be examined.....		521
Main entrance door .....		538
Marking articles .....		529
Matron .....		538
Matron, Book to be kept by .....		534
Meals in cells .....		530
Medicines.....		533
Ministers of any denomination.....		517
Money, &c., in possession of convict.....		547
Money statements.....		525
Moneys received .....		524
Muster roll.....		521
Officers annual report.....		546
Officers, Books to be kept by.....		555
Officers default book.....		534
Officers generally, Duties of.....		540
Officers report book.....		552
Officers salaries, <i>Note</i> .....		564
Officers uniform clothing.....		562
Official checks book by Accountant.....		553
Orders book .....		553
Outhouses .....		523
Overseer. <i>See</i> Hospital Overseer.....		532
Police and discipline.....		521
Post mortem examination.....		519
Prayer Book.....		515
Precautionary measures.....		522
Prescriptions and medicines.....		533
Prison routine.....		559
Prisoners, effects book.....	512, 529,	555
Privilege of being visited.....		550
Provision book.....		554
Punishment of females.....		558
Punishment of males.....		557
Purchases of goods, &c.....		526
Rations register.....		554
Receptacles to be emptied.....		524
Register of official letters.....		553
Register of sick convicts.....		556
Register to be kept by Clerk.....		553
Registers to be kept by Chaplains.....		552
Religious belief of convict .....		544
Religious instruction.....		515
Remission of sentence.....	522,	550
Remission of time.....		539
Report of Warden, Annual.....		509
Residence and grounds.....		561
Residence of officers.....		540
Returns and reports of Warden.....		508
Revenue and expenditure statements book by Accountant.....		553
Revolver loaded, Officer to be armed with.....		541

*Index.*

## P

Penitentiary Regulations— <i>Continued.</i>	PAGE.
Revolvers, &c. ....	521
Rising from and going to bed .....	548
Roster, to be kept by Deputy Warden .....	552
Roster, what to contain .....	520
Routine, <i>See</i> Prison routine .....	559
Rules, Reading of .....	514
Salaries, Increase of .....	561
Salaries of Officers. <i>Note</i> .....	564
Sale of articles to officers .....	563
Schoolmaster .....	530
Schoolmistress .....	531
Schools, Chaplains to direct operations of .....	516
Scrubbing and whitewashing .....	528
Selection of officers by Warden .....	507
Shaving and hair-cutting .....	528
Sick and convalescent convicts .....	532
Silence and non-intercourse .....	513
Silent system .....	543
Soiling clothing or call .....	547
Speaking to another convict .....	548
Speaking to convict, Visitor .....	550
Spiritual charge of convicts .....	549
Spying prohibited .....	542
Stables and outhouses .....	523
Statements of account .....	525
Steward, Books to be kept by .....	554
Steward, Duties of .....	527
Stock book .....	526
Store-keeper, Book to be kept by .....	554
Store-keeper, Duties of .....	526
Straw in bed .....	528
Striking a convict .....	544
Subordinates, Habits of .....	522
Sunday school .....	530
Supernumerary guards .....	507
Supper .....	560
Supplies .....	511
Supplies in use book .....	554
Surgeons .....	517
Surgeons duties amended. <i>See</i> Supplement .....	1070
Survey Board of unserviceable articles .....	551
Tender book by accountant .....	553
Time book must be kept by every Officer .....	555
Time book of trade instructors .....	524
Tour of dormitory wings .....	536
Trade instructors .....	531
Trade instructors, Control of .....	520
Trial for escape or attempt .....	545
Uniform, Clothing of Officers .....	562
Uniform of female convicts .....	539
Uniform of Officers .....	540
Ventilation and cleanliness .....	527
Ventilation, &c. ....	533
Vigilance as to property .....	522
Vigilance in charge of gate .....	537
Vigilance over persons having business .....	522

*Index.*

P		PAGE.
<b>Penitentiary Regulations—Continued.</b>		
Visiting convicts sick, &c.....		516
Visiting wards of hospital.....		633
Visitors.....		550
Visitors' book.....	536,	556
Visitors entering.....		537
Vouchers for payment.....		524
Washing, mending, &c.....		528
Warden.....		507
Warden, Annual report of.....		509
Warden, Books to be kept by.....		551
Warden, Responsibility of.....		508
Watching convicts at work.....		546
Water supply.....		523
Whistling, shouting, &c.....		549
Whitewashing.....		523
Work book.....		539
Writing letters for convicts.....		516
Yearly estimate of expense.....		526
<b>Perfection Scales.....</b>		<b>314</b>
<b>Petition of Right.....</b>		<b>419</b>
<b>Petroleum. See Dominion Mining Regulations.....</b>		<b>870</b>
<b>Petroleum and Naphtha.....</b>		<b>348</b>
<b>Petroleum, Seizure of.....</b>		<b>349</b>
<b>Piers. See Harbors, Piers, &amp;c.....</b>		<b>716</b>
<b>Pig Iron, Bounty on.....</b>		<b>126</b>
<b>Pilotage Districts.....</b>		<b>726</b>
Annapolis.....		726
Antigonish.....		726
Bathurst.....		726
Bay Verte and Port Elgin.....		727
Bonaventure.....		727
Bras d'Or Lake and Great and Little Bras d'Or.....		727
Brulé.....		734
Buctouche.....		727
Caraquet.....		727
Charlotte.....		728
Cocagne.....		728
Crapaud.....		728
Economy.....		728
Esquimalt.....		735
Glace Bay.....		728
Halifax..... See.....		729
Hants.....		729
Liscomb.....		733
Louisburg.....		730
Miramichi.....		730
Moncton.....		730
Nanaimo.....		730
New London.....		730
New Westminster.....		736
North Sydney.....		734
Parraboro.....		731
Part of Prince County.....		731
Pictou.....		731
Pugwash.....		731
Restigouche.....		732

*Index.*

## P

	PAGE
<b>Pilotage Districts—Continued.</b>	
Richibucto.....	732
Richmond County.....	732
Sackville.....	733
St. John.....	733
St. Mary's and Liscomb.....	733
St. Mary's Bay.....	733
Shediac.....	734
Summerside.....	734
Sydney and North Sydney.....	734
Tatamagouche and Brulé.....	734
Tidnish.....	735
Victoria and Esquimalt.....	735
Wallace.....	735
Yale and New Westminster.....	736
Placer Mining.....	876
Plants free of duty. <i>See</i> Fruits, &c.....	122
Platform Scales. <i>See</i> Weigh-bridges, &c.....	312, 313
Platform Scales, Weigh-bridges and Balances with unequal arms.....	313, 325
Platform Scales, when rejected.....	325
Police. <i>See</i> Dominion Police Regulations.....	405
Port Dover Harbor Works transferred.....	833
Port Warden, Duties and powers of.....	746
Port Warden, Montreal.....	747
Port Warden, Prince Edward Island.....	742
Port Warden, Quebec.....	749
Port Wardens, Ports and Fees.....	737
Annapolis.....	737
Chatham.....	737
Cow Bay.....	737
Departure Bay.....	740
Esquimalt.....	745
Halifax.....	738
Hastings.....	741
Hawkesbury.....	741
Hopewell Cape.....	739
International Pier, Sydney.....	739
Louisburg.....	739
Moncton.....	739
Montreal.....	747
Mulgrave.....	741
Nanaimo and Departure Bay.....	740
New Castle.....	740
North Sydney.....	740
Pictou.....	740
Port Hastings.....	741
Port Hawkesbury.....	741
Port Mulgrave.....	741
Prince Edward Island.....	742, 743
Quebec.....	749
Rimouski.....	742
Shediac.....	742
St. Andrews.....	744
Sydney.....	744
Vancouver and Burrard Inlet.....	745
Victoria and Esquimalt.....	745
Victoria Pier.....	744
Yarmouth.....	745



*Index.*

	PAGE.
Portage du Fort Bridge, no longer a public work.....	842
Ports and Places of Entry.....	147
Ports of Entry for Customs.....	147
British Columbia.....	148
Manitoba.....	148
New Brunswick.....	148
North-West Territories.....	148
Nova Scotia.....	148
Ontario.....	147
Prince Edward Island.....	148
Quebec.....	148
See also Supplement.....	1066
Ports, Warehousing.....	157
Post Office Department.....	565 to 578
Post Office Savings Banks.....	565
Amount of deposits.....	565
Declaration by depositor.....	566
Depositor who can not write.....	566
Deposits, how received, &c.....	567
First deposit.....	565
Hours of business.....	565
Interest.....	565, 567
Withdrawal from another office.....	567
Postal Inspection Divisions.....	575
Barrie.....	577
British Columbia.....	578
Kingston.....	577
London.....	578
Manitoba and North-West Territories.....	578
Montreal.....	576
New Brunswick.....	575
Nova Scotia.....	575
Ottawa.....	576
Prince Edward Island.....	578
Quebec.....	575
Stratford.....	577, 578
Three Rivers.....	576
Toronto.....	577
Prince Edward Island, Fishery Regulations.....	661, 662
Prince Edward Island, Government House transferred to.....	830
Prince Edward Island, Port Warden.....	742
Prince Edward Island Railway.....	1023
Propagation of Fish.....	662
New Brunswick.....	669
See also Bass in Miramichi, (Supplement).....	1070
Ontario and Quebec.....	668
Ontario, Province of.....	667
Prince Edward Island.....	670
Quebec and New Brunswick.....	669
Quebec, Province of.....	668
Salmon, Ontario.....	667
Protection of Indian Reserves.....	163
Protection of Navigable Waters.....	666
Provisional Districts in the North-West Territories.....	935
Alberta.....	935
Assiniboia.....	935
Athabasca.....	936
Saskatchewan.....	935

*Index.*

	PAGE.
<b>Public Analyst.</b> <i>See</i> Adulteration Act.....	306
<b>Public Bridge over Ottawa River,</b> no longer a public work.....	843
<b>Public Buildings,</b> transferred to the Government of New Brunswick.....	829
<b>Public Buildings,</b> transferred to the Government of Ontario.....	828
<b>Public Buildings,</b> transferred to the Province of Quebec.....	827
<b>Public High-ways,</b> Minnedosa. <i>See</i> Trails leading to Minnedosa.....	931
<b>Public Officers,</b> Commissions to.....	592
<b>Public Property,</b> transferred to British Columbia.....	830
<b>Public Works,</b> Department of.....	809 to 846
<b>Public Works,</b> Transfer and abandonment of.....	827 to 846

**Q**

<b>Quarantine of Animals</b> .....	71
<b>Quarantine of Animals</b> in Manitoba, North-West Territories and British Columbia.....	82
<b>Quarantine Ports,</b> regularly organized.....	59
Charlottetown, P.E.I.....	59
Halifax, N.S.....	59
Hawkesbury, N.S.....	59
Miramichi, Harbor of.....	59
Pictou, N.S.....	59
St. John, N.B.....	59
Sydney (Cape Breton), N.S.....	59
Victoria, B.C.....	59
<b>Quarantine Regulations</b> .....	41
Asiatic Cholera, &c. <i>See</i> Ports of Richibucto, &c.....	64
Azoff, Sea of. <i>See</i> Infected Ports.....	68
Baltic. <i>See</i> Infected Ports.....	68
Black Sea. <i>See</i> Infected Ports.....	68
Certificate for Collector of Customs.....	63
Charlottetown. <i>See</i> Ports of Richibucto, &c.....	64
Charlottetown Quarantine limits.....	65
Clean Bill of Health.....	44, 47, 55, 57
Collector of Customs, when to act as Quarantine Officer.....	56
Collectors of Customs, Quarantine directions of.....	59
Duties of Medical Superintendent at Grosse Isle.....	43 to 45
General Provisions.....	53, 68
Grosse Isle, Quarantine at.....	42
Halifax and St. John, N.B., Pilots of the ports of.....	52
Halifax and St. John, N.B., Powers and duties of Inspecting Physicians for the ports of.....	51
Halifax and St. John, N.B., Vessels in quarantine at the ports of.....	52
Halifax, Inspecting Physician at.....	50
Halifax, Port of.....	49
Halifax, Quarantine limits defined.....	50
Hawkesbury. <i>See</i> Ports of Richibucto, &c.....	64
Hawkesbury, Quarantine Limits.....	66
Hours of Inspection.....	61
Immigrants, Pauper.....	53
Inspecting Physician at Quebec, Duties of.....	48
Inspecting Physicians for the ports of Halifax and St. John, their powers and duties.....	51
Infected Ports.....	68 to 70
Inspection Stations, Rimouski and Grosse Isle.....	58
Justices of the Peace.....	70
London in England. <i>See</i> Infected Ports.....	69
Mails, Steamships conveying Her Majesty's.....	57
Marmora, Sea of. <i>See</i> Infected Ports.....	68
Marseilles. <i>See</i> Infected Ports.....	69

*Index.*

Q

**Quarantine Regulations—Continued.**

	PAGE.
Medical Superintendent at Grosse Isle.....	43
Mediterranean Sea. <i>See</i> Infected Ports.....	69
Miramichi. <i>See</i> Ports of Richibucto, &c.....	64
Miramichi, Quarantine Limits.....	65
Montreal, Vessels entering or clearing at Quebec and.....	53
Passengers, on arrival of vessel at Grosse Isle.....	46
Pauper Immigrants.....	53
Penalties under Supplementary Regulations.....	61
Penalty for contravention of rules.....	53
Pictou. <i>See</i> Ports of Richibucto &c.....	64
Pictou, Quarantine limits.....	65
Pilots of the ports of Halifax and St. John, N. B.....	52
Pilots, St. Lawrence.....	46
Port of Halifax, Nova Scotia.....	49
Port of St. John, New Brunswick.....	50
Ports of Richibucto, Miramichi, Pictou, Charlottetown, Victoria, Sydney and Hawkes- bury.....	64
Ports other than Quarantine Stations, Regulations for.....	54
Quarantine directions of Collectors of Customs.....	59
Quarantine Ports regularly organized.....	59
Quebec and Montreal, Vessels entering or clearing at.....	53
Quebec, Halifax and St. John.....	41
Quebec, Inspecting Physician at.....	48
Quebec, Port of.....	42
Questions to be put to master or person in charge of vessel by Medical Superintendent at Grosse Isle.....	43
Questions to officers of vessels.....	61
Rags from countries in which infectious disease prevails.....	60
Regulations for Ports other than regular Quarantine Stations.....	54
Richibucto. <i>See</i> Ports of Richibucto, &c.....	64
Richibucto Quarantine limits.....	64
Rimouski, Medical Officer at.....	57
Second Quarantine Inspection.....	59
Signals for Quarantine Inspection.....	60
St. John, N. B., Inspecting Physician at.....	51
St. John, N. B., Quarantine limits defined.....	51
St. John, Port of.....	50
St. Lawrence, Pilots.....	46
St. Lawrence, Steamships or sailing vessels by the.....	57
St. Lawrence, Vessels coming up the.....	41
Steamships or sailing vessels by the St. Lawrence.....	57
Supplementary regulations.....	57
Supplementary regulations for regularly organized ports.....	59
Sydney. <i>See</i> Ports of Richibucto, &c.....	64
Sydney, Quarantine limits.....	65
Toulon. <i>See</i> Infected Ports.....	69
Traders, Sutlers, Grocers, &c.....	45
Vessels coming up the St. Lawrence.....	41
Vessels in quarantine at Ports of Halifax and St. John, N.B.....	52
Vessels liable to make their quarantine at Grosse Isle.....	47
Vessels of War exempted.....	52
Victoria. <i>See</i> Ports of Richibucto, &c.....	64
Victoria, Quarantine limits.....	65
<b>Quartz Mining. <i>See</i> Dominion Mining Regulations.....</b>	<b>370</b>
<b>Quebec, Port Warden.....</b>	<b>749</b>
<b>Quebec (Province of), Fishery regulations.....</b>	<b>657</b>
<b>Quebec, Public buildings transferred to Province of.....</b>	<b>82</b>

*Index.*

	PAGE.
<b>Railway Belt, British Columbia. <i>See</i> Dominion Lands in Railway Belt in B.C.</b> .....	902
<b>Railway Belt, British Columbia, Timber. <i>See</i> Timber on Dominion Lands</b> .....	861
<b>Railway through Canada, Carriage by</b> .....	137
<b>Railways and Canals, Department of</b> .....	945 to 1062
<b>Railways, General Regulations for Government</b> .....	956
Baggage masters.....	956
Brakemen.....	964
Conductors.....	958
Driver. <i>See</i> Engine driver.....	965
Engine driver.....	965
Firemen.....	971
Flags.....	947
Fog signals.....	949
General Regulations.....	945
Lamps.....	947
Maintenance of way.....	971
Passenger and station regulations.....	950
Signals.....	947
Speed, Table showing.....	965
Station baggage master.....	956
Tools, List of, for engine driver.....	966
Torpedoes.....	949
Track-laborers.....	971
Track-masters.....	971
Train baggage masters.....	964
Staff, Rules to be observed by.....	945
Station masters.....	953
Station regulations.....	950
Switchmen.....	957
Whistling signals.....	948
Works exempted.....	974, 975
<b>Refining of Sugar and Molasses in bond</b> .....	95
<b>Registration Fees in the North-West Territories</b> .....	937
Disposal of Registrar's Fees.....	939
Return, Form of.....	940
Tariff of Fees.....	937
<b>Registration of Shipping, Ports</b> .....	750
British Columbia.....	751
Manitoba.....	751
New Brunswick.....	751
Nova Scotia.....	751
Ontario.....	750
Prince Edward Island.....	751
Quebec, Province.....	751
<b>Regulations affecting Dominion Lands in Railway Belt in British Columbia</b> .....	902
<b>Regulations affecting Dominion Lands in the Province of Manitoba and the North-West Territories. <i>See</i> Dominion Lands Regulations</b> .....	847
<b>Regulations affecting timber on Dominion lands</b> .....	861
<b>Regulations for the Disposal of Dominion Lands</b> .....	166
<b>Regulations for the Transportation of Goods in transit through the United States</b> .....	140
<b>Regulations governing the disposal of Dominion Lands containing minerals</b> .....	870
<b>Regulations respecting transporting, manifesting and reporting dutiable goods by Railway in or through Canada</b> .....	137
<b>Removal Bond, Excise</b> .....	243
<b>Reprints of British Copyright works</b> .....	100
<b>Reserves, Protection of Indian</b> .....	163

*Index:*

R

	PAGE.
Revised Statutes of Canada, proclaimed.....	611
Rideau Canal Basin .....	1036
Rideau Canals .....	1050
Right, Petition of .....	419
River St. Maurice. <i>See</i> Slides and booms.....	814 to 817
Roman balances .....	312
Rouge Boom Company .....	359
<i>Rocky Mountain Park</i> S	
Saguenay, Slides and booms at.....	813
Sale of timber on Indian Lands in Ontario and Quebec.....	170
Salt carts. <i>See</i> Weights and Measures .....	316
Salvage. <i>See</i> Wrecks and Salvage.....	755
Sanitary Medical Officer.....	1, 2
Sanitary Statistics .....	2
Savings Banks, Government.....	212
Agents, Bonds to be given by .....	220
Amount of deposit and withdrawal .....	213
Auditor to submit statement.....	219
Bonds to be given by Agents .....	220
Branch Banks in N. S., and N. B.....	216
Change of residence .....	212
Circulars from Department.....	214
Circulars to be sent depositors.....	219
Death of depositor, sum exceeding \$300.....	215
Death of depositor, sum not exceeding \$300.....	215
Death of illegitimate depositor.....	216
Departmental regulations.....	219
Depositor become insane, &c.....	216
Depositor, unable to attend.....	213
Form of Order in such case .....	213
Deposits by married women .....	215
Deposits by minors.....	215
Deposits in local banks .....	218
Dispute between Department and depositor.....	216
Entry in depositor's pass-book .....	217
First deposit, how made.....	212
Inspection .....	218
Inspector to visit each office .....	218
Interest, how computed .....	212
Ledger and personal account .....	219
Manager of head office.....	217
Manager to assist Inspector .....	219
Mode of keeping and depositing moneys .....	218
Office days and office hours.....	212
Pass-book, lost or destroyed.....	214
Declaration in such case.....	214
Production of pass-book.....	213
Provision when no local bank.....	218
Regulations to be observed in the Department .....	219
Report by Inspector.....	219
Savings bank ledger.....	217
Scale of bonds to be given by Agents.....	220
Unexpected demands.....	218
Verification of pass-book.....	215

*Index.*

## S

	PAGE.
<b>Saving Banks, Government—Continued.</b>	
"Weekly," Meaning of term .....	218
Weekly return by agent .....	217
Weekly return by managers .....	217
<b>Savings Banks, Post Office .....</b>	<b>565</b>
Amount of deposit in one year .....	565
Application for withdrawal .....	570
Deceased depositor .....	572
Declarations by depositor on making first deposit .....	566
Depositor under 21 years .....	569
Depositor who can not write .....	566
Deposits by trustee .....	568
Deposits how received .....	567
Disputes, how settled .....	573
Fraud or impersonation .....	571
Hours for business .....	565
Illegitimate depositor .....	573
Information not to be disclosed .....	574
Insane depositor .....	573
Interest .....	567
Interpretation .....	574
Minor under 10 years .....	569
Report to Postmaster General .....	567
Total amount of deposit .....	565
Trustee, Declaration by .....	568
Trustee who can not write .....	569
Withdrawal, Notice of .....	570
<b>Scales. See Weights and Measures .....</b>	<b>312, 313</b>
<b>Schedule for Mortuary Statistics .....</b>	<b>3</b>
<b>School Lands. Timber permits on .....</b>	<b>868</b>
<b>Secretary of State, Department of .....</b>	<b>579 to 614</b>
<b>Seeds free of duty. See Fruits, &amp;c. ....</b>	<b>122</b>
<b>Shawenegan Bay. See Slides and Booms. ....</b>	<b>816</b>
<b>Shawenegan Falls. See Slides and Booms. ....</b>	<b>818</b>
<b>Sheep Scab, The Disease of .....</b>	<b>79</b>
<b>Shipping Master. See Shipping offices .....</b>	<b>753</b>
<b>Shipping Offices .....</b>	<b>753</b>
New Brunswick .....	754
Nova Scotia .....	753, 754
Prince Edward Island .....	754
Quebec .....	753
<b>Shipping, Registration of .....</b>	<b>750</b>
<b>Shipping, Surveyors of .....</b>	<b>752</b>
<b>Silver. See Dominion Mining Regulations .....</b>	<b>870</b>
<b>Slaughtering and curing imported swine in bond .....</b>	<b>97</b>
<b>Slides and Booms .....</b>	<b>809</b>
Chaudière Falls .....	819
Chicoutimi .....	814
Chisholm's Rapids .....	826
Collection of dues .....	813
Collector of slide dues .....	811
Cribs, Number and description of .....	811
Damages, how ascertained .....	812
Deputy Slide Master .....	809
Entrance or outlet .....	811
Fenelon River .....	825

*Index.*

## S

<b>Slides and Booms—Continued.</b>	<b>PAGE.</b>
Free access of officer to examine.....	811
Gatineau booms.....	821
Gatineau River.....	820
General regulations.....	809
Grand Mère.....	818
Grand Piles.....	818
Gres Falls.....	818
Heeley's Falls.....	826
Liability for all dues.....	813
Middle Falls.....	826
Newcastle District.....	825
Notice to be given.....	810
Obstructing Collector, Penalty.....	812
On arrival of timber at slides.....	810
Ottawa District.....	819
Ottawa Works, Tariff on.....	823, 824
Owner or person in charge.....	810
Penalties, how ascertained.....	812
Pocket boom.....	811
Powers and duties of officers.....	809
Public auction, Sale at.....	813
Responsibility for damage.....	812
River Trent.....	825
Saguenay District.....	813
Seizure and detention of raft, &c.....	812
Shawenegan Falls.....	818
Slide Master.....	809
St. Maurice District.....	814
<b>Slides and Booms, Ottawa District.....</b>	<b>819</b>
<b>Slides and Booms, Saguenay District.....</b>	<b>813</b>
Chicoutimi booms and slides.....	814
Tamarac Timber.....	814
Tolls.....	814
<b>Slides and Booms, St. Maurice District.....</b>	<b>814 to 817</b>
<b>Slides and Booms, St. Maurice Tolls.....</b>	<b>818</b>
<b>South West Boom Company.....</b>	<b>845</b>
<b>Spafford Improved Standard Platform Counter Scale. See Supplement....</b>	<b>1069</b>
<b>Spirits, Drawback on corn used in the manufacture of distilled.....</b>	<b>108</b>
St. John, Pilotage.....	733
St. John, Vessels arriving at.....	146
St. Lawrence Canals.....	1050
St. Maurice District, Slides and booms.....	814 to 817
St. Maurice Slides, Standard of measurement.....	818
St. Peter's Canal.....	1062
Stamping of Weights, Measures, etc.....	315
Staple Articles. See Inspection of staple articles.....	329
Statistical Officer.....	2
Statistics, Criminal.....	5
Statistics, Mortuary.....	1
Statutes, See Revised Statutes of Canada.....	611
Steam-Boats, See Inspection of boilers and steam-boats.....	760
Spirits, Regulations respecting.....	246
Application for removal.....	249
Bottling spirits in bond.....	246
British Columbia, Removal of duty paid spirits into.....	251





*Index.*

	PAGE.
Tariff of Dues on Timber cut on Indian Lands.....	169
Telegraph Lines, British Columbia.....	844
Temperance. <i>See</i> Canada Temperance Act.....	597
Timber Cut under license on Indian lands, Dues on.....	169
Timber for Homesteaders.....	869
Timber license, Form of.....	864 to 866
Timber licenses.....	861
Timber marks. <i>See</i> Trade Marks and Designs, &c.....	37
Timber on Dominion Lands.....	861
Burnt timber.....	867
Dues, Exemption from.....	868
Draw-back or rebate.....	868
Dues.....	866, 867
Exemption from dues.....	868
Homesteaders, Timber for.....	869
License, Form of.....	864 to 866
Licenses.....	861
Permits and dues.....	866
Permits on school lands.....	868
Rebate.....	868
Renewal of license or timber berth.....	863
School lands, Permits on.....	868
Timber permits and dues.....	866
Timber permits on school lands.....	868
Tin. <i>See</i> Dominion Mining Regulations.....	870
Tobacco and Cigar Regulations.....	255
Abandoned tobacco, &c., Destruction of.....	292
Abandoned tobacco, &c., Stamping.....	292
Additional forfeiture.....	302
Affixing stamps, Mode of.....	270
Affixing stamps on imported tobacco and cigars.....	287
Assessment for deficiencies.....	301
Bonded removal permit stamps.....	268
Boxes not before used.....	291
Branding cigar boxes.....	297
Branding for exportation. <i>See</i> Special provisions, &c.....	281
Canada Twist, Stamps for.....	266
Cancellation of stamps, by whom to be done.....	277
Cancellation of stamps on wooden packages.....	285
Cancellation on metal packages.....	286
Cancellation on packages of paper, linen, &c.....	285
Cancellation stamps, &c., Use and care of. <i>See</i> Directions, &c.....	303
Cancelling dies and stamps.....	273
Cancelling the stamps on imported tobacco and cigars.....	285
Cancelling tobacco and cigar stamps, Mode of.....	275
Caution notices.....	277, 289
Certificate, Form of.....	256
Cigar boxes, Marking or branding.....	297
Cigar samples.....	297
Cigarettes, how to be put up.....	271
Cigars, Stamps for.....	266
Cigars, Warehousing and ex-warehousing.....	299
Collectors of Inland Revenue.....	291
Condemned tobacco &c., Distribution of.....	292
Condemned tobacco &c., Stamping.....	292
Cull Cigars.....	297

*Index.*

## T

Tobacco and Cigar Regulations— <i>Continued.</i>	PAGE.
Customs, Stamps for.....	269
Cut stamps, Return of packages with.....	299
Cutting machines.....	300
Cuttings. <i>See</i> Raw leaf tobacco, scraps, &c.....	255
Daily Record.....	259, 302
Dealing with raw leaf tobacco, &c.....	255
Deficiencies, Assessment for.....	301
Destruction of abandoned, condemned or forfeited tobacco or cigars.....	292
Destruction of the stamps on packages when emptied.....	277
Dies, Cancelling stamps and.....	273
Directions for the use and care of cancellation rollers and rubber stamps.....	303
Drawback.....	303
Duty paid boxes of cigars.....	298
Entry, Ports of, for raw leaf tobacco.....	304
Ex-warehoused for removal in bond. <i>See</i> Special provisions, &c.....	281
Ex-warehousing of cigars.....	299
Fine-cut shorts, Removal of.....	261
Forfeited tobacco, &c., Destruction of.....	292
Forfeited tobacco, &c., Stamping.....	292
Forfeiture, Additional.....	302
Government die for cancellation.....	274
Illicit manufacture. <i>See</i> Reward for information, &c.....	303
Illicit sale. <i>See</i> Reward for information, &c.....	303
Imported tobacco and cigars, Manner of affixing stamps on.....	287
Imported tobacco and cigars, Packing and stamping &c.....	285
Information, &c. <i>See</i> Reward for information, &c.....	303
Label to be affixed by importer of tobacco.....	288
Leaf tobacco.....	258
Licensed cigar factory.....	298
Licorice, &c. <i>See</i> Raw leaf tobacco, scraps, &c.....	255
Manner of affixing stamps on imported tobacco and cigars.....	287
Manufactured tobacco and cigars.....	281
Marking or branding cigar boxes.....	297
Mode of affixing stamps.....	270
Mode of cancelling tobacco and cigar stamps.....	275
Notices. <i>See</i> Caution Notices.....	277, 289
Outer covering not to be stamped.....	272
Packages with cut stamps, Return of.....	299
Packing and stamping imported tobacco and cigars, cancelling the stamps thereon and for removal of same in bond from one customs port to another, &c.....	285
Packing in wood, metal, paper, &c.....	291
Paste, Receipt for.....	272
Permit stamps.....	268
Raw leaf tobacco, Ports of entry for.....	304
Raw leaf tobacco samples.....	263
Raw leaf tobacco, scraps, cuttings &c.....	255
Raw material.....	255
Rebate.....	294, 296
Recipes.....	272
Removal in bond.....	290
Removal in bond. <i>See</i> Packing and stamping &c.....	285
Return of packages with cut stamps.....	299
Reward for information in regard to illicit manufacture and sale of tobacco and cigars.....	303
Re-working of cigars.....	295
Re-working of tobacco.....	293

*Index.*

T

	PAGE.
<b>Tobacco and Cigar Regulations—Continued.</b>	
Roller stamps for cancellation .....	274
Rollers, Use and care of &c. <i>See</i> Directions, &c. ....	303
Rubber stamps, Use and care of. <i>See</i> Directions &c .....	303
Sale from manufactory premises .....	291
Sale of manufactured tobacco and cigars .....	290
Sale of scraps, cuttings, stems and sweepings in bulk .....	260
Sample boxes of cigars .....	297
Scale, Construction of .....	257
Scraps. <i>See</i> Raw leaf tobacco, scraps, &c .....	255
Sizes of packages .....	286
Snuff-flour and fine-cut shorts, Removal of .....	261
Special caution notice .....	280
Special provisions for warehousing tobacco and cigars, and for stamping same when ex-warehoused for removal in bond, for consumption or for branding same when for exportation .....	281
Stamping. <i>See</i> Special provisions &c. ....	281
Stamping imported tobacco, &c. <i>See</i> Packing and stamping, &c. ....	285
Stamping tobacco, &c., abandoned, condemned or forfeited, when sold for the benefit of the Dominion of Canada .....	292
Stamps. <i>See</i> Return of packages, &c. ....	299
Stamps and rollers, Use and care of. <i>See</i> Directions, &c. ....	303
Stamps and dies, Cancelling .....	273
Stamps for Canada Twist .....	266
Stamps for Cigars .....	266
Stamps for Customs .....	269
Stamps for Tobacco .....	265
Stamps, Manner of affixing on imported tobacco and cigars .....	287
Stamps, Mode of affixing .....	270
Stamps, Mode of cancelling .....	275
Stamps on imported tobacco and cigars, Cancelling ..	285
Standard tobacco, defined .....	255
Statements .....	302
Steel cutting roller for cancellation of stamps .....	273
Steel die .....	275
Stemmed raw leaf tobacco .....	257
Stems. <i>See</i> Raw leaf tobacco, scraps, &c .....	255
Stems, Mode of destroying .....	259
Stock statements .....	302
Strip stamps, how attached .....	288
Supply of stamps .....	269
Surveying officers, Duty of .....	291
Ticket or tag on package .....	257
Tin-foil, how stamped .....	288
Tobacco cutting machines .....	300
Tobacco stems .....	259
Tobacco, Stamps for .....	265
Use and care of cancellation stamps, &c. <i>See</i> Directions, &c. ....	303
Varnish, Recipe for .....	272
Warehousing. <i>See</i> Special provisions, &c. ....	281
Warehousing and ex-warehousing of cigars .....	299
Wood, metal, paper, &c., for packing tobacco or cigars .....	291
<b>Tobacco and Cigars, Warehousing and ex-warehousing .....</b>	<b>244</b>
<b>Trade Marks and Designs and Timber Marks, General Rules .....</b>	<b>37</b>

*Index.*

## T

	PAGE.
<b>Trade Marks, &amp;c., Appendix of Forms</b> .....	38
Registration of General Trade Mark.....	38
of Industrial Designs.....	39
of Specific Trade Mark.....	39
of Timber Mark.....	40
<b>Trade Unions Act, Regulations</b> .....	579
Alteration of rules, Registry of.....	583
Annual return for change of officers.....	583
Annual return of alterations.....	581
Annual return of receipts, &c.....	582
Application for registry.....	579
Certificate of registry.....	584
Certificates, Forms of.....	587
Declaration for registry of partial alteration of rules.....	584
Registration.....	579
Registry of complete alteration of rules.....	586
Registry of partial alteration of rules.....	585
<b>Trading Vessels, Foreign</b> .....	135
<b>Trails leading to Minnedosa established as Public High-ways</b> .....	931
<b>Trails ordered to be surveyed in Manitoba</b> .....	930
<b>Trails ordered to be surveyed in the North-West Territories</b> .....	928
<b>Trails transferred to Lieutenant Governor of North-West Territories</b> .....	932 to 934
<b>Transfer and abandonment of Public Works</b> .....	827
<b>Transit through the United States</b> .....	140
<b>Trees free of duty. See Fruits, &amp;c.</b> .....	122
<b>Trent Valley Canal</b> .....	106

## U

<b>United States, Transit through</b> .....	140
<b>Upper Ottawa Improvement Company</b> .....	353 to 357

## V

<b>Values of Foreign Currencies</b> .....	144
<i>See also Supplement</i> .....	1066
<b>Vegetables free of duty. See Fruits, &amp;c.</b> .....	122
<b>Vessels arriving at St. John, N.B.</b> .....	146
<b>Vessels, Foreign Trading</b> .....	135
<b>Verification of Measures. See Weights and measures</b> .....	315 to 322
<b>Verification of Weights. See Weights and measures</b> .....	311, 315
<b>Veterinary Inspector in case of sheep scab</b> .....	80

## W

<b>Wany or Octagonally Shaped Timber, Mode of measuring</b> .....	328
<b>Warehouses, Customs</b> .....	89
<b>Warehousing Ports</b> .....	157
British Columbia.....	161
Manitoba.....	161
New Brunswick.....	159
North-West Territories.....	162
Nova Scotia.....	160
Ontario.....	157
Prince Edward Island.....	162
Quebec.....	159
<i>See also Supplement</i> .....	1068
<b>Warehousing Regulations, Excise</b> .....	238
<b>Weigh-bridges. See Platform scales</b> .....	313, 325

*Index.*

W

	PAGE.
Weigh-bridges, hay scales and platform scales . . . . .	312
Weighing Machines. <i>See</i> Weights and measures. . . . .	311 to 321
Weighing Machines, when to be rejected . . . . .	313
Weights and Measures, Divisions. . . . .	325
Belleville . . . . .	325
British Columbia, Province of. . . . .	327
Cape Breton . . . . .	327
Charlottetown. . . . .	327
Fredericton. . . . .	326
Hamilton. . . . .	325
Kings, N.B. . . . .	327
Kingston . . . . .	325
Manitoba, Province of. . . . .	327
Montreal. . . . .	326
New Brunswick, Province of . . . . .	326
Nova Scotia, Province of. . . . .	327
Ontario, Province of. . . . .	325
Orillia. . . . .	325
Ottawa . . . . .	325
Pictou. . . . .	327
Prince Edward Island, Province of. . . . .	327
Quebec, Division. . . . .	326
Quebec, Province of. . . . .	326
Sherbrooke. . . . .	326
St. John . . . . .	326
Three Rivers. . . . .	326
Toronto. . . . .	326
Victoria, B.C. . . . .	327
Winnipeg. . . . .	327
Windsor . . . . .	326
Yarmouth. . . . .	327
<i>See also Supplement.</i> . . . .	1060
Weights and Measures, Regulations. . . . .	311
Weights and Measures, Schedules . . . . .	317
Avoirdupois weights . . . . .	323
Bullion weights. . . . .	323
Decimal Grain weights. . . . .	324
Dominion Measures of Capacity. . . . .	319
Fees for verification of measures. . . . .	320
Fees for verification of weigh-bridges, &c. . . . .	321
Fees for verification of weights . . . . .	318
Lineal measures. . . . .	322
Measures of capacity. . . . .	324
Measures of length. . . . .	324
Railway Track Scales . . . . .	321
Remedy or allowance for error. . . . .	323
Verification, Weights admitted to. . . . .	317
Weights, Measures, &c., Verification and stamping of . . . . .	315
Welland Canal Tolls . . . . .	1049
Wharves. <i>See</i> Harbors, Piers, &c. . . . .	716
Wheat, &c., Grades of. <i>See</i> Grades of Wheat, &c. . . . .	337
Wilson's Improved Weigh-Bridge . . . . .	314
Windsor Branch of the Intercolonial Railway . . . . .	
Freight Tariff. . . . .	1018
Passenger Tariff. . . . .	1021
Special Freight Rates. . . . .	1022

*Index.*

	<b>PAGE.</b>
<b>Wrecks and Salvage, Districts</b> .....	<b>755</b>
British Columbia.....	<b>759</b>
New Brunswick.....	<b>757, 758</b>
Nova Scotia.....	<b>756, 757</b>
Ontario.....	<b>759</b>
<i>See also Supplement</i> .....	<b>1070</b>
Prince Edward Island.....	<b>755, 756</b>
Quebec, Province of.....	<b>758, 759</b>