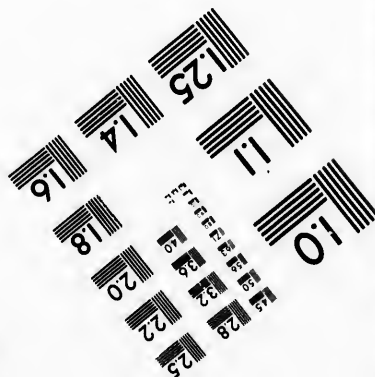
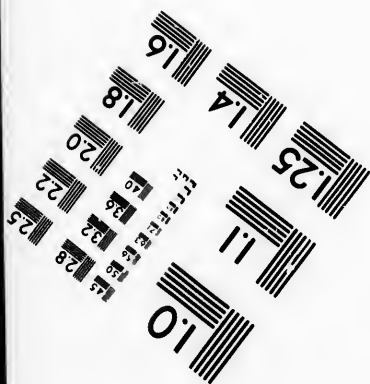
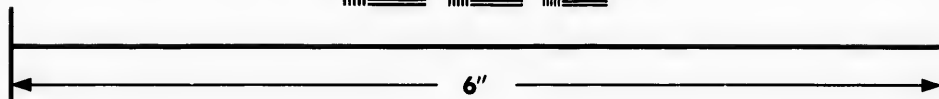
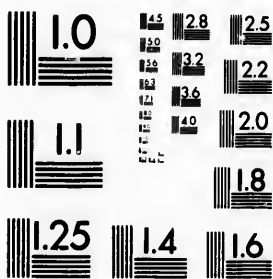

**IMAGE EVALUATION
TEST TARGET (MT-3)**



**Photographic
Sciences
Corporation**

23 WEST MAIN STREET
WEBSTER, N.Y. 14580
(716) 872-4503

**CIHM/ICMH
Microfiche
Series.**

**CIHM/ICMH
Collection de
microfiches.**



Canadian Institute for Historical Microreproductions / Institut canadien de microreproductions historiques

© 1986

Technical and Bibliographic Notes/Notes techniques et bibliographiques

The Institute has attempted to obtain the best original copy available for filming. Features of this copy which may be bibliographically unique, which may alter any of the images in the reproduction, or which may significantly change the usual method of filming, are checked below.

L'Institut a microfilmé le meilleur exemplaire qu'il lui a été possible de se procurer. Les détails de cet exemplaire qui sont peut-être uniques du point de vue bibliographique, qui peuvent modifier une image reproduite, ou qui peuvent exiger une modification dans la méthode normale de filmage sont indiqués ci-dessous.

- Coloured covers/
Couverture de couleur
- Covers damaged/
Couverture endommagée
- Covers restored and/or laminated/
Couverture restaurée et/ou pelliculée
- Cover title missing/
Le titre de couverture manque
- Coloured maps/
Cartes géographiques en couleur
- Coloured ink (i.e. other than blue or black)/
Encre de couleur (i.e. autre que bleue ou noire)
- Coloured plates and/or illustrations/
Planches et/ou illustrations en couleur
- Bound with other material/
Relié avec d'autres documents
- Tight binding may cause shadows or distortion along interior margin/
La reliure serrée peut causer de l'ombre ou de la distorsion le long de la marge intérieure
- Blank leaves added during restoration may appear within the text. Whenever possible, these have been omitted from filming/
Il se peut que certaines pages blanches ajoutées lors d'une restauration apparaissent dans le texte, mais, lorsque cela était possible, ces pages n'ont pas été filmées.
- Additional comments:/
Commentaires supplémentaires:

- Coloured pages/
Pages de couleur
- Pages damaged/
Pages endommagées
- Pages restored and/or laminated/
Pages restaurées et/ou pelliculées
- Pages discoloured, stained or foxed/
Pages décolorées, tachetées ou piquées
- Pages detached/
Pages détachées
- Showthrough/
Transparence
- Quality of print varies/
Qualité inégale de l'impression
- Includes supplementary material/
Comprend du matériel supplémentaire
- Only edition available/
Seule édition disponible
- Pages wholly or partially obscured by errata slips, tissues, etc., have been refilmed to ensure the best possible image/
Les pages totalement ou partiellement obscurcies par un feuillet d'errata, une pelure, etc., ont été filmées à nouveau de façon à obtenir la meilleure image possible.

This item is filmed at the reduction ratio checked below/
Ce document est filmé au taux de réduction indiqué ci-dessous.

10X	14X	18X	22X	26X	30X
<input type="checkbox"/>	<input type="checkbox"/>	<input type="checkbox"/>	<input type="checkbox"/>	<input type="checkbox"/>	<input checked="" type="checkbox"/>
12X	16X	20X	24X	28X	32X

The c
to the

The i
possib
of the
filmin

Origina
beginn
the la
sion,
other
first p
sion,
or illu

The l
shall
TINU
which

Maps
differ
entire
begin
right
requir
meth

The copy filmed here has been reproduced thanks to the generosity of:

Metropolitan Toronto Library
Science & Technology Department

The images appearing here are the best quality possible considering the condition and legibility of the original copy and in keeping with the filming contract specifications.

Original copies in printed paper covers are filmed beginning with the front cover and ending on the last page with a printed or illustrated impression, or the back cover when appropriate. All other original copies are filmed beginning on the first page with a printed or illustrated impression, and ending on the last page with a printed or illustrated impression.

The last recorded frame on each microfiche shall contain the symbol \rightarrow (meaning "CONTINUED"), or the symbol ∇ (meaning "END"), whichever applies.

Maps, plates, charts, etc., may be filmed at different reduction ratios. Those too large to be entirely included in one exposure are filmed beginning in the upper left corner, left to right and top to bottom, as many frames as required. The following diagrams illustrate the method:

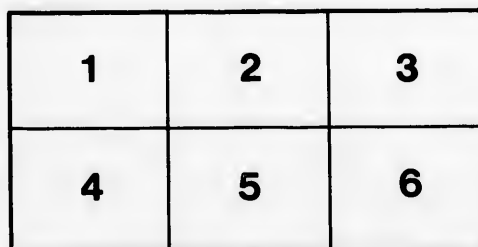
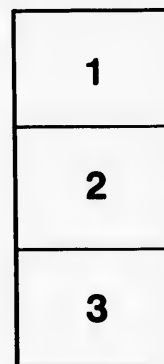

L'exemplaire filmé fut reproduit grâce à la générosité de:

Metropolitan Toronto Library
Science & Technology Department

Les images suivantes ont été reproduites avec le plus grand soin, compte tenu de la condition et de la netteté de l'exemplaire filmé, et en conformité avec les conditions du contrat de filmage.

Les exemplaires originaux dont la couverture en papier est imprimée sont filmés en commençant par le premier plat et en terminant soit par la dernière page qui comporte une empreinte d'impression ou d'illustration, soit par le second plat, selon le cas. Tous les autres exemplaires originaux sont filmés en commençant par la première page qui comporte une empreinte d'impression ou d'illustration et en terminant par la dernière page qui comporte une telle empreinte.

Un des symboles suivants apparaîtra sur la dernière image de chaque microfiche, selon le cas: le symbole \rightarrow signifie "A SUIVRE", le symbole ∇ signifie "FIN".

Les cartes, planches, tableaux, etc., peuvent être filmés à des taux de réduction différents. Lorsque le document est trop grand pour être reproduit en un seul cliché, il est filmé à partir de l'angle supérieur gauche, de gauche à droite, et de haut en bas, en prenant le nombre d'images nécessaire. Les diagrammes suivants illustrent la méthode.

errata
to

pelure,
n à



32X

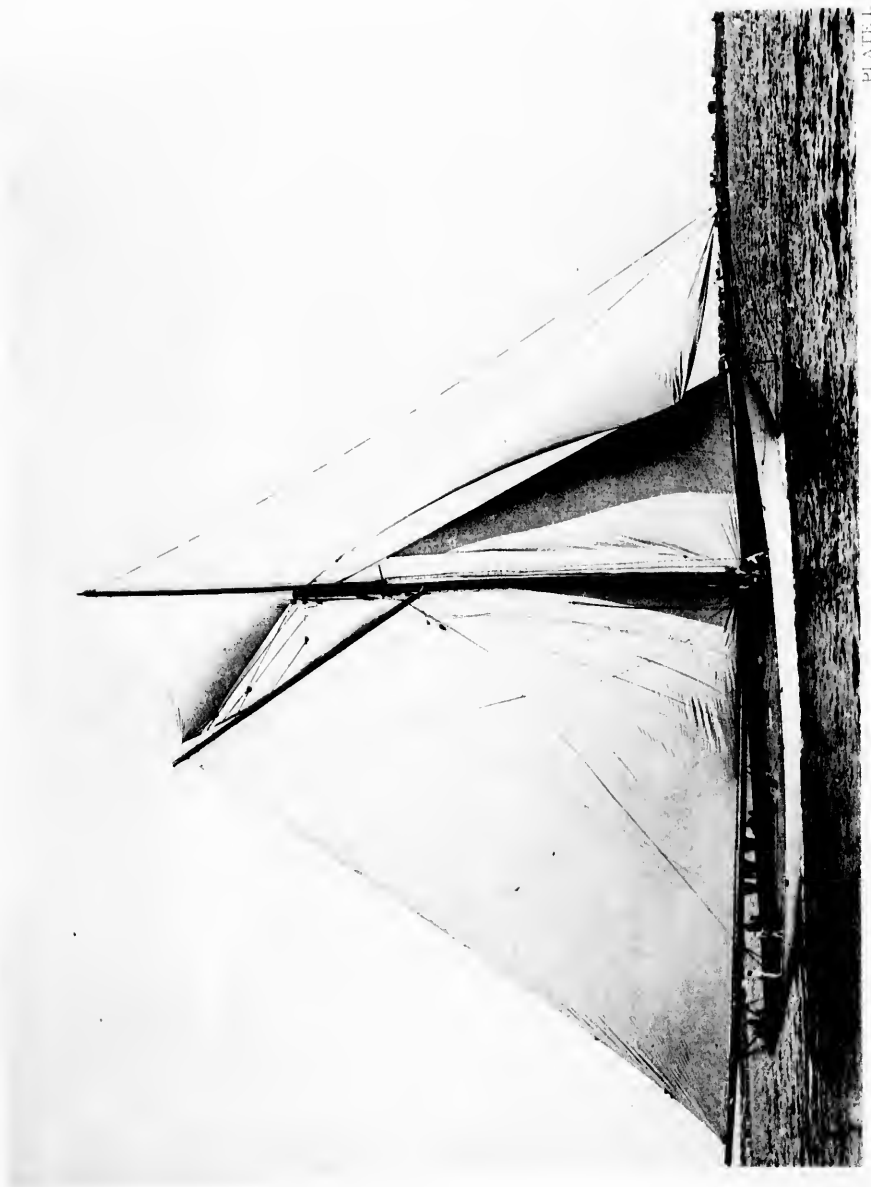

PLATE I

COPYRIGHT BY BOLLES.

VIGILANT.

THE

YACHTS AND
YACHTSMEN OF
AMERICA

A STANDARD WORK OF REFERENCE

CONTAINING THE NAMES OF YACHT CLUBS, AS WELL AS OF THE YACHTS, BOATS,
AND SAILORS OF THE FOUNDERS AND MEMBERS OF THE YACHTING CLUBS
OF THE UNITED STATES AND CANADA.

HENRY A. WATTS, JR., EDITOR, ETC.

COMPANY,

NEW YORK

NEW YORK

VIGILANT.

COPYRIGHT BY BOLLES.

PLATE I.

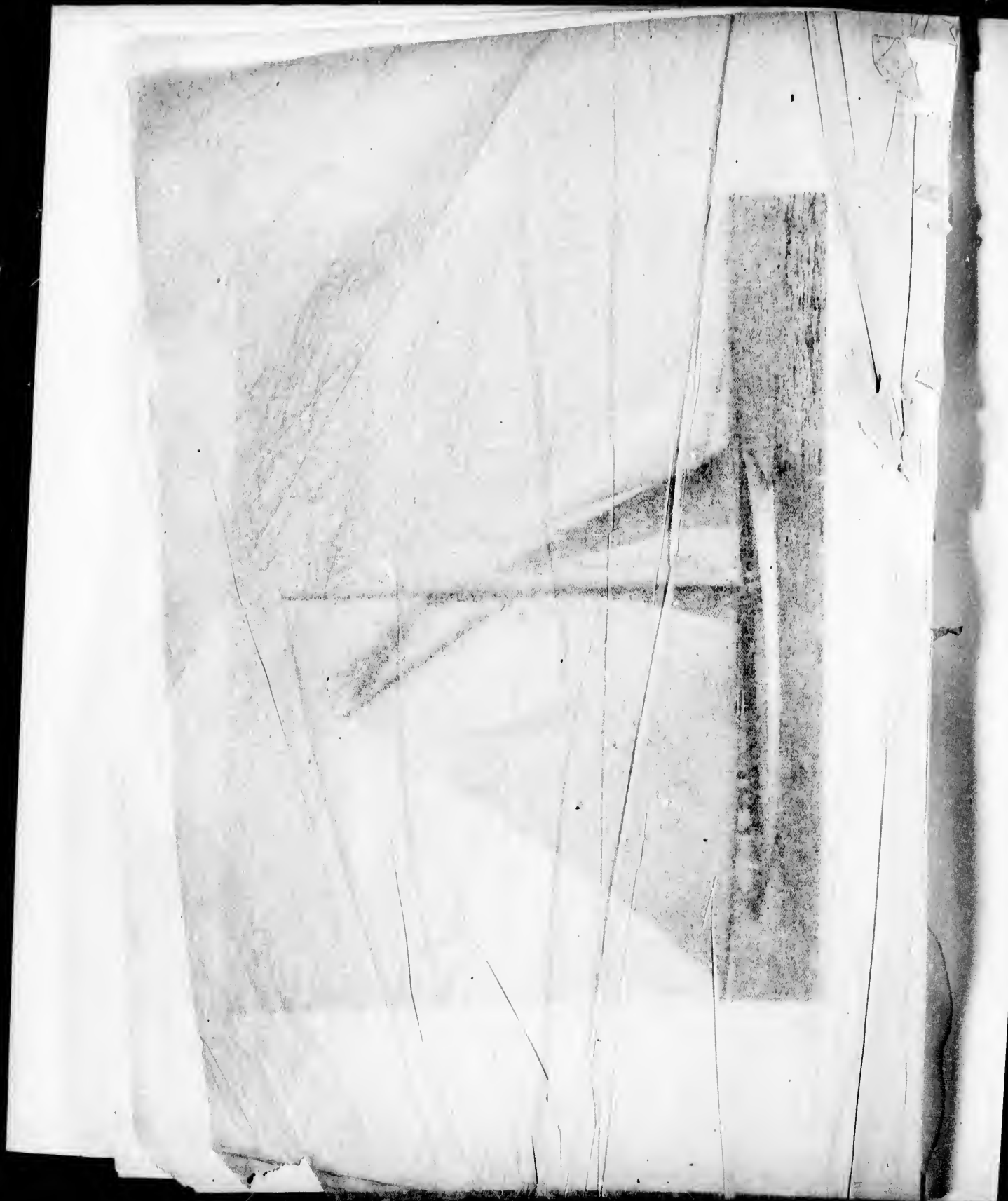

THE
YACHTS AND
YACHTSMEN OF
AMERICA.

A STANDARD WORK OF REFERENCE.

Being a History of Yachting and of Yacht Clubs, as well as of the Various Yachts,
with Biographies of the Founders and Members of the different Clubs
of the United States and Canada.

EDITOR:
HENRY A. MOTT, PH. D., LL. D., ETC.

VOLUME I.

PUBLISHERS:
INTERNATIONAL YACHT PUBLISHING COMPANY,
W. GLENN TAYLOR, President. WM. P. THORP, Sec'y and Treas
OFFICE: 155-157 BROADWAY, NEW YORK.

PRINTING AND BINDING
BY
L. STRATTON & SON,
NEW YORK.

79997

COPYRIGHT, 1904.

BY

THE INTERNATIONAL YACHT PUBLISHING CO.



ETCHINGS
BY
STEVENS & MORRIS,
NEW YORK.

PHOTOTYPES
BY
THE F. GUTEKUNST CO.
PHILADELPHIA, PA.

PAPER FROM
PETER ADAMS CO.
NEW YORK.

PREFACE.

THE International Yacht Publishing Company offers no apology in presenting the first volume of THE YACHTS AND YACHTSMEN OF AMERICA to the public, as up to the present time no one has attempted to produce a work of a like character. The preparation of the work was commenced just two years ago, after the objects had been endorsed by a number of Commodores and yachtsmen of the leading yacht clubs of this country. It was the opinion of yachtsmen that a work which would contain a history of the various yacht clubs of the United States and Canada, as also important facts relative to yachts and yachting, would meet with a hearty reception by all true lovers of sport.

The Editor has endeavored to comply with these conditions and he takes this opportunity to express his appreciation of the efforts made by the Secretaries of the different yacht clubs to assist him in obtaining the necessary facts. The valuable information obtained from "Forest and Stream," the "Field" (of London), "Rudder, Sail and Paddle," the New York daily press, viz.: "Herald," "World," "Sun," "Tribune," "Times," "Recorder," "Press," "Post," "Mail and Express," Boston, Chicago and other papers, the Editor wishes to acknowledge.

Respecting the work itself, it is to be hoped that the leading chapters, relative to the "Evolution of the Yacht," "History of Yachting," "Yachting in the United States," "Type of Yachts," "The Centerboard," "Rig of Yachts," etc., will prove instructive as well as interesting.

In reference to the dimensions of yachts an explanation is due, not so much to yachtsmen as to those who are not familiar with yachts and the rules and regulations of yacht clubs; reference is more particularly made to some apparent contradictions relative to the dimensions of the same yacht in various parts of the work. In other words, it will be found that the dimensions of a given yacht will not be the same in the different tables or in the description of the yacht. The Editor wishes to say that he had to assume that the tables furnished by yacht clubs, in their club books in which the dimensions were given, were correct, and that he feels relieved from responsibility as they have been correctly reproduced. In such cases where the description of a yacht is given the dimensions were obtained directly from the owner and are presumably accurate.

In reference to cutters and sloops, the Editor regrets that it was impossible to designate each yacht correctly in accordance with the theory that the rig of a yacht should determine its appellation, the reason being that the various club books are not as yet based upon this now conceded distinction.

As the large number of yacht clubs in the United States prevents the introduction of their history in one volume, it is the intention of the Company to issue a second volume which will contain, besides leading chapters relative to motor-powers (of every description) as applied to yachts, record of America's Cup, etc., the history, record of races, etc., of such yacht clubs as do not appear in the first volume.

That the present volume has entailed great labor and a large expenditure of money in its preparation will be apparent after a careful examination, and for this reason, if the work is found to fulfill the objects contemplated, the Company expects that yachtsmen will recommend THE YACHTS AND YACHTSMEN OF AMERICA to all who are interested in the sport, and thus increase its circulation.

EDITOR.

New York, March 13th, 1894.

TABLE OF CONTENTS.

	PAGE
EVOLUTION OF THE YACHT.	5
HISTORY OF YACHTING.	45
YACHTING IN THE UNITED STATES.	57
SPEED RECORDS OF SAILING YACHTS.	77
TYPE OF YACHTS.	87
CENTERBOARD.	101
THE RIG OF YACHTS.	109
COST OF YACHTING AND YACHT DECORATIONS.	125
TROPHIES.	129
HISTORY OF THE NEW YORK YACHT CLUB.	163
HISTORY OF THE ROYAL CANADIAN YACHT CLUB.	221
HISTORY OF THE EASTERN YACHT CLUB.	233
HISTORY OF THE ROYAL HAMILTON YACHT CLUB.	259
HISTORY OF THE LARCHMONT YACHT CLUB.	267
HISTORY OF THE ST. LAWRENCE YACHT CLUB.	307
HISTORY OF THE HULL YACHT CLUB.	323
HISTORY OF THE ROYAL NOVA SCOTIA YACHT SQUADRON.	355
HISTORY OF THE ATLANTIC YACHT CLUB.	367
HISTORY OF THE MIRAMICHI YACHT CLUB.	395
HISTORY OF THE BROOKLYN YACHT CLUB.	403
HISTORY OF THE CLEVELAND YACHT CLUB.	415
HISTORY OF THE SOUTHERN YACHT CLUB.	423
HISTORY OF THE OSWEGO YACHT CLUB.	433
HISTORY OF THE NEW HAVEN YACHT CLUB.	443
HISTORY OF THE MINNETONKA YACHT CLUB.	451
HISTORY OF THE CORINTHIAN (New York) YACHT CLUB.	467
HISTORY OF THE CORINTHIAN (Marblehead) YACHT CLUB.	477
HISTORY OF THE CAROLINA (South) YACHT CLUB.	499
HISTORY OF THE AMERICAN (Rye) YACHT CLUB.	505
HISTORY OF THE AMERICAN (Newburyport) YACHT CLUB.	513
HISTORY OF THE STAMFORD YACHT CLUB.	519
HISTORY OF THE BUFFALO YACHT CLUB.	523
HISTORY OF THE SAN FRANCISCO YACHT CLUB.	535
HISTORY OF THE CORINTHIAN (California) YACHT CLUB.	541
HISTORY OF THE RIVERTON YACHT CLUB.	545
HISTORY OF THE ROCHESTER YACHT CLUB.	549
HISTORY OF THE DETROIT YACHT CLUB.	563
HISTORY OF THE ST. AUGUSTINE YACHT CLUB.	571
HISTORY OF THE CORINTHIAN (Philadelphia) YACHT CLUB.	575
HISTORY OF THE BALTIMORE YACHT CLUB.	585
HISTORY OF THE CANASIE YACHT CLUB.	591
HISTORY OF THE LAKE YACHT RACING ASSOCIATION.	599
HISTORY OF THE PORTLAND YACHT CLUB.	607
HISTORY OF THE OHIO YACHT CLUB.	613
HISTORY OF THE RIVERSIDE YACHT CLUB.	617
HISTORY OF THE BOSTON YACHT CLUB.	627
HISTORY OF THE HOUSE SHOES HARBOR CLUB.	635
HISTORY OF THE ISLAND AMERICAN YACHT CLUB.	645
HISTORY OF THE MICHIGAN YACHT CLUB.	647
HISTORY OF THE DELAWARE LAKE YACHT CLUB.	653
HISTORY OF THE FOX LAKE YACHT CLUB.	657
HISTORY OF THE OCONOMOWOC YACHT CLUB.	661
HISTORY OF THE LINCOLN PARK YACHT CLUB.	665
HISTORY OF THE HEMPSTEAD HARBOUR YACHT CLUB.	671
YACHTS NOT ENROLLED IN ANY REGISTERED YACHT CLUB.	677

NOTE.—INDEX FOLLOWS PAGE 679.

PHOTOGRAVURES.

YACHTS.

PAGE		PLATE	FACING PAGE
5			
45			
57	ADMIRAL, (screw schooner)	XXI.	245
77	ADRIENNE, (centerboard schooner)	LXXXI.	431
87	AILEEN, (cutter)	XL	347
101	ALCEA, (keel schooner)	XIX.	237
109	ALPHA, (centerboard jib and mainsail)	LXV.	554
135	ARETHUSA, (centerboard schooner)	LXXI.	610
139	ARIEL, (centerboard schooner)	XI.	191
163	AVENEL, (screw schooner)	LXXIX.	643
221	AZTEC, (screw schooner)	XXXII.	311
233	BALLYMENA, (screw schooner)	LXXXIII.	666
259	BARBARA, (keel cutter)	XXIV.	263
267	CABIN OF MAGIC,	III.	125
307	CLARA, (keel cutter)	XLVI.	379
323	CLERMONT, (side-wheel schooner)	XXXVI.	331
355	COMET, (centerboard schooner)	LVIII.	493
367	COMMODORE, (centerboard jib and mainsail)	LXIV.	547
395	CONQUEHOE, (screw schooner)	XXXVIII.	339
401	CORSAIR, (screw schooner)	IX.	159
415	CREW OF DAUNTLESS,	V.	128
423	CREW OF VIGILANT, (half tone)	VI.	127
433	CRUSADER, (centerboard schooner)	XXVII.	283
443	DAUNTLESS, (keel schooner)	LIV.	447
451	DARE, (centerboard sloop)	LXXXVII.	637
467	DISH, (keel cutter)	LIII.	437
477	DRESILLA, (lu keel cutter)	VIII.	173
499	EL CHICO, (keel jib and mainsail)	XXXI.	305
505	ELECTRA, (screw schooner)	XII.	197
513	ELSIEMARIE, (schooner)	X.	185
519	EMMA, (screw schooner)	XXVIII.	287
529	EMPEROR TROJAN, THREME, (etching)	II.	14
535	ESPIRITO, (centerboard cutter)	XIII.	203
541	FENELLA, (keel schooner)	LXXXIV.	561
545	FORTUNA, (keel schooner)	XLIX.	399
549	GLOBIANA, (keel cutter)	LXXII.	616
563	GOLDEN ROD, (screw schooner)	LXXX.	649
571	GRACE, (screw schooner)	LXXXVI.	654
575	GRAYLING, (keel schooner)	XXV.	271
585	HARPOON, (centerboard cutter)	L.	407
591	LASCA, (centerboard schooner)	XVI.	217
599	LINTA, (screw schooner)	LXXVII.	581
607	LOYAL, (centerboard schooner)	LIX.	503
613	MAGIC, (centerboard schooner)	LV.	459
617	MARGUERITE, (centerboard schooner)	XXXV.	327
627	MAY, (screw schooner)	VII.	165
635	MAYFLOWER, (centerboard schooner)	XLI.	353
645	MEHLE, (centerboard cutter)	LXXXII.	660
647	MEHLS, (centerboard schooner)	XLV.	375
653	MINEOLA, (keel cutter)	LXXVIII.	589
657	MONHEGAN, (keel schooner)	XXX.	297
661	NAIAD, (screw steamer)	LI.	419
665	NANCY, (cutter)	LII.	427
671	NIRVANA, (keel schooner)	LXVI.	565
677	NOURMAHAL, (screw bark)	XIV.	207

PHOTOGRAVURES.—Continued.

YACHTS.

	PLATE	FACING PAGE
	LXXXVIII.	677
	XLVIII.	387
	XLIII.	361
	XXXIX.	343
	XXII.	251
	LXII.	535
	LXIII.	541
	XXXVII.	335
	LX.	527
	XX.	213
	LXXIII.	621
	LXIX.	597
	LVI.	471
	XVIII.	231
	XLII.	357
	LXXVII.	610
	XC.	616
	LXX.	605
	IV.	127
	XXXIII.	315
	LXXVIII.	637
	XX.	241
	LXXXV.	675
	XLVII.	383
	XXIII.	257
	LXXXIX.	678
	XVII.	225
	XXXIV.	319
	I.	Title Page
	XXIX.	291
	XXVI.	277
	LVII.	485
	XLIV.	365
		371

CLUB HOUSES.

	FACING PAGE.	FACING PAGE.
AMERICAN YACHT CLUB HOUSE. (Rye).	505	LARCHMONT YACHT CLUB HOUSE. 267
ATLANTIC YACHT CLUB HOUSE.	367	MICHIGAN YACHT CLUB HOUSE. 647
CORINTHIAN YACHT CLUB HOUSE. (Marblehead).	377	NEW HAVEN YACHT CLUB HOUSE. 443
CORINTHIAN YACHT CLUB HOUSE. (Philadelphia).	575	RIVERSIDE YACHT CLUB HOUSE. 617
EASTERN YACHT CLUB HOUSE.	233	ROYAL CANADIAN YACHT CLUB HOUSE. 221
HULL YACHT CLUB HOUSE.	323	ROYAL HAMILTON YACHT CLUB HOUSE. 359
		STAMFORD YACHT CLUB HOUSE. 519

CING PAGE.

677
387
301
343
251
535
541
335
327
213
621
597
471
231
357
630
616
605
127
315
637
241
675
383
257
678
225
319
Title Page
291
277
485
365
371

FACING PAGE.

E. 267
647
SE. 443
617
HOUSE. 321
HOUSE. 250

THE
in
e
l

The or
man by v
may seen
onds may

The ne
of logs, t
are lusher
and mild
longest at
white, th
ing the
tary for
which, in
a rift ul
a catanu
forms a
M a d r a
through
islands.

The r
the coun
sometim
length
broad; t
of very
and a
navigate
as to be
centre
down fo
twee n

Where p
transport
vated p
structed
upright
these r
covered
as f e n
formi
deck; v
comple

In H
raft wit
exceedi
scribed

Fig.
the Pas
attache
so that
To cou

EVOLUTION OF THE YACHT.

THE progressive steps in the evolution of the magnificent floating palaces which ornament the waters, although to some extent defined, still interblend or link one into the other similarly to the links of a chain.

The ordinary log was undoubtedly the first means suggested to man by which he intrusted himself to the water and, curious as it may seem, even at the present time the log simply pointed at the ends may be found in use on the northwest coast of Australia.

The next step in advance resulted from lashing together a number of logs, thus constructing a raft. In New Guinea three great logs are lashed together with ratan at or near the ends, near the centre, and midway between the centre and the ends. The central log is the longest and projects at each end, being carved and painted red and white, thus constructing the most elementary form of vessel which, in fact, is but a raft although called a catamaran. Similar forms appear on the Madras coast and throughout the Asiatic islands.

The rafts in use on the coast of Peru are sometimes 70 feet in length and 20 feet broad; they are made of very buoyant wood and are frequently navigated by sails so as to be able to tack, centreboards being let down fore or aft between the timbers. Where goods are to be transported an elevated platform is constructed by means of upright timbers and these are frequently covered over as well as fenced in, thus forming a covered

deck; without such elevated platform the sea would naturally wash completely over the raft.

In Homer's *Odyssey* we find that Ulysses was instructed to make a raft with a raised platform upon it and select trees "withered of old, exceeding dry, that might float lightly for him." The above described raft may have been similar to the raft of Ulysses.

Fig. 3 represents a raft rigged with a fishing apparatus used in the Passat river.* The raft is formed of bamboos arranged lengthwise, attached to others placed across and further apart from one another, so that there are five or six longitudinal layers on top of one another. To counterbalance the weight of the fishing apparatus, which is op-

erated only at one end, more bamboos are placed across on this end and at the other end a cabin of cane covered with thatch is placed. The rectangular net of the Salambas is supported by two long bamboos solidly bound to others which hold them in position; the first are connected in the form of a cross with ratan, and this point of junction is suspended at the end of two pieces of wood united as if for a crane. The latter rests in mortises upon a round piece serving as a hinge, placed horizontally between cleats at the end of the raft, which carries also, towards the stern, a perpendicular boom bound by ratans to the top of the crane, so that by bearing down on the end of the boom the whole arrangement is made to rise up and the net comes out of the water, its corners being attached to the boat itself. Then by raising the nearest part with ropes, only sufficient of the net re-

mains in the water to form a sack from which the fish can be taken by a small net. To regulate the working of the swing, stones are suspended to the rear boom, the length of the ropes being so arranged that they lie one after another upon the raft, and thus the stones lose their action in proportion as the net offers less resistance in rising up. These weights are so well proportioned that a child can easily manage the apparatus.

The fishermen who live on the raft move from one place to another by pushing from the bottom on the shoals; they consequently catch only small fish, as they keep near land. The raft is about 30 feet

long by 10 feet wide, and the net is 50 to 55 feet by 25 to 30 feet on a side. The corners of the net are kept apart by bamboos arranged in the bow. Similar contrivances are used in India, and particularly in Cochin.

The next step in advance was probably a canoe constructed by hollowing out the trunk of a tree. This was accomplished by burning out the centre of a log or by the use of such primitive flint tools as were used by savage races. This step showed great progress, as the simple log and raft depended upon the mere buoyancy of the solid material out of which they were constructed, and it may not be out of place to briefly touch upon the subject of buoyancy, which should be well understood.



FIGURE 1.

* See "Essai sur la Construction Navale," M. Paris, p. 66.

EVOLUTION OF THE YACHT.

It is a well-established fact that water presses equally in all directions. The resistance offered by water when we attempt to sink a body lighter than water in that liquid proves that the water presses with a force upward as well as downward. A piece of iron weighing, say one ton, sinks instantly in water, because the latter lacks sufficient resistance; it loses, however, about one-eighth of its weight and if



FIGURE 2.

it is hammered into the shape of a vessel of such form that it will occupy about eight times as much space as before, it will then weigh less than an equal bulk of water and will consequently float, sinking just to the brim. If hammered twice as large it will displace one ton of water, consequently twice its own weight, and will then sink to the middle and can be loaded with half a ton weight before sinking entirely. It follows that if the bulk or volume of any body is lighter than an equal bulk of water it will float; if heavier, it will sink. The buoyancy of a hollow solid, whether of wood, iron, aluminum or other materials, is therefore used for the construction of vessels and for supporting heavy weights on water.

Just what suggested the idea of hollowing out the trunks of trees is naturally a subject of speculation; one thing is certain, that such practice can be traced to the very earliest stages in the history of man.

It has been suggested that shells floating on the surface of the water, or split reeds, or perhaps the Nautilus, first induced man to hollow out the trunk of a tree; however this may be, trunks of trees were hollowed out by fire and by such primitive tools as were used by the savage races with skill and dexterity, and thus was produced the first canoe which depended upon something else other than the mere buoyancy of its material for supporting a load.

Among the ancient Swiss lake dwellings dug-out canoes of a single tree have been discovered, associated with objects of the stone age, and also in the bogs of Ireland and in the estuaries of England and Scotland. We are told by Rev. Dr. Edmund Warre, that several "dug-outs" have been obtained from the depth of twenty-five feet below the soil in Ireland.

When Columbus landed on his fourth voyage on one of the Guanaja islands he received certain visitors who arrived in a large canoe used for trading purposes, which was loaded with freight. The canoe was formed

out of the trunk of a single tree and was eight feet in width. It was occupied by the wives and children of the Cacique, the cabin being enclosed by an awning. It was thought to have come from Yucatan, about forty miles away, being propelled by twenty-five rowers.

Boats of this description possessed sea-going qualities and endurance which seem almost incredible. The South Sea Islanders and the inhabitants of the northwest coast of America often make voyages of one hundred miles or even more in extremely rough weather in these crude canoes. In many instances the South Sea Island canoes have been blown off the coast and drifted for hundreds of leagues without being swamped.

The following illustration, Fig. 5, represents a large dug-out or war canoe, about the size of the one seen by Columbus. It was secured by G. Swan and exhibited at the Centennial Exhibition and it is now deposited in the National Museum at Washington, D. C.

This canoe is made from a single log of yellow cedar (*Thuja Gigantea*); its length is 59 feet; beam 8 feet; height stern, 5 feet 3 inches; stern 7 feet 3 inches; amidships 3 feet, 7 inches. It is of the so-called Chinook model, and, according to Swan, was made for Moquilla, a Nootnan chief and grandson of the Moquilla mentioned by Mears. Vancouver and others; it was given by him to a Nimpkish chief residing at Alert bay near Fort Rupert, on the northeastern coast of Vancouver Island. It was shaped and hollowed out with axes and rude implements made by the Indians, the requisite flare or beam being secured by filling the canoe with water which was heated by means of red-hot stones and a slow fire made on the outside by rows of bark laid on the ground a short distance off, but near enough to warm the cedar without burning it; this rendered the wood flexible, and stretchers similar to a boat's thwarts increased the width from 8 to 12 inches. J. W. Collins, the Honorable Curator of the National Museum, states

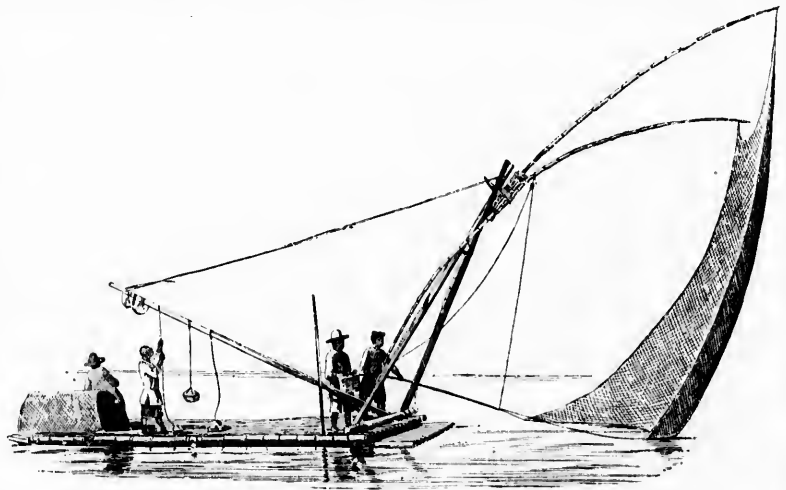

FIGURE 3.

that "this canoe is sharp forward and aft and has long, finely shaped lines and round floor, moderately flaring sides, the gunwale being curved so as to curve outward. It is quite straight on top, except on the extreme bow which curves abruptly upward. The outwater curves forward and terminates in a long projecting snout which is a marked characteristic of the canoes of the northwest coast. The stern is

nearly rising peculiar trans-produce in which combi-ity, this e green. The ing of Mr. S these New Y clippe- Dug Indian peculiar of the canoe sharp round so as The rake, stern very fishin forward differ canoe bee-li cessiv treuc like e be. pose tual sions

bet in width. It was
que, the cabin being
come from Yucatan,
ly-five rowers.

qualities and endur-
th Sea Islanders and
st coast of America
ndred miles or even
ther in these crude
e South Sea Island
coast and drifted for
ng swamped.

Fig. 5. represents a
at the size of the one
secured by G. Swan
rial Exhibition and
National Museum at

single log of yellow
ngth is 59 feet; beam
ches; stern 7 feet 3
ches. It is of the
according to Swan,
an chief and grand-
by Meers, Vancouver
ish chief residing at
stern coast of Van-
with axes and rade
flare or beam being
was heated by means
side by rows of bark
r enough to warm the
flexible, and stretch-
a from 8 to 12 inches.
National Museum, states



s long, finely shaped
the gunwale being
lit on top, except on
The outwater curves
at which is a marked
coast. The stern is

nearly vertical and is surmounted by a curved knob-like projection rising about a foot above the gunwale. The lines of this canoe, particularly at the bow, have a striking resemblance to those of the trans-Atlantic steamer CITY OF NEW YORK. One looking at this product of the savage art cannot fail to be struck with the manner in which the Indian has solved the problem of least resistance, and combined that with the necessary buoyancy and stability. For nearly a quarter of its length at each end this canoe is painted with totems in blue, white, green, black and red."

The largest of these canoes are capable of carrying one hundred persons with all their equipments. Mr. Swan states that "it is said from the model of these chinook-shaped canoes brought to Boston and New York by early fur-traders, the idea of our modern clipper ships was first obtained."

Dug-out canoes are extensively used by the Makah Indians and are distinctive in type, possessing certain peculiarities of form. J. W. Collins, in the Bulletin of the United States Fish Commission, describes a canoe from Neah Bay, Washington, as follows: "It is sharp at both ends with long easy lines, a rather flat rounded bottom, flaring sides, the latter being curved so as to curve outward somewhat at the gunwale. The stern is vertically straight and has little if any rake. The bow or outwater (or what would be the stern of an ordinary boat) is curved strongly, and very much resembles in shape the stern of a clipper fishing schooner. The upper part projects sharply forward and terminates in a long pointed beak, which differs radically in shape from the bow of a Sitkan canoe. It has little sheer except at the ends. The bee-like bow raises with a pronounced but not excessive curve upward, while there is a quick upward turn at the extreme stern which cannot be termed sheer, but forms a sort of knob-like elevation where in a common boat the top of the stern-post would be. Elliot thinks that these projections are only for the single purpose of ornamentation, and this seems probable where there is no actual addition to the sheer of the canoe. The following are the dimensions of this canoe:

Length over all.	15 feet 5½ inches.
Beam extreme.	3 feet 0 inches.
Depth amidships.	1 foot 2 inches.
Height amidships, gunwale to bottom of floor.	1 foot 3 inches.
Height of stern.	2 feet 0 inches.
Highest point of bow.	2 feet 9 inches.
Thickness of gunwale.	0 feet 1 inch.
Length of paddles, each.	4 feet 8 inches.
Width of paddle blade.	0 feet 7 inches.

The Clioqnot and Nittinat tribes or clans on Vancouver Island are

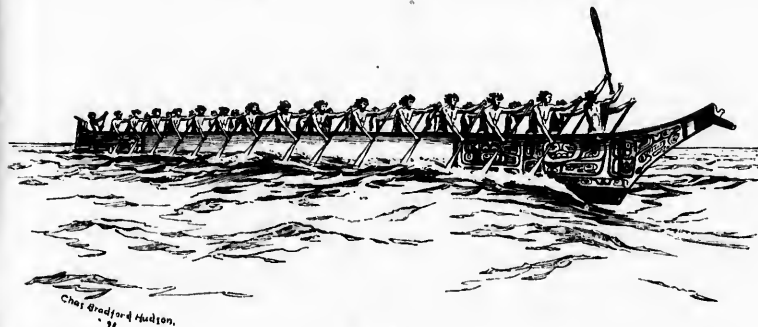

FIGURE 5.

expert in constructing canoes made on the same model as those used by the Makahs.

All the tribes or clans in the Sitkan Archipelago use dug-out canoes, the sizes of which vary from ten or twelve feet to upward of thirty feet in length. The special feature that characterizes the canoe of the Sitkan region are easily recognizable, although, perhaps



FIGURE 4.

not entirely confined to boats of this locality. Its chief peculiarity is in the bold upward curve of the ends, and particularly in the remarkable overhang at the bow. Indeed, the average white man, unless informed on the subject, would think that the bow was the stern and the stern the bow. Both ends are sharp, and often the canoes have long, graceful, easy lines—sometimes made on the 'wave system'—and are, therefore, well adapted for speed."

Fig. 6 illustrates an Alaskan dug-out canoe.

The minimum measurement for dug-out canoes in Alaska is as follows:

Length (extreme),	8 feet 10 inches.	Depth amidships,	1 foot 7½ inches.
Beam,	2 feet 2½ inches.	Height at stern,	1 foot 10 inches.

These canoes are most commonly propelled with paddles, with lanceolate-shaped blades and are often highly ornamented. Sometimes a small sail is used, and running with a free wind they will make good speed, but having no keel, they cannot, of course, make much progress windward. They set lightly on the water, moving easily, and the natives paddle them with considerable rapidity.

The New Zealanders also build canoes out of the trunks of trees (see Fig. 7), some being forty or fifty feet in length and about three feet beam; these are called *kaupapas*, others are called *tirani*, which sit so low in the water that they appear to have no gunwale; fern leaves are laid at the bottom of the canoes on which the passengers recline. "The vessels, however," says the Rev. J. G. Wood, in his work on Natural History, "of which the Maoris are most fond and on which they expend the most

labor, are the large canoes in which the warriors embark when on a campaign. These canoes are made from the cowrie pine, and the tree being a very large one the natives are able to make their canoes of considerable size. Some of these canoes are upwards of eighty feet in length, and consequently are able to carry a



FIGURE 6.

great number of warriors. They are built in a rather elaborate manner. First, the trough-like vessel is formed from the tree-trunk, and if it were left in that state it would simply be a large *kaupapa*. As, however, it is intended for sea voyages and may have to endure rough weather, it is much wider in proportion than the boat which is only used on rivers and is, moreover, rendered more seaworthy by gunwales. These are made separately and are lashed firmly to the sides of the boat by the ordinary flax ropes.

Both the head and stern of the canoe are decorated with carvings.

They are pierced with the most elaborate patterns, which have as their basis the contour of the human countenance and the semi-spiral curve. Perhaps a single canoe-head will have fifty or sixty human faces on it, each with the tongue protruded, with the cheeks and forehead covered with tattooed lines, and with a pair of goggle eyes made of the *haliotis* shell.

Besides carving the canoes, the Maori paints them with vermilion in token of their warlike object and decorates them profusely with bunches of feathers and dog's hair, just like the tufts which are attached to the patu.

These boats are furnished with a very remarkable sail made of the *raupo* rush. It is small in proportion to the size of the vessel, is triangular in shape, and is so arranged that it can be raised or lowered in a moment. Sometimes from fifty to sixty men paddle in one of these canoes, singing songs in time with the stroke, being guided both in time and stroke by a conductor who stands in the middle of the canoe.* The canoes are named *MARATUAI*, *i. e.* Devouring Fire; there are also *INVINCIBLES*, *TERIBLES*, *THUNDERERS* and the like.

On the eastern side of the Bay of Bengal, which is inhabited by the Burmese, there are no very good mariners and their vessels are nothing more than river boats. Their war boats, the largest of which are from 80 to 100 feet in length and 8 feet wide, are also made out of the trunk of a tree hollowed out by fire and cutting. They carry from fifty to sixty rowers using short oars on a pivot. A cannon is put in the prow. The sailors have swords and lances near them when they row and in addition to the crew there are generally thirty soldiers on board with guns. The largest boats do not draw over 3 feet of water. Fig. 8 illustrates one of these war dug-outs.

BARK CANOES.

Whatever suggested the construction of canoes out of the bark of trees, whether the hollowing out of the trees or not, canoes of this character certainly constituted an additional step in advance and were soon followed by the substitution of pliable materials such as skins, hides, etc.

* See Natural History.—Rev. J. G. Ward.

"In Australia, when a native wishes a canoe he chooses a stringy bark tree, the lines of which are straight and not gnarled," says Dr. Wood; "he then chops a circle around the tree so as to sever the bark and about seven or eight feet higher he chops a second circle. His next proceeding is to make a longitudinal cut down one side of the tree and a corresponding one on the other side. He then inserts the handle of his tomahawk, his digging stick or any such implement between the bark and the wood and, by judicious handling, strips off the bark in two semi-cylindrical, trough-like pieces, each of which is capable of being made into a canoe (see Fig. 9). Should he be alone, he seldom troubles himself to do more than tie the bark together at each end of the trough and in this frail vessel he will commit himself to the river. If a second person should be with him he makes the canoe more trustworthy by digging some clay out of the river bank, kneading it into each end of the trough and tying the bark over the clay. The bark is bent like the birch bark of the North American Indians, by moisture and heat, and in this way a canoe is constructed which is more than a mere trough of bark."

Fig. 10 illustrates how some canoes are kept in proper shape by means of cross-pieces of wood and also shows the edges to be strengthened, and, altogether, this canoe shows a great advance in boat building. Another simple form of canoe, drawn from a specimen in the British Museum and illustrated in Fig. 11, is made on a totally different principle from those described;

instead of being a hollow trough of bark, it is a solid bundle of reeds and sticks tied together in a very ingenious manner, giving support to one or more persons according to its size.

The North American Indians construct canoes out of birch bark, both sexes taking part in the work. "The men first select the largest and finest birch trees with the smoothest skins and strip off a large piece of the bark. The women then take charge of the bark, and while it is still fresh and moist clean and scrape it as if it were leather and then sew the pieces together so as to make the cloak of the future canoe. While the women are at work the men are busily preparing the skeleton of the canoe, and this marks another step in advance. The lightness and pliability of the material necessitates some kind of internal frame work, not only to keep the sides apart, but to form a support for the canoe. This is made of white cedar;



FIGURE 7.

and the ribs, being cut and scraped until they are quite thin and light, are held in their places by smaller cross-pieces and a long thin piece of wood which runs round the entire edge of the boat and is, in fact, the chief supporter of the canoe."



FIGURE 8.

This, says Wood, is technically called the "maitre." No nails are

used, t
buss ob
The
brought
grees b
"faux
to prot
sawed
dry, th
the ju

from t
strengt

These
as the
draw t
to the
sit in t
a patte
by fast

The
of the
take ar
Fig.

mon
and s
flesh
credit
their
Some
and 3
the w
mated
Th
in Fi
tende
tiouls

The
and
bers
bulw
doubt
bent

used, the whole of the junctions being effected by means of thongs of buss obtained from the inner bark of the white cedar.

The skeleton being completed, it is laid upon the cloak which is brought over the ribs, closely lashed to the "maitre," and then by degrees brought into proper shape. A strengthening piece called the "faux maitre" is next tied along the whole of the gunwale in order to protect it from injury, and the interior is lined with cedar boards scarcely thicker than pasteboard. When the canoe is finished and dry, the holes through which the lashings have passed, as well as all the junctions of the bark, are carefully stopped with pitch obtained



FIGURE 9.

from the pine or fir tree, and the weaker parts of the bark are also strengthened with a coat of pitch.

These canoes are wonderfully light, can be propelled at high speed as they sit on the surface of the water, and, when empty, scarcely draw two inches of water. The number of paddles varies according to the size of the canoe, but the course is regulated by the two who sit in the stern or bow. Fig. 12 represents a canoe decorated with a pattern and is owned by Rev. J. G. Wood. The decoration is made by fastening dyed porcupine quills on the sides of the vessel.

These quills are never so long or so thick as those of the porcupine of the Old World, and are naturally white or gray so they can easily take any desired dye.

Fig. 13 illustrates the character of the native canoe of the Solo-



FIGURE 10.

mon Islands. The natives of these islands are most bloodthirsty, and so addicted to cannibalism that, as Capt. Cheyne says, human flesh forms their chief article of diet. The Polynesians have the credit of being most expert in handling their frail craft, as proved by their long voyages, and the builders of canoes are held in high respect. Some of their canoes are 50 to 70 feet in length, 2 to 3 feet wide, and 3 to 4 feet in depth. The sterns are frequently 18 inches out of the water. The bow is often curved like the neck of a swan, terminated with a figure of the bird's head.

The typical pirogue of the Bay of Vankora, Santa Cruz, is shown in Fig. 14, and in Fig. 15 a pirogue is shown which is specially intended for fishing, and it is only in the eastern part of Java and particularly at Bezouki that pirogues of this character are met with.



FIGURE 11.

The lower part of their body is a long piece of wood hollowed out and built up by one or two planks which are united by vertical timbers nailed on the inside like ribs. Sometimes they have only small bulwarks joined by inside lashings. As they are very narrow, a double outrigger of bamboo is used, with the forward levers slightly bent towards the sea, formed of two pieces of wood bevelled

and sunk in the bamboo, which is fixed in the deck by two lashings. The rear lever is very much elevated and is seen to be curved. Why it should be elevated is a question to be solved, as the forward one



FIGURE 12.

which is exposed to the waves is never so. On this latter the men place themselves to counterbalance the strain on the sails, although they bear down the bow and, to some extent, prevent the boat from rising up. The sails are arranged for sailing very close to the wind; they have the shape of a long isosceles triangle, the small side of which is half of the others, which are strung on bamboos ending in a fork, which is used for raising the sail until the foot of it can be supported at the bottom of the pirogue.*

The sails are always made of matting, the lust width, however, be-



FIGURE 13.

ing made of cotton of a color which indicates the port to which the boat belongs. The larger pirogues have a ratan cabin, thatched and supported by lathes. These pirogues are met with as far as the Bali Straights. They are always painted white, as well as their outriggers, and are always kept clean. Owing to the lightness of their construction, the average size pirogue may be carried upon cross-pieces of wood. Both paddles and sails are used, and these pirogues are extensively used for fishing on the eastern coast of Java. Another character of pirogue is illustrated in Fig. 16 representing one of the Viti pirogues, which are handled with great dexterity by the



FIGURE 14.

negroes of this Archipelago. These natives have always had the reputation of being cannibals and of a very war-like disposition. Some of those pirogues are very hollow in proportion to their length. The outrigger used is joined to the pirogue by five arms arranged like those of a Tohga Tabou, supporting a platform where four uprights are fastened, carrying a bench under which is an oblique roof. The sails have little surface, the yards not being as long as the hull, which

* See "Essai sur la Construction Navale," M. Paris, p. 80.

makes the short mast tip move. At Lakela, in the eastern part of the Archipelago, as well as at Viti-Leyon towards the west, the same pirogues are used, and they behave very well in a rough sea:

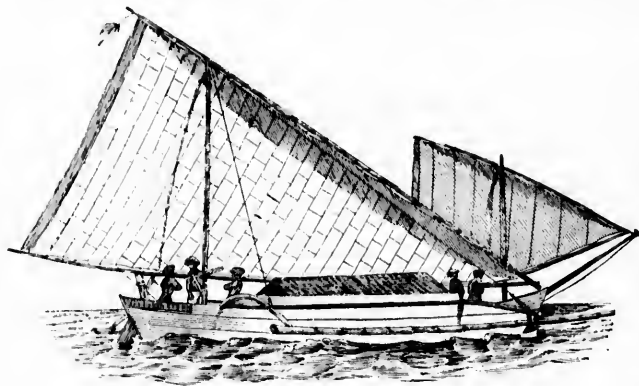

FIGURE 15.

still, from wrenching of their parts they have to be repaired frequently.

Canoes are also made of birch bark, and Fig. 17 shows the use to which such small canoes are put on the Red river of the North, and with what degree of skill they are handled.

The canoes which are used by the North American Indians for racing are also made of birch bark and are almost always of small size. The natives are masters of their fragile craft, they stand erect in it and move about as easily as if on land; in fact, they frequently load a canoe within an inch and a half of the water's edge, and paddle it a whole day without dreaming of danger. They have a curious way of propelling canoes which is often adopted when there is no necessity for speed and the wind is favorable. The man who stands up in the front of the canoe extends a robe or blanket in his two hands, and then presses the other two corners at the bottom of the boat with his feet. The robe becomes an extemporized sail, of which the man is the mast. In this way the canoe is often carried for a considerable distance, to the great relief of the paddlers.

Fig. 18 illustrates a double canoe (or catamaran), used by the Fiji Islanders.

Two boats are placed side by side in such a manner that one of them acts as the outrigger and the other as the canoe. They are covered over, says Wood (who gives the following elaborate description), so as to keep out the water and are connected by a platform which projects over the outer edges of both boats. Hatchways are cut through the platform so as to enable the sailors to pass into the interior of the canoes. In the illustration, a man is seen emerging from the hatch of the outer canoe. Upon this platform is erected a sort of deck-house for the principal persons on board, and on the top of the deck-house is a platform on which stands the captain of the vessel so that he may give orders from this elevated position like the captain of a steamboat on the paddle box or bridge. The mode of managing the vessel is extremely ingenious. The short mast works on a pivot at the foot and can be slacked over to either end of the vessel. When the canoe is about to get under way, the long yard is drawn up to the end of the mast and the latter inclined, so that the mast, the yard and the deck form a triangle.

The halyards are then made fast and act as stays. When the vessel is wanted to go about, the mast is slacked off to the other end so that the stern becomes the bow, the tack and the sheet changing places, and away goes the vessel on the other course. It will be seen that such a canoe sails equally well in either direction, and, therefore, that it can be steered from either end. The rudder is a very large oar some 20 feet in length, of which the blade is 8 feet and is 16 inches wide. The leverage of such an oar is tremendous, and in a stiff gale several men are required to work it. In order to relieve them in some degree rudder bands are used, but even with this assistance the men have great difficulty in keeping the canoe to her course, and are sure to receive some very sharp blows in the side from the handling of the steering oar. Sometimes a sudden gust of wind or a large wave will bring round the rudder with such violence that the handle strikes a man in the side and kills him. With all these drawbacks, canoe-sailing is a favorite occupation with the Fijians, who are as merry as possible while on board, singing songs to encourage the steersman, watching the waves and giving notice of them, and adding to the joyous tumult by beating any drum that they may happen to have on board. Even

when the wind fails and the canoe has to be propelled by poling if she should be in shoal water, or by sculling if she should be too far out to sea for the poles, the crew do their work in gangs which are relieved at regular intervals—those who are resting singing songs to encourage those who are at work. Sculling one of these large canoes is rather heavy work, the great paddles being worked from side to side in perfect unison. As many as eight sculls are sometimes employed at the same time, should the canoe be a large one and the crew particularly numerous. The sculling oars pass through holes in the deck, an equal number being out fore and aft. The mode of building these canoes is so ingenious that a description will be of interest. The



FIGURE 16.

first pro
wood of
fixed, w
part of
tied tog
Along t
which a

so that
exactly

When
edges a
strip of
opened
are call
and ve
The b
through
be see
order
inserte
the m

By
when
his ad
line of
pitch
pletel
size,
inche
The
requi
of we
bands
and
the c
of th
polis
of or
canoe
in pa
On
with
mast
shel
A
of t

to Bancroft, esteemed these skin boats so highly at one time that they adopted them exclusively for navigating the waters. Elliot states, however, that long before the Russians visited Alaska, the Aleuts built and used kaiaks.

Fig. 21 represents a bidarka with single hole. Fig. 22, a bidarka with three holes, which was used on the revenue cutter Corwin

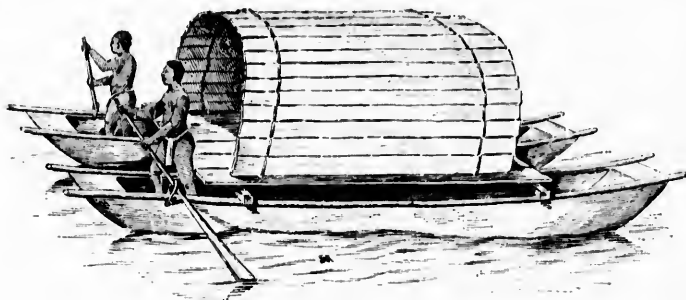

FIGURE 19.

in making Pierce's explorations in Alaska and Behring Sea. Length over all, 24 feet 8 inches. Fig. 23 illustrates an Alaskan kaiak from St. Michael, and Fig. 24 an Alaskan oomiak or bidarrah.

The Aleutian bidarka is propelled wholly by double-bladed paddles, and the lances, harpoons and other implements are held in place underneath strips of seal or walrus hide which extend from side to side over the deck of the boat. The length varies slightly, but the following are about the average dimensions of a two-hole bidarka: Length 17½ feet, beam 2 feet and depth 15 to 16 inches.

"The Kuskokvim and Nuskagak Eskimo," says Capt. Collins, "make boats of the skins of the Mahlklok (*Erignathus barbatus*), of the Neupah (*Phoca vitulina*) and the walrus; while for the same purpose the Eskimo of the Arctic Ocean, Behring Straits, and St. Lawrence Islands use walrus hides and the skins of the ringed seal (*Phoca fetida*)."

According to Turner, the Kadiakers, with the single and double manholes, have not the split which characterizes the double hole bidarkas, but the bow resembles that of the canoes of the Kuskokvim which is distinguished by having a hole in it for the insertion of the hand. On Kadiak the peculiar split bow is found only on the large bidarkas which have three manholes.

The canoes used by the Eskimo men as shown in Fig. 25, are called kajaek, or kia by some, and the form used by the women, which has already been alluded to, is called oomiak. The kajaek is shuttle-shaped, both ends being sharply pointed. "It is made," says Wood, "of a very slight framework of wood and whalebone, over which is stretched a covering of skin. In the middle there is a hole just large enough to admit the body of the rower; when he takes his seat he gathers the skin together and ties it around his waist, so that the boat is absolutely impervious to water. The average length is 25 feet, and so light are the materials of which it is made that a man can carry his kia on his head from the house to the water."

These slight canoes have no keel and sit so lightly on the water that they can be propelled over rather than through it, with wonderful speed. A double paddle held in the middle, is used in a manner which is now rendered familiar to us by the canoes which have so largely taken the place of skiffs. It is between nine and ten feet in length, small in the middle, which serves as a handle, and gradually widening to the blades, which are about 4 inches in width and edged with ivory, not only for ornament but for strength. It is evident that the slight and fragile kia, useful as it is for hunting purposes, cannot be employed for the conveyance of baggage or for the

transport of more persons than one. The oomiak is therefore used, a large, clumsy, straight-sided, square ended, flat-bottomed vessel, more like a skin trough than a canoe. The framework of the oomiak is made of wood and whalebone and the covering of sealskin from which the hair has been removed. When wet, these skins are nearly transparent, so that the forms of the persons sitting in the

boat can be distinctly seen. The sides of the boat are about 3 feet in height, and the weight which a well-made oomiak will carry is wonderful. Capt. Lyons mentions that in one of these boats, measuring 25 feet in length by 8 in width and 3 in depth, more than 20 human beings were conveyed. There are two very clumsy paddles by which the boat is slowly propelled and it is steered by another paddle in the stern. The post of the steerer is usually occupied by an old man who is unable any more to manage the kai, but is still capable of guiding the oomiak and of flinging a knife, a harpoon, a seal-hook, or anything that may come to hand at the women if they neglect their paddling. To each oomiak there can be attached a very primitive mast with its sail. The mast is but a short one and is

stepped in the fore-part of the boat. Towards the top it is pierced, and in the hollow is placed a sheave or deeply-grooved wheel of ivory on which the halyards run. The sail is that simplest of all sails, the lug, and is made of the intestines of the walrus split open so as to form strips of some 4 inches in width. These strips are sewn together and form a sail which is remarkable both for its strength and its extreme lightness. Herodotus,* speaking of the circular boats made of skin which traveled down the river Euphrates to Babylon, says "The frames, which are willow, are cut in the country of the Armenians, above Assyria, and on these, which serve for hulls, a covering of skins is stretched outside, and thus the boats are made without either stem or stern, quite round like a shield." The more modern boats of the Euphrates are of closely woven willow payed with bitumen.

In civilized countries, owing to the ease and cheapness of construction, boats are built of boards or planks. Such boats combine great strength, lightness and facility of repair, consequently they are em-

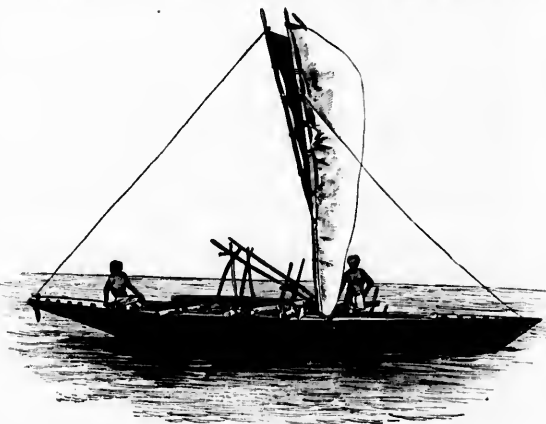

FIGURE 20.

ployed for most purposes. Lately, boats made of corrugated sheet metal have been introduced, but their use must be limited to harbors where establishments exist at which they can be repaired, for a carpenter, with merely the usual means available on ship to make repairs, is not able to do the work. Still such boats combine safety,

*Herodotus I. p. 183.

niak is therefore used, flat-bottomed vessel. The framework of the covering of sealskin when wet, these skins are persons sitting in the sea. The sides of the height, and the weight niak will carry is variations that in one of 5 feet in length by 8 in more than 20 human beings are two very clumsy but is slowly propelled by a paddle in the stern, usually occupied by an man more to manage the of guiding the oomiak harpoon, a seal-hook, to hand at the women ling. To each oomiak very primitive mast with a short one and is at the top it is pierced, and a wheel of ivory on the top of all sails, the lug, it open so as to form are sewn together and length and its extreme or boats made of skin Babylon, says "The of the Armenians, hulls, a covering of made without either o more modern boats o payed with bitumen. cheapness of construction boats combine great frequently they are em-

strength and lightness to a high degree and for life-boats are very useful.

Paper boats are in use, being made by fitting sheets of paper the length of a boat over a model of the form selected; successive sheets breaking joint or laid on with a coat of varnish between each.

The model and paper envelope are then removed to a drying room where they are payed with boiled oil and turpen-



FIGURE 21.



FIGURE 22.



FIGURE 23.



FIGURE 24.

tine and afterwards with shellac varnish. The shell is then fitted with an inner frame, thwarts and the usual appendages.

Fig. 26 is by Hume Nisbet representing a lakotoi or native trading vessel belonging to the village of Kerepunu, New Guinea, and is the kind of vessel employed in voyages along the coast westward to Ports Moresby or Motuniotu.

Kerepunu is some two hundred miles east of Cape York, the most



FIGURE 25.

northerly point of Anstralia. The natives carry on much traffic by their annual coast navigation. In going to sea, two, three or four of the largest canoes are often placed side by side and lashed together with ratans. The largest lashed together in this way are called "lakotoi," the next in size being an "akona," one smaller an "atsi," and the smallest single canoe a "vanaki." The sails are made of the bark of the sago palm hammered into a sort of felt, or sometimes of matting. They are either square and set between two masts or of a picturesque elliptical shape. A lakotoi, being a compound vessel, may display half a dozen square sails. It is steered by oarsmen squatting on platforms which project fore and aft and by other men with oars at the sides.

From a pyramid grave of Sakkara the following illustration, Fig. 27, was obtained, showing the vessels used during the fifth dynasty, 3,000 years before Christ, and establishing the fact that, besides a large number of oarsmen, sails were used at that time.



FIGURE 26.

Still more interesting is the fact that the rudder made its first appearance during the twelfth dynasty in the crude form illustrated in the following Fig. 28. Previous to this time, oarsmen performed the function of steering as shown in Fig. 27.

Ships, distinct from canoes and boats, were built and used by Egyptians fully 3,000 years before Christ; still the more perfect development of the ship and of the art of navigation, we ascertain from the Assyrians, properly belongs to the Phoenicians, who constructed merchant vessels capable of carrying large cargoes, and they probably invented the bireme and trireme by which increased oar-power, and consequently speed, was acquired without materially increasing the length of the vessels. It was from the Greeks that we obtain more detailed information. The Homeric vessels carried from fifty to one hundred and twenty men all of whom used oars except the chiefs. The vessels were not decked all over; the stems and sterns were high and

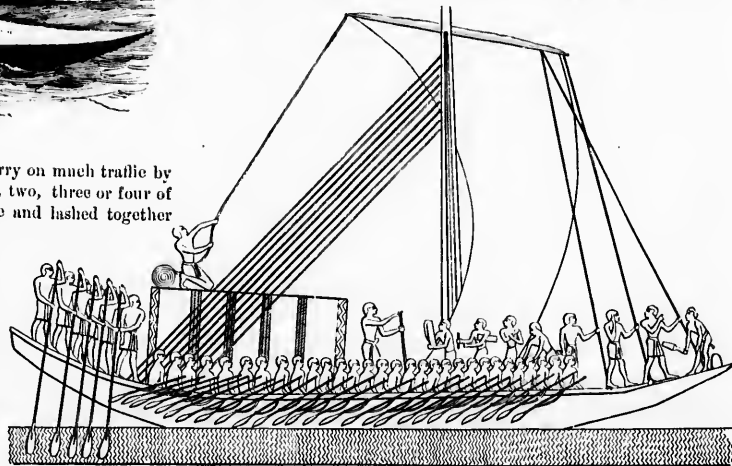

FIGURE 27.

of corrugated sheet limited to harbors repaired, for a cargo ship to make boats combine safety,

upraised, resembling the horns of oxen thus presenting a parallel to the Vikings' vessels of the North Sea.

The trireme was the war ship of Athens during her prime, but soon vessels were constructed having as many as sixteen banks of oars. Some vessels were "aphract" and others "cataphract," meaning "unfenced" and "fenced," referring to bulwarks which covered the upper tier of rowers from attack. The object of arranging the oars in banks, as already stated, was to economize space, obtaining increased oar-power without adding length to the vessel. The thralamite, or oarsman of the highest bank, was nearest the stern of the set

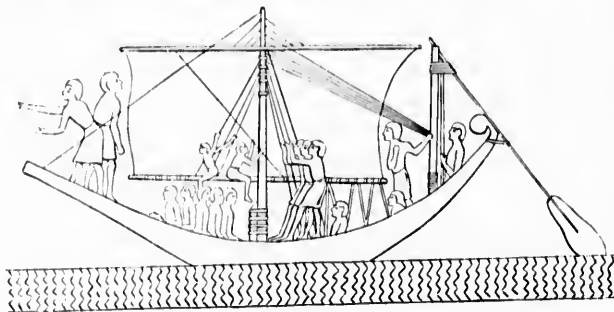

FIGURE 28.

of three to which he belonged. Below him, and next behind sat his zygite or oarsman of the second bank, and next below and behind the zygite sat the thalamite, or oarsman of the lowest bank. The vertical distance between these seats was two feet, the horizontal distance being about one foot.

The Attic tables give the length of the oars of the top bank as 14 feet 3 inches; the next was probably 10½ feet; and the next below about 7½ feet.

The Attic trireme was built light, for speed and for ramming purposes. Dr. Warre says "Her dimensions, so far as we can gather them from scattered notices of antiquity, were probably approximately as follows: length of rowing space (*ἐκώτορ*), 93 feet; bow, 11 feet; stern, 14 feet; total, 118 feet, to which should be added 10 feet for the beak. The breadth at water line is calculated at 14 feet, and above at the broadest part 18 feet, exclusive of the gangways. The space between the diaphragmata was 7 feet; the deck was 11 feet above the water line, and the draft about 8 to 9 feet. All the Attic triremes appear to have been built upon the same model and their gear was interchangeable.

The crew of the Attic triremes consisted of from 200 to 255 men in all. Of these, 174 were rowers, 54 on the lower bank (thalamites), 58 on the middle bank (zygites), and 62 on the upper bank (thralamites); the upper oars being more numerous because of the contraction of the space available for the lower tiers near the bow and stern. Besides the rowers, there were about ten mariners (*ἐπιβαί*) and twenty seamen. The officers were the trierarch, and next to him the helmsman (*καβίρηνος*) who was the navigating officer of the trireme. Each tier of rowers had its captain (*στρατηγός*). There were also the captain of the forecastle (*πρωμηνός*), the 'kelenstes,' who gave the time to the rowers, and the ship's piper (*τρομπανίτης*). The rowers descended into the seven-foot space between the diaphragmata and took their places in regular order, beginning with the thalamites.

The economy of space was such that, Cicero remarks, there was not room for one man more.

The improvement made in the build of their vessels by the Corinthian and Syracusan shipwrights, by which the bows were so much strengthened that they were able to meet the Athenian attack stem on (*προσβολή*), caused a change of tactics and gave an impetus to the building of larger vessels—quadriremes and quinqueremes—in which increased oar-power was available for the propulsion of heavier weights.

Plate II illustrates a trireme accompanied by two biremes, the Emperor Trojan being on the former. The three banks of oars can be plainly seen on the trireme and the two banks on the bireme. On the side of the ship's rostrum is depicted a sea-horse for ornament. The Emperor Trojan stands on the deck. Arrian says: "He ordered that long vessels should be made both aphractes and cataphractes." The fleets were generally composed of these two kinds of vessels. Polybius says: "He prepared twelve cataphractes vessels, eight aphractes or open ones." Pliny says it was the Thasians who invented the long and decked ships. In former times fighting was only done with prow and poop. At the back of the poop on the trireme shown on the plate is the chemise. At the head of the aplustre which projects over the trireme hangs a lantern which was used to give light to the vessel. There is on this trireme a cavalry standard, and in the bireme below there are military ensigns of the legions. On the rostrum of this bireme there is a large eye, in order that the whole rostrum may have the figure of an animal's head. On the upper bireme is seen a sail furled and attached to a long pole to spread whenever it becomes necessary. This bireme has also on the poop a curved goose's head.

VIKING SHIPS.

An illustration of one of the ships built about A. D. 800 is to be found in the VIKING, a ship dug out of the "King's Mound," near the little seaport of Sandfjord, Norway, about twelve years ago. This archaeological discovery is considered of great importance and the ship was purchased by the Archaeological Museum of Norway. The discovery was due to two brother seamen. A chieftain had, in fact, been buried there, and after the custom of the old Norsemen

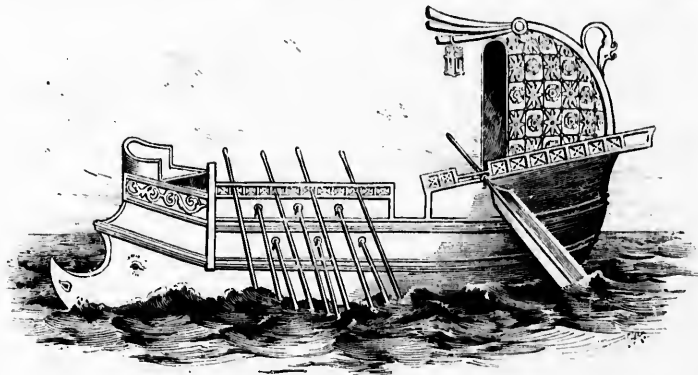

FIGURE 29.

his body was interred in his stanch ship, surrounded by his weapons and earthly goods. It appears, however, that the grave had been opened before, probably by curiosity seekers in by-gone times, and little of interest was found except the ship.

All who have seen the model (Fig. 30) agree that owing to its great

hero was not
by the Cor-
ere so much
attack stem
impetus to
eremes—in
on of heavier

mes, the Em-
aree banks of
and the two
e ship's rose-
The Em-
a says: "He
th aphraetes
ly composed
e says: "He
ht aphraetes
sius who in-
former times
pop. At the
n the plate is
lustre which
a which was
e is on this
ireme below
ns. On the
at the whole
n the upper
le to spread
on the poop

. 800 is to be
found," near
e years ago,
ortance and
of Norway.
tain had, in
ld Norsemen

his weapons
ve had been
e times, and

g to its great

PLATE II.
TRIREME AND BIREMES OF EMPEROR TROJAN.

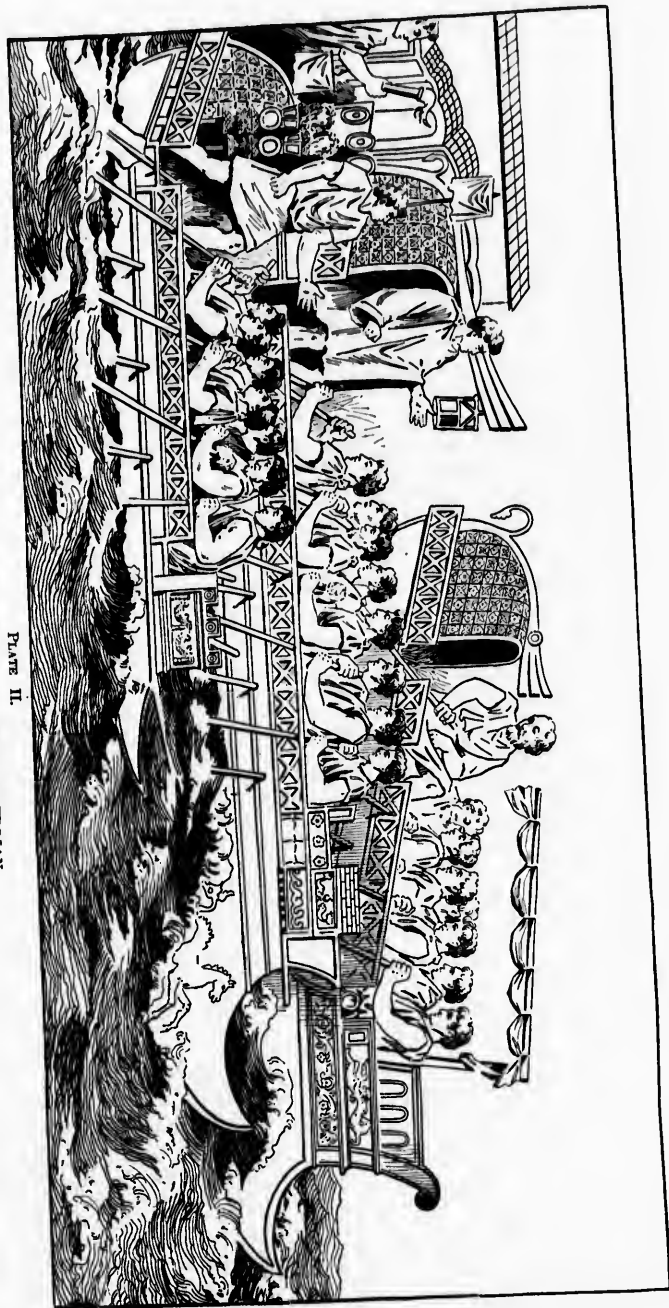

sharpness and fine sheer both fore and aft, it can easily bear comparison with some of the best yacht models of the present day, especially those used on the English coast for sailing in deep water, while the construction of its bottom, which is flattened amidships, gives it more steadiness than an English cutter. It is, in fact, a very singular type, something between the cutter and the centerboard boat. A full description of the VIKING ship of Grogstad has been written by N. Nicolaysen and published in book form.

The VIKING ship, Fig. 31 and 32, is 65½ feet on its keel, 80 feet

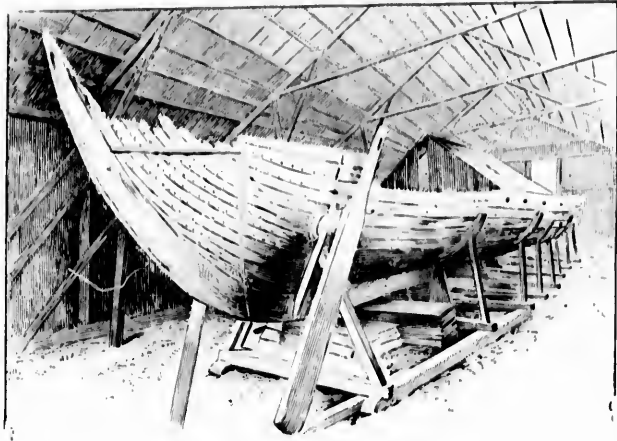

FIGURE 30.

from stem to stern, 17 feet beam, with a depth of hold of about 6 feet to the top rail. When afloat, it probably drew 4 or 5 feet of water and its measurement was somewhere about thirty tons.

It is made entirely of oak, clinker built, each plank overlapping the one below, and is fastened together by large headed bolts, clinched and riveted on the inside. The planks are not bolted to the frame timbers but are fastened to these by ropes of vegetable fibre (withes), which are rove through cleats on the planks and tied around the timbers. The rowlocks, or holes intended for the oars (sixteen on each side) are in the third plank from the top.

The VIKING crossed the Atlantic under full sail, having twelve picked men on board when she set out from Bergen and she sailed with the God-speed of all Norseland. The ship was commanded by Capt. Magnus Andersen, who was born in Larvik in 1857 and became a sailor at the age of fifteen. The first mate was Johan Gustav Gundersen, the oldest man on board, being forty-three years of age. The second mate was Christen Christensen, and he was the one who directed the building of the VIKING and was commander during a dangerous voyage which she made through the ice to Christiansia.

The VIKING was provided floating piers of reindeer skin which were attached to the sides of the ship. The men slept on skins of the reindeer just as the sea dogs of the north did 1,000 years ago.

The rudder is on the starboard side. The radical departure from the primitive ship is the introduction of four water-tight compartments of oak containing the compass, ship's instruments, charts and the crew's baggage. It had one mast amidships and one or possibly two sails. The Norwegian Government built a fac simile of the VIKING, Fig. 32, and exhibited the same at the Columbian Exhibition. The VIKING left Bergen, Norway, and in forty-three days dropped anchor in New London, Conn., June 13, 1893. Although the greater part of the voyage was fair, at times the weather was quite severe. Her average

speed was eight knots, though she often made more. She entered New York harbor June 17th, and left for Chicago on the 26th of June.

Quite interesting are the coasters of the Gulf of Tonquin; they are notable for their sail, which is rounded to the stern. The fore part is an oblique yard and from the bottom of it radiate sticks of wood which are sewed to the sail. This solid and heavy sail works well, keeps almost flat, and its surface is easily diminished by lowering the yard so that the lower sticks fall one upon another. The stern is flat, very narrow, and has a rudder; the bow is very low and slender.

These boats are never painted and their construction is rude.

The advent of the World's Fair to celebrate the discovery of America by Christopher Columbus suggested the importance of reproducing the squadron which was commanded by the illustrious Admiral of Castile when he started in search of the New World. To reproduce the three ships which started from Huelva on the third of August, 1492, it became necessary for elaborate investigation to be made to determine their exact type and maritime value.

It was known that these vessels were called *caracoels*, but investigation clearly showed that this term applied to no particular class of vessel. The Spaniards used the word *carabela*, borrowed from the French language and derived from the Greek word *karati*, to designate ships very unlike one another in construction and size.

According to the *Revue Maritime Autrichienne*, of Pola, the investigations brought together the writings of the Admiral (especially his log book), the sketches made upon his published maps by his pilot, Juan de la Cosa, and ancient publications concerning this subject which enabled Rafael Manleon, the marine painter, to represent them as shown in Fig. 31.

The three ships were named SANTA MARIA, NIÑA and the PINXA. The first of these was of the following dimensions: Length of keel, 62 feet; between perpendiculars, 75 feet; greatest width, 23 feet; depth, 14½ feet; burden, from 120 to 130 tons. As the crew never exceeded ninety men, the ship was capable of carrying quite a large supply of food and water. The Admiral's log mentions that his pinnace was 30 feet in length, but the same document speaks only superficially of the armament. It mentions, for example, that on the 26th of December the Admiral fired *una lombarda y una espingarda*. The latter of these arms is well known, the former was a gun of small calibre that originated in Lombardy.

The suit of sails of SANTA MARIA was that of a small three-

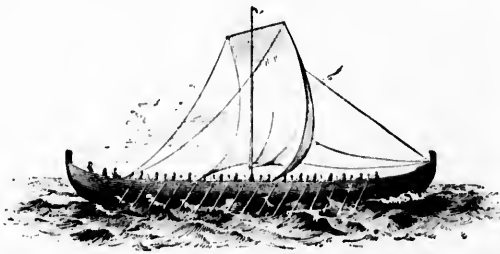

FIGURE 31.

masted vessel with five sails only, a jib, foresail, mainsail, topsail, and a lateen. The mainmast was provided with a top which the sketch represents as round and basket-shaped, and which was capable of affording shelter to firers of grenades. The general form of the

hull was
poop and
and the
aboard, I
sail.

The n
Admiral
and had
two oth
miles an
vessels s
as an ex
journey
by Vinc
Porto S

The d
are not
as muc
celebrat
had a c
85 ton
sembles

ATA.
ried h
her t
least, u
of the

Admir
that us
(the c
set of s
by sq
order
might
same c
other

The
sailing
the fl
the m
of the
mize
divi
square
two w
each
the

These
of C
Arge
by th
havin
Adm
crow
Isab
on th
Span
thos

PI
earv
SAN
the s
was
was
pain
abor
win

She entered New York harbor June 26th of 1492, and was towed by the *Touquin*; they were towed by the foremast. The foremast was made of wood and worked well, but by lowering the mast the stern is low and slender, their construction

to celebrate the voyage of Columbus and the squadron of the Admiral. The search of the three ships which were called *caravel* and that this term was borrowed from the Greek word *karabos* meaning a mother in

Reine d'Autriche, at together the sketches in his log book, and the maps by his contemporaries, but publications of the marine

NINA and the dimensions: Length, 30 feet; greatest width, 10 feet; 100 tons. As the log mentions the carrying capacity of the log mentions the document speaks for example, that *caravel* was a small three-

a small three-

hull was that of the round ships of the period. There was a large poop and a small forecabin. The freeboard was very low amidships, and the deck was open. The pinnace could not be taken aboard, so Mr. Mauleon has represented it in tow of the ship under sail.

The nautical qualities of *SANTA MARIA* were excellent, as the Admiral's log proves: "This ship behaved very well in bad weather, and had the speed of a good sailer." The same was the case with the two other ships, and the log often mentions a speed of 15 Italian miles an hour, equivalent to 11 nautical miles—a very good speed for vessels sailing as consorts. The *Reine d'Autriche* cites, moreover, as an example of the high speed reached by the ships of this epoch, a journey of 600 Italian miles made in 39 hours by a caravel commanded by Vincente Lago, which visited in succession the Canaries, Maleria, Porto Santo and Gambia in 1444.

The dimensions of the two other ships commanded by Columbus are not indicated. The sketches and the picture represent them as much smaller, which is not to be wondered at. *VICENTA*, celebrated for having made the tour of the world for the first time, had a capacity of but 85 tons. *NINA* resembled *SANTA MARIA*. *PINTA* carried lateen sails on her three masts, at least, at the beginning of the voyage, but the Admiral's log tells us that at the first stop (the Canaries) this set of sails was replaced by square ones, in order that this ship might be placed in the same condition as the other two.

These three ships sailing as consorts flew the flag of Castile at the mainmast and that of the Admiral at the mizzen. The first was divided into four squares, two red and two white. The latter each bore a lion and the others a castle. These were the arms of Castile. Those of Aragon were excluded

by the orders of Queen Isabella, the Government of that country having refused to participate in the expenses of the expedition. The Admiral's flag was a white pennant with a green cross between two crowned letters F and I—the initials of the names of Ferdinand and Isabella, who had given these arms to Columbus. A cross was painted on the sails of the ships, according to the custom adopted by the Spanish and Portuguese in order to distinguish their vessels from those of the infidels.

Plate III is a reproduction from photographs by Bolles of the three caravels which were built for exhibition at the World's Fair (1893). *SANTA MARIA* as here illustrated is intended to be an exact copy of the ship in which Columbus sailed to discover a new world. She was built in Cadiz, her keel being laid April 21, 1892. She was launched June 26th. Her hull is exclusively of wood and she is painted olive green, with a dark red stripe. She has a speed of about 6 knots an hour (free), and 8 to 8½ knots an hour with a fair wind. She carried a crew of 52 men, and, in company with *PINTA*

and *NINA*, entered New York harbor April 26, 1893, having arrived at Hampton Roads, April 21st.

SANTA MARIA was towed by *REINA REGENTE*, *PINTA* by *INFANTA ISABEL* and *NINA* by *NEVA ESPANA*. Part of the voyage was quite rough and all were glad when it was over. *SANTA MARIA* sprung a leak during the early part of the trip, but it was speedily caulked.

The water allowance was very scanty, and the rations of the simplest description.

The caravels remained at New York for some time, finally setting out for Chicago and the World's Fair.

The following illustrations are from the maps referred to, published at that epoch, which furnished data of great value in studying the nature of the squadron of Columbus.

Having reviewed the progressive steps from the log up to the three vessels which conducted the Admiral of Castile across the ocean, it will be proper to devote some attention to the vessels of modern times, and then to set forth the various types, including the yachts, which have done so much to advance ship building and naval architecture.

CLIPPER SHIPS.

Not many years ago the American clipper ships, swift as Pegasus, swept the western ocean, and the deeds of the brave men who commanded them are still held up for the emulation of the younger generation of seamen.*

The impetus to the establishment of the great packet service was given in 1816 by the foundation of the famous "Black Ball Line." During these early times twenty-three days was considered rather a quick passage to the eastward, and forty days to the westward. For five years the Black Ball vessels were the only safe and habit-

able ships crossing the Atlantic. In 1821 a second line, known as the "Red Star Line," was founded by Byrnes, Grimble & Co., with such magnificent specimens of naval architecture as *HERCULES*, *PANTHER*, *METEOR* and *MANHATTAN*.

Next came the "Swallow Tail Line" with four vessels, *GEORGE*, *YORK*, *NAPOLEON* and *SILAS RICHARDS*. So that by 1822 there was a weekly packet service between New York and Liverpool. The "Dramatic Line" with such noble ships as *SHAKESPEARE*, *SIDDONS*, *SHERIDAN* and *GARRICK* was next established. *PATRICK HENRY* made more money than any other vessel of like tonnage in the world. The packet ship reached its zenith about 1846, when the *NEW WORLD*, a 1,400 ton ship, was built by Donald McKay of East Boston. At this time passages were occasionally made in fourteen days by *INDEPENDENT*, *MONTEZUMA*, *PATRICK HENRY* and *SOUTHAMPTON*.

RAINBOW, a 750 ton vessel, was the first clipper to win fame for

* See article "Famous American Clipper Ships" published in July, 1892, by the *New York Recorder*.

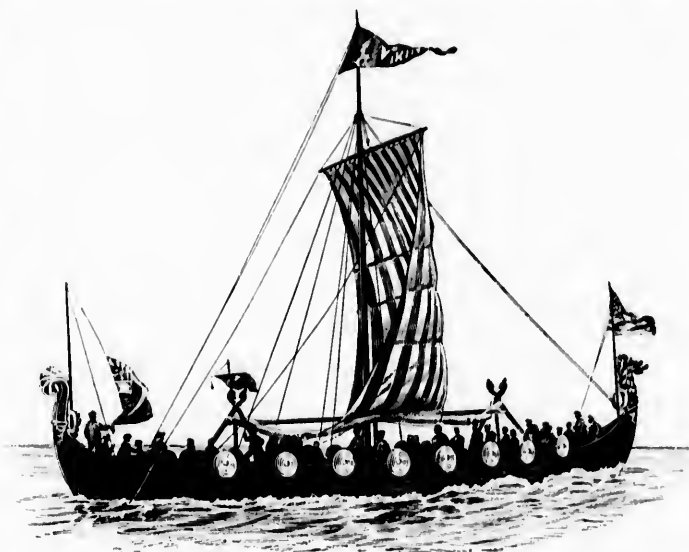

FIGURE 32.—THE VIKING SHIP EXHIBITED AT THE WORLD'S FAIR, 1893.

(From Photo, by Bolles.)

America in the China trade. She was built by Smith & Denion in 1843 for William H. Aspinwall. *HELINA*, *HOUQUA*, *SEA WITCH* and *SAMUEL BISSSELL* were next built, and were the pioneers of the clipper service. Everything was sacrificed to speed, so that a long

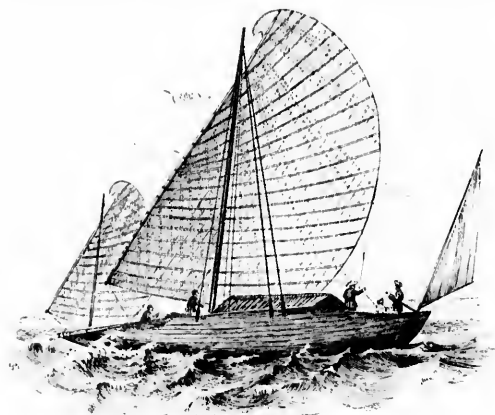

FIGURE 33.

and tedious voyage across the Pacific, with the boisterous winds of the Cape, strained them very seriously. Naturally, the great cost of repairing at each end of the long trip reduced their freight money to almost nothing. This state of affairs brought out a new type of vessel that combined speed, capacity and strength. They were built in 1851 by William H. Webb. The first of these vessels was *CHALLENGER* of 2,000 tons, built for N. L. & G. Griswold, and commanded by Captain Bob Waterman. The others were *INVINCIBLE*, *COMET* and *SWORD FISH*, which sailed from Shanghai to San Francisco in thirty-one days, averaging 249 miles per day. Of these, *COMET* made the round trip to San Francisco in seven months and nine days. Other famous craft in these days were *TORNADO*, *FLYING CLOUD*, *BLACK SQUALL* and *SOVEREIGN OF THE SEAS*. Last, but not least of the famous vessels was the clipper *DREADNAUGHT*, Captain Samuel Samuels. She was built in Newburyport for Gov. E. D. Morgan and is shown in Fig. 40. The *DREADNAUGHT* was launched in June, 1853, and it was an old saying that nothing ever passed the *DREADNAUGHT*, not even a steamer. On her first voyage to the westward this celebrated vessel reached New York as soon as the Cunard steamer *CANADA* reached Boston, the latter leaving Liverpool one day earlier. Again, in 1859 she made a run of 3,000 miles, from Sandy Hook to Rock Light in thirteen days and eight hours, and later in 1860 covered 2,700 miles from Sandy Hook to Queenstown, in the unprecedented time of nine days and seventeen hours.

If the fame of the clipper ships was great, how much greater was

that of the brave seamen who commanded them. Of all American skippers of those days, Captain Samuel Samuels stands pre-eminently alone. Another famous clipper Captain was Edward G. Tinker, Capt. Lancelan McKay, when in command of *SOVEREIGN OF THE SEAS*, distinguished himself by rigging his vessel at sea after she had been dismantled in a gale off Valparaiso. He made a voyage of 10,000 miles in eighty-two days, without tacking or wearing—a passage never equaled.

Again, Lieut. Manry reported to the Secretary of the Navy, that *SOVEREIGN OF THE SEAS* had made the unprecedented run of 6,245 miles in twenty days, an average of 285.9 miles a day; and that the greatest distance traveled from noon to noon was 419 miles—a run which only the swiftest steamers surpass to-day.

LUGGER.

A lugger-rigged vessel is illustrated in Fig. 41. The sails are quadrilateral and are bent upon yards that hang obliquely to the mast, at about one-third of its length.

A lugger usually carries two or three masts and often has a running bowsprit on which two or three jibs are set.

ROANSOKE.

The giantess of wooden sailing craft is the new clipper *ROANSOKE*, built by the well-known firm of Arthur Sewall & Co., of Bath, Maine. She is next to the largest ship afloat, the biggest being the steel leviathan *LA FRANCE*, which will be described further on. There was one American clipper larger than *ROANSOKE*, and that was *GREAT REPUBLIC*, built by Donald McKay at East Boston in 1853. *GREAT REPUBLIC* measured 4,555 tons gross, and was 334 1-2 feet long, 53 1-2 feet beam, and 38 feet deep. *ROANSOKE*, which was launched August 22, 1892, is 311.2 feet in length, 49.2 feet in breadth, 29.2 feet in depth and her gross tonnage is 3,539.03; her net tonnage being 3,400.43. The height of her mainmast from deck to truck is 170 feet. The weight of her heaviest anchor is 6,700 lbs., and the number of sheets of metal used in coppering was 5,150. Her master is Captain Jos. P. Hamilton. The spars are loftier than were those of *GREAT REPUBLIC*, and she spreads more canvas. It is said that *GREAT REPUBLIC* could crowd on 15,653 square yards of duck, while *ROANSOKE* can carry 20,000 square yards.

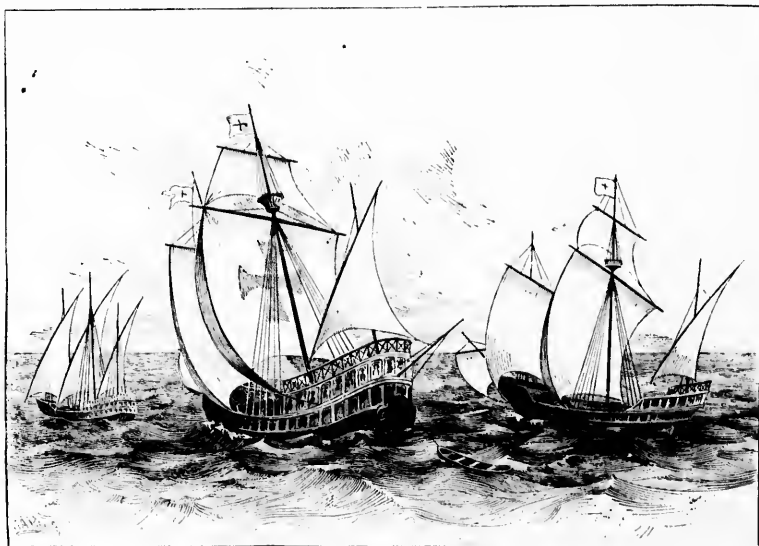

FIGURE 34.

This magnificent vessel makes a triangular voyage between New York, San Francisco and Liverpool.

The second largest wooden vessel afloat is SHENANDOAH, shown in Fig. 42, and was also built by Arthur Sewall & Co. This enterprising firm have built and launched over 90 vessels with an aggregate tonnage (net) of about 90,000. The SHENANDOAH was launched Nov. 26, 1890. This magnificent piece of ship architecture registers 3,406.78 tons gross, and 3,258.47 tons net. Length 299.7 feet. Although not an extreme clipper, her lines are such as to give

she a schooner. She was made at the Bath Iron Works, where she was also supplied with all ship machinery. She is commanded by Capt. James F. Murphy. On Monday, Feb. 2, 1890, she sailed from New York on her maiden voyage to San Francisco. Her first wheat cargo was 5,025 tons, and she made the voyage from San Francisco to Havre in one hundred and nine days.

This enterprising firm is constructing another vessel which will be very much larger than either ROANOKE or SHENANDOAH and it will naturally be a further advance in ship architecture.

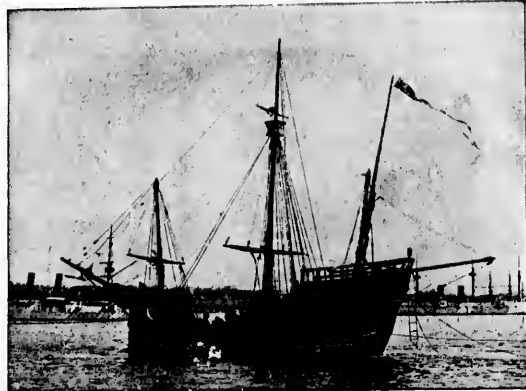
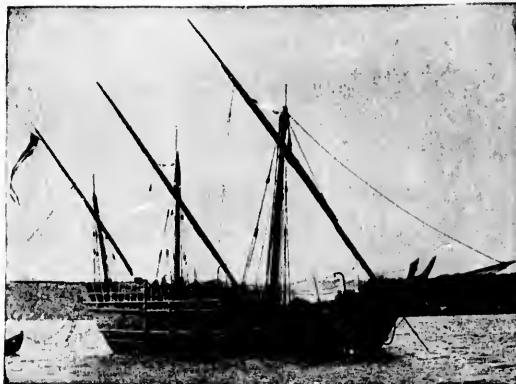

NINA.

PINTA.

her great speed and her proportions are very handsome. She has loftier spars than any other vessel in the world. She has four masts, fore, main, mizzen and jigger, and on all but the last she carries double topsails, topgallants, royals and sky sails. When the wind is following and not too strong, she sets studding sails on the main and foremast. Her lower main yard is 93 feet long and, with studding sail-booms attached, the entire length of the boom is 186 feet. With all sail set she can spread 11,000 square yards of canvas. She has a steel bowsprit weighing 13 tons but no jib-boom. She is



SANTA MARIA.

(Photographed by Dolles.—Plate III.)

constructed of oak. Her rigging is of wire and her hawser of steel. All of the hand work on board, such as setting sail and weighing anchor, is done by steam. To copper this vessel it required 5,165 sheets of metal, while one-half a ton of nails were used to secure the metal in place. Her anchors weigh 6,800 and 6,400 pounds apiece, and 200 fathoms of 2 1/3 inch chain are connected with them. The cabins are elegantly finished in antique oak, hand carved. Her foremast is 80 feet, her main and mizzen masts are 90 feet and her spanker mast is 96 feet. The first three are about 38 inches in diameter and the last is 26 inches. Her topmasts are 56 feet each, except that on her spanker mast which measures 82 feet. The measure of her topgallant masts is 28 feet, her royals 15 feet and her sky sails 16 feet, with poles 6 feet in length. Her yards are as large as a common sized mast on a

ceiling, planking and decks. The centerboard is thirty-five feet long, nine inches thick, and will drop fourteen feet below the keel. Two of the anchors weigh, respectively, 7,000 and 6,000 pounds, with 80 fathoms of 2 1/4 inch chain attached to each. The cabin has three rooms 12x15 feet, four staterooms, a large wash room, a bath room and a large pantry. The after cabin and the captain's room are finished in polished antique oak. The measurement of the schooner shows the gross tonnage to be 1,778.77, net 1,689.84. Her light water draft is 9 feet, but when loaded with 3,000 tons of coal she is expected to draw 20 feet. She was designed by Albert H. Winslow of Taunton, Mass., and built by the day under the superintendence of Mr. Levitt Storer, an experienced builder. She cost \$80,000.

GOVERNOR AMES, as shown in Fig. 43, represents the largest five masted schooner-rigged vessel in the world. Her frame was cut and moulded in Virginia in the winter of 1888, and in the Spring she was transported by water to Waldoboro, Maine. The keel was laid the first week in July, the length being 232 feet. The other dimensions are as follows:—Length over all, 265 feet; breadth of beam, 50 feet; depth of hold, 21 feet. Five hundred cubic tons of the best white oak timber were used in the frames, and 876,000 feet of the best quality of Georgia pine went into the

Of all American
ands pre-eminently
Edward G. Tinker.
SOVEREIGN OF THE
at sea after she had
made a voyage of
or wearing—a pas-

of the Navy, that
ented run of 6,245
day; and that the
419 miles—a run

1. The sails are
g obliquely to the
often has a run-

clipper ROANOKE,
o., of Bath, Maine,
st being the steel
urther on. There
OKE, and that was
t East Boston in
t gross, and was
deep. ROANOKE,
et in length, 49.2
nnage is 3,539.03;
er mainmast from
est anchor is 6,700
ppering was 5,150.
ars are loftier than
uds more canvas,
on 15,653 square
000 square yards.



Shortly after she was launched at Waldoboro, Maine, she sailed for Baltimore in ballast. When two days out of port she encountered a heavy gale which carried away every one of her masts, leaving her helpless and at the mercy of the waves. A Morse wrecking tug was sent to her rescue and she was towed into Boston for repairs. After being thoroughly re-fitted, she proceeded to Portland, Maine, and loaded with lumber for Buenos Ayres, S. A., taking on board the largest cargo of lumber ever carried by one vessel, 1,896,000 feet. Her deck load alone was 496,000 feet, a cargo sufficient for any ordinary vessel. On her return voyage she came from Buenos Ayres

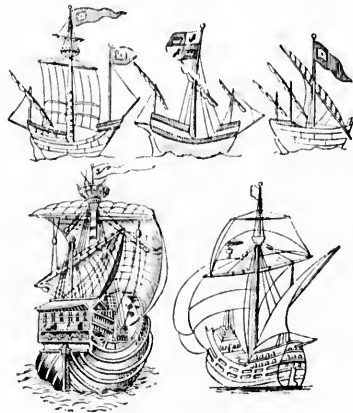

FIGURES 35 TO 39.

to Baltimore light, and without ballast. Her experience in a terrible gale on our coast on January 23, 1890, proved her to be a staunch, able and seaworthy vessel in every respect.

The five masts are named, respectively, foremast, mainmast, mizzenmast, spanker-mast and jigger-mast. The lower masts are each 115 feet in length and thirty inches in diameter. The top masts are 56 feet long and 22 inches in diameter at the cap. From the deck to the main truck is 147 feet. The jib-boom is 75 feet long and 22 inches in diameter at the bowsprit cap. The jib-boom is 75 feet long and 22 inches in diameter at the bowsprit cap. There were seven thousand yards of heaviest duck used in the sails. Her carrying capacity is remarkable, being nearly double her registered tonnage. Her first load of coal was 2,983 tons. She is commanded by the able and much respected Captain C. A. Davis, who takes great pride in this magnificent vessel.

It is well established that there is a limit to the use of wood for the construction of ships; but what is almost impossible with wood, which does not permit of allying force of resistance with lightness (two essential elements with great tonnage), has become relatively easy with the immense progress made in the use of steel in the construction of ships.

Fig. 44 illustrates LA FRANCE, which is the largest sailing vessel afloat, and is certainly a grand achievement in ship architecture.

This grand vessel was built upon the Clyde for the shipping house of A. D. Bordes & Son, of Paris. Her total length is 376 feet, her extreme breadth 50 feet, and her depth from the upper deck to the bottom of the hull is 34 feet. The masts and yards, like the hull, are of steel. The mizzenmast, which is in a single piece,

is 144 feet in height, nearly twice the height of a five story house. The four square rigged masts are 195 feet in height. The distance between each mast is 69 feet.

When this magnificent ship is compared with the old native vessel of China, a junk, the advancement in ship architecture will become more apparent. It will be seen that junks (Fig. 45) are clumsy looking vessels with mat sails which are difficult to trim so as to catch the breeze. In these vessels the crew are shareholders, each one having the privilege of putting a certain quantity of goods on board, trade being their chief object. From the lack of discipline, the vessels are frequently in danger of being destroyed.



CARAVEL OF FIFTEENTH CENTURY.

YACHTS.

Passing from the merchant ships and vessels of olden times to strictly pleasure craft, it will be of interest to study the various types and rigs of yachts which decorate the waters in different sections of the world. As the best conception of the various type of yachts can be formed from illustrations, it will hardly be

necessary to go into elaborate detail. Starting with the simplest type of pleasure boat, the sharpie, we will pass on to the cat, mosquito boat, double cat, periauger, cut-yawl, jib and mainsail, sloop, cutter, fin-keel, lugger, catamaran, buck-eye, ketch, schooner, yawl and house-boat.



SHIP OF WAR WITH HIGH POOP 17TH CENTURY.

SHARPIE.

The first type of boat we have to consider then is the sharpie, two illustrations of which are given in Figs. 46 and 47.

Sharpies are inexpensive to build and are fast sailers; they are particularly adapted to shoal waters. Some have been constructed with fine cabins, and certain modifications have been made in their structure, such as overhanging bows and sterns, etc.; still, the genuine sharpie is, as stated, a flat bottomed boat with a leg-o-mutton sail.

The schooner-rig BULLDOG is a centerboard sharpie, designed by W. H. H. Murray, and is owned by W. A. Crombie, Horatio Hickok and Joseph Auld. She hails from Burlington and sails with

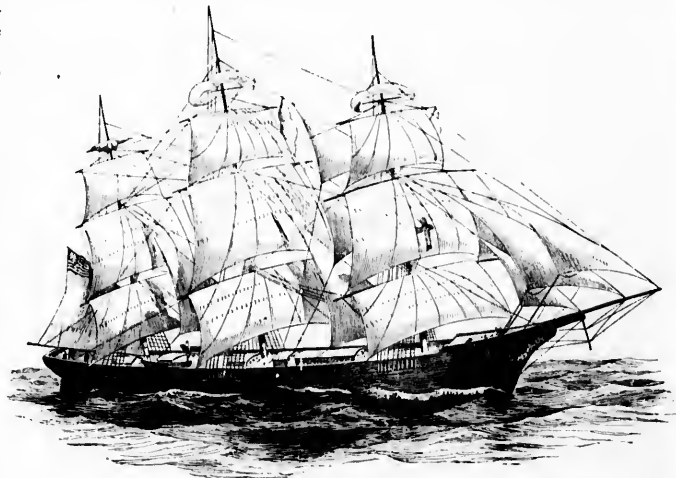

CAPT. SAMUELS' FAMOUS YANKEE PACKET SHIP "DREADNAUGHT."—FIGURE 40.

the fleet follows; load wat

Next speed a general boats a Americ light d

Fig. MAY, c launch Howard of the sions a 13 feet feet 10 3 feet

The simple cruising is better heavy of same as the every of larg

The a huro most c inexe

the fleet of the Lake Champlain Yacht Club. Her dimensions are as follows: Length over all, 45 feet; beam, 11 feet 2 inches; length load waterline, 37 feet; draft, 2 feet.

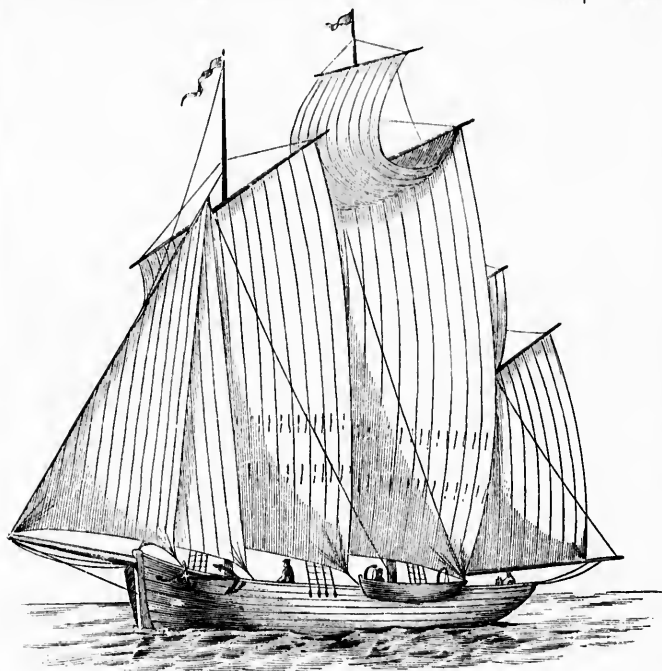

LUGGER.—FIGURE 41.

THE CAT-BOAT.

Next we have to consider the cat-boat, a type of boat which for speed and handiness has always been a great favorite. The "cat" is generally a centerboard boat; still, keel cat-boats are frequently built, but the typical American "cat" is the centerboard boat of light draft, big beam and huge sail.

Fig. 48 represents the centerboard cat MAY, designed and built by W. Crosby and launched in 1887. She is the property of Howard S. Jaffray, and sails with the fleet of the New York Yacht Club. Her dimensions are: Length over all, 35 feet; beam 13 feet 10 inches; length load waterline, 30 feet 10 inches; depth 4 feet 0½ inch. Draft 3 feet 7 inches.

The cat is very fast, quick in stays and simple in rig. The keel-cat is a superior cruising boat to the centerboard cat, which is better suited to smooth water than a heavy sea. When the ballast consists of bags of sand such cats are called "sandbaggers," as the bags are shifted to windward with every tack, in order to enable the carrying of large sail.

The "skipjack" or "smoothing iron" is a hard-bilged, light-draft boat possessing most excellent sailing qualities and, being inexpensive, is adopted by a great many.

MOSQUITO BOAT

Mosquito boats of Atlantic City differ from the mosquito yacht of Boston and Long Island, and for ableness and speed equal any of the smaller classes of boats. The mosquito boats are built, for the most part, on models giving them a length over all of 15 feet, with a keel length of 11 feet 6 inches, making the waterline measurement average 13 feet. The beam averages 5 feet and the draft from 6 to 12 inches, while the freeboard measurement varies from 8 feet to 12 feet.

Within these dimensions there are boats showing widely different lines, some having overhauling sterns, some elliptical, some square with considerable rake to the transom, several full bowed and some hollow bowed, according as the owner has gratified his peculiar individual ideas of what a boat should be, in his model. So much for the type.

The main peculiarity of this class of boats is in the rig. This may be spoken of as the old sprit leg-o'-mutton sail, modernized so as to meet the wants of the mosquito boat. A glance at Fig. 49 will show the sail as used in Atlantic City and elsewhere where these yachts are rapidly coming into favor. The sail as here used measures on the mast about 17 feet, carries a 14 foot sprit, running to an 18 inch club at the end of the sprit. The boats have three or four sails to meet the extremes of weather.

When sailing under club rules, they are restricted to 108 square feet, or must give heavy allowance for excess; some, however, carry 154 square feet.

These mosquito boats are very able, standing almost any amount of weather, and in both driving off and windward work are excellent. In club races they have sailed over a course of ten miles with a stiff southwesterly breeze in a little less than one hour and nineteen minutes to windward or leeward and return.

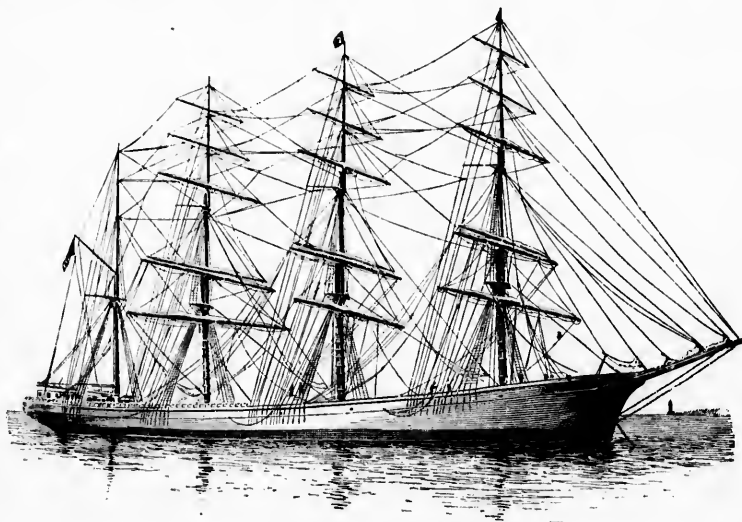

SHENANDOAH.—FIGURE 42.

THE DOUBLE-CAT.

The double-cat has recently become quite a favorite yacht, especially on the lakes; it differs from the cat principally in its rig. The

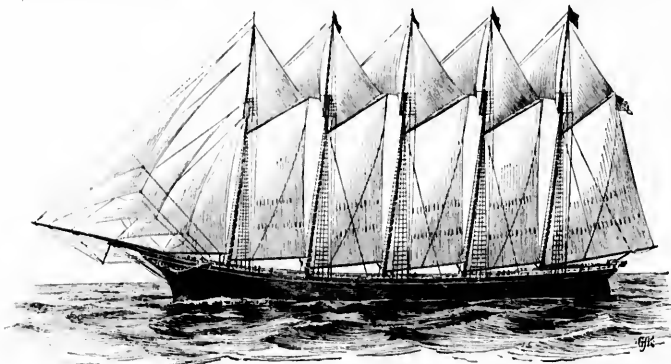

THE GOVERNOR AMES.—FIGURE 43.

double-cat DORIS is shown in Fig. 50 and LOIS in Fig. 51. The single hander DORIS was designed by Richard P. Joy for his own use. She is used for cruising on Lake Le Clair where this type of yacht is quite well-known. She is a fine sea-going boat and a good sailer. She was built by the Detroit Boat Works, and launched October 5, 1889.

Her dimensions are as follows:

Length over all,	22 feet 6 inches.
Length load waterline,	19 feet 4 inches.
Draft (without board),	1 foot 8 inches.
Freeboard of,	1 foot 6 inches.
Foremast,	24 feet 6 inches.
Outside ballast,	1,000 lbs.
Beam,	7 feet.
Depth (moulded),	2 feet 10 inches.
Draft (with board),	5 feet.
Sail area,	280 square feet.
Mainmast,	21 feet 5½ inches.
Inside ballast,	1,500 lbs.

LOIS is also a centerboard double-cat-boat, and belongs to W. Cook, of the Detroit Yacht club. Her dimensions are: Length load waterline, 17 feet 11 inches; beam, 5 feet 3 inches; depth of hold, 2 foot 4 inches. Numerous other yachts of this type and rig will be illustrated in the chapter relative to the history of the Detroit Yacht Club.

THE PERLAUGER.

THE PERLAUGER might be called a double-cat-rigged boat, and is a style of craft rarely seen now-a-days. It has been called a pirogue. It is a double-ended, narrow-hulled vessel, rigged with two masts each carrying a gaff-sail.

THE PERLAUGER PERWINKLE shown in Fig. 52 is a keel boat and was built by R. Youmans, of Newport, Rhode Island. She was launched in 1879, and is now owned by James Francis; she is enrolled in the squadron of the New York Yacht Club. Her dimensions are as follows: Length over all, 38 feet; length load waterline, 38 feet; beam, 13 feet 6 inches; draft, 7 feet.

Pinghorn,* speaking of the pirogue, says that at one time it was "the Jersey Dutchman's favorite boat, and in early days, when New York was still remembered as 'New Amsterdam' and Jersey City was known as 'Powles' Hook,' a pirogue ferry was operated by the enterprising Dutch of the two towns on the opposite shores of the Hudson. In those days, a 'voyage' across the river against adverse winds was considered quite a journey, consequently the pirogue became famous, making the best time.

* Century Magazine, May, 1892, "Coast and Inland Yachting."

A comparison between the pirogue ferry of those times and the equipment of such ferries as now ply across the Hudson is suggestive of the march which progress has made in a few decades. The pirogue is generally used as a hunting and pleasure sailing craft. Originally it was fitted with a lee-board, but in the modern boat the centerboard takes the place of that discarded contrivance."

THE CAT-YAWL.

Since the construction of the first cat-yawl, this rig of yacht has grown in favor, and it is conceded that although the cat-boat is a great favorite for cruising purposes, the cat-yawl is far superior. At present a number of them are owned in Boston and other Eastern ports, several being enrolled in New York clubs.

The first cat-yawl ROMP,† was built by the Herreshoffs in 1876 for the former owner of the schooner yacht TURTLE Mr. George A. Thayer. ALICE was next built, then CONSUELO and CLARA. The last named was an excellent craft, and besides being very fast was a good sea boat. Mr. Nat Herreshoff was often seen on board of her in Buzzard's Bay with his family, and although having no other man on board to help him handle her, yet he did not



LA FRANCE.—FIGURE 44.

† See "Rudder, Sail and Paddle," pp. 17-18, 1892.

apparently
feet load
one man
The B
which wa

KUMA (Fig
in Boston
load water
all her ball
James No
his summer
part of the
sailing wi
Harbor the
cuts to w
KUEDIVE.
line, 10 fo
draft, 5½
is all the b
finished in
four trans
berths for
table leave
has 5 feet
ple locker
launched.
The cat
for Mr. A
feet over
draft and
and is ca
and has so
being a s
room and
is well ple
The nes
over all, 2
and 2 feet
is fitted
Pryor &
cat-yawl
designs.
line, 8 feet
is a keel
for cruise
Pryor t
the old r
has an ir
the garbo
ten inches

apparently mind the weather. Her dimensions are 35 feet over all, 29 feet load waterline, 8 feet beam and 6 feet draft. With any other rig one man could not do much handling a yacht of this size.

The Boston Yacht Agency drafted the first yacht of this rig, which was built in Boston by W. K. Pryor & Co. She was called



CHINESE JUNK.—FIGURE 45.

KUMA (Fig. 54), and was built for exhibition at the Maritime Fair held in Boston in 1889. Her dimensions are 26 feet over all, 22 feet length load waterline, 10 feet beam and 2 feet 6 inches draft. She carried all her ballast, 1½ tons, inside. After the close of the exhibition Mr.

James Notman, of Boston, purchased her for use at his summer home in the Bay of Chaleur, which is a part of the Gulf of St. Lawrence. It was found by sailing with some of our fast cut-boats in Boston Harbor that the cut-yawl was even better than the cats to windward. The next cut-yawl built was KHEMIVE. She is 31 feet over all, 24 feet load waterline, 10 feet 3 inches beam, and 3 feet 6 inches draft. She has an iron keel of about 3 tons, which is all the ballast she carries. She, like KUMA, has been finished in mahogany, has four folding berths besides four transom sofas which slide out, making good berths for eight people. She has a centerboard and table leaves are hung on the centerboard well. She has 5 feet 2 inches head room, with water-closet, ample locker room and good chance to cook. She was launched June 6th, by W. K. Pryor & Co.

The cut-yawl built at Fall River by Reed Bros. for Mr. Andrew Borden, was next in order. She is 40 feet over all, 27 feet load waterline, 5 feet 6 inches draft and 9 feet beam; has 5 1-2 tons of iron outside and is called LANCE (Fig. 55). She is a keel boat, and has so far proved a very fair sailer to windward, being a splendid sea boat. She has 6 feet of head room and all conveniences for cruising. Her owner is well pleased with her.

The next one was named RENEI; she is 34 feet over all, 24 feet load waterline, 9 feet 6 inches beam and 2 feet 6 inches draft. Has 5 feet head room and is fitted up for cruising. She was built by W. K. Pryor & Co. This same firm then built another cut-yawl for Lako Champlain parties, from their designs. She is 26 feet over all, 21 feet load waterline, 8 feet 6 inches beam and 4 feet 6 inches draft; is a keel boat, has 5 feet head room, well outfitted for cruising. Her name is ALHAJAH.

Pryor then built a cut-yawl which had no log keel, the old and present style of building yachts. She has an iron keel of 4 tons, and cast into the keel is the garboard strakes, one and a half inches thick by ten inches deep. Keel and garboards conform to shape

of moulds. The frames are of oak, stemmed and bent, and are fastened by screw bolts to iron garboards, holes being drilled and counter-sunk, making a smooth surface outside. Stem to stern posts are bolted to the iron keel, thus doing away with log keels entirely. The advantages of this construction can be readily seen, as by building this kind of a keel space is saved inside, which is needed very much in small boats for head room, as it allows the floor to be lowered from 6 to 12 inches. KHEMIVE is built on this plan and it brings her ballast as low as possible if iron is used. She spreads 800 square feet of canvas in the two sails and displaces 6 tons, so her sail plan is small in proportion to other yachts of her size.

JESTER was next built, and she was 25 feet on the water line, 35 feet over all, 9 feet 6 inches beam and 3 feet draft. She was built for A. M. Davis of the Savin Hill Yacht Club, and proved very fast; on the wind she would lay within three points. Then followed LINDA and CURNOOK, the latter spreading 1,100 square feet of canvas besides her club topsail and spinnaker, and being the first cut-yawl fitted with light sails. Her dimensions are 44 feet over all, 29 feet waterline, 11 feet beam and 3 feet 6 inches draft. She is owned by J. J. Gill, of Steubenville, Ohio, and was built on the same general plan as KHEMIVE, LINDA and ALHAJAH, having no wooden keel at all; stern and sternpost bolting on the keel and the frames bolt on to what would be the garboard strake if of wood.

JIB AND MAINSAIL BOATS.

Strictly speaking, when a boat is rigged with a jib and mainsail she is really sloop-rigged, but as a full sloop-rigged boat carries

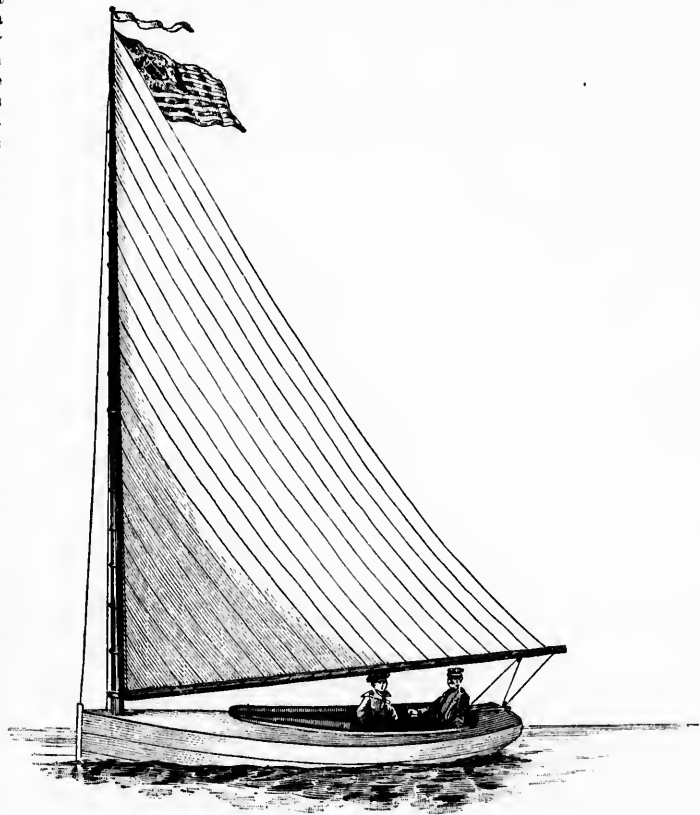

A MODERN SHARPIE.—FIGURE 46.

other sails it is more convenient to consider them separately. Attempts were made at one time to distinguish between a "jib and mainsail boat" and what was called a "cut-sloop" or "jib-cut boat." While it is true that in the so-called "jib-cut" the jib is very much smaller than would be expected in a correctly rigged jib and mainsail boat, still if they have a jib and mainsail it would seem best to consider them together.

RAVINE (Fig. 56), represents a large cut to which a small jib has been added and hence must be called a jib and mainsail boat. She is owned by Wm. F. Palmer, of Taunton, Mass., and her rig has proved very convenient, being easily handled by one man.

A true jib and mainsail boat is seen in Fig. 57, which represents the famous well-known yacht **CUTISER**. She is owned by the yachtman A. Bryan Alley, and has been his property since 1880. She was designed and built by E. A. Willis, in 1869, for Greenville Kane, and has been owned by Thomas Jerome and C. Smith Lee. She is a centerboard boat and sails with the Larchmont Yacht Club.

Her dimensions are:
Length over all, 29 feet 6 inches.
Length load waterline, 29 feet 6 inches.
Beam, 9 feet 10 inches.
Depth, 2 feet 3 inches.

In 1884, Mr. Alley offered to sail **CUTISER** against the entire small boat fleet of Boston. Seven matches took place in one week and every one was won by **CUTISER**.

Jib and mainsail boats are commonly known as sloopers. They were at one time the favorite racing boat; the excitement of shifting ballast and risks taken, owing to the large area of sail, added greatly to the sport in sailing them.

The following illustration (Fig. 58), is of the famous **El Chico**, the type of which is hooked and her rig jib and mainsail. She was built by the Herreshoff Mfg Co. for H. Maitland Kersy, and was launched in May, 1892, but was afterwards sold and sailed on Lake Champlain last summer.

Her dimensions are as follows:

Length over all,	39 feet.
Depth,	3 feet 4 inches.
Length load waterline,	25 feet.
Draft,	6 feet 6 inches.
Beam,	7 feet 1 inch.

El Chico has a very enviable record, which for 1892 was as follows:

Saturday, May 28th: Seawanhaka Opening. Beat NAMELESS, 3 min. Light breeze.

Monday, May 30th: Larchmont. **PYXIE** won. **El Chico** disqualified. Drifting match.

Saturday, June 4th: Larchmont. Won by 12 min. 34 secs. Fresh N. E. breeze and sea. \$75.00 cup.

Saturday, June 11th: Marine and Field. Won by 38 mins. Fresh S. E. breeze and sea. \$75.00 cup.

Tuesday, June 14th: Atlantic. Won by 6 min. 31 secs. Fresh S. W. wind and sea. \$30.00.

Saturday, July 2nd: Seawanhaka. Won by 5 min. 29 secs. Moderate S. W. wind and sea. Two prizes, \$25.00 each.

Saturday, July 16th: Seawanhaka. Gave up no count short-handed.

Saturday, Sept. 10th: Larchmont. Won by 35 secs. 4 entries. \$75.00 cup.

Saturday, Sept. 21th: Seawanhaka. Becalmed. Did not finish.

Saturday, Oct. 1st: Seawanhaka. Special \$50.00 cup. R. A. Osborne, Esq. Won by 6 min. 42 secs. 4 entries. Strong N. wind.

SLIDING GUNTER RIG.

The next illustration (Fig. 59), is of **THE BEE**, a jib and mainsail rigged boat belonging to Sherwood & Duggan, of the St. Lawrence Yacht Club. It will be seen that she is fitted with the sliding gunter rig. The principle of this rig is that a yard (top mast) slides up and down the mainmast in a vertical direction, two irons or travelers forming the connection. The sail is laced to the yard. This rig has many advocates and it is claimed to do well in going to wind-

ward. In places where it is necessary to reduce sail and top hamper quickly, this rig has advantages.

Vessels in the United States Navy have shipboats fitted with the sliding gunter rig.

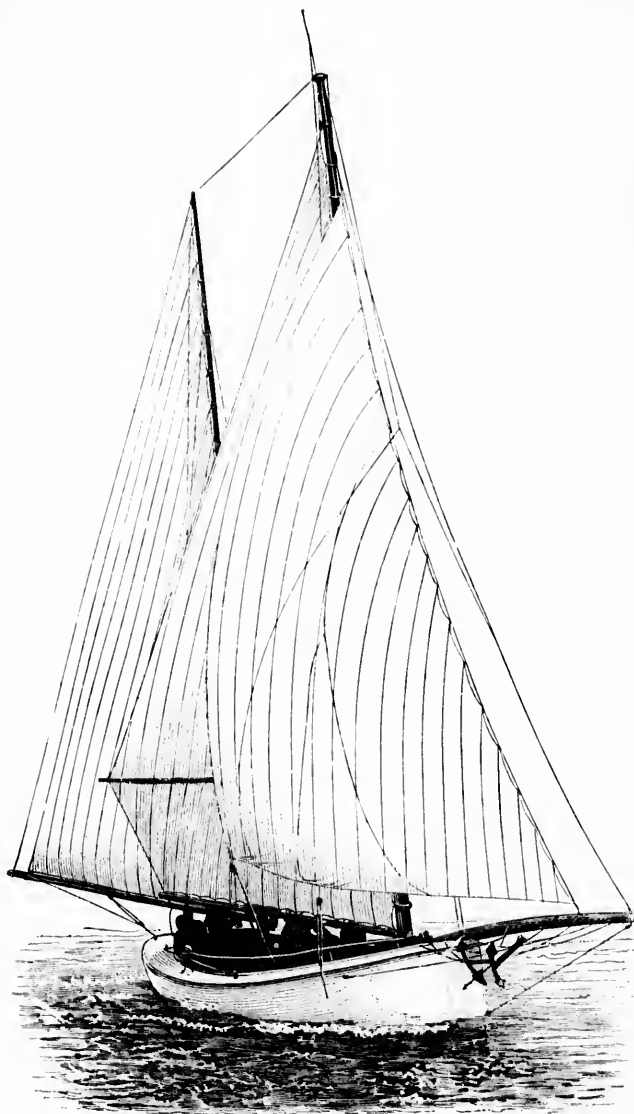

SHARPE BURLINGTON.—FIGURE 47.

In former sloops and cut-sloops by the late centerboard boat, principal sails were understood that boat, having a be-decked (hooked) principal sails consisting of staysail and jib, not having the sloop then staysail all in o-

SLOOPS AND CUTTERS.

In former times when speaking of the sloop and cutter, it was generally understood by the layman that a sloop was a centerboard boat, with a fixed bowsprit, and her principal sails were mainsail, topsail, and jib, while when referring to a cutter it was understood that she was a narrow, deep keel boat, having a straight bowsprit, which could be decked (housed) when desired, her principal sails consisting of mainsail, topsail, fore-staysail and jib set to bowsprit end. Cutters not having a jibstay, the jib hoisting and hanging by halyards alone. The jib of the sloop then, consisted of the jib and fore-staysail all in one.



MAY.—FIGURE 48.

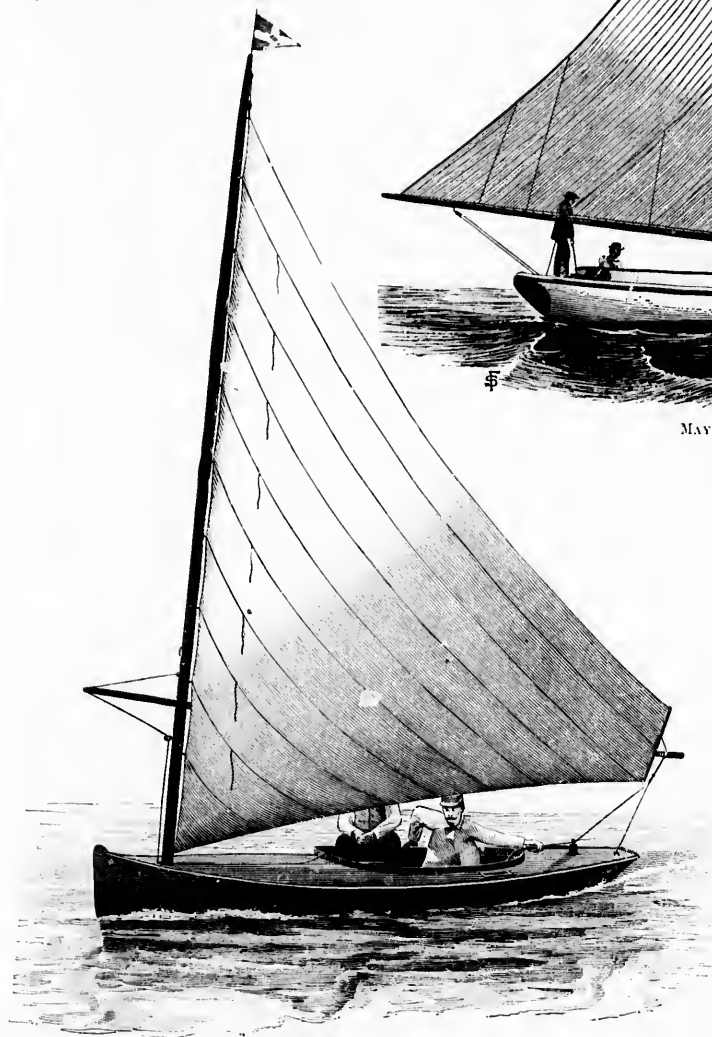

WASP, CAPT. SAMUEL WOTTON.—FIGURE 49.

More recently, owing to marked modifications in the hull of yachts, when the "type" of yacht is spoken of it refers to the hull alone, while when the "rig" is spoken of, it refers to the sails and, therefore, we speak of a sloop-rig, cutter-rig, yawl-rig, schooner-rig, etc.

This distinction became necessary, owing to the fact that the cutter-rig is not confined to keel boats, but on account of the handiness of the rig, it has been substituted for the sloop rig in the majority of cases on centerboard boats, so that the cutter rig is now used on the various types of yachts, such as keel, keel centerboard, fin-keel, bulb-fin-keel and centerboard. It likewise follows that a sloop does not of necessity carry a centerboard, as a keel boat with a sloop-rig must be called a sloop in order to maintain consistency.

As this question of the sloop and cutter is one which should be settled firmly in the minds of yachtsmen, by permission of *Forest and Stream*, the following article on the subject from the pen of their able editor, Mr. Wm. P. Stephens, is introduced, and if carefully read and digested this much discussed question will be settled once and forever.

"The whole question of cutter and sloop is so old that many yachtsmen have lost all

EVOLUTION OF THE YACHT.

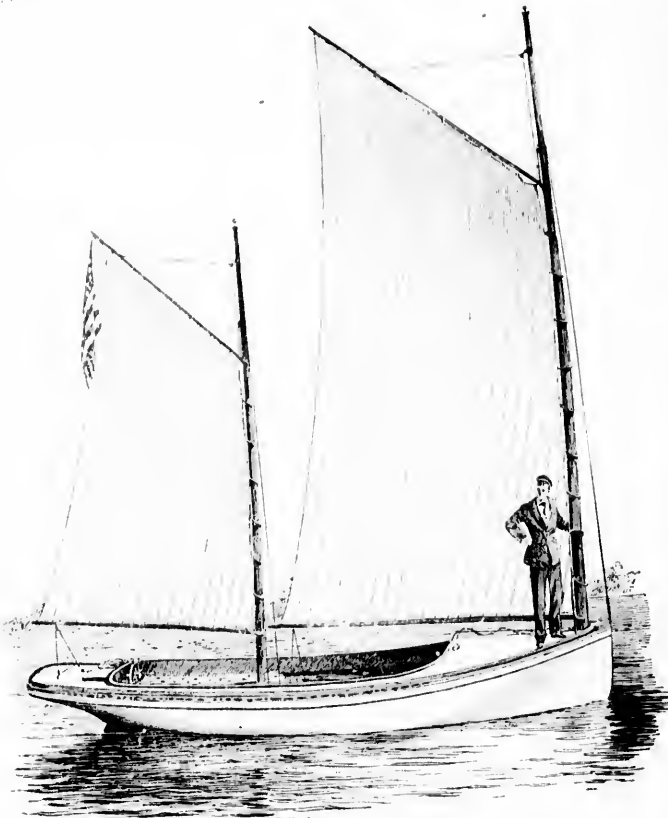

DOUBLE-CAT DORIS.—FIGURE 50.

interest in the discussion; but on the other hand there are many who have come into yachting only since the disappearance of the American sloop with the building of the Burgess boats, and to whom the question is new and interesting.

“So far from being ‘any vessel rigged with one mast and carrying ‘headsails,’ the sloop is but one, and the least numerous and important one at that, of the two great fleets of single-stick vessels to which the general characteristics of one mast, and carrying headsails’ can properly apply.

“While there are certain modifications of the single-masted rig which are neither sloops nor cutters, the great majority of the rig may be divided into these two classes, the points of difference between them being numerous and radical. Without going back so far as to determine which is the older, the cutter or the sloop, the inquirer who takes up the history of the subject about the middle of the last century will at once remark a most radical difference. The cutter-rig of that date is essentially a sea-going rig, showing plainly its derivation from the smaller naval vessels of the day; in fact, it was mainly used in the British Navy.

In proportions and mechanical details the rig was an adaptation of the schooner or brig to a single-masted vessel, with the same square topsails and cumbersome and complicated gear. The sloop of the same time, on the contrary, as found in the same waters of the Channel and the North Sea, was a shoal water craft, probably of Dutch origin, and the rig, evolved from the necessities of inland navigation, was of the most simple and primitive form, derived from the sail-bout instead of the naval vessel, a long mast and bowsprit rigidly set up, and with a large mainsail, one jib and perhaps a fore and aft topsail. In Holland, in England and in America the small, simply rigged sloop was extensively used for inland navigation both for commerce and pleasure, so far as the latter end was followed at the time; while the cutter was used for all sea work, whether in smuggling, in chasing smugglers, or in the few yachts of the day.

“This prime difference once noted, we may pass over almost a century, and take up the question some twenty-five years back, at the time when the single-stick rig first began to compete with the schooner in American yachting. During this long period the cutter had disappeared as a smuggler or chaser of smugglers, and had come into general use in Great Britain as a pleasure yacht, first with its high sides pierced with gun ports and its square topsails, then without its armament and with fore and aft topsails, but still preserving its main characteristics.

“On this side of the water the development of

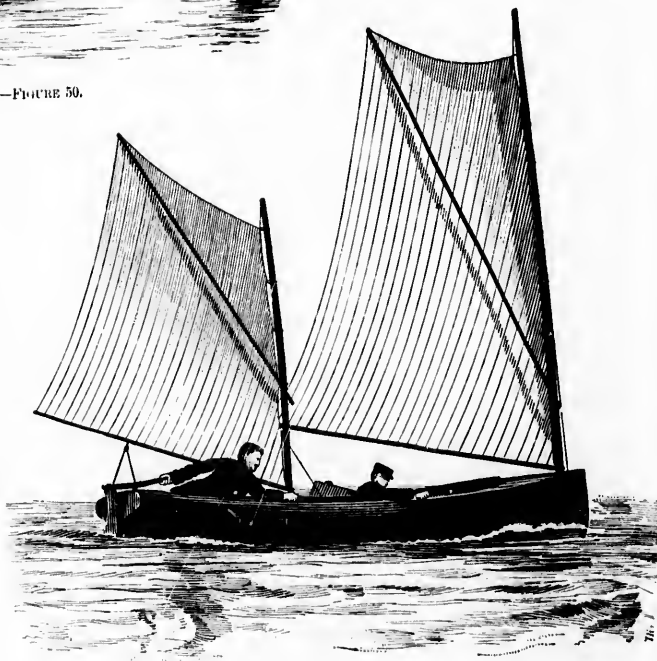

DOUBLE-CAT LOIS.—FIGURE 51.

a century ha
of the Briti
the noble slo
heavy floed
in America
ever schoon
the carrier
lumber, hay
and the pleu
or the smal
differing in
finish, but a
form in mo
“It was abou
the sloop yac
increase in si
bers and coo
ously with t
which up t
had monop
the racing a
abroad in th
50 feet, an
take the sloo
day and con
the cutter-fo
found in Br
“The sloop
general outl
lofty, but a
base, a high
and this sa
made up of
sail with gr
short gaff,
of great siz
small work
The mast,
stepped far
very long i
to the wa
masthead
was short,
mast was
spar, out
tion to the
The bowspr
and heavy
erally squ
or even
section any
in as a pu
and bulwa
“This
supported
main bobs
a variety o
stays, nec
individua
builder o
The mast
aft direct
hole in t
main bob
cups, co
and unsl
whole rig

a century had been exclusively confined to the Dutch sloop instead of the British cutter, and the type had attained its perfection in the noble sloops of the Hudson River, with their huge lower masts, heavy fixed bowsprits and single jibs. Wherever vessels were used in American inland waters, the sloop alone was found, the small river schooners coming in at a later date; it was the passenger boat, the carrier of bricks, lumber, hay and grain, and the pleasure yacht or the small sail-boat, differing in size and finish, but almost uniform in model and rig. "It was about 1870 that the sloop yacht began to increase in size and numbers and compete seriously with the schooner, which up to this time had monopolized all of the racing at home and abroad in the sizes over 50 feet, and we will take the sloop-rig of that day and compare it with the cutter-rig as then found in British waters.

"The sloop sail plan in general outline was very lofty, but short on the base, a high narrow rig, and this sail plan was made up of a large mainsail with great hoist and short gaff, a single jib of great size, and a very small working topsail. The mast, which was stepped far forward, was very long in proportion to the waterline, the masthead or doublings was short, and the topmast was a short, light spar, out of all proportion to the lower mast. The bowsprit was a large and heavy timber, generally square, octagonal or even triangular in section and solidly built in as a part of the hull and bulwarks.

"This bowsprit was supported by a heavy main bobstay and often a variety of smaller bobstays, according to the individual tastes of the builder or shipsmith. The mast was set up with shrouds and its sole support in a fore and aft direction was a heavy jibstay, from the masthead through a beehole in the bowsprit and then down to the stem, just inside of the main bobstay. The top mast was permanently shipped in the iron caps, could not be housed when in use, and was only shipped and unshipped with difficulty when repairs made it necessary. The whole rig was as fixed, rigid and inflexible as that of a toy yacht; the

spars, once shipped when the yacht was built, remained in place until they rotted or blew away. The cutter-rig differed from the sloop in every point mentioned, the outline of the sail plan was long and low rather than narrow and high, the mainsail had a long boom, a very long gaff, and a short hoist, this sail being but a moderate proportion of the total area; in place of the one large jib, carried always, and reduced in area only by reefing or taking out the 'bonnet,' there were two headsails, the jib proper, set to the bowsprit end as in the sloop, and the fore staysail, set to the stemhead. The topsail was much larger in proportion than in the sloop, and a greater variety of sizes was carried.

"The mast of the cutter, a short stick, but with long masthead, was stepped near the middle third of the waterline, further aft than in the sloop, and was supported in a totally different manner; it was independent of the bowsprit, the forestay running from the masthead to the stem of the yacht at the deck, where it was set up with a tackle, and in addition on each side of the masthead was a pendant and runner, set up with a tackle also, to take the strain off the jib, the weather tackle being always set up and the lee one slacked off when off the wind to allow the boom to swing off.

"The topmast of the cutter was of great length, almost or quite that of the lower mast, and this taut spar was so fitted that it could be readily lowered to the cap or even stowed on deck in a strong breeze. The bowsprit was a clean round spar, also fitted to run in and out easily, and to this end the solid bobstay of the sloop, with its preventers and 'baby' bobstays, was replaced by a short bobstay of copper or of wire rope, and a strong tackle by which it was set up. The two bowsprit shrouds were also rigged with tackles, so that they could be shortened and set up again when the bowsprit was 'housed,' or drawn in on deck in bad weather. The jibstay of the sloop was lacking in the cutter, there being no stay from the masthead to the bow sprit end.



THE PERLAUGER PERIWINKLE.—FIGURE 52.

The solid bobstay of the sloop, with its preventers and 'baby' bobstays, was replaced by a short bobstay of copper or of wire rope, and a strong tackle by which it was set up. The two bowsprit shrouds were also rigged with tackles, so that they could be shortened and set up again when the bowsprit was 'housed,' or drawn in on deck in bad weather. The jibstay of the sloop was lacking in the cutter, there being no stay from the masthead to the bow sprit end.

EVOLUTION OF THE YACHT.

25

The sloop was limited to just three working sail—a large mainsail, a large jib and a working aft gafftopsail. The cutter, on the contrary, carried a mainsail, five or six jibs, two forestaysails, two topsails and a gafftrysail—a second and smaller mainsail for very heavy weather, or for saving the racing mainsail in making passages. Whatever the conditions of sea and wind, the spars of the sloop were fixed and immovable, and she was limited, outside of the spinnaker, jib topsails and club topsail to three working sails, with the choice of stowing the top sail entirely, and of reefing the main sail and jib. The cutter, on the other hand, could exercise an almost unrestricted choice of the spars and sails for any particular weather, ranging from the whole main-

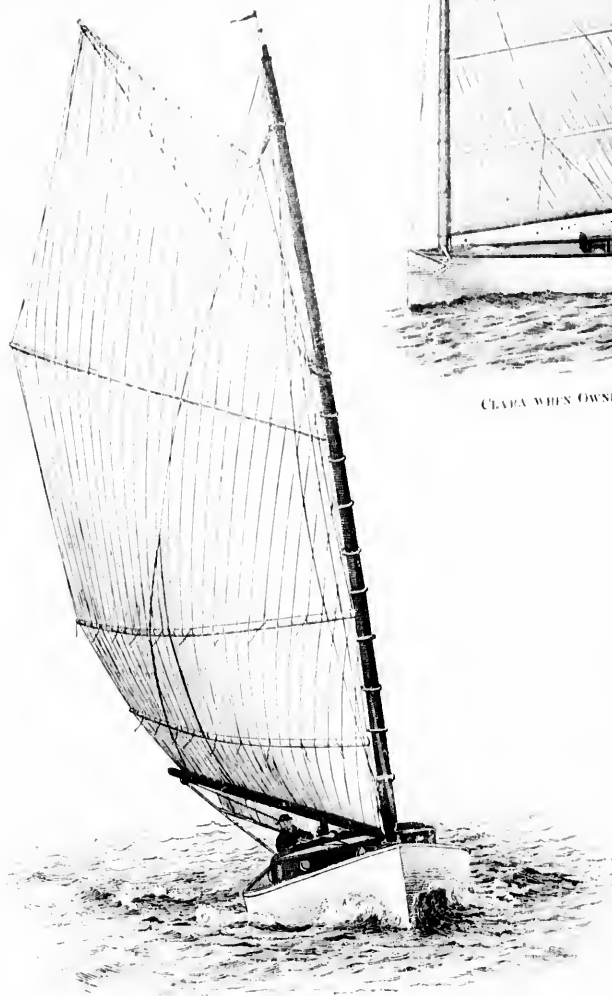

KIWA.—FIGURE 54.

(From a Photograph by Peabody.)

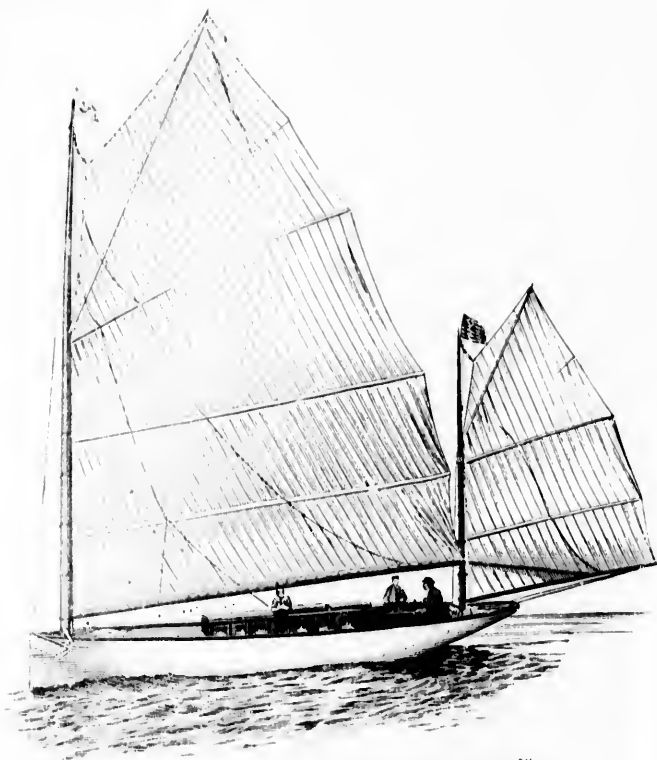

CLAVA WHEN OWNED BY MR. NAT. HERRESHOFF.—FIGURE 53.

sail and the largest jib and forestaysail of very light material, with a yard or sprit topsail instead of the jib-headed working topsail, down to the housed topmast with the whole lower sails, or the reefed mainsail with smaller jib to suit; or, further down, until her topmast was on deck, her bowsprit housed well inboard, her mainsail stowed on the boom and a small heavy storm trysail set, with its corresponding storm jib.

The sloop was a great sail-boat or toy yacht, fitted for light weather and unable to adopt her spar and sail plan to more severe conditions. The cutter was essentially a miniature ship with housing spars set up by runners and tackles, and with a large outfit of sails for all weathers, and capable in an hour's time of making a radical change in her entire sail plan.

This vast difference in the two rigs is found in the primitive craft of the last century, in the yachts of less than a generation ago, and later, some dozen years back, when had just begun the process of adaptation and improvement which has resulted in the extinction of the American sloop rig.

With these essential points of difference were some minor ones that are worth noting, though they were more matters of mechanical detail than of principle. While the mainsail of the sloop was made of cotton, usually of very light canvas, and was laced along the foot to the boom, that of the cutter was of

hemp,
ing, n
an out
clump
another
boom
from th
cutter
from th
as a qu
but on
one cur
being t
to ve

hemp, linen, of heavier texture; and the foot was made full and rounding, not laced to the boom, but falling below it, the clew made fast by an onthaul, allowing it to be set up or stacked off, according to the dampness of the weather, the tack being hauled down to the deck by another tackle, or triced up when it was desired to reduce sail. The boom of the sloop was usually supported by a single 'topping lift,' from the masthead to the boom end on one side of the sail; while the cutter had two similar lifts, one on each side of the sail, but running from the slings of the mainsheet instead of the boom end, and known as 'quarter lifts.' Then, too, the mainsheet of the sloop was rove with but one hauling end amidships; while that of the cutter was led with one end to each quarter and along each side of the deck; one thus being to windward all the time. The method of setting the jib was very different, the one big jib of the sloop was permanently

lashed to hanks which ran on the jibstay, the sail being stowed on the bowsprit and kept out there through the season; on the cutter each of the many jibs was set on its own luffrope, there being no jibstay; the tack was loose and was hooked to a ring which traveled on the bowsprit, and one jib could be quickly lowered, taken in, and

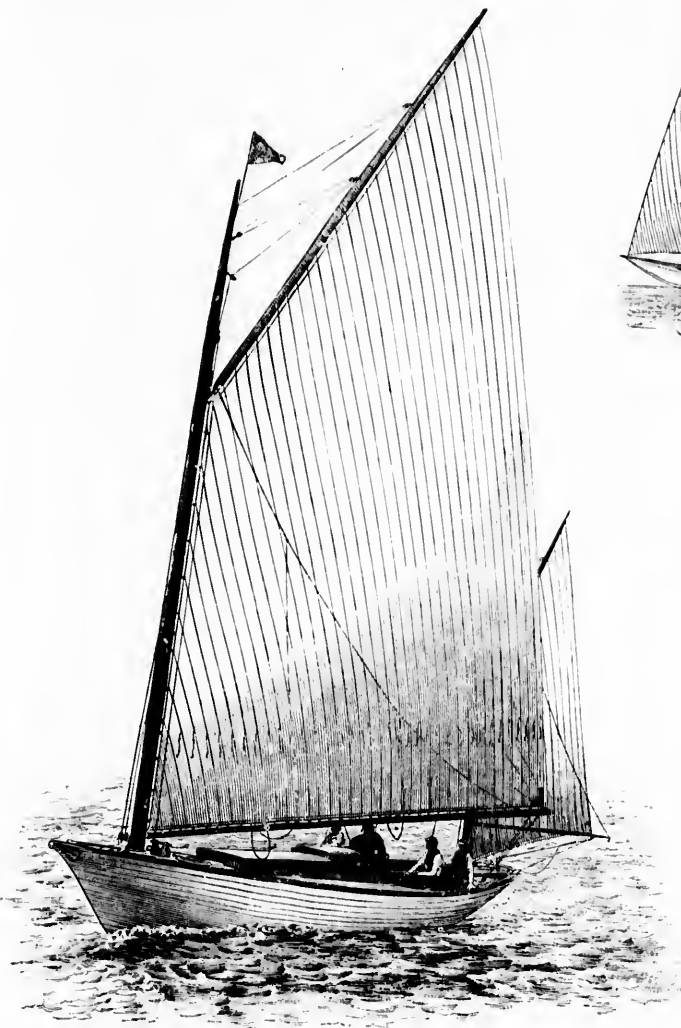

LANOE.—FIGURE 55.

(From a Photograph by Peabody.)



RAISE.—FIGURE 56.

stowed below in its bag, a larger or smaller one being set in its place. The club or jackyard topsails, too, were different, those of the sloop being set on spars parallel with the gaff and topmast, while the topsail yard and jackyard of the cutter crossed the topmast and gaff respectively.

The minor mechanical details of the cutter were more numerous and perfect than the sloop, all tending to carry out the great principle of adaptability to all possible conditions.

Those yachtsmen who watched and studied, as so many did, the Scotch cutter *MADGE* when she came to New York in 1881, and who from constant use were familiar with the sloops of that day, such as *SHADOW*, *MINSTREL* or *SCHEMER*, will recognize the distinctive features which we have pointed out as belonging to the two rigs. If the fact has not struck them before they may note in this connection that to-day the sloop rig has entirely disappeared save in a few old yachts of the smaller classes, so much so that when once in a while on the New York Yacht Club cruise a veritable sloop with single jib, clumsy bowsprit and short topmast, falls in with the fleet for a day or two, coming from some out-of-the-way nook and disappearing no one knows where, even old yachtsmen look at her with wonder. The typical sloop yachts, those which made the rig famous, *ARROW*, *GRACIE*, *FANNY* and *HILDEGARD*, have been so thoroughly altered that they are as near to the modern cutter rig

EVOLUTION OF THE YACHT.

30

as it is possible to make them, and the term 'sloop' now fails to describe them correctly.

While many features of the cutter-rig were adapted to American yachts between 1880 and 1886, the turning point in the great change of rig is marked by the building of *PURITAN* in the latter year. She and the many Burgess single-sticker which followed in the next six years were essentially cutters in rig, both spar and sail plans being based on the principles which we have already shown were characteristic of that rig. At the same time there is no question that the American modification of the conventional cutter-rig has been from the first an improvement on the original. The general proportions of the rig and the subdivision of the sails has been retained, though in applying the rig to different models and different climatic conditions many minor proportions and mechanical details have been altered, and for the better.

While the modern proportions of mast and topmast differ from the fashionable fad of 1880, the characteristic long housing topmast of the cutter is found on all American yachts in place of the stubby boom-stick that served as a topmast for the old sloop. On many of the first American cutters the bowsprit was fitted to house in the conventional British fashion, but with different models on both sides; the housing bowsprit is now almost a thing of the past in America and England. In setting the sail American practice is not uniform, the sail being sometimes set flying and sometimes on a stay; but in the distinctive characteristic of the cutter-rig, the use of two headsails in place of one, the British custom is followed exclusively. The use of runners and tackles is

also universal, while the fittings of spars and blocks, the hounds, masthead, gunnion strap and a hundred details are taken from the cutter and not from the sloop. It must be said that in almost all

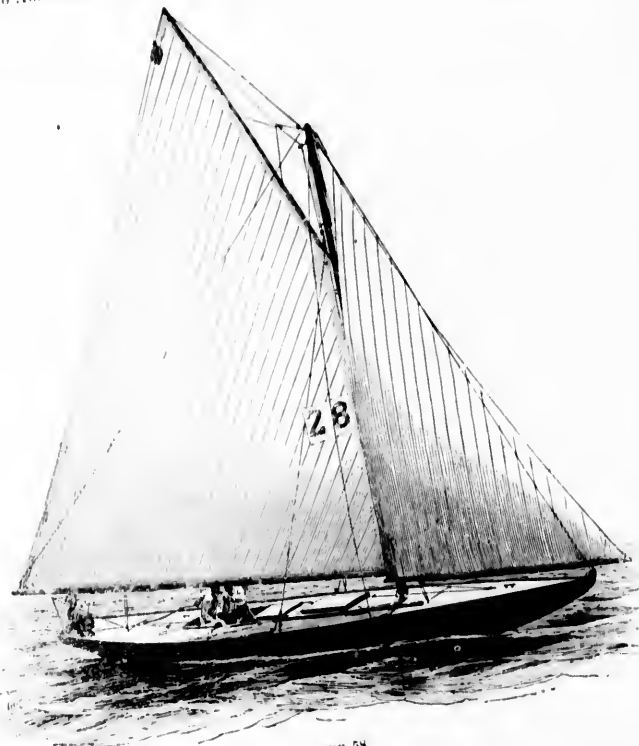

EL CHICO.—FIGURE 56.

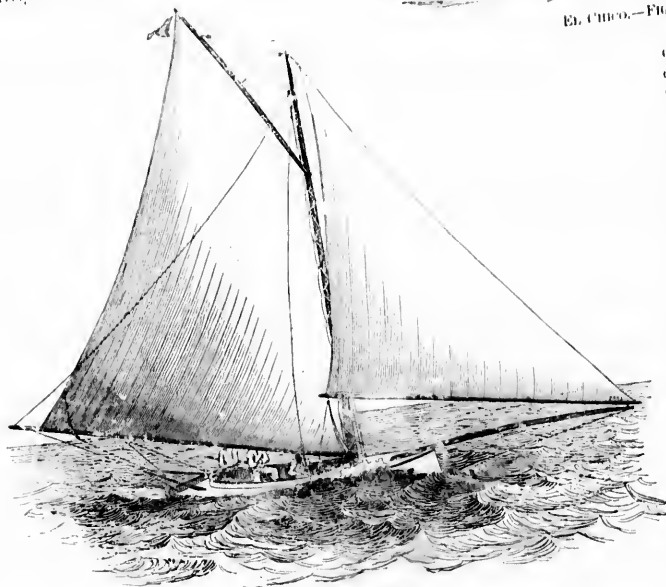

CRUISER.—FIGURE 57.

cases an improvement has been made on the original detail, but that detail was taken from the cutter rig and not the sloop.

There are three important points of American practice which have been retained on this side and adopted on the other—the use of cotton in place of linen, the lacing of the mainsail to the boom and the cutting of the club topsail with the yards parallel to topmast and gaff instead of crossing them.

The many changes of keel contour in both sloop and cutter, and the adoption of the length and sail area rule, have led to alterations in the position of mast, length of bowsprit and other details, but they have not affected the main proportions and principles which distinguish the cutter-rig from the sloop, and the rig of the larger American single-stick yachts today is a modification of the cutter-rig that had no relationship whatever to the national sloop-rig of 1880.

We have thus far confined the discussion to the limits laid down by . . . [some writers.] the rig and not the hull as determining the class; but most of our readers know that

there is a considerable strictly speaking happened convenience names which have been them. The technical and convey

is understood described character we have necessary will take of their apart from the other any influence 1860 to coming waters.

The 1880 position there was sloop masted and built in many to that beam to



The Dea.—FIGURE 59.

there is really much more involved in a thorough consideration of the question. While it is the rig, strictly speaking, which gives the name, it has happened in practice, as a mere matter of convenience and in default of suitable terms, that the names which properly belong to the rigs alone have been transferred to the hulls which carried them. This practice has been followed in America and England for a dozen years, and though technically incorrect, it has the sanction of usage and convenience.

Under this enlarged definition the term 'sloop' is understood to mean a vessel rigged as we have described, and also possessing certain marked characteristics of hull. To compare the hulls as we have already compared the rigs, it will be necessary to select some certain period, and we will take the sloop and cutter during the period of their greatest development and improvement apart from each other, the one in America and the other in England, and each entirely free from any influence of the other. This time will be from 1820 to 1880, after the latter date the two types coming into direct competition in American waters.

The yacht which carried the sloop rig up to 1880 possessed a strongly marked individuality, there was nothing of compromise about her, the sloop men had the courage of their convictions and built their boats and argued for them boldly in many a hot discussion. The typical sloop up to that time was a vessel of great proportionate beam to length, very limited draft, small displace-

ment, with light and bulky ballast, stone, slag and sometimes iron, distributed over the inside of the hull, a large cockpit and trunk cabin, and a large centerboard and no outside keel. These were the essential features of the design, and to them may be added the secondary features of heavy and bulky wooden build, a low freeboard amidships, a very crooked sheer with high bow and especially a high stern, a nondescript 'clipper stem' and a short, heavy counter, the steering being done by a wheel instead of a tiller.

The sloop model shows comparatively little change in shape and proportions from the primitive forms down to the yachts of a very recent period, but the model of the cutter has changed materially from time to time, according to intended use, and, in the case of yachts, to measurement rules and improvements in construction. While always much deeper than the sloop, the cutter model was originally very wide, differing little, if any, from the sloop in beam.

In the course of the peculiar evolution which British yachts underwent between 1840 and 1880 under the stimulus of racing and the old tonnage rule, the proportions of the original models were greatly changed, the depth being increased and the beam gradually decreased. Up to about 1870 the principal cutters were of moderate



SCHEMER.—FIGURE 60.

EVOLUTION OF THE YACHT.

32

beam and depth, showing a hollow or S section quite similar to the section adopted here in recent years in the new keel boats. The proportion of beam to length ran down very rapidly between 1870 and 1880, as the use of a lead keel became universal, and at the latter date it was but 1 to 5, or 16 feet beam for 80 feet load waterline, and in the next five years it ran to the extreme point in GALATEA of nearly six beams, even going as high as seven in the smaller classes.

None of the older and wider cutters ever crossed the Atlantic, and American yachtsmen troubled themselves very little about foreign and presumably inferior models until they were forced to do so by the attacks of the early 'cutter cranks' about 1878, and the actual invasion of the sloop's waters by a hostile fleet of British models either imported or built here from imported designs.

The 'typical' cutters imported about 1880 were all small, and even more extreme in narrow beam and great depth than the larger cutters of the day, and their rig, with its preposterously short lower mast and equally long topmast represented the extreme carrying out of a fashionable fad which was popular in England only for a short time. Considering the interest which these peculiar craft excited among American yachtsmen, and the hot arguments over their merits as compared with the sloop,

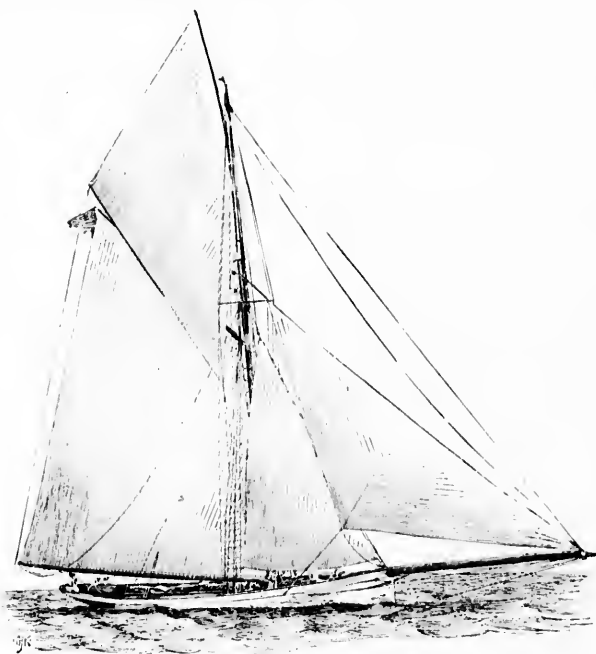

PORTUS — FIGURE 61.

it most naturally followed that from that time to the present day the word 'cutter' has been understood to mean exactly such a yacht as MARYE or CLARA, ignoring all past or future varieties of the rig and model.

The characteristic features of these cutters were narrow beam, great depth and draft, and corresponding heavy displacement; a flat side, a very straight sheer with high freeboard amidship, a plumb stem, a long counter tapering to a fine edge, a flush deck and no cockpit or cabin trunk, while the bottom of the yacht was carried down in a fair curve into a deep keel of lead, there being no centerboard. Many of these points, though characteristic, were merely secondary, such as the use of a tiller for steering, the absence of a cockpit, the sheer and contour of stem and stern; the essential principles of the cutter, distinguishing it from the sloop, being greater displacement, different proportions of beam and depth, the shaping of the hull into a keel, dispensing with the centerboard, and the use of lead ballast in place of iron, stone or slag, such ballast being placed outside the vessel. It is interesting to note also that the cutter was of much more elaborate and stronger construction than the sloop, and was built from a design on paper made by a professional yacht designer, while the sloop, as a rule, was produced by the builder alone from a half model cut out of wood.

Literally speaking, had the rig of MARYE been transferred to SCHEMER, and vice versa,

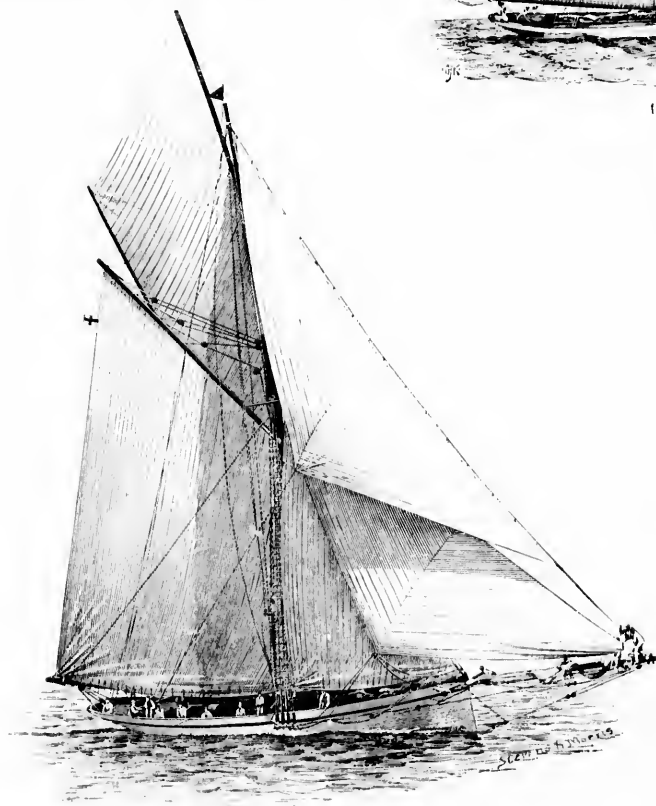

GALATEA — FIGURE 62.
From a Photograph by Johnson.



GLORIANA—FIGURE 63.

the first would have become a sloop and the latter a cutter; a sort of *reductio ad absurdum* which shows how faulty and inadequate is the dictionary definition according to rig. While the extension of the two terms to cover the model and hull as well as the rig has led to much confusion, it was perhaps the easiest and best method at the time of distinguishing the two rival types.

In our opinion then, the distinction between the cutter and sloop, according to the popular use of these terms, involves certain important principles of rig and hull, accompanied by a still larger number of minor characteristics, and where a question arises of the classing of a particular vessel, it must be decided not on one or two alone, but on a majority of these principles and details. The addition of a lead keel and a double head rig to an old centerboard sloop does not necessarily make her a cutter, nor does the possession of a centerboard, a cockpit, a wheel or a cabin trunk make a vessel a sloop.

Coming now to the heart of the whole discussion, let us look at the earlier Cup defenders, the great Burgess-Paine trio. Taking the sail plan first, that of *PRITAN*, *MAYFLOWER* and *VOLUNTEER* has nothing in common with the sloop rig of the time, as shown on *GRACIE*, *ARROW* and *FANNY*. Not only are the proportions different, but the number and disposition of the sails is directly the opposite of the sloop. It is true that

the mainsail is lashed to the boom, the topsails are cut in American fashion, the topmast is shorter than in the small imported cutters, while there are many improvements in minor mechanical details, but in spite of this it needed but a glance at *PRITAN* in company with such typical vessels as the sloop *GRACIE* and the cutter *GINESTA* to show that she was utterly unlike the former and very like the latter.

Now, looking at the hull, the first point which strikes the eye is the beam of the yacht, which is thoroughly American in extent, even wider by several feet than the old cutters. The next feature, however, the form of the topsides, including the sheer, stem and counter, is merely that of the cutter, every characteristic of the sloop's topsides being lacking. Taking next the yacht out of water the broadside view shows a cutter of moderate draft, with a little drag to the keel and a moderate rake to the stempost, but nothing at all suggestive of the straight keel, square forefoot and plumb sternpost of the sloop, while the greatly increased depth and the positive keel outside the hull, and that of lead too, all point to the cutter rather than the sloop as the original point of departure from which all alterations have been made.

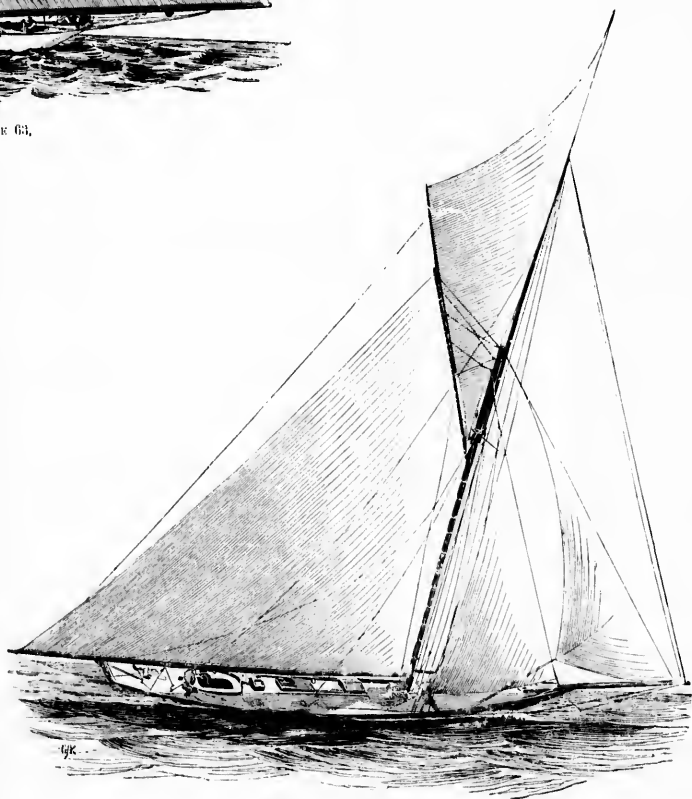

WASP.—FIGURE 64.



V. DUFFE.—FIGURE 65.

"Coming to the mid-ship section, a marked departure from the compressed beam of the extreme cutter is found, the beam and bilge suggesting the old sloop, but as we go downward into the reversed curve of the floor continued into the deep keel all resemblance to the sloop is lost, the section being really a revival of the old cutter section of the days before the beam was sacrificed to the tonnage rule. On deck and below we look in vain for the cockpit and great cabin trunk of the sloop, but we find the same centerboard trunk and board, still an essential feature of the design in PURITAN.

"In summing up this inventory of leading features, we find that two, and two only, of the vital ones are derived from the sloop, the beam and the centerboard; the others are taken from the cutter, improved in some details; the form of the top-sides is copied directly from the cutter, the depth, amount of displacement and mid-ship section are each a compromise, but to an extent that was condemned by the theory and practice of the sloop men, but which finds its counterpart in one stage of the cutter's development; while the lead keel was taken bodily from the British. The construction of the early 'compromise' was that of the cutter rather than the sloop, and would have been still better had it leaned even more to the former and further from the latter.

"Considering not the vessel alone, but the previous training of her designer, his expressed opinions, and the long controversy over points of design which preceded her building, we have always classed PURITAN as a centerboard cutter, and have denied the tardy claims of relationship put forward by the sloop men after she had proved a success, and not the failure they confidently predicted. While in no sense a servile copy of British models, and displaying in all parts of her hull and rig the skill and enterprise of her designer and those associated with him, she was essentially a cutter and not a sloop.

"Whatever question might be raised over her, there was no possible ground for dispute in the later yachts, VOLUNTEER, with still greater depth, and then the large fleet of Burgess cutters in which the centerboard was entirely discarded. In deference to national prejudices, it has been the custom of most American writers to class all of these later yachts, more particularly the successful ones, such as PAPPOOSE and GOSBOON, as 'keel sloops;' but, in addition to the fact that all of these yachts possessed the distinguishing characteristics of the cutter, in hull and rig; it is also true that there has never existed in this country a class of typical sloops.

"Although keel sloopers were numerous in American waters, the sloops were almost exclusively centerboard craft, and without the least semblance of an outside keel, even of wood. The *Yacht List* of 1874, out of a total of over 500 yachts, shows but seven keel sloops of any size over 30 feet length waterline, and only two of these over 40 feet. There are in the same list a couple of dozen small keel boats, about 18 to 25 feet length waterline, mostly located about Boston, but in none

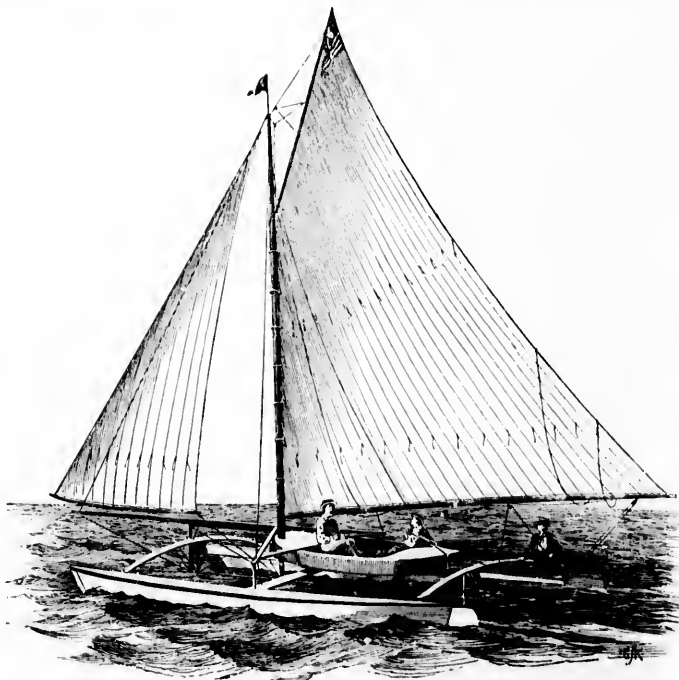

TARANTELLA.—FIGURE 66.

were a
ing at
into an
the typ
only di
known
beam
Colon
"The
sloop w
teen ye
25 to 30
stantial
board y
oak an
keel sl
sacred
iron si
in nu
ideas t
the in
same p
the co
the m
which
and de
"The
in yar
within
half ex
been a
old Th
old slo
by the
to mes
challe
rules i
structi

of our researches have we been able to discover any well defined type of keel sloop in this country prior to the beginning of the cutter agitation and the importation of designs and yachts from England. The few keel boats other than the large schooners existing here

"One important result has been the total extinction of the American centerboard sloop, even the existing vessels of that type having been so radically altered that they are no longer recognizable. Another important result has been the widening of the once narrow British cutter to its original proportions, with many changes of secondary details. A third result has been the construction of a new and better pleasure fleet in America, still wide, and in some cases still retaining the centerboard; but based primarily on those principles of safe proportions, low weight and sea-going rig, which from the first have constituted the great superiority of the cutter over the sloop.

"If the Burgess boats are, as we contend, properly cutters, it is not necessary to discuss the later Herreshoff craft, they are identical in principle and differ mainly in having even greater draft.

"If *GLORIANA* is a sloop in rig or hull, what then were *FANITA* and *VIXEN*, the representatives of the 46 foot class, up to the time that Americans began to adopt the ideas embodied in the cutter? One may search in vain through the history of American yachting for anything in the past suggesting the model or rig of *GLORIANA*, *WASP*, *NAVAHOE* and *COLONIA*; all that he will find will be in direct opposition to the model, the rig and the ballasting of these yachts. The most marked suggestion of the sloop principles in some years is found in the extreme beam, the high bilge and the live ballast of *VIGILANT*, but the good old sloop men like Capt. Coffin and 'Devoted Yachtsman,' would turn in their graves

at the suggestion of an American sloop with a cutter-rig, a lead keel of 70 tons and a draft of 14 feet.

"There is nothing in the history of yachting that is more fascinating and instructive than the study of primitive models and rigs, and of their gradual changes, combinations and improvements, with the in-

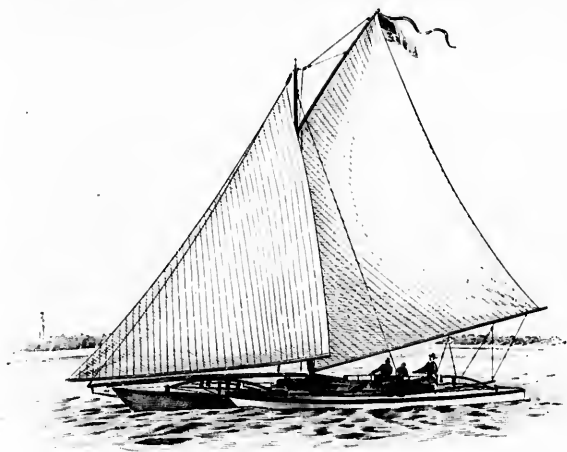

DUPLEX.—FIGURE 67.

were as exceptional as the few centerboard sloops and cut-boats existing at the same time in England, and it is impossible to group them into any distinct class. The American sloop was a centerboard sloop, the type which first displaced her was the centerboard cutter, and the only distinct type of keel single-sticker which this country has ever known, is the cutter, whether of moderate beam like *BEDOUIN* or great beam like *COLONIA*.

"The nearest approach to a native keel sloop was found in eastern waters nearly fifteen years ago; the vessel in various sizes from 25 to 90 feet length waterline, being built substantially on the moulds then used for centerboard yachts, but with a deep outside keel of oak and a sloop rig. While these were really keel sloops, though they violated the most sacred canon of the sloop men in carrying an iron shoe below the oak keel, they were few in number; and with the spread of cutter ideas they soon disappeared, giving place to the imported 'Itchen boat' of about the same proportion of beam and draft, but with the conventional cutter-rig and a deep body, the midship section showing a fair S curve which merged the hull proper into the wide and deep lead keel.

"There have been more important changes in yachting on both sides of the Atlantic within the past ten years than in the previous half century; many and complex causes have been at work—the extreme to which the old Thames rule ran itself, the defeat of the old sloops by the imported cutters, followed by the defeat by the American cutters built to meet them of the larger cutters which challenged for the Cup, the abandonment of many old measurement rules in favor of the length and sail area rule, improvements in constructing and ballasting, the use of steel and of composite build,

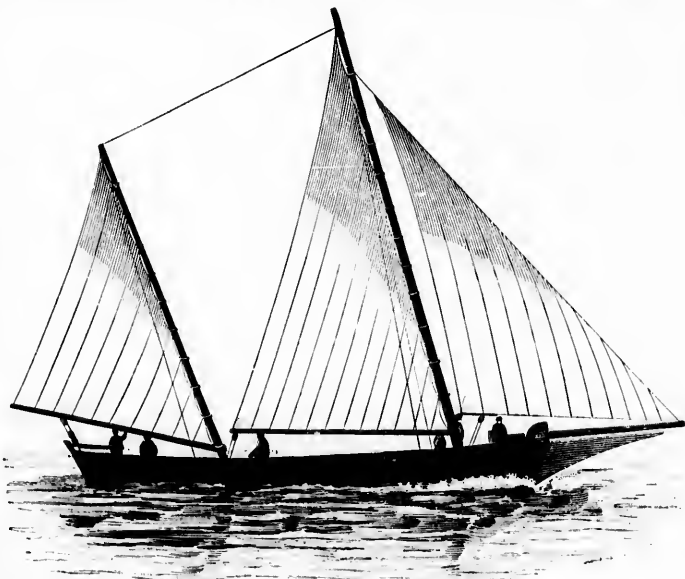

BUCK-EYE.—FIGURE 68.

fluences such as measurement rules, local conditions and increased technical knowledge which have produced these changes. If anything is to be learned from such a study, however, it must be conducted

EVOLUTION OF THE YACHT.

26

from a purely impartial technical standpoint, setting aside all patriotic and political feeling and looking only for established facts, wherever they may be found."

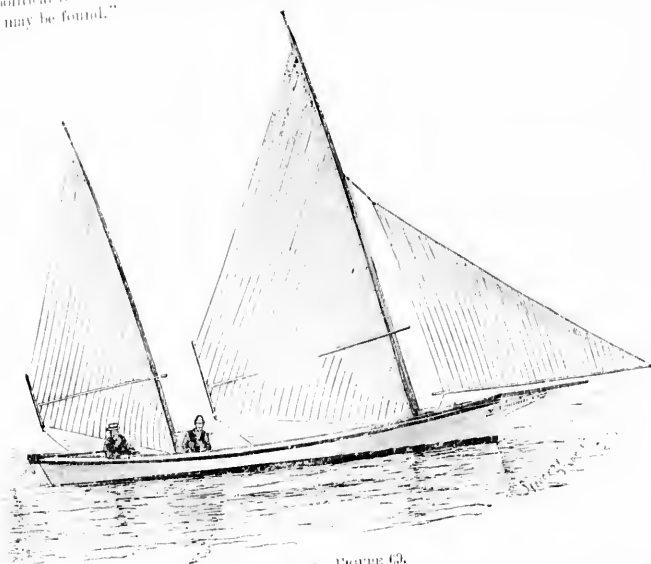

CHESAPEAKE.—FIGURE 60.

A full description of the rig of a sloop and cutter will be found in the chapter relative to the RIG OF THE YACHTS.

The following illustration, (Fig. 60) is of a centerboard type of yacht having a sloop-rig and Fig. 61 represents the well-known yacht PURITAN, which is a wooden centerboard type with a modern cutter-rig. She was designed by Edward Burgess for a syndicate of eleven Boston gentlemen. She was built by Geo. Hawley & Son, of South Boston, and was launched in 1885. Her present owner is J. Malcolm Forbes of Boston, Mass.

Her dimensions are:

Length over all,	91 feet.
Beam,	22 feet 7 inches.
Displacement,	105 tons.
Top-mast,	44 feet.
Gaff,	47 feet.
Sail area (N. Y. Y. C. Rules),	7,332 feet.
Length load waterline,	81 feet 1½ inches.
Draft,	8 feet 8 inches.
Mast, deck to hound,	60 feet.
Boom,	76 feet 6 inches.
Bowsprit (outboard),	38 feet.
Ballast (inside and keel),	18 tons.
Racing measurement,	83.85 feet.

On June 30, 1885, PURITAN sailed her first race in the regatta of the Eastern Yacht Club, when she won easily, beating the entire fleet. She beat PRISCILLA 17 min. 40 sec. on August 3rd, winning the Goolet Cup after joining the cruise of the New York Yacht Club. She beat PRISCILLA two out of three races in August and was then selected to defend the AMERICA'S Cup. A description of her races with GENESTA will be found in the chapter on the AMERICA'S Cup. It is sufficient to say here that she won the two races sailed. On

June 19, 1886, she won the Cup in the regatta of the S. C. Y. C. On June 29, she beat PRISCILLA and MAYFLOWER in the regatta of the Eastern Yacht Club.

The next illustration (Fig. 62), is of the celebrated English racing yacht GALATEA, with which Lieutenant William Horn, R. N., tried to win back AMERICA'S Cup in 1886, but which was beaten in the two races sailed by MAYFLOWER. A full account of which will be found in the chapter relative to AMERICA'S Cup in the second volume. It will be seen that she carries a cutter-rig, and, like all such rigged yachts, before it was modernized the mainsail was not laced to the boom.

Her dimensions are as follows:

Length over all,	100 feet.
Length load waterline,	86 feet.
Depth,	13 feet 3 inches.
Draft,	13 feet 3 inches.
Beam,	15 feet.

We now come to a typical American cutter; the famous yacht GLORIANA (Fig. 63). She is one of nine yachts of the 46 foot class, designed by N. G. Herreshoff, and built by the Herreshoff Mfg. Co., in the year 1891. She was originally owned by Vice-Commodore E. D. Morgan, of the New York Yacht Club, but is now the property of W. Barton Hopkins, M. D., of Philadelphia. She was built

under the personal direction of her former owner, and while most of the other 46 boats were partially completed before GLORIANA'S keel was laid, she was aloft before any of the other nine. It is worth while

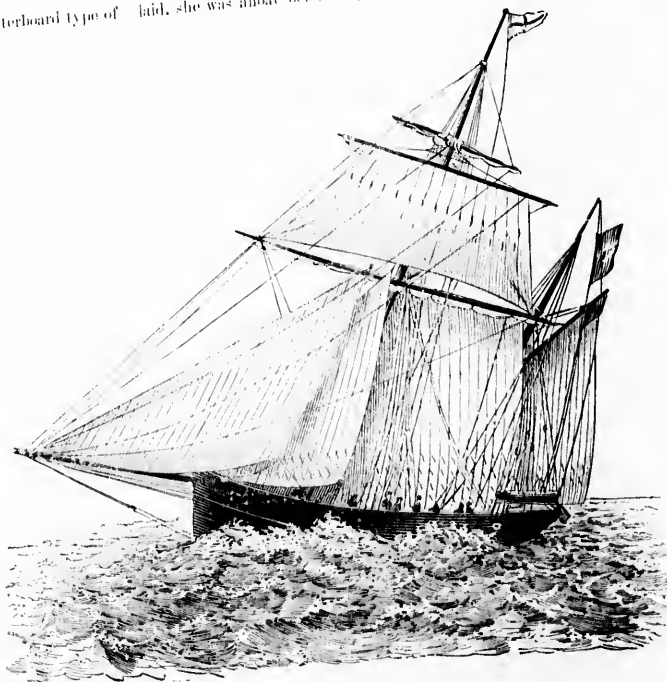

KESTREL.—FIGURE 70.

noting that
ning of the
last of Augu
GLORIANA:
by the Her
they never
fast yachts.
hood of \$1
and buildin
were manife
degree, for
of accidents

The follow
Length ove
Length lon
Depth,
Draft,
Beam,

The racin
follows:
New York
GLORIAN
and JES
Goolet C
SAYONA
compe
first priz
Atlantic Ya
gatta, J
TILUS, J
yachts w
again de
GLORIAN
modore
Seawanhuka
NATH
Corinthian

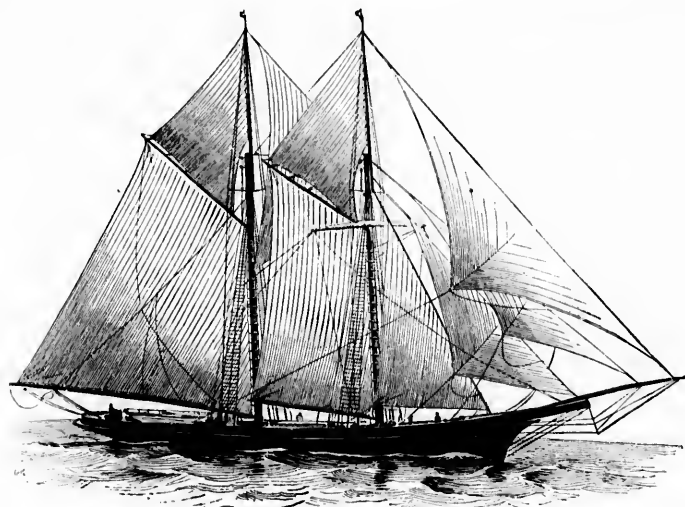

AMBRESS —FIGURE 71.

noting that she was in as good trim at the beginning of the season as she was at the close, in the last of August.

GLORIANA was the first boat of any note built by the Herreshoffs in many years, even though they never ceased to be regarded as builders of fast yachts. Her cost was in the neighborhood of \$12,000, and both in her designing and building the greatest care and earnestness were manifested, which may account, in a great degree, for her staunchness amid the general run of accidents which befell the 46 foot class of 1891.

The following are her dimensions:

Length over all,	70 feet.
Length load waterline,	45 feet 2 inches.
Depth,	10 feet 5 inches.
Draft,	10 feet 6 inches.
Beam,	13 feet.

Official Number, 80,152.

The racing record of GLORIANA for 1891 is as follows:

New York Yacht Club, Regatta, June 18th:—GLORIANA won, beating MINEOLA, NAUTILUS and JESSICA. Again on August 7th, in the Gulet Cup series, she won from BARBARA, SAYONARA, etc. On August 13th, GLORIANA competed for the Special Cups and won the first prize, a cup valued at \$500.

Atlantic Yacht Club, Twenty-sixth Annual Regatta, June 16th:—GLORIANA defeated NAUTILUS, JESSICA and MINEOLA. These same yachts with the addition of SAYONARA, were again defeated in the Special Race of June 23, GLORIANA winning the cup offered by Commodore Banks.

Seawanhaka Corinthian Yacht Club:—Won from NAUTILUS and JESSICA in a race held June 20.

Corinthian Yacht Club of New York:—In the

Annual Races held June 22nd, GLORIANA defeated JESSICA and SAYONARA. In the Sweepstakes Race of August 17th, she won a prize of \$505, coming in first with seven starters.

Racing Record, 1892:

Annual Cruise, New York Yacht Club, August 3, 1892:—WASP beat GLORIANA, SAYONARA, and LIHS on the run to New London.

Run from New London to Newport, August 4th:—GLORIANA beat WASP, MINEOLA, UVIRA and SAYONARA in order named.

In the race from Newport starting at Brenton's Reef, HARPOON beat GLORIANA after a whole day's flight.

On August 6th in the race to Vineyard Haven, GLORIANA and HARPOON had a close race, the former winning, however, by a few seconds.

In the fifth race of the Cruise, from Vineyard Haven to Marblehead, WASP beat GLORIANA.

The composite keel cutter WASP, illustrated in Fig. 64, shows the modernized cutter-rig. She was owned by Archibald Rogers of Hyde Park on Hudson, N. Y., who recently sold

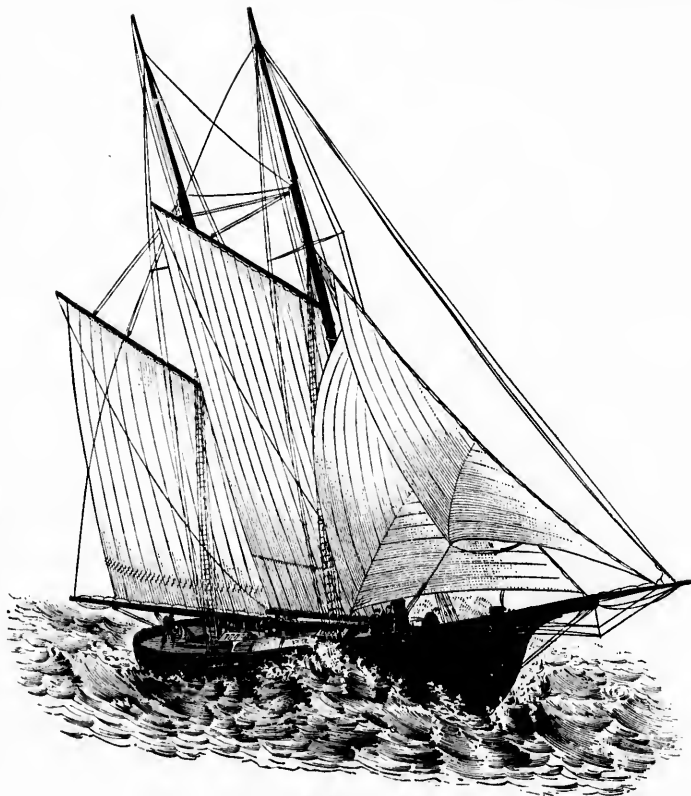

MADELINE.—FIGURE 72.

(From a drawing by Cozzens.)

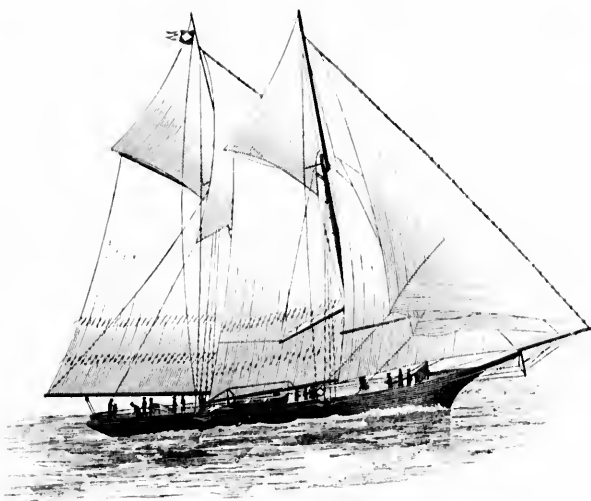

SAPHO.—FIGURE 73.

her to H. F. and R. L. Lippitt. She was designed by N. G. Herreshoff and built by the Herreshoff Mfg. Co., being launched in 1892.

Her dimensions are:

Length over all,	72 feet.
Length load water-line,	45 feet 6 inches.
Depth,	11 feet.
Draft,	10 feet 8 inches.
Beam,	13 feet.

LUGGER.

A lugger-rigged boat is shown in Fig. 68. The old fashioned lug sail was without boom and is now confined principally to fishermen's boats. It is liked because when the sheet is let go the sail is nothing more than a flag. In a "dipping lug" the sail has to be lowered at every tack, shifted to the other side, and again hoisted. The tack of the lug is carried past the mast and made fast to the weather bow. For safety, a boom should be used or the tack of the sail should be made fast either to the mast or to the mast thwart.* The lugger illustrated in Fig. 65 is VEDETTE, owned by F. M. Gray of the Royal Canadian Yacht Club, and fairly represents the modernized lugger-rigged yachts, of which there are quite a number.

Her dimensions are:

Length over all,	47 feet 3 inches.
Length load waterline,	34 feet.
Draft (board up),	6 feet 2 inches.
" (board down),	9 feet 4 inches.
Beam,	9 feet 6 inches.
Spars: Pole mast,	37 feet.
Yard,	31 feet 5 inches.
Boom,	36 feet.
Bowsprit (outboard),	11 feet 4 inches.

VEDETTE was designed by William Fyfe, and built by H. Stanton of Toronto; she was launched May 23, 1893. She is a keel yacht with a small

* See "Boat Sailing for Amateurs," p. 35.

steel centerplate, which does not come above keel. She has a cabin with flush decks.

After fourteen starts in 1892, she won nine firsts, one second and two thirds. In cup races she won four out of five starts, winning the Lansdowne, Lorne, Monck, and White Wings Cups.

CATAMARAN OR DOUBLE-HULLED SAIL-BOAT.

The name catamaran is borrowed from the East and West Indies and South America, where it is applied to native rafts of three pointed logs, the large craft of this sort carrying sails and being used as lighters. The double-hulled boat was probably originated by some Fiji Islander. His sole material was the log, and no boat could be built with greater beam and stability than the dug-out already described. No safe sailing being possible in such a contrivance, he probably hit upon the happy expedient of joining two canoes by an intervening deck, and at once invented the well-known Fiji war canoe, and thus the

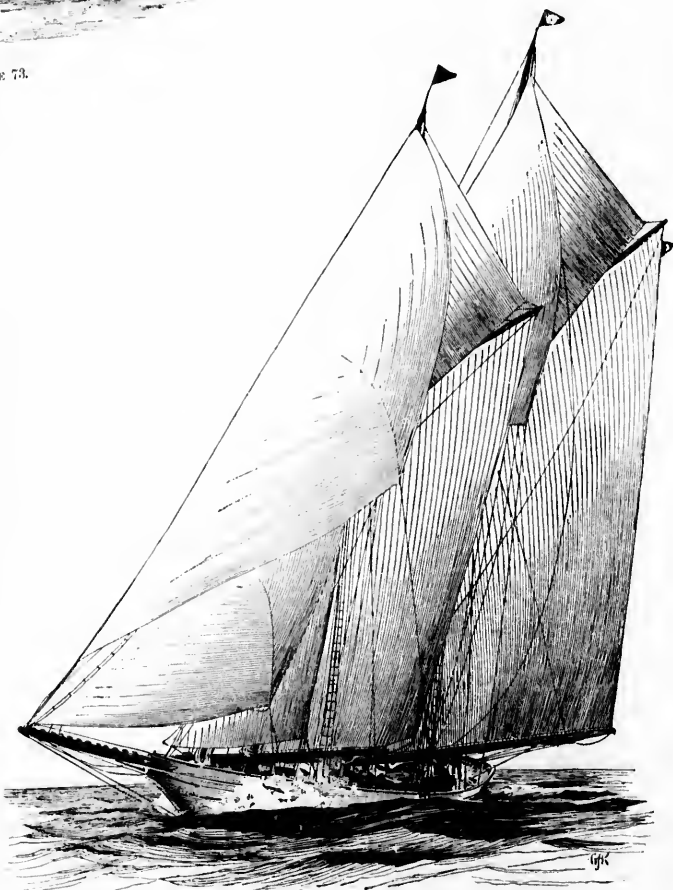

ALCEA.—FIGURE 74.

"catamaran and the junction the motions of from the excessively heral years applied the permit canoe own sea. ER, JOHN which were in detail at Fig. 66, a tween GILBERT is 15 in timed to wind free, is 6 1-2 mil gives satisf that a rig The catam but a rou steers very quickly as are very es water she is The the that by set

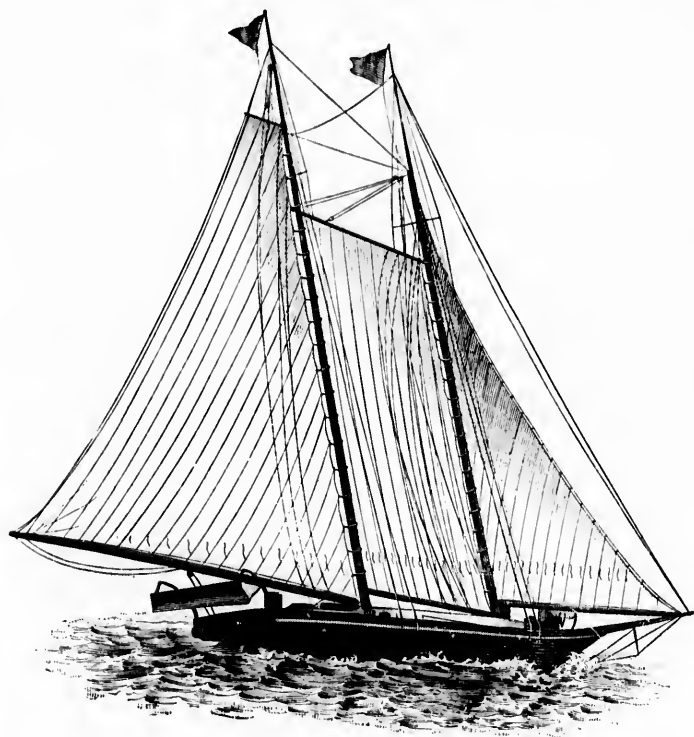

CHISPA.—FIGURE 75.

"catamaran" came into existence.* The Fiji boat and the majority of catamarans possess the objection that in rough water the independent motions of the hulls will ultimately wrench them from the deck, unless the connections are excessively heavy. Mr. Herreshoff undertook several years ago to make a light deck frame, and applied the ball and socket joint, which would permit each hull to accommodate itself to its own sea. He built AMARYLLIS, ARION, TEASER, JOHN GILPIN and TARANTELLA, all of which were substantially the same, differing only in detail and size. TARANTELLA is shown in Fig. 66, and the only point of difference between GILPIN and TARANTELLA is that the latter is 15 inches longer. TARANTELLA has been timed to make 18 miles an hour, with the wind free, and the maximum speed to windward is 6 1-2 miles per hour. The joined deck frame gives satisfaction, and Herreshoff does not believe that a rigid one would do as well in any water. The catamaran makes no leeway in smooth water, but a rough sea lifts her bodily to leeward. She steers very readily, but does not come about as quickly as a single-hulled boat. Her motions are very easy but when driven hard in rough water she is very wet.

The theory of the catamaran's designers was that by setting sails upon two narrow, sharp hulls

* See "Sci. Am. Supt.," Jan. 5th, 1878.

placed wide apart, great speed could be obtained, because of the small resistance offered by the water against such hulls and because the wide-spread of the two boats would render the craft uncapizable under lateral wind pressure. The catamaran certainly does show speed, but in rough water she is generally out of order and sometimes a moderate chop sea will shake her in twain. She has a habit of losing her rudder, and her centerboard gets twisted out at times. She will not rise to a sea, and will not go through it steadily, at times capsizing.*

On June 23, 1876, in the second race in the series of Centennial Races, the famous catamaran AMARYLLIS made her appearance. She was so diminutive, only 24 feet long, and so strangely constructed that she encountered great laughter and ridicule. The sundruggers, however, strenuously objected to the catamaran; still she started and crept ahead of vessels several times her length, until she led all of her competitors and came in fifteen minutes ahead of the first yacht. She was, however, ruled out and did not receive the prize she so justly won.

On June 27, 1877, a race between two catamarans, AMARYLLIS and JOHN GILPIN, took place, and a novel accident happened to the former. While going at a very rapid rate, the bows of her two hulls ran under and her momentum was so great that she

* See "Century Magazine," May, 1882; "Coast and Inland Yachting," F. W. Fauborn.

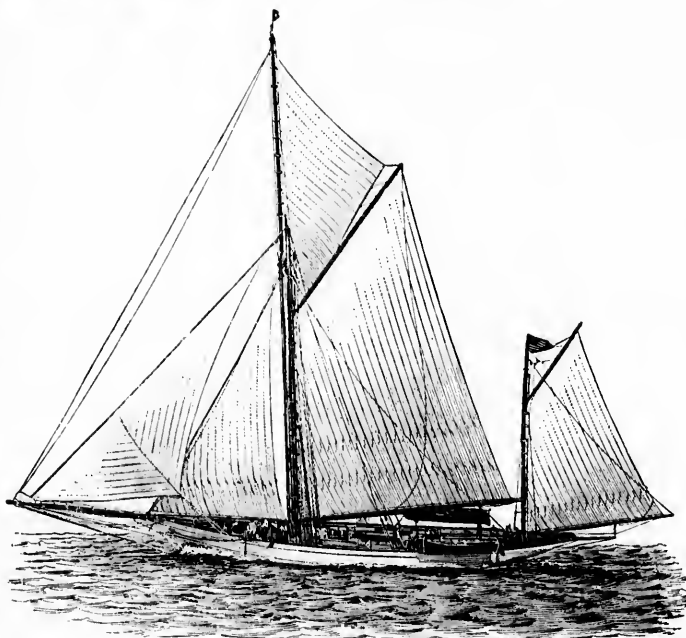

MONTECITO.—FIGURE 76.

EVOLUTION OF THE YACHT.

40

turned completely end over end. Since that time the hulls have been built with a rank sheer forward, in order to counteract this tendency to run under. The following is a list of the principal catamarans still in service:

Name.	Owner.	Length Over All	Beam	Draft	Displacement
Corsair.	R. W. Inman.	42.6	37.0	28.0	4.3
Duplex.	J. H. Longstreet.	49.0	38.6	20.0	3.1
Battie.	F. D. Hughes.	40.0	...	19.0	...
(Fully Rigged)					
John Gilpin.	A. Panich.	31.10	31.0	12.5	...
Lodola.	C. Littlefield.	31.0	30.0	18.6	...
Lou.	Geo. E. Felt.	32.0
Nightmare.	R. M. Weed, M. D.	42.0	...	21.0	...
Nip & Tuck.	F. Roosevelt.	...	33.0
Paradox.	C. Coughtry.	29.0	28.0	15.0	...
Primo.	...	33.0	31.6	18.0	...
Tornado.	W. Grey et al.	26.0

Fig. 67 represents DUPLEX, owned by Mr. J. H. Longstreet, built in 1882 by Thomas Fearon of Yonkers, New York. In 1887-8 she was rebuilt by H. C. Ford.

Her dimensions are:
 Length over all,
 Length load waterline,
 Beam,
 Draft.

40 feet.
 38 feet 6 inches.
 20 feet.
 1 foot 10 inches.

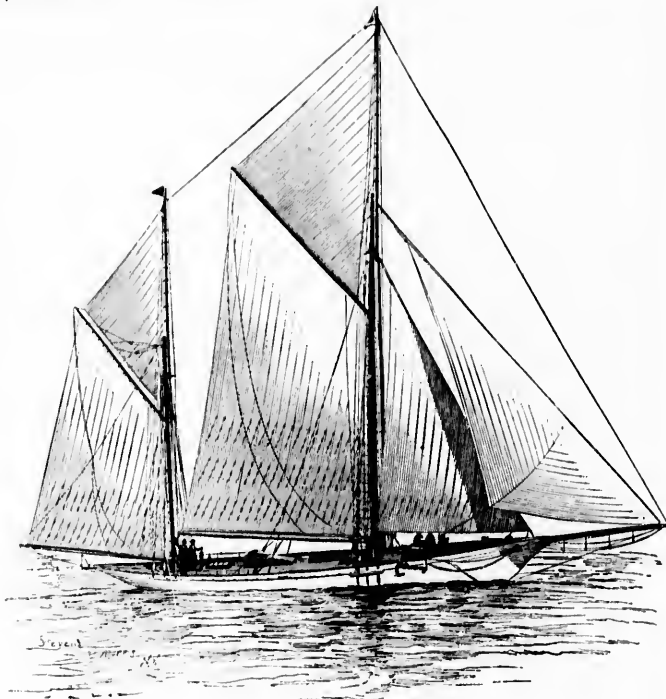

ARGO.—FIGURE 77.

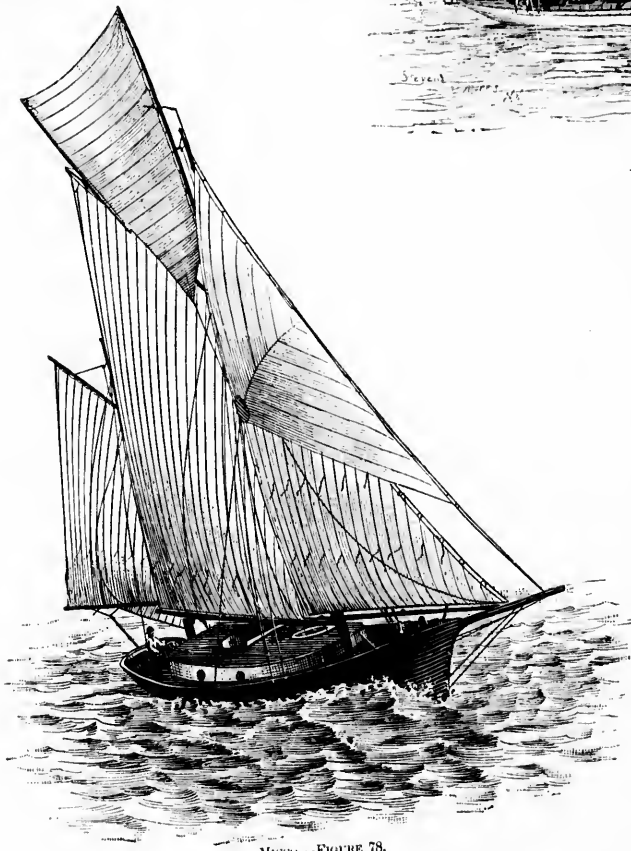

MICO.—FIGURE 78.

THE HUCKEYE.

The buckeye is a type of yacht which originated in the South; it has sometimes been called "bugeye," and, according to tradition, it was first conceived by the dug-out builders of the Dismal Swamp. "Originally," says Pangborn, "the buckeye* was a log hollowed out and shaped into a boat and was used by the negroes. To-day, however, buckeyes are built upon carefully drawn plans and many of them are excellent vessels. They are common on the coast waters south of the Delaware Bay and are used chiefly for hunting-boats, their cheapness, handiness and roominess rendering them useful to the sportsman. A true buckeye is a double-ender, but some large ones have been built with an overhang stern, which destroys the ideal and creates a new kind of craft. The buckeye is not considered 'pretty' by yachting men, but it is in every respect a serviceable boat, being both speedy and safe. The lee-board, a primitive contrivance designed to check the drift of a sailing vessel, was attached to the earlier buckeyes, but nowadays the regulation centerboard is used with these boats."

Fig. 68 represents a typical buckeye and Fig. 69 illustrates CHESAPEAKE, a modern

* "Century Magazine," May 1892, "Coast and Inland Yachting," F. W. Pangborn.

buck
 CHES
 to CH
 Fair.
 elega
 Lamb
 ing f

The
 mast
 main
 aft
 ever,
 a fo
 com



WADUN.—FIGURE 79.

bukeye built for Robert D. Lambden of the CHESAPEAKE BAY YACHT CLUB and was sent to Chicago for exhibition at the World's Fair. This canoe is a beautiful model, is elegantly finished and is a credit to Mr. Lambden, who has a reputation for building fast canoes.

KETCH.

The original ketch was a form of two masted vessel carrying a tall, square-rigged mainmast forward, and a shorter fore-and-aft rigged mizzen abaft: recently, however, the square rig has given way to a fore-and-aft rig. The yachts at the commencement of the present century

were rigged as ketches, according to Falconer.*

However, the ketch rig was never a favorite with yacht owners, although, no doubt, a few existed in the early days of the ROYAL YACHT SQUADRON; and so late as 1846 Lord Yarborough owned the yacht *KESTREL*, of about 200 tons, shown in Fig. 70, from *The Field*. In 1850 only one ketch appeared in Hunt's *Yacht List*, and she was of ten tons. In 1860 no ketch at all appeared in the *List*, but at the present time there are at least a half dozen in existence, though they are really more like dandies than the ketch of 1800. The rig was generally objected to on account of its lofty, narrow sails, and because it was not nearly so weathery as the yawl or dandy, and, indeed, even inferior to the schooner in this respect. However, English ketches like *LUFRA*, *VERONICA*, *VENTURA*, *BRIDESMAID*, etc., have proved themselves very little inferior to the yawl of similar length and total sail area.

A ketch was a favorite form of mortar-vessel, owing to the clear deck amidships, and the bomb-ketch is frequently mentioned in the wars of the last century.

The American yawl has been, until quite recently, called a ketch—an illustration of which is given in *Mreco*, Fig. 78.

SCHOONER.

A schooner-rigged yacht, on account of the ease with which she can be handled and the fact that she is peculiarly adapted to all weathers, is the favorite rig for large yachts and is becoming the popular rig for yachts above forty feet in length. She is less expensive to handle, as a small crew can manage such a vessel with ease, while a sloop of the same size would require a much

* Marine Dictionary.

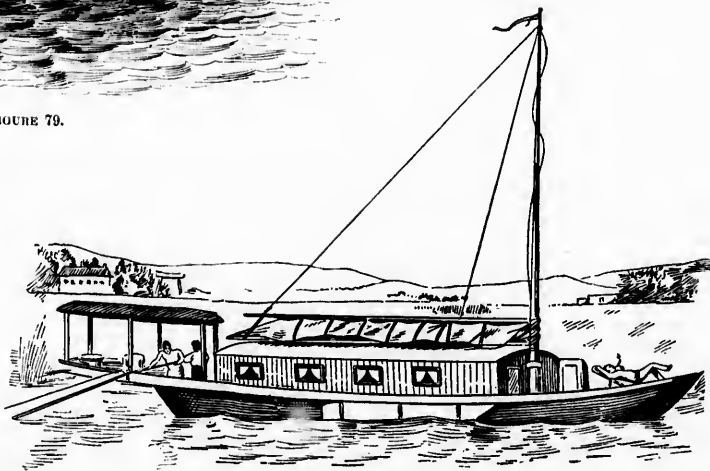

A MODERN SHANGHAI HOUSE-BOAT.—FIGURE 80.

larger crew. It is natural to think of a schooner as a large yacht, for until recently but few small yachts had adopted this rig. Year by year, however, the number has increased and certainly will

modern American schooner-rig, the old time schooners having disappeared almost as completely as the sloop.*

Fig. 72 represents the schooner *MADELINE* as she was in her earlier days when owned by Jacob Voorhis, Jr.

The famous schooner *SAPPHO* is shown in Fig. 73, and represents with *AMBASSADRESS*, the schooner-rig of many years past.*

ALCEA, illustrated in Fig. 74, represents the largest schooner yacht that came off the ways in 1892. She is a steel yacht, designed by William Gardner, and was built by Lawley & Son corporation for Messrs. Charles and Lewis Clark, of St. Louis, Mo.

Her dimensions are as follows:

Length over all,	124 feet.
Length load waterline,	80 feet.
Draft,	13 feet.
Beam,	22 feet 6 inches.

As shown by the difference between her waterline length and length over all, the yacht has a long overhang both fore and aft. The bow has a particularly graceful curve and shows a reasonable fullness, while her rail sheer is remarkably perfect and handsome. The

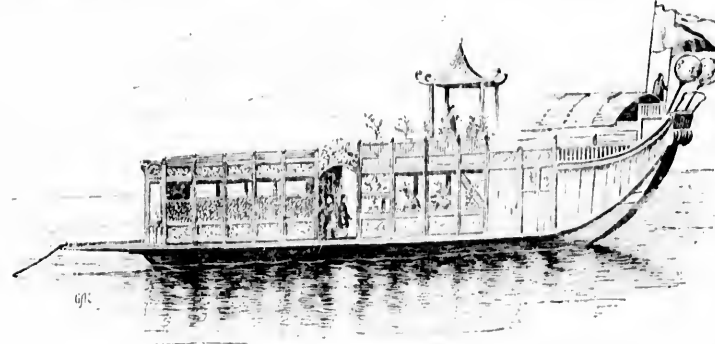

PLEASURE BOAT OF CANTON.—FIGURE 81

increase, especially for such yacht-men who wish to secure pleasure, comfort and safety.

The largest schooner-rigged yacht in the world is *AMBASSADRESS*, shown in Fig. 71. She is a keel boat at present, though originally a centerboard. She was built and designed by Davis Coll, City Island, New York, launched in 1877, and was the property of Nathaniel Thayer of Boston until quite recently when she was purchased to be used as a trading vessel.

Her dimensions are:

Length over all,	116 feet 1 inch.
Length load waterline,	130 feet 6 inches.
Depth,	12 feet 3 inches.
Draft,	12 feet 3 inches.
Beam,	28 feet 2 inches.

Under the head of sloops and cutters the course of development in single-stick yachts was set forth, showing how the modernized and modified cutter had replaced the old sloop. The same development has taken place in the case of the schooner yacht. Mr. Stephens says: "The old American schooner-rig used up to 1885, with a large foresail, single jib and flying jib-boom, has given place to the English rig made famous by *MIRANDA* in 1876, with a very large mainsail, small foresail and the head rig of a cutter with pole bowsprit and double headsails. The rig, by the way,

keel line is broken just below the foremast step by that peculiar notch characteristic of Mr. Gardner's latest designs. Taken as a whole, the model is extremely pleasing to the eye.

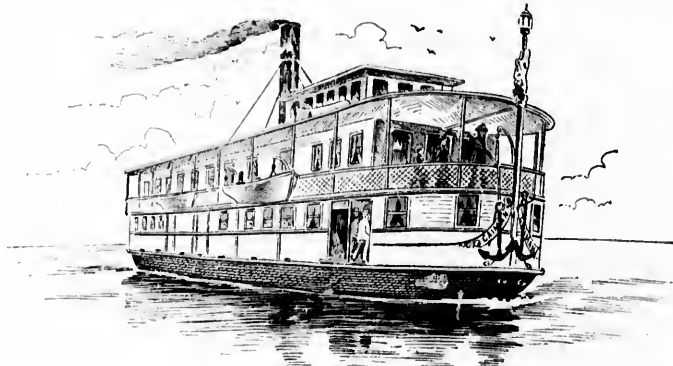

CAJMAN.—FIGURE 82.

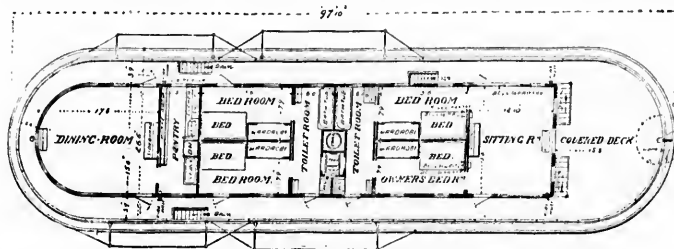

PLAN OF THE "CAJMAN."

FIGURE 83

was known for a long time as the "two-masted cutter," a nickname often given to *MIRANDA* in her earlier days. It is the basis of the

the Pacific coast, owing to the high velocity of the wind along the coast.

* "Forest and Stream" Dec. 16, 1885.

* See Chapter on "Yachting in the United States."

Tac
not be
It h
sails c
a fore
the sail
by reas
handle,
wind, it
headsail
In tu
boat's h
and in l
be sheet
possible
sury, th
the boat
more we
and be v
stays.

Obser
shown th
the cutter
the forme
faster, but
the latter
safer and
handled, so
that on s
one man c
the sails
In the old
the mizzen
a lug sail
mainsail was
a boom.

Fig. 76
the yawl M
owned by
Maitland,
York. She
of steel and
ing been de
A. Cary S
built by
City Islan
in 1889.

Her dime

The latest
77. She wa
Mass., and w
Her dime

Alce is in
windiness,
spread. He
which gives

THE YAWL.

The yawl-rig is one which has been in use for some time, but has not been adopted by yachtsmen until late years.

It has been spoken of as a schooner-rig with a small mainsail. The sails consist of a mainsail considerably narrower than that of a cutter, a fore staysail jib, topsail and mizzen. Owing to the subdivision of the sails, the yawl can be handled by fewer men than a cutter, which by reason of her large mainsail and lengthy boom is more difficult to handle. The mizzen in a squall will bring the yacht's head to the wind, if it should be necessary to ease off the mainsail as well as the headsails.

In tacking, the mizzen is hauled as taut as possible, as it helps boat's head around, and in beating it can be sheeted as flat as possible when necessary, thus enabling the boat to carry a more weather helm and be very quick in stays.

Observation has shown that between the cutter and yawl, the former is much faster, but the rig of the latter is much safer and more easily handled, so much so that on small yawls one man can handle the sails with ease. In the older yawls the mizzen was always a lug sail and the mainsail was devoid of a boom.

Fig. 76 represents the yawl *MONTICELLO*, owned by Alexander Maitland, of New York. She is made of steel and iron, having been designed by A. Cary Smith and built by Piepgras, City Island, N. Y., in 1889.

Her dimensions are:

Length over all,	68 feet 3 inches.
Depth,	8 feet 8 inches.
Length load waterline,	53 feet.
Draft,	9 feet 2 inches.
Beam,	15 feet.

The latest modification in the yawl-rig is illustrated in *Ango*, Fig. 77. She was designed by her owner, David Hall Rice, of Boston, Mass., and was built by Moses Adams of Essex, Mass., in 1892.

Her dimensions are:

Length over all,	70 feet.
Beam,	16 feet 8 inches.
Length load waterline,	56 feet 6 inches.
Depth, (forward of mast),	8 feet.
Draft,	9 feet 3 inches.

Ango is intended to have all the advantages of the yawl-rig in close windedness, with the advantages of a schooner in division of sail spread. Her hull is waterborne 6 feet abaft of her mizzen masts, which gives her great ease in a seaway and enables her to carry a

mizzen-sail of about the size of a schooner's foresail. She lies fully half a point nearer the wind than a schooner of the same size and sails as fast. Three men before the mast, besides a sailing master, are her regular complement, and these handle her as well as five men would a schooner of the same size, or seven men a cutter-rig. She is ballasted by a steel keel of 17 tons outside and 9 tons of inside ballast.

Figures 78 and 79 represent centerboard *American Yawls*. At one time *MICRO* and *WANDER* were designated as ketches, but at a meeting of the BISCAYNE BAY YACHT CLUB, to whose fleet these yachts belong, it was decided to call them American yawls.

MICRO was designed by R. M. Munroe, her owner, and was built by A. C. Brown & Son, of Tottenville, New York, in 1891.

Her dimensions are: Length over all, 49 ft. 8 in.; depth, 4 ft. 9 in.; draft, 3 ft. 2 in.; beam, 13 ft.

WANDER, illustrated in Fig. 79 is owned by R. M. Munroe, and has the following dimensions: Length over all, 40 ft.; draft, 2 ft.; beam, 13 ft.

In a regatta sailed Feb. 22, 1893, she beat her competitors more than half an hour over a twenty mile course.

HOUSE-BOATS.

The house-boat in all its perfection is to be found on the river Thames, while in this country the house-boat may properly be considered a novelty even to-day.

It has been suggested that the idea of a house-boat probably emanated from conceptions of Noah's ark, or from the fact that a large part of the population of the great

coastwise cities of China, Burmah and India is known to have been born, lived and died in such houses. However this may be, it has been established that the *primitive* house-boat dates back to the early days of American history and the Indian wars. At this time crude house-boats or even house-rafts gave comparative security to many an isolated family of settlers.

From the stationary house-boat evolved the auxiliary house-boats, thus enabling them to be shifted from one locality to another at a moderate speed. The house-boat strictly includes such vessels in which the form of superstructure, and in most cases that of hull also, is dictated by the requirements of the dwelling rather than the sea-going or navigable vessel.*

* In a modern yacht the arrangements for the convenience and comfort of the crew are as complete and elaborate as in the finest houses; comfortably furnished apartments, bath-rooms and running water; perfectly equipped kitchens and store-rooms, with ranges, ice-boxes and other essentials for luxurious living. At the same time, all

* See "Forest and Stream," April 13, 1893, p. 327, which has been freely used.

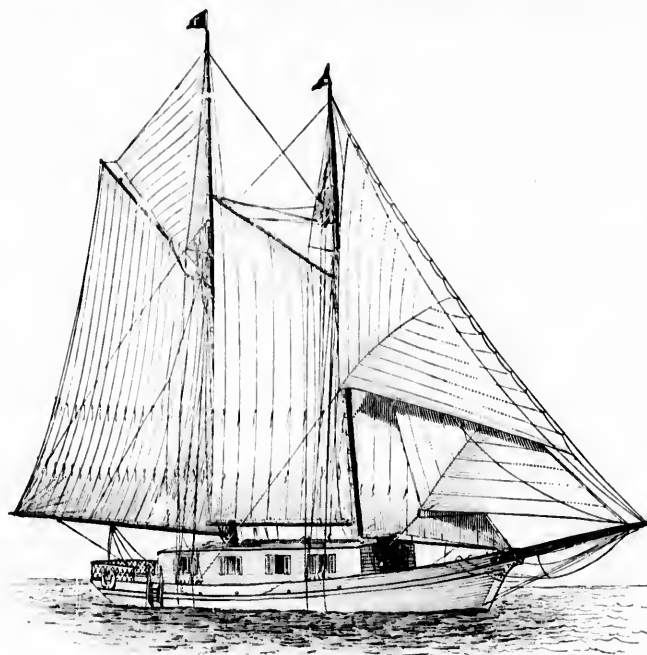

STUDIO.—FIGURE 84.
(From a Photo by Johnson.)

EVOLUTION OF THE YACHT.

these arrangements are subordinate to the demands of the naval architect, the prime requirements of safety, seaworthiness, stability and speed compel the owner to put up with rooms of limited dimensions, irregular shape and small windows, and this same subordination of the dwelling to those of the ship controls the whole design.

In the case of the house-boat, however, the designer, even though a naval architect, works with a freer hand. While he produces a craft that will float, that will not capsize, and that may even be sailed with reasonable speed under favorable conditions, at the same time he departs widely from the conventional ship form; his hull is practically a box or scow, and on it he rears a rectangular structure which at once proclaims the relationship of the entire craft to the house rather than to the boat.

The large or small house-boat, making a speed of seven or eight miles under sail or steam, or anchored for the whole summer in some quiet nook, is the house-boat of civilization, but the house-boat family is a very large one if we take the world over, the rivers of China alone teeming with small craft, each inhabited by a family the members of which are born and pass their whole life aboard, seldom setting foot on dry land and knowing no other home than the rude sampan, with its hut of reeds and primitive hearth for the family fire.

Such is the case at Canton. In this section of the world, on the rivers and canals, are house-boats which form the only dwellings of a large population; districts of boats with watery streets between. In Canton there is a large floating city with shops on the boats, displaying their merchandise, as also a swarm of little boats carrying goods around. Women work them. In the evening the boats are lighted up with colored paper lanterns. Many boats are devoted to pleasure; these are flat and long, with a platform toward the bow and projecting sides for the boatmen to walk along and push. In the middle is an elegantly furnished room. Porcelain tables and chairs are set around, also pots of flowers. The top is often surrounded by a balustrade, and surmounted by a little kiosk. These boats are regular restaurants. The stern is said to contain the goddesses so often worshipped by the Chinese. One of these pleasure boats is illustrated in Fig. 81, and is certainly very attractive in appearance.

The largest and most pretensions of American house-boats is the steam craft CAIMAN* (Fig. 82), owned by Pierre Lorillard and built in 1891 by Pusey & Jones of Wilmington, Del., from the plans of

* First illustrated in "Music and Drama."

Gustave Hillman. The hull is of steel and her dimensions are: Length over all 96 feet; beam at top 24 feet 6 inches, at bottom 20 feet and depth 5 feet 6 inches, the guards overhanging 1 foot on each side. The superstructure is of wood, two stories high, the hold being used for stores, etc., the first floor or main deck for the engineer and servants, the second story containing the owner's apartments.

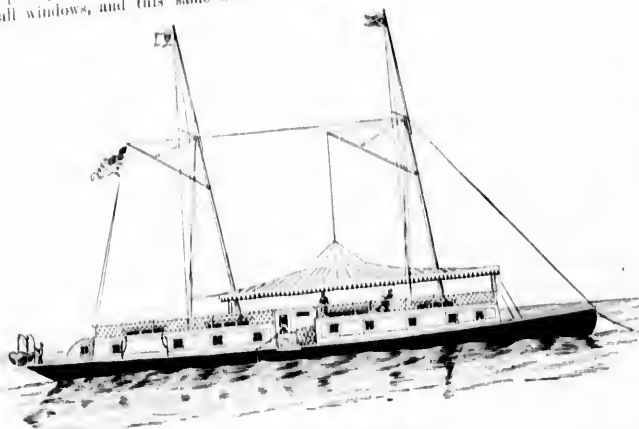

WESTON HOUSE-BOAT.—FIGURE 85.

The plan of this floor is shown in Fig. 83 and clearly shows what comfort and luxury can be derived from a house-boat of this character. The forward deck is enclosed, making a space where horses can be carried. The engines are triple compound 5, 8 and 13x8 inches, driving twin screws 38 inches in diameter and 6 feet pitch. The main floor is elegantly furnished, the house being lighted by electricity and heated by steam. CAIMAN has been in use for two winters in Florida waters, making a most comfortable home. In addition to the size of the rooms, and their light and ventilation, as compared with a steam yacht, she has the advantage of light draft and of self propulsion at a fair speed. Fig. 84 represents the centerboard schooner-rigged house-boat SRYMO, which was designed and built by James E. Terry and launched in 1890 and is now the property of M. F. Tobin of New York. Her dimensions are: She was lengthened by A. Witman in 1892. Length over all, 40 ft.; draft, 1 ft. 3 in.; length load waterline, 28 ft.; beam, 13 ft. She is elaborately fitted up, has a roomy kitchen, store-rooms, state-rooms, cabin, etc. Owing to her light draft she can sail almost anywhere, and on account of her centerboard is able to sail with the fleet of the BROOKLYN YACHT CLUB on their cruises.

She is used as a yacht as well as a house-boat, but on account of the nature of her cabin house and its general arrangement, which differs greatly from a cabin house, she must be classed as a house-boat.

The Weston house-boat is illustrated in Fig. 85. This beautifully designed house-boat has a saloon 12x17 feet, with piano, side-board and transom sofas. The guests' state-room is 8x12 feet, with berth, sofa, two ward-ropes and washstand. The family chamber is 10x17 feet, with double bed, two sofas, two ward-ropes, a bureau and washstand. The reception room is 6½x8½ feet

and has a sofa and other conveniences. There is a fine bath-room 5½x8½ feet with washstand and bath tub on board. Also other state-rooms, closets, servants' quarters, ice-house and kitchen.

The Burmese shoopanndogee or royal barge (Fig. 86), is deserving of mention in this place. It was used by the King when he went in state on the water. The length of the vessel was a hundred cubits (more than a hundred and fifty feet). The stern is seen to be elevated, and the royal pisath is in the center where a mast might be situated. The vessel was magnificently gilded and ornamented.

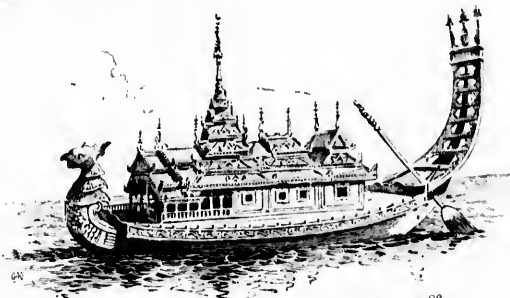

BARGE OF THE KING OF THE BURMESE.—FIGURE 86.

IN glance known try of unkno their pleas ence save a legendary, much con The mo nounced from its hunt; Ger Ger. jach according more m tion of t A vesse convey pu sadors an personag kingdom At the it must be the man plicable used e pleasure Size o longer e sideratio devoted pleasure she Tu Up to ten to yacht cribed sel, con best in eleganc and e for ple presen two d yacht ballast propo fit for If ing w its or Th porar Euro Th desir • Se

HISTORY OF YACHTING.

Glancing through history it is a singular fact that but little is known of the yachting of our grandfathers, either in this country or in England. The founders of the present system are unknown even by name, and the vessels in which they took their pleasure have passed away, leaving no memento of their existence save a few isolated facts which are in their character almost legendary. It may be truly said: "Around them much embryo, much confusion lies."

The most satisfactory paternity we can find for the word yacht (pronounced "yot") is the Dutch *ijagt* (formerly spelled *jacht*) so named from its speed, from Dutch *ijagen* (formerly *jachten*) to speed, to hunt; Ger. *jagd*, a chase, from Dut. and Ger. *jagen*, to chase, hunt; Ger. *jacht*, *jachtschiff*; Dan., *jagt*, Sib., *jakt*; *jaktskepp*. It is, accordingly, applied to vessels which have an aptness for speed. A more modern definition of the word was "A vessel of state to convey princes, ambassadors and other royal personages from one kingdom to another."

At the present time it must be conceded that the name yacht is applicable to any vessel used exclusively for pleasure and racing. Size or rig are no longer elements of consideration. A vessel devoted exclusively to pleasure is a yacht, be she large or small. Up to within the last ten to fifteen years, a yacht could be described as a decked vessel, constructed sons to best insure strength, elegance and speed, and exclusively used for pleasure. At the present time there are two distinct species of

yacht; the mere racer, with enormous spars and sails and deeply ballasted hull with fine lines, and the elegant, commodious, well-proportioned traveling yacht, often with steam propelling machinery, fit for a voyage around the world.

If we are to be influenced by tradition, the History of Yachting would commence at a very remote period.* To trace the art to its original source would be impossible.

Though unknown by its present name it is doubtless contemporaneous with the earliest record of ships, whether developed in Europe, Asia or Africa.

The uniformity with which the human mind, prompted by the same desires and aided by the same faculties, has arrived at a result at

* See article "N. Y. Herald," June 8, 1860, of which free use has been made.

one and the same time in various quarters of the globe totally unconnected with each other and the inhabitants of which were totally ignorant of each other's existence, leads to the supposition that neither of these Continents can claim precedence in the invention of yachting.

How little is the difference in respect to principle, for instance, between the rough canoe of the Esquimaux, framed of the bones and skins of beasts and fishes and covered with the skins of seals, and the Welsh coracles of the early Britons, made of basket work covered with hides; or of the terra-cotta boats of the Egyptians filled in with the leaves of the papyrus, or the still more remote rafts of the Romans, whose borders were of wicker work covered with leather; or, in later times, among the ruder nations of the world what a comparatively slight difference exists between the felucca of the Barbary coast, the swift baggala of the piratical Arabs, the garooka of the Persians, the galley of the Venetians, the gaydiang of Anam, the junk of the Chinese, the pattenur of the East Indies, the flying proas of the South Seas, the pirogues of the Cingalese on the coasts of Malabar, and the tartan and kebec of the Mediterranean. The same principle governs them all.

To return to early times, however, we read in Genesis that ships were as old on the Mediterranean even as the days of Jacob and that 1,830 years before Christ, Amnon built 'long and tall ships with sails,' on the Red Sea; and that ninety years afterwards the

ship Argo was built; 'the first Greek vessel which ventured to pass through the sea without sight of land, being guided only by the stars.' Proceeding still further along we read of the yacht, if by a stretch of dictionary license we may use the word, that was built in centuries past for Ptolemy Philopater, King of Egypt, for sailing up and down the Nile, called 'the bedchamber ship,' and we wonder what that costly vessel could have been like with her immense conveniences and magnificent apartments. No less wonderful was the yacht built by Hiero, King of Syracuse, who delighted in conceiving vast designs and possessed a peculiar taste for naval architecture. This ancient floating edifice was built under the direction of the celebrated mathematician Archimedes by a shipbuilder of Corinth, and the wood was cut from Mt. Etna. The floors of this remarkable

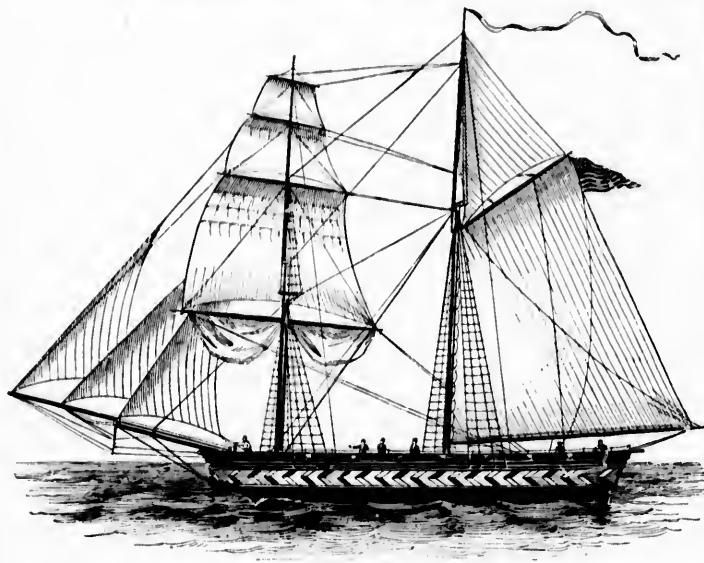

CLEOPATRA'S BAROE.

"Thomas, Earl of Ossory, and other persons of honor, embarked on board this vessel, which promised to excel all others in sailing, carriage and security, but she was at last lost in a tempest which overwhelmed a great fleet the same night. While the Dutch and the Venetians may have the credit of conceiving the idea, to Englishmen belong the honor and glory of having adopted this right royal amusement."

From this time, yachting, sturdily patronized by royalty, became a favorite pastime of the nobility and gentry and is now so general that almost every country can boast of one or more organized yacht clubs.

Almost all Governments encourage yachting; first, because it supplies an excellent training for seamen, who in time of war become available, and second, because the science of naval architecture is continually being benefited.

The pedigree of yachting, therefore, without being definitely discovered, is traceable to its rudest elements, and the sport comes down to us with the seal of ages upon it, so dim and misty in retrospect that their existence seems almost a fabulous creation of the mind.

The first yacht club of which we have any reliable knowledge was organized in Queenstown, Ireland, in the year 1720, under the name of the CORK HARBOR WATER CLUB, now the ROYAL CORK YACHT CLUB. Its commanding officer is styled Admiral, though most clubs call him Commodore, while in the YACHT CLUB DE FRANCE he is called President.

Maitland, in his "History of London" (1739), mentions sailing and rowing on the Thames as among the amusements then indulged in; and Strutt, in his "Sports and Pastimes" (1801), says that the Cumberland Society, consisting of gentlemen partial to this pastime, gave yearly a silver cup to be sailed for in the vicinity of London. The boats usually started from Blackfriars Bridge, went up the Thames to Putney and returned to Vauxhall, being, no doubt, mere sailing boats and not decked vessels. From the middle to the end of the eighteenth century, yachting developed very slowly; although matches were sailed at Cowes as far back as 1780, very few yachts of any size, say 35 tons, existed in 1800 there or elsewhere.

We have now to cross the Atlantic and return to America, and while there are no records which enable us to trace the history of yachting in this country previous to the year 1800, still, every child is familiar with the triumphs of our Baltimore clipper schooners, our privateers and vessels of marque, which long before this date were identified with events of the times that have made them celebrated in history for speed and daring.

The first yacht built in America was constructed at Salem, Mass., in the year 1801, and was called JEFFERSON. She was owned by Captain George Crowninshield and built by Christopher Turner. She was of 22 tons capacity and a good sailer. In 1812 she was made a privateer and was the second vessel thus commissioned. She made only one voyage under the command of Captain John Kehew in July, 1812, taking three prizes, sending to Salem the second prize of the war, the schooner NYMPH. She was too small for such work, carrying a crew of thirty, though she remained the property of the firm until it was dissolved in 1815. Then, as a part of the estate of the elder George Crowninshield, after his death, she was sold in 1815 for a fishing vessel to Gloucester. She belonged at one time to Captain John Crowninshield Very, and later to Caleb Johnson, of Nahant.

The next yacht or pleasure boat of which we have any account is the famous little DIVER, built in the year 1802 by the late John C. Stevens. Subsequently, he constructed several other yachts of larger tonnage, among which were TROUBLE and WAVE, doubtless yet remembered by some of our older yachtsmen, the latter boat being without a competitor in her time. Following this was ONKAHE, which was his first attempt at a sharp bow and clean run. But its success was only partial, and it was soon afterwards adapted as a pilot boat and sold into the navy.

Two or three other boats were built by him after this, among them

being GIMCRACK; but, unquestionably, the masterpiece of Mr. Stevens' architecture was the unrivalled yacht MARIA, which, it is conceded, was one of the fastest of her tonnage in either the Old or the New World.

Fifteen years after the building of the yacht JEFFERSON, another yacht was built in Salem to which the name CAR OF CONCORDIA was first given, and which was changed to CLEOPATRA'S BARGE December, 1816, the first name never having been painted on her stern. It is to the late Captain Benjamin W. Crowninshield we are indebted for a description of this yacht. She was built south of Derby street and to the eastward of India or Crowninshield's wharf, where AMERICA and FAME were constructed. Her reputation spread abroad, and before she was launched, while on the stocks, people came from far and wide to see her as she grew under the builders' hands. In every respect she was a peculiar vessel, as the illustration will show. In her hull and rigging nothing was spared to make her surpass everything that had preceded her. As there were no yachts in America at that time on whose rig and fittings she might be an improvement, her prototype came from among commercial vessels, particularly from among vessels of war and privateers. And in her appearance she looked much like a small man-of-war. While still on the stocks, she was not only completely built, as to her hull, but her inside fittings and furniture were well along; all her spurs were on end, her yards crossed, her rigging set up. Also her sails were bent and all her running rigging rove, so that when she was launched and went into the water she was completely ready for sea, except her heavy stores. The cabin furniture was completed December 6th, and after being shown to the family, she was open to the public at large. Captain George Crowninshield stated that in one day one thousand nine hundred ladies and seven hundred gentlemen came on board, and that the visitors, while the yacht was in Salem, averaged nine hundred each day. Many presents of ornaments and useful things were received from friends. Commodore Bainbridge sent a patent log suitably inscribed, and country people sent fruit and vegetables.

Captain George, during the building of the vessel, passed all his time in and about her. All of her fittings were made from his own designs, and particularly in the rigging of the vessel was his individuality shown. He had on her a wheel of his own construction and a capstan made after his own ideas. The standing rigging was all set up in a different way from the customary manner. On the deck of this yacht as a pendant to the capstan, was a wooden statue of a North American Indian the size of life, splendid in war paint and feathers. When the vessel was afterwards on her cruise in the Mediterranean the sailors used to impose upon the simple peasants by telling them that it was alive and introduced them to it. And while in Genoa the sailors, noticing the many statues of saints in churches, told the peasants that this was the statue of an American saint and they would kneel to it and even kiss its feet. Some of the 'ropes' about the quarter deck were served with velvet and some were of different colors. Everything above and below decks was not only peculiar, but very elegant. The furniture and fittings of the cabin was in mahogany and bird's-eye maple, being of the style known as the "First Empire," with gilt bronze ornaments. In her cabin, which was 19 feet by 20, were two long sofas of mahogany and bird's-eye maple 11 feet in length. One of these is in the house of the late Benjamin W. Crowninshield to-day, and is considered a remarkable and very handsome piece of furniture. The saloon had a chandelier, a sideboard, two large mirrors with gilt eagles above, imitation windows and draperies, and the furniture was covered with red velvet and gold lace. She was fitted out with a complete and very large service of silver and the china and glass were made specially for her. The state-rooms were also elegantly fitted up. Some idea of this can be obtained from the fact that when after the death of her owner the vessel was sold at auction, the furniture removed from her was appraised at \$8,000.

The vessel itself cost him \$50,000 and was sold by auction for \$15,000. She was 83 feet long on the waterline, 22 feet 11½ inches

wide, and 11 feet 5½ inches in depth. The late Mr. Burgess assured Mr. Benj. Crowninshield that these are almost precisely the dimensions of the famous MAYFLOWER when she was a sloop, which was 85 feet long on the waterline, 24 feet wide and, measured according to the plan then in vogue, would be about 11 feet in depth. She being to the plan then in vogue, would be about 11 feet in depth. She tonned 191 41-65, which Mr. Burgess said would be almost precisely the tonnage of the MAYFLOWER measured in the same way.

No two yachts could well be more dissimilar in appearance than these two, notwithstanding. CLEOPATRA'S BARGE was painted in different patterns on her two sides: one side being painted in horizontal stripes of many colors and the other side with a herringbone pattern. She had a wide stern, with little cabin windows opening out on it, a wooden figure-head, and she was rigged as a maphrologite brig; that is, square rigged on the foremast, and fore and aft on the mainmast. Although not intended as a racing vessel, she was yet provided with every species of light sail known to those days, and with some that have become a curiosity to-day, notably the ring and water sail which have almost gone out of existence. Instead of the spinnaker of to-day, the yacht being square rigged on the foremast, had studding sail booms. Capt. George Crowninshield died on his yacht of heart disease the 26th of November, 1817, and in the following summer the yacht was dismantled, sold and fitted up for a merchant vessel. On April 2, 1819, she was again sold and used as a packet ship, after which she was fitted up for a voyage to the northwestern coast and, after proceeding to that place, was taken to the Sandwich Islands and sold to King Kamehankā I, to be used by him as a yacht for about a year. Then, owing to unsuccessful seamanship, she was run upon a reef of rocks and wrecked.

We have now to return to England for the next progressive step, and we find in the year 1812, when JERRINSON became a privateer, "THE YACHT CLUB" was organized at Cowes by fifty yacht owners, the members taking an active interest in yachting and adding continually to their number, until 1820 when William IV, Duke of Clarence, ordered that its name should be changed to THE ROYAL YACHT CLUB, which was done. After his accession to the throne he requested that the name should be again changed to THE ROYAL YACHT SQUADRON as "a token of his approval of an institution of such national utility;" this change of name was made in 1832.

According to E. D. Brickwood, the yachts of this time were built of heavy materials like the revenue cutters, full in the fore body and fine aft; but it was soon discovered that the timbers and seathing were unnecessarily strong, and they were then made much lighter. It was also found that the single-masted cutter was more weatherly than the brigs and schooners of the time, so the former rig was adopted for racing, and, as there was no time allowance for difference of size, they were all built of considerable dimensions.

Among the earliest of which there is any record were PEARL, 95 tons, built by Sainty at Wivenhoe near Colchester in 1820, for the Marquis of Anglesey, and ANROW, 84 tons, originally 61 feet 9½ inches long, and 18 feet 5½ inches beam, built by Joseph Weld in 1822, still extant as a racing yacht, having been rebuilt and altered several times and again entirely rebuilt in 1887-88. The Thames soon followed the example of the Solent, and established THE ROYAL THAMES YACHT CLUB in 1823. In Scotland, the ROYAL NORTHERN YACHT CLUB was founded on the Clyde in 1824, and the ROYAL WESTERN YACHT CLUB was founded at Plymouth in 1827. During this year the ROYAL YACHT SQUADRON passed a resolution disqualifying any member who should apply steam to his yacht; this was probably done because T. Assheton Smith, an enthusiastic yachtsman and hunter, had just built on the Clyde a paddle-wheel steam yacht called MENAI.

In 1830 Joseph Weld had ALAN built by Inman at Lympington, one of the largest cutters constructed up to that time. She was 82 feet on the load line by 24 feet beam, and was reckoned of 193 tons, in which length, breadth and half-breadth (supposed to represent depth) were the factors of computation.

According to Mr. Brickwood, "Some yachtsmen at this time pre-

ferred still larger vessels, and owned square top-sail schooners and brigs like the man-o-war brigs of the day, such as WATERWITCH, 381 tons, built by White, of Cowes, in 1832, for Lord Belfast and the barque BRILLIANT, 493 tons, belonging to J. Holland Ackers, who invented a scale of time allowance for competitive sailing. In 1831, the first Royal Cup was given by William IV to the ROYAL YACHT SQUADRON—a gift which has been continued ever since (except in 1862, when it was dropped for one year, owing to the death of the Prince Consort) and, in recent years, supplemented by similar gifts to other clubs."

In 1836 the ROYAL EASTERN YACHT CLUB was founded at Grenton, near Edinburgh; in 1838 the ROYAL ST. GEORGE at Kingston, and the ROYAL LONDON; in 1843 the ROYAL SOUTHERN and the SOUTH-AMPTON and the ROYAL HARWICH; in 1844 the ROYAL MERSEY at Liverpool, and the ROYAL VICTORIA at Ryde.

It was a yacht of the ROYAL MERSEY, QUEEN OF THE OCEAN, owned by Commodore Littledale, which was used to save the lives of thirty-two of the passengers and crew of the emigrant ship OCEAN MONARCH, of Boston, burned August 24, 1848, in Abergele Bay.

The number of vessels kept pace with the clubs—the fifty yachts of 1812 increasing nearly ten-fold before the middle of the century, which was the critical epoch of yacht building. France, in the meantime, had been doing well in building pleasure boats. Cherbourg on the north and Marseilles on the south, had quite a fleet of small yachts; but there was no concentration of effort, nor did the nobility show any disposition or encouragement to associations. There could be no successful yachting on the Seine—the sea coast being too far away from the French courts, and the gayeties of the Tuilleries and Versailles were more attractive than boat sailing.

We have now to return to the United States, where we find that THE NEW YORK YACHT CLUB has the distinction of being the first yacht club organized in America. It was founded July 30, 1844, and for five years was the only yacht club on the Continent. It was organized by a few gentlemen on board the little 25 ton schooner GIMCRACK, belonging to Mr. Stevens, while the yacht was lying off the Battery. On February 16, 1865, this club was incorporated by Edwin A. Stevens, Ambrose C. Kingsland, Alexander Major, Robert S. Howe, William H. McVicar, Anson Livingston and Hamilton Morton as a yacht club in the city of New York for the purpose of encouraging yacht building, naval architecture and the cultivation of naval science.

In 1844 the NEW YORK YACHT CLUB was comprised of nine members and of as many yachts. In 1845 the number was 17 and members 171, their headquarters or club house being located at the Elysian Fields, near Hoboken on the Hudson. In 1875 the club registered 38 schooners (5,566 tons), 27 sloops (924 tons) and 13 steamers (1,000 tons); and in 1883 there are registered 89 schooners, 95 sloops, cutters and yawls, and 126 steamers, and the membership of the club now numbers 1,018. The first Commodore of the club was the late John S. Stevens, the present Commodore being Mr. E. D. Morgan.*

The second yacht club organized in this country was the (1st) MOBILE YACHT CLUB in the year 1847. The officers were: Commodore John B. Todd; Vice-Commodore, J. O. Belknap; Treasurer and Secretary, F. M. English.

These officers continued in service until 1859 when the club disbanded; it was reorganized, however, in 1866 with Charles E. Vincent, Commodore; T. M. English, Vice-Commodore and Morton Toulmire, Secretary and Treasurer, under the name of the MAGNOLIA YACHT CLUB which continued in existence until 1871 when it was disbanded. The present MOBILE YACHT CLUB was not organized until 1882. The SOUTHERN YACHT CLUB was organized in 1849 and is still in existence, being in a flourishing condition and consequently must be placed second on the list of existing yacht clubs, to be followed by the NEPTUNE YACHT CLUB. The following alphabetical list sets forth the more prominent yacht clubs which are in existence to-day, both

* See "History of NEW YORK YACHT CLUB."

† See "SOUTHERN YACHT CLUB."

in the Uni
their respec
Albany,
American,
American
Argentino,
Atlantic (I
Atlantic (I
Audubon,
Barnstable
Baltimore,
Bar Harbo
Bay Head
Bayonne
Bayswater
Bay Shor
Bay View
Bay of Q
Beach Ha
iliary),
Bellinghu
Beverly,
Biddeford
Bilge Wa
Biscayne
Bijon,
Bohemian
Boston,
Bridgepo
Assoc
Brookly
Buffalo,
Bunker
Cape A
Cape C
Capital
Cannrsi
Carolin
Carolin
Cartlin
Catalin
Cedar
Chelse
Chesap
Chicagu
Chicagu
Row
Clevel
Citize
Ass
Colum
Colum
Colum
Colum
Coop
Corti
Cor.
Corti
Corti
(
Cor
Cor
Cor
Cor
Cor

in the United States and Canada, with the name and address of their respective Secretaries:

- Albany, Thos. Wilkinson, 62 State St., Albany, N. Y.
 American, Thos. L. Scovill, 25 Park Place, New York.
 American (Mass.), E. N. Fouldsbee, 53 State St., Newburyport.
 American Model, Harry Melvin, 144 Park Place, Brooklyn.
 Argentinio, A. N. Williams, Calle Piedad 350, Buenos Ayres.
 Atlantic (Boston), Com. E. W. Dixon, Boston, Mass.
 Atlantic (Brooklyn), G. H. Church, 45 William Street, New York.
 Audubon, E. O. Kramer, 153d St. & X. R., New York.
 Barnstable, Barnstable, Mass.
 Baltimore, F. McAllister, 3 N. Charles St., Baltimore.
 Bar Harbor, Bar Harbor, Maine.
 Bay Head, W. N. McAuley, 131 S. 4th St., Philadelphia.
 Bayonne City, P. J. Mooney, 44 W. 52d St., Bayonne, N. J.
 Bayswater, L. P. Hubbard, 115 Nassau St., New York.
 Bay Shore, G. M. Smith, Bay Shore, Long Island.
 Bay View, W. A. Cook.
 Bay of Quinte, George N. Leavens, Belleville, Ont.
 Beach Haven (Auxiliary), John T. Fox, Beach Haven, N. J.
 Bellingham Bay, L. A. Wheeler, New Whateam, Washington.
 Beverly, Wm. Amory 2nd, 50 State St., Boston (1894).
 Biddeford, George Towne, Biddeford, Maine.
 Bilge Water, San Francisco.
 Biscayne Bay, Kirk Munroe, Canal Street, New York.
 Bijou, E. S. Waller, 2nd St., New York.
 Bohemian, Harry Roseland, Flatlands, L. I.
 Boston, Thos. Dean, 28 State Street, Boston.
 Bridgeport Boating Association, A. H. Davis, 429 Maine St., Bridgeport, Conn.
 Brooklyn, William Cagger, Box 154, Brooklyn.
 Buffalo, Howard A. Baker, Buffalo.
 Bunker Hill, F. M. Williams, Charleston, Mass.
 Cape Ann, F. H. Shute, Gloucester, Mass.
 Cape Cod, D. W. Dean, Orleans, Mass.
 Capital, Allen C. Smith, Washington, D. C.
 Canarsie, John Taylor, 73 Bedford Street, Brooklyn.
 Carolina (North), J. McRae Cowan, Wilmington, N. C.
 Carolina (South), C. E. Prioleau, Box 215, Charleston, S. C.
 Carthage Ice, Robt. Danwoody, Carthage Landing, N. Y.
 Catalina, Los Angeles, Cal.
 Cedar Point, W. M. Thomas, Box 14, Saugatuck, Ct.
 Chelsea, F. L. Dow, 12 Post Office Square, Boston.
 Chesapeake Bay, J. G. Morris, Easton, Md. (1894).
 Chicago, W. V. B. Rossing, Commodore.
 Chicago Yachting & Rowing Assn., Wm. Netling, Chicago, Ill.
 Cleveland, J. O. Gardner, Cleveland, Ohio.
 Citizens' Yachting Association, John Look, Detroit, Mich.
 Columbia, Geo. Parkhill, 61 E. 130th St., New York.
 Cohasset, W. C. Le Petrie, 182 M St., South Boston.
 Commonwealth, W. D. Payne, Chicago, Ill.
 Columbia (Chicago), W. D. Payne, Chicago, Ill.
 Conant, Dr. H. J. Rhett, Jamestown, R. I. (1894).
 Cooper's Point, F. E. Baker, 114 Beale St., San Francisco.
 Corinthian, Cal., Chas. Chamberlin, New York.
 Cor. Mosquito Flt., Chas. E. Rust, Galveston, Texas.
 Corinthian (Texas), Chas. E. Rust, Galveston, Texas.
 Corinthian Fleet (Atlantic City), W. W. Hollingsworth, M. D., Philadelphia.
 Corinthian (New York), G. A. Cormack, 62 Stone St., New York.
 Corinthian (Marblehead), Everett Paine, Marblehead, Mass.
 Corinthian (Philadelphia), A. F. Baneroff, 114 S. 6th St., Phila.
- Corinthian (Baltimore), H. E. Meredith, 1,505 Mosher St., Balt.
 Coronet, W. S. Merceddy, Brooklyn, New York.
 Detroit, J. A. Minwogen, Detroit, Mich.
 Delavan Lake, C. V. Bachellet, Delavan Lake, Wis.
 Dorchester, H. W. Smith, 40 Mill St., Dorchester, Mass.
 Douglaston, James Hixon, Douglaston, L. I. (1894).
 East Bay, R. A. Stackpole, 80 Broadway, New York.
 Eastern, Wm. S. Eaton, 281 Franklin St., Boston.
 Essex, W. C. Rothe, Newark, N. J.
 Excelsior, J. M. Russell, 213 Warren St., Brooklyn.
 Excelsior Ice, T. P. Daly, Burlington, Vermont.
 Fall River, Wm. E. Blossom, 70 Juno St., Fall River, Mass.
 Rockaway Corinthian, Woodward Babcock, Far Rockaway, L. I.
 Florida, H. H. Buckman, Jacksonville, Florida.
 Fox Lake, Byron Boyden, Fox Lake, Illinois.
 Great South Bay, F. C. Bliss, Islip, L. I.
 Greenville, Geo. F. Kraus, 120 Old Bergen Road, Jersey City.
- Gloucester, Gloucester, Massachusetts.
 Gunpowder, Baltimore, Maryland.
 Gravesend Bay, Com. John Cottier, Gravesend Bay, L. I.
 Habana, J. A. Frias, 128 Agnente St., Habana, Cuba.
 Harlem, F. W. Creegan, 519 E. 121st St., New York.
 Haverhill, C. H. Marrow, 356 Washington St., Boston.
 Hempstead Bay, C. H. Alliger, Hempstead, L. I.
 Hempstead Harbor, (Auxiliary) Robert T. Cook, Glen Cove, L. I.
 Horseshoe Harbor, Chas. S. Gaubert, Larchmont, N. Y.
 Hudson River, A. G. Buckholz, 751 9th Ave., New York.
 Hudson River Ice, E. P. Rogers, Hyde Park, N. Y.
 Hobb's Hole, Hobb's Hole, Massachusetts.
 Hull, Wm. A. Cary, 23 Court St., Boston.
 Hull Corinthian, Fitz Henry Smith, Jr., 132 Newberry St., Chicago, Illinois.
 Inland American, Cameron Currie.
 Idlewild, Idlewild on the Hudson, N. Y.
 Illini, H. B. Sparks, Alton, Illinois.
 Indian Harbor, Louis R. Alberger, 86 Liberty St., New York.
 Inceog, Commodore Henry Curlin, Jamaica Bay, L. I.
 Jamaica Bay, Samuel Gilmore, Oceanus, L. I.
 Jamestown, W. N. Murray.
 Jeffries, C. A. Braynard, Chamber of Commerce Building, Boston.
 Jersey City, J. V. Woleott, 366 Communipaw Av., Jersey City.
 Junior Ice, Red Bank, N. J.
 Kennebec, William Brown, Bowdoinham, Me. (1894).
 Kennebunkport, Kennebunkport, Me.
 Key City, J. W. Jones, Port Townsend, Washington.
 Kill von Kull, F. H. Dehile, Port Richmond, S. I.
 Keystone, E. C. Smith, Woodsburg, L. I.
 Kingston, Jas. Galloway, Kingston, Ontario.
 Knickerbocker, O. H. Chellborg, 1 Broadway, New York.
 Lako Champlain, A. G. Whittemore, Burlington, Vermont.
 Lako Geneva, W. S. McCrea, Lako Geneva, Wisconsin.
 Lako George, Chas. E. Warren, 32 E. 42nd St., New York.
 Lako Hopatcong, C. A. Brindley, 6 W. Park St., Newark, N. J. (1894).
 Lake Mahopac, Lake Mahopac, N. Y.
 Larchmont, C. C. Bittle, Larchmont, N. Y.
 Lako Yacht Racing Association, George E. Evans.
 Lincoln Park, C. O. Andrews, 75 Lincoln Ave., Chicago.
 Lynn, F. E. Newhall, 22 Newhall St., Lynn, Mass.
 Longport Yachtsmen Association, Bolton Stellman, Longport, N. J.

HISTORY OF YACHTING.

Manchester,
 Manville, (La.)
 Meadow,
 Manayunk Model,
 Manhattan,
 Marine & Field
 (Auxiliary),
 Massachusetts,
 Meadow Creek
 Outing,
 Merrimac Valley,
 Michigan,
 Milwaukee,
 Minnetonka,
 Miramichi,
 Mobile,
 Monaquot,
 Morton,
 Mosquito Fleet (So-
 Boston),
 Narragansett,
 Neptune,
 Newark,
 Newark Bay,
 New Bedford,
 New Hamburg Icc,
 New Haven,
 New Jersey,
 New Jersey, A. C.,
 New Rochelle,
 New York,
 N. Y. V. R. Assn.,
 North Shrewsbury
 North Shrewsbury, Icc.,
 Nyarth Corinthian,
 Oak Point,
 Oceanic,
 Oconomowoc,
 Ohio,
 Old Colony,
 Olympic,
 Old Mill,
 Onondaga,
 Orange Lake Ice,
 Oriole,
 Oshkosh,
 Ossining,
 Oswego,
 Owaseo,
 Oyster, Bay,
 Patchogue,
 Pine Lake,
 Pacific,
 Pavonia,
 Pequot Assn.
 (Auxiliary),
 Philadelphia,
 Piscataqua,
 Plymouth,
 Pleon,
 Portland,
 Providence Corin-
 thian,

C. A. Cooley, 3 School St., Boston.
 M. J. Gaerne, New Orleans, La.
 South Shrewsbury (or Seabright), N. J.
 J. Hart (1894).
 S. H. Stuart, 58-60 Broadway, New York.
 Louis J. Boury, Bath, L. I.
 Wm. B. McClellan, Box 2,541, Boston.
 C. A. Arnist, Club House, Sheephead Bay,
 L. I.
 J. W. Bartlett, West Newbury, Mass.
 J. E. Harris, 42 Jefferson Ave., Detroit, Mich.
 H. B. Wilborg, 363 Washington St., Milwan-
 kee, Wis.
 R. G. Gale, 229 Nicollet Ave., Minneapolis,
 Minn.
 George Watt, Miramichi, N. B.
 J. K. Vincent, 204 S. Anthony St., Mobile, Ala.
 C. G. Sheppard, Weymouth, Mass.
 Harry Young, Chester, Pa.
 Geo. L. Paget, 3 Bay View Place, S. Boston.
 F. A. Rhodes, 20 Market Sq., Providence, R. I.
 A. L. Hall, 193 W. 10th St., New York.
 E. F. Atchinson, 46 New St., Newark, N. J.
 Jas. Spavin, 78 W. 25th St., Bayonne, N. J.
 John P. Rhodes, New Bedford, Mass.
 Wm. Van Wyke, New Hamburg, New York.
 W. A. Chamberlain, Box 1,266, New Haven,
 Conn.
 Louis Wunder, 119 Broadway, New York.
 Jas. D. Boyd, 77 Broad St., New York.
 R. C. Eddy, New Rochelle, N. Y.
 J. V. S. Oldie, 67 Madison Ave., New York.
 George Parkhill, 61 E. 130th St., New York.
 J. B. Weaver, Box 203, Red Bank, N. J. (1894)
 Providence, Rhode Island.
 Henry Schmitt, 667 E. 156th St., New York.
 G. D. Horbett, 190 Pavonia Ave., Jersey City.
 Oscar F. Jones, Oconomowoc, Wis. (1894).
 G. G. Keip, Toledo, Ohio (1894).
 George A. Hall, Boston, Mass.
 R. Orr, Brooklyn, New York.
 Jamaica Bay, L. I.
 J. W. Schneider, Syracuse, N. Y.
 A. X. Chambers, Newburg, N. Y. (1894.)
 Canarsie, L. I.
 Oshkosh, Wisconsin.
 J. V. Kirby, 29 Wall St., New York.
 W. B. Conch, Oswego, N. Y. (1894.)
 Auburn, New York.
 E. M. Townsend, Jr., Oyster Bay, L. I.
 Patchogue, L. I.
 A. C. Riethrook, Oconomowoc, Wis.
 V. K. Gaskill, 26 Bush St., San Francisco, Cal.
 James B. Fiskel, Jersey City, N. J. (1894.)
 W. H. Hale, 87 Church St., New Haven, Conn.
 George T. Gwilliam, 1,715 Chestnut St. Phila.
 Fred A. Bradbury, Dover, N. H. (1894).
 A. L. Barnes, Box 567, Plymouth, Mass.
 Marblehead, Mass.
 Chas. F. Flagg, 42 Exchange St., Portland, Me.
 J. W. Gammell, 113 Burnside St., Prov. R. I.

Provincetown,
 Pittsburg,
 Queen City,
 Quebec,
 Quiney,
 Racine,
 Raritan,
 Rhode Island,
 Riverside,
 Riverton,
 Rochester,
 Rough Weather,
 Royal Bermuda,
 Royal Canadian,
 Royal Hamilton,
 Royal Jamaica,
 Royal Nova Scotia,
 Ruffle Bar,
 St. Lawrence,
 St. Augustine,
 Salem Bay,
 San Francisco,
 Savannah,
 Sayin Hill,
 Sayville,
 Seitate,
 Sehoodie,
 Set Cliff,
 Seattle,
 Seawanhaka Corin-
 thian,
 Sewaren Land and
 Water (Auxiliary),
 Shackamaxon,
 Shelter Island,
 Shenandoah,
 Shimcoock,
 Shrewsbury,
 Sing Sing,
 Sippican,
 South Amboy,
 South Boston,
 Southern,
 Southwark,
 Squantum,
 Stamford,
 St. Augustine,
 Staten Island, (Auxil-
 iary),
 Stevens,
 Stoney Point,
 Tappan Zee,
 Tacoma,
 Tappan Zee, Icc,
 Tarpon Springs,
 Toledo,
 Tomahawk,
 Tom's River,
 Tower Ridge,
 Troy,
 Volunteer,
 Volunteer Sailing
 Club,

Provincetown, Mass.
 Com. C. E. Painter, Pittsburg, Pa.
 W. D. Thomas, Toronto, Canada.
 H. H. Sharples, Quebec.
 Geo. E. Pfaffman, 40 India Wharf, Boston.
 Racine, Wis.
 W. H. Hesser, 61 Fayette St., Perth Amboy.
 F. P. Eddy, 27 Page St., Providence, R. I.
 John G. Porter, Riverside, Ct.
 Norman Ellison, 24 S. 6th St., Philadelphia.
 T. B. Pritchard, 607 Ellwagon & Barry Bldg.,
 Rochester, N. Y.
 Jamaica Bay, Long Island.
 F. J. Jones, Hamilton, Bermuda.
 S. Bruce Harman, Toronto, Canada,
 Thomas W. Lester, Hamilton, Ontario.
 Com. E. Nankivele, R. N., Kingston, Jamaica.
 H. M. Wylde, Box 520, Halifax, Nova Scotia.
 J. C. C. Almon, Bank of Montreal, Montreal.
 John W. Denny, Hyde Park, Massachusetts.
 Robin Damon, Salem, Massachusetts.
 Geo. W. Reed, 502 Battery St., San Francisco.
 M. A. Cohen, 93 Bay St., Savannah, Ga.
 J. H. Shaw, Box 1,760, Boston, Massachusetts.
 Com. Ridgeway, Sayville, Long Island.
 W. E. Davidson, Calais, Me.
 D. W. Pardee, Grand Central Depot, N. Y.
 Seattle, Wash.
 L. F. d'Oremienlux, 7 East 32 St., New York.
 E. D. Wright, Sewaren, New Jersey.
 Henry S. Anderson, 309 Northeast Ave., Phila.
 C. Pliny Brigham, 406 Prestman Street, Balti-
 more, Maryland.
 Wm. T. Litner, Troy, New York.
 John Cook, Red Bank, New Jersey.
 Robert T. Dennis, Sing Sing, N. Y.
 J. Henry Clark, Jr., Marion, Mass. (1894).
 Samuel Locker, South Amboy, New Jersey.
 Hubert Pope, 386 Broadway, South Boston,
 Mass.
 F. M. Hall, 59 St. Charles St., New Orleans.
 Jos. R. Stephens, 1,504 S. 4th St., Phila.
 J. E. Drew, Box 102, Boston.
 Malcolm R. Pitt, Stamford, Connecticut.
 W. S. Hall, St. Augustine, Florida.
 C. C. Martin, Stapleton, Staten Island.
 A. M. Lozier, Hoboken, New Jersey.
 Harry C. Banks, Port Morris, New York.
 C. Williamson, Piermont, New York,
 Maury Island, Puget Sound, Tacoma, Wash-
 ington.
 C. Williamson, Piermont, New York.
 L. T. Safford, Tarpon Springs, Florida.
 Fred. Greiner, Toledo, Ohio.
 Tomahawk Lake, Wisconsin.
 Thos. W. Middleton, Tom's River, N. J.
 Wm. Ross, Jr., Hastings-on-Hudson, N. Y.
 W. S. Hyde, 11 1st Street, Troy, New York.
 W. B. Newhall, 53 Atlantic St., Lynn, Mass.
 H. W. Mathias, 10 Olive St., New Haven, Ct.

Worcester,
 West Ham
 (Auxiliary)
 West Lyn
 White Be
 Williams
 West End
 Windwar
 Wawasee
 Wintthrop
 Yale Cor
 Yonkers
 Yorkville
 Prob
 and into
 of yacht
 followin
 of this s
 4, Tar
 21, Tar
 4, Tar
 11, Tar
 18, Tar
 16, St
 6, M
 8, T
 9, M
 22, C
 23, C
 24, M
 26, C
 1, M
 6, C
 7, C
 12,
 13,
 13,
 20,
 24,
 25,
 26,
 27,
 27,

Weeapong,	Wm. B. Wait, Jr., 9th Ave. & 34th St., N. Y.	28, Pavonia.
West Hampton (Auxiliary).	Aug. Zabriskie, 71 West 71st St., New York.	30, Excelsior. Open, New York Bay.
West Lynn,	B. B. Browne, 38 Prospect St., Lynn, Mass.	30, Atlantic. Opening, New York Bay.
White Bear,	A. A. McKechnie, Metropolitan Block, St. Paul, Minnesota.	30, Sewaren Land and Water. Race, Arthur's Hull.
Williamsburgh,	Geo. W. Siemes, Jr., 738 Albert Street, Long Island City.	30, Review and Race. Buzzard's Bay.
West End,	Detroit, Michigan.	30, Rochester. Handicap Race.
Windward,	Chas. E. Safford, Jamaica Bay, Long Island.	30, New Bedford.
Wawasee,	Wawasee, Indiana.	30, Encinal Boat Club.
Winthrop,	Chas. G. Bird, 162 Congress Street, Boston.	31, Opening Cedar Point. Cedar Point.
Yale Corinthian,	Harold W. Bush, New Haven, Connecticut.	
Yonkers,	Geo. L. Bolwell, (Recording Secretary), New York, (1891).	
Yonkers Corinthian,	Franklin K. Rigby, Yonkers, N. Y. (1894.)	
Yorkville,	Wm. Lahn, 311 East 101st Street, New York.	

YACHTING FIXTURES.

Probably no better index can be given to demonstrate the activity and interest manifested in yachting than to carefully peruse the list of yachting events which have taken place in any given year. The following list will consequently be of great interest to any true lover of this sport:

YACHTING FIXTURES, JANUARY, 189

- 4, Tarpon Springs.
- 21, Tarpon Springs.

YACHTING FIXTURES, FEBRUARY, 1893.

- 4, Tarpon Springs.
- 11, Tarpon Springs.
- 18, Tarpon Springs.

YACHTING FIXTURES, MARCH, 1893.

- 16, St. Augustine. First race of the year.

YACHTING FIXTURES, APRIL, 1893.

- 6, Mosquito Fleet, South Boston. Open Cash, under 15 feet.
- 8, Tarpon Springs.
- 9, Monayunk Model. Opening Schuylkill River.
- 22, Corinthian, San Francisco. Opening, Tiburon, Cal.
- 23, Corinthian, San Francisco. Squadron. Cruise and Reception.
- 24, Miramichi.
- 26, Corinthian. Atlantic City.

YACHTING FIXTURES, MAY, 1893.

- 1, Monayunk Model. Regatta, Schuylkill River.
- 6, Corinthian, San Francisco. Cruise, Saucelito.
- 7, Corinthian, San Francisco. Cruise with San Francisco Yacht Club Fleet.
- 12, Corinthian. Atlantic City.
- 13, Southern, Annual Regatta. Lake Pouchatrain.
- 13, 14, Corinthian, San Francisco. Cruise, Vallejo.
- 20, Southern, Sully Cup. New Orleans.
- 24, Royal Hamilton, 21 & 25 foot classes and skiffs.
- 25, Winthrop. First Race, Moonlight.
- 26, Corinthian. Atlantic City.
- 27, Philadelphia. Opening Cruise, Delaware River.
- 27, Rochester. Opening Cruise to Sodus, Charlotte, N. Y.
- 27, Buffalo. Opening Cruise, Lake Erie.

YACHTING FIXTURES, JUNE, 1893.

- 3, Lynn, Expert Cup. Lynn, Mass.
- 3, Quiney. Club Race, Mass
- 3, Savin Hill. First Championship, Dorchester Bay.
- 3, Williamsburg. Opening.
- 3, Winthrop. Pennant.
- 3, Dorchester. First Championship Race.
- 3, 4, San Francisco. Cruise to Drake's Bay and Return.
- 4, PAVONIA.
- 4, Yorkville. Annual Regatta.
- 4, Hudson River Race. Triangular course.
- 30, Brooklyn. Opening, Gravesend Bay.
- 30, American Model. Prospect Park.
- 30, South Boston. Opening, South Boston.
- 30, Fall River. Opening, Mt. Hope Bay.
- 30, Corinthian, San Francisco. Annual, San Francisco Bay.
- 30, Monayunk Model. Regatta, Schuylkill River.
- 30, Cape Ann. Club, Gloucester.
- 30, Plymouth. Club, Plymouth.
- 30, PAVONIA. Club, Regatta.
- 30, Audubon. Annual Regatta.
- 30, Staten Island. Club Regatta, Stapleton to Great Kills.
- 30, Harlem. Annual Regatta.
- 30, Kill von Kull. Annual Regatta.
- 30, Oceanic. Club Regatta, New York Bay.
- 30, Ocean Club. Regatta.
- 30, American of New York. Club House Opening.
- 25, Winthrop. Cruise to Slate Island.
- 25, Excelsior. Annual Regatta, New York Bay.
- 25, Olympic. Second Annual Regatta.
- 25, Capital. Annual Regatta.
- 26, Rhode Island.
- 26, Communipaw.
- 26, PAVONIA, Annual. New York Bay.
- 26, Eastern, Annual. Half-way Rock, Marblehead.
- 26, Winthrop. Moonlight Sail.
- 27, Commonwealth.
- 30, to July 13, Philadelphia. Club Cruise.

YACHTING FIXTURES, JULY, 1893.

- 1, Indian Harbor.
- 1, Royal Nova Scotia.
- 1, New Rochelle, Annual. New Rochelle.
- 1, Seawanhaka. Annual Oyster Bay.
- 1, Beverly. Marblehead.
- 1, Williamsburgh. Club Cruise.
- 1, Hull. Regatta.
- 1, Winthrop. Cash Race, Hough's Neck.
- 1, St. Lawrence. A 30 foot and 25 classes and steam Yacht Race.
- 1, Miramichi. Cruise to Bay du Vin.
- 1, Hempstead Bay. Annual Hempstead Bay.
- 1, Royal Hamilton. Queen's Cup, Hamilton.
- 1, Minnetonka. Club Race.
- 1, 4, Corinthian, San Francisco. Martinez, Suisquin and Vallejo.
- 3, Manchester.

HISTORY OF YACHTING.

- 3, Indian Harbor. Special, Greenwich, Connecticut.
 4, Larchmont. Annual. Larchmont.
 4, Corinthian. Marblehead, Club Race.
 4, Beverly. First Buzzard's Bay Championship. Monument Beach.
 4, Buffalo. Club Regatta, Lake Erie.
 4, Rochester. Annual. L. Y. R. A., Charlotte, New York.
 4, City of Boston. Open, City Point.
 4, Plymouth. Annual.
 4, Keystone. Annual Regatta.
 4, Owaseo.
 4, Riverton. Annual Regatta.
 4, White Bear. Championship 1st and 2nd classes, Commodore's Cup and Pennant Race.
 4, Pavonia. Commodore's and Vice-Commodore's Cups. Connecticut.
 4, Squantum.
 4, American Model.
 4, Shrewsbury.
 4, Volunteer.
 4, Minnetonka. Club Race.
 4, Excelsior. Regatta.
 4, Kill von Kull. Annual Regatta.
 4, American (New York). Special Regatta, Naptha Launches.
 4, Lake Geneva Races.
 4, Audubon. Fifth Annual.
 4, Jamaica Bay. Regatta.
 4, Indian Harbor. Cup Race.
 4, 5, Citizens' Association. Detroit.
 5, Southwark.
 5, Philadelphia. Open Regatta. Delaware River.
 6, Massachusetts. Dorchester.
 6, Chesapeake Bay.
 6, Manchester. Annual Race, Open.
 7, Fall River. Ladies' Day, Fall River.
 7, Buffalo. Ladies' Day.
 8, Montauk. Open, Weymouth, Ct.
 8, Riverside. Annual, Riverside, Ct.
 8, Beverly. Second Open Sweepstakes, Quisset.
 8, Knickerbocker Club. Sloops and Cutters, College Point.
 8, Dorchester.
 8, Savin Hill. First Cup, Dorchester Bay.
 8, South Boston. First Championship, South Boston.
 8, Mosquito Fleet. Championship, South Boston.
 8, Cape Ann. Open, Gloucester.
 8, Quincy, Club.
 8, Winthrop. Cruise to Downer Landing.
 8, St. Lawrence. 30 foot, 21 foot and skiff classes, Montreal.
 8, L. Y. R. C. Royal Hamilton, Hamilton.
 8, Royal Nova Scotia.
 10, Royal Canadian.
 10, Riverside Cruise.
 10, Corinthian. Atlantic City.
 10, L. Y. R. A. Royal Canadian, Toronto.
 10, Buffalo. Pennant, 35, 25, 20 foot, Lake Erie.
 10, Chelsea. Mosquito Race.
 10, Winthrop. Subscription Race, Hough's Neck.
 10, Larchmont. Spring Regatta, Larchmont.
 10, New Jersey, Annual. New York Bay.
 10, Cape Cod. First Regatta.
 10, Royal Hamilton. 30 and 40 foot classes.
 10, 11, Corinthian, San Francisco. Cruise with Encinal Yacht Club Fleet.
 10, St. Lawrence. 25, 18 foot and skiff classes, Montreal.
 10, Yale Corinthian. First Sail.
 10, Royal Nova Scotia Yacht Squadron. First Race.
 11, Manchester.
 11, Winthrop. Evening, Tender Race.
 11, American. Newburyport First Club Cruise.
 11, Oceanic. Annual Regatta.
 11, Keystone. Annual Regatta.
 11, Pavonia. Consolation Race, Randall Cup.
 12, Philadelphia Model. Steamboat Race.
 12, Brooklyn. Annual, Gravesend Bay.
 12, Shackamaxon. Annual Regatta.
 13, Miramichi. Newcastle to Chatham.
 13, Atlantic Annual. New York Bay.
 11, Knickerbocker Annual. Open, College Point.
 11, Douglaston.
 11, Atlantic Cruise, Rendezvous in Cold Spring Harbor off the Casino, afternoon.
 15, Atlantic.
 15, Newburyport.
 15, Knickerbocker.
 15, American Model.
 15, Hull.
 15, Royal Nova Scotia.
 15, Philadelphia. Pennant and Sweepstakes Race, Delaware River.
 15, Commonwealth. First Pennant, Boston.
 15, Jersey City. Cruise.
 15, Corinthian. Marblehead, First Championship.
 15, American. Newburyport, Club.
 15, Chelsea. Hyde Challenge Cup.
 15, Winthrop. Cash Race, Hough's Neck.
 15, White Bear. First class, Gozian Cup; Second class, Kitten Cup.
 15, St. Lawrence. 25 foot, 18 foot and skiff classes, Montreal.
 15, Minnetonka. Club Race.
 15, Royal Canadian. skiff class, Toronto.
 15, Staten Island. Open Regatta.
 15, Sippican. First Championship, Marion.
 15, Hempstead Harbor. Annual Regatta.
 15, Columbia (Chicago), triangular course.
 15, New York. Annual New York.
 15, Rochester. Review and Ladies' Day, Charlotte, New York.
 15, Miramichi. Chatham Triangle.
 15, Pavonia.
 16, Columbia. Annual, North River.
 16, South Carolina. Pennant Race.
 17, Commonwealth. Cup, Boston.
 17, Massachusetts. Annual Cup, Off Nahant.
 17, Beverly. Open Sweepstakes, Monument Bay.
 17, Corinthian. Marblehead, Handicap.
 17, Corinthian. Annual, New York.
 17, Mosquito Fleet. Club, South Boston.
 17, Philadelphia. Opening Race, 15 foot, Boats Delaware River.
 17, Hull. Club, Hull.
 17, Plymouth. Club, Pennant.
 17, Winthrop. First Championship.
 17, Beverly. Monument Beach, Open Sweepstakes.
 17, Delaware River Racing.
 17, Larchmont.
 17, Royal Nova Scotia.
 17, Manchester.
 17, Horse Shoe Harbor. Spring Regatta, Long Island Sound.
 17, Buffalo. Ladies' Day.
 17, Royal Canadian, 1st and 21 foot classes, Toronto.
 17, St. Lawrence, A, 30 foot and 21 foot classes, Montreal.
 17, Staten Island. Club Regatta.
 17, Yonkers Corinthian. Annual, Hudson River.
 17, Tacoma. Opening.
 17, Seawanhaka Corinthian. Race for 25 footers and Naptha Launches.
 17, Rhode Island. Cup.
 17, Atlantic. Sail to New London.

17, South
 17, Minne
 18, Stuten
 18, Atlant
 19, Willia
 19, Atlant
 19, 20, Sa
 19, Portlu
 20, Quine
 20, Monat
 20, Rivert
 21, Corint
 22, Quine
 22, Rhode
 22, Schoo
 22, New I
 22, Oecon
 22, Canar
 22, Delav
 22, Shrew
 22, Baysw
 22, Seawa
 22, Mobil
 22, Oriol
 22, Greec
 22, Mosq
 22, Roch
 22, River
 22, Corin
 22, Beve
 22, Savin
 22, Hull
 22, River
 22, Roya
 22, Man
 22, Roya
 22, Exec
 23, Oak
 23, Sout
 23, Cori
 23, Win
 23, 29, I
 24, Hull
 24, Jerss
 24, Dou
 24, Stat
 24, Roy
 24, Cori
 24, St
 24, Larc
 24, Exc
 24, Mar
 24, Whi
 24, Son
 24, Roy
 24, Bal
 24, Col
 24, Ton
 24, Car
 24, To
 24, 25,
 24, Mi
 24, 30,
 25, Wi
 25, 27,
 26, Sh

- 17, Southern. Walker Cup, Lake Ponchartrain.
 17, Minnetonka. Cup, Championship, Lake Minnetonka.
 18, Staten Island. Club Race, Staten Island.
 18, Atlantic. Run to Shelter Island.
 19, Williamsburgh. Spring Regatta.
 19, Atlantic. Run to Stonington or Newport.
 19, 20, San Francisco. Cruise in Squadron.
 19, Portland. Annual Challenge Cup Regatta.
 20, Quincy.
 20, Monaquot. Ladies' Day, Weymouth.
 20, Riverton. First Race of New Mosquito Fleet.
 21, Corinthian of Philadelphia. Annual, Delaware River.
 22, Quincy. Club Race, Boston Harbor
 22, Rhode Island. Ladies' Day.
 22, Schoodie. Annual, Calais, Me.
 22, New Haven. Annual Spring Regatta.
 22, Oconomowoc.
 22, Canarsie.
 22, Delavan.
 22, Shrewsbury.
 22, Bayswater.
 22, Seawanhaka Corinthian.
 22, Mobile.
 22, Oriole.
 22, Greenville.
 22, Mosquito Fleet. Championship, South Boston.
 22, Rochester. Skiff, Charlotte, N. Y.
 22, Riverside. Special Cup, Riverside, Ct.
 22, Corinthian. Marblehead, 21 footers.
 22, Beverly, 3rd Open Sweepstakes, Monument Beach.
 22, Savin Hill. Union Race, Dorchester Bay
 22, Hull, Club.
 22, Riverton, Midsummer Regatta.
 22, Royal Canadian, 21 foot class, Toronto.
 22, Manchester. Cup Race.
 22, Royal Hamilton, 30 and 40 foot classes.
 22, Excelsior. Regatta.
 23, Oak Point.
 23, Southwark.
 23, Corinthian of Philadelphia.
 23, Winthrop. Cruise to Brewsters.
 23, 29, N. Y. Y. R. A., Cruise.
 24, Hull Corinthian. First Championship, Hull.
 24, Jersey City. Annual, Commnippaw.
 24, Douglaston. Annual Douglaston, Long Island.
 24, Staten Island. Ladies' Day.
 24, Royal Canadian, 30 foot and skiff classes, Toronto.
 24, Corinthian of Philadelphia. Special, Delaware River.
 24, St. Lawrence, 25 and 18 foot and skiff classes, Montreal.
 24, Larchmont.
 24, Excelsior. Regatta.
 24, Marine & Field Club. Regatta, New York Harbor.
 24, White Bear. First class, Gotzian Cup; Second class, Kitten Cup.
 24, South Boston. Championship.
 24, Royal Hamilton, 21 and 25 foot and skiff classes.
 24, Baltimore. Second Annual Race.
 24, Columbia (Chicago). Race to Michigan City.
 24, Tom's River. Annual Regatta, Barnegat Bay.
 24, Canarsie. Annual, Jamaica Bay.
 24, Tower Ridge, 1st Annual Regatta to Spuyten Duyvil.
 24, 25, San Francisco. Annual Cruise.
 24, Minnetonka. Tournament and Carnival.
 24, 30, Hempstead Bay. Cruise, Long Island Sound.
 25, Winthrop. Evening Race, 3rd and 4th classes.
 25, 27, 28, New York. Astor Cups, Newport.
 26, Shrewsbury.
 26, Matapoissett.
 26, Winthrop. Moonlight Sail.
 27, Fall River. Ladies' Day, Mt. Hope Bay.
 28, Owasco.
 28, Savin Hill. Moonlight Sail.
 29, Indian Harbor. Annual, Greenwich, Ct.
 29, American. Newburyport, Club.
 29, Buffalo. Annual Cruise, Lake Erie.
 29, Cape Ann. Club, Ipswich Bay.
 29, Hull Corinthian. Cash Race, Hull.
 29, Winthrop. Cruise to Nahant.
 29, Royal Canadian. Lansdowne Cup, 30, 35 and 40 footers, Toronto.
 29, Minnetonka. Club Race.
 29, White Bear, 1st and 2nd classes. Pennant Races.
 29, Royal Nova Scotia, 3 raters, Halifax.
 29, Chesapeake Bay. Special, St. Michaels.
 29, Great South Bay. Annual, Bay Shore.
 29, Sippiem. First Open Sweepstakes, Marion.
 29, Barnstable.
 29, Corinthian.
 29, Lincoln Park Y. C.
 31, Oconomowoc.

YACHTING FIXTURES, August, 1893.

- 2, Chesapeake Bay.
 2, Monaquot. First Championship, Weymouth,
 2, American. Newburyport, Open.
 3, Plymouth. Ladies' Day.
 4, Savin Hill. Second Championship, Dorchester.
 4, Quincy. Ladies' Day.
 5, Shrewsbury.
 5, East Bay.
 5, Tacoma.
 5, Seawanhaka Corinthian.
 5, Greenwich.
 5, Shelter Island.
 5, Corinthian. Marblehead, Second Championship.
 5, South Boston. Second Championship, South Boston.
 5, Beverly. Second Buzzard's Bay Championship, Monument Beach.
 5, Knickerbocker Club. Open Cash, College Point.
 5, Riverside. Pennant Regatta, Riverside, Conn.
 5, Mosquito Fleet. Championship, South Boston.
 5, Commonwealth. Ladies' Day, Boston Harbor.
 5, Quincy. Club Race, Quincy, Mass.
 5, Lynn. Expert Cup, Lynn, Mass.
 5, Corinthian. Second Championship.
 5, Hull, Club.
 5, Winthrop. Ladies' Day.
 5, Royal Canadian. 21 foot class and McGaw Cup, Toronto.
 5, Royal Hamilton. White Wings Cup, all classes.
 6, Jamaica Bay.
 6, Greenville.
 7, Winthrop. Evening Race, 3rd and 4th classes.
 7, New York. Cruise, Rendezvous at Glen Cove, Commodore's Cup.
 7, Royal Nova Scotia. Annual Cruise, Halifax.
 8, Massachusetts. Open, under 23 feet, Dorchester Bay.
 8, New York. Cruise, Run to Morris Cove.
 9, New York. Run to New London.
 9, Sippiem. Second Championship, Marion.
 10, Wawassee.
 10, Rochester. Ladies' Day, Charlotte, N. Y.
 10, Miramichi. Stewart Pennant, Black Brook.
 10, New York. Cruise, Run to Newport.

- 10, New York. Gulet Cups, Newport.
 12, Oriole.
 12, Mattapoisett.
 12, Southern Yacht Club.
 12, Buffalo.
 12, Oconomowoc.
 12, Beverly. Marblehead.
 12, Chelsea. Mosquito Race.
 12, Hull. Corinthian, Second Championship.
 12, Winthrop. Cash Race.
 12, Royal Canadian. Cruising Race, 1st, 30 foot and 25 foot classes, Toronto.
 12, Minnetonka. Cup Race.
 12, White Bear. White Bear Cup, all classes.
 12, Royal Hamilton. Cruising Class, Handicap.
 12, New York. Cruise, Run to Martha's Vineyard.
 13, Jamaica Bay.
 13, Corinthian. San Francisco. Rowing Races, Tiburon.
 13, Winthrop. Cruise to Fort Point, Weymouth.
 14, Hempstead Bay. 3rd Club, Hempstead Bay.
 14, New York. Cruise, Run to New Bedford.
 14, 19, Corinthian. Marblehead, Midsummer Series.
 15, Scawanhaka.
 15, Manchester.
 15, Hobb's Hob.
 15, 17, 19, Return of New York Fleet to Newport. Race for Astor Cups for 85 footers.
 16, Larchmont.
 16, Owaseo.
 16, Lake Champlain.
 16, Monaquot. Second Championship, Weymouth.
 16, Savin Hill. Sail Off, Dorchester Bay.
 19, Shelter Island.
 19, Scawanhaka.
 19, Lynn. Expert Cup, Lynn, Mass.
 19, Mosquito Fleet. Championship, South Boston.
 19, Riverside. Ladies' Day, Race, Riverside, Conn.
 19, Quiney. Club Race, Quiney, Mass.
 19, Beverly. First Open, Quissett.
 19, South Boston. Third Championship, South Boston.
 19, Newark Bay.
 19, West Falmouth.
 19, Patchogue Yacht Club, L. I.
 19, Savin Hill. Union Open, Dorchester Bay.
 19, American. Newburyport, Club.
 19, Winthrop. Second Championship.
 19, Royal Canadian, skiff class, Toronto.
 19, Royal Hamilton. Marguerite Cup, for 25 foot class, and Greening Cup for 21 foot class.
 19, White Bear. Wildwood Cup, all classes.
 19, 20, Corinthian, San Francisco. Cruise, Goat Island.
 20, Mobile.
 20, American. Newburyport, 2nd Club Cruise.
 20, Manchester, (Mass.) Cup Race.
 21, Hull. Club.
 21, Rhode Island. Open.
 22, Massachusetts. Club, Dorchester Bay.
 22, Fall River. Open, Mount Hope Bay.
 23, New Jersey.
 23, Winthrop. Evening Race, 3rd and 4th classes.
 24, Corinthian Mosquito.
 24, Rochester. Club, Charlotte, N. Y.
 24, Commonwealth. Second Pennant, Boston.
 24, American. Newburyport, Moonlight Sail.
 24, Winthrop. Moonlight Sail.
 25, Staten Island. Ladies' Day.
 26, Stippican. Open, Marion.
 26, Corinthian Mosquito Fleet. Annual Regatta, New Rochelle.
 26, Cape Cod.
 26, Hull.
 26, American Model.
 26, Lake Geneva.
 26, Minnetonka. Sail off.
 26, White Bear, 1st and 2nd class Championship.
 26, Royal Nova Scotia. Open, Ladies' Prizes, Halifax.
 26, Buffalo. Ladies' Day.
 26, Corinthian. Atlantic City, Annual.
 26, Corinthian. Marblehead, Third Championship.
 26, Monaquot. Third Championship, Weymouth.
 26, Larchmont. Oyster Boat, Larchmont.
 26, Winthrop. Cruise to Marblehead.
 26, 27, Corinthian, San Francisco. Cruise, Petaluma Creek.
 26, 28, Royal Canadian. Cruise.
 27, Manchester, (Mass.) Cup Race.
 28, Eastern. Weld Cup, Marblehead.
 30, Incog Yacht Club.
 31, Larchmont, 85 foot Special. Long Island Sound.
 31, Atlantic, 85 foot class, New York.
 31, Corinthian. Sweepstakes, 85 foot class, Newport.

YACHTING FIXTURES, SEPTEMBER, 1893.

- 1, Newark.
 2, Old Colony.
 2, St. Lawrence.
 2, 5, Southwark, Yacht Club.
 2, Savin Hill, 2nd Cup, Dorchester Bay.
 2, Corinthian. Marblehead, Sail off.
 2, Beverly. Fourth Open Sweepstakes, Monument Beach.
 2, Knickerbocker. Club Open Boats, College Point.
 2, Quiney. Club Race, Quiney, Mass.
 2, Rochester. Cruise, Charlotte, N. Y.
 2, Lynn. Expert Cup, Lynn, Mass.
 2, Winthrop. Consolation Race.
 2, Royal Nova Scotia. Open, Halifax.
 2, Royal Canadian. Cruising Race, 1st class, Toronto.
 2, Larchmont. Fall Regatta, Larchmont.
 2, Royal Hamilton. Monek Cup for 40 foot class, and Luens Cup for 30 foot class.
 3, Manchester, (Mass.) Cup Race.
 3, Southern.
 4, Citizens' Yacht Racing Association.
 4, West End.
 4, Squantum.
 4, American Model.
 4, Scawanhaka Corinthian.
 4, Bayswater.
 4, Mosquito Fleet.
 4, Lynn. Open, Nahant.
 4, Corinthian. Marblehead, Club, Regatta.
 4, N. Y. Y. R. A. Annual, New York Bay.
 4, Beverly. Second Open, Monument Beach.
 4, Plymouth. Outside Race.
 4, Fall River. Club, Mount Hope Bay.
 6, Corinthian. Atlantic City.
 6, Winthrop. Evening Race, 3rd and 4th classes.
 7, New York. Trial Races begin for America's Cup.
 7, Knickerbocker. Ladies' Day, College Point.
 9, Shrewsbury.
 9, South Boston.
 9, Beverly. Marblehead.
 9, Commonwealth. Third Pennant, Boston.
 9, Corinthian. San Francisco, Channel Cruise and Race.
 9, Buffalo. Cruising, Sweepstakes. All classes, Lake Erie.

- 9, Larehmont. Special, Schooners and 85 foot class, Larehmont.
 9, Royal Canadian. Prince of Wales' Cup, Toronto.
 9, Miramichi. Newcastle, triangle.
 9, White Bear. 1st class, Commodore's Cup; 2nd class, Pennant Race.
 9, Sippican. Third Championship, Marion.
 10, Excelsior.
 14, Beverly. Third Buzzard's Bay Championship, Monument Beach.
 14, Rochester. Review and Ladies' Day, Charlotte, N. Y.
 14, Mosquito Fleet. Cash, South Boston.
 15, New York. Autumn Sweepstakes, New York Bay.
 16, Shrewsbury.
 16, Beverly.
 16, Greenville.
 16, Miramichi.
 16, Philadelphia. Open, Delaware River.
 16, Lynn. Expert Cup, Lynn, Mass.
 16, Plymouth Club.
 16, Royal Canadian. 30 foot class, Toronto.
 16, Royal Nova Scotia. Special class, Edwards Cup.
 16, White Bear. White Bear Cup, all classes.
 16, Royal Hamilton. 21 and 25 foot classes and skiffs.
 19, 21, Shrewsbury.
 19, Chelsea. Annual and Hydro Challenge Cup.
- 21, Corinthian. Atlantic City.
 23, White Bear.
 23, Royal Canadian. Cosgrove Cup, 25 foot class, Toronto.
 23, 24, Corinthian. San Francisco, Cruise and Corinthian Games.
 30, Royal Hamilton. 30 and 40 foot classes.
 30, American Yacht Club.

YACHTING FIXTURES, OCTOBER, 1893.

- 1, Jamaica Bay.
 1, Audubon.
 1, Southwark.
 2, Brooklyn.
 2, Detroit Yacht Club.
 5, 7, 9, New York. America's Cup, Sandy Hook.
 7, Plymouth Club.
 7, Miramichi. Chatham, Newcastle.
 7, 8, Corinthian. San Francisco, Cruise.
 9, Miramichi.
 14, Corinthian. San Francisco. Closing Day, Tiburon.
 14, Buffalo. Closing Cruise.
 14, Commonwealth. Novelty Race, Boston Harbor.
 21, Closing Day. San Francisco, Yacht Club.
 21, Old Mill Yacht Club.

W

fection of
From
superior
century
the fairy
in contest
ority of t

The fl
the prec
BAND E.
built for
tary of
schooner
Rollins.
John C.
HVE; sh
Govern
Caynos

Then
by Web
ward C
Geo. R.
She wa
13.6 fe
was lost
schoone
for Jo
tonnag
States
sand d

In 1
was bu
Her le
feet, b
mage
the fa
benter
She e
was 1
1839
built
all, 4
tonna
CLW

In
yacht
ARON
was l
feet
1842
was

YACHTING IN THE UNITED STATES.

WHEN yachting had become a national sport in England, if Americans were not able to equal their British cousins in point of wealth, of members they were, even at that time, leaving them far to leeward both as regards perfection of model and capacity for speed.

From first to last, on the sea Americans have been their superiors, whether testing their prowess with the flying privateers of a century ago, with the stately clippers of a more recent date or with the fairy-like craft which they have sent across the ocean to engage in contests for victory. Americans have ever maintained the superiority of their boats.*

The first American yacht of which we have any record, as stated in the preceding chapter, was JEFFERSON, the next being CLEOPATRA'S BARGE, and then we find that in 1821 the schooner yacht TEASER was built for George B. Rollins who afterwards held the position of Secretary of the New York Yacht Club; following this in 1824, the schooner yacht UNDINE was built by Cole & Oddie also for George B. Rollins. The next yacht recorded was built by Capes in Hoboken for John C. Stevens and was named ONKANYE; she was sold to the United States Government in 1843 and was lost off Caynos reefs, West Indies, in 1848.

Then followed the building of DREAM by Webb in 1832, for Prescott Hall, Edward Center, Col. Pennington Hossach, Geo. R. J. Bowden and John C. Jay. She was a keel schooner, 47 feet over all, 13.6 feet beam and 7.6 feet draft. She was lost in a collision off Bridgeport. The schooner WAVE was also built this year for John C. Stevens and was of 93½ tonnage. She was sold to the United States Government in 1838 for eight thousand dollars.

In 1833 the centerboard schooner SYLPH was built for John B. Cushing of Boston. Her length over all was 72 feet, keel 65 feet, beam 18 feet, draft 8 feet and tonnage 72. SYLPH was considered among the fastest yachts in her class; she was beaten, however, by WAVE off Nantucket. She eventually became a pilot boat and was lost off the New Jersey coast. In 1839 the yacht NORTHERN LIGHT was built for Col. Chas. P. Winchester of Boston. She was 60 feet over all, 45 feet keel, 7 feet 6 inches beam, 10 feet draft and was of 79.95 tonnage. NORTHERN LIGHT and SYLPH joined the NEW YORK YACHT CLUB at Newport in 1844 when on its first cruise.

In 1839 at the age of sixteen the late George Steers built a small yacht 17 feet long named MARTIN VAN BUREN, which beat GLADIATOR, a yacht having quite a record. The centerboard sloop PÉTRÉL was built in 1840 for George B. Rollins; she was 33 feet over all, 4.6 feet beam, 4 feet draft, 4.6 feet depth and was of 15 tonnage. In 1842 the centerboard sloop RAPINS was built by Robert Fish; she was 11½ tons and her dimensions were:

Length over all,	40 feet.	Beam,	12 feet.
Keel,	38 feet.	Draft,	12 feet.

* See "N. Y. Herald, June 8, 1860.

During the same year the sloop LANCET was built by Cole and Oddie and was afterwards altered into a schooner. She was owned by Geo. B. Rollins and was 22½ tonnage. Her length over all was 44 feet, beam 12.6 feet, keel 39 feet and draft 8.6 feet.

In 1841 George Steers built a boat 30 feet long, which was called JOHN C. STEVENS. With a crew aboard, she drew only 4 inches of water and weighed only 140 pounds being for this reason quite remarkable. In 1842 he built the pilot boat WILLIAM G. WAOSTAFF for the New Jersey pilots, and it is said that her speed was so great as to excite the animosity of the New York pilots. Steers afterwards built the famous pilot boat MARY TAYLOR, which will be fully described in the chapter on the "Type of Yachts."

Then followed the building of the keel schooner yacht LA COQUILLE (28 tons) by Steers at Williamsburg in 1842. She was formerly the cut-riggered MANHATTAN and was owned by John C. Jay, who held at one time the position of Secretary of the New York Yacht Club. In 1843 the sloop MIST was built for L. A. Depanu of New York. In 1844 the keel schooner SPRAY was built by Brown & Bell, for Humilton Wilks; the keel schooner CYONET (45 tons), illustrated in Fig. 88, was also built the same year, as well as the keel schooner MINNA (30 tons). The former was constructed by Steers & Hathorne at Williamsburg for D. L. Suydam, the latter being built by the same firm for Oscar Coles. In 1845 the keel schooner PET (46 tons) was built by Lewis Winde at East Boston, Mass., for Thomas Parsons. It was during the summer of this year that the first regatta was held in Massachusetts Bay, the yacht RAVEN, owned by the late Hon. Benj. C. Clark, being the winner. It may be mentioned here that in 1832 the same yachtsman owned a yacht by the name of MERMAID which was well known to Eastern yachtsmen.

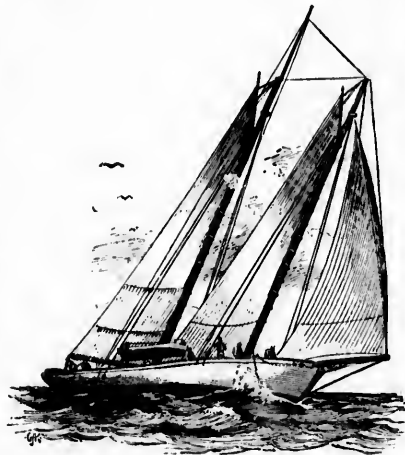

CYONET.—FIGURE 88.

(From an outline drawing by Cozzens.)

The keel schooner BRENDA was built by Winde & Chinchard of East Boston for David Sears, Jr., in 1843; she was of 33 tonnage. BRENDA sailed a race off Bermuda against the yacht PEARL and won the race, attracting considerable attention at the time. The keel schooner HORNET (30 tons), which was a pilot boat for a while and was then turned into a pleasure vessel, was built for Jessie Barker in 1846, and in the same year the keel schooner MYSTERY was built at Newburyport, Mass.; the famous MARIA also made her first appearance this year.

MARIA was built at Hoboken by William Capes in 1846. She was modeled by the late Commodore John S. Stevens and George Steers, also remodeled later on by Robert Fish. She was altered in 1847, 1849, 1851 and 1852. Her first measurements were as follows:

Length over all,	110 feet.
Load waterline,	97 feet.
Beam,	26 feet 6 inches.
Draft,	5 feet 2 inches.
Displacement,	145 tons.

She was fitted with a lead keel and two centerboards, one of which weighed seven tons. Her main boom (built of staves, like a cask), was 95 feet long; foot of mainsail, 93 feet; head, 50 feet; hull, 66 feet; loech, 110 feet; sail area, 5,850 square feet. The cloths of this wonderful mainsail ran horizontally, in order to minimize the friction on the seams. The main boom was a rather curious structure of thirty-one staves of yellow pine 2 1/2 inches thick. The extreme diameter was, at the sheet, 2 feet 2 inches; and smallest at the goose-neck, 14 inches. The boom was bound with iron hoops,



MARIA.—FIGURE 89.
(From an outline Drawing by Cozzens.)

dowelled and internally trussed with bar iron. The proportions of MARIA filled the yachting mind with awe in 1846.

MARIA was afterward altered to conform with the wave-line theory (see Fig. 103, Type of Yachts), and the following were her dimensions after the alterations:

Length over all,	122 feet, 1 inch.
Length load waterline,	114 feet, 6 inches.
Breadth,	26 feet, 6 inches.
Draft,	5 feet, 2 inches.

MARIA made her first appearance in a race given under the auspices of the NEW YORK YACHT CLUB, October 6, 1846, the first Corinthian race held in this country. It took place over a course from a stake-boat off Fort Washington Point; thence to a stake-boat anchored in the Narrows, returning to the starting point, a distance of 40 miles.

The sloops LANCET and MARIA started in this race, as also the schooners CYGNET, LA COQUILLE and SIREN. There was a strong breeze blowing from southwest. MARIA won easily, beating SIREN 58 minutes, 15 seconds, actual time.

MARIA next sailed a match race October 10, 1846, for \$1,000 a side with the schooner COQUETTE, MARIA being entered at 154 tons. The course was 25 miles to windward and return, and it was the first ocean race sailed. MARIA started with double-reefed mainsail and bonnet off her jib, while COQUETTE carried all sail. COQUETTE won in 6 hours, 35 minutes, MARIA covering the distance in 7 hours, 1 minute.

MARIA won the first prize in the second Annual Regatta of the NEW YORK YACHT CLUB, June 2, 1847, entered at 115 tons. USA appeared for the first time in this race, and won the second prize.

MARIA entered at 118 tons in the third Annual Regatta, sailing against SIREN and CORNELIA, the last named yacht winning, as in a sudden gust of wind MARIA snapped her mast and her mainsail and boom went overboard.

In the fourth Annual Regatta of the NEW YORK YACHT CLUB, June, 1849, MARIA entered at 119 tons, and sailed against ULTRA, CORNELIA and SIREN. CORNELIA came in first, but went on the

wrong side of the western bank. ULTRA won on time allowance, as MARIA came in only 14 minutes ahead.

In the fifth Annual Regatta, June, 1850, MARIA entered again, this time at 126 tons, but was beaten on time allowance by both ULTRA and BREEZE.

On July 8th, 1850, MARIA sailed against ULTRA and BREEZE. When off the False Hook the wind blew so fresh that the masthead of MARIA was sprung and splintered, obliging her, when about half way between the Hook and the Light-ship to settle away her mainsail and return.

On August 10th, 1854, MARIA entered at 116 tons and sailed in the first yacht race held at Newport, JULIA, USA, GERTRUDE, IRENE, AMERICA (40 tons) and ELLA JANE starting. The sloops were limited to mainsail and jib. MARIA won, beating ELLA JANE 45 minutes, 13 seconds, over the course of 45 miles. The wind was northeast and there was considerable sea.

In 1862, at the Annual Regatta of the NEW YORK YACHT CLUB MARIA appeared as a schooner. She was altered for several reasons, among which was the fact that it had been found impossible to keep her stick in her; being of enormous beam and great initial stability, and her sail spread was something enormous for those times.

In 1847, the keel schooner SYDIE (44 tons), the keel schooner SIREN (70 tons) and the centerboard sloop USA were built. The first was built by George Steers in Williamsburg for Christopher B. Miller, the second was also built by Steers for William E. Miller, and USA was built by the same party for James Waterberry. She was altered in 1854 and 1855.

The keel schooner BREEZE (70 tons) and the centerboard sloop ULTRA were built in 1848, the first by Winde & Clinsherd in East Boston for David Sears, Jr., and the second by Robert Fish in Newburgh for Christopher B. Miller. In 1849 the sloop MIST, belonging to L. A. Depan, made its appearance, and in 1850 the centerboard sloops ALPHA (24 tons), built by John Letts for Richard Morris, and UNDIS, built by Robert and Isaac Fish in Brooklyn for H. C. Babcock, made their appearance.

The year 1851 is notable for giving to the yachting world the famous AMERICA, shown in Fig. 90 as she was, and in Fig. 91 as she appears to-day.

This keel schooner (170 tons) was built by George Steers for the

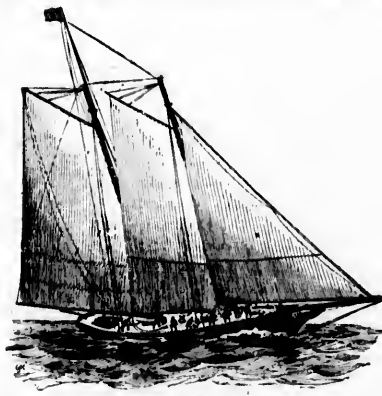

AMERICA (AS SHE WAS).—FIGURE 90.
(From an outline Drawing by Cozzens.)

late Commodore John C. Stevens and others. The greatest event in the history of American yachting was the triumph of the schooner AMERICA over the yachts of the ROYAL YACHT SQUADRON in 1851. Her history is fully given in the chapter in the second volume relative to the AMERICA'S CUP.

Among a number of revolutions—political or social, terrestrial or aquatic—which have occurred in England, none probably over

wron
pecu
third
hand
first;
great
durat
embla
leewa
that a
of yac
than
chang
impul
of yac
in exi
eighty
Engla
their s
in a g
and gl
as muc
were in
of the
In fac
success.

Enco
yacht S
CLUB, w
that th
water.
ing kee
was ren
pense w
feet long
was 50
deck wa
6 1/2 feet
upwards
that no
such pr

cham
were
which
race,
length
wind
to en

wrought so many changes as the advent of AMERICA. Her main peculiarities were a long, sharp bow, a width which was greatest two-thirds of the length from the stern, and sails which, in American hands, were always trimmed quite flat. The objects attained were: first, greater speed; second, greater stability in the vessel; third, greater evenness and equality of motion; fourth, greater powers of endurance in rough weather, and fifth a steadiness of motion which enabled her in sailing to keep close to the wind and lose but little leeway. She was a novelty as well as a success, and the result was that a wholesale reformation commenced which has brought the art of yacht building and yacht sailing to a higher degree of perfection than it had ever before attained. The ancient bluff bows were exchanged for the sharp nose and clean run of AMERICA, thus an impulse was given to the sport all over the world and a large number of yachts, mostly on the Yankee model, were added to those already in existence. Within two years after her appearance no less than eighty-five yachts were lengthened at the bows, or, as it is termed in England, "Americanized," after they were built. In addition to their speed it was found that, like AMERICA, they "lay to" easier in a gale of wind, shipped less water over their bows in a heavy sea, and glided along with less disturbance, not careening and plunging as much as they did before their alteration. Besides this, the sterns were improved, the sails and rigging simplified and the configuration of the hull made to combine the qualities of both comfort and speed. In fact, the Anglo-American amalgamation proved a complete success.

Encouraged by the success of AMERICA, the centerboard sloop yacht SILVIE, belonging to Mr. Louis Depau of the New York Yacht Club, was carried into English waters in 1853. Her peculiarity was, that though of 106 tons measurement, she drew only 4½ feet of water. By a peculiar arrangement, however, of centerboard or sliding keel, which dropped below the bottom to the depth of 7 feet, she was rendered perfectly stiff in strong winds and was enabled to dispense with the necessity of using shifting ballast. Her mast was 82 feet long, her boom 72 feet; from the end of the bowsprit to the mast was 50 feet, and the jib-boom was 18 feet out. The length of the deck was 80 feet, beam 24 feet 6 inches, depth 7 feet, draft of water 6½ feet aft, 3½ feet at the fore. The first cost of the vessel was upwards of \$20,000. Under these circumstances, and from the fact that no craft was expected on the other side which had not given such proofs of her superiority as would justify her in claiming the

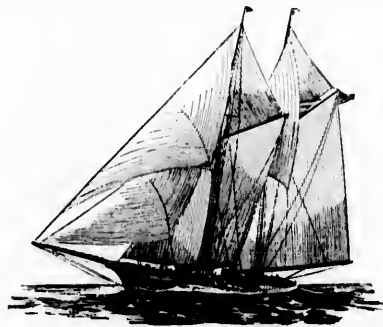

AMERICA (AS SHE IS).—FIGURE 01.

(From a Photo by Johnson.)

championship, great interest was excited. Her fine and peculiar lines were much admired, being entirely different from those of the yachts which had previously visited England. She sailed in only one race, and on this occasion she was beaten by JULIA by about the length of a bowsprit, but it is proper to say that there was not enough wind to keep her sheets full and it was a drift contest from beginning to end. Mr. Depau immediately raised a challenge flag to his mast-

head, and offered to sail a race for any amount, but he failed to find a competitor. The Englishmen had gotten an American yacht beaten and they proposed to keep her so. No other race, consequently, took place. Mr. Depau remained on the British coast about two years and then returned to the United States with his yacht.

TURKEY is another American yacht which went to England in 1852 to engage in the animating contests for superiority which have been



HENRIETTA.—FIGURE 02.

(From an outline Drawing by Cozzens.)

so frequent; and, though a Lilliputian in size, being only 3½ tons measurement, she amply realized the high expectations of all who knew her qualities. She was built in 1852 for R. M. Grinnell of New York City, and after several private trials here she was taken to Great Britain, where she won three prizes in Liverpool and two in Ireland in less than a year after her arrival. She was the first Yankee clipper that ever sailed on the Thames, and her repeated successes soon induced offers for her from a gentleman belonging to the BIRKENHEAD MODEL YACHT CLUB, which resulted in her transfer to him.

In the same year that AMERICA and SILVIE made their appearance the centerboard sloop BLANCA (21 tons) was built by Fish & Clark, of New York, for Charles MacAlester, Jr., of Philadelphia. In 1852, Colonel Thomas T. Ferris had the schooner HONNET rebuilt and made into a 30 ton sloop which he named SPORT, and in the same year the centerboard sloop GERTRUDE (82 tons) was built by Isaac Fish for J. M. Pendleton. During the following year the centerboard sloop L'ESPERANCE (23 tons) was built by George Steers, for Woodbury Langdon, the keel sloop RAY (29 tons) by Steers for F. M. Ray and the keel schooner HAZE was built for William Butler Duncan by George Steers.

One of the most important events in the history of private yachting was a journey to Europe, in 1853, of NORTH STAR, belonging to Commodore Vanderbilt. This was a steam yacht of the largest size, built expressly for her owner to make a pleasure voyage in, and combining all the requisites to insure comfort and safety. She left New York in May, 1853, having on board a family party, consisting of Commodore Vanderbilt, his wife, eighteen of his sons and sons-in-law and daughters and daughters-in-law, besides his family doctor and clergyman, with their ladies. After a pleasant run across the Atlantic they touched first at Southampton, from thence the party proceeded to London, Liverpool, Rome, Naples, Florence, Leghorn, Copenhagen, Cronstadt, St. Petersburg, Gibraltar, visiting in fact, nearly all the prominent seaports of the Continent and many of the interior cities. The presence of a private citizen of the United States on such a mag-

nificent pleasure jaunt, attended by all the surroundings of royal splendor, naturally excited wonder wherever he went, and throughout the trip the tourists were the recipients of hountiful hospitality. After spending three months in this agreeable manner, leaving the impression wherever he went that Brother Jonathan could "do some things as well as others," the Commodore turned his adventurous prow homeward, dropping anchor on the 27th of September in New York Bay.*

In 1854, the centerboard schooner *STARLIGHT* (58 tons) and the two centerboard sloops *CERES* (22 tons) and *JULIA* (83 tons) made

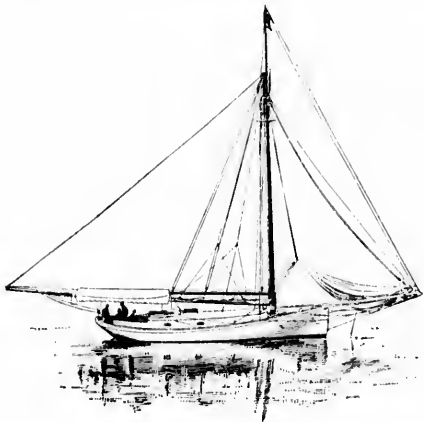

QUIVIVER.—FIGURE 93.

their appearance, while in 1855, the sloop *JULIA*, which proved herself a wonder, and eight centerboard sloops were launched, namely: *LUCKEY* (20 tons), *AMERICA* (47 tons), *MARGARET* (15 tons), *PRIMA DONNA* (15 tons), *REBECCA* (17 tons), *WAVELET* (21 tons) and, last but not least, *FANNY* (38 tons), built by Robert Fish of New York for E. H. White. The schooners *VOLANTE* (55 tons) and *SEADRIFT* (64 tons), formerly *JULIETTE* (C. B.), were also built the same year. In 1856 the keel schooner *FAVORITA* (130 tons) and *RESTLESS* (95 tons) made their appearance, as also the centerboard sloops *RICHMOND* (26 tons), *ESCORT* (34 tons), *EDGAR* (17 tons) and *ISLAND FAWN* (18 tons).

The keel schooner *WANDERER* (243 tons), built by James M. Baylis in Port Jefferson, L. I., and designed by Capt. Thomas B. Hawkins for J. D. Johnson of Islip, L. I., in 1857, is deserving of mention. She cost \$25,000 and was of the following dimensions:

Keel,	95 feet.
Depth of hold,	26 feet.
Beam,	10 feet.

Though belonging to a New York yacht club she was never entered in a race from the fact that with her measurement and canvas she would have to give too much to the other boats.

Her interior accommodations were of the most costly and luxurious character, her cabin presenting the appearance of a magnificently furnished parlor, while outside, when employed for purposes of pleasure, everything was as taut, tidy and shipshape as the daintiest yachtsman could desire. During the ensuing winter the owner, with a party of gentlemen, started on a cruise to the West Indies, Havana, New Orleans, and other Southern ports, where they were hospitably received and entertained. Soon after this she was disposed of for the sum of \$12,000, to Capt. William C. Currie of Savannah. She became suddenly famous by it being discovered that her owner was using her for the transportation of negroes from

* See "New York Herald," 1860.

Africa. For this Capt. Currie was expelled from the New York Yacht Club on February 3, 1859.

The same year (1857), the centerboard sloop *VICTORIA* (85 tons), was launched, and also *MADGIE* (59 tons), which was built by Thomas Byerly & Son of Philadelphia, and designed by R. F. Loper. This yacht was altered in 1864 into a schooner and received the name of *MAGIE* (97 tons), a yacht which became famous in protecting America's Cup, and which will be described in its appropriate place. In 1857 the centerboard sloops *MINNIE* (59 tons) and *ROWENA* (40 tons), were built, as also the keel sloop *PETREL*, which had a well for live fish, and which was sold to a yachtsman from San Francisco. *AZALEA* (54 tons), a wooden centerboard schooner, built by D. J. Lawlor of Chelsea, Mass., for John M. Forbes of Boston, was launched the same year, and also the centerboard iron schooner *EDITH*, which was built by Otis Tufts of Boston for R. B. Forbes. *EDITH* is another American yacht which traveled a long distance from home. After being used as a yacht for two years she was sold as a pilot boat to parties in Buenos Ayres, and made the passage from Boston to Montevideo in forty-seven days, the mainmast having gone by the board on the way. It is an interesting fact in connection with this craft, that the flag of the New York Yacht Club was carried by *EDITH* further into the upper waters of the Uruguay and Rio Negro than the American flag had ever been carried. She is probably the first boat of the New York Yacht Club Squadron that visited the Southern hemisphere.

In 1858 the keel schooner *GIPSEY* (148 tons) and the centerboard schooner *ZINGA* (136 tons), made their first appearance, as also the four centerboard sloops, *FLYING CLOUD* (25 tons), *HASWELL* (28 tons), *NARRAGANSETT* (32 tons), and *MANERSING* (42 tons). During the following year three centerboard sloops were launched, namely: *LAPWING*, (25 tons), *MALLORY* (45 tons) and *PILOVER* (40 tons). In 1860 the centerboard sloop yacht *NETTLE* (45 tons) was built by Al-



(From an outline drawing by Cozzens.)
FLEETWING.—FIGURE 94.

bertson Bros. of Philadelphia, for L. D. Senat and others. She was sold afterward to W. W. Shippen of Hoboken and named *DRIFT*. The centerboard sloops *NACTILUS* (26 tons) and *ANNIE* (26 tons) were built in 1861, and the keel schooner *NETTIE* (116 tons), *HOPE* (132 tons), and last, but not least, the famous *HENRIETTA* (158 tons), which was designed by William Tooker and built by Henry Steers, Groenpoint, for James Gordon Bennett. *HENRIETTA* is illustrated in

Fig. 92 and the account of her great Ocean Race will be given in another place.

The keel schooner ALARM (225 tons) and the centerboard schooner JUNIATA (82 tons) were launched in 1863, and the centerboard sloop BREEZE (25 tons), so well remembered, in 1864. This was the year that John N. Herreshoff built QUI VIVE (Fig. 93), for Thomas Clapham. This sloop was the first order filled by the distinguished designer and builder. During the following year two centerboard sloops EVELYN (21 tons) and DAPHNE (32 tons) were launched, and also three centerboard schooners, CALYPSO (109 tons), IDLER (133 tons) and PALMER (194 tons), besides the famous FLEETWING, (Fig. 94) which was designed and built by J. B. Van Deusen for George A. Osgood. It was on September 11th of this year (1865) that the first race was sailed from Sandy Hook to Cape May. FLEETWING competed with HENRIETTA for \$500 a side, the former winning by two hours and a half. On October 16th HENRIETTA sailed a race with PALMER and won by 21 minutes. During the same year (1865) the keel sloop GLANCE (24 tons) made her first appearance.

The year 1866 will always be remembered and looked back to with interest, as the great Ocean Race between HENRIETTA, FLEETWING and VESTA took place. Before this great race HENRIETTA sailed a race October 9th with VESTA from Sandy Hook to Cape May and return. Both yachts met with accidents, but VESTA was the winner of the \$500 stakes, by 56 minutes. VESTA, on August 17th, had sailed a match race with WIDGEON for \$1,000 a side over what is known as the "Block Island Course," but she was beaten by 1 minute, 4 seconds. In a race, however, with HALCYON, a centerboard schooner (121 tons) owned by J. H. Hubbard and just launched, VESTA won the \$250 stakes on October 23rd, the course being from Sand's Point to Bartlett's Reef Lightship.

Then came the Ocean Race. In the various discussions which must of necessity arise concerning so unusual an event, there was a certain unanimity on some points. First, all agreed that December was the very worst time to cross the Atlantic, and that HENRIETTA and FLEETWING were the only safe yachts; that is, that VESTA was considered unsafe, being a centerboard craft, and liable to "broach to." Then, too, many argued against HENRIETTA, urging the superiority of FLEETWING on account of the former's want of beam. Nevertheless, each yacht was upheld, and that very strongly, by her supporters.

Needless to say, each vessel was in the pink of condition. The start was made December 11, 1866. The steamer RIVER QUEEN with about 160 invited guests on board, accompanied the yachts to the Hook. One little circumstance must be noted—the crews of HENRIETTA and VESTA were placed under naval discipline, while it was not so on board FLEETWING. About 12:50 o'clock the yachts began to spread their canvas, and at 1 o'clock precisely each of the three made a dash as if for liberty, and the great race was begun. The wind was blowing briskly. VESTA led, with HENRIETTA in her wake, and then came FLEETWING.

On board VESTA were Mr. Stuart Taylor and Mr. Geo. Lorillard, who were to act as judges for HENRIETTA and FLEETWING; FLEETWING took as judges for the two others Messrs. Ernest Staples and Henry Centre; while on board HENRIETTA were Mr. Laurence Jerome and Mr. A. M. Knapp as judges, and also her owner Mr. Jas. G. Bennett, Jr. and Mr. Fisk. VESTA was commanded by Capt. Johnson, HENRIETTA by Capt. Samuels, who was master of DREADNAUGHT (see Fig. 40) when she made the trip from Liverpool to New York in 13 days, 8 hours, and FLEETWING was under the command of Capt. Thomas.

There could not have been a more beautiful day for the start, wind and weather seemed alike to smile upon the daring yachts. To enable passing vessels to tell one yacht from the other, HENRIETTA displayed a blue flag, FLEETWING a red one, while that of VESTA was white. The race was for \$90,000, the winner to take all.

Very little was heard from the yachts during the passage, but on Christmas day at 5:45 o'clock, HENRIETTA arrived at the Needles off

Cowes, FLEETWING comes up at two o'clock A. M. December 26th, while VESTA was hard on her track, arriving at 3:30 A. M. FLEETWING had a very rough voyage. Six sailors were washed off the bowsprit while furling the jib during a gale. Nothing to speak of took place on board VESTA. The accident on board FLEETWING happened on the eighth day out and it was impossible to save the men on account of the heavy wind. HENRIETTA made the entire passage on one tack. The greatest day's run was 280 miles and the least 113 miles, the latter being during a heavy storm when she was forced to heave to for several hours.

Quoting from the London Times—"The Americans have once more done a thing never before attempted by any other people. No observer of American character will be surprised at the interest which this unprecedented contest has excited on the other side of the Atlantic. It was reserved for the Americans to send three yachts to do in the Atlantic not only what is generally done on an inland sea but to carry on a race of this kind for a whole fortnight! This ocean race has brought high national qualities into play but the Americans were true to their pretensions (!) and shot clear ahead of the old World!"

The official time was 22 days, 13 hours, mean time.

We now come to the year 1866, when the famous DAUGHTLESS (Fig. 95) was built by Forsyth & Morgan, Mystic Bridge, Conn. She was originally called L'Hiirondele and was owned by S. Dexter Bradford, Jr. She was a keel schooner. In 1869 she was purchased by Mr. Jas.

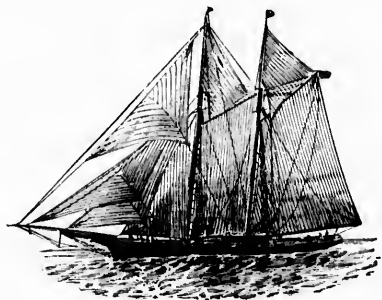

DAUNTLESS.—FIGURE 95.

Gordon Bennett, who had her remodeled by J. B. Van Deusen at Noank, Conn., her tonnage being increased from 350 to 267 tons. In 1866 she sailed a race with VESTA for a piece of plate, and, her size telling in her favor, she won. The next event in the history of DAUNTLESS was the ocean race from Gaunt Head to Sandy Hook Lightship with the schooner CAMBRIA for a \$250 Cup. The yachts entered under the following measurements:

Name	Owner	Tons	Measurements.
		N. Y. Y. C.	R. T. Y. C.
Dauntless	Jas. Gordon Bennett	268.0	321
Cambria	Jas. Ashbury	227.6	188

The start was made July 4, 1870, at 2 P. M. For days all was conjecture at home, and very little definite news was heard until CAMBRIA passed the buoy off Sandy Hook where the yachts were timed. The race was very close, CAMBRIA arriving July 27 at 3:30 P. M., and DAUNTLESS coming in the same day at 4:47 P. M. CAMBRIA was better navigated, sailing 2,917 miles in 23 days, 5 hours, 17 minutes and 5 seconds, while DAUNTLESS sailed 2,963 miles in 23 days, 7 hours—coming in just one hour and 17 minutes later than her rival, but having sailed 46 miles further.

DAUNTLESS probably had too much talent aboard, as there were Capt. Samuels who won the race with HENRIETTA, "old Dick Brown" who sailed on AMERICA when she won the Cup, Captain Martin Lyons, a well known Sandy Hook pilot, and Mr. Bennett.

Captain Tannock, who had commanded ships between Liverpool

and Montreal, sailed CAMBRIA. All hands on board DAUNTLESS felt very blue, finding that they had sailed 46 miles more than was necessary and had still lost the race.

On October 14th, of the same year, DAUNTLESS won from CAMBRIA over a 40 mile course, the prize being 50 guineas. She won by 7 minutes, 18 seconds, corrected time. On October 24, 1871, LIVONIA raced with DAUNTLESS for a 50 guinea Cup, which the latter won by 6 minutes, 3 seconds, corrected time. This was the day that LIVONIA sailed over the course alone for AMERICA'S CUP.

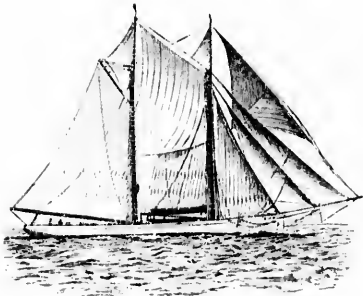

CORONET.—FIGURE 96.

In 1871 DAUNTLESS also beat the famous DREADNAUGHT, winning a \$250 Cup.

On September 21, 1875, Mr. Garner, owner of MOHAWK, issued a challenge offering to sail any yacht a race of 20 miles to windward and return, outside of Sandy Hook. Mr. Bennett promptly responded and offered to sail the proposed match for \$1,000 a side over a course starting from the Lightship and return, or from Brenton's Reef to the Lightship for \$5,000 or \$10,000 a side. On the 26th of October the race took place, the course decided on was the run of 20 miles and return, starting from the Lightship. DAUNTLESS was hastily prepared for the contest; she had been resting, as it were, for some two years, and was duly on hand. This was an unusual race, and would have been easily won by MOHAWK had she only been better handled. As it was, the prize, a \$1,000 cup, was awarded to DAUNTLESS.

More challenges followed and several races. The next, however, in which DAUNTLESS figured was with RESOLUTE, October 28th, from the Club House, Staten Island, around Cape May Lightship and return. In this race DAUNTLESS won by nearly two hours. The real time was 18 hrs., 28 min., 3 sec., breaking all previous records and establishing one which has not since been bettered.

In the early part of 1887, Mr. Bush, owner of the schooner CORONET, issued a challenge to any American keel yacht (schooner) to race across the Atlantic for a purse of \$1,000 a side. This challenge was hardly out before Mr. Bennett replied, expressing his desire to sail such a race with DAUNTLESS as his representative. The course was from a line off Owl's Head to Roche's Point, Queenstown, Ireland. The start was made March 12th, two days after the appointed time, and the starting signal was given at 1:10 P. M. It would be useless to enter into the full details of the trip, suffice it to say that the weather encountered by both vessels was most severe and the experience of those on board one not to be willingly repeated. On March 27th CORONET passed Roche's Point, DAUNTLESS not arriving until the following Monday. The time of the two yachts was, respectively: CORONET, 14 days, 23 hrs., 33 min.; DAUNTLESS, 16 days, 1 hr., 43 min.

DAUNTLESS was purchased by Commodore Caldwell H. Colt of the LARCHMONT YACHT CLUB and is still in his possession. She

has been rebuilt several times and is still a first class yacht. Her present dimensions are as follows:

Length over all,	123 feet 10 inches.
Length load waterline,	110 feet 7 inches.
Depth,	10 feet.
Draft,	12 feet 6 inches.
Beam,	20 feet 7 inches.

Her racing record for the year 1891 is as follows:

NEW YORK YACHT CLUB:—In the regatta of June 18th, she was disabled while sailing with VIATOR; the latter won. Beaten by PALMER on the Squadron Run of August 6th, and by CONSTELLATION in the run of August 8th.

Racing record for 1892:

NEW YORK YACHT CLUB:—DAUNTLESS won in the Squadron Run of August 3rd, beating CONSTELLATION, CORONET, FORTUNA, etc. Beaten by CONSTELLATION August 4th. She won in the keel schooner class August 8th, beating SPERANZA, RAMONA, etc.

LARCHMONT YACHT CLUB:—Won in the 13th Annual Regatta, July 4th. Beat GEVALIA and PHANTOM in the cruise of July 15th. Beaten by RAMONA in the Fall Regatta, September 10th.

In 1867 three centerboard sloops made their appearance—GRUSSIE (30 tons), MADDIE (60 tons) and ADDIE (45 tons), the latter being built by David Kirby at Rye, N. Y., for Commodore William Voorhis of Nyack, N. Y. This same year the famous SAPPHO was launched, and the following are facts relative to this yacht:

She was built and owned by the Poillons of Brooklyn. Her lines were very fine and she was confidently expected to prove the fastest yacht afloat. Her first race came off in August, 1867, over a 35 mile course, for a Cup. Out of the twelve starters, only one finished within the time limit, namely EVA. Again she raced on August 10th; PALMER was the winner, with SAPPHO second. This race took place

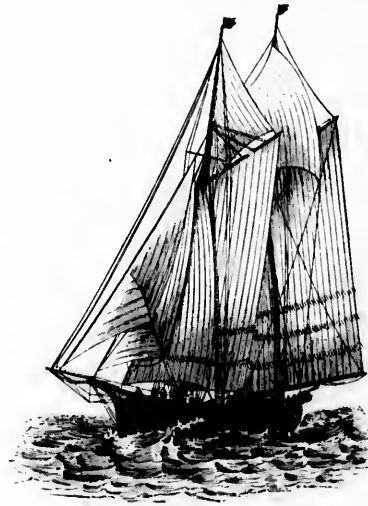

SAPPHO.—FIGURE 97.

off Newport. In 1868 she was sent to England and offered for sale. While there she sailed a match race around the Isle of Wight, and among the other entries was CAMBRIA, of AMERICA'S CUP fame. When about half of the course had been gone over, SAPPHO lost her jib-boom and was defeated. This defeat, of course, ruined any chance there might have been for selling her on the other side, so she soon afterward returned to this country and was sold to W. P. Douglass.

She was then altered in several particulars and at once began a

mos
Don
vict
to br
for t
and
The
first
she g
was r
cours
to th
that
start,
winne
SAPP
with f
Oet
was ag
by 50
next c

which
raced I
she hor
In 18
beat b
a little
petitors
Cup, e
raced
yachts
It was
around
min. 3
sailed
include
July
her old
Fifteen
passed

most successful career. In 1870 she again started for England, Mr. Douglass being determined to atone for her past defeats by future victories. And now the former expectations of her first owners began to be fulfilled. Articles were signed for three races with *CAMBRIA*, for 50 guinea Cups. Two races were to be 60 miles to windward, and the third over a triangular course, with sides of 20 miles. These races were all to be sailed without any time allowance. In the first race *CAMBRIA* was so far behind, after going some 40 miles, that she gave up. In the second race there was a dispute, for the wind was not dead to windward, and Mr. Ashbury refused to sail over the course on this account; but the judges declared that it was as much to the windward for him as it was for the American yacht, and said that the race must be sailed. Whereupon Mr. Ashbury refused to start, *SAPHO* sailing over the course alone and being declared the winner. The third race of the series was sailed May 17th when *SAPHO* again defeated the English boat, and was duly presented with the three Cups.

October 30, 1870, a match race between *SAPHO* and *CAMBRIA* was again sailed, this time off Sandy Hook Lightship. *SAPHO* won by 50 min., 50 sec., and received another 50 guinea Cup. The next day there was a race between *DAUNTLESS* and *CAMBRIA*, in

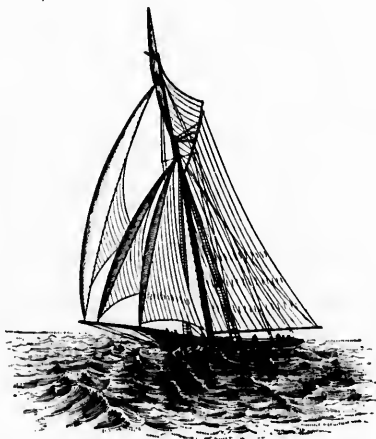

(GRACIE (AS SHE WAS.)—FIGURE 98.

which the former was the winner, and as a final triumph *SAPHO* raced *DAUNTLESS*, beating her, and winning for herself a title which she honorably deserved—the "Queen of the Seas."

In 1871, in a race of some forty miles off Cape May, *WANDERER* beat both *SAPHO* and *DAUNTLESS*, but when *SAPHO* was eased a little the following day, she easily showed her heels to all her competitors. In this year *SAPHO* won the Citizens' Cup and the Benson Cup, each valued at \$1,000. August 24, 1871, the Lorillard Cup was raced for—value \$1,000—but on account of the very dense fog the yachts did not start. *SAPHO*, however, went over the course alone. It was a distance of 64 miles, being known as the "Long Course" around Block Island Buoy. She made the run in 7 hrs, 48 min. 30 sec, beating the record. On October 9th, the race was sailed and *SAPHO* won, breaking all previous records, her own included, her time being 7 hrs. 24 min. 58 sec.

July 12, 1872, in a regatta at Havre (France), *SAPHO* again met her old acquaintance Mr. Ashbury, now represented by *LIVONIA*. Fifteen minutes after the latter had started, *SAPHO* went after her, passed her, and came in an hour and a half ahead.

Some time between 1872 and 1876 *SAPHO* was sold to Prince Maffeo Sciarra, of Naples, Italy.

During the following year (1868), the centerboard sloops *ELAINE* (37 tons) and *COMING* (53 tons) were launched, the former being built for George B. Durfee, of Fall River and the latter for W. B. Nichols. The keel schooner *MANCAP* (21 tons) was also launched this year, having been built for C. W. Connor, of Sullivan, Me.

The year 1868 produced the phenomenal and celebrated sloop *GRACIE*, (Fig. 98) which is entitled to considerable attention.

GRACIE was designed by A. G. Polhemus, of Nyack, N. Y., and was launched in June, 1868, for William Voorhis. She was built by A. A. Schanck at Nyack. She is a wooden centerboard sloop and has been for a long time one of the fastest sloops in American waters. In 1869 she was bought by Messrs. Johnson and Krebs, in 1872 was bought by Mr. Samuel Colgate, in 1873 was bought by Mr. John R. Waller, and in 1879 was sold to Messrs. J. P. Earle, W. Goodwin, E. Robert and C. R. Flint. In 1890 she passed into the hands of Mr. Earle alone. Up to 1880 her racing record had been thirty-three races, out of which she had won eighteen firsts, twelve seconds, and only one third, while two of the races were not finished. She had also been three times rebuilt during this time, had won several handsome prizes, among them being the Citizens' Cup for sloops, when she defeated *VINDEX* some 2½ minutes and the Bennett Cup, which she won from *ADLIZ*, winning by 22 seconds.

In October, 1881, after having won several prizes in the earlier part of the season, she took part in the trial races for the selection of a defender for the AMERICA'S CUP, one race of which she won. In this year she won nine out of fourteen races with *MISCHIEF*. In 1882 she won seven firsts and three seconds; in 1883, four firsts, four seconds, and two thirds. Her owner lost \$2,000 in 1883, she being beaten by *BENOVIN* and *FANNY* in two races, the stakes being \$1,000 each. She won the first prize in the ATLANTIC YACHT CLUB, and second in the NEW YORK YACHT CLUB in 1884. The next year, 1885, she had five firsts to her credit, with two seconds and two thirds.

In 1886 she was rebuilt by Piepgras, her tonnage being increased from 84 to 102.68 tons, and her racing was continued in 1887, when she took first place in the first regatta of the ATLANTIC YACHT CLUB, and she was also first in the cruise of the NEW YORK YACHT CLUB to Newport. She was second in the Morgan Cup Race, in the regatta of the EASTERN YACHT CLUB, in the Annual Regatta of the NEW YORK YACHT CLUB and third in the contest for the Goelet Cup.

In 1891 she was third in the Squadron Run of the NEW YORK YACHT CLUB, August 4th, beaten by *KATRINA* and *BENOVIN*. Second in the run of August 6th, defeated by *KATRINA*. The only starter in her class in two other runs, August 11th and 12th.

Her record for 1892 was not particularly creditable, and it is without question that she has been outbuilt, though this cannot detract in any degree from the magnificent record she has made in by-gone days.

GRACIE is now rigged as a cutter with a lead keel, and is almost twice as large as she was originally. Her present dimensions are:

Length over all,	79 feet 10 inches.
Length load waterline,	72 feet 2 inches.
Draft,	8 feet.
Depth,	7 feet 2 inches.
Beam,	21 feet 6 inches.

During the year 1869, Peter Voorhis had built the keel sloop *STORM KING* (21 tons), and Jacob Voorhis, Jr., had David Kirby of Rye build a large centerboard sloop to which he gave the name of *MADEIRA* (90 tons), was altered to a schooner the same year and was afterwards altered in 1870, 1871 and 1873, the alterations being made by Edward Smith at Nyack. As a sloop, she was a failure. She appeared in a regatta at New London.

The keel schooner *TAROLINTA* (204 tons) was built the following year, 1870, for Henry A. Kent, Sr., as well as the centerboard *TIDAL WAVE* (153 tons), by A. A. Schanck for William Voorhis, the

brother of the late Jacob Voorhis, Jr. Many were the races in which MADELINE and TIDAL WAVE competed; the latter, however, proving herself the superior yacht. TIDAL WAVE passed through several hands and was finally purchased by Dr. Ranney, of New York, and was completely destroyed in 1891 by running on a ledge of rock. The keel schooner VASTIL (12 tons) was also launched in 1870, for J. B. Herreshoff, her designer. The beautiful keel schooner ENTERPRISE (276 tons) was built the same year for George L. Lorillard.

The schooner PEEBLESS, formerly a sloop (54 tons), was built for J. Rogers Maxwell the following year 1871, and the centerboard (afterwards changed to keel) schooner WANDERER (208 tons) was launched the same year for Louis L. Lorillard, of New York. The centerboard sloop ALBERT (85 tons), was also launched for Henry Vail; the iron cutter VINDEN made her appearance, having been designed by A. Cary Smith and Robert Center, and built by Reany, Son & Archibald, at Chester, Pa., for Robert Center. The sloop NIMBUS was built by Herreshoff & St. ne, having been designed by N. G. Herreshoff. She was formerly owned by Edward Burgess, but is now owned by ex-Commodore J. Stearns Cushing, of the WINTHROP YACHT CLUB. This yacht has been considered one of the fastest yachts in Eastern waters. She is a sister yacht to the famous SHADOW, and has beaten her several times. Her dimensions are.

Length over all,	36 feet 9 inches.
Length load waterline,	33 feet 3 inches.
Depth,	5 feet 1 inch.
Draft,	4 feet 6 inches.
Beam,	12 feet 9 inches.

The schooner RAMBLER (240 tons), was also launched in 1871 for James H. Banker, of New York, and in 1886 she was lengthened for William H. Thomas, her tonnage being increased to 240 tons.

The famous centerboard schooner COLUMBIA (206 tons), designed and built by J. B. Van Deusen at Chester, Pa., was launched for Franklin Osgood, of New York, the same year, and is deserving of notice.

She was rebuilt in 1884 by David Carl, of Northport. Her first owner was Mr. Osgood, later Lester Wallack and she is now owned by Joseph T. Perkins.

In 1871 she was beaten by TIDAL WAVE for the Bennett Cup. In June 27, 1871, she raced in a regatta of the BROOKLYN YACHT CLUB; the yacht MADELINE was decided to be the winner, though it was regarded as so unjust a decision that a protest was sent to the judges by Mr. Osgood. She was beaten the same year by SAPHO in a race for a \$1,000 Cup. She, however, won prizes in the EASTERN YACHT CLUB regattas, and also the Swampscott prize.

For the details of her races with LIVONIA, in which she was the victor, see chapter relative to AMERICA'S CUP in the 2nd Vol.

The year 1871 also produced the centerboard sloop KAISER WILHELM I. (20 tons), designed and owned by Geo. E. Beling, at Pam-rapo, N. J., and built by P. Metcalfen. This yacht was owned for three years by Henry A. Mott, and finally became the property of John B. Norris, in 1876.

The centerboard sloop META was built the same year for George A. Beling, and was altered to a schooner rig in 1874, for W. E. Iselin. CAPRICE (184 tons), a keel schooner built for David Sears, and the centerboard schooner RESOLUTE (210 tons), built for A. S. Hatch, were also launched in 1871, as well as the centerboard sloop ARIADNE which was altered in 1872, 1874 and 1876 for Theo. A. Strange.

In 1872 the following yachts were launched: sloop VISION, centerboard (58 tons), for J. J. Alexander; centerboard sloop WEST WIND (27 tons) which was owned by William E. Iselin in 1873; centerboard schooner TRITON (64 tons) which was owned by Harry E. Dodge, in 1882.

The well known cut-yacht ROCKET, was built this year (1872) by Capt. Benj. F. Boss, and was purchased by Secretary H. M. Faxon, of the QUINCY YACHT CLUB, in 1886, when she was rebuilt and re-modeled, and her sail plan was largely increased. From 1888 to 1890

ROCKET stood at the head of her class, receiving twenty-four prizes out of eighty starts. In 1890, she gained fifteen firsts; nine seconds; one third; once disabled by squalls, out of twenty-six starts. She took the championships of the QUINCY, HULL, DORCHESTER and MONASTIC YACHT CLUBS and first prize in the CITY OF BOSTON Open Regatta, July 4; also in the Open Regattas of the LYNN and SAVIN HILL YACHT CLUB in September. ROCKET was sold to Mr. F. Vogel, Jr., of Milwaukee, Wisconsin, in August, 1891.

The keel schooner PROSPERO (101 tons), was built for C. H. Con-toit, in 1873, and the centerboard schooner ATALANTA (97 tons), CLIO (67 tons) and CORNELIA (56 tons) were also built; the first for William Astor, the CLIO for Messrs. John R. Platt, T. B. Asten and T. C. P. Bradhurst of New York, and the last for Dr. J. H. Vondy, of Jersey City. The centerboard sloop EGERIA (27 tons) was also built for John J. Driscoll, of New York.

In 1874, the centerboard schooner COMET, (107 tons), modeled by Philip Ellsworth, and built by Alonzo E. Smith, of Long Island, for William H. Langley of New York, was launched, and also the centerboard schooner ESTELLE (90 tons), built by J. Richards, at South Norwalk, Ct., for Francis Burritt, of Norwalk, and which in 1876, became the property of James D. Smith. The centerboard sloops

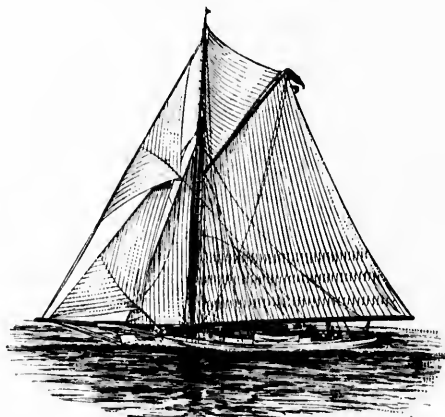

FANNY.—FIGURE 90.

ARROW (32 tons) and WAYWARD (32 tons) were also launched this year, the former for Daniel Edgar, Jr., of New York, and the latter for William E. Morris, of New Rochelle, N. Y.

In 1875 the unfortunate schooner MOHAWK (346 tons) was launched, (See Fig. 100) and a few particulars relative to this yacht will not be out of place.

MOHAWK was launched June 9, 1875, being built by Joseph Van Deusen, of Brooklyn. She was owned by the late Commodore William E. Garner. She carried 32,000 square feet of canvas, and her main saloon was 23 feet long. She has been spoken of as a floating palace. She was never much of a racing craft, being used more as a cruiser. Was beaten by MADELINE, September 15, 1875, and was also defeated by DACTLESS, October 26, 1875, in a 20 mile to windward and return course from Sandy Hook Lightship, which she should and would have won but for culpable mismanagement.

KATIE GUEV, a centerboard sloop, well known on the lakes and thereabouts, was launched in 1875. She has sailed and won many races, under the auspices of the OSWEGO, ROYAL HAMILTON, ROYAL CANADIAN YACHT CLUBS, the LAKE YACHT RACING ASSOCIATION, etc. She was designed and built by A. Cuthbert. She is now owned by William B. Phelps, of Oswego, N. Y.

She is 32 feet 9 inches over all, and two feet less on the waterline,

with
honor
twelve
ZELM.
MA
York
Pierce
Bosto
Georg

of Quin
year to h
For fl
and size
1886, 188
of thirty
She n
YACHT C
Her di

Five
tons), fr
A. W. S
send, A
York ar
The f
by Davi
the sloo
and cha
York, 1
In 1
and tri
for Ans
was bu
was lau
schoon
the lar
built b
New Y
is now
The
1877, a
in the
Two

with a beam of 11 feet. *KATIE GREY* has won many prizes and honors, and out of a total thirty-nine starts won twenty firsts, twelve seconds, six thirds and one fourth, defeating such yachts as *ZELMA*, *GRACE*, *DIXIE*, *VISION*, etc.

MABEL, a centerboard cutboat, now owned by E. A. Sumner of New York city, was launched this year. She was designed and built by Pierce Bros., of South Boston, for Commodore Roberts, of the SOUTH BOSTON YACHT CLUB. In 1884, she was passed into the hands of George R. Howe, who sold her to F. L. Dunne, in 1886. H. L. Rice

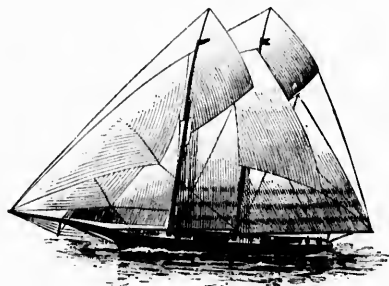

MOWAWK.—FIGURE 100.

of Quincy, Mass., purchased her in 1890, selling her the following year to her present owner.

For fifteen years *MABEL* was probably the fastest boat of her type and size in Boston, if not in Eastern waters. In the three years, 1886, 1887 and 1888, she won twenty-five firsts and ten seconds out of thirty-seven starts.

She now hails from Boston, sailing with the INDIAN HARBOR YACHT CLUB.

Her dimensions are:

Length over all,	22 feet 4½ inches.
Waterline,	19 feet ¾ inches.
Draft,	2 feet.
Beam,	9 feet 4 inches.
Mast,	30 feet.
Boom,	20 feet.
Gaff,	17 feet 6 inches.

Five centerboard sloops were also launched in 1875: *ACTIVE* (40 tons), for F. W. J. Hurst of New York; *REGINA*, (32 tons), for W. A. W. Stewart of New York; *ONWARD* (40 tons) for P. K. Townsend, Albany, N. Y.; *MADCAP* (27 tons) for Joseph R. Bush of New York and *WINDWARD* (38 tons), for Hugh L. Willoughby.

The famous centerboard sloop *FANNY* (90 tons) was built in 1876, by David O. Richmond, at Mystic, Ct., for Charles H. Mallory, and the sloop *KELPIE* (formerly *AMERICA*), which was afterwards rebuilt and changed to keel (28 tons) in 1880, for Jas. N. Winslow of New York, made her appearance in 1876.

In 1877 the catamaran schooner *NEREID* (21 tons), with double and triple hull, was built by Lewis Town, at New Brighton, S. I., for Anson Phelps Stokes of New York. *VOLANTE*, a 24 ton cutter, was built for Thomas and F. B. Hitchcock; *VISION*, a 63 ton sloop was launched for J. J. Alexandre; *CLYDIE* (123 tons), a centerboard schooner, was built for William E. Brooks of Stamford, Conn., and the largest of all sailing yachts, the schooner *AMBASSADRESS*, was built by David Carll, at City Island, N. Y., for William Astor of New York. In 1881 she was altered from centerboard to keel, and is now (1893) owned by Nathaniel Thayer of Boston. See Fig. 71.

The sloop *HILDEGARD*, formerly *NANTIC*, made her appearance in 1877, and the schooner *PETREL*, formerly sloop *MARY*, was launched in the same year.

Two cutters, *MAGGIE* (15 tons) and *MURIEL* (31 tons), were

launched in 1878 and also two centerboard sloops *THISTLE* (62 tons) and *SAGITTA* (54 tons), the former being owned for some time by William Ziegler of New York and the latter having been built for Col. J. Porter. This same year the keel schooner yacht *INTREPID* (270 tons) was launched for Lloyd Phoenix of New York.

In 1879, the keel schooners *FROLIC* (45 tons), belonging to Alex. Cassatt of Philadelphia, and *NORMA* (211 tons), belonging to Chas. A. Condit of New York, were launched, as also the keel schooner *MISCHIEF* (36 tons), belonging to Dr. Chas. R. Gill of West Park, N. Y. The centerboard iron sloop *MISCHIEF*, designed by A. Cary Smith, and built by Harlan, Hollingsworth Co., Wilmington, Del., for Chas. A. Condit of New York, was also launched, and will receive full attention in another place.

In 1880 the centerboard schooner *SYLPH* (75 tons) was built by D. O. Richmond at Mystic, Conn., for Chas. H. Mallory. She is now the property of George H. Chase of New York.

The schooner *CRESCADER* (118 tons) was also built this year by John F. Munn at Brooklyn, for J. Rogers Maxwell. *VIVID*, late *CURLEW*, was built by R. Brown at Tarrytown, N. Y. She was altered by James E. Smith of Nyack in 1882. She is owned by W. W. Thompkins of New York. The centerboard sloops *FANITA*, *WIZARD*, *PENI*, and *ROVER* were also built this year. *FANITA* (34 tons) was designed by Philip Ellsworth and built by Erastus Young at Greenpoint. She is owned by George J. Gould. *WIZARD* (24 tons) was built by Erastus Young for Gouverneur Kortright of New York; *PENI* (22 tons) was built by Alonzo E. Smith, Islip, L. I., for J. G. Cassatt of Philadelphia, and *ROVER* (30 tons) was built by Henry Piopgrus for Wm. E. Iselin of New York. The centerboard schooner, *SOUTHERN CROSS* (84 tons) was built by E. Decker for John A. Mousell of Brooklyn the same year, as also the keel schooner *SOCIAL* (53 tons) was built for Henry and C. Warren Lippitt of Providence. She was formerly *CORNELIA* which was designed by Robert Fish. In 1881 the keel schooner *NORSEMAN* (311 tons) was built by Poillon Bros.

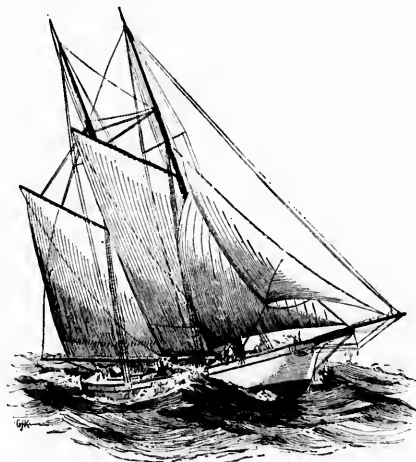

MADELEINE.—FIGURE 101.

(From an outline drawing by Crozans.)

for Ogden Goellet, the centerboard schooner *RUTH* (171 tons) was built by Robert Palmer at Naumk, Conn., for Charles Watrous, and the following centerboard sloops were built the same year: *POCAHONTAS* (84 tons), *WHILEAWAY* and *ECLIPSE*. *POCAHONTAS* was built and designed by David Kirby of Rye, N. Y., for John R. Waller, J. D. Smith and Hermann Oelrichs of New York, to defend the AMERICA'S CUP against the Canadian sloop *ATALANTA*, but she was a disappointment; further particulars will be given in the chapter rela-

tive to AMERICA'S CUP, in the second volume. *WHILEAWAY* (38 tons) was built by Smith & Terry at Greenpoint, for George F. Randolph, and *ELDEST* was built by C. A. Willis at Port Washington, L. I., for E. A. Willard. The well-known cutter, *ORIVA* (48 tons) was also built in 1881. She was built by Henry Piepgras at Greenpoint, L. I., for C. Smith Lee.

In 1882 the keel schooner *GITANA* (192 tons) was built by D. J. Lawler for William F. Weld, Jr., and was altered by W. B. Smith of South Boston in 1886 (207 tons).

The famous cutter *BEDOUIN* (100 tons) was built this year by Henry Piepgras at Greenpoint, having been designed by John Harvey for Archibald Rogers of New York.

The keel sloop *MYSTERY* (50 tons) was built by Alonzo E. Smith of Ship, L. I., for William Barclay Parsons the same year, 1882, as also the well-known centerboard schooner *MONTAUK*. She was designed by Philip Ellsworth and built by C. & R. Poillon. She was originally owned by Samuel R. Platt, afterwards by Francis H. Weeks and is now owned by Lewis Cass Ledyard.

Her length over all is,	103 feet 10 inches.
Length load waterline,	91 feet 8 inches.
Depth,	9 feet.
Draft,	8 feet 6 inches.
Beam,	25 feet 4 inches.

The keel schooner *VARIANA* (183 tons), built by Robert Palmer at

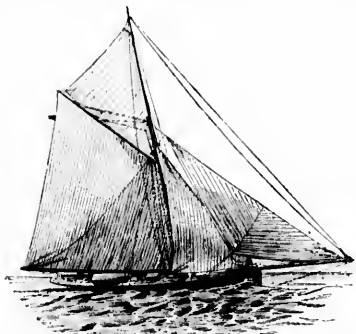

CLARA.—FIGURE 102.

Noank, Conn., for George H. B. Hill of New York, was also launched in 1882.

We now approach within ten years of the present time and it will not be necessary to do more than call attention to such yachts as have distinguished themselves, as in the chapters relative to the races held by each club since its organization; the performance and description of the various yachts built since 1880 are to be found in the clubs under which they are enrolled.

In 1883 several famous racing crafts were launched, the keel schooner *FORTUNA* (194 tons) designed by A. Cary Smith and built by Poillon Bros. in Brooklyn for Henry S. Hovey of Boston; the centerboard schooner *GRAYLING* (136 tons) was also launched by Poillon for Latham A. Fish, having been designed by Philip Ellsworth; the keel cutter *HUNOX* was built by Wm. B. Smith of South Boston for Wm. Gray, Jr. of Boston; and the famous centerboard sloop *RIVAL*, designed by Thatcher of New Haven for Frank J. Hitchcock, and sold by him to Francis Burrill of South Norwalk, Conn. He in turn recently sold her to Benjamin Carpenter of Chicago, her present owner. *RIVAL* has a remarkable racing record.

The first race of *RIVAL* was with *PROFESSIONAL*, for \$300 a side, at Bridgeport. This race was won by *RIVAL*. She won the championship for three years, 1888, 1889 and 1890, in the *CEDAR POINT YACHT CLUB*, both in Cat and Jib and Mainsail

classes. Won every race of the *BRIDGEPORT YACHTING ASSOCIATION* in which she was entered. In the regattas of the *INDIAN HARBOR YACHT CLUB* for 1891 and 1892 *RIVAL* won championship of her class.

She won the first two races out of a possible three, racing with *ERREKA* of Boston for \$300 a side. Won sweepstakes at Greenwich against *SIREN* and others. Has beaten all her competitors in Long Island Sound, and won in her class in the first regatta of the *NEW YORK YACHT RACING ASSOCIATION*, beating the whole fleet, big and little.

RIVAL is a very remarkable boat; she is good in all weathers. She was beaten, however, the past summer (1893) in a regatta of the *LAKE GENEVA YACHT CLUB* by a yacht named *VANADIS*, owned by Billings and McCrea.

The following are her dimensions:

Length over all,	21 feet.
Length load waterline,	21 feet.
Draft,	24 inches.
Beam,	10 feet.
Mast,	35 feet.
Boom,	20 feet.
Gaff,	10 feet.
Bowsprit, (outboard.)	20 feet 6 inches.

The open centerboard cat, *CADET*, formerly *WHIFF* and originally *LECY*, was built this year for C. L. Smith, a member of the *WINTHROP YACHT CLUB*, and in 1892 she was first in the six races in which she entered. She is 19 feet 1½ inches over all and 16 feet 4½ inches load waterline.

CARRIE VAN VOORHIS, a centerboard sloop owned by John H. Thorn of the *YONKERS CORINTHIAN YACHT CLUB*, recorded in 1892 three firsts out of three starts. She is 31 feet over all and 32 feet 2 inches load waterline.

This is the year that the magnificent steam yacht *ATALANTA* was launched from Cramp's Yard in Philadelphia for the late Jay Gould.

The *GRAYLING*, already referred to, capsized and sunk this year but she was raised and put in order within eighteen days so as to take part in the Decoration Day Regatta. It will be remembered that this was the year that *GRACE* sailed a match race with *BEDOUIN* for \$1,000, outside of Sandy Hook; *BEDOUIN* winning by 15 min. 5 sec. A few days later the *GRACE* won easily. On October 25th *FANNY* defeated *GRACE* also for \$1,000. *DAUNTLESS* in December made a run from New London to Gibraltar in 10 days, 12 hrs.

In the second race for the Goelet Cups, *GRACE* won the Sloop Cup beating *MISCHIEF* 9 min., 20 sec. and *MONTAUK* won the Schooner Cup, beating *FORTUNA* 5 min., 18 sec.

In 1884 the famous composite keel cutter *CLARA* (Fig 102) made her appearance. She was designed by W. Fife, Jr., and built by the Culzean Ship Building Co., Mayhole, N. B. She was launched in 1881. In 1885 she came to America, and until the 46 foot class out-did her she was known as a very fast yacht. One by one she defeated the crack yachts of this country, including the well known *CINDERELLA*. She is now owned by Robert A. Osborn. Her dimensions are as follows:

Length over all,	63 feet, 1½ inches.
Length load water level	54 feet.
Depth,	8 feet, 6 inches.
Draft,	9 feet, 10 inches.
Beam,	9 feet, 1 inch.

Her racing record for the year 1891 is as follows:

NEW YORK YACHT CLUB:—Beat *CINDERELLA* on August 6th in a Squadron Run, repeating the same on the 8th of the same month.

On August 10th she won from *CINDERELLA*, *HILDEGARD* and *MISCHIEF*. Was beaten by *CINDERELLA* on August 11th. *CLARA* again won from *CINDERELLA* in the Squadron Run of August 12th.

ATLANTIC YACHT CLUB:—Vanquished *ANACONDA* in the 26th Annual Regatta of the *ATLANTIC YACHT CLUB*, June 16th.

SEAWANAHKA CORINTHIAN YACHT CLUB:—Beat *VENTURA* on June 20.

MARIN
the
hel
This
other
was
Astor
times
this
yacht
and
mont
to
short
Island
R. Trav
A \$500
by FANN
D. Platt
50 sec.
race was
variable
and rough
of the gain
much the
schooners
by the cut
In 1885
(140 tons)
Hawley &
chairman.
feet 9 inch
centerboard
Holingswor
Bennett and
Her dim

PRISCILLA
not selected
trophies aft
with GENE
will appear
won the Ge
for schoone
It will be
AMERICA'S
Reef Cups,
won by NA
in another
first appear
and built
the property
Her dim

For the
the latter
John F. M
1885. At
plex took
a side.
Begin 6 m

MARINE AND FIELD YACHT CLUB—CLARA beat ANACONDA again in the third Annual Regatta of the MARINE AND FIELD YACHT CLUB, held June 17th.

This same year the cutter **GENESTA** a record of which is given in another place, was built in Scotland by D. & W. Henderson. **NOURHAMAL** was launched in July of this year by Harlan & Hollingsworth for Wm. Astor and she was the largest steam yacht in American waters at that time. The iron screw steamer **ELECTRA** (485 tons) was also launched this year by the same firm for Eldridge T. Gerry. The only steam yacht club in America at this time was the **AMERICAN YACHT CLUB** and it held its first regatta this year, the course being from Larchmont to New London. **ATALANTA** won, covering the distance in the shortest time. On June 16, 1884, a great race was started around Long Island for various prizes. A \$500 Cup for schooners offered by Wm. R. Travers was won by **GRAYLING** in 43 hrs., 37 min., 46 sec. A \$500 Cup for sloops offered by ex-Com. James D. Smith was won by **FANNY** in 44 hrs., 37 mins., 10 sec.; a \$300 Cup offered by S. D. Platt for second class sloops was won by **VIXEN** in 46 hrs., 4 min., 59 sec. Six schooners, five sloops and three cutters competed but the race was not considered a satisfactory test of speed owing to the variable winds. **GRACIE** won the Scawunhaka race in a reefing breeze and rough water; her time was 5 hrs., 20 min., 29 sec. Illustrative of the gain in speed in 1892, **GLOHANA** covered the same course under much the same conditions in 3 hrs., 30 min. The Goelet Cup for schooners this year was won by **GRAYLING**, the sloop Cup being won by the cutter **BENOUIN**.

In 1885 Edward Burgess produced the centerboard sloop **PURITAN** (140 tons) for the defense of AMERICA'S CUP. She was built by G. Hawley & Son, for a syndicate of gentlemen of which Mr. J. Paine was chairman. She was 93 feet over all, 81 feet 1 inch load waterline, 22 feet 9 inches beam and 8 feet 2 inches draft. The same year the iron centerboard sloop **PRISCILLA** (142 tons) was built by the Harlan & Hollingsworth Company of Wilmington, Delaware, for James Gordon Bennett and W. P. Douglass, likewise to defend the AMERICA'S CUP.

Her dimensions are:

Length over all,	93 feet, 1 inch.
Length waterline,	85 feet.
Draft,	18 feet 6 inches.
Beam,	22 feet 6 inches.

PRISCILLA proved herself inferior to **PURITAN** and therefore was not selected, but in the following season she won several prizes and trophies after being purchased by A. Cass Canfield. **PURITAN** raced with **GENESTA**, the yacht sent over by Sir Richard Sutton, and won as will appear in the chapter relative to AMERICA'S CUP. **PURITAN** also won the Goelet Cup for sloops this year, **FORTUNA** winning the Cup for schooners.

It will be remembered that **GENESTA**, while not capturing the AMERICA'S CUP, did secure from **DAUNTLESS** the Cape May and Brenton Reef Cups, which she took back to England, the latter of which was won by **NAVAHOE** this last summer, 1893, and which will be referred to in another place. The keel schooner **CORONET** (210 tons) made her first appearance this year (1885). She was designed by Smith & Terry and built by Poillon Bros. for R. T. Bush of Brooklyn. She is now the property of John D. Wing.

Her dimensions are:

Length over all,	133 feet.
Length load waterline,	125 feet.
Depth,	11 feet 7 inches.
Draft,	12 feet 6 inches.
Beam,	27 feet.

For the account of her ocean race with **DAUNTLESS** see record of the latter yacht. The centerboard sloop **DAPHNE** (42 tons), built by John F. Mumm of Brooklyn for J. Rogers Maxwell, was also built in 1885. An interesting race between the catamarans **ÆGIR** and **DUPLEX** took place in the month of April over a 40 mile course for \$200 a side. **DUPLEX** won in 4 hrs., 18 min., 52 sec., beating **ÆGIR** 6 min. **LIZZIE S.** distinguished herself in the Decoration Day

Regatta under the auspices of the **KRICKEBOCKER YACHT CLUB**, covering 20 miles in 3 hrs., 48 min., 15 sec.

The keel sloop **FROLIC**, built in 1885 and owned by Stephen Decatur of the **PISCATAQUA YACHT CLUB**, has proved to be a fast boat. Out of four starts in 1892 she came in first three times. She is 28 feet 5 inches over all, and 24 feet 3 inches load waterline.

In 1886 **ALICE ENRIGHT** was launched, having been designed and built by O. M. Hepburn for a syndicate of Toledo gentlemen. She has a very excellent racing record. Out of twenty-one recorded starts she has won sixteen firsts, two seconds, one third, and has been twice disabled. She has won any number of cash prizes, pennants and cups.

The following are her dimensions:

Length over all,	44 feet 8 inches.
Length load waterline,	34 feet 8 inches.
Draft,	5 feet.
Beam,	10 feet.

The centerboard schooner **ORIOLE** was likewise launched in 1886, having been designed by A. Cary Smith. She sails with the **ROYAL CANADIAN YACHT CLUB**.

Her dimensions are:

Length over all,	87 feet 6 inches.
Length load waterline,	73 feet.
Draft,	7 feet 9 inches.
Beam,	20 feet 3 inches.

ORIOLE has quite a racing record, having beaten **VREDA**, **ZELMA**, **CONDOR**, **CINDERELLA**, **AILEEN**, etc. In 1892 she won the Prince of Wales' Cup.

To meet **GALATEA**, brought over to this country by Lieut. Henn with a view of capturing the AMERICA'S CUP, the late Edward Burgess designed the centerboard sloop **MAYFLOWER** (171 tons). She was built by George Lawley & Son of South Boston for Gen. Chas. J. Paine.

Her dimensions were:

Length over all,	100 feet.
Length load waterline,	85 feet 7 inches.
Beam,	23 feet 5 inches.
Draft,	10 feet.

It is only necessary to state here that she beat **GALATEA** in two races, as the details will be given in the chapter relative to AMERICA'S CUP. **MAYFLOWER** won the Goelet Cup for sloops this year, beating **PURITAN** and won all other races except the first three she sailed. She became the property of E. D. Morgan, and two years ago was sold to Francis T. Underhill, who altered her into a schooner; she was afterward sold to W. A. Gardner of Boston.

This same year, 1886, Jay Gould raced **ATALANTA** with the steamer **MARY POWELL**, from 22nd street to Irvington, a distance of 22 miles, and won by four lengths. The wind was northwest and the tide ebb. Another fast trip was the run of Norman L. Moore's steam launch **HENRIETTA** on September 10th. She traveled from Catskill to Sandy Hook, 133½ miles, in 5 hrs., 40 min., an average of 20½ miles per hour.

The steam yacht **ALVA**, which was recently lost, was launched in October (1886) at Wilmington, Del., for William K. Vanderbilt. She was 215 feet in length. **GRAYLING** won the Goelet prize for schooners this year, beating **MONTAUK**.

KATRINKA, a centerboard sloop yacht, designed and built by P. McGiehan, Pamrapo, New Jersey, and launched in the Spring of 1886, is deserving of mention. She hails from Charleston, South Carolina, and is owned by W. D. and F. Y. Porcher, of the **CAROLINA (SOUTH) YACHT CLUB**.

Her dimensions are:

Length over all,	37 feet.
Length load water line,	32 feet 10 inches.
Depth,	6 feet 10 inches.
Draft,	3 feet 4 inches.
Beam,	12 feet 0½ inches.

Her racing record is as follows:

1886	Carolina Yacht Club, Annual Regatta, second.
1886	Carolina Yacht Club, Challenge Pennant Race, first.
1887	Isle of Hope Yacht Club Regatta, first.
1887	Carolina Yacht Club, Annual Regatta, first.
1887	Carolina Yacht Club Challenge Pennant Race, second. (carried away topmast; lost race by 3 seconds.)
1888	Floral Fair, Special Regatta, first.
1888	Carolina Yacht Club, Annual Regatta, (disqualified), second.
1888	Isle of Hope Regatta, first.
1889	Carolina Yacht Club, first.
1889	Carolina Yacht Club, Annual Regatta, first.
1889	Carolina Yacht Club, Special Regatta, fourth.
1889	Carolina Yacht Club, Special Regatta, July 4th, second.
1889	Carolina Yacht Club, Challenge Pennant, second.
1889	Savannah (Ga.) Annual Regatta, (ran aground while leading fleet).
1890	Savannah (Ga.) Annual Regatta, second.
1890	Carolina Yacht Club, Annual Regatta, first.
1891	Carolina Yacht Club, Annual Regatta, second.
1891	Inter-State Cup Race, second.
1891	Carolina Yacht Club, Special Race, first.

In 1887 some very fast yachts were built in different sections of the country. The cutter *AGGIE* was launched this year; she was designed and built by Jas. Andrews and rebuilt by him in 1892. She sails with the *ROYAL HAMILTON* and *ROYAL CANADIAN YACHT CLUBS*. *AGGIE* has beaten such yachts as *CONDOR*, *WHISTLEWING*, *WHITE WINGS*, *ZELMA* and *VREDA*.

WHITE WINGS, a centerboard cutter, is familiar to all yachtsmen of Canada and the Lakes. She was built in 1887 and is now owned by Thomas W. Lester *et al.*, of Hamilton, Ontario. She is 52 feet over all, and 43 feet 5 inches waterline. She was designed and built by Alex. Cuthbert and was formerly owned by Emilius Jarvis. She has sailed in many races, and has a record of eleven consecutive firsts on Lakes Ontario and Erie. She has beaten *CYGNET*, *VERVE*, *AGGIE*, *CONDOR*, etc.

The centerboard cut *UNDINE* was also built this year. She is the property of Com. Clinton R. James of Brooklyn, for whom she was designed and built by Wallin & Gorman. She is 21 feet 10 inches over all, 21 feet 10 inches load waterline, 2 feet draft and 9 feet 6 inches beam. Since July 4, 1887 until the beginning of the past season of 1893, *UNDINE* had twenty-eight recorded starts, with nearly 100 competitors. Out of the said number of starts, she has to her credit twenty-one firsts and seven seconds. She has won several pennants and cups and made the fastest time on record over the *ESSEX YACHT CLUB* course, July 25, 1891. This past season 1893, *UNDINE* was beaten by *JINTRY* owned by Fred Oakes, and also by *ENIGMA*.

The centerboard steel sloop *VOLUNTEER*, designed by the late Edward Burgess to defend *AMERICA'S CUP*, was built and launched this year (1887) by Pusey, Jones & Co. of Wilmington, Del., for Gen. Chas. J. Paine. Her length over all was 104 feet, length load waterline, 85 feet 9 inches, beam, 23 feet 2 inches and draft 10 feet.

The challenging yacht this time was the steel cutter *THISTLE* (253 tons), designed by George L. Watson and built by D. & W. Henderson of Glasgow, Scotland, for James Bell and others. She was 108.05 feet over all, 86.46 feet load waterline, beam 20.03 feet and draft 13.8 feet.

In the trial race between the American yachts, *VOLUNTEER* defeated *MAYFLOWER*, September 16, 1887. The races between *THISTLE* and *VOLUNTEER*, when the latter won, will be fully described in the chapter relative to *AMERICA'S CUP*. *VOLUNTEER* won fifteen firsts out of eighteen starts the first three years she was in commission. It is no wonder that the late Edward Burgess was placed in the foremost rank as a designer after the production of three such remarkable yachts as *PHUTAN*, *MAYFLOWER* and *VOLUNTEER*. In recognition of the great service done by Gen. Paine and Edward Burgess, the *NEW YORK YACHT CLUB* appropriated \$500 for a testimonial to Gen. Paine and \$500 as a National purse for Edward Burgess. Six thousand people were present at a reception that was given at Faneuil Hall, Boston, to Messrs. Paine and Burgess on October 7th. A reception

was given them later by the *NEW YORK YACHT CLUB*. The Paine-Burgess testimonial closed November 2d, with \$12,163.

VOLUNTEER won the Goelet prize for sloops this year (1887), and the centerboard schooner *SACHEM* (169 tons), also designed by Burgess, won the schooner prize.

It was this year that the great ocean race between *CORONET* and *DAUNTLESS* took place for \$10,000 a side, (which has already been alluded to in the record of *DAUNTLESS*) and which was won by *CORONET*.

TITANIA, a centerboard sloop (121 tons), the first of the 70 foot class, was launched this year for C. Oliver Iselin, having been built by Henry Piegras, at City Island, N. Y., from designs of Edward Burgess; and *ANACONDA*, the 60 foot sloop, was launched by Poillons for John G. Prague.

The centerboard cabin cut *CLIMAX*, formerly *CREEP*, was built in 1887 and is owned by M. F. Kelly, of the *SOUTH BOSTON YACHT CLUB*; out of six starts in 1892 she recorded five firsts. She is 26 feet 3 inches over all, and 26 feet 2 inches load waterline.

In the following year several yachts were launched which became quite prominent.

The centerboard schooner *MARGUERITE* (170.67 tons), designed by Edward Burgess and built by George F. Lawley & Son of South Boston, was launched for William F. Borden.

MARGUERITE has proved herself to be a splendid yacht, especially during the years 1891-2. Out of twenty-one starts she has recorded nine firsts, nine seconds, nine thirds and two fourths, winning the Gerry Cup and the Larchmont Cup for schooners in 1892, besides a \$500 Cup and \$600 in money in the Autumn Sweepstakes of the *NEW YORK YACHT CLUB*. She is now the property of R. S. Palmer, of New York. Her dimensions are:

Length over all,	96 feet 11 inches.
Length load waterline,	79 feet 11 inches.
Depth,	10 feet 7 inches.
Draft,	11 feet.
Beam,	21 feet.

The centerboard steel sloop *KATRINA* (165.36 tons), designed by A. Cary Smith and built by Henry Piegras at City Island, was also launched for Edwin S. and Hugh D. Auchincloss, and races between *KATRINA*, *SHAMROCK* and *TITANIA* were frequent this year.

The centerboard sloop *SHAMROCK* (94 tons), having been designed by H. C. Winttingham and built by John F. Mumm for J. Rogers Maxwell, and the centerboard steel sloop *TITANIA*, designed by Edward Burgess and built by Henry Piegras for C. Oliver Iselin were launched in 1887.

KATRINA won her maiden race in the *NEW YORK YACHT CLUB* Regatta on June 21, 1888, and many others during the season. In the great blizzard of March 12th, the yawl *CYTHELA* was lost with all on board, and it was thought that inasmuch as the pilot boat *ENCANTRESS* was also lost, they may have collided and foundered at sea.

The Goelet Cups this year (1888) were won by *VOLUNTEER* and *SACHEM*.

The steel cutter *VREDA*, designed by G. L. Watson & Co. of Glasgow and built by the Ailsa Ship Builders' Co., was launched this year and won some forty-eight prizes in England during her first two seasons, the Queen's Cup being among these prizes. In 1890 she became the property of Commodore A. R. Boswell of the *ROYAL CANADIAN YACHT CLUB*, and has met with much success as a racer in this country. In 1890 she won the Queen's Cup, presented to Canadian yachtsmen as a challenge Cup, and also won the Prince of Wales' Cup.

She has met and defeated *AILEEN*, *WHITE WINGS*, *CONDOR*, *VERVE*, *ORIOLE*, *ONWARD*, etc. She is 53 feet 3 inches over all, and 45 feet 9 inches waterline.

The open cut *ANGLESSY* was launched this year and is owned by Lankemat Bros.; she is 19 feet 10 inches over all and 19 feet 10 inches load waterline. Out of six starts in 1892 she placed five firsts to her credit.

The centerboard open cut **TATTLEB** won three firsts out of three starts in 1892. She is owned by C. J. Hart and E. C. Hart, Jr., and sails with the **NEW ROCHELLE** and other yacht clubs. She is 24 feet 10 inches load waterline. The sloop **GERTIE**, now **CYRETTA**, became prominent the following year in the races of the **CORINTHIAN YACHT CLUB** of San Francisco; she is owned by Harry Jones and is considered one of the fastest yachts in those waters. The following is her racing record:

May 30, 1889,	PILGRIM, CHARLOTTE, AGATHA, GERTIE (now CYRETTA) winner.
May 18, 1890,	CISNE, CYRETTA winner.
May 30, 1890,	POLLYWOG, CISNA, SPEC. WINDWARD, ORCA, CYRETTA , (fastest time ruled out, failed buoy).
July 20, 1890,	CISNE, CERES, CYRETTA winner.
July 26, 1890,	FAWN, CYRETTA winner.
Sept. 9, 1890,	LARK, CISNE, CERES, RAMBLER, CYRETTA winner.
May 30, 1891,	FROG, CISNE, CERES, OLIVETTE, CYRETTA winner.

The famous 40 foot class appeared this year (1889). **MINERVA**, designed by Wm. Fife, Jr., at Fairlie on the Clyde, built in 1888 for John Lee Carroll, Jr., and only 40 feet on the keel, crossed the Atlantic, sailed against American yachts and at the end of the season her record was well ahead. She won twenty-three prizes out of thirty-five starts in two seasons.

The sloop **TITANIA** and schooner **SEA FOX** won the Golet Cup this year. This centerboard steel schooner (234.84 tons) was designed by her owner, A. Cass Canfield, and built by the Harlan, Hollingsworth Co. of Wilmington, Delaware, the year previous (1888). In 1890 races between the schooner yachts of the **NEW YORK YACHT CLUB SQUADREN** was the feature, **MAVFLOWER** winning the Golet Cup for schooners and **VOLUNTEER** the Golet Cup for sloops.

The open centerboard cut **PHYLLIS**, owned by Wm. J. and Frank B. Jones, was built this year and was very successful in 1892. In various races held by the **NEW ROCHELLE, INDIAN HARBOR, RIVERSIDE** and **LARCHMONT YACHT CLUBS**, she has been first. Her record is five firsts out of five starts. She was designed and built by John H. Cornwall at Port Washington, and was launched in May, 1890. Her dimensions are as follows:

Length over all	19 feet 11 inches.
Length load waterline	19 feet 11 inches.

PHYLLIS also won several races in 1891.

The centerboard sloop **SILAMBOCK**, owned by H. C. and J. F. Kendall, A. A. Martz and C. Campbell, is deserving of mention. She was designed by Edward Mitchell, built by Hepburn Bros. of Toledo, and has had a remarkable record. She was launched in the Spring of 1890, and up to the close of the racing season of 1891 she was never beaten, winning three first prizes before going to Detroit, and ten more since that time. She has many championship flags won in different contests in various yacht clubs. She carries a Corinthian crew, and her owner is her sailing master.

HAWK, a centerboard cutter, also launched in 1890, was designed by Burgess and built by Lawley & Son for her owner, Gordon Dexter of Boston. **HAWK** is one of the best known racing yachts on Eastern waters. In 1891 she won the class championship of the **BEVERLY YACHT CLUB**, besides many other honors. She defeated such yachts as **FANCY, SALADIN, MELBRED**, etc. In 1892 she won several cash prizes, winning from **FANCY, CHAPOQUOIT, HANSEL**, etc. She is 40 feet 3 inches over all and 29 feet 11 inches on the load waterline, being of 11 feet beam and 5 feet draft. It was this year (1890) that John B. Paine came forward with the 21 foot boat **HORNET**, built by W. B. Smith of City Point. This remarkable boat won twelve races in two years, losing none. She was jib and mainsail rig, 28 feet over all; 20 feet load waterline; beam 8 feet and draft 5 feet.

The 30 foot yachts were the favorites at this time in New York waters, and in 1889 and 1890 some excellent races were won by the fast **KATILEES**, owned by Mr. William Whitlock. She won twelve

firsts and five second prizes out of nineteen starts in 1889 and in 1890 she had nine winnings out of ten races to her credit.

The centerboard open cut **RATTLEB**, 20 feet 2 inches over all and of the same load waterline, designed by Philip Ellsworth and owned by Thos. A. Howell of the **SHELTER ISLAND YACHT CLUB**, recorded in 1892 four firsts and one second out of five starts. **BIRD**, designed by Herreshoff and owned by Wm. Peet, Jr., of the **MINNETONKA YACHT CLUB**, won the six races she entered in 1892. She is a centerboard open cut, 19 feet over all and 15 feet 11½ inches load waterline.

YAMA, a cutter yacht also launched in 1890, is owned by Allen Ames of Oswego, New York. She was designed by William Fife, Jr., and was built by H. C. Wintringham of South Brooklyn. She hails from Oswego and sails with the **OSWEGO YACHT CLUB**.

YAMA has proved herself to be a wonderful yacht. Her list of victories is almost unbroken, and up to the close of the season of 1892, she had a record of thirteen firsts and one third out of fourteen starts. She had before that date defeated the well known **MERLE, PAPOOSE, AGGIE, PSYCHE** and, as a final effort, defeated her rival **ZELMA**, specially built and designed to win her laurels. In addition to the above named crafts, she had met many others in her three years of racing.

Her dimensions are:

Length over all,	52 feet.
Length load waterline,	30 feet.
Depth,	7 feet 8 inches.
Draft,	9 feet.
Beam,	9 feet 3 inches.

The centerboard cutter **TIGRESS**, designed by Philip Ellsworth and launched this year for James Weir, was first in the four races in which she entered in 1892; she is 46 feet 6 inches over all, and 34 feet 11 inches load waterline. She sails with the **ATLANTIC** and other yacht clubs.

The racing class for 1891 had added to it nine 46 footers, five of which were built from Burgess' designs, and one each from the designs of Paine, Fife, Wintringham and Herreshoff. Edwin D. Morgan, the present Commodore of the **NEW YORK YACHT CLUB**, believing that the Burgess boats could be beaten, gave an order to the Herreshoffs for a keel sloop, which he named **GLORIANA**, (See Fig. 63) 22-21, 55-42 U. S. tonnage. She was a complete surprise to yachtsmen, being of a radically different model from any other yacht and was capable of beating her antagonist in any kind of a breeze. She won the first season eight first prizes and did not record a single defeat. **BEATRIX** and **OWEENE**, designed by Burgess, were next to **GLORIANA** in speed. **BEATRIX**, now known as **HARPOON**, is a centerboard cutter, the property of G. C. and C. F. Adams of Boston, Mass. She was built by Frisbee of Salem, Mass. She was originally built for C. A. Prince and John Bryant, and was launched in 1891. Her ballast plan and rig were changed in 1892. She now hails from Cohasset, sailing with the **NEW YORK, EASTERN, BEVERLY, HULL, QUINCY** and **CORINTHIAN YACHT CLUBS**.

Her dimensions are as follows:

Length over all	62 feet 2 inches.
Length load waterline	45 feet 6 inches.
Depth,	8 feet.
Draft,	7 feet 5 inches.
Beam,	16 feet.

Her racing record for 1891 is as follows:

EASTERN YACHT CLUB:—Second in her class in the Annual Regatta of the **EASTERN YACHT CLUB**, June 29, **GOSHOON** first. Won prize of \$100 in the special race sailed July 23d, beating **OWEENE, GOSHOON, ALBORAK**, etc. Again a winner in the Autumn Regatta, winning \$500 and defeating **SAYONARA** and **OWEENE**.
MASSACHUSETTS YACHT CLUB:—Defeated by **OWEENE** in a special race, sailed July 16th for a \$250 silver Cup.

CORINTHIAN (MARBLEHEAD) YACHT CLUB—Won sweepstakes race sailed July 23rd beating OWENE, BARBARA, etc. Beaten by both OWENE and BARBARA on the 25th of August, in the Fifty-fourth Regatta. On the next day, August 25th, BEATRIX, as she was then called, won again, beating her usual competitors. This defeat was repeated on the 29th of the same month, when she was nearly 12 minutes ahead in a run of 24 miles.

CORINTHIAN (NEW YORK) YACHT CLUB—August 17th, Sweepstakes of \$100 each. BEATRIX won third prize, with GLORIANA first and OWENE second.

Her racing record for 1892 is as follows:

EASTERN YACHT CLUB—Special Race, August 11th. WASP, HARPOON and GLORIANA, the last named breaking down, and the first named winning. In the Autumn Regatta, September 3rd, HARPOON won from GLORIANA and BARBARA, receiving a prize of \$75.

NEW YORK YACHT CLUB—HARPOON won the Goelet sloop, cutter and yawl Cup, valued at \$500, defeating GRACE, WASP and GLORIANA, on the 5th of August. In the Squadron Run of August 6th, HARPOON was second, GLORIANA winning. Third in the Run of August 8th, GLORIANA second, WASP winning, made but an indifferent showing in the Morgan Cup Races of August 8th. Beaten by WASP for Commodore Gerry's Cup, August 10th.

CORINTHIAN (NEW YORK) YACHT CLUB—HARPOON was second in the fourth Annual Sweepstakes, sailed at Newport, August 23d. WASP won, GLORIANA third.

The fact that BEATRIX (HARPOON) was a centerboard yacht tended to attach to her greater interest, as it is the popular belief in this country that the centerboard yacht is a typical American boat.

SAVANNA, belonging to Bayard Thayer, and MINICOLA, belonging to August Belmont, were continually racing with one another during the summer of 1891.

The following table prepared by some enthusiastic yachtsman will probably give as satisfactory a record of the 46 foot class for 1891 as can be formulated:—

	starts.	Per cent.	Number of Times							Did not Finish.
			1st.	2d.	3d.	4th.	5th.	6th.	7th.	
Gloriana.	8	100	8	0	0	0	0	0	0	0
Beatrix.	11	64	7	4	1	0	0	0	0	0
Owene.	19	20	5	8	3	1	0	0	0	0
Jessie.	19	26	5	7	3	1	2	1	0	0
Savannah.	25	24	6	8	8	1	1	0	0	1
Minicola.	24	17	4	6	5	2	2	0	1	5
Barbara.	10	10	1	1	1	4	0	0	0	3
Albion.	8	0	0	3	2	2	0	0	0	1
Nautilus.	12	0	0	2	3	5	1	1	0	0
Thelma.	1	0	0	0	1	0	0	0	0	0

The winners of the Goelet prizes for this year were the schooner VOLUNTEER and the keel sloop or, more properly, American cutter GLORIANA.

The advent of SMUGGLER was the introduction of a new class of yacht known as 25-footers, all their ballast being placed outside, and carrying only jib and mainsail. Boats of this class proved to be good in heavy or light weather and were very fast.

YOULA is a cutter which was designed and built by Fife and was finished by Stanton at Picton, Ontario. She was launched this year (1891). YOULA started in twenty-one races given under the auspices of the R. N. S. Y. SQUADRON and won fourteen firsts, six seconds and one third. She has met and defeated LEXOR, ETEENXE, HEBE, WYM, MENTOR, NAUTILUS, MINNEHADA, ESMÉ, PSYCHE, WENONAH, etc. She is 37 feet over all, 26 feet on the waterline and 7 feet 4 inches beam. The well known centerboard sloop VALDA, owned by G. Herriek Duggan, was also built this year, by G. St. Onge of Laehne. During her first year VALDA beat COQUETTE, FROLIC, MOLLY BAWNS, BREEZE, etc., and in 1892 she defeated most of the

same boats again and in addition VIKING, EAGLE, COQUETTE, etc. She won the Cup offered by Sir Donald A. Smith and also the Baylis Cup, besides various pennants. VALDA has a record of sixteen firsts, three seconds out of nineteen starts.

The steam launch SCOTT shown in Fig. 103 becomes of great interest as she was the last yacht designed by Edward Burgess. She was built by J. J. Beckett at Camden, N. J., and was launched June 26, 1891, for her owner, John S. Muecke, a member of the PHILADELPHIA YACHT CLUB.

Her dimensions are:

Length over all.	23 feet 4 inches.
Length load waterline.	20 feet.
Depth of hold.	2 feet 4½ inches.
Beam.	5 feet 1 inch.
Draft (at stern)	20 inches.

EOLUS a cabin cut-boat owned by Wm. J. Beckwith, is deserving of mention, as she won in 1892 four firsts out of six starts. She is 29 feet 7 inches over all, 25 feet 8 inches load waterline and sails with the SHELTER ISLAND YACHT CLUB. The centerboard sloop CHIPPEWA, designed by Thos. Clapham for himself and J. F. Grenough, was first in the three races which she entered in 1892. She is 33 feet over all and 23 feet 9 inches load waterline. The open cut MAR, designed by Herreshoff for Com. John Shaw of the QUINCY YACHT Club, won eight firsts and three seconds out of eleven races in 1892. She is 18 ft. 8 in. over all and 15 feet 9 inches load waterline.



FIGURE 103.

In May the Herreshoff Manufacturing Company launched EL CHICO, a fin-keel yacht, for H. Maitland Kersey.

Her dimensions are:

Length over all.	30 feet.
Length load waterline.	25 feet.
Depth.	3 feet 4 inches.
Draft.	6 feet 0 inches.
Beam.	7 feet 1 inch.

Like most of the racing yachts launched by this firm, EL CHICO proved very fast; her record is most enviable. In 1892 EL CHICO beat NAMELESS 3 minutes in the opening race of the SEAWASHAKA CORINTHIAN YACHT CLUB in a light breeze. On May 30th, in the Larchmont opening, EL CHICO was disqualified. PYXIE, a yacht yet to be spoken of, won. In the regatta of June 4th, Larchmont, EL CHICO won a \$75 Cup by 12 min., 34 sec. in a fresh northeast breeze and sea. On June 11th she won another \$75 Cup by 38 minutes in a fresh southeast breeze and sea in the MARINE AND FIELD CLUB Regatta. On June 14th she won \$30 by 6 min., 34 sec. in the ATLANTIC YACHT CLUB Regatta in a fresh southwest wind and sea.

On July 2nd, in the SEAWASHAKA CORINTHIAN YACHT CLUB Regatta she won two prizes of \$25 each in a moderate southwest wind and sea.

On September 10th she won a \$75 Cup at the Larchmont Regatta by 35 sec., there being four entries.

In the SEAWASHAKA CORINTHIAN YACHT CLUB race held October 1st, she won a \$50 special Cup given by R. A. Osborne, by 6 min., 42 sec. in strong north wind, there being four entries.

Owing to her brilliant record, EL CHICO was purchased by E. M. Fulton, and taken up to Lake Champlain.

The keel sloop PYXIE, designed by W. E. Gardner and built by A.

Woo
of a
H
Py
of clo
met w
She
started
On Se
second
PYX
remark
LARCH
and in
PYXIE
The
BURRIE
firsts in
INDIAN
HANS
load wa
CLUB, a
BEATR
Cavanah
line, wa
records
The c
year, an
She is 2
She was
of the M
MAUR
for Cha
16 feet
line. S
The
Miller
one of
and 24
ROCHES
MAUR
Manns,
races in
all, and
GES'
CLUB.
The
HARLE
entered
load w
VAN
launched
record,
second
as EX
inches
The
N. G.

Wood & Son, City Island, N. Y. for Oswald Sanderson, is also worthy of attention. She was launched in 1892.

Her dimensions are:

Length over all,	30 feet 6 inches.
Length load waterline,	24 feet 9 inches.
Depth,	5 feet.
Draft,	6 feet 6 inches.
Beam,	7 feet 8 inches.

PYXIE has a very good racing record; during her first season out of eleven races, she won four firsts and two seconds, in two races she met with accidents which deprived her of winning.

She has beaten EL CHICO, NADJY, the latter when seven yachts started. She also beat NAMELESS in a special race on September 4th. On September 5, 1892, in a handicap, PYXIE scratch, she came in second with eleven starters.

PYXIE sailed from Larchmont to Boston in 55 hours which was remarkable time for so small a yacht. In the Annual Regatta of the LARCHMONT YACHT CLUB, July 4, 1893, PYXIE beat WAHNETA, and in the SEAWANTHAKA YACHT CLUB Regatta, June 17, 1893, PYXIE beat THINKET and INDOLENT.

The open sloop COMMODORE, 27 feet waterline, was built for Francis Burritt this year, and has proved to be very fast, winning three firsts and one second out of four starts. She is enrolled in the INDIAN HARBOR YACHT CLUB.

HANDBEL, a fin-keel sloop, 45 feet over all, and 29 feet 9 inches load waterline, was built for James R. Hooper, of the HULL YACHT CLUB, and out of eight starts, she won six firsts and one second.

BEATRICE, a centerboard sloop designed and owned by John Cavanaugh, 32 feet 10 inches over all and 24 feet 10 inches load waterline, was also launched this year, and out of seven starts she records six firsts. She sails with the HULL YACHT CLUB.

The centerboard open cat MAGPIE sailed twenty-four races this year, and placed fourteen firsts and four seconds to her credit. She is 20 feet 3 inches over all and 19 feet 5 inches load waterline. She was designed by C. C. Hanley and is owned by H. Gray Otis of the MASSACHUSETTS and other yacht clubs.

MARCHIONESS, the centerboard open cat designed by Frank Smith for Charles E. Hodges, of the SAVIN HILL and other yacht clubs, is 16 feet 8 inches over all, and 15 feet 9 inches on the load waterline. She records five firsts and one second out of eight starts.

The centerboard lugger NOX, designed by W. M. Fife, Jr. for Miller Bros. and Meerdink, was successful in winning every one of the five races in which she entered. She is 36 feet over all, and 24 feet 6 inches on the load waterline. She sails with the ROCHESTER YACHT CLUB.

MAUD M., a centerboard open sloop belonging to W. W. MacManus, of the HARLEM YACHT CLUB, won four firsts out of five races in which she entered this year. She is 27 feet 2 inches over all, and the same on the load waterline.

GES' SO, belonging to Joe Ellsworth of the JERSEY CITY YACHT CLUB, won four firsts and one second out of five starts this year.

The centerboard yacht JESSIE, owned by John O'Brien of the HARLEM YACHT CLUB, was first in the five races in which she entered this year. She is 25 feet over all and the same on the load waterline.

VANESSA, a fin-keel yacht designed by the Herreshoff's and launched this year 1892 for A. Bigelow, Jr., has a very good racing record. In 1892 she entered eighteen races, winning six firsts, six seconds, three thirds and three fourths. She has beaten such yachts as EXILE, REAPER, KOORALI, CATSPAW, etc. She is 30 feet 6 inches over all, and 20 feet 10 inches load waterline.

The most remarkable yacht built this year was WASP, designed by N. G. Herreshoff and built by the Herreshoff Mfg Co. for Archibald

Rogers, who gave instructions to Mr. Herreshoff that he wished him to design a yacht which would beat GLORIANA.

Her dimensions are:

Length over all,	72 feet.
Load waterline,	45 feet 6 inches.
Depth,	11 feet.
Draft,	10 feet 8 inches.
Beam,	13 feet.

Her racing record 1892 was as follows.

NEW YORK YACHT CLUB:—First in the Regatta sailed June 9th, beating CLARA. Won in the Squadron Run sailed August 3rd, defeating SAYONARA, GLORIANA and LIRIS. Beaten by GLORIANA on August 4th, and beaten by both HARPOON and GRACIE (the latter winning) in the race for the Goelet Cup, August 5th. In the Squadron Run of August 8th, WASP won from GLORIANA, etc. Won the Morgan Cup for sloops on August 8th. She also won Commodore Gerry's Cup for sloops on the 10th of August, beating HARPOON, BARBARA and GLORIANA.

ATLANTIC YACHT CLUB:—WASP was the winner in her class in the Twenty-seventh Annual Regatta, sailed June 14th.

EASTERN YACHT CLUB:—In the Annual Regatta, sailed June 27th. WASP won a first prize of \$75 and also the Puritan Cup for the year. In a Special Race for a purse of \$250, sailed August 11th. WASP won again, beating HARPOON and GLORIANA.

SEAWANTHAKA CORINTHIAN YACHT CLUB:—Annual Regatta, July 2d. WASP was the winner in her class.

LARCHMONT YACHT CLUB:—WASP won in her class, Thirteenth Annual Regatta, sailed July 4th.

MAINE AND FIELD YACHT CLUB:—WASP won in her class June 11th. CORINTHIAN YACHT CLUB OF NEW YORK:—WASP was the winner of the Fourth Annual Sweepstakes, sailed at Newport, August 22nd. HARPOON and GLORIANA were also entered.

In Eastern waters in 1892, the 21-foot class was the most interesting.

The following table shows the number of starts and the position attained by each boat in the races. The percent. of firsts is also given. Table No. 2 shows the number of times each boat beat or was beaten by every other one in the fleet, and bears out the result of table No. 1. The number of times a boat has beaten another reads across the columns. The number of times she has been beaten reads down the columns.

TABLE No. 1.

	Number of Starts.	Firsts.	Seconds.	Thirds.	Fourths.	Fifths.	Sixths.	Sevens.	Eighths.	Disabed.	Did not Finish.	Retired Out.	Per cent of Firsts.
Alpha	15	14933
Freak	11	5	..	3	1	1	.455
Reaper	14	4	5	1	2	1	1	.286
Vanessa	19	2	9	4	3	1	.105
Catpaw	16	1	7	3	..	1	..	2	..	2063
Exile	16	1	5	3	3	2	1	1	..	.063
Thrush	11	1	2	2	..	1	2	1	2	..	.091
R. D.	7	..	1	1	2	1	..	1	1
Sirocco	6	..	1	1	..	1	1	..	2
Tadpole	6	..	1	..	1	..	1	1	..	1	1
Romance	2	1	..	1
Koorali	5	1	1	..	1	..	2
Gally	2	1	1
Spurt	2	1	1
Asp	3	1	1	1
Typhoon	2	1	..	1

YACHTING IN THE UNITED STATES.

TABLE No. 2.

	Alpha.	Hepler.	Vanessa.	Reaper.	Keokah.	Thresh.	R. D.	Stowac.	Tadpole.	Bonanza.	Kearl.	Thysson.
Alpha beats	..	1	1	1	2	8	1	5	2	1	2	0
Croak beats	1	..	5	3	3	3	1	3	3	0	2	0
Reaper beats	0	5	..	5	1	5	6	1	6	3	1	5
Vanessa beats	0	3	3	..	8	0	7	5	1	1	1	2
Catspaw beats	1	2	3	5	..	5	8	7	3	1	0	3
Exile beats	1	3	1	3	1	..	5	4	1	5	2	4
Thresh beats	0	1	0	0	2	3	..	1	2	3	3	0
R. D. beats	0	0	0	0	1	1	0	..	0	1	0	0
Stowac beats	0	2	0	0	0	0	1	0	..	1	0	3
Tadpole beats	0	0	0	0	1	1	1	..	1	0	2	0
Bonanza beat	0	0	0	1	0	0	0	0	..	0	0	0
Keokah beats	0	1	0	0	1	0	1	0	0	0	0	1
Godly beats	0	0	1	1	0	1	2	0	0	0	1	0
Thysson beats	0	0	0	0	0	0	0	0	1	1	0	0

As it is questionable whether any other boat has made such a record as ALPHA, it seems proper to give full particulars relative to this yacht. ALPHA is a centerboard jib and mainsail yacht, and is the property (1893) of E. J. Phelps of the MINNETONKA YACHT CLUB. When she made her great record she was owned by the well known Corinthian yachtsmen, J. E. Brown, J. L. Peering and A. P. Hunt, of the HULL and other yacht clubs. She was designed by N. G.

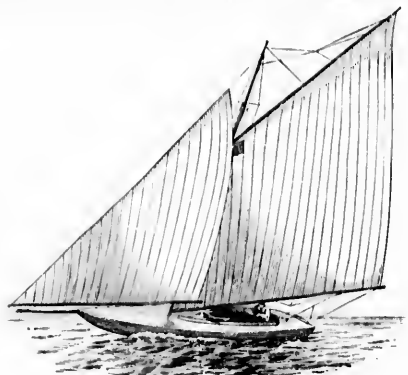

ONAWA.—FIGURE 104.

Herreshoff, and built by the Herreshoff Mfg Co. in 1892. Her dimensions are:

Length over all.	28 feet 5 inches.
Length lead waterline.	19 feet 4 inches.
Depth.	1 foot 4 inches.
Draft.	2 feet 10 inches.
Beam.	8 feet.

RECORD FOR 1892.

SOUTH BOSTON YACHT CLUB :—ALPHA won in the Open Regatta of May 30th, beating EXILE.

EASTERN YACHT CLUB :—ALPHA won the prize in a Special Race, sailed July 28th, and also the Medal of the Club. In this race she beat CATSPAW, VANESSA, BREAK, REAPER, KOORALI, etc.

MASSACHUSETTS YACHT CLUB :—ALPHA won in her class in the Club Race of June 15th. In the Annual Open Race sailed June 17th, she was again the winner, this time with eleven starters.

QUINCY YACHT CLUB :—ALPHA beat MOONDYNE in the race sailed May 28th. In the Invitation Race, sailed on the 13th of August, she won again, beating VANESSA.

HULL YACHT CLUB :—Beat CATSPAW in a Club Race, held June 16th. She also won June 25th, in a Special Open Sweepstakes. A Club Race was sailed July 2nd, in which ALPHA won from CATSPAW. Beat CATSPAW again in a Club Race, August 12th.

Open Subscription Race, August 31st, ALPHA winning and receiving a prize of \$50.

CORINTHIAN YACHT CLUB OF MARBLEHEAD :—June 18th, Fifty-ninth Regatta, ALPHA won, beating eight other entries.

HULL CORINTHIAN YACHT CLUB :—ALPHA was a winner in the Club Regatta, sailed July 23rd. September 3rd, Open Race, she won again.

During the yachting season of 1893, ALPHA had her Waterloo on Lake Minnetonka, at the hands of the fleet OSAWA. This yacht was built to defeat ALPHA, and was designed by Arthur Dyer.

Up to the time of racing with OSAWA, ALPHA had never been fairly beaten in a race—in one instance she was ruled out for a technical violation of the rules. Next to ALPHA in 1892 stood BREAK, designed by her owner, John B. Paine. REAPER and VANESSA, the two Herreshoff fins, stood third and fourth and then came the heavy centerboards, CATSPAW, EXILE and THRESH.

OSAWA, Fig. 104, the champion 21-footer of Lake Minnetonka, was designed and built by Arthur Dyer. She was specially built to defeat KITE and ALPHA, the undisputed champions of the Lake. In her first race she won from ALPHA and in the second race she beat KITE by nearly 17 minutes corrected time. She is very light and strongly constructed, and is covered with light canvas, both hull and deck, for the purpose of additional protection.

She is owned by Mr. Ward Burton of Minneapolis, Minn., and sails with the MINNETONKA YACHT CLUB.

It was in 1892 when Royal Phelps Carroll ordered the Herreshoffs to build for him a keel-centerboard yacht, for the purpose of crossing the Atlantic so as to compete for the Brenton's Reef and Cape May Cups, which seven years before were won in this country by GENESTA. Mr. Carroll named his yacht NAVAHOE. She is 133 feet over all, 84 feet lead waterline, 12 feet 6 inches draft and 23 feet beam, thus making more of a cruising than a racing yacht.

After crossing the ocean, the first race in which NAVAHOE took part was on July 31st, 1893.

The following is a record of her races:—

Date	Yacht Club	Wind	Name of Yachts	Time
July 31,	Royal London.	Fresh.	Britannia (winner),	3 40 16
			Valkyrie (second),	3 47 19
			Navahoe,	3 47 39
			Satanita,	3 50 00
August 1,	Royal Southampton.	Light.	Navahoe (winner),	3 55 30
			Satanita,	4 00 08
			Calluna,	gave up
			Iverna,	gave up
August 3,	R. Y. S.	Strong.	Satanita (winner),	1 40 30
			Valkyrie,	1 49 02
			Navahoe,	gave up
			Calluna,	gave up
August 4,	R. Y. S.	Fresh.	Satanita (winner),	2 31 05
			Valkyrie,	2 33 14
			Calluna,	2 30 27
			Navahoe,	2 38 41
August 5,	Royal Southampton.	Moderate.	Navahoe (winner),	4 31 20
			Calluna,	4 42 54
			Britannia (winner),	3 54 33
			Navahoe (second),	3 58 23
August 10,	R. V. Y. C.	Light.	Satanita,	4 04 54
			Calluna,	4 06 37
			Britannia (winner),	2 21 26
			Satanita,	2 31 7
August 14,	Royal Albert.	Light.	Calluna	2 36 55
			Navahoe,	2 39 28
			Britannia (disq),	0 41 12
			Satanita (winner)	0 43 20
August 16,	Royal Albert.	Light.	Navahoe	gave up
			Calluna,	gave up
			Britannia (winner),	3 57 40
			Calluna (second),	3 57 45
August 19,	Royal Dorset.	Fresh.	Navahoe	4 04 05
			Satanita	4 08 32
			Satanita (winner),	2 06 40

Augu
Augu
Augu
Sept. 6.
Sept. 7.
Sept. 11
Sept. 14
Sept. 15
It wi
ROYAL
the reg
ROYAL
second i
was sco
In he
finally d
The c
from th
English
bourg II
In the
was: Bu
02 min.,
The r
without
line the
The w
and whe
was a he
nouvenir
entrance
at 5 hrs.
heavy an
About
astern.
use thei
BRITA
HOE was
The c
min., 35
TANNIA
of time
Thus
in the
minute
more th
into con
remark
Mr. C
half a le
tion and
a prote
NAVAH
each of
Lighth

THE YACHTS AND YACHTSMEN OF AMERICA.

August 31, Torquay Regatta. Fresh.	Britannia (second),	2 08 59
	Navahoe,	2 11 35
	Calluna,	2 13 03
	Britannia (winner),	2 09 08
	Calluna (second),	2 13 36
	Satanita,	2 16 13
	Navahoe,	gave up
August 25, Royal Dartmouth. Light.	Satanita (winner),	6 08 03
	Navahoe (second),	6 15 48
	Calluna,	gave up
August 27, Start Bay. Light,	Britannia (winner)	3 37 53
	Satanita (disq),	3 45 00
	Navahoe (second),	3 47 18
	Calluna,	3 50 37
Sept. 6, R. V. Y. C. Gold Cup. Light,	Britannia (winner),	4 50 02
	Navahoe,	5 06 29
Sept. 7, R. V. Y. C. Gold Cup. Fresh,	Britannia (winner),	4 50 46
	Navahoe,	5 24 57
Sept. 11, R. V. Y. C. Gold Cup. Strong,	Britannia (winner)	4 20 17
	Navahoe,	4 44 25
Sept. 14, Brenton's Reef Cup.	Navahoe (winner)	10 38 32
	Britannia,	10 37 45
Sept. 15, Cape May Cup.	Britannia (winner),	24 12 14
	Navahoe,	24 48 32

It will be seen from this record that NAVAHOE was first in the ROYAL SOUTHAMPTON Regatta, sailed August 1st; she was first in the regatta of the same club sailed August 5th; was second in the ROYAL VICTORIA YACHT CLUB Regatta, sailed August 8th; was second in the ROYAL DARTMOUTH Regatta, sailed August 25th and was second in the START BAY Regatta, sailed August 27th.

In her race with BRITANNIA for the Brenton's Reef Cup, she was finally declared to be the winner.

The course sailed for the Brenton's Reef and Cape May Cups was from the Needles, at the west end of the Isle of Wight, across the English Channel to Cherbourg, rounding the breakwater of Cherbourg Harbor from west to east and return, a distance of 120 miles.

In the race for the Brenton's Reef Cup the official time of the start was: BRITANNIA, 12 hrs., 01 min., 08 sec., and NAVAHOE, 12 hrs., 02 min., 05 sec.

The race was sailed under the NEW YORK YACHT CLUB rules but without time allowance. Five minutes was allowed for crossing the line the difference to be corrected at the finish.

The wind was blowing strong from the eastward when they started and when the yachts were in mid-channel, about 2 hrs., 30 min., there was a heavy run of sea. NAVAHOE began to gain, and by skillful maneuvering passed BRITANNIA to windward. The buoy at the western entrance of the breakwater was passed at 5 hrs., 1 min. by NAVAHOE and at 5 hrs., 1 min., 10 secs. by BRITANNIA. The wind was now very heavy and the sea ngly, and both vessels were eased of their foresails.

About 5 miles from the Needles, NAVAHOE was about two lengths astern. The wind was much lighter now, which enabled them to use their foresails again.

BRITANNIA gave the Goose rock a clear birth, while NAVAHOE was off to the westward a half mile.

The official time of crossing the line was: BRITANNIA, 10 hrs., 37 min., 35 sec., and NAVAHOE, 10 hrs., 38 min., 32 sec. Thus BRITANNIA crossed the line 57 seconds ahead, but owing to the difference of time at the start which was 54½ secs., this was reduced to 2½ secs.

Thus ended one of the most remarkable yacht races known in the history of yachting—at no time were the yachts more than a minute ahead of one another, and most of the time there was not more than two lengths between them, and, when these facts are taken into consideration with the length of the course, it is all the more remarkable.

Mr. Carroll claimed that NAVAHOE crossed the true finish line within half a length of Britannia, that the committee boat had shifted her position and that what was called the finish line was incorrect, and he entered a protest which was considered by the committee who declared NAVAHOE the winner, admitting that the times were taken directly each of the vessels came in line with the stream of the Needle Lighthouse, as this was considered better than being obtained from a

floating mark which would have been necessary, as a vessel can not anchor in a fair way at night time.

NAVAHOE thus received the Brenton's Reef Cup, which has been brought back to this country to be competed for once more on this side of the ocean.

In the race for the Cape May Cup over the same course on September 15th, the wind was light and from the southwest with a smooth sea. Both yachts carried club-topails and jib-topails. The time of Britannia off the Needles was 1 hr., 02 min., 37 sec. and NAVAHOE 1 hr., 5 min., 15 sec. On Saturday morning in a light wind and fog BRITANNIA reached Cherbourg at 5 hrs., 29 min. and NAVAHOE at 5 hrs., 57 min., 15 sec. The wind on the return trip was light and from the east until the Isle of Wight shore was picked up when the wind came in ahead and the yachts trimmed sheets.

BRITANNIA arrived at 12 hrs., 57 min., 14 sec., and NAVAHOE 1 hr., 33 min., 32 sec. BRITANNIA winning by 36 min., 18 sec. elapsed time.

On December 13, 1892, the NEW YORK YACHT CLUB accepted a challenge from the ROYAL YACHT SQUADRON of England, on behalf of Lord Dunraven for the AMERICA'S CUP, to be decided by the best three out of five races to be sailed in the Fall of 1893.

As an elaborate account of these races will be given in the chapter relative to the AMERICA'S CUP, so it will not be necessary in this place to give more than a brief summary of the same.

The yachts built to defend the cup against VALKYRIE, Lord Dunraven's yacht, were VIGILANT, COLONIA, JUBILEE and PILGRIM, and it will be interesting to review the dimensions of these yachts as also their individual records.

The following are the particulars and dimensions of the four Cup defenders:

NAME.	VIGILANT.	COLONIA.	JUBILEE.	PILGRIM.
Designer,	N. G. Herreshoff	N. G. Herreshoff	John H. Payne	Stewart & Binney.
Builder,	Herreshoff	Herreshoff	Lawley Co.	Pusey & Jones.
	516, Co.	516, Co.		
Owning,	G. D. Beall	Arch. Rogers	Gen. C. J. Palmer	H. S. Palmer
Launched,	June 14, 1893.	May 15, 1893.	June 11, 1893.	June 12, 1893.
Type,	Keel center-board.	Keel.	Keel center-board.	Keel center-board.
Keel,	Cutter.	Cutter.	Cutter.	Cutter.
Length over all,	128 ft.	120 ft.	120 ft.	120 ft.
Length lead waterline,	86 ft. 12-100.	85 ft. 48-100.	84 47-100 ft.	85 28-100 ft.
Beam,	20 ft.	20 ft.	22 ft. 6 in.	23 ft.
Depth,	14 ft.	15 ft. 9 in.	11 ft.	22 ft.
Sail area,	11,312 sq. ft.	11,353 sq. ft.	11,340 sq. ft.	10,250 sq. ft.
Racing length (actual)	101.24.	96.31.	95.48.	93.15.
Racing length (measured)	101.80.	101.21.	95.48.	93.15.
Allowance for thirty fathoms miles,	11 sec.	37 sec.	1 min. 30 sec.	
Must, deck to bounds,	68.00 ft.	68.00 ft.	67.00 ft.	65.70 ft.
Topmast,	56.88 ft.	56.88 ft.	57.00 ft.	47.68 ft.
Main boom,	101.00 ft.	101.00 ft.	91.00 ft.	93.84 ft.
Gaff,	63.70 ft.	55.25 ft.	54.00 ft.	51.55 ft.
Bowsprit outboard,	33.00 ft.	33.00 ft.	30.00 ft.	28.00 ft.
Spinnaker boom,	73.02 ft.	73.00 ft.	73.00 ft.	71.33 ft.
Perpendicular for measurements,	122.88 ft.	122.75 ft.	75.00 ft.	111.38 ft.
Must to jibstay,	74.85 ft.	74.02 ft.	75.00 ft.	73.11 ft.
Must to jibtopmast stay,	75.00 ft.	76.27 ft.		73.12 ft.

The allowances are calculated on the basis suggested by Lord Dunraven, that any yachts exceeding the limit of 85 feet length waterline by more than 2 per cent. should be disqualified from racing, and that any excess under 2 per cent. should be doubled. Thus VIGILANT is 86.12 feet, or 1.12 feet over the limit, her waterline being assumed as 87.24 feet or 2.24 feet excess in place of 1.12 feet. JUBILEE, is the only one of the four which escaped a penalty by being under the limit.*

The first race in which either of the cup defenders participated took place August 7, 1893, for the Commodore's Cup, over a 26 mile triangular course. The wind was northwest and strong.

The following yachts started:

	Elapsed Time.
	H. M. S.
Colonia	2 06 39
Vigilant	disabled.
Queen Mab	2 38 03
Hildegard	2 50 49

COLONIA being the winner of the Cup.

* See "Forest and Stream" Sept. 16, 1893.

YACHTING IN THE UNITED STATES.

71

The next race took place August 10, 1893, from New London to Newport. The wind was light, weather fair and sea smooth.

	Elapsed Time.		
	H.	M.	S.
Jubilee	5	02	52
Vigilant	5	00	41

VIGILANT won by 1 min., 11 sec.
On August 11, 1893, all four yachts competed for the Goolet Cup, over a 38 mile course. The wind was southeast and very light. The weather was foggy and sea smooth.

	Elapsed Time.		
	H.	M.	S.
Colonia	13	49	49
Vigilant	11	00	31
Jubilee	14	11	40
Pilgrim	withdrew.		

COLONIA being the winner received the Cup.
In the Fourth Squadron Run of the NEW YORK YACHT CLUB three of the yachts competed from Newport to Vineyard Haven. The wind was fresh north northeast, shifting to southwest.



VIGILANT.—FIGURE 105.

	Elapsed Time.		
	H.	M.	S.
Vigilant	5	30	52
Jubilee	5	41	31
Colonia	5	41	45

VIGILANT won over JUBILEE by 10 min., 42 sec.
The next race was for the Astor Cups and VIGILANT, JUBILEE and COLONIA started August 19th, 1893, as the wind was light; the course was not covered within the limit of 6 hours, so a second race was sailed over a triangular course, a distance of 30 miles on August 22, 1893, this time only VIGILANT and PILGRIM started.

	Elapsed Time.		
	H.	M.	S.
Vigilant	4	05	57
Pilgrim	4	30	30

VIGILANT won, beating PILGRIM 24 min., 33 sec. and was awarded the Cup.
The Trial Races for the selection of a yacht to defend AMERICA'S

Cup, commenced September 7, 1893. The course was from Scotland Lightship, 15 miles to windward and return. The wind was south southeast, fresh and steady, the sea was moderate.

	Racing Length ft.	Time Allowance M. S.	Elapsed time			Corrected Time		
			H.	M.	S.	H.	M.	S.
Colonia	95.50	0 2	3	31	55	3	31	45
Vigilant	97.02	Allows	3	53	41	3	31	41
Jubilee	95.18		Disabled					
Pilgrim	93.15		Did not start.					

COLONIA won on time allowance by 6 seconds.
Upon re-measurement of VIGILANT, it was found that her racing length should be 96.80 feet instead of 97.02 feet, and that the allowance to COLONIA in the future should be 14 seconds. This allowance would have made the first race a dead heat.

The Second Trial Race took place September 9, 1893, over a triangular course from Scotland Lightship a distance of 30 miles. The wind was light from east southeast and the sea was smooth.

	Racing Length ft.	Time Allowance M. S.	Elapsed Time			Corrected Time		
			H.	M.	S.	H.	M.	S.
Pilgrim	93.15	1 56	4	11	10	4	12	40
Colonia	95.26	0 11	4	17	03	4	10	55
Jubilee	95.18	0 37	4	09	40	4	09	03
Vigilant	96.80	Allows	4	01	31	4	01	31

VIGILANT won, beating COLONIA 8 min., 9 sec.
The Third Trial Race took place September 11, 1893, from Scotland Lightship, 15 miles to windward and return. The wind was easterly, fresh and steady. The sea was rough and lumpy.

	Racing Length ft.	Time Allowance M. S.	Elapsed Time			Corrected Time		
			H.	M.	S.	H.	M.	S.
Vigilant	96.80	0 14	4	13	23	4	13	09
Colonia	94.26	1 56	4	31	35	4	36	02
Pilgrim	93.15	0 37	4	15	22	4	24	51
Jubilee	95.18							

VIGILANT won, beating COLONIA 6 min., 43 sec.
The corrected time in the case of Pilgrim was calculated as if she started at 11 hrs., 42 min., 00 sec., instead of 11 hrs., 48 min., 06 sec., as the limit for starting was 2 minutes after the starting gun, which was fired at 11 hrs., 40 min., 00 sec., therefore, making a handicap of 6 min., 6 sec. In the case of JUBILEE, which started at 11 hrs., 49 min., 06 sec., she was handicapped 7 min., 6 sec. for the same reason. The Cup Committee met after this race on board the flagship MAY, and at once selected VIGILANT to defend AMERICA'S Cup against Lord Dunraven's yacht, VALKYRIE.

VALKYRIE is a keel composite cutter designed by G. L. Watson and built by D. & W. Henderson & Co. of Glasgow, Scotland, for the Earl of Dunraven. She was launched April 29, 1893.

Her dimensions as obtained in England are as follows:

Length over all.	126 feet
Length load waterline.	85 feet 6 inches.
Beam.	20 feet 6 inches.
Draft.	16 feet 6 inches.
Sail area.	10,207.4 sq. feet.
Rating.	147.70.

As a result of the measurement of VALKYRIE and VIGILANT by Mr. Hyslop, the following are the official figures:

	VALKYRIE. Feet.	VIGILANT. Feet.
Length load waterline	85.50	86.19
End of main boom to forward side of mast.	62.60	69.37
Fore side of mast to jib stay.	66.16	73.80
Fore side of mast to jib topsail stay.	66.16	74.85
Fore side of mast to forward point of measurement.	72.00	74.62
Fore side of mast to outer end of spinnaker boom.	3.03	3.08
Deck to upper side of main boom.	114.86	125.06
Deck to topsail halliard block	63.30	69.08
Deck to hounds.	51.56	56.88
Length of topmast.	55.57	54.76
Length of gaff.	10,042.	11,272.
Sail area.	100.21	106.17
Square root of sail area.	93.11	96.78
Racing length.	1 min., 48 secs.	
Allowance.	VALKYRIE being measured for 6 ft. of excess of spinnaker boom.	

THE INTERNATIONAL YACHT RACES.*

On Thursday, October 5, 1893, an attempt was made to sail the first of the series between VIGILANT and VALKYRIE.

About 150 vessels laden with human beings assembled to witness the races and a conservative estimate places the number of people present at fully 25,000.

The course was 15 miles to leeward, due south, and return.

VIGILANT crossed the line just as the gun was fired on board MAY. Her time was 11 hrs., 25 min., 24 sec. VALKYRIE crossed at 11 hrs., 25 mins., 53 secs., or 29 seconds after VIGILANT. VIGILANT gained slowly and in about an hour was nearly two lengths ahead. The most exciting incident occurred at 1 hr., 15 min. when the wind came out suddenly from the southwest. VIGILANT was quick to take advantage of it, but it soon turned out to be a puff which left her motionless. VALKYRIE took advantage of this and held on to the original northern wind as long as possible, then luffed a little and quickly ran by VIGILANT. At 1.20 in came her spinnaker, the staysail was broken out, the sheet of the jib topsail was flattened and VALKYRIE by aid of the light southwesterly breeze was making for the outer mark. VIGILANT remained motionless, and VALKYRIE was a mile ahead before she could gather way and head on her course. It was simply a question then if the wind would freshen sufficiently for VALKYRIE to complete the course within the time limit, but this point was settled at 5:15 when a signal from the flagship MAY announced that the race was abandoned.

FIRST RACE, SECOND DAY, OCTOBER 7, 1893.

(WINDWARD AND LEEWARD.)

The preparatory gun was fired at 11:15 A. M. VALKYRIE was the first away, but the two yachts crossed the line at almost the same time. VIGILANT broke out her spinnaker, which was set in stops; as she crossed the line VALKYRIE set hers flying and afterwards set her balloon jib topsail. It was a sight which won the admiration of all present.

VALKYRIE was in the lead, and the two boats sailed quite evenly for half an hour, when VIGILANT commenced to gain and soon passed VALKYRIE, increasing her lead until she was half-a-mile ahead, possibly receiving stronger currents of air, but probably on account of having her sails in better trim. This gain, however, was by some considered as made entirely through a fluke. When the wind headed at 12:25, VIGILANT took in her spinnaker as also did VALKYRIE, but they were out again about 12:50, and carried until 1:23, the wind working to the south. VIGILANT luffed around the mark, one mile ahead, at 1:50:50 or 2 hrs., 25 min., 50 sec. VALKYRIE followed 8 min., 6 sec. afterwards.

The wind was about south by west and fluctuating in intensity. VALKYRIE gained on the home reach at first, then fell back towards the end. Balloon jib topsails were set near the line by both boats, and the line was crossed with them still set.

The times were:

	Start	Finish	Elapsed	Corrected
	H. M. S.	H. M. S.	H. M. S.	H. M. S.
VIGILANT,	11 25 00	3 30 47	4 05 47	4 05 47
VALKYRIE,	11 25 00	3 38 23	4 13 23	4 11 35

VIGILANT consequently won by 5 min., 48 sec.

This ended the first race—satisfactory to Americans, but hardly conclusive as a test, as the wind was unreliable and neither boat was actuated by the same conditions.

SECOND RACE, THIRD DAY, OCTOBER 9th.

TRIANGULAR COURSE.

On MAY were set three strings of course signals which read: Southwest by south, east half south, and northwest half west, each ten miles nautical, the first leg being dead to the windward. The first gun was fired at 11:15.

VIGILANT crossed the line at 11:25:19 and VALKYRIE at 11:25:21.

* See Chapter Relative to AMERICA'S CUP, Vol. II.

Baby jib topsails were broken out by each and the windward work was begun. VALKYRIE soon took the lead and gained for at least twenty minutes. At 12:07 VALKYRIE went on port tack and VIGILANT did likewise. Both yachts took in their jib topsails as the wind had freshened.

At this time the VIGILANT was ahead, but to leeward. She commenced to gain and did so steadily on all future tacks, and finally at the turn had on the ten mile beat beaten VALKYRIE 4 min., 35 sec. The wind was now a fifteen mile breeze. The next ten miles was a reach, and at 1:59:55 VIGILANT jibed round the second mark just 8 min., 57 sec. ahead of VALKYRIE. The wind was now blowing about twenty miles, and on the latter part of the leg reached a velocity of twenty-five miles, about S.W. by S. VIGILANT traveled very fast and was heeled well down on the last half of the leg. She crossed the line at 2:50:01, having gained on this leg 3 min., 26 sec.

The times were:

	Start	Finish	Elapsed	Corrected
	H. M. S.	H. M. S.	H. M. S.	H. M. S.
VIGILANT,	11 25 00	2 50 01	3 25 01	3 25 01
VALKYRIE,	11 25 00	3 02 24	3 37 24	3 35 36

VIGILANT consequently won by 10 min., 35 sec.

The merit of VIGILANT'S speed was fully acknowledged by her opponents.

VIGILANT sprung her bowsprit, but by Wednesday she was ready for the third race with a new one, supplied by Piepgras and fitted by Wintringham.

THIRD RACE, FOURTH DAY, OCTOBER 11, 1893.

(WINDWARD AND LEEWARD.)

At 11 o'clock the sea was calm and there was no breeze, at 11:30 there was but little. About noon the letter G went up on MAY, asking consent to a postponement. VIGILANT consented, but VALKYRIE preferred to wait longer. Wind came up at times from the southwest, and at 1:25 MAY set the signals for a course S. by W., and the preparatory gun was fired at 1:35. VALKYRIE crossed the line at 1:46:13 and VIGILANT at 1:47:19. VALKYRIE took the lead and gained on each tack until about 3:31, when VIGILANT began to pick up her loss and at 4:18 VIGILANT crossed VALKYRIE'S bow. VIGILANT continued to gain all the time and rounded the mark at 6:07:17, just 6 min., 43 sec. ahead of VALKYRIE.

After running for a while, as there was no prospect of a finish within the time limit, the race was abandoned. Up to the time 3:31, when VIGILANT set her jubilee jib topsail, VALKYRIE did some good work on the wind, holding and pointing well.

THIRD RACE, FIFTH DAY, OCTOBER 13, 1893.

(WINDWARD AND LEEWARD.)

Lord Dunraven concluded to add two more tons of ballast to VALKYRIE before sailing again and it was stowed as low as possible. This changed the waterline and trim, necessitating a remeasurement, and the time allowance was reduced to 1 min., 33 sec., her waterline being 85.92 feet and her racing length 93.57 feet.

It was 11:15 before VALKYRIE approached the lights on Friday morning, having been detained on account of one of the throat halliard blocks needing repairs to the shell.

After MAY had floated the course signals, due east, VIGILANT signalled for time to make repairs. Her centerboard had jammed and in trying to raise it the cogs in the winch had broken. It was finally lowered eleven feet and carried this way on the wind. Off the wind it was raised by a tackle until but five feet projected.

In the meantime MAY had signalled: "Race postponed on account of fog." At 12:07 the blue peter went up, signifying a start, and the preparatory gun was fired at 12:17. VALKYRIE and VIGILANT did some fine maneuvering, but VALKYRIE crossed the weather end of the line at 12:27:10, and VIGILANT crossed the lee end at 12:27:13, on a course dead to windward.

VALKYRIE did good work, pointing as high as VIGILANT. At 12.50 the latter was footing faster, but not improving her weather position.

YACHTING IN THE UNITED STATES.

Captain Cranfield tried to blanket *VIGILANT*, but she footed too fast. *VIGILANT* tacked at 1:12 in hopes of weathering *VALKYRIE*, but had to go back to starboard tack, which placed her under *VALKYRIE*'s lee in a worse position. *VIGILANT* kept on losing after this, until at 2:15 *VALKYRIE* led by three-eighths of a mile. *VALKYRIE* huffed around the mark at 2:33:10, just 1 min., 55 sec. ahead of *VIGILANT*, thus making the beat of fifteen miles in 2:06:30.

Now *VIGILANT* commenced to gain, and rushed along with spinnakers set. At 3:30 *VIGILANT* ran through *VALKYRIE*'s weather. At the same moment, *VALKYRIE*'s spinnaker split clear across; another was substituted, which likewise split from head to foot. *VALKYRIE*'s chances of winning were now gone, as the finish was only about three miles away. At 3:38, *VALKYRIE* had a large jib topsail set as a spinnaker, but it was too late, as *VIGILANT* went rushing forward way ahead, and finally crossed the line at 3:51:39, 2 min., 43 sec. ahead of *VALKYRIE*, having gained 4 min., 8 sec. off the wind.

The times were :

	Start	Finish	Elapsed	Corrected
<i>VIGILANT</i>	12 27 00	3 51 39	3 24 39	3 25 19
<i>VALKYRIE</i>	12 27 00	3 53 52	3 26 52	3 25 19

VIGILANT, therefore, won the race by 40 seconds corrected time. It was a fine race and well worth seeing. Whether *VALKYRIE* would have won if she had not been so unfortunate with her spinnakers, is a question which almost all who witnessed the race are willing to concede. However this may be, according to the rules and regulations, *VIGILANT* won for the third time; thus completing the defense of AMERICA'S CUP, and insuring at least one other contest in the future before it will leave America.

Included in the record of 1893 should be mentioned the performance of *LASCA*, *ARIEL* and *QUEEN MAB*. *LASCA* is a centerboard schooner owned by John E. Brooks, and is built of steel. She was designed by A. Cary Smith, and built by Henry Piepgras, at City Island in 1892. Her tonnage is 124-115, 23-17.

In the First Squadron Run of the New York Yacht Club, August 8, 1893, *LASCA* was first, defeating *ALCEA*, *MAYFLOWER*, *EMERALD* and *ATLANTIC*. On the 9th of August, in the Second Squadron Run, she beat the same racers again, winning first place. August 10th, Third Squadron Run, *LASCA* defeated nine yachts, among them being *ALCEA*, *VOLUNTEER*, *EMERALD*, etc.

Second in the Goelet Cup Race, sailed August 14th, beaten by *VOLUNTEER*. August 14th, Fourth Squadron Run, *LASCA* first, beating *MIRANDA*, *MAYFLOWER*, *VOLUNTEER*, etc. In the Fifth Squadron Run, August 15th, *LASCA* was beaten by *VOLUNTEER* and *ALCEA*; she won, however, from *MAYFLOWER* and *ATLANTIC*. On the following day, in the Sixth Squadron Run, she was defeated by *ALCEA*, *MAYFLOWER* and *ATLANTIC*, winning only fourth place. She was first in the Annual Regatta of the New York Yacht

Club, and also won the LARCHMONT YACHT CLUB schooner Cup, September 16th, beating *ARIEL*, *EMERALD* and *DAUNTLESS*.

ARIEL is a steel centerboard schooner, launched in 1893, and owned by George H. B. Hill. She was designed by A. Cary Smith, and built by the Harlan & Hollingsworth Co., Wilmington, Del. She hails from New York City, sailing with the New York, ATLANTIC, CORINTHIAN of New York, EASTERN and SEAWASHTAKA CORINTHIAN YACHT CLUBS.

Her dimensions are :

Length over all.	100 feet.
Draft.	10 feet.
Beam.	21 feet 6 inches.

During the season of 1893, *ARIEL* has participated in the following races, all sailed under the auspices of either the New York or LARCHMONT YACHT CLUBS: August 8th, First Squadron Run, (N. Y. Y. C.), beaten by *DAGMAR* and *SHAMROCK*. August 10th, third squadron run, *ARIEL* was second, beaten by *LASCA*, but defeating *ALCEA*, *VOLUNTEER*, *MARGUERITE*, *EMERALD*, *DAGMAR*, *SHAMROCK*, etc. August 14th, Fourth Squadron Run, second, beaten by *SHAMROCK*. August 15th, Fifth Squadron Run, first, defeating *SHAMROCK*. August 16th, Sixth Squadron Run, in the contest for the LARCHMONT. Second, on September 16th, in the contest for the LARCHMONT YACHT CLUB schooner Cup. *LASCA* won, but *ARIEL* beat *EMERALD* and *DAUNTLESS*.

QUEEN MAB is a centerboard sloop yacht, built in England. She was designed by Watson and built by Henderson & Co. in 1892 for T. C. B. West. She was purchased by Percy Chubb who brought her to America. She is of composite construction, and is of an unusual size which makes her practically alone in her class, since we have no modern yachts which will prove of equal or approximately equal measurement. She sails with the New York Yacht Club, hailing from New York.

Her dimensions are :

Length load waterline.	59 feet 3 inches.
Draft.	11 feet.

In the season of 1892, while racing abroad, *QUEEN MAB* had a record of twenty-four firsts, eleven seconds and one other prize out of forty-six starts.

In 1893, *QUEEN MAB* made her debut as an American racer. During the season she raced as follows, with the New York and LARCHMONT YACHT CLUBS. In the First Squadron Run of the New York Yacht Club, August 8th, she was second in her class, being defeated by *HILDEGARDE*. In the Third Squadron Run, August 10th, she beat *HILDEGARDE* and *WAYWARD*, defeating the same yachts on the 14th of the same month. In the Fifth Squadron Run, August 15th, she out-ran *WAYWARD*, repeating the victory the following day. On the 2nd of September, in a regatta of the LARCHMONT YACHT CLUB, *QUEEN MAB* won from *BEDOUIN* and *KATRINA*.

SPEED RECORDS OF SAILING YACHTS.

THE Speed Record of sailing yachts is a most important subject for investigation and, strange to say, but little attention has been paid to it in this country.

In June, 1892, through the efforts of a yachtsman—the *Forest and Stream* was placed in a position to publish a table relative to the speed of sailing yachts, which is of such value that its introduction will unquestionably meet with approval.

It is but just to state that at the close of the season of 1887 there appeared in *Engineering* an elaborate article on the same subject by Lt. Col. J. F. Bucknill of Southampton, England, giving the speeds of the then existing Itchen boats or "lengthers." The calculation which will be presented in the tables is not as thorough as the one made by Lt. Col. Bucknill, as the course and conditions in this case are much more diversified.

Two very interesting questions suggest themselves on an examination of the tables. The highest speed shown was attained in cruising trim, and the speed with a quartering wind compares so favorably with those under spinnakers as to suggest the desirability of tacking to leeward rather than running wing and wing. A further continuation of the inquiry promises to throw much light on these and similar questions. In connection with the tables, *Forest and Stream* contains the following valuable article:

"The subject of the actual speed of sailing yachts is one that has received far less attention than from its importance it deserves, as it is the only true basis of comparison by which the improvements of recent years can be accurately estimated. It is generally assumed, and in all probability correctly, that the yachts of the last six years are materially faster than their predecessors immediate or remote, but at the same time there are very few reliable records of new or old yachts to substantiate this claim, or to show in what years the improvement was most marked.

"With the amount of racing now done in America and Great Britain the collection of reliable records should be an easy matter. That it is not systematically done is largely due to the fact that in racing it is the relative and not the actual speed which is of importance; so long as the yacht is the first in her class, it matters little whether she is sailing at six knots or ten.

"The conditions of yacht racing were never more favorable than at the present time for the collection of data relating to speed; the courses of the various clubs have been much improved of late years, being permanently laid down and the length of each leg known; the timing is usually very accurate, the yachts in each class are more nearly of the same measurement, thus eliminating time allowance; and though the racing classes just now are comparatively few, in those that do any racing at all, such as the 46 foot and 21 foot, there will be a great deal of keen competition.

"The figures on which the accompanying tables are based were compiled by a yachtsman from the results of last season's racing and were placed at our disposal some time since. Although their compilation involved a great deal of labor, they are by no means as complete as is desirable, owing to the difficulty of verifying times, distances and conditions in certain races. At the same time the results as they stand are interesting and valuable. We publish them partly to call attention to the subject, in the hope that the regatta committees and racing men may take such interest in it as to lead to a careful and systematic collection of similar data during the coming season.

"The regular racing courses of the leading clubs are now, as a rule, marked by permanent buoys or other marks, so that it is only necessary at the beginning of the season to verify the distances and note a few changes. This is the case in the EASTERN, NEW YORK, ATLANTIC, CORINTHIAN OF MARBLEHEAD and SEAWANAKA CLUBS. In some cases where markboats are depended on in part, a greater degree of accuracy is desirable in anchoring them, so that the distances may be absolutely the same in each race. In nearly all races a good anemometer may be used on the club house or even on the judge's boat; from which, aided by the observations of the United States Signal Service at the leading ports, the force of the wind may be obtained.

"The timing of the yachts is now done with great accuracy, and no change is needed in this detail. The most troublesome detail is that of the tides, but it is nearly always possible for the regatta committee to note the general effect of the tide on each leg of a course. There are many occasions on which it will be useless to take any observations, owing to fluky winds, calms or very strong tides but in nearly every race there will be one or more legs sailed under such fair conditions as to give satisfactory results.

"To make a complete and useful record, it is necessary to know the force of the wind and sailing course on each leg from which it will be possible to ascertain the true speed and relative merits of each yacht in light, moderate and heavy weather, as well as in running, reaching and beating. In the present tables the details are hardly complete enough to permit of any close analysis, and we have simply taken the rough averages of the speeds on, off and along the wind. Incomplete as they are, the results are very interesting, and we hope that they will lead to a general attempt to collect such data during the coming season as may enable us to publish a far more complete and accurate table in the Fall.

"The inquiry was originally begun mainly with a view to ascertaining the maximum speeds attained in racing and consequently the results are well above the average. The highest speeds attained may in each case be in part attributed to favoring tides, which are very important factors in New York Bay and in Vineyard Sound. In Long Island Sound above Larchmont, off Newport and off Marblehead, the influence of the tides is less important.

"In the tables the observed speed is given in nautical miles per hour. It has not been possible to note as closely as is desirable, the direction of the wind, as the rough divisions of running, reaching and beating are hardly definite enough.

"The following times, which are closely approximate, though not official, show the speeds of three well-known yachts under conditions favorable to accurate observation:

"They were taken in a special race of the NEW YORK YACHT CLUB in Vineyard Sound on August 10, 1891, the wind being fresh and the tide running from 1 to 2½ knots with the wind.

	Nauticat miles.	Marguerite 80 ft. l. w. l.	Troquois 80 ft. l. w. l.	Quickstep, 65 ft. l. w. l.
First leg	2¼ Close reach.	5 02	5 55	5 45
Second leg	8 Beat.	3 73	3 71	3 75
Third leg	8 Wing and wing	8 79	9 28	8 92
Fourth leg	4¾ Quartering	13 04	11 48	10 79

"There are many localities where a number of yachts are frequently raced in still water, or under such known conditions as may be readily allowed for. In these cases a careful observation throughout the season will give important results, however small the yachts may be.

The subject of speed records of American yachts for the year 1892, was taken up by *Forest and Stream*, and presented with elaborate tables and appropriate remarks, and for the same reason, as the first article on the subject was introduced, it is thought advisable to present the second. *Forest and Stream* states as follows:

"These tables have been prepared in the same manner as those for the season of 1891, published in our issue of June 2d last.

"The times of the yachts are taken from the official reports, if those give the special data; otherwise from unofficial reports or private observations after making a critical examination.

"The wind velocities are taken from anemometer records when obtainable, otherwise from comparison of reports. The notes on tides are taken from the Government predictions and charts.

"It is found that there was a decided improvement in the past season in the precision of the courses, and the official reports of the races give more data than in previous years; in the unofficial reports

an improvement might well be made in noting the correspondence of the timer's watch with that of the judges'. In one of the most important races the watch of the most accurate observers of the turns was manifestly about 4 min., 38 secs. slow of the official time.

"The season did not give as many races as were at first expected, but of the races that did take place, a smaller proportion than last year were spoiled by failure of wind.

"It has been the purpose in this summary to note all races which are free from manifest flukes of winds and from confusing tides, and which offered competition between yachts of any size and sporting character to furnish data for comparison.

"With the growth of interest in yachting on Lake Ontario it seemed desirable to note the performance of the yachts there, though *CANDELLA* is the only one recently known on the seaboard through which a line might be drawn on the others for comparison. The records of the lake fleet will be given below:

RECORDED SPEEDS OF 46-FOOT CLASS, 1891.

Date.	LOCALITY—CLUB.	Wind.	Course.	Nautical Miles.	Gloriana.	Beatrix.	Oswego.	Sagamora.	Miscoba.	Nautilus.	Barbara.	Albion.	Jessie.
June 16	New York Bay—American Y. C. Regatta,	Moderate.	Free.	31	6.82	7.00	7.01	6.70
		Moderate.	Free.	15	9.11	8.05	8.13	8.16
June 18	New York Bay, New York Y. C. Regatta,	Fresh.	Free.	61	10.23	10.08	10.27	10.47
		Fresh.	Beut.	51	5.69	5.03	5.10
		Fresh.	Free.	13	8.03	7.53	7.63
June 20	New York Bay, Scowabuka Corinthian Y. C. Regatta,	Moderate.	Free.	4	8.70
		Moderate.	Free.	71	8.48
		Moderate.	Free.	15	8.31	8.07	7.97
June 27	New York Bay, Corinthian Y. C. Regatta,	Moderate.	Free.	1	8.02
		Moderate.	Free.	71	7.87	8.01	7.54
		Moderate.	Free.	13	7.31	7.71	7.39
June 23	New York Bay, American Y. C. Special,	Moderate.	Free.	61	8.44	8.10	8.28	8.24	8.01
		Moderate.	Beut.	61	7.60	6.65	7.29	7.37	7.23
		Moderate.	Free.	15	9.32	9.19	8.87	9.03	8.50
July 2	Long Island Sound, Scowabuka Special,	Fresh.	Beut.	5	8.43	8.60	8.31
		Fresh.	Close reach.	71	4.47	4.81	4.60
		Fresh.	Quartering.	71	6.12	6.38	6.46
July 4	Long Island Sound, Larchmont Y. C. Regatta, whole course,	Fresh.	20	6.02	6.01	6.68	7.01
		Fresh.	Reach.	3	8.00	8.05	8.77	8.72
July 6	Long Island Sound, American Y. C. Regatta, whole course,	Fresh.	20	8.72	8.51	8.39
		Fresh.	Quartering.	61	8.92	9.06	8.69	8.75
		Fresh.	Broad reach.	61	8.02	8.56	8.12	8.31
July 7	Long Island Sound, New Rochelle Y. C. Regatta,	Fresh.	44	0.11
		Fresh.	Beut.	5	4.91	4.83
July 22	Marblehead, Eastern Y. C. Regatta,	Fresh.	Reach.	7	8.91	8.68	8.05	8.70
		Moderate.	Free.	101	7.93	7.91	7.70	7.99
July 23	Marblehead, Corinthian Y. C. Series, whole course,	Fresh.	Triangular.	21	7.17	6.87
		Fresh.	Free.	8	9.32	9.11	9.08	8.80
		Fresh.	Beut.	8	4.85	4.80	4.77	4.61
		Fresh.	Reach.	8	9.66	9.58	9.51	9.20
Aug. 4	Long Island Sound, New York Y. C. Cruise to New London,	Strong.	Beut.	93	5.23	5.12	5.13
Aug. 7	Newport, Gulet Cup.	Moderate.	Free.	18	8.33	8.29	8.18
Aug. 10	Vineyard Sound, New York Y. C. Special,	Fresh.	Reach.	61	8.00	8.00
		Fresh.	Free.	121	9.17	9.21	9.25	9.20
Aug. 12	New Bedford to Newport, New York Y. C. Cruise,	rough sea	Strong.	27	5.90
Aug. 17	Newport Sweeptakes, Corinthian Y. C. of New York,	Moderate.	Quartering.	8½	7.79	7.82	7.84	7.74	7.82	7.53
		Moderate.	Reach.	8½	8.21	8.15	8.13	8.10	8.10	8.00
Aug. 26	Marblehead, Corinthian Y. C. Series,	Moderate.	Reach.	8	8.58	8.56	8.25	8.45
Aug. 29		Fresh.	Free.	8	9.07	8.98	8.87	8.77	8.80
Sept. 10	Marblehead, Private Match,		Reach.	111	8.46	8.45

AVERAGE SPEED—

Running,	8.45	9.00	8.82	8.85	8.80	8.33	8.18	8.44	8.05
Reaching,	7.88	8.30	8.54	8.33	8.05	8.21	8.33	8.50	7.90
Beating,	5.03	4.98

THE YACHTS AND YACHTSMEN OF AMERICA.

TABLE IV.—SPEED RECORDS OF AMERICAN YACHTS, 1892. 25-FOOT CLASS.*

Date	Yacht	Locality	Distance sailed.	Course sailed.	Wind from.	Wind velocity.	Tide ran.	Tide velocity.	Sea.	Orion, schooner	Clinkerella.	Vreda.	White Wings.	Aggie.	Zelma.	Yama.	Vedette.	Erna.	Nady.
June 4	Larchmont.	Larchmont.	13	Q.	E.	Fresh	N. E.	0.2	Lumpy	5.30	6.03
July 2	Sea Coy.	Oyster Bay.	18	T.	S. W.	Strong	S. W.	0.5	Lumpy	5.43	5.58
July 9	"	"	11	N. W. by W.	S.	Light	N.	0.25	Smooth	5	5.13	4.63	4.80	5
"	"	"	21	1st log.	E. N. E.	Light	N.	0.25	Smooth	5.46	5.09	5.27	5.22	5.27
"	"	"	25	"	S. W.	Light	N.	0.25	Smooth	2.25	1.90	1.98	2.07	1.88
"	"	"	11	"	N. W. by W.	Light	N.	0.25	Smooth	4.92	5.13	...	4.82	4.94
"	"	"	21	1st log.	E. N. E.	Light	N.	0.20	Smooth	5.42	5.41	...	5.29	5.61
"	"	"	25	"	S. W.	Light	N.	0.20	Smooth	3.40	3.25	3.40
"	"	"	25	"	T.	Fresh	N.	0.6	Fair	4.28	...	3.25	3.91	3.17	...	3.63	3.82
Sept. 5	"	"	11	1st log.	N. W. by W.	Light	S.	0.40	Smooth	3.99	3.74	3.17	3.25	3.82
Sept. 24	"	"	21	1st log.	E. N. E.	Light	S.	0.40	Smooth	4.76	4.98	5.23	5.25	5.41
"	"	"	21	1st log.	S. W.	Light	S.	0.40	Smooth	2.71	2.61	2.53	2.56	2.70
Oct. 1	"	"	13	N. W. and S. E.	N. W.	Strong	N. E.	0.40	lumpy	4.87	5.08

Added.—Sept. 1st, Larchmont Y. C., at Larchmont, distance 13 miles, quadrilateral course, S. E. and N. E. and reverse, wind strong N. E., tide running S. W., velocity 1.0, fair sea, the record stood: Psyche 5.03, El Chico 5.05. Numbers 6122, Nemadly 2.84.

TABLE V.—SPEED RECORDS OF AMERICAN YACHTS, 1892. LAKE YACHT RACING ASSOCIATION FLEET.*

Date	Yacht	Locality	Distance sailed.	Course sailed.	Wind from.	Wind velocity.	Tide ran.	Tide velocity.	Sea.	Orion, schooner	Clinkerella.	Vreda.	White Wings.	Aggie.	Zelma.	Yama.	Vedette.	Erna.	Norma.
June 18	Hoop Can.	Toronto.	9	Q.	E.	Light	Smooth
July 1	Hoop Can.	Hamilton.	10	T.	W.	Light	Smooth
July 15	R. of Quinte.	Belleville, 1st round.	10	T.	W.	Light	Smooth
"	"	"	8	T.	S. W.	Mod.	Smooth	5.03	...	5.52	5.21
"	"	"	8	T.	S. W.	Mod.	Smooth	7.29	...	6.46	5.72
"	"	"	8	T.	S. W.	Mod.	Smooth	7.28	...	7.23	6.71
July 18	Oswego.	Oswego, 1st round.	10	W. and L.	W.	Fresh.	Lumpy	6.10	6.36	...	5.05	...	5.84	5.85	5.11	4.85	4.30
"	"	"	10	W. and L.	W.	Mod.	Lumpy	5.28	5.40	...	4.78	4.00
"	"	"	21	1st round.	W.	Mod.	Lumpy	5.28	5.40	...	4.78	4.00
July 22	Hoehsteter.	Thurlston, N. Y., 1st round.	12	T.	S. W.	Mod.	Smooth	4.95	5.04	5.19	5	5.02
July 28	Hoop Can.	Toronto, 1st round.	12	T.	S. W.	Fresh.	Smooth	4.60	6.42	6.30	4.68	4.74	4.23
"	"	"	15	T.	S. W.	Light	Smooth	6.61	...	6.21	5.72	5.98	5.22
Aug. 6	"	"	15	T.	S. W.	Mod.	Smooth	7.56	...	6.73	3.70	6.75	6.33
"	"	"	12	W. and L.	N. W.	Fresh.	Smooth	5.33

*—Pursuit & Stream.—Figs. 9, 188.
 †—Thirty rounds, three miles of the route are: Oracle 57.90, Clinkerella 57.90, Yreda 57.69, White Wings 45.74, Aggie 40.83, Zelma 39.96, Yama 39.96, Vedette 39.91, Erna 39.75, Norma 38.95.
 ‡—Amateur Yachts.—W. "whiskered"; L. "leeward"; T. "trapezoidal" course, generally equilateral; Q. quadrilateral course, or two sides leeward and reverse. Distances are in italical italics; tides the same. Wind velocities in statute miles.

The very complete and elaborate records of the speed of American yachts during the past season which have appeared in the *Forest and Stream* during the past three weeks, are the work of a yachtsman who has given serious attention to the subject for several years, and who has this year in particular expended a great deal of careful labor on the task. The tables cover all the races in which the results were not manifestly useless on account of calms or other dukes. The information as to courses, wind, tide, etc., is most complete, making the results of far more value than is usually the case with such records.

The task of compiling and tabulating any accurate averages of the speeds of each class on the various points of sailing would be a long and tedious one, but those interested in any special class or group of yachts will find much interesting data for comparison. It will be observed that the figures do not bear out the extravagant estimates of speed often indulged in by yachtsmen, a speed of six knots being much oftener found than ten, even in the very large craft. The best records are those of *RAMONA* and *LARCA* at Larchmont on Sept. 13 when the speed ran within a very small fraction of 13 knots, 12.98 and 12.95, respectively.

To make the record complete there should be included a race omitted by mistake, that of the *LARCHMONT YACHT CLUB* of Sept. 10th, the course being 21 miles for the larger schooners and 20 miles for the smaller and the one cutter starting, the wind being strong N. E., the tide running S. W., with a velocity 15, the sea fair. The speeds were: *DAUNTLESS*, 6.19; *RAMONA*, 6.68; *ATLANTIC*, 6.53; *HOQUOIS*, 6.12; *SMUGGLER*, 6.13; *VICTOR*, 7.10; *AZALEA*, 6.24, and *CLARA*, 7.30.

The most interesting of the records are those of the two small classes, the 21 foot lead waterline class in the East, and the 25 foot class about New York, or, more properly, about Oyster Bay and Larchmont. These two classes came together to a certain extent this year through the visit to Marblehead of the fastest of the New York boats, *PYXIE*; and her marked defeat by the Boston boats has been quite generally accepted a conclusive argument against what is very incorrectly known here as the "rating class." The following table is interesting in this connection:

COMPARISON OF DIMENSIONS AND SPEEDS OF 21 AND 25 FOOT CLASSES, 1892.

Name.	Type	Lead		Beam	Draft	Sail Area	Speed	
		waterline	ft. in.				sq. ft.	17'24"
		ft. in.	ft. in.	ft. in.	ft. in.	sq. ft.	knots	knots
<i>Alpha</i>	c. b.	21.	8.	1.3	700	7.68	5.33	
<i>Reaper</i>	bulb fin	21.	6.9	6.6	733	7.29	5.51	
<i>Vanessa</i>	bulb fin	21.	6.9	6.6	733	7.61	5.22	
<i>Cat-sparw</i>	c. b.	21.	10.6	1.6	990	7.14	5.13	
<i>Exile</i>	c. b.	21.	11.	1.6	1000	8.05	5.48	
<i>Thrush</i>	c. b.	21.	12.	1.6	1112	7.12	5.08	
<i>Freak</i>	bulb fin	21.	7.6	...	932	7.07	5.23	
<i>Pyxie</i>	fin	23.6	7.8	6.6	700	96.56	5.08*	
<i>El Chico</i>	bulb fin	25.	7.1	6.6	625	6.03	5.37	
<i>Nameless</i>	keel	25.	6.9	6.6	625	5.72	5.13	
<i>Dodo</i>	c. b.	24.8	10.6	5.52	5.14	
<i>Meteor</i>	c. b.	25.	10.6	1.8	...	5.77	5.23	
<i>Nadly</i>	c. b.	27.11	11.6	2.	...	6.20	5.53	

**Pyxie's* record of home races only, shows a highest speed of 5.93 and an average of 5.16 knots.

The boats comprise a wide range of types of all periods, from *NADY* (the old *BROOKLYN*, built in 1876) to the latest Herreshoff craft fresh from the shop. *ALPHA*, the crack in her class last season, is a shoal centerboard of narrow beam and small sail area, with a Tobin bronze board of 400 lbs. *REAPER* and *VANESSA* are new Herreshoff fin-keels with the bulb-fin, like *EL CHICO* and *WEXONAH*, like *ALPHA* of very light construction, double skin. *CATSPAW*, designed by Stewart & Binney, is a shoal centerboard racer with a large sail plan and inside lead ballast. *THRUSH*, designed by A. G. McVey, is a similar boat but wider and with larger rig. *EXILE* is of the Cape cat type, but with a sloop rig, and *FREAK* is a bulb-keel

designed by John B. Paine. *PYXIE* is a new Gardner boat, a keel cutter, but with small underwater body and exaggerated keel amounting to a fin. *NAMELESS* is also a Gardner boat of 1891, a small keel cutter; *EL CHICO* is a Herreshoff bulb-fin, while *DODO*, *METEOR* and *NADY* are of the old type of open jib-and-mainsail racing boats, with the ordinary wooden centerboards. Their corrected lengths bring them out of the 25 foot class, but they have sailed in a number of races with the 25-footers.

The highest speeds in the table are the highest recorded in any race; the averages are made up by taking only speeds of four knots and over, assuming that the lower speeds of two or three knots are due to conditions which fail to give a correct gauge of the relative performances of the boats. It will be noticed at once that not only the highest speeds but the averages of the Boston 21-footers are considerably above those of the New York boats. At the same time it is equally plain that the former are carrying considerably more sail over much smaller hulls, the displacement also being very much less. The records of the wind velocity are lacking in the New York races, but the fact is brought out that nearly all the recorded races at Larchmont and Oyster Bay were sailed in light winds, while a large number of the records obtained off Marblehead were made in winds of a velocity of 15 to 18 miles.

The obvious conclusion from the various facts disclosed by the tables is not that a waterline classification produces a fast boat and a sailing length classification a slow one, but that the Boston designers have dealt more successfully than those of New York with the conditions of the problem, and have consequently produced a boat better adapted to the purpose in view. A good standard of comparison is afforded by the old type centerboard racing boats *DODO*, *METEOR* and *NADY* (*BROOKLYN*), all recognized as fast in their day in a large fleet of open racing boats, and now probably faster than of old, as they have benefited by the modern improvements in sails and rigging. Against these boats the new 25-footers have more than held their own, and that, in weather distinctly favorable to the old and unfavorable to the new types. It would thus appear that the 25-footers are not by any means slow boats according to local standards of speed.

That they are slower than the Eastern 21 foot class is clearly proven, but in order to show that the classification is responsible for this, it must first be demonstrated that the limit of 25 foot sailing length directly encourages a *NAMELESS* or *PYXIE*, and discourages a shorter boat with more sail. So far from this being the case, it is evident that *ALPHA*, as she stands, with a sailing length of 23.70 feet, could win from the larger boats at Oyster Bay or Larchmont as easily and surely as she has from the rest of the 21 foot class at Marblehead, while a larger *ALPHA*, built to the full limit of 25 foot sailing length, or even the same 21 foot *ALPHA* with a larger sail plan, could do even better. The sailing of the new 21 foot cutter *SIROCO* in the Eastern races, a boat somewhat of the type of *NAMELESS* and *SMUGGLER*, though with a very much larger sail plan, shows that the ordinary keel cutter, even of the best model, has no chance against either the fin-keel racer or the shoal centerboard, such as *ALPHA* and *CATSPAW*. It is now open to any enterprising New York yachtsman to build a boat for the 25 foot class of, for instance, 21 foot lead waterline and 840 sq. ft. of sail, making 25 foot sailing length, or perhaps a foot longer, and with 781 feet of sail, either a bulb-fin or a centerboard, with which he can win the light weather races on the Sound, being beaten, if at all, in the comparatively few hard blows that are met with in the summer. By refinement of model and improved construction, it is reasonable to expect that a marked advance in speed will be shown, and the limit of possible improvement be still more nearly approached.

The following tables* compiled by Captain J. C. Summers, contain matter of interest relative to yachting records and are worthy careful perusal:

* "N. Y. World" Almanac, 1891.

N.
STEAM
New Y
Atlan
Scot
Dante
Sapph
Sea Y
Gray B
Sachem
R.
Kathin
Shamro
Puritan
Mayflow
CAT
Julia
CATAM
Tarrant
Duplex
STEAM L
Henrich
* Betw
N.A.
Henrich
Fleetwing
Vesta
Cant. In
Dukeless
Coronet
Dukeless
SAILI
1851.
OAK; 1
1866, 81
1868, s
METEOR
and 1
1874, s
1879, s
INTRE
1886, s
FORTY
ERVA;
steamer
GALAT
both w
In 1
lights
min., 3
to lee
the slo
FLOW
VOLU
the r
beatin
most
11 kn
made
of 10
In t
(third
* The
* See

YACHTING RECORDS.

NAME.	Length.	Owner.	Distance.	Course.	Time.	Date.
STEAM YACHTS. Tonn.						
Now Then,	80 1/2	S. L. Munro,	0	Long Island Sd.	0 10 00	July 12, 1887.
Atlanta,	21 3/4	Jay Gould,	22	Chesd Hudson River.	1 14 00	June 3, 1886.
SCHOONERS.						
Dauntless,	121 1/2	C. D. Colt,	25	Atlantic Ocean	15	Oct. 26, 1875.
Sappho,	135	W. P. Donzlass,	2,570	Atlantic Ocean	10	Apr. 26, 1876.
Sea Eya,	115	A. Cross, Confield,	31	New York Bay	3 32 10	June 11, 1886.
Grey Gull,	98	L. A. Fish,	31	New York Bay.	4 33 40	Sept. 24, 1886.
Sachem,	100	Owen & Co. Capt.	27	Atlantic Ocean	2 30 00	Aug. 9, 1886.
SLOOP.						
Katrina,	85 1/2	F. S. & H. D. An-	71	New York Bay	3 13 00	June, 1888.
Shamrock,	81	J. Rogers Mackwell,	31	New York Bay	3 31 00	Sept. 24, 1888.
Puritan,	81	J. M. Forbes,	27	Atlantic Ocean	2 33 22	Aug. 9, 1886.
Mayflower,	100	Charles J. Pate,	25	Vineyard Id. & Buzzard Bay.	2 10 00	Aug. 10, 1886.
CAT BOATS.						
Julia,	21 1/2	J. Hatch,	10	Boston Harbor	1 12 00	Sept. 16, 1888.
CATAMARAN.						
Tarantula,		Frederic Hughes,	115	Long Island Sd.	7 30 00	Apr. 5, 1878.
Duplex,	40	J. H. Longstreet,	40	Long Island Sd.	4 18 2	Apr. 23, 1885.
STEAM LAUNCH.						
Henrietta,		S. L. Munro,	180 1/2	Hudson River	2 40 00	Sept. 10, 1886.

* Between Newport and New York.

TRANS-ATLANTIC YACHT RACES.

NAME.	Length.	Owner.	Distance.	Time.	Date.
Henrietta (wom),	105	J. G. Bennett,	3,100	13 21 55	1863
Fleetwing,	106	George A. Osgood,	3,135	14 01 10	1863
Vesta,	105	George L. Lardner,	3,111	14 01 50	1863
Camel (wom),		James Ashbury,	2,881	21 05 17	1870
Dauntless,	121	J. G. Bennett,	2,781	21 07 01	1870
Coronet (wom),	131	R. T. Bush,	2,669	11 23 30	1887
Dauntless,	121	C. H. Colt,	2,617	16 01 41 1/2	1887

SAILING YACHTS WHICH HAVE CROSSED THE ATLANTIC OCEAN.

1851, schooner AMERICA and sloop SILVIE; 1857, sloop CHARTER OAK; 1858, sloop CHRISTOPHER COLUMBUS; 1863, schooner GYPSIE; 1866, sloop ALICE and schooners HENRIETTA, FLEETWING and VESTA; 1868, schooner SAPPHO; 1869, schooners SAPPHO, DAUNTLESS and METEOR; 1871, schooner ENCHANTRESS; 1872, schooners SAPPHO and DAUNTLESS; 1873, schooners ENCHANTRESS and FAUSTINE; 1874, schooner VIKING; 1876, schooners ERMENEGARDE and VESTA; 1879, schooner EXTREPID; 1881, schooner DAUNTLESS; 1883, schooners EXTREPID, NORSEMAN and GITANA; 1881, schooner DAUNTLESS; 1886, schooner CORONET; 1887, schooners CORONET, DAUNTLESS and FORTUNA and cutter THISTLE; 1888, cutter CLARA; 1889, cutter MINERVA; 1893, July, NAVAHOE, Boston to Southampton, 19 days. The steamers NAMOUNA, AWY, ATALANTA, ALVA, the cutter GENESTA, GALATEA, CLARA, THISTLE and MINERVA, have made the passage both ways. The last cutter to cross was VALKYRIE.*

In 1885 PURITAN made the run from old Buoy 10 to Sandy Hook Lightship, a distance of 8 1/2 nautical miles, with a good wind, in 58 min., 32 sec. In the second race GENESTA made the run of 20 miles to leeward in 2 hrs., 14 sec. These, however, were supposed to be the slowest of the giants of 1885, 1886 and 1887. The races of MAYFLOWER and GALATEA were valueless as tests of speed. In respect to VOLUNTEER and THISTLE: In the first race the English yacht made the run from the Lightship to Old Buoy 10 in 51 min., 32 sec., beating the American 2 min., 31 sec. on this leg of the race, that was most favorable to speed, and thus traveling a rate not quite up to 11 knots. In the race of 20 miles to windward and return THISTLE made the run home in 1 hr., 54 min., 12 sec., which is at the rate of 10 1/2 knots an hour.*

In the contest between VIGILANT and VALKYRIE on the second race (third day) over the triangular course, VIGILANT's average speed on

* The "N. Y. World" Almanac 1891.
* See "N. Y. Herald," June 9, 1884.

the first leg to windward was 6 knots, on second leg, free reach, was 12 knots, on third leg reach, was 11.3 knots, and on whole course was 8 1/2 knots.

The largest day's run ever made by any yacht was made by the schooner DAUNTLESS in her great ocean race with CORONET, when, with half a gale over her quarter, she reeled off 328 miles in 24 hours, traveling at the rate of 13 1/2 knots an hour, and it is well known that a big schooner with a strong quarter wind will outrun the fastest sloop.

As the following table of time allowance has been adopted by the leading yacht clubs, it will prove valuable for reference.

TABLE OF TIME ALLOWANCE.

The allowances in this table are based upon the rule accepted by naval architects that, within economic limits, opportunities for speed vary in different vessels as the square roots of their respective lengths. As strong winds are required, however, to give to larger vessels the full extent of their advantage in size, and as such a scale of allowance is not adapted to ordinary summer racing, 50 per cent. only of the allowance due to the rule is given in the table, and may be stated thus:

$$\text{Time equals } 5 \sqrt{\frac{3600 - 3000}{L - 100}}; 3,000 \text{ representing the number of seconds in an hour, } L \text{ the small yacht, and } L \text{ the large one.}$$

$$\text{Practically the formula is } \sqrt{\frac{1800 - 1000}{L - 100}}; \text{ five-tenths of } 3,000 \text{ being } 1,800.$$

RULE FOR USING THE TABLE.

The figures to be found in the table show in seconds and hundredths of a second what a yacht of the measurement opposite to these figures would be allowed by one of 130 feet in sailing one nautical mile.

To find what a yacht of any measurement should receive from a larger one, take the figures to be found opposite to the smaller measurement; from these subtract the figures opposite to the measurement of the larger yachts, and the difference multiplied by the number of nautical miles in the course will give the amount of the allowance due to the smaller vessel, in seconds and hundredths of a second.

EXAMPLE.

What time will a yacht of 70 feet racing length have to allow to one of 65 feet racing length, in a course of 20 nautical miles?

The time opposite 65 feet is,	65.00
The time opposite 70 feet is,	57.29
Difference,	8.71
Number of Nautical Miles,	20
Allowance,	174.20
Or 2 minutes 54 1/5 seconds.	

For fractions of a foot in the measurement use the nearest tenth to be found in the table.

WIND.

The relation between the velocity of wind and its pressure against an obstacle placed either at right angles to its course, or inclined to it, has not been well determined; and still less so its pressure against curved surfaces. The pressure against a large surface is probably proportionally greater than against a small one. It is generally supposed to vary as the squares of the velocities; and when the obstacle is at right angles to its direction, the pressure in pounds per square foot of exposed surface is considered to be equal to the square of the velocity in miles per hour, divided by 200. On this basis, which is

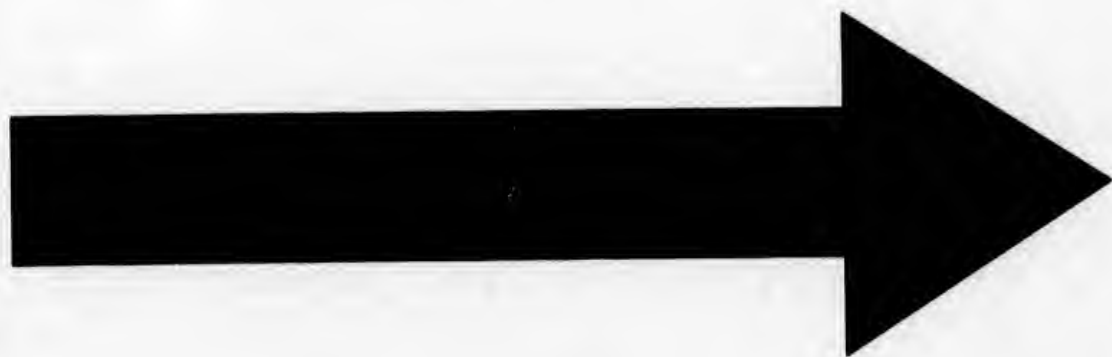

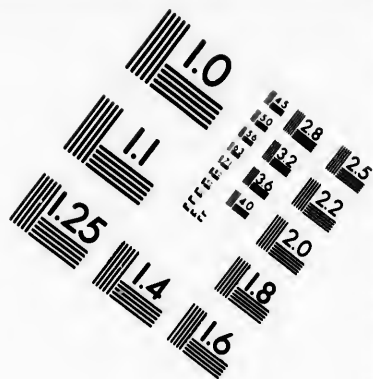
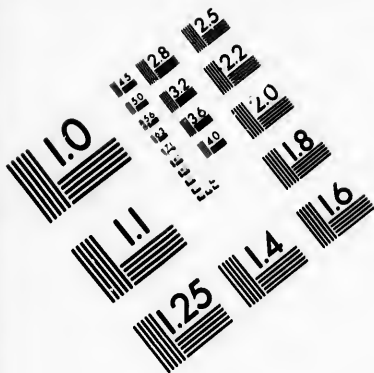

**IMAGE EVALUATION
TEST TARGET (MT-3)**

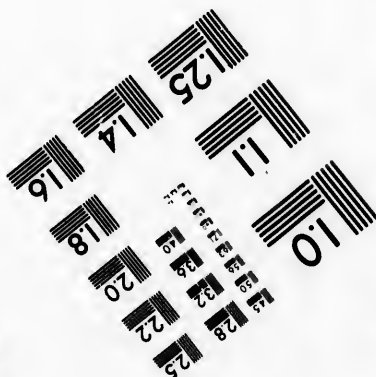
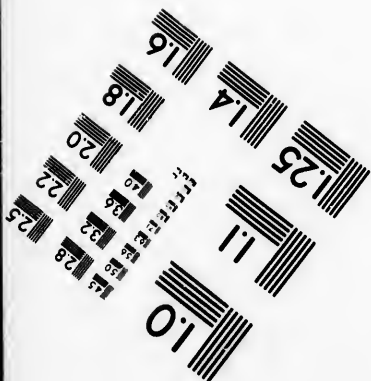
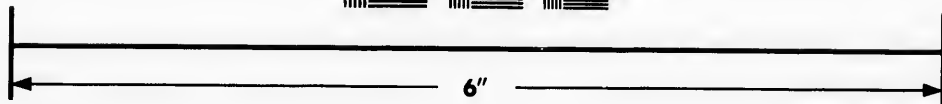
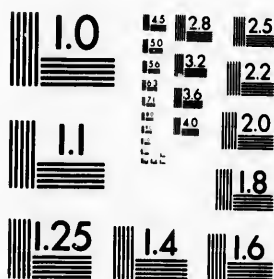

**Photographic
Sciences
Corporation**

23 WEST MAIN STREET
WEBSTER, N.Y. 14580
(716) 872-4503

1.8 2.0 2.2 2.5
3.6 4.0 4.5 5.0
5.6 6.3 7.1 8.0

1.0
1.5
2.0

probably quite defective, the following table, as given by Smeaton, is prepared:

Description.	Velocity in Miles per hour.	Velocity in feet per second.	Pressure in lbs. per square foot.
Hardly perceptible,	1	1.407	0.005
Pleasant,	2	2.633	0.020
Light Air,	3	4.400	0.045
Light Air,	4	5.807	0.080
Light Wind,	5	7.331	0.125
Light Breeze,			0.240*
Light Breeze,			0.327*
Moderate Breeze,			0.427*
Moderate Breeze,	10	14.07	0.5
Fresh Breeze,	12½	18.33	0.781
Fresh Breeze,	15	22.	1.125
Fresh Breeze,	20	29.33	2.000
Fresh Breeze,	25	36.67	3.125
Brisk Wind,	30	44.	4.5
Strong Wind,	40	58.07	8.
High Wind,	50	73.33	12.5
Storm,	60	88.	18.
Violent Storm,	80	117.3	32.
Hurricane,	80	146.7	50.
Violent Hurricane,	100		

* Interpolations

An open or half-decked boat had better make tracks before the pressure of the wind becomes 3.5 lbs per square foot. When the pressure is 6 lbs. per square foot the sea-going abilities of a five-

tonner will be taxed to the uttermost, and a ten-tonner would be proud if she came well out of a 9 lbs. pressure to the square foot.*

The following table will be found convenient for reference, and is consequently introduced:

TABLE OF KNOTS AND MILES.

Knots.		MILES.		Knots.		MILES.		Knots.		MILES.	
1	1,1520	26	29,0692	51	58,7850	76	87,6025				
2	2,3053	37	41,1219	52	59,1085	77	89,7351				
3	3,4589	28	32,2746	53	61,0012	78	90,8078				
4	4,6100	29	33,4273	54	62,3438	79	91,0004				
5	5,7633	30	34,5799	55	63,3065	80	92,2131				
6	6,9159	31	35,7326	56	64,5492	81	93,3658				
7	8,0686	32	36,8852	57	65,7018	82	94,5185				
8	9,2213	33	38,0379	58	66,8545	83	95,6711				
9	10,3740	34	39,1906	59	68,0072	84	96,8238				
10	11,5269	35	40,3432	60	69,1598	85	97,9765				
11	12,6792	36	41,4959	61	70,3125	86	99,1291				
12	13,8319	37	42,6485	62	71,4652	87	100,2818				
13	14,9845	38	43,8012	63	72,6178	88	101,4344				
14	16,1372	39	44,9539	64	73,7705	89	102,5871				
15	17,2899	40	46,1065	65	74,9232	90	103,7398				
16	18,4425	41	47,2592	66	76,0758	91	104,8925				
17	19,5952	42	48,4119	67	77,2285	92	106,0451				
18	20,7479	43	49,5645	68	78,3812	93	107,1977				
19	21,9005	44	50,7172	69	79,5338	94	108,3504				
20	23,0532	45	51,8699	70	80,6865	95	109,5031				
21	24,2059	46	53,0225	71	81,8391	96	110,6558				
22	25,3586	47	54,1752	72	82,9918	97	111,8084				
23	26,5112	48	55,3279	73	84,1445	98	112,9611				
24	27,6639	49	56,4805	74	85,2971	99	114,1138				
25	28,8166	50	57,6332	75	86,4498	100	115,2664				

1 Land Mile—5280 feet.

1 Nautical Mile—6080.07 feet.

1 Land Mile—8053 Nautical Miles.

1 Nautical Mile—1,15264 Land Miles.

* See "Boat Sailing for Amateurs," G. C. Davies, p. 60.

ABBREVIATED TABLE OF TIME ALLOWANCE FOR ONE NAUTICAL MILE—IN SECONDS AND DECIMALS.

Measurement	Allowance	Measurement	Allowance	Measurement	Allowance	Measurement	Allowance	Measurement	Allowance	Measurement	Allowance	Measurement	Allowance	Measurement	Allowance						
20.	244.02	25.	202.14	30.	170.77	35.	146.40	40.	126.75	45.	110.47	50.	96.70	55.	84.85	60.	74.52	65.	65.40	70.	57.29
1	243.62	1	201.42	1	170.22	1	145.06	1	126.39	1	110.17	1	96.41	1	84.63	1	74.32	1	65.22	1	57.13
2	242.63	2	200.70	2	169.68	2	143.53	2	126.03	2	109.87	2	96.18	2	84.41	2	74.12	2	65.05	2	56.97
3	241.64	3	199.99	3	169.14	3	142.10	3	125.67	3	109.57	3	95.93	3	84.19	3	73.93	3	64.88	3	56.81
4	240.66	4	199.29	4	168.60	4	141.67	4	125.32	4	109.27	4	95.68	4	83.96	4	73.74	4	64.71	4	56.66
5	239.69	5	198.59	5	168.06	5	141.24	5	124.97	5	108.97	5	95.42	5	83.75	5	73.55	5	64.54	5	56.51
6	238.72	6	197.89	6	167.53	6	140.81	6	124.62	6	108.68	6	95.17	6	83.54	6	73.36	6	64.37	6	56.36
7	237.76	7	197.20	7	167.00	7	140.38	7	124.27	7	108.39	7	94.92	7	83.33	7	73.17	7	64.20	7	56.21
8	236.81	8	196.51	8	166.48	8	140.95	8	123.92	8	108.10	8	94.67	8	83.12	8	72.98	8	64.03	8	56.06
9	235.86	9	195.83	9	165.95	9	140.52	9	123.57	9	107.82	9	94.43	9	82.91	9	72.79	9	63.87	9	55.91
10	234.92	10	195.15	10	165.44	10	140.10	10	123.25	10	107.54	10	94.19	10	82.67	10	72.61	10	63.71	10	55.76
11	234.00	11	194.47	11	164.92	11	141.72	11	122.90	11	107.25	11	93.94	11	82.45	11	72.42	11	63.54	11	55.60
12	233.07	12	193.79	12	164.40	12	141.30	12	122.56	12	106.96	12	93.69	12	82.23	12	72.23	12	63.37	12	55.45
13	232.14	13	193.12	13	163.88	13	140.89	13	122.22	13	106.67	13	93.44	13	82.02	13	72.04	13	63.20	13	55.30
14	231.23	14	192.45	14	163.36	14	140.48	14	121.88	14	106.38	14	93.20	14	81.81	14	71.85	14	63.03	14	55.15
15	230.33	15	191.79	15	162.85	15	140.07	15	121.54	15	106.09	15	92.95	15	81.59	15	71.66	15	62.86	15	55.00
16	229.43	16	191.14	16	162.34	16	139.66	16	121.20	16	105.80	16	92.71	16	81.38	16	71.47	16	62.69	16	54.85
17	228.54	17	190.48	17	161.83	17	139.26	17	120.87	17	105.52	17	92.47	17	81.17	17	71.28	17	62.53	17	54.70
18	227.65	18	189.83	18	161.33	18	138.86	18	120.54	18	105.24	18	92.23	18	80.96	18	71.10	18	62.37	18	54.55
19	226.77	19	189.18	19	160.83	19	138.45	19	120.21	19	104.97	19	92.00	19	80.76	19	70.92	19	62.21	19	54.41
20	225.89	20	188.54	20	160.34	20	138.06	20	119.89	20	104.70	20	91.76	20	80.56	20	70.74	20	62.05	20	54.27
1	225.02	1	187.90	1	159.84	1	137.66	1	119.55	1	104.42	1	91.51	1	80.34	1	70.55	1	61.88	1	54.12
2	224.16	2	187.26	2	159.34	2	137.26	2	119.22	2	104.14	2	91.27	2	80.13	2	70.36	2	61.71	2	53.97
3	223.30	3	186.63	3	158.85	3	136.86	3	118.89	3	103.86	3	91.03	3	79.92	3	70.17	3	61.54	3	53.82
4	222.45	4	186.00	4	158.36	4	136.46	4	118.56	4	103.58	4	90.79	4	79.71	4	69.99	4	61.38	4	53.67
5	221.60	5	185.37	5	157.87	5	136.07	5	118.23	5	103.31	5	90.55	5	79.50	5	69.81	5	61.22	5	53.53
6	220.76	6	184.75	6	157.38	6	135.68	6	117.84	6	103.04	6	90.31	6	79.30	6	69.63	6	61.06	6	53.38
7	219.93	7	184.13	7	156.90	7	135.29	7	117.50	7	102.77	7	90.08	7	79.10	7	69.45	7	60.90	7	53.23
8	219.10	8	183.52	8	156.43	8	134.90	8	117.27	8	102.49	8	89.85	8	78.90	8	69.27	8	60.74	8	53.08
9	218.28	9	182.91	9	155.95	9	134.52	9	116.95	9	102.22	9	89.62	9	78.70	9	69.09	9	60.58	9	52.95
10	217.46	10	182.30	10	155.48	10	134.14	10	116.61	10	101.95	10	89.39	10	78.50	10	68.92	10	60.42	10	52.81
11	216.64	11	181.69	11	155.01	11	133.76	11	116.27	11	101.67	11	89.15	11	78.29	11	68.73	11	60.25	11	52.66
12	215.84	12	181.09	12	154.53	12	133.37	12	115.92	12	101.40	12	88.91	12	78.08	12	68.55	12	60.09	12	52.51
13	215.04	13	180.49	13	154.06	13	132.99	13	115.58	13	101.13	13	88.68	13	77.87	13	68.37	13	59.93	13	52.37
14	214.24	14	179.89	14	153.59	14	132.61	14	115.24	14	100.86	14	88.45	14	77.67	14	68.19	14	59.77	14	52.23
15	213.45	15	179.30	15	153.12	15	132.23	15	114.90	15	100.59	15	88.22	15	77.47	15	68.01	15	59.61	15	52.09
16	212.66	16	178.71	16	152.66	16	131.85	16	114.53	16	100.32	16	87.99	16	77.27	16	67.84	16	59.45	16	51.95
17	211.88	17	178.12	17	152.20	17	131.47	17	114.17	17	100.06	17	87.76	17	77.07	17	67.67	17	59.29	17	51.81
18	211.10	18	177.54	18	151.74	18	131.10	18	113.81	18	99.79	18	87.53	18	76.87	18	67.49	18	59.14	18	51.67
19	210.33	19	176.96	19	151.29	19	130.73	19	113.45	19	99.52	19	87.31	19	76.68	19	67.31	19	58.99	19	51.53
20	209.56	20	176.38	20	150.84	20	130.37	20	113.09	20	99.25	20	87.09	20	76.49	20	67.14	20	58.84	20	51.39
1	208.80	1	175.81	1	150.38	1	130.00	1	112.73	1	99.00	1	86.86	1	76.29	1	66.99	1	58.68	1	51.24
2	208.04	2	175.24	2	149.93	2	129.63	2	112.38	2	98.75	2	86.63	2	76.08	2	66.82	2	58.52	2	51.09
3	207.28	3	174.67	3	149.48	3	129.26	3	112.02	3	98.49	3	86.40	3	75.88	3	66.66	3	58.36	3	50.95
4	206.53																				

TYPE OF YACHTS.

UP to the time when the pilot boat MARY TAYLOR was launched in this country, and possibly the cutter MOSQUITO in English waters, the Cod's head and Mackerel's tail type of yacht was firmly believed in. The proportions* were from 3 to 3½ beams to length of waterline, and the greatest transverse section was placed ahead of the middle of length, varying in distance from one-tenth to one-fiftieth of the length. The center of buoyancy was generally situated at about the center of length, and it appears to have been an aim of the designers to keep the displacement of the fore-

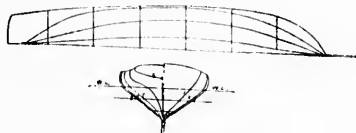

CYGNET.—FIGURE 106.

body and after-body equal. The upper horizontal waterlines of the bow were short and full, making an angle of about 30 degrees with the center fore and aft line, and the load waterline aft was generally a trifle fuller, but the buttock or vertical lines were long and flat.

The pilot boat MARY TAYLOR was built by Mr. George Steers upon a new principle of construction which he claimed to have discovered as the result of a lifetime devoted to the science of ship building. Previous to this alleged discovery by Steers, it had been held that the center of displacement should be forward of the beam. Mr. Steers

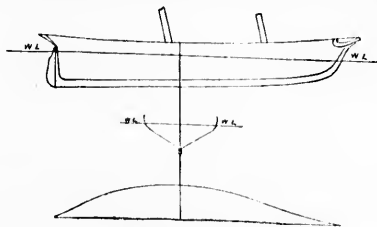

AMERICA.—FIGURE 107.

maintained that the best sailing qualities of a vessel could be developed only by the uniform displacement of the water along her lines and this modification marked a *new era* in yacht architecture. Any one visiting the NEW YORK YACHT CLUB who is privileged to see the various models of yachts exhibited will be very much surprised at the radical change in the character of models before 1850 and after that date. No gradual development of the long bow, easy and hollow and of graceful form will be seen, but an abrupt and complete change.

SYBEN, SYBIL, LA COQUILLE and other of George Steers' models of yachts built previous to 1848 are to be seen, but none of these, other than the model of CYGNET even suggest the characteristic features of SYLVIE or of AMERICA. The character of

* See "Fifty Years of Yacht Building," by Dixon Kemp.

yacht built in the United States between 1840 and 1848 may be illustrated by the lines of CYGNET (Fig. 106) and when these are compared with the lines of AMERICA (Fig. 107) or MARY TAYLOR (Fig. 108) the difference will be clearly manifest. The lines of AMERICA show her to have a long bow, easy and hollow, also graceful in form, being

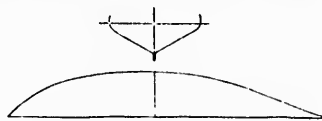

MARY TAYLOR.—FIGURE 108.

built on the wave principle, having broad shoulders in the water enabling her to stand up under press of sail, and her length and depth of longitudinal immersed section enable her to lie close on the wind. To illustrate the radical change that took place after AMERICA's great victory, the *Field* said the yacht AMERICA turned everything topsy-turvy at Cowes, and that in three years one hundred yachts had been lengthened forward, or altered. Mr. J. Hyslop states in his article on "The AMERICA'S CUP" that "while

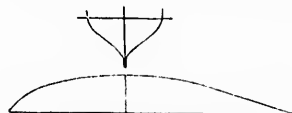

MOSQUITO.—FIGURE 109.

it does not seem to be disputed that AMERICA converted the yachting fraternity everywhere to a strong belief in long bows and hollow lines, it seems equally incapable of contradiction that MARIA, owned by John C. Stevens, of Hoboken, had an extremely long and hollow bow put upon her two years or so before AMERICA was launched." This is unquestionably true, but the pilot boat MARY TAYLOR was built by Steers before MARIA was altered.

The following figure gives the waterline and cross section of MARIA



FIGURE 110. (1).



MARIA.—FIGURE 110.

and will show the character of the boat. The nature of the alterations made are shown by dotted lines.

The model on the premises of the NEW YORK YACHT CLUB shows MARIA after she was lengthened in 1849, and represents the only really long bow and fine entrance in a yacht of that date in the club's collection. "It is on record," says Hyslop, however, "that early in

"Fifty Years of Yacht Building."

the century Mr. R. L. Stevens, after vainly trying to overcome the opposition and fear of ridicule of a firm of shipbuilders whom he asked to put a long false bow on a river steamer to increase her speed, finally had the work carried out under his own immediate direction with results very advantageous to speed.* This would seem to indicate that the credit for increasing the length of the bow should be awarded to Mr. Stevens.

In doing this it would not be right to overlook the fact on the other side of the water that Mr. John Scott Russell had also advanced the theory that the bow should be longer than the stern. And in 1847 an iron cutter yacht was built according to the theory of Mr. Russell which was launched in 1848 and christened *Mosquito*. She was 59 feet on the waterline and 15 feet 4 inches beam. Her bow was long and $2\frac{1}{2}$ inches hollow. Her midship section was placed four feet 6 inches abaft the middle of length of waterline and her center of buoyancy was two feet abaft it.

Mr. Dixon Kemp* writing about *Mosquito* said:

"According to the old practice, *Mosquito* should have no good qualities at all, especially in strong winds, but the fact is she excelled in all the good qualities claimed for the bluff bowed craft; she was faster than any other yacht of her length on any point of sailing, and in a strong wind, to windward, she was a marvel compared with other yachts. However, so strong was the prejudice against the 'long, lean bow,' and so alarming the predictions—that some day *Mosquito* would take a dive and never come up again—that no one could be found to try the experiment on a more extensive scale. It thus seemed likely that the old type would be continued, in spite of *Mosquito* having, in a superior degree, all the good qualities it was contended a yacht should have.

"*AMERICA* visited us in 1851, and achieved a remarkable success at Cowes over our schooners. This success was, no doubt, mainly due to the qualities of her hull, but the unusual flatness of her sails contributed largely to her fine weatherly qualities. The immediate effect of *AMERICA*'s success was rather startling; almost every yacht in existence at that time, including *Fair Rosamond*, was lengthened by the bow, her masts raked and sails laced to the booms; and the principles which had been so strikingly exemplified in *Mosquito* three years before, were now adopted as a new discovery of infallible merit. This marked the commencement of a new era in yacht-designing and the subsequent development of yachts into the now fashionable narrow type has shown no considerable departure from the principles observed in the design of *Mosquito*, so far as relative length of bow and stern goes."

The idea that the area of the midship section is a measure of resistance, that because the pressure in water is greater at lower depths, consequently a deep-draft vessel is more difficult to propel and that a forefoot is an essential requisite to windwardly qualities—

* In "Outing," 1888.

were notions which were swept aside after *AMERICA*'s victory, and that hybrid fish (as Hyslop expresses it) that was neither cod nor mackerel ceased to be any longer the trusted pattern of the British yachtsmen.

KALA-FISH, illustrated in the following figure, was built in accordance with the specification of a patent granted to Dr. J. Collis Brown, in 1872.* Dr. Brown maintained as a result of observation, that when a vessel under canvas or steam was forced through the waves, she raised or drove before her bow large volumes of water and that this body acted largely in retarding her rate of speed, as it effectually overcame her momentum. By constructing the bow as illustrated, he claims that when the vessel advances to the wave, her bow presents at once an angle of reflection to the angle of incidence belonging to the water, the consequence being that she rises to it, the water passing off on either side, the wave and vessel forming a plane common to both. *KALA-FISH*, according to report, has proved herself a splendid sea boat, meeting seas that would deluge other craft, while she would dash on regardless of them. She has sailed into the Mersey, visited France, Portsmouth, Plymouth and many other ports, been up and down the Straits of Dover and the Channel, without shipping a sea. The following illustrations (Figs. 112,

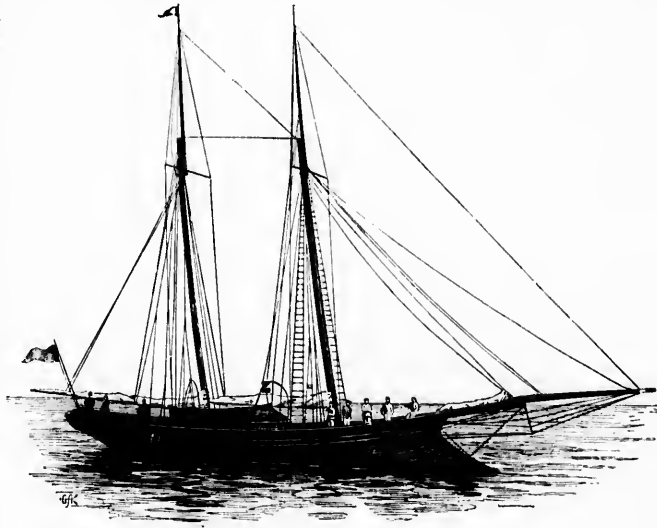

KALA-FISH.—FIGURE 111.

113, 114, 115,) furnish a better idea of what is claimed by Dr. Brown, and are consequently of interest.

It will be seen that when *KALA-FISH* advances to the wave, her bow rises to it. In constructing the vessel aft as in front, the same power of flotation as in the bow is seen in sending a sea; running after lifts instead of poops, the weight of water coming sternwise, literally acting hydraulically by elevating her as she rushes from sea to sea.

It must not be forgotten that Dr. Darin Davidson, of New York, as far back as 1850 designed a side-wheel steamer called *Sword Fish*, the hull of which closely resembles *KALA-FISH*.

Yacht designing is not, as many have supposed, an exact science, especially in the case of sailing boats; it is really, as Mr. Wm. Gardner has said, † "a compromise in the selection of good and bad qualities, the better boat possessing the fewest bad qualities." In a yacht there are three main factors: resistance, sea-going qualities and structure. It is an error to suppose that it is impossible to get a roomy boat and a fast one at the same time, and so far as sea-going qualities are concerned, by bestowing proper care on the design such a craft can be made an excellent sea boat. One fact not generally realized is that the boat at rest is not the boat in motion, and also, that the lines that are suitable at one speed are not at another. The resistances of a yacht are wave-making surface, eddy making and rudder. The wave making of sailing yachts is very great; owing to the large displacement for the length, it amounts to 60 and 70 per cent. at high speed. In a light wind, frictional surface is the important element of resistance and designers, appreciating this, are apt to cut it away too much, thus making the boat leewardly or unsteady.

* "Scientific American", August 3, 1872.

† In an able lecture delivered before the PHILADELPHIA YACHT CLUB, which is freely used here.

The object of the designer is not to eliminate wave making, as that is impossible, but to produce waves that, although appearing large at high speeds, require but a moderate amount of energy to produce them; that is, to produce a true wave formation. Mr. Gardner cites *MIXENVA* as a remarkable example of this; her wave making was much more pronounced than most of the yachts she sailed against, but she was traveling faster with less sail.

Eddy making is caused by undue fullness or leanness in some one place. If the after edge of a rudder is left wide, there is considerable eddy making; all edges should be made as sharp as practicable. The rudder forms a very important factor of resistance, and when a boat takes a hard helm her speed is materially reduced. The helm is materially influenced by the movement of the boat; if the run is fine, the quarters wide and the bow wedge-shaped, the boat will go down by the head as she heels; this throws the center of the lateral plane forward, and makes the boat gripe.

A large portion of the water must pass under the boat, or at any rate she must keep her head up. *VOLUNTEER* was a remarkable example of this; she always kept her head up, and was in consequence an easy boat to sail, while *GLORIANA* possesses the same characteristics in a still more marked degree.

The deep boat has the greatest transverse wave making, less diverging waves and less rudder, but has more displacement.

The object of a designer should not be to foster one type of boat, but when the type has been determined, either by the waters to be navigated or some particular requirement of the owner, to produce the best boat of the type possible, always remembering that each particular type has its own characteristics.

On account of his knowledge of the characteristics possessed by boats of different types, the designer may be of great assistance to the sailing master, the highest results having been obtained where the designer and sailing master have worked together.

The sailing master is full of ideas in regard to the design, and in many cases he wishes to make changes, very often in his effort to eradicate all faults. He does not realize that the designer has voluntarily accepted certain faults as the lesser of two evils. It is the sailing master's place to indicate the faults, but it is the designer's place to remedy them.

Theories and dogmas in regard to the exact shape of the waterlines, although modified from time to time, still exist and have exercised far too great an influence with many designers.

The *Forest and Stream** says:

"Considering the ease with which the horizontal waterlines are obtained from a wooden model or laid down in a design, it is not surprising that in the course of years they should have been exalted to a position of importance out of all proportion to their merits, and should have taken precedence over all the other lines of a yacht. The young yachtsman from the first, sees the waterline prominently outlined on every model, he is treated to lengthy dissertations on the merits of a little hollow there and just so much fullness here, and if he takes up designing or turns to the books for information the waterlines confront him everywhere. The subordinate theories as to the exact shape of the waterlines may change from time to time, but the main theory, that the essential feature of a design is the form of the waterlines, has existed for many years."

At one time, as already stated, the "cod's head" and "mackerel's tail" form of waterline was followed, when about the time of *AMERICA* came the complete revolution "by which the full bows and fine runs were reversed, the new theory being carried to its extreme in the wave line form of Mr. J. Scott Russell. While never returning to the old idea of the cod's head, the fashion in waterline has changed greatly from time to time, until in the work of Pife, Watson and others a positively convex waterline is found.

"For some years past the influence of the waterlines with the designers has grown less and less, the wave form theory having done much to destroy it, and Sir Robert Montague's investigations of the

diagonal lines long since demonstrated their great value, but at the same time nearly every designer has become welded to a certain form of waterline which recurs in all of his boats. Indispensable as they are to the draftsman and designer, forming a foundation on which a design may be readily constructed, the horizontal waterlines really form no essential feature of a design, and are of little importance compared with the diagonals and section lines.

AMERICA is a conspicuous instance, George Steers depending for his shape in her (as he did in all his yachts and pilot boats) mainly on the diagonals as laid down on the mould loft floor, and on the same lines as shown by the ribbands when the yacht was in frame. The whole character of the model is shown better by the diagonals and section lines than by any others, a fact that was emphasized some twenty years ago by Mr. J. W. Griffiths in his treatise on ship building, but which, up to the present time, has not been as generally understood as it should be. As Mr. Griffiths points out, the waterlines are valuable from their convenience, but they are important not from their own shape but from the resulting shape of the

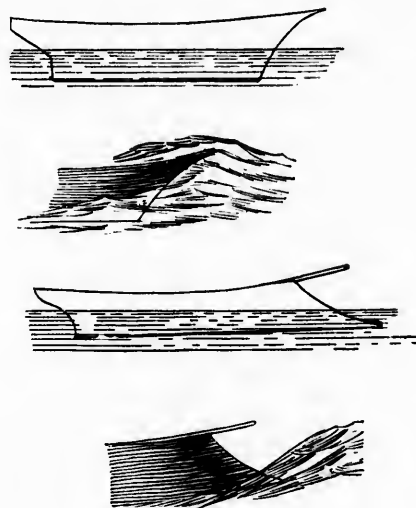

FIGURES 112, 113, 114, 115.

diagonals and section lines. If it were not for the mechanical difficulties of the drafting, designers would be only too ready to abandon the horizontal waterlines entirely and to start the design with the yacht not in a vertical but in an inclined position, at the average sailing angle, the section lines and diagonals alone being shown."

As Herreshoff in designing *GLORIANA* threw aside all the conventional theories concerning the waterline and opened a new path in which others have hastened to follow, it will be interesting to consider the characteristic features of this yacht which has won such an enviable record.

GLORIANA is one of the nine yachts built in 1891 for the new 46 foot waterline class she is a keel cutter of the American type so far as the midship-section and lateral plan is concerned, and does not differ materially in these respects from the general run of modern keel craft. The lateral plane of the interior arrangement is of the triangular outline used by Burgess, Pife, Gardner and Watson, the rake of the sternpost being about 10 degrees less than the average of the last three. The midship section has the S curve and strong bilge of the later American keel boats, with the wide keel. There is, how-

* May 5, 1892.

TYPE OF YACHTS.

ever, a radical departure from the conventional in the length and outline of the two ends, which are carried out to an extent heretofore unknown, while the angle of the stem and the center timber of the stern with the waterline, is much more acute than in the average yacht. Superficial and extraneous as these long ends are, they attract the eye at once, and nearly all of the critics and commentators having seen, have believed and have sought no further than these abnormal extremities for the reasons of the superiority of GLORIANA over the rest of her class.

It is unfortunate that her lines and exact dimensions are kept a secret by her builder. The accompanying design made by the *Forest and Stream*, while not official, is based on a close study and observation of her through her first season, aided by many sketches and photographs taken both in and out of the water.

The dimensions and elements of the design as given by the *Forest and Stream*, to whom we are indebted for the illustrations and comments, are as follows:

DIMENSIONS AND ELEMENTS OF DESIGN.

Length on waterline,	45 feet 3 inches.
Forward overhang,	12 feet 3 inches.
After overhang,	13 feet 6 inches.
Length over all, stemhead to tailrail,	70 feet 9 inches.
Beam extreme,	13 feet.
Beam (load waterline),	12 feet 5 inches.
Draft extreme,	10 feet 3 inches.
Freeboard, least,	3 feet.
Sheer above stern,	2 feet 6 inches.
	1 foot.
Rake of sternpost, degrees,	30.
Displacement, long tons,	34.25.
Ballast, lead keel, long tons,	21.
Ratio of ballast to displacement,	60 per cent.
Area of midship section,	40.28 square feet.
load water plane,	404.
lateral plane,	319.
riddle,	21.
Center of load waterline to—	
Mid-hip section,	2.50 feet.
Center of buoyancy,	2.00.
Center of lateral resistance,	3.22.
Center of effort,	2.33.
Center of effort above load waterline,	26.40.
Center of buoyancy below load waterline,	2.70.
Center of lateral resistance below load water line,	4.27.

DIMENSIONS OF SAIL PLAN.

Must from fore end of load waterline,	14 feet.
deck to hounds,	41 feet.
diameter at deck,	11 inches.
masthead,	9 feet.
topmast—fuel to hounds,	37 feet 3 inches.
Bowsprit—crane iron to end of load waterline,	30 feet 6 inches.
stem,	18 feet 6 inches.
gammon iron,	21 feet.
Boom,	56 feet 6 inches.
Gaff,	37 feet.
Spinnaker boom,	44 feet.
Topsail yard,	35 feet.
club,	29 feet.
Main-sail,	2072 square feet.
Jib,	900 square feet.
Staysail,	440 square feet.
Working topsail,	328 square feet.
Total	3640 square feet.
Lower sail,	3112 square feet.
Seawantaka rule sail area,	4137 square feet.
square root,	64.3.
Sailing length,	54.17.
Y. R. A. rule sail area, working topsail,	4287 square feet.
rating,	32.1.

In designing GLORIANA, Herreshoff boldly turned his back on "the waterlines, striving merely to secure as large an area as possible for purposes of stability, and his attention has been directed almost

entirely to the diagonals. These are long, clean and easy, the main diagonal, cutting the flat part of the floor, offering an unobstructed passage to the water, and being especially clean aft. Blunt and round as the immersed waterline appears to be, an easy passage for the water is provided underneath, rather than around, by the diagonals and buttock lines.

"In all this there is no new principle, no great discovery, no marvellous invention, as some would have us believe, but there is a bold

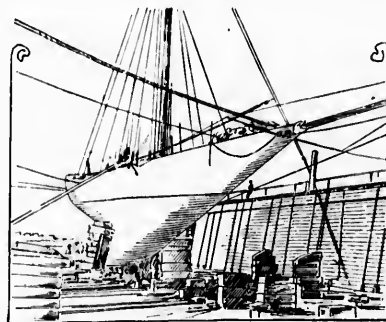

GLORIANA IN DRY DOCK.—FIGURE 116.

stroke of genius in the way in which GLORIANA'S designer has thrown aside all the conventional theories concerning the waterline, and broken a new path in which others are hastening to follow him. The value of the diagonals was established a generation ago, the desirability of a large area of loadwater plane has been realized by designers for years, the practicability of the convex waterline in certain types has long since been demonstrated by Watson and Fife, but at the same time designers have followed the conventional path, hampered by usage and tradition in regard to the particular form of waterline which they were at liberty to use in a wide boat, and it has

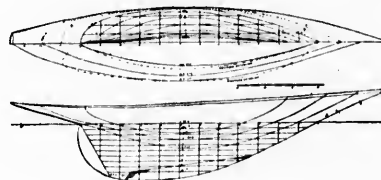

DESIGN OF A 46 FOOT YACHT SIMILAR TO GLORIANA.—FIGURE 117.

remained for Mr. Herreshoff to remove the barrier to a field which promises to be productive of the best results in the future. In our opinion, GLORIANA would have been none the less valuable as a teacher had she been no better than third or fourth in the fleet; even in that case she would have served to disprove the old fallacies as to the importance of a special form of waterline, and to have started designers in the new direction. As a teacher she stands beside AMERICA and MOSQUITO; they served to disprove certain accepted theories which were directly in the way of progress, and she has done the same; having done this, the question of how many mugs she has won or may win becomes of little importance.

"Looking at the actual value of the long ends, apart from the peculiar form of the boat proper, the first point noticeable is that while they result naturally from the carrying out the long fore and aft curves to their legitimate endings, a large part of each end might be cut off without loss of power; in fact, so far as speed in smooth water is concerned and apart from all question of appearance, the two ends might be cut off plumb with the waterline, as in the scows to which *GLORIANA* had so often been compared. Even with such a shortening as this, she would possess the same load water plane and the same powerful and easy bottom, and her performance in smooth water would suffer but little. Forward the loss would be nothing, there would be the same entrance, the same lines below water, even when heeled. Aft there would be some loss, though by no means proportionate to the extreme length of the counter.

"The value of after overhang was never better understood than by the builders of the type of sloop once in common use about New York under the mean length rule, the tax on overhang induced the designers and builders to take no more than the last inch that was absolutely helpful to the boat, and how much this was we know from *GRAYLING*, *FANTA*, *MISCHIEF* and the rest of the old stub-tails. The counter was carried out, the center timber is low as in modern boats, but as soon as this timber was well clear of the water under all ordinary condition of heeling and immersion, it was chopped off abruptly. Those who have observed the modern boats traveling at a high speed have doubtless noticed that the quarter wave runs sometimes the entire length of the counter, but it must not be supposed

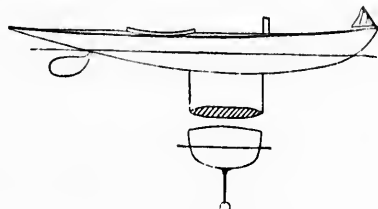

DILEMMA.—FIGURE 118.

that there is either stability or effective length for this distance; quite a considerable part of this water is probably carried along by the boat, with even a positive retarding influence, and the valuable portion of the entire after overhang is certainly not greater than a third of the average length.

"Under a rule taxing overhang we would see *GLORIANA*'s ends cut off in proportion to the extent of the tax; taking the boat as she is, it would be possible to reduce both ends materially, without harm to her sailing qualities; a matter of 4 feet off the stem and of 5 feet from the stern would, as will be seen from the design, make no important difference in the lines save a turning in short about the deck. Something of this kind is apparent in the new *WASP* and the fin-keels, the bows of *WASP* are even fuller than *GLORIANA* about the waterline, but the lines are turned in quicker about the stemhead."

DILEMMA, launched by Herreshoff on October 9, 1891, is illustrated by Fig. 118. She is a 25-footer, and though embodying an old idea, she is interesting. Her hull is much like a canoe, long, narrow, and of little depth (the hull being 39 feet over all, the length load waterline being 25 feet and the beam 7 feet), with a nearly flat floor and quick bilge, though with a strong rocker to the keel and an overhang to each end.

Like a canoe she has no proper keel, but has the same flush deck with a high crown and an elliptical opening for the crew. The chief feature is the appendage by which she obtains her stability. Underneath the main keel is hung a steel plate, 4 feet deep and 6 feet long, nearly rectangular in shape, to the bottom of which is bolted a cigar-shaped mass of lead some 10 inches in diameter. The plate weighs

883 lbs., and the lead cylinder 2 tons, the total draft being between 5 and 6 feet. The after overhang is quite long, and the sections are flat as in *GLORIANA*, but the bow is by no means so long. At the same time it overhangs the waterline considerably, while the full round sections give it the same character as *GLORIANA*, though at a mere glance the overhang is very different. She is very fast, also very comfortable to sail in, being always on an even keel or nearly so; and as far as safety from capsizing, speed and ease of handling the type is concerned, she is admirable for day sailing and racing.*



DAISY (1882).—FIGURE 119.

The "Ballast Fin," just described, has been spoken of by hymens as something quite unique in naval architecture, while in the "Transactions of the Institute of Naval Architects," numerous modifications of this idea can be found long before *DILEMMA* was constructed.

There can be but little doubt that for a racing machine the "Ballast Fin" is an excellent adjunct.

Mr. A. J. Kenaley says "But that it will ever be compatible with the exigencies of a cruiser I cannot believe. . . . A combination racing and cruising craft seems now impossible. If ever such a craft existed its era is over. The type of yacht in which our

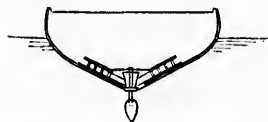

MIDSHIP SECTION OF BOAT WITH HANGING LEAD KEEL.

Corinthians took their pleasure and sport a dozen years ago is obsolete. This is a progressive age in yacht development, not because anything really novel has been invented, but rather on account of the improvement in old types and the scientific evolution of crude and antique devices such as the "Ballast Fin." It may be said with considerable accuracy that the useful craft known across the Atlantic as 'a good cruiser and a first class racer,' is rapidly on the decline. Seaworthiness, combined with a moderate degree of comfort in days gone by, used to be considered as indispensable characteristics of a gentleman's pleasure craft. Now-a-days everything



SHEER PLAN (1870)—FIGURE 120.

is sacrificed to speed. Thus the man who goes to a naval architect and gives his order for a craft able enough to round Cape Horn and also to beat the fastest of modern racing machines, is very likely to be disappointed. It is impossible in yacht architecture to unite the speed of the race horse with the sturdy endurance of the dray horse."

General J. Garrard, of Frontenac, Minnesota, claims to have created the "Ballast Fin" in 1881; this, however, was not the case, as it is well

* See "Forest and Stream," Dec. 10, 1891.

† "Outing," July 1891, p. 220.

established that the "Ballast Fin" evolved from the antique fixed centerboard keel having a weight at the bottom. It is true that he purchased the New York centerboard sloop *DAISY*, a typical skimming dish, 22 foot keel, 10 foot beam, and that he took out the centerboard and trunk and attached a fin, intending that it should take the place of the centerboard and of all ballast of whatever kind, and made a success, still the principle is very much older.

Fig. 119 shows the sheer plan of *DAISY*, and the type of "Ballast Fin" invented in 1882 by General Garrard is clearly shown.

In 1870, a plan to suspend the lead keel by steel bars was proposed.



EVOLUTION.—FIGURE 121.

The midship section of this craft and her sheer plan is shown in Fig. 120.

Dixon Kemp* remarks that, "the obvious objection to this plan is that the bars would have to be of the greatest width transversely to withstand the lateral strain, and would thus offer a surface of much greater resistance than would arise from the whole of the space between the two keels being filled in solid."

Mr. Kennedy says:† "It might not be uninteresting to compare the midship section of this craft with that of *DILEMMA*. It may afford food for thought. It will, at any rate, expose the fallacy of the notion that the principle of the "fin," as exemplified in *DILEMMA*, is a modern creation."

In 1880, an English yachtsman designed a 10-tonner yacht which he called *EVOLUTION*, the above being the sheer plan.

Mr. Dixon Kemp says:‡ "The yacht was not a success, but that

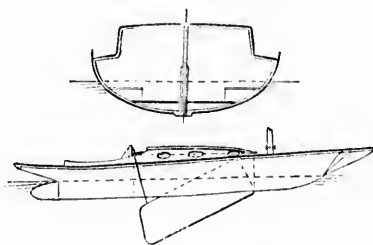

ROCKET.—FIGURE 122.

was mainly because she was of insufficient beam and displacement. The form of the lead keel was quite a sound conception and was much recommended for small yachts as a "fixed centerplate." In 1887, Lieutenant Tipping, R. N., fixed such a keel to his centerboard, and since then the idea has been successfully carried out in the small classes for racing on the Solent, like *LADY NAN* and *DOLPHIN*.

In 1873, John Harvey designed and built *ROCKET* for Mr. Alfred Neek, who wished to beat the famous "tonnage cheater," the yacht *KITTEN*. *ROCKET* had an adjustable cast iron centerboard weighing 3½ tons, the heaviest sliding fin ever put in a boat of the *ROCKET*'s dimensions. She was only 42 feet over all. The draft of *ROCKET* with her board up was only 2 feet 10 inches, as the board when hoisted into its trunk was completely within the hull. The object

* "Yacht Architecture,"

† "Outline" p. 291.

‡ "Yacht Architecture,"

for which *ROCKET* was built was achieved, as she beat *KITTEN*. Until quite recently the work of most designers of Fife, Watson, Gardner and Burgess tended in the direction of a triangular outline for the lateral plane, with greatest draft at or near the heel, as in *LINUS*, *KATHLEEN*, *MINEVA*, *YAMA* and *GOSHOON*, and in *GLORIANA*. Mr. Herreshoff followed the general practice, but without going to such an extreme in draft and triangular outline, as in *BARBARA* for instance. Within the past two seasons, especially in the smaller classes of English yachts, a very different form of lateral plane has been adopted, the keel contour from the fore end of the waterline downward being irregular and broken, the keel, in fact, taking the form of an appendage rather than an integral part of the hull.

Thus far the "fin-keel," as it has been named, was confined to 2½ to 6 rating, or from 25 to 33 feet; but Mr. Herreshoff made bold to carry the experiment into a larger size of yacht, and has embodied the same idea in the 46-footer illustrated below in Fig. 123.* It will be seen that the fore edge of the lead drops quickly down from the bottom of the boat, being, of course, sharpened away to a mere vertical edge, the two vertical sides showing much of the same curve as a rifle bullet. This figure 123 represents *WASP* and gives a very good idea of her general appearance, though the boat has more hollow above the keel than the section shows.

The dimensions of *WASP* are:

Length over all,	72 feet.
Length lead waterline,	45 feet 8 inches.
Beam,	13 feet
Draft,	10 feet 8 inches.
Depth,	11 feet.

Her displacement, to judge by the eye, is very nearly the same as *GLORIANA*, but in spite of the close agreement in dimensions,

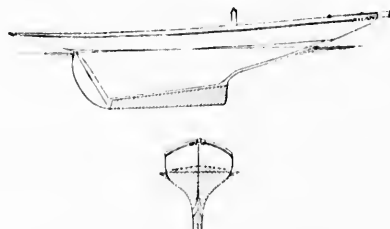

OUTLINE SIMILAR TO WASP.—FIGURE 123.

there is a marked difference in many leading features, and it will not be far from correct to say that *WASP* is even more closely allied to *DILEMMA* and her numerous and interesting family of fin-keels than to *GLORIANA*, the more conventional cutter model of the 46 and 40 foot classes.

The midship section is much like *GLORIANA*, the beam being apparently a little less, while the depth of bilge is the same and the total draft decidedly greater. Looked at from abeam, however, the resemblance to *GLORIANA* disappears very quickly. The after overhang is the same, the rake of sternpost is apparently the same, about 35 degrees, but the post runs down to the heel of the keel, instead of stopping a little above it. The keel, instead of curving upward both forward and aft as in the *GLORIANA*, is perfectly straight for a length of about 20 feet, the contour being very closely shown in the drawing. While in *GLORIANA* the line of the stem was practically straight for some distance below water and slightly concave from the water to the stemhead, in the new boat the same line is one convex curve from about under the mast up to within a short distance of the stemhead, from which point it turns in quite rapidly, as shown. The whole bow is fuller and rounder than in *GLORIANA*, both in

* See "Forest and Stream," March 3, 1892.

section and waterlines, and if the stem line were produced in the same way as in *GLORIANA*, the overhang would be something astounding. As it is, the really vital features of *GLORIANA*, the round form and fullness of waterline, are carried out still further, while the mere overhang which was the subject of so much idle talk last Spring is practically no longer. The whole bow and forebody

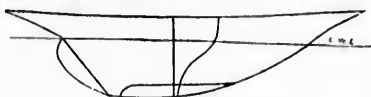

SIRROCCO.—FIGURE 124.

suggest the new fin-keels, in which craft Mr. Herreshoff, with an actual length of overhang which is quite moderate, has preserved the large area of waterline plane and the clean diagonals which are really the original and vital features of all his later yachts."

In the 21 foot class several new boats were launched during the Summer of 1892 and it will be of interest to study their design.

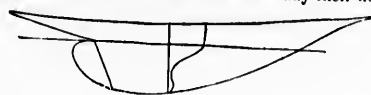

R. D.—FIGURE 125.

The cutter *SIRROCCO* (Fig. 124), designed by Stewart & Binney and built by Geo. Lawley & Son Corporation, was the first float. She measures 31 feet over all, 10 feet 9 inches load waterline, 8 feet breadth and 6 feet draft.

Her midship section is full and powerful, her displacement large and power high by reason of beam and an unusual amount of lead

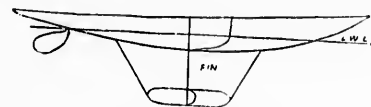

TADPOLE.—FIGURE 126.

hung low. Her lines are good, however, with the full bow and the joined line of stem and keel forward.

The cutter *R. D.*, or *RADICAL DEPARTURE*, shown in Fig. 125 is so named because she is somewhat of a departure from the ordinary type. She has an extra long overhang both forward and aft, her length over all being 36 feet, breadth 7 feet and draft 5 feet. She is of less



CATSPAW.—FIGURE 127.

beam and lighter draft than *SIRROCCO*, but on account of low lead, gains power by means of her bulb keel.

The Waterhouse fin-keel *TADPOLE* is shown in Fig. 126. She was built by Higgins & Gifford, being 30 feet over all; 20 feet 6 inches waterline, 7 feet 3 inches breadth and 6 feet 3 inches draft.

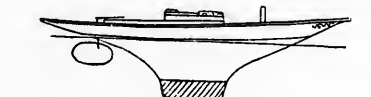

PYXIE.—FIGURE 128.

The centerboard splasher *CATSPAW* is illustrated by Fig. 127. She was designed by Stewart & Binney and built by Lawley & Son Corporation. Her length over all is 30 feet, length load waterline 20

feet 8 inches, breadth 10 feet 6 inches and draft 1 foot 6 inches.

CATSPAW is an excellent type of the improved "splasher" or boat of great beam, small draft and nearly flat floor. Her lines show a full bow and not much overhang forward, while the run is clear and



ZELMA.—FIGURE 129.

the overhang aft made long enough to do away with the necessity of an outrigger for the mainsheet. She carries only "live" ballast.

The well known *PYXIE*, designed by William Gardner and built by A. Wood & Son of City Island, illustrated in Fig. 128, was also launched in 1892. She is 36 feet 6 inches over all, 23 feet 7 inches load waterline, 7 feet 8 inches breadth and 6 feet 6 inches draft. She has proved herself a remarkable boat. She has a low freeboard and not a great deal of sheer. Her midship section shows small displace-

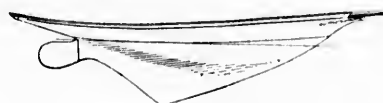

SMUGGLER.—FIGURE 130.

ment. The body of the boat is carried well out toward the ends. The sternhead is carried out a little further than a Herreshoff and gives a reverse curve to the stern in the upper portion without any sacrifice of clean lines. The run is a very easy one, with a clean looking counter. From the garboards the keel runs straight down

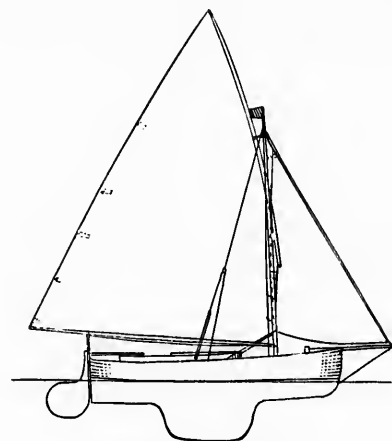

HUMMING BIRD.—FIGURE 131.

for about 4½ to 5 feet, and the lower two feet of it is lead. The lead keel is about 7 feet long and a foot thick. All dead wood is cut away both fore and aft and a balance metal rudder is used.

ZELMA, a Fife cutter, is illustrated in Fig. 129. She was built in Toronto, but was designed and partly constructed by Mr. Wm. Fife,

Jr., at the Fairlie yard. ZELMA was designed to beat the cutter YAMA, who has held the championship since her first appearance, but up to the present has not succeeded. Her length over all is 55 feet 6 inches, load waterline, 37 feet 6 inches, beam 10 feet 7 inches and draft 8 feet 8 inches.

The cutter SMUGGLER, built in 1891 by Thomas Weber after designs by Wm. Gardner, is illustrated in Fig. 130. She is 34 feet over all, 24 feet on the waterline, 7 feet breadth and 5 feet 3 inches draft.

The English boat HUMMING BIRD is illustrated in Fig. 131. She is



GENERAL PLAN OF BOUNCER BOATS.—FIGURE 132.

a 2½ water and has been quite successful. For a time she had everything her own way and her success led to the building of a large number of the same class.

The dimensions of HUMMING BIRD are:

Length over all.	28 feet 6 inches.
Length load waterline.	24 feet.
Draft.	6 feet.
Beam.	8 feet.
Displacement.	5 tons.

The Bouncer type of boat* is shown in Fig. 132. The idea that a yacht designed on the Bouncer principle must of necessity have a draft of water not exceeding a few inches is erroneous. The reason for making them shoal boats is the result of experience, as better speed is obtained with great beam and light displacement than with a narrow wedge-like section.

In designing a Bouncer boat, only curves approximating as nearly as possible segments of circles for all longitudinal lines below the water surface are employed. If the proper proportions of beam and immersed body are selected, the boat will be fast. The deeper the immersed body the narrower it should be and *vice versa*.

Mr. Thomas Clapham gives the following directions how any one with a knack for such matters can design a fast and handy boat.

"The first thing is to have an implement with which circular segments can be quickly struck, and I have found nothing better for this purpose than a thin batten of straight-grained white pine with a piece of string stretched from end to end in such a manner that by tautening the string a short radius is obtained, and by slackening it the radius is lengthened. The batten should be, say, 36 inches long, 1-4 inch diameter at center and tapered to about 1-8 inch diameter at the ends. The way to use the batten is as follows:

"First—Mark a straight base line (A) and, having decided on the length of waterline, freeboard at stem and stern, and draft of water desired, bend the batten until the curve obtained will strike the points (C) (BB) and (DD), then mark the curve with a pencil.

"Second—Mark the straight line (E) and at center of same measure downward until you get the amount of sheer you wish. Again bend the batten to the curve (F) which gives you this sheer, and mark the curve as before.

"Third—Bend the batten until the curve strikes points (DDD); mark this line and you have the longitudinal curve of the bilge.

"Having fixed these curves, assuming that your boat is to have vertical sides above the bilge, it is apparent that any amateur builder can from the lines so laid down take off the shape of the boat when her breadth of beam has also been established, it being understood that the horizontal curve of the outer edge of her deck is the segment of a circle, and that she is sharp at both ends, like a canoe."

Mr. Clapham says:

"This is the simplest form of the Bouncer type. It is easy to build, yet if given plenty of beam will out sail any other kind of boat (not a Bouncer) either with or without shifting ballast. Some per-

*See "Forest and Stream," Jan., 1888.

sons have objected to the angular bilge, but while Bouncers can be, and are built with a round turned bilge, I have as yet been able to find no improvements in speed by the change, though the cost of construction is greatly increased. Speaking of the fact that boats designed on this principle can never get out of trim fore and aft, no matter how fast you drive them, I will add that in a regatta of the INDIAN HARBOR YACHT CLUB, with wind blowing half a gale abeam, CHIPPEWA (length on waterline 24 feet) frequently had her stern somewhat below the level of the water, yet at the same time was skating right away from the 35 and 40-footers; she standing up and going, while the big fellows were rooting, laboring and carrying away their topmasts in a manner that must have been discouraging to the believers in 'lead hung low, you know.'"

TYPES OF YACHTS WHICH HAVE COMPETED IN INTERNATIONAL YACHT RACES.

A comparison of the vessels that have challenged for and defended AMERICA'S CUP has always been a fascinating pastime for the naval architect, the shipbuilder and the intelligent yachtsman and, possibly, no better index could be produced to illustrate the advances which have been made in naval architecture than illustrations of the various types of these very vessels which have competed for and defended the famous cup, as well as striven to acquire the "blue ribbon of the sea." A careful study of the various types of yachts illustrated in Figures 133 to 150, will indicate that yacht designing has taken many advanced steps in forty years throughout the world. The "rule of thumb," the "jackknife," the alleged "straight eye," and "guess work," have been abandoned, the designing board has taken their place and detailed plans are now placed before intelligent artisans. Guess work has given way to scientific methods. Figures tell eloquent stories until, with the completion of his drawings, the designer "knows his boat" before her keel is laid.

"The schooner AMERICA,* winner of the cup, naturally takes precedence. She was built from a model by George Steers in the early part of 1851 and was a keel boat. Her construction was after the method popular in those days, and as now with wooden vessels—that is, the frames were double, with a heavy ceiling inside and then planked outside and fastened with tremils and composition spikes below the waterline, while iron was used above. The ballast was of iron, cast to fit; her mast a very great rake, and the maintopmast was quite short. The rigging on the masts was of hemp and the jibstay of the same. This rig was high and narrow and the jib had a boom on it. The sails set so well that in England they were called 'boards.' AMERICA created a consternation among the yachtsmen of England that is referred to at this day by Americans with great pleasure and pride. It was this boat that won the cup, and her builder, George Steers, with her distinguished and patriotic owner, have always been close to the loyal American heart.

THE FIRST ATTEMPT AT RECAPTURE.

"The cup, as is known, found a resting place with the NEW YORK YACHT CLUB, but after nineteen years the yachtsmen of Great Britain remembered it and wanted it back. They challenged for it and sent over the schooner CAMBRIA owned by Mr. James Ashbury. The British craft was defeated. She was a vessel constructed in the orthodox fashion of those days. Her hull was of wood and there were four tons of lead bolted on the keel. She carried sixty-five tons of ballast in all, twenty of which was of iron. When CAMBRIA went on the dock in South street shortly after her arrival, it was seen that she had been built in a solid manner and her copper was wonderfully smooth, telling the same story. CAMBRIA was also a well rigged boat and her topsails were a revelation to Americans. They would stand like boards in a stiff wind, and with fresh breezes the yacht did well to windward but in moderate weather she was not a match for the boats here. In going to windward, CAMBRIA was wonderfully quick in stays, and her jib set flying taught the yachtsmen on this side of the Atlantic a thing or two that have since been profited by.

* See "N. Y. Herald," Sept. 17, 1868.

YACHTS WHICH HAVE COMPETED FOR AND DEFENDED AMERICA'S CUP.



AMERICA.—FIGURE 131.
1851.

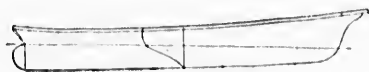

MAGIC.—FIGURE 134.

1870.



CAMBRIA.—FIGURE 135.

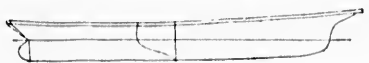

COLUMBIA.—FIGURE 136.

1874.



LIVONIA.—FIGURE 137.



SAPPHO.—FIGURE 138.



MADELEINE.—FIGURE 139.

1876.



COUNTESS OF DUFFERIN.—FIGURE 140.



MISCHIEF.—FIGURE 141.

1881.

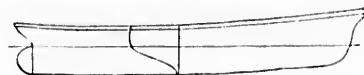

ATALANTA.—FIGURE 142.



PURITAN.—FIGURE 143.

1885.



GENESTA.—FIGURE 144.



MAYFLOWER.—FIGURE 145.

1886.



GALATEA.—FIGURE 146.

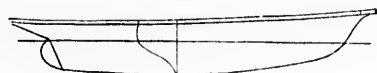

VOLUNTEER.—FIGURE 147.

1887.



THISTLE.—FIGURE 148.



VIGILANT.—FIGURE 149.

1893.

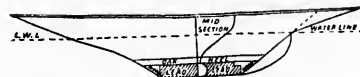

VALKYRIE.—FIGURE 150.

"The schooner *Magic* was the winner of the races in which *Cambria* was beaten. *Magic* was the result of many alterations, the last one being due to the late David Curll, of City Island. It would be difficult to say who was her real designer. This yacht was built in the double framed manner, with ceiling inside and trenail fastening. She was a centerboard with what was then called a deep draft. Her owner at that time, Mr. Franklin Osgood, was a past master at making a boat go. Ballast was put in, taken out, she was trimmed forward, then aft, and so on, always experimenting, until at last the best results were obtained. And so with the canvas of his boats, it was tried and tried until it was satisfactory. Yachtsman Osgood was not easily beaten. *Magic's* victory was from a start at anchor, and the quickness of her crew, it is remembered to this day, proved of great service to her.

"Thus is given the first challenging yacht for the cup, and facts relative to the boat that defeated her.

LIVONIA'S VISIT.

"Mr. James Ashbury made his second attempt for the cup the following year, 1871. His challenging yacht was the schooner *Livonia*. She was a keel boat, closely approaching in cross section the schooner *Sappho*, and was ballasted with lead and iron. Six tons of lead were put in the garboards and about twenty-five tons were inside. In all the ballast reached nearly seventy-one tons. In rig *Livonia* approached more closely that of to-day than *Cambria* did. She had a pole bowsprit, lug foresail, tall mainmast and large mainsail. She was, altogether, a slightly vessel, but the principal trouble was with the shortness of her bow. When pressed by a strong wind a large bow wave was made that retarded her greatly.

"The schooner yacht *Columbia* was one of the boats chosen to meet *Livonia*. She was built in the double frame manner, with heavy planking outside, stout ceiling inside, and fastened with trenails from plank to ceiling. No attempt had been made up to that time to obtain a light hull. Her ballast was all inside and of iron. She belonged to Mr. Franklin Osgood, and everything that his experience suggested was done to put her in shape for her great battle. The results again proved that Mr. Osgood was very hard to beat. *Columbia* won the first and second races, but in the third met with an accident and she finished second. *Columbia* was, and is still, a very powerful boat and is a typical old style yacht—very comfortable, indeed, but not so speedy by far as the improved racers of the schooner classes of to-day.

THE GREAT SAPHO.

"When *Columbia* retired from the international contest with *Livonia*, the schooner yacht *Sappho* was substituted by the club. *Sappho's* great performances here and abroad are still green in the memory of the older yachtsmen. She was constructed in the old way—with double frame, heavy ceiling inside and spike and trenail fastening. Her first appearance in England was a great disappointment. *Cambria* beat her to windward. Upon her return she was purchased by Mr. William P. Douglass, New York Yacht Club, and under the care of Robert Fish her planking was removed from the plank-sheer to near the keel. The frames of the bilge were then pulled out about eighteen inches at the deepest point. This alteration was carried from nothing at the bow to nothing at the stern and the planking replaced. The mainmast was then shifted forward and part lead ballast put in, but none outside. *Sappho* went to England again after all these alterations, and she sought her old enemy *Cambria*. She met her and easily defeated her, especially one day in the Channel when the wind was very strong and she was reefed. She "clipped over the sea like a duck" were the words of one English reporter in referring to her behavior in the seaway. *Sappho* came back from England, and, as good fortune would have it, arrived in New York on the day when *Magic* was winning the cup. She received, as was due her, a round welcome, with screeching whistles, ringing cheers, booming cannons and waving handkerchiefs, while Mr. Douglass received the congratulations from every American

and also from many British gentlemen then living in New York. *Sappho* did her duty nobly, and in two races sailed late in October, laid low any remaining hope *Livonia* may have had regarding her ability to capture the cup.

"After five years, or in 1876, there was another challenge and the races followed in due season. This time the challenging yacht was the schooner *Countess of Dufferin*. She was a centerboard boat, built in the double frame manner, and fastened iron. Captain Alexander Cuthbert, of Toronto, modelled her. When *Countess* sailed for the cup, she had the advantage of a very large crew, mostly hailing from about New York, and every effort was made to make her the winner, even to the casting off of the lee main shroud that the big foresail might draw true. *Countess* was not an attractive looking vessel by any means, and her workmanship was very crude. Still she made a good bid for the cup and, though defeated, the margin was not so bad as to make the Canadians lose all hope. In fact, they believed they could build a winning boat and did try again five years later, when the same Captain Cuthbert threw down the mailed glove of defiance.

"The schooner *Madeleine*, which yacht met and defeated *Countess of Dufferin*, began life as a sloop and gradually grew to what she is now, for she is yet on the club list and has never been altered since the days when she saved the cup. Her construction was of the old double frame, heavy ceiling and planking, and fastened with spikes and trenails. *Madeleine's* model, even in this advanced day of yacht designing, can yet go very fast down the wind. To windward, however, she would be very deficient when compared with the modern "pigs," a name recently applied to the racers *Lancea*, *Atcæa*, *Ariel*, *Emerald* and new two-stickers.

"This was the last time that schooner yachts either challenged or defended the trophy.

THE SLOOPS THAT FIRST MET.

"The sloop *Atalanta* comes next in the record as a challenging craft. This was in 1881, only twelve years ago, bringing the cup struggles up to a date that is easily recalled by the majority of yachtsmen. *Atalanta* also came from Canada. The failure of *Countess* had only whetted the appetites of the Canadians, and they had another trial for the prize. *Atalanta* was designed and built by Captain Cuthbert. She was in the old style, and her planking looked like white pine and appeared to be fastened with iron spikes. The whole boat was very cheaply constructed, but it must be borne in mind that what may be good enough in fresh water will not do at all in salt water. She was a slender looking boat and ballasted with dross of some kind and, withal, had a very poor outfit in every way. Captain Cuthbert's enthusiasm, it has always been thought, had in some way made him so hopeful that he was careless."

The sloop *Mischief* came against *Atalanta* and, it is unnecessary to add, defeated her. This boat was designed by Mr. A. Cary Smith, was built of iron without any attempt at lightness and was ballasted with lead, all being inside. Her sail plan was very large, in fact, she was one of the first boats to have the forefoot cut away—rank heresy in those days—in order to carry large sail and corresponding ballast. When she met the *Atalanta* she had 24 tons of lead, and as the yachts turned to windward, both being reefed, the Canadian was shown not to be of any possible account.

The owner of *Mischief* was Mr. Joseph R. Busk, a gentleman still in the vigor of life and just as enthusiastic in all yachting matters of importance as when his boat was defending the cup.

PURITAN.

We are thus brought to the period when the Boston yachtsmen became interested in the defence of the cup. The fifth challenge was received and accepted in 1885, and Sir Richard Sutton came over with his cutter *Genesta*, bent on carrying the prize back in her lockers. He did not succeed, but it was a bold attempt. *Puritan* was the boat that successfully defended it. She was designed

by the late Edward Burgess, and was a great step forward in yacht designing and yacht building. She was only partly ceiled, and in her construction every pound was left off that could be safely spared. Her hatches, rail and other things were cut down to the lowest limit of usefulness. Her rig was that of a cutter, jib was set flying, short lower mast, big topsail, etc. She was a beautiful boat to look at and a "glutton" in bad weather. The crew of PURITAN was the flower of Boston, comprising as it did Edward Burgess, General Paine, the Forbes brothers, Dr. Bryant and others well known to be victorious in many a hard race. The old seafaring stock of Massachusetts was represented in this array of amateurs, and when the crowd tailed on to a halliard, it was a sight to remember. General Paine, in his gray flannel shirt and his red suspenders was as well known at a cup race as the name of yachts, and added to the great crew was Captain Joe Ellsworth, as pilot. In the last race with GENESTA there was a heavy squall, and while a man could hardly face it PURITAN "lifted out" to windward in a marvelous manner, showing that in bad weather as well as fine the centerboard was superior to the keel.

GENESTA, the challenging yacht of PURITAN year, was designed by Mr. J. Beaver Webb, now of New York, and was a composite vessel—that is, the frames and deck beams were of steel—for the keel had a plate to connect the frames and straps held the frames together; on this wood planking was placed, fastened with bronze bolts, and the under water part was coppered. GENESTA was a narrow keel boat of large displacement and carried a great deal of ballast, while she had plenty of room below; she was, in a few words, a good all around boat and sightly to look at.

* Thus the fifth match was decided in favor of the Americans.

MAYFLOWER AND GALATEA.

"The next challenge was received the following year, in 1886. Boston again furnished the champion boat, MAYFLOWER. The cutter GALATEA, owned by Lieutenant William Henn, R. N., was the challenging craft. MAYFLOWER was designed by the same hand that planned PURITAN and had the same crew in her races. In MAYFLOWER the idea was to carry more sail than PURITAN did, and every ounce of weight and gear and outfit that was possible was left off her. She was of wood and built in the lightest possible manner, similar in this respect to PURITAN. It is said that General Paine made a friend leave his handbag on shore when the final race was to be sailed. MAYFLOWER required much tuning up, but General Paine was equal to the effort and at last led GALATEA across the line the victor.

GALATEA was a steel vessel pure and simple, with lead run in a round bottomed keel and plenty of it. She was a good sea boat and comfortable below. On deck not one ounce of superfluous skylight or hatch was to be seen. GALATEA proved to be no match for MAYFLOWER, but her genial owner did not appear to be cast down, while he made hosts of friends who were ready to give him anything in the world but the cup, and made his stay here so pleasant that he has returned and had a winter's cruise in Southern waters with a centerboard boat of the old-fashioned American kind.

VOLUNTEER AND THISTLE.

The next challenging yacht was the Scotch cutter THISTLE, that to-day is METEOR, owned by Emperor William of Germany. She was designed by Mr. G. L. Watson of Glasgow, the same who planned VALKYRIE. THISTLE belied her name, as she looked like a steel dream clothed in silk, and was admired by all. She looked so smooth she had the appearance of being in one piece—perhaps she was. There was nothing wrong in the construction of this ship. Aft the rail was a promise merely, and forward not much better, while the gear and outfit were of the best. It was found when she faced VOLUNTEER, her competitor, that she would not hold on, would foot as well as her enemy but would not go to windward satisfactorily. Thus she was beaten.

"The sixth attempt by British yachtsmen to obtain the cup is thus narrated, and the boats engaged in the struggle will not be easily forgotten."

THE CUP DEFENDERS OF 1893.

The following illustrations of the various yachts built by the Herreshoffs and of the Boston boats are worthy of careful study, as a glance at them will show a wide difference in types.

The first yacht launched by the Herreshoffs was NAVAHOE, a keel-centerboard boat which is illustrated in Figures 151-152-153. She was built for Royal Phelps Carroll and is 123 feet over all, 84 feet load



NAV. HOE.—FIGURE 151.*

waterline, 12 feet 6 inches draft and 33 feet beam, thus making more of a cruising than a racing yacht. She has a round stern, ending in a knife edge, and there is also a little sweep to her stern above the water. She is built of steel, her frames being 3x2½x



NAV. HOE.—FIGURE 152.†

inches, spaced about 20 inches on centers, similar to those on ALCEA. She has a plate centerboard 1½ inches thick which weighs about 3 tons. It is 17 feet long and drops nearly 10 feet, so that the boat draws with the board down about 22 feet. As stated, she is 23 feet beam with slack bilge, and her keel measures in its widest part about 42 inches.

The second design of Nat. G. Herreshoff was COLONIA, a yacht

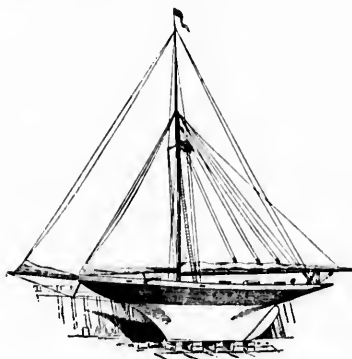

NAV. HOE.—FIGURE 153.‡

built for the Rogers syndicate, and her sheer plan and midship section is shown in Fig. 154. She was launched May 15, 1893; her type is that of a keel and her rig is that of a cutter. Her length over all is 126 feet, length load waterline 85 48-100 feet, beam 24 feet, draft 15 feet 9 inches. She is built of steel, her frames being similar to those of NAVAHOE, spaced 21 inches on centers.

* From "Boston Herald," March 20 1883.

† From "New York Herald," May 3 1893.

‡ From the "Boston Herald."

The Morgan syndicate boat illustrated in Figures 155-156 is **VIGILANT**, also designed by Nat. G. Herreshoff and built by the Herreshoff Mfg. Co. She is of a keel-centerboard type and has a cutter-rig.

Her dimensions are:

Length over all,	128 feet.
Length load waterline,	86 12-100 feet.
Draft,	11 feet.
Beam,	26 feet.

Her under body is plated with Tobin-bronze, the top sides with steel, this being the first time that Tobin-bronze has been used on



COLONIA.—FIGURE 154.*

a yacht. It is claimed that the bottom is smoother, offers less resistance and creates less friction. The line of the counter aft has a good sweep to it, thus making a curve line aft, similar to that of the bow. The bottom of the keel in its widest part measures about 35 inches. The overhang forward in **VIGILANT** is the greatest of the three Herreshoff yachts, while the overhang aft is the shortest.

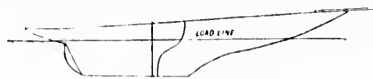

VIGILANT.—FIGURE 155.

The keel of **NAVAHOE** is shortest, with **COLONIA** next; that of **VIGILANT**, the longest.

The John B. Paine boat **JUBILEE**, illustrated in Fig 157, was built by the Lawley Co. for General Charles J. Paine, and was launched June 14, 1893. **JUBILEE** is of the bulb-fin, centerboard type yacht,



VIGILANT.—FIGURE 156.

having a cutter-rig. She is 123 feet over all, 84 47-100 feet load waterline, 22 feet 6 inches beam, and 14 feet draft. Two centerboards are used, one of which is a small one placed forward so as to prevent her from falling off in light winds. **JUBILEE** is the most radical departure yet made in the fin type. Her main centerboard adds six feet to her draft. She has been styled a "skimming-dish-

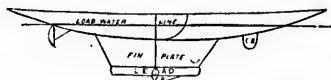

JUBILEE.—FIGURE 157.*

fin," as she has a light draft. On a reach and run she should do her best. She is a well-turned boat, built of steel, with easy diagonals and rather full waterlines forward. She has very much less displacement than any of the Herreshoff boats and lacks the power of **COLONIA** or **VIGILANT**.

PILGRIM was the yacht designed by Stewart & Binney, for the R. S. Palmer syndicate, and is illustrated in Fig. 158. She was built by Pusey & Jones and was launched June 12, 1893. **PILGRIM** is of the

*From the "Boston Herald."

bulb-fin keel type, and has a cutter rig. She is 120 feet over all, 85 28-100 feet load waterline, 23 feet beam and 22 feet draft. She has

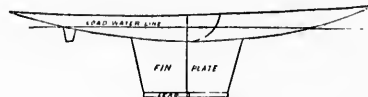

PILGRIM.—FIGURE 158.*

more dead rise to her midship section than the Paine fin, and an easier bilge. She has good overhangs and easy ends.

THE THREE SCOTCH CUTTERS.

The keel composite cutter **VALKYRIE**, illustrated in Figs. 159 and 160, was designed by G. L. Watson and built by Messrs. D. & W. Henderson & Co. of Glasgow, Scotland, for the Earl of Dunraven. **VALKYRIE** is 126 feet over all, 85 feet 6 inches load waterline, 20



VALKYRIE.—FIGURE 159.

feet 6 inches beam, 16 feet 6 inches draft and is a 147.70 rater. Her lead weighs in the neighborhood of 75 tons, is carried well forward with a gradual rise, while aft she is finely tapered in the way of a fin down to the keel, giving her a tremendous grip.

The Prince of Wales' yacht **BRITANNIA**, Fig. 161, is next of inter-



VALKYRIE.—FIGURE 160.

est. She was also designed by G. L. Watson and is 125 feet over all, 85 feet on load waterline, 22 feet 6 inches beam and 15 feet draught, **BRITANNIA** has her lead more in the shape of a bulb than **VALKYRIE**, but like the latter has it carried well forward with a gradual rise and a slight snib on its forepart, her tapering aft is also considerably less.

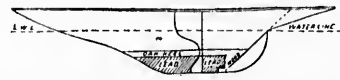

BRITANNIA.—FIGURE 161.*

CALLUNA, built by A. & J. Inglis of Glasgow, from designs of Wm. Fife, Jr. for a syndicate of Glasgow merchants headed by Mr. Peter Donaldson, is illustrated in Fig. 162. She is 128 feet over all, 85 feet load waterline, beam 25 feet and draft 14 feet. **CALLUNA** varies considerably from the Watson cutters, and, in fact, from any cutter

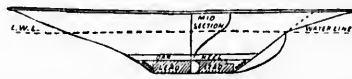

CALLUNA.—FIGURE 162.*

Mr. Fife has designed thus far. Her counter looks to be about 30 feet long, that is, outside of her perpendicular sternpost, which seems to be excessively raked. With her great beam, the cutter shows a high bilge, a sharp floor and very hollow run. Her lead keel weighs about 70 tons.

From the illustrations it must be conceded that **BRITANNIA** is

* From "Boston Herald."

practically a big WASP and that CALLENA leads strongly that way, while VALKYRIE has more of a triangular shaped underbody, and in this resembles QUEEN MAE. Still she is certainly a revelation to English yachtsmen, and the effect of American ideas is visible in many places. The builders had to build a boat that could cross the ocean as well as race, and it is this element of designing to which the most thought was given.

THE PROGRESS IN SINGLE STICKERS.

Starting with the famous sloop MARIA, which was built in 1846 by William Capes from a model by John C. Stevens and George Steers, and which has already been referred to and illustrated in Fig. 110, the sloop USA was next in prominence, then came ALPHA. UNDINE, SUEVE, BIANCA, SPOFF (keel), IRENE, GERTRUDE, RAY, CERES, JULIA, AMERICA (sloop), MARGARET, PRIMA DONNA, REBECCA, WIDGEON, RICHMOND, ESCORT, MARGIE, now the famous

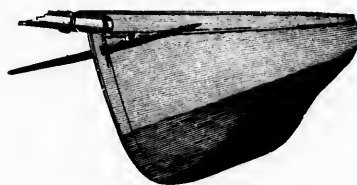

PURITAN.—FIGURE 163.

MAGIC (schooner), WAVELET, BONITA, MINNIE, FANNY, FLYING CLOUD, HASWELL, MANERSING, LAPWING, MALLORY, PLOVER, NETTLE, ANNIE, BREEZE, EVELYN, GLANCE, EVA, SADIE, PSYCHE (keel), MARGIE, (1867) ADDIE V., ELAINE, JOSIE, COMING and the well-known GRACE, designed by A. G. Polhemus and built by A. A. Sehanek in 1869; then followed STORM KING, PEERLESS, ALERT, VINDEK, a cutter designed by A. Cary Smith & Robert Center and built of iron in 1871; next came KAISER WILHELM I., VIXEN, MADELEINE—a sloop of 90 tons but as such a failure, now a schooner—passing on up to MISCHIEF, an iron sloop designed by A. Cary Smith and built by the Harlan, Hollingsworth Co. in 1879 for Joseph R. Busk,

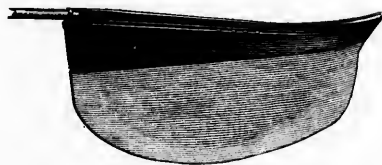

GENESTA.—FIGURE 164.

when we reach a production which showed a marked advance in yacht designing from the wooden sloops of the old type. The next greatest compromise was made in the centerboard cutter PURITAN, Fig. 163. PRISCILLA was in all respects, namely, her model and rig, distinctively a sloop. The rig of PURITAN, however, was shown to be superior to the sloop rig of PRISCILLA, and the deep keel with ballast in it showed some superiority.

In the race in which PRISCILLA and GENESTA (Fig. 164) competed,* the value of moderate beam, depth and displacement as opposed to extreme narrow beam and great displacement were exhibited, and the peculiarities of GENESTA were demonstrated. The result of this race was the abandonment to some extent of the old type of centerboard sloop, in model, ballast, construction and rig, on the one hand, and on the other the abandonment of the old British

* See "Forest and Stream," Sept. 16, 1893.

tonnage rule, with its severe restrictions on beam. MAYFLOWER was but an enlarged PURITAN, just as GALATEA was an enlarged GENESTA.

In 1887, VOLUNTEER made her appearance, being a more powerful MAYFLOWER. Mr. Burgess and General Paine were considered the champions of the nation; and the heads of the work of Cup-defence, in the selection of the three Boston boats as the only representatives of the natural type of "compromise sloop." The result of the VOLUNTEER-THISTLE race was probably of more value to the designer of THISTLE (Fig. 166), than to any one else. The beautiful curved form and rounded keel of THISTLE were sufficient for a home yacht, but not sufficient to suit foreign rules and conditions.

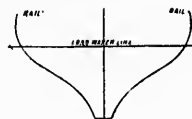

VOLUNTEER.—FIGURE 165.

While all progress in yacht designing was not necessarily stopped by the cessation of AMERICA'S CUP racing, it was kept alive only in the classes under 70 feet, and in the schooners; merely, in fact, in the classes under 40 feet. So, as far as mere designing goes, the loss was not so great, but the construction of the racing cutter, keel or centerboard, of 86 feet waterline, was naturally a matter of special engineering, which could gain little from the experiments in the 46 foot and 21 foot classes.

The changes of the last three years:—first, the evolution of the fin-keel, then the introduction of the new form of boat with its very full waterlines and long, easy diagonals and finally, the replacement of

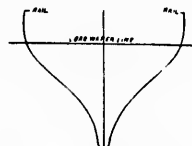

THISTLE.—FIGURE 166.

the plain lead fin by the plate fin and lead bulb—have been so many and so radical that it is a difficult matter to sum up the present condition of yacht designing and to say just what advance has been made. One thing is certain, that it is no longer a case of moderate beam and power against narrow beam and insufficient power; but of extreme beam and extreme high power against moderate beam and absolutely high power.

Mr. Wm. P. Stephens says:*

"In building VIGILANT her designer went to far greater extremes
* See "Forest and Stream", Oct. 28, 1893.

in dimensions and power than has been attempted heretofore; and in doing this he has produced a vessel that, while very fast under certain conditions, is nearer to the machine and further than anything of her size before floated from that vague ideal which we will cherish of a sailorman's yacht. Mr. Herreshoff has acted fairly and wisely in introducing in the largest class a type which by general consent

NOMENCLATURE OF THE HULL.

For the benefit of those who have not as yet become familiar with the nomenclature of the hull, the following illustration (Fig. 167) which represents Wasp is introduced, and the names of the various parts are as follows: *

1 is the mast; 2 the bowsprit; 3 the cut-water; 4 the bow; 5 the

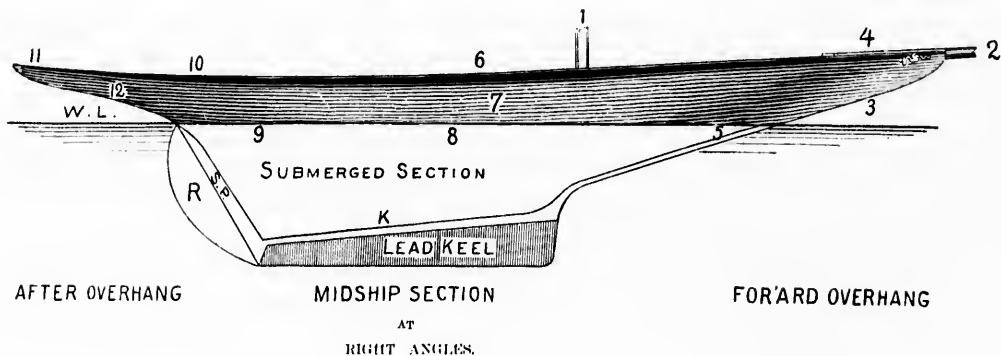

FIGURE 167.

has heretofore been confined to yachts of 40 feet and under. The question of "keel or centerboard is solely one of detail, and the real essence of the discussion lies in the application of extreme power on a given length, to meet certain conditions which generally, but not invariably, decide the winner in American racing."

entrance; 6 the waist; 7 the freeboard; 8 the bilge; 9 the run, 10 the quarter; 11 the stern; 12 the counter.

K the keel; R the Rudder; S.P. the stern post and W.L. the load waterline. The submerged section is more properly called the lateral plane by designers.

* See article "The Sailing Yacht of To-day," by Chas. G. Norton. "Outing" June, 1891.

CENTERBOARD.

It has been claimed that the era of American yachting began with the adoption of the centerboard,* and for this reason it will be of unquestionable interest to devote some space to this subject.

The use of a wide, flat board through the bottom of a craft to prevent leeway may be placed back well into the last century, and is probably still older; but when the "sliding keel" first assumed the form of the present centerboard, it is difficult to say.†

Mr. Dixon Kemp, who is authority on matters of nautical history, in summing up the subject in a recent issue of the *Field*, writes as follows:

"The *European Magazine* for 1792, in discussing Captain Schanck's 'invention' of the three sliding keels, as fitted to H. M. S. *TRIM*, *LADY NELSON*, etc., says: 'If the discovery of the sliding keels is great the public are indebted for it to the Indians of South America, whose balsas, described in Ulloa's voyage (A. D. 1735), have these sliding keels; and from these the idea has been taken and very ingeniously improved upon.' But these sliding keels of the South American Indians were seen by Pizarro two centuries earlier (A. D. 1535). In Prescott's 'History of the Conquest of Peru' we read: 'As he (Pizarro) drew near, he found it was a large vessel, or rather raft, called balsa, consisting of a number of huge timbers of a light, porous wood, tightly lashed together with a frail flooring of reeds raised on them by way of deck. Two masts, or sturdy poles, erected in the middle of the vessel sustained a large square sail of cotton; while a rude kind of rudder, and a movable keel made of plank and inserted between the logs, enabled the mariner to give a direction to the floating fabric, which held on its course without the aid of oar or paddle.' Whether a Chinese boat had been blown to Peru, or whether a Peruvian was blown to China and so communicated the idea, there is no doubt that the British have no more claim to the invention than any of the United States citizens have. Captain Schanck, it is evident, as remarked in the *European Magazine*, merely adapted the South American sliding keels to the hulls of sea-going vessels; while Capt. Shuldham, of the English Navy, further improved on the adaptation in 1809 by pivoting the board at one corner, and it was at the time termed a revolving keel. It is also worthy of note that Evelyn, in his diary (November, 1662), records that Sir William Petty invented a 'vertical keel hung on hinges for the improvement of the sailing of ships.'"

It is a fact that Admiral John Schanck, above referred to, built a boat containing a centerboard in Boston, Mass., in 1774, for Earl Percy, afterward Duke of Northumberland and, according to the *Field*,‡ the centerboard was introduced into several vessels by the British admiralty from 1774 onward, the earliest of which were used upon the American lakes during the War of the Revolution. Trips were made upon boats fitted with centerboards by the Government for experimental purposes. One such experiment was with the cutter *TRIAL* and was made off Gravesend, on July 3, 1792. In January, 1800, the 60 ton brig *LADY NELSON*, fitted with centerboards, left the Thames River for Australia, and her model is now in the Naval Museum at Greenwich.

The result of these experiments seems to have given satisfaction, but did not lead to the common use of the centerboard in transatlantic vessels, nor for coast service in yachts or trading vessels, except-

ing for certain ports and localities, and the *Field* finally adds that 'the centerboard doubtless better meets the requirements of American waters than it does those of Europe.'

One thing is very certain, that in American waters the centerboard has been perpetuated; in fact, over three quarters of the coasting fleet of this country are provided with this service, while in England, the centerboard has been looked upon as a mere racing device and yachts utilizing the same could not at one time enter into regattas in English waters. Lately, however, no further objections have been made and this modification in the rules is largely due to the efforts of Lieutenant Henn.

The centerboard, unquestionably, owes its chief development in American waters to the frequency of small and shallow harbors, into which boats of deep draft cannot be carried, while in England, owing to the deep harbors, the draft of a boat in this sense has not been an element of serious consideration.

In searching the Record of the United States Patent Office, it will be found that 117 patents have been issued for centerboard and keel devices. The first patent granted appears to be the following:

THE UNITED STATES OF AMERICA.

To all to whom these Letters Patent shall come:

Whereas, Jacob Swain, Henry Swain and Joshua Swain, citizens of the United States, have alleged that they have invented a new and useful improvement in the keelboard, which improvement they state has not been known or used before their application, and have affirmed that they do verily believe that they are the true inventors or discoverers of said improvement, have paid into the Treasury of the United States the sum of \$30, delivered a receipt for the same and presented a petition to the Secretary of State, signifying a desire of obtaining exclusive property in the said improvement, and praying that a patent may be granted for that purpose. These are therefore to grant according to law, to the said Jacob Swain, Henry Swain and Joshua Swain, their heirs, administrators or assigns for the term of fourteen years from the tenth day of April, 1811, the full and exclusive right and liberty of making, constructing, using and vending to others to be used, the said improvement; a description whereof is given in the words of the said Jacob Swain, Henry Swain and Joshua Swain themselves, in the schedule hereto annexed and is made a part of these presents.

In testimony whereof, I have caused these letters to be made patent and the seal of the United States to be hereunto affixed.

Given under my hand at the City of Washington this tenth day of April, in the year of our Lord one thousand eight hundred and eleven, and of the Independence of the United States of America the thirty-fifth.

JAMES MADISON.

By the President, JAS. MONROE, Secretary of State.

City of Washington, to wit:

I do hereby certify that the foregoing letters patent were delivered to me on the tenth day of April, in the year of our Lord one thousand eight hundred and eleven, to be examined; that I have examined the same and find them conformable to law; and I do hereby return the same to the Secretary of State, within fifteen days from the date aforesaid, to wit: on this tenth day of April, in the year aforesaid.

C. A. RODNEY, Attorney General of the U. S.

The schedule referred to in these letters patent and making part

* See "Century Magazine," May, 1882. Article by Frederick W. Pangborn.

† See "Forest and Stream," Dec. 23, 1893.

‡ October 15 and 22, 1887. London.

of the same containing a description in the words of the said Jacocks Swain, Henry Swain and Joshua Swain themselves of their new invented leeboard :

"The vessel that is intended to be built with a leeboard through the bottom, the keel must be worked wide in the middle so as to give sufficient strength after the mortise is worked through for the leeboard to pass; then there must be two pieces of timber worked the same thickness that the mortise is through the keel, and wide enough to be sufficiently strong, and one set at the forward end, the other at the after end of said mortise and let down into the keel two-thirds of the depth through, so as to stand on a square from the keel and bolted into the keel: then a rabbet is to be cut on each side of said mortise in the keel of the same width of the thickness of the plank that is intended to plank up the sides of the sheath for said leeboard and deep enough into the keel to spike into the frame; then fit down a plank on each rabbet and spike them into the first-mentioned then the lower part of the sheath is formed, then after the floor ribbands of the vessel is run, fit in knees enough on each side of said sheath to make it sufficiently strong running from the floor heads to the aforesaid plank from thence by plum line high enough to tenant into a coming fitted into the beams, then when the deck frame is in fit up plank on each side to the deck fitting the frame tight to beams; then in planking up the intermediate space plank may be trammed on every other one, leaving one end of the opening an inch or two wider than the other end, and then when the shutters are put in by working them large and driving them in end foremost it may be made sufficiently tight without any caulking.

"The leeboard is made as follows: It is to be made of two thicknesses of plank, laid together crossing each other enough to make it sufficiently strong and thick enough to play through the aforesaid mortise and haul up into the said sheath whenever necessary, and

wide enough to fill up said sheath from near the bottom of the keel to the beam that passes across the top of the said sheath and the length agreeable to the length of the said sheath with the after end swept off on a true sweep from the bolt hole that it hangs on, said bolt hole to hang it by is to be about four-fifths from the after end and near enough to the bottom for a true sweep that strikes, the forward end to strike the bottom and worked off to the same, it is to be hung on a bolt sufficiently strong, passing through one pair of the aforesaid knees with a head on one side and a forelock on the other, high enough to fetch the bottom within a keel with a clasp and thimble riveted on the upper side of the after end of the purpose of a lanyard or tackle to be made fast to hoist it into the sheath when necessary the top of the sheath, the after part to pass through the deck with a cheek fitted at the after end of the frame, with a sheath in it for the lanyard to pass through for the purpose of hoisting it up, and to make the said sheath sufficiently strong there must be a keelson run on each side of the frame and bolted through the aforesaid knees into the keel.

JACOCS SWAIN,
HENRY SWAIN,
JOSHUA SWAIN.

Witnesses: Elija Townsend, John Townsend."

Mr. Stephens referring to this patent, says: "It is particularly interesting on account of the minute details of construction given in it, and though the device may have been already invented in England by Captain Shuldham, it is quite probable that it was original so far as they knew with the American patentees, the dates being very close together. The real 'centerboard,' as used down to the present time, is a combination of two devices comparatively well known at the dates mentioned, 1809-11, the Dutch leeboard and Captain Schank's sliding keel, and there is nothing improbable in the combination being made by two persons independently at about the same time. The American patentees have certainly worked out the details with a completeness which shows that they had carried



FIGURE 168.

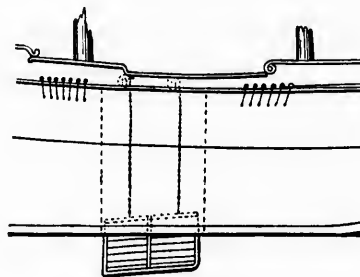

the device beyond the mere experimental stage, and presented it in a practicable working form. The placing of the slot on one side of the main keel, an auxiliary keel being used to complete the foundation of the trunk, is merely a variation of the mechanical details to suit larger vessels, avoiding the weakening of the main keel, and would probably be covered by the above patents."

By referring to Fig. 168, a very good idea of the leeboards already spoken of can be obtained. They consist of flat pieces of wood which are attached on each side of flat-bottomed boats by means of a bolt on which it traverses. The board is let down in the water reaching below

*"Forest and Stream," Dec. 23, 1893.

the keel on the lee side when the vessel is close-hauled, so as to resist the tendency of the boat to drift too fast to leeward when she is listed over by the wind.

The next United States patent issued relative to a "centerboard and keel" was granted to Mr. J. Wiltse, May 4, 1821, and is illustrated in Figures 169, 170 and 171. The object of the Wiltse invention is to do away with the cumbersome "leeboard."

The centerboard will be seen constructed directly over the keel, making a slot in the latter, through which the board could be lowered and raised by means of chains operated by a windlass on deck. The centerboard fits in a trunk and when not in use occupies this compartment up to the deck.

It would appear from an inscription on a tombstone in Greenwood Cemetery that at least the family of the late Salem Wines con-

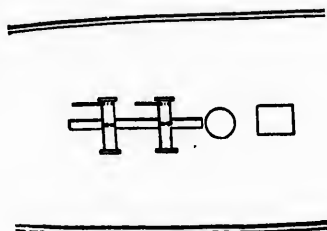

FIGURE 170.

sidered him to be the inventor of the centerboard, as the inscription reads: "Salem Wines, Boat Builder and Inventor of the Centerboard, died June 5, 1861, aged 72 years, 10 mos., 28 days."

It is admitted by Wines' surviving relatives that he never patented his device as he did not realize its importance, but that he was always regarded as the inventor of the centerboard by those who knew him. From what has already been stated, it is clear that Wines was not the inventor of the centerboard, although he doubtless experimented

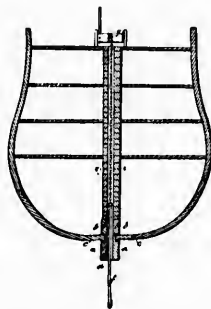

FIGURE 171.

in this direction without knowledge of the result obtained by others even before his birth.

Of the numerous patents which have been issued relative to centerboard devices, some are curious and interesting if not valuable, and, consequently, it will not be out of place to consider a few of them.

On August 22, 1865, a patent was granted to George M. Fay of Eureka, Cal., for an improved centerboard, which is illustrated in Fig 172. The object of the invention is to permit the centerboard to rise and fall parallel, so that when it is lowered the full width of the centerboard, equalling the whole length of the case, is brought into

action. The inventor claims that in many cases the safety of a vessel depends upon the effective surface of the centerboard, and it is desirable, therefore, to lower the centerboard in such a manner that the same whether lowered wholly or partially, will offer the largest possible effective surface to the action of the water. Two years later, Jan. 8, 1867, a patent was granted to Robert Chambers of Detroit, Mich., for an improvement in sliding keels or centerboard for vessels, and is illustrated in Figures 173 and 174. It consists of two boards in one box, the boards being hung in such a manner that the lee board will stand vertically in the water when the vessel is careened. When the vessel is put about on another tack, the board which is down is taken up while the vessel is in stays and the other board is lowered. An alarm bell is attached, so as to be sounded by the sluttling movement of either centerboard when it strikes bottom and thereby gives warning of shoal water.

On May 19, 1874, a patent was granted to James T. Hatfield, of Hoboken, New Jersey, for an improvement in centerboards for vessels. The invention embraces a peculiarly constructed centerboard for sailing vessels (Fig. 175), and also apparatus for controlling it (Fig. 176); and is claimed to have four distinct advantages over the swinging centerboard now used.

First, the increased area of exposure when the centerboard is lowered, by reason of the dropping of the forward end of the board. Secondly, positively acting mechanism for controlling the position of the board, capable of being operated without changing the course of

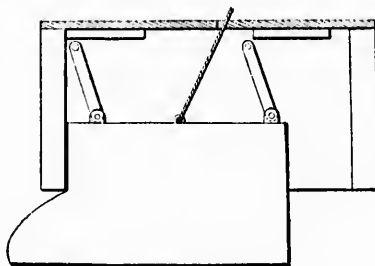

FIGURE 172.

the vessel. Thirdly, mechanism for taking up the slack of the hoist rope as the board rises. Fourthly, devices for holding the board at any prescribed point.

The board may be fixed at any elevation by dropping the pawls upon the ratchet wheels, or may be left free to move either up or down by releasing either one of the pawls respectively. The board, either up or down, causes rotation of the drums, which are geared together, so that the down-haul and the hoist-rope are never slack, either one, respectively, being wound up as the other is unwound. This furnishes a means of preventing fouling by jamming of either rope between the centerboard and the trunk.

For an improvement in adjustable centerboards a patent was granted to Dennis McColgan, of San Francisco, California, October 8, 1878.

The improvement consists, first, in attaching the centerboard to a vertical shaft which extends up through the deck so that the board may be raised or lowered by means of a windlass on the deck; secondly, in the use of operating mechanism in connection with the vertical shaft holding the centerboard, so that when the centerboard is down it may be turned at an angle from the direction in which the ship is moving, so as to more effectually increase the lateral resistance and prevent the vessel from drifting to leeward; thirdly, in the use of a peculiarly constructed centerboard casing, which is all fitted below the keelson, so that no floor-timbers of the vessel have to be cut off to

put it in place; fourthly, in the peculiar construction of a metal centerboard, whereby great strength is obtained and great friction in raising or lowering it is obviated; fifthly, in the peculiar construction of the case in which the centerboard shaft is inclosed and the sockets in which said case is held in place, so that there is no friction of the

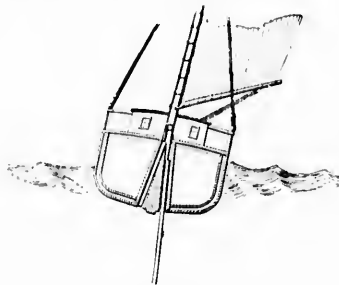

FIGURE 173.

shaft in said case and no danger of water entering the vessel from it (see Fig. 177). Usually two of these centerboards are used on a vessel, one forward and one aft, so that by turning them at opposite angles the vessel may be readily turned from one course to another.

The next novelty is embraced in a patent granted to Thomas Chap-

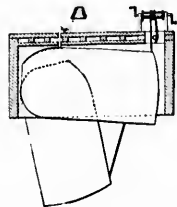

FIGURE 174.

ham, of Roslyn, N. Y., May 23, 1882, the object of which is to provide boats with movable centerboards that are arranged and operated outside of the vessel (see Fig. 178).

In this particular case the centerboard is suspended under the keel of the vessel, by means of rods which extend up through the keel

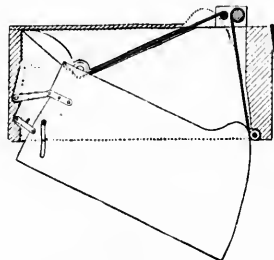

FIGURE 175.

into the interior of the boat. The rods work within tubes which serve to exclude the water from the interior of the vessel, these tubes being attached to the inner portion of the keel or bottom. When not in use the centerboard may be turned and held in a horizontal position at right angles to the keel.

To retain the perpendicularity of the centerboard, Messrs. Geo. L. Mills and Upton Gordon of San Rafael, California, took out a patent, dated January 15, 1884. The invention consists in hinging a centerboard along its top longitudinally, and pivoting it at one end, and also a means for turning it laterally on its hinge as shown in Fig. 179. The object is to maintain the perpendicularity of the centerboard, no matter what may be the list of the boat, in order to prevent her from falling off. The board is under the complete control

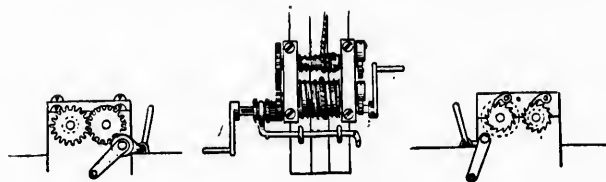

FIGURE 176.

of the helmsman.

For convenience in unshipping and replacing the centerboard without the necessity of removing the pivotal pin, a patent was granted to Robert Center, February 13, 1884. It has been customary to pivot the centerboard of a vessel on a pin driven through the trunk and passing through a hole in the centerboard, so that when it becomes necessary to remove the centerboard, the pin must be driven out,

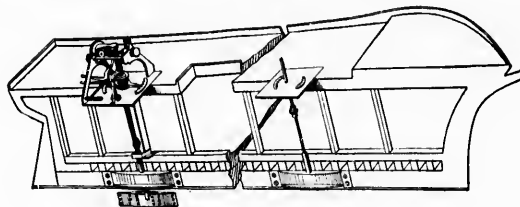

FIGURE 177.

thus allowing more or less water to enter the vessel before the holes in the trunk are stopped. The invention, illustrated in Fig. 180, is designed to obviate this difficulty by allowing the pin to remain permanently in the trunk and providing convenient means for placing the centerboard on the pin, and removing it therefrom.

Devices have been made so that centerboards could be removed

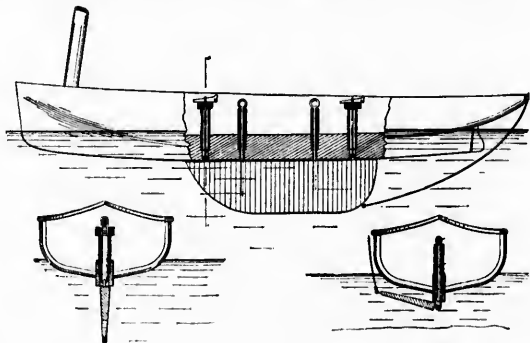

FIGURE 178.

from the deck of the vessel—by means of a removable bar, to which the centerboard is hinged; by a hinged hook attached to the centerboard; and also, by means of a curved slot in the walls of the well,

and a series of stop-water boards—but the above described device differs from these in construction and is simpler and more readily operated.

In 1886, (Feb. 16th), William Welch, of Moss Point, Mississippi, was granted a patent for an improved construction and combination

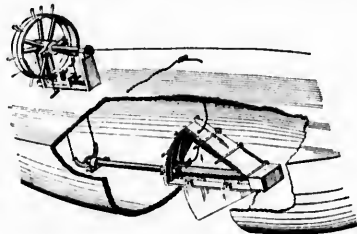

FIGURE 179.

of parts of a centerboard having an adjustment relative to the keel of the vessel, which enables the vessel to sail closer to windward than a vessel having its centerboard without the adjustment. The device is illustrated in Fig. 181.

The inventor claims that it will be seen from the device that when the vessel is on the port tack and the forward end of the centerboard is set toward the starboard side, by means of the screw shown, that the pressure of the board which is let down into the water will have a tendency to force the vessel to windward, thus preventing the vessel from making too much leeway, and at the same time forcing the vessel by the power of the water bearing against the centerboard, as the vessel moves forward to windward.

The angle at which the board will accomplish the best results without retarding the vessel is ascertainable by experiment, then the centerboard may be set at the desired angle by means of the screw, and the nut thereby clamps the forward end of the board.

The casing for the centerboard is designed so as to contract at its middle, in consequence of which the board has a fulcrum in the same, enabling it to rock upon the middle of the contracting sides; this strengthens the board, which

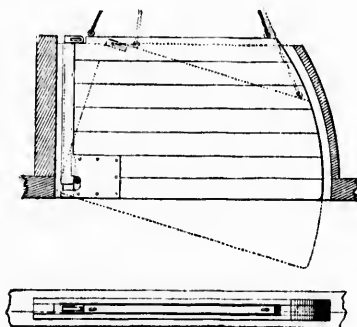

FIGURE 180.

naturally will bear with its forward end against one of the sides of the casing as it is tilted to one side or the other.

Following this patent we find that on November 16, 1886, a patent was granted to Thos. G. Edmondson, of Tarpon Springs, Florida, for a skeg attachment for vessels. The advantages claimed for this invention are, first, that it occupies waste space and the hull is not pressed or weakened at any point where there is space available for storage of cargo, etc. Secondly, the skeg casing is so secure that it serves also as a firm point of attachment for the rudder. Thirdly, it does not come below the line of the keel, and will hence clear or pass whatever the latter does. The illustration (Fig. 183), clearly sets forth the invention.

The folding centerboard invented by Thomas R. Brough, of Gananoque, Ontario, Canada, and patented August 2, 1887, is illustrated in Fig. 184. A centerboard case is shown secured to the keelson of a boat, which contains a series of blades arranged to swing on a common pivot and provided with cam-slots arranged in different positions in the different blades, and a forked arm secured to a shaft extending through the sides of the casing, carrying a roller fitted to the slots of the blades, adapted to swing the blades on their pivots as the forked arm is turned in such a manner as to project the free ends of the blades from the centerboard casing at different velocities, the lower blades being carried downward with greatest rapidity, the upper one with the least and the intermediate blades with a motion

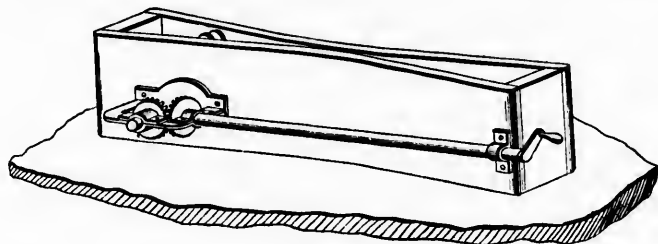

FIGURE 181.

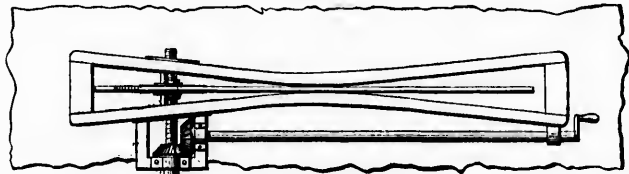

FIGURE 182.

corresponding with their respective positions in the centerboard.

There is also a mechanism for operating the forked arm by which the centerboards are moved and controlled.

A curious patent was granted to Peter F. Gaughen of Boston, Massachusetts, August 30, 1887, which relates more especially to means for preventing sail-boats from capsizing in rough weather or when struck by a sudden blow of wind, and is illustrated in Fig. 185. The keel is preferably composed of lead or similar material, and instead of being rigidly secured to the hull as is ordinarily the custom, it is provided at either end with an upwardly projecting arm and is suspended from or pivoted on bolts, passed horizontally through the arms and respectively secured in the stern and bow of the hull at the lowest possible point in such a manner that it will swing laterally under the hull.

The keel operates as a counter balance to the mast and sail, and when the sail is thrown over the keel is immediately swung in the opposite direction by means of an arm to which the mast is secured, thus maintaining the center of gravity of the hull in its normal position and causing the boat to ride on an "even keel," the claim being that it is practically impossible for it to be upset by sudden gusts or flaws of wind.

Other inventors have rigidly connected the mast to a swinging keel, but in such cases the keel is pivoted above the center of gravity of the hull instead of at the lowest points as in the above-described invention.

CENTERBOARD VS. KEEL.

The centerboard and keel controversy commenced years ago, and in 1878 reached its height. Up to the present time it is a subject which is discussed with much animation by the advocates of the centerboard on the one side, and of the keel on the other.

One advance has resulted from the discussion; the old skimming-

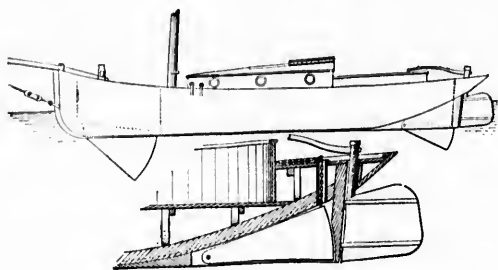

FIGURE 183.

dish type of centerboard sloop has practically disappeared from our waters and the much more reliable and useful type, namely, the deep keel centerboard, has taken its place. In other words, there has been a compromise between the two extremes of broad and shallow and deep and narrow which is superior to either.

The idea that a body could be moved over the water easier than through it was finally considered untenable, hence the building of vessels of more moderate beam and of increased depth, the lack of stability due to narrowing the models being made up by outside lead.

Among the pioneer American advocates of the keel type* was the late C. P. Kuhnert, the yachting editor of *Forest and Stream*, and following him is the present editor, whom we have had frequent occasion to refer to, Mr. W. P. Stephens. Mr. M. Roosevelt Schuyler, the well known yachtsman, has also been a pronounced advocate of the keel-model. Mr. Roosevelt built *YOLANDE*.

Her dimensions are:

Length over all,	32 feet.
Length lead waterline,	25 feet.
Beam,	7 feet 6 inches.
Depth,	5 feet.

She had a deep rocker keel composed entirely of lead, which weighed 8,700 lbs., and 1,300 lbs. of lead was moulded to fit the frames.

YOLANDE and *MURIEL* marked the introduction of a type of yacht that had some advantages; still in the shallow waters of most harbors this type is certainly unsuited to the conditions.

The old centerboard sloop † embodied the idea of an excess of power at all moderate angles of heel, derived from excessive beam, and of ample lateral plane in a most effective form in the centerboard.

The keel center, on the contrary, through her narrow beam and low lead, possessed a very moderate amount of power at normal sailing angles, though coupled with an unlimited reserve for purposes of safety; and her lateral plane, dependent on the form of the hull alone, was but moderate in area and ineffective through its curved form and great angle of keel. These old and extreme points of difference no longer exist in the recently constructed yachts such as *VIGILANT* and *VALKYRIE*.

* "In Yachting." "The Yachting Outlook for '93" by Chas. Ledyard Norton, April, 1893.
† See "Forest and Stream," Oct. 28, 1883.

Mr. Stephens says: "These two vessels both possess ample power for match sailing, as well as reserve stability for mere safety from capsizing, through their great beam and extreme low lead. Both also possess ample power, a very large and effective lateral plane in the hull alone, apart from the centerboard; even in *VIGILANT* the board is not required for windward work in cruising or ordinary sailing, but even in racing and with the centerboard fully housed, or with the slot filled with lead, she would unquestionably defeat any keel cutter built before this year, such as *THISTLE*, *IVERNY*, *INEX* and *GENESTA*."

"In the old type of boat the board was everything, with it jammed, lost or otherwise disabled, the boat was a helpless hulk so far as windward work was concerned; but in *VIGILANT*, the board has shrunk to the position of a mere auxiliary, intended to give a necessary but very moderate increase of weatherly ability.

"*VIGILANT* could be made quite as fast and weatherly by the addition of a deeper keel." And he further says: "It is a question whether it is desirable to have a weight of three or four tons loosely hung beneath a boat, supported by a chain which is inaccessible save by the aid of a diver, certainly an unseaworthy appliance. Both *NAVAROE* and *VIGILANT* have experienced trouble with the lifting gear or

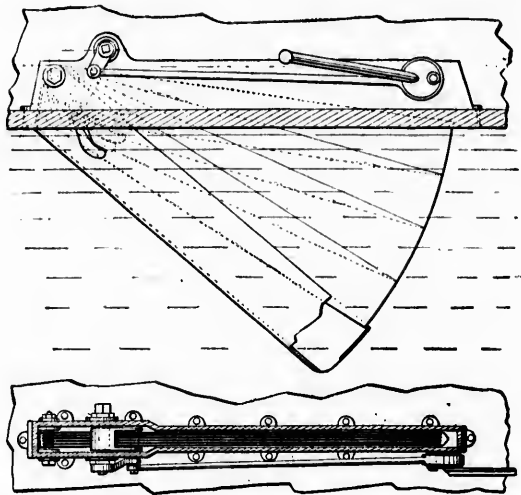

FIGURE 184.

chain and it is easy to imagine that the parting of a chain in a race, while not a remote contingency, might be a most serious one involving the loss for the vessel."

In an article entitled "Coast and Inland Yachting," Mr. Frederic W. Pangborn, referring to the endless "centerboard and keel" controversy, says:

"As applied to small cruising yachts, it is not out of the way to state that, unless shoal waters make it imperative that one should have only a light-draft boat, the deep-keel vessel is much the better craft for the yachtsman to use. In such a boat depth gives accommodation, the absence of the centerboard trunk leaves the cabin freed from a great inconvenience, while the stability of such a boat contributes to safety. It is generally agreed that the best small cruiser is a boat of good beam and draft, carrying her ballast on her keel. Such a yacht is uncapizable, a great advantage in a small vessel. The compromise or keel and centerboard type of boat is also popular. A boat of this kind has good draft, lead or iron keel ballast, and the centerboard is considered a benefit to her in going about and in racing. The very light draft centerboard yacht is not the best

• "Century Illus. Mag.," May, 1892.

cruiser, the only excuse for her use in that capacity being the necessity of light draft in waters which are shallow as are the waters of many of our small harbors. A general deduction from these points

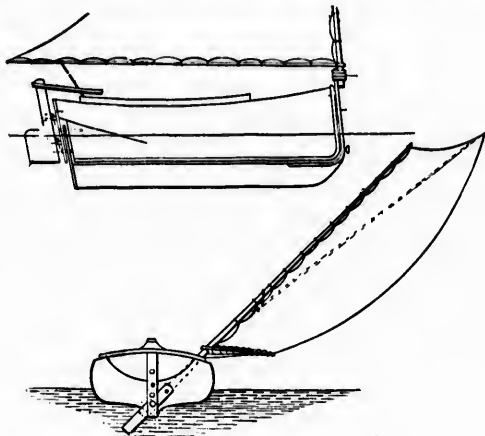

FIGURE 185.

of view may be summarized thus: use a keel boat if you can; a centerboard boat if you must.

“With racing yachts the case is different. A racer should be built with one idea—to win; and if light draft and a big centerboard will win, one should use them. For rough water racing, however, it has been demonstrated quite conclusively that the ‘skimming-dish,’ as the light draft boat is called, is not the best yacht. In bad weather the yacht with good body and draft and ballast well down, has often proved herself the champion. The narrow beamed cutter with very deep draft has also held her own in such weather against all comers.”

In summing up this problem there can be but little if any doubt for a strictly pleasure or cruising yacht, that the deduction given by Pangborn is correct, that is: “use a keel boat if you can; a centerboard boat if you must,” and this is especially true of the modern capacious keel boats.

For speed or for racing purposes, where comfort is no longer an element of consideration, it is still to some extent an open question,

although from theoretical considerations the centerboard boat should be superior to the keel boat.

If two keel yachts were constructed from the same design and with the intention that in every possible respect they should be exactly alike, and a slight modification was made in the keel of one, to permit of the use of a centerboard, and both yachts were fitted out with exactly the same rig, it would be possible in a number of races to determine the true value of the centerboard.

This assumes that each boat is manned by an equally competent crew and officers, and secondly, so as to eradicate any possible question as to the relative skill of the officers and crew, that at least two races should be conducted in which the officers and crew of one yacht should interchange and assume command of the other yacht.

Experiment has shown that it is difficult to build two yachts on exactly the same lines, one of which will not be superior to the other; still, by adopting this method the risk is reduced to a minimum, and it is difficult to see how this question of centerboard versus keel can be definitely settled by the adoption of any other method. Deductions based upon entirely different models and conditions can never furnish the true solution of this important problem.

Mr. Dixon Kemp, at a recent meeting of the LONDON SAILING CLUB,* states “that the centerboard was simply a contrivance to improve the inherent defect of leewardness of shallow, flat-floored craft, and that the board cannot have the same influence on a heavy, deep-bodied craft that it has on a heavy, shallow-bodied vessel. He considers that the shape of the board exercised considerable influence on the effective lateral resistance, and in a general way it could be said that area for area and depth for depth, the triangular board was more effective than the rectangular, because under these limitations it would have a longer leading edge to be continually entering undisturbed or solid water.

“Usually the board had represented a large percentage of the effective lateral resistance of the yacht, but of late years the deepening of the body and especially of the keel had brought about a reduction in the board area and led to the contention that, but for the expediency of having the draft of water under control, the centerboard had little to recommend it.”

In reference to Mr. Kemp's remarks relative to the influence of the centerboard on a “heavy, deep-bodied craft,” the correctness of his position would be established if a test should be made on the plan above suggested. Build, for instance, another COLONIA and add a centerboard, then test keel COLONIA against the centerboard boat in the manner above indicated, and the value of the centerboard would be established.

* See “New York Herald,” Jan. 3, 1891.

I

sui
the
suc
deu
thi

ap
cu
sa
M
V
T
fr
or
se

at
P
se
t
w
t
M

t
f
r

THE RIG OF YACHTS.

In the chapter on Type of Yachts the "sheer plan" and "cross sections" of a number of yachts are presented. Details relative to "diagonals," "tables of offsets," "theories of wave lines," etc., were purposely omitted as such considerations are more suited for a work relative to yacht architecture.

In this chapter the "Rig of Yachts" will be briefly presented, the nomenclature of the various rigs will be set forth and only such other matter relating to sails will be considered as is deemed advisable and consistent with the nature and character of this work.

SAILS.

The square sail represented in the Egyptian and Greek sculptures appears to be the simplest and earliest form into which man put canvas for the purpose of driving his vessel. This early form of sail was not only used by the natives living upon the shores of the Mediterranean, but was also the sail of the northern sea Kings, the Vikings of the Baltic and the piratical rovers of the north Atlantic. The first change made in the form of the sail was to transform it from a square into a triangle. This was done by simply clewing up one corner of the sail to the yard, an operation that is known among seamen to-day as *goose-winging*.

It was evidently the only method of reefing the early square sails, and in a curved picture in the British Museum showing a fleet of Phœnician galleys, there are several of the vessels with their sails so reduced. If the yard is topped up, so as to bring one yard arm to the deck and allow the other to soar aloft, in the resulting goose-winged square sail the lateen is produced. The lateen sail is undoubtedly a direct descendant of the old square sail of the early Mediterranean navigators.*

The lateen sail thus comes in between the square sail and the fore-and-aft, and is the connecting link. The change from the lateen to the fore-and-aft rig, as seen to-day in the sloop and cutter, was very simply brought about.

In the earliest types of square rigged vessels the sail on the after mast, now known as the spanker or driver, which is a fore-and-aft sail, was a lateen, and it was not until the first part of this century that this form of sail went practically out of use.

The first alteration that took place in its shape was to cut off the portion that was forward of the mast, which was a jib-shaped piece.

That part which was cut off became the mizzen staysail, and the after part the driver. As the portion of the yard forward of the mast was no longer of use, it was cut away and the after part became the gaff. Thus if we take the lateen sail where it passes the mast and divide it into two sails, we have a crude form of jib and mainsail, and that is, undoubtedly, the way that the fore-and-aft rig was evolved.

In 1845, the schooner was without a fore topmast, having only a short main topmast, a short gaff, no crosstree or mast head spreader and had only a small topsail, which in all cases was sent up from the deck, no jib topsail being used, however. This description applies equally to the sloop of the time, which had a short bowsprit, short topmast and no jibboom. Balloon sails were not then used and neither was wire rigging. According to Coffin, it was not until 1854 that

* See "Rudder, Sail and Paddle," 1862, p. 20.

balloon sails, elubtopsails, etc., made their appearance in this country, while the first balloon gaff topsail or balloon jib topsail that Mr. Sawyer, the sailmaker, remembers to have seen was on *PSYCHE*, in 1867, and since then have come the immense balloon main topmast staysail for schooners and the spinnaker, an English contrivance of comparatively recent date.

Canvas made of flax, hemp or cotton is the material generally selected for the making of sails. For large sails the coarser and heavier qualities are used, especially where great strength is required.

In the case of sails intended for moderate winds or such sails as balloon jibs, spinnakers, elub topsails, etc., these are made of lighter material and recently have been made, at least in the case of *VALKYRIE*, of Irish linen.

Up to 1870 the designing and drafting of sail and spar plans was confined to professional builders, riggers and sailmakers; at this time, however, the young yachtsmen who had studied naval architecture as well as visited England to study British yachts, came forward with ideas of their own, and the result was the construction of a type of yacht suited to our shallow and generally smooth waters, combining the best features of the British yachts.

In 1880 Capt. R. F. Coffin wrote as follows:*

"In rigging and in canvas we have been constantly improving; wire has entirely superseded rope for standing rigging, and the bringing of the head stay to the knight heads with receivers from the masthead aft, has given a stability to the mast which prevents the canvas from getting out of shape in strong breezes. This, of course, necessitates a double head sail, instead of the one large jib formerly used, and although there is in this substitution, a loss of propelling power in moderate breezes, a defect of the old rig is cured by this substitution and the yacht is handier in a reefing breeze. Formerly, when the wind increased so that the mainsail of the sloop had to be reefed, there was a difficulty in reducing the forward canvas. A reef was clumsy in a jib; a bonnet, for a yacht nine-tenths of whose service is in whole sail breezes, was scarcely to be thought of, and a 'bob jib' was an abomination.

"With the double head sails, the difficulty is obviated, and generally the small jib can be carried in any breeze to which the usual service of a yacht exposes her; at all events, she can always carry the fore staysail. A mistake made by sailing masters at the first introduction of the double head sails was that in reefing they took in the jib first. This should never be done as long as it can be carried, as there is but slight propelling power in the staysail.

"The advantage of the large jib is so apparent that some of the yachts have their forestays fitted so that they can be come up with at will, and the big jib can be used if necessary, in races; while for ordinary sailing and cruising, the handier double sails are used."

It must not be imagined that guess work is permissible in the designing of the sail plan for a yacht; far from it, in fact, each sail plan being calculated with mathematical exactness in its relation to the body it is intended to drive. Every yachtsman must remember that the relations between sail areas and immersed bodies of yachts bear an intimate relation to each other for purposes of speed.

The relative power of the hull,† as it is called, that is, its ability to carry a large spread of canvas, depending upon its displacement

* "Outing," August, 1880, p. 50.

† See "Boston Journal," Saturday, July 15, 1880.

and the relations of ballast to the center of buoyancy of the hull, which may be compared to the center of gravity acting upward, must be figured out to decimals. This part of the problem relates to the stability of the boat—its resistance to any force tending to heel it to one side or the other.

Then with the same accuracy the relations of lateral resistance to the center of effort of the sails must be considered. The center of lateral resistance of course means that point of the underwater body to which, if a rope be attached and a force applied to it acting at right angles to a line drawn lengthwise through the center of the boat, the boat will be moved in the direction of the force without changing this right angle. The areas of the fins, keels, centerboards, rudders or whatnot must be found, their centers located, lines drawn

Mr. W. E. Robinson says: "The cut shows approximately the height of the mast and its position, the length of the main boom and gaff, the hoist of the mainsail and the length of the bowsprit outboard.

"It should be remembered, however, that when high and low power are spoken of it is in a comparative sense. PILGRIM, the low powered boat of the quartet, has more power and more sail than the old VOLUNTEER, which was considered when she came out, to carry a remarkable spread of canvas and to be really a phenomenal boat in that line, as compared with PURITAN and MAYFLOWER.

"That even the smallest rigged of the new boats exceed VOLUNTEER, shows the progress which has been made in carrying more sail on a given waterline length, and now the only question appears

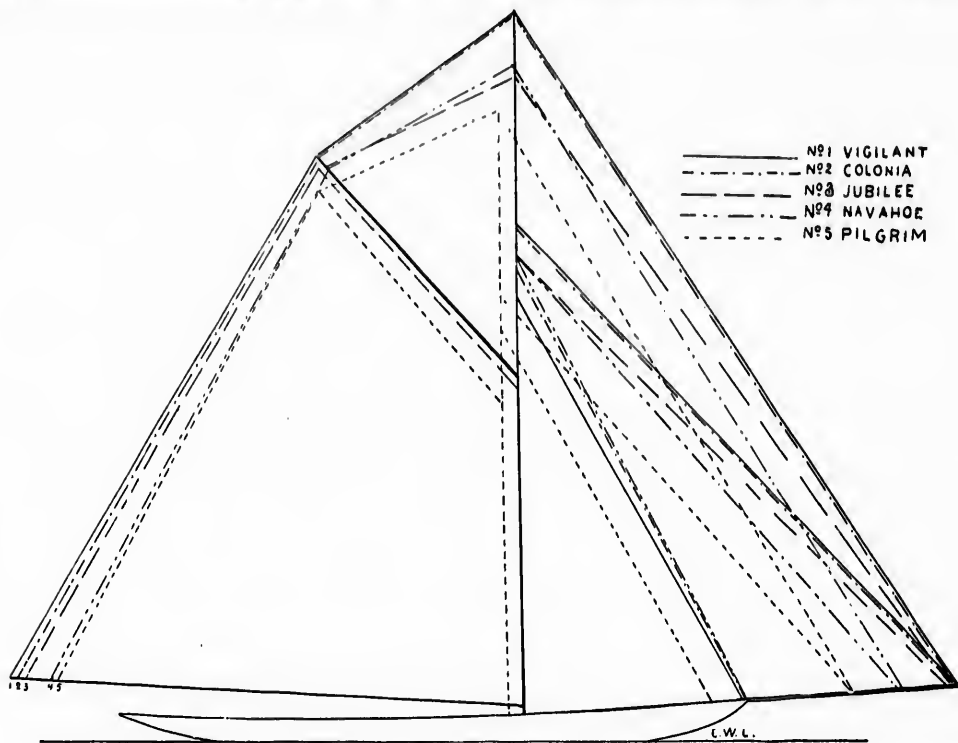

FIGURE 186.

from center to center and the center of the whole found by the rules of proportion.

Then the plans of the sails must be treated in the same way and their centers of effort found and reduced to a common center. If this common center is in a vertical line over a center of lateral resistance, the boat when built will be well balanced; that is, she will steer easily. If the center of effort is forward of the center of resistance, the boat will carry a lee helm, so that when sailing on the wind, the helm will have to be pushed toward the mainsail in order to bring her head to the wind. If the center is aft she will carry a weather helm. In either case the resistance of the rudder will be more or less greater than it should be and the boat will lose in speed.

The following illustration† (Fig. 186), shows the sail plan of the VIGILANT, COLONIA, JUBILEE, NAVAHOE and PILGRIM, superimposed one upon the other.

†From "The Globe," of Boston, July 13, 1883.

to be as to what extent such an increase may be carried to advantage.

"The Herreshoff boats go to the extreme in sail area and displacement, JUBILEE follows close behind in the matter of sail, and PILGRIM brings up the rear in both respects.

"In order that all the new 85-footers may be compared, the sail plan of NAVAHOE is also given in the cut. The difference in the overall length of the boats is so small that one hull is deemed sufficient upon which to show the sail plans.

"From the cut it will be seen that the masts of the three Herreshoff boats and of JUBILEE are about in the same place in relation to the waterline length. The mast of PILGRIM is, however, some two or three feet further aft, and this at once stamps her as different in design from any of her competitors.

"At the same time it will be noted that the headsails of PILGRIM are very much smaller than any of the others, and that her bowsprit is but about half as long outboard as on the Herreshoff boats. This is in consequence of the model of the boat—a long hull,

As the value of *Diagonal Sails* (Fig. 188) is at present under consideration owing to a recent patent being granted for the same in England—it will at least be interesting to hear what Mr. Dixon Kemp has to say relative to such sails:

"There is no doubt that one of the chief bothers of yacht sailing is the stretching and *taking up* of sails, but stretching is the worst, and *nothing* is more annoying in racing than a sail which has grown too large for the spars. The bellying has been pretty well got over, and the sail now sets as flat as the proverbial card, but the stretching is as bad as ever. Until the sail area rule of rating came into use this was not of much consequence, as the spars could be made longer than the edges of the sail to allow for stretching, but now that every inch is measured, the sail must cover the spars from end to end from *stopping*, and little or nothing can be allowed for stretching.

"Diagonal sails were patented years ago by Matthew Orr, Kipping & Pittard, and their plans are still in use, but none of them hit on the arrangement of cloths as just patented. In the new patent it is claimed that, by their arrangement, the sails can be made to fit from the start, and will stand as well at first as at any subsequent period. This also means that the sails do not require a continual stretching to get them into shape, and they will not afterward stretch out of shape. The principal stretching takes place in the direction of the warp lengthwise of the cloths, while there is very little stretching in the direction of

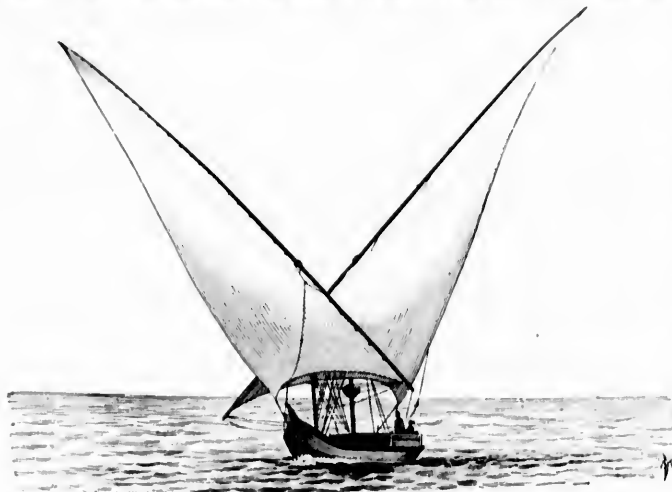

FIGURE 187.

with the body, fullness and weight well aft, and the driving power concentrated in the mainsail. PILGRIM's forestay also comes well in on the deck while the others go out to the gammon iron.

"VIGILANT, COLONIA, NAVAROE and JUNILEE represent the generally accepted ideas of sail plans. PILGRIM represents a new idea in this line, an idea which is the legitimate result of her fin keel of extreme depth and placed well aft. In this, as well as in other ways, she is the most radical departure from accepted types of any of the fleet."

It will hardly be necessary to enumerate the various sails which are used on yachts of different rig in this place, as under the head of *Nomenclature of Various Rigs* which follows, almost every sail is exhibited and the few not shown under this head will be found in the chapter on the "Evolution of the Yacht."

Inasmuch, however, as the lateen sail has only been referred to and not illustrated, it will be of interest to examine the same in Fig. 187, which represents an Italian type of vessel sailing with her canvas wings on either side.

A glance at the figure (187) at once explains why the sails of vessels are often spoken of as *white wings*.* It is not in the modern rig that this resemblance to the pinions of a bird is most marked, but it is in the exquisitely graceful sails peculiar to the Mediterranean, those triangular spreads extended upon light, lofty yards borne by the feluccas of the Italian and Spanish waters and the dahabeyahs of the Nile, that almost an exact reproduction of the delicate and shapely pinions of the sea-bird is to be found.

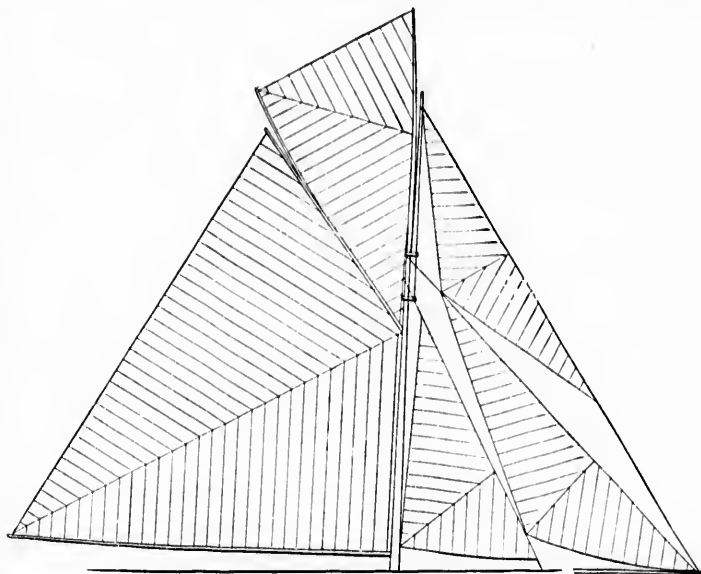

FIGURE 188.

the weft, the threads which cross the warp. The shrinkage in the direction of the weft is also much less than in the direction of the warp. By the new arrangement of cloths the weft runs parallel to the foot of the leech, and they claim that the arrangement is suitable for all descriptions of fore-and-aft sails.†

* See "Rudder, Sail and Paddle," 1892.

† "Scientific American Supplement," May 20, 1892.

THE NOMENCLATURE OF VARIOUS RIGS

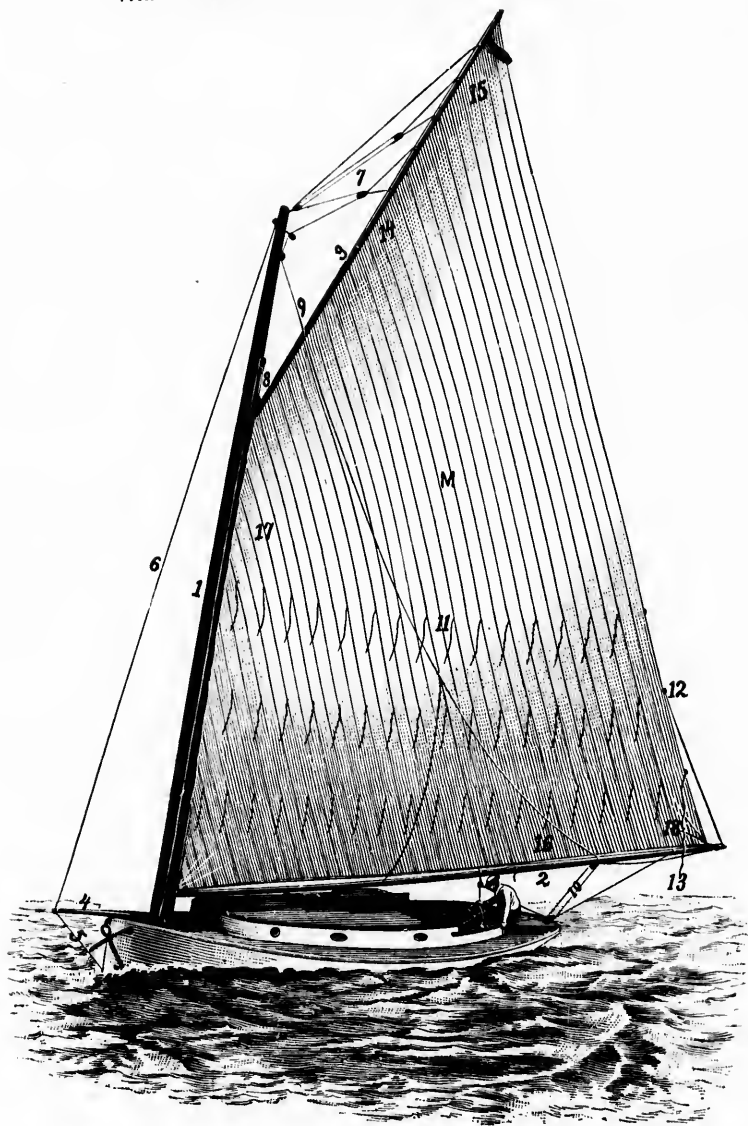

THE CAT BOAT.—FIGURE 189.

- | | |
|---|------------------|
| 1 Mainmast. | 13 Pennant. |
| 2 Boom. | 14 Head of Sail. |
| 3 Gaff. | 15 Peak of Sail. |
| 4 Bowsprit. | 16 Foot of Sail. |
| 5 Bobstay. | 17 Luff of Sail. |
| 6 Forestay. | 18 Clew of Sail. |
| 7 Peak Halliards. | M Mainsail. |
| 8 Throat Halliards. | |
| 9 Topping Lift (In many cases located at the hounds or head of mast.) | |
| 10 Mainsheet. | |
| 11 Reef Points. | |
| 12 Cinglers. | |

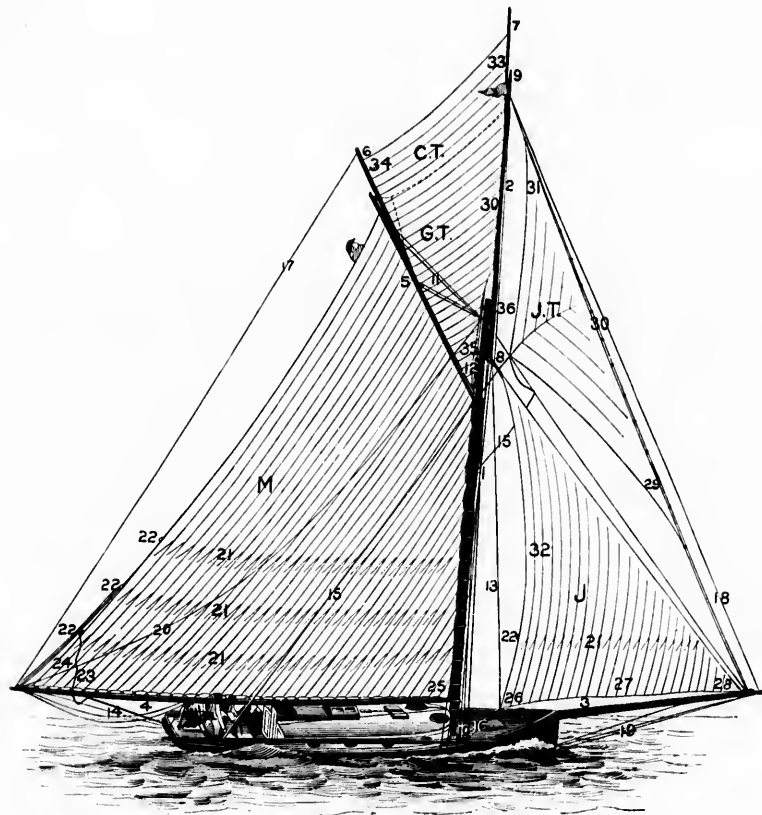

SLOOP YACHT.—FIGURE 100.

- | | |
|----------------------------------|--------------------------|
| 1 Mainmast. | J Jib. |
| 2 Topmast. | J.T. Jib Topsail. |
| 3 Bowsprit. | T Gaff Topsail (dotted). |
| 4 Boom. | C.T. Club Topsail. |
| 5 Gaff. | 21 Reef Points. |
| 6 Topsail Club. | 22 Cringles. |
| 7 Topsail Sprit. | 23 Reef Pendant. |
| 8 Crosstrees. | 24 Clew of Mainsail. |
| 9 Truck. | 25 Tack of Mainsail. |
| 10 Shrouds. | 26 Clew of Jib. |
| 11 Peak Halliards. | 27 Foot of Jib. |
| 12 Throat Halliards. | 28 Tack of Jib. |
| 13 Jib Lift. | 29 Tack of Jib Topsail. |
| 14 Mainsheet. | 30 Luff of Jib Topsail. |
| 15 Jib Topsail Sheet. | 31 Head of Jib Topsail. |
| 16 Jib Sheet. | 32 Leach of Jib. |
| 17 Club Topsail Guy. | 33 Head of Club Topsail. |
| 18 Topmast Stay. | 34 Clew of Club Topsail. |
| 19 Bobstay and Bowsprit Shrouds. | 35 Hounds. |
| 20 Topping Lift. | 36 Eye for Topping lift. |
| M Mainsail. | |

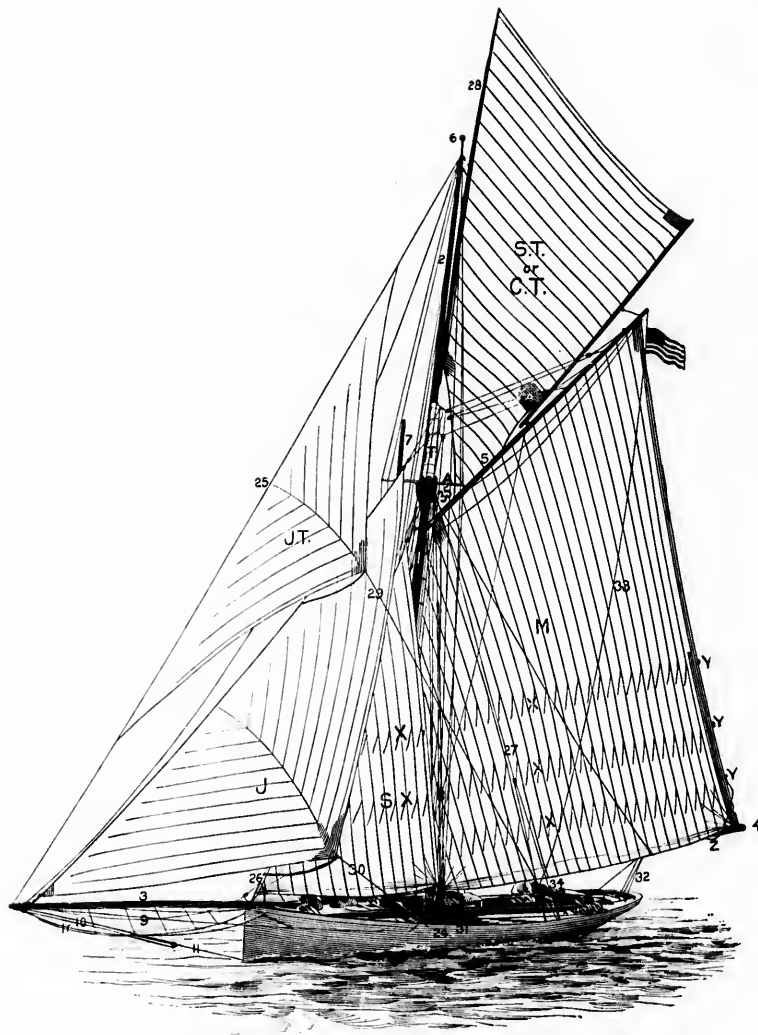

- 1 Lower Mast.
- 2 Topmast.
- 3 Bowsprit.
- 4 Main Boom.
- 5 Gaff.
- 6 Truck.
- 7 Spinnaker Boom.
- 8 Shrouds.
- 9 Bowsprit Shrouds.
- 10 Bobstay Fall.
- 11 Bobstay.
- 24 Channels.
- 25 Topmast Stay.
- 26 Fore Stay.
- 27 Back Stay (masthead).
- 28 Topsail Sprit.
- 29 Jibsail Sheet.
- 31 Staysail.
- 30 Jibsheet.
- 32 Mainsheet.
- 33 Ensign Halliards.

THE CUTTER.—FIGURE 101.

- 34 Wheel.
- 35 Hounds.
- M Mainsail.
- S Jib.
- J Staysail.
- JT Jibtopsail.
- ST Sprit Topsail or Club Topsail.
- T Gaff Topsail or working topsail in stops.
- X Reef Points.
- Y Cringles.
- Z Reef Pennant.
- A Crosstrees.

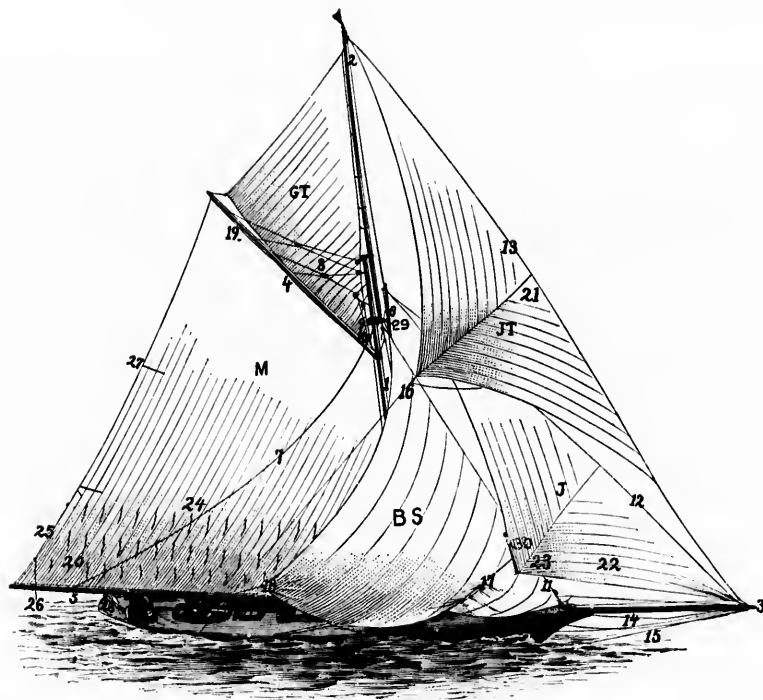

THE MODERNIZED CUTTER.—FIGURE 192.

- | | |
|------------------------------------|--------------------------------------|
| 1 Mainmast. | 18 Balloon Forestaysail Sheets. |
| 2 Topmast. | M Mainsail. |
| 3 Bowsprit. | B S Balloon Forestaysail. |
| 4 Gaff. | J Jib. |
| 5 Boom. | J T Jib Topsail. |
| 6 Spinnaker Boom. | G T Gaff Topsail or Working Topsail. |
| 7 Topping Lift. | 19 Peak of Mainsail. |
| 8 Peak Halliards. | 20 Clew of Mainsail. |
| 9 Crosstrees. | 21 Luff of Jib Topsail. |
| 10 Throat Halliards. | 22 Foot of Jib. |
| 11 Fore Stay. | 23 Clew of Jib. |
| 12 Luff, or in some cases Jibstay. | 24 Reef points. |
| 13 Topmast Stay. | 25 Cringles. |
| 14 Bowsprit Shrouds. | 26 Pennant. |
| 15 Bobstay | 27 Buttens. |
| 16 Jib Topsail Sheet. | 28 Mainsheet. |
| 17 Jib Sheets. | 29 Hounds. |

THE RIG OF YACHTS.

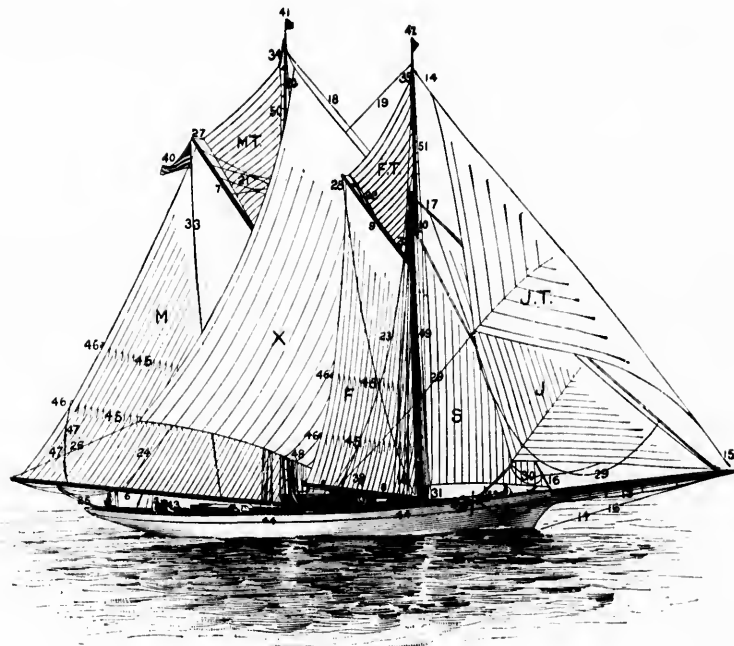

SCHOONER YACHT.—FIGURE 192.

- | | | | |
|----|---------------------------------|-----|-----------------------------|
| 1 | Mainmast. | 31 | Staysail Sheets. |
| 2 | Foremast. | 32 | Fore Throat Halliards. |
| 3 | Bowsprit. | 33 | Ensign Halliards. |
| 4 | Maintopmast. | 34 | Main Gafftopsail Halliards. |
| 5 | Foretopmast. | 35 | Fore Gafftopsail Halliards. |
| 6 | Mainsail Boom. | 36 | Cable. |
| 7 | Mainsail Gaff. | 37 | Anchor (fished). |
| 8 | Foresail Boom. | 38 | Davits. |
| 9 | Foresail Gaff. | 39 | Boat Grips. |
| 10 | Fore Crosstrees. | 40 | Ensign. |
| 11 | Mainmast Shrouds. | 41 | Private Signal. |
| 12 | Foremast Shrouds. | 42 | Club Flag. |
| 13 | Bowsprit Shrouds. | 43 | Wheel. |
| 14 | Bobstay. | 44 | Channels (fore and main). |
| 15 | Foretopmast Stay. | M | Mainsail. |
| 16 | Forestay. | F | Foresail. |
| 17 | Jib Halliards. | S | Staysail. |
| 18 | Maintopmast Stay. | J | Jib. |
| 19 | Foretopmast Stay. | J T | Jib Topsail. |
| 20 | Maintopmast Staysail Halliards. | M T | Main Gafftopsail. |
| 21 | Main Peak Halliards. | F T | Fore Gafftopsail. |
| 22 | Fore Peak Halliards. | X | Maintopmast Staysail. |
| 23 | Foresail Boom Topping Lift. | 45 | Reef Points. |
| 24 | Mainsail Boom Topping Lift. | 46 | Cringles. |
| 25 | Mainsail Sheet. | 47 | Reef Pennants. |
| 26 | Maintopmast Staysail Sheet. | 48 | Mainsail Hoops. |
| 27 | Main Gaff Topsail Sheet. | 49 | Foresail Hoops. |
| 28 | Fore Gaff Topsail Sheet. | 50 | Main Gafftopsail. |
| 29 | Jib Topsail Sheets. | 51 | Fore Gafftopsail. |
| 30 | Jib Sheets. | | |

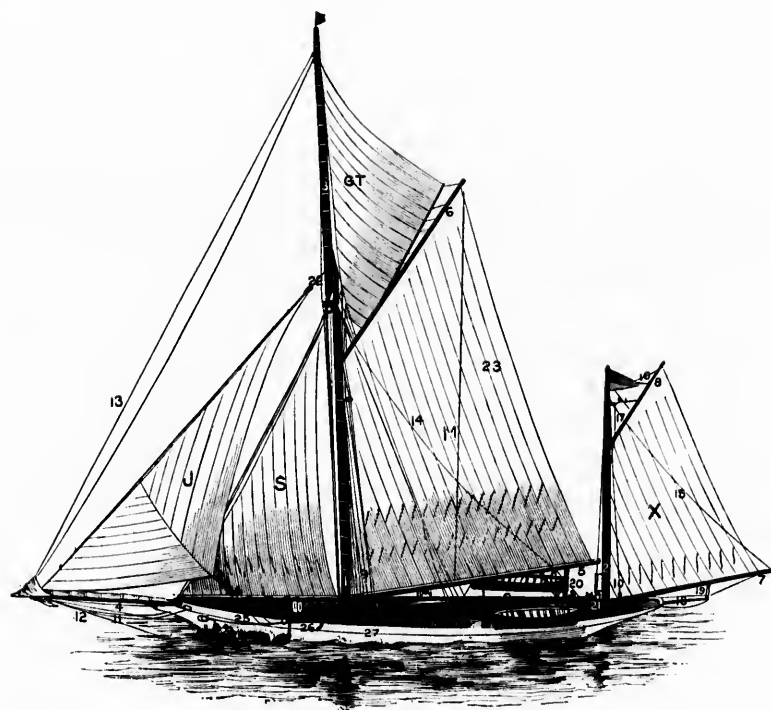

THE YAWL.—FIGURE 194.

- | | |
|-----------------------------|---------------------|
| 1 Mainmast. | 18 Outtrigger. |
| 2 Jiggermast. | 19 Jigger Sheet. |
| 3 Topmast. | 20 Main Sheet. |
| 4 Bowsprit. | 21 Wheel. |
| 5 Mainsail boom. | 22 Jib Halliards. |
| 6 Mainsail gaff. | 23 Topsail Sheet. |
| 7 Jigger boom. | 24 Jib Sheet. |
| 8 Jigger gaff. | 25 Cable. |
| 9 Main shrouds. | 26 Anchor (fished). |
| 10 Jiggermast Stay. | 27 Channels. |
| 11 Bowsprit shrouds. | M Mainsail. |
| 12 Bobstay. | S Staysail. |
| 13 Topmast stay. | J Jib. |
| 14 Main topping lift. | J T Jib Topsail. |
| 15 Topping lift on Jigger. | G T Gaff Topsail. |
| 16 Jigger peak halliards. | X Jigger. |
| 17 Jigger throat halliards. | |

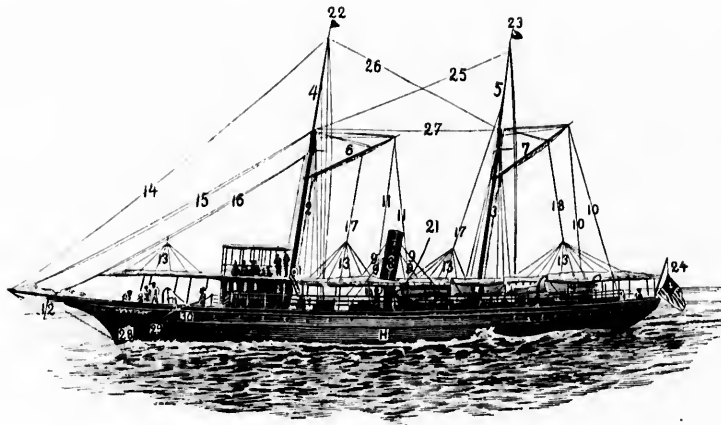

STEAM YACHT.—FIGURE 195.

- | | | | |
|----|-------------------|----|------------------------------|
| 11 | Hull. | 16 | Fore Stay. |
| 1 | Bowsprit. | 17 | Midship awning Gantline. |
| 2 | Foremast. | 18 | Quarterdeck awning Gantline. |
| 3 | Mainmast. | 19 | Cutter. |
| 4 | Foretopmast. | 20 | Gig. |
| 5 | Maintopmast. | 21 | Ventilators. |
| 6 | Fore Gaff. | 22 | Club Flag. |
| 7 | Main Gaff. | 23 | Private Flag. |
| 8 | Smokestack. | 24 | Ensign. |
| 9 | " " " Guys. | 25 | Maintopmast Stay. |
| 10 | Main Gaff Vangs. | 26 | Foretopmast Stay. |
| 11 | Fore Gaff Vangs. | 27 | Spring Stay. |
| 12 | Dolphin Striker. | 28 | House Hole. |
| 13 | Awning Crowsfoot. | 29 | Cable. |
| 14 | Foretopmast Stay. | 30 | Anchor (shipped). |
| 15 | Jib Stay. | | |

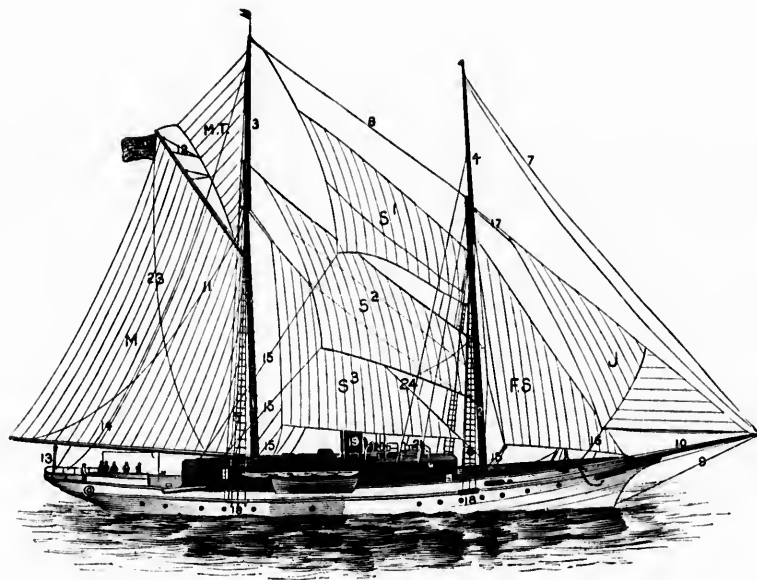

AUXILIARY STEAM YACHT.—FIGURE 106.

- | | |
|----------------------|--------------------------|
| 1 Mainmast. | 16 Jib Sheets. |
| 2 Foremast. | 17 Jib Halliards. |
| 3 Maintopmast. | 18 Chunnels. |
| 4 Foretopmast. | 19 Smokestack. |
| 5 Main Shrouds. | 20 Ventilators. |
| 6 Fore Shrouds. | 21 Bridge. |
| 7 Fore topmast stay. | M Mainsail. |
| 8 Main topmast stay. | S Staysail (main). |
| 9 Bobstay. | S' Maintopsail Staysail. |
| 10 Bowsprit. | FS Forestaysail. |
| 11 Topping Lift. | J Jib. |
| 12 Gaff Halliards. | MT Maintopsail. |
| 13 Main Sheet. | 22 Ensign. |
| 14 Signal Halliard. | 23 Ensign Halliards. |
| 15 Staysail Sheets. | 24 Jumper or Mainstay. |

THE RIG OF YACHTS.

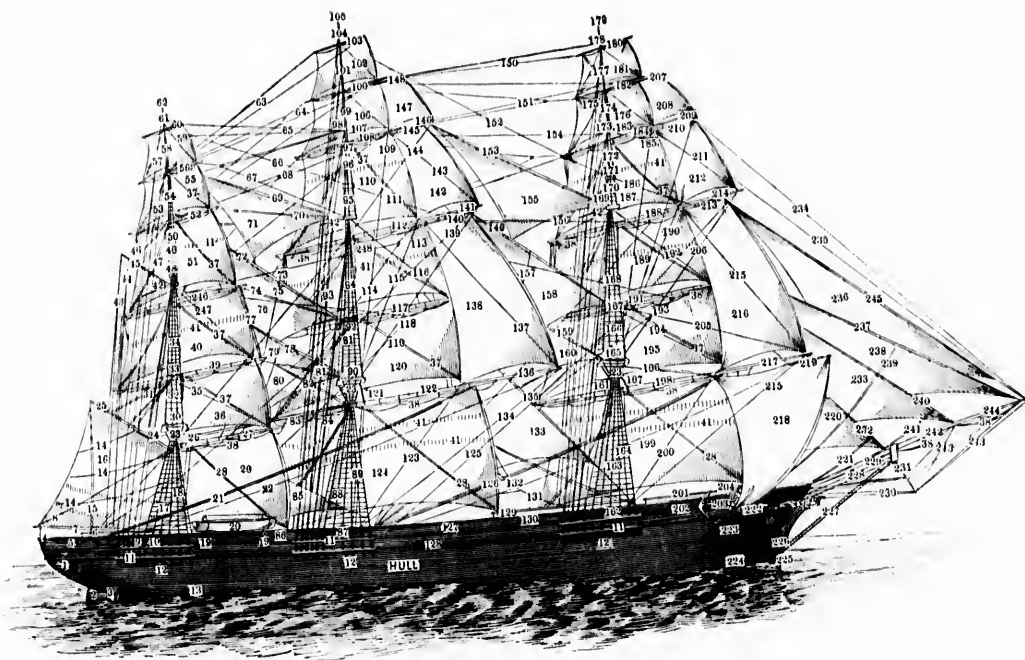

FULL RIGGED SHIP.—FIGURE 197.

- | | |
|------------------------------------|---|
| 1 Stern. | 32 Mizzenmast-head. |
| 2 Rudder. | 33 Mizzen Topmast Shrouds. |
| 3 Counter. | 34 Mizzen Topmast. |
| 4 Spanker Sheet. | 35 Crossjack Lift. |
| 5 Taffrail. | 36 Mizzen Lower Topsail. |
| 6 Cabin Trunk. | 37 Clue Lines. |
| 7 Spanker Boom. | 38 Foot-ropes. |
| 8 Spanker Boom Topping Lift. | 39 Mizzen Lower Topsail-yard. |
| 9 Weather Crossjack Sheet. | 40 Mizzen Upper Topsail. |
| 10 Mizzen Chains. | 41 Reef Points. |
| 11 Channels. | 42 Outriggers. |
| 12 Chain Plates. | 43 Signal Halliards. |
| 13 Run. | 44 Monkey-gaff Vangs. |
| 14 Spanker Brails. | 45 Monkey-gaff. |
| 15 Spanker-gaff Vangs. | 46 Monkey-gaff Lift. |
| 16 Spanker. | 47 Mizzen Topgallant-backstays. |
| 17 Mizzen Shrouds. | 48 Mizzen Topmast-head. |
| 18 Mizzenmast. | 49 Mizzen Topgallant Shrouds. |
| 19 Davits. | 50 Mizzen Topgallant Mast. |
| 20 Quarter-boat. | 51 Mizzen Topgallant Sail. |
| 21 Main Brace. | 52 Mizzen Topgallant Yard. |
| 22 Main Topmast Studdingsail Tack. | 53 Mizzen Royal Backstays. |
| 23 Futtock Shrouds (3). | 54 Mizzen Royalmast. |
| 24 Mizzen Topmast Backstay. | 55 Mizzen Royal. |
| 25 Spanker Gaff. | 56 Mizzen Royal-yard Maintopgallant Sail. |
| 26 Mizzen Stay. | 57 Mizzen Skysail Backstays. |
| 27 Crossjack Yard. | 58 Mizzen Skysail Mast. |
| 28 Clue Garnets. | 59 Mizzen Skysail. |
| 29 Crossjack. | 60 Mizzen Skysail Yard. |
| 30 Mizzen Top. | 61 Mizzen Skysail Pole. |
| 31 Spanker Peak Halliards. | 62 Mizzen Truck. |

- 63 Main Skysail Brace.
 64 Main Royal Brace.
 65 Mizzen Skysail Brace.
 66 Mizzen Skysail-stay.
 67 Mizzen Royal Brace.
 68 Main Topgallant Brace.
 69 Mizzen Royal-stay.
 70 Mizzen Topgallant Brace.
 71 Mizzen Royal-staysail.
 72 Mizzen Topgallant-stay.
 73 Upper Mainsail Downhaul.
 74 Mizzen Uppertopsail Brace.
 75 Mizzen Royal-staysail Sheet.
 76 Mizzen Topgallant-staysail.
 77 Upper Mizzen-topsail Downhaul.
 78 Mizzen Topmast-stay.
 79 Mizzen Topgallant-staysail Sheet.
 80 Mizzen Topgallant-staysail.
 81 Mizzen Lower Topsail Brace.
 82 Main Trysail-gaff.
 83 Cross-jack Brace.
 84 Main Topmast-backstays.
 85 Mizzen Staysail.
 86 Weather Mainsheet.
 87 Main Chains.
 88 Main Shrouds.
 89 Mainmast.
 90 Main-top.
 91 Mainmast-head.
 92 Maintopmast Shrouds.
 93 Maintopgallant-backstays.
 94 Maintopmast.
 95 Maintopmast-head.
 96 Maintopgallant Shrouds.
 97 Maintopgallant mast.
 98 Main Royal-backstays.
 99 Main Royalmast.
 100 Main Royal-yard.
 101 Main Skysailmast.
 102 Main Skysail.
 103 Main Skysail-yard.
 104 Main Skysail-pole.
 105 Main Truck.
 106 Main Royal.
 107 Maintopgallant Studdingsail Halliards.
 108 Maintopgallant-yard.
 109 Main Royal Studdingsail Sheet.
 110 Maintopgallantsail.
 111 Maintopmast Studdingsail Halliards.
 112 Main Upper Topsail-yard.
 113 Main Upper Topsail.
 114 Forebrace.
 115 Maintopgallant Studdingsail Sheet.
 116 Main Lowertopsail Lift.
 117 Main Lowertopsail-yard.
 118 Main Lowertopsail-brace.
 119 Main Lift.
 120 Main Lower Topsail.
 121 Mainstay.
 122 Mainyard.
 123 Maintopmast Studdingsail Sheet.
 124 Mainsail or Maincourse.
 125 Foretopgallant Studdingsail Tack.
 126 Forebrace.
 127 Bulwarks.
 128 Waist.
 129 After Deck-house.
 130 Weather Fore-sheet.
 131 Main Bowline.
 132 Bowline Bridle.
 133 Maintopmast Lower Staysail.
 134 Maintopmast Studdingsail Downhaul.
 135 Maintopmast Stay.
 136 Maintopmast Studdingsail Boom.
 137 Maintopmast Studdingsail Downhaul.
 138 Maintopmast Studdingsail.
 139 Maintopgallant Studdingsail Tack.
 140 Maintopmast Studdingsail-yard.
 141 Maintopgallant Studdingsail Boom.
 142 Maintopgallant Studdingsail.
 143 Maintopgallant Studdingsail Downhaul.
 144 Main Royal Studdingsail Tack.
 145 Maintopgallant Studdingsail-yard.
 146 Main Royal Studdingsail Boom.
 147 Main Royal Studdingsail.
 148 Main Royal Studdingsail-yard.
 149 Maintopgallant Stay.
 150 Foreskysail Brace.
 151 Fore Royal Brace.
 152 Mainskysail Stay.
 153 Main Royal Stay.
 154 Foretopgallant Brace.
 155 Maintopgallant Staysail.
 156 Fore Upper Topsail Brace.
 157 Main Royal Staysail Sheet.
 158 Maintopgallant Staysail.
 159 Spring Stay.
 160 Maintopmast Upper Staysail.
 161 Foretopmast Backstays.
 162 Forechains.
 163 Foreshrouds.
 164 Foremast.
 165 Foretop.
 166 Foretopmasthead.
 167 Foretopmast Shrouds.
 168 Foretopmast.
 169 Foretopgallant Backstays.
 170 Foretopmasthead.
 171 Foretopgallant Shrouds.
 172 Foretopgallantmast.
 173 Fore Royal Backstays.
 174 Fore Royalmast.
 175 Foreskysail Backstays.
 176 Fore Royal.
 177 Foreskysailmast.
 178 Foreskysail Pole.
 179 Fore Truck.
 180 Foreskysail-yard.
 181 Foreskysail.
 182 Fore Royal-yard.
 183 Foretopgallant Studdingsail Halliards.
 184 Foretopgallant-yard.
 185 Fore Royal Studdingsail Sheet.
 186 Foretopmast Studdingsail Halliards.
 187 Foretopgallantsail.
 188 Fore Upper Topsail-yard.
 189 Fore Upper Topsail.
 190 Foretopgallant Studdingsail Sheet.
 191 Fore Lower Topsail-yard.
 192 Fore Lower Topsail Lift.
 193 Fore Lower Topsail Brace.
 194 Fore Lift.
 195 Fore Lower Topsail.
 196 Lower Studdingsail Inner Halliards.
 197 Forestay.
 198 Foreyard.

- 199 Fore sail or Forecourse.
 200 Foretopmast Studdingsail Sheet.
 201 Forward Deckhouse.
 202 Lower Studdingsail Sheet.
 203 Anchor.
 204 Cathhead.
 205 Lower Studdingsail Halliards.
 206 Foretopgallant Studdingsail Downhaul.
 207 Fore Royal Studdingsail-yard.
 208 Fore Royal Studdingsail.
 209 Fore Royal Studdingsail Boom.
 210 Foretopgallant Studdingsail-yard.
 211 Foretopgallant Studdingsail Downhaul.
 212 Foretopgallant Studdingsail.
 213 Foretopmast Studdingsail-yard.
 214 Foretopgallant Studdingsail Boom.
 215 Foretopmast Studdingsail Downhaul.
 216 Foretopmast Studdingsail.
 217 Foretopmast Studdingsail Boom.
 218 Lower Studdingsail.
 219 Lower Studdingsail-yard.
 220 Foretopmast Staysail.
 221 Weather Jib Sheet.
 222 Cable.
 223 Bow.
 224 Entrance.
 225 Outwater.
 226 Stem.
 227 Bobstays.
 228 Bowsprit.
 229 Bowsprit Shrouds.
 230 Martingale Guys.
 231 Dolphin Striker.
 232 Foretopmast Stay.
 233 Jib.
 234 Foreskysail Stay.
 235 Fore Royal Stay.
 236 Jib Topsail.
 237 Flying Jibstay.
 238 Flying Jib.
 239 Weather Jibtopsail Sheet.
 240 Jib Stay.
 241 Weather Flying Jib Sheet.
 242 Jib-boom.
 243 Martingate Stays.
 244 Flying Jib-boom.
 245 Fore Topgallant Stay.
 246 Mizzen Upper Topsail-yard.
 247 Mizzen Lower Topsail Lift.
 248 Main Upper Topsail Brace.

HOW YACHTS ARE MEASURED.

In the earlier days of yacht racing "it was soon discovered" says Frederick W. Pangborn * "that a big boat could beat a small one, and the necessity of time allowance rules became obvious to the yachters.

"At first it was deemed sufficient to grade the boats according to size; and actual size being an unattainable measure, length was adopted as a standard of size.

"So the yachts were measured over their decks for the purpose of classification. Then began an era of building to beat the racing rule, and the result was a boat longer on the keel than over deck.

"Objection was made to this unfairness, and the rule was changed, the measure of length on the keel being adopted as fair. In a short time the yachting world witnessed the birth of a new type of boat with the keel cut away forward and aft. Again the boat was made bigger than her measure indicated.

* "Century, Ill. Month. Mag." May, 1882.

"Next came the waterline rule of measurement, which was fair, excepting that it took no account of the overhang sterns of many yachts, which thus gained advantage over square-sterned boats of equal waterline length. So a reckoning was made for overhang, and this is the general practice to-day. When the NEW YORK YACHT RACING ASSOCIATION was organized, this question of racing-length was decided in a manner so satisfactory that no just complaint of unfairness has ever risen; and the majority of clubs in the country have adopted the Association rule, which is simple, sportsmanlike, and free from the complications that always cause trouble in clubs which use tonnage and sail-area rules. The Association rule measures a yacht by this formula:

$$\frac{\text{Length over deck} + \text{waterline length}}{2} = \text{Sailing measure}$$

that is to say, one half of the overhang of the stern is allowed."

The NEW YORK YACHT CLUB,† however, has adopted the Seawanhaka rule, which is expressed by the formula:

$$\frac{L. W. L. + \sqrt{\text{SAIL AREA}}}{2}$$

that is, the length on the waterline is added to the square root of the sail area and then divided by two. This is an arbitrary rule, having been adopted because it seemed to aid in developing as a type of racing yacht the boat of moderate power and small sail area.

Such a boat under this rule has a racing length not much greater than her actual waterline, while the modern extreme racing machine has her racing length very much increased by this rule, over the waterline measurement.

The measuring of racing yachts in these days of close calculation, when races are won by a couple of seconds, and boats come within a quarter of an inch of being too large for their class, has become a science demanding mathematical exactness.

The racing length then determines the allowance or handicap which is given by a large yacht to a smaller one.

To illustrate how carefully yachts are measured it will be interesting to examine the official figures obtained by Mr. Hyslop, the measurer of the NEW YORK YACHT CLUB, as a result of his measurement of VALKYRIE and VIGILANT:

	Valkyrie.	Vigilant.
	Feet.	Feet.
Length boat waterline,	85.50	80.10
End of main boom to forward side of mast,	02.00	00.37
Fore side of mast to jib stay,	06.16	73.80
Fore side of mast to jib topsail stay,	06.16	75.00
Fore side of mast to forward point of measurement,	06.10	74.85
Fore side of mast to outer end of spinnaker boom,	72.00	74.02
Deck to upper side of main boom,	3.03	3.08
Deck to topsail halliard block	114.88	125.00
Deck to hounds,	63.30	60.08
Length of topmast,	51.50	50.88
Length of gull,	55.57	51.76
Sail area,	10,042	11,272
Square root of sail area,	100.21	106.17
Racing length,	93.11	90.78
Allowance,	1 min., 48 secs.	

VALKYRIE being measured for 6 ft. excess of spinnaker boom.

Substituting the requisite figures in the above formula

$$\frac{85.50 + \sqrt{10,042}}{2} = 93.11, \text{ Racing length of VALKYRIE.}$$

$$\frac{86.10 + \sqrt{11,272}}{2} = 90.78, \text{ Racing length of VIGILANT.}$$

In determining these factors, it is necessary to remove each yacht to some perfectly smooth body of water. Mr. Hyslop begins his operation by sending a man aloft with the end of a steel tape long enough to reach from the topmast to the deck.

MEASURING THE SAIL AREA.

"The man aloft holds his end touching the under side of the heave or block through which the topsail halliard runs, while below

† See "New York Herald," Sept. 24, 1893, for illustrations and descriptions.

the distance is taken to the upper side of the main boom, just where it goosenecks to the mast. This is taken as the perpendicular of the triangle which the mainsail jib, forestaysail and topsail are supposed to form.

"To find the base of the triangle the distance is taken from the end of the main boom to a point half way between the jib and jib topsail stay on the bowsprit.

"If there were no gaff this would be all that was necessary to get the approximate sail area, but the end of the gaff projects beyond the line from the topmast to the end of the main boom. To include this strip of sail outside the main triangle in the sail area, eighty per

cent. of the length of the topmast is subtracted from the gaff measurement, and the remainder added to the base line.

"To get the points on the bow and stern from which the water line is measured, a piece of wood floating level with the surface of the water is pushed under the overhang until it reaches the point of junction with the water. Here it is held and moved a little back and forth until the exact point where the water touches the hull is found."

"This is carefully marked and the same operation gone through with at the other end of the boat. When these spots have been located, a plumb line is dropped from the rail just above the mark at the waterline, and regulated by sighting until it is plumb with the spot below. This is done forward and aft and the distance between these

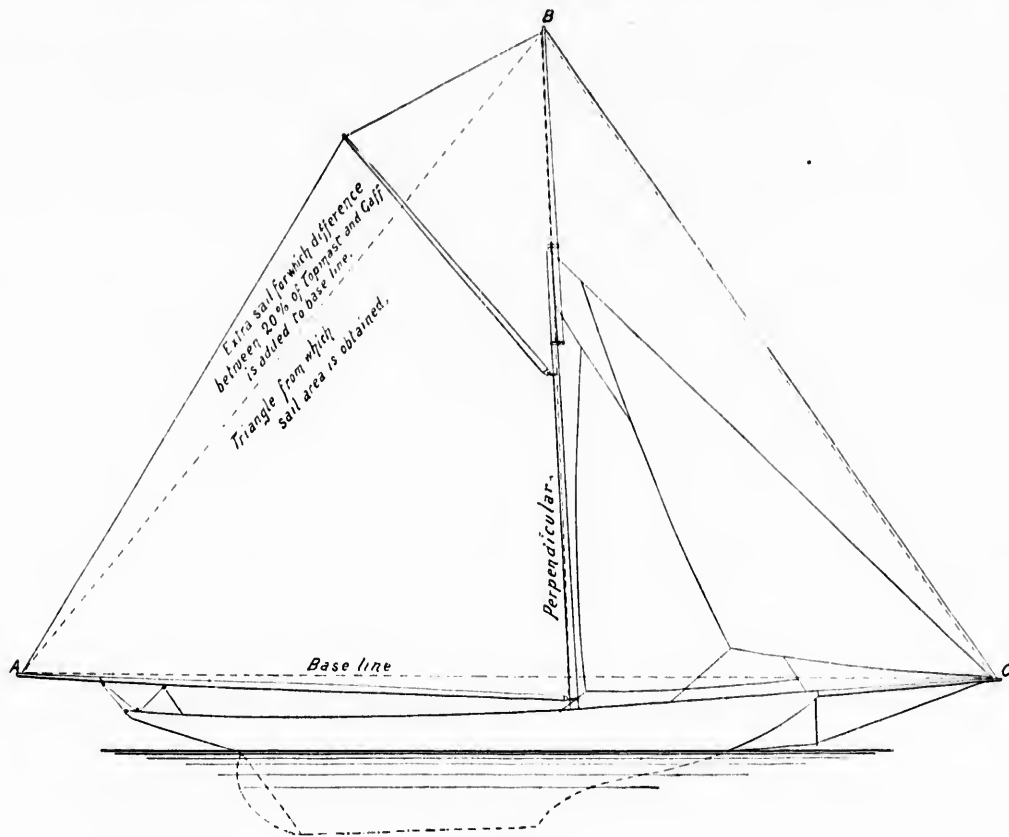

FIGURE 198.

cent. of the length of the topmast is subtracted from the gaff measurement, and the remainder added to the base line.

"To find the sail area from these measurements all that is necessary is to multiply the base by the perpendicular height, and divide by two when he has found the sail area," which in VALKYRIE is 10,042 square feet, and in VIGILANT is 11,372 square feet.

"The measurer has next to get the length on the waterline, and here is where the difficulty comes in measuring modern yachts. Any one can see that a boat with a straight bow and short stern would change her waterline length very little if raised or lowered an inch or two in the water and that, consequently, there could be no

"To get the points on the bow and stern from which the water line is measured, a piece of wood floating level with the surface of the water is pushed under the overhang until it reaches the point of junction with the water. Here it is held and moved a little back and forth until the exact point where the water touches the hull is found."

This is carefully marked and the same operation gone through with at the other end of the boat. When these spots have been located, a plumb line is dropped from the rail just above the mark at the waterline, and regulated by sighting until it is plumb with the spot below. This is done forward and aft and the distance between these

spots transferred to the deck, where a tape stretched between them gives the exact waterline length, which in VALKYRIE'S case (before the last International Race) was 85.50 feet, and in the case of VIGILANT was 86.19 feet."

Owing, therefore, to the quantity of sail carried by these two yachts their length for time allowance is increased 7.01 feet in the case of VALKYRIE, and 10.59 feet in the case of VIGILANT over their waterline length. The difference between the racing length of these two yachts is 3.67 feet greater in the case of VIGILANT which

made a time difference of exactly 1 min., 48 sec. in favor of VALKYRIE over the course sailed.

Respecting the rigging of VIGILANT, opinions differ; it is novel and original, and has stood this season successfully.

The masthead shrouds and the double stays down the foreside of the mast certainly hold the spar perfectly to all appearances; but it is a question with many experienced sailors, whether the large number of stays and the necessity of the perfect adjustment of the strain on each is not in itself a serious element of weakness.

...or of VALKYRIE

...ffer; it is novel

...the foreside of
...erances; but it
...the large num-
...ent of the strain



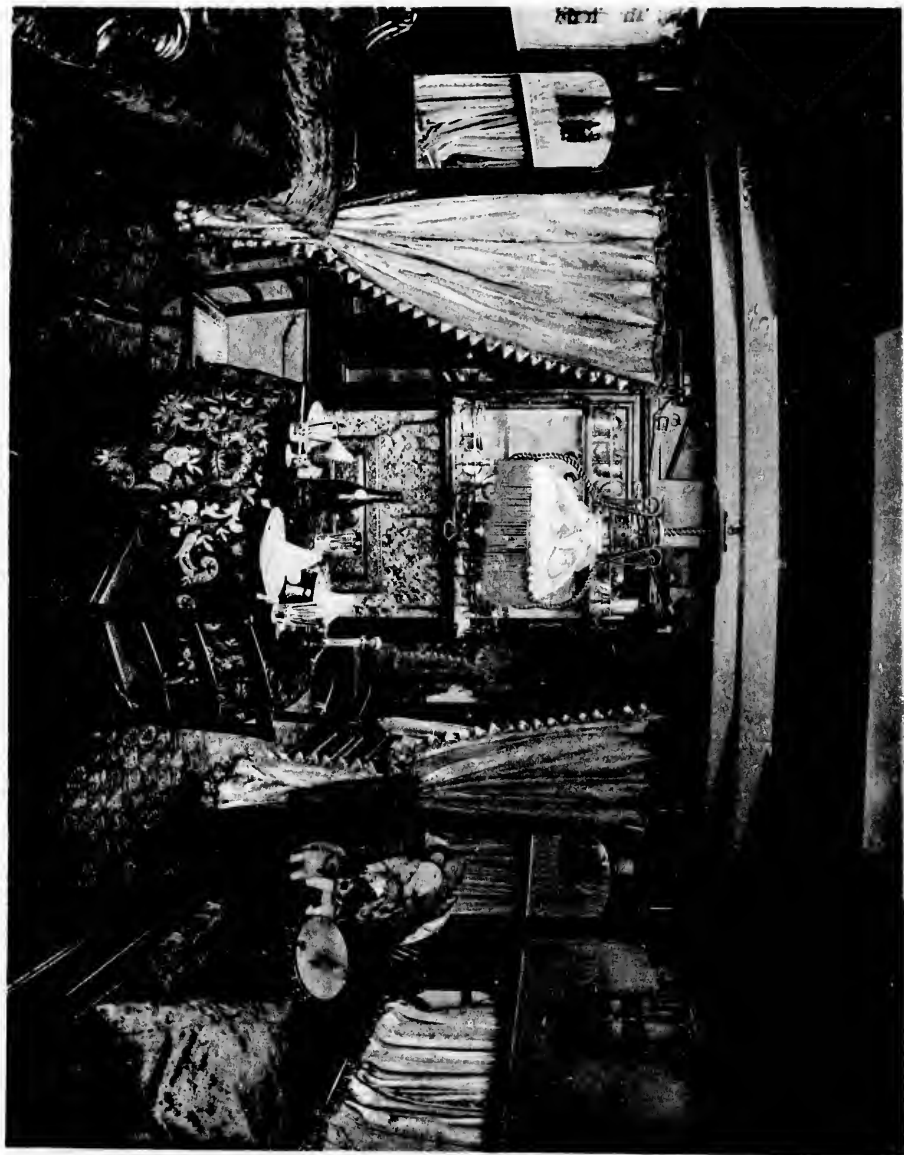

CABIN OF YACHT MAGIC.

PLATE III.

of a yacht
the large
of the ship



Cost of Yachting and Yacht Decorations.

A glance at the yachting records will disclose the fact that there are more than six thousand yachts enrolled in over two hundred and fifty yacht clubs distributed over the United States and Canada.

The amount of money thus invested is enormous and would be difficult to estimate. In determining the cost of yachting another difficult problem is presented and one might as well attempt to estimate on what it costs to keep house as to estimate what yachting costs to men of extravagant ideas or when actuated by liberal or social impulses.

Naturally, the first cost of yachting is the purchase price of the yacht, and this expense can only be arrived at when the character of yacht is known and whether the yacht is to be a new or an old one.

The following data* from a reliable source will serve as an index as to what some of the larger yachts have cost in the past:

Damless, \$70,000.	Palmer, \$50,000.
Sappho, \$50,000.	Eva, \$18,000.
Vesta, \$45,000.	Magic, \$33,000.
Phantom, \$42,000.	Sylvie, \$30,000.
Rambler, \$28,000.	Widgeon, \$38,000.
Falcon, \$20,000.	Fleetwing, \$18,000.
Henrietta, \$10,000.	

Coming down to the present time, investigation shows that JUBILEE, PILGRIM and COLONIA cost in the neighborhood of \$50,000, and that the first cost of VIGILANT, including her \$10,000 Tobin-bronze bottom was about \$60,000. If steam yachts, such as VALLANT, NOTRE-DAME, ATALANTA, NAMOUNA, etc., are considered, the cost of these yachts are in the hundred thousands, while, on the other hand, if small pleasure yachts are considered, the price for which they can be built or purchased is not a very serious matter.

Naturally, the cost of a yacht will depend largely upon her interior furnishings and decorations; these can be elaborate or unpretentious, the same as the furnishing and decorations of a private dwelling.

Plate III, illustrates the cabin of the famous yacht MAGIC, while plate IV, shows the luxury and comfort to be found in the state-rooms of the well-known yacht DAUNTLESS. Other illustrations could be given which would show possibly more elaborate furnishing and decorations, but the subjects selected sufficiently illustrate what palatial floating residences are to be found.

The yacht being secured, the next cost is its maintenance—and right here it will be necessary to draw a line between the actual cost of maintenance and the amount of money a liberal or extravagant yachtsman sees fit to spend for social entertainment, etc. It may safely be stated that if a man is extravagant on shore he very likely will be so on board his yacht, as long as he and his guests enjoy themselves. In fact, to express it more forcibly than elegant, "money don't count" with such yachtsmen, and it must be conceded that, if it affords them pleasure to give costly entertainments and their wealth permits of it, the expense is purely a private matter. Outside of the entertainment of guests, the cost of maintenance of a yacht will naturally depend upon her size. There is the salaried expense of the Captain, officers and crew on large yachts, the feeding of them, then the cost of additional spars, sails, rigging and painting of the yacht, etc. Respecting the crew, the wages paid to them is rather more than the pay in the

merchant service, and the men are better fed and clothed. The average is about \$30 a month,* and at the end of the season, if their work has been creditably performed, it is the custom to give them an additional sum as "merit money." As a rule, the sailors are foreigners, many of them being Scandinavians and Germans. If they happen to be Americans, the majority have had an admirable training on fishing smacks and coasters and are naturally good all-round sailors. Special aptitude, however, is required on a regular fore-and-aft vessel, especially when that craft is a yacht. While there are hundreds of navigators, it is but a small minority who are proficient in the handling of a yacht in a race.

"During a contest much depends upon a capable crew; not everything, of course, for the wind may be obstinate and uninviting, in which case they are powerless, but if a yachtsman's breeze prevails, the prize often belongs to the trained men with brains and muscle whose quick movements and good judgment become an essential part of a superb mechanism. Yacht owners know this, and to encourage the best efforts it is customary to divide a purse among the crew after a successful encounter. From \$5 to \$20 are not infrequently given to each man.

"The life of the officers and sailors is not an uneasy one. They enjoy the best of rations, sleep in quarters that are fitted up in elegant style, flit in and out of harbors two or three times a week, wear fine uniforms at the other fellows' expense and see much that occurs on the outskirts of social life. If the Captain is an able navigator, he is good for one or two hundred dollars a month; a first-class cook is easily worth \$50 a month, while the steward who looks after the supplies with business-like economy and superintends the attendance upon the guests, is regarded as cheap at twice that salary. On steam yachts, the engineer and his assistants receive about the same pay as the sailing master and mates, and the fireman the same as the man before the mast.

"In England, men before the mast receive from three to four pounds a month, with which they form their own mess and live as they choose. The officers are also paid less than they are on this side of the Atlantic.

"Calculating the number of officers and seamen who man the various yachts of this country, the carpenters, riggers and painters who are employed in construction and repair, the cooks and stewards, the butchers, bakers, grocers, wine merchants and others who serve the owners, it is safe to say that the money of the millionaire who affords this species of luxury flows through the hands of fifty or sixty thousand people and through hundreds of channels of trade."

M. De Fontaine, speaking of the steam yacht NAMOUNA, which is 246 feet long and 845 tons burden, says:

"She is an iron three-master, with steel decks, and at all times carries a full complement of men. Her crew numbers upward of fifty and, in case of necessity, she can at any moment man all of her boats. Besides Mr. Bennett, who much of the time navigates her himself, there are four officers who take watch and watch, four engineers, nine firemen and coal passers, ten men before the mast, a boatswain, ship's carpenter, gunner, four quartermasters, a chief cook and four assistants, a first and second steward, four cabin waiters, two deck and cabin boys, and a private secretary whose

* "Scientific American" Sept. 10, 1870.

* See "New York Daily News", May 28, 1883. Article by Felix G. De Fontaine.

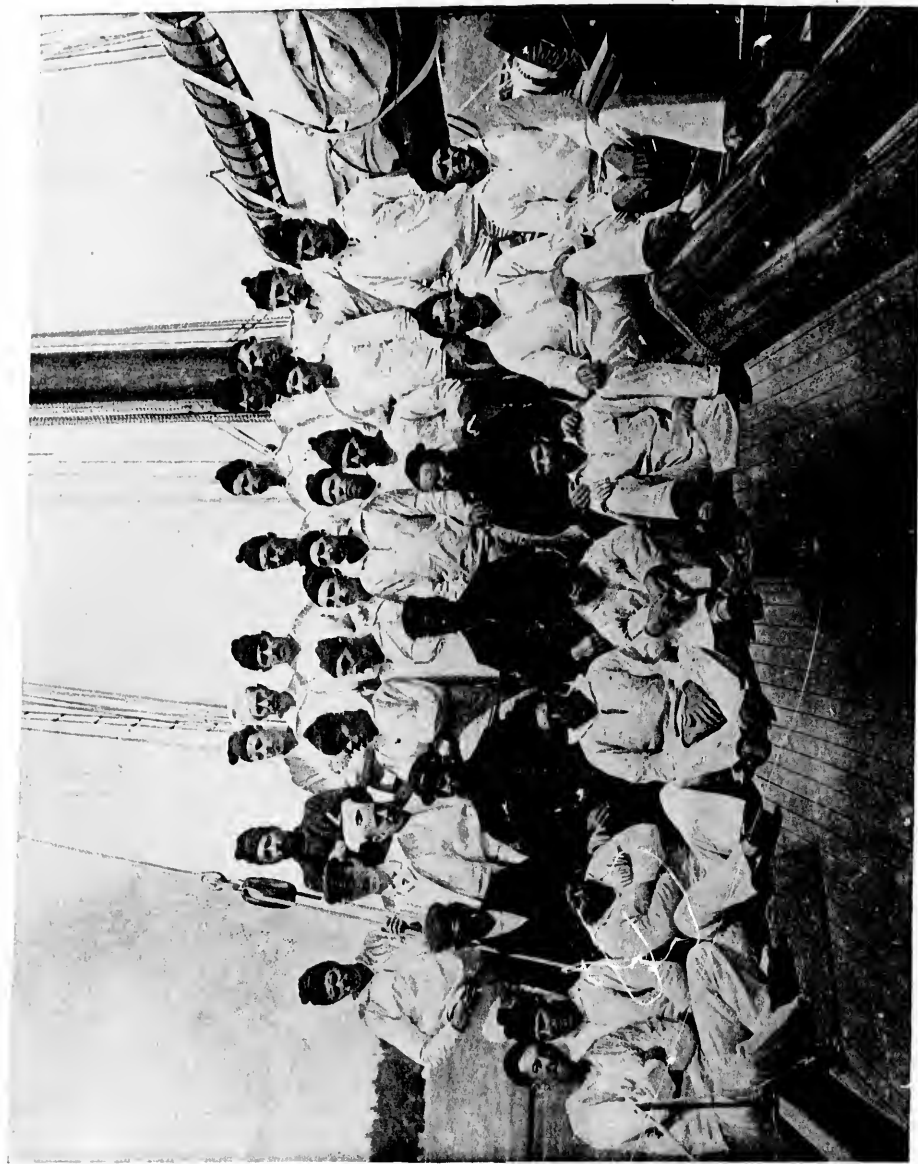

CREW OF VIGILANT.—PLATE VI.



CREW OF VIGILANT.—PLATE VI.



PLATE IV

STATEROOMS IN YACHT DAUNTLESS.

in advance of
two and a half
1 in refitting,
accidental ex-

ent and sur-
motive plan
ltsmen who

club, and
him, each
eg. They
hon cruiss-
186 Asso-
man who

an ama-
ort in the

ich were
Another
operate,
of their

ys. Mr
could
in the
in the
, they
ners,
ubs,
t. at

his
by

nds
an
be
oft
in
t,
r-
l

1



salary is not less than \$2,500 a year. Altogether, the monthly payroll of the owner must be in the neighborhood of \$2,500. Add to this an average of 50 cents a day to feed the crew and the officers, and you have the snug little sum of \$150 per month.

"When at sea on active duty this private cruiser or portable clubhouse, as some have called it, burns in the neighborhood of 20 tons of coal a day, which, reckoned at \$3.75 per ton, amounts in a month of cruising to \$2,250. Add to this the cost of repairs, engineers' and mates' stores, the interest at 6 per cent. on \$125,000, the cost of the ship, and a reasonable allowance for the annual depreciation of the value of the investment, and it will be seen that, without including the cost of maintaining the cabin and wine lockers, which is probably as changeable as the colors in a kaleidoscope, the expense of running a yacht like *XAMONA* is not far from \$61,000 a month, or say \$75,000 a year. But see what he gets for it. He has a floating palace as a home, can escape from that part of humanity which he wishes to avoid, and may enjoy immunity from every care he does not invite."

By referring to Plate V the regular crew employed on the yacht *DAUNTLESS* will be seen, and Plate VI illustrates most of the crew employed on *VIGILANT*. For regular daily work twenty-five men were under pay, but when racing, *VIGILANT* had fifty men on board. These men did not sleep on *VIGILANT*. To house them and feed them a boat was secured as a sort of tender. The clothing of the sailor was supplied by the syndicate owning the yacht. Fully \$35,000 was spent for additional spars, sails, rigging and maintenance during the trial races and during the races when *VIGILANT* defended the *AMERICA'S CUP*, making a total outlay of at least \$100,000.

The cost of maintenance, therefore, of large yachts is a matter of very serious import, and should not be attempted by men of moderate incomes; on the other hand, a yachtsman can own and maintain a fair sized yacht by the expenditure of a very moderate amount of money, hence the thousands of pleasure crafts which are to be found in and out of the various watering places.

As soon as it is necessary to employ a crew of professionals, then the expense of yachting commences, but so long as the yacht is handled by Corinthian crews the expense is insignificant.

Mr. Stinson Jarvis says: *

"The best record, pecuniary and otherwise, made by an English yacht is said to have been that of *ULERIN*. She raced one season and won in her class all but two prizes. At the end of the season her owner sold her, and, after calculating the advanced selling price and the amount the yacht won, he found himself out of pocket only £28.

"But in the records of cheap and good yachting *WHITE WINGS* is pre-eminent. She still belongs to the *ROYAL CANADIAN YACHT CLUB* and has been the most successful craft on the upper lakes. Cutburt, the designer, who sent two failures to compete for the *AMERICA'S CUP*, built her. Being a mere shell, with no outside ballast, her price in 1887 was only \$1,400. Her winnings for the balance of that summer were \$314; for 1888 her winnings were \$958.50; for 1889 they were \$583, making a total of \$1,855. Her record for the two and a half seasons before Mr. Emilius Jarvis sold her was twenty-three first prizes and three second prizes out of twenty-six starts. She had to sail against the celebrated imported cutter *MADGE*, which previously had defeated everything of her class in New York; also against the imported Watson cutter *VERVE*, owned by Commodore Boswell, *ROYAL CANADIAN YACHT CLUB*, at Toronto, as well as against other fast craft.

*"New York Recorder," July 4, 1883.

"In the winter of 1889, *WHITE WINGS* was sold at an advance of \$100, so that the owner made in all \$1,955.50 in his two and a half years of possession of her. Of this sum \$550 was paid in refitting, etc., and the remainder covered all club fees and incidental expenses."

It may be said that it was only by the speed of this yacht and superior skill that loss was prevented. But the owner had another plan which, in fact, may be found useful to such would-be yachtsmen who are on the lookout for cheap yachting.

He induced six or eight members belonging to the same club, and who felt they could not afford to own a yacht, to join with him, each paying a stated sum for the privilege of the year's sailing. They also divided with him the cost of provisioning the yacht when cruising, or when on the race circuit of the *LAKE YACHT RACING ASSOCIATION*. This further revenue paid for the services of a man who was cook as well as sailor.

In this way these young men were thoroughly trained by an amateur of ability, and were consequently fitted to take active part in the various races of the season.

While cruising they lived on board, and their meals, which were comfortable, cost no more than the price of the provisions. Another saving arose, naturally, from the fact that they were all temperate. Of course, shore expenses are not counted, but the actual cost of their season's yachting did not probably amount to more than \$100.

"This is certainly cheap yachting" and it is difficult," says Mr. Jarvis, "to think of any summer trip of any duration which could be enjoyed for the same money. For this sum they traveled, in the pleasantest way, over two thousand miles. Incidental to being in the fleet of yachts on the *INTERNATIONAL ASSOCIATION* race circuit, they were of course, guests, with the others, at all the dances, dinners, suppers and other entertainments given by the various yacht clubs, and by the residents of the cities, both American and Canadian, at which regattas are regularly held."

The yachts referred to were all in the 46 foot class. This is about the largest boat which can be comfortably handled by amateurs.

A 46 foot yacht, however, is large in comparison to the thousands of smaller yachts, which afford great pleasure to the Corinthian yachtsmen, and which can be seen at every watering place during the yachting season. The expense of maintenance of these smaller craft is insignificant and the actual pleasure to be derived from them in cruising and in competitive sailing is not to be ignored; in fact, many owners of such yachts who could well afford to own and maintain much larger yachts, decidedly prefer the cut, double-cut, cut-yawl or jib-and-mainsail so far as the sport of yachting is concerned.

A prominent writer has modestly stated that "a fairly economical owner of a first-class sloop or schooner, need not spend more than \$20,000 or \$25,000 a year, but instances are numerous in which this sum is doubled and trebled." Of course, the writer combines with the actual cost of maintenance the outlay for social entertainment, the latter expense naturally depending upon the generous impulses of the yachtsman.

It can, however, be stated as a fact that a 70 foot schooner can be maintained at an expenditure of not more than \$300 to \$350 a month, including ordinary repairs, feeding of the crew, etc., if the owner sees fit to be economical.

This being the case with a large yacht, on which a professional crew has to be employed, it is clear that the expense attached to Corinthian yachting can not be a matter of very serious consideration, and for this reason should be encouraged.





PLATE V.

CREW OF YACHT DAUNTLESS.



TROPHIES.

It cannot be denied that there is a certain degree of pleasure to be derived from the receipt of a prize or trophy as the result of being the successful contestant in any competitive trial, whether in the domain of one sport or of another—but it must be conceded that the contestant who simply competes for the sole object of winning the prize offered on account of its intrinsic value, descends, in a sense, to mere mercenary achievements which should be foreign to the thoughts and aspirations of any true lover of sport.

There are certain classes of sport which have been reduced to this level, but it is gratifying to know that the competitive tests to determine the superiority of yachts have never as yet descended to such a condition.

This one fact is sufficient to establish the elevating nature of the sport of yachting and to pronounce it a sport in which gentlemen may participate.

It is true, that in a few competitive races prizes of great value have been offered; as for example, in the cases of the famous race across the Atlantic, when the yachts *HEXILETTA*, *FLEETWING* and *VESTA* started, with the view of establishing the superiority of one yacht over the others—the purse being for \$30,000. Still, it must be remembered that the owners of the contesting yachts were men of great wealth who could well afford to lose the stake contributed, and it cannot be doubted that the paramount object the owners of these yachts had in racing was to establish the seaworthiness and merit of their yachts and not the acquisition of the unquestionably tempting purse to be placed at the disposal of the winner. However this may be in this particular case and the few other isolated cases which are recorded when yachting was practically in its infancy in this country, it is fortunate that the yachtsmen of to-day who take active interest in the manly sport of yachting are in the main composed of gentlemen who derive more pleasure from winning a race on the merit of their yacht, which has been designed or caused to be designed by them, than from the acquisition of a mere purse or prize which they would receive by virtue of being the owner of the winning yacht. While all this is true, still when the magnificent cups offered by generous yachtsmen and yacht clubs to be competed for are examined, it is but natural to feel a desire to become the owner of them, but it is very questionable if any true yachtsman would accept a duplicate cup or its equivalent in dollars, if he had to be deprived of the satisfaction and pleasure derived by winning a race with his favorite yacht.

What intrinsic value would be attached to the possession of the AMERICA'S CUP if it was not the emblem of yachting supremacy of the world? It is not intrinsic value in this case but intrinsic worth, and it is for this reason that hundreds of thousands of dollars have been spent to secure this cup on the one side and to retain it on the other.

AMERICA'S CUP.

Probably no prize that has ever passed through the hands of the silversmith is more widely known than the "One Hundred Guinea Cup" presented to the yacht *AMERICA* by the ROYAL YACHT SQUAD-

RON of Cowes, Isle of Wight, after she gloriously defeated all competitors in the race which took place on August 22, 1851.

The cup is of silver and was made in 1849 by R. & S. Garrard, of England, from a design prepared by an artist named Spencer. It stands, exclusive of its pedestal, 27 inches high and weighs 135 ounces. The design can hardly be called original, as it closely resembles, if not largely borrowed from, designs of the 16th century, while the bulbous ornamentation is taken almost directly from the German hampers of the 17th century.

Although considered beautiful at the time it was made, but little praise is bestowed upon it as a work of art at the present day. Its chief point of interest resides in the fact that it stands a symbol of the American yacht.

As the chapter relative to AMERICA'S CUP in the second volume will give a detailed description of how this cup was won and how it has been retained in America, it will only be necessary to state in this place that the owner of the yacht *AMERICA*, shortly after winning the cup, under consideration, presented the same to the NEW YORK YACHT CLUB subject to certain conditions, which constituted the first deed of gift. In the Fall of 1881, the NEW YORK YACHT CLUB returned the cup to Mr. George L. Schuyler, the only surviving donor and it was re-accepted by the club under a new deed of gift. In 1887 the cup was again returned to Mr. Schuyler and was by him conveyed to the NEW YORK YACHT CLUB under a third deed of gift.

The record of races for the AMERICA'S CUP may be tabulated as follows:

DATE	NAME OF YACHT	COURSE	TIME		
			H.	M.	S.
Aug. 22, 1851	1 America	From Cowes around Isle of Wight (Aurora second)	10	37	00
Aug. 8, 1870	1 Aurora		3	58	21.2
	1 Magie	N. Y. Y. C. course (Columbia 10th)	4	37	38.9
Oct. 16, 1871	1 Columbia	N. Y. Y. C. course	0	19	11
	1 Layonia		0	40	45
Oct. 18, 1871	1 Columbia	20 miles to windward off Sandy Hook lightship and return	3	7	11.7
	1 Layonia		3	18	15.9
Oct. 19, 1871	1 Layonia	N. Y. Y. C. course (Columbia disabled)	4	02	25
	1 Columbia		4	17	35
Oct. 21, 1871	1 Supho	20 miles to windward off Sandy Hook lightship and return	5	39	02
	1 Layonia		0	09	23
Oct. 23, 1871	1 Supho	N. Y. Y. C. course	4	10	11
	1 Layonia		5	11	55
Aug. 11, 1870	1 Madeleine	N. Y. Y. C. course	5	23	54
Aug. 12, 1870	1 Madeleine	20 miles to windward off Sandy Hook lightship and return	5	34	53
Nov. 9, 1881	1 Atlanta	N. Y. Y. C. course	7	18	46
Nov. 10, 1881	1 Mischiff	10 miles to leeward from buoy 5 off Sandy Hook and return	7	10	00
Sept. 14, 1885	1 Puritan	N. Y. Y. C. course	4	17	00
Sept. 16, 1885	1 Genesta	20 miles to leeward off Sandy Hook lightship and return	4	45	28.7
Sept. 9, 1886	1 Mayflower	N. Y. Y. C. course	1	51	23
Sept. 11, 1886	1 Galatea	20 miles to leeward off Sandy Hook lightship and return	1	53	47
Sept. 27, 1887	1 Thistle	N. Y. Y. C. course	0	06	05
Sept. 30, 1887	1 Volunteer	20 miles to windward off Scotland lightship and return	0	22	24
Oct. 7, 1887	1 Vigilant	N. Y. Y. C. course	5	03	11
Oct. 9, 1883	1 Valkyrie	30 miles off Sandy Hook lightship	5	12	41.5
Oct. 13, 1883	1 Vigilant	30 miles triangular course off Sandy Hook	5	42	56.1
	1 Valkyrie		5	51	45.4
	1 Vigilant		4	45	47
	1 Valkyrie		4	11	35
	1 Vigilant		3	25	01
	1 Valkyrie		3	35	30
	1 Vigilant		3	21	30
	1 Valkyrie		3	25	19



AMERICA'S CUP—FIGURE 199.

THE BRENTON'S REEF CUP.

This cup* is a fine work in silver and was at the time of its production one of the best efforts of Tiffany & Co. It was presented to the NEW YORK YACHT CLUB by Ex-Commodore James G. Bennett, March 23, 1871. The conditions attached to this cup are as follows:

Presented by Ex-Commodore James G. Bennett, March 23, 1871.

This cup will be offered to the yachts of all nations, to be sailed for in an ocean race, on a course from the Lightship, off Newport, to and around the Lightship off Sandy Hook and outside of Long Island, and return. Said cup to be held by the winner for the term of thirty days after the race, without liability to challenge. Upon the expiration of said period, the winner of the cup must accept any

The ocean races for the Brenton's Reef Cup will be sailed according to the rules of the NEW YORK YACHT CLUB, but without allowance for time.

It is understood that in case any yacht holding one of the before mentioned challenge cups shall be sold out of the NEW YORK YACHT CLUB, the cup is not disposed of with her but must be returned to the NEW YORK YACHT CLUB, to be sailed for again in the manner and form before provided for the schooners and sloops and for the ocean races.

It is also understood that in case a foreign yacht should hold the challenge cup, and should be sold out of a ROYAL YACHT CLUB, the cup is not sold with her, but must be returned to the NEW YORK YACHT CLUB to be sailed for again in an ocean race, as above provided.



THE BRENTON'S REEF CUP.—FIGURE 200.

challenge and be prepared to sail a race over the same course within the space of fifteen days next ensuing the receipt of such challenge, or forfeit the cup to the challenger. Should any yacht succeed in holding the cup in two consecutive races during one season, the owner thereof will not again be liable to challenge until the commencement of the yachting season of the year next ensuing.

In the event of the cup being held at the close of a season by a foreign yacht, the owner thereof will be liable to challenge during the season of the year ensuing for an ocean race over a course from the Needles, Isle of Wight, to and around a stake boat off the harbor of Cherbourg and return.

* Illustrated from "Jeweller's Circular."

The yachting season in American waters for the before named challenge cup will be from the third Thursday in June until the third Thursday in October.

Upon this challenge cup there shall be engraved the names of those yachts, and the owners thereof that have held the same, and a die, with appropriate devices thereon shall be engraved from which a medal can be struck to be held by the owners of said yachts.

Any yacht challenging the holder must deposit five hundred (\$500) dollars with the Regatta Committee, to be forfeited in case the challenging party is not successful in winning, otherwise to be returned to him. If forfeited to be invested in a cup to become the property of the challenged party.

THE BRENTON'S REEF CUP RECORD OF RACES.

DATE.	YACHT.	OWNER.	TONNAGE.	START. SANDY HOOK LIGHT- SHIP.	BRENTON REEF LIGHTSHIP.	FINISH. SANDY HOOK LIGHT- SHIP.	TIME.
July 25, 1872.	Maddine, Schr. Rambler, Schr.	Jacob Voorhis, Jr. J. M. Forbes.	175. 240.	4.01.00 4.03.01	7.29.30 7.38.37	Put into New London. 7.59.00 (27th)	— —
Sept. 19, 1873.	Rambler, Schr. Maddine, Schr.	J. M. Forbes, Jacob Voorhis, Jr.	240. 175.	Brenton Reef Lightship. 8.51.22 8.38.31	Sandy Hook Lightship. 3.38.00 6.53.00	Brenton Reef. 4.16.54 (21st) 8.09.12 (21st)	43.25.32 47.18.41
July 26, 1876.	Idler, Schr. America, Schr. Wanderer, Schr. Fidel Wave, Schr. Countess of Dufferin, Schr.	S. J. Colgate. B. F. Butler. James Stillman. W. Voorhis. Major C. Gifford.	191.26 170. 107.83 211.12 138.20	4.12.30 4.12.33 4.13.29 4.13.59 4.14.56	6.30.15 (27th) 7.00.19 (27th) 6.40.30 (27th) 6.30.00 (27th) 7.00.35 (27th)	12.30.46 (29th) Not timed. 2.42.20 (29th) Not timed. Not timed.	32.18.16 — 34.28.51 — —
Sept. 21, 1885.	Genesta, Cutter. Dauntless, Schr.	Sir Richard Sutton, Bart. Caldwell H. Colt.	80.* 126.40	5.13.00 5.23.00	9.38.50 (23d) 1.24.00 (23d)	5.10.04 (23d) 11.16.42 (23d)	48.19.40 —
Aug. 11 and 15, 1886.†	Irex, Cutter. Genesta, Cutter.	J. Jameson, Esq. Sir Richard Sutton, Bart.	85.* 80.*	10 A.M., 14th August. 10 A.M., 14th August.		1.10.28 P.M., 15th August. 4.57.54 P.M., 15th August.	
Sept. 11, 1893.	Britannia, Cutter. Navahoe, Cutter.‡	Prince of Wales. R. Phelps Carroll.	151. 156.	12.01.06, 14th September. 12.02.05, 14th September.		10.37.35 (14th) 10.38.32 (14th)	

* English Tonnage.

The 1886 and 1893 races were from Cowes, round the Cherbourg Breakwater and return. Distance, 144 miles.

† Navahoe was awarded the Cup.

‡ Table to this point taken from "The American Yacht List," 1893.

THE CAPE MAY CUP RECORD OF RACES.

DATE.	YACHT.	OWNER.	TONNAGE.	START.	FIVE FATHOM BANK LIGHTSHIP.	FINISH.	TIME.
Oct. 10, 1872.	Dreadnaught, Schr. Palmer, Schr.	A. B. Stockwell. R. Stuyvesant.	240. 194.	4.57.50 4.59.55	3.26.00 4.30.00	9.03.30 (11th) 7.46.00 (11th)	25.05.40 26.45.05
Oct. 10, 1873.	Enchantress, Schr. Dreadnaught, Schr.	J. F. Loubat. A. B. Stockwell. S. J. Colgate.	311. — 191.26	12.13.00 Did not put in an appearance 5.09.50	— — 2.45.00	11.35.00 (15th) — 9.45.00 (6th)	— — 46.35.10
Sept. 4, 1877.	Idler, Schr. Dreadnaught, Schr. Rambler, Schr. Vesta, Schr.	C. J. Osborn. W. H. Thomas. S. M. Mills.	264.03 293.55 225.	5.10.11 5.11.00 5.08.25	Not timed. 2.57.15 —	— 12.14.00 (6th) 1.45.00 (6th)	— 43.03.39 44.34.00
Sept. 26, 1885.	Genesta, Cutter. Dauntless, Schr.	Sir Richard Sutton, Bart. Caldwell H. Colt.	80.* 126.40	3.57.15 3.58.20	3.35.23 10.10.00	10.11.55 (28th) 3.20.00 (29th)	42.11.55 50.20.00
Aug. 14 and 15, 1886.†	Irex, Cutter. Genesta, Cutter.	J. Jameson, Esq. Sir Richard Sutton, Bart.	85.* 80.*	10 A.M. (14th) 10 A.M. (14th)	— —	1.10.28 P.M. (15th) 4.57.54 P.M. (15th)	27.10.28 30.57.54
Sept. 12, 1889.	Wendur, Yawl. Irex, Cutter.	T. B. C. West, Esq. —	125.* —	11 A.M. Did not put in an appearance.	Cherbourg. 12.15 P.M. (13th) —	1.25.00 A.M. (14th) —	38.25.00 —
Sept. 15 and 16, 1893.	Britannia, Cutter. Navahoe, Cutter.	Prince of Wales. R. P. Carroll.	156. 151.	12.40.09, Sept. 15th. 12.48.59, Sept. 15th.		12.57.19, Sept. 16th. 1.39.32, Sept. 16th.	

* English Tonnage.

The 1886, 1889 and 1893 races were from Cowes, round the Cherbourg Breakwater and back. Distance, 144 miles.

† Table to this point taken from "The American Yacht List," 1893.

THE CAPE MAY CHALLENGE CUP.

The course for the Cape May Challenge Cup, presented to the club in 1872 by Ex-Commodore James Gordon Bennett, is established as follows:

From an imaginary line between the judge's steamer and Buoy No. 5, off Sandy Hook, to and around the Five Fathom Lightship, off Cape May, leaving it on the port or starboard hand at will, and back

challenge, and be prepared to sail a race over the same course within fifteen days from the receipt of such challenge, or forfeit the cup to the challenger; but should any yacht succeed in holding the cup in two consecutive races during one season, it will not again be liable to challenge until the commencement of the yachting season of the following year. The cup will become the *bona-fide* property of any yacht holding it successfully through three consecutive contests.

3d. The yachting season in American waters, in reference to this



THE CAPE MAY CHALLENGE CUP.—FIGURE 201.

to Sandy Hook Lightship, passing the same to the southward and eastward, within one hundred yards distance.

The cup will be awarded subject to the following conditions, as expressed in the letter of the donor:

1st. It is to be held by the winner for thirty days after the race, without liability to challenge.

2d. Upon the expiration of that period the winner must accept any

cup, is understood to be from the third Thursday in June until the third Thursday in October in each year.

4th. Should a yacht holding this cup be sold out of the New York Yacht Club, the cup shall not go with her, but shall be returned to the club to be again sailed for; and if the cup should be held by a foreign yacht, and she should be sold out of the club to which she belongs the cup shall not be sold with her, but shall be

TIME.

41.25.32
47.18.41

32.18.16

44.28.51

48.19.40

August.
August..

TIME.

25.05.40
26.45.05

40.35.10

43.03.30
44.34.00

42.11.55
59.20.00

27.10.28
30.57.54

38.25.00

pt. 16th.
pt. 16th.

returned to the NEW YORK YACHT CLUB to be sailed for again as above provided.

5th. In the event of the cup being held at the close of a season by a foreign yacht, the owner thereof will be liable to challenge during the season of the next year for an ocean race, over a course from the Needles, Isle of Wight, to and around a stake boat off the harbor of Cherbourg, and return.

Any yacht challenging the holder must deposit five hundred (\$500) dollars with the Regatta Committee, to be forfeited in case the challenging party is not successful in winning, otherwise to be returned to him. If forfeited, to be invested in a cup to become the property of the challenged party.

52 sec., beating schooner FORTUNA, Henry S. Hovey, 5 min., 18 sec.; sloop GRACIE, Joseph Earle, beating J. Busk's MISCHIEF, 9 min., 20 sec.; Peter Hansen, a sailor, lost overboard from sloop ANROW.

Third Race—James G. Bennett, Commodore, steamer NAMOUNA.

1881—August 9: Wind, light, W. & S. W.; course (46 m.) from Brenton's Reef Lightship to and around the buoy off north-east end of Block Island, thence to a stake boat half a mile off West Island and back to Lightship. Winners: schooner GRAYLING, L. A. Fish, 11 hrs., 48 min., 44 seconds, beating schooner VARUNA, G. H. B. Hill, 1 hr., 31 min., 50 sec.; cutter BENOIX,



THE GOELET CUP WON BY GLORIANA IN 1891.—FIGURE 202.

GOELET CUP RACES.

OFFERED ANNUALLY BY CAPTAIN OGDEN GOELET, OWNER OF THE SCHOONER YACHT NORSEMAN.

First Race—James D. Smith, Commodore, schooner ESTELLE. * 1882—August 8. Wind, S. W., fresh; course, from Fort Adams, Newport, R. I., to buoy off east end of Block Island and return. Winners: schooner MONTAUK, Samuel R. Platt, time, 5 hrs., 35 min., 39 sec.; beating schooner HALCYON, Charles J. Paine, 11 min., 59 sec.; cutter FANNY, Prince and Whitely; time, 6 hrs., 08 min., 35 sec., beating cutter OLIVA, C. Smith Lee, 1 min., 49 sec.

Second Race—James D. Smith, Commodore, schooner ESTELLE. 1883—August 6: Wind, W. by N., fresh; course, Brenton's Reef Lightship to and around Sow and Pigs Lightship and return. Winners: schooner MONTAUK, S. R. Platt; time, 3 hrs., 52 min.,

* From "Who Won."

Archibald Rogers, 19 hrs., 16 min., 40 sec., beating cutter ILEEN, E. M. Padelford, 7 min., 17 sec.

Fourth Race—James G. Bennett, Commodore, steamer NAMOUNA.

1885—August 3: Wind, E. S. E., a reefing breeze, with rough water; course, from Beaver Tail buoy to and around Sow and Pigs and Hen and Chickens Lightships and return. Winners: schooner FORTUNA, Henry S. Hovey, 5 hrs., 45 min., 56 sec., beating schooner MONTAUK, J. E. Brooks, 2 min., 38 sec.; sloop PURITAN, J. Malcolm Forbes et al., 5 hrs., 32 min., 30 sec., beating sloop PRISCILLA, J. G. Bennett and W. P. Douglas, 11 min., 40 sec.

Fifth Race—Elbridge T. Gerry, Commodore, steamer ELECTRA. 1886—August 7: Wind, E., light, freshening, with rain at finish; course, Beaver Tail to Sow and Pigs and Hen and Chickens Lightships, and finish at Brenton's Reef Lightship—45 miles.

Winners: schooner GRAYLING, L. A. Fish, 4 hrs., 42 min., 32 sec., beating schooner MONTAUK, J. E. Brooks, 7 min., 17 sec.; sloop MAYFLOWER, Chas. J. Paine, 4 hrs., 31 min., 44 sec.; beating sloop PURITAN, J. Malcolm Forbes, 4 min., 41 sec.

Sixth Race—Elbridge T. Gerry, Commodore, steamer ELECTRA. 1887—August 5: Wind, S. E., light, course, Beaver Tail to Sow and Pig and Hen and Chickens Lightships, and finish at Brenton's Reef Lightship. Winners: schooner SACHEM; Jesse Metcalf and Charles D. Owen, 5 hrs., 16 min., 18 sec.; beating schooner IROUOIS, T. J. Coolidge, Jr., 6 min., 4 sec.; sloop VOLUNTEER, Chas. J. Paine, 4 hrs., 54 min., 2 sec.; beating sloop MAYFLOWER, 8 min., 39 sec.; PURITAN 3rd, 5 hrs., 03 min., 40 sec.

Seventh Race—Elbridge T. Gerry, Commodore, steamer ELECTRA. 1888—August 10: Wind, N. E. to S. W., mild, regular course, 39 miles. Winners: schooner SACHEM, Metcalf and Owen, owners,

Brenton's Reef Lightship, S. W. to Block Island buoy, to West Island stake boat, to finish. Winners: schooner VOLUNTEER, 5 hrs., 30 min., 9 sec., beating IROUOIS; GLORIANA, 5 hrs., 44 min., 02 sec., beating BARBARA.

Eleventh Race—Elbridge T. Gerry, Commodore, steamer ELECTRA.

1892—August 5: Wind and course same as in 1891. Winners: schooner MERLIN, 6 hrs., 15 min., 04 sec., beating MARGUERITE; sloop WASP, 5 hrs., 51 min., 13 sec., beating GLORIANA.

THE GOELET CUP FOR SCHOONERS.

The Goelet Cup which is herewith illustrated, is a silver love cup, oxidized. It is fourteen inches high. Throughout, the cup is a decorative embodiment of the sea and its accompaniments, cleverly wrought into a harmonious design.

Under the wavy rim is the inscription "Goelet Cup, 1891," in

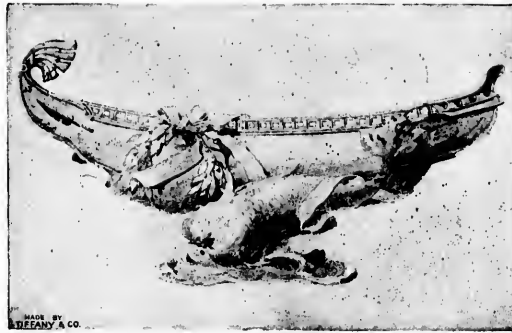

GOELET CUP SCHOONER PRIZE (1892) WON BY MERLIN.—FIGURE 203.

27 min., 12 sec.; beating schooner GRAYLING 2 min., 29 sec.; sloop VOLUNTEER, Charles J. Paine, 8 hrs., 20 min., 37 sec.; beating the sloop KATRINA 12 min., 2 sec.

Eighth Race—Elbridge T. Gerry, Commodore, steamer ELECTRA.

1889—August 9: Wind, S. W., strong; triangular course, 37 miles, Brenton's Reef Lightship to Block Island, West Island and return. Winners: schooner SEA FOX, A. Cass Canfield, 4 hrs., 55 min., 26 sec.; beating schooner GRAYLING, 5 min., 57 sec.; sloop TITANIA, C. O. Iaelin, 4 hrs., 58 min., 50 sec.; beating sloop KATRINA 2 min., 19 sec.

Ninth Race—Elbridge T. Gerry, Commodore, steamer ELECTRA.

1890—August 1: Wind, light, S. E. by E. first, E. S. E., fresh, last; course, 39 miles, Brenton's Reef Lightship to Vineyard Sound Lightship, to Hen and Chickens Lightship, to starting point. Winners: schooner MAYFLOWER, beating MERLIN; sloop VOLUNTEER, 4 hrs., 55 min., 49 sec.; beating PURITAN, 31 min., 13 sec.

Tenth Race—Elbridge T. Gerry, Commodore, steamer ELECTRA.

1891—August 7: Wind, S., light first, fresh, last; course, 37 miles,

* For the description we are indebted to the "Jewelers' Circular" of N. Y.

letters of almost wild design on the body of the cup, which is chased to represent a mass of swirling water, and four mermaids clad in robes of seaweed. The motion of the water is excellently carried out. Near the foot on either side two winged dolphins leap from the water and touch at the neck of the cup, thus forming the handles. Upon their breasts are emplacements of shells giving a highly marine effect. Around the foot of the cup a decoration of entwined shells and seaweed is applied.

In general outline the cup is beautiful, and original as well, the whole reflecting great credit upon Tiffany & Co., its makers.*

The Goelet Cup for schooners (1892) will be seen to be in the shape of a center piece. It is solid silver, † 26 inches in length and weighs 235 ounces. The design is bold and handsome. A Roman galley rests upon the backs of two large dolphins, and on the side of the ship is tied a wreath of laurel, the ends of which knot, and running through the wreath, afford a space for the name of the winning yacht. The most elaborate work marks the whole of the ornamentation and finish. It was made by the well known firm of Tiffany & Co.

† For the description we are indebted to the "New York Herald" July 31, 1892.

THE GOELET CUP FOR SLOOPS.

The Goelet Cup for sloops (1892) is in its general outline of the Greek vase shape.* On the body of the vase is etched in relief a

a conch shell in the other is proclaiming the victor. The handles of the vase are made up of dolphins. Around the lower part of the body of the vase is introduced the conventional treatment of the



GOELET CUP SLOOP PRIZE, 1892, WON BY HARRISON.—FIGURE 204.

picture suggesting the classical idea of water gods and nymphs. The central figure holds an ancient anchor in one hand, and through

*See "N. Y. Herald" July 31, 1892.

palm branch and trident, while thrown carelessly over the neck is a bold laurel wreath, the whole producing the prettiest and most artistic effect. The winner's name was placed on the reverse side.

THE LARCHMONT CUP FOR 1892.

This cup was made by the Whiting Mfg. Co., of New York for the wind up of the racing season of 1892. It is a two-handled loving cup, 19 inches in height with the ebony pedestal, and 14 inches in width at the broadest part. This cup is a marvel in originality and consistency of design. The design in *ensemble* gives a vivid im-

exultingly displays the signal of the LARCHMONT YACHT CLUB. The figure is perfectly modeled, while the drapery clings to her, wet with salt water, and her hair long and wild waves in the sea breezes. Toward the right of the front is the seal of the club, while above the figure is the name of the trophy in beautifully etched letters: "The Larchmont Cup of 1892." The handles are quite original. The fibres are bound with seaweed, which at the juncture merges



THE LARCHMONT CUP.—FIGURE 205.

pression of the motion of water. The outline of the cup itself is a water movement. The wild, twining, floating seaweed which forms the ground of the decoration is full of life. This seaweed effect is a fine example of chasing. The main feature of the decoration is the sea nymph riding the mythical dolphin, while above the waves she

harmoniously into the body of the cup. The nymph and the dolphin are light-oxidized, producing a shadow on the water, such as a passing yacht would cast. It was pronounced by many connoisseurs the finest loving cup they had ever seen.*

*Description from "Jeweler's Circular."

handles of
art of the
ent of the

the neck is a
most artistic
le.

COMMODORE'S CUP.

The Commodore's Cup is a large silver pitcher, 34 inches in height, including the ebony base. Seated upon the upper swell of the body is the figure of the lost Pleiad, Electra, looking for her sisters. This figure is in itself a work of art, and would reflect credit upon any

and leaves of the marguerite artistically conventionalized, forming the handle, which at the center of the body forms a large bud, whence the stems split and swirl about in spirals on the side of the body, terminating in three large flowers and a bud. The decoration of the base is conventional, while that about the neck, which forms into a water movement toward the rim, is a beautiful combination of



THE COMMODORE'S CUP, WON BY MARGUERITE.—FIGURE 206.

professional sculptor. She holds in one hand a wreath to be given to the winner of the race.

The general character of the piece is Louis XVI; the cost being \$1,000. The whole piece is the embodiment of graceful lines. Starting from and uniting with the neck is a collection of the stems

marguerite leaves and stems. The entire ground of the piece is bright finished, the matt finish of the flowers bringing them out with fine effect. The figure is lightly oxidized. Altogether, the Whiting Mfg. Co. is deserving of the highest praise for this production.*

* Description from "Jewelers' Circular."

THE GERRY CUP.

The cup presented to the NEW YORK YACHT CLUB by Commodore Gerry in 1892, herewith illustrated, is a specimen of typical Greek

art, the twisted hair of Poseidon and Amphitrite being twisted together. Poseidon married Amphitrite, who thereby became the goddess of the sea.

The border of the cup, which gives a crown effect on both sides, is a Greek water movement. In the centre above Poseidon is a tri-



THE WASP TROPHY, OBVERSE AND REVERSE SIDES.—FIGURES 207 AND 208.

art. It is 20 inches in height exclusive of the pedestal, and is in the form of a Greek rhyton, bearing on the obverse side the head of Poseidon, and on the reverse that of Amphitrite, both in repoussé. The handles of the cup are formed of the hair of the god and god-

dent, while above Amphitrite are shown two sea horses with which the goddess rode the sea. The twisted hair forming the handles flows under the chins with wild water effect. The inscription is in the main the same as that on the Marguerite Cup.

* Description from "Jewelers' Circular."

NEW YORK YACHT CLUB TROPHY FOR CLASS D.

This trophy is in the form of a solid silver urn, about 12 inches high and the same in circumference. The base is conventional, the

of the trophy. On the front of the urn is an etching of the victorious yacht, circled with a wreath of seaweed, and having at the top a waving ribbon with the words "NEW YORK YACHT CLUB, 1892." The handle represents an elongated dolphin with a double twisted



THE NEW YORK YACHT CLUB TROPHY FOR CLASS D. WON BY VIATOR—FIGURES 209 AND 210.

sea shells and marine plants represented being in repoussé work. From a symmetrically formed shell the urn rises and swells outward until the shoulder is reached, where the neck supports a gracefully formed and artistically chased shell which acts as the neck and spout

tail. Resting as if it had been placed over the neck of the urn is a laurel wreath. The workmanship of the trophy is of a very high order. It was designed and made by the Gorham Mfg. Co.

* Description from "Jewelers' Circular."

TROPHY WON BY WASP.

In the conceiving of trophies in silver for yacht races the ideas of designers have principally hovered over cups, vases and bowls, till human ingenuity in this connection seems almost to have expended itself. Whiting Mfg. Co., New York, however, conceived of a design for a trophy which was awarded WASP in 1892; that is a complete departure from anything before embodied in a production of its class. This trophy is a drinking horn of silver and ivory.

The Fourth Annual Sweepstakes Race given by the CORINTHIAN YACHT CLUB of New York was for the 46-footers, and it was sailed on August 22, 1892, off Newport. There were only three starters, owing somewhat to the lateness of the season, these being

horn is 20 inches in height, 27 inches in length and 6 inches in diameter at the top. It rests in sockets on a stand, and can be easily removed when required for use. The stand, the horn and its covers are of silver, while the upper part for about 8 inches is of ivory, which has been most artistically colored and etched, one side displaying the necessary inscription as seen in the illustration, and the other the picture of the victor, WASP. The piece of ivory used for the purpose is unusually large, and great care was taken in its selection. The delicate coloring produces the effect of old ivory, and is an admirable example of this class of work. The chasing of the silver is in a peculiar style of interlacing bands, suggesting water movements, with scrolls which terminate in fanciful and grotesque



TROPHY WON BY WASP 1892.—FIGURE 211.

WASP, owned by Archibald Rogers, GLORIANA and HARPOON. WASP won, HARPOON being second and GLORIANA third. The race made WASP the indisputable champion of her class. The CORINTHIAN club prizes for their sweepstakes races have always been of such handsome and unique designs and fine workmanship as to excite universal admiration. The WASP trophy, the drinking horn referred to and illustrated in Fig. 211, is no exception. It was made by the Whiting Mfg. Co.

The trophy is a faithful reproduction of the drinking horns of the Viking age in the matter of shape, but that, happily, is all that will remind the owner of the prize of the tough old Norse pirates. The

heads of sea-horses, dolphins, swordfish and other marine wonders found on the greater portion of Viking relics. The trophy weighs 122 ounces, is lightly oxidized and superbly finished throughout.

The horn, besides being a remarkable example of silversmithing and an object of ornamentation, will be found to be useful. The cover can be easily removed, and the inside to a depth of about eight inches is lined with silver; so, there being plenty of room for a "bottle" and the necessary ice, it may be handed around in the same satisfactory manner as the old Norse pirates passed around their horns in the days of yore.*

* Description from "Jeweler's Circular," June 11, 1893.

THE PUNCH BOWL FOR THE U. S. S. "NEW YORK."

The punch bowl presented to the U. S. S. NEW YORK by the members of the NEW YORK YACHT CLUB is a most beautiful and thoroughly artistic affair. The bowl is fifty-three inches in circumference and, with its pedestal, fourteen inches in height. Rising

with this inscription in relief "U. S. S. NEW YORK, from THE NEW YORK YACHT CLUB, May 19th, 1892."

Between the prows are four seals, one to each quarter: the present and former seals of the NEW YORK YACHT CLUB, the coat of arms of New York and the coat of arms of the United States. This gift was



THE PUNCH BOWL FOR THE U. S. S. NEW YORK.—FIGURE 212.

from the base, with its open work representing the rolling waves, are four prows, whose graceful curves suggest the racing yacht of to-day. Each of these prows is surmounted by an American eagle, with outstretched beak and wings. Around the top of the bowl runs a ribbon,

designed and made by the Whiting Mfg. Co., and it would be indeed difficult to find a piece of workmanship more elegant in its simplicity, or more patriotic in its significance.*

* Description from "Jeweler's Circular."

GERRY TESTIMONIAL CUP—1893.

At a meeting of the NEW YORK YACHT CLUB after the retirement of Mr. Elbridge T. Gerry as Commodore—the new Commodore, E. D. Morgan, moved that a piece of silver be presented by the club to Ex-Commodore Gerry in appreciation of his long and valuable services as

Upon the front is the inscription: "THE NEW YORK YACHT CLUB to Elbridge T. Gerry, in recognition of his services as Commodore from 1886 to 1892." It has two handles and a cover, which is surmounted by the figure of Victory rising fully eight inches above the lid, making the total height of the cup over 24 inches. The modeling of this figure, the graceful pose, standing and bal-



GERRY TESTIMONIAL CUP (1893).—FIGURE 213.

chief flag officer. Dr. Morris J. Asch, Mr. Frederick W. Vanderbilt and Mr. W. E. Iselin were appointed to take the matter in hand.

The testimonial illustrated above is in the form of an elaborate loving cup, which was designed by Tiffany & Co., and is regarded as one of the handsomest nautical cups made during the present season.

• Description from "N. Y. Mail and Express," August 19, 1893.

ancing herself on the right foot, the left arm raised above the head, the right outstretched about to award the laurel wreath held in her hand, are all marvels of exquisite workmanship, every curve of which reveals the artist's touch.

The general style of the cup is Roman. The handles are ornamented with clinging sea urchins twining garlands of seaweed around

THE NEW
e present
f arms of
gift was

be indeed
simplicity,

the handles. Upon the front of the body of the cup is an etching of Mr. Gerry's steam yacht, *ELECTRA*. This is another fine piece of work. Upon the opposite side is the inscription quoted above. Seaweed, shells and other appropriate ornamentation complete the decorative features. The body of the cup stands 16½ inches high, the figure 8 inches more, and the whole weighs 165 ounces.

piece of silver work* in a style suggesting the Louis though in itself entirely original.

Its main feature is that of a mermaid of most graceful form, entwined with dolphins and other insignia of the sea, upholding a large and beautiful shell which forms a bowl of usefulness and grace. On each side of the shell is a plaque-like shield on one of



THE GOELET PRIZE FOR SCHOONERS (1893) WON BY VOLUNTEER.—FIGURE 214.

The testimonial was presented on Wednesday, August 16, 1893, while the Ex-Commodore was watching the work of the cup-defenders from the flagship *MAY*. Commodore Morgan made a very pleasant speech in making the presentation, and Ex-Commodore Gerry briefly thanked the members of the club for the gift.

THE GOELET CUPS FOR 1893.

The \$1,000 Goelet Cup for schooners (1893), is a large and artistic

which is the title of the piece, "Goelet Prize for Schooner Yachts, 1893," the other being left vacant for the name of the winner. These are surrounded by beautifully chased wreaths of laurel. The meaning of the design is, "True rejoicing on the sea." The cup stands 23 inches high and weighs 418 ounces. It reflects great credit on Tiffany & Co., the makers.

* See "Jewellers' Circular," Aug 10, 1893.

THE GOELET CUP FOR SLOOPS.

The \$500 Goelet prize for sloops (1893) is a wine cup of silver, and in design is quite a departure from the general run. It is of an old

selves lightly to the upper part of the neck. The handles give the cup a strong suggestion of its use. On each side of the piece is a shield, the border of which is formed by two mermaids whose



GOELET CUP FOR SLOOPS (1893), WON BY COLONIA.—FIGURE 215.

Roman period.* One of the most striking features of these cups is the peculiar character of the handles, which seem to come with grace and boldness from the body of the piece and attach them-

* See "Jewelers' Circular," Aug. 10, 1891.

entwined tails form the lower part of the escutcheon. This is all in raised work chased. On the shield, under full sail, is a sloop yacht etched in an artistic manner. The height of the cup is 15 inches and its weight 232 ounces. It was made by Tiffany & Co.

THE MORGAN CUP, NO. 1.

The Morgan Cup No. 1 was presented by Commodore Morgan, of the NEW YORK YACHT CLUB. It is a silver vase* of strictly classical character, being in shape and ornamentation purely Grecian. It

the victors of the day. Under this and a little to the right, is the Greek word "Nike," victory. The ornamentation introduced on the lower part of the body of the piece is composed of palm branches and tridents with the Greek conventional water border. Around the neck is the laurel wreath. The meaning of the design



MORGAN CUP, No. 1 (1893), WON BY ARIEL.—FIGURE 216.

has around the upper part of the body a frieze composed of a number of sea gods, nymphs, mermaids and the like, all with their sea horns, shells and trumpets to their mouths sounding the notes of praise to

* See "Jewelers' Circular" Aug. 16, 1893.

is "Victory on the sea." The ivy on the foot bespeaks friendship. The name of the victor, ARIEL, is inscribed on the side of the piece. The height of the vase is 17 inches and it weighs 129½ ounces. It was made by Tiffany & Co.

THE MORGAN CUP, NO. 2.

Morgan Cup No. 2 (1893) was also presented by Commodore Morgan, and is a vase of graceful form,* in (Greco-Roman style. Upon

of a truly classical nature—a true work of art rather than one of a nautical character. It is a specimen of most perfect repoussé work. On the outside of the light and graceful handles are introduced the laurel branches of victory. The borders around the neck and foot



MORGAN CUP, No. 2 (1893), WON BY COLONIA.—FIGURE 217.

the side of the body of the piece is a group composed of Venus and Cupids with the arrows, the bows, the rose wreath and the doves. This piece was designed and made with a view of producing a trophy

* See "Jewelers' Circular," Aug. 16, 1893.

ure of ivy, treated in the peculiar manner and shape of the period. The ivy leaf of this particular time and for certain uses was represented as heart shaped. The height of this vase is 19½ inches, and its weight 92 ounces. It was made by Tiffany & Co.

THE ASTOR CUP FOR SLOOP.

One of the Astor prize cups (1893) is illustrated below. It is about 9 inches in height and 17 inches in diameter and weighs 196 ounces. It is a true nautical* design, being thickly covered in a most pleasing manner with seaweeds and shells, with which is introduced on both sides in a most masterly style of etching the wording explanatory of the nature of the prize. The handles are formed of two demi-figures of the sea blowing the shell-like trumpets of reward. On one side of the cup are the words, "Astor Cups won by VIGILANT."

value of \$600 each, to be sailed for on Tuesday, July 25th, Thursday, July 27th and the third race, if necessary, on Saturday, July 29th. The race to take place off Newport, and the cups to be open to sloops of the New York Yacht Club, reserving to myself the right to admit any foreign yacht then in our waters to compete.

"The course for each race to be a quadrilateral triangle, each leg of which is to be ten knots, and the first leg to windward if possible. The racing rules and time allowance of the New York Yacht Club to govern, except that the race must be sailed in six hours.

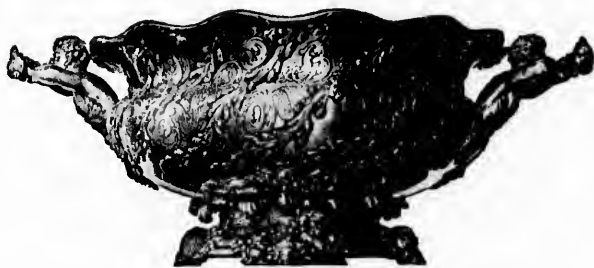

THE ASTOR PRIZE CUP FOR SLOOP. NEW YORK YACHT CLUB, 1893. WON BY VIGILANT.—FIGURE 218.

On the other side are the words, "Newport, Rhode Island, 1893."

The letter of Mr. Astor presenting the cups for competition is as follows:

"ESTATE OF WILLIAM ASTOR,
"No. 23 WEST TWENTY-SIXTH STREET,
"New York, Feb. 2, 1893."

"Commodore GERRY, N. Y. Y. C.:

"DEAR SIR—I desire to present for competition two cups, of the

* See "Jewelers' Circular," Aug. 16, 1893.

"The conditions are as follows:—The winner of the first day's race to take one cup, and the winner, second and third boats shall compete in the second race for the other cup. In the event of the second cup being won by the boat which was second or third in the first day's race there shall be a third race between these two boats (heat winners), and the winner of the third race shall take both cups.

"Sincerely yours,

"J. J. Astor."



ASTOR CUP, No. 2, (1893) WON BY VIGILANT.—FIGURE 219.

ASTOR CUP NO. 2.

Astor Cup No. 2 (1893) is of the loving cup form, but having two handles instead of three. The handles* and the foot are beautifully chased, the ornament being entirely composed of all things

*See "Jewelers' Circular," Aug. 16, 1893.

nautical—the heads of dolphins, sea monsters, shells and seaweeds. On the body of the piece is an etching of the yacht race with the words, "Astor Cup, Rhode Island, 1893." The cup stands nearly 15 inches high and weighs 150 ounces.

Thursday,
y 29th. The
loops of the
admit any

each leg of
if possible.
ACHT CLUB

the first day's
d boats shall
event of the
r third in the
ese two boats
all take both

Astor."

COMMODORE CALDWELL B. COLT'S CUP.

The Commodore's Cup for the first class sloops is in the form of a caravel, the long, sweeping lines of which the artists have taken the

The graceful figure of Victory at the extreme end of the prow stands ready to give to the victors the prize. The keel of the caravel forms itself into four feet, made up of handsome shells, seaweed and



COMMODORE COLT'S CUP.*—FIGURE 220.

excellent opportunity afforded to decorate. The sides of the trophy show mermaids in inspiring poses, urging on a trio of sea horses in a chase for supremacy.

*Courtesy of "Who Won?" Publishing Co.

similar typical embellishments, making an appropriate decoration of the rear of this beautiful cup.

It is 28 inches long, and the figure of Victory is 20 inches above the table.

THE COLUMBUS CUP.

The condition of the deed of gift of the Columbus Cup is that it shall always remain the property of the SHELTER ISLAND YACHT CLUB, shall be raced for three consecutive years by the three classes of

MAHA, while the opposite side is left blank for engraving the names of the winners thereon. On the bottom is the following inscription:

"The gift of Eben Norton Horsford to the SHELTER ISLAND YACHT CLUB, August 3, 1892. The four hundredth anniversary of the departure of Columbus from Palos, August 3, 1492."

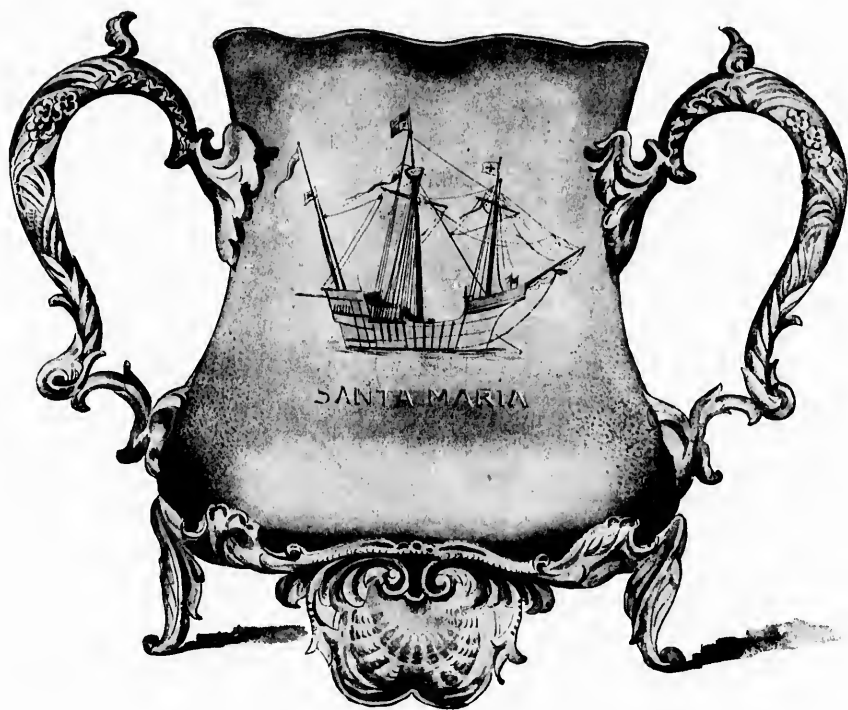

COLUMBUS CUP—FIGURE 221.

cat-boats enrolled in the club, the date of the race to be August 3rd. The winner in each class to be engraved on the cup.

This cup is solid silver, 6 1-2 inches high, 6 inches in diameter, loving cup design. On one side is an engraving of SANTA

Winners so far are:

1892—PIGEON, Class 1.
CURLER, Class 2.
MENDOTA, Class 3.

1893—MYRTLE, Class 1.
ÆOLUS, Class 2.
MENDOTA, Class 3.



AMERICAN YACHT CLUB (RYE), INTERNATIONAL CHALLENGE CUP (1893) FOR STEAM YACHTS.—FIGURE 222.

AMERICAN YACHT CLUB (RIVE) INTERNATIONAL CHALLENGE CUP
FOR STEAM YACHTS.

RULES AND REGULATIONS.

Any organized yacht club of a foreign country, incorporated, patented or licensed by the legislature, admiralty or other executive department, having for its annual regatta an ocean watercourse on the sea or on the arm of the sea, or one which combines both, shall always be entitled, through one or more of its members, to the right of sailing a match for this cup with a yacht propelled by steam, with or without the aid of sails, constructed in the foreign country aforesaid, against any one or two yachts constructed in the country of the club holding the cup.

The challenging party shall give six months' notice, naming the day for the proposed race, which day shall not be later than seven months from the date of the notice.

The parties intending to sail for the cup may by mutual consent, make any arrangement satisfactory to both as to the date, course, time allowance, number of trials and any other conditions of the match, in which case also the six months' notice may be waived.

In case the parties cannot mutually agree upon the terms of the

match, then the challenging party shall have the right to contest for the cup in one trial sailed over the usual course of the annual regatta of the club holding the cup, subject to its rules and sailing regulations.

Accompanying the six months' notice there must be a Custom House certificate of measurement.

No vessel which has been defeated in a match for this cup can be again selected by any club for its representative until after a contest for it by some other vessel.

Vessels intending to compete for this cup must proceed on their own bottom to the port where the contest is to take place.

Should the club holding the cup be for any cause dissolved, the cup shall be handed over to any yacht club of the same nationality it may select, which comes under the foregoing rules; and in case there should not exist any such other club, then the cup shall be returned to its original owners, the AMERICAN YACHT CLUB, or in accordance with its directions.

It is to be distinctly understood that the cup is to be the property of the club, and not of the owners of the vessel winning it in a match, and that the condition of keeping it open to be sailed for by organized yacht clubs of all foreign countries upon the terms above stated, shall forever attach to it, thus making it perpetually a challenge cup for friendly competition among nations.

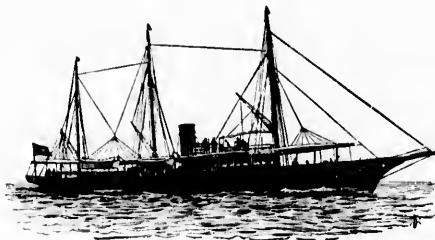



THE WELD CUP (1893).—FIGURE 223.

THE WELD CUP, 1893.

This magnificent cup was presented to the EASTERN YACHT CLUB,

to be competed for by the large schooner class of 75 feet waterline, by the widow of the late William F. Weld, out of respect to the memory of her husband. The cup was won by MAYFLOWER.

THE QUEEN'S CUP.

Her Majesty, the Queen, having graciously presented a valuable challenge cup on the petition of the ROYAL CANADIAN YACHT CLUB, to be competed for annually by yachts belonging to Canadian yacht clubs, such competition to take place on Lake Ontario, in the province of Ontario, the following are the terms and conditions under which it shall be sailed for:

Only such yachts as are *bout-fide*, owned in Canada and belonging to a Canadian yacht club, with a membership of not less than (50) fifty, all the owners of which are British subjects or permanent residents of Canada, and members of a Canadian yacht club, shall be entitled to compete for the cup.

Yachts competing for the cup shall be divided into three (3)

auspices of the club which shall have held the cup in the preceding year.

Subsequent races for the cup shall take place under the auspices of the home club to which the winning yacht belongs, in her respective class; provided that if a yacht belonging to a club situate on the Bay of Quinte shall win the cup such club shall have the right to name the port on Lake Ontario where the next race in the same class shall be sailed, and shall be responsible for the management and expense of the same.

The course, in all cases, shall be an open lake course, triangular, and on Lake Ontario, of 30, 20, and 25 nautical miles, according to the respective classes, and so laid out that once round the triangle shall be half the length of the course.



THE QUEEN'S CUP.—FIGURE 224.

classes, and it shall be sailed for annually, as follows:

FIRST YEAR.—Yachts over 40 feet and not exceeding 70 feet corrected length. Shall be sailed at Toronto, under the auspices of the ROYAL CANADIAN YACHT CLUB.

SECOND YEAR.—Yachts of 30 feet corrected length and under. Shall be sailed at Hamilton, under the auspices of the ROYAL HAMILTON YACHT CLUB.

THIRD YEAR.—Yachts over 30 feet, up to and including 40 feet corrected length. Shall be sailed at Kingston under the auspices of the KINGSTON YACHT CLUB. Sailed at Hamilton, as the KINGSTON YACHT CLUB had disbanded.

Provided, that if there be no qualified club at Hamilton or Kingston, at the time above appointed for the contests at those respective places, or if a club holding the cup at any future time should disband, the race which should be held under the auspices of such disbanded club shall for that year be held at the port and under the

All races shall be started at 10 o'clock A. M., and finished by 8 o'clock P. M.

The race to be sailed annually on Dominion Day (the first of July). In the event of this falling on a Sunday, to be sailed on whatever day shall be declared by Royal Proclamation or by statute to be the legal holiday.

The time allowance and sailing rules shall be those of the LAKE YACHT RACING ASSOCIATION, subject to such alterations as they shall make from time to time. Each race to be under the management of the local committee of the club under whose auspices it is held.

The ROYAL CANADIAN YACHT CLUB shall be the custodian of the cup, to whom a bond, to be approved by the Committee of Management of the ROYAL CANADIAN YACHT CLUB, shall be given for its safe return on the first day of June following each race, said bond to be for the sum of one thousand dollars, and in the event of any

club presenting a medal to commemorate the winning of the cup, the value shall not exceed twenty-five dollars.

These rules and regulations shall be subject to change from time to time by and with the consent of his Excellency the Governor-General, upon representation being made by one or more clubs.

These rules appear to me to carry out very fairly the result of our discussion at Toronto, in 1891, with the representatives of the yacht clubs concerned.

Approved, May, 1892.

Signed,

STANLEY OF PRESTON,
Governor-General

RECORD.

First Race at Toronto, 1891
Second " at Hamilton, 1892
Third " at Hamilton, 1893

Winner VIEGA,
" NANCY,
" ZELMA.



THE SAN FRANCISCO YACHT CLUB CUP.—FIGURE 225.

THE LELAND CORINTHIAN CHALLENGE CUP.
(INSTITUTED 1889.)

SEAWANAHKA CORINTHIAN YACHT CLUB:—

§ 1. The contests for the possession of this cup shall be open to members of the SEAWANAHKA CORINTHIAN YACHT CLUB only.

§ 2. All contests shall be governed by the racing rules and time allowances, and shall be under the direction and control of the Race Committee of the SEAWANAHKA CORINTHIAN YACHT CLUB, except that winners shall not be amenable to Rule 12 of the racing rules.

§ 3. The Race Committee shall announce at the beginning of each season the class to which contestants shall be confined during the season, and the first contest in each season shall take place in the Annual Corinthian Race. In the event of but a single entry in such class in the Annual Corinthian Race, the Committee shall have power, previous to starting such race, to offer the cup for contest in another class, in which case contestants shall be confined to that class during the remainder of that season.

§ 4. The Race Committee shall have power to name the course to be sailed over in every contest subsequent to the first one in each season, and all such subsequent courses shall be of the same length as the club course for the class, but the holder and challenger may mutually agree upon any course of not less than the stated length, subject to the approval of a flag-officer or any two members of the Race Committee.

§ 5. If a contest is arranged to take place away from the waters of New York during a Club Squadron Cruise, the flag-officer in command shall, in the absence of any members of the Race Committee appoint one or more judges to take charge of the contest.

§ 6. The holder of the cup shall be subject to challenge during the season ending October 15th in each year by any yacht in the same class, and not more than ten days' notice of challenge shall be required by the holder.

§ 7. The challenger shall give due notice to the chairman of the Race Committee of the day agreed upon for the contest.

§ 8. The winner of three successive contests in the same season shall have the privilege of declining any further challenge during the remainder of that season.

§ 9. A prize, recording the names of the competitors, will be given by the club to the winner in each contest.

§ 10. The holder of the cup at the end of each season shall retain possession until the opening of the following season, when the cup shall be returned to the club through the chairman of the Race Committee, and the holder shall be responsible for the safe keeping of the cup while it remains in his possession.

§ 11. The trustee of the club shall have power to modify the special conditions attaching to the cup, excepting between May 15th and October 15th of each year.

THE ALFRED ROOSEVELT MEMORIAL CUP.
(INSTITUTED 1893.)

Endowed by Mrs. James A. Roosevelt, of New York, as a memorial of her eldest son who was one of the twelve founders of the club.

The deed of trust, under which the principal of the fund is held by the treasurer of the club as trustee, provides that the club shall offer every year as a prize in a race, the class, terms and conditions of which shall be determined by its Race Committee for the time being, a cup of the value of not less than seventy-five dollars, to be delivered to the winner upon compliance by him with the rules and regulations of the club then in force concerning prizes and prize-winners.

This class, terms and conditions of the race for this year will be

announced by the Race Committee in a printed circular which will be sent to members in June.

EASTERN YACHT CLUB.—PURITAN CUP.

The Gulet Cup won by PURITAN, August 3, 1885, is, by deed of gift of her original owners, awarded each year to the yacht belonging to the club making the best corrected time over the course in the Annual Regatta, to be held by her owner until the next Annual Regatta; and the name of the said yacht is to be inscribed upon the cup.

PHILADELPHIA YACHTING SOCIETY.—THE MIDDLETON CUP.

For First Class sloops. To become the absolute property of the yacht winning it three years in succession, provided at least six first class yachts are enrolled in the club.

WON BY.

Ventzia,	June 9, 1886,
Ventzia,	June 13, 1887,
Restless,	Sept. 28, 1888,
Nanon,	June 21, 1890,
Ventzia,	June 9, 1890,
Nanon,	June 15, 1891,
Nanon,	June 4, 1892,
Nanon,	June 5, 1893

THE ELIAS CUP.

To the yacht making the fastest time, irrespective of class or time allowance.

WON BY.

Ventzia,	June 9, 1886,
Ventzia,	June 13, 1887,
Ventzia,	Sept. 28, 1888,
Ventzia,	June 21, 1890,
Ventzia,	June 9, 1890,
Nanon,	June 15, 1891,
Nanon,	June 4, 1892,
Yvette,	June 5, 1893.

THE MEDANIEL CUP.

For Third Class sloops. To become the absolute property of the yacht winning it three years in succession.

WON BY.

Narina,	June 9, 1890,
Narina,	June 15, 1891,
J. S. M.	June 4, 1892,
Weona,	June 5, 1893.

ST. LAWRENCE YACHT CLUB.

The cup given by the Honorary Commodore shall be sailed for by "A" Class.

The cup given by the Commodore shall be sailed for by 30 foot Class.

The cup given by the Vice-Commodore shall be sailed for by 21 foot Class.

The cup given by Rear-Commodore shall be sailed for by 18 foot Class.

The cups given by the club shall be sailed for by Skiff Classes.

Cups will be given by the club for second place and prize pennants to the first, second and third boat in each class series race. The first prize pennant will have the club's device in black on a yellow field, the second prize pennants the club's device in blue on a red field, and the third prize pennants the club's device in red on a blue field. Money prizes will be given to the first, second and third boat in the steam yacht race.

SIR DONALD A. SMITH'S CHALLENGE CUP—RACING RULES

§ 1. The cup shall be a perpetual Challenge Cup to be sailed for annually on Dominion Day, under the rules of the St. LAWRENCE

by the club to the yacht, when the cup is returned to the club.

§ 3. The races for the cup to be open to the yachts of the St. LAWRENCE YACHT CLUB of "A," 30 and 25 foot classes. Sailing length as defined by Rule III.



SIR DONALD A. SMITH'S CHALLENGE CUP—FIGURE 226.

YACHT CLUB.

§ 2. The cup may be held by the yacht winning it until the first day of June following—a satisfactory bond being given to the committee for its safe return. A commemorative medal shall be given

§ 4. The course for the cup races to be over the St. LAWRENCE YACHT CLUB course as decided each year.

§ 5. All disputes shall be decided by the Sailing Committee of the club—for this purpose not less than five members being a quorum.

THE FISHER CHALLENGE CUP.

This cup is a solid silver emblem valued at \$500, and was presented by Hon. W. J. Fisher on July 8, 1882, to the CHICAGO YACHT CLUB, as a challenge cup open to competition by sloops belonging to any regularly organized yacht club on the great lakes, to be raced for under certain specific conditions.

The following conditions have recently been drawn up to govern the contest for the Fisher Cup, now held by NORAN, Mr. John Bell, of Belleville, Ontario:

Whereas, The rules governing the competition for the Fisher Cup for sloop yachts have proved in practice wholly inadequate;

And whereas Mr. W. J. Fisher, the generous donor of the said cup, has declared that "I have given up yachting entirely" and declines to further interest himself in the matter;

And whereas the CHICAGO YACHT CLUB, under whose auspices the cup was first offered for competition, is extinct and no authority

challenger; but should any yacht succeed in holding the cup in two consecutive races during one season, it will not again be named to challenge until the commencement of the yachting season of the following year.

3. The challenge for this cup shall be in writing and shall fix the day of the race not less than twenty-five days from the date of the receipt of the challenge by the holder of the cup, unless otherwise agreed between the parties.

4. This cup will become the *bona-fide* property of any yacht holding it successfully for four consecutive races, or for two consecutive yachting seasons without a race.

5. The yachting season in reference to this cup, is to be from the first Saturday in June until the last Saturday in September in each year.

6. Should a yacht holding this cup be destroyed or rendered unfit for racing, or the owner thereof die, or should she be sold out of the

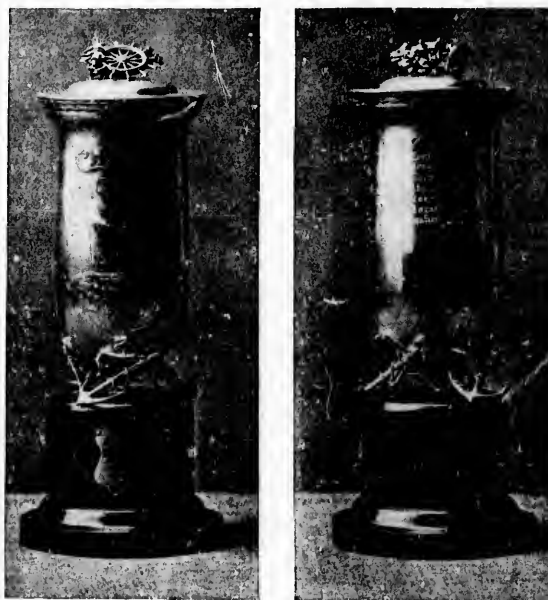

THE FISHER CHALLENGE CUP.—FIGURE 227.

competent to render said rules practical and workable exists outside of the BAY OF QUINTE YACHT CLUB;

Therefore, be it resolved, by the BAY OF QUINTE YACHT CLUB, by and with the consent of the trustees of the said cup, that in order to encourage *bona-fide* competition for the Fisher Cup aforesaid and thus stimulate and promote yachting in our midst, the following shall be the terms and conditions upon and under which the said cup shall hereafter be competed for:

This cup is subject to challenge by sloop yachts (belonging to any regularly organized yacht club) of not less than 36 feet, corrected length measured by the LAKE YACHT RACING ASSOCIATION measurement, as existing in 1891 upon the following conditions:

1. It is to be held by the winner thirty days after race without liability to challenge.

2. At any time after the expiration of that period, and up to the first of September in each year, the winner must accept any challenge, and be prepared to sail a race for the same within thirty days from the receipt of such challenge in writing, or forfeit the cup to the

club to which she belongs and not into another yacht club, the cup shall be returned to the club to be again sailed for; and if the cup should be held by a foreign yacht, and she should be sold out of the club to which she belongs and not into another yacht club, the cup shall not go with her, but shall be returned to the club to which she belonged when the cup was won, to be sailed for again; and in case any yacht is sold and her owner enrolls her in another club the cup shall go with her to such other club, to be sailed for the same as if no transfer had been made.

7. The course shall be 30 nautical miles in length, triangular in shape, 10 miles around, three rounds, and be sailed over within 6 hours by the winning yacht or no race. In the event of failure to cover the course within the time limited the attempt to be renewed day after day, except Sunday, until a race has been completed within the time aforesaid.

In case of either yacht failing to start, or withdrawing before a race has been completed, the cup shall be awarded to the other competitor. No restriction as to crews or steersman.

The sailing rules, time allowance and regulations of the L. Y. R. Association shall govern in all other respects.

8. The challenger shall address his challenge to the Secretary of the club to which the yacht holding the cup belongs.

9. The challenger shall name one judge, the holder of the cup a second judge, and these judges may name a third judge.

10. The buying of the course and all other matters of arrangement and detail shall be in charge of the club to which the holder of the cup may belong.

W. H. BIGGAR, Commodore B. Q. Y. C.
GEO. N. LEAVENS, Sec-Treas., B. Q. Y. C.
D. B. ROBERTSON, Trustee Fisher Cup.
R. S. BELL, Trustee, Fisher Cup.

BELLEVILLE, May 1, 1882.

RECORD.

Won by Cora, Chicago Yacht Club,	July 8, 1882.
Won by Cora, Chicago Yacht Club,	Sept. 9, 1882.
Won by Cora, Chicago Yacht Club,	May 11, 1882.
Won by Atlanta, Chicago Yacht Club,	Aug. 8, 1883.
Won by Nora, Belleville Yacht Club,	Sept. 11, 1883.
Won by Nora, Belleville Yacht Club,	July 30, 1892.
Won by Onward, Rochester Yacht Club,	Sept. 19, 1892.
No race to a finish,	1893.

THE "BREWSTER CHRISTIAN CUP."

(PRESENTED TO THE SOUTHERN YACHT CLUB IN 1887).

1. The contests for this cup shall be open to members of the SOUTHERN YACHT CLUB only, and shall be confined to cruising sloop yachts over 30 feet in cruising rig.

2. The race to take place on the last Tuesday in June.

3. The winner of the cup shall hold it until within two weeks of the next annual match, when he shall deliver it to the Secretary of the club.

4. The holder of the cup shall have the privilege of substituting

*Won by Atlanta's default.

any boat other than the one that won the cup originally, provided said boat be *bona-fide* his own property.

5. Any member winning the cup for three successive years shall retain absolute possession of it.

6. All contests shall be governed by the racing rules and time allowance in force at the time of each race.

7. The course shall be 15 miles over the regular club course; and each yacht shall be limited to one man for each four feet of boat waterline length or fraction thereof. The helmsman, who must be an amateur, shall not be included in this number. The crews shall be composed of amateurs, with the exception of the sailors regularly employed on the boat, who may be part of the crew.

CONDITIONS OF RACES FOR CHAMPION PENNANT.

(PRESENTED BY JOHN T. MOTT TO THE OSWEGO YACHT CLUB.)

1. The pennant to be known as the Champion Pennant of the OSWEGO YACHT CLUB.

2. All races for it to be open to yachts of the 35 and 40-foot classes (owned at and making Oswego their home port) of the OSWEGO YACHT CLUB.

3. The sailing rules of the OSWEGO YACHT CLUB shall govern, except that on the Opening Cruise, the number of the crew shall not be limited; the Regatta Committee shall have charge of all pennant races.

4. The pennant shall be raced for at the Opening Cruise and at the Annual Regatta each year.

5. At the Opening Cruise the start shall be from the Oswego beacon light, and the finish from the outer light at the port of destination.

6. The course at the Annual Regatta shall be the 35-foot class course at that time.

7. The time of the 40-foot class yachts of the club, shall be taken as they complete the 35-foot class course.

RECORD OF VARIOUS TROPHIES FOR 1891 AND 1892.

NAME OF CUP.	YACHT CLUB.	WHEN WON.	WON BY	NO. OF COMPETITORS.	COURSE.	TIME OF RACE. H. M. S.
Archibald Challenge Cup	Royal N. S. Sloop	June 6, 1891	Lenore	Youla, Psyche, Hebe, Mentor	11 miles	2 03 45
Chauncey Challenge Cup	" "	June 13, 1891	Youla	Lenore, Wenonah, Mentor, Psyche	16 1-2 miles	2 58 39
United Banks Challenge Cup	" "	June 27, 1891	Youla	7 yachts	10 4-5 miles	1 48 30
Land-downe Challenge Cup	" "	July 18, 1891	Youla	8 yachts	16 1-2 miles	5 30 57
Wenonah Challenge Cup	" "	July 23, 1891	Youla	4 yachts	23 1-4 miles	5 41 55
Ruth Challenge Cup	" "	Aug. 22, 1891	Youla	8 yachts	11 3-10 miles	2 34 31
Capt. L. Russell's Challenge Cup	" "	Aug. 29, 1891	Lenore	5 yachts	16 1-2 miles	3 25 43
Lord Alex. Russell's Challenge Cup	" "	Sept. 5, 1891	Youla	7 yachts	11 3-10 miles	2 04 59
Madame de Zibinski Cup	Buffalo	Oct. 8, 1892	Erethless	Hinpooc, Iris	8 7-16 knots	2 41 11
First Rouse and Wetmore Cup	Seawanhaka	June 25, 1892	Meteor	5 yachts including Pyxie	Club House, Cold Spring Light Center Island buoy, Lloyd's Point, Spring Light, Club House	5 21 10
Second Rouse and Wetmore Cup	" "	July 9, 1892	Pyxie	7 yachts	12 nautical miles	3 01 06
Third Rouse and Wetmore Cup	" "	Aug. 20, 1892	Nameless	9 yachts, 3 fin., Pyxie dismasted	"	3 19 03
Brese Handicap Cup	" "	" "	Rose Marie	" " "	"	3 19 36
Fourth Rouse and Wetmore Cup	" "	Sept. 24, 1892	Near Ijy	11 yachts, 1 fin'd., including Pyxie	"	2 56 21
R. A. Osborn Cup	" "	Oct. 1, 1892	El Chico	El Chico, Pyxie, Nameless, No- madly disabled	Stakeboat, Bell buoy, Buoy Cap- tain's Island and return	2 33 28
Columbus Cup,	Shelter Island	Aug. 6, 1892	1, Pigeon	6 yachts	Class 1 and 2,	2 30 10
1st, 2nd, and 3rd Class			2, Curlew	5 yachts	same course	2 58 27
			3, Mendota	4 yachts	Class 3, separate course	1 45 31

RECORD OF VARIOUS TROPHIES FOR 1891 AND 1892 *Continued.*

Wenonah Cup	Royal N. S. Squad.	July 30, 1892	Youla	5 yachts	21 1-2 miles	1 48 18
Ruth Cup	" " "	Aug. 20, 1892	Wym	4 yachts	11 3-10 miles	2 09 05
Chamceey Cup	" " "	Aug. 31, 1892	Youla	4 yachts	16 5-6 miles	1 05 05
Leonard Russell's Cup	" " "	Sept. 10, 1892	Youla	5 yachts	11 3-10 miles	3 31 54
Lord Alex. Russell's Cup	" " "	Sept. 13, 1892	Wym	4 yachts	6 5-16 miles	2 48 31
Fisher Cup	Bay of Quinte	July 30, 1892	Norah	Norah, Onward	Triangular—8 2-3 knots 3 times	5 33 51
Fisher Cup	" "	Sept. 19, 1892	Onward	Norah, Onward	" " "	3 35 36
Sir Donald A. Smith Challenge Cup	Sr. Lawrence	July 1, 1892	Valda	7 yachts	11 miles	2 00 03
Baylis Cup	" "	July 16, 1892	Valda	4 yachts	8 miles	1 26 11
Rear Com.'s Cup	" "	Sept. 10, 1892	Elsie	Elsie, Elvida	11 miles	2 10 18
Lansdowne Cup	Royal Canadian	Aug. 6, 1892	Volette	4 yachts	Across Trouts Bay, thence E. to west and return in Lake.	2 11 15
Cosgrove Cup	" "	Aug. 20, 1892	Wa-Wa	5 yachts	Around Toronto Is., 11 miles	3 17 36
McGaw Cup	" "	Aug. 27, 1892	G'ndoline	4 yachts	Triangular, 10 miles	2 35 55
Prince of Wales Cup	" "	Sept. 10, 1892	Orlole (?)	3 yachts	30 miles	3 27 00
Lorne Cup	" "	Sept. 17, 1892	Volette	2 yachts	11 miles	1 38 00
Lansdowne Cup	Royal N. S. Squad.	June 11, 1892	Etienne	6 yachts	10 8-10 miles	1 12 58
United Banks Cup	" " "	June 25, 1892	Youla	7 yachts	11 3-10 miles	2 11 01

CUPS SAILED FOR IN 1893 IN CONNECTION WITH CUPS ALREADY MENTIONED.

YACHT CLUB.	DATE.	NAME OF CUP.	YACHT CLUB.	DATE.	NAME OF CUP.
Southern.	May 20,	Sully.	Mimetonka.	August 12,	Club.
Royal Hamilton.	July 1,	Queen's.	White Bear.	August 12,	White Bear (all classes).
Pavonia.	July 11,	Randall.	New York.	Aug. 15-17-19,	Astor Cups.
Commonwealth.	July 17,	Commonwealth.	Lynn.	August 19,	Expert.
Massachusetts.	July 17,	Annual.	Royal Hamilton.	August 19,	Marguerite.
White Bear.	July 21,	1st class Gotzian, 2d class Kitten.	White Bear.	August 19,	Wildwood.
Portland.	July 19,	Annual Challenge Cup.	Manchester, Mass.	August 20,	Club.
White Bear.	July 4,	1st and 2d classes Commodore Cup.	Manchester, Mass.	August 27,	Club.
Pavonia.	July 4,	Commodore, Vice-Commodore Cups.	Eastern.	August 28,	Weid.
Indian Harbor.	July 4,	Club.	Lynn.	Sept. 2,	Expert.
Chelsea.	July 15,	Hyde challenge.	Royal Hamilton.	Sept. 7,	Monck, for 10 ft. class, Lucas for 30 ft. class.
White Bear.	July 15,	1st class Gotzian, 2d class Kitten.	Manchester, Mass.	Sept. 2,	Club.
Rhode Island.	July 17,	Club.	New York.	Sept. 7,	America's.
Mimetonka.	July 17,	Club.	Royal Canadian.	Sept. 9,	Prince of Wales.
Riverside.	July 22,	Special.	White Bear.	Sept. 9,	1st class Commodore, 2d class Pennant.
Manchester.	July 22,	Club.	Lynn.	Sept. 16,	Expert.
New York.	July 25-27-28,	Astor Cups.	Royal Nova Scotia.	Sept. 16,	Edwards.
Royal Canadian.	July 29,	Lansdowne.	White Bear.	Sept. 16,	White Bear.
Lynn.	August 5,	Expert.	Chelsea.	Sept. 19,	Annual and Hyde challenge.
Royal Hamilton.	August 5,	White Wings (all classes).	Royal Canadian.	Sept. 23,	Cosgrove.
New York.	August 7,	Commodore's.	New York.	Oct. 5, 7, 9,	America's.
New York.	August 10,	Goelet.			



COMMODORE E. D. MORGAN.

NEW YORK YACHT CLUB.

History of the New York Yacht Club.

THE NEW YORK YACHT CLUB has the distinction of being the first yacht club organized in America.*

On the afternoon of the 30th of July, 1844, a number of gentlemen, in pursuance of a previous notice, assembled on board of the little twenty-five ton schooner *GIVENACK*, belonging to Mr. John C. Stevens, then lying off the Battery, for the purpose of organizing a yacht club. There were present John C. Stevens, Hamilton Wilkes, John C. Jay, George L. Schuyler, Louis A. Dupau, George A. Rollins, James M. Waterbury, and James Rogers.

At the meeting it was resolved that the title of the club be the **NEW YORK YACHT CLUB**. John C. Stevens was unanimously chosen Commodore of the club, and a committee of five, consisting of John C. Stevens, George L. Schuyler, John C. Jay, Hamilton Wilkes and Capt. Rogers, were appointed to report rules and regulations for the government of the club.

It was further resolved that the club should make a cruise to Newport, Rhode Island, under command of the Commodore, and Friday, August 2, 1844, at 9 o'clock, A. M. was the time appointed for starting. At this meeting the following yachts were represented:

<i>Gimerack</i> ,	John C. Stevens.
<i>Spray</i> ,	Hamilton Wilkes.
<i>La Coquille</i> ,	J. C. Jay.
<i>Cygnet</i> ,	William Edgar.
<i>Dream</i> ,	George L. Schuyler.
<i>Minna</i> ,	Jas. M. Waterbury.
<i>Mist</i> ,	Louis A. Dupau.
<i>Peirel</i> ,	George B. Rollins.
<i>Ida</i> ,	James Rogers.

On the 2nd of August the foregoing yachts with the exception of *IDA*, took part in the first cruise of the **NEW YORK YACHT CLUB**. The fleet stopped at Huntington, on Long Island, New Haven, Gardiner's Bay and Oyster Pond Point, arriving at Newport on Monday afternoon, August 5th. The pilot boat *BELLE*, chartered by R. B. Forbes of Boston, arrived at Newport on the night of the 4th, and on the following day the yacht *NORFOLK LIGHT*, Capt. Chas. Winchester of Boston, also added her presence to the occasion. The fleet left for New York on the 11th, after having passed a very enjoyable time. The first regular election of officers was held at Windust's in New York city on the 17th of March, 1845, and the following gentlemen were elected:

Commodore,	John C. Stevens.
Vice-Commodore,	Hamilton Wilkes.
Corresponding Secretary,	George B. Rollins.
Recording Secretary,	J. C. Jay.
Treasurer,	William Edgar.

At the same meeting the secretary was requested to have a flag ready for exhibition at the next meeting. The first yacht club dinner took place at the Astor House on the 9th of April, 1845, and at a meeting held at Delmonico's on June 3, 1845, a flag was adopted.

So popular was this movement that almost immediately members began to flock in, and hardly a meeting has been held by the club since that new members ranking among the highest social and financial circles of the community, have not been admitted. At the end of 1845, the number of yachts enrolled in the club increased to 17, and

* See "Evening Post," N. Y., July 1, 1844.

members to 111, while in 1875 the club registered 38 schooners (5,566 tons), 27 sloops (924 tons), and 13 steamers. At the present time (1893) there are enrolled in the club 89 schooners, 95 sloops, cutters and yawls, 126 steamers and 7 naphtha launches, and the membership now numbers 1,018. The First Annual Regatta of the club took place July 14, 1845, and will be fully described in the Record of Races. The Club House in summer was found located at the Elysian Fields, Hoboken. The older members remember its charming location and the pleasant dinners which were had there in early Spring and during the yachting season. On the 18th of February, 1846, a first appropriation of \$500 was made to furnish this cottage Club House. On the 24th of June following, a further sum of \$250 was appropriated for the same purpose. In those early days economy was more necessary, and more widely practiced than at present. The Second Annual Regatta of the club, occurred during the same summer, after taking possession of its new headquarters.

The following yachtsmen have held the honorable position of Commodore of the **NEW YORK YACHT CLUB**, since its organization:

1. John C. Stevens,	1844 to 1855.
2. William Edgar,	1855 to 1860.
3. Edward O. Stevens,	1860 to 1866.
4. William H. McVickar,	1866 to 1867.
5. Henry G. Stebbins,	1867 to 1871.
6. James Gordon Bennett, Jr.,	1871 to 1875.
7. George L. Kingsland,	1875 to 1877.
8. S. Nicholson Kane,	1877 to 1880.
9. William N. Thomas,	1880 to 1881.
10. John R. Waller,	1881 to 1882.
11. James D. Smith,	1882 to 1884.
12. James Gordon Bennett, Jr.,	1884 to 1886.
13. Elbridge T. Gerry,	1886 to 1893.
14. Edwin D. Morgan,	1893 to —.

In 1855 Commodore Stevens after having been in office eleven years, tendered his resignation to the club in a letter wherein he says:

"The conviction of my inability longer to perform the duties that the Commodore should both be willing and able to do, renders this determination on my part, if not absolutely necessary, at least advisable.

I do not want the will, but I lack both the health and the spirits to enable me to make the attempt. Old age and hard service have worked with me their usual and inevitable results, and I cannot but sigh to think 'I shall never more be fit for the sea.' That I am fairly entitled to my discharge, I trust you will admit, when I have been a yacht owner for over half a century, commencing in 1802, as builder, captain, cook and all hands of the celebrated yacht *DIVEN*, 9 feet long, 3 feet wide and 3 feet deep, and ending as the Commodore of a squadron whose flag ship *MANTA* carries her pennant 150 feet above the surface of the sea."

Mr. William Edgar was then elected Commodore of the club, but, after retaining the office for four years, he also resigned. Mr. Moses H. Grinnell was tendered the position, which he declined on account of a contemplated trip abroad. The following gentlemen were elected in 1860: Commodore, Edward A. Stevens; Vice-Commodore, Ambrose C. Kingsland; Secretary, Hamilton Merton; Treasurer, Robert S. Howe; Measurer, Charles H. Haswell; Surgeon, Dr. Woodward; Regatta Committee, Charles S. Haswell, J. Howard Wainwright, John C. Jay.

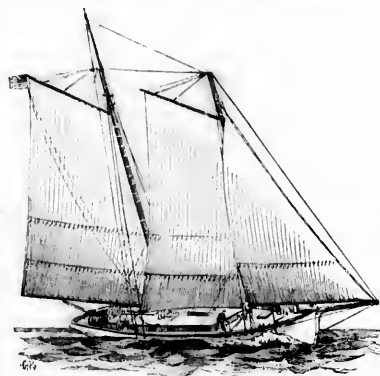

GIMERACK.—FIGURE 228.
(From an Outline Drawing by Cozzens.)

In 1865 an act incorporating the New York Yacht Club was passed by the New York Legislature. Section I of this act reads as follows:

"Edwin A. Stevens, Ambrose C. Kingsland, Alexander Major, Robert S. Howe, William H. McVickar, Anson Livingston, Hamilton Morton and such other persons as are now associated as a Yacht Club in the city of New York, or may hereafter become associated with them, are hereby constituted a body corporate, by the name of THE NEW YORK YACHT CLUB, to be located in the city of New York for the purpose of encouraging yacht building, naval architecture and the cultivation of naval science."

The motto of the club on its corporate seal is, *Nos Agimus Tuncidus Velis.*

In the Spring of 1868, the club purchased from Mrs. N. H. Wolfe, for a Club House, a property on Staten Island near the lower landing for the sum of \$24,000, paying 80,000 cash and the balance remaining on mortgage. It contained two acres of land, sloping down to a road which separated it from the shore about one mile this side of the Narrows. From the piazza of the Club House all vessels coming into the port of New York could be readily seen. The house was large and roomy and in the English style.

Until 1868 the site and Club House at the Elysian Fields, Hoboken, had been gratuitously furnished for the use of the club by John C. Stevens, Robert Stevens and Edwin A. Stevens. On the occasion of their moving to their new abode, the club, in an engrossed letter to Mr. Edwin A. Stevens, expressed their high appreciation of such courtesy and liberality.

Both the station and anchorage at Staten Island were subsequently given up.

In November, 1872, the club took possession of commodious rooms over the AMERICAN JOCKEY CLUB, situated on the southeast corner of Madison Avenue and Twenty-seventh Street. This house was originally built for club purposes and was admirably adapted for the

club. The New York Yacht Club occupied the whole of the second story, consisting of three rooms, conveniently furnished. The walls were covered with yacht models and nautical engravings. There were at that time (1874) four hundred and sixty-three members.

At a meeting of the club, held October 23, 1873, a communication from Mr. Arkwright of Savannah, Ga., was read, in which he offered

to give all the property necessary in Savannah Harbor for a winter rendezvous. A vote of thanks was accorded him, and Messrs. Wright, Bend and Johnson were appointed a committee to consider the expediency of accepting the offer.

In the month of May, 1884, the club moved into its present mansion on Madison Avenue, No. 67. (See illustration.)

The building is fitted up with every possible convenience, and at all times in the year prominent yachtsmen (frequently from all parts of the world) are to be found within its walls.

According to the By-Laws of the club, "a correct model of every yacht entered for a regatta or other club race shall be deposited with the club and retained in its possession (see Rules and Regulations), in consequence of which the club has the finest collection of yacht-models in the world. These models are hung on the walls so as to permit of easy inspection and study, and constitute the most prominent feature of the Madison Avenue home.

To owners, designers, naval architects and all others interested in the development of pleasure vessels, and, for that matter, any type of craft, this collection of models must be very instructive. It shows what Americans have done in the matter of building yachts with view of increased speed

on the one side and increased comfort on the other. It shows why and how Americans are the leaders to-day in the yachting world. It shows how they have obtained the supremacy in this sport, and why they have retained it. It shows that genius and patient toiling have been behind it all. There are nearly three hundred models in the collection and they can be said to stand for the history of yachting.

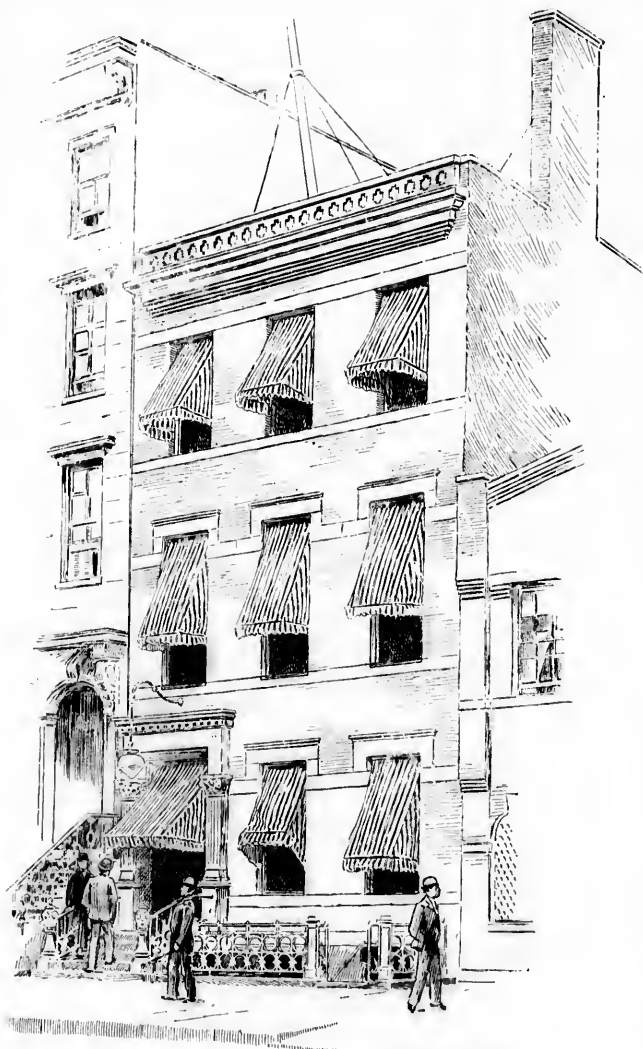

HOME OF THE NEW YORK YACHT CLUB.—FIGURE 229.

the whole of the
y furnished. The
engravings. There
three members.

, a communication
n which he offered
e all the property
ary in Savannah
r for a winter ren-
s. A vote of
was accorded
id Messrs. Wright,
and Johnson were
ed a committee to
r the expediency
pting the offer.

e month of May,
e club moved in-
eseot mansion on
n avenue, No. 67.
istration.)

building is fitted
h every possible
ence, and at all
n the year prom-
achtsmen (fre-
from all parts of
eld) are to be
ithin its walls.

lling to the By-
the club, "a cor-
et of every yacht
for a regatta or
ib race shall be
t with the club
ined in its pos-
see Rules and
ons), in conse-
which the club
finest collection
-models in the
these models are
the walls so as
t of ea y in-
and study, and
the most prom-
ure of the Mad-
ue home.

ners, designers,
hitects and all
erested in the
ent of pleasure
l, for that mat-
ype of craft,
tion of models
ery instructive.
hat Americans
in the matter
g yachts with
reased speed
hows why and
rld. It shows
why they have
e been behind
ollection and



PLATE V

THE STAN. A. CO. PHOTOGRAPHY

MAY.

MAY.



to
any-
this
ords
th,
u-
e



To the designer and the thoughtful and progressive followers of yachting deeds and history and, to-day the club finds itself this pastime, there is in them much food for reflection. To such, the at the head of the leading clubs of the world.

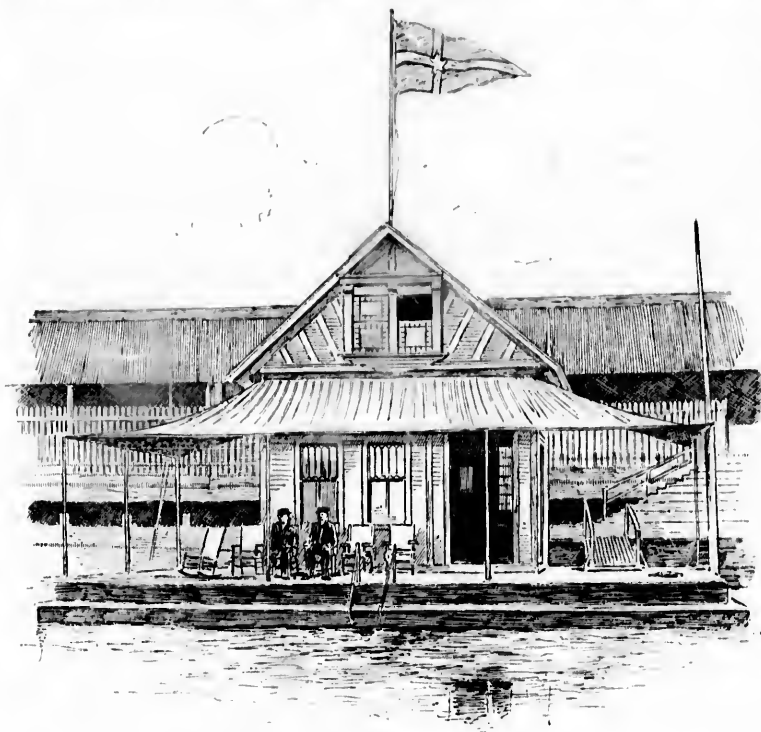

STATION NO. 1: BAY RIDGE.—FIGURE 230.

silent wooden shapes recall the early history of the club, its generous and energetic founders, the trials and obstacles they encountered, the courage with which they worked, and at last the success which crowned their efforts. Here you may see in miniature the first vessel that ever caused public attention to be directed to yachting in this country. Here you may note the handiwork of the early builders and how the penknife genius whittled into form the patterns from which was constructed the craft of nearly fifty years ago. Here you can recall the distinguished yachtsmen of the past, the reason of their success and of the many contests in which they were engaged. Here, race after race at home and across the ocean will come up before the mind, and imagination need not be given much latitude to bring again before the mental vision the mighty crowds that have gathered to note these contests and to cheer the victors; and these models also bring to mind how from the parent organization there has spread throughout the land the great love for the pastime, so that to-day America stands the leader, as well as the holder of the "blue ribbon of the ocean," denoting yachting supremacy. It is just forty-nine years since the organization of the club, almost half a century, a period rich in

²See "New York Herald," 1873.

It burgee is respected and its members welcomed whenever yachting sport is known. It has not been all smooth sailing; white squalls, black squalls and prolonged storms have been weathered, until now its anchorage is so secure that it is proof against all assault. Clever and courageous yachtsmen have done this; though many have made their last cruise, their memories are kept green, while their judgment afforded and their sacrifices may well serve as bright and shining examples to the generations that follow them.

The principal aquatic feature of the club is its Annual Cruise, which during the numerous summers has grown more and more in favor and popularity. Racing from port to port on the cruise has been so attractive that at the club regattas, the number of yachts participating is much less than formerly. The majority of the owners of fast boats undoubtedly feel that they can obtain sufficient racing in this way, and do not take the same interest in the Annual and Fall Regattas. A well-known yachtsman has said: "The cruise is now the yachting rage and no amount of work seems to be able to galvanize our regular regattas into anything like life." To some extent this is true, yet if we examine the records of the various regattas held by the club, there still remains considerable enthusiasm. One other reason might be mentioned to account for the falling off in the number of yachts taking part

in the regattas, and that one is that all contests are limited to yachts enrolled in the club, while in most other yacht clubs, the regattas are open to yachts of any organized yacht club. Under such conditions, it is easily understood why the regattas of clubs other than the NEW YORK YACHT CLUB have such a large number of starters.

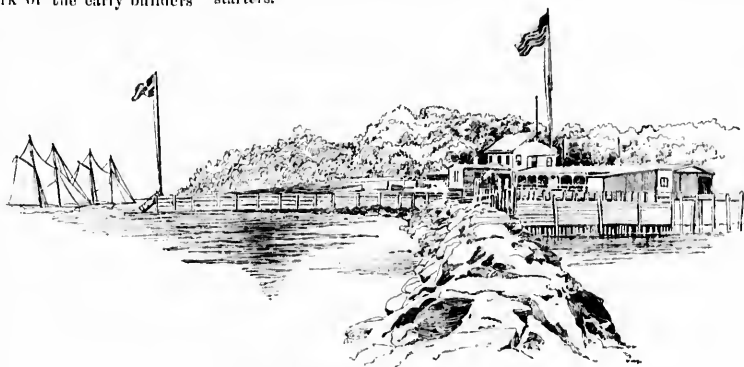

RENDEZVOUS: GLEN COVE.—FIGURE 231.

The advisability of establishing stations where yachtsmen could congregate or receive proper attention while cruising along the mag-

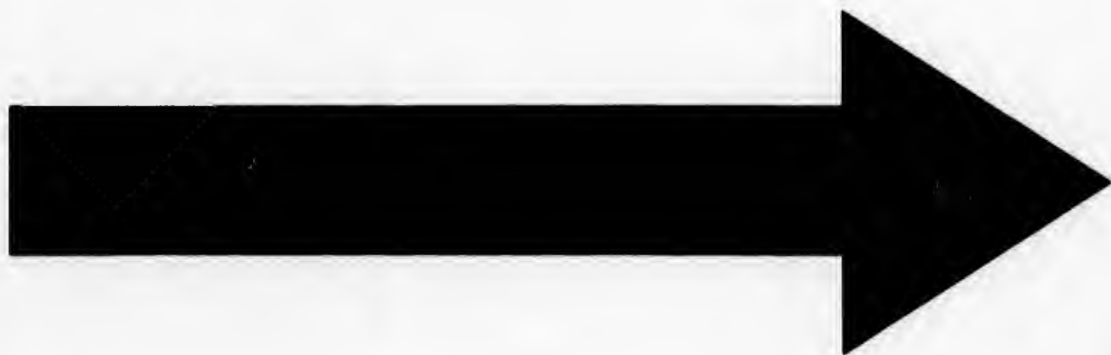

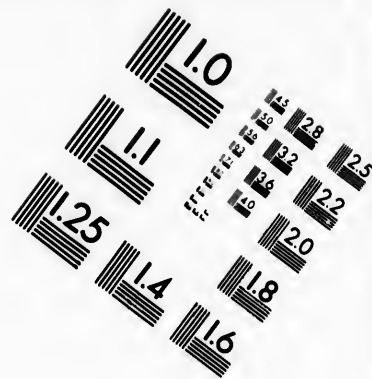
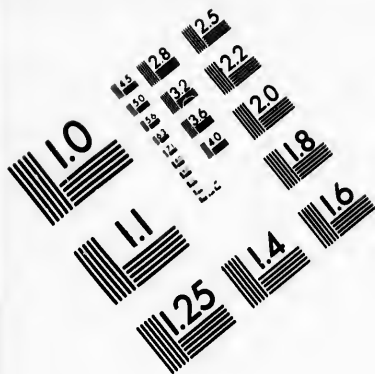

**IMAGE EVALUATION
TEST TARGET (MT-3)**

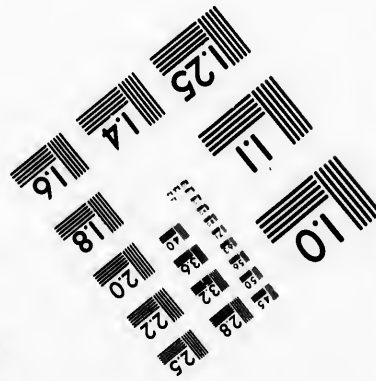
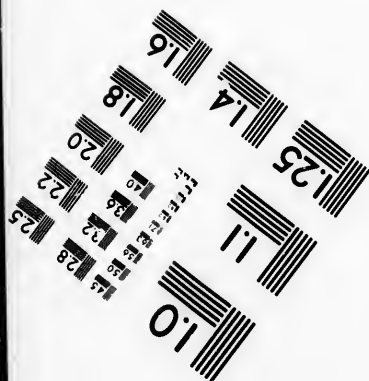
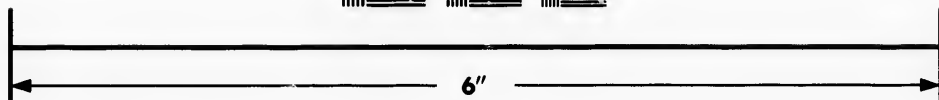
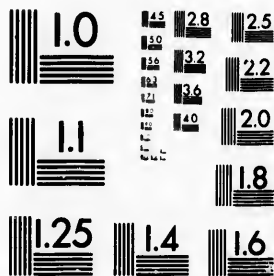

**Photographic
Sciences
Corporation**

23 WEST MAIN STREET
WEBSTER, N.Y. 14580
(716) 872-4503

1.5
1.8
2.0
2.2
2.5
2.8
3.2
3.6
4.0
4.5

10
11
12
13
14
15
16
17
18
19
20

nificent stretches of yachting waters from New York and Long Island Sound to Martha's Vineyard came next under consideration and grew out of a desire expressed by many members that the club should have out of town locations for their comfort and convenience. A committee was appointed to report on the advisability of the same, but their report was not favorable. The matter, however, was not

and in a most convenient location. Stations No. 2, located in New York, are merely landing flónts and approaches thereto, and are under the eye of Vice-Commodore Duncan. These are at the foot of East 26th street, East River, and at the foot of West 35th street, North River. The former has proved itself a great convenience to the many steam yacht owners, who use it daily in coming to and returning from their business in the city. The station at Whitestone, on the Sound, is the first of the new ones. It was built under the general superintendence of Mr. Clarence McKim, a gentleman doing business in New York, but whose summer home is near Whitestone. It is of the same general size and style as all the new structures. It is only a short distance from the Long Island Railroad Depot and close to the *Herald's* ship news station. The Whitestone station is easy to reach from this city, and will be found invaluable for the purposes intended. It is No. 3 in the list.

Next in order is that of New London, which is known as station No. 4. It has had much attention from Mr. David Banks, owner of the schooner yacht *WATER WITCH*, but this year is under the supervision of Mr. Charles Clark. The structure is neat, and has proved satisfactory to the club. It is located on Pequot avenue, known to all yachtsmen as the delightful shore drive from the city of New London to the lighthouse at the entrance of the harbor, and is only a few steps from the Pequot House. The ground on which the station is built has a frontage of 181 feet on Pequot avenue, while its depth is about 140 feet. Piazzas are on the front,

allowed to drop there. The flag officers believed that there should be stopping places on the Sound, provided for the club's cruising fleet and they were backed in their opinion by the much-respected and enthusiastic yachtsman Ex-Commodore Nicholson Kane, Chairman of the Regatta Committee, who finally suggested to those interested the course to pursue. A special committee was soon appointed, consisting of the flag officers, who acted ex-officio, Mr. Clarence McKim, Mr. David Banks, (Commodore of the A. Y. C.), Mr. H. A. Tucker and Mr. Frank T. Robinson. Numerous meetings were held, many offers of land were considered, and much work done before anything was literally accomplished.

However, in the month of July, 1892, the new stations of the club were opened; the yachtsmen who looked after them in the interests of the club for 1892, were as follows: Commodore Elbridge T. Gerry, Clarence McKim, David Banks, Frank T. Robinson, E. D. Morgan and H. A. Tucker. Last year (1893) one extra station was created and some new officers were substituted, so that these stations and officers in charge are as follows:

STATION	LOCATED
1.	Bay Ridge.
2.	New York, N. Y..
3.	Whitestone, N. Y..
4.	New London, Conn..
5.	Shelter Island, N. Y..
6.	Newport, R. I..
7.	Vineyard Haven, Mass.

Station No. 1, located at Bay Ridge, is invaluable to yachtsmen

YACHTSMEN IN CHARGE.
William H. Thomas.
Vice-Com. W. Butler Duncan.
Clarence McKim.
Charles Clark.
Frank T. Robinson.
Frederick P. Sands.
H. A. Tucker.

sides and rear of the house. A platform 35 feet 10 inches by 16 feet 10 inches is reached from the front piazza, which leads to a strongly built plank walk 9 feet wide and 215 feet 8 inches long, ending in a pier 31 feet by 21 feet 4 inches, where the club float is moored.

New London has always been a favorite port for yachtsmen of the NEW YORK YACHT CLUB to visit; and several yachtsmen have homes there in the rapidly growing cottage colony bordering on the water,



STATION NO. 3: WHITESTONE.—FIGURE 232.

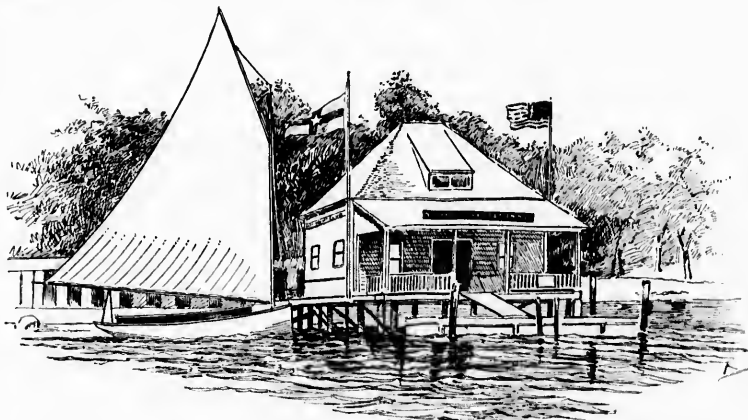

STATION NO. 5: SHELTER ISLAND.—FIGURE 233.

The harbor is magnificent, and in years gone by the club held regattas there over a course always found to be unsurpassed. The majority of club members can easily recall many good times had at

Station No. 6. This structure is, of course, more elaborate than the others, being two stories in height with a cupola. The landing stairs and float are on an extensive scale, and there is a broad piazza in the rear of the house, overlooking the harbor. As Newport harbor is the favorite anchorage of the N. Y. Y. C. yachtsmen, this station of necessity had to be more commodious than the others and, under the care of Mr. Charles Clark, will always be a most desirable place to while away leisure hours.

Passing on to the eastward, a skip is made to Vineyard Haven, the harbor of Martha's Vineyard. The fleet always visits it during the cruise and frequently remains at anchor there two or three days. Station 7 has been built on the New York Dock, so called because the propellers from this city to the eastward touched there. It was

and is under the charge of Mr. H. A. Tucker, who looked after its construction as a member of the club and committee. The style of the house is similar to that on Shelter Island and is the neatest look-

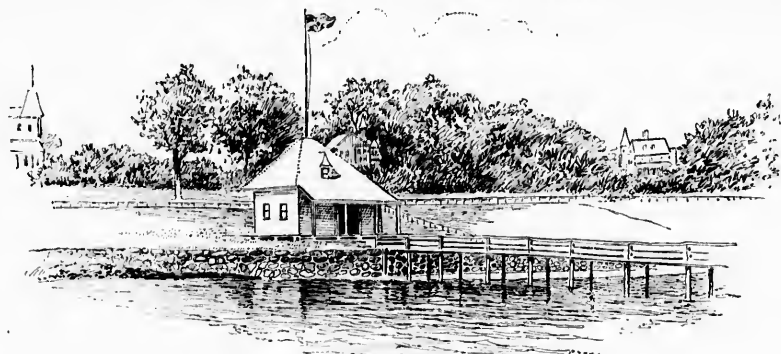

STATION No. 4: NEW LONDON.—FIGURE 234.

this port, and it would seem that the future is filled with promises of frequent repetitions of the days so pleasantly passed. The New London station has proved very convenient to the yachtsmen, and it also is one of the most interesting of the new out of town sites, as it is one of the busiest.

Across the sound on Shelter Island will be found Station No. 5. It is situated on Deering's Cove, about seventy-five feet south of the old Manhasset boat landing, and is almost buried in foliage. Near it is the summer cottage of Mr. Frank T. Robinson, the club member who looked after its construction and equipment. There is good deep water in the Cove and room to anchor a fleet. The Manhasset House is very near and the Prospect House is not far away. Across the bay is the old town of Greenport, once a favorite yachting resort, which is the terminus of the Long Island Railroad. And through Gardiner's Bay there is no better yachting to be had anywhere. This station is a favorite spot with the yachtsmen, as its location is unsurpassed and its accessibility of the best. The house is very taking in its appearance. There is a broad piazza in front from which the float is reached. Around the side are broad walks, and from the rear there is a wide walk leading to the land—the Manhasset Grove. The waiting-room is large and pleasant. This, of course, is the only room of moment in any of the new structures, which are of one story with appropriately finished roofs. The retiring rooms are quite spacious, and the keeper has pleasant sleeping quarters. Newport followed, and the comparatively new house there owned by the club now fell into line, and became



STATION No. 6: NEWPORT.—FIGURE 235.

ing structure just at that point of Vineyard Haven. The float is large, and ample room is afforded in every particular.

HISTORY OF THE NEW YORK YACHT CLUB.

Such is the station record. The houses are not immense structures as can be seen from the illustrations, as nothing of the kind was ever intended. They are the club's way-houses along the favorite cruising waters of America. They were constructed for the convenience of the members. Each is in charge of a competent keeper dressed in the uniform. All stores intended for yachts may be sent to these stations, and they will be cared for and safely delivered as ordered. All letters may be directed to them, and they will be found by the cruising yachtsmen on entering port; and letters may be mailed, in turn, and articles sent to friends as desired. The new houses have also with the city to which it is nearest, as is the case at the Newport Club House, so that carriages may be quickly obtained, telegraph messages speedily sent, stores hurriedly ordered, or any other business transacted as circumstances may require.

HONORARY MEMBERS OF THE NEW YORK YACHT CLUB, 1833.

The President of the United States, *ex-officio*,
The Secretary of the Navy of the United States, *ex-officio*,

Alex. Cadden Rhind, Rear-Admiral U. S. N.
Hamilton Morton, Esq., New York City.
Duke of Gothland, Sweden.
Hon. Samuel Blatchford, U. S. Supreme Court.
Wm. J. Wallace, U. S. Circuit Court, New York.
Lieut. William Henn, R. N.
Rear-Admiral Stephen B. Luce, U. S. N.
Rear-Admiral John L. Worden, U. S. N.

Officers of the Club and Standing Committees for 1833 are as follow:

Commodore,	Elwin D. Morgan.	Vice-Commodore,	W. Butler Duncan Jr.
Rear-Com.,	Ralph N. Ellis.	Secretary,	J. V. S. Oddie.
Treasurer,	F. W. J. Hurst.	Measurer,	John Hyslop
		Fleet Surgeon,	Morris J. Ash, M.D.

REGATTA COMMITTEE:

Chairman, S. Nicholson Kane. Secretary to Com., Chester Griswold.
Irving Grinnell.

COMMITTEE ON ADMISSIONS:

Chairman, Edward M. Brown. Secretary to Com., Frank T. Robinson.

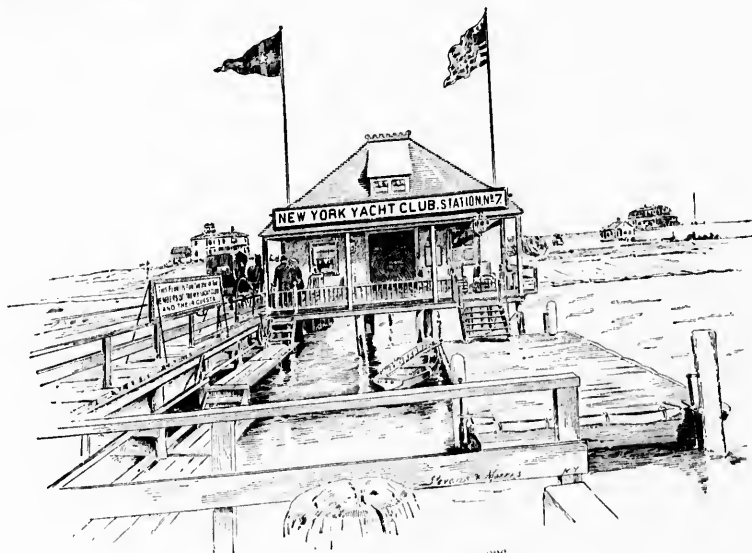

STATION No. 7, VINEYARD HAVEN.—FIGURE 236.

The Secretary of the Treasury of the United States, *ex-officio*.
The Collector of the Port of New York, *ex-officio*.
The Admiral of the New York Station, *ex-officio*.
The Commander of the Navy Yard at Brooklyn, *ex-officio*.
His Royal Highness the Prince of Wales.
The Earl of Dufferin.
D. L. Braine, Rear-Admiral U. S. N.
The Commodore Royal Leeward Yacht Club, *ex-officio*.
The Vice-Commodore " " " "
The Rear-Commodore " " " "
The Secretary " " " "
The Treasurer " " " "
The Commodore Royal Harwich " " " "
The Vice-Commodore " " " "
The Rear-Commodore " " " "
The Secretary " " " "
The Admirals Royal Cork Yacht Club, " "
The Vice-Admiral " " " "
His Imperial Highness the Grand Duke Alexis of Russia.
Baron Adolphe de Rothschild.
Sir Robert Peel, Bart.

Robert Center,

Daniel T. Worden.

James C. Bergen.

HOUSE COMMITTEE:

Chairman, E. A. Houghton. Secretary to Com., Frank M. Cronise.
Alonzo B. Jones. L. Vaughan Clark.
The Secretary.

LIBRARY COMMITTEE:

J. M. Woodbury, M. D. Sanford B. Pomeroy.
William Gardner.

COMMITTEE ON CLUB SITES, STATIONS AND FLOATS:

The Flag Officer, *ex-officio*.
Clarence McKim. William H. Thomas.
Sec'y to Committee, Frank T. Robinson.
H. A. Tucker. Gouverneur Kortright.
Charles Clark.

LIST OF YACHTS ENROLLED IN THE NEW YORK YACHT CLUB.

SCHOONERS.

Racing Numbers.	International Code of Signal Letters.	Name.	Owners.	Port.	Measurement for Tonnage or Representation of Tonnage for U. S. M. C. Chap. 4, R. L.	Tonnage		Length over all.	Length of Water Line.		Extreme Breadth of Beam.		Depth of Hold.		Depth of Water.		Construction or Keel.		
						Gross.	Net.		ft. in.	ft. in.	ft. in.	ft. in.	ft. in.	ft. in.					
52	KCVH	Agnes	J. Norton Winslow	New York	58.41	30.47	28.63	67	5	53	11	10	0	5	0	5	10	e b	
46	KGFH	Alert	J. N. Lanning	"	91.58	99.52	94.31	107	5	101	12	5	11	12	5	13	0	k k	
71	KLHY	Alexa	Charles Cook, L. Vaughn Clark	"	113.95	108.24	125	8	122	3	3	11	13	13	13	0	k k	
	J8NL	Alola	S. C. Powell, M. D.	Newport	11.87	11.28	38	3	36	13	3	5	5	5	3	3	k k	
		Ambassador	Nathaniel Thayer	Boston	431.12	237.61	231.01	170	1	150	5	12	12	12	12	8	k k	
		Archivist	P. de Fombelle	Boston	17.32	16.45	49	0	41	5	10	5	6	6	6	e b	
45	KDJM	Ariad	George H. B. Hill	New York	86.31	150.81	81.57	80.50	99	2	6	21	6	10	3	0	e b	
	KDJW	Ariadelle	Wilson Munsell	"	e b	
58	KDHL	Ariadne	Francis G. Lehman	"	40.49	38.10	75	5	65	7	7	9	9	9	9	0	e b	
14	KDRQ	Azalea	J. Francis Smith	"	61.20	48.28	27.32	72	2	59	17	7	11	11	11	3	3	e b	
	KDQS	Brunhilde	David H. King, Jr.	"	127.29	151.04	128	10	102	11	11	11	11	11	0	k k	
	KDJS	Carotta	George H. Duray	"	80	11.97	11.78	79	13	65	10	10	10	10	10	0	k k	
	KDJI	Cavallier	Jefferson Hogan	"	e b	
	KDJI	Colchete	Engene L. Busle	"	17.46	17.65	51	5	50	8	8	8	8	8	0	e b	
49	KCFH	Columbia	Henry C. Ward	"	e b	
	KJGS	Comanche	J. T. Perkins	"	e b	
		Comet	Wm. D. Bishop, Jr., A. E. Flower	Bridgeport	85.71	181.05	181.05	82.04	107	11	100	3	3	9	4	11	11	e b	
9	KDJH	Constellation	W. H. Langley	New York	81.80	72.13	49.53	80	74	11	12	12	12	12	0	e b	
		Coronet	Wm. H. Goodwin, Frederick Swift	Boston	107.24	157.79	149.82	101	10	100	3	3	10	10	10	10	0	e b	
72	KDJT	Curlew	John D. Wing	New York	280	104.20	132.67	133	125	12	3	12	12	0	k k	
		Curlew	W. E. Brooks	Stamford	83.26	121.20	71.93	65.24	91	5	83	7	21	6	8	39	11	e b	
		Duquesne	Robert W. Inman	New York	e b	
1	HMQQ	Ebenezer	Cubbed H. Tait	New York	e b	
4	KDIB	Essex	Gardner B. Penhman	New London	111.00	251.01	151.10	123.10	123	10	110	7	20	7	12	6	0	e b	
36	KDHP	Egna	H. L. Bokamp	New York	141.20	21.13	20.18	95	3	14	1	4	4	4	4	0	e b	
		Elenore	J. Roger Maxwell	"	e b	
		Emerald	George E. Chisoin	"	e b	
		Enigma	W. A. Hazard	"	e b	
		Enola	J. E. De Lamar	"	e b	
13	KDHI	Fleetwing	George Trotter	"	66.93	63.50	81	8	72	6	21	11	11	11	7	10	e b	
10	KHQQ	Flour de Lys	W. A. Hazard	"	2.058	111.08	105.53	125	4	104	0	10	6	9	6	0	k k	
91	KDHS	Fortuna	H. W. Conley	New York	91.55	85.08	90.83	109	4	97	0	12	6	11	4	12	e b	
78	KDHS	Gevalia	W. W. Conley	Glooucester	61.91	297.36	198.58	101.65	111	0	100	10	11	11	11	13	0	k k	
21	KCMD	Griana	George W. Weld	Boston	k k	
12	KDGS	Groening	Latham A. Fish	New York	37.85	36.26	62.95	91	88	1	2	5	8	8	0	e b	
57	KDSE	Haley	E. S. Hammond	"	122.50	67.15	64.70	79	4	81	2	1	1	1	1	0	e b	
	KDSE	Hartinger	Henry G. Russell	Providence	67.52	e b	
	KDSE	Helen	C. D. Middleton	Philadelphia	e b	
	KDSE	Hesperia	John W. Murray	New York	42.60	25.60	24.32	61	54	15	4	4	4	4	0	e b	
	KDSE	Hillegale	George J. Gould	"	e b	
	KDSE	Hillegale	C. Cooper Clark	Stamford	184.00	103.00	112	10	100	2	11	8	0	11	8	0	k k	
64	KDST	Hillegale	Ralph S. Edis	New York	82.21	101.24	92.79	88.16	91	3	80	3	11	6	10	10	0	e b	
		Jewel	Arthur M. Hodge	"	e b	
		Lady Evelyn	A. Edward Tower	"	111	81.05	112	0	91	5	18	10	10	12	6	e b	
		Lancel	John E. Brooks	"	93.17	121.23	115.17	119	0	112	10	11	12	10	8	0	e b	
		Lotus	Daniel Appleton	"	64.83	26.10	26.15	64	1	58	11	10	8	10	8	0	e b	
		Loyal	B. Frank Sutton	"	47.00	44.05	70	0	70	7	7	7	7	7	0	e b	
		Madeline	J. S. Dufresnoy	"	171.40	80.25	146	0	135	23	2	9	2	1	4	e b	
		Maie	Ang. W. Mett	"	87.20	66.23	44.83	84	0	80	11	20	10	7	0	10	e b	
18	KFGH	Marguerite	Henry W. Lamb	"	85.48	110.06	106	10	80	3	21	10	9	11	0	e b	
4	KDIB	Marylower	W. Amory Gardner	Boston	89.93	171.74	84.67	81.41	100	80	7	10	6	9	1	10	7	e b	
25	KHFN	Merlin	W. H. Fortes	"	84.35	106	80	0	23	6	11	9	3	0	e b	
		Meteor	Henry Prince	Providence	81.24	44.05	41.70	81	6	71	10	20	3	7	6	8	10	e b
		Montegan	Andrew T. Johnson	"	290.00	120.28	114.27	139	6	104	8	24	10	8	12	4	e b	
		Mohican	H. D. Burnham	"	23.10	21.95	57	45	8	14	5	7	3	8	0	e b
75	KJWB	Montank	Lewis C. Lydial	New York	103.26	12.12	87.62	104	5	94	3	25	4	8	10	8	e b	
		Norma	George L. Tyson	Providence	69.31	35.11	34.04	76	5	71	17	9	0	6	7	10	e b	
		Norma	Edward H. Coleman	Philadelphia	60.20	53.01	50.93	80	4	73	0	20	7	10	5	12	k k	
15	KJFW	Norseman	Edwin Good	New York	2.1	80.17	85.00	105	0	105	0	15	2	2	8	0	e b	
89	KDRT	Onion	Hugh Cochrane	New York	311.19	174.22	140.41	143	112	25	22	11	6	12	6	0	e b	
		Orion (Ketch)	Willie Ford Stuyvesant	Boston	89.52	149.53	71.83	68.23	93	75	19	0	10	12	12	12	0	k k	
2	KJFW	Palmier	J. Edward Achley	New London	22.07	21.54	54	4	43	15	5	6	5	3	3	e b	
53	KCFP	Parus	James Francis	New York	102.11	226.25	124.58	118.35	129	104	24	2	11	1	12	3	0	k k	
		Petewinkle	James Francis	"	16	58	13	0	k k	
92	KJFR	Phantom	H. S. Parmelee	New Haven	80.52	125.93	72.51	64.161	100	3	80	24	11	7	7	6	0	e b	
		Quickstep	Frederick Cromell	Providence	70.11	57.77	54.80	85	65	0	4	4	4	4	0	e b	
		Ramona	Harry M. Gillig	New York	105.84	232.20	126.89	120.69	132	110	11	25	7	8	7	12	2	e b	
		Ray	W. W. Tompkins	"	35	25.17	22.62	63	50	14	0	0	7	8	0	e b	
		Republic	George Matthews	"	183.63	94.20	85.88	104	9	98	0	23	0	0	2	0	e b	
11	KDPC	Rebecca	Edward Dudley	Philadelphia	38.60	36.73	82	70	19	6	3	2	0	0	e b	
		Romance	William Thielhelm	New York	32.10	30.58	69	3	59	17	4	0	8	0	0	e b	
19	KCFV	Sachsen	Henry Mormann	"	109.50	80.63	85.15	98	54	103	2	25	9	8	0	8	e b	
		Sage	F. T. Adams, John G. Moore	"	109.11	81.74	77.66	102	2	80	10	23	8	8	0	8	10	e b
		Saga Fox	Alison Tucker	Boston	24.84	10.75	10.47	116	5	89	5	23	10	10	11	11	0	e b
23	KDML	Sandrock	Willard P. Ward	New York	73.18	64.81	20.11	47.61	80	5	70	0	20	1	7	8	8	5	e b
102	KDHP	Santanza	O. D. Wilkinson																

LIST OF YACHTS ENROLLED IN THE NEW YORK YACHT CLUB.

SLOOPS, CUTTERS AND YAWLS.

Boating Numbers.	International Code Signal Letters.	Name.	Owners.	Port.	Measurement Tonnage Gross.	Tonnage Net.	Length over all.	Length of Water Line.	Extreme Breadth of Beam.	Depth of Hold.	Draft of Water.	Chartered or Keel.	Measurement Tonnage Gross.		Tonnage Net.		Length over all.		Length of Water Line.		Extreme Breadth of Beam.		Depth of Hold.		Draft of Water.		Chartered or Keel.	
													Measurement Tonnage Gross.	Tonnage Net.	Length over all.	Length of Water Line.	Extreme Breadth of Beam.	Depth of Hold.	Draft of Water.									
57	KHLP	Active	W. L. Matson	Hartford	49.75	25.28	41.02	69	7	11	5	e	60	31.41	16.25	49	2	11	5	10	2	5	10	5	10	5	10	e
		Adelante	Robert W. Inman	New York	30.51	23.24	30.25	61	8	49	2	e															e	
		Althorak	Charles J. Paine	Boston	25.78	24.59	40.01	61	0	45	0	e															e	
		Allee	Robert C. H. Brock	Philadelphia	11.22	10.08	42	34	0	12	6	e															e	
		Ariadne	H. M. Anthony	New York	16.63	17.13	50	41	2	12	6	e															e	
		Atina	Goldwell H. Codd	"	15.04	15.11	43	37	8	13	4	e															e	
		Arthon	E. R. Hanson	"	10.11	28.01	60	7	15	7	4	e															e	
		Edith	R. K. McMurray	"	19.07	16.32	48	10	10	10	10	e															e	
		Barbara	Chas. H. W. Foster	Boston	21.51	20.44	63	40	0	13	5	e																e
		Barbara	Joseph S. Bass	New London	22.80	21.80	35	29	8	10	5	e																e
		Bonnie Kate	Frederick A. Child	New York	15.34	7.53	7.44	43	30	12	5	e																e
		Bedouin	Samuel Mather, C. W. Wetmore	Boston	73.11	65.58	53.70	83	70	8	15	e																e
		Carroll	Chas. H. W. Foster	New York	18.55	17.05	40	38	0	13	9	e																e
		Charlotte	Edwin C. Larned	Boston	17.42	16.74	49	0	39	0	0	e																e
		Chipitta	Aug. Hemenway	New York	42.38	21.48	29.70	63	14	51	9	e																e
		Chern	J. Howard Adams	"	120.22	126.44	128	141	85	23	0	e																e
		Colonia	Archibald Rogers	"	32.02	22.15	21.05	76	3	49	2	e																e
		Concord	J. M. Masonough	"	130	101.84	101.84	101	63	23	1	e																e
		Corsair	H. C. Fuller	"	26.80	20.52	18.80	50	48	17	5	e																e
		Crescent	William Graham	"	10.49	10.05	48	0	30	11	11	e																e
		Cygnette	Daniel Edgar	"	12	11	11	11	11	11	11	e																e
		James H. Whiting	James H. Whiting	"	13	11	12	40	44	35	0	e																e
		Daisy	Robert S. Church	"	17	8.36	7.96	37	31	14	0	e																e
		Edith	L. J. Gilman	"	25.28	24.00	60	51	0	40	2	e																e
		E. F. O'Shaughnessy	E. F. O'Shaughnessy	"	20	19	2	31	0	23	0	e																e
		Eleanor	Alex. S. Williams	"	27.54	20.17	53	3	47	17	5	e																e
		Espresso	H. A. Hutcheson	"	20.27	19.03	18.08	41	14	16	0	e																e
		Frederick D. Eske	Frederick D. Eske	"	81.11	40.09	40.04	78	68	8	23	e																e
		Fanny	Dwight Brannan	"	22.74	21.00	58	0	49	0	0	e																e
		Frederick	L. J. Gilman	"	17	8.36	7.96	37	31	14	0	e																e
		Galata	Wm. Henry, R. N.	Glasgow	171.14	87	87	134	4	10	8	e																e
		Gayola	H. Morris Edwards	New York	58.01	28.47	25.15	58	0	51	3	e																e
		Gloriana	W. R. Hopkins, M. D.	Philadelphia	54.17	22.56	21.42	70	43	3	13	e																e
		Gracie	Joseph P. Fazio	New York	102.68	68.69	58.90	91	54	09	30	e																e
		John H. Cole	John H. Cole	"	23.52	22.35	53	47	2	15	2	e																e
		Harpoon	George C. Adams	Boston	28.01	27.18	01	45	3	10	0	e																e
		Espresso	George C. Adams, Edward J. Greenen	New York	11	11	11	11	11	11	11	e																e
		Hesper	W. H. Forbes	Boston	25.17	23.01	53	4	45	9	15	e																e
		Hillegard	James C. Boyen	New York	60.15	55.14	37.30	30	62	72	0	e																e
		John	W. Butler Dunson, Jr.	Providence	48.44	37.38	37.38	51	5	69	04	e																e
		Idriam	C. Vanderbilt, Jr.	Newport	28.05	24.05	34.05	60	0	45	9	e																e
		Ideen	Fredrick Gehard	New York	70.28	31.44	25.84	78	65	6	11	e																e
		Iuz	John H. Cole	"	13.42	12.84	4	38	9	13	0	e																e
		Jessica	J. M. Macdonough, Frederick E. Gilbert	"	50.22	30	30	61	45	10	11	e																e
		Julie	Chas. J. Paine	Boston	11	11	11	11	11	11	11	e																e
		Katrina	George Wreck	New York	105.30	62.57	50.45	80	0	69	44	e																e
		Lotus	Maumth G. Foster	"	38.20	25.10	24.88	51	0	30	10	e																e
		Mariposa	Henry F. Lippitt, R. Lincoln Lippitt	Providence	48.00	40.78	35	38	11	13	9	e																e
		May	Howard S. Jodry	New York	17.22	16.00	35	30	10	13	10	e																e
		Medusa	Robert Center	"	60.30	28.70	27.34	64	54	7	11	e																e
		Minesa	August Belmont	"	53.20	25.10	23.94	62	45	10	10	e																e
		Mincera	Phos. C. Zeeva	"	49.61	30.24	24.00	54	30	11	0	e																e
		Montecito	Alex. Malhan	"	33.02	31.37	68	3	53	15	0	e																e
		Navalio	H. Phelps Carroll	Newport	113.20	67.54	123	84	0	43	31	e																e
		Nauticus	W. D. Dickey	New York	22.54	21.42	62	41	1	23	0	e																e
		Nimpy	John H. Lidgerwood	"	32.45	11.83	38	5	33	13	0	e																e
		Nompareille	H. A. Sanderson	"	52.00	49.83	80	68	0	30	10	e																e
		Nympha	Henry W. Harris	"	14.27	13.66	50	39	10	14	7	e																e
		Oriva	Herman Clarke	"	48.24	23.50	22.42	62	7	50	84	e																e
		Peri	Chas. Stek, Loser	"	13.94	13.17	41	7	30	10	14	e																e
		Peabontas	James D. Smith	Greenport	84.00	40.24	41	11	07	09	24	e																e
		Parla	C. L. F. Robinson	New York	18.02	0.08	8.																					

THE YACHTS AND YACHTSMEN OF AMERICA.

LIST OF YACHTS ENROLLED IN THE NEW YORK YACHT CLUB.

STEAMERS.

International Code Signal Letters.	Name.	Owners.	Port.	Tonnage		Length over all.	Length of Water Line.	Extreme Breadth of Beam.	Depth of Hold.	Draft of Water.	Dimensions of Engines.	
				Gross.	Net.							
				ft. in.	ft. in.							
KDPW	Adelita	Nath'l C. Nash	Boston	55.00	27.55	93	87	16	8	7 8	C. 1 2 Cy. 15-11 & 22-11	
KLPM	Admiral	H. W. Comstock	Providence	163.28	51.64	115	98	20	10 6	7 4	C. 1 2 Cy. 12 & 22-15	
KCGM	Alba	William P. Douglass	New York	37.65	18.63	95	90	12	6 3	4 0	C. 1 2 Cy. 8 & 11-11	
KJQP	Albena	S. V. R. Granger	"	301.89	105.50	172	160	24	13 6	9 0	Tr. Ex. 3 Cy. 17-28 & 42-22	
KHLC	Almy	Frederic Gallatin	"	22.73	11.37	70	73	0	5 6	3 0	Tr. Ex. 3 Cy. 7-11 & 17-10	
KJDS	Antia	William Du Pont	Wilmington, Del.	304.75	219.09	177	155	6	21	11	0 0	Tr. Ex. 3 Cy. 17-28 & 42-22
KLQN	Au-Revoir	William Du Pont	"	74.08	50.60	112	99	16	8 6	4 6	C. 1 2 Cy. 10 & 22-12	
	Aurora	Dudley L. Pickman	Boston	347.00	212.00	181	150	23	6	12 6	8 8	Tr. Ex. 3 Cy. 16-20 & 40-22
	Ava	Alonzo Flint	Providence	65.00	32.85	92 11	87 6	17 5	7 8	7 0	C. 1 2 Cy. 11 & 25-14	
KFGM	Avenel	G. Wever Loper	New York	73.30	36.69	108	91	17 1	9 6	6 0	Tr. Ex. 3 Cy. 4-11 & 28-14	
KHGS	Azier	D. A. Loring	"	10.65	6.23	131	104	18	10 5	9 0	Q. Ex. 4 Cy. 8-12-16 & 24-18	
	Ballymena	John N. Brown	Baltimore	28.49	18.53	78	66	11 2	5 10	4 0	Tr. Ex. 3 Cy. 7-11 & 17-10	
	Barnstable	Williamby Weston	New York	145.05	72.53	148 7	131 6	17 10	10 6	7 3	Q. Ex. 5 Cy. 10-13 & (30-22)-15	
MBJK	Beatrice	Robert Golet	Newport	230.00	160.65	125	114	20 2	11	10	C. 1 2 Cy. 21 & 31-20	
	Beya	Geo. L. Romilda	"	12.81	6.04	56 3	50 9	4	6 3	3 0	Tr. Ex. 3 Cy. 41-61 & 101-8	
KFGH	Bo-Pep	E. H. Townsend	New York	20.00	18.84	65	58	12	5	4	Tr. Ex. 3 Cy. 5-8 & 13-8	
	Charlotte	Wm. J. Hiker	"	10.22	15.22	61	61 6	11 6	3 6	Tr. Ex. 3 Cy. 4-6 & 10-8	
	Chaiman	Pierre Lorillard	"	151.07	98.43	46	91 3	21 6	5 4	2 6	Tr. Ex. 6 Cy. (25-5 & 28-8) & (29-18)	
	Calmet	Charles G. Emery	Cape Vincent, N. Y.	35.11	22.31	83 9	70 8	11	4 6	Tr. Ex. 3 Cy. 7-12 & 10-10	
KGWI	Cham	Chas. Kellogg	Philadelphia	45.17	22.84	98 6	92	11 6	7 3	1 6	Ver. Beam. 14-72	
KLAW	Clermont (S W)	A. Van Santvoord	New York	230.12	112.81	160	140	25 6	10 6	5 0	Tr. Ex. 4 Cy. 21-41, (23-31) 20	
	Columbia	J. H. Ladew	"	357.21	190.61	185	165	25	11 3	10 6	Tr. Ex. 4 Cy. 14-21 & 30-21	
HMRB	Comanche (Brazilian)	H. McVie Hanra	Cleveland	380.18	174.20	203	188	24 7	15 2	13	Tr. Ex. 3 Cy. 15-21 & 40-33	
	Compass	F. W. Vanderbilt	New York	560.63	280.32	241 6	204	27	16 6	13	Tr. Ex. 3 Cy. 21-33 & 54-30	
KJSV	Corsair	J. Pierpont Morgan	Norwich	42.68	21.34	97	81 1	12 6	7 8	5 0	C. 1 2 Cy. 8 & 11-14	
KCMD	Cosette	Edwin H. Bennett	New York	35.75	17.88	78	68	11	6 4	4 6	Tr. Ex. 3 Cy. 6-11 & 18-10	
KDSB	Daunt	George M. Preston	Bristol	54.25	40.31	104 6	90	15	6 6	6 1	C. 1 2 Cy. 10 & 22-12	
	Delipse	L. M. Kortright	"	485.70	233.08	190 61	172 6	182 6	23	12 10	9 6	C. 1 2 Cy. 28 & 46-20
KCMN	Electra	Edridge T. Gerry	New York	124.64	68.35	117 12	102	18 9	13 6	7 6	Tr. Ex. 3 Cy. 10-16 & 34-16	
KGHI	Elfreda	W. Seward Webb	Burlington, Vt.	160	153	20	11	8	Tr. Ex. 3 Cy. 10-21 & 34-21	
	Embla	John H. Haman	New York	65.35	35.27	108 5	100 3	17 6	7 3	6	C. 1 2 Cy. 14 & 20-16	
JWGL	Empress	P. A. Schermerhorn	"	43.42	28.11	85	72	13 1	7	5 8	Tr. Ex. 3 Cy. 8-12 & 10-12	
KLGI	Evelyn	J. R. Hezeman, Jr.	Hayre	411	100	100	22	16 6	12 1	Tr. Ex. 3 Cy. 18-30 & 48-32	
	Fauvette	Eugene A. Perignon	New York	181.85	88.06	116 61	122	101	20 4	10 8	C. 1 2 Cy. 14 & 24-20	
KDLH	Fedham	Edward M. Brown	"	71	37.61	21.20	86	7 6	15	9 6	Comp. 2 Cy. 10 & 10-10	
	Forget-Me-Not	Geo. T. Butler, W. H. Butler	Montreal	71.96	48.57	98	75	17	10 6	10	C. 1 2 Cy. 8 & 16-12	
VSPK	Gadabout	Edward M. Fulton	Philadelphia	40.00	20.63	81	71	12 6	8	4 0	Tr. Ex. 3 Cy. 7-11 & 18-9	
KLPV	Gretchen	J. E. Reybarn	New York	80.65	41.52	125	103 3	16	8	6 6	C. 1 2 Cy. 12 & 20-16	
	Haleyon *	Andrew B. Culver	"	38.14	21.01	91	78	13 6	6 6	6 4	C. 1 4 Cy. (27-4 & 2) 14-9	
	Haleyon	Chas. H. W. Foster	Boston	58.18	28.69	97	85	15 10	8	8	C. 1 2 Cy. 11 & 25-14	
KJNC	Hannibal	C. O. D. Iselin	New York	37.12	18.50	92	80	Tr. Ex. 3 Cy. 8-12 & 20-12	
	Hevelia	W. C. McMillan	Detroit	57.20	31.40	120	95	15 6	7 6	5	Tr. Ex. 3 Cy. 9-14 & 24-14	
	Idler	J. L. Hutchinson	New York	6.73	3.37	48	47	7 6	3 8	2 6	Tr. Ex. 3 Cy. 9-14 & 10-8	
KLPP	Intrepid (Aux.)	Eloyl Phoenix	"	360.99	190.40	165 6	152	27	10 41	13 6	Tr. Ex. 3 Cy. 9-14 & 24-10	
KJVB	Iraha	J. H. Flieger	"	62.60	45.13	121	116	16 2	6 2	6 4	C. 1 2 Cy. 10 & 18-18	
KPYG	Iraha	August Belmont	"	213	111.53	98.45	150	135 6	19 7	12 10	9 6	Tr. Ex. 3 Cy. 10-16 & 20-22
KHBS	Javelin	Chas. R. Flint	"	37.48	20.10	97 9	91	10 2	6 7	4 0	Tr. Ex. 3 Cy. 9-14 & 22-12	
KJPT	Jean	James Renwick	"	91.44	60.16	106	90	17	11	7	Tan. C. 1 4 Cy. (25-12 & 29-12)	
	Judy	T. R. Hostetter	"	44.09	27.20	102 3	86	11 6	7 9	5 9	Tr. Ex. 3 Cy. 7-12 & 19-10	
	Kalohah	Chas. L. Hubbard	Norwich	42.32	16.21	92	75	13 8	4 9		
	Katrina	C. L. Hubbard	"	20.79	10.40	73	68	9 3	3 7	Tr. Ex. 3 Cy. 5-9 & 14-9	
MBQW	Linotto	Eugene A. Perignon	Hayre	32.80	107	94	16 6	8	6 6	C. 1 2 Cy. 12 & 21-18	
KJMH	Lagoda	John H. Hull	Hartford	31.88	27.16	98	92	13	7 4	5 4	C. 1 2 Cy. 8 & 14-14	
KGGP	Lanoho	T. Henry French	New York	42.90	27.16	98 6	88 4	16 9	5 2	7	C. 1 2 Cy. 13 & 22-16	
	Laratus	George C. Clark	Ogdensburg	52.05	29.48	90	82	13 6	5 6	6 6	C. 1 2 Cy. 10 & 18-14	
	Lucie	George W. Vanderbilt	New York	19.09	11.28	69	61	9 2	4 0	3 6	C. 1 2 Cy. 6 & 10-10	
KGJT	Larline	W. Boernum Wetmore	"	198.41	65.49	138.23	104 7	162	16 10	7 6	C. 1 2 Cy. 14 & 24-14	
KCHL	Magnolia	Fairman Rogers	Philadelphia	132	61.00	45.53	99	16	17 6	8 6	C. 1 4 Cy. (26-6 & 29-10)-10	
	Marietta	Harrison B. Moore	"	113 2	95	16	8 5	6 6	Tr. Ex. 3 Cy. 10-15 & 24-15	
	Marion	James J. Payne	"	39.81	25.84	97 6	90	17	5 6	5 10	C. 1 2 Cy. 10 & 20-11	
	May	Edwin D. Morgan	Newport	655.71	445.88	230	203 8	27 8	17 8	11 5	Tr. Ex. 3 Cy. 19-31 & 51-33	
	Minnehaha	Henry J. Burby	Geneva, Switz.	65	60	8 6	3 6	3	Bul. 2 Cy. 11, First, (28 x 8	
JYWB	Nanonina	James Gordon Bennett	New York	745.20	420.29	298.15	231	216	26 1	18	11 6	Tr. Ex. 3 Cy. 21-31 & 55-39
KGWP	Narwhal	C. H. Osgood	New London	157.27	68.04	144	120	18 4	11	7 8	C. 1 2 Cy. 11 & 21-10	
	Nathlius	H. M. Howe, M. D.	Bristol	56	48 6	10 4	3 8	C. 1 2 Cy. 7 & 12-10	
KDVB	Nedra	Chas. A. Gould	Philadelphia	111.39	78.97	130	115	20 9	9 7	3	C. 1 2 Cy. 15 & 28-16	
	Nirvana	William H. Sands	New York	106	86	16	9	5 6	Tr. Ex. 3 Cy. 9-14 & 22-11	
	Nomnd	Adrian Iselin, Jr.	"	24.81	19.29	74	68	10	13	5 5	Tr. Ex. 3 Cy. 6-10 & 16-10	
	Nooya	John N. Dickerson	"	288.68	169.92	125	104	18 6	9 8	10	C. 1 2 Cy. 19 & 32-22	
KCTS	Nourmahud	E. N. J. Astor	"	745.20	420.00	243 1	221	30	18 7	14 3	C. 1 2 Cy. 34 & 60-30	
KDSQ	Now Then	J. Edward Adicks	Boston	25.30	12.70	80 4	85	10	6	4	Tr. Ex. 3 Cy. 7-12 & 10-10	
KHJM	Nylin	Ray V. Pierce, M. D.	Buffalo	68.84	37.62	99	82 6	15 9	9 2	5 8	C. 1 2 Cy. 11 & 22-15	
	Oberon	W. J. Matheson	New York	16.21	11.90	65	50	10 7	4 7	4	Tr. Ex. 3 Cy. 41-61 & 11-8	

* Chartered to J. Walter Thompson.

LIST OF YACHTS ENROLLED IN THE NEW YORK YACHT CLUB.

STEAMERS—(CONTINUED).

International Signal Letters.	Name.	Owners.	Port.	Tonnage for Representation U. S. C. Chap. 4, R. L.		Tonnage		Length over all.	Length of Water Line.	Extreme Breadth of Beam.	Depth of Hold.	Draft of Water.	Dimensions of Engines.					
				Gross.	Net.	Gross.	Net.											
														ft. in.	ft. in.	ft. in.	ft. in.	
KIND	Ondia	E. C. Benedict	New York	57	141.38	71.20	138	121	6	29	0	11	7 1/2	8	0	C. 1.5 Cy. 15 & 23-18		
JWCB	Oriente	E. R. Ludew	"	95.90	51.14	125	117	17	8	1	7	8	1	7	0	Tr. Ex. 3 Cy. 11-20 & 20-14	
KLBJ	Postline	Frank H. Walker	Detroit	49.51	29.18	110	98	15	3	8	6	7	6	6	0	840l. C. 1.4 Cy. (25.10 & 25.20)-12	
MWTK	Pewees	Chas. W. Harbuss	New York	227.60	143.80	194	130	0	22	11	9	8	6	6	0	Tr. Ex. 3 Cy. 17-24 & 11-22	
KGSR	Que on Mab	John Taylor Lord	"	111	86.00	50.19	120	140	15	9	2	8	9	0	0	0	C. 1.2 Cy. 10 & 23-18	
KLBJ	Radia	J. Burke Wolfe	"	191.01	97.10	160	112	29	4	12	9	9	0	0	0	C. 1.3 Cy. 13-23 & 35-23	
KLBJ	Reva	Pierre Lottard	"	125.77	81.18	116	6	135	20	9	1	1	1	1	0	C. 1.1 Cy. (29.08 & 29.11)-12	
KLBJ	Roverie	Freck. G. Bourne	"	92.15	53.18	130	100	16	8	8	7	5	8	0	0	Tr. Ex. 3 Cy. 11-10 & 20-12	
KLBJ	Roposo	"	"	29.83	14.92	73	68	11	6	8	5	6	6	0	0	C. 1.2 Cy. 6 & 10-10	
KLBJ	Rival	Frank F. Chysoide	"	81	71.29	43.78	102	1	32	17	6	5	1	0	0	0	C. 1.2 Cy. 11 & 20-16	
KLBJ	Saugmore	Blair S. Scott	Philadelphia	242.81	173.37	185	100	25	13	3	12	11	3	12	0	Tr. Ex. 3 Cy. 15-24 & 37-50	
KLBJ	Saugmore	Bartholomew Strouvesant	New York	49.12	25.82	61	61	15	7	1	11	0	0	0	0	C. 1.1 Cy. 29.4 & 29.7-7	
KLBJ	Sapphire	Amz L. Barber	"	129.28	69.14	137	110	19	6	10	2	9	0	0	0	Tr. Ex. 3 Cy. 12-10 & 0-13	
KLBJ	Sapphire	J. J. Alexandre	"	56.13	30.34	93	83	5	6	2	6	6	0	0	0	C. 1.2 Cy. 10 & 18-12	
TEWS	Satellite (Aux.)	Perry Belmont	"	261	109.08	114.97	130	133	6	22	0	13	13	6	0	0	C. 1.2 Cy. 13 & 22-13	
TEWS	Satellite	A. Van Santvoord	"	37.10	11.64	60	80	12	6	6	5	5	0	0	0	Stpl. C. 1.1 Cy. (29.7 & 29.11)-0	
TEWS	Semora	William C. Dickson	Norfolk	175.11	78.56	148	6	130	19	11	5	10	18	0	0	C. 1.2 Cy. 15 & 10-18	
MBTD	Semora (Twin Screw)	James Gordon Bennett	Paris	72.00	35.00	101	95	13	6	10	5	7	7	0	0	C. 1.1 Cy. 10-10. Emr. 6-91 (29.4 & 31.14)-10	
KLBJ	Shenoeset	Geo. H. Watson	New London	15.08	7.89	48	45	11	4	8	5	5	5	0	0	Com'g. 1. Cy. 8 & 9	
KLBJ	Shourwater	Henry H. Wolcott	New York	169.01	55.92	124	104	18	8	7	6	6	6	0	0	C. 1.2 Cy. 12 & 25-20	
KLBJ	Sigma	S. C. Reynolds	Toledo	270	158.58	100.26	150	130	21	10	8	0	0	0	0	0	C. 1.2 Cy. 10 & 21-28	
KLBJ	Silva	Multon H. Forrest, M. D.	Philadelphia	32.88	21.25	80	69	12	6	7	6	1	6	0	0	Tr. Ex. 3 Cy. 7-11 & 17-10	
KLBJ	Skyhawk	Arthur M. D'Olge	New York	39.17	23.17	105	91	3	10	1	3	5	7	0	0	C. 1.2 Cy. 12 & 20-12	
KLBJ	Sparkle	W. M. Sincerely	Philadelphia	25.40	13.29	60	52	13	5	3	3	3	3	0	0	Ver. Com. 2 Cy. 0 & 11-0	
KLBJ	Springfield	E. H. Harriman	New York	242.29	178.46	181	105	13	7	0	6	5	0	0	0	Tr. Ex. 3 Cy. 16-24 & 11-10	
KLBJ	Starling	David Dows, Jr.	"	109.13	54.59	127	131	23	15	6	0	0	0	0	0	C. 1.2 Cy. 15 & 21-22	
KLBJ	Stella	James H. Dreslin	"	32.22	26.56	68	56	3	15	5	8	4	8	0	0	C. 1.2 Cy. 8 & 11-10	
KLBJ	Striae	Thos. A. McIntyre	"	11.28	11.74	55	50	9	4	5	3	3	0	0	0	Tr. Ex. 3 Cy. 41-61 & 10-8	
KLBJ	Stranger	Jos. C. Howland	"	100.60	247.40	124.70	187	173	5	21	8	11	6	10	6	0	0	C. 1.2 Cy. 21 & 41-24
KLBJ	Sultana (Aux.)	Trenor L. Park	"	391.10	229.89	187	155	37	6	17	6	11	6	0	0	0	Tr. Ex. 3 Cy. 13-24 & 31-21
KLBJ	Susquehanna	Joseph Stickney	"	233.32	116.60	150	151	22	13	9	0	0	0	0	0	Tr. Ex. 3 Cy. 17-28 & 12-22	
KLBJ	Thyra	C. Bannum Seelye	"	56.22	26.58	70	64	11	7	5	4	4	0	0	0	C. 1.2 Cy. 8 & 11-14	
KLBJ	Tillie	W. H. Starbuck	"	158.22	79.26	137	137	13	9	9	8	8	0	0	0	C. 1.3 Cy. 26-32 & 32-21	
KLBJ	Tripartito	Samuel B. Stratton	"	21.31	28.42	80	64	6	11	0	7	4	5	0	0	C. 1.2 Cy. 6 & 10-10	
KLBJ	Troby	Edwin H. Bennett	"	52.70	35.62	99	90	13	9	6	4	5	3	0	0	C. 1.3 Cy. 8-12 & 21-12	
KLBJ	Triand	T. H. Newberry	"	140.38	50.10	132	108	17	6	0	0	0	0	0	0	Tr. Ex. 3 Cy. 10-16 & 25-13	
KLBJ	Triand	T. H. Newberry	Detroit	32.14	23.01	87	6	74	16	5	1	5	5	0	0	840l. C. 1.2 Cy. 9 & 16-12	
KLBJ	T'owann (Aux.)	Wm. W. Durant	New York	414.23	266.63	191	155	37	8	16	9	11	0	0	0	Tr. Ex. 3 Cy. 10-15 & 25-20	
KLBJ	Vallum (Twin Screw)	W. K. Vanderbilt	"	21.00	331	263	39	25	6	16	6	0	0	0	Tr. Ex. 6 Cy. (29.23 & 29.30) & (29.71-30)	
KLBJ	Vannose	William R. Hearst	San Francisco	63.27	31.63	112	6	108	12	4	9	6	6	0	0	Tr. Ex. 1.5 Cy. 11-15 & (1.22)-15	
KLBJ	Vollette	M. C. D. Borden	New York	93.49	53.67	124	6	161	8	15	6	6	0	0	0	Tr. Ex. 3 Cy. 15 & (29.20)-21	
KLBJ	Voga	Frederic Manroe	"	30.00	17.07	73	8	65	13	2	6	1	4	0	0	C. 1.1 Cy. (30.7) & (31.12)-10	
KLBJ	Vesta	James Laughlin, Jr.	Pittsburgh	108	89	4	15	0	5	10	0	0	C. 1.2 Cy. 12 & 21-14	
KLBJ	Viking	H. A. Hutchins	New York	141.38	71.39	138	122	21	10	1	9	0	0	0	0	C. 1.2 Cy. 15 & 28-18	
KLBJ	Vision	Clarence McKim	"	45.20	32.77	100	84	16	5	3	6	4	0	0	0	C. 1.2 Cy. 12 & 21-14	
KLBJ	Ylra	M. S. Smith	Detroit	69.58	48.51	100	84	17	6	8	5	0	0	0	0	C. 1.2 Cy. 10 & 18-14	
KLBJ	Yadena	J. H. Wade, Jr.	Cleveland	250	198.97	74.81	165	147	21	12	10	6	6	0	0	0	Tr. Ex. 3 Cy. 15-50 & 42-22	
KLBJ	Wampanoag	H. L. Willoughby	Newport	52.00	28.18	14.20	67	58	12	8	6	5	5	0	0	0	Tr. Ex. 3 Cy. 10-10 & 16-10	
KLBJ	Wanda	James Stillman	New York	111.27	55.64	138	127	18	11	3	10	2	0	0	0	C. 1.2 Cy. 20 & 30-24	

STEAM LAUNCHES.

Name.	Owners.	Port.	Tonnage		Length over all.	Length of Water Line.	Extreme Breadth of Beam.	Depth of Hold.	Draft of Water.	Dimensions of Engines.			
			Gross.	Net.									
											ft. in.	ft. in.	
Cricket	Archibald Rogers	New York	41	8	9	3				
Daisy	S. Nicholson Kane	Newport	6.73	3.37	48	47	7	6	3	8	2	8	Tr. Ex. 3 Cy. 4-6 & 10-8
Down	J. S. Newberry	Detroit	48	47	7	6	3	8	2	8	Tr. Ex. 3 Cy. 4-6 & 10-8
Iroquois	J. J. O'Donohue	New York	4.	2.	45	41	7	6	3	9	2	8	C. 1.2 Cy. 4 & 7-7
Lotos	Fred. Roosevelt	Skauteleas	49	42	8	3	9	2	6	0	Wells Pat. 1 Cy. 6-12
Marguerite	R. W. Inman	New York	40	3	40	5	6	3	2	6	Tr. Ex. 3 Cy. 21-51 & 9-6
Oslole	Gunn M. Hutton	Newport	50	46	9	3	6	0	0	
Sentinel	G. L. Ronalds	New York	42	40	9	

-14

(2) 20-12

22

1

12

-12

-30

1

-14

(2) 14-0

0.50) - (2) 04

1-10

9

10

11-8

13-21

12-22

24

2

5-134

4-12

25-20

8 (2) 71-30

7 (1) 22) 15

0-24

21-10

1

12-22

10-10

rhines.

10-8

0-8

2

9-6

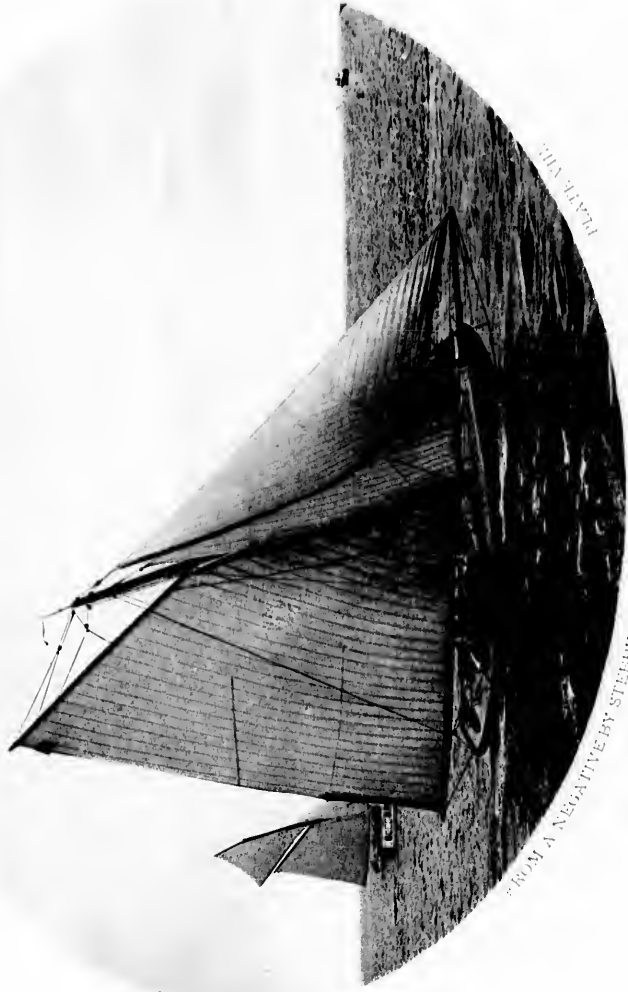

DRUSILLA.



RULES AND REGULATIONS.

According to the By-Laws of the club, no yacht shall be entitled to a representation until she shall have been registered on the club record, in the name of her owner or owners, shall have been launched and a certificate signed by the measurer, filed with the secretary, specifying her dimensions, tonnage according to the old measurement which is as follows: Take the length from the fore part of stem to the after side of the stern post, at the height of the main deck; the extreme breadth wherever found, the depth from the under side of the deck plank to the ceiling of the hold, then deduct from the length 3-5 of the beam; multiply the remainder by the breadth, and the product by the depth; divide this last product by 95, and the quotient is the tonnage.

EXAMPLE.

Length for measurement	100	feet
Deduct 3-5 of breadth—23 feet*	76.8	

Multiply by breadth—	80.2	

	258.6	

	1724	

	1982.6	

Multipled by depth—	9	feet

Divide by 95 (17,823.1 (187.79-95 tons.

Dimensions of her rig must be given and she must be fifteen tons or over (old measurement) and a full decked vessel, reasonable cockpit excepted.

No yacht shall be entitled to representation if she shall have been out of commission for two consecutive years.

Yachts shall be rated for time allowance according to the following system:

To the square foot of the sail area, add the load waterline length and divide the sum by two,

$$\frac{1}{2} \frac{SA + L}{2}$$

The result is the measurement for time allowance. The measurement shall be obtained as follows:

A base line to be taken from a point midway between the jib topsail stay and the jibstay on bowsprit, or the flying jibstay on jibboom, in a straight line to the end of the main boom, with the excess of the length of gaff, measured from after side of mast to end, over 80% of the topmast measured from hounds to lower side of sheave of topsail halliard block.

The length of base line as above defined shall be modified in any case where the spinnaker boom measures more than the distance from the fore side of foremast in a schooner, or mainmast in a single masted vessel, to the forward point of base line as previously defined. Any excess in the length of spinnaker boom beyond this point shall be added to the base line. For yawls the base line to be taken from the same point to the end of the mizzen boom.

A perpendicular line to be taken along the after side of the mainmast from the under side of the sheave for gaff topsail halliard to the upper side of boom when resting on the saddle or on the lowest part of gooseneck, the distance of which point from main-deck on house deck to be recorded by the measurer, together with the other points used in measurements.

To obtain the estimated area from these figures, multiply the base by the perpendicular and divide the product by two.

Length is the length on the load waterline exclusive of any portion of the rudder or rudder stock and is to be ascertained when the yacht is aloft and in her ordinary trim, and with the crew, if aboard, stationed amidships. The measurer, at the time of making his measurement, to fix a distinctive mark at each point.

Any change in these measurements to be reported by the owners, as customary, to the measurer.

Allowances shall be calculated according to the table adopted by the club.*

COURSES.

Course No. 1. Start across an imaginary line drawn from the judge's boat anchored to the east of Buoy No. 11, and about two cables length from it to Buoy No. 14 near Southwest Spit, passing to the west and south of it; thence south of Buoy No. 12 and north of Bell Buoy, off the point of Sandy Hook, to Sandy Hook Lightship, turning from the north and east, and returning over the same course.

Course No. 2. The same as course No. 1, substituting Southland Lightship for Sandy Hook Lightship.

All yachts must pass to the eastward of west bank Buoys Nos. 7 and 9, both going and returning.

Course No. 3. Start from an imaginary line, between Buoy No. 14, near Southwest Spit, and a stake boat anchored south of it; thence south of Buoy No. 12 and north of Bell Buoy off the point of Sandy Hook, to and around Sandy Hook Lightship, turning it from the north and east; thence to and around a mark boat anchored near the buoy on Shrewsbury Rocks, turning it from the west and south, and returning over the same course.

Course No. 4. 38 miles. Start across an imaginary line drawn from a stake boat to "Brenton's Reef" Lightship; to and around a mark due east of Block Island Buoy one mile; to and around a mark about 2 miles S. W. by W. from West-Island Light, and finish over a line drawn as for the start.

Course No. 5. 38 miles. Start as in course No. 4, to and around the "Vineyard" Sound Lightship, (formerly known as Sow and Pigs L.S.) to and around Hen and Chickens Lightship, and finish as in course No. 4.

MANAGEMENT OF RACES.

The following racing rules shall govern all the races of the club, and any race sailed under its auspices unless otherwise specified between the parties making the race, but as no rules can be devised capable of meeting every incident and accident of sailing, it shall be the duty of the Regatta Committee to decide any question which may arise not provided for in these rules, and all attempts to win a race by other means than fair sailing and superior speed and skill are to be discouraged.

DECISIONS OF COMMITTEE.

The decisions of the Regatta Committee shall be final. (Const., Art. X.)

CLASSIFICATIONS.

(1.) For Club Races, yachts shall be divided into classes as follows, but this classification shall not apply to races for any challenge cup held by or belonging to the club:

SCHOONERS.

- (2.) Class 1, all over 100 feet load waterline length.
- Class 2, all over 90 feet and not over 100 feet load waterline length.
- Class 3, all over 80 feet and not over 90 feet load waterline length.
- Class 4, all over 70 feet and not over 80 feet load waterline length.
- Class 5, all over 70 feet load waterline length and under.

SLOOPS, CUTTERS AND YAWLS.

- (3.) Class 1, all over 80 feet load waterline length.
- Class 2, all over 70 feet and not over 80 feet load waterline length.
- Class 3, all over 61 feet and not over 70 feet load waterline length.
- Class 4, all over 53 feet and not over 61 feet load waterline length.

*The length to be measured for the spinnaker boom shall be the extreme distance, when in use, of its outer end, from the center of the fore side of the mast on which the spinnaker is carried.

Class 5, all over 46 feet and not over 53 feet load waterline length.

Class 6, all over 40 feet and not over 46 feet load waterline length.

Class 7, all of 10 feet load waterline length and under.

(4.) Course No. 2 is intended for Classes 6 and 7 of sloops, cutters and yawls.

(5.) Any yacht which shall have been launched prior to the 20th day of June, 1888, exceeding the higher limit in any class by not over the fraction of a foot, shall be included in that class.

SAILS.

(1.) Yachts in races may carry the following sails:

(2.) Schooners—mainsail, foresail, forestaysail, jib, flying jib, jib-topsail, fore and main gaff topsail, main topmast staysail and spinnaker.

(3.) Sloops and Cutters—mainsail, forestaysail, jib, flying jib, jib-topsail, gaff topsail and spinnaker.

(4.) Yawls—same as sloops and cutters, with mizzen and mizzen staysail.

BALLOON SAILS.

(5.) Yachts may set light sails over working sails.

TIME OF RACE NOT LIMITED.

There shall be no limit to the time in which a race is to be sailed.

TABLE OF TIME ALLOWANCE.

The allowance is based upon the rule accepted by naval architects that, within economic limits, opportunities for speed vary in different vessels as the square roots of their respective lengths. As strong winds are required, however, to give to larger vessels the full extent of their advantage in size, and as such a scale of allowance is not adapted to ordinary summer racing, 50 per cent. only of the allowance due to the rule is given in the table, and may be stated thus:

Time equals $5\sqrt{\frac{2610 - 2620}{11} - \frac{2620}{11}}$; 3,600 representing the number of seconds in an hour, 1 the small yacht, and 1 the large one.

Practically the formula is $\sqrt{\frac{180 - 1800}{11} - \frac{1800}{11}}$; five-tenths of 3,600 being 1,800.

MODELS.

A correct model of every yacht entered for a regatta or other club race shall be deposited with the club and retained in its possession; and no person, other than a United States Naval Constructor, shall be permitted to copy it, unless he shall have obtained written authority from the owner of the yacht; nor shall it be removed without authority from the secretary of the club, who shall keep, in a book provided for that purpose, a record of same with full particulars relating to each model, and to any changes that may be made.

All models to be on a scale of three-eighths of one inch to the foot for all yachts of 80 feet waterline and over, and of one-half of one inch to the foot for all yachts under 80 feet waterline; but this

rule as to scale shall not necessarily apply to any model in the possession of the club at the time of the passage of this By-Law.

CUPS.

The deed of gift relative to AMERICA'S CUP is set forth in the chapter devoted to the history of this famous trophy.

NEW YORK YACHT CLUB COURSE CUPS.

(PRESENTED BY EX-COMMODORE JAMES GORDON BENNETT, 1872.)

CUP NO. 1.

will be offered to the schooner yachts of the NEW YORK YACHT CLUB, to be sailed for at the June Regatta, over the usual course, viz: from the anchorage off Staten Island to and around the Lightship off Sandy Hook and return. Said cup to be held by the winner for the term of thirty days after the race without liability to challenge. Upon the expiration of said period, the winner of the cup must accept any challenge sent by a member of said club, and be prepared to sail a race over the same course, or such other course as may be designated by the annually elected Regatta Committee of

the NEW YORK YACHT CLUB, or in the absence of the members thereof, by a committee appointed by the Commodore of said club, or by the senior officer present, within the usual cruising limits of the NEW YORK YACHT CLUB SQUADRON, and of equal distance (say not over 40 statute miles), within the space of fifteen days next ensuing the receipt of such challenge, or forfeit the cup to challenger. During the time in which the yachts are sailing in squadron, such race must be sailed upon a notice of five days, instead of fifteen days as above required. Should any yacht succeed in holding the cup in two consecutive races during the season, the winner thereof will not again be liable to

challenge until the commencement of the yachting season of the next year ensuing.

The races will be sailed according to the rules of the NEW YORK YACHT CLUB, with time allowance.

CUP NO. 2.

will be offered to the sloop yachts of the NEW YORK YACHT CLUB to be sailed over such a course and at such a time as may be designated by the Regatta Committee, or by such other as is provided for above, and to be run and held upon the same conditions as the cup for the schooner yachts.

BREXTON'S REEF CUP.

This cup will be offered to the yachts of all nations, to be sailed for in an ocean race, on a course from the Lightship off Newport to and around the Lightship off Sandy Hook and outside of Long Island, and return. Said cup to be held by the winner for the term of thirty days without liability to challenge. Upon the expiration of said period the winner of said cup must accept any challenge, and be prepared to sail a race over the same course within the space of fifteen days next ensuing the receipt of such challenge, or forfeit the

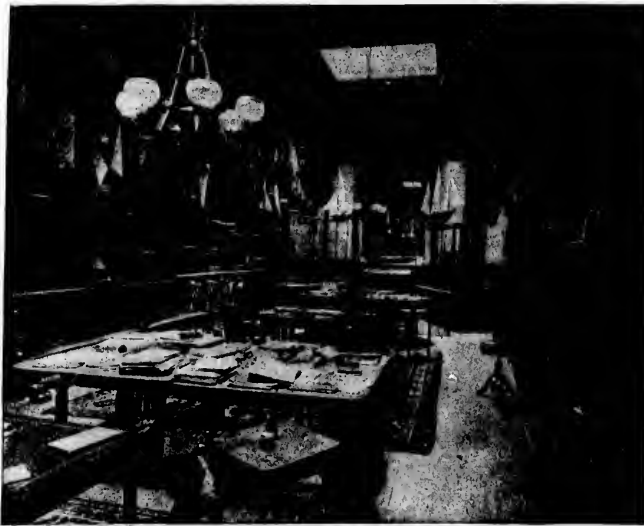

Copyright, 1894, by W. J. Demorest.

MODEL ROOM.—FIGURE 237.

cup to the challenger. Should any yacht succeed in holding the cup in two consecutive races during one season, the owner thereof will not again be liable to challenge until the commencement of the yachting season of the year next ensuing.

In the event of the cup being held at the close of the season by a foreign yacht, the owner thereof will be liable to challenge during the season of the year next ensuing, for an ocean race over a course from the Needles, Isle of Wight, to and around a stake boat off the harbor of Cherbourg and return.

The ocean races for the Brenton's Reef Cup will be sailed according

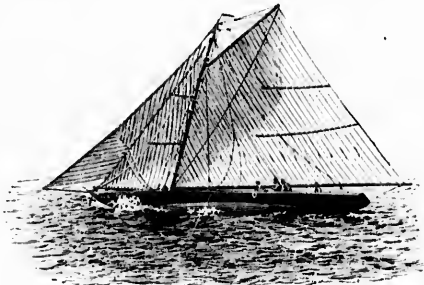

DRESILLA.—FIGURE 238.

to the rules of the NEW YORK YACHT CLUB, but without allowance of time.

It is understood that in case any yacht holding one of the before mentioned challenge cups shall be sold out of the NEW YORK YACHT SQUADRON, the cup is not disposed of with her but must be returned to the NEW YORK YACHT CLUB, to be sailed for again in the manner and form before provided for the schooners and sloops and for the ocean races.

It is also understood that in case a foreign yacht should hold the challenge cup, and should be sold out of a ROYAL YACHT CLUB, the cup is not sold with her, but must be returned to the NEW YORK YACHT CLUB, to be sailed for again in an ocean race as above provided.

The yachting season in American waters for the before named challenge cups will be from the third Thursday in June until the third Thursday in October.

Upon each of the challenge cups there shall be engraved the names of those yachts and the owners thereof that have held the same; and a die, with appropriate devices thereon, shall be engraved, from which medals can be struck to be held by the owners of those yachts which have been successful in competing for any of the before mentioned prizes.

CAPE MAY CHALLENGE CUP.

The course for the Cape May Challenge Cup, presented to the club in 1872, by James Gordon Bennett, Esq., is established as follows:

From an imaginary line from the judge's steamer and Buoy No. 5, off Sandy Hook, to and around the Five Fathom Lightship, off Cape May, leaving it on the port or starboard hand, at will, and back to Sandy Hook Lightship, passing the same to the southward and eastward within one hundred yards distance.

The cup will be awarded subject to the following conditions as expressed in the letter of the donor:

1st.—It is to be held by the winner for thirty days after the race, without liability to challenge.

2d.—Upon the expiration of that period, the winner must accept any challenge, and be prepared to sail a race over the same course within fifteen days from the receipt of such challenge, or forfeit the cup to the challenger; but should any yacht succeed in holding the

cup in two consecutive races during one season, it will not again be liable to challenge until the commencement of the yachting season of the following year. The cup will become the *bona-fide* property of any yacht holding it successfully through three consecutive contests.

3d.—The yachting season in American waters, in reference to this cup, is understood to be from the third Thursday in June until the third Thursday in October in each year.

4th.—Should a yacht holding this cup be sold out of the NEW YORK YACHT CLUB, the cup shall not go with her, but shall be returned to the club, to be again sailed for; and if the cup should be held by a foreign yacht, and she should be sold out of the club to which she belongs the cup shall not be sold with her, but shall be returned to the NEW YORK YACHT CLUB, to be sailed for again as above provided.

5th.—In the event of the cup being held at the close of a season

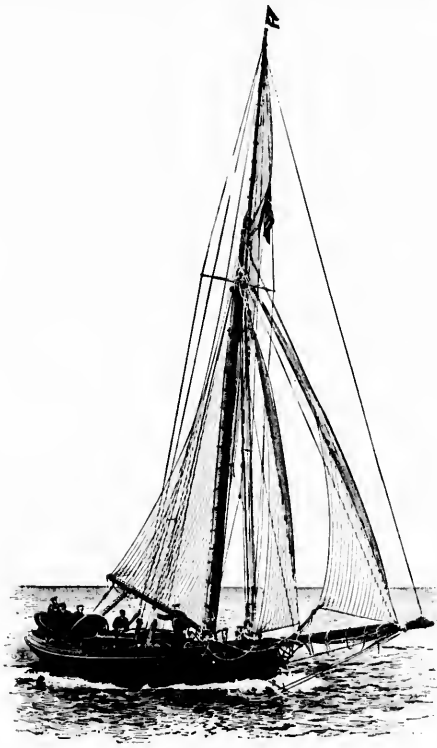

ESPIRITO.—FIGURE 239.

by a foreign yacht, the owner thereof will be liable to challenge during the season of the next year for an ocean race over a course from the Needles, Isle of Wight, to and around a stake boat off the harbor of Cherbourg, and return.

Note.—At a general meeting of the NEW YORK YACHT CLUB, held March 23, 1876, the following resolution was adopted:

Resolved, That under the sanction of Ex-Commodore Bennett, the following be added to the conditions under which the Brenton's Reef and Cape May Challenge Cups, presented by him, shall be held hereafter:

“Any yacht challenging the holder must deposit five hundred (\$500) dollars with the Regatta Committee, to be forfeited in case

the challenging party is not successful in winning, otherwise to be returned to him. If forfeited, to be invested in a cup to become the property of the challenged party.

RECORD OF THE RACES.

The First Annual Regatta given by the NEW YORK YACHT CLUB took place July 17, 1845, and it can readily be imagined that it was

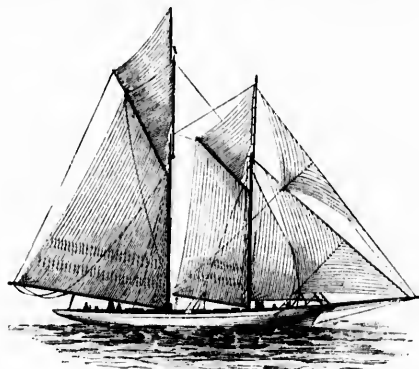

SACHEM.—FIGURE 240.

a great event; so much so that the day was practically a general holiday.

Thousands of people witnessed the race and crafts of all dimensions up to steamboats were filled with spectators.

The following yachts took part and started at:

NAME.	TONNAGE.	OWNER.	TIME.		
			H.	M.	S.
Addy	17	James Rogers	9	31	00
Lancet	20	Geo. Robbins	9	35	30
Gimcrack	25	John C. Stevens	9	37	00
La Coquille	27	J. C. Jay	9	38	30
Minna	30	J. Waterbury	9	40	45
Newburgh	33	H. Robinson	9	44	33
Spray	37	H. Wilkes	9	49	30
Sybil	42	C. Miller	9	53	30
Cygnnet	45	W. Edgar	9	51	50
Siren	72	W. Miller	9	53	40
Ianthe	79	G. Cadwallader	9	53	40

The course over which the race was sailed commenced at a stake

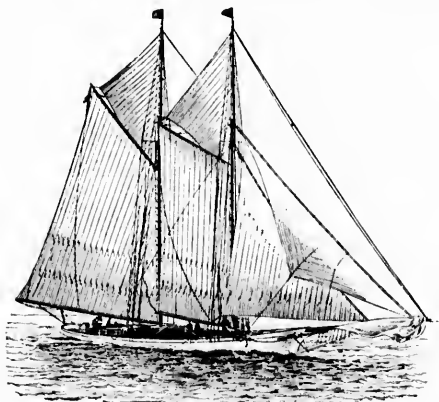

PEERLESS.—FIGURE 241.

boat off Robbins Reef, to a stake boat off Bay Ridge, L. I.; thence to a stake boat off Stapleton, S. I., and thence to and around the

Southwest Spit Buoy, returning over the same course. At ten minutes past eleven o'clock the fleet was between the Quarantine ground and Robbins Reef, ADDY leading; LANCET second, LA COQUILLE third, GIMCRACK fourth, and to leeward; MINNA fifth, SPRAY sixth, SYBIL seventh, CYGNET and IANTHE eighth and ninth, very near together; SIREN tenth, fast gaining on the others and taking the lead as soon as they got well out in the bay, and NEWBURGH eleventh and to leeward. The race was sailed for a silver cup purchased out of the entrance money, which was fixed at twenty-five dollars for each yacht, and was won by CYGNET, she covering the distance in 5 hours, 23 minutes, 15 seconds. SYBIL came in second in 5 hrs., 25 min., 25 sec., and GIMCRACK third, in 5 hrs., 30 min., 30 sec. The other yachts were everywhere, so to speak.

An allowance of 45 seconds per ton of Custom House measurement was made, but no allowance for difference of rig was considered, the schooners and sloops being classed together.

The schooners had no foretopmast and consequently no jib or club topsail was used. The sloops had no jib boom and the bowsprit was short, as was also the topmast.

The Second Annual Regatta of the NEW YORK YACHT CLUB, after taking possession of its new headquarters at Elysian Fields, Hoboken, occurred during the same summer (on July 16 and 18, 1846), and was for a prize valued at \$200, offered by the club to any yacht that could sail over the following course in eight hours:

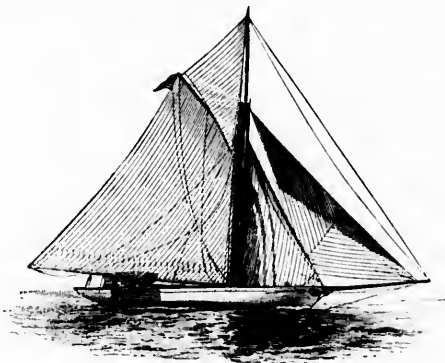

MILDRED.—FIGURE 242

From a stake boat off the Elysian Fields to a stake boat off Stapleton, S. I., thence to a stake boat off the Long Island shore, thence to the Southwest Spit, returning over the same course. The yachts which participated were:

BRENDA, 33 tons; COQUETTE, 26 tons; CYGNET, 45 tons; GIMCRACK, 25 tons; LA COQUILLE, 27 tons; LANCET, 23 tons; MINNA, 30 tons; MIST, 44 tons; NORTHERN LIGHT, 70 tons; NEWBURGH, 33 tons; PET, 46 tons; SIREN, 73 tons; SPRAY, 37 tons and SYBIL, 42 tons.

The prize was awarded to MIST, owned by Mr. L. Deppau, sailing the full course in 7 hrs., 37 min., the only yacht accomplishing the feat within the prescribed time.

The yachts which took part on July 18th over the same course were: Schooners BRENDA, COQUETTE, CYGNET, GIMCRACK, HORNET, MINNA and SIREN. Sloops ANN MARIA, 52 tons, DART, MIST and PRERSALL.

The prize, a beautiful silver cup valued at \$200, was awarded to HORNET on time allowance. DART won second prize, \$130, entrance money.

GIMCRACK came in first, MIST second, HORNET third and DART fourth.

On October 6, 1846, the first amateur CORINTHIAN REGATTA took place over a course from a stake boat (GIMCRACK) anchored off Club House, Elysian Fields, thence to and around a stake boat anchored off Washington Point; thence to a stake boat anchored in the Narrows, returning to the place of starting, a distance of 40 miles, with an allowance of 25 seconds per ton (Custom House measurement). The prize, a cup, was subscribed by the NEW YORK YACHT CLUB. The orders were that none but club members would be allowed to sail or handle the boats.

The yachts which participated were the sloops LANCET (20 tons) and MARIA (160 tons) and the schooners CYGNET, LACQUILLE, SPRAY and SIREN. The day was just suited for a race, as there was a strong breeze blowing from the southwest. MARIA made her first appearance in this race and won easily, beating SIREN on actual time 58 min., 15 secs.

The First Ocean Race was sailed October 10, 1846, the course being 25 miles to windward and return. The wind was strong

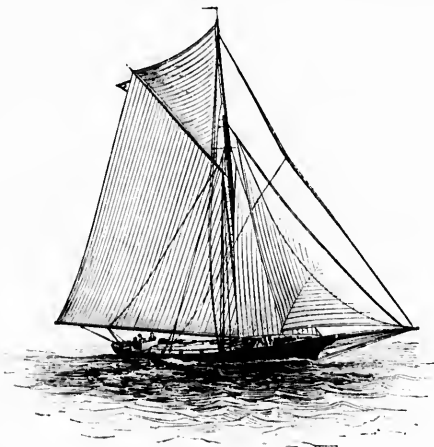

HILDEGARD.—FIGURE 243.

from the northeast, and the two yachts competing, namely, the sloop MARIA (entered at 154 tons), and the schooner COQUETTE (74 tons), went from the white buoy at the entrance of Gedney's Channel to a stake boat off the south end of the Woodlands.

The match was for \$1,000 a side, which for a club only two years old, must be considered as showing considerable enterprise.

COQUETTE carried all her sail during the race. MARIA started with double reefed mainsail and bonnet off her jib. It was a close and exciting race—COQUETTE won; time, 6 hrs., 55 min., 30 sec. MARIA covered the distance in 7 hrs., 1 min.

The next year on May 25, 1847, a match race between SYBIL and CYGNET was sailed for \$500 a side over the regular club course, about 40 miles, without time allowance, SYBIL arriving at Elysian Fields at 6 P. M. with a lead of a quarter of a mile.

Another match race took place May 31, 1847, between the schooners CORNELIA and CYGNET over the regular club course for \$500 a side, without time allowance. CORNELIA grounded off Ellis Island and CYGNET won.

The Third Annual Regatta took place June 2, 1847. The prizes consisted of two elegant pieces of plate valued at \$200 each.

The yachts which competed were:

First Class Yachts:

SCHOONERS.		
Siren,	53 tons	W. E. Miller
Cornelia	65 tons	Wm. Edgar

SLOOPS.		
Dart	59 tons	Not belonging to Club
Maria	119 tons	John C. Stevens

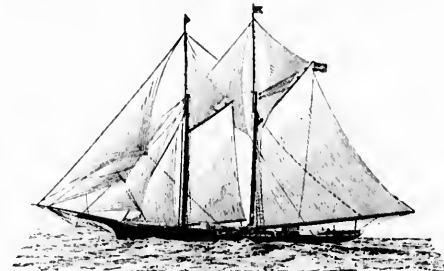

WANDEBER.—FIGURE 244.

Second Class Yachts:

SCHOONERS.		
Coquille	21 tons	J. C. Jay
Hornet	25 tons	Not belonging to Club
Dream	22 tons	J. P. Hall
Mimna	21 tons	L. Coles
Peter Smith	—	Not belonging to Club
Sybil	38 tons	C. Miller
Spray	35 tons	H. Wilkes
Cygnat	38 tons	L. Suydam

SLOOPS.		
Pearsall	27 tons	Not belonging to Club
Uma	39 tons	L. Waterbury

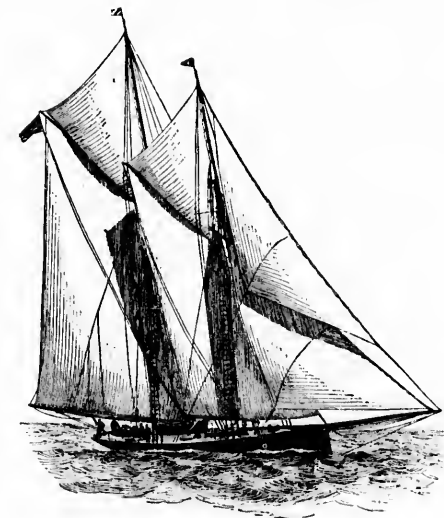

ELMA.—FIGURE 245.

The yachts started from opposite the Elysian Fields. The course was to a stake boat off Marine Hospital, at Staten Island, to another off Long Island and thence to Southwest S. B. Buoy.

The prizes were won by MARIA and UMA. MARIA having rounded the stake boat at the starting point at ten minutes before five o'clock

and *UNA* at thirteen minutes of five. *UNA*, being of the second class boats, was only entitled to the second class prize.

This was the first race in which *UNA* took part and her owner was well pleased with the result. *DART* won the general purse in the outside boats.

On Oct. 12, 1847, the Second Amateur Corinthian Regatta took place over the regular club course.

The schooners *GIMCRACK*, *DREAM*, *SPRAY*, *CYGNET*, *SIREN* and *CORNELIA* and the sloop *UNA* (59 tons) started. The yachts were manned and sailed exclusively by members, each yacht being allowed a pilot. *UNA* won the prize, a Subscription Cup; time, 3 hrs., 43 min., 40 sec., *SIREN* was second, time 4 hrs., 23 min., 00 sec., and *SPRAY* third, time, 4 hrs., 28 min., 28 secs.

The Fourth Annual Regatta of the NEW YORK YACHT CLUB was held June 6, 1848, and took place opposite the Elysian Fields at about 10 o'clock.

The breeze was slight at starting, quite stiff and somewhat squally later.

The yachts which took part were divided into two classes.

First class over 50 tons. Allowance of time, 35 seconds per ton.

SCHOONERS.

<i>Siren</i>	60 tons	W. E. Miller
<i>Cornelia</i>	75 tons	Wm. Edgar

SLOOPS.

<i>Maria</i>	118 tons	R. L. Stevens
--------------	----------	---------------

The race was a beautiful sight and well contended throughout, especially when turning the stake boat at the Southwest Spit where all the skill of the different boats were brought into play.

The winning boat was *CORNELIA*, time, 3 hrs., 12 min., 14 sec., she being very skillfully handled. On beating up, she passed the Battery at the rate of 15 knots, with the sloop *MARIA* about a mile astern. *MARIA* snapped her mast shortly afterwards, in a sudden gust of

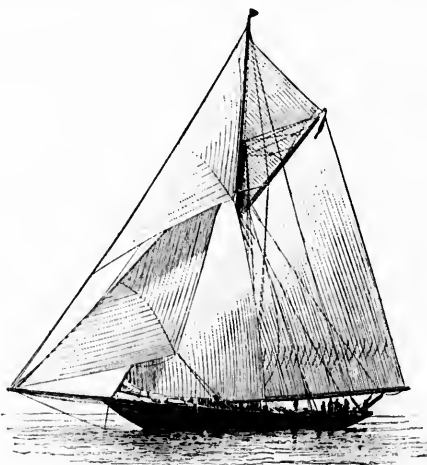

NAVAHOE.—FIGURE 246.

wind. When this happened *CORNELIA* was about $\frac{3}{4}$ of a mile ahead and would beyond doubt have held her own, had *MARIA* continued without accident.

Thus *CORNELIA* won the race, making the 40 miles in a little over five hours, beating *MARIA* some 48 minutes. *MARIA* would have been second in had she not met with the accident; as it was, *SIREN* was second, time, 3 hrs., 59 min., 52 secs.

The second class yachts were under 50 tons, and the allowance of time was 45 seconds per ton.

SLOOPS.

<i>Lancet</i>	10 tons	R. R. Patton
---------------	---------	--------------

SCHOONERS.

<i>LaCoquille</i>	21 tons	J. C. Jay
<i>Dream</i>	28½ tons	J. P. Hull
<i>Spray</i>	34 tons	H. Wilkes
<i>Cygnel</i>	39 tons	D. L. Snyder

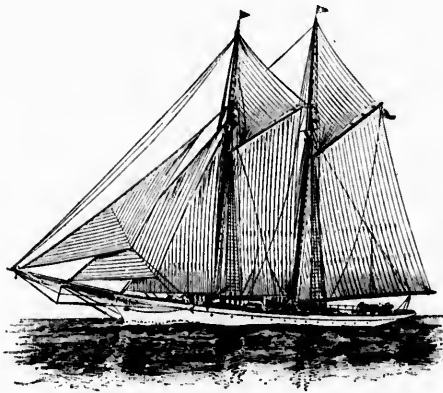

YAMPA.—FIGURE 247

CYGNET was first; time, 4 hrs., 14 min., 45 sec.; *LA-COQUILLE* second; time, 4 hrs., 17 min., 25 sec., *SPRAY*, third, *DREAM* fourth and *LANCET* fifth.

The Third Amateur Corinthian match was attempted Oct. 26, 1848, for three pieces of silver subscribed by members.

The yachts that participated were:

SCHOONERS.

<i>Sybil</i>	C. Miller
<i>Siren</i>	W. E. Miller
<i>Breeze</i>	Mr. Coles
<i>Cornelia</i>	Wm. Edgar

The course for the race was the regular club course, but owing to lack of wind, the race was sailed again November 3rd. On this occasion, only the schooners *SYBIL*, *SIREN* and *CORNELIA* took part. *SIREN* grounded near Fort Diamond. *SYBIL* won and received the first prize, while *CORNELIA* received the second prize. As no sloops entered, the third prize was reserved.

Before the second trial of the above mentioned race took place, *ULTRA* (62.6 tons) and *UNA* (36 tons) raced over the club course on October 31, 1848.

ULTRA, although allowing *UNA* 17 min., 15 sec., won the race by 15 seconds.

The Fifth Annual Regatta took place June 5, 1849. The following yachts took part:

First Class—*MARIA* (119 tons), *CORNELIA* (75 tons), *ULTRA* (63 tons), and *SIREN* (65 tons). The first prize was a very elegant silver liqueur stand; the second a handsome pitcher, chastely engraved. The time allowance (for all first class yachts over 50 tons,) was the usual 35 seconds. The wind was quite light and, therefore, against the favorite, *MARIA*.

allowance of

am



...: LACQUILLE
...l, DREAM fourth

...ed Oct. 26, 1848,

...iller
...gar

...ese, but owing to
...d. On this occa-
...ELLA took part.
...and received the
...ce. As no sloops

...race took place,
...he club course on

...won the race by

...1849. The follow-

...tons), ULTRA (63
...very elegant silver
...hastely engraved.
...er 50 tons.) was
...it and, therefore,

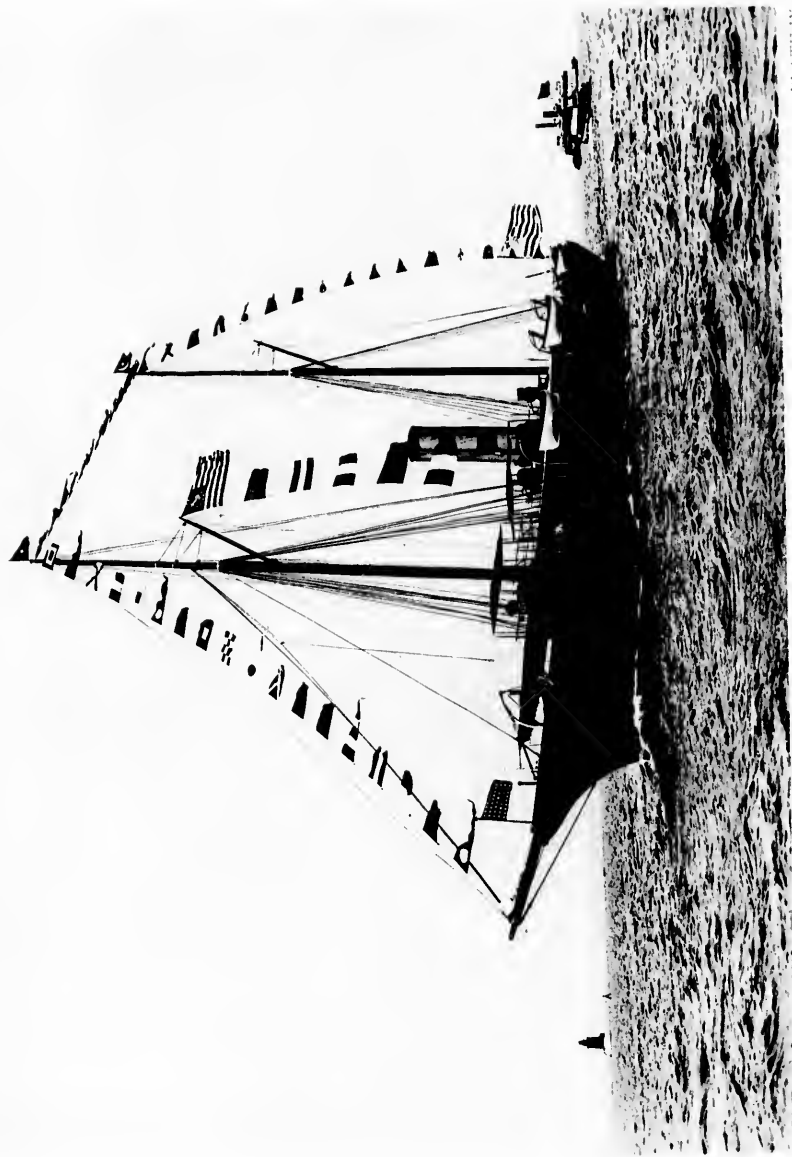

FROM A NEGATIVE BY BOLLES.

PLATE IX.

CORSAIR.

YACHTSMEN OF AMERICA

The following
 List of
 Names
 of the
 Yachts
 which
 were
 entered
 for the
 Race
 on the
 1st of
 June



and were
 entered
 for the
 Race
 on the
 1st of
 June
 The following
 are the
 names of the
 Yachts
 which
 were
 entered
 for the
 Race
 on the
 1st of
 June
 The names
 of the
 Yachts
 which
 were
 entered
 for the
 Race
 on the
 1st of
 June
 are
 as
 follows
 The names
 of the
 Yachts
 which
 were
 entered
 for the
 Race
 on the
 1st of
 June
 are
 as
 follows
 The names
 of the
 Yachts
 which
 were
 entered
 for the
 Race
 on the
 1st of
 June
 are
 as
 follows

The following
 are the
 names of the
 Yachts
 which
 were
 entered
 for the
 Race
 on the
 1st of
 June
 The names
 of the
 Yachts
 which
 were
 entered
 for the
 Race
 on the
 1st of
 June
 are
 as
 follows
 The names
 of the
 Yachts
 which
 were
 entered
 for the
 Race
 on the
 1st of
 June
 are
 as
 follows

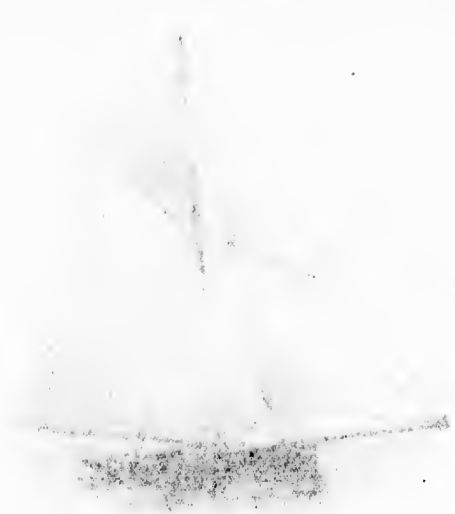

The following
 are the
 names of the
 Yachts
 which
 were
 entered
 for the
 Race
 on the
 1st of
 June
 The names
 of the
 Yachts
 which
 were
 entered
 for the
 Race
 on the
 1st of
 June
 are
 as
 follows
 The names
 of the
 Yachts
 which
 were
 entered
 for the
 Race
 on the
 1st of
 June
 are
 as
 follows

CORSAIR.

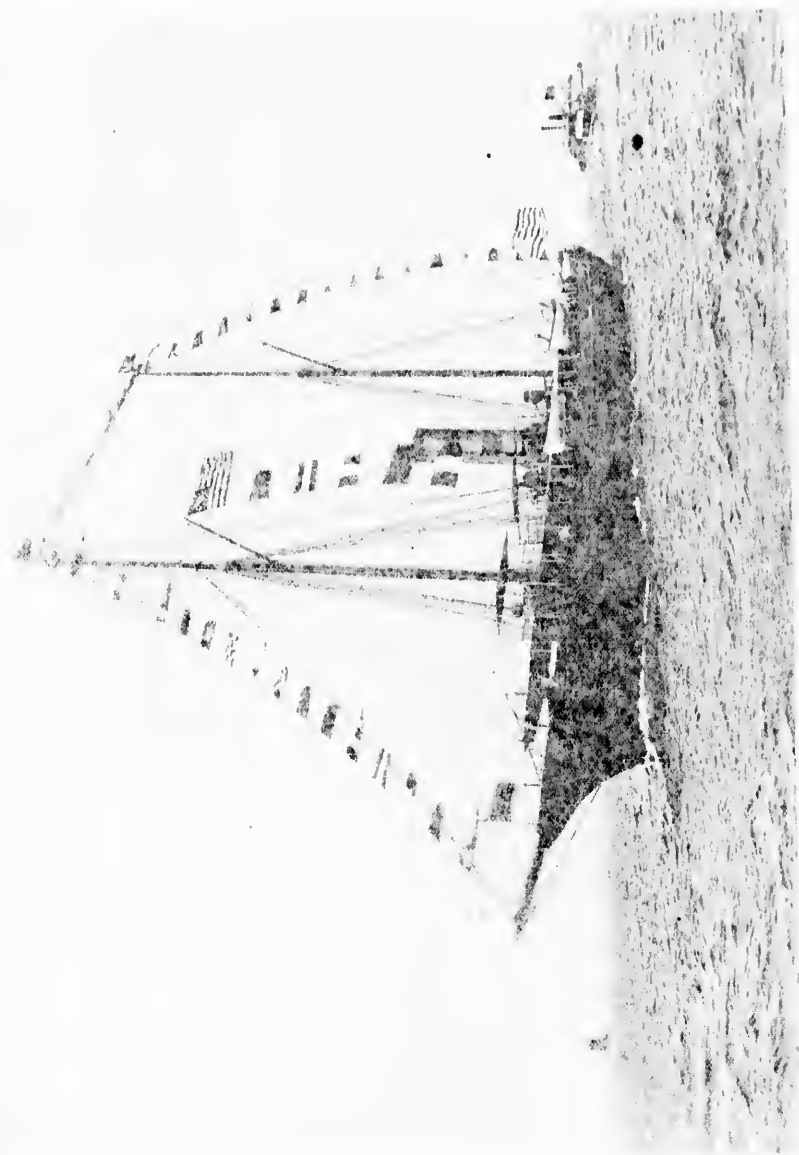

The following was the sailing :

To Southwest Spit.		To the Elysian Fields.	
	H.M.S.		H.M.S.
Maria	1 3 58	Cornelia	4 54 50
Ultra	1 7 12	Maria	5 2 10
Cornelia	1 8 37	Ultra	5 13 9
Siren	1 22 50	Siren	5 46 50

The schooner CORNELIA, owned by Mr. Edgar, came in first and would have won the race but that through mistake she went the wrong side of the western bank; STREX won the second prize.

ULTRA, belonging to Mr. Miller of Newburgh, was the winner of the

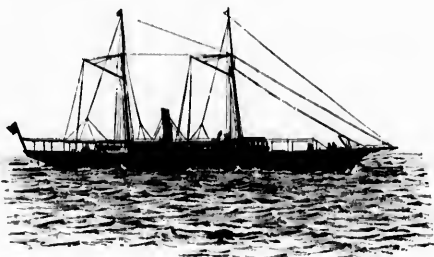

SENECA.—FIGURE 218.

first prize on time allowance, as MARIA came in only 14 minutes ahead.

MISCHIEF, being too late for entering, sailed with the other boats and beat them all.

Second Class—This class started at the same time.

The following is the result :

Round Southwest Spit.		To the Elysian Fields.	
	H.M.S.		H.M.S.
Sybil	1 20 11	Sybil	5 31 40
Spray	1 21 28	Spray	5 43 28

The first prize was a silver pitcher and was won by SYBIL; the second a smaller one.

The race was the inside course, namely, to the Narrows and back.

On June 7, 1849, the race was the outside course to the Hook.

The day was fine but the wind was too light for much sport. As on the day before, MISCHIEF (or as she is sometimes called, HORNET) beat them all; though not being entered she could not of course win the prize.

On October 13, 1849, a Match Race was sailed around the lightship, starting from Robbin's Reef, between CORNELIA and BREEZE; the latter carried away her bowsprit, the wind being very fresh from the northeast and, although CORNELIA sprung her mast, she won the race in 3 hours and 30 minutes.

The Sixth Annual Regatta took place June 6, 1850, over regular club course.

Entries for First Class yachts were :

Maria	126 tons	J. C. Stevens.
Ultra	72 "	C. Miller.
Cornelia	75 "	Wm. Edgar.
Breeze	75 "	Mr. Coles.

Second Class Yachts were :

Una	46 tons	James Waterbury
Spray	34 "	Hamilton Wilkes.
Dream	22 "	J. P. Hill.
Undine	19 "	Dr. J. Barden.

CORNELIA and SPRAY did not start.

BREEZE drew away from MARIA for the first 8 or 10 miles, while the wind was light. About a mile below the Narrows, after turning the stake boats, the wind freshened and MARIA took the lead. MARIA passed the stake boat at the Elysian Fields at 3 hrs., 37 min., 7 sec., ULTRA at 3 hrs., 45 min., 20 sec. and BREEZE at 3 hrs., 56 min., 29 sec. ULTRA won the first prize on time allowance and BREEZE the second.

In the second class only UNA and UNDISINE started. UNA won easily, passing the stake boat an hour and twenty seconds ahead of UNDISINE. Each yacht received a prize as there were two.

The second day Annual Regatta came off on June 7, 1850. The course was from a stake boat stationed at Robbin's Reef, around the buoy of the Southwest Spit, thence around the Light-ship at sea, then returning to the buoy of the spit and back to Robbin's Reef, a distance of about forty miles. In the first class, MARIA, ULTRA, BREEZE and CORNELIA were entered. In the second class, UNA, UNDISINE, SPRAY and DREAM. When off False Hook the breeze became so fresh as to spring and splinter the mast-head of MARIA, obliging her when about half-way between the Hook and the Light-ship, to settle away her mainsail and return.

The result was as follows :

1st Class—MARIA disabled. 2nd Class—UNA received first prize.

BREEZE ruled out.

SPRAY did not start.

CORNELIA did not start.

DREAM did not start.

ULTRA forfeited.

UNDISINE won second prize.

The Seventh Annual Regatta took place June 5 and 6, 1851. The first day six yachts started in two classes—CORNELIA, ULTRA, UNA, SPORT, ABEL and ALPHA, and only four on the second day. UNA won first prize in her class and SPORT first prize in her class. AMERICA'S RACE May 9, 1851, will be elaborately detailed in the chapter on AMERICA'S CUP in Vol. II.

AMERICA sailed a Match Race August 28, 1851 in English waters, against the schooner TITANIA, for £50. The course was from

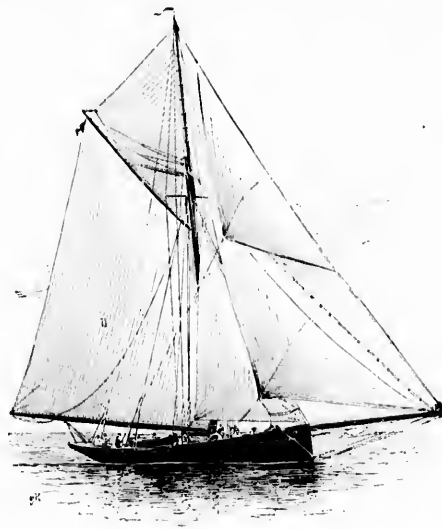

HERON.—FIGURE 249.

the Nab to a station twenty miles away. The wind at the start was fresh from the northwest which increased to a gale changing to north by west. AMERICA won, beating TITANIA 4 minutes and 12 seconds. Another race was sailed from the station back to the Nab, also for £50. AMERICA came in 52 minutes ahead, thus winning both races.

The Eighth Annual Regatta of the NEW YORK YACHT CLUB for 1852, was sailed on June 3rd, over the regular club course. The yachts were divided into classes. In the first class were the sloops UNA, SYLVIE and ULTRA, and the schooner CORNELIA—yachts over 50 tons.

In the second class, yachts between fifty and twenty-five tons, was

the sloop *SPORT*, and in the third class yachts, twenty-five tons and under, *ALPHA* (17 tons), and schooner *ARIEL* (20 tons). This was the first time the yachts had been divided into three classes. *SYLVIE* won prize in first class and *SPORT* won prize in second class, and no prize was awarded in third class on account of accident. On June

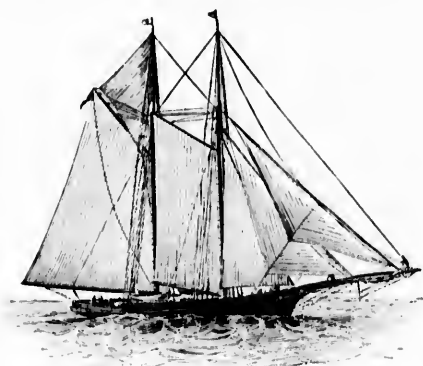

WAVE CREST.—FIGURE 250.

4th, the course was around the flag ship from Robbin's Reef, but on account of insufficient wind, the race was postponed to the 7th, and for the same reason was again postponed until the 9th. The sloop *SYLVIE* won a \$50 prize, this being her first race. She was the property of Mr. Louis A. Depan. *SPORT* and *ALPHA* won in their class. *SYLVIE* was the first American sloop to cross the Atlantic. On June 2, 1853 the Ninth Annual Regatta was sailed over the old club course, from the Elysian Fields; *UNA*, *UNDINE* and *ALPHA* won in their class.

On the 3rd of June, in the race around the Lightship, only four yachts started, the sloops *ALPHA*, *SPORT*, *UNA* and the schooner *CORNELIA*. *UNA* took 1st prize, *SPORT* 2nd and *ALPHA* 3rd prize. The American yacht *SYLVIE*, on August 9, 1853, entered the race at Cowe's, Isle of Wight, and she was beaten by the cutter *JULIA* about 6 minutes, 38½ seconds, over a 66½ mile course.

On June 1, 1854, the Tenth Annual Regatta was sailed over the regular course; 14 yachts started, *UNA* winning the 1st prize, *RAY* 2nd prize, *L'ESPERANCE* 3rd prize. On June 2nd the second day, there was no race. On June 3rd, *ALPHA* was the only yacht ready to sail the outside course. She started at 11:48 A. M. and finished at 7 hrs., 10 min., 00 sec. P. M., winning the third class prize. In first class *HAZE* won and in second class *IRENE* won. The New York Yacht Club passed a resolution that there should be no restrictions as to canvas for yachts contending for prizes. On August 10, 1854, the first yacht race was sailed at Newport, the starters were sloops *MARIA*, *JULIA*, *UNA*, *GERTRUDE*, *IRENE*, *AMERICA* and *ELLA JANE*. The schooners *HAZE*, *CORNELIA*, *MYSTERY* and *SPRAY*. It was the first race for *JULIA*, and *ELLA JANE* was a working vessel. The sloops were limited to mainsail and jib, the schooners to three lower sails, all yachts starting with topmast down, the course being from off Fort Adams to and around the Block Island Buoy, and returning a distance of forty-five miles. The wind was northeast and there was considerable sea. The race was for a cup valued at \$500 for all yachts of any yacht club and \$100 for working vessels. *MARIA* beat *ELLA JANE* 54 minutes, 13 seconds, both of these yachts winning the prizes. Only one race took place in June, 1855, the Eleventh Annual Regatta which was sailed on June 8th, instead of June 7th, on account of weather; there was not much interest taken in it; *JULIA*, *RAY* and *ALPHA* won

in their respective classes. A regatta for the prize contributed by the citizens of Glen Cove, L. I., of which W. E. Burton, the actor, was the principal contributor, was sailed August 3, 1855, just before the cruise of the club. Five schooners and fourteen sloops started. It was the first race of the club on Long Island Sound, the course being from off the steamboat dock to a stake boat off Throgg's Point, thence to Matinecock Point, and back to the place of departure, a distance of twenty-five miles under an allowance of 25 seconds per ton. *JULIA* won the \$150 prize and *MARY* won the second prize of \$100. On August 14th, a race took place from Fort Adams to Hop Island and return, a distance of twenty-two miles, this being a new course which, however, has been abandoned. In each class four yachts started and there were two prizes, one of \$200 and one of \$100. *JULIA* won \$200, *IRENE* \$200, second class; and *RICHMOND* \$100, third class. In 1856, the time allowance was based upon sail area, so that yachts carrying less than 2,300 square feet of canvas should have an allowance of one and one-half seconds per square foot, to be placed in the third class. Yachts carrying 2,300 square feet and upwards were allowed one and one-quarter seconds per foot and placed in the second class, and yachts having a sail area of 3,300 square feet and upwards, were given an allowance of one second, and were placed in the first class. There was only one day's racing this year, the Twelfth Annual Regatta, which took place June 5, 1856. Thirty-six yachts started, distributed in three classes—in first class *JULIA* won, in the second class *UNA* and in the third class *RICHMOND*. At New Bedford, August 8, 1856, the club sailed its First Regatta, the course being 32 1-4 miles. The entries for this race were *SYLVIE* (100 tons), carrying 4,580.88 square feet of canvas,

	TONS.	CANVAS.
Widgeon,	101.9	3,592.44
Julia,	83.0	3,307.45
SCHOONERS.		
Favorite,	128.0	3,983.20
Haze,	87.2	3,542.05
Twilight,	73.0	3,283.20

JULIA won, and *WIDGEON* was second, the race being very close.

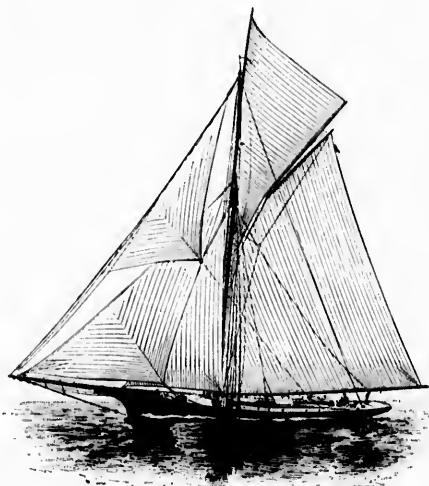

GRACIE.—FIGURE 251.

The time allowance was fortunately unfair, as *WIDGEON*, a larger yacht than *SYLVIE*, received time from her and also from *HAZE*, a vessel 14 tons smaller than herself. There were three classes; *AMER-*

REBECCA won in second class, and RICHMOND in third class. On June 4, 1857, the Thirteenth Annual Regatta was sailed over the regular club course, there being but one race in which twenty-one yachts started, two not finishing; and on August 13, 1857, a race was sailed at New Bedford. First class, HAZE won; second class, MINNIE won; and third class RICHMOND won. The Fourteenth Annual Regatta (1858) was sailed over the old club course on June 3rd.

The day was bright and pleasant, though the wind gave but little promise of a good racing day. At the time set for the start there was no wind, and not until half an hour later, 11:30, was there a sufficiently strong breeze. The course was from a point off the Club House around the Southwest Spit and return.

There were three classes, the first for yachts with 3,300 square feet of canvas and above; the second, 2,300 to 3,300; and the third, those with less than 2,300 square feet. The following were the starters:

First Class (allowance, 1 second per square foot).—Schooners



BARBARA.—FIGURE 252.

WIDGEON, HAZE, ZINGA, SYLVIE, FAVORITE and GYPSY; sloops, REBECCA, MADGIE, and JULIA.

Second Class (allowance, 1½ seconds per square foot).—Schooners, AMERICA, STELLA and SEA DRIFT; sloops, HASWELL, UNDINE, IRENE, SCUD, USA and MINNIE.

Third Class (allowance, 1¼ seconds per square foot).—Sloops, LUCKEY, MARGARET, ISLAND FAWN, EDGAR and FANNY.

The wind, however, continued very light, and an hour after the start, the yachts were off Jersey City. Then the wind freshened, and one by one the racers caught it and made for the turning point. JULIA was the first to round the buoy; REBECCA had torn her jib, preventing her the full extent of her sailing power, but she still continued, though she eventually came to anchor before reaching the stake boat.

The finish was as follows:

YACHT.	CLASS.	TIME.		
		H.	M.	S.
Julia,	I	7	2	00
Una,	II	7	11	15
Minnie,	II	7	14	30
Edgar,	III	7	17	45
Haswell,	II	7	21	00
Madgie,	I	7	45	11
Rebecca,	I	4	42	00
Haze,	I	7	56	45
Island Fawn,	III	7	58	50

Darkness prevented any further official timing. The prizes and their winners were:

First Class:—JULIA, silver tankard and silver.

Second Class:—HASWELL, silver tea set.

Third Class:—EDGAR, punch bowl.

Independent Schooners:—HAZE, tureen.

The first Ocean Sweepstakes Race around Long Island was sailed June 21, 1858; the course was from the Elysian Fields, through the Narrows and out by Sandy Hook, the finish being at Fort Schuyler. There was no restriction as to canvas. The schooners HAZE, SYLVIE, FAVORITE, WIDGEON, started, and the sloops, REBECCA, MADGIE, UNDINE, USA and MINNIE. The entrance fee was \$50 for each yacht. REBECCA reached Montank Point first, two minutes ahead of FAVORITE. Mr. J. G. Bennett, owner of REBECCA, took a short cut through Plum Gut instead of through the race; and the owner of MINNIE protested, and REBECCA was ruled out. The schooner prize was won by SYLVIE; and the sloop prize by MINNIE. The Autumn Regatta was held September 30, 1858. The start was made from off Owl's Head for the first time, and out and around the Lightship, the finish being at the same place as the start. In third class, were NARRAGANSETT, MARGARET and FANNY; second class, MANSERSING, IRENE and SCUD; first class, USA, JILLIE, RESTLESS, MADGIE, ZINGA, REBECCA, VICTORIA, FAVORITE and GYPSY.

First prize awarded to ZINGA, of the schooners.

" " " REBECCA, 1st sloops.

" " " MANSERSING, 2nd sloops.

" " " FANNY, 3rd sloops.

In 1859 the system of measurement for time allowance was changed, the length and breadth being taken into account, and this method remained unchanged until 1870 when the rule was changed to the cubical contents measurements. Nothing remarkable occurred at the Annual Regatta in 1859 which took place on June 2nd, except the change of area sail to area hull. MADGIE, DEER, HASWELL and FLYING CLOUD won in their respective classes.

On August 6th there was a Match Race between the sloop REBECCA and the schooner RESTLESS for \$500 a side, the distance being 154 miles from Brenton's Reef Lighthouse off the harbor at Newport through the Sound to Throgg's Neck Buoy. RESTLESS won by 12 minutes. There was a good strong breeze from the southwest. A Match Race occurred at New London, Aug. 8, 1859, between GYPSY and ZINGA, the former winning. The fleet on their annual cruise had a regatta at Newport. The Autumn Regatta was sailed from off Owl's Head and around the Lightship on the 26th of

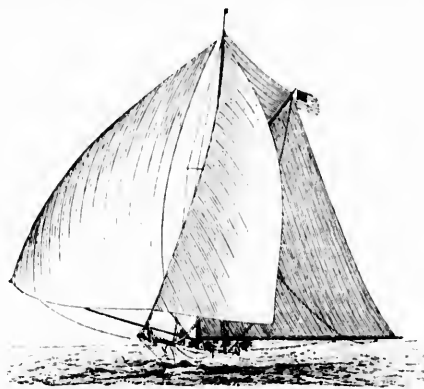

LOTOWANA.—FIGURE 253.

September, the wind falling on the 22nd, when the race was to have been sailed. ZINGA won first prize, as also MALLOBY and NARRAGANSETT in their respective classes.

The schooners GYPSY, FAVORITE and ZINGA sailed a Sweepstakes Race Oct. 6, 1859, from off Hart Island to and around a buoy off Eaton's Neck, a distance of 38 miles; entrance \$50 each. FAVORITE twisted her rudder head and GYPSY won the race, beating

ZINGA by 30 minutes, 2 seconds, sailing under reefed sails.

The Sixteenth Annual Regatta was sailed on the 5th of June, 1860. The morning was dull and rainy, the wind was light, and the prospect was anything but encouraging. However, at 10:35 a start was made, the third class sloops leading the way. In this class there started: NARRAGANSETT, RAY, GLENGARRY and ALPHA.

At 10:42 the second class sloops started, there being four yachts in this class: ROWENA, MANERSING, MALLORY and FANNY.

The first class sloops (one starter, REBECCA) sailed off at 10:50, accompanied by the second class schooners, RESTLESS, BONITA, HAZE, STELLA and DAWN. Five minutes later, the first class schooners were under way, there being two in this class, ZINGA and

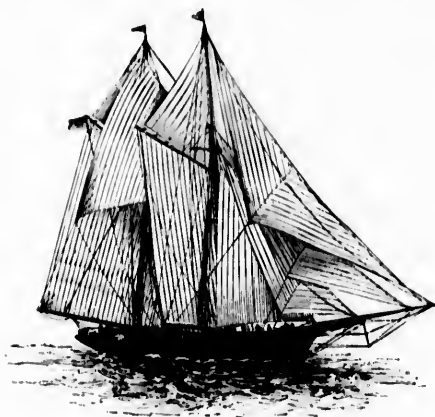

NORSEMAN.—FIGURE 254.

FAVORITE. The allowance of the second class sloops and schooners was 1:35 seconds per square foot, while that of the first class sloops and schooners was 1 second per square foot.

The course was from a point off the club house around the buoy on the Southwest Spit and return.

The finish and winners were as follows:

	H.	M.	S.
Haze (winner) Second schooner class,	4	36	31
Favorite (winner) First schooner class,	4	37	15
Zinga,	4	40	10
Rebecca (winner) First sloop class,	4	41	24
Restless,	4	42	28
Manersing (winner) Second sloop class,	4	47	10
Mallory,	4	56	04
Rowena,	5	04	20
Dawn,	5	13	24
Glengarry (winner) Third sloop class,	5	18	37
Narragansett,	5	20	42
Ray,	5	25	57
Alpha,	5	30	18
Fanny,			
Bonita,			
Stella,			

A Match Race was sailed between JULIA and REBECCA, twenty miles to windward from Sandy Hook, for \$250 a side, on the 2nd day of August, 1860. Yachts sailed with hoisted topmasts and with only jib and mainsails. JULIA won, beating REBECCA 13 minutes, which was the first race over this course, time 3 hours, 9 minutes. The fleet on their Annual Cruise held a regatta at New Bedford. There were three classes of sloops and two of schooners; JULIA won the champion prize for sloops and MARGIE for schooners. On ac-

count of the war breaking out in 1861 there was no Annual Regatta held. In 1862, the Seventeenth Annual Regatta took place on June 5th. MARIA appeared for the first time as a schooner, and raced with FAVORITE and ZINGA, FAVORITE winning. In 1863 the Eighteenth Annual Regatta was sailed June 11th. It was a handicap, the first in the history of the club. There were nine schooners entered and seven sloops, the race being over the old course. In 1864 the Nineteenth Annual Regatta was sailed on June 3rd, over the regular course, between two classes of sloops and two of schooners, ANNIE, METTLE, JULIA and MARGIE won prizes. On June 8, 1865, the Twentieth Annual Regatta was sailed around the Lightship from off Owl's Head. There was one class of each rig; three of the single masted vessels and three of the schooners. There was a strong breeze and only three yachts were timed to the finish; MARGIE won, beating MARIA 22 minutes, 31 seconds. A review of the yachts for the benefit of the ladies was given on June 13, and thirteen yachts appeared at the "Horseshoe." Five days later MARGIE and JOSEPHINE sailed a Match Race for \$1,000 a side; the course was 15 miles to the windward, the stipulation being that the tack should be 30 minutes duration, that there should be no restriction of canvas or number of crew, and no time allowance. MARGIE reached the mark all right and ran back successfully; JOSEPHINE on account of the thick fog which shut down soon after the start, lost the race.

On September 11, a Match Race for \$500 a side took place between HENRIETTA, (a 230 ton schooner) belonging to James Gordon Bennett, and FLEETWING, (a 206 ton schooner,) belonging to Mr. George A. Osgood. The course was from Sandy Hook to Cap May, being the first race sailed over this course. FLEETWING won by 1 hr., 30 min. A Match Race for \$500 a side was sailed Oct. 16, 1865, between HENRIETTA, (a 194.22 ton schooner,) and PALMER, belonging to

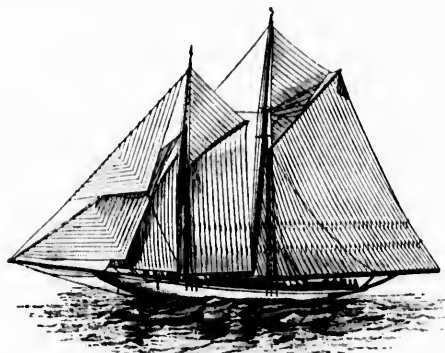

DAGMAR.—FIGURE 255.

R. F. Loper; HENRIETTA won, beating PALMER by 21 minutes. Another Match Race for \$500 a side from Sands Point to Bartlett's Reef Lightship, was sailed between HENRIETTA and the schooner RESTLESS, the former winning by 20 minutes. The Twenty-first Annual Regatta took place June 14, 1866, starting from Owl's Head to and around the Lightship instead of from the Elysian Fields.

There were four sloops and three schooners entered for this Regatta, but two of the sloops subsequently did not start, leaving the starting yachts as follows:

	M.	S.
Schooner Calypso,	allowance	6 50
Schooner Haze,	"	15 20
Schooner Magie,	"	7 29
Sloop Bonita,	"	26 41
Sloop Dream,	"	44 42

The sky was threatening, and the weather was afterwards very

inclement, the fog thickened, and towards the finish there was rain. The wind was quite light, scarcely perceptible at the start, though it freshened as the day grew older, and was strong at times.

The course was off Owl's Head to Southwest Spit Buoy, around the Lightship and return. The start was made at 11:31.

There were two prizes offered, each valued at \$250, one for the winning schooner, and the other for the fastest sloop. The one was a silver silver, and the other a large tureen. The finish was as follows:

	H. M. S.
Magic,	0 50 05
Bonita,	3 50 55
Haze,	0 52 00
Dryaso,	0 51 40
Dream,	7 2 10

HAZE and BONITA were the winners.

A Match Race was sailed August 17, during the Annual Cruise between WIDGON and VESTA, for \$1,000 a side, the course being off Fort Adams to and around Block Island Buoy and return; WIDGON won, beating VESTA 1 min. 4 sec. A Match Race between HENRIETTA and VESTA was sailed from Sandy Hook Lightship and return, for \$500 a side on October 9, 1866. VESTA lost her jibboom and HENRIETTA parted her forestay and had to lie to, to repair damages which took several hours. The wind was a gale from eastward. The VESTA won, beating HENRIETTA 56 minutes, sailing the complete course in 29 hrs., 10 min. A Match Race was sailed between VESTA (201 tons), and HALYCON, (121 tons,) for \$250 a side from Sands Point to Bartlett's Reef Lightship. VESTA won by nearly an hour. A Match Race sailed between VESTA and L'HIRONDELLE, built by Dexter Bradford, and entered at 262.8 tons: the race was 20 minutes to windward, from Sandy Hook Lightship and return for a piece of plate. L'HIRONDELLE won, this being her first season. A Most remarkable race took place between FLEETWING, VESTA and

cent. of the money to be deposited with Leonard W. Jerome on the 3rd of November, the balance to be deposited on the first Tuesday in December, play or pay; signed by J. G. Bennett, Franklin Osgood, George A. Osgood and P. Lorillard, Jr., December 7, 1866."

The race was ordered to be sailed according to the rules of the NEW YORK YACHT CLUB, waving allowance of time, the sails to be carried as follows: Mainsail, foresail, jib, dying jib, jib-topsail, fore and main gaff topsails, storm staysail, trysail and squaresail. Neither yacht was allowed to take a channel pilot from this city. The yachts were allowed to shift everything but ballast, and they were allowed to trim ship up to the very moment they started. By a third agreement it was ordered that the yachts must start on Thursday, December 11th, at 1 o'clock P.M., the starter to be H. S. Fear-

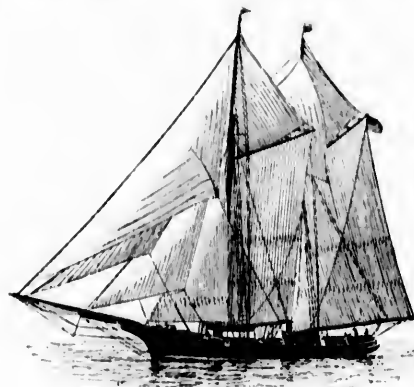

REPUBLIC.—FIGURE 257.

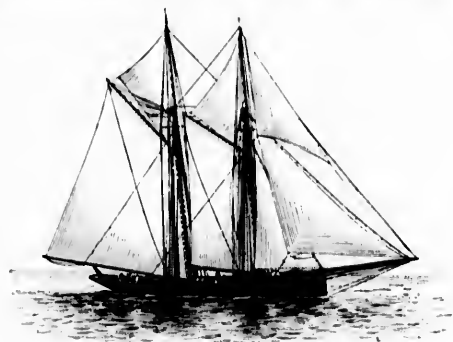

ALERT.—FIGURE 256.

HENRIETTA, starting on the second Tuesday of December, 1866, from Sandy Hook to the Needles on the coast of England, for \$30,000 a side. This race originated from a bet made by Messrs. George and Franklin Osgood, with P. Lorillard, Jr., that FLEETWING could beat VESTA over the above named course. Mr. Bennett, hearing that such a race was to take place, signified his desire to enter HENRIETTA, and later it was agreed that the yacht HENRIETTA could be entered by the payment of \$30,000, and the following article was added to the original agreement: "The yacht, HENRIETTA enters the above race by paying \$30,000 subscription, by the members of the NEW YORK YACHT CLUB; any minor points not embraced in the above that cannot be settled by Messrs. Osgood, Lorillard and Bennett, shall be decided as follows: Each shall choose an umpire. The umpires chosen, in case of disagreement, to choose two others. Twenty per

cent. of the money to be deposited with Leonard W. Jerome on the 3rd of November, the balance to be deposited on the first Tuesday in December, play or pay; signed by J. G. Bennett, Franklin Osgood, George A. Osgood and P. Lorillard, Jr., December 7, 1866."

The race was ordered to be sailed according to the rules of the NEW YORK YACHT CLUB, waving allowance of time, the sails to be carried as follows: Mainsail, foresail, jib, dying jib, jib-topsail, fore and main gaff topsails, storm staysail, trysail and squaresail. Neither yacht was allowed to take a channel pilot from this city. The yachts were allowed to shift everything but ballast, and they were allowed to trim ship up to the very moment they started. By a third agreement it was ordered that the yachts must start on Thursday, December 11th, at 1 o'clock P.M., the starter to be H. S. Fear-

ing, the race to terminate when the lighthouse on the west end of the Isle of Wight appears abeam, with the yachts on the true channel course. In exactly 13 days, 21 hrs., and 55 min., HENRIETTA covered 3,106 miles and won the race. FLEETWING covered a distance of 3,135 miles in 14 days, 6 hrs., 10 min., and was second. VESTA covered 3,144 miles, coming in last, requiring 14 days, 6 hrs., 50 min. VESTA would certainly have been second if her navigator had not blundered in his allowance of the force of Runnel's current, which caused her to fall to leeward off the Sicily Islands. The day before, the yachts getting in with the land, VESTA was ahead of both. The difference of time between FLEETWING and VESTA was only 46 minutes, but HENRIETTA beat VESTA 8 hrs., 50 min., sailing 38 miles shorter distance. Remarkable as it may seem, only one accident happened, which was to FLEETWING; while scudding before a hard gale on December 19th under double-reefed foresail and forestaysail, she took a sea aboard at 9 o'clock in the evening, which washed six of her crew out of the cockpit, the men being lost. FLEETWING laid to under her double-reefed foresail for five hours. Although this accident was a very sad one, it was, as stated, very remarkable that three yachts, starting with racing spars and canvas to cross the ocean at a racing speed, should have met with no other accident. This brilliant race did much to enhance interest in the NEW YORK YACHT CLUB, and the list of membership of the club was greatly increased, as it was considered an honor to join an organization which had become so famous.

The Twenty-second Annual Regatta was held June 13, 1867. Thirteen yachts participated, PHANTOM and EVELYN being the winners.

A race took place at New London Aug. 7, 1867. There were five sloops and seven schooners started. SAPHO, a keel schooner (274.4 tons) built by Poillons made her first appearance; the race was for a cup

offered by the Commodore. EVA was the only yacht that succeeded in finishing within the limit of time, the other yachts not finishing until midnight, owing to a thick fog.

A race from Brenton's Reef to a stake boat anchored about a mile east by north from the lighthouse on Sandy Point off Block Island, and returning to a point off Fort Adams, took place on August 10th. SAPHO and PALMER contended, the latter being a centerboard schooner of 294.2 tons and 2,371.9 feet area. In this race, which was

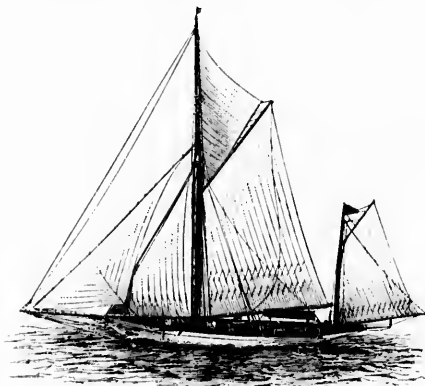

MONTECETO.—FIGURE 258.

to be sailed within 8 hours, PALMER won, beating SAPHO exactly 2 minutes actual time, which was considered a bad beat, owing to the difference in the size of the two boats.

A regatta was held at New London Aug. 11, 1868, for a cup presented by Pierre Lorillard, Jr. Twelve schooners participated, HALCYON was the only yacht that completed the race in 8 hours and therefore won the prize.

On August 14, 1868, a race was sailed at Newport, for cups offered by Dr. Thos. C. Durant. Twenty yachts started. WHITE WING won the cup for sloops and EVA the cup for schooners.

A subscription Sweepstake Race was sailed at New Bedford, August 17, 1868, PALMER, PHANTOM, IDLER and EVA competing. The race was declared off, the course not being covered within the prescribed time.

The NEW YORK YACHT CLUB established itself at Clifton, S. I., in 1868, and held an Annual Regatta on August 18th, but on account of lack of wind the race was abandoned. On the following day, GRACIE and WHITE WING, as also the schooners MAGIC, IDLER, SYLVIE and RAMBLER, made their appearance. MAGIC won the schooner prize, there being a strong breeze; WHITE WING was disabled.

A Match Race between PAULINE (81.2 tons), and MAGIC (112.5 tons), took place July 15th, the owner of MAGIC betting \$3,000 to \$2,500. At the start the wind was variable but freshened at the Hook. The race was over the regular course, and PAULINE led MAGIC from the start to the finish, coming in 30 min., 15 sec. ahead, actual time. Corrected time: MAGIC, 7 hrs., 13 min., 30 sec. PAULINE, 5 hrs., 25 min., 15 sec. It may be stated that PAULINE struck the breeze before MAGIC and got out to the Lightship before her, which was inside of the Hook, and received no benefit from the freshening of the wind; still it was a bad beat for MAGIC, a boat that was most remarkably smarter.

Pierre Lorillard offered a cup at New London and Dr. Thos. Durant offered one at Newport. During the Annual Cruise at Clark's Point there was an Ocean Sweepstakes, 20 miles and return, but the race was not finished within the five hours allotted time.

SAPHO not having been purchased in this country, was sent to England to be sold, and entered a regatta but was badly beaten, and all chances of selling her were lost; so she returned to this country, and was sold to Mr. W. P. Douglass, who had her "hipped out" and from that time she became a success.

On September 22, 1868, the Autumn Regatta took place. Mr. Bennett, at that time Vice-Commodore, presented four cups to be sailed for. The course for this regatta was from a point off the Club House, by the Southwest Spit, around the Lightship and return. The wind was steady and good throughout the race, and the weather was fair.

The start was made at 10:50. All the yachts got away beautifully except PALMER, who was still hauling in her anchor when the others were bowling along. This told against her, as a matter of course, throughout the race.

There was no time allowance and the limit was seven hours, one yacht being obliged to finish within that time. The starters were:

Sloops—ADDIE V., GRACIE, WHITE WING, SADIE, and the sloop NETTIE also started, though she did not finish.

Schooners—PALMER, SYLVIE and PHANTOM.

The finish was as follows:

	H. M. S.		H. M. S.
PHANTOM,	5 14 00	ADDIE V.,	5 17 10
GRACIE,	5 17 30	WHITE WING,	5 18 30
SADIE,	5 23 00	PALMER,	5 24 05

The winners were PHANTOM and ADDIE V., who received the prizes



ACTIVE.—FIGURE 259.

offered by the Vice-Commodore for the fastest sloop and schooner.

On June 10, 1869, the Twenty-fourth Annual Regatta took place. There were five schooners and ten sloops started: the wind was very strong; PHANTOM carried away her main topmasthead on her way out to the Lightship. SYLVIE lost her flying jibboom and PALMER carried away her fore topmast. IDLER won in the schooner class, time 4 hrs., 50 min., 09 sec.; SADIE, time 4 hrs., 26 min., 08 sec.

as sent to
aten, and
country,
out " and

Mr. Ben-
he sailed
ab House,
The wind
was fair.
eautifully
the others
of course,

ours, one
s were:
the sloop

M. S.
17 10
18 30
24 05
the prizes



hooner.
ook place.
I was very
h her way
d PALMER
oner class,
. 08 sec.

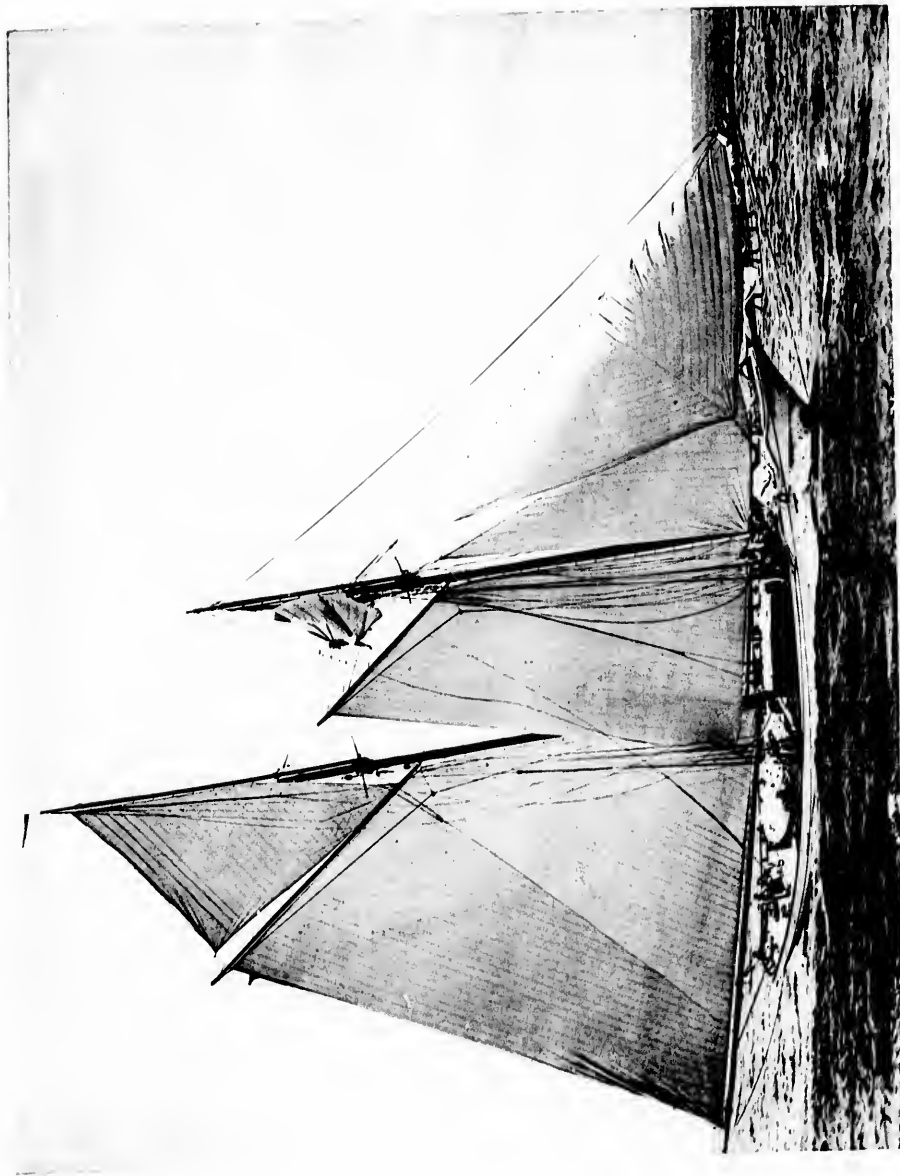

PLATE X

FR. M. A NEGATIVE BY BOLLES

ELSIEMARIE.



n
4
b
k
w
st
th

L
ca
th

ag
th
tri
for
Do
ent
sui
mil
the
66
A
was
how
O
SAP
1 hr
4 hr
SAP
T
Elev
Tid
Alto
the

MAGI
On
tween
Sandy
passed
3:30 p
secs.
2,963
than C
If D
edly w
NAUGH
Cowes

in the first sloop class; and WHITECAP in the second class, time 4 hrs., 44 min., 45 sec. On the same day there was a Match Race between RAMBLER (164.4 tons) and MAGIC (97.17 tons). Mr. Banker, the owner of the former bet \$1,000 to \$500 that his boat would win; MAGIC won easily by 7 min., 43 sec., being in the lead in the start and finish.

The present RAMBLER was not built for Mr. Banker until 1871; the record of this boat will be given later.

RAMBLER, MAGIC and sloop GRACIE won cups in a race from New London to Newport Aug. 10, 1869. PHANTOM, EVA and GRACIE, each won cups on August 11, 1869, in the Newport Regatta, there being no time allowance in this race or the one before.

In 1870 SAPHO crossed the ocean to sail a match of three races against CAMBRIA for a fifty guinea cup. In each case the course for the first two races was 60 miles to windward, and the third a triangle with sides of 20 miles. Articles were signed by Mr. Kemp for Mr. Ashbury, owner of CAMBRIA, and by J. D. Lee for Mr. Douglass. There was no allowance for time, although SAPHO entered at 310 tons, and CAMBRIA at 199 tons. The first race was sailed on May 10th, when CAMBRIA bore up after sailing about 40 miles, as she was far astern. The second race was sailed on May 14th, the course being from the Nab to the Cherbourg breakwater, 66 miles to southwest, instead of 60 miles as originally intended. A dispute arose about the direction of the wind and that the course was not dead to windward, but this was not allowed. CAMBRIA, however, refused to start, and SAPHO sailed the course alone.

On May 14th the third race was sailed over the triangular course: SAPHO reached the first mark at 1 hr., 7 min., 35 sec.; CAMBRIA, 1 hr., 11 min., 14 sec. The second mark was reached by SAPHO at 4 hrs., 20 min., and CAMBRIA did not reach this mark until 6 hours. SAPHO came in a grand winner and won the three cups.

The Twenty-fifth Annual Regatta was sailed June 13, 1870. Eleven schooners started, namely MADGIE, MAGIC, FLEETWING, TIDAL WAVE, MADELEINE, ALARM, SYLVIE, PALMER, PHANTOM, ALICE, and IDLER; very few sloops started. IDLER won in her class, the sloop SADIE in the 1st class and WHITECAP in the 2nd class.

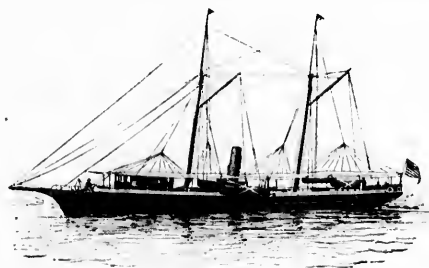

NARWHAL.—FIGURE 260.

MAGIC carried away her jib topsail and stay, causing some delay.

On July 4, 1870, a great Ocean Race for a £250 cup commenced between CAMBRIA and DAUNTLESS from Gaunt Head Island to the Sandy Hook Lightship. The official time was taken when the yachts passed the buoy off Sandy Hook. CAMBRIA arrived July 27th, at 3:30 P. M., having sailed 2,917 miles in 23 days, 5 hrs., 17 min., 5 secs. DAUNTLESS arrived July 27th, at 4:47 P. M., having sailed 2,963 miles in 23 dys., 7 hrs., thus saving 46 miles greater distance than CAMBRIA, which only beat DAUNTLESS 1 hr., 42 mins., 45 secs. If DAUNTLESS had been navigated as well as CAMBRIA she undoubtedly would have won. DAUNTLESS had Captain Samuels of DREAUGHT fame, who won the great Ocean Race from Sandy Hook to Cowes with HENRIETTA. Old Dick Brown, who was on board AMER-

ICA when she won the cup in 1851, Captain Martin Lynch, a Sandy Hook pilot of great experience, and Mr. Bennett were on board. CAMBRIA was navigated by Captain Tannock, who had commanded ships in the trade between Liverpool, Quebec and Montreal. The measurement of CAMBRIA according to the NEW YORK YACHT CLUB, was 227.6 tons, and according to the R. T. Y. C., was 188 tons. The measurement of DAUNTLESS was respectively 268 and 321 tons.

The first race in this country for AMERICA'S CUP was sailed August 8, 1870, CAMBRIA sailing against the whole fleet, although Mr. Ashbury claimed that the NEW YORK YACHT CLUB should put up a single rep-

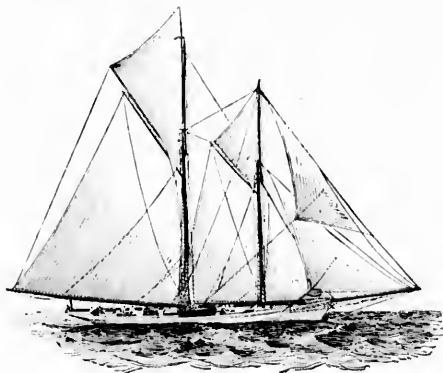

MARGUERITE.—FIGURE 261.

resentative against CAMBRIA. A vote of the club decided that inasmuch as AMERICA was obliged to sail against the whole fleet in order to win the Cup, so all subsequent competitors must do the same. This race will be found fully described in the chapter on AMERICA'S CUP in Vol. II.

CAMBRIA accompanied the NEW YORK YACHT CLUB on its Annual Cruise, and at Newport there were a series of very interesting races. The yachts raced from New London to Newport; IDLER won and CAMBRIA was not far behind. At Newport, Mr. Ashbury presented two 50 guinea cups for schooners and sloops, and the NEW YORK YACHT CLUB presented a cup of the same value for second class schooners, on time allowance. Thirteen schooners and four sloops started, the course being from Fort Adams around Block Island Buoy and return. MAGIC won, beating CAMBRIA who was second, only 26 seconds actual time. GRACIE won in the schooner class and was awarded the Ashbury Cup, while MAGIC took the Ashbury Cup for schooners, and CAMBRIA secured the Subscription Cup offered by the NEW YORK YACHT CLUB.

A Match Race between PALMER, owned by Rutherford Stuyvesant, having 2,371.9 square feet of area, and CAMBRIA, having 2,105.8 square feet area, for a 50 guinea cup. PALMER won by 7 min., 9.4 sec., the breeze freshening from the start to the finish.

On August 18th a Match Race took place between IDLER, having 1,934.6 square feet* area, and CAMBRIA. Captain B. F. Coffin had the pleasure of being on board CAMBRIA, and describes the race as follows: "Wind was from southwest and was a fair whole sail breeze. The yachts on the starboard tacked and encountered a rather troubled sea. CAMBRIA went off with the lead, IDLER in her wake as both reached the southward. "From time to time, I allowed my head to get above CAMBRIA's rail to glance out, but in her wake I saw plainly that she (IDLER) was gradually eating the course of our wake and coming in a position on her weather quarter. Suddenly about a half hour after leaving the Brenton's Reef Lightship, IDLER tacked and it became a seri-

*See "Outing" and "Yachts and Yachting," p. 46.

ous question with us whether we should allow her to go off alone. The plain rules of racing required that we should go around after her, but the southern tack was so manifestly the best, the westerly tide being on our lee-bow, that we continued on.

"We were more than satisfied with this course when, upon tacking later on, the yacht's head came up to west by south, and sometimes west by southwest, and we weathered IDLER very neatly and fetched the mark, and at the finish CAMBRIA had the race by 7 min., 40 sec., corrected time. But then I learned that the reason for IDLER'S tacking and leaving us was, that the plate to which the bobstay sets up had been drawn out of the stem and she could no longer head the sea without danger of losing bowsprit and mast. On the port tack, the sea was more abeam and to a strip through the hawser holes, a tackle was caught to the bowsprit end and the course was completed. I am certain, however, that IDLER lost more than 8 minutes, and but for this accident she would have won."

The race for the Bennett Cup at Newport was sailed September 8, 1870. CAMBRIA, SAPHO, PALMER, VESTA, TIDAL WAVE, IDLER, MADELEINE, HALCYON, PHANTOM and MAGIC, competed over a course of 64 miles. There was a fresh breeze from the southeast; SAPHO lost her main topmast and split her mainsail. PHANTOM won the Bennett Cup, her time being 6 hrs., 34 min. CAMBRIA won the Subscription Cup, which was paid for out of the money received from the yachts entering the race, which was \$25 apiece. Her time was 6 hrs., 38 min.

For a 50 guinea cup, PHANTOM beat CAMBRIA 22 min., 53 sec., over the Block Island course, on September 9th, and MADELEINE was second, beating CAMBRIA 9 min., 43 sec., although she lost her bowsprit shrouds at the start of the race.

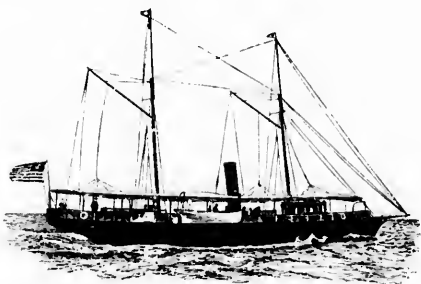

NYDIA.—FIGURE 262.

It was generally conceded that this was the most complete defeat that CAMBRIA received while in this country. The citizens of Newport wished to recognize Mr. Ashbury's endeavors to advance yachting interest and in his honor, subscribed to a cup valued at \$500, which was offered with a Subscription Club Cup for the schooner winning second place. These were competed for on September 11th over the regular club course, and was one of the most notable races up to that time. PALMER, PHANTOM, CAMBRIA, CALYPSO, TIDAL WAVE, MAGIC, DAUNTLESS, IDLER, HALCYON and MAGIE competed. PHANTOM won the Citizens' Cup, beating PALMER 1 min., 30 sec., and PALMER obtained the Subscription Cup. The race was over the regular course; the air was light from the southwest, freshening towards the finish. DAUNTLESS came in next, followed by CAMBRIA, a long way astern.

On September 28th, after the fleet's return, a regatta took place from Buoy No. 5½, off Sandy Hook, 20 miles to windward and return,

for four cups. DAUNTLESS won the Douglass Cup, TIDAL WAVE the Ashbury Cups, and MADELEINE won the Stuyvesant, which was offered so that if CAMBRIA was first or second she would receive it, but unfortunately, she was nowhere.

A Match Race between SAPHO and CAMBRIA was sailed October 13th, over a 20 mile course, for a 50 guinea cup. SAPHO came in 50 min., 50 sec. (by time allowance 46 min.) ahead of CAMBRIA, but did not receive the cup as the race was not completed within five hours, the stipulated time.

The race between DAUNTLESS and CAMBRIA, 20 miles to windward was won by DAUNTLESS, by 7 min., 18 sec. corrected time, and she re-

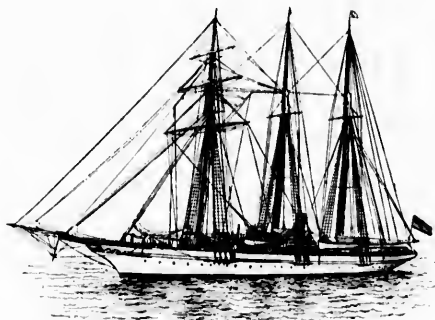

SULTANA.—FIGURE 263.

ceived the prize, a 50 guinea cup. The last race of the season was an Ocean Race between SAPHO and DAUNTLESS, SAPHO winning by 12 min., 45 sec.

The Twenty-sixth Annual Regatta took place June 22, 1871, when the cubical contents measurement was substituted for that of superficial area. Twenty-six yachts took part. TIDAL WAVE won the Club cup, Subscription cup and Bennett Challenge Cup, time, 6 hrs., 9 min., 8 sec. ADIE won similar cups for Class 1.; time, 6 hrs., 31 min., 9 sec.

On June 27, 1871, the club took part in the regatta given under the auspices of the BROOKLYN YACHT CLUB. DAUNTLESS received the schooner prize without time allowance. MADELEINE received the Club and Union prize, beating COLUMBIA by 3 seconds on time allowance. Franklin Osgood protested, but the BROOKLYN YACHT CLUB at a meeting voted that the decision of their Regatta Committee must be final. The result was the resignation of all the yacht owners of the NEW YORK YACHT CLUB from the BROOKLYN YACHT CLUB.

On the cruise, July 1, 1871, a Sweepstakes Race took place between DAUNTLESS, SAPHO and WANDERER for a cup valued at \$500, to be awarded to the schooner which first arrived at Cape May Lightship; the start was made at 9 P.M. WANDERER arrived at 7:28 P.M., DAUNTLESS at 8:26 P.M., SAPHO at 8:42 P.M., on July 2nd.

On July 4, 1871, the NEW YORK YACHT CLUB was invited to sail a race for two \$1,000 cups, offered by the residents of Cape May. The course was from a point off the hotels at Cape May, to and around the Five Fathom Lightship, thence five miles northeast to a stake boat, and back to the place of departure, a total distance of 39 7-8 miles.

This regatta was postponed until the next day, on account of dense fog. There was a third prize, a cup presented by Mr. Edward N. Benson of Philadelphia, valued at \$500. The start was at 10.35 A.M. The wind was light, almost a calm at times, freshening later.

SCHOONERS.	ELAPSED.		CORRECTED.	
	H.	M. S.	H.	M. S.
Sappho.	6	03 24	6	08 30
Danforth.	6	10 08	6	14 35
Columbia.	6	10 58	6	13 08
Madeleine.	6	11 31	6	15 15
Rambler.	6	20 04	6	23 18
Tidal Wave.	6	21 07	6	20 54
Palmer.	6	25 45	6	22 25
Wanderer.	6	22 40	6	25 18
Eva.	6	28 51	6	26 31
Alarm.	6	30 01	6	31 12
Madgie.	6	37 00	6	36 51
Sunshine.	not timed			
Sloops.				
Gracie.	6	25 56	6	20 52
Vindex.	6	41 45	6	22 45
Daphne.	6	41 45	not calculated.	

SAPPHO won citizens' prize for schooners, also Benson Cup; GRACIE won citizens' prize for sloops.

In August, 1871, the Annual Cruise was held, and when the fleet

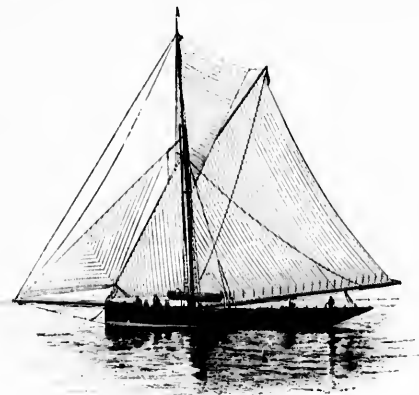

BEDOUI.—FIGURE 264.

arrived at Newport the EASTERN YACHT CLUB joined with them for the first time, a custom which became permanent.

A regatta was held at Swampscott, Mass., the citizens of this place offering two prizes, one of \$800 for schooners and one of \$400 for sloops, no time allowance; and the EASTERN YACHT CLUB offered \$1,000 for schooners and \$500 for sloops, to be contended for in accordance with its rules and regulations. Thirty-three yachts started over a course of 39 1/4 miles; the breeze was moderate from east southeast. The two prizes for schooners were awarded to COLUMBIA, and GRACIE captured both of the sloop prizes.

On August 21, 1871, the owner of TIDAL WAVE returned to the club a cup which was awarded to her, over which there had been such a dispute about Buoys 8 1/2 and 10. The deed of gift stated that it could be competed for over either of the club's courses.

A cup was offered by the flag officers for sloops. MADGIE, on time allowance, beat SAPPHO 45 1/2 seconds, eight schooners having started, and SADIE won the cup for sloops, four having started.

On August 22, 1871, the schooners WINDWARD, ALARM, DAUNTLESS, DREADNAUGHT, PALMER, TIDAL WAVE, and MADGIE, attempted to sail a 64 mile course for the \$1,000 Douglass Cup, but none of the yachts arrived within the time limit.

On August 24th, SAPPHO, PALMER and DREADNAUGHT anticipated sailing for the \$1,000 LORILLARD CUP, but owing to a fog the yachts did not start. SAPPHO, however, started at 12 hrs., 12 min., to sail over the course. There was a good breeze from the southwest, and she arrived home at 8 hrs., 30 min., having beaten the record, as she covered 64 miles in 7 hrs., 56 min., 36 sec.

Another attempt was made on the 25th, between SAPPHO, DREADNAUGHT and MADGIE; MADGIE dropped out, and the two other yachts had a very close race, but the distance was not covered in 9 hours.

The citizens of Newport presented a cup valued at \$1,000 to be sailed for over the Block Island course on August 26th. The prize was won by SAPPHO, who beat COLUMBIA, 3 min., 8 sec. At one time PALMER looked a sure winner, but on account of one of Mr. Stuyvesant's guests being knocked overboard by the main-sheet, she rounded about to pick up the gentleman.

The BENNETT CUP was won on October 2nd, by GRACIE, who beat ADDIE, 0 min., 22 sec., corrected time.

SAPPHO won the LORILLARD CUP on October 9th, in 7 hrs., 24 min., 58 sec., over a 64 mile course, beating her own record, as also PALMER, DREADNAUGHT, and ENCHANTRESS.

DREADNAUGHT won her magnificent race over the Newport course for the \$1,000 Douglass Cup, in 7 hrs., 33 min., 13 sec., leaving PALMER, MADGIE and WANDERER.

The races between COLUMBIA and LIVONIA for AMERICA'S Cup took place October 16, 18 and 19, 1871, and the races between SAPPHO and LIVONIA took place on the 21st and 23d of the same month. For full particulars see chapter relative to AMERICA'S Cup, Volume II.

The Twenty-seventh Annual Regatta of the NEW YORK YACHT CLUB was sailed June 20, 1872, with a flying start for four \$250 cups. IANTHE, a yacht with no record beat all the schooners entered, a calm prevailing the greater part of the time, although IANTHE managed to get the benefit of what breeze there was. PEERLESS was second, and in the sloop class, GRACIE and VIXEN won.

MADELEINE secured a cup on June 24, 1872, offered by Lester Wallack, beating PEERLESS 7 min., 10 sec. RESOLUTE, TIDAL WAVE, FOAM, EVA and MAGIC took part.

GRACIE beat META on time allowance in a race sailed July 23, 1872, 20 miles to windward for \$250, 4 min., 14 sec.

RAMBLER won the Brenton's Reef \$1,000 Challenge Cup, presented

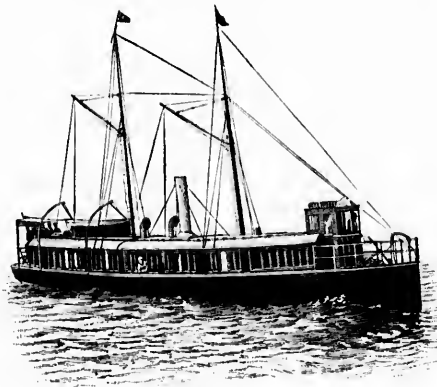

CHARLOTTE.—FIGURE 265.

by Commodore Bennett, sailing the course in 39 hrs., 55 min., 59 sec. thus beating MADELEINE, her only competitor.

COLUMBIA won a Handicap Race, Aug. 16, over the regular Block Island course, MADELEINE second, FOAM being ruled out, RESOLUTE, TIDAL WAVE, VIKING, MAGIC, EVA, ALICE and MADGIE took part.

A regatta was held August 19, 1872 at Newport MAGIC won the schooner prize and VIXEN the sloop prize, these being the only yachts which arrived within the time limit.

A Challenge Match between TIDAL WAVE and MADGIE was

sailed for the Bennett Challenge Cup returned by TIDAL WAVE to the club, on August 21, 1871. TIDAL WAVE won the cup by 38 seconds corrected time.

A race in which numerous accidents occurred was sailed Aug. 21, 1872, in a thick fog, from Brenton's Reef to the Sow and Pigs Lightship and return, the first race sailed over this course. META sailed by Captain "Joe" Ellsworth, won the sloop prize.

RAMBLER sailed a Match Race with MADELEINE from Brenton's Reef Lightship to Sandy Hook, Sept. 19, 1872, and won, beating

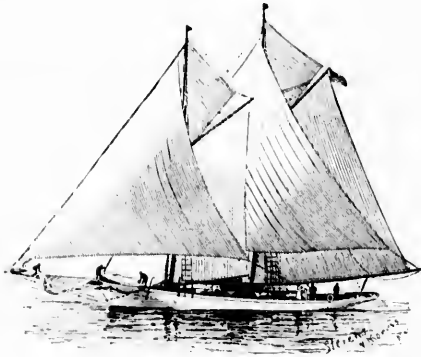

HARBINGER.—FIGURE 266.

MADELEINE 3 hrs., 53 min., 9 sec. Time of race 43 hrs., 25 min., 32 sec.

VISION raced with GRACIE on September 20, 1872, for the Bennett Challenge Cup for sloops, which was first won by ADDIE, and then captured by GRACIE. Both yachts sailed with three reefs, VISION winning; five men of GRACIE were knocked overboard by the mainsheet, which compelled her to stop. The course was not the usual one, owing to the severity of the weather. It was from the Narrows around the Spit Buoy, then to Craven Shoal Buoy, returning over the same course, and ending at Craven Shoal.

GRACIE, VISION and META sailed a Sweepstakes Race September 23, 1872, for a cup valued at \$500. META won, beating GRACIE 17 min., 07 sec., corrected time.

DREADNAUGHT sailed a Match Race with PALMER for the Cape May Challenge Cup on October 10, 1872, and won the cup, beating PALMER, 1 hr., 39 min., 25 sec., over a 212 mile course, time 25 hrs., 06 min., 03 sec.

The Twenty-eighth Annual Regatta of the NEW YORK YACHT CLUB took place on June 6, 1873, although attempted on June 5th: MADELEINE winning; time 3 hrs., 57 min., 43 sec. A squall struck the fleet as they were crossing the line, and MADGIE was nearly capsized.

The first yacht race sailed by the NEW YORK YACHT CLUB on a Sunday, July 5, 1873, was between META and VISION for \$500 a side, 20 miles to leeward, outside of Sandy Hook. META lost her topmast, and VISION, having hoisted hers, won by 7 min., 32 sec.

EXCHANTRESS challenged DREADNAUGHT for the Cape May Cup and the race was fixed for October 14, 1873. The owner of DREADNAUGHT, however, stated that his yacht was not in condition to race and asked for an adjournment. This the owner of EXCHANTRESS would not grant, and the latter vessel sailed over the course and took the cup as also a \$1,000 check from Mr. Stockwell. Owing, however, to newspaper criticism, Mr. Loubat returned the cup and donated the check to charitable purposes.

The Newport Regatta was sailed August 21, 1873, for a cup presented by the Commodore. Twelve yachts took part: MADELEINE won

the schooner prize, beating MADGIE 2 min., 53 sec.; VISION won sloop prize, beating VIXEN 7 min., 48 sec.

In the Regatta over the Brenton's Reef course MADELEINE won, beating IDLER 18 min., 5 sec., and VISION beat VIXEN 10 min., 10 sec.

The Autumn Regatta was held Oct. 2, 1873, ten yachts starting. EVA won the schooner prize and VISION the sloop prize.

On Oct. 6, 1873, VISION and META sailed a Match Race; the wind blew a gale, consequently the race was not finished, several accidents happening to rigging, etc.

An Ocean Regatta was sailed Oct. 9, 1873, between Yachts, Pilot boats and Working Vessels. EXCHANTRESS sailed 12½ miles in 39 hours and won Yacht prize, Pilot boat THOMAS NEGUS won \$250 prize, and two working schooners received prizes.

The Twenty-ninth Annual Regatta took place June 11, 1874, ten schooners and seven sloops started—TIDAL WAVE, MAGIC, GRACIE and WAYWARD won in their respective classes.

Ladies' Day Regatta was held over the regular course, June 25, 1874. Nine yachts took part—TIDAL WAVE, CORONET and VISION won in their respective classes.

A Handicap Race was attempted at Newport August 11, 1874; thirteen yachts started, but as the course was not covered in the required time, it was adjourned to the following day when seven yachts started; MAGIC won the schooner and GRACIE the sloop prize.

A set of colors were sailed for August 14th, from off the Lightship on Brenton's Reef—DAUNTLESS won the schooner colors and VIXEN won the set of colors for sloops.

A remarkable race took place between MAGIC, then owned by Wm. T. Garner, and COMET, owned by Wm. H. Langley, October 13, 1874. MAGIC won, beating COMET 4 min., 50 sec., and about \$100,000 changed hands, as both yachts were very heavily backed.

The Thirtieth Annual Regatta was sailed June 16, 1875; eighteen



POCAHONTAS.—FIGURE 267.

yachts participated—three being steam yachts—LURLINE, IDEAL and LOOKOUT—LURLINE won, beating IDEAL 10 seconds and receiving \$250 purse. PALMER, COMET, VISION and MADCAP won in their respective classes. The owners of keel schooners made up a \$500 purse, which was won by WANDERER, beating ALARM and RAMBLER.

A Match Race was sailed between the steam yacht IDEAL, belonging to Theodore A. Havemeyer, 200 tons, and LOOKOUT, belonging

to Jacob Lorillard, July 1, 1875, for \$1,000, around Long Island. IDEAL won the race, beating LOOKOUT 2 hrs., 18 min., 35 sec., making an average speed of 12 1-2 knots to LOOKOUT'S 11 knots.

MOHAWK sailed her first race July 13, 1875, in the Cape May Regatta, but was beaten by MADELEINE, IDLER, RAMBLER and RESOLUTE. MADELEINE won the schooner prize and VINDEX the sloop prize.

A regatta was sailed at Newport, August 15, 1875, for cups presented by Commodore Kingsland. RAMBLER, MOHAWK, IDLER, DREADNAUGHT, RESTLESS, CLIO, sloops WINDWARD, ADDIE VOORHIS, VINDEX and GENIA participated. CLIO won the schooner prize, beating MOHAWK 28 min., 06 sec., corrected time, WINDWARD won sloop prize, beating ADDIE VOORHIS 14 min., 38 sec.

Another regatta was sailed August 16, 1875, for prizes presented by Vice-Commodore Wm. T. Garner, over the Block Island course. RAMBLER, IDLER, RESTLESS, ALARM, CLIO and EVA competed, and GENIA, ADDIE VOORHIS, WINDWARD and VISION. RAMBLER won first class schooner prize and RESTLESS the second class, VISION the first class sloop and GENIA the second class sloop prize.

Still another regatta was sailed August 18, 1875, for cups presented by James Gordon Bennett. MOHAWK, ALARM, RAMBLER, DREADNAUGHT, IDLER, RESTLESS and EVA took part and VINDEX, ADDIE VOORHIS, VISION, GENIA and WINDWARD. MOHAWK won the schooner prize, beating DREADNAUGHT 2 min., 20 sec., and VISION won the sloop prize.

MADELEINE beat MOHAWK in a Match Race, September 15th, over the NEW YORK YACHT CLUB course, coming in 9 min., 56 sec. ahead.

The Fall Regatta was sailed for cups offered by Commodore J. Nicholson Kane. At the same time MADCAP, 1,491 cubic feet,

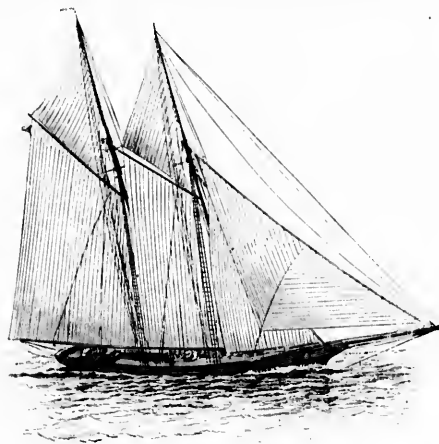

PALMER.—FIGURE 265.

challenged VISION, measuring 2,545 cubic feet, the time allowance being 12 min., 44 sec. Sixteen yachts started, but on account of the strong tide and lack of wind only nine yachts reached the Hook. The breeze outside was fine and the sea was heavy. ATALANTA, COMET and SADIE won, the latter being the only sloop that covered the course. PEERLESS was dismantled and also lost her bowsprit.

On October 6th, RESOLUTE sailed a match race with ESTELLE, allowing her 12 min., 10 sec. There was a very strong breeze, east to southeast, and ESTELLE won by 2 min., 8 sec., owing

to the bad judgment exercised by the Captain of RESOLUTE. This was the first of what was known as "Match" series of races. The second Match Race between RESOLUTE and COMET was sailed on October 8th; the wind was very light and COMET won, although the race was not sailed within 8 hours. The allowance was 17 min., 8 sec.

The third race of this series was sailed October 12. RESOLUTE, DREADNAUGHT and VESTA competed. The course was from Sandy Hook Lightship to Cape May Lightship and return; there was no

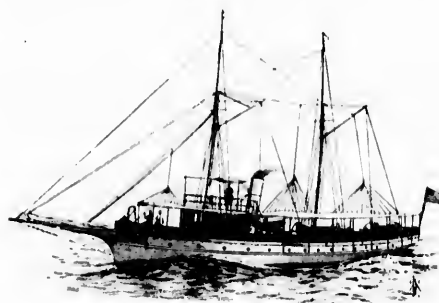

DARING.—FIGURE 266.

time allowance. RESOLUTE won, beating DREADNAUGHT on corrected time, 7 min., 17 sec., and VESTA 2 hrs., 11 min., 46 seconds.

A Match Race between DAUNTLESS and MOHAWK was sailed for \$1,000 a side October 26, 1875, 20 miles to windward and return. DAUNTLESS won, having complied with sailing directions; time, 6 hrs., 41 min., 50 sec.

The last race of this series was sailed between RESOLUTE and DAUNTLESS on October 27th, from off the Club House at Stapleton, S. I., to and around the Cape May Lightship, returning and finishing at the Sandy Hook Lightship. DAUNTLESS led from start to finish, covering the distance, 222 miles in 18 hrs., 28 min., 03 sec., beating the record and also beating RESOLUTE by 1 hr., 52 min., 18 sec.

At the Twenty-first Annual Regatta held June 8, 1876, there was a very strong wind. GRACIE and ADDIE VOORHIS were compelled to withdraw. ARROW won, beating VINDEX 9 min., 44 1-2 sec., winning the prize for her class, as also the Bennett Challenge Cup prize. COMET won the Bennett Challenge Cup. The actual time of IDLER was 3 hrs., 50 min., 40 1-2 sec., starting from Stapleton and finishing off Buoy No. 15, which was the best time on record for this course. RAMBLER won the keel schooner prize.

The first of the series of Centennial Races for the Commissioner's Medal and Diploma was sailed June 22, 1876, and won by DREADNAUGHT and PEERLESS and by the sloops, ARROW and ORION.

The second race of this series was sailed June 23rd, 32 yachts starting, with the famous catamaran AMARYLLIS. The sand-baggers objected to the catamaran, still she sailed over the course, winning easily, but was ruled out after the race. No yachts of the NEW YORK YACHT CLUB took part, as the race was for yachts under 15 tons.

The third race of this series was sailed June 26th, but was not much of a success, ALARM and AMERICA sailing against one another, and GRACIE and ARROW; AMERICA won, beating ALARM 8 hrs., 11 min., 10 sec.; ARROW beat GRACIE 41 min., 50 sec.

While the yachts were at Glen Cove Harbor, July 20th, news reached there that MOHAWK was capsized with Mr. Garner, his wife and friends on board. She filled and sank, Mr. Garner being drowned while endeavoring to save his wife from the cabin.

but owing to shifting of the ballast she also lost her life. MORAWK had all her after canvas set, even to her enormous club topsail, and she was getting under way. "Her chain had been hove short, and her jibs had been run up in order that as she gathered way, she might break out the anchor from its hold on the bottom, her captain being of insufficient power. The helm was a-weather when a hard squall from the northwest struck the yacht as she lay without way, and without the possibility of gathering way, so she went down till she filled and sunk."

IDLER, WANDERER, TIDAL WAVE, AMERICA, and also COUNTESS of DEFFERIN, which latter was not entered, sailed July 27, for the Brenton's Reef Challenge Cup. IDLER won and WANDERER was second; the other yachts were nowhere.

The race between COUNTESS of DEFFERIN and MADELEINE on August 11th, will be fully described in the chapter on the "AMERICA'S" Cup in Vol. II. It may be stated, however, that MADELEINE won by 27 min., 14 sec., corrected time.

The Annual Cruise of the fleet commenced August 14. Eleven schooners and five sloops assembled at Glen Cove Harbor. The yachts visited Shelter Island, New London, Newport and Vineyard Haven, the fleet disbanding at Edgartown, August 21.

A Regatta for Flagg Officers' Cups was sailed September 19, 1876. There were four cups, valued at \$200 each.

IDLER, RAMBLER, PEEBLES, META, GRACIE and MADCAP took part. IDLER won first class schooner prize; PEEBLES, the second class. GRACIE won first class sloop prize and MADCAP the second class.

IDLER and ATALANTA sailed an Ocean Race on October 12th, for a \$1,000 cup, presented the club by Mr. J. E. Lombard. The course was from off Owl's Head to and around Sandy Hook Lightship, thence to and around Cape May Lightship and return. ATALANTA won, beating IDLER 2 hrs., 58 min., 3 sec.

At the Thirty-second Annual Regatta, held on June 14th, WANDERER crossed the line a winner, beating RAMBLER about 1 minute. A squall at the finish caught RAMBLER and WANDERER, and they were obliged to let all their sails go by run, and as WANDERER crossed the line, her club topsail was flying far off to leeward. COMET won the second class schooner prize; VISION won first class sloop prize and ACTIVE second class sloop prize.

The Annual Cruise took place when the yachts left Glen Cove making the usual stoppages and breaking up August 17th.

IDLER won the Cape May Challenge Cup, September 7, 1877.

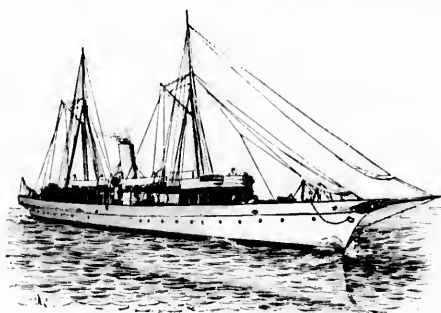

WADENA.—FIGURE 270.

beating RAMBLER, VESTA and DREADNAUGHT, RAMBLER being second. After IDLER was sold, this cup was returned to the New York Yacht Club, and held until 1885, when it was won by the British cutter GENESTA.

The Thirty-third Annual Regatta was sailed June 13, 1878—twelve yachts participating. TIDAL WAVE, PEEBLES and RESTLESS won

schooner prizes; VISION and VIXEN won sloop prizes. PEEBLES also received Bennett Challenge Cup for schooners and VIXEN that for sloops.

The next Annual Cruise took place in August, 1878, the fleet going direct from Glen Cove to Greenport, thence to New London, and afterwards to Newport, where THISTLE sailed a 20 mile course against VIXEN and REGINA on August 13th. THISTLE was beaten by ACTIVE



VIGILANT.—FIGURE 271.

and by VIXEN, the latter winning the prize on corrected time. REGINA was beaten by THISTLE 2 min., 44 sec.

NEREID beat the whole fleet on their cruise from Vineyard Haven to Newport, arriving 20 seconds ahead of the second boat, VIXEN.

GRACIE and VISION sailed a Match Race October 15, 1878, 20 miles to windward and return. GRACIE won in 6 hrs., 39 min., 23 sec. VISION's time 6 hrs., 53 min., 09 sec. The Thirty-fourth Annual Regatta was sailed June 19, 1879, the following yachts participating:

Keel Schooners:	Elapsed.			Corrected.		
	H.	M.	S.	H.	M.	S.
Rambler,	5	45	31	5	45	31
Intrepid,	5	51	14	5	50	13
Class 1, C. B. Schooners:						
Tidal Wave,	5	13	03	5	13	00
Class 2, C. B. Schooners:						
Estelle,	not timed.					
Peerless,	5	18	33	5	07	41
Nereid,	6	18	40	5	51	50
Class 1, C. B. Sloops:						
Vision,	5	42	14	5	42	14
Class 2, C. B. Sloops:						
Regina,	5	13	55	5	13	55
Vixen,	5	14	17	5	13	34
Keel Sloops:						
Psyche,	6	13	10	6	13	10
Glance,						
Volante,	6	07	13	6	00	57

PEERLESS
d VIXEN

fleet go-
adon, and
se against
y ACTIVE

ime. Re-

ord Haven

VIXEN.

, 1878, 20

9 min., 23

fourth An-

ts partici-



PLATE XI

FROM A NEARBY POINT

ARIEL

GRACE won,

1881, respecting
 A. B. and a de-
 MENTON CUP,
 6, 1881. Fine



6.17

SNETT CUP,
 corrected time.

H. M. S.
 5 52 19

5 29 37
 6 25 39
 6 30 17

6 24 25

5 25 21
 5 32 28
 5 22 31
 6 30 00
 5 19 00
 6 10 30

6 08 59
 6 06 15

IXEN were
 ie Bennett

Newport to
 8, 40 min.
 try of the

1 for two
 HALCYON
 E. FANNY
 led to sail
 MISCHIEF
 see.



The races between MISCHIEF and ATALANTA for AMERICA'S CUP were sailed November 9th and 10th, 1881, and will be fully described in Volume II., article "AMERICA'S CUP."

Usual course; start at 11:24 A. M. The winners were RAMBLER, PEERLESS, VIXEN and VOLANTE.

A Match Race was sailed June 24, 1879, between VIXEN and REGINA over NEW YORK YACHT CLUB course. VIXEN won, beating REGINA 3 min., 20 sec.

The Annual Cruise was sailed as usual. At New Bedford there were two regattas. TIDAL WAVE and MAGIC won in their class, and NANTIC and VIXEN in their respective classes.

MISCHIEF, REGINA, WAVE and BLANCHE sailed a race on October 17, 1879, from Sandy Hook Lightship around Cape May Lightship and return, for a \$700 cup previously offered by Mr. Robert Center. MISCHIEF, being a much larger boat, won easily. The time was 39 hrs., 47 min., beating REGINA who was second; WAVE was third.

The Thirty-fifth Annual Regatta was sailed June 10, 1880. A perfect day, bright, sunny, breezy. The starters were:

SCHOONERS (C. B.)

Class 1.—TIDAL WAVE, CRUSADER, CLYTIE.
Class 2.—ESTELLE, CLIO.

SLOOPS (C. B.)

Class 1.—GRACIE, MISCHIEF, VISION, COMING, WIZARD.
Class 2.—ROVER, REGINA, VIXEN.

SLOOPS (K.)

PSYCHE, GLANCE, VOLANTE, MURIEL.

The course was as usual, by the Southwest Spit Buoy, around the Lightship, and return.

OFFICIAL RECORD.

	CLASS CUPS.		CHALLENGE CUP.	
	Corrected time.		Corrected time.	
	H. M. S.	H. M. S.	H. M. S.	H. M. S.
Dauntless,	4 41 52	4 41 52	4 41 52	4 41 52
Tidal Wave,	4 38 00	4 38 01	4 38 01	4 38 01
Crusader,	4 45 32	4 40 33	4 40 33	4 40 33
Clytie,	4 42 13	4 37 13	4 37 13	4 37 13
Estelle,	5 12 09	4 57 36	4 57 36	4 57 36
Clio,	4 43 51	4 29 18	4 29 18	4 29 18
Gracie,	4 45 38	4 45 38	4 45 38	4 45 38
Mischief,	4 39 11	4 39 11	4 39 11	4 39 11
Vision,	4 47 28	4 47 28	4 47 28	4 47 28
Coming,	5 03 14	5 03 14	5 03 14	5 03 14
Wizard,	5 03 15	5 03 15	5 03 15	5 03 15
Rover,	5 38 25	5 14 30	5 14 30	5 14 30
Regina,	5 31 30	5 07 35	5 07 35	5 07 35
Vixen,	5 15 57	4 52 02	4 52 02	4 52 02
Psyche,	6 07 00	5 43 13	5 43 13	5 43 13
Glance,	6 11 22	5 50 45	5 50 45	5 50 45
Volante,	5 42 12	5 18 25	5 18 25	5 18 25
Muriel,	51 22	5 30 35	5 30 35	5 30 35

The prizes were valued at \$250 each. TIDAL WAVE, CLIO, MISCHIEF, VIXEN and VOLANTE won. (Prize for keel schooners not awarded, no race.) CLIO and MISCHIEF were also winners of the Bennett Cups for the fastest schooner and sloop, DAUNTLESS being among the contestants for the Bennett Cup for schooners.

A Handicap Race between three schooners and six sloops, was sailed for a \$250 cup, offered by Mr. Charles Minton. DAUNTLESS won in the schooner class, and MISCHIEF in the sloop class. MISCHIEF beat DAUNTLESS 20 min., 37 sec.

At New Bedford, during the Annual Cruise, August 18, 1880, CRUSADER, MISCHIEF and REGINA won three prizes, and PEERLESS, of the NEW BEDFORD YACHT CLUB, won a prize. The yachts of the EASTERN YACHT CLUB also participated.

A race for two cups valued at \$500 each was sailed for September 14, 1880. RAMBLER, TIDAL WAVE, PHANTOM, CLYTIE and ESTELLE, schooners, and GRACIE, MISCHIEF and FANNY, sloops, competed.

TIDAL WAVE won, beating PHANTOM 3 minutes, and GRACIE won, beating MISCHIEF 4 min., 53 sec.

On May 26, 1881, the challenge of the CANADIAN CLUB, respecting ATALANTA was accepted by the NEW YORK YACHT CLUB, and a description of this race will be given in the chapter on the AMERICA'S CUP. The Thirty-sixth Annual Regatta was sailed June 16, 1881. Fine breeze, beautiful day; usual course.

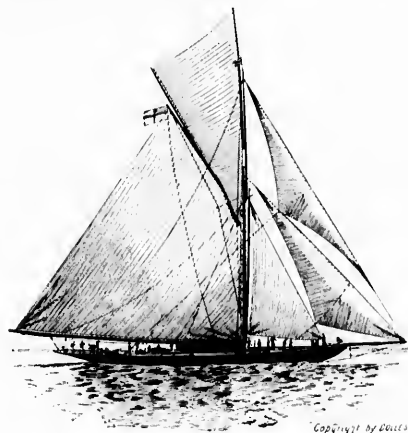

VALKYRIE.—FIGURE 272.

SCHOONERS.

	CLASS CUPS.		BENNETT CUP.	
	Corrected time.		Corrected time.	
	H. M. S.	H. M. S.	H. M. S.	H. M. S.
Dauntless,	5 52 19	5 52 19	5 52 19	5 52 19
Fleetwing,				
I (Centerboard)				
Tidal Wave,	5 34 36		5 29 37	
Cruiser,	6 30 38		6 25 39	
Clytie,	6 35 17		6 30 17	
II (Centerboard)				
Estelle,	6 38 08		6 23 25	
Southern Cross,			not timed.	
Madeup,			"	
SLOOPS.				
I (Centerboard)				
Gracie,	5 25 21		5 23 21	
Fanny,	5 32 28		5 32 28	
Mischief,	5 27 31		5 22 34	
Vision,	6 30 00		6 30 00	
Hildegarde,	5 19 00		5 19 00	
Wizard,	6 10 30		6 10 30	
II (Centerboard)				
Regina,	6 33 38		6 08 50	
Vixen,	6 30 10		6 08 15	

DAUNTLESS, TIDAL WAVE, ESTELLE, HILDEGARDE and VIXEN were the winners. HILDEGARDE and TIDAL WAVE also won the Bennett Cups.

On the Annual Cruise, there was a Scrub Race from Newport to New Bedford, August 3, 1881. PEERLESS won in 3 hrs., 40 min. The cup was presented by Mr. Chas. A. Minton, Secretary of the club.

On August 5, 1881, there was a Regatta at New Bedford for two prizes valued at \$500 each, presented by Mr. E. A. Bush. HALCYON won the schooner cup, beating PEERLESS 9 min., 5 sec. GRACIE, FANNY and MISCHIEF claimed the sloop cup; it was therefore decided to sail the race off for sloops in New York Harbor. GRACIE and MISCHIEF competed October 22, 1881, and GRACIE won by 10 min., 14 sec.

The Thirty-seventh Annual Regatta was sailed June 15, 1882. Good wind, fair weather. Start at 11:10 A.M., usual inside course.

SCHOONERS.		CLASS CUPS, Corrected time.	BENNETT CHALLENGER CUP, Corrected time.
		H. M. S.	H. M. S.
I (Keel)			
Rambler,		4 05 28	4 05 28
Fletwing,			
II (Keel)			
Albatross,		4 23 24	4 23 23
Social,			not timed.
I (Centerboard)			
Tidal Wave,		3 58 48	3 53 08
Montauk,		3 50 43	3 45 33
II (Centerboard)			
Clytie,		4 11 14	4 00 50
Crusader,		4 06 12	3 55 48
Estelle,		4 22 51	4 12 27
SLOOPERS.		Elapsed time.	Corrected time.
		H. M. S.	H. M. S.
I (Keel)			
Mystery,			carried away mast.
Oriva,			disabled.
I (Centerboard)			
Julia,			disabled.
Gracie,		4 02 50	4 02 38
Fanny,		4 03 39	3 58 37
Vision,		4 26 51	4 15 30
Hildegarde,			disabled.
II (Centerboard)			
Eclipse,		4 38 56	4 38 56
Valkyr,		4 32 12	4 29 57
Vixen,		4 43 13	4 39 51
Christine,			turned back.

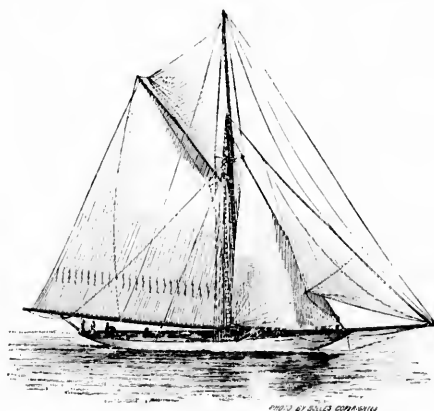

COLONIA.—FIGURE 273.

Winners: RAMBLER, ALBATROSS, MONTAUK, CRUSADER, FANNY and VALKYR. MONTAUK also lowered the record made by IDLER, and won Bennett Cup for schooners.

The Cook Cups were sailed for at New London, August 5, 1882. Two schooner cups valued at \$300 each and two sloop cups valued at \$200 each were sailed for.

MONTAUK won the first class schooner cup, but did not receive the prize, owing to a dispute and the death of Mr. Cook before a decision was reached. PEERLESS took the second class schooner cup, FANNY the first class sloop and VIXEN the second class sloop cup.

The First Annual Regatta for cups presented by Mr. Ogden Golet was sailed at Newport, August 8, 1882. Nineteen schooners took part and eleven sloops. MONTAUK won the schooner cup and FANNY the sloop cup.

Regatta of the EASTERN and NEW YORK YACHT CLUBS took place off Marblehead, August 14, 1882. HALCYON won schooner cup; FANNY and VIXEN the Paine Cups. VIXEN and MAGGIE sailed a Match Race August 15, 1882, for \$250 a side, VIXEN winning by 19 minutes.

The Thirty-eighth Annual Regatta for 1883 was sailed on June 21st. Hazy, Light wind; start at 11:03 A.M.

SCHOONERS.		Elapsed time.	Corrected time.
		H. M. S.	H. M. S.
I (Keel)			
Intrepid,		5 45 30	5 45 39
Fortuna,		5 45 45	5 43 27
Montauk,		5 41 57	5 39 18
Grayling,		5 34 44	5 27 48
Crusader,		5 33 40	5 26 05
Estelle,			not timed.
Clytie,		5 43 40	5 33 36
I CLASS SLOOPERS.		Elapsed time.	Corrected time.
		H. M. S.	H. M. S.
Gracie,		5 31 12	5 31 12
Bedouin,		5 37 15	5 36 05
Julia,		5 42 05	5 40 32
Fanny,		5 31 20	5 27 55
Mischief,		5 39 05	5 32 30
Hildegarde,			dismasted.
Wenonah,		5 31 27	5 26 23
Whiteaway,			carried away topmast.
II CLASS SLOOPERS.		Elapsed time.	Corrected time.
		H. M. S.	H. M. S.
Oriva,		5 46 02	5 46 02
Fanita,		5 44 15	5 38 58
Vixen,		5 43 20	5 36 51
Rover,		5 47 41	5 39 25

The winners were CRUSADER, WENONAH and VIXEN.

The Second Annual Race for the Golet Cup was sailed off Newport, August 6, 1883. MONTAUK won the cup, beating FORTUNA 5 min., 18 sec. GRACIE won the sloop cup, beating MISCHIEF 9 min., 30 sec. VIXEN and MAGGIE sailed a Match Race for \$250 a side, the former winning by 15 min., 37 sec., actual time.

The EASTERN and NEW YORK YACHT CLUB Regatta was sailed off Marblehead, August 10, 1883. HALCYON won the first class schooner prize and CLO won in the second class. The cutter WENONAH won the first class sloop prize and VIXEN the second class.

On October 9, 1883, FANNY and GRACIE had a Match Race, twenty miles to windward and return. GRACIE was handicapped 1 min., 8 sec., and FANNY, 1 min., 10 sec.; the race was declared off, not being completed within 8 hours, but was resailed on October 25th, when FANNY beat GRACIE 7 min., 18 sec.

BEDOIN and GRACIE sailed a match race October 16, 1883. BEDOIN won by 19 min., 5 sec. On October 18th, BEDOIN won again, beating GRACIE 15 min., 5 sec. BEDOIN, GRACIE and ORIVA raced October 20, 1883. GRACIE won, beating BEDOIN 3 min., 55 sec., and ORIVA, 33 min., 2 sec.

The Thirty-ninth Annual Regatta was sailed June 12, 1884. There was a very light wind, and the race was not finished within the time limit—eight hours. On June 13th, the race was resailed. There was a good wind, though the sky was overcast. The start was made at 12:00 noon.

SCHOONERS.		CLASS CUPS, Corrected time.	BENNETT CUPS, Corrected time.
		H. M. S.	H. M. S.
Second Class:			
Montauk,		4 15 27	4 15 27
Grayling,		4 25 16	4 25 16
Estelle,			did not go over course.
Clytie,		4 51 18	4 51 18
Third Class:			
Clo,			did not go over course.

First Class:	SLOOPS.	
	Elapsed.	Corrected.
	U. S. S.	U. S. S.
Gracie,	4 49 08	4 49 08
Fanny,	4 47 27	4 47 27
Heen,	4 52 45	4 52 45
Mischief,	did not go over course.	
Hildegard,	4 36 30	4 36 30
Wenonah,	disabled.	
Athlon,	did not go over course.	
Second Class:		
Oriva,	5 17 41	5 00 58
Eclipse,	did not go over course.	
Faula,	did not go over course.	
Vixen,	5 20 58	5 04 15

MONTAUK won both club and challenge prizes, as did also FANNY ORIVA won club prize.

A race around Long Island was sailed June 16, 1884, for \$500 cup for schooners, presented by Wm. Travers; \$500 cup for first class sloops, presented by James D. Smith; \$300 cup for second class sloops, presented by Archibald Rogers and S. R. Phail.

FLEETWING, FORTUNA, MONTAUK, RUTH, GRAYLING and ESTELLE started in schooner class. GRACIE, LEEEN, FANNY, WENONAH and HILDEGARD in first class sloops, and ATHLON, VIXEN and ORIVA in second class. GRAYLING won in 43 hrs., 37 min., 46 sec., FANNY won in 43 hrs., 37 min., 10 sec., and VIXEN won in 46 hrs., 04 min., 59 sec.

The Goelet Cups, \$1,000 cup for schooners, and \$500 cup for sloops, were sailed for August 8, 1884. GRAYLING won schooner cup and BEDOUIN cup for sloops.

The Commodore's \$500 Cups were sailed for from Brenton's Reef Lightship to Oak Bluffs without time allowance, on August 9, 1884. MONTAUK won the schooner prize and BEDOUIN the sloop prize.

In the Handicap Race for the Commodore's \$500 Cups, sailed August 11, 1884, CLIO won the schooner cup and ATHLON the cup for sloops.

On August 12, 1884, the race for the Commodore's Cups took place over the sixty mile course. In this race MONTAUK won the \$500 cup for the first class schooners; VARUNA the second class prize (\$500 cup); cutter BEDOUIN won the \$500 cup for first class sloops, and cutter ORIVA won the \$500 cup for second class sloops. MISCHIEF took the \$250 cup for best corrected time, beating BEDOUIN one second.

The Fortieth Annual Regatta took place June 11, 1885.

GIYANA won the keel schooner cup and MONTAUK the Russell cup being the first schooner crossing the home line. GRAYLING won second class schooner cup and the Bennett Challenge Cup.

NIRVANA won the third class schooner cup, which was declined by Mr. E. N. Brown, her owner, owing to the CLYTIE having collided with the mark boat at the start.

MISCHIEF won the first class cup for sloops, as also the Russell Cup, being the first sloop home. ATHLON and ESPERITO won in their class.

The Annual Cruise for 1885 commenced July 30th, at 5.30 A. M., the fleet leaving Glen Cove for New London. The wind was light from northeast. The first away was VIXEN and next PRISCILLA, the latter soon taking the lead and maintaining it all day. PRISCILLA, GRAYLING, BEDOUIN and GRACIE arrived at the Pequot House shortly after eight o'clock; the rest of the fleet, some 14 yachts, did not get in until the morning, CLYTIE near 4 A. M. and the last yacht NORNA about 9 A. M.

PURITAN and STRANGER were at anchor at New London.

On Saturday about 12 o'clock the fleet left for Newport. There was a brisk southeast breeze most of the time.

PURITAN arrived first, her elapsed time being 4 hrs., 24 min., 03 sec.; then came PRISCILLA, 4 hrs., 24 min., 37 sec.; followed by GRAYLING, 4 hrs., 27 min., 15 sec.; then DAUNTLESS, 4 hrs., 29 min., 35 sec. The other yachts were MONTAUK, GRACIE, RAMBLER,

FORTUNA, NORNA, BEDOUIN, ATALANTA, ESTELLE, MISCHIEF, LEEEN, NORSEMAN, CLYTIE, RUTH, ARROW, NIRVANA, STRANGER, VARUNA, WAVE CREST, M. WESTWORTH, MADELEINE.

GENESTA arrived at Newport at 6 P. M., having on board her owner Sir Richard Sutton.

The race for the Goelet Cups was sailed Aug. 3rd. There was a strong wind from the southeast with a heavy sea. The following yachts started: Schooners, MONTAUK, FORTUNA, MONTAUK and GRAYLING. Sloops, PRISCILLA, PURITAN, GRACIE, BEDOUIN,

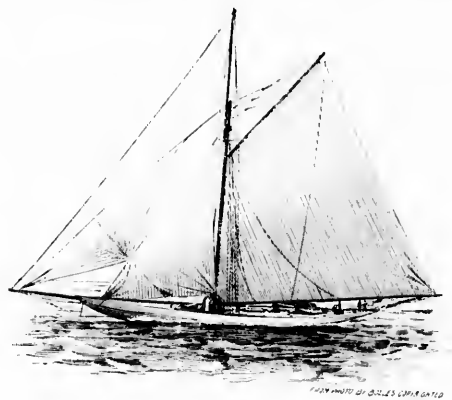

PIRATIM.—FIGURE 274.

ATHLON and IRIS—all crossed the line on time except BEDOUIN. The course was from a line between the Regatta Committee's tug and Brenton's Reef Lightship and around the Sow and Pigs Lightship, thence to the Hen and Chickens Lightship and back to Brenton's Reef, being a triangular course of about 45 miles. GRACIE and GRAYLING soon gave up and returned; DAUNTLESS and WANDERER carried away their gulls, the main gull of the former breaking in two; MONTAUK lost her foremast, masthead and jib boom; STRANGER suffered some in rigging; CLIO snapped her triatic stay and BEDOUIN lost her bowsprit short off. Neither IRIS, ATHLON nor STRANGER crossed the finish line. PURITAN sailed a splendid race, beating PRISCILLA 11 min., 40 sec., 19 seconds actual time. FORTUNA carried her top-sail throughout the worst part of the race, while her rival was under lower sail only. The double victory went to Boston and was fairly deserved.

The race between PURITAN and GENESTA will be given in the chapter relative to AMERICA'S CUP.

The Forty-first Annual Regatta was sailed June 17, 1886, 35 yachts entered. The SEAWANAKA YACHT CLUB presented a \$1,000 cup for special class sloops, in case three or four started. BEDOUIN won in the big sloop class, beating FANNY, GRACIE and THISTLE, as also PRISCILLA and CLARA. CLARA won, beating yachts from 11 to 17 feet longer than herself.

The race for the Goelet Cups was sailed at Newport August 7, 1886. The race was very satisfactory; GRAYLING won the schooner cup and MAYFLOWER won the sloop cup, beating ATLANTIC, PRISCILLA, PURITAN and eleven other cutters and sloops.

The race between MAYFLOWER and GALATEA will be given in the chapter relative to AMERICA'S CUP.

The first Trial Race between MAYFLOWER, ATLANTIC, PRISCILLA, and PURITAN was sailed Aug. 21, 1886, and the second race Aug. 25, 1886. MAYFLOWER was declared the winner.

On September 18th, the race for the Citizens Cups of Newport took place, the cutter GALATEA being invited to participate.

GALATEA was ruled out for fouling Block Island; Buoy CINDERELLA was ruled out for not having a club member on board. GITANA, MAYFLOWER, STRANGER and CLARA won in their respective classes.

SACHEM and MIRANDA sailed a Match Race off Newport, Oct. 2, 1886—20 miles to windward or leeward; SACHEM won by 8 min., 44 sec.

An Ocean Race between DAUNTLESS and CORONET was sailed March 12, 1887, which is described in the chapter on the History of Yachting. It is sufficient to say here that CORONET won.

The Forty-second Annual Regatta took place June 9, 1887. At 12:44 the last gun was fired for the start. There was only a light southeast breeze at first, but it freshened later. Nearly all the yachts were handicapped. The course was from off Owl's Head by Buoys 10 and 8] around Sandy Hook Lightship and return over the same course to Buoy 15, 3½ nautical miles; the eight hour limit was abolished. The entries were: GITANA and SPERANZA (keel schooners); MONTAUK and SACHEM (second class); CLIO and AGNES (third class); GALATEA, ATLANTIC and PRISCILLA (first class sloops); seven sloops in second class; nine sloops in third class and ESPIRITO and ULIDIA in fourth class. SPERANZA won the keel schooner prize by 1 min., 28 sec.; SACHEM won by 9 minutes in second class; AGNES won by 9 min., 44 sec., in third class; ATLANTIC won, beating GALATEA 47 min., 27 sec., and PRISCILLA, 59 min., 2 sec. SHAMROCK beat GRACIE 4 min., 49 sec., and TITANIA, 8 min., 21 sec. FAXITA beat CINDERELLA 3 min., 15 sec., elapsed time in third class sloops, and ULIDIA, beat ESPIRITO 1 min., 43 sec., elapsed time. ATLANTIC carried the wind nearly all day. GRACIE and CINDERELLA lost their lead at the Hook when bound in; FAXITA was a half hour astern of CINDERELLA at the outer mark but came in ahead of her.

Rendezvous at New London. First Race Annual Cruise from New London to Newport, August 4, 1887:—ELECTRA took a position outside the harbor at 9:30 and fired a gun for the start. There was a light breeze from the northeast. ESPIRITO was first away, followed by PURITAN and VOLUNTEER. The fleet straggled along, the last yachts being two hours behind. At noon the wind changed to southeast and freshened.

The only yachts timed on reaching Newport were as follows:

YACHT.	ELAPSED TIME.		
	H.	M.	S.
Volunteer	8	18	40
Puritan	8	26	01
Atlantic	8	28	25
Gracie	8	46	14
Titania	8	50	07
Belouin	9	03	37
Huron	9	13	24
Mayflower	9	15	23
Sachem	9	20	57
Cinderella	9	27	29
Grayling	9	41	19
Thistle	9	42	36

VOLUNTEER'S performance indicated that she was a very fast boat.

The Goolet Cups, one for \$1,000 and one for \$500, were sailed for the following day around the Sow and Pigs and Hen and Chickens Lightships. The yachts sailed over the course as fast as the wind allowed, the water being smooth and the wind light. Nearly all carried club topsails and jib topsails.

STRANGER joined in the race and did good work. Fourteen sloops competed. VOLUNTEER won; MAYFLOWER second; ATLANTIC third; PURITAN fourth; BEDOUIN fifth; STRANGER sixth, etc. The corrected time of VOLUNTEER was 4 hrs., 54 min., 02 sec.; of MAYFLOWER, 5 hrs., 02 min., 41 sec.; of ATLANTIC, 5 hrs., 04 min., 35 sec.

Seven schooners started. SACHEM won, time, 5 hrs., 25 min., 17 sec.; TROQUOIS second, PALMER third, etc.

Newport to Vineyard Haven, Aug. 6th.—At 9 o'clock the yachts worked out to Brenton's Reef Lightship. The wind was moderate

from the south. The yachts started about 11 o'clock. NORSEMAN arrived first, with MAYFLOWER, carrying a club topsail and jib topsail then came SACHEM, with PURITAN and VOLUNTEER following. Twenty-five schooners, twenty-one sloops, five cutters and one yawl started. SACHEM won on time allowance, her elapsed time being 3 hrs., 50 min., 00 sec., that of NORSEMAN 3 hrs., 45 min., 00 sec. MAYFLOWER did much better, her time (elapsed) being 3 hrs., 49 min., 25 sec., that of PURITAN, 3 hrs., 53 min., 43 sec., and VOLUNTEER 3 hrs., 54 min., 12 sec. BEDOUIN won easily in her



JUBILEE.—FIGURE 275.

class; time, 4 hrs., 14 min., 09 sec.; that of HURON 4 hrs., 54 min., 30 sec., and of STRANGER 4½ hrs., 56 min., 30 sec. The time of the yawl NONPAREIL was 5 hrs., 38 min., 31 sec.

Vineyard Haven to Marblehead, Aug. 8th and 9th:—The start was made shortly after 7 o'clock the next morning. VOLUNTEER held the lead from start to finish. The yachts arrived as follows:

Schooners:	Elapsed Time.			Corrected Time.		
	H.	M.	S.	H.	M.	S.
Sachem	27	40	54	27	08	18
Troquois	28	54	40	27	49	22
Magie	29	33	22	28	45	45
Trondalour	31	20	02	30	51	38
Palmer	31	19	19	31	11	22
Republie	31	56	53	31	39	02
Norseman	32	33	10	32	23	10
Mohican	33	12	20	33	04	17

First Class Sloops and Cutters:

	Elapsed.			Corrected.		
	H.	M.	S.	H.	M.	S.
Volunteer	24	42	13	24	42	13
Mayflower	27	07	28	27	05	22
Priscilla	27	22	18	27	14	42
Atlantic	27	40	45	27	35	35
Puritan	Not timed					

Second Class Sloops and Cutters:

	Elapsed.			Corrected.		
	H.	M.	S.	H.	M.	S.
Belouin	27	20	26	27	17	04
Gracie	27	28	10	27	28	20
Clara	29	15	45	28	19	07
Huron	28	41	21	28	23	03
Stranger	28	41	17	28	25	24
Cinderella	29	33	38	28	41	22
Fanny	32	41	09	32	31	41
Ulidia	33	28	03	32	36	38
Pocahontas	33	08	10	33	01	50

SACHEM beat IROQUOIS 41 min., 4 sec. VOLUNTEER beat MAYFLOWER 2 hrs., 23 min., 9 sec. The cutter BEDOUIN beat GRACIE 6 min., 25 sec.

EASTERN YACHT CLUB REGATTA AND HERALD CUP RACE.

This was the most important race of the cruise and was sailed August 11, 1887. In the first class were VOLUNTEER, PURITAN, ATLANTIC, PRISCILLA and MAYFLOWER. In schooner class—SACHEM, IROQUOIS, TROUBADOUR, AMERICA, RESOLUTE, MAGIC and GITANA. In second class—BEDOUIN, TITANIA, STRANGER, HURON, GRACIE and FANNY. In third class were CLARA, ZIGEFNER, VIXEN, CINDERELLA and DREAM. The EASTERN YACHT CLUB offered the following prizes—\$250 and \$50 for schooners; the same for first class single-stickers; \$100 and \$50 for second class and \$75 for third class sloops.

The *Boston Herald* offered a magnificent \$1,000 cup to be raced for by first and second class single-stickers. A moderate southwest by south wind dispersed the fog and the yachts started between 11:30 and 11:50 A. M. The start was off Half Way Rock between a marked boat to the eastward and the rock, thence 12 miles south, southwest, to a buoy of Harding's Lodge, thence east 12 miles to a buoy, and thence north-west by north 12 miles to starting point.

	H.	M.	S.
Volunteer was first	4	19	57
Puritan " second	4	23	44
Mayflower " last in this class	4	30	50

SACHEM beat IROQUOIS, which was second in the schooner class. TROUBADOUR third. BEDOUIN carried away her spruner, TITANIA and STRANGER carried away their topmast and gaff; and they were not timed, HURON winning, GRACIE second and FANNY third; the latter losing her topmast. In the third class CLARA won with ZIGEFNER second and VIXEN third.

VOLUNTEER proved herself the better boat of her two sisters in a breeze to windward.

The cruise to Vineyard Haven was not much of a success, as many yachts dropped out; ELECTRA left at 10:20, arriving at 6:35 P. M. On Monday at 9:45, ELECTRA fired the starting gun and the yachts SACHEM, PALMER, MAGIC, NORSEMAN and HALCYON, schooners and the sloops VOLUNTEER, PURITAN and MAYFLOWER started for Newport to win the Providence Cups. SACHEM was in the schooner class with PALMER second, and VOLUNTEER won in the sloop class with PURITAN second.

The Newport Cups were raced for on August 16th, over the Sow and Pigs course. SACHEM won in the schooner class, VOLUNTEER in the first class sloops, GRACIE beat MISCHIEF in the second class and CINDERELLA won in the third class.

This race, which was for \$650, \$350 and \$200 cups terminated the cruise and the yachts disbanded on the following day.

The races between VOLUNTEER and THISTLE for AMERICA'S CUP were sailed September 27 and 30, 1887, and will be described in detail in the chapter relative to this cup in Volume II.

The Forty-third Annual Regatta of the NEW YORK YACHT CLUB for 1888 took place on June 21st.

PALMER won, beating DAUNTLESS and RAMONA; GRAYLING won, beating SACHEM, MARGUERITE, MIRANDA and TROUBADOUR.

KATRINA (sloop) won, beating FANNY and STRANGER; HILDEGARD won, beating WHILEAWAY and THISTLE and ADELAIDE won, beating REGINA and HEULT.

The Annual Cruise commenced at New London, August 9, 1888, where the yachts had assembled. The first run was to Newport; fifty-four yachts started about 11 o'clock, accompanied by the steamers ELECTRA, CORSAIR, MAGNOLIA, SAGAMORE, SAPPHIRE, WAMPANOAG, SAY WHAT, SENTINEL, VISION, STERLING, VEDETTE and FEDERALMA.

The winners in the various classes were PALMER, SACHEM, IROQUOIS, LYDIA, PURITAN, FANNY, HILDEGARD, BERTIE and REGINA. SACHEM covered the distance in 5 hrs., 07 min., 59 sec. BEDOUIN

and MARGUERITE struck on rocks off Watch Hill and had to be hauled off by CACTUS of the lighthouse department; otherwise the run was successful.

The race for the Golet Cups took place the following day, August 10th. The wind was light at the start but freshened. The fleet ran out about 10 A. M., and found the signal for the Sow and Pigs course. The yachts crossed the line shortly after 10:30 and finished about seven o'clock. The times of the leaders were:

	ELAPSED TIME.			CORRECTED TIME.		
	H.	M.	S.	H.	M.	S.
Volunteer	8	26	37		20	37
Katrina	8	43	52		32	39
Puritan	8	41	48		38	07
Grayling	8	45	51		8	29
Sachem	8	40	48		8	27
Sea Fox	8	51	26		8	10
Mayflower	9	00	12		8	50

The ten other yachts were not timed. VOLUNTEER beat PURITAN 17 min., 31 sec.; KATRINA 12 min., 4 sec., and Mayflower 38 min., 46 sec.; KATRINA beat PURITAN 3 min., 48 sec.

In the schooner class SACHEM beat GRAYLING 1 min., 36 sec., and SEA FOX 12 min., 37 sec. PURITAN and VOLUNTEER did good work, but MAYFLOWER made a poor showing.

The Second Run of the SQUADRON was from Newport to Vineyard Haven, the yachts starting about 10:45 on August 11th.

There was a moderate breeze from the east, later the wind changed to southeast, but soon died out. The finish was to be off the Sea View House, but owing to the lateness of the hour the yachts were timed at West Chop Light about 7:30 P. M.

Won in First Class Schooners, Alarm			
"	Second	"	Montauk
"	Third	"	Grayling
"	Fourth	"	Iroquois
"	Fifth	"	Harbinger
"	First	Sloops,	Puritan
"	Third	"	Bedouin
"	Fourth	"	Melosa
"	Fifth	"	Athlon
"	Sixth	"	Nymph

On the following day a race over a thirty-six mile course was planned—the prizes were:

For all keel schooners \$250; all centerboard schooners over 80 feet, \$250; those not over 80 feet, \$200. For sloops, cutters and yachts—all over 80 feet, \$250; class 2, all over 61 feet and not over 80 feet, \$200; class 3, all over 58 feet and not over 61 feet, \$150; class 4, all over 46 feet and not over 53 feet, \$100; class 5, all under 46 feet, \$100. On account of the weather the race was postponed until Tuesday.

The race for the Cottage City prizes was sailed in a stiff southwest with a rough sea.

It was the second time BEDOUIN met the centerboard KATRINA and the cutter won again. MIRANDA and ALERT finished very close. SACHEM won in the centerboard schooner class. PURITAN beat MAYFLOWER 4 min., 23 sec.; BERTIE beat ATHLON 31 min., 46 sec. and HESPER beat VIXEN in the fifth class, her elapsed time being 5 hrs., 46 min., 59 sec.; that of VIXEN 5 hrs., 55 min.

HILDEGARD had a sail over. Twenty-two yachts participated in the race.

The run of the fleet to New Bedford took place on August 15th, the yachts starting about 10 o'clock. There was a fine southwesterly wind and some sea.

Palmer	won beating	Ramona and Intrepid
Grayling	" "	Sea Fox and Sachem
Clio	" "	Lydia
Bedouin	" "	Pocahontas and Katrina
Bertie	" "	Cinderella and Athlon

MAYFLOWER was disqualified for rounding the buoy instead of

Sow and Pigs Lightship, it seems the breaking of a turnbuckle on her bobstay necessitated squaring away too soon. PURITAN covered the 45 mile course in 4 hrs., 59 min., 26 sec., corrected time, making 1 second better time than SACHEM and being 28 seconds behind GRAYLING.

The run to Newport was made August 17. There was a strong wind from southwest and the sea was heavy. The schooners hoisted their topmasts and PURITAN and MAYFLOWER reefed down. BEDOUIN and MIRANDA were the first to show working topmasts. MAYFLOWER covered the distance in 4 hrs., 06 min., 47 sec., beating PURITAN 33 min., 53 sec. PALMER in the first class (schooners) won, arriving in 4 hrs., 47 min., 37 sec., beating INTREPID, DAUNTLESS, and RAMONA. SACHEM won in third class, arriving in 4 hrs., 43 min., 18 sec., beating MIRANDA. BEDOUIN beat KATRINA 1 min., 28 sec., and BERTIE beat CINDERELLA 21 min., 37 sec.

On Monday, August 20th, the race for the cups presented by the citizens of Newport took place.

The course was 15 miles and return from Brenton's Reef. The race was a failure, being practically a drifting match. VOLUNTEER was the only yacht to finish within the eight hours limit, her elapsed time being 6 hrs., 42 min., 41 sec. DAUNTLESS covered the distance in 8 hrs., 52 min., 27 sec. FANNY in 8 hrs., 25 min., 26 sec. (cor. time) KATRINA in 8 hrs., 29 min., 58 sec., corrected time.

The Fan Regatta was sailed September 20, 1888. The entries were very few which did not speak very well for the club; they were DAUNTLESS and ALARM; MAGIC and GRAYLING; KATRINA, SHAMROCK and FANNY; WIZARD and ADELAIDE. The start was made from off Buoy 10, near the Southwest Spit, then out to the Sandy Hook Lightship, $9\frac{1}{2}$ knots, then to the buoy off Shrewsbury Rocks where a tug was anchored, $7\frac{1}{2}$ knots, and home over the same course, making 33 knots. The wind was southeast by south and quite strong. The yachts started about 11:35 A. M. WIZARD carried away her topmast on the way in and did not finish.

DAUNTLESS won, beating ALARM; GRAYLING won, beating MAGIC 29 min., 42 sec., and SHAMROCK won beating KATRINA 2 min., and FANNY 22 min., 20 sec. GRAYLING covered the distance in 3 hrs., 29 min., 40 sec., corrected time. The interest in the race was centered in the contest between SHAMROCK and KATRINA.

The Forty-fourth Annual Regatta was sailed June 13, 1889. The distance sailed except for "forties" was 31 knots, the forties only sailing 25 knots. The start was made at 11:34 A. M. The wind was from the southwest and there was a strong ebb tide. In the Schooner Class 1, PALMER won; 3 hrs., 54 min., 48 sec., beating DAUNTLESS 10 min., 25 sec. GRAYLING won in Class 3, in 3 hrs., 49 min., 56 sec., beating SEA FOX 2 min., 14 sec. AGNES won in Class 5, beating AZALEA 2 min., 06 sec. KATRINA won in Class 3 (sloops) in 3 hrs., 53 min., 59 sec., beating SHAMROCK 3 min., 7 sec. In Class 4 HILDEGARD won in 4 hrs., 17 min., 58 sec., beating WILLEWAY 6 min., 6 sec. In Class 5 CLARA won, beating BERTIE 11 min., 26 sec., and in Class 7 NYMPH won.

BEDOUIN was grounded, TITANIA was disabled, GORILLA lost her topmast and LIRIS was dismasted.

On August 8th, the Annual Cruise took place, the yachts having been ordered to rendezvous at New London on August 7th. The first race of the fleet was from New London to Newport, on August 8, 1889. The yachts got off between 9:30 and 10:24. The wind was light. The winners were: CONSTELLATION, MONTAUK, GRAYLING, QUICKSTEP, KATRINA, HILDEGARD, CLARA and GORILLA.

Shortest time over course: GRAYLING, 5 hrs., 37 min., 58 sec.

The next race was for the \$1,000 and \$500 Goelet Cups, which took place on August 9, 1889. The starting gun was fired at 11 o'clock. SEA FOX won, time 4 hrs., 55 min., 26 sec., beating GRAYLING 5 min., 57 sec., and CONSTELLATION 13 min., 11 sec. TITANIA won, time 4 hrs., 58 min., 50 sec., beating KATRINA 2 min., 19 sec., and BEDOUIN managed to come in ahead of GRACIE.

The Second Run of the squadron was from Newport to Vineyard

Haven on August 10th. There was a strong breeze from the southwest and the yachts got off between 10:35 and 11:18 A. M. CONSTELLATION made the run in 3 hrs., 31 min., 10 sec., winning in first class (schooners); FORTUNA, SEA FOX, MARQUERITE and QUICKSTEP won in their respective classes. TITANIA, HILDEGARD, BERTIE, ADELAIDE and GORILLA won in their respective classes.

The Vineyard Haven Cups were sailed for on August 12th. The yachts started about 10:30. The course was from a line off the Sea View House at Cottage City, past the Whistling Buoy off Nobska Head, then on five miles further to a mark boat off Turpallin Cove for the smaller schooners and single stickers, and about 3 miles further still to a second mark boat off Robinson's Hole for the larger yachts, about 22 and 28 knots. A Special Sweepstakes of \$25 each was made up to be sailed at the same time.

GRAYLING beat SEA FOX 2 min., 43 sec.; QUICKSTEP beat AZALEA 9 min., 6 sec. TITANIA beat GRACIE 4 min., 33 sec., and KATRINA 6 min., 25 sec.; PAPOOSE beat ALICE 7 min., 43 sec., actual time—about 10 minutes corrected time—and LIRIS beat MARQUITA 21 sec. SEA FOX, time 4 hrs., 34 min., 17 sec.; QUICKSTEP, 3 hrs.; 34 min., 08 sec.

The Third Run of the Cruise was from Vineyard Haven to New Bedford on August 13th, the yachts starting about 10:10 A. M. There was a strong southwest breeze. CONSTELLATION beat PALMER 10 min., 15 sec.; NORNA beat FORTUNA 7 min., 58 sec.; GRAYLING beat SEA FOX 2 min., 2 sec.; IROUOIS beat MARQUERITE 14 min., 14 sec.; QUICKSTEP beat HARBINGER 36 min., 13 sec.; TITANIA beat KATRINA 12 min., 42 sec., HILDEGARD and BERTIE won in their class and GORILLA beat MARQUITA 21 min., 45 sec. TITANIA 5 hrs., 12 min., 24 sec., (shortest time over course).

The Fourth Run was from New Bedford to Newport on August 15th. The wind was light and from northeast. The yachts started about 10 A. M. MARQUITA had trouble with her extension spinnaker boom and broke it.

CONSTELLATION arrived in 4 hrs., 42 min., 19 sec., beating PALMER 20 min., 9 sec.; FORTUNA won in her class, time 5 hrs., 11 min., 10 sec.; SEA FOX beat GRAYLING 1 min., 44 sec.; IROUOIS beat GENOXE 18 min., 10 sec.; QUICKSTEP beat HARBINGER 16 min., 4 sec.; TITANIA beat GRACIE 3 min., 4 sec.; GRACIE beat KATRINA 5 min., 10 sec.; CLARA beat BERTIE 5 min., 33 sec.; GORILLA, in seventh class, beat LIRIS 3 min., 35 sec.; LIRIS beat MARQUITA 13 min., 40 sec., and MARQUITA beat LOTOWANA 15 min., 29 sec.

On Friday, August 16th, there was a special race at Newport for 70 and 40-footers that had not hauled out or cleaned bottom since the cruise began, the prize being a \$250 cup for the 70 foot class and a \$150 cup for the 40 foot class, with a second prize of \$100 for more than her entries in each class.

DAUNTLESS, PALMER and FORTUNA started for the latter prize, and of the seventies TITANIA, GRACIE and BEDOUIN. In the 40 foot class, GORILLA, LIRIS, MARQUITA and TOMAHAWK. The start was made about 11:30 A. M. There was a slight wind from northwest. FORTUNA beat PALMER 2 min., 9 sec.; TITANIA (Class 3) beat GRACIE 4 min., 11 sec.; TOMAHAWK beat LIRIS 44 seconds. The fleet disbanded the following day. The flag ship ELECTRA returned to New York after attending a very successful cruise.

On September 19, 1889, a race for cups was sailed for off Newport, TITANIA, BEDOUIN, GORILLA, PAPOOSE, LIRIS and AWA competing.

TITANIA won the \$350 cup offered by Capt. Morgan over a twelve mile course. GORILLA won \$150 cup offered by Capt. Morgan over a nine mile course and PAPOOSE took the second prize, \$100 cup in her class.

The Forty-fifth Annual Regatta took place June 19, 1890. Course No. 1.—31 miles. Sandy Hook Lightship. Course No. 2.—25 miles. Scotland Lightship. For Classes 6 and 7, sloops, etc.

the south-
M. CoX-
inning in
nd QUICK-
LLEGARD,
esses.

th. The
o off the
off Nob-
Tarpaulin
l about 3
le for the
ces of \$25

t AZALEA
KATRINA
ctual time
IQUITA 21
3 hrs.; 34

n to New
10 A. M.
t PALMER
LING beat
4 min., 14
NTIA beat
their class
5 hrs., 12

gust 15th.
ted about
aker boom

. beating
5 hrs., 11
sec.; IR-
ARBINGER
RACIE beat
33 sec.;
IRIS beat
WANA 15

port for 70
since the
ass and u
for more

ter prize,
In the 40
K. The
wind from
TITANIA
LIRIS 44
flag ship
successful

Newport,
compet-

r a twelve
rgan over
00 cup in

. Course
o. 2.—25
oops, etc.

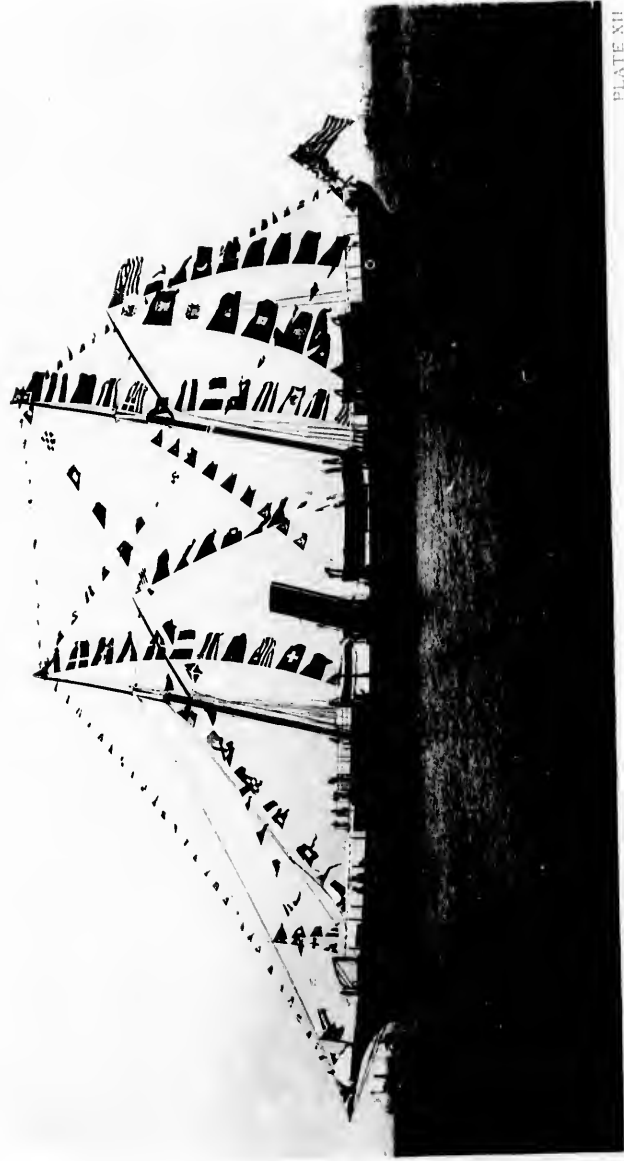

PLATE XII

FROM A NEGATIVE BY BOLLE

ELECTRA.

Appendix

1. 1940

2. 1941

3. 1942

4. 1943

5. 1944

6. 1945

7. 1946

8. 1947

9. 1948

10. 1949

11. 1950

12. 1951

13. 1952

14. 1953

15. 1954

16. 1955

17. 1956

18. 1957

19. 1958

20. 1959

21. 1960

22. 1961

23. 1962

24. 1963

25. 1964

26. 1965

27. 1966

28. 1967

29. 1968

30. 1969

31. 1970

32. 1971

33. 1972

34. 1973

35. 1974

36. 1975

37. 1976

38. 1977

39. 1978

40. 1979

41. 1980

42. 1981

43. 1982

44. 1983

45. 1984

46. 1985

47. 1986

48. 1987

49. 1988

50. 1989

51. 1990

52. 1991

53. 1992

54. 1993

55. 1994

56. 1995

57. 1996

58. 1997

59. 1998

60. 1999

61. 2000

62. 2001

63. 2002

64. 2003

65. 2004

66. 2005

67. 2006

68. 2007

69. 2008

70. 2009

71. 2010

72. 2011

73. 2012

74. 2013

75. 2014

76. 2015

77. 2016

78. 2017

79. 2018

80. 2019

81. 2020

82. 2021

83. 2022

84. 2023

85. 2024

86. 2025

87. 2026

88. 2027

89. 2028

90. 2029

91. 2030

92. 2031

93. 2032

94. 2033

95. 2034

96. 2035

97. 2036

98. 2037

99. 2038

100. 2039

101. 2040

102. 2041

103. 2042

104. 2043

105. 2044

106. 2045

107. 2046

108. 2047

109. 2048

110. 2049

111. 2050

112. 2051

113. 2052

114. 2053

115. 2054

116. 2055

117. 2056

118. 2057

119. 2058

120. 2059

121. 2060

122. 2061

123. 2062

124. 2063

125. 2064

126. 2065

127. 2066

128. 2067

129. 2068

130. 2069

131. 2070

132. 2071

133. 2072

134. 2073

135. 2074

136. 2075

137. 2076

138. 2077

139. 2078

140. 2079

141. 2080

142. 2081

143. 2082

144. 2083

145. 2084

146. 2085

147. 2086

148. 2087

149. 2088

150. 2089

151. 2090

152. 2091

153. 2092

154. 2093

155. 2094

156. 2095

157. 2096

158. 2097

159. 2098

160. 2099

161. 2100

162. 2101

163. 2102

164. 2103

165. 2104

166. 2105

167. 2106

168. 2107

169. 2108

170. 2109

171. 2110

172. 2111

173. 2112

174. 2113

175. 2114

176. 2115

177. 2116

178. 2117

179. 2118

180. 2119

181. 2120

182. 2121

183. 2122

184. 2123

185. 2124

186. 2125

187. 2126

188. 2127

189. 2128

190. 2129

191. 2130

192. 2131

193. 2132

194. 2133

195. 2134

196. 2135

197. 2136

198. 2137

199. 2138

200. 2139

201. 2140

202. 2141

203. 2142

204. 2143

205. 2144

206. 2145

207. 2146

208. 2147

209. 2148

210. 2149

211. 2150

212. 2151

213. 2152

214. 2153

215. 2154

216. 2155

217. 2156

218. 2157

219. 2158

220. 2159

221. 2160

222. 2161

223. 2162

224. 2163

225. 2164

226. 2165

227. 2166

228. 2167

229. 2168

230. 2169

231. 2170

232. 2171

233. 2172

234. 2173

235. 2174

236. 2175

237. 2176

238. 2177

239. 2178

240. 2179

241. 2180

242. 2181

243. 2182

244. 2183

245. 2184

246. 2185

247. 2186

248. 2187

249. 2188

250. 2189

251. 2190

252. 2191

253. 2192

254. 2193

255. 2194

256. 2195

257. 2196

258. 2197

259. 2198

260. 2199

261. 2200



Preparatory signal, 11:20. Start 11:30. Handicap, 11:40.
 Weather clear, with sea calm and tide at start first ebb. A light air from the north as the vessels crossed, flattened to a dead calm off the West Bank. Later, occasional faint airs from north westerly winds with the ebb, carried the fleet to buoy 10 and out. At three o'clock a breeze came out from north and west, freshening towards the finish to a fair sailing breeze.

Number and Name.	SCHOONERS.		
	Time Allowance.	Elapsed Time.	Corrected Time.
	M. S.	H. M. S.	H. M. S.
Fourth Class.			
18 Marguerite,		Did not start.	
Fifth Class.			
58 Azaba,		Crossed line before signal.	
	SLOOPS.		
Second Class.			
39 Florida,		Not timed.	
Third Class.			
31 Katrina,		7 27 11	7 27 11
29 Shamrock,	51	7 29 49	7 28 49
15 Gracie,	Not measured.	Did not start.	
34 Fanny,	" "	" "	
Fourth Class.			
100 Wizard,	Not measured.	" "	" "
49 Whiloway,	Not measured.	Not timed.	
Fifth Class.			
37 Clara,		7 49 11	7 49 11
Sixth Class.			
*59 Nirvana,	Not measured.	Not timed.	
Seventh Class.			
50 Liris,		Did not start.	
47 Tomahawk,	44	7 15 45	7 15 45
48 Marquitta,	1 26	7 23 25	7 22 45
23 Choctaw,	2 45	7 27 30	7 27 41
45 Minerva,	4 21	6 44 30	6 40 54

* Sailed in Clara's Class.
 WINNERS:—Katrina, Clara and Minerva.

THE GOELET CUPS.
 (August 1st, 1903.)

Offered by Capt. Ogden Goelet, New York Yacht Club, for schooners, and sloops, cutters and yawls, of the New York Yacht Club that had not hauled out to clean since the commencement of the cruise. Sailed for off Newport, under the racing rules of the club, and with its time allowances. Capt. Goelet reserved the privilege of inviting foreign yachts in American waters, to enter.

For Schooners, - - - - - \$1,000 Cup.
 For Sloops, Cutters and Yawls, - - - - - \$500 Cup.

Course.—From Brenton's Reef Lightship to and around Vineyard Sound Lightship, to and around Hen and Chickens Lightship, to starting point—39 miles.

Weather clear and smooth sea, with ebb tide at start and light breeze from southeast by east. Between the Lightships the breeze freshened from easterly southeast and stiffened on the run into a good spinnaker breeze from the same quarters.

Preparatory signal, 11:33. Sloops start 11:43; Schooners start 11:48. Handicap 11:53.

	SCHOONERS.		
	Time Allowance.	Elapsed Time.	Corrected Time.
	M. S.	H. M. S.	H. M. S.
Palmer		No finish.	
S.a Fox,	Not measured.	6 18 23	
Merlin,	5 08	5 56 21	5 51 13
Mayflower,		6 10 29	6 14 25
Marguerite,	11 50	No finish.	
Enone,	14 19	6 34 03	6 19 44

	SLOOPS.		
	Time Allowance.	Elapsed Time.	Corrected Time.
	M. S.	H. M. S.	H. M. S.
Volunteer,		4 55 40	1 55 40
Paritan,	Not measured.	5 18 34	
Katrina,	11 31	5 38 33	5 27 02
Gracie,	13 22	6 31 46	6 21 24
Clara,	31 25	6 38 20	6 03 55
Gosoon,	Not measured.	6 29 20	
WINNERS:—Merlin, (Schr. Cup), Time over course, 0h. 13m. 21s.			
Volunteer, (Sloop Cup), " " " " 3h. 11m. 40s.			
REAR-COMMODORE ISELIN'S CUP.			

NEWPORT, August 2d.
 A \$250 cup offered by Rear-Commodore Iselin, for Class 7. Sloops, cutters and yawls of the club, that had not hauled out to clean since the commencement of the cruise. Course, 12 miles to windward, or to leeward and return, from Brenton's Reef Lightship.

Tide at start half ebb; weather clear with fair sailing breeze and compass course southeast.

	SLOOPS.		
	Time Allowance.	Elapsed Time.	Corrected Time.
	M. S.	H. M. S.	H. M. S.
Mariquita,		4 38 50	4 38 50
Gosoon,	20	4 26 08	4 55 48
Moccasin,	59	4 30 50	4 35 57
Choctaw,	1 06	5 04 21	5 03 15
Minerva,	2 48	4 27 47	4 24 50

Minerva won by 49 seconds.

SPECIAL CUPS.

NEWPORT, August 8th.
 For cups offered by the club as follows, for yachts of the club that had not hauled out to clean since the commencement of the cruise.

Schooners:	Cups.
Keel Schooners (open to all),	\$200 Cup.
1st Class Schooners,	200 Cup.
2d " "	200 Cup.
Classes 3, 4 and 5, Schooners,	300 Cup.
Sloops:	Cups.
1st Class,	\$200 Cup.
3d " "	200 Cup.
4th and 5th Class,	200 Cup.
6th and 7th " "	200 Cup.

Course all to windward, or to leeward and return. For all schooners, and Classes 1, 3, 4 and 5 sloops, etc., 13 min. Classes 6 and 7 sloops, etc., 9 min.

Tide at start first flood; weather clear with light sailing breeze true through the day. Compass course south, southeast from Brenton's Lightship.

	SLOOPS.		
	Time Allowance.	Elapsed Time.	Corrected Time.
	M. S.	H. M. S.	H. M. S.
Fourth & Fifth Class Schooners:			
Iroquois,	Not measured.	6 36 55	
Enone,		6 31 59	6 31 59
Quickstep,	6 11	6 17 58	6 11 47
Seventh Class Sloops:			
Liris,		4 10 05	
Mariquita,	10	4 10 29	4 10 20
Gosoon,	21	3 55 09	3 54 45
Moccasin,	54	No finish.	
Minerva,	2 16	4 00 45	3 58 19

WINNERS:—Schooners, Quickstep. Sloops, Gosoon; 3d, Minerva.

RUNS FROM PORT TO PORT.
 CONDITIONS.

Anchors on the bow and cables stowed; cruising complement of boats carried; cruising deck, cabin and galley fittings and fixtures in place; topsails extending above the truck or beyond the end of the gal, barred.

A prize in each class when two or more start; if four, or more, a prize for second.

NEW LONDON TO NEWPORT, July 31st.

Time was not taken in consequence of the death of Mr. George

L. Schuyler on board the flag ship in the early morning. The squadron proceeded at will, with colors half-masted, under command of the Vice-Commodore.

The flag ship followed at noon, with Mr. Schuyler's remains on board, and on reaching Newport anchored to the N. of Long Wharf. The Commodore read the services and Mr. Schuyler's remains were escorted to the shore. The flag ship then rejoined the Squadron.

NEWPORT TO VINEYARD HAVEN, August 4th.

A start was made at 9 o'clock, but on reaching the outer harbor the fog was rolling in so thick that after waiting for an hour or more, the squadron was ordered back to its anchorage.

At 1:30 o'clock the conditions being favorable, a second start was made, and with the wind strong from southwest, a quick run was made to the Haven, the entire squadron being at anchor shortly after colors.

VINEYARD HAVEN TO NEW BEDFORD, August 5th.

Tide at start half flood, with weather clear and wind strong from southwest and true through the run.

SCHOONERS.

Class.	Name.	Time Allowance.	Elapsed Time.	Corrected Time.
First Class.	Palmer,		4 57 13	4 57 13
Third Class.	Sea Fox,	Not measured.	4 47 05	
	Merlin,		4 32 28	4 32 28
	Mayflower,	1 48	4 57 31	4 55 43
	Miranda,	3 16	5 19 13	5 15 57
Fourth Class.	Iroquois,	Not measured.	5 09 57	
	Enone,		5 21 04	
Fifth Class.	Quickstep,		5 20 31	
SLOOPERS.				
First Class.	Volunteer,		4 10 03	
	Paritan,	Not measured.	4 49 57	
Fifth Class.	Cinderella,		5 50 00	5 50 00
	Clara,	3 50	5 24 37	5 20 47
Seventh Class.	Liris,		4 50 57	4 50 57
	Gossoon,	33	4 11 33	4 11 30
	Moccasin,	1 12	No finish	

WINNERS—Merlin; 2d, SEA FOX.

IROQUOIS, VOLUNTEER, CLARA, GOSSOON.

NEW BEDFORD TO NEWPORT, August 7th.

Tide at start first flood, with high airs west southwest, hauling to the south, and dying away off the "Hen and Chickens." Off West Island a sailing breeze came from the north and west and lasted to the finish of the leading vessels and freshened from north and east while the rear yachts were crossing.

SCHOONERS.

Class.	Name.	Time Allowance.	Elapsed Time.	Corrected Time.
Third Class.	Merlin,		7 20 52	7 20 52
	Mayflower,	1 26	No finish	
Fourth Class.	Marguerite,		No finish	
	Enone,	1 42	7 39 47	7 38 05
	Iroquois,	Not measured	No finish	
Fifth Class.	Quickstep,		7 50 00	

SLOOPERS.

Class.	Name.	Time Allowance.	Elapsed Time.	Corrected Time.
First Class.	Volunteer,		6 18 23	
Third Class.	Gracie,		6 22 58	6 22 58
	Huron,	3 40	7 27 21	7 23 05
Fourth Class.	Wayward,		6 20 43	
Fifth Class.	Cinderella,		8 03 08	8 03 08
	Nivana,		No finish	
	Clara,	3 03	6 42 47	6 30 44
Seventh Class.	Liris,		No finish	
	Gossoon,	37	6 48 15	6 47 39
	Moccasin,	1 21	No start	
	Minerva,	3 24	6 48 32	6 45 08

WINNERS—MERLIN, ENONE.

GRACIE, CLARA, MINERVA; 2nd, GOSSOON.

NEW BEDFORD, AUGUST 6, 1890.

LAUNCHES.

Class of Boats giving Time.	Time allowance by Fleet-Captain Peabody's formula.		
	Class of Boats Receiving Time.		
	H. P. O., 5 h. p.	H. P. O., 3 h. p.	H. P. N., 2 h. p.
	M. S.	M. S.	M. S.
H. P. O., 8 h. p.	9 03	12 50	15 10
H. P. O., 5 h. p.		9 47	6 10
H. P. O., 3 h. p.			2 29
Name.	Start.	Finish.	Time.
Electra 5 H. P.	4 18 46	4 41 30	25 53
Yampa 2 "	4 12 30	4 45 02	32 32
Palmer 5 "	4 18 46	4 45 41	26 55
Laurine 2 "	4 12 30	4 40 31	33 51
Wanderer 4 "	4 14 52	4 40 50	31 48
Electra 8 "	4 27 49	4 57 50	24 07

ELECTRA'S 5 H. P. Launch won the first prize with YAMPA'S Launch second.

The Forty-sixth Annual Regatta took place June 18, 1891. Course No. 1: 31 miles. Sandy Hook Lightship. Course No. 2: 25 miles. Scotland Lightship. For classes 6 and 7; sloops, etc. Weather cold and wet, with strong wind from north and east, holding through the day. Sea heavy and lumpy.

Name.	Allows.	Elapsed Time.	Corrected Time.
KEEL SCHOONERS.			
ALL CLASSES.	M. S.	H. M. S.	H. M. S.
Dauntless		Disabled	
Viator	28 45	5 29 13	5 00 28

SCHOONERS.

Class.	Name.	Time Allowance.	Elapsed Time.	Corrected Time.
Fourth Class.	Marguerite,		4 35 23	
SLOOPERS.				
Third Class.	Katrina,		4 05 28	4 05 28
	Shamrock,	54	4 16 47	4 15 53
Fourth Class.	Hildegard,		Did not finish	
Sixth Class.	Mincola,	Not measured	Disabled	
	Gloriana,		3 18 03	3 18 03
	Nautilus,	59	3 32 21	3 31 22
	Jessica,	4 08	3 29 24	3 25 16
	* Ventura,	7 42	Did not finish	

SEVENTH CLASS.
Liris, Cruising trim 3 35 20

WINNERS.—Viator, Katrina, Gloriana; 2nd, Jessica.

* Ventura moved up one class.

THE YACHTS AND YACHTSMEN OF AMERICA.

199

THE GOELET CUPS.
(Eleventh Series.)

NEWPORT, August 7, 1891.

Offered by Capt. Ogden Goelet, New York Yacht Club, for schooners and sloops, cutters and yawls of the New York Yacht Club that had not hauled out to clean since the commencement of the cruise, and sailed for off Newport, under the racing rules of the club and with its time allowances. Capt. Goelet reserved the privilege of inviting foreign yachts in American waters, to enter.

For Schooners, \$1,000 Cup,
For Sloops, Cutters and yawls, \$500 Cup,
Course No. 4.—38 miles.

Weather clear. Quiet sea and light breeze at start from southeast. The wind continued true but flattened off Block Island mark. Later it stiffened up to a good whole sail breeze and held till finish.

SCHOONERS.

Name of Yacht.	Measure.	Allows.	Elapsed Time.		Corrected Time.	
			M. S.	H. M. S.	H. M. S.	H. M. S.
Volunteer,	95 21		5 30 00	Protests (all'd)		
Fortuna,	91 57	22	5 54 17	5 53 55		
Merlin,	93 35	1 11	5 47 40	5 46 29		
Mayflower,	89 83	3 27	5 40 12	5 39 45		
Marguerite,	83 48	7 55	5 47 41	5 39 49		
Iroquois,	82 58	8 30	5 30 07	5 30 31		

SLOOPS.

Name of Yacht.	Measure.	Allows.	Elapsed Time.		Corrected Time.	
			M. S.	H. M. S.	H. M. S.	H. M. S.
Gracie,	71 63		Protests.		Not allowed.	
Barbara,	None.		5 58 16			
Owenee,	51 61	21 45				
Sayonara,	51 21	22 10	0 07 55	5 45 30		
Gloriana,	54 17	22 10	5 41 02	5 41 43		

WINNERS:—Schooner Cup, \$1,000, VOLUNTEER.
Sloop Cup, \$500, GLORIANA.

SPECIAL CUPS.
(August 10th.)

VINEYARD HAVEN SOUND.—25 miles.

SCHOONERS.

Classes 1, 2 and 3, \$200 Cup.
Classes 4 and 5, 200 Cup.
Keel Schooners (all classes), 200 Cup.

SLOOPS, CUTTERS AND YAWLS.

Class 3, \$150 Cup.
Classes 4 and 5, 150 Cup.
Class 6, 100 Cup.
Class 7, 100 Cup.

Weather clear, with strong wind west-southwest, and nothing of a sea. Wind remained true through the day.

SCHOONERS.

Name of Yacht.	Measure.	Allows.	Elapsed Time.		Corrected Time.	
			M. S.	H. M. S.	H. M. S.	H. M. S.
First, Second and Third Class:						
Damless,	None.		Did not finish.			
Palmer,	102 11		4 29 43	5 29 43		
Fortuna,	94 57	2 53	4 37 57	4 35 04		
Merlin,	93 35	3 25	4 25 40	4 22 15		
Mayflower,	89 83	4 55	4 25 01	4 20 06		
Fourth and Fifth Class:						
Class B.						
Marguerite,	83 48		4 15 38	4 15 38		
Iroquois,	82 58	27	4 16 16	4 15 49		
Enone,	80 37	1 34	4 38 05	4 34 31		
Quickstep,	70 10	7 31	4 20 23	4 12 52		

MARGUERITE'S protest against QUICKSTEP not allowed.

KEEL SCHOONERS.

Name of Yacht.	Measure.	Allows.	Elapsed Time.		Corrected Time.	
			H. M. S.	H. M. S.	H. M. S.	H. M. S.
All Classes:						
Class C.						
Damless,	None.		Did not finish.			
Palmer,	102 11		4 29 43			
Fortuna,	94 57	2 53	4 37 57	4 35 00		
Enone,	80 37	9 25	4 36 05	4 26 40		

SLOOPS.

Name of Yacht.	Measure.	Allows.	Elapsed Time.		Corrected Time.	
			H. M. S.	H. M. S.	H. M. S.	H. M. S.
Third Class:						
Class B.						
Bedouin,	73 11		4 17 28	4 17 28		
Huron,	68 44	2 58	4 28 52	4 25 51		
Fourth and Fifth Class Sloops.						
Class F.						
Hildegard,	66 12		4 13 49	4 13 49		
Mischief,	None.		Did not finish.			
Cinderella,	57 80	6 10	4 16 33	4 10 14		
Clara,	55 12	8 47	4 20 08	4 17 21		
Sixth Class Sloops.						
Class G.						
Sayonara,	54 24	22	4 03 44	4 03 22		
Mineola,	54 20	22	4 04 41	4 04 10		
Owenee,	54 61	Allows	4 05 35	4 05 35		
Seventh Class Sloops.						
Class H.						
Gossoon,	47 83		4 47 47	4 47 47		
Ventura,	47 12	48	Did not finish.			

Winners: 1st, 2nd, and 3rd class schooners, MAYFLOWER; 4th and 5th class, QUICKSTEP. Keel schooners (all classes) ENONE; 3rd class sloops BEDOUIN; 4th and 5th class sloops CINDERELLA; 6th class SAYONARA; and 7th class sloops GOSSOON.

SPECIAL CUPS.

NEWPORT, August 13, 1891.

Open to Class 6, sloops, etc., of the New York Yacht Club, that had not hauled out to clean since the commencement of the cruise.

\$500 Cup for First.
\$150 " " Second (with two starters).
\$50 " " Third (with four or more starters).

Course 12 miles to windward or to leeward and return.

Quiet sea and light breeze from northeast through the day.

Name.	Measure.	Elapsed Time.		Corrected Time.
		H. M. S.	H. M. S.	
Gloriana,	54 17	3 43 23	3 43 23	
Sayonara,	54 24	3 43 51	3 43 51	
Uvira,	47 14	3 53 44	3 46 37	
Mineola,	54 20	3 46 45	3 46 45	
Jessica,	50 22	3 51 06	3 47 17	

(Jessica receives 3 min., 40 sec. Uvira 7 min., 07 sec.)

WINNERS:—Gloriana, \$500 cup. Second, Sayonara, \$150 cup. Third, Uvira, \$50 cup.

SQUADRON RUNS.

With anchors on the bow and cables stowed; cruising complement of boats carried; cruising deck, cabin and galley fitting, and fixtures in place; topsails extending above the truck or beyond the end of the gaff, barred.

A prize in each class when two, or more, started; if four, or more, a prize for second.

HUNTINGTON BAY TO NEW LONDON, August 4th: 63 miles.

Weather wet and dirty. Sea heavy and lumpy, with strong wind from north and east. Late in the afternoon the weather moderated.

HISTORY OF THE NEW YORK YACHT CLUB.

SCHOONERS.				Allowance.		
	Time Allowance.	Elapsed Time.	Corrected Time.	M. S.	H. M. S.	H. M. S.
First Class.	M. S.	H. M. S.	H. M. S.			
Norseman,		12 53 20	12 53 20		8 07 26	8 07 26
Constellation,	107 28	10 55 37	10 55 37	43	8 12 51	8 12 08
Palmer,	102 11	11 03 02	11 01 27	2 31	8 30 50	8 28 19
Intrepid,	98 01	13 02 56	12 55 21			
Second Class.					8 27 45	8 27 45
Fortuna,	91 59	11 22 56	11 22 56	not measured		not timed
Fleur de Lys,	not measured	15 50 30		SLOOPs,		
Third Class.						
Mayflower,	89 63	11 10 41	11 10 41		7 39 18	7 39 18
Phantom,	not measured	15 19 01		1 57	8 05 18	8 03 21
Fourth Class.						
Marguerite,	83 18	11 44 16	11 44 16		8 13 04	8 13 04
Iroquois,	82 58	11 11 38	11 10 30	33	8 14 30	8 13 57
Onone,	80 37	15 21 05	15 17 07	not measured	8 55 40	
Sylph,	72 40		did not finish	not measured	8 37 46	
Fifth Class.						
Quickstep	70 10	12 51 18	12 51 18		8 38 08	8 38 08
Cho,	not measured	11 16 28		3 49	8 29 13	8 25 24
	SLOOPs,			12 22		not timed
Third Class.						
Katrina,	76 08	10 38 21	10 38 21		7 48 49	7 48 13
Belouin,	73 11	11 04 25	11 00 01	36	7 50 12	7 49 36
Gracie,	74 03	12 14 10	12 11 06	30	8 28 09	8 26 02
Huron,	68 41	12 28 16	12 10 21	2 07	7 40 20	7 40 20
				allows,	7 40 20	7 40 20
Fourth Class.				2 20	9 08 42	9 16 16
Hildegard,	66 12	12 25 01	12 25 01	12 28	8 01 00	7 48 32
Whiteaway,	not measured		did not finish	6 58	8 13 20	8 06 22
Fifth Class.						
Cinderella,	58 29	12 51 18	12 51 18		8 28 01	8 28 01
Whitby,	49 70		did not finish	3 01	8 51 12	8 48 08
Forget-me-not	not measured		did not finish			
Sixth Class.						
Sayonara,	51 24	12 17 39	12 16 42			
Mineola,	51 20	12 16 17	12 15 20			
Nautilus,	53 23	14 36 44	14 33 21			
Owene,	51 61	12 02 19	12 02 19			
Seventh Class.						
Liris,	48 81	13 41 58	13 41 58			
Gosoon,	47 83		did not finish			
WINNERS.—1st Class Schooners.	Constellation, 2d Prize, Palmer.					
2d " "	Fortuna.					
3d " "	Mayflower.					
4th " "	Iroquois, 2d Prize, Marguerite.					
5th " "	Quickstep.					
3d " Sloop.	Katrina, 2d Prize, Belouin.					
4th " "	Hildegard.					
5th " "	Cinderella.					
6th " "	Owene, 2d Prize, Mineola.					
7th " "	Liris.					
NEW LONDON TO NEWPORT, August 6th: 40 miles.						
Weather clear with quiet sea. Light breeze at start from south and east, which flattened out off Watch Hill. A good sailing breeze came up from the south about 3 o'clock and held to the finish.						
SCHOONERS.				Name of Yacht.		
Name of Yacht.	Time Allowance.	Elapsed Time.	Corrected Time.	Time Allowance.	Elapsed Time.	Corrected Time.
First Class.	M. S.	H. M. S.	H. M. S.	H. M. S.	M. S.	H. M. S.
Dauntless,	not measured	9 05 25		not measured	6 49 44	
Palmer,		8 12 40	8 12 40		6 48 02	6 48 02
Intrepid,	1 51	9 28 13	9 26 19	2 41	7 33 27	7 30 40
Second Class.				6 58	7 15 16	7 08 18
Fortuna,		8 01 51	8 01 51			
Fleur de Lys,	not measured	9 05 39			7 10 31	7 10 31
Montauk,	not measured	8 46 00			6 55 16	6 53 03
Third Class.					7 21 49	
Merlin,	1 15	7 44 47	7 42 32			
Volunteer,		7 44 43	7 44 43			
Mayflower,	3 46	7 13 56	7 13 10			
Phantom,	not measured	8 56 59				
Fourth Class.						
Marguerite,		5 57 49	5 57 49			
Crusader,	04	7 36 19	7 36 15			
Iroquois,	40	7 23 35	7 23 35			
Onone,	2 19	7 13 20	7 11 01			
Fifth Class.						
Quickstep,		6 10 37	6 10 37			
Viator,	3 58	7 33 37	7 29 59			
	SLOOPs,					
Third Class.						
Thetis,		7 10 26				
Huron,		6 46 47				

NEWPORT TO VINEYARD HAVEN, August 8th: 37 miles.

Weather clear, with quiet sea. Light breeze from north, north-east at start and then all round the compass, and light through the day.

SCHOONERS.

Name of Yacht.	Time Allowance.	Elapsed Time.	Corrected Time.
	H. M. S.	M. M. S.	H. M. S.
First Class.			
Dauntless,	not measured	6 49 44	
Constellation,		6 48 02	6 48 02
Palmer,	2 41	7 33 27	7 30 40
Fortuna (2d Class),	6 58	7 15 16	7 08 18
Third Class.			
Merlin,		7 10 31	7 10 31
Mayflower,	2 13	6 55 16	6 53 03
Phantom,	not measured	7 21 49	
Fourth Class.			
Marguerite,		5 57 49	5 57 49
Crusader,	04	7 36 19	7 36 15
Iroquois,	40	7 23 35	7 23 35
Onone,	2 19	7 13 20	7 11 01
Fifth Class.			
Quickstep,		6 10 37	6 10 37
Viator,	3 58	7 33 37	7 29 59
	SLOOPs,		
Third Class.			
Thetis,		7 10 26	
Huron,		6 46 47	

corrected.
M. S.
07 20
12 08
28 19
27 45
ed
30 18
03 21
13 04
13 57
38 08
25 24
48 13
49 36
26 02
40 20
16 16
48 32
06 22
28 01
48 08
th, north-
rough the
corrected
Time.
M. S.
6 48 02
7 30 40
7 08 18
7 10 31
6 51 03
5 57 49
7 36 15
7 23 55
7 11 01
6 10 37
7 29 59

		SLOOPERS.		
		Allowance, H. M. S.	Elapsed, H. M. S.	Corrected, H. M. S.
Fourth Class.	Hildegard,		7 32 31	7 32 31
	Wayward,	31	7 28 38	7 28 07
	Mischief,	not measured	7 26 48	
Fifth Class.	Cinderella,		7 32 30	7 32 30
	Clara,	3 39	7 30 05	7 32 20
Sixth Class.	Owene,		6 25 22	6 25 22
	Sayonara,	23	6 40 33	6 40 00
	Mineola,	33	5 56 11	5 55 38
	Nautilus,	1 58	6 20 40	6 18 42
	Milicete,	2 15	not timed	
Seventh Class.	Liris,		7 41 26	7 41 26
	Gossoon,	1 39	6 20 20	6 24 41
	Ventura,	2 51	not timed	

WINNERS:—1st Class Schooners, Constellation.
 3d " " Mayflower.
 4th " " Marguerite, 2d Prize, Ebone.
 5th " " Quickstep.
 3d " Sloops, Huron.
 4th " " Mischief.
 5th " " Clara.
 6th " " Mineola, 2d Prize, Nautilus.
 7th " " Gossoon.

Vineyard Haven to New Bedford, Aug. 11th. (Through Quick's Hole): 21 miles.

The start was in very light air at 11:28 to 11:54 A. M. Off Noyes' Point a fair breeze came from west, southwest and freshened to a good sailing breeze during the run.

		SCHOONERS.		
		Elapsed Time, H. M. S.	Corrected Time, H. M. S.	
First Class.	Constellation,	4 10 23	4 10 23	
	Palmer,	4 27 14	4 25 42	
Third Class.	Volunteer,	4 18 23	4 18 23	
	Merlin,	4 08 17	4 07 38	
Fourth Class.	Iroquois,	4 39 22	4 39 22	
Fifth Class.	*Quickstep,	4 04 00	3 58 04	
Third Class.	SLOOPERS.			
	Gracie,	4 34 35	4 34 35	
	Fourth Class.	Hildegard,	3 56 28	3 56 28
		Mischief,	4 37 28	not measured
	Fifth Class.	Cinderella,	4 45 40	4 45 40
Clara,		5 00 54	5 04 49	
Sixth Class.	Sayonara,	4 32 29	4 32 10	
	Mineola,	no finish		
	Nautilus,	4 55 03	4 53 56	
	Owene,	no finish		
	Milicete,	5 08 46	5 07 29	
Seventh Class.	*Gossoon,	4 33 44	4 27 52	

* Gossoon moved up into 6th Class. Quickstep moved up into 4th Class.

WINNERS:—1st Class Schooners Constellation.
 3d " " Merlin.
 4th and 5th " Quickstep.
 4th " Sloops, Hildegard.
 5th " " Cinderella.
 6th and 7th " Gossoon, 2d Prize, Sayonara.

NEW BEDFORD, August 12th: 27 miles.

A strong breeze at start from south and west. Start was made 10:10 to 10:30 A. M. Off the "Hen and Chickens" it freshened up to a stiff wind from west, southwest and held till finish, with a lumpy and fairly heavy sea.

		SCHOONERS.	
		Elapsed Time, H. M. S.	Corrected Time, H. M. S.
First Class.	Constellation,	4 12 36	4 12 36
	Second Class.		
Second Class.	*Fortuna,	4 23 42	4 18 30
	Third Class.		
Third Class.	Merlin,	4 22 38	4 22 38
Fourth Class.	*Iroquois,	4 29 32	4 24 16
	Fifth Class.		
Fifth Class.	Quickstep,	4 35 00	
Third Class.	SLOOPERS.		
	Gracie,	4 38 11	
	Fourth Class.		
Fourth Class.	Hildegard,	4 56 37	4 56 37
	Mischief,	5 26 11	
Fifth Class.	Cinderella,	4 56 30	4 56 30
	Clara,	4 51 44	4 49 01
Sixth Class.	Sayonara,	4 34 25	4 31 25
	Mineola,	4 50 26	4 50 20
	Nautilus,	4 56 02	4 55 00
	Owene,	4 43 47	

* Moved up one class.

WINNERS:—1st and 2d Class Schooners, Constellation.
 3d and 4th " " Merlin.
 4th " Sloops, Hildegard.
 5th " " Clara.
 6th " " Sayonara, 2d Prize, Owene

NEW LONDON, August 5th, 1891.

LAUNCHES:—Time allowance by Fleet Capt. Peabody's formula. Entries from ELECTRA, COLUMBIA, IROQUOIS, SAPPHIRE, HALCYON and FLEUR-DE-LYS.—COLUMBIA 1st; SAPPHIRE, 2d.

Forty-seventh Annual Regatta took place June 9, 1892.

Regular prizes: In each Class, \$200 Cup for first; \$15 Cup for second. Special Prizes: For yachts in cruising trim—\$150 Cup for first, \$50 Cup for second.

Cups of equal value were offered for keel schooners, sailing as one class.

Strong ebb at start, with light breeze from southward and eastward, which freshened at the Spit and maintained itself out to the Lightship and home again, hauling easterly. Through the day frequent rain and thunder.

Start, 12:25; Handicap, 10:35. Course No. 1, 31 miles; Course No. 2, 25 miles for Classes 6 and 7.

		SCHOONERS.			
		Racing Measurement.	Time Allowance, M. S.	Elapsed Time, H. M. S.	Corrected Time, H. M. S.
Keel.	{ Handless,	111 01		Did not finish.	
	{ Alter, (3d),	91 58	8 54	4 52 52	4 43 58
Third Class.	Fleur de Lys,	not measured.		5 27 28	
	Comanche,	85 74		4 57 20	
Fourth Class.	Regular { Marguerite,	83 48		4 05 32	4 05 32
	{ Shamrock,	73 18	6 56	4 08 37	4 01 41
Fifth Class.	Peerless,	68 03		5 34 19	5 31 19
	Viator,	65 92	1 47	4 57 57	4 56 10

HISTORY OF THE NEW YORK YACHT CLUB.

Fifth Class.	SLOOPS.			
	Measurement.	Allowance.	Elapsed.	Corrected.
		M. S.	H. M. S.	H. M. S.
Sunbeam,	not measured.		did not finish.	
Clara,	55 12		5 40 13	5 46 13
Wasp (6th),	54 97	06	4 07 20	4 07 14
All but 4th Class schooners were in cruising trim.				
WINNERS:—Alert, Comanche, Shamrock, Peerless, Wasp. 2d Prize, Clara.				

THE GOELET CUPS.
(12TH SERIES.)

NEWPORT, August 5th.

Offered by Capt. Ogden Goelet, NEW YORK YACHT CLUB, for schooners and sloops, cutters and yawls of the NEW YORK YACHT CLUB that had not hauled out to clean since the commencement of the cruise, and sailed for under the racing rules of the club, and with its time allowances. Capt. Goelet reserved the privilege of inviting foreign yachts in American waters to enter.

For Schooners, \$1,000 Cup.
For Sloops, Cutters, and Yawls, \$500 Cup.
Course, No. 4.—38 miles.

Weather clear. Wind south southwest, light at start, freshening somewhat off Point Judith, and stiffening at Block Island to a good, whole sail breeze until half way to West Island mark, when it fell light again, but again freshened after mark was rounded, and continued so to finish.

Start, Sloops, 2.20 P. M.

" Schooners, 2.25 "

5 minutes to cross in each class.

Block Island.	SCHOONERS			
	Racing Measurement.	Time Allowance.	Elapsed Time.	Corrected Time.
		M. S.	H. M. S.	H. M. S.
5 07 19	Constellation	107 24	6 26 55	6 26 55
5 08 57	Aleeva		6 33 48	
5 10 40	Merlin	93 35	7 51	6 15 07
5 09 27	Lusca	93 17	7 58	6 22 24
	no Alert	91 58	9 00	
5 09 31	Mayflower	89 83	10 11	6 27 42
5 21 09	Atlantic	86 31	12 36	6 40 06
5 11 17	Marguerite*	83 48	14 39	6 31 17
5 14 21	Iroquois	82 24	15 38	6 34 16
5 28 18	Quickstep	70 11	26 04	6 51 01
SLOOPS.				
5 06 21	Gracie	74 03	6 17 18	6 17 18
5 10 18	Wasp	54 97	21 11	6 12 24
5 02 15	Harpoon	54 54	21 20	6 08 35
5 04 02	Gloriana	54 17	22 19	6 14 07

WINNERS:—Schooners, Merlin. Sloops, Harpoon.

*Marguerite—Aleeva. The Marguerite's protest has been allowed.

THE MORGAN CUPS.
(August 8th.)

Offered by Capt. J. Pierpont Morgan, NEW YORK YACHT CLUB, for the run from Vineyard Harbor to Marblehead, and open to yachts making the cruise with the NEW YORK YACHT CLUB.

A \$1,000 Cup for the First Schooner.

A \$500 " " Sloop, Cutter or Yawl.

Course: from East Chop Buoy to Marblehead Light, leaving the Shovelful Lightship on the starboard and the Pollock Rip Lightship on the port hand.—103 miles.

Weather clear, and a fair tide at start. Wind true from southwest through the day. It was light at start and continued light over the Shoals. Off Chatham it stiffened, and between the Nauset and Highland Lights it strengthened up to strong, with heavy puffs. There was some sea going across the Bay, with the wind lightening toward the finish.

Start, Schooners, Class 5. } 5:35 A. M.
" Sloops, " 5, 6 and 7. }

All others, 5:45 A. M.

SCHOONERS.			
Racing Measurement.	Time Allowance.	Elapsed Time.	Corrected Time.
	M. S.	H. M. S.	H. M. S.
Dauntless,	111 04		10 26 15
Constellation,	107 24	5 10	9 56 31
Ramona,	105 84	7 07	10 46 42
Fortuna,	94 57	24 25	10 58 58
Aleeva,			10 50 14
Merlin,	93 35	26 26	10 35 30
Alert,	91 58	29 31	11 06 00
Mayflower,	89 83	32 46	11 02 03
Fleur de Lys,			
Phantom,	86 52	38 57	11 33 33
Speranza,			12 00 07
Atlantic,	86 31	39 20	11 13 41
Miranda,	85 90	40 06	11 11 44
Marguerite,	83 48	44 51	10 59 05
Iroquois,	82 24	47 32	10 53 06
Genoa,	80 37	51 20	11 41 02
Quickstep,	79 11	55 48	11 46 42
Peerless,	68 03	81 27	12 27 33
Azalea,	63 36	94 48	12 26 23

SLOOPS.

Katrina,	76 08		11 26 50
Wayward,	65 58	27 18	12 06 49
Clara,	55 12	62 04	12 57 33
Wasp,	54 97	62 27	12 20 16
Harpoon,	54 85	63 50	12 29 54
Gloriana,	54 17	65 30	11 21 28
Mariquita,	48 09	91 20	13 41 43

WINNERS:—Schooner Cup, Constellation; Sloop Cup, Wasp.

Between the Nauset and Highland Lights MAYFLOWER and MIRANDA carried away their foretopmasts, and KATRINA carried away her topmast.

COMMODORE GERRY'S CUP.

MARBLEHEAD, August 10th.

Offered by Commodore Gerry, and open to yachts of the EASTERN and NEW YORK YACHT CLUBS that had not hauled out to clean since the commencement of the cruise.

A Cup for Schooners.

A Cup for Sloops, Cutters and Yawls.

Course: an equilateral triangle, 12 miles to a leg, from "Half-way" Rock to Harding's Bell Buoy, to outer mark and return.

Weather clear and no sea. Tide at start, half ebb. Wind very light from south, southwest at start and nearly down to "Harding's." When nearing "Harding's" it flattened out and then came up from the south. From "Harding's" on, it stiffened up to a moderate sailing breeze, finally settling from south, southwest and holding to the finish.

Start, Sloops, 10:55 A. M.

" Schooners, 11:00 "

5 minutes to cross in each class.

SCHOONERS.			
Racing Measurement.	Time Allowance.	Elapsed Time.	Corrected Time.
	M. S.	H. M. S.	H. M. S.
Constellation	107 24		4 53 54
Aleeva			5 11 28
Merlin	93 35	7 20	5 01 27
Mayflower	89 83	9 39	5 01 37
Marguerite	83 48	13 52	5 03 53
Iroquois	82 24	14 48	5 10 31
SLOOPS.			
Barbara			5 21 21
Wasp	54 97	0 08	5 30 29
Harpoon	54 85	1 04	5 38 34
Gloriana	54 17		5 37 30

WINNERS:—Schooners, Marguerite. Sloops, Wasp.

er ected.
Time.
M. S.

26 15
51 21
39 35
32 13

09 04
36 26
29 17

54 36

34 21
31 38
14 14
05 34
49 42
30 54
06 06
51 35

26 50
39 31
55 20
17 49
27 04
25 58
10 23

VER and
carried

of the
ated out

“ Half-
n.
ind very
rding's.”
up from
moderate
olding to

er ected
me.

M. S.
53 54

54 01
51 58
50 01
55 45

21 24
30 21
37 30

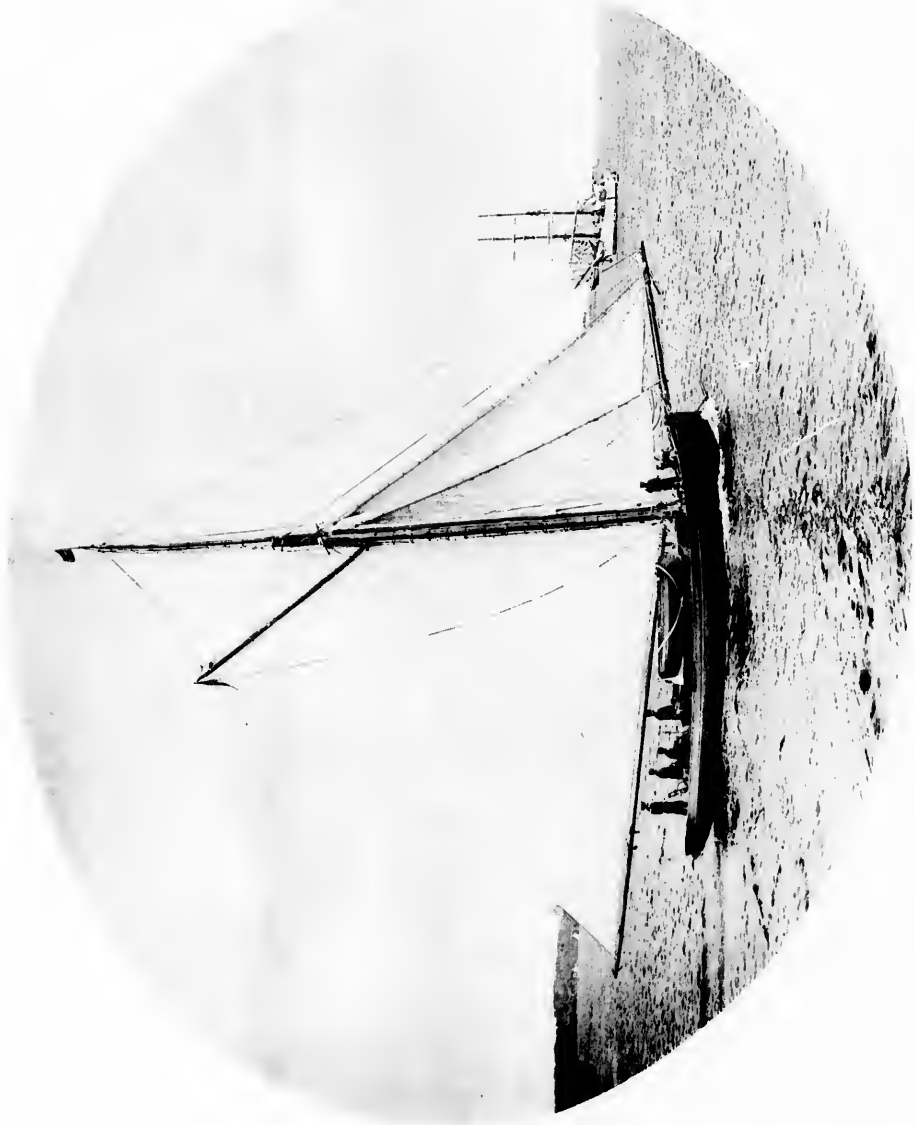

ESPIRITO.

PLATE XIII

To the
of the
follows

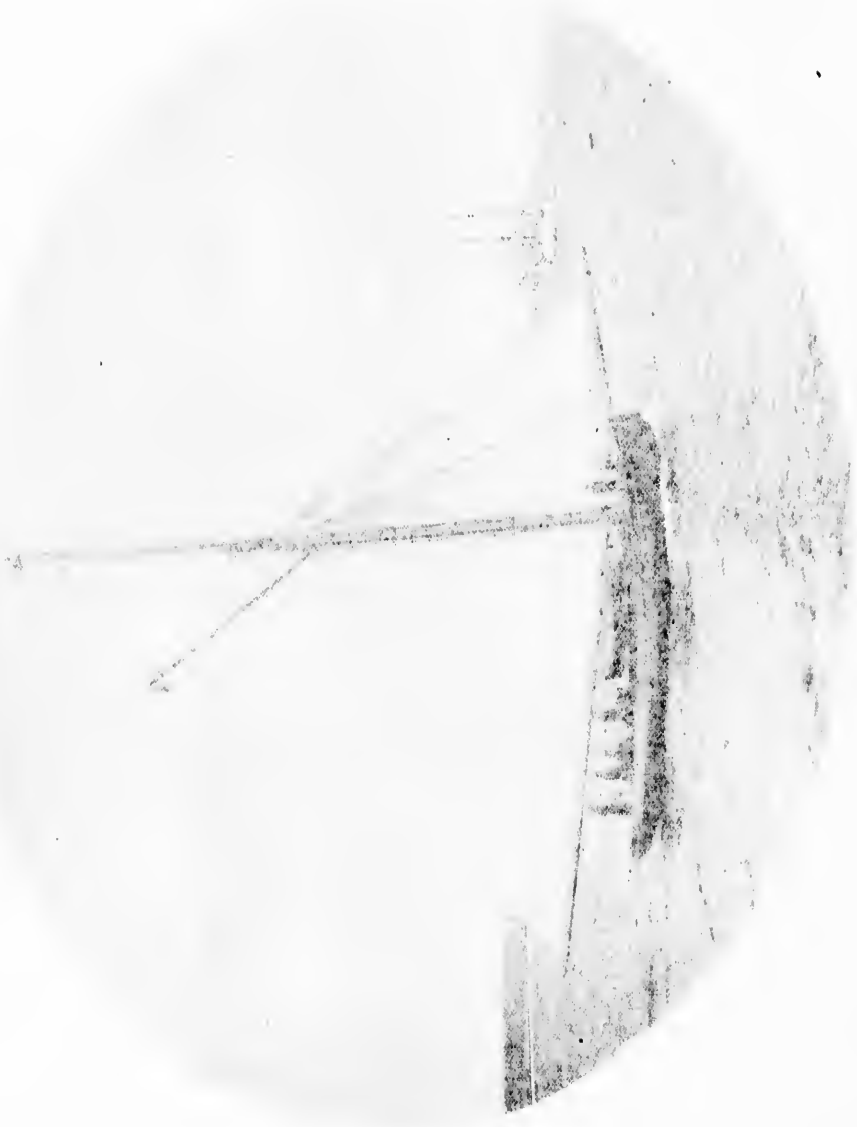

A
V
N
M
L

Hi
Ech
The
date th
was cl
was giv
summa

Dauntles

ARIEL w
cup.
On Augu
The wind w
The summa

THE YACHTS AND YACHTSMEN OF AMERICA.

When nearing Harding's, *GLORIANA* carried away her club, soon after leaving Harding's, *BARBARA* drew out her stem hobstap bolt.

The Forty-eighth Annual Regatta of the **NEW YORK YACHT CLUB** was sailed June 15, 1893, in a fair breeze and good weather. The course was from Buoy No. 11, south and west of Buoy No. 12, to Buoy No. 10, to Scotland Lightship and return.

The start was effected after an impatient waiting for *EOLUS*, at 12:05. The full times were as follows—the winners being *YAMPA*, *LASCA*, *SHAMROCK*, *VIATOR*, *HILDEGARD*.

FIRST CLASS—SCHOONERS.			
Yacht.	Owners.	Elapsed time.	Corrected time.
		H. M. S.	H. M. S.
Brumhilde	D. H. King, Jr.	not timed	
Coronet	John D. Wing	5 12 43	5 12 43
Dauntless	Calcl H. Colt	4 50 00	4 48 31
Ramona	Henry F. Gillig	4 41 11	4 41 01
Yampa	C. W. Chapin	4 26 09	

THIRD CLASS—SCHOONERS—RACING TRIM.			
Yacht.	Owners.	Elapsed time.	Corrected time.
		H. M. S.	H. M. S.
Emerald	J. R. Maxwell	4 15 26	4 12 48
Lasca	John E. Brooks	4 05 36	4 05 36

FOURTH CLASS—SCHOONERS—CRUISING TRIM.			
Yacht.	Owners.	Elapsed time.	Corrected time.
		H. M. S.	H. M. S.
Clytie	Henry C. Ward	did not finish.	
Shamrock	Willard P. Ward	4 59 18	4 54 54

FIFTH CLASS—SCHOONERS—CRUISING TRIM.			
Yacht.	Owners.	Elapsed time.	Corrected time.
		H. M. S.	H. M. S.
Azalea	J. Clinch Smith	did not finish.	
Viator	W. G. Brokaw	5 08 13	5 08 13
Neera	Warren R. Fales	5 33 47	5 27 35
Monhegan	A. T. Johnson	did not finish.	
Loyal	H. F. Sutton	5 41 06	

THIRD CLASS SLOOP—RACING TRIM.			
Yacht.	Owners.	Elapsed time.	Corrected time.
		H. M. S.	H. M. S.
Hildegard	J. C. Bergen	4 51 34	4 51 34
Eclipse	L. J. Callahan	5 57 57	5 47 46

The Annual Cruise began at Glen Cove, L. I., Aug. 7th, on which date the contest for the Commodore's Cups took place. The weather was clear and warm, with a stiff northwest wind. The starting signal was given at 12:25 P. M., the course being a 26 mile triangle. The summary is as follows:

SCHOONERS.		
Yacht.	Elapsed H. M. S.	Corrected H. M. S.
Ariel	2 16 45	not measured
Constellation	2 10 05	not measured
Lasca	2 16 33	2 07 32
Aleca	2 15 56	2 08 33
Daguar	2 28 23	not measured
Emerald	2 25 07	2 11 21
Ramona	2 16 18	2 11 54
Marguerite	2 28 43	2 13 16
Coronet	2 23 22	2 16 09
Dauntless, Mayflower and Loyal		2 23 22

CUTTERS AND SLOOPS.		
Yacht.	Elapsed H. M. S.	Corrected H. M. S.
Colonia	2 06 39	
Queen Mab	2 38 02	2 00 00
Hildegard	2 50 49	
Vigilant		

ARIEL won amongst the schooners, while *COLONIA* won the sloop cup.

On August 8th the run from Glen Cove to Morris Cove was sailed. The wind was very light, and the start was not made until 12:10. The summary follows:

SCHOONERS.		
Class.	Elapsed Time.	Corrected Time.
	H. M. S.	H. M. S.
First Class.		
Coronet	not timed	
Dauntless	11 06 34	11 01 18
Constellation	9 33 03	9 29 26
Yampa	not timed	
Ramona	not timed	
Palmer	not timed	
Fleetwing	not timed	
Brumhilde	not timed	
Second Class.		
Fortuna	not timed	
Third Class.		
Lasca	7 24 58	7 24 58
Aleca	7 15 07	not meas.
Mayflower	11 11 05	11 09 11
Emerald	10 41 40	10 41 31
Atlantic	11 10 37	11 00 07
Fourth Class.		
Marguerite	11 00 50	11 00 50
Ariel	8 33 02	not meas.
Daguar	10 41 04	10 34 42
Shamrock	11 07 17	10 59 01
Fifth Class.		
Viator	not timed	
Loyal	11 21 08	
Givulia	10 39 26	
Neera	9 35 51	10 25 03
		9 28 27
Third Class.		
Katrina	10 48 07	10 48 07
Gracie	10 59 45	10 57 57
Belouin	11 17 10	11 14 41
Huron	10 17 27	10 10 29
Fourth Class.		
Hildegard	10 47 15	10 47 15
Queen Mab	11 14 50	11 10 26
Ventura	not timed	
Fifth Class.		
Eclipse	11 33 57	
Clara	not timed	
Sixth Class.		
Wasp	10 36 47	10 36 47
Jessica	11 28 54	11 21 52
Mariquita	11 26 20	11 15 58
Uvira	11 14 45	11 02 41
Seventh Class.		
Crocodile	not timed	
Nymph	not timed	
Rosalind	not timed	

SCHOONERS.		
Class.	Elapsed H. M. S.	Corrected H. M. S.
First Class.		
Coronet	8 07 23	8 07 23
Dauntless	7 05 45	7 03 56
Constellation	5 59 48	5 50 05
Yampa	7 32 26	7 28 22
Fleetwing	8 12 13	8 05 01
Second Class.		
Fortuna	6 51 12	6 40 23

The run to New London was sailed August 9th. There was a light southwest wind. The first start was at 9:50 A. M., but the light wind and calms prevented any interesting finishes. The following is the summary of the day's records:

HISTORY OF THE NEW YORK YACHT CLUB.

SCHOONERS.			SLOOPS.		
	Elapsed Time. H. M. S.	Corrected Time. H. M. S.		Elapsed Time. H. M. S.	Corrected Time. H. M. S.
Third Class.			Third Class.		
Lasca	6 11 40	6 11 40	Katrina	5 35 09	5 35 09
Aleca	7 38 21	not meas.	Gracie	6 14 03	6 12 06
Mayflower	7 26 34	7 24 37	Bolouin	6 01 54	5 59 06
Emerald	6 58 28	6 55 14	Huron	5 46 08	5 38 36
Atlantic	7 11 28	7 03 50	Fourth Class.		
Fourth Class.			Wayward	6 24 21	6 24 21
Marguerite	6 59 22	6 59 22	Hildegard	6 00 49	6 00 35
Ariel	6 49 51	not meas.	Queen Mab	6 04 30	5 59 31
Shamrock	7 37 45	7 29 15	Fifth Class.		
Dagmar	6 57 52	6 51 19	Eclipse	6 41 56	6 41 56
Fifth Class.			Clara	6 41 44	6 44 35
Gevalia	7 46 47	7 46 47	Sixth Class.		
Neuera	7 25 40	7 22 32	Wasp	3 25 19	5 35 19
SLOOPS.			Jessie	6 28 02	6 20 29
Third Class.			Cornelia	6 24 21	
Katrina	7 35 37	7 35 37	Uvira	6 15 06	6 02 03
Gracie	9 01 53	9 00 02	Seventh Class.		
Bolouin	7 57 05	7 54 20	Mariguita	6 21 28	6 21 28
Huron	7 50 37	7 43 28	Bonnie Kate		
Fourth Class.			Rosalind		
Queen Mab	8 37 48	8 37 48	Nymph	6 38 50	
Ventura		not timed	WINNERS:—Constellation, Ramona, (2d); Fortuna, Lasca, Mayflower, (2d); Ariel, Emerald (2d); Neuera, Katrina, Huron (2d); Queen Mab, Eclipse, Wasp, Uvira (2d); Mariguita, Nymph (2d). As Vigilant and Jubilee were not measured it is not known which won.		
Fifth Class.			The race for the Goelet Cup was held August 11th. The day was cloudy, the wind light. A start was made at 11:35 A. M. VOLUNTEER won her fifth Goelet Cup, and COLONIA won the sloop trophy.		
Clara	9 19 20	9 11 14	SCHOONERS.		
Sixth Class.			Elapsed.	Corrected	
Wasp	6 54 46	6 54 46	H. M. S.	H. M. S.	
Mariguita	8 59 32	8 48 57	Volunteer	17 31 50	17 25 10
Seventh Class.			Lasca	17 37 51	17 29 23
Zigara		not timed	Aleca	18 55 45	not meas.
Bonnie Kate		not timed	CUTTERS.		
The winners are:—Constellation, Fortuna, (2d), Lasca, Emerald (2d), Ariel, Dagmar (2d), Neuera, Katrina, Huron (2d), Queen Mab, Wasp.			Colonia	13 49 49	not meas.
August 10th, the run to Newport was sailed. The day was fair and bright, and there was a light breeze. The first division of yachts started at 10:10 A. M.			Vigilant	14 00 31	not meas.
SCHOONERS.			Jubilee	14 41 40	not meas.
Elapsed.	Corrected.		Pilgrim		withdrew
H. M. S.	H. M. S.		On Aug. 14th, the fleet sailed for Vineyard Haven. VIGILANT, CONSTELLATION, LASCA, SHAMROCK, KATRINA, QUEEN MAB, and HARPUN were winners. The summary is given below:		
First Class.			SCHOONERS.		
Dauntless	5 47 27	5 47 27	Elapsed.	Corrected.	
Constellation	5 22 54	5 20 51	H. M. S.	H. M. S.	
Yampa	5 04 41	5 52 18	Dauntless	6 24 55	6 24 55
Ramona	5 40 31	5 37 45	Constellation	5 45 50	5 43 59
Fleetwing	6 18 50	6 13 09	Yampa	6 35 58	6 33 46
Fortuna	5 51 12	5 51 12	Ramona	5 54 20	5 51 46
Montauk	6 15 08		Palmer		did not finish
Second Class.			Second Class.		
Volunteer	5 45 34		Volunteer	6 04 58	6 04 58
Lasca	5 13 11	5 11 48	Aleca	5 53 37	5 53 06
Aleca	6 10 23		Lasca	5 53 53	5 52 36
Mayflower	5 20 03	5 25 37	Mayflower	6 20 02	6 16 52
Emerald	5 47 40	5 43 09	Miranda		did not finish
Atlantic	6 06 40	5 54 25	Third Class.		
Marguerite	5 56 09	5 56 09	Ariel	6 15 29	6 15 29
Ariel	5 24 15	5 21 18	Shamrock	6 23 11	6 14 55
Dagmar	6 02 25	5 55 35	SLOOPS.		
Shamrock	6 06 18	5 52 22	First Class.		
Fifth Class.			Vigilant	5 30 52	not meas.
Gevalia	6 33 56	6 33 56	Jubilee	5 41 34	not meas.
Loyal	6 32 58		Colonia	5 41 45	not meas.
Neuera	6 25 54	6 22 30			
SLOOPS.					
First Class.					
Jubilee	5 02 52	not measured			
Vigilant	5 01 41	not measured			

THE YACHTS AND YACHTSMEN OF AMERICA.

205

SLOOP.		
	Elapsed Time.	Corrected Time.
	H. M. S.	H. M. S.
Third Class.		
Katrina	5 58 51	5 58 51
Belouin	6 31 07	6 31 32
Huron	6 22 43	6 15 45
Fourth Class.		
Wayward	6 26 58	6 21 58
Hildegard	6 31 27	6 31 14
Queen Mab	6 25 29	6 20 51
Fifth Class.		
Wasp	6 22 34	6 22 34
Harpoon	6 18 20	5 18 12
Jessica	6 09 45	6 32 46
Carmita	did not finish	

YACHTS RACING ALONE IN THEIR CLASS.

Eighth Class.		
	Elapsed Time.	Corrected Time.
	H. M. S.	H. M. S.
Eclipse, sloop	6 56 31	6 56 31
Neuera, schooner	6 35 22	6 28 25

August 15th. From Vineyard Haven to New Bedford. Moderate westerly wind, and weather clear and bright. Signal for smaller classes to start given at 10:20 A. M. The winners were CONSTELLATION, VOLUNTEER, ARIEL, HURON, QUEEN MAB, WASP and VIGILANT. The times were:

SCHOONERS.		
	Elapsed Time.	Corrected Time.
	H. M. S.	H. M. S.
First Class.		
Constellation	4 03 14	4 02 21
Ramona	4 31 25	4 32 58
Yampa	4 36 19	4 35 01
Dauntless	5 12 06	5 12 06
Third Class.		
Volunteer	4 01 56	4 01 56
Alcea	4 14 11	4 13 50
Lasca	4 16 27	4 15 44
Mayflower	4 37 00	4 35 12
Atlantic	5 11 44	5 08 27
Fourth Class.		
Ariel	4 09 33	4 06 38
Shamrock	4 36 04	4 31 23
Third Class.		
Huron	4 31 23	4 30 26
Katrina	4 39 27	4 39 27
Fourth Class.		
Queen Mab	4 18 05	4 15 31
Wayward	4 38 42	4 28 42
Sixth Class.		
Wasp	4 06 41	4 06 41
Harpoon	4 11 10	4 11 11
Jessica	4 52 29	4 48 31
Eighth Class.		
Vigilant	3 14 36	not measured
Eclipse		
Neuera	4 40 01	4 25 32
Mariquita	4 56 00	4 35 25
Fortuna	4 44 02	4 44 02

The run from New Bedford to Newport was sailed August 16th. As the starting time grew near, the breeze freshened, and the gun fired at 10:50 A. M. The winning yachts were RAMONA, ALCEA, SHAMROCK, HURON, QUEEN MAB and JESSICA. The times were as follows:

SCHOONERS.		
	Elapsed Time.	Corrected Time.
	H. M. S.	H. M. S.
First Class.		
Dauntless	3 43 52	3 43 52
Constellation	3 40 48	3 39 27
Yampa	3 42 57	3 41 21
Ramona	3 41 00	3 39 17
Third Class.		
Alcea	3 37 52	3 37 52
Lasca	3 43 07	3 42 38
Mayflower	3 42 38	3 40 46
Atlantic	3 43 37	3 39 50
Fourth Class.		
Ariel	3 44 06	3 44 06
Marguerite	3 42 37	3 42 37
Shamrock	3 49 01	3 34 02

SLOOP.

Third Class.		
	Elapsed Time.	Corrected Time.
	H. M. S.	H. M. S.
Katrina	3 42 52	3 42 52
Huron	3 43 02	3 37 57
Fourth Class.		
Wayward	3 46 20	3 46 20
Queen Mab	3 46 38	3 43 16
Fifth Class.		
Fredonia	3 47 25	not timed
Sixth Class.		
Wasp	3 47 24	3 47 28
Harpoon	3 44 02	3 43 56
Jessica	3 46 29	3 41 19

The first race for the Astor Cup (valued at \$1,200) took place August 17th, off Newport. The wind was good, and the start was at 11:35 A. M. PILGRIM was disabled during the home stretch, VIGILANT winning.

Elapsed.	
	H. M. S.
Vigilant	4 02 52
Jubilee	4 08 13
Colonia	4 08 21
Pilgrim	did not finish

Vigilant beat Jubilee 7 min., 21 sec., and Colonia 7 min., 29 sec.

August 18th the second Astor Cup Race was sailed. PILGRIM being unable to compete. The start was at 12:10 P. M. The wind was fluky and discouraging. At 5:45 P. M. the contest was abandoned on account of the lack of wind.

August 19th. The attempted race of the day previous was resailed, the start being at 12:20 P. M. The wind was again unsatisfactory, but a finish was made as follows, VIGILANT winning:

Elapsed.	
	H. M. S.
Vigilant	6 10 00
Jubilee	6 17 41
Colonia	6 26 19

For the record of the Trial Races see pages 73 and 74, and for the record of Races for AMERICA'S CUP, see pages 74 and 75.

AUTUMN SWEEPSTAKES.

N. Y. Y. C.

NEW YORK, September 15th.

Opened June 1st, to Class 3 of schooners belonging to the club, and closed according to notice, August 5th, with the following entries: ALCEA, ALERT, INDIANS, LASCA, and MARGUERITE. MARGUERITE and INDIANS (4th class) entered with the permission of the others.

Entries.—\$200 each half forfeit; the winners to take the stakes if

only two started; if three or more started, the second to save her entrance money.

The club added a \$500 cup for the winner, if two or more started, and a \$150 cup if three or more started.

Course.—Triangular, 10 miles to a leg, outside of Sandy Hook.

Time Limit.—7 hours for first attempt, but without *time limit* if race failed on first day.

The race was sailed September 15th, in fine weather, with a light breeze at start from west northwest, which remained true, stiffening somewhat towards the close and with no sea. The first leg was down the wind, the second was a reach and the third was on end.

ALCANA and ALERT paid forfeit.

Start 11:35, with 5 minutes to cross.

SCHOONERS.

	Racing Measurement.	Time Allowance.	Elapsed Time.	Corrected Time.
		M. S.	H. M. S.	H. M. S.
Lasca,	68 17		3 50 50	3 50 50
Marguerite,	81 48	5 10	3 52 07	3 46 51
Iroquois,	82 24	6 03	3 58 23	3 52 20

MARGUERITE won the \$500 cup and \$900 in stakes. LASCA won the \$150 cup and saved her entrance money.

SQUADRON RUNS.

In Cruising Trim,—Anchors on the bow and at least one cable bent; cruising complement of boats carried; cruising deck, cabin and galley fittings and fixtures in place; topsails extending above the truck or beyond the end of the gaff, barred.

MORRIS COVE to NEW LONDON, August 3d: 39 miles.

Weather clear with no sea. There was a light puff from the northward at the start, and then with alternate calm and baffling airs the fleet moved down to Thimble Islands and beyond. Between Sachem's Head and Faulkner's Island a breeze came up from southward which finally settled from southward and stiffened up to a good sailing breeze.

Start, Schooners, Class 5, 11:30,
" Sloop, etc., " 5, 6, and 7, 1

All others 10:40.

SCHOONERS.

	Racing Measurement.	Time Allowance.	Elapsed Time.	Corrected Time.
		M. S.	H. M. S.	H. M. S.
First Class.				
Dauntless,	111 01		8 00 08	8 00 08
Constellation,	107 24	1 57	8 03 28	8 01 31
Ramona,	105 84	2 42	8 10 07	8 13 52
Coronet,				
Fortuna, (2d)	94 57	9 15	8 45 01	8 35 46
Third Class.				
Alena,			8 31 33	
Merlin,	93 35		7 58 56	7 58 56
Lasca,	93 17	0 08	7 01 30	7 01 22
Alert,	91 58	1 11	8 45 11	8 34 00
Phantom,	86 52	4 44	8 00 55	7 50 11
Atlantic,	86 31	4 53	7 58 14	7 53 21
Comanche,	85 71	5 19	8 52 56	8 47 37
Fourth Class.				
Marguerite,	83 48		7 11 53	7 11 53
Iroquois,	82 24	1 01	7 42 07	7 41 06
Chene,	80 37	2 27	8 45 36	8 43 09
Shamrock,	73 18	8 43	7 41 24	7 32 41
Fifth Class.				
Quickstep,	70 11		8 15 40	8 15 40
Gevalia,	61 91	8 58	8 22 41	8 13 46
Azalea,	63 36	7 11	9 01 18	8 54 07

SLOOPS.

	Measurement.	Allowance.	Elapsed Time.	Corrected Time.
			H. M. S.	H. M. S.
Third Class.				
Katrina,	76 08		8 25 43	8 25 41
Gracie,	74 03	1 51	8 41 08	8 42 14
Fanny,			7 04 30	
Fourth Class.				
Ventura,	60 22			
Clara,	55 12	6 50	9 08 23	9 01 33
Athlon,	59 08	1 28	9 08 45	9 07 17
Sixth Class.				
Wasp,	54 07		7 07 27	7 07 27
Suyomara,	54 24	1 00	7 13 25	7 12 16
Gloriana,	54 17	1 09	7 37 33	7 36 24
Liris, (7th)	48 84	9 43	9 02 00	8 53 17

WINNERS:—1st Class Schooners, Dauntless, 2d Prize, Constellation.

3d " " Lasca, 2d Prize, Atlantic.

4th " " Marguerite, 2d Prize, Shamrock.

5th " " Gevalia.

5th " Sloop, Clara.

6th " " Wasp, 2d Prize, Suyomara.

NEW LONDON to NEWPORT, August 4th: 40 miles. Through the race, leaving Race Rock on the port hand.

Weather clear and no sea. Light airs from southward at start, stiffening from southward and eastward off Race Rock and growing from Witch Hill on, up to a good whole sail breeze from south and west.

Start Schooners, Class 5, 11:35,
" Sloop, etc., " 5, 6 and 7, 1

All others 11:35.

SCHOONERS.

	Racing Measurement.	Time Allowance.	Elapsed Time.	Corrected Time.
		M. S.	H. M. S.	H. M. S.
First Class.				
Dauntless,	111 01		5 47 38	5 47 38
Constellation,	107 24	2 00	5 10 05	5 08 05
Ramona,	105 84	2 46	6 23 00	6 20 14
Montauk, (2d Cl.)			5 39 21	
Third Class.				
Alena,			5 17 55	
Merlin,	93 35		5 10 21	5 10 21
Lasca,	93 17	0 08	5 01 16	5 01 08
Alert,	91 58	1 13	5 51 14	5 53 01
Mayflower,	89 83	2 28	5 16 26	5 13 58
Flour de Lys,			6 51 31	
Phantom,	86 52	4 52	6 10 12	6 11 20
Speranza,			6 48 07	
Atlantic,	86 31	5 04	5 15 42	5 10 38
Comanche,	85 71	5 27	6 07 44	6 02 17
Fourth Class.				
Marguerite,	83 48		5 20 35	5 20 35
Iroquois,	82 24	1 02	5 21 19	5 20 17
Shamrock,	73 18	8 56	5 38 10	5 29 23
Fifth Class.				
Quickstep,	70 11		5 19 53	5 19 53
Peerless,	68 03	2 12	6 13 47	6 11 35
Gevalia,	61 91	0 12	5 55 07	5 45 55
Azalea,	63 36	7 22	6 33 07	6 25 45

SLOOPS.

	Racing Measurement.	Time Allowance.	Elapsed Time.	Corrected Time.
		M. S.	H. M. S.	H. M. S.
Third Class.				
Katrina,	76 08		5 33 25	5 33 25
Gracie,	74 03	1 57	5 42 20	5 40 20
Fanny,			5 43 30	
Huron,	68 44	7 32	5 33 53	5 26 21

Observed. Corrected.
H. M. S. H. M. S.

8 25 43 8 25 41
8 44 08 8 42 14
8 44 30

8 24 9 01 33
8 45 9 07 17

7 27 7 07 27
4 25 7 12 10
7 03 7 30 24
2 00 8 53 17

Constellation,
Polaris,
Starrock.

Summary.
Notes. Through the

Southward at start,
Rock and growing
size from south and

(7) 11:25

Observed. Corrected
Time.
H. M. S.

5 47 38
5 08 05
6 20 14

5 10 21
5 01 08
5 53 01
5 13 58

6 11 20

5 10 38
6 02 17

5 20 35
5 20 17
5 29 21

5 10 53
6 11 35
5 45 55
6 25 45

Corrected
Time.
H. M. S.

5 33 25
5 40 29

5 26 21

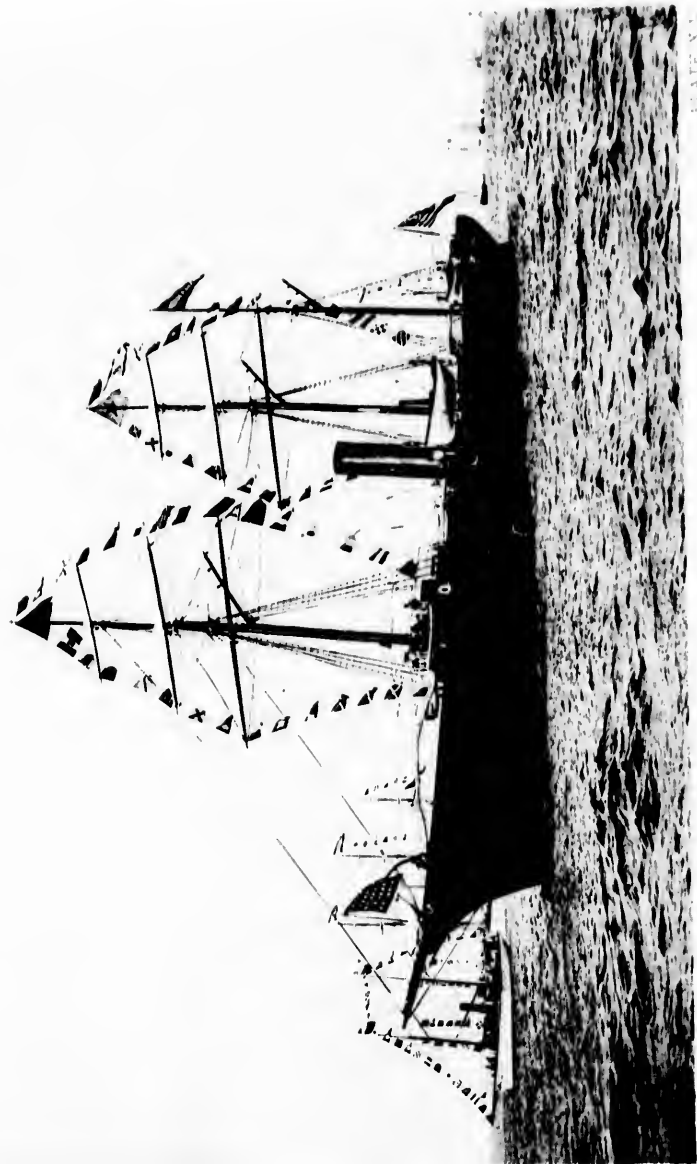

PLATE X.

FROM A NEGATIVE BY BULL.

NOURMAHAL

dep.
on
noon

Rock, leaving
ek Rip Lightship

due from southwest
continued light over
ren the Nauset and
gg, with heavy puffs,
n the wind lightening

8.

15.

Speed Time.	Corrected Time.
----------------	--------------------

M. S.	U. M. S.
06 31	0 56 31
0 38	10 37 23

0 11	
30	10 35 50
03	10 55 43
33	11 21 42
11	11 00 47

7	10 50 05
1	10 50 25
	11 31 31

	11 06 12
	12 21 51
	12 07 21

	11 26 50
	11 30 31

	12 20 16
	12 20 31
	12 28 25
	3 12 51

	0 26 15
	39 43
	36 26
	11 38

MAY-
away



THE YACHTS AND YACHTSMEN OF AMERICA.

207

Fourth Class.	SLOOPS.		Elapsed Time.	Corrected Time.
	Racing Measurement.	Time Allowance.		
Ventura*	60 22	M. S.	5 03 12	5 03 12
Clara (5)	55 13	7 00	5 54 09	5 47 09
Athlon	50 08	1 20	6 28 25	6 26 50
Sixth Class.				
Wasp	51 97		5 21 16	5 21 16
Sayonara	54 24	1 11	5 41 30	5 40 19
Minola	54 20	1 11	5 27 31	5 26 20
Gloriana	51 17	1 11	5 22 19	5 21 08
Uvira	47 14	13 03	5 53 16	5 40 13
Seventh Class.				
Liris	48 83		5 58 45	5 58 45
Mariquita	48 00	1 14	5 19 09	5 17 55
Minerva	45 61	5 55	6 17 03	6 11 08
Verona			6 17 18	

* Crossed with wrong division.

WINNERS:—Schooners,		1st Class, Constellation.	
3d	"	Lasca, 2d Prize, Merlin.	
4th	"	Troquois.	
5th	"	Quickstep, 2d Prize, Gevalia.	
Sloops,		3d	" Huron, Katrina.
		4th	" Clara.
		6th	" Gloriana, 2d Prize, Wasp.
		7th	" Liris, 2d Prize, Minerva.

NEWPORT TO VINEYARD HAVEN, August 6th: 37 miles.

Weather clear. Wind true from southwest, fresh down to Gay Head and strong from there on to finish.

Start, Schooners, Class 5, 11:30
" Sloops, etc., " 5, 6 and 7, " 11:30

All others 11:40

First Class.	SCHOONERS.		Elapsed Time.	Corrected Time.
	Racing Measurements.	Time Allowance.		
Dauntless	111 04	M. S.	3 19 40	3 19 40
Constellation	107 24	1 51	3 11 13	3 12 22
Ramona	105 84	2 31	3 24 43	3 22 09
Fortuna (2d)	94 57	8 40	3 27 19	3 18 33
Third Class.				
Alcaza			3 26 22	
Merlin	93 35		3 25 37	3 25 37
Lasca	93 17	0 07	3 20 40	3 20 33
Alert	91 58	1 07	3 30 08	3 29 01
Phantom	86 52	4 33	3 38 53	3 31 23
Atlantic	86 31	4 38	3 31 32	3 29 51
Comanche	85 74	5 03	3 37 57	3 32 51
Fourth Class.				
Marguerite	83 48		3 29 48	3 29 48
Troquois	82 24	0 58	3 31 55	3 33 37
Enone	80 37	2 19	3 38 57	3 36 38
Fifth Class.				
Quickstep	70 11		3 46 13	3 46 13
Peerless	68 03	2 02	4 01 52	3 59 50
Gevalia	61 91	8 30	4 00 37	3 52 06
Azalea	63 36	6 49	3 53 15	3 45 26
Third Class.				
SLOOPS.				
Katrim	76 08		3 39 55	3 39 55
Gracie	74 03	1 48	3 55 37	3 53 49
Huron	68 44	6 58	3 50 28	3 43 30
Fourth Class.				
Wayward	65 58		3 50 57	3 50 57
Ventura	60 22	6 01	4 15 21	4 09 20
Athlon	59 08	7 21	4 01 35	3 57 12
Clara (6th)	55 12	12 30	4 11 53	3 59 23
Sixth Class.				
Wasp	51 97		4 15 43	4 14 37
Sayonara	50 24	1 00	4 06 16	4 06 16
Harpoon	54 85	0 08	4 05 58	4 01 50
Gloriana	54 17	1 06	4 26 12	4 11 08
Uvira	47 14	12 04		
Seventh Class.				
Mariquita	48 00		Did not finish.	
Verona			4 29 13	

WINNERS:—1st Class Schooners, Constellation, 2d Prize, Fortuna.			
3d	"	Lasca,	Merlin.
4th	"	Marguerite,	
5th	"	Azalea,	Quickstep.
3d	"	Sloops, Katrina,	
4th	"	Wayward,	Athlon.
6th	"	Gloriana,	Harpoon.

VINEYARD HAVEN TO MARBLEHEAD, August 8th.

Course.—From East Chop Buoy to Marblehead Rock, leaving the Shoeful Lightship on the port, and the Pollock Rip Lightship on the starboard hand: 163 miles.

Weather clear and a fair tide at start. Wind true from southwest through the day. It was very light at start and continued light over the shoals. Off Chatham it stiffened, and between the Nauset and Highland Lights it strengthened up to strong, with heavy puffs. There was one sea going across the bay, with the wind lightening toward the finish.

There was a special prize for keel schooners.

Start, Schooners, Class 5, 5:35
" Sloops, etc., " 5, 6 and 7, " 5:35.

All others 5:45.

First Class.	SCHOONERS.		Elapsed Time.	Corrected Time.
	Racing Measurements.	Time Allowance.		
Constellation	107 24	M. S.	11 56 31	11 56 31
Fortuna (2d)	94 57	19 15	10 56 38	10 37 23
Third Class.				
Alcaza			10 50 14	
Merlin	93 35		10 35 30	10 35 30
Mayflower	89 83	6 20	12 12 03	10 55 43
Phantom	86 52	12 31	11 33 33	11 21 02
Atlantic	86 31	12 54	11 13 41	11 00 47
Fourth Class.				
Marguerite	83 48		10 59 05	10 59 05
Troquois	82 21	2 41	10 53 06	10 50 25
Enone	80 37	6 28	11 41 02	11 31 34
Fifth Class.				
Quickstep	70 11		11 46 42	11 46 42
Peerless	68 03	5 39	12 27 23	12 21 51
Azalea	63 36	18 59	12 23 23	12 07 21
Third Class.				
SLOOPS.				
Katrim	76 08		11 26 50	11 26 50
Wayward (4th)	65 58	27 18	12 06 49	11 39 31
Fifth Class.				
Clara	55 12		12 57 33	
Sixth Class.				
Wasp	51 97		12 20 16	12 20 16
Harpoon	51 85	0 23	12 29 51	12 29 31
Gloriana	51 17	3 03	12 31 28	12 28 25
Mariquita (7th)	48 09	28 52	13 41 43	13 12 51
KEEL SCHOONERS.				
Dauntless	111 04		10 26 15	10 26 15
Ramona	105 84	6 59	10 46 12	10 39 43
Alert	91 58	29 34	11 06 00	10 36 26
Miranda	85 90	40 06	11 11 44	10 31 38
Fleur de Lys				
Speranza			12 00 07	

Between the Nauset and Highland Lights MIRANDA and MAYFLOWER carried away their foretopmasts and KATRINA carried away her topmast.

WINNERS:—1st Class Schooners, Constellation.

3d	"	Merlin, 2d Prize, Mayflower.
4th	"	Troquois.
5th	"	Quickstep.
3d	"	Sloops, Katrim.
6th	"	Wasp, 2d Prize, Gloriana.

Keel Schooners Prize, Dauntless.



ELBRIDGE T. GERRY, EX-COMMODORE NEW YORK YACHT CLUB.

BIOGRAPHICAL SKETCHES AND DESCRIPTION OF YACHTS ENROLLED IN THE CLUB.

EDWIN D. MORGAN, Commodore of the **NEW YORK YACHT CLUB**, resident of New York City, and grandson of the late Governor Edwin D. Morgan. Commodore Morgan is an enthusiastic yachtsman, having been interested in yachting since boyhood; he has probably owned as many, if not more yachts than any other member of the **NEW YORK YACHT CLUB**.

In the early part of the "seventies" Commodore Morgan became the owner of the yacht **DUDLEY**, which was followed by the first iron sloop ever built in America, **VINDEX**. The schooners **WANDERER** and **ALBATROSS** were his next yachts, after which he purchased the steamer **AMY**, an English vessel, and still later bought the steamer **CATARINA**, then known as **SASS PEUL**. The famous **MAYFLOWER** and **GLORIANA** were at one time owned by him, as also the steamer **JAVELIN** and the cat-boat **MUCCLAGE** (now **ISIS**). The Commodore has also owned the sloops **COMFORT**, **MURIEL**, **MOCCASIN**, **TOMAHAWK**; the schooner **CONSTELLATION**; the steamers **TRUXA** and **DAISIE**; the cat-yawl **GANNET**; the fin-keel **DRUSILLA**, and has chartered **WISPER** and **POLYNIA**. He is at present the owner of the steam yacht **MAY**, the finest vessel of the list, and which is now the flag ship of the **NEW YORK YACHT CLUB**. He is one of the syndicate owning the cup defender **VIGILANT**.

Commodore Morgan has not only owned yachts for the pleasure to be derived from them, but he has owned yachts so as to study how to improve yacht architecture. Of the yachts mentioned, he built **CONSTELLATION**, **MOCCASIN**, **TOMAHAWK**, **GLORIANA**, **JAVELIN**, **GANNET** and **DRUSILLA**.

Few yachtsmen are looked up to and respected more than Commodore Morgan—first as a gentleman of culture, and then for his superior knowledge in all that appertains to yachting. His enterprise in advancing interest in yachting must command the respect of all.

MAY.

The yacht **MAY**, the new flag ship of the **NEW YORK YACHT CLUB**, is a screw schooner, belonging to Commodore E. D. Morgan. She was designed by G. L. Watson, who designed **THISTLE**, and is also the designer of the two new yachts, **VALKYRIE** and **BRITANNIA**. Built by the Ailsa Shipbuilding Company, Troon, Scotland, and launched in 1891 for W. B. Stewart, a member of the **ROYAL THAMES YACHT CLUB**. She is beautifully fitted up and magnificently furnished throughout. She hails from New York City and is a handsome addition to the already noted fleet of the **NEW YORK YACHT CLUB**. She also sails with the **ATLANTIC**, **SEAWASHAKA**, **LARCHMONT** and **CORINTHIAN** of New York Yacht Clubs. See plate VII.

DIMENSIONS.

Length over all,	240 feet.	Length load waterline,	233 feet.
Depth,	17 feet 6 inches.	Draft,	11 feet.
Beam,	27 feet 8 inches.		

Engines: Triple expansion, cylinders 19 in., 31 in. and 51 in. x 33 in. David Rowen & Son, Glasgow. Speed of 13 knots per hour. Boilers: One and auxiliary. 130 nominal horse power.

DRUSILLA.

DRUSILLA is a fin-keel yacht, designed and built by the Herreshoff Mfg Co., for her present owner, Commodore E. D. Morgan of New York City. She is cutter-rigged. She hails from New York, and sails with the **NEW YORK YACHT CLUB**. See Fig. 238 and plate VIII.

DIMENSIONS.

Length over all,	72 feet.	Length load waterline,	31 feet 7 inches.
		Draft,	8 feet 3 inches.
Beam,	9 feet 4 inches.		

ELBRIDGE T. GERRY, lawyer, Ex-Commodore of the **NEW YORK YACHT CLUB**, born December 25th, 1837, in New York City. Son of Thomas R. Gerry of the United States Navy, and Hannah G. Gerry, and grandson of the great statesman Elbridge Gerry who was Vice-President of the United States. Member of the **NEW YORK**, **ATLANTIC** and **LARCHMONT YACHT CLUBS**, and has held the honorable position of Commodore of the **NEW YORK YACHT CLUB** for the past seven years; is the owner of the steam yacht **ELECTRA**. Graduated at Columbia College in 1857; studied law with and became a partner of Wm. Curtis Noyes. After the death of Mr. Noyes, he became a partner of Wm. F. Allen and Benj. V. Abbott, which partnership was subsequently dissolved. He is a noted member of the bar, and owns a law library consisting of 15,000 volumes. Mr. Gerry has held and still holds many prominent positions. He was the Chairman of the Executive Committee of the Centennial, Chairman of the Mayor's Committee on Lunacy, Governor of the New York Hospital, Chairman of the State Commission on Capital Punishment, one of the founders of the Society for the Prevention of Cruelty to Children, was elected President of the Society in 1879, and still holds the office.

The Commodore has been more or less connected with nautical affairs ever since his boyhood. When a law student, he would spend all his spare time on board a pilot boat, and during his summer vacations he used to make trips out to sea, on which voyages he learned the rougher side of a sailor's life, and also made good use of his opportunities, since he became thoroughly proficient in navigation.

ELECTRA.

An iron keel steam yacht designed by G. Hillman and built by Harlan & Hollingsworth in 1881 for Ex-Commodore Elbridge T. Gerry. **ELECTRA** has two cabins, has never been altered, except in some details of her machinery. She hails from New York. See plate XII.

CODE SIGNAL LETTERS, E. C. M. S.

Official number, 135,772.

DIMENSIONS.

Length over all,	71 feet.	Length load waterline,	61 feet 6 inches.
Depth,	12 feet.	Draft,	10 feet 6 inches.
Beam,	23 feet.		

Engines: Two compound inverted direct acting, surface condensing. Stroke of Piston, 26 x 44 x 26 inch.

Boilers: Cylindrical steel, Scotch pattern.

Horse Power: 200 nominal, 998 actual.

ELECTRA has made a record of 16 knots.



FREDERICK W. ADAMS.

FREDERICK T. ADAMS, stock broker, New York City, N. Y. Born in Chicago, Ill., 1853. A member of the **ATLANTIC YACHT CLUB**, the **NEW YORK YACHT CLUB** and the **LARCHMONT YACHT CLUB**. Ten years interested in yachting. Late owner of the yacht **ESPIRITO**, launched in 1883, designed and built by T. R. Webber. Part owner of **SACHEM**, his present yacht.

ESPIRITO.

ESPIRITO is a centerboard sloop, designed and built by T. R. Webber, New Rochelle, N. Y., for R. B. Hartshorn, and was the property of Frederick T. Adams, New York City, now owned by H. A. Hutchins. She was launched in 1883, and has

been in the possession of Mr. Adams for four years. She was altered in 1890, being lengthened seven feet on the stern. Has a cabin; hails from New York. Her owner is a member of the LARCHMONT, ATLANTIC and NEW YORK YACHT CLUBS. See Fig. 239 and plate XIII.

CODE SIGNAL LETTERS, K. C. D. W.

Official number, 135,690.

DIMENSIONS.

Length over all,	52 feet.	Length load waterline,	45 feet.
Depth,	5 feet 6 inches.	Draft,	6 feet 8 inches.
Beam,	16 feet.		

SACHEM.

A wooden centerboard schooner, designed by Edward Burgess and built by Geo. Lawley & Son, Boston, for Jesse Metcalf and C. D. Owen, of Providence, R. I. Was launched in July, 1886. Afterwards the property of the estate of W. Arnold, and now belonging to F. T. Adams and John G. Moore. Hails from New York and sails with the fleet of the NEW YORK YACHT CLUB, etc. See Fig. 240 and plate XV.

DIMENSIONS.

Length over all,	65 feet.	Length load waterline,	58 feet 5 inches.
Depth,	9 feet 5 inches.	Draft,	8 feet 6 inches.
Beam,	23 feet 5 inches.		

CODE SIGNAL LETTERS, K. G. D. T.

Official number, 116,352.

Won third place in race for Goelet Cup when but two weeks out of the builders' hands. She beat the English schooner MIRANDA on October 1st. In 1887 beat IROQUOIS several times and also defeated MONTACK. In the same season she won the Morgan Cup, Goelet Cup, Providence City Cup (beating MAGIC), and lastly, the Newport Citizens' Cup, also won from MAGIC. In both these races with MAGIC, the latter received double time allowance.

NOIRMAHAL.

A screw bark, owned by John J. Astor of New York City. Was designed by Gustav Hillman and built by the Harlan & Hollingsworth Company, Wilmington, Del. She was launched in 1884, hails from New York City and sails with the NEW YORK YACHT CLUB. See plate XIV.

CODE SIGNAL LETTERS, K. C. P. S.

Official number, 130,306.

DIMENSIONS.

Length over all,	26 feet.	Length load waterline,	27 feet.
Depth,	18 feet 5 inches.	Draft,	11 feet 3 inches.
Beam,	30 feet.		

Engine: Compound inverted, two cylinders, 34 in. and 60x36 in. Boilers: Four steel cylindrical boilers, 8 ft. 3 in. x 10 ft. 6 in. x 12 ft. Engine and boilers built by Harlan & Hollingsworth Co.

CLARA.

CLARA is a composite cutter, formerly owned by Robert A. Osborn, now owned by John Howard Adams, New York. Was designed by W. Fife, Jr., and built by the Culzean Ship Building Co., Maybole, N. B. She was launched in 1884, hails from New York and sails with the NEW YORK, SEAWANSHAKA CORINTHIAN, LARCHMONT, AMERICAN (of New York) and CORINTHIAN (of New York) YACHT CLUBS, and also the ROYAL NOVA SCOTIA YACHT SQUADRON. See plate XLIV.

CODE SIGNAL LETTERS, J. W. M. S.

DIMENSIONS.

Length over all,	61 feet 13 inches.	Length load waterline,	53 feet.
Depth,	8 feet 4 inches.	Draft,	9 feet 10 inches.
Beam,	9 feet 1 inch.		

Racing Record for 1891:—

ATLANTIC YACHT CLUB—Beat ANACONDA, June 16th, Twenty-sixth Annual Regatta.

SEAWANSHAKA CORINTHIAN YACHT CLUB—Won from VENTURA on June 29th.

MARINE and FIELD YACHT CLUB—Beat ANACONDA again in the Third Annual Regatta of this club, held June 17th.

NEW YORK YACHT CLUB—August 6th, CLARA beat both CINDERELLA and WHITBY in the Squadron Run. Won again from CINDERELLA on August 8th. Beaten by HILDEGARD (sailing out of her class) and CINDERELLA in the races for special cups, August 10th, and again beaten by CINDERELLA on the 11th. On the last day of the cruise CLARA won again, defeating CINDERELLA.

Racing Record for 1892:—

NEW YORK YACHT CLUB—CLARA was second in the regatta of June 9th, being beaten by WASP. On the 3rd of August, she defeated ATHLON and VENTURA, in the Squadron Run from Morris Cove to New London. She won from the same yachts the next day. In the Squadron Run of August 6th, CLARA sailed out of her class and came in fourth. In the contest for the Morgan Cups she came in last; this race was sailed August 8th.

ATLANTIC YACHT CLUB—CLARA won in her class in the Twenty-seventh Annual Regatta sailed June 14th.

LARCHMONT YACHT CLUB—In the run of July 10th, CLARA won with eight starters. In the Fall Regatta she was the winner in her class.

PEERLESS.

A centerboard schooner yacht, owned by J. Ed. Ackley of New York City. PEERLESS was designed by W. Townsend and built by C. & R. Poillon of Brooklyn in 1871; has been repeatedly altered and rebuilt. PEERLESS was one of the fast yachts of an earlier day, but is naturally outbuilt at the present time. She sails with the NEW YORK YACHT CLUB. See Fig. 241.

CODE SIGNAL LETTERS, K. C. F. T.

Official number, 150,073.

DIMENSIONS.

Length over all,	76 feet.	Length load waterline,	67 feet 2 inches.
Depth,	5 feet 9 inches.	Draft,	6 feet 2 inches.
Beam,	18 feet 7 inches.		

Racing Record, 1892:—

NEW YORK YACHT CLUB—Second, VIATOR first, in the Regatta of June 9th. Third, beating AZALEA in the Squadron Run of August 4th.

ATLANTIC YACHT CLUB—Won in her class in the Twenty-seventh Annual Regatta, June 14th.

SEAWANSHAKA CORINTHIAN YACHT CLUB—Won in the Annual Regatta sailed July 2nd.

LARCHMONT YACHT CLUB—Second, VIATOR first, in the Spring Regatta of June 4th. Second, AZALEA first, July 4th.

MILICETE.

A centerboard sloop, designed by Edward Burgess and built by Lawley. Launched in 1890; was owned by the late William A. Able, hails from New Bedford and sails with the NEW YORK and NEW BEDFORD YACHT CLUBS. See Fig. 242.

CODE SIGNAL LETTERS, K. J. T. H.

Official number, 92,306.

DIMENSIONS.

Length over all,	58 feet.	Length load waterline,	45 feet 7 inches.
Depth,	7 feet.	Draft,	7 feet.
Beam,	16 feet 5 inches.		

LASCA.

LASCA is a steel centerboard schooner, belonging to John E. Brooks, of New York City. She was designed by A. Cary Smith and built by Henry Piepgras, City Island, New York, and was launched in 1892. She hails from New York City and sails with the NEW YORK, ATLANTIC and SEAWANSHAKA CORINTHIAN YACHT CLUBS. See plate XVI.

DIMENSIONS.

Length over all,	119 feet.	Length load waterline,	89 feet 6 inches.
Depth,	11 feet 2 inches.	Draft,	10 feet 8 inches.
Beam,	23 feet.		

Racing Record, 1892:—

NEW YORK YACHT CLUB—LASCIA was first, with seven starters, in the Squadron Run sailed August 3rd, beating MERLIN, PHANTOM, ATLANTIC, ALCEA, etc. She won again the following day, defeating the same yachts, and also MAYFLOWER, FLEUR DE LYS, etc. Was fourth in the race for the Golet Cup, held August 5th. First again in the run of August 6th. The Autumn Sweepstakes, sailed September 15th, was won by MARGUERITE, with LASCIA second. LASCIA won a \$150 cup and entrance money.

LARCHMONT YACHT CLUB—In the contest for the Larchmont Cup for Schooners, LASCIA came in second, beaten by BROUQOIS; there were seven starters.

HILDEGARD.

A centerboard sloop, formerly NIANTIC, owned by Jas. C. Bergen of New York City. Designed and built by A. E. Smith, 151st Long Island, and launched in 1876. She was given a new keel in 1890-91. Hails from New York and sails with the NEW YORK, ATLANTIC, SEAWASHAKA CORINTHIAN and SHELTER ISLAND YACHT CLUBS. See Fig. 243.

CODE SIGNAL LETTERS, K. C. F. S.

Official number, 130,970.

DIMENSIONS.

Length over all,	69 feet 5 inches.	Length load waterline,	60 feet 6 inches.
Depth,	6 feet 5 inches.	Draft,	6 feet.
Beam,	19 feet 2 inches.		

Racing Record, 1891:—

ATLANTIC YACHT CLUB—June 16, won in her class.

NEW YORK YACHT CLUB—August 4th, won in her class. Won again on August 6th, (Squadron Run), beating WAYWARD, the two other starters not finishing. Beaten by WAYWARD on August 8th. Was second on August 10th, CINDERELLA being first and CLARA third. Won from MISCHIEF on the 11th of August, and again on the 12th.

WANDERER.

A keel schooner, designed by R. Fish and built by Samuel Pine, Greenpoint, New York. She was launched in 1871, is the property of Watson F. Blair of Chicago, hails from Chicago, and sails with the NEW YORK YACHT CLUB. See Fig. 244.

CODE SIGNAL LETTERS, K. C. G. H.

Official number, 80,179.

DIMENSIONS.

Length over all,	118 feet 3 inches.	Length load waterline,	100 feet 3 inches.
Depth,	8 feet.	Draft,	11 feet 6 inches.
Beam,	21 feet 3 inches.		

ONEIDA.

An iron screw schooner, formerly UTOWANA. Was lately owned by Washington E. Connor, now belongs to E. C. Benedict of New York City. Was designed and built by John Roach & Son, Chester, Pa., being launched in 1883. She has been altered in several particulars by her present owner and has been painted white. She hails from New York and sails with the NEW YORK, LARCHMONT, AMERICAN (of New York) and RIVERSIDE YACHT CLUBS. See plate XLIII.

CODE SIGNAL LETTERS, K. B. S. D.

Official number, 25,254.

DIMENSIONS.

Length over all,	138 feet.	Length load waterline,	125 feet 6 inches.
Depth,	10 feet.	Draft,	8 feet 2 inches.
Beam,	21 feet 6 inches.		

Engines: Compound inverted, two cylinders, 15 in. and 28 in. x 18 in. Nominal horse power, 420. Built by John Roach & Son. Boiler: One coil boiler, built by Ward of Virginia.



Robert Lenox Belknap

ROBERT LENOX BELKNAP, of New York City, is the son of Aaron Betis Belknap and Jennet Lenox Belknap, nee Maitland; born 1819 in New York City. He is a member of the SEAWASHAKA CORINTHIAN and NEW YORK YACHT CLUBS, and has been for several years a trustee of the former club. His present yacht is ELMA; LISWOOD, HETTIE and AIGROW have also belonged to him. Mr. Belknap has been interested in yachting since 1864.

ELMA.

A centerboard schooner, belonging to Robert L. Belknap of New York City. She was designed by A. C. Smith and built by Harlan & Hollingsworth Co., Wilmington, Del., for William P. Douglas, launched in 1885. When a sloop, as she originally was, she was known as PRISCILLA. Before passing into the hands of Mr. Belknap she was owned for some time by A. Cass Canfield. Altered to schooner rig by Piepgras, in 1888; owned by Mr. Belknap since 1888; hails from New York City. See Fig. 245.

CODE SIGNAL LETTERS, K. D. H. P.

Official number, 150,353.

DIMENSIONS.

Length over all,	91 feet 9 inches.	Length load waterline,	85 feet 11 inches.
Depth,	8 feet 8 inches.	Draft,	11 feet 4 inches.
Beam,	20 feet.		



JOHN C. BARRON.

JOHN C. BARRON, M.D., Vice-Commodore of the HUDSON RIVER ICE YACHT CLUB, a surgeon of repute, Tarrytown, N. Y., born in Woodbridge, N. J., 1837. His ancestors were among the earliest English settlers, and were, in many ways, closely connected with the history of New Jersey. He is the son of John Barron and Mary Connor. Since 1879 actively interested in yachting. He has been the owner of several yachts, (ATHLON, WAVE and CLARA) and is now the owner of two ice yachts, NORTHERN LIGHTS and POLARIS. Vice-Commodore Barron has held his position in the HUDSON RIVER ICE YACHT CLUB since its organization. He is also a member of the NEW YORK, SEAWASHAKA, ATLANTIC, LARCHMONT and SHENECOCK YACHT CLUBS. In time past he has held these offices: Rear-Commodore of the SEAWASHAKA YACHT CLUB in 1881; Vice-Commodore of the ATLANTIC YACHT CLUB in 1885, and Rear-Commodore of the NEW YORK YACHT CLUB in 1886.



BENJ. R. BEDLE.

BENJ. R. BEDLE, Jersey City, N. J., is the son of Ex-Gov. Jos. D. Bedle and Althea F. Randolph. He was born at Freehold, N. J., July 7, 1862. He is a stock-broker and a member of the New York Stock Exchange, has owned several small boats, has been a yachtsman for the past ten years and is a member of the NEW YORK, LARCHMONT and NEW JERSEY YACHT CLUBS.

VELETTE.

A screw schooner, designed by Phillips Phoenix and built by Ward, Stanton & Co., Newburgh, N. Y., in 1878. Owned by M. C. D. Borden of New York City, and sails with the NEW YORK and Ar-

LANTIC YACHT CLUB fleets. She was re-built and altered in 1891-92. See plate XVII.

Official number, 25,949.

DIMENSIONS.			
Length over all,	123 feet,	Length load waterline,	91 feet.
Depth,	9 feet 3 inches.	Draft,	9 feet.
Beam,	18 feet.		

Engine: Compound inverted, two cylinders, 15 inch and 30 x 24 inch. Indicated horse power, 440. Ward, Stanton & Co.
Boiler: One, 8 x 12 ft. Ward, Stanton & Co.



LEONARD F. BECKWITH.

LEONARD FORBES BECKWITH, born in 1843 and a resident of New York City; son of Nelson M. Beckwith and Frances M. Forbes. Mr. Beckwith is a civil-engineer, and is the chief engineer of the Consolidated Telegraph & Electric Subway Co. of New York City. His father was Commissioner-General of the United States during the Paris Exposition of 1867. Mr. Beckwith is the owner of the yacht VIXEN, and he has also owned the cut-boat FAUNTS. He has been a yachtsman five years, and is a member of the New York YACHT CLUB.

VIXEN.

VIXEN is a centerboard sloop, and was built by Albertson Bros. of Philadelphia in 1871. She is the property of Leonard F. Beckwith of New York City, who has owned her for four years. She was formerly the property of Mr. Lawrence of New York and Dr. Loring of Beverly, Mass. She hails from New York and sails with the NEW YORK YACHT CLUB. She was re-built by Bayles.

CODE SIGNAL LETTERS, K. C. E. U.

Official Number, 25,843.

DIMENSIONS.			
Length over all,	52 feet 7 inches.	Length load waterline,	45 feet 6 inches.
Depth,	5 feet.	Draft,	4 feet 2 inches.
Beam,	10 feet 4 inches.		

Spars: Mast, 44 ft. 7 in., Topmast, 31 ft. 4 in., Boom, 46 ft. 9 in., Bowsprit, 33 ft. 4 in., Gaff, 29 ft. 9 in.

Record: 14 miles per hour.

AMZI L. BARBER, Chairman of the Barber Asphalt Paving Co., was born June 22, 1843, at Saxton's River, Vt. He is the son of Rev. Amzi D. Barber and Nancy I. Bailey. His present address is Washington, D. C., and Irvington-on-the-Hudson. He formerly owned the yacht TROPHY and is now the owner of the steam yacht SAPPHIRE. Has been interested in yachting for four years. He is a member of the NEW YORK, CORINTHIAN (of New York) and NEW HAVEN YACHT CLUBS, and the PEQUOT ASSOCIATION.

SAPPHIRE.

A screw schooner of 120 tons (gross), designed by Edward Burgess and built by the Bath Iron Works, Bath, Me., for John Stetson of Boston. Launched in 1888; has been owned by Amzi L. Barber since September 6, 1890. She has never been altered. SAPPHIRE has a cabin, hails from New York and sails with the NEW YORK and CORINTHIAN (of New York) YACHT CLUBS. See plate XVIII.

CODE SIGNAL LETTERS, K. H. S. V.

Official number, 116,223.

DIMENSIONS.			
Length over all,	137 feet.	Length load waterline,	130 feet.
Depth,	11 feet 6 inches.	Draft,	9 feet.
Beam,	19 feet 4 inches.		

Engine: Triple expansion, three cylinders, 13 in., 19 in. and 30 x 18 inch. Boilers: Scotch return tubular, 10 ft. x 4 ft. 4 in.

YAMPA.

A steel schooner, keel; built by the Harlan & Hollingsworth Co. of Wilmington, Del., and designed by A. Cary Smith. The property of Chester W. Chapin of New York City. She was launched in 1887. Hails from New York, and sails with the NEW YORK, SEAWARD, CORINTHIAN, and CORINTHIAN (of New York) YACHT CLUBS. YAMPA has been chartered by W. C. Whitney. See Fig. 247.

CODE SIGNAL LETTERS, K. D. W. S.

Official number, 27,631.

DIMENSIONS.			
Length over all,	133 feet.	Length load waterline,	110 feet.
Depth,	13 feet 3 inches.	Draft,	13 feet 7 inches.
Beam,	25 feet.		

Racing Record for 1892:—

CORINTHIAN YACHT CLUB of New York—YAMPA won from ALERT in the Annual Race of June 25th.

ALCEA.

A steel keel schooner, owned by Chas. and L. Vaughan Clark of St. Louis and New York. Was designed by William Gardner and built by Geo. Lawley & Son for her present owners. Was launched in May, 1892. She hails from New York, and sails with the NEW YORK YACHT CLUB. See Fig. 74, cover of Book and Plate

CODE SIGNAL LETTERS, K. H. V. L.

DIMENSIONS.			
Length over all,	127 feet.	Length load waterline,	10 feet.
Depth,	19 feet.	Draft,	13 feet.
Beam,	22 feet 3 inches.		

SYLPH.

SYLPH, a centerboard schooner (formerly SADIE), was designed by C. A. Edwards, and built by J. M. Bayles & Son, Port Jefferson, N. Y., in December, 1889; she was launched and finished June, 1890. She was built for her present owner, George E. Chase, Stamford, Conn. She hails from New York, and sails with the NEW YORK YACHT CLUB. See plate XX.

CODE SIGNAL LETTERS, K. C. G. S.

Official number, 116,298.

DIMENSIONS.			
Length over all,	85 feet.	Length load waterline,	72 feet 6 inches.
Depth (of hold),	8 feet 7 inches.	Draft,	7 feet 2 inches.
Beam,	21 feet 7 inches.		

SENECA.

SENECA is a screw schooner, lately the property of A. B. Cliffin of New York City, but at present owned by Messrs. Johnson and William C. Dickson of Norfolk, Va. SENECA was designed by J. H. Dahl and built by William McKie of East Boston, Massachusetts, in 1888. She sails with the NEW YORK YACHT CLUB. See Fig. 248.

CODE SIGNAL LETTERS, K. F. H. D.

Official number, 116,228.

DIMENSIONS.			
Length over all,	118 feet 6 inches.	Length load waterline,	110 feet.
Depth,	11 feet 5 inches.	Draft,	10 feet.
Beam,	19 feet.		

Engine: Condensing, two cylinders, 15 in. and 30 in. by 18 inch.

ADMIRAL.

ADMIRAL is a screw schooner, belonging to Richard W. Comstock, of Providence, R. I. She was designed by D. J. Lawlor, and built by the Providence Dry Dock & Marine R'y Co. She was built for Mr. Comstock and was launched April 20, 1892. She hails from Providence, and her owner is a member of the RHODE ISLAND and NEW YORK YACHT CLUBS. See plate XXI.

Official number, 106,921.

DIMENSIONS.			
Length over all,	116 feet.	Length load waterline,	108 feet.
Depth,	11 feet.	Draft,	7 feet 4 inches.
Beam,	19 feet 8 inches.		

Billingsworth Co.
The property
was launched in
NEW YORK, SEA-
w York) YACHT
itney. See Fig.

110 feet.
13 feet 7 inches.

won from ALERT

ughan Clark of
iam Gardner and
Was launched
ls with the New
d Plate

line 90 feet.
13 feet.

ADIE). was de-
yles & Son, Port
ched and finished
George E. Chase.
ils with the NEW

72 feet 6 inches.
7 feet 2 inches.

of A. B. Claffin
rs. Johnson and
s designed by J.
r, Massachusetts,
n. See Fig. 248.

ee line, 130 feet.
19 feet.

in. by 18 inch.

Richard W. Com-
J. J. Lawlor, and
She was built
392. She hails
e RHODE ISLAND

108 feet.
7 feet 4 inches.

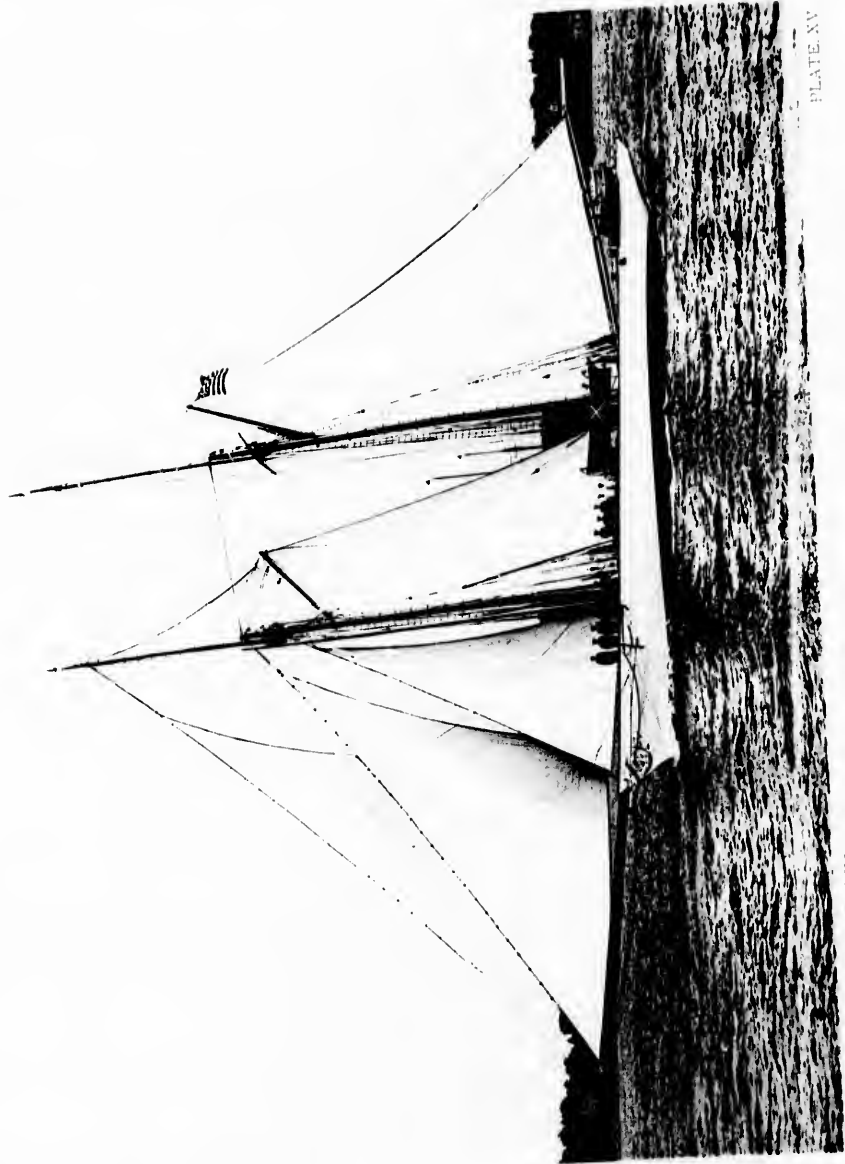

PLATE XV

FROM A NEGATIVE BY BOLLES

SACHEM.



S
a
Y

V
P
ta
ch
M
Y
w

Sh
Sh
Du
hu
Co
nt

M
F
& F
L
ave

It
by V
rob
B. L
Cl
L
denc

It
In
5, 18
of th

Engines: Inverted, direct acting, fore and aft, compound, 2 cylinders, 12 ft. and 22x16 feet. Fore River Engine Co., Weymouth, Mass.

Boiler: Two, Army water tube. Providence, R. I. Horse Power, (indicated) 225. Stroke of Piston, 16 in.
Speed Record: 12 knots, natural draft.

ORIVA.

ORIVA is a cutter, owned by Herman Clarke of New York City. She was launched in 1881, having been designed by Harvey & Prior, and built by H. Piepgras, Greenpoint, N. Y. Sails with the NEW YORK YACHT CLUB. See plate XXII.

CODE SIGNAL LETTERS, K. C. F. B.

Official number, 155,038.

DIMENSIONS.

Length over all,	60 feet 0 inches,	Length load waterline,	51 feet 4 inches,
Depth,	9 feet 5 inches,	Draft,	9 feet 11 inches,
Beam,	11 feet 0 inches,		

WILLIAM B. DUNCAN, Jr., Vice-Commodore of the NEW YORK YACHT CLUB, is a resident of New York City. Was born in Providence, R. I., in 1862. Is a United States Navy man, and has taken an interest in everything pertaining to the sea from his early days. Is the owner of the yacht HURON, and has also owned MOYA and MONA. He has held his office in the NEW YORK YACHT CLUB for two years. Is a member of the NEW YORK, SEAWASHAKA CORINTHIAN, LARCHMONT and EASTERN YACHT CLUBS.

UTOWANA.

UTOWANA is a steel auxiliary screw schooner, with three masts. She was designed by J. Beaver Webb and built by Neufie & Levy Ship Building Co., Philadelphia, Pa., in 1891 for her owner, W. West Durant, of New York City. She was launched in March, 1891. She sails from New York and sails with the NEW YORK, SEAWASHAKA CORINTHIAN and EASTERN YACHT CLUBS, and also with the IMPERIAL and ROYAL AUSTRIAN YACHT SQUADRON. See plate XXIII.

CODE SIGNAL LETTERS, K. J. P. E.

Official number, 25,821.

DIMENSIONS.

Length over all,	90 feet,	Length load waterline,	75 feet,
Depth,	16 feet 9 inches,	Draft,	11 feet 6 inches,
Beam,	27 feet 6 inches,		

Masts: 66, 62 and 57 feet, respectively.

Engine: Triple expansion, 10 ft., 15 ft., and 25x20 feet. Neufie & Levy.

Boiler: Return tubular. Indicated horse power, 300. Speed: She averaged 222 knots per 24 hours for nine days.

HURON.

HURON is a keel cutter, designed by W. Gray, Jr., and built by W. B. Smith, South Boston, Mass. Was launched in 1883. Was rebuilt and lengthened 2 feet by Smith in 1885. She belongs to W. B. Duncan, Jr., formerly Rear Commodore of the NEW YORK YACHT CLUB, and sails with the NEW YORK, SEAWASHAKA CORINTHIAN, LARCHMONT and EASTERN YACHT CLUBS. She hails from Providence. See Fig. 249.

CODE SIGNAL LETTERS, K. J. H. N.

Official number, 95,753.

DIMENSIONS.

Length over all,	73 feet 4 inches,	Length load waterline,	61 feet 5 inches,
Depth,	9 feet 3 inches,	Draft,	10 feet 10 inches,
Beam,	15 feet 9 inches,		

Racing Record for 1891:—

In the Squadron Run of the NEW YORK YACHT CLUB of August 5, 1891, with four starters, HURON was fourth. In the Squadron Run of the 8th of August, she came in first, defeating THETIS. On the

10th of August, competing for Special Cups, she was beaten by BEDOUTS.

Racing Record for 1892:—

NEW YORK YACHT CLUB—HURON was first in the Squadron Run of August 14th, beating KATHINA, GRACIE and FANNO. Beaten by KATHINA August 6th, with GRACIE third.

WAVE CRUISE.

A centerboard schooner, owned by E. N. Dickerson of New York City. Was built by Albertson Bros. of Philadelphia, and launched in 1865. Was formerly called JEANITA. She was rebuilt by Piepgras in 1882. She is enrolled among the yachts of the NEW YORK, LARCHMONT and CORINTHIAN (New York) YACHT CLUBS. Hails from New York. See Fig. 250.

CODE SIGNAL LETTERS, K. C. F. M.

Official number, 12,667.

DIMENSIONS.

Length over all,	91 feet,	Length load waterline,	81 feet 3 inches,
Depth,	7 feet,	Draft,	7 feet,
Beam,	21 feet,		

GRACIE.

A centerboard sloop, designed by A. A. Sheack and built by James E. Smith at Nyack, N. Y. Launched in June, 1868, and hails from New York. She is owned by Joseph P. Earle and sails with the NEW YORK, ATLANTIC, SEAWASHAKA CORINTHIAN and NARRAGANSETT YACHT CLUBS. Now chartered to Arthur M. Dodge. See Fig. 251.

CODE SIGNAL LETTERS, K. C. J. L.

Official number, 10,902.

DIMENSIONS.

Length over all,	79 feet 10 inches,	Length load waterline,	72 feet 2 inches,
Depth,	7 feet 2 inches,	Draft,	8 feet,
Beam,	12 feet 6 inches,		

See chapter on "Yachting in the U. S." for record of this remarkable yacht.

BARBARA.

A composite keel cutter, owned by C. H. W. Foster. Was designed by Wm. Fife, Jr., and built by Geo. H. Lawley & Son, being launched in May, 1880. She hails from Marblehead, Mass., and sails with the fleet of the NEW YORK, EASTERN, MASSACHUSETTS and CORINTHIAN (Marblehead) YACHT CLUBS. See Fig. 252.

Official number, 3,501.

DIMENSIONS.

Length over all,	63 feet,	Length load waterline,	45 feet 9 inches,
Depth,	19 feet 5 inches,	Draft,	11 feet 8 inches,
Beam,	13 feet,		

Racing Record for 1891:—

CORINTHIAN YACHT CLUB (Marblehead): BARBARA won in a regatta sailed August 27th, beating OWENNE, BEATRIZ, ALROVAK, etc.

Racing Record for 1892:—

EASTERN YACHT CLUB: BARBARA was second in the Annual Regatta of June 27th., WASP first. Third in the Autumn Regatta, September 3d.

LOTOWANA.

LOTOWANA is a cutter. She was designed by Burgess and built by Lawley, being launched in June, 1889. The property of Macomb G. Foster of New York City. She hails from New York, and sails with the LARCHMONT, SEAWASHAKA CORINTHIAN and NEW YORK YACHT CLUBS. See Fig. 253.

CODE SIGNAL LETTERS, K. J. M. S.

Official number, 141,135.

DIMENSIONS.

Length over all,	51 feet 6 inches,	Length load waterline,	39 feet 9 inches,
Depth,	7 feet 2 inches,	Draft,	8 feet 10 inches,
Beam,	13 feet 8 inches,		

CHARLES R. FLINT, ship-builder and owner, New York City, N. Y. Born Jan. 24, 1850, in Thomaston, Maine, of Welsh descent, the son of Benjamin Flint. Has been the owner of the

sloops SARACEN, SPORT and GRACIE. A yachtsman since 1879, and belonging to the NEW YORK YACHT CLUB. He was a United States delegate to the International American Conference of 1889-90.

GRAYLING.

GRAYLING is a centerboard schooner, built and designed for Latham A. Fish of New York City. Designed by Phillip Ellsworth, and built by C. & R. Poillon. Was so unfortunate as to be capsized on her trial trip, but was at once raised. In 1887 she was altered in several particulars, having her stern lengthened and some changes were made in her spars. She hails from New York, and sails with the NEW YORK, ATLANTIC, EASTERN, NEW ROCHELLE and SHELTER ISLAND YACHT CLUBS. See plate XXV.

CODE SIGNAL LETTERS, K, B, G, S.
Official number, 85,775.

DIMENSIONS.

Length over all,	98 feet.	Length load waterline,	81 feet 4 inches.
Depth,	8 feet 2 inches.	Draft,	8 feet 6 inches.
Beam,	24 feet.		

Racing Record for 1881:—

Sailed in the NEW YORK YACHT CLUB Regatta, taking second place,



W. W. DURAN.

and winning the same position in the contest of the ATLANTIC YACHT CLUB. In 1881 she won first prize in the ATLANTIC and second prize in the NEW YORK YACHT CLUBS. There was a race around Long Island this year, held in June. In this race she won the prize for schooners, and also won in the race for the Goelet Cup. Was beaten by MONTAUK in a sail from Newport, she being second, with seventeen other schooners entered.

1885—First prize in both ATLANTIC and New York Regattas; won several times in the Squadron Runs, and was once beaten by FORTUNA. Won the Bennett Cup from FORTUNA in the fall of this year.

1886—Again won first prizes in ATLANTIC and New York Regattas, and won in race for Goelet Cup. GRAYLING did not race in 1887, though she joined the cruising fleet of the NEW YORK YACHT CLUB.

CRESVIER.

A centerboard schooner, owned by Wendell Goodwin and Fred. Swift, both of New York City. Designed by J. R. Maxwell and built by J. P. Mumm, South Brooklyn, N. Y. Launched in 1880 and lengthened by Mumm in 1881. Sails with the NEW YORK, ATLANTIC, EASTERN, NEW BEDFORD and SEAWARDYAKA CORINTHIAN YACHT CLUBS. This yacht has been recently chartered to J. Willis Martin. See plate XXVII.

CODE SIGNAL LETTERS, K, D, G, T.
Official number, 125,823.

DIMENSIONS.

Length over all,	97 feet.	Length load waterline,	81 feet.
Depth,	6 feet 5 inches.	Draft,	8 feet 3 inches.
Beam,	21 feet 6 inches.		

NORSEMAN.

A keel schooner, designed by William Townsend and built by C. & R. Poillon, Brooklyn, N. Y. Launched April 21, 1881. She is owned by Ogden Goelet. Sails with the NEW YORK YACHT CLUB, and hails from New York City. NORSEMAN was not built for racing purposes. See Fig. 254.

CODE SIGNAL LETTERS, J, A, G, E.
Official number, 130,194.

DIMENSIONS.

Length over all,	120 feet.	Length load waterline,	111 feet 3 inches.
Depth,	11 feet 5 inches.	Draft,	12 feet 2 inches.
Beam,	25 feet 2 inches.		

FREDERICK GEBHARD of New York City was born in New York, and is the son of the late F. G. Gebhard. He is a charter member of the NEW YORK YACHT CLUB, and belongs also to the LARCHMONT YACHT CLUB. He owns the cutter yacht ILEEN, and has been interested in yachting for several years.

ILEEN.

ILEEN is a cutter, owned by Frederick Gebhard of New York City. Was designed by J. Harvey and built by H. Piepgras of Greenpoint, N. Y., and launched in 1881. Hails from New York and sails with the NEW YORK and LARCHMONT YACHT CLUBS.

CODE SIGNAL LETTERS, K, C, P, P.
Official number, 100,341.

DIMENSIONS.

Length over all,	78 feet.	Length load waterline,	65 feet 4 inches.
Depth,	11 feet 8 inches.	Draft,	11 feet.
Beam,	10 feet 7 inches.		

JOHN H. HANAN, shoe manufacturer, New York City, N. Y. Born in Ireland. A member of the NEW YORK, ATLANTIC and LARCHMONT YACHT CLUBS, and of several other organizations—the Montauk Club, the Riding and Driving Club, Brooklyn, and the Crescent Athletic Club. For seven years an active yachtsman. Has owned three steamers: AVENEL (formerly NAMOD); RUBY; the schooner SOUTHERN CROSS, and the cut-boat WILBERD. His present yacht is the schooner EMBLA.

EMBLA.

EMBLA is a composite screw schooner, designed and built by Charles L. Seabury & Co. for John H. Hanan, her present owner, and launched in May, 1893. She hails from New York City and sails with the NEW YORK, ATLANTIC, LARCHMONT and RIVERSTIDE YACHT CLUBS. See plate XXVIII.

Engines: Triple expansion, 3 cylinders, 13½ in., 21 in. and 34 in. x 21 in. Built by Seabury & Co.
Boilers: Two, Seabury's Patent Safety Water Tube, 1,000 horse power.

DIMENSIONS.

Length over all,	162 feet.	Length load waterline,	131 feet.
Depth,	10 feet.	Draft,	8 feet.
Beam,	20 feet.		

VIVIENNE.

A composite screw schooner, formerly AUGUSTA. Designed by N. G. Herreshoff and built by the Herreshoff Mfg. Co., in 1883. Lately owned by J. L. Hutelunson, but recently sold by him to R. D. Evans of Boston. Hailed from New York, and sailed with the NEW YORK YACHT CLUB. See plate XXIX.

CODE SIGNAL LETTERS, K, G, L, S.
Official number, 106,635.

DIMENSIONS.

Length over all,	131 feet.	Length load waterline,	109 feet.
Depth,	9 feet 8 inches.	Draft,	7 feet.
Beam,	17 feet 6 inches.		

Engine: Inverted triple expansion, three cylinders. Built by the Herreshoff Mfg. Co.
Boiler: Square Tubular, Herreshoff.

DAGMAR.

A steel centerboard schooner, formerly the cutter TITANIA. Designed by Edward Burgess and built by Henry Piepgras, being launched in 1881. For some time belonging to C. Oliver Iselin, and now owned by Robert Inman of New York City. Hails from New York and sails with the NEW YORK YACHT CLUB. See Fig. 255.

DIMENSIONS (as a cutter).

Length over all,	82 feet.	Length load waterline,	69 feet 11 inches.
Depth,	8 feet.	Draft,	8 feet 9 inches.
Beam,	21 feet.		

MONHEGAN.

A 46-footer, 57 feet over all, and draft 8 feet. She is one of Burgess' latest keel boats, and her characteristics are much the same as those of VOLUNTEER and MAYFLOWER, of which something is known.

About she looks every inch a handsome racing craft, and can climb over choppy seas and weather gales that would stagger larger boats.

In 1890-91 she won several races off Portland and around the coast of Maine, and last year was the admiration of all yacht experts in Newport Harbor.

MONHEGAN was lately owned by Edward M. Clark, but has been sold to Edwin C. Johnson of the NEW YORK YACHT CLUB.



HOWARD SUMMERVILLE JAFRAY.

MABEL, DOLPHIN and BARD. Mr. Jafray is a member of the NEW YORK YACHT CLUB. See Fig. 48 for cut MAY.

HOWARD SUMMERVILLE JAFRAY of New York City, was born in New York, July 23, 1847. Is at present the owner of the yachts MAY and IMP, and was previously the owner of



H. MATLAND KERSEY.

H MATLAND KERSEY, of New York City, was born in England. Is the New York manager of the White Star Line of steamships. Lately the owner of the 112-keel sloop Et. CITEO. Mr. Kersey is a member of the New York, LARCHMONT, SEAWASHAKA, ROYAL NORTHERN, ROYAL HARWICH, NEW THAMES, ROYAL PORTSMOUTH, CORINTHIAN, ROYAL WESTERN and CASTLE YACHT CLUBS. See plate XXXI and Fig. 58.



S. NICHOLSON KANE.

S NICHOLSON KANE, born at Newport, R. I., son of DeLancey Kane and Louise Langdon. Served in the United States Navy, having graduated from Annapolis, and received command of the yacht AMERICA. Studied law at Cambridge University, England, and was admitted to the New York Bar after a course at the Albany Law School.

Was for several years Commodore of the NEW YORK YACHT CLUB, and for four years has been chairman of the Regatta Committee. Is a member of the NEW YORK, SEAWASHAKA CORINTHIAN and EASTERN YACHT CLUBS and also a member of the Knickerbocker, Union, Flyers, Racquet, New York Conching and many other clubs.

The launch DAISY has lately been purchased by Mr. Kane from the former owner, Commodore Edw. D. Morgan.

AZTEC.

A screw schooner, designed and built by Chas. L. Seabury & Co. for D. A. Loring, her present owner. She was launched in July, 1890. In the year 1890 she was altered, having 14 feet, 6 inches, added to her length. Her owner belongs to the NEW YORK YACHT CLUB, the CHERRY DIAMOND, and the ST. AUGUSTINE YACHT CLUBS. AZTEC hails from New York. See plate XXXII.

CODE SIGNAL LETTERS, K, H, J, S.

DIMENSIONS.			
Length over all,	70 feet.	Length load waterline,	66 feet.
Depth,	5 feet 10 inches.	Draft,	4 feet 6 inches.
Beam,	11 feet 2 inches.		



DANIEL A. LORING.

Spars: Mainmast, 30 ft., Foremast, 28 ft., Boom, 17 ft.

Engine: Triple expansion, three cylinders, 7 in. 11 in. and 13 in. x 10 inch. Stroke of piston, 10 in.

Boiler: Seabury's patent safety tubular. 250 horse power.

ALERT.

ALERT is a keel schooner, owned by John Nicholas Loring of New York City. Designed by Henry Bryant, Esq., and built by W. B. Smith of South Boston, Mass. Launched in May, 1888. Hails from New York, and sails with the CORINTHIAN (of New York), and the NEW YORK YACHT CLUBS. ALERT has been chartered to George W. Weld. See Fig. 255.

CODE SIGNAL LETTERS, K, G, I, H.

Official number, 106,551.

DIMENSIONS.

Length over all,	67 feet.	Length load waterline,	50 feet.
Depth,	11 feet.	Draft,	13 feet.
Beam,	23 feet 5 inches.		

Racing Record for 1892:—
NEW YORK YACHT CLUB—ALERT won from PAINTLESS in the Annual Regatta, sailed June 9th.



THOMAS A. MCINTYRE.

THOMAS A. MCINTYRE, merchant, born in New York City and still living there. The son of Ewen McIntyre and Emily Amelia Bridgeman. A member of the NEW YORK YACHT CLUB, and the owner of the steam yacht STRAE. This yacht was designed and built for Mr. McIntyre by Charles L. Seabury & Co., and was launched in October, 1891. Mr. McIntyre has been actively interested in yachting and all that which appertains to it for the past three years.

STRAE.

A screw steamer, designed and built by Chas. Seabury & Co. for her present owner, and launched in October, 1891. She is the property of Thos. A. McIntyre of New York City. He is a member of the NEW YORK YACHT CLUB. STRAE hails from New York City. See plate XXXIII.

DIMENSIONS.

Length over all,	55 feet.	Length load waterline,	51 feet.
Depth,	4 feet 6 inches.	Draft,	4 feet 6 inches.
Beam,	9 feet.		

Engines: Triple expansion, Seabury type. Stroke of piston 8 in. Boiler: One; Seabury type. Horse power, 75.

STRAE is claimed to have shown a speed of 12½ miles.

CORSAIR.

CORSAIR is a screw schooner, owned by J. Pierpont Morgan of New York City. She was designed by J. Benvor-Webb, and built by Neafie & Levy, Philadelphia, Pa. CORSAIR is constructed of steel, and was slightly altered in 1893. She was launched in April, 1891, hails from New York and sails with the fleet of the NEW YORK YACHT CLUB. See plate IX.

CODE SIGNAL LETTERS, K, J, S, A.

Official number, 126,777.

DIMENSIONS.

Length over all,	211 feet 6 inches.	Length load waterline,	201 feet.
Depth,	16 feet 8 inches.	Draft,	13 feet.
Beam,	27 feet 2 inches.		

Engine: Vertical, direct acting, inverted triple expansion, three cylinders, 21 in., 33 in. and 54 x 30 inch. Indicated horse power 1,000. Built by Neafie & Levy.

Boiler: Two return tubular boilers, built by Neafie and Levy.

REPUBLIC.

REPUBLIC is a keel schooner yacht, owned by George Matthews of the New York Yacht Club. She was designed and built by J. E. Smith, Nyack, New York, and was launched in June, 1880. Was lengthened by Mumm in 1885. Sails with the New York and New Rochelle Yacht Clubs, hailing from New York City. See Fig. 257.

CODE SIGNAL LETTERS, K, D, J, C.
Official number, 110,427.

DIMENSIONS.			
Length over all,	112 feet.	Length load waterline,	94 feet.
Depth,	8 feet 4 inches.	Draft,	9 feet.
Beam,	23 feet.		

MONTECITO.

MONTECITO is a keel yawl built of steel and iron, and owned by Alexander Maitland of New York City. She was designed by A. Cary Smith and built by Henry Piegras, City Island, New York; was launched in 1889. MONTECITO sails with the fleet of the New York Yacht Club. Fig. 258.

CODE SIGNAL LETTERS, K, J, R, H.
Official number, 92,106.

DIMENSIONS.			
Length over all,	68 feet 3 inches.	Length load waterline,	51 feet.
Depth,	8 feet 8 inches.	Draft,	9 feet 2 inches.
Beam,	15 feet.		

ACTIVE.

Centerboard sloop, owned by Wm. L. Matson, Hartford, Conn. Designed by A. Cary Smith, and built by W. Foree, Keyport, N. J., in 1875. The stern was raised and the yacht lengthened in 1890. Has a cabin, and hails from Hartford, Conn. In the New York and Larchmont Club fleets. See Fig. 259.

CODE SIGNAL LETTERS, K, H, L, F.
Official Number, 105,519.

DIMENSIONS.			
Length over all,	61 feet.	Length load waterline,	51 feet.
Depth,	5 feet 10 inches.	Draft,	4 feet 10 inches.
Beam,	16 feet 2 inches.		

Spars: mainmast, 53 ft. 11 in., Topmast, 21 ft. 6 in., Bowsprit, 22 ft. 3 in., Boom, 47 ft. 6 in., Gaff, 26 ft.



NIELS OLSEN.

ing work for the press for many years.

Mr. Olsen has compiled twenty great volumes of yachting notes, which constitute one of the largest and most exact yachting records in existence.

CHAS. H. OSGOOD, wholesale druggist, Norwich, Conn., born in 1842 at Norwich, of New England descent. The son of Charles and Sarah L. Osgood. His father was President of the New London Northern Railroad and was also Mayor of Norwich.

The son has been three years Commodore of the American Yacht Club, having been connected with yachting affairs since 1862. He is at present the owner of the steamer NARWHAL, and has also owned the yachts TRITON and BENNETT (sloops), the schooner HAZE and the steamers ARROW, SOPHIA and TALISMAN. A member of the New York, American, Larchmont and New Haven Yacht Clubs.

NARWHAL.

A screw steamer, owned by Chas. H. Osgood, of Norwich, Conn. Designed by Gustav Hillman, and built by Robert Palmer & Sons, Noank, Conn., and launched in 1887. Built for Mr. Osgood, who is a member of the New York, Larchmont, American and New Haven Yacht Clubs. She hails from New London. See Fig. 260.

CODE SIGNAL LETTERS, K, G, W, P.
Official Number, 130,385.

DIMENSIONS.			
Length over all,	142 feet.	Length load waterline,	120 feet.
Depth,	11 feet.	Draft,	7 feet 6 inches.
Beam,	18 feet 4 inches.		

Engines: Compound inverted, two cylinders, 14 in. and 24½ x 16 inch. Stroke of piston, 16 in.

Boiler: Two Scotch, 6 x 10 inch. Both built by the New York Safety Steam Power Co.

Record: about 13½ knots.



J. VAN SCHAICK ODDIE.

JOHN VAN SCHAICK ODDIE, broker, New York City; born in New York in the year 1845, of English and Dutch descent. His parents were W. B. Oddie and Mary Van Schaick. Has been a yachtsman since 1865, and holds the honorable position of Secretary of the New York Yacht Club. His grandfather was President of the Croton Water Board and the originator of the plan for the utilization of the Croton. Mr. Oddie is one of the leading spirits amongst the yachtsmen of the New York Yacht Club, and indeed of the country. He has owned the yacht FORENTE and is a member of the Larchmont, New York, Eastern and Manhattan Yacht Clubs.

MARGUERITE.

A centerboard schooner, designed by Burgess, and built by Geo. Lawley & Son of South Boston. Launched in 1888. The property of R. S. Palmer, of New York City. MARGUERITE sails with the New York, Eastern and Seawanhaka Corinthian Yacht Club Fleets hailing from New York. MARGUERITE has lately been sold to Henry W. Lamb. See Fig. 261 and Plate XXXV.

CODE SIGNAL LETTERS, K, F, G, B.
Official number, 92,001.

DIMENSIONS.			
Length over all,	96 feet 11 inches.	Length load waterline,	79 feet 11 inches.
Depth,	10 feet 7 inches.	Draft,	11 feet.
Beam,	21 feet.		

Racing Record, 1891:—

NEW YORK YACHT CLUB—August 4th, Squadron Run: MARGUERITE beaten by IROQUOIS. Run of August 6th, first, defeating IROQUOIS and GENOXE. Again first in the Squadron Run of the 8th of August; winning from the same yachts. August 10th, Special Cups: MARGUERITE a winner again, defeating IROQUOIS, etc.
BENKER HILL YACHT CLUB—Second in the two races for the championship, both times beaten by GLADYS.
EASTERN YACHT CLUB—Special Race, July 22nd, third.
ATLANTIC YACHT CLUB—Twenty-sixth Annual Regatta, June 16th:

AMERICAN
since
and has
nooner
ember
AVEN

Conn.
Sons,
who is
NEW
g. 260.

mes.

3 inch.

York

DIE,
n New
h and
re W.
Has
holds
of the
grand-
Water
an for
Oddie
est the
FACT
UCINE
S and

y Geo.
operty
th the
CLUB
n sold

mes.

EBITE
g Bro-
of the
special
ete.
cham-

16th:

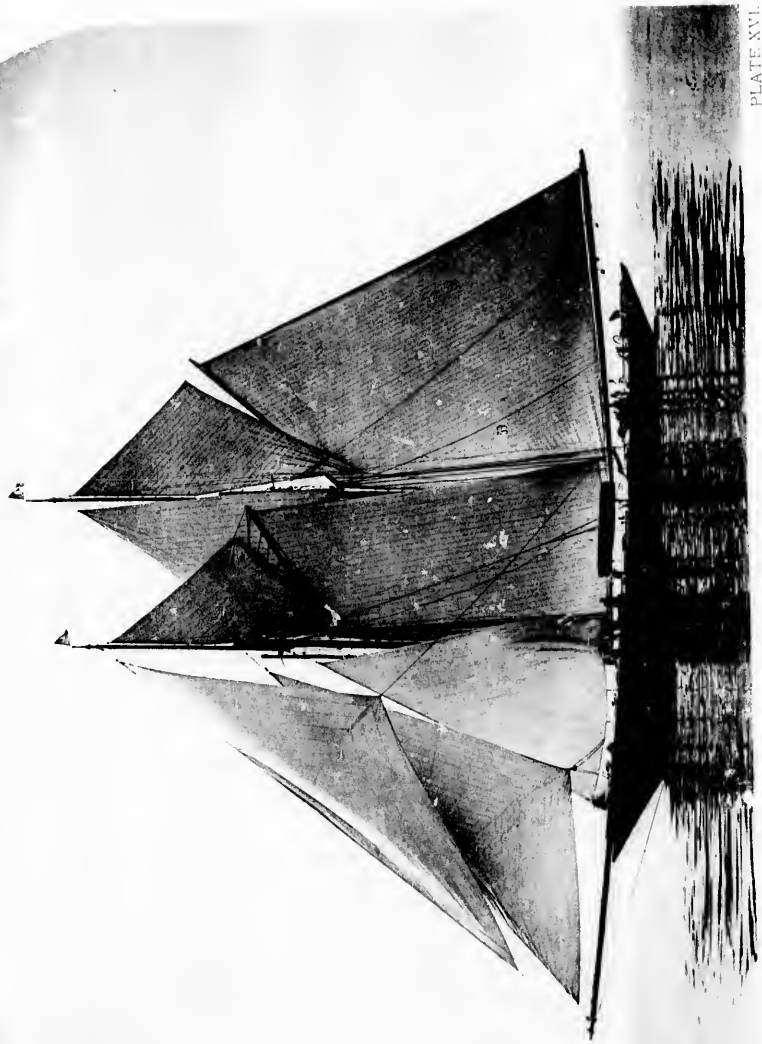

PLATE XVI

LASCA.



ty.
6.
She
SSG.
Cork
Acht

est.
est.

ylinders
ork.
Works.

roll. She
Herreshoff
1893. She
cut Clin.
aters. She
ust 1st; was
as second in
August 8th;

Cup, she was
for further

riosity by the
GILBERT, hoped
ing the ability of
ITANNIA. The
placed upon the

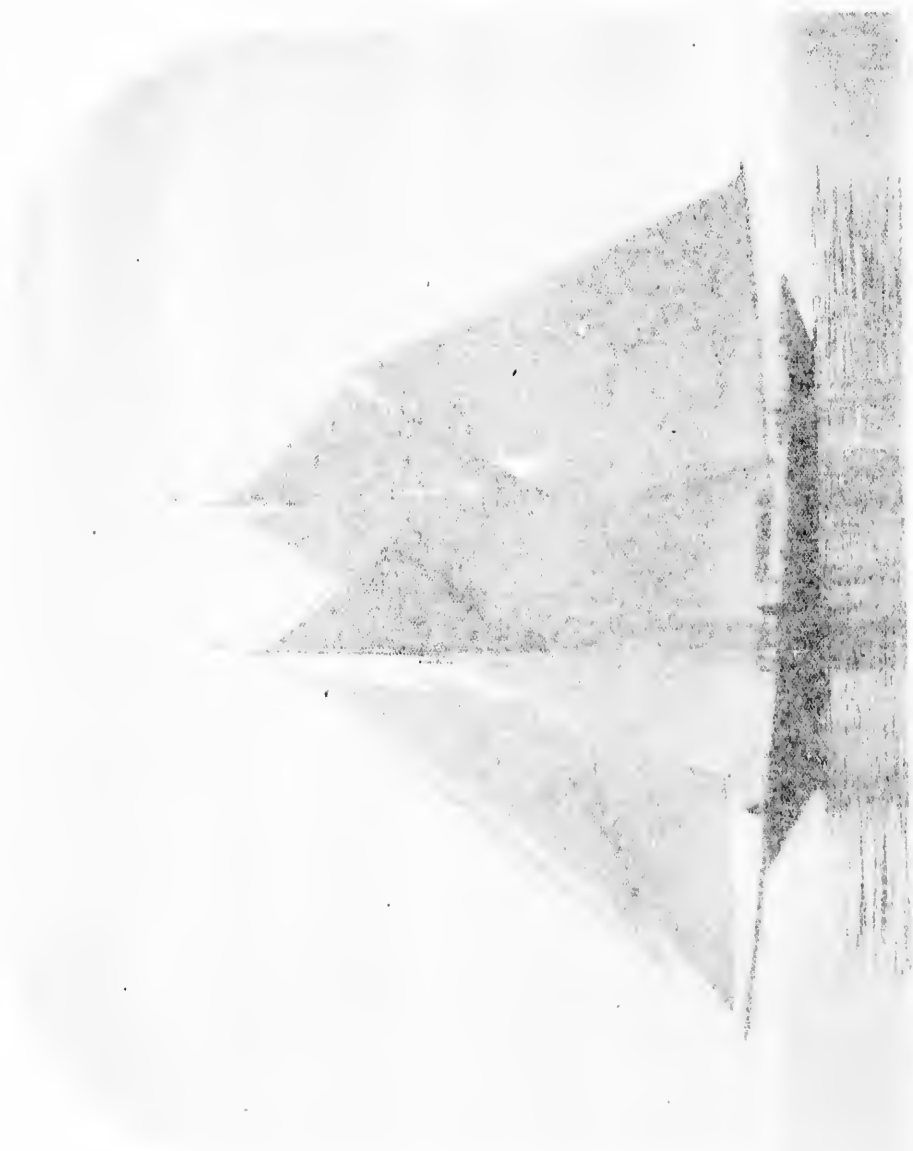

AN

EX

LA

N
and
Gie
Lau
and J

L
D
B
Eng
des
Boil

ST
with th
Handr
The pr
Yacht

Len
Depth
Beam
Engin
and 53 x
Boiler
from 10
are empl



ARCHIT

York YAC

THE YACHTS AND YACHTSMEN OF AMERICA.

MARGUERITE, winner in her class.
 Racing Record for 1892:—

NEW YORK YACHT CLUB—MARGUERITE was beaten by SHAMROCK in the Regatta of June 9th. A winner in the Squadron Run of August 3rd, beating IROQUOIS, etc. Beaten by IROQUOIS on the 5th, MERLIN winning. Beat IROQUOIS in the contest for the Golet Cup, August 6th, and beaten by IROQUOIS and OXONE in the following day. Fourth in the race for the Morgan Cup, August 8th, with nineteen starters. On August 10th, MARGUERITE won the cup offered by Commodore Gerry, beating MERLIN, MAYFLOWER, IROQUOIS, etc. In the Autumn Sweepstakes, September 15th, she won a \$500 Cup and \$600 in money.

ATLANTIC YACHT CLUB—Beaten by SHAMROCK in the Twenty-seventh Annual Regatta, June 14th.

EASTERN YACHT CLUB—In the Annual Regatta, June 27th, MARGUERITE won the first prize of \$100. Beaten later by MAYFLOWER in a Private Sweepstakes.

LARCHMONT YACHT CLUB—MARGUERITE was fourth in the race for the Larchmont Cup for schooners, September 13th, IROQUOIS winning, LASCY second, SHAMROCK third.

SYDIA.

SYDIA is a screw schooner, belonging to Ray V. Pierce, M. D., and hailing from Buffalo, N. Y. She was designed by Henry J. Gielow and built by H. C. Whittingham, Bay Ridge, New York, launched in the year of 1890. Sails with the NEW YORK, BUFFALO and ATLANTIC YACHT CLUBS. See Fig. 262.

CODE SIGNAL LETTERS, K. D. J. M.
 Official Number, 130,486.

DIMENSIONS.	
Length overall,	38 feet 6 inches.
Depth,	9 feet 2 inches.
Beam,	15 feet 10 inches.
Length load waterline,	32 feet 6 inches.
Draft,	6 feet.

Engine: Fore and aft, direct acting, compound inverted, 2 cylinders, 11 in. and 22 x 15 inch.
 Boiler: Water tube, built by Riley & Cowley, Brooklyn.

SULTANA.

SULTANA is a screw topsail yard schooner, built of five-eighths steel with three masts. Was designed by J. Beaver-Webb and built by Handren & Robbins, of Brooklyn, N. Y., and launched in 1889. The property of Trezor L. Park, and sails with the NEW YORK YACHT CLUB. Fig. 263.

CODE SIGNAL LETTERS, K. D. E. A.
 Official Number, 116,332.

DIMENSIONS.	
Length overall,	187 feet 6 inches.
Depth,	16 feet 2 inches.
Beam,	25 feet 6 inches.
Length load waterline,	155 feet.
Draft,	11 feet 6 inches.

Engine: Condensing, triple expansion, three cylinders 13 in., 20 in., and 33 x 24 inch. Built by D. & W. Henderson, of Glasgow.
 Boiler: Two, Belleville, 1891. Her speed under steam alone is from 10 to 12 knots, being much greater when both steam and sail are employed.



ARCHIBALD ROGERS.

ARCHIBALD ROGERS, Hyde Park on Hudson, N. Y., born in Jersey City, N. J., 1832. The son of Edmund P. Rogers; has been a yachtsman for the last thirteen years, and has owned several yachts, BEDOUTS, WASP, TOM BOY, BASTARD and the steamers OSSAROW, DALL HOUB, SPEEDWELL and JETTEL.

He has held many important offices in the different yacht clubs of which he is a member. Vice-Commodore and Commodore of the SEAWASHAKA CORINTHIAN YACHT CLUB, Rear Commodore of the NEW YORK YACHT CLUB, and Treasurer of the HUDSON RIVER ICE

YACHT CLUB. In addition to these clubs, he belongs to the CORINTHIAN, LARCHMONT and EASTERN.

BEDOUTS and WASP were until quite recently owned by Mr. Rogers.

BEDOUTS.*

Owned by Archibald Rogers, New York City, a keel sloop, designed by J. Harvey, and built by H. Piepgras, Greenpoint, N. Y. Launched in 1882, has a cabin, and hails from New York. Sails in the SEAWASHAKA, NEW YORK, EASTERN, CORINTHIAN and LARCHMONT YACHT CLUBS. See Fig. 264.

CODE SIGNAL LETTERS, J. W. K. V.
 Official number, 32,18.

DIMENSIONS.	
Length overall,	81 feet.
Depth,	12 feet 5 inches.
Beam,	15 feet 8 inches.
Length load waterline,	70 feet 1 inch.
Draft,	12 feet.

Racing Record, 1891:—
NEW YORK YACHT CLUB—On August 4th, in a Squadron Run, BEDOUTS was beaten by KATHINA, the former being second with four starters.
 On August 10, BEDOUTS beat HUCON in a special cup race of twenty-five miles.

WASP.

A keel sloop, owned by Archibald Rogers, designed by N. G. Herreshoff, and built by the Herreshoff Mfg. Co., Bristol, R. I. Launched 1892. WASP was chartered last summer to Edward R. Coleman, and has since been sold to the Lippitt Bros. of the NARRAGANSETT YACHT CLUB. See Fig. 64 and Plate XXVI.

DIMENSIONS.	
Length overall,	32 feet.
Depth,	9 feet 2 inches.
Beam,	13 feet.
Length load waterline,	45 feet 6 inches.
Draft,	10 feet 8 inches.

Racing Record for 1892:—
NEW YORK YACHT CLUB—First in the Regatta sailed June 9th, beating CLARA. Won in the Squadron Run sailed August 3rd, defeating SAVONARA, GLORIANA and LIBIS. Beaten by GLORIANA on August 4th, and beaten by both HARPOON and GRACIE (the latter winning) in the race for the Golet Cup, August 5th. Squadron Run of August 8th, WASP won from GLORIANA, etc. Won the Morgan cup for sloops on August 8th. She also won Commodore Gerry's cup for sloops on the 10th of August, beating HARPOON, BARBARA and GLORIANA.

ATLANTIC YACHT CLUB—WASP was the winner in her class in the Twenty-seventh Annual Regatta, sailed June 14th.
EASTERN YACHT CLUB—In the Annual Regatta, June 27th, WASP won a first prize of \$75 and also the PUGHAN Cup for year. In a Special Race for purse of \$250, sailed August 11th, WASP won again, beating HARPOON and GLORIANA.
SEAWASHAKA CORINTHIAN YACHT CLUB—Annual Regatta, July 2nd, WASP was the winner in her class.
LARCHMONT YACHT CLUB—The winner in her class, in the Thirtieth Annual Regatta, sailed July 4th.
MARINE AND FIELD YACHT CLUB—WASP won in her class June 11th.
CORINTHIAN YACHT CLUB OF NEW YORK—WASP was the winner of the Fourth Annual Sweepstakes, sailed at Newport, August 22nd. HARPOON and GLORIANA were also entered.

CHARLOTTE.

A screw steamer, formerly called JERSEY LILY, the property of William J. Riker, of New York. Was designed by N. G. Herreshoff, and built by the Herreshoff Mfg. Co., being launched in April, 1888. Hails from New York City, and sails with the NEW YORK YACHT CLUB. Fig. 265.

Official Number, 126,648.

*Present owners Sam'l Mather and C. W. Wetmore.

lers

arks,

She

shoff

She

Club.

She

was

and in

t 8th :

he was

further

by the

5, hoped

bility of

s. The

upon the

DIMENSIONS.			
Length over all,	65 feet.	Length load waterline,	61 feet.
Depth,	5 feet 6 inches.	Draft,	3 feet 6 inches.
Beam,	10 feet.		

Engine: Triple expansion, condensing, vertical, three cylinders, lin. $6\frac{1}{2}$ in. and 10 x 8 inch. Built by Herreshoff in 1888.

Boiler: Water Tube, 1892. Built by Chas. L. Seabury & Co., Nyaek, New York.

HARBINGER.

A centerboard schooner, designed by A. C. Smith and built by Lawley & Son. Was launched in July, 1881. Now owned by Henry G. Russell and hailing from Providence, R. I. HARBINGER sails with the NEW YORK and other yacht clubs. See Fig. 266.

CODE SIGNAL LETTERS, U. D. S. L.

Official Number, 95,913.

DIMENSIONS.			
Length over all,	38 feet 6 inches.	Length load waterline,	35 feet 8 inches.
Depth,	7 feet 6 inches.	Draft,	6 feet 4 inches.
Beam,	19 feet 3 inches.		



JOHN D. SMITH.

JOHN D. SMITH, banker and broker, late Commodore of the NEW YORK YACHT CLUB, born in 1831 in Exeter, Rockingham county, N. H., son of John and Ester Mary Smith, member of the NEW YORK, ATLANTIC, LARCHMONT, OAK BLUFF'S, RIVERSIDE and STAMFORD YACHT CLUBS, held the position of Commodore of the NEW YORK YACHT CLUB for two years; has been the owner of four yachts; the schooner ESCORT, steam yacht IALIA, schooner ESTELLE, and the sloop POCAHONTAS, the latter

being his present yacht; was chairman of the committee appointed by the NEW YORK YACHT CLUB to protect the interest of AMERICA'S CUP in the race which took place in 1886, when GALATEA competed, in 1887 when THISTLE contended, in 1889 when VALKYRIE intended to compete, and was on the committee last year.

Few yachtsmen have taken such an active interest in yachting, and few are regarded as such high authority in matters relative to yachting.

Commodore Smith has held many other prominent positions, having been President of the New York Stock Exchange for two years, and President of the New York Club for six years.

POCAHONTAS.

Wooden centerboard sloop, designed by David Kirby and built by him also, for J. R. Walter, J. D. Smith and Herman Gelrich. The property of Jas. D. Smith for the past five years. Hails from New York. Sails with the NEW YORK, ATLANTIC, LARCHMONT and STAMFORD YACHT CLUBS. See Fig. 267.

Official Number, 150,231.

DIMENSIONS.			
Length over all,	72 feet.	Length load waterline,	67 feet 10 inches.
Depth,	7 feet.	Draft,	7 feet 6 inches.
Beam,	21 feet 6 inches.		

Spars: Mast, 74 ft., Topmast, 40 ft., Boom, 65 ft., Gaff, 35 ft., Bowsprit, 25 ft., Spinnaker Boom, 75 ft.

Ballast (inside) 20 tons. New measurement, 49.24.

PALMER.

A keel schooner, the property of Rutherford Stuyvesant of New York City. She was built by T. Byerly & Sons, Philadelphia, and was launched in 1865. Has been several times altered; in 1871 by Steers, and again in 1874. Rebuilt by Piegras in 1887. One of the

well-known yachts of the earlier days of the NEW YORK YACHT CLUB, in whose fleet she may still be seen. See Fig. 268.

CODE SIGNAL LETTERS, H. P. T. W.
Official number, 20,147.

DIMENSIONS.			
Length over all,	48 feet 4 inches.	Length load waterline,	44 feet 3 inches.
Depth,	10 feet.	Draft,	12 feet.
Beam,	24 feet 2 inches.		

Racing Record, 1891:—

NEW YORK YACHT CLUB—Second in the Squadron Run of August 4th, being beaten by CONSTELLATION. Won on August 6th, beating ISTREPID. Third in the run of the 8th of August, four starters. On August 10th, in contest for special cups, she came in third, with five starters. Beaten by CONSTELLATION on August 14th.

ERNEST STAPLES, born in New York City in 1847, the son of Wm. J. Staples. Was Minister to France under Polk. A member of the NEW YORK, EASTERN, LARCHMONT, AMERICAN and NEW ROCHELLE YACHT CLUBS. The owner of the sloop WIZARD, his yacht for four years. Sailed as judge for James Gordon Bennett in the Ocean Race of 1866, between FLEETWING, HENRIETTA and VESTA. Also sailed in DAUNTLESS in the Ocean Race of 1887 to Queenstown, when DAUNTLESS sailed against CORONET. Mr. Staples is highly respected by all who know him.

WIZARD.

A centerboard sloop, belonging to Ernest Staples of New York City, a member of the EASTERN, LARCHMONT, AMERICAN, NEW YORK and NEW ROCHELLE YACHT CLUBS. Designed by Philip Ellsworth, and built by E. Young, Greenpoint, N. Y., and launched in 1880. Rebuilt and lengthened 15 feet in 1882 by J. C. Terry; and rebuilt in '89 by C. & R. Poillon. Has been owned by Mr. Staples four years. She hails from New York.

CODE SIGNAL LETTERS, K. C. Q. D.

Official number, 80,769.

DIMENSIONS.			
Length over all,	63 feet.	Length load waterline,	58 feet.
Depth,	5 feet 3 inches.	Draft,	7 feet 10 inches.
Beam,	18 feet 4 inches.		

CLERMONT.

A side wheel schooner, designed and owned by Alfred Van Santvoord of New York City. Built by H. Lawrence, Greenpoint, L. I. Was launched in March, 1892. Sails with the yachts of the NEW YORK YACHT CLUB. CLERMONT has the distinction of being the only side wheel yacht in America. See plate XXXVI.

DIMENSIONS.

Length over all,	100 feet.	Length load waterline,	130 feet.
Depth,	10 feet 6 inches.	Draft,	5 feet 6 inches.
Beam,	25 feet.		

Engine: Surface condensing, beam engine, 40 x 72 inch. Built by W. & A. Fletcher & Co.

Boiler: Return flue, built by H. Lawrence.

HARING.

A screw schooner, belonging to L. de Ver Warner of Bridgport, Conn. She was designed by J. Lorillas and built by Samuel Pine, Greenpoint, N. Y. Was launched in 1863 and sails with the NEW YORK YACHT CLUB. Was lengthened in 1890-91. HARING has recently been sold to George M. Preston of Boston. See Fig. 269.

CODE SIGNAL LETTERS, K. D. S. D.

Official number, 157,180.

DIMENSIONS.			
Length over all,	105 feet 6 inches.	Length load waterline,	88 feet.
Depth,	6 feet 4 inches.	Draft,	6 feet 4 inches.
Beam,	36 feet.		

Engine: Vertical compound condensing, 2 cylinders, 10 in. and 21 x 12 inch.

Boiler: Vertical tubular; both engine and boiler by Green.

CONQUEROR.

Fred W. VanJerbilt's steam yacht CONQUEROR is a screw schooner. She was designed by W. Cornel and built by Russell & Co., Port Glasgow. She is constructed of iron and was launched in February, 1889. Hails from New York City; and sails with the fleet of the NEW YORK and LARCHMONT YACHT CLUBS. See plate XXXVIII.

DIMENSIONS.		DIMENSIONS.	
Length over all,	261 feet.	Length load waterline,	188 feet.
Depth,	13 feet 5 inches.	Draft,	13 feet.
Beam,	21 feet 6 inches.		

Engine: Inverted, triple expansion, 3 cylinders, 15½ in., 24 in. and 40 x 33 inch. Built by W. King & Co.

Boiler: Steel.



HENRY D. TIFFANY.

He was graduated from Yale College in 1864. Mr. Tiffany is the descendant of the maker of the dies for the first silver coinage of 1652, the "pine tree" shillings. The land upon which the "Fox Homestead" now stands, was granted to an ancestor of Mr. Tiffany in the year 1660, so that the present owner is the eighth generation to live on the soil of his forefathers.

Mr. Tiffany is a member of the NEW YORK YACHT CLUB, and the owner of the yacht VENTURA, a yacht of his own designing, and built in accordance with a carefully thought-out theory of his own.

VENTURA.

VENTURA is a keel cutter, personally designed and built by Henry D. Tiffany of New York City, a member of the LARCHMONT YACHT CLUB. She was launched on the Bronx River, in August, 1890. She was altered in several particulars in 1892, having her stern carried out and her keel lowered. She hails from New York. Was chartered by Willard H. Jones last summer but has recently been sold. See plate XXXIV.

Official number, 161,642.

DIMENSIONS.		DIMENSIONS.	
Length over all,	73 feet 3 inches.	Length load waterline,	57 feet.
Depth,	11 feet 11 inches.	Draft,	9 feet.
Beam,	13 feet.		

Spars: Mast, keel to truck, 70 ft. 3 in.; Topmast, keel to truck, 34 ft. 10 in.; Main Boom, 51 ft. 9 in.; Spinnaker, 44 ft. 6 in.; Gaff 31 ft. 2 in.; Bowsprit, 30 ft. 7 in.



BENJAMIN MORRIS WHITLOCK.

BENJAMIN MORRIS WHITLOCK, New York City, N. Y.; was born in New York City; he is the son of Benjamin M. and A. M. Whitlock. He is President of the Boston Woven Cordage Co., and General Inspector of Rifle Practice of the State of New York—on the staff of Gov. Flower. He has been a yachtsman for fifteen years and has been the owner of the sloop IDLER and the yacht THISTLE while his present yacht is the launch BRAT. He is a member of the NEW YORK and SEAWASHAKA CORINTHIAN YACHT CLUBS.

WADENA.

A screw schooner (steel), designed and built by the Cleveland Ship Building Co. for J. H. Wade, her present owner, and launched in 1891. She hails from New York, and sails with the NEW YORK and SEAWASHAKA CORINTHIAN YACHT CLUBS. See Fig. 269.

Official number, 81,316.

DIMENSIONS.		DIMENSIONS.	
Length over all,	155 feet.	Length load waterline,	117 feet.
Depth,	12 feet.	Draft,	10 feet 6 inches.
Beam,	21 feet.		

Engine: Triple expansion, 3 cylinders, 15½ in., 26 in., and 42 x 22 inch.

Boiler: Return tubular, 12 ft. x 12½ ft., 600 indicated H. P., A speed of 13 knots. Stroke of piston, 22 in.



J. BURKE WOLFE.

J. BURKE WOLFE, importer, New York, was born in New York, the son of Ubaldo Wolfe and Anna T. Burke. He is the owner of the steam yacht RADUA, and has likewise been the owner of NIVANA. Has been interested in yachting for more than twenty years, and is a member of the NEW YORK and SEAWASHAKA CORINTHIAN YACHT CLUBS.

RADUA.

A screw schooner, owned by J. Burke Wolfe of New York City, was designed by Gustav Hillman and built by Ward, Stanton & Co., Newburgh, N. Y., and launched in 1881 for Pierre Lorillard. She has a cabin, a large saloon and six state rooms. Was re-built in 1886, and had four feet added to her bow in 1890. She hails from New York and sails with the NEW YORK and SEAWASHAKA CORINTHIAN YACHT CLUBS. See plate XXXVII.

CODE SIGNAL LETTERS, K. G. S. R.

Official number, 110,460.

DIMENSIONS.		DIMENSIONS.	
Length over all,	140 feet.	Length load waterline,	112 feet.
Depth,	12 feet.	Draft,	9 feet.
Beam,	20 feet 11 inches.		

Engine: Horizontal surface condensing, triple expansion, cylinders 13½ in., 23 in. and 35 x 24 inch. John W. Sullivan, New York.

Boiler: Scotch return tubular, 1891. Lake Erie Boiler Works, Buffalo, N. Y. Horse power, 800; speed about 17 knots.

NAVAHOE.

Centerboard cutter yacht, owned by Royal Phelps Carroll. She was designed by N. G. Herreshoff and was built by the Herreshoff Manufacturing Company, being launched in February, 1893. She hails from New York, and sails with the NEW YORK YACHT CLUB.

NAVAHOE took part in numerous races in English waters. She was first in the Royal Southampton Regatta sailed August 1-11; was first in a regatta of the same club sailed August 5th; was second in the ROYAL VICTORIA YACHT CLUB Regatta, sailed August 8th; was second in the Start Bay Regatta, sailed August 27th.

In her race with BRITANNIA for the Breton's Reef Cup, she was finally declared the winner. (See pages 22 and 23 for further details.)

NAVAHOE was regarded with great interest and curiosity by the critics who, knowing her decided resemblance to VIGILANT, hoped to be able to draw some definite conclusions concerning the ability of the latter by the success NAVAHOE had with BRITANNIA. The results only go to show how little dependence can be placed on the

fact of resemblance, especially when that greater factor, circumstance, sees fit to take a hand.

DIMENSIONS.			
Length over all,	120 feet.	Length load waterline,	84 feet 6 inches.
Beam,	25 feet.	Draft,	12 feet.

VIGILANT.

VIGILANT, the pride of America, was launched June 14th, 1893. She was designed by N. G. Herreshoff and built by the Herreshoff Manufacturing Company. She is a keel centerboard yacht, and is owned by C. O. Iselin and a syndicate of yachtsmen. She is built of Tabin bronze and steel, the use of the bronze on her bottom being largely an experiment. She sails with the NEW YORK YACHT CLUB, and hails from New York City. See plate I and Fig. 105.

In the Second Trial Race September 9, 1893, VIGILANT beat COLONIA 8 min., 9 sec., also defeating JUBILEE and PILGRIM. VIGILANT likewise won in the Third Trial Race, beating COLONIA by 6 min., 43 sec., and again defeated JUBILEE and PILGRIM.

In the race for AMERICA'S CUP, October 7, 1893, VIGILANT beat VALKYRIE 5 min., 48 sec. On October 9, 1893, VIGILANT won the second race, beating VALKYRIE 10 min., 35 sec., and on October 13, 1893, she won the third race by 40 seconds corrected time, thus protecting the cup. (For details see pages 74, 75, 76, and also chapter relative to AMERICA'S CUP, Volume II.)

DIMENSIONS.			
Length over all,	128 feet.	Length load waterline,	86.12 feet.
Beam,	26 feet.	Draft,	11 feet.

VALKYRIE.

A keel composite cutter, designed by G. L. Watson and built by D. & W. Henderson & Co. of Glasgow, Scotland, for the Earl of Dunraven. She was launched April 29, 1893.

DIMENSIONS (as obtained from England).

Length over all,	126 feet.	Length load waterline,	85 feet 6 inches.
Beam,	20 feet 6 inches.	Draft,	16 feet 6 inches.
Sail area,	10,297 sq. ft.	Rating,	17,700 feet.

(For record of her races in this country, see pages 74, 75 and 76, and also chapter relative to AMERICA'S CUP in volume II.)

COLONIA.

A steel cutter, designed by N. G. Herreshoff, and built by the Herreshoff Manufacturing Company, Bristol, R. I. She was built for the defense of the AMERICA'S CUP. She was, however, defeated in the Trial Races. COLONIA was launched in May, 1893, and is owned by Archibald Rogers, *et al.* She sails with the fleets of the NEW YORK, EASTERN, SEAWANAHAKA CORINTHIAN, LARCHMONT

and CORINTHIAN (of New York) YACHT CLUBS, hailing from New York City.

In the race of August 7, 1893, for the Commodore's Cup, NEW YORK YACHT CLUB, COLONIA won, beating QUEEN MAH and HILDEGARD; VIGILANT was disabled. In the race August 11, 1893, for the Golet Cup, COLONIA won, defeating VIGILANT and JUBILEE; PILGRIM withdrew.

In the First Trial Race, September 7, 1893, COLONIA won, beating VIGILANT. In this race JUBILEE was disabled and PILGRIM did not start. (See pages 73 and 74 for details.)

DIMENSIONS.			
Length over all,	120 feet.	Length load waterline,	85.48 feet.
Beam,	25 feet.	Draft,	15 feet 9 inches.

PILGRIM.

A fin-keel cutter yacht, built of steel. She was designed by Stewart & Binney, and built by Pusey & Jones, of Wilmington, Delaware. PILGRIM is owned by R. S. Palmer, *et al.*, and was launched June 12, 1893.

In the race for the Astor Cups, August 19, 1893, PILGRIM raced with VIGILANT and was beaten 24 min., 33 sec. In the first trial race PILGRIM did not start. In the second trial race she was third, beating COLONIA. In the third trial race PILGRIM was last, being beaten by VIGILANT 29 min., 36 sec. (See pages 73 and 74 for particulars.)

DIMENSIONS.			
Length over all,	120 feet.	Length load waterline,	85.28 feet.
Beam,	25 feet.	Draft,	22 feet.

JUBILEE.

Was designed by John B. Paine, and was built by Geo. Lawley & Son Corporation, South Boston, Mass., being launched June 11, 1893. She is a bulb-fin centerboard cutter, and is owned by Gen. Chas. J. Paine, of Boston. She is built of steel. JUBILEE hails from Boston, and sails with the NEW YORK, ATLANTIC, PORTLAND, EASTERN, SEAWANAHAKA CORINTHIAN, BEVELLY, NEW BEDFORD and CORINTHIAN (of Massachusetts) YACHT CLUBS.

In the race August 10, 1893, from New London to Newport between JUBILEE and VIGILANT, the latter won by 1 min., 11 sec., JUBILEE was third in the race for the Golet Cup, August 11, 1893, COLONIA winning.

JUBILEE beat COLONIA in the run from Newport to Vineyard Haven, but was beaten by VIGILANT 10 min., 42 sec. In the first trial race JUBILEE was second, being beaten by VIGILANT 4 min., 32 sec., but beating COLONIA and PILGRIM; and in the third trial race JUBILEE was third. (See pages 73 and 74 for details.)

DIMENSIONS.			
Length over all,	125 feet.	Length load waterline,	81.47 feet.
Beam,	22 feet 6 inches.	Draft,	14 feet.

, hailing from New

modore's Cup, NEW
EN MAN and HILDE-
August 11, 1893, for
EAST and JUBILEE;

LOXIA won, beating
and PIGGIM did not

85.48 feet.
15 feet 9 inches.

s designed by Stew-
mington, Delaware.
s launched June 12.

393. PIGGIM raced
In the first trial
race she was third.
PIM was last, being
73 and 74 for par-

85.28 feet.
22 feet.

by Geo. Lawley &
unched June 11.
is owned by Gen.
UBILEE hails from
. PORTLAND, EAS-
EW BEDFORD and

n to Newport be-
y 1 min., 11 secs.
August 11, 1893.

port to Vineyard
sec. In the first
BLANT 4 min., 32
e third trial race
(ills.)

81.47 feet.
14 feet.



FROM A NEGATIVE BY BRUCE, TORONTO.

ROYAL CANADIAN YACHT CLUB HOUSE.

ROYAL CANADIAN YACHT CLUB HOUSE.

ord
ion.
as
Mr.
ith
wu

ter
se
ns
re
re
g
r

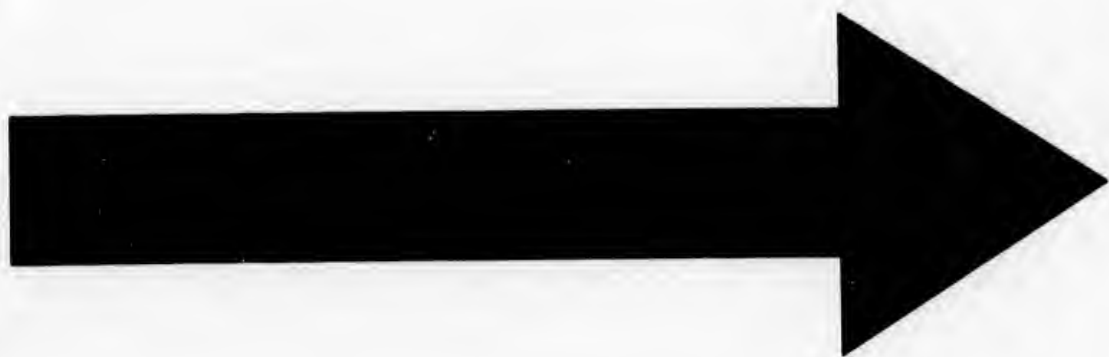

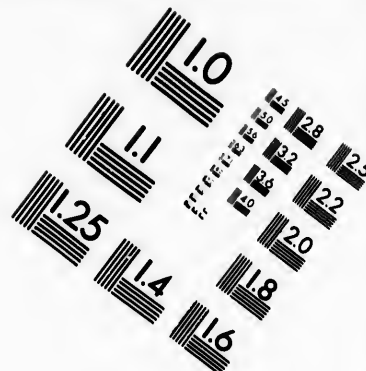
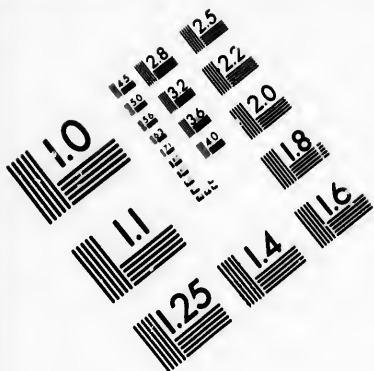

**IMAGE EVALUATION
TEST TARGET (MT-3)**

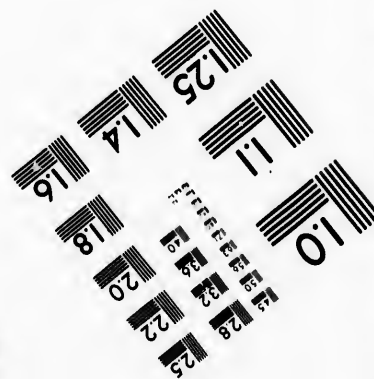
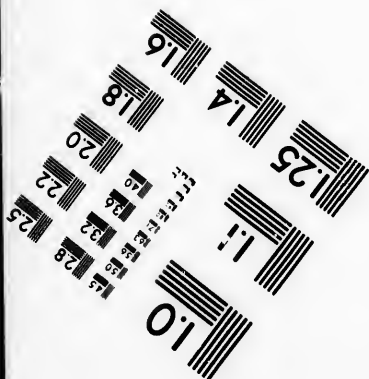
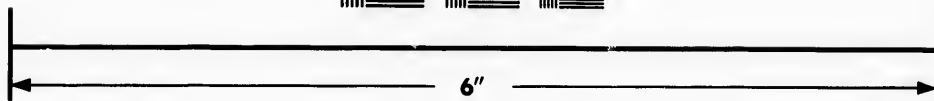
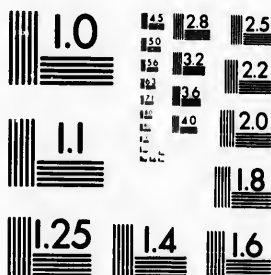

**Photographic
Sciences
Corporation**

23 WEST MAIN STREET
WEBSTER, N.Y. 14580
(716) 872-4503

1.5
1.8
2.0
2.2
2.5
2.8
3.2
3.6
4.0
4.5
5.0
5.6
6.3
7.1
8.0
9.0
10.0
11.2
12.5
14.0
16.0
18.0
20.0
22.5
25.0
28.0
32.0
36.0
40.0
45.0
50.0
56.0
63.0
71.0
80.0
90.0
100.0

1.5
1.8
2.0
2.2
2.5
2.8
3.2
3.6
4.0
4.5
5.0
5.6
6.3
7.1
8.0
9.0
10.0
11.2
12.5
14.0
16.0
18.0
20.0
22.5
25.0
28.0
32.0
36.0
40.0
45.0
50.0
56.0
63.0
71.0
80.0
90.0
100.0



SCHOOL BUILDING, ...

History of the Royal Canadian Yacht Club.

THE suitability of the Canadian lakes for yachting* cannot be better illustrated than by the fact that this comparatively new country possesses one of the largest yacht clubs in the world. The ROYAL CANADIAN YACHT CLUB of Toronto enjoys this enviable distinction. It has a membership of seven hundred and fifty. This club was organized in 1852 by a small but enthusiastic coterie of men, one or two of whom are still living to note the marvelous growth of their pet project. Prominent among these and still living are Messrs. William Armstrong, C. E. John Arnold, Charles Heath, Thomas Shortiss (since deceased), Dr. Hodder, Major Magrath and Captain Fellows. It was first known as the CANADIAN YACHT CLUB, with headquarters at Toronto. In August, 1854, it was authorized by her Majesty to assume the

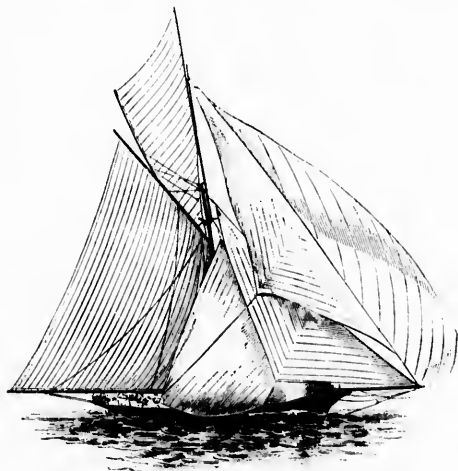

VREDA.—FIGURE 275.

style of Royal, and in 1858 permission was given by the Admiralty to the club to wear the blue ensign of her Majesty's fleet with a crown in the fly.

The first meetings of the original promoters of the club were held in the office of Captain Fellows, commission merchant, on Melinda street. There, seated on flour barrels, the club scheme was projected and further matured at the latter conclaves held in a room over John Seel's saloon, which stood near the present Academy of Music on King street. The first building used by the club was owned by Messrs. Gzowski and Macpherson and stood where the Union Station now stands. The first Club House proper was erected on a scow and was moored just west of what was known as Rees' Wharf. This house was occupied by the club until 1858, when it was found so seriously injured by muskrats and heavy weather that it had to be abandoned. The club then purchased the wrecking steamer

*See the Toronto "Saturday Night."

PROVINCIAL which was fitted up as a Club House and moored between Tinning's and Rees' wharves, opposite the Union Station. This was found to be a very unsatisfactory resting place, however, as the vessels frequently contrived to get adrift. "Often" said Mr. William Armstrong, "was I called up in the middle of the night with the information that she had broken loose, and then I had to go down and put in the rest of the night getting her fast again."

This ship was occupied until 1869, when the club acquired a water lot west of Rees' wharf, where they erected a commodious Club House and a substantial wharf. During the Autumn of 1873 the club engaged for use during the winter months the premises now known as Club Chambers. In 1874 the property on King street adjoining the old Montreal House was purchased as a town Club House. Here they remained until 1877, when a social union was effected with the TORONTO CLUB, the ROYAL CANADIAN YACHT CLUB still retaining their water Club House and their individuality as yachtsmen. In 1880, finding that they were being crowded out of an anchorage for their yachts, the club sold their water premises to the Grand Trunk, and having obtained a suitable site on the island erected their present Club House. A city landing and Club House were secured at the foot of Lorne street, and the steam yacht ESPERANZA was purchased to convey the members of the club to and fro. In 1889, the ROYAL CANADIAN YACHT CLUB and the TORONTO YACHT CLUB (the latter of which had been in existence since 1880) effected an amalgamation. The Lorne street landing was disposed of and the new organization retained the Club House of the TORONTO CLUB as their own headquarters and landing place.

Thus the ROYAL CANADIAN YACHT CLUB is at present very comfortably situated with regard to club equipment, although the town headquarters are rather insufficient and will be improved at an early date. Their island home is a commodious and well equipped summer club. The site was chosen by the present Honorary Secretary, Mr. S. Bruce Harman and Colonel Grasett, the latter having been Honorary Secretary previously for a number of years. Ten acres of

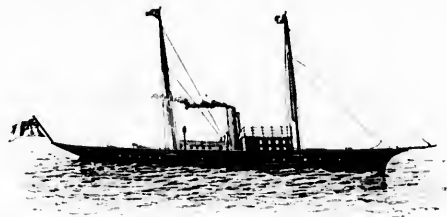

CLEOPATRA.—FIGURE 276.

marsh land were leased from the city and on this ground, reclaimed and filled, was erected the present handsome structure. The lawn is one of the most beautiful in the city and contains a tennis court, bowling and quoit grounds. Within the building is a comprehensive steward's department, fully competent to cope with a yachtsman's appetite—a first class recommendation. The dining room, drawing room, reading and billiard rooms are neatly and comfortably furnished throughout.

The patrons of the ROYAL CANADIAN YACHT CLUB are H. R. H. the Prince of Wales, H. R. H. the Duke of Connaught and the Governor General of Canada. When the Prince of Wales visited Canada in 1860 a regatta was held in his honor. In return for this he presented the club with a beautiful challenge cup valued at £500 sterling, which is raced for annually on September 7th, unless that day falls on Sunday. The cup is in the form of a vase of frosted silver, partly burnished. Two principal medallions in low relief illustrate the incident in the voyage of Columbus when he quells his mutinous sailors and the coding of the land afterwards called Pennsylvania to William Penn. Two graceful female figures form the handles;

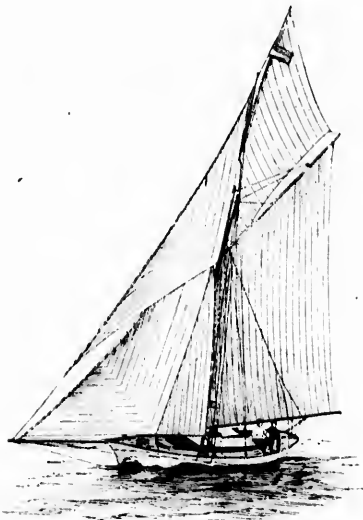

KELME.—FIGURE 277.

the cover of the cup is surmounted by a figure of Britannia. The base is of ebony, bearing two shields with the arms of the Prince of Wales.

The following yachts have won this cup since its presentation: In 1861, WIDEAWAKE; 1862, '63, '64, GORILLA; 1865, '66, no race on account of bad weather; in 1867, RIPPLE; 1868, GERALDINE; 1869, no race; 1870, IDA OF LACHINE; 1871, race abandoned; 1872, GORILLA; 1873, IONA; 1874, no race; 1875, ORIOLE; 1876, BRUNETTE; 1877, '78, '79, ORIOLE; 1880, MADCAP; 1881, no race; 1882, CYGNET; 1883, '84, '85, AILEEN; 1886, '87, '88, '89, '90, ORIOLE (new); VREDA in 1891; ORIOLE in 1892 and ZELMA in 1893.

Over \$2,000 is spent annually by the club on regattas. Besides the Prince of Wales' Cup, the following challenge cups have been presented to and are held by the club and raced for annually: Lansdowne, Murray, Lorne, Cosgrave and McGaw. Other cups have been presented at times to be held by the winner. Notable among these is the John Weir Anderson Cup.

The Royal Canadian Yacht Club is socially an important body, comprising as it does many of the ablest and wealthiest men of the city. It has always been self-sustaining. The ball of the club is one of the features of Toronto's gay season, and garden parties, socials, etc., at the Island in Summer, and smoking concerts at the town Club House in Winter complete the chain of sociability which extends over the whole year. Although the membership of the club includes no ladies, still this does not debar the fair sex from participating

in many a quiet sailing party, as well as in the gaieties on terra firma.

The officers for the year 1893 are as follows:

Commodore,	A. R. Boswell.
Vice-Commodore,	C. A. B. Brown.
Rear Commodore,	N. B. Dick.
Hon'y Secretary,	S. Bruce Harman.

ACCORDING TO THE RULES AND REGULATIONS:

All club races shall be governed by the sailing regulations of the L. Y. R. A., subject to any exceptions made by these rules.

Each home yacht exclusively owned, and each foreign yacht one-half owned by a member or members of the club, shall be enrolled as a club yacht, on written application specifying her name, class, rig and ownership being made to the Assistant Secretary. No yacht shall be allowed to sail for any of the club's cups unless exclusively owned by a member or members of the club resident in the Dominion of Canada.

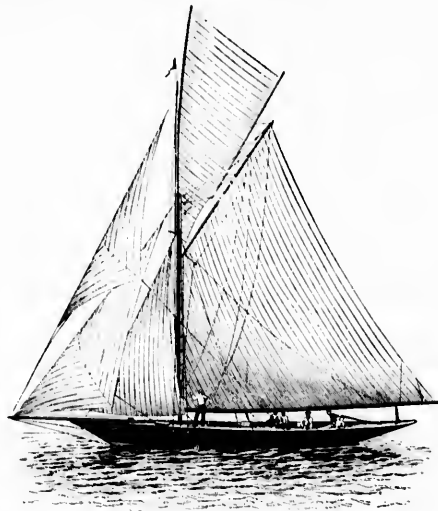

ZELMA.—FIGURE 278.

Yachts shall be classified according to their corrected length as follows:

First Class—Yachts over 46 feet corrected length.

46 foot Class—Yachts over 30 feet, up to and including 46 feet, corrected length.

30 foot Class—Yachts over 25 feet, up to and including 30 feet, corrected length.

25 foot Class—Yachts over 21 feet, up to and including 25 feet, corrected length.

21 foot Class—Yachts 21 feet and under.

There shall be no time allowed in skiff class races.

The start in every race shall be a flying one, and no time shall be allowed for crossing the line.

There shall be a time limit of four hours in local races for the 30, 25, and 21 foot and skiff classes.

No one but Corinthian yachtsmen will be allowed to sail in club races except in the cruising class. In this class only such professional or professionals shall sail on each yacht as may be regularly employed to take charge of and to sail on her throughout the season, and in no case shall any such professional act as sailing master or direct in any way the management or working of the yacht. Yachts under 40 feet corrected length and skiffs must be steered in club races by members of the ROYAL CANADIAN YACHT CLUB.

CLASSIFIED LIST OF CLUB FLEET—1893.

FIRST CLASS.	OWNER.	PORT	HIG	K. or C. R.	L. W. T.	HACING LENGTH
Aileen	H. Myles	Toronto	Cutter	k	55.	50.00
Lady Evelyn	Sir R. Cameron	New York	Schooner	k	92.	94.50
Orjole	George Gooderham	Toronto	"	k & c h	73.	74.77
Vesta	A. B. Boswell, <i>et al</i>	"	Cutter	k	45.16	45.89
FORTY-SIX FOOTERS.						
Aggie	Marlatt & Armstrong	Oakville	Cutter	k	40.01	41.14
Conlor	C. A. Brown <i>et al.</i>	Toronto	"	k	39.	42.7
Papoose	J. P. Mott	Oswego	"	k	37.97	42.37
Whistling	E. Clarke <i>et al</i>	Toronto	"	s	36.16	40.75
Verve	J. Hendri	Hamilton	"	k	41.66	44.29
FORTY FOOTERS.						
Idolante	W. H. Biggar	Belleville	Sloop	e b	34.66	37.23
Laura	S. C. Calvin	Kingston	"	e b	36.92
Vision	Black & Burnet	Cobourg	"	e b	30.73	35.21
Norma	F. Strange	Kingston	Cutter	k	34.8	34.17
Zelma	N. B. Dick <i>et al.</i>	Toronto	"	k	37.32	39.95
Lenore	J. H. Plummer	"	Yawl	k
THIRTY-FIVE FOOTERS.						
Cricket	Jas. Thompson	Tonawanda	Cutter	k	32.59	34.66
Cyprus	W. S. Thompson	Toronto	"	k	32.8
THIRTY FOOTERS.						
Emma	L. V. Percival	Toronto	Cutter	k	26.	29.76
Vedette	Reed & Gray	"	Lugger	k & c h	31.	29.91
Wona	C. C. Gray	"	Cutter	k	21.25	27.52
TWENTY-FIVE FOOTERS.						
Ariel	M. de S. Waskel <i>et al</i>	Toronto	Cutter	k	22.42	24.46
Brenda	A. A. Allan	"	Sloop	e b	21.08	22.00
Ehru	G. P. Reid	"	"	e b	19.25	21.13
Hilda	H. Jennings	"	"	e b	20.08	22.69
Kelpie	F. Dallas <i>et al.</i>	"	Cutter	k	21.5	24.98
Emmie	J. King	"	"	k	22.10	24.06
Volante	Chas. Black	"	Sloop	e b	20.16	21.52
Wa Wa	S. H. Townsend	"	Lugger	k	22.75	24.86
TWENTY-ONE FOOTERS.						
Christabel	G. Crean	Toronto	Sloop	k	19.33	21.
Caprice	N. B. Eagan	"	"	e b	18.	20.45
Erebless	George Chisolm	Buffalo	Cutter	k	18.10	20.26
Gwendoline	G. Robertson	Toronto	Lugger	e b	18.58	17.94
Pixie	Capt. Stuart	"	Yawl	e b	17.16	18.3
Heemih	W. H. Parsons	"	Lugger	e b	19.06	18.59
Kathleen	H. D. Ellis	"	Sloop	e b	18.75	19.19
Thistlesdown	E. Jarvis	"	Lugger	e b	20.47
SKIFF CLASS.						
Egeria	E. C. Thompson	Toronto	Sloop	e b		
I. C. F.	H. Gordon <i>et al.</i>	"	But wing Schooner	e b		
Gie Gie	P. J. Robertson.	"	Sloop	e b		
Parachute	H. Garrett	"	"	e b		
Viola	E. Webb	"	Lugger	e b		
Finesy	W. H. Bonnell	"	Sloop	e b		
STEAM YACHTS.						
Esperanza	R. C. Y. C.	Toronto				
Albema	A. B. Gooderham	"				
Viola	J. T. Matthews <i>et al.</i>	"				
Sommar	G. Boyd	"				
Ish Koolah	G. Ryerson	"				
Zephyr	F. B. Polson	"				
Alexandra	A. McDonald	Quebec				
Cleopatra	A. B. Gooderham	Toronto				
Galahad	E. M. Fulton	Montreal				

the
ern
in
sen
ling
fall
par
the
sail
to

the
base
Walk
TI
1861
conn
no r
GORE
NETT
Cye:
VREI
Ov
the I
prese
down
been
these
Th
cong
city.
of th
etc.,
Club
exten
inclu

HISTORY OF THE ROYAL CANADIAN YACHT CLUB.

RECORD OF RACES, 1891-92.

May 30, 1891: Course of ten miles, no time allowance. Wind west 1-2 north, moderate. Skill class:

	H. M. S.
Encasy	2 41 30 second
Ripple	3 15 00
Puritan	2 42 30 first
Ole Girl	did not finish

June 6, 1891: Course ten miles. Wind southwest, moderate. 25 foot class.

	H. M. S.	H. M. S.
Brenda	2 12 27	2 10 22 second
Hilda	2 09 39	2 07 18 first
Finette	did not finish	
Ariel	2 16 35	2 16 35

June 13, 1891: Course ten miles. Wind west, light. 21 foot class:

	H. M. S.	H. M. S.
Edna	3 21 00	3 21 00
Wooes		
Widgeon	3 11 30	3 13 52 first
Caprice	3 18 00	3 17 12 second
Freida	did not finish	
Kathleen	did not finish	
Gwendoline	3 23 30	3 18 13 third

June 20, 1891: Cruising Race, over 30 mile course. Wind east by south. First and 46 foot classes:

	first	second	third
Oriole			
Vreha			
Condor			
Aggie			
Verve			



WOXA.—FIGURE 279.

June 27, 1891: 30 foot class race, over 13 mile course. Wind northwest, very light:

	H. M. S.	H. M. S.
Samoa	5 43 00	5 43 00
Erna	5 23 00	5 22 46
Wona	did not finish	
Kelpie	did not finish	

Race declared off, not finished within time limit.

July 1, 1891: First race Queen's Cup; sailed over triangular course in Lake Ontario. Twice around, a distance of 30 miles.

	H. M. S.	H. M. S.
Oriole	6 12 35	6 12 35
Aileen	6 29 40	6 23 18
Vreha	6 14 30	5 57 07 first
Whitewings	6 17 20	5 57 09 second
Verve	6 26 12	6 03 29 third

July 4, 1891: 21 foot class race, over 10 mile course. Wind southwest.

	H. M. S.	H. M. S.
Edna	2 32 50	2 32 50 second
Widgeon	2 12 39	2 12 01 not officially entered
Caprice	did not finish	
Gwendoline	2 05 12	1 59 55 first

July 11, 1891: 30 foot class race. Course 13 miles. Wind west by north, 1-2 north.

	H. M. S.	H. M. S.
Samoa	2 10 54	2 10 54 first
Erna		disabled
Wona	2 51 45	2 49 46 second

July 11, 1891: 25-foot class race, over 10 mile course. Wind, northwest, fresh.

	H. M. S.	H. M. S.
Kelpie	1 49 06	1 49 06 third
Ariel	1 46 48	1 46 22 second
Hilda	1 47 08	1 44 10 first
Imogene	2 10 00	

July 16, 1891: Annual Regatta, twice around the 15 mile triangular course. Wind, fresh, southeast 1-2 east. This was the regatta of the LAKE YACHT RACING ASSOCIATION, given under the auspices of the ROYAL CANADIAN YACHT CLUB.

First class.

	H. M. S.	H. M. S.
Vreha	4 28 28	4 12 15 first
Oriole	4 23 38	4 23 38

46 foot class.

	H. M. S.	H. M. S.
Yama	5 19 36	5 11 05 first
Whitewings	5 42 33	5 42 33 second
Condor	5 50 39	5 46 17 third
Verve	5 50 41	5 48 12
Aggie	6 07 11	6 00 42

40 foot class.

	H. M. S.	H. M. S.
Psyche	5 00 52	4 58 04 first
Verve	5 05 21	5 05 21

35 foot class.

	H. M. S.	H. M. S.
Vision	5 13 18	5 13 18 disqualified
Dinah	5 28 45	5 28 09 first
Cyprus	6 01 28	5 58 38 second
Alert	did not finish	
Gracie	did not finish	

30 foot class.

	H. M. S.	H. M. S.
Samoa	2 46 50	2 46 50 first
Nadia	3 00 31	2 59 40 second
Erna	3 05 30	3 05 11 third
Lotus	3 07 05	3 05 34
Volante	3 12 45	3 12 22

25 foot class.

	H. M. S.	H. M. S.
Maud B.	3 23 34	3 23 08 first
Quickstep	3 29 04	3 28 32 second
Hilda	3 38 01	3 33 52 third
Ariel	3 38 48	3 37 57
Florrie B.	3 38 52	3 38 27
Odie	3 42 47	3 42 24
Kelpie	3 44 44	3 44 44
Nellie G.	3 57 03	3 50 11
Dolphin	3 59 03	3 57 49

er triangular course
miles.

M. 8.
2 25
3 18
7 07 first
7 09 second
3 29 third

se. Wind south-

ad
officially entered

miles. Wind west

n. s.
9 54 first

40 second
e course. Wind,

n. s.
06 third
22 second
10 first

e 15 mile triangu-
s was the regatta
under the auspices

s.
15 first
08

s.
05 first
33 second
17 third
12
12

s.
14 first
21

s.
8 disqualified
9 first
28 second

s.
0 first
1 second
1 third
4
2

s.
8 first
2 second
2 third



PLATE XVII.

FROM A NEGATIVE BY STEBBINS.

VEDETTE.

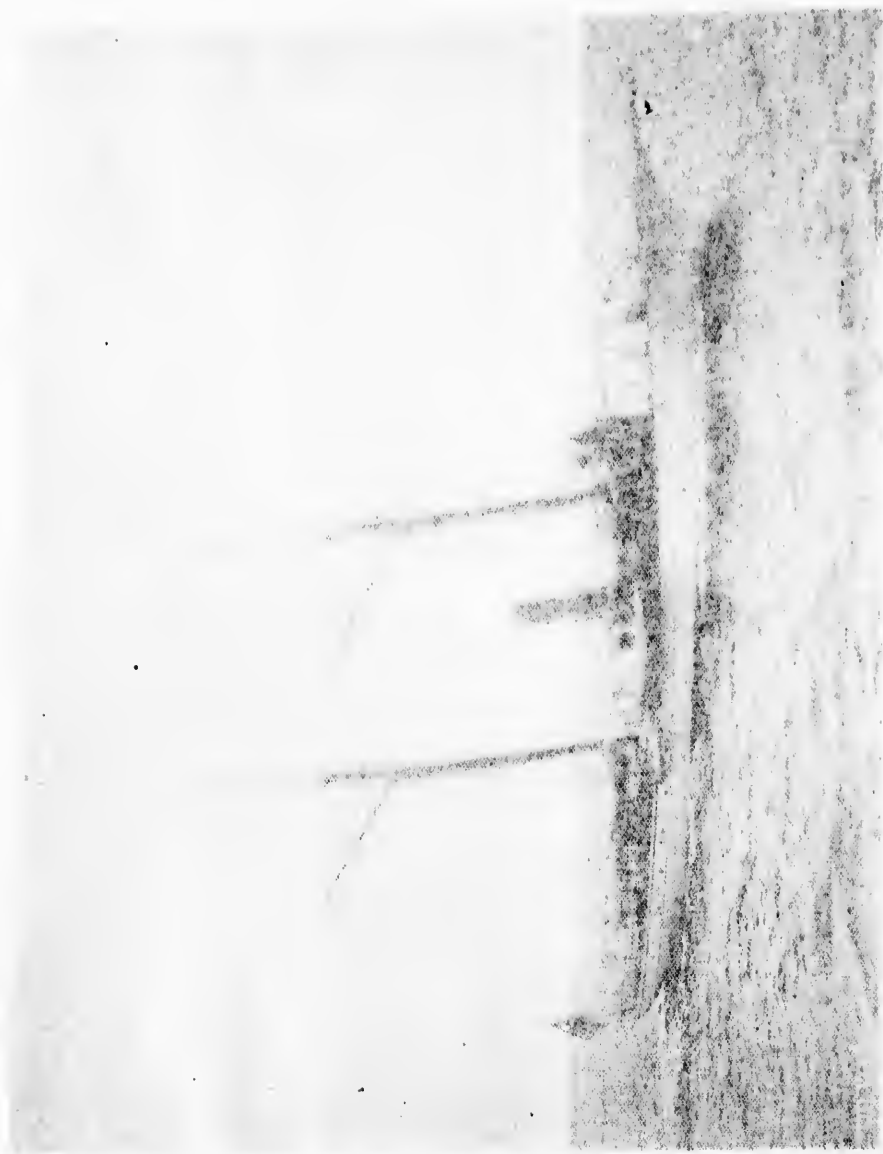

VII

21 foot class.

	H. M. S.	H. M. S.
Kathleen	1 42 19	1 30 22 first
Elsie	1 41 15	1 40 07 second
Alliance	1 45 20	1 42 13 third
Edna		time not taken
Java		time not taken
Gwendoline		time not taken
Unesy		time not taken
Caprice		time not taken
Widgeon		disabled, run down

August 1, 1891: Skill class, over course of 10 miles.

	H. M. S.
Puritan	did not finish
Unesy	1 58 25 first
Ole Girl	2 01 58 second
Ripple	2 01 33 third

August 8, 1891: Cruising race for 30 foot class to Port Dalhousie, 30 miles. Wind west, very light and shifting.

	H. M. S.	H. M. S.
Samoa	10 45 00	10 45 00
Erna	12 41 00	12 40 12
Wona		did not arrive

August 1, 1891: Race for Lansdowne Cup. Wind southeast. Verve

In this race there were no competitors VERVE sailing over course alone.

August 15, 1891: Race for Cosgrove Cup, 25 foot class. 10 mile course, with a light wind, northwest.

	H. M. S.	H. M. S.
Kelpie	2 13 15	2 13 15
Alert		did not finish
Hilba	2 01 30	2 01 32 second
Edna	1 54 00	1 48 51 first
Ariel	2 12 30	2 11 51 third

August 22, 1891: Race for the McGaw Cup, 21 foot class. 10 mile course, with a light westerly wind.

	H. M. S.	H. M. S.
Caprice	3 10 12	3 10 12 second
Kathleen	3 13 58	3 11 53 third
Gwendoline	3 13 17	3 08 48 first
Irene		did not finish

August 29, 1891: Race for skill class, over 10 mile course.

	H. M. S.
Unesy	1 41 00 first
Ole Girl	1 47 08 second
Puritan	1 50 31 third
Ripple	1 53 01
Adela	2 01 45

September 5, 1891: 30 foot class. Course, 11 miles. Wind westerly moderate.

	H. M. S.
Samoa	1 58 15 second
Erna	1 56 15 first
Escape	did not finish
Wona	2 57 57 third

September 7, 1891: Race for Prince of Wales' Cup. Wind fresh, southeast; fell light and shifting.

	H. M. S.	H. M. S.
Oriole	5 37 32	5 37 32
Vreda	5 41 09	5 23 46

September 12, 1891: Cruising race for first and 46 foot classes, over 20 mile course.

First class

	H. M. S.
Oriole	did not finish
Cygnnet	first

46-footers.

	H. M. S.	H. M. S.
Condor	5 27 00	5 27 00
Verve	1 31 00	1 30 13 first

May 28, 1892: 25 foot class, 10 mile course. Wind light, southeast.

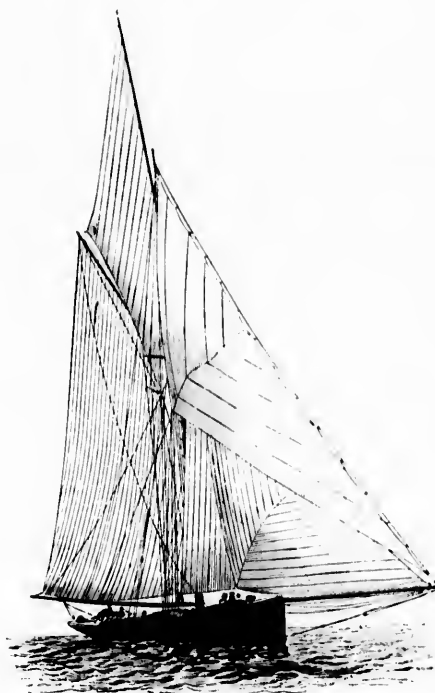

VERVE.—FIGURE 280.

	H. M. S.	H. M. S.
Kelpie	2 19 02	2 19 02 second
Ariel	2 07 20	2 06 40
Edna	2 12 27	2 06 37 first
Brenda	2 17 35	2 14 28

Protest entered against ARIEL and BRENDA; both disqualified. June 4, 1892:—Race of skill class over 10 mile course. Wind fresh, west by south.

	H. M. S.
Unesy	1 45 10 second
Ole Girl	did not finish
Parachute	did not finish
Ripple	1 53 00 third
Viola	1 43 13 first

June 11, 1892:—Cruising Race to Port Dalhousie, 30 miles, for first and 40 foot classes. Wind moderate, northwest.

	H. M. S.	H. M. S.
Oriole	did not finish	
Aileen	did not finish	
Vreda	6 00 00	5 46 00
Condor	6 00 10	5 38 46 third
Aggie	5 35 10	5 10 15 first
Zelma	5 47 05	5 20 55 second

June 18, 1892:—30-foot class.

	Elapsed Time.	Corrected Time.
	H. M. S.	H. M. S.
Cyprus	1 57 55	1 57 55 second
Vedette	1 56 55	1 51 14 first
Erma	2 01 05	1 58 15 third
Wawa		did not start

July 3, 1892:—10 mile course for 21 foot class. Wind light, west.

	H. M. S.	H. M. S.
	Caprice	2 07 23
Kathleen	2 08 11	2 06 08 third
Gwendoline	2 06 18	1 56 38 first
Recruit	2 02 28	1 59 10 second

Skiff class, July 30, 1892:—10 mile course; wind moderate, west.

	H. M. S.
	Ole Girl
Unesy	2 16 18 second
Viola	2 28 50 third
Muta	did not finish

Landsdowne Cup Race, August 6, 1892:—Course, across Bay and return, thence out on Lake 4 miles westward and return. Distance, 11 miles, wind northwest, fresh.

	H. M. S.	H. M. S.
	Zelma	2 10 05
Vedette	2 23 05	2 11 45 whs by 1 min. 15 sec.
Erma		did not finish
Wa Wa		did not finish

August 20, 1892:—Cruising race to Hamilton, 31 miles. Wind northwest, light.

	H. M. S.	H. M. S.
	Oriole	
Vreda	7 21 20	7 00 23 second
Zelma	6 19 00	6 18 28 first
Condor		did not finish

Cruising race to Oakville: 20 miles, 30 foot class. August 20, 1892.

	H. M. S.	H. M. S.
	Cyprus	5 48 10
Vedette		did not finish

August 20, 1892:—25-foot class and Cosgrove Cup, over 10 mile course.

	H. M. S.	H. M. S.
	Kelpie	
Ariel	4 07 20	4 06 40 third
Brenda		did not finish
Wa Wa	3 52 17	3 47 30 first
Caprice	4 00 00	3 58 47 second

August 27, 1892:—21 foot class and McGaw Cup; course of 10 miles, wind shifting from northwest to southwest, light.

	H. M. S.	H. M. S.
	Kathleen	2 49 50
Recruit	2 50 13	2 55 07
I. C. U.	2 55 58	2 52 31 third
Gwendoline	2 39 35	2 35 35 first

September 3, 1892: Cruising race to Niagara, 30 miles.

	H. M. S.	H. M. S.
	Oriole	5 20 00
Vreda	6 03 45	5 48 45
Condor		time of finish not taken
Aggie	5 46 00	5 21 01 third
Zelma	5 25 00	4 59 22 first
Cyprus		time not taken
Vedette		time not taken
Wa Wa		time not taken

September 3, 1893:—Skiff class, 10 mile course with fresh east wind.

	H. M. S.
	Unesy
Ole Girl	1 45 30
Viola	1 48 27
Muta	1 49 11
Ripple	1 53 15

September 10, 1892:—Race for Prince of Wales' Cup, over 30 mile course. Wind, southeast, fresh.

	Elapsed Time.	Corrected Time.
	H. M. S.	H. M. S.
Oriole	3 27 00	3 27 00 first
Vreda	3 58 15	3 40 50
Zelma	3 50 20	3 29 54 second

September 15, 1892:—Cruising race to Whithy, 22 miles. First, 16 and 10 foot classes; wind northwest, moderate.

	H. M. S.	H. M. S.
	Oriole	2 48 00
Vreda	3 15 30	3 01 10
Condor	3 14 30	2 54 11 third
Zelma	3 11 30	2 47 20 first

September 17, 1892:—30 foot class for Lorne Cup; 10 miles; wind fresh, northwest.

	H. M. S.	H. M. S.
	Cyprus	1 38 00
Vedette	35 12	1 32 28 first

September 17, 1892:—21 foot class over 10 mile course.

	H. M. S.	H. M. S.
	Kathleen	1 30 48
Recruit	1 40 00	1 41 54
I. C. U.	1 32 30	1 30 12 first
Gwendoline	1 31 11 second	



ERMA.—FIGURE 281.

September 24, 1892:—25 foot class, over 10 mile course.

	H. M. S.	H. M. S.
	Kelpie	3 53 21
Ariel	3 45 17	3 41 37 first
Brenda	3 46 17	3 43 20 disqualified
Wa Wa	4 01 00	3 56 23 third
Caprice		did not finish

Annual Regatta of the LAKE YACHT RACING ASSOCIATION, July 28, 1892. First class, triangular course, 5 miles each side. Twice around.

	H. M. S.	H. M. S.
	Oriole	4 15 10
Vreda	4 32 54	4 15 31 second

46 foot class, twice around triangle; 30 miles.

	H. M. S.	H. M. S.
	Aggie	4 50 57
Whistling	5 14 54	5 14 54 second
Condor	5 35 25	5 30 44

40 foot class, twice around triangle; 30 miles.

	Elapsed Time.		Corrected Time.
	H. M. S.	H. M. S.	
Zelma	4 43 07	4 43 07	first
Dinah	5 20 25	5 35 00	second
Psycho	did not finish		

35 foot class, 25 mile course.

	H. M. S.		H. M. S.
	Elapsed	Corrected	
Vision	4 20 20	4 20 20	first
Alert	5 05 24	5 01 10	second
Vygnus	did not finish		

30 foot class, once around triangle; 15 miles.

	H. M. S.		H. M. S.
	Elapsed	Corrected	
Vedette	2 43 40	2 43 40	first
Erna	2 49 15	2 48 42	second
Volante	2 59 48	2 52 40	

25 foot class, 15 miles.

	H. M. S.		H. M. S.
	Elapsed	Corrected	
Maud B.	3 07 34	3 07 34	first
Nox	3 09 00	3 07 49	second
Sulola	3 10 15	3 09 24	third
Caprice	did not finish		
Edna	did not finish		



VEDETTE.—FIGURE 292.

25 foot class, 10 miles.

	H. M. S.		H. M. S.
	Elapsed	Corrected	
Ethel	1 58 20	1 56 43	first
Gwendoline	2 02 18	1 57 15	second
Canuck	2 03 13	1 59 04	
Ill Away	2 02 41	2 02 10	

In 1893 races were held as follows by the ROYAL CANADIAN YACHT CLUB.

June 10: length of course, 11 miles; wind northwest; weather fine.

Yacht.	Owner.	Class.	Rig.	Feet.	Elapsed Corrected	
					Time.	Time.
					H. M. S.	H. M. S.
Kelpie	F. Capon.	25 ft	cutter	24.98	3 13 01	3 13 01
Ariel	W. B. Brumell <i>et al.</i>	25 ft	cutter	24.46	3 08 24	3 07 44
Wawa	S. H. Townsend	25 ft	lugger	21.61	3 14 17	3 09 58

Won by ARIEL.

June 17: length of course, 10 miles; wind, west; weather, fine and light.

Yacht	Owner	Class	Rig	Feet	Elapsed Corrected	
					Time.	Time.
					H. M. S.	H. M. S.
Caprice	N. B. Engan	21 ft	sloop	20.45	2 56 05	2 54 02
Kathleen	H. D. Ellis	21 ft	sloop	19.19	2 53 00	2 53 00
I. C. U.	H. Gordon	21 ft	batwing	18.42	3 08 10	2 56 19
Gwendoline	G. Robertson	21 ft	lugger	17.20	2 51 20	2 47 40
Thistle-down	E. Jarvis	21 ft	lugger	18.53	2 58 45	2 57 30

Won by GWENDOLINE.

June 24: length of course, 34 miles; wind west and north; weather light and fine.

Yacht	Owner	Class	Rig	Feet	Elapsed Corrected	
					Time.	Time.
					H. M. S.	H. M. S.
Vreda	A. R. Boswell <i>et al.</i>	1st	cutter	47.09	10 23 00	10 23 00
Condor	C. A. Brown	1st	cutter	42.07	10 31 00	10 23 24
Aggle	Marlatt & Armstrong	1st	cutter	40.61	0 10 00	0 27 20
Zelma	N. B. Dick <i>et al.</i>	1st	cutter	39.92	8 21 00	8 11 20

Won by ZELMA.

June 24: length of course, 11 miles; wind west; weather fine.

Yacht	Owner	Class	Rig	Feet	Elapsed Corrected	
					Time.	Time.
					H. M. S.	H. M. S.
Cyprus	W. S. Thompson	30 ft	cutter	32.80	2 40 40	2 40 40
Vedette	J. C. Reed <i>et al.</i>	30 ft	lugger	29.91	3 07 55	3 05 12
Erna	L. V. Percival	30 ft	cutter	29.75	3 01 00	2 58 04
Rowena	J. Lawrie	30 ft	cutter	not meas.	8 45 00	

And on the same day, over a 10 mile course, the following yachts started:

Uneasy	W. Bonnell	skiff	sloop	2 45 05	2 45 05
Viola	E. Weld	skiff	lugger	2 34 10	2 34 10
Ole Girl	P. Robertson	skiff	lugger	3 00 15	3 00 15
Miss Marlon	C. Cluthe	skiff	lugger	did not finish	

The winners in the two classes were, respectively, CYPRUS and VIOLA.

ZELMA won in a regatta sailed July 1st, over a course of twenty miles.

July 15: length of course, 10 miles; weather, fine; wind, moderate from southwest.

Ole Girl	P. Robertson	skiff	lugger	1 35 30	1 35 30
Viola	E. Weld	skiff	lugger	1 40 17	1 40 17
Uneasy	W. Bonnell	skiff	sloop	1 43 24	1 43 24

OLE GIRL won.

July 22: length of course, 10 miles.

Kathleen	H. D. Ellis	21 ft	sloop	19.19	did not finish
Thistle-down	E. Jarvis	21 ft	lugger	18.53	1 42 45
I. C. U.	W. H. Gordon	21 ft	batwing	17.41	upset at the line.
Ethel	G. H. Gooderham	21 ft	lugger	17.77	1 47 00
Gwendoline	G. Robertson	21 ft	lugger	17.20	1 48 25

The winner was THISTLE-DOWN.

August 5: length of course, 10 miles.

Kathleen	H. D. Ellis	21 ft	sloop	19.19	1 46 46
Thistle-down	E. Jarvis	21 ft	lugger	18.53	1 47 00
I. C. U.	W. H. Gordon	21 ft	batwing	17.41	1 40 00
Gwendoline	G. Robertson	21 ft	lugger	17.20	2 00 00
Syngamma	F. Warren	21 ft	lugger	16.02	carried away mast.

Winner, I. C. U.

August 12: length of course, 22 miles.

Vreda	A. R. Boswell <i>et al.</i>	1st	cutter	47.69	2 15 25
Condor	C. A. Brown	1st	cutter	42.07	2 20 02
Zelma	N. B. Dick <i>et al.</i>	1st	cutter	39.92	2 10 40
Aggle	Marlatt & Armstrong	1st	cutter	40.61	2 20 05
Gracie	W. Lawrie	1st	cutter	36.93	2 48 16

ZELMA won.

Cyprus	W. S. Thompson	30 ft	cutter	32.80	2 36 12
Vedette	J. C. Reed <i>et al.</i>	30 ft	lugger	29.91	2 37 50
Erna	L. V. Percival	30 ft	cutter	29.75	2 42 15
Woma	C. C. Gray	30 ft	cutter	27.52	time not taken
Kelpie	F. Capon <i>et al.</i>	25 ft	cutter	24.98	3 03 14
Ariel	W. Brumell	25 ft	cutter	24.46	2 53 31
Wawa	S. H. Townsend	25 ft	lugger	21.61	2 53 15
Edna	G. P. Reid	25 ft	sloop	21.13	did not finish

ZELMA, VEDETTE and WAWA were the winners, in their respective classes.

HISTORY OF THE ROYAL CANADIAN YACHT CLUB.

The contest for the Lansdowne Cup took place August 19th, over a 12½ mile course. ZELMA won as follows:

Yacht	Owner	Class	Rig	Foot	Elapsed Corrected	
					Time.	Time.
Zelma	N. B. Dick <i>et al.</i>	40 ft cutter		30 92	3 35 00	3 35 00
Violente	J. C. Reed <i>et al.</i>	30 ft lugger		29 91	did not finish	

On the same day a regatta was sailed, over a 10 mile course, as follows:

Uneasy	W. Brumell	skiff	sloop	2 58 00	2 58 00
Vesta	E. Wold	skiff	lugger	2 36 00	2 36 00
Ole Girl	P. Robertson	skiff	lugger	2 46 30	2 46 50

VESTA won.

September 2nd: 30 mile course.

Zelma	A. R. Boswell	1st cutter	47 69	3 23 30	3 23 30
Zelma	N. B. Dick	1st cutter	39 92	3 29 00	3 47 01
Grace	W. Lawrie	1st cutter	36 93	4 31 00	4 43 48

ZELMA won.

The race for the Prince of Wales' Cup was sailed on the 9th of

September, over a 20 mile course. The weather was fine and fresh and wind from the east.

Yacht	Owner	Class	Rig	Feet	Elapsed Corrected	
					Time.	Time.
Zelma	A. R. Boswell <i>et al.</i>	1st cutter		47 69	4 02 20	4 02 20
Zelma	N. B. Dick <i>et al.</i>	40 ft cutter		39 92	4 07 58	3 50 50
Velette	J. C. Reed <i>et al.</i>	30 ft lugger		29 91	did not finish	

ZELMA won.

There was also a race for the 30 foot class the same day, over a course of 16 miles.

Cyprus	W. S. Thompson	30 ft cutter	32 8	1 45 17	1 45 17
Velette	J. C. Reed	30 ft lugger	29 91	1 40 15	1 38 02
Erna	L. V. Percival	too late at start			

Won by VELETTE.

September 23rd: 11 miles; wind east; weather fine and fresh.

Kelpie	F. Capon <i>et al.</i>	25 ft cutter	24 98	3 43 00	3 43 00
Ariel	W. Brumell <i>et al.</i>	25 ft cutter	24 46	3 12 15	3 11 35
Wa wa	S. H. Townsend	25 ft lugger	21 61	3 29 00	3 24 01

ARIEL was the winner.

BIOGRAPHICAL SKETCHES AND DESCRIPTION OF YACHTS ENROLLED IN THE CLUB.

A. R. BOSWELL, Commodore of the ROYAL CANADIAN YACHT CLUB, is a barrister, residing in Toronto, Ontario, Canada. He was born in Coburg, Austria, the son of George M. Boswell and Susan Boswell. His father held the office of Judge of the County Court, while he himself was Mayor of Toronto, 1881-1884. He is also President of the Canadian Association of Amateur Oarsmen. He has owned the yacht MADCAP, but is now the owner of the fast and famous steel cutter VREDA. Com. Boswell has been a yachtsman for thirty years or more, having held his present office of Commodore of the ROYAL CANADIAN YACHT CLUB for some seven or eight years. He is also a member of the ROYAL HAMILTON YACHT CLUB.

VREDA.

A steel cutter, designed by G. L. Watson & Co., of Glasgow, and built by Ailsa Ship Building Co. for William Hodgson, being launched in 1888. In 1890 she was bought by A. R. Boswell, Commodore of the ROYAL CANADIAN YACHT CLUB. She has never been altered, hails from Glasgow, and sails with the ROYAL CANADIAN and ROYAL HAMILTON YACHT CLUBS. See Fig. 275.

DIMENSIONS.

Length over all,	54 feet 3 inches.	Length load waterline,	45 feet 9 inches.
Draft,	9 feet 6 inches.	Beam,	16 feet 1 inch.

Racing Record: In her first season she won (England, 1888) twenty firsts and one second prizes, having been beaten only once or twice. In 1889 she won (also in England) twenty-seven prizes, including the Queen's Cup at Cork. In Canada she has been successful in most of the races in which she was entered. In 1891 she won the Queen's Cup, which was presented by Her Majesty Queen Victoria that year to Canadian yachtsmen as a challenge cup. The same year she won the Prince of Wales' Challenge Cup which was presented to the ROYAL CANADIAN YACHT CLUB many years ago. These cups are magnificent trophies.

Below is a partial list of the races in which she has sailed in this country.

- Aug. 13, 1890, First, winning from ORIOLE and AILEEN.
- Aug. 25, 1890, Beaten by ORIOLE, OSWEGO YACHT CLUB.
- Aug. 28, 1890, First, AILEEN second, and ORIOLE third; L. Y. R. A.
- June 20, 1891, Second, beaten by ORIOLE with CONDOR third.
- July 1, 1891, First, WHITE WINGS second and VERVE third.

July 14, 1891, First, ORIOLE second.

July 16, 1891, First, ORIOLE second.

July 20, 1891, First, with OSWARD (disabled) second.

Sept. 7, 1891, Won the Prince of Wales' Cup, ORIOLE second.

July 15, 1892, First, ORIOLE second, WHITE WINGS third.

July 22, 1892, Second, Beaten by CYNDELLA, L. Y. R. A.

July 26, 1892, First, ORIOLE second.

July 28, 1892, Beaten by ORIOLE.

Aug. 20, 1892, ZELMA first, VREDA second.

Sept. 3, 1892, Fourth, ZELMA winning, followed by ORIOLE and AGGIE.



THOS. G. BLACKSTOCK.

THOMAS GIBBS BLACKSTOCK, barrister-at-law, Toronto, Ontario, Canada, was born at Streetsville, Ontario, the son of the Rev. W. S. Blackstock and Mary Hodge Gibbs. Mr. Blackstock has been interested in yachting for ten years, and is a part owner of the yacht CLEOPATRA, having also owned AILEEN and the steam yacht AERONA. He is a member of the ROYAL CANADIAN YACHT CLUB, and was for two years Vice-Commodore of that body.

CLEOPATRA.

Screw steamer, belonging to Albert E. Gooderham and T. G. Blackstock, both of Toronto, Ont. She was designed and built by G. L. Watson of Glasgow, Scotland, for her present owners, and was launched in the Spring of 1893. She is enrolled in the fleets of the ROYAL CANADIAN and ROYAL HAMILTON YACHT CLUBS, hailing from Toronto. See Fig. 276.

DIMENSIONS.

Length over all,	118 feet 6 inches.	Length load waterline,	102 feet.
Depth,	9 feet 3 inches.	Draft,	7 feet.
Beam,	17 feet 1 inch.		

Engine: Triple expansion, 10 in., 15 in. and 25 x 12 inch.; designed by Redfield H. Allen, built by the Kerr Engine Company, Ltd., of Walkersville, Ont.

One tubular boiler, built by Thornycroft. Indicated horse power, about 350.

and fresh

Corrected
Time.
U. S. S.
20 4 02 20
28 3 59 50
t finish

ay, over a

7 1 45 17
5 1 38 02

fresh.

0 3 43 00
5 3 11 35
0 3 24 01

cond.

ed.

A.

TOLE and

STOCK,

Ontario,

Ontario,

stock and

stock has

ten years.

CLEOPA-

and the

member

TR CLUB,

mmodore

G. Black-

by G. L.

unched

ROYAL

om Tor-

fect.

fect.

ch.; de-

ty, Ltd.,

e power,



COMMODORE R. BOSWELL.

ROYAL CANADIAN YACHT CLUB.



A. E. GOODERHAM.

ALBERT E. GOODERHAM, distiller, Toronto, Ontario, Canada. He was born in 1861 in Toronto, the son of George Gooderham. Has been a yachtsman for twenty years, and has owned the yachts VICTORY, ILEX, AERONA and his present boat, which he is a part owner of (the steamer CLEOPATRA), recently launched.

Is a member of the ROYAL HAMILTON and ROYAL CANADIAN YACHT CLUBS.



GARDINER BOYD.

GARDINER BOYD, stock broker, and ex-Rear and Vice-Commodore of the ROYAL CANADIAN YACHT CLUB, Toronto, Ont., was born in Canada in 1845; a yachtsman for twenty-three years, and is the owner of the screw schooner SONNTAG, and has also owned the yachts MYSTIC, MAIA and NAJAD. A member of the ROYAL CANADIAN YACHT CLUB.

SONNTAG.

SONNTAG is a screw schooner, owned by Gardiner Boyd of Toronto, Ontario.

He designed and built her for his own use, and has owned her since the time of her launching, October, 1891. She hails from Toronto, and sails with the ROYAL CANADIAN YACHT CLUB.

DIMENSIONS.

Length over all,	42 feet,	Length load waterline,	31 feet.
Depth,	6 feet 6 inches,	Draft,	4 feet.
Beam,	8 feet 2 inches,	Masts,	21 feet hoist.

She has schooner-rigged double lugs, with forestaysail and jib.

Engine: Single, non-condensing, 5 in. x 6 in.; John Doty, Toronto.

Boiler: Upright, submerged tubes; six-horse power.



C. A. B. BROWN.

CA. B. BROWN, of the Bradstreet Company, Toronto, was born in Toronto in 1856. His father was Thomas Brown, an ex-President of St. George's Society, an organization familiar to all Canadians.

Mr. Brown has been fond of yachting since his boyhood, and he is now the owner of the yacht CONDOR. He was Captain of the ROYAL CANADIAN YACHT CLUB for two years, Rear-Commodore for one year, and is at present Vice-Commodore. He is a member of the ROYAL

CANADIAN and ROYAL HAMILTON YACHT CLUBS, and assisted in bringing about the amalgamation of the TORONTO and ROYAL CANADIAN YACHT CLUBS.

CONDOR.

CONDOR is a cutter yacht, owned by C. A. B. Brown, *et al.*, of Toronto. She hails from Toronto, and sails with the ROYAL CANADIAN YACHT CLUB. She is 39 feet on the waterline, and 42.7 feet meing length.

KELPIE

A cutter, belonging to F. J. Campbell and F. Dallas of Toronto, Ontario. She was designed and built by H. Stanton, of Picton, Ont. and was launched in April, 1889. She was originally built for L. V. Percival. She hails from Toronto, and sails with the ROYAL CANADIAN YACHT CLUB. See Fig. 277.

Official number, 47.

DIMENSIONS.

Length over all,	27 feet 6 inches,	Length load waterline,	21 feet 5 inches.
Draft,	6 feet,	Beam,	7 feet 6 inches.

FJ. CAMPBELL, Toronto, Ontario, was born in Toronto, the son of W. C. Campbell, formerly Vice-Commodore of the ROYAL CANADIAN YACHT CLUB, and the owner of the original ORIOLE. Mr. Campbell, Jr. has taken a deep interest in yachting from boyhood, and is at present a part owner of the yacht KEEPIE. He is also a member of the ROYAL CANADIAN YACHT CLUB, and was for two years on the Sailing and Executive Committees.

ZELMA.

A cutter, owned by Norman B. Dick of Toronto, Ont. Was designed and built by William Fife for Norman B. Dick, S. Haas and W. Hawke. She was launched in 1892. Is a cabin yacht, and hails from Fairlie, Scotland. She sails with the fleet of the ROYAL CANADIAN YACHT CLUB. See Fig. 278.

DIMENSIONS.

Length overall,	56 feet,	Length load waterline,	35 feet 6 inches.
Depth,	8 feet 8 inches,	Draft,	8 feet 8 inches.
Beam,	10 feet 6 inches,	Mast, (deck to hounds)	30 feet.
Boom,	42 feet,	Gaff,	26 feet.

ZELMA was built for the express purpose of defeating the hitherto unconquerable YAMA. She was planned with the YAMA's lines before the designer, but in the crucial test, July 18, 1892, she failed to out-speed the latter.



NORMAN B. DICK.

NORMAN B. DICK, Toronto, Ont., was born in Toronto in 1855. He is an architect, and has been a yachtsman as well for fifteen years. Has owned the yachts BONITA, VERVE and his present yacht, the keel cutter ZELMA. Mr. Dick is a member of the ROYAL CANADIAN YACHT CLUB, and has been a member of the executive and sailing committees of this organization.

GEORGE E. EVANS, Honorary Secretary of the LAKE YACHT RACING ASSOCIATION; barrister-at-law, Toronto, Ont. Was educated at Trinity College, Dublin, his father living at Gortmerron House, Dungamore, County Tyrone, Ireland.

Mr. Evans was one of the organizers of the LAKE YACHT RACING ASSOCIATION, and has held his office of Secretary since 1884. Was the captain of the TORONTO YACHT CLUB in 1884-86. Though not a yacht owner, he has been a successful sailing master in many a well won race. Is a member of the executive and sailing committees of the ROYAL CANADIAN YACHT CLUB.

WONA.

A cutter yacht, owned by C. C. Gray of Toronto, Ont., Canada. She sails with the ROYAL CANADIAN YACHT CLUB, hailing from Toronto. She is 33.25 feet waterline length, and 27.52 racing length.



JEFFREY FOOT.

JEFFREY FOOT, Assistant Secretary of the ROYAL CANADIAN YACHT CLUB, Toronto, Canada, is a merchant. He was born in Monkstown, County Dublin, Ireland, the son of Simon and Marianne Foot. He has been a yachtsman for thirty-five years, and has held his office of Assistant Secretary for seven years.

ORIOLE.

Schooner, with outside ballast and centerboard; designed by A. Cary Smith of New York, and built for her present owner, George Gooderham, of Toronto, Ont. Launched in A. . .

1886. She has a cabin below decks, hails from Toronto, and sails with the ROYAL CANADIAN YACHT CLUB. See plate XXXIX.

DIMENSIONS.			
Length over all,	87 feet 6 inches.	Length load waterline,	73 feet.
Depth,	10 feet 6 inches.	Drift,	7 feet 9 inches.
Beam,	20 feet 3 inches.		

Racing Record:—

Every one who is at all familiar with the racing history of the ROYAL CANADIAN, ROYAL HAMILTON, LAKE YACHT RACING ASSOCIATION and other yachting organizations of that section is also familiar with the name ORIOLE. A part of the races in which she has sailed are herewith given, though by no means her entire list of victories.

- August 19, 1889—First.
- August 13, 1890—Second, with VREDA first, and AILEEN third.
- August 25, 1890—First, beating VREDA; OSWEGO Y. C.
- July 14, 16, 1891—Second, VREDA first.
- June 20, 1890—Won from VREDA and CONDOR.
- Sept. 7, 1891—Race for the Prince of Wales' Cup: beaten by VREDA.
- July 15, 1892—Second, VREDA first; BAY OF QUINTE Y. C.
- July 18, 1892—Beat CINDERELLA; OSWEGO Y. C.
- July 26, 1892—Second, beaten by VREDA.
- July 28, 1892—Won from VREDA.
- September 3, 1892—First, winning the Prince of Wales' Cup, ZELMA second.
- September 17, 1892—ZELMA first, ORIOLE second, CONDOR third.



GEORGE GOODERHAM

GEOURGE GOODERHAM, banker and distiller, Toronto, Ont., was born in March, 1830, in Schole, Norfolk, England. He is the President of the Bank of Toronto, President of the Manufacturers' Life Insurance Co., and President of the Gooderham & Worts Limited, the largest distillery in Canada. Interested in yachting for thirty-five years, and the owner of two yachts, both called ORIOLE. Was Commodore of the ROYAL CANADIAN YACHT CLUB in 1885.



S. BRUCE HARMAN.

S BRUCE HARMAN, insurance, Toronto, Ont., Canada, was born in the West Indies. His father was Samuel Bickerton Harman.

Mr. Harman has been more or less a yachtsman since 1862; he is a member of the ROYAL CANADIAN YACHT CLUB, and has held the position of Honorary Secretary of that club since the year 1883, and has also been Chairman of the Committee of Management for some years.



E. EMILIUS JARVIS.

EDWARD EMILIUS JARVIS, stock broker, Toronto, Ont. Born in Toronto in 1860, the son of Wm. Doremus Jarvis, a barrister. His family emigrated from Connecticut about 1750, remaining loyal to the English crown. His grandfather was an officer in the Revolutionary War, and afterward was Provincial Secretary of Upper Canada. His grandfather was Chief Superintendent of Indian Affairs. Mr. Jarvis has owned the yachts CACIQUE, WHISTLEWING, WHITE WINGS and SAMOA, having designed and built the second and last, as well as

CHAPERON (1 and 2). For two years Captain of the ROYAL HAMILTON YACHT CLUB, and a member of the ROYAL CANADIAN, ROYAL HAMILTON and QUEEN'S CITY YACHT CLUBS. Was one of the founders of the ROYAL HAMILTON YACHT CLUB.

THISTLEDOWN.

A centerboard lugger, owned by Emilius Jarvis of the ROYAL CANADIAN YACHT CLUB. She is 20.47 feet on the waterline, and is enrolled in the fleet of the ROYAL CANADIAN YACHT CLUB.

VERVE.

A well known cutter yacht, lately owned by Norman B. Dick, but now the property of William Hendri of Hamilton, from which port the yacht hails. She is 41.60 feet length waterline, and 44.29 feet racing length. VERVE has always been a racer, the following being a summary of her successes since 1891:

- July 1, 1891—First race for Queen's Cup, third, VREDA first.
 - Aug. 1, 1891—Lansdowne Cup, first.
 - Sept. 12, 1891—Cruising Race, first.
- VERVE is enrolled in the ROYAL CANADIAN YACHT CLUB.



THOMAS MCGAW.

THOMAS MCGAW, capitalist, Toronto, Ont. Was born in Toronto, of Scotch descent. One of the oldest yachtsmen in that section of the country, having been a devotee of the sport for forty years. He was a charter member of the TORONTO YACHT CLUB (now amalgamated with the ROYAL CANADIAN), and is now a member of the ROYAL HAMILTON and ROYAL CANADIAN YACHT CLUBS.

Has owned the yachts INA (his own design) and CYNET, and is now building a new yacht which has not yet been named. Held the office of Commodore in the TORONTO YACHT CLUB for eight years, and has been Vice-Commodore of the ROYAL CANADIAN for one year. He is quite a prominent Mason, a member of St. Andrew's Society, Member of the Board of Trade, etc.



ROBERT MYLES.

ROBERT MYLES, of Toronto, Ont., was born in St. John, New Brunswick, July 22, 1853. He is the son of James and Janet (nee Peebles) Myles. Mr. Myles is the owner of the cutter AILEEN, and has been interested in yachting for twenty years. He is a member of the ROYAL CANADIAN, ROYAL HAMILTON and OSWEGO YACHT CLUBS.

AILEEN.

A cutter, owned by Robert Myles of Toronto, Ont. She was designed and built by G. L. Watson for G. Gooderham, and was launched in the summer of 1882. She has been owned by Mr. Myles for three years. She has never been materially altered. She hails from Toronto, and sails with the ROYAL CANADIAN, ROYAL HAMILTON and OSWEGO YACHT CLUBS. See plate XL.

Official number, 3.

DIMENSIONS.			
Length over all,	64 feet,	Length load waterline,	55 feet.
Depth,	6 feet 4 inch.	Drift,	8 feet 6 inches.
Beam,	11 feet 4 inches.		

Spars: Bowsprit, 25 ft.; Main boom, 47 ft., 6 in.; Mast, 30 ft.; Topmast, 38 ft.; Gaff, 31 feet.

he ROYAL HAM-
ANADIAN, ROYAL
Was one of the

is of the ROYAL
e waterline, and is
YACHT CLUB.

erman B. Dick, but
ilton, from which
waterline, and 44.29
aceer, the following

, VREDA first.

YACHT CLUB.

mpitalist, Toronto,
n in Toronto, of
o of the oldest
ion of the country.
o of the sport for
e charter member of
YACHT CLUB (now amalga-
L CANADIAN), and
ROYAL HAMILTON
YACHT CLUBS.

ts INA (his own de-
d is now building a
ot yet been named.
YACHT CLUB for eight
YACHT CLUB CANADIAN for
ber of St. Andrew's

s, of Toronto, Ont.
John, New Bruns-
s. He is the son of
nee Peebles) Myles.
wner of the cutter
n interested in yacht-
He is a member of
AN, ROYAL HAMIL-
YACHT CLUBS.

EEN.

by Robert Myles of
e was designed and
and was launched in
Mr. Myles for three
d. She hails from
S, ROYAL HAMILTON

terline, 55 feet.
8 feet 6 inches.

t., 6 in.; Mast, 30 ft.:

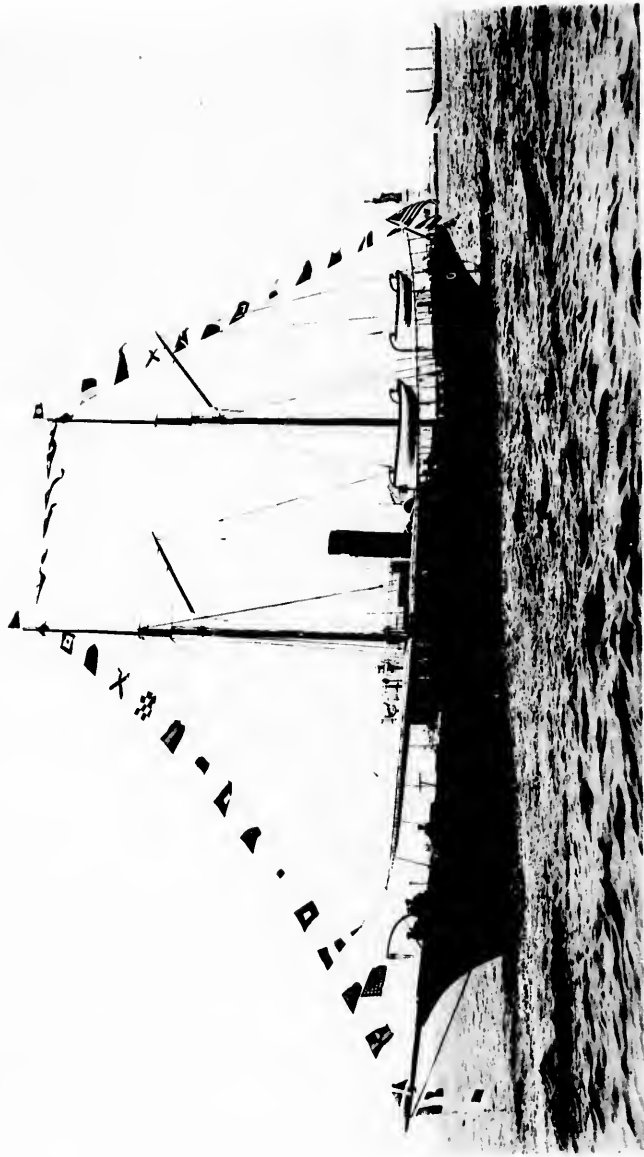

FROM A NEGATIVE BY BOLLES.

PLATE XVIII.

SAPHIRE.

SAPPHIRE.



THE SAPHIRE
is a gemstone of great value and beauty. It is a variety of the mineral corundum, and is found in various parts of the world. The most famous sapphires are those from Ceylon, which are of a deep blue color. Other sapphires are found in India, Burma, and the United States. Sapphires are used in jewelry, and are also used in industry for their hardness and resistance to wear.

The sapphire is a gemstone of great value and beauty. It is a variety of the mineral corundum, and is found in various parts of the world. The most famous sapphires are those from Ceylon, which are of a deep blue color. Other sapphires are found in India, Burma, and the United States. Sapphires are used in jewelry, and are also used in industry for their hardness and resistance to wear.

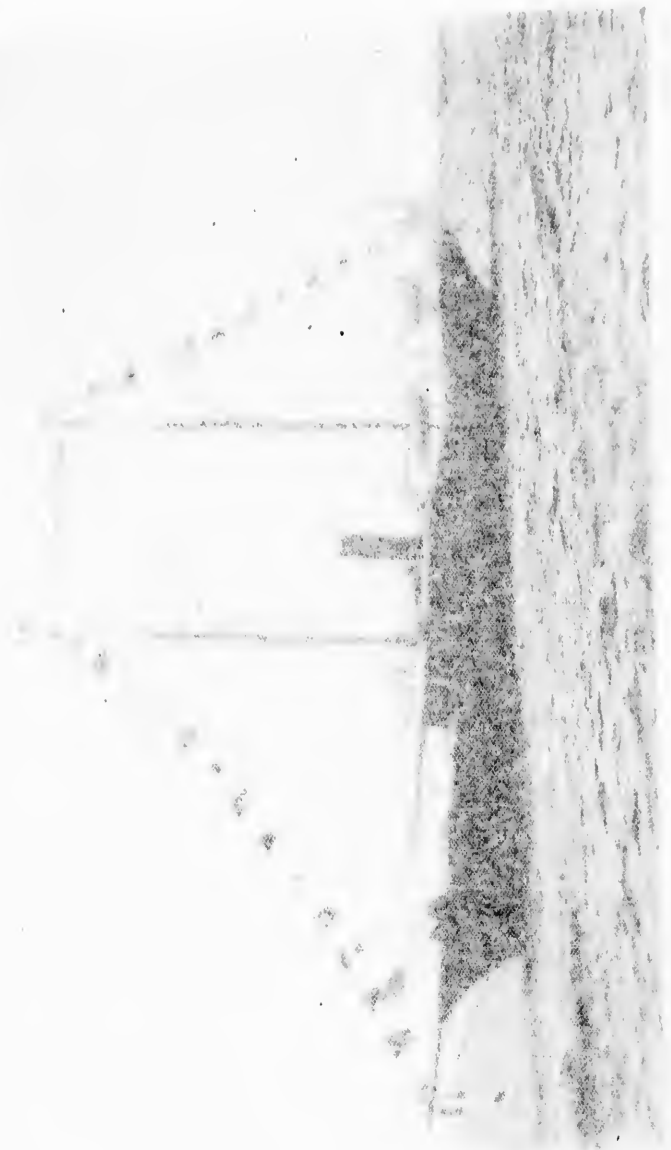



J. CARL REED.

J. CARL REED, agent fire insurance, Toronto, Ont., Canada, was born in 1869 at Whitertown, Ont., the son of Joseph B. Reed. Is a part owner of the yacht VEDETTE, and has also owned the VOLANDE. Actively interested in yachting since 1885, and a member of the ROYAL CANADIAN and ROYAL HAMILTON YACHT CLUBS.



FRANK M. GRAY.

FRANK M. GRAY, barrister-at-law, Toronto, Ont. Was born in Toronto, March 28, 1865. Has owned the yachts CAPRICE and WONA and is now part owner of VEDETTE. Interested in yachting all his life, and a member of the ROYAL HAMILTON and ROYAL CANADIAN YACHT CLUBS. Has been Honorable Mesurer of the latter organization since the year 1887.

VEDETTE.

A lugger, hailing from Toronto, and owned by Frank M. Gray and J. Carl Reed. Designed by Wm. Fife and built by H. Stannton, Toronto, for her present owners, and launched May 23, 1882. She is a keel yacht, with a small steel centerplate which does not come above keel. She has a

cabin, with flush decks. She sails with the ROYAL HAMILTON and ROYAL CANADIAN YACHT CLUBS. See Fig. 282.

DIMENSIONS.

Length over all, 47 feet 3 inches, Length lead waterline, 31 feet.
Draft (board up) 4 feet 2 inches, (board down) 9 feet 1 inches.
Beam, 9 feet 6 inches.

Spars: Pole mast, 37 ft.; Yard, 31 ft., 5 in.; Boom, 36 ft.; Bowsprit, 11 ft., 4 in. (outboard).

Record of VEDETTE, 1892:—

Out of fourteen starts, nine first places, one second, two thirds.
In Cup races—won four out of five starts winning LANSDOWNE, LOESE, MOSCK and WHITE WINGS.

ERMA.

A cutter. Designed and built by Henry Stanton, Picton, Ont., Canada, and launched in April, 1891. Owned by L. V. Percival of Toronto, from which port she hails. ERMA sails with the ROYAL CANADIAN YACHT CLUB.

Official number, 193.

DIMENSIONS.

Length over all, 26 feet 5 inches, Length lead waterline, 26 feet.
Draft, 6 feet, Beam, 8 feet 3 inches.
Racing length, 25.50 feet.

Racing Record:—

ROYAL CANADIAN YACHT CLUB—In 1891, August 8th, ERMA was first in the Cruising Race, with SAMOA second. September 5th, 1891, she was first with SAMOA second and WONA third. June 18th, 1892, third, VEDETTE first and CYPRUS second.
LAKE YACHT RACING ASSOCIATION—July 26, 1892, Annual Regatta, ERMA was first, VOLANDE second and VEDETTE third.

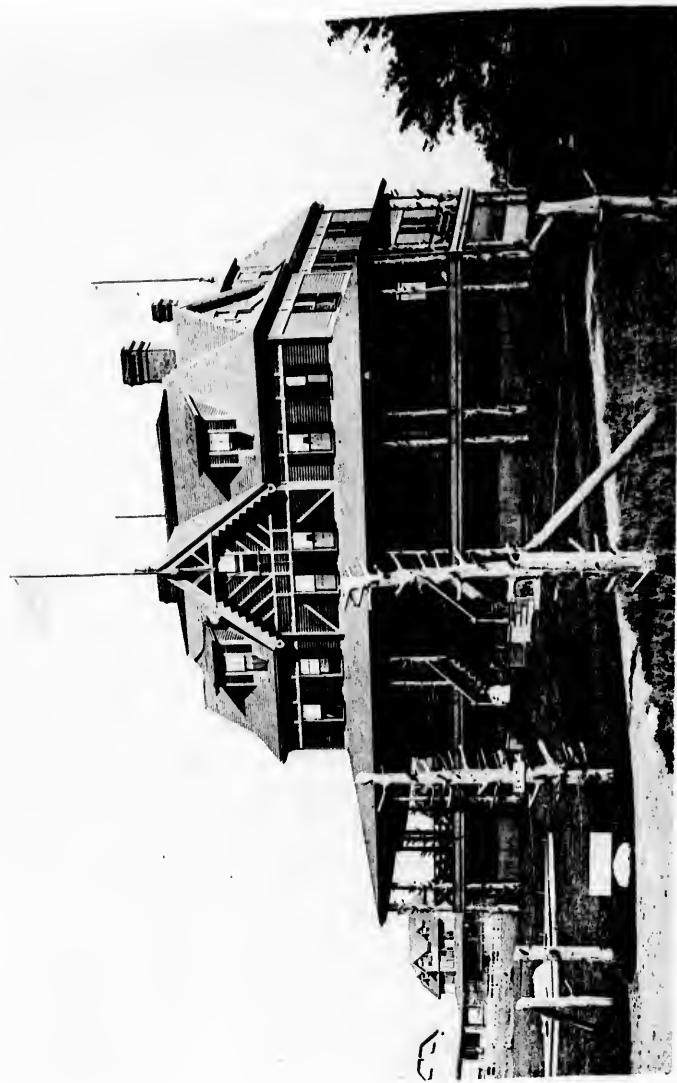

EASTERN YACHT CLUB HOUSE.

History of the Eastern Yacht Club

The Eastern Yacht Club was organized on the 15th day of June, 1884, at the residence of Mr. J. W. ... in the city of New York. The first meeting was held on the 17th day of June, 1884, at the residence of Mr. J. W. ... and was attended by the following gentlemen: ...



The first meeting was held on the 17th day of June, 1884, at the residence of Mr. J. W. ... and was attended by the following gentlemen: ...

The first meeting was held on the 17th day of June, 1884, at the residence of Mr. J. W. ... and was attended by the following gentlemen: ...



The first meeting was held on the 17th day of June, 1884, at the residence of Mr. J. W. ... and was attended by the following gentlemen: ...

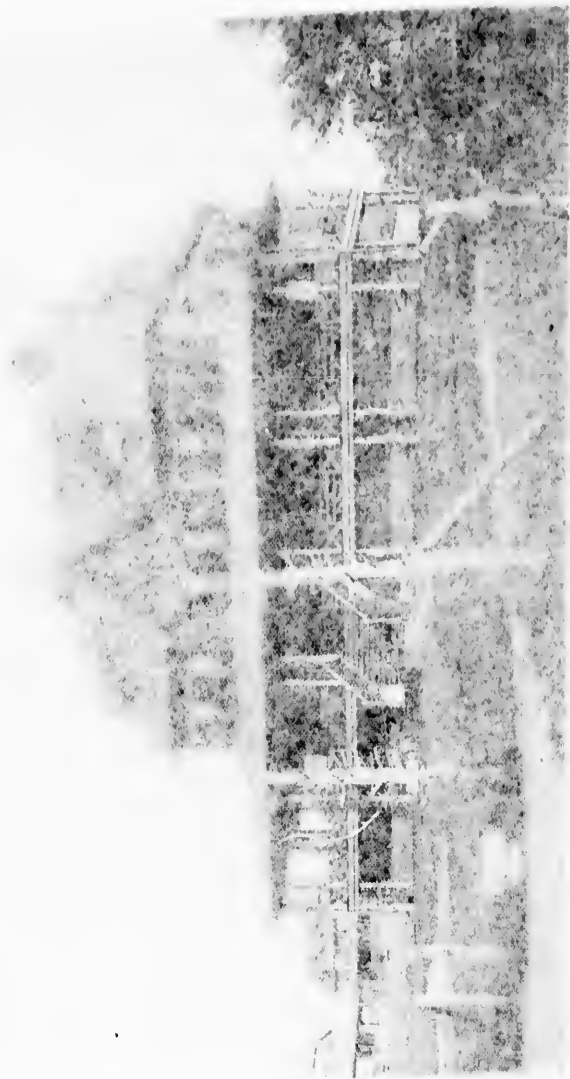

CITY OF NEW YORK

ne
On
So
Ev
con
na
Pa
Joh
con
the
of
hoc
Bu
Gar
reg
ado
the
T
Reg
T
and
Edi

History of the Eastern Yacht Club.

IN 1860 a number of gentlemen owning or interested in yachts, living in Boston, Salem and on Beverly Shore formed an association called the **ESSEX COUNTY YACHT SQUADRON**, which had two regattas that year. Among the members were Messrs. John Heard, David Sears, John G. Cushing, T. Donnie Boardman, Wm. C. Palmé, James L. Little, Jr., John H. Reed, Stanton Whiting, Wm. T. Otis, W. D. Pickman, Greeley Curtis, F. Gordon Dexter, Richard D. Tucker and George Z. Silsbee. Out of this association was eventually developed the **EASTERN YACHT CLUB**.

On the evening of March 5, 1870, a meeting was held at the residence of Mr. Heard in Boston, to talk over the matter of forming a

ALARM and LOUISE. The Annual Cruise has with some exceptions been continued.

The initiation fee at the beginning was \$20, and the annual assessment \$10, which have been increased at times till they are now (1894) \$30 for initiation, and \$20 for the annual assessment.

The club was incorporated by an Act of the Massachusetts Legislature, approved February 7, 1870, which was duly accepted at a meeting held for that purpose on February 10, 1871. Twenty-two members were present. At the same meeting a new constitution, by-laws, uniforms, dress, and sailing regulations were adopted. On this date the membership had increased to one hundred and fifty-eight.

On the evening of August 11, 1871, by invitation from the **EASTERN YACHT CLUB**, the **NEW YORK YACHT CLUB** fleet, comprising the schooners **COLUMBIA**, **HALCYON**, **MAGIC**, **EVA**, **IDLER**, **SPOTTE**, **FOAM** and **RANGLER**, and the sloops **GRACIE**, **VIXEN** and **VINDEN**, arrived off Minot Light in Boston Bay on a visit. On August 14th, a regatta was sailed from off Swampscott by the combined fleets, for prizes of \$1,000 for schooners, and \$500 for sloops, offered by the **EASTERN YACHT CLUB**, and also for prizes of \$800 for schooners and \$400 for sloops, presented by the residents of Swampscott. Thirty-three yachts started, and thirty of these completed the course, being



VOLUNTEER.—FIGURE 283.

new yacht club. There were present Messrs. Heard, Sears, Cushing, Otis, Whiting, Pickman, and Tucker of the "ESSEX COUNTY YACHT SQUADRON," and also Messrs. Edward Motley, A. T. Perkins, P. L. Everitt, Jacob C. Rogers, and John Jeffries, Jr.

After much discussion, it was decided to organize a club, and a committee was appointed to report at a future meeting, a suitable name, constitution, by-laws, etc., which meeting was held at the Parker House in Boston on the last day of March, 1870, with Mr. John P. Bayley in the chair and John Jeffries, Jr., Secretary. The committee appointed at the meeting of March 5th, reported for a name, the **EASTERN YACHT CLUB**, and also a constitution, by-laws, etc., all of which were adopted, and the club was formally organized by hoisting for Commodore, John Heard; for Vice-Commodore, Franklin Burgess; for Secretary, John Jeffries, Jr., and for Treasurer, Jos. P. Gardner. At a subsequent meeting, April 26, 1870, a code of sailing regulations, rules for uniforms, etc., a club flag and a club seal were adopted, the flag and seal being the same as now in use. At this time there were seventy members.

The first regatta was sailed on July 12, 1870. (See Record of Regattas).

The first cruise of the club, started July 25, 1870, to Bar Harbor, and the following boats took part: Schooners **BELLE**, **REBECCA**, **EDITH**, **ETHEL**, **JUNIATA**, and sloops **COMING**, **SADIE**, **GESSIE**,

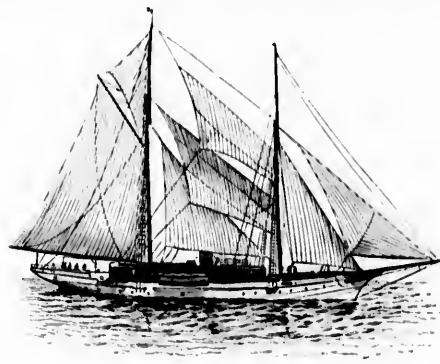

WILD DUCK.—FIGURE 284.

the largest number ever started in this country, up to that time. An account of this race will be found in the list of regattas.

The club had no headquarters or room (except a temporary one the first year) for ten years, but in the winter of 1879-'80, at an informal meeting of some members at the residence of Commodore Boardman, the matter of a Club House on the sea-shore was talked over, and it was decided to procure information as to site, etc., and have it considered at the next annual meeting, which would be February 10, 1880. At this meeting, Mr. B. W. Crowninshield gave an interesting account of the various sites examined, especially those on Marblehead Harbor, and after a long discussion, during which it was evident that nearly all, if not all, there present preferred a lot on Marblehead Neck. Messrs. Crowninshield, John Jeffries and

Daniel Appleton were appointed a committee with full power to purchase land and buildings, or a piece of land, and erect buildings thereon, at a cost of ten thousand dollars, which limit was increased to eighteen thousand dollars at a subsequent meeting, March 31, and to twenty thousand at the second general meeting of the year, April 6, 1880.

Under this authority the Committee bought the site now occupied by the Club House on Marblehead Neck, about sixty thousand square feet, and built under their own supervision the present struc-

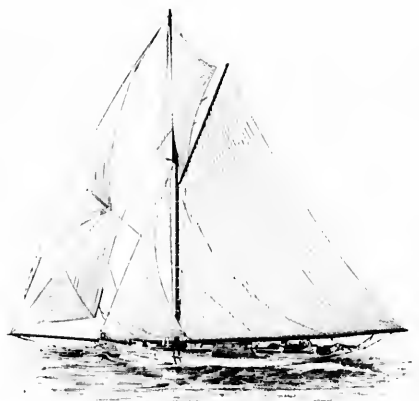

HARRISON.—FIG. 111. 285.

ture: the same with some small additions and changes as it stands to-day, from the designs of George Snell, Architect, of Boston (late deceased).

In 1883 an adjoining piece of land of more than ten thousand feet was procured, and a stable and carriage sheds were built. There has also been a substantial and convenient landing pier built at an expense of more than two thousand dollars. The Club House was formally opened on the evening of June 9, 1881, with a handsome reception to the members and their families, given by the Flag Officers, Commodore Charles H. Joy, Henry S. Hovey and Frank E. Peabody, which was fully attended in spite of a heavy northeast rain storm.

The first week in August, 1881, many yachts of the club made their rendezvous in the harbor of New Bedford, on the invitation of the NEW YORK YACHT CLUB, who entertained them with a dinner and ball and a regatta of the combined fleets was sailed for cups presented by Capt. E. A. Bush of the NEW YORK YACHT CLUB. The record will be found in the list of regattas. A fog interfered much to the disappointment of all and the cup for sloops was not awarded but was sailed for a second time by GRAYLE and MISCHIEF, and won by GRAYLE.

The NEW YORK YACHT SQUADRON arrived in Marblehead Harbor, August 12, 1882, and were received and entertained by the EASTERN YACHT CLUB. A regatta was sailed on August 14th, in charge of a special committee of both clubs, with NEW YORK YACHT CLUB allowance over a course of fifteen miles seaward and return, thirty nautical miles, which will be found in the list of EASTERN YACHT CLUB Regattas.

There was also a visit from the NEW YORK YACHT CLUB, under Commodore Gerry in August, 1892.

During the first ten years of its existence, the membership of the

club varied from 138 in April, 1870, to 252 in 1873 and 1874 (the annual list compiled in April being taken in all cases), and then slowly diminished until in 1878 it stood at 218, and in '79 at 237.

In the latter part of 1879, the plan of having permanent headquarters on the sea-shore began to take shape, which resulted in the building of the Club House, as hereinbefore described, and in April, 1880, there were 316 members, in 1881 390 members, and in 1882, after the house had been opened one season, 443. Since then it has slowly and somewhat irregularly increased, there having been 589 names on the club book in 1892. In February, 1893, the number was increased to 595. These figures do not include "Honorary Members" who number at present twelve or thirteen.

The following is the list of the officers of the club since its organization:

COMMODORES.

John Heard	1870-72
David Sears, Sen.	1873
John M. Furler	1874-77
T. Donnie Boardman	1878-79
Charles H. Joy	1880-82
D. L. Pickman	1883-84
Henry S. Hovey	1885-86
William F. Weld	1887-88
Henry S. Hovey	1889
Alanson Tucker	1890-91
J. Malcolm Forbes	1892-93

VICE-COMMODORES.

Franklin Burgess	1870-71
Stanton Whitney	1872-73
John Jeffries	1874-75
T. Donnie Boardman	1876
C. W. Amory	1877-79
Henry S. Hovey	1880
Frank E. Peabody	1881-82
J. Malcolm Forbes	1883-88
Alanson Tucker	1889
F. Gordon Dexter	1890-91
Wm. Amory Gardner	1892-93

REAR COMMODORES.

Richard D. Tucker	1874
A. C. Wheelwright	1875
Charles Whitney	1876
David Sears	1877-78
Henry S. Hovey	1879
John Bryant	1880-82
Edward Burgess	1883
William F. Weld	1884-86
F. Gordon Dexter	1887-89
Aug. Hemenway	1890-91
C. F. Adams, 2d	1892-93

SECRETARIES.

John Jeffries	1870-72
Henry B. Jackson	1873-81
Sidney W. Burgess	1882-83
Edward Burgess	1884-91
W. S. Eaton, Jr.	1892-93

TREASURERS.

Jos. P. Gardner	1870-71
Madison Child	1872-74
Patrick T. Jackson, Sen.	1875-84
Patrick T. Jackson	1885-93

REPRESENTATION.

At all meetings a yacht may be represented by its owner, or by any one of its owners (if there be more than one), provided that such representative shall be a member of the club. No yacht shall be represented unless she has been launched, and a certificate, signed by the Measurer, has been filed with the Secretary, specifying her length on waterline and her rig; and no representation shall be admitted of any yacht under 30 feet on the waterline, nor of other than full-decked vessels, reasonable cockpits excepted, nor of any yacht which shall have been out of commission for two consecutive years.

Yachts under 30 feet on the waterline, belonging to members of the club, shall be allowed to carry the club signal and accompany the squadron on a cruise.

YACHTS LET OR HIRED.

Any yacht which shall be let, unless to a member of the club, shall be debared all rights and privileges of the club during the time in which she shall be so let.

Any member of the club hiring a yacht shall be permitted to carry the club signal, and to accompany the squadron on its cruise, but no hired yacht, not belonging to a member, shall be allowed to be entered in any regatta, or to compete for any prize offered by or for the club. A member of the club hiring a yacht belonging to another member for not less than thirty days, shall enjoy all the privileges to which the owner himself would be entitled.

The model of every yacht entered for a regatta shall be the property of the club and retained in its possession, and no person, other than a United States Naval Constructor, shall be permitted to copy

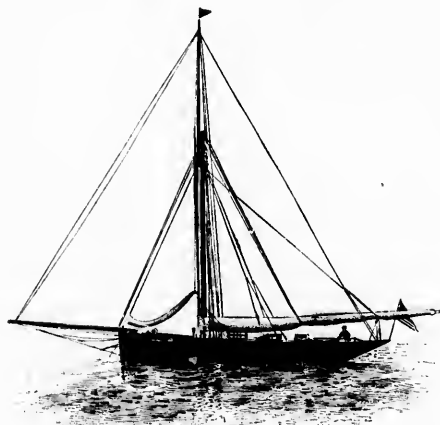

ZIOENER.—FIGURE 286.

it unless he shall have obtained written authority from the owner or builder of the yacht.

Yachts shall be divided into classes, according to their length on the water line, as follows:

SCHOONERS.

- First class, all over 75 feet waterline.
- Second class all between 75 feet and 30 feet inclusive.

SLOOPS, CUTTERS AND YAWLS.

- First class, all over 70 feet waterline.
- Second class, all over 61 feet, and not over 70 feet.
- Third class, all over 53 feet, and not over 61 feet.
- Fourth class, all over 46 feet, and not over 53 feet.
- Fifth class, all over 40 feet, and not over 46 feet.

Sixth class, all over 35 feet, and not over 40 feet.

Seventh class, all of 30 feet or over, and not over 35 feet.

In arranging regattas the Regatta Committee may, at its discretion, combine two or more of these classes.

In case of only one entry in any class, the Regatta Committee shall place such entry in the next higher class in which there is a yacht entered, beginning with the smallest class.

Any yacht which was launched before June 1, 1888, exceeding the higher limit of any class by not over the fraction of a foot, may enter in that class.

Any yacht may enter a race in a higher class than that in which she belongs, by assuming the minimum waterline measurement of the class entered.

In cases where different rigs sail together, schooners shall be rated for time allowance at four-fifths and yawls at seven-eighths of their racing measurement.

Yachts shall be rated for time allowance according to the follow-

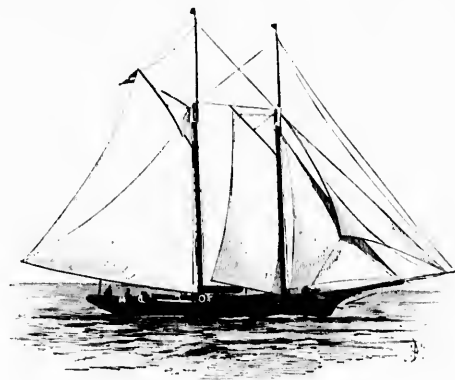

KATHLEEN.—FIGURE 287.

ing measurement: To the square root of the sail area add the waterline length, and divide this sum by two:

$$\frac{\sqrt{S} + L}{2}$$

These measurements shall be obtained as follows:

A base line to be taken from a point midway between the jibtop-sail-stay and the jib-tack on the bowsprit, or flying jibstay on the jib-boom, in a straight line to the end of the mainboom (mizzenboom in yawls) with one-quarter the length of the gaff measured from the afterside of the mast to the end, added thereto.

If the distance from the outer end of the spinnaker boom to the side of the mast, when the boom is shipped in place and square with the middle line of the hull, exceeds the distance from the foreside of the mast (foremast in schooners) to the point taken as the forward end of the base line, such excess shall be added to the base line.

A perpendicular to be taken along the afterside of the mainmast from the underside of the gafftopsail block or sheave on topmast, to the upper side of boom when the latter is resting on the saddle, the distance of such point from the main-deck or house-deck to be recorded by the Measurer, together with all other points used in measurements.

To obtain the estimated sail-area from these figures, multiply the base by the perpendicular and divide by two.

The length shall be measured from the forward side of stem at the waterline to the end of the waterline at stern wherever found, exclusive of any part of the rudder or rudder-post. This measurement shall be taken when the yacht is afloat and in her racing trim: the crew need not be aboard, but if aboard must be stationed amidships.

Allowances shall be figured according to the table adopted by the club. For reckoning allowances, any fraction of a half-foot shall be counted as a half-foot.

No member shall be interested in more than one yacht competing for the same prize.

No prize shall be given in any class unless two or more yachts start, except in the Annual Regatta, or, in the case of a re-sailed or postponed race, where two or more yachts shall have originally started in the class in question.

Only fore and aft sails and spinnakers may be carried in any race.

Yachts contending for prizes may carry the following sails:
Schooners—Mainsail, foresail, jib, flying jib, jibtop-sail, forestaysail fore and main gafftopsails, main topmast staysail, and spinnaker.
Sloops and Cutters—Mainsail, fore staysail, jib, flying jib, jibtop-sail, gafftopsail and spinnaker.

Yawls—The same sails as the cutters, and mizzen in addition.
Head sails may be set either flying or on the stays.

Sloops, cutters and yawls of the fourth class or smaller, contending

shall be carried during a race, and these must not be used as shifting ballast, or for altering the trim of the yacht. After starting, ballast shall not be shifted or trimmed in any way whatever during a race.

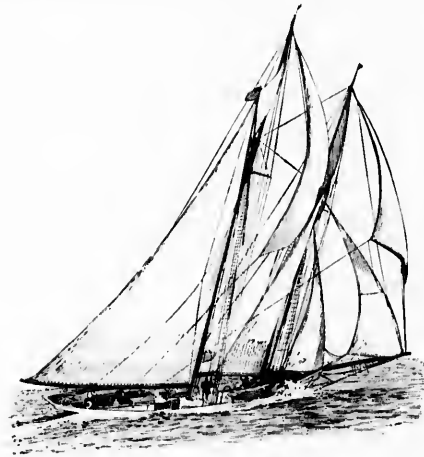

ESONE.—FIGURE 289.

No ballast shall be shipped or unshipped after 9 P. M. of the day previous to the race. A race re-sailed shall, so far as this rule applies, be considered a new race.

No race in any class shall be considered made unless finished by one of the yachts in that class within thirty minutes after the time of sunset, as given in the table in the Club Annual.

No means of propulsion except sails shall be allowed.

The Regatta Committee require that when yachts are to race in cruising trim:—

No doors, tables, cabin skylights, stoves, or other fittings on or below deck (davits excepted) shall be removed from their places before or during the race.

No topsails shall be carried extending beyond the truck or the gaff end; and in yachts exceeding forty feet on the waterline no sails or other gear shall, barring squalls, be put into the main cabin.

Anchors and chains suitable to the size of the yacht shall be carried; and of these, one shackled to the chain shall be in the usual place on the bow.

Each yacht above fifty-three feet water-line shall carry two serviceable boats; each smaller yacht, except the Seventh Class sloops, shall carry one such boat.

Except a pilot, no more than the regular crew of the yacht shall be allowed, and no more persons than can be suitably lodged at night.

The Golet Cup, won by PURITAN, August 3, 1885, is, by deed of gift of her original owners, awarded each year to the yacht be-

longing to the club making the best corrected time over the course in the Annual Regatta, to be held by her owner until the next Annual Regatta; and the name of the said yacht is to be inscribed upon the Cup.

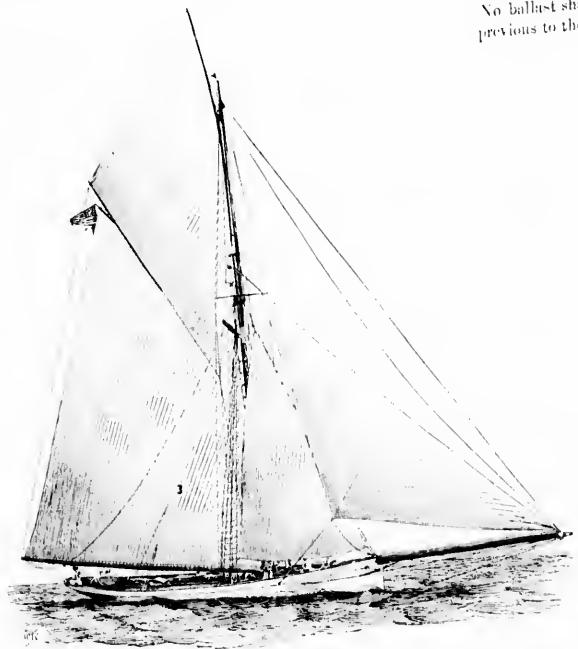

PURITAN.—FIGURE 288.

for prizes, shall not carry more than one man for each four feet racing measurement or fractional part.

No water shall be started from, or taken into the tanks, after the start has been made. No more than the usual anchors and chains

shifting
g, ballast
g a race.

of the day
le applies.

ered made
that class
of sunset.
al.
is shall be

that when
stoves, or
(a excepted)
before or

ing beyond
yachts ex-
no sails or
out into the

size of the
one shackled
l place on

water-line
each smaller
loops, shall

regular crew
d no more
l at night.
ITAX, Aug-
her original
o yacht be-
no over the
ntil the next
be inscribed

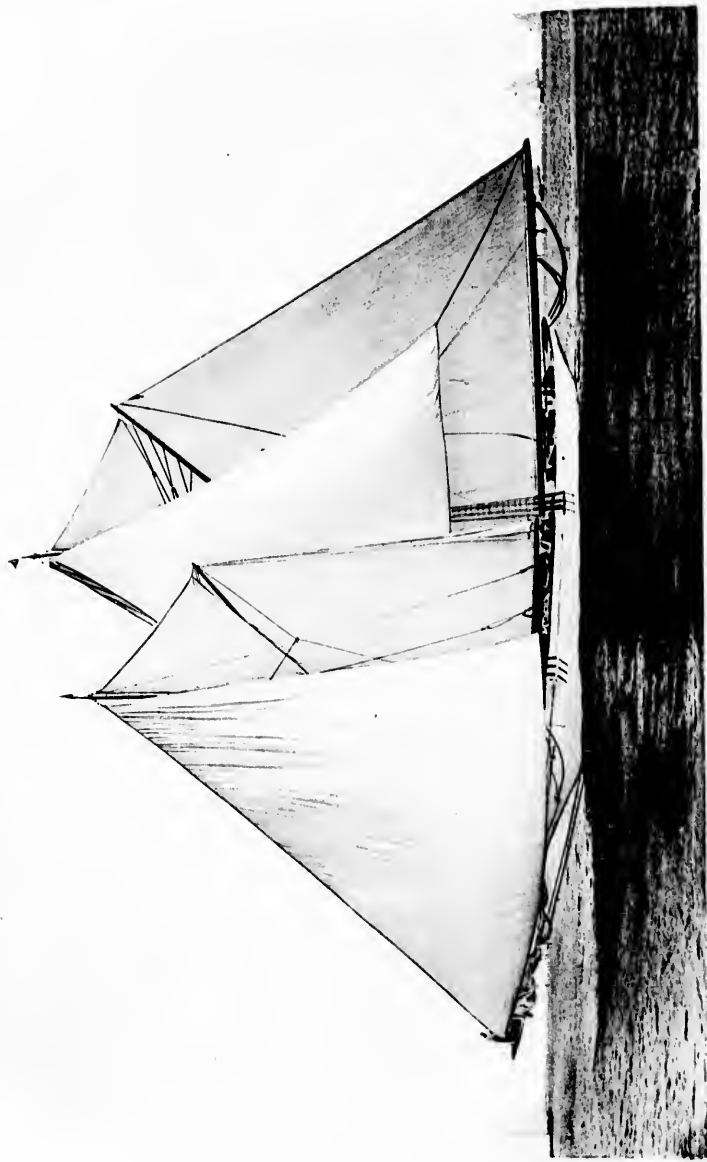

PLATE XIX.

ALCÆA.

THE ALCÆA

1850

ALCÆA

ALCÆA

ALCÆA



1111

A
J
A
C
C
D
D
D
F
F
F
G
G
H
H
H
K
L
L
M
M
M
M
M
N
O
O
O
R
S
V
W

LIST OF YACHTS ENROLLED IN THE EASTERN YACHT CLUB, 1893.

SCHOONERS.

Yacht's Name.	Port.	Owners.	Tonnage.		Length over all.	Length on Water Line.	Beam.	Draft.	Keel or C. B.	Racing Measurement.	Class.
			Gross.	Net.							
Aleca	New York	Louis V. Clark	121.50	30.	22.25	13.	k	94.58	1
Alice	Boston	Clas. H. Andrews	91.	82.	71.50	24.50	11.	k	2
Ambassadors	"	Nathaniel Thayer	491.12	242.61	160.10	139.50	28.20	12.80	k	1
Ariel	New York	George H. B. Hill	109.	79.50	21.50	10.	e b	1
Comanche	Bridgeport	A. H. Fowler	87.30	82.30	90.	81.	23.25	10.	e b	1
Constellation	Boston	Bayard Thayer	157.	149.	131.	106.	24.75	12.75	e b	110.10	1
Crusader	New York	Frederick Swift, <i>et al.</i>	71.33	68.34	97.	81.	21.50	8.25	e b	1
Damless	"	C. H. Colt	251.64	126.40	124.10	110.70	26.70	12.60	k	109.85	1
Dorothy Q	Portland	Walter Woodman	26.	18.57	48.49	42.	14.40	7.	k	2
Dreadnaught	Boston	A. W. Nickerson	264.90	130.25	115.75	24.42	11.31	k	1
Fleur de Lys	New York	George Trotter	93.95	86.	108.	84.50	22.	13.	k	1
Foam	Beverly	Arthur Dexter	102.10	64.95	88.70	82.31	21.80	7.20	e b	1
Fortuna	Gloucester	Henry S. Hovey	109.00	96.30	22.00	12.	k	94.69	1
Frelle	Boston	William W. Dodge	26.31	25.01	58.	51.	15.70	8.30	k	2
Grayling	Brooklyn	L. A. Fish	137.85	66.26	91.	83.30	21.	8	e b	86.05	1
Gaudrel	Boston	Benjamin Vaughan	19.77	18.78	55.	45.50	14.50	7.00	k	49.40	2
Haleyon	New York	David S. Hammond	122.50	63.47	91.75	79.67	23.42	6.	e b	1
Harbinger	Providence	Henry G. Russell	45.90	47.67	79.60	65.90	19.25	6.30	e b	66.80	2
Iroquois	New York	Ralph N. Ellis	161.25	88.16	91.25	89.04	21.	9.75	e b	82.	1
Kathleen	Boston	E. A. Barnes, <i>et al.</i>	67.25	35.30	65.	56.	19.	7.75	k	2
Lasca	New York	John E. Brooks	121.23	115.17	119.	89.75	23.	19.66	e b	1
Lona	Boston	O. W. Penbody	13.83	41.	39.	15.	5.66	k	2
Marguerite	New York	R. S. Palmer	76.42	65.33	99.70	79.81	21.	11	e b	81.74	1
Mayflower	Boston	W. Amory Gardner	19.40	85.32	23.50	19.	e b	89.06	1
Merlin	"	William H. Forbes	108.	89.80	23.50	9.20	e b	93.45	1
Meta	Beverly	A. A. Lawrence	74.	43.	75.80	62.21	19.50	5.50	e b	2
Mohican	Boston	Henry D. Burnham	120.	106.25	k	103.68	1
Norseman	New York	Ogden Goelet	311.43	166.61	131.	113.25	25.10	11.20	k	1
Onone	Boston	Hugh Cochrane	71.83	68.24	93.	75.	19.30	12.	k	79.60	2
Princess	"	C. B. Tower	21.78	14.64	42.	35.75	13.31	7.	k	2
Quickstep	Providence	Frederick Grinnell	83.	65.	20.	7.	e b	70.18	2
Ruth	New York	Henry Marquand	169.59	98.45	93.15	23.	e b	1
Son Fox	"	Alanson Tucker	107.	89.78	23.82	11.	e b	90.43	1
Yoga	Pittsburgh	E. M. Ferguson	176.	91.33	95.80	85.30	24.33	8.	k	1
Wanderer	Nowport	Watson F. Blair	197.83	97.61	118.50	100.30	23.50	12.	k	1

HISTORY OF THE EASTERN YACHT CLUB.
LIST OF YACHTS ENROLLED IN THE EASTERN YACHT CLUB, 1893.
SLOOPS, CUTTERS AND YAWLS.

Yacht's Name.	Port.	Owners.	Tonnage.		Length over all.	Length on Water Line.	Beam.	Draft.	Keel or C. B.	Racing Measurement.	Class.	
			Gross.	Net.								
			63.20	44.75	14.20	k	55.68	8	
Altmark	Boston	John B. Paine	15.88	18.	41.66	14.50	e b	5	
Aurora	"	A. G. Baxter and J. O. Shaw, Jr.	52.	30.60	13.	8.20	k	46.80	6	
Baldoon	"	G. A. Goddard	54.30	45.	9.10	8.	k	48.80	5	
Bayshore	"	T. Watson Merrill	42.	32.50	10.30	7.	k	7	
Beatrice	New York	Theo. Danham and Edw. K. Danham	31.83	10.66	3.81	e b	7		
Betty	Salem	Geo. S. Osborne	7.33	6.97	30.10	30.	11.	5.34	e b	7	
Camilla	Boston	Francis C. Welch	70	45.75	12.66	11.50	fin	5	
Carantha	Marblehead	C. H. W. Foster	62.	39.80	13.	7.	e b	46.88	6	
Chiquita	Boston	Aug. Hemenway	123.	85.	24.	14.06	k	1	
Colonia	New York	Archibald Rogers	49.31	42.50	16.	4.50	e b	5	
Dream	Manchester	Gresly S. Curtis	31.85	52.	34.80	9.	8.33	k	7	
Erusilla	New York	E. D. Morgan	35.09	30.	11.	6.04	7	
Elf	Boston	Henry Howard	41.20	30.40	9.16	7.00	k	36.07	7	
Fancy	Newport	C. F. Lyman	49.60	44.60	17.	5.	e b	50.80	5	
Fanita	Boston	T. H. Shepard	49.20	44.50	10.30	4.	e b	5	
Frolic	New Bedford	C. W. Clifford	17.98	49.20	44.50	10.30	4.	e b	5
Galatea	Glasgow	William Henn	171.14	90.	102.	87.	15.	14.60	k	86.74	1	
Gladys	Boston	W. P. Fowle	42.	30.	10.	7.	k	7	
Gloriana	Philadelphia	W. B. Hopkins, M.D.	70.	45.30	13.	10.20	k	5	
Gorilla	Boston	Odin B. Roberts	21.80	19.85	54.	40.	14.50	7.50	e b	6	
Gossip	"	H. B. Richardson	15.25	55.	40.	12.80	10.	k	6
Gosson	"	Chas. A. Moss, Jr.	51.	39.50	12.	9.25	k	48.	6	
Handsel	"	J. H. Hooper	44.87	30.	9.50	7.75	fin	32.22	7	
Harpoon	"	G. C. Adams and C. F. Adams, 2d.	62.20	45.40	16.	7.50	e b	54.61	5	
Hawk	Beverly	Gordon Dexter	40.24	30.21	11.	5.	e b	36.85	7	
Hesper	Boston	W. H. Forles	38.75	54.14	46.43	15.50	e b	51.12	6	
Hibba	Swampscott	Chas. P. Curtis	38.75	31.40	11.	6.00	k	35.05	7	
Huron	Providence	W. B. Dumeau, Jr.	39.98	37.98	73.42	63.50	15.84	11.	k	2	
Mildred	Boston	Nathaniel C. Nash	42.	30.	9.50	7.50	k	7	
Navalhoe	New York	Royal P. Carroll	
Nebula	Boston	Clarence W. Jones	16.43	15.61	43.	35.	12.	7.50	k	7	
Noaparelle	New York	S. H. Pomeroy	72.	45.77	78.	65.	15.	12.	k	2	
Norma	Boston	George B. Upham	35.	30.	7.10	6.	k	7	
Oweene	"	W. O. Gay	60.50	45.70	k	54.54	5	
Pilgrim	"	W. A. Gardner and B. Thayer, et al.	120.	85.	23.	22.	fin	
Puritan	"	J. Malcolm Forbes	93.	81.10	22.00	8.20	e b	85.22	1	
Rondina	"	David C. Percival	7.40	36.40	30.40	7.30	6.90	k	7
Saladin	"	J. Prince Loud and C. E. Loud	42.	30.	10.	7.	k	7	
Sayonara	"	Bayard Thayer	24.	22.	60.60	45.10	12.50	10.50	k	54.12	5	
Shadow	"	John Bryant	18.84	12.86	36.76	33.71	14.40	5.33	e b	7	
Shona	New York	Chas. H. Tweed	32.70	5.75	k	7	
Stranger	Liverpool	Geo. H. Warren	77.60	64.63	13.60	11.	k	68.07	2	
Surf	Boston	W. G. Titcomb	17.61	13.46	44.50	36.33	8.33	7.33	k	38.	6	
Thelma	"	William O. Gay	24.	62.	45.50	13.42	9.67	k	5
Titania	New York	C. Oliver Iselin	80.	60.96	21.30	8.80	e b	76.40	2	
Tilda	"	James Stillman	42.	k	7	
Valhalla	Boston	W. Stanford Stevens	15.30	14.13	40.	35.	14.20	6.30	k	7	
Varande	Beverly	Wm. Caleb Loring	35.	k	7	
Vixen	St. Louis	J. C. Richardson	61.50	49.50	7.16	k	4	
Volunteer	Boston	J. Malcolm Forbes	116.60	110.77	100.90	90.	23.	10.	e b	1	
Wayward	"	David Sears	78.20	60.20	14.50	11.	k	64.87	3	
Whitecap	"	W. C. Forbes	40.	35.	14.18	3.33	e b	7	
Whitewing	"	Charles R. Sturgis	37.	32.	9.	7.25	k	7	
Winsome	Newport	Charles Fairchild	19.28	47.	42.40	15.10	e b	5
Wizard	New York	Ernest Staples	35.54	31.76	63	58.	18.40	6.50	e b	8	
Zepher	Newport	Max. Agassiz	62.30	42.	12.60	8.	k	46.75	5	

LIST OF YACHTS ENROLLED IN THE EASTERN YACHT CLUB, 1893.

STEAMERS.

Yacht's Name.	Port.	Owner.	Tonnage.		Length over all.	Length on Water Line.	Beam.	Draft.	Depth.
			Gross.	Net.					
Adella	Boston	N. C. Nash	53.00	37.55	93.	87.	10.	7.07
Aquila	New York	George A. Thayer	104.	85.	15.	7.	8.50
Aurora	Beverly	D. L. Pickman	90.	79.	17.	7.
Avenel	New York	G. Weaver Loper	127.81	67.40	134.	106.33	18.	9.50
Chetolah	Nowburyport	Charles Lunt	91.20	47.13	106.	91.	17.	8.
Corona	Boston	John P. Cushing	21.95	13.53	90.	88.	12.	6.67
Corsair	New York	J. Pierpont Morgan	200.53	280.32	211.5	204.	27.17	13.	16.50
Darling	Boston	George M. Preston	61.00	49.00	100.0	89.	15.	6.40
Dora	"	Daniel S. Ford	94.	80.	12.	5.31
Edgewater	"	William G. Titcomb	102.00	98.30	11.50	5.30
El Placita	"	J. W. Abbott	41.	71.	59.	12.75	5.
Ermenegardo	Isle of Wight	Geo. P. Russell	103.	18.58	9.
Faustino	"	Geo. P. Russell	95.25	52.48	80.50	71.50	10.81	8.	7.75
Fidget	W. Manchester.	W. C. Cabot	70	12.
Gadabout	Salem	Klug Upton	65.	57.	10.	5.
Gayfota	New York	John R. Dos Passos	51.19	30.24	77.20	14.20	7.
Gyda	Boston	Edgar Harding	71.	62.	12.41	5.50
Hanniel	"	C. H. W. Foster	97.	85.	15.10
Hermes	"	I. S. Palmer	41.	35.00	8.	3.00
Ibis	"	S. C. Lawrence	259.60	150.03	131.50	121.	23.90	8.	7.70
Idlewild	Wood's Hole	J. S. Fay, Jr.	35.	31.50	7.	2.50
Intrepid	New York	Lloyd Phoenix	300.49	190.49	161.50	132	27.	13.50
Javelin	Newport	E. D. Morgan	97.80	94.50	10.25
Luette	Duxbury	Geo. W. Wright	41.90	24.11	90.	85.	11.60	5.00
Madeleine	Taunton	Frederick Mason	35.	..	7.	3.
Marian	Boston	W. H. Swift	35.	31.	8.	2.00
May	Newport	E. D. Morgan	229.	204.	27.50	14.50
Namouna	New York	J. G. Bennett	845.10	616.29	220.00	217.	26.33	14.25	15.30
Now Then	Boston	J. E. Adlecks	80.	85.	10.	4.
Polly	"	S. Cunningham	41.	37.	7.00	3.00
Polly	"	C. S. Eaton	13.28	69.	64.	9.16	3.50
Princess	"	Edwin Moray	44.	22.23	83.	69.	14.90	6.
Random	"	F. B. McQuesten
Sagamore	Philadelphia	Edgar T. Scott	322.81	163.	185.	160.	20.	12.
Shearwater	New York	Henry R. Wolcott	120.	108.	17.92	6.50	8.75
Sulrana	"	Trenor L. Park
Susquehanna	"	Joseph Stickney	170.	151.	21.58	9.	13.
Swallow	Boston	Henry Whitman	20.51	10.06	61.90	50.	11.	4.00
Tolnetto	New York	Robert D. Evans	132.	109.	18.80
Turtle	Boston	Arthur Amory	20.47	10.23	60.75	60.75	19.	2.75
Utowana	New York	W. West Durant	414.	236.	191.	155.	27.50	11.50
Vaucluse	Islesboro, Me.	J. R. Brackett	35.	11.	4.
Wanda	New York	James Stillman	111.27	55.64	148.	128.	18.	10.
Wild Duck	Boston	John M. Forbes	146.	125.	20.	7.50	12.

RECORD OF RACES.

First Regatta of the EASTERN YACHT CLUB was sailed on July 13, 1870, from Marblehead Rock around Halfway Rock to Davis Ledge Buoy, Graves, and return, about 40 nautical miles.

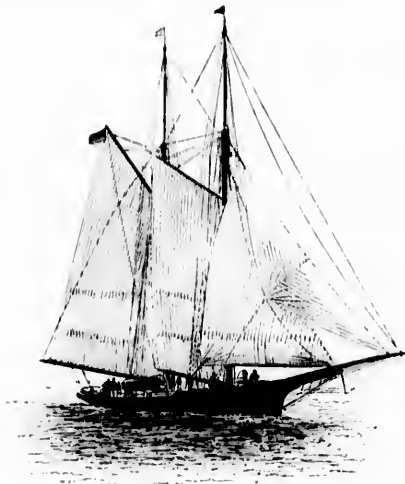

FIAM.—FIGURE 200.

SCHOONERS.		
	Tonnage O. M.	Finish.
Dawn, Prize \$150	41 8	5 09 00 C. B.
Ethel	57 00	5 17 05 K.
Wivern	53 40	5 25 00 K.
Rebecca	77 60	5 28 15 C. B.
Janthe	35 00	5 46 00 K.
Belle	40 00	5 49 00 K.
Juliet	81 51	5 50 05 C. B.
Edith	47 09	6 08 00 C. B.

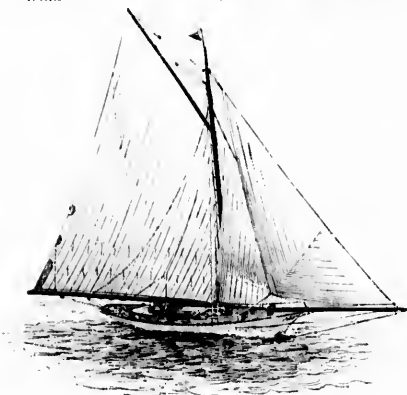

LASSIE.—FIGURE 201.

SLOOPS.		
Coming	53 0	4 25 00 C. B.
Sadie, Prize \$100	26 9	4 30 25 C. B.
Gussie	27 0	4 55 50 C. B.
Louise, 2d Prize \$25		C. B.
Mary	12 0	C. B.

A Subscription Regatta of the EASTERN YACHT CLUB was sailed off Swampscott, Sept. 8, 1870, to Halfway Rock, Dog Bar and the Graves and return, about 33 nautical miles.

SCHOONERS.		
Junata, 1st Prize	82 0	5 03 15
Rebecca, 2d Prize	77 60	5 13 58
Janthe	35 0	5 42 37
Dawn	41 8	5 43 15
Edith	47 09	6 02 27
Wivern	53 40	6 25 40
Belle	40 0	6 28 50

SLOOPS.		
First Class.		
Sadie	26 9	5 06 45
Gussie	27 0	5 15 00
Drum	28 6	did not finish
Second Class.		
Clytie, 1st Prize	—	3 14 46
Mary	12 0	3 48 00
Daisy	12 34	4 13 30

The Annual Regatta of the EASTERN YACHT CLUB, sailed June

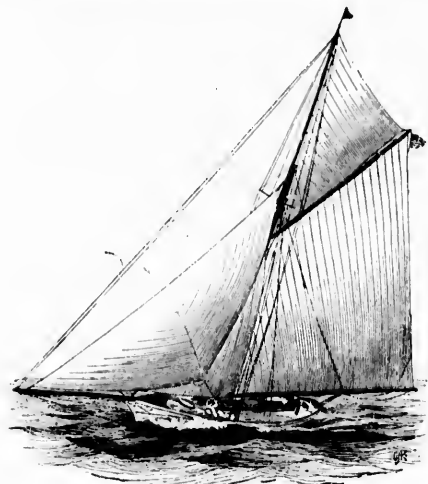

SARACEN.—FIGURE 202.

13, 1871, from Marblehead Rock to Halfway Rock, Graves, Egg Rock, and return, about 20 miles.

SCHOONERS.			
	Tonnage O. M.	l. w. l.	Cor. Time.
Wivern	53 40	48.33	did not make the race
Janthe	35 00	48.25	did not make the race
Edith	47 09	56.75	
Ethel	57 0	63.00	
Julia	83 4	71.17	5 03 34
Sylvie, 1st Prize	106 2	74.07	4 29 47
Junata	82 0	74.75	5 03 23
Rebecca	77 6	66.75	4 36 15

SLOOPS.			
Sadie	26 9	46.0	did not make the race
White Cap	17 57	34.74	did not make the race
Alice	68 27	59.8	
Coming, 1st Prize	53 0	57.0	4 55 37
Violet	15 68	32.2	did not make the race

SYLVIE was disqualified, and the first prize went to REBECCA, but

LUH was sailed off
og Bar and the

5 05 15
13 58
42 07
43 15
02 27
25 40
28 50

06 45
15 00
did not finish

14 46
48 00
13 39

UH, sailed June



ces, Egg Rock,

. Time.
ot make the race
ot make the race

03 34
29 47
03 23
36 15

t make the race
t make the me-

7
t make the race
REBECCA, but



SYLPH.

PLATE XX



Fig. 1. Sylph, 1800.
Fig. 2. Sylph, 1800.
Fig. 3. Sylph, 1800.
Fig. 4. Sylph, 1800.

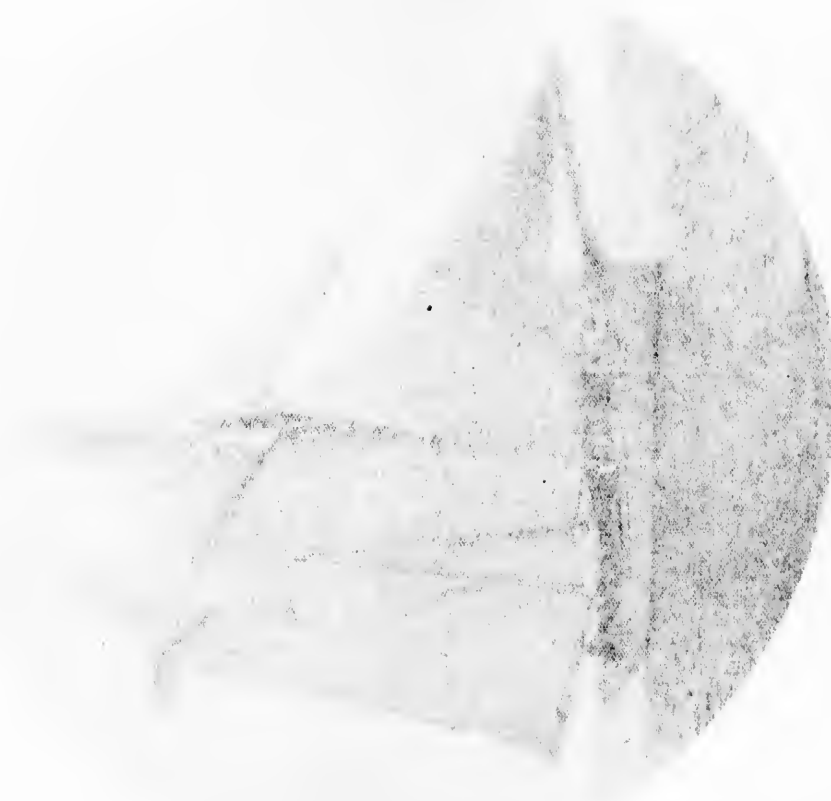

Com. Heard refused to accept it and it was sailed for a second time by schooners in the next Regatta, Sept. 19, 1871.

The Regatta sailed off Swampscott, Aug. 14, 1871, to Davis Ledge, Halfway Rock and return by the NEW YORK YACHT CLUB and EASTERN YACHT CLUB combined fleet, for two cups presented by the EASTERN YACHT CLUB and two presented by the residents of Swampscott:

SCHOONERS.

	L. W. L.	Cor. Time.
Columbia, two first prizes	98.0	5 09 35
Damless	110.7	5 20 08
Sappho		5 34 01
Wanderer	106.06	5 35 21
E. Ianthe	48.25	5 36 28
E. Junata	74.75	5 39 14
Huleyon	79.35	5 40 07
Magic	80.25	5 41 51
E. Sylvie	74.07	5 41 58
Idler		5 47 43
Eva		5 53 50
Tarolinta	95.38	5 55 57
E. Rebecca	66.75	5 57 06
E. Julia	71.17	5 58 46
E. Ethel	63.0	6 03 63
Sprito		6 03 55
E. Dawn	51.0	6 06 26
Foam	76.5	6 09 49
Dreadnaught	115.75	6 11 22
E. Belle	48.6	6 11 42
Rambler		6 14 21
Vesta		6 17 36
E. Edith	56.75	6 20 00
E. Glimpse		did not finish

around North End Baker's Island to stake boat off Eastern Point, to Graves' Bell Buoy and return, about 33½ nautical miles.

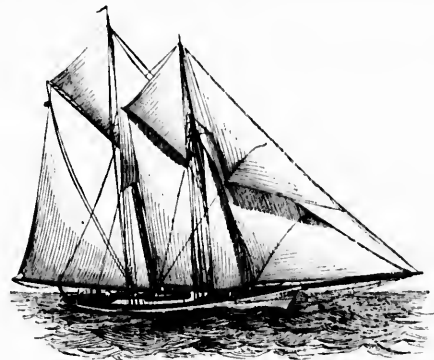

QUICKSTEP.—FIGURE 294.

SCHOONERS.

	L. W. L.	Cor. Time.
Junata	74.75	5 25 13
Sylvie	74.7	5 31 22
Fearless	51.15	5 43 35
Rebecca	66.75	5 50 57
Julia	71.17	6 19 54
Ianthe	48.25	6 31 57

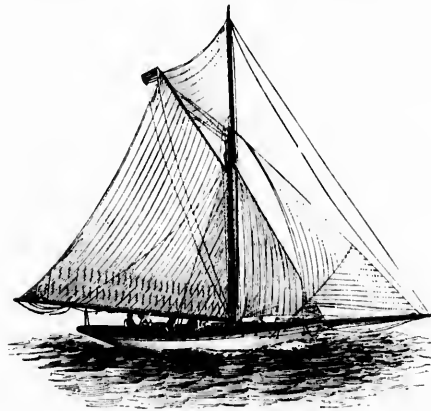

BABOON.—FIGURE 293.

SLOOPS.

Gracie, Two first prizes		4 54 55
Vixen	41.5	5 07 28
E. Sudie	46.9	5 09 40
Vindex	56.33	5 17 16
E. Coming	57.0	5 31 48
E. Violet	32.2	5 37 20
E. Alarm	30.2	5 43 46

Those marked E. are Eastern Yacht Club boats. Alice and Narragansett did not finish.

A Handicap Race for cup valued at \$400 presented by the Commodore, was sailed off Beverly Shore September 19, 1871, over a course

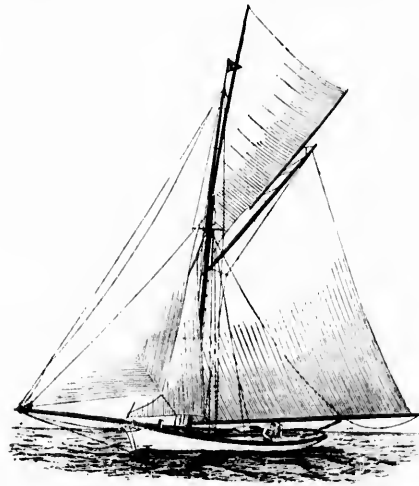

ELF.—FIGURE 295.

SLOOPS.

Sadie	46.0	5 26 29
Coming	57.0	5 32 24

BELLE, WIVERS, BONITA, NARRAGANSETT, DREAM, GLIMPSE, and DAISY, time not taken.

JUNATA won Commodore's Cup and schooner's prize. COMING won sweepstakes.

The Annual Regatta for 1872 was sailed on the 12th of June from Marblehead Rock to Eastern Point, Graves Buoy and return, about 40 nautical miles.

HISTORY OF THE EASTERN YACHT CLUB.

SCHOONERS.

	L. W. L.	Cor. Time.
Fearless, 1st Prize \$150	51.15	5 31 39
Vision, 2d Prize \$75	55.0	6 15 51
Sylvie	71.7	6 10 38
Lafona	55.5	6 35 09
Julia	71.17	6 53 11
Caprice	85.00	6 55 15

SLOOPS.

Coming, 1st Prize \$100	57.0	5 51 29
Shadow, 2d Prize \$50	33.5	6 24 04
White Cap	31.74	6 34 22

A Special Regatta was sailed August 11, 1872, from Swampscott in a fog.

SCHOONERS.

	L. W. L.
Fearless	51.15
Haze	59.33
Romance, 2d Prize	55.0
Vision, 1st Prize	55.0
Edith	59.75
Dawn	51.0
Zephyr	53.9

SLOOPS.

White Cap

A race for a cup offered by Vice-Commodore Whitney and a sweepstakes, was sailed off Beverly Shore, September 4, 1872. Not made in time; sailed again, on next day.

SCHOONERS.

	L. W. L.	Cor. Time.
Haze, Sweepstakes	59.33	7 37 40
Lafona, V. C. Cup	55.5	7 31 53
Sylvie	71.7	7 55 27
Vision	55.0	7 41 16
Romance	55.0	7 41 57
Julia	71.17	did not finish.

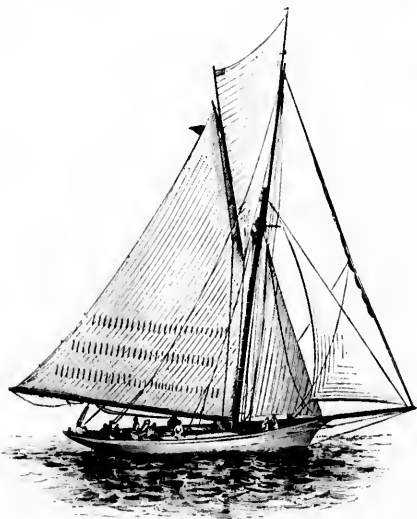

ALIA.—FIGURE 206.

A Special Regatta for prizes subscribed for by residents, sailed from Swampscott, September 7, 1872:

SCHOONERS.

	L. W. L.	Act. Time.
Fearless, 1st Prize \$150	54.15	6 37 36
Vision, 2d Prize \$100	55.0	6 52 46
Junia	74.75	6 55 3
Romance	55.5	6 56 10
Dawn	51.0	7 00 18
Zephyr		time not taken
Sylvie		time not taken

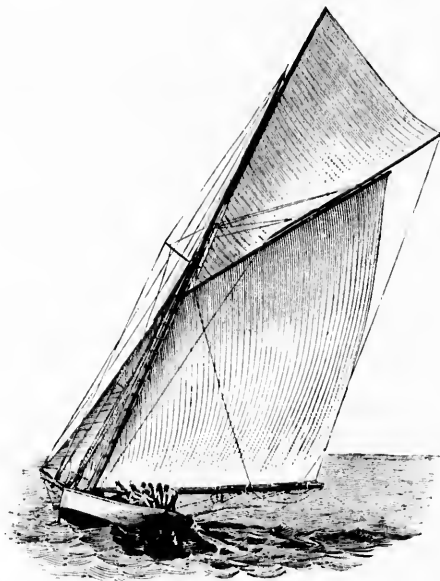

ALBORAK.—FIGURE 207.

SLOOPS.

Coming, Prize \$150	57.0	5 32 08
Alice	59.8	time not taken

The Annual Regatta sailed off Marblehead Rock, June 11, 1873, to Halfway Rock, Egg Rock, Graves Buoy, Harding's Ledge and return, about 35½ miles.

SCHOONERS.

	L. W. L.	Cor. Time.
Julia	71.17	4 47 06
Vision, Prize	55.0	4 27 50
Sylvie		disabled
Azalea, Prize	54.6	4 31 11
Halecyon		did not start
Brenda		did not start
Haze		did not start
Fearless		did not start
Junia	74.75	4 50 53

SLOOPS.

Coming	57.0	4 31 20
Clytie	33.55	5 18 35
Shadow	33.50	5 15 05

A Regatta was sailed off Swampscott, June 28, 1873, as follows:

SCHOONERS.		L. W. L.	Act. Time.
First Class.			
Halcyon, 1st Prize \$100		79.0	5 54 25
Julia		71.17	5 56 43
Rebecca		66.75	
Silvie		74.7	6 50 10
Second Class.			
Haze		59.55	6 03 52
Latona		55.5	6 50 25
Vision		55.0	6 39 57
Fearless, 1st Prize \$125		51.15	6 03 42
Coming		57.0	5 55 38

SCHOONERS.		L. W. L.	Cor. Time.
First Class.			
Halcyon		79.35	3 58 22
Brenda		61.20	4 21 24
Julia		71.17	4 21 47
Silvie		71.7	1 07 27
Second Class.			
Vision		55.0	4 59 28
Fearless		54.15	4 31 46
Glumpse			time not taken
SLOOP.			
Coming		57.00 (Act)	10 23 07

HALCYON took prize for 1st boat in her class, also 1st on allowance.

Fearless took 1st prize, 2d class
 Silvie " 2d " 1st "
 Vision " 2d " 2d "

The Annual Regatta of the EASTERN YACHT CLUB was sailed on July 1, 1874.



CLYTIE.—FIGURE 298.



WAYWARD.—FIGURE 299.

SLOOP.		
White Cap, Prize \$75	35.0	6 27 17
Clytie		time not taken
Shadow		time not taken

A regatta was sailed off Swampscott, September 4, 1873, for a cup given by Rear-Commodore Jeffries, (HALCYON excepted, owned by Commodore Jeffries) and a Sweepstakes for 2d class schooners.

SCHOONERS.		L. W. L.	Cor. Time.
First Class.			
Halcyon, 2d Prize \$75		79.35	5 45 14
Foam, 1st Prize \$125		76.50	5 44 29
Rebecca		66.75	6 01 52
Azalea		60.60	5 48 05
Brenda		61.20	5 34 51
Second Class.			
Fearless, 1st Prize \$125		54.15	5 56 34
Latona		55.50	6 00 25
Edith		56.75	6 32 27
Romance		55.60	6 16 14
SLOOP.			
Coming		57.00	disabled
First Class.			
Clytie		38.00	6 21 41
Nimbus, 1st Prize \$75		33.55	6 17 19
White Cap		35.00	time not taken
Imogen		34.10	time not taken

The Fall Regatta of the EASTERN YACHT CLUB was sailed off Swampscott, September 16, 1873.

Time.
 7 36
 2 40
 5 3
 6 10
 0 18

5 32 08
 time not taken

ock, June 11, 1873,
 ling's Ledgo and re-

Cor. Time.
 4 47 06
 4 27 50
 4 31 11
 4 31 11
 4 50 53

4 31 20
 5 18 35
 5 15 05

ES, 1873, as follows:

The Fall Regatta of the EASTERN YACHT CLUB was sailed September 5, 1874, from Beverly Shore to Harding's Bell Buoy, Graves Bell Buoy, Egg Rock and return.

SCHOONERS.			
First Class.	L. W. L.	Cor. Time.	
Haleyon, Prize \$125	79.35	4 00 02	
Foam	76.50	4 03 29	
Rebecca	66.75	time not taken	
Second Class.			
Fearless, Prize \$125	51.15	4 15 51	
Latona	56.50	4 39 30	
Romance	55.60	time not taken	
Belle	18.60	1 57 48	

SLOOPS.			
First Class.	L. W. L.	Cor. Time.	
Coming	57.00	3 37 05	
Second Class.			
Imogen	31.10	time not taken	
Gambet, Prize \$75	33.00	5 16 35	

A special race between sloops COMING and VINDEX, was sailed September 16, 1874, from Swampscott to Halfway Rock, Harding's Ledge, Graves Bell Buoy, and return.

SLOOPS.			
	L. W. L.	Cor. Time.	
Coming, Prize \$125	57.00	5 37 28	
Vindex	56.00	5 50 14 1/2	

The Annual Regatta was sailed June 22, 1875, from Swampscott

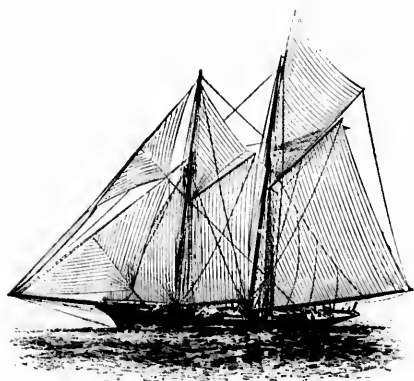

CONSTELLATION.—FIGURE 300.

to Harding's Bell Buoy, Halfway Rock and return; about 33 nautical miles.

SCHOONERS.			
First Class.	L. W. L.	Cor. Time.	
Haleyon, Prize \$125	79.35	3 48 01	
Foam	76.50	3 58 29	
Rebecca	66.75	4 36 58	
Brenda	61.20	4 05 29	
Azalea	60.60	4 29 14	
Second Class.			
Edith	56.75	5 00 50	
Romance	55.60	1 52 37	
Fearless, Prize \$100	54.15	4 19 54	

SLOOPS.			
First Class.	L. W. L.	Cor. Time.	
Coming	57.00	4 09 36	
Second Class.			
Clytie	33.60	5 03 26	
Nimbus, Prize \$75	33.55	5 03 05	

The Fall Regatta was sailed September 16, 1875, from Swampscott, around Harding's Bell Buoy, Halfway Rock and return; about 33 nautical miles.

SCHOONERS.			
First Class.	L. W. L.	Cor. Time.	
Haleyon, Prize \$125	79.35	4 20 15	
Foam	76.50	5 03 27	
Brenda	61.20	5 01 20	
SLOOPS.			
Second Class.			
Nimbus	33.55	5 56 22	
Shadow, Prize \$50	33.50	5 46 36	

The Annual Regatta was sailed August 29, 1876, from Swampscott to Davis Ledge, Minot's Ledge, and return; about 29 1/2 miles.

SCHOONERS.			
	L. W. L.	Cor. Time.	
Haleyon, Prize \$200	79.35	5 39 45	
Foam, Prize \$100	76.05	5 41 46	
Latona	55.05	6 00 32	
Fearless	51.15	5 43 31	
Magie	80.25	6 05 35	

SLOOPS.			
	L. W. L.	Cor. Time.	
Wayward, Prize \$125	31.02	5 41 17	
Shadow	33.05	5 48 30	

The Annual Regatta was sailed June 21, 1877, from Marblehead Rock, to Halfway Rock, Harding's Ledge, Egg Rock and return, about 28 1/2 miles.

SCHOONERS.			
First Class.	L. W. L.	Cor. Time.	
Magie	80.25	4 15 24	
Haleyon, Prize \$200	79.35	4 06 30	
Brenda	61.02	4 31 32	
Foam	76.05	4 27 22	
Azalea	60.00	4 26 58	
Second Class.			
Romance		time not taken	
Fearless, Prize \$100	54.15	4 36 30	
Latona		disabled	

SLOOPS.			
First Class.	L. W. L.	Cor. Time.	
Madeup	42.00	5 01 50	
Wayward, Prize \$100	43.00	4 58 05	

The Annual Regatta was sailed June 27, 1878, from Marblehead Rock, same course as last year; about 28 1/2 miles.

SCHOONERS.			
First Class.	L. W. L.	Cor. Time.	
Foam		Ret'd out	Re-sailed July 7, 1878.
Haleyon		Ret'd out.	Re-sailed July 7, 1878.
Second Class.	L. W. L.	Cor. Time.	
Anna, Prize \$100	47.00	5 57 41	
Breeze		did not finish	
Dream		did not finish	

SLOOPS.			
First Class.	L. W. L.	Cor. Time.	
Enterprise	43.00	5 01 14	
Madeup, Prize \$100	42.00	4 58 13	
Second Class.			
Whitcup, Prize \$75	35.00	5 10 32	
Shadow		did not finish	
Haleyon	79.35	4 10 12	
Foam	81.50	5 29 06	

from Swamp-
1 return; about

Time.
0 15
8 27
03 20

00 22
10 36
from Swampscott
miles.

Time
30 45
41 40
00 32
43 31
05 35

41 17
48 30
from Marblehead
back and return.

Time
15 24
00 30
31 32
27 22
26 58

n
36 30

01 50
58 05
from Marblehead

uly 7, 1878.
uly 7, 1878.

or. Time.
5 57 41
inish
inish

5 01 14
4 58 13

5 10 32
inish
4 10 12
5 29 00



FROM A NEGATIVE BY CHILD.

PLATE XXI.

ADMIRAL.

ADMIRAL.

The Admiral
 was built at
 the Admiralty
 Dock, London
 in 1793
 and was
 the first
 ship of the
 class.

The Admiral
 was built at
 the Admiralty
 Dock, London
 in 1793
 and was
 the first
 ship of the
 class.



The Admiral
 was built at
 the Admiralty
 Dock, London
 in 1793
 and was
 the first
 ship of the
 class.

The Admiral
 was built at
 the Admiralty
 Dock, London
 in 1793
 and was
 the first
 ship of the
 class.

The Admiral
 was built at
 the Admiralty
 Dock, London
 in 1793
 and was
 the first
 ship of the
 class.

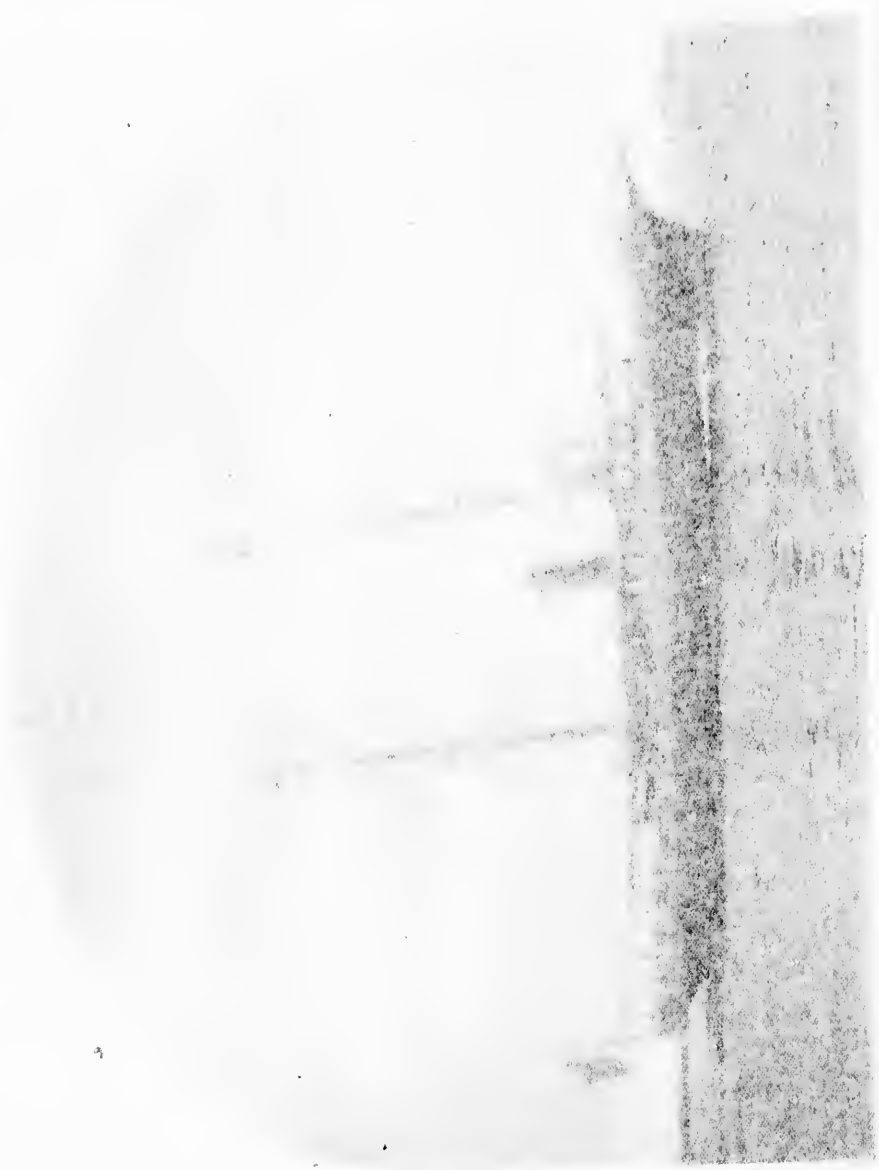

Re-sailed Race between HALCYON and FOAM, July 17, 1878, from Marblehead Rock to Halfway Rock, Harding's Bell Buoy, Egg Rock, and return.

The Fall Regatta of the EASTERN YACHT CLUB was sailed September 11, 1878, from stake boat off Little Nahant, to Halfway Rock, Harding's Bell Buoy, Egg Rock and return, 2 1/2 nautical miles.

SCHOONERS.			
First Class.	L. W. L.	Cor. Time.	
Foam	70.50	4 53 16	
Magle, Prize \$100	80.25	4 47 58 1/2	
Rebecca	66.75	4 57 38	
Brenda	61.2	4 58 22	
Second Class.			
Pearless, Prize \$75	51.15	4 51 31	
Latona	61.00	5 13 27	
Anna		time not taken	
Dream		time not taken	

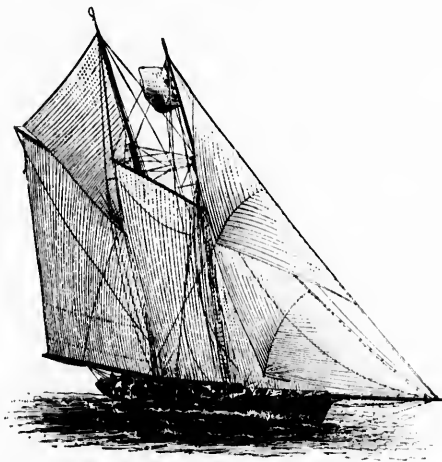

SEA FOX.—FIGURE 301.

SLOOPS.			
Second Class.			
Shadow, Prize \$50	33.5	5 19 31	
Whitecap	35.00	5 26 27	

At the same time the schooners FOAM and REBECCA sailed a private match over same course, FOAM allowing REBECCA twenty minutes.

	L. W. L.	Act. Time	Cor. Time.
Foam	70.50	4 53 16	4 53 16
Rebecca	66.75	5 05 15	4 45 15

A second race between same boats was sailed September 21, 1878, over the same course.

	L. W. L.	Act. Time	
Foam	70.50	5 32 40	
Rebecca	66.75	time not taken	

The Annual Regatta of the EASTERN YACHT CLUB was sailed July 9, 1879, from Marblehead Rock.

Course for 1st and 2d class schooners, and 1st class sloops, 3 1/2 nautical miles.

Course for 3rd class schooners, and 2nd class sloops, 2 1/2 nautical miles.

SCHOONERS.			
First Class.	L. W. L.	Act. Time	Cor. Time.
Phantom, Prize \$50	80.00	6 40 40	6 19 40
Halcyon, Prize \$100	79.35	6 51 07	6 47 07
Foam	81.50	7 21 32	7 17 32

Second Class.			
	L. W. L.	Act. Time	Cor. Time.
Latona	61.00	7 31 05	7 31 05
Brenda	61.2	time not taken.	
Fearless, Prize \$75	54.15	7 05 15	6 59 50
Sylph, 2d Prize \$40	45.5	7 33 17	7 19 51

Third Class.			
	L. W. L.	Act. Time	Cor. Time.
Dream, Prize \$50	42.50	3 42 46	3 42 46
Hornes, 2d Prize \$25	31.58	4 06 18	3 58 00
Loiterer	32.80	4 13 18	4 03 57

SLOOPS.			
First Class.			
Enterprise, Prize \$75	43.00	7 22 57	7 22 57
Madeup	42.00	7 25 54	7 21 30
Second Class.			
Ellie, Prize \$50	35.00	3 31 35	3 31 35
Ariadne	31.5	3 47 15	3 46 40

A Handicap Race of the EASTERN YACHT CLUB was sailed August 20, 1879, but not made in the time required by the sailing regulations, and it was postponed to September 9, 1879, at which date no first or second class schooner, or first class sloop completed the course in time, and it was not re-sailed this year.

The time of the smaller boats was as follows:

HANDICAP.			
	Act. Time.	Cor. Time.	
Ellie, allows.	4 10 42	4 10 42	
Sylph, 5 min., Prize \$50	3 32 38	3 27 38	
Dream, 7 min., Prize \$25	3 47 20	3 40 20	
Ariadne, 10 min.	4 17 33	4 07 23	

SCHOONERS.			
Third Class.	L. W. L.	Act. Time	Cor. Time.
Sylph, Prize \$25	45.5	3 32 38	3 32 38
Dream	41.5	3 47 20	3 45 00
Breeze,		did not finish	

SLOOPS.			
Second Class.			
Anna	39.08	4 19 40	4 19 40
Ellie	35.00	4 19 42	4 16 32
Ariadne	31.5	4 17 23	4 13 13
Shadow, Prize \$25	33.5	3 52 08	3 40 49

The Annual Regatta of the EASTERN YACHT CLUB was sailed on June 23, 1880, from Marblehead Rock to Graves' Bell Buoy, and Egg Rock, Graves' Bell Buoy and Egg Rock again and return, (for first and second class schooners and first class sloops).

For second class sloops, Halfway Rock, Graves' Bell Buoy, Egg Rock, and return.

SCHOONERS.			
First Class.	L. W. L.	Act. Time.	Cor. Time.
Phantom, Prize \$75	86.00	5 18 41	5 18 41
Halcyon	79.35	5 25 06	5 22 04
Foam		time not taken	

Second Class.			
	L. W. L.	Act. Time.	Cor. Time.
Sylph, Prize \$50	45.5	5 27 37	5 15 54
Meta, 2d Prize \$30	62.00	5 30 30	5 30 39
Latona	61.00	5 32 59	5 31 32
Brenda	61.2	5 34 38	5 33 46
Clochette	48.00	time not taken	

HISTORY OF THE EASTERN YACHT CLUB.

First Class	SLOOP'S.			
	L. W. L.	Act. Time.	Cor. Time.	
		H. M. S.	H. M. S.	
Anna, Prize \$50	39.08	5 31 08	5 12 23	
Madeup, 2d Prize \$30	42.0	5 27 47	5 11 11	
Siren	48.5	5 31 45	5 16 00	
Imperia	41.85	5 33 30	5 18 35	
Wayward	43.20	5 32 46	5 19 10	
Viva	45.0	5 32 10	5 21 22	
Hesper	45.0	5 42 05	5 32 00	
Addie V.	50.1	5 36 50	5 30 50	
Alice	50.8	5 42 38	5 42 38	
Active		time not taken		
Enterprise		time not taken		
Second Class.				
Shadow, Prize \$30	33.71	4 20 23	4 20 17	
Elle	36.00	4 28 58	4 28 58	

A Sweepstakes Race for sloops, \$20 subscription, second boat to save entrance money, was sailed off Marblehead Rock on Sept. 14, 1880. Course to Halfway Rock, Harding's Bell Buoy, Graves Bell Buoy, Egg Rock and return in a northeast rain storm.

	L. W. L.	Act. Time.	Cor. Time.	
Addie V.	50.1	5 10 30	5 10 30	
Active	50.16	5 52 27	5 45 27	
Hesper	45.0	5 55 58	5 51 50	
Anna	completed the course		time not taken	
Enterprise	dismasted		time not taken	
Wayward	withdrew		time not taken	
Madeup	withdrew		time not taken	

ACTIVE lost 12 minutes in picking up a man overboard, and the 2d prize was awarded to HESPER, but Capt. Forbes declined to accept it under the circumstances and it was given to ACTIVE.

The Spring Regatta of the EASTERN YACHT CLUB was sailed on June 15, 1881, from Marblehead Rock to Egg Rock, thence to Halfway Rock and stake boat, repeating the distance from the stake boat to Halfway Rock and return.

Third class schooners and second class sloops to omit second turning of Halfway Rock.

Second Class.	SCHOONERS.		
	Rac. Meas.	Act. Time.	Cor. Time.
Meta, Prize \$50	63.5	2 34 55	2 36 55
Lafona	60.5	2 43 31	2 42 07

First Class.	SLOOPS.		
	Rac. Meas.	Act. Time.	Cor. Time.
Siren, Prize \$50	42.0	2 45 36	2 38 54
Hesper, 2d Prize \$30	47.5	2 43 30	2 41 01
Enterprise	46.0	2 45 28	2 41 48
Anna	40.0	2 56 20	2 47 57
Active	51.5	2 48 12	2 48 12
Imperia	44.0	2 56 21	2 51 13
Viva	48.0	2 54 03	2 51 48
Recreation	45.0	2 58 35	2 54 12
Addie V.	60.5	disabled, did not start	
Elle	41.0	started in wrong class	

Second Class.	SLOOPS.		
	Rac. Meas.	Act. Time.	Cor. Time.
Shadow, Prize \$30	37.5	2 11 20	2 11 04
Hera	38.0	2 15 45	2 15 45

A Regatta of the combined NEW YORK and EASTERN YACHT Squadrans was sailed at New Bedford, August 5, 1881. 31 nautical miles, with EASTERN YACHT CLUB measurements and allowances.

SCHOONERS.	RAC. MEAS.		
	Rac. Meas.	Act. Time.	Cor. Time.
	Feet.	H. M. S.	H. M. S.
Rambler	112.5	did not finish	
Damless	104.5	4 08 20	4 06 17
Phantom	85.5	3 50 50	3 41 25
Acton	85.0	did not finish	
Haleyon, wins	70.0	3 40 40	3 27 50
Water Witch	70.5	4 41 30	4 30 22
Social	50.5	5 08 23	4 40 18
Olio	65.5	4 02 10	3 41 00
Peerless	61.5	3 58 48	4 37 01
Azulon	61.0	4 35 30	4 11 07
Caroline	48.0	5 07 50	4 31 35

SCHOONERS.	RAC. MEAS.		
	Rac. Meas.	Act. Time.	Cor. Time.
Gracie	70.0	time disputed	
Fanny	68.5	3 56 48	3 55 49
Mischief	61.5	3 59 30	3 53 33
Addie V.	60.5	time not taken	
Active	51.5	4 41 50	4 27 13
Whiteway	50.0	4 45 30	4 34 00
Hesper	48.0	time not taken	
Vixen	47.0	4 23 42	4 04 24
Wizard	46.5	4 30 13	4 10 22
Enterprise	46.0	4 50 35	4 30 10
Rover	41.5	4 50 43	4 28 34
Ariel	30.0	time not taken	

The race for sloops being claimed by both GRACIE and MISCHIEF, it was sailed off late in the season, and won by GRACIE.

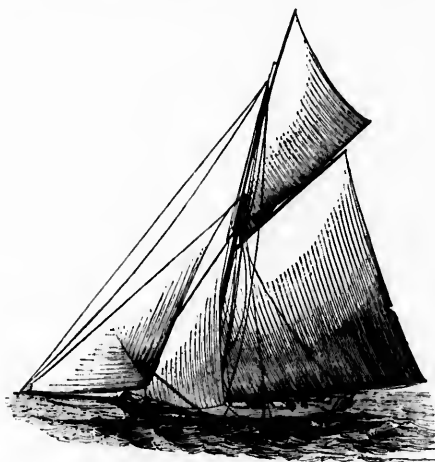

OWEENE.—FIGURE 302.

The Fall Regatta of the EASTERN YACHT CLUB was sailed September 13, 1881, from Marblehead Rock. Course for first and second class schooners and first class sloops, 20½ miles, and for second class sloops and third class schooners, 15 miles.

SCHOONERS.	RAC. MEAS.		
	Rac. Meas.	Act. Time.	Cor. Time.
First Class.			
Haleyon, Prizes \$75	78.00	2 20 24	2 27 10
Phantom, carr'd away both topmasts		2 32 42	2 32 42
Second Class.			
Lafona	60.5	2 44 17	2 33 54
Or, if Lafona is put up to 70 feet,			2 38 44

r. Time.
1. M. S.
06 17
41 25
27 56
30 23
40 18
41 06
37 01
11 07
31 35

55 49
53 33
27 13
34 00
04 24
10 22
30 10
28 34
en
and MISCHIEF,

sailed Septem-
t and second
second class

Cor. Time.
2 27 10
2 32 42
2 33 54
2 38 44

SLOOPS.			
First Class.	Rac. Meas.	Act. Time.	Cor. Time.
	Feet.	H. M. S.	H. M. S.
Madenp, Prize \$50	11.87	2 48 22	2 42 45
Ariadne	53.00	2 46 00	2 40 00
Viva	18.00	2 55 47	2 52 24
Second Class.			
Elle, Prize \$30	30.58	2 00 00	2 00 00
Viking	37.08	2 07 24	2 04 33
Third Class.			
SCHOONERS.			
Dream	15.47	2 04 41	

The Spring Regatta of the EASTERN YACHT CLUB for 1882, was sailed on June 21st, over Club Course No. 6 for all classes; 19 3/4 nautical miles.



SCHOONER.—FIGURE 303.

SCHOONERS.			
First Class.			
Alice (B. Y. C.)		No race.	
Rebecca	69.72	" "	
Third Class.			
Hermes, Prize \$50	35.50	4 08 17	4 03 40
Mist	37.60	disabled	
SLOOPS.			
First Class.			
Hesper, Prize \$100	47.47	3 14 27	3 00 47
Ariadne, 2d Prize \$50	53.17	3 12 12	3 08 23
Addie	60.47	2 17 06	3 17 06
Anna	39.68	3 31 05	3 17 39
Maggie	39.64	disabled, with race in hand.	
Second Class.			
Shadow, Prize \$50	37.38	3 23 20	3 21 56
Hera	47.06	3 29 50	3 28 55
Valhalla	38.65	3 20 23	3 20 23
Viking	37.78	3 32 00	3 31 35
Sigdrifa	38.22	4 03 27	4 03 00
Third Class.			
Beetle, Prize \$15		3 51 58	
Mavis		3 45 55	
Kelpie	29.33	time not taken.	

A Special Regatta for first and second class sloops was sailed July 20, 1882, over Course No. 1; 15 nautical miles.

SLOOPS.			
First Class.	Rac. Meas.	Elapsed Time	Cor. Time
	Feet.	H. M. S.	H. M. S.
Undine (B. Y. C.)	51.22	2 14 24	2 14 23
Maggie	30.61	2 11 58	2 08 35
Etho	30.66	2 24 40	2 18 26
Second Class.			
Hera	37.06	2 32 34	2 31 48
Shadow	37.38	2 25 30	2 17 23
Nimbus	35.25	2 34 12	2 30 24

Regatta sailed off Marblehead, August 14, 1882, by NEW YORK and EASTERN YACHT CLUBS, over a 30 nautical mile course, under NEW YORK YACHT CLUB allowance and measurements, for a cup for schooners, given by flag officers of the EASTERN YACHT CLUB, and a cup for sloops over fifty feet (length waterline), and one cup for all under fifty feet, given by Capt. Chas. J. Payne.

SCHOONERS.			
First Class.			
Damless	117.0	5 26 50	5 20 50
Haleyon, wins.	80.0	5 27 40	5 11 11
Clytie	78 1/2	5 40 06	5 20 40

SLOOPS.			
First Class.			
Gracie	71.0	5 05 38	5 05 38
Funny, wins	69.0	5 01 38	4 58 26
Active	52.0	6 00 23	5 46 06
Addie V	50 1/2	5 51 22	5 43 28
Oriva	51.0	5 32 23	5 17 00

Second Class.			
Maggie	45.0	5 55 43	5 55 43
Vizen, wins.	41 1/2	5 32 08	5 31 34

Third Class.			
Hera	35.0	6 03 40	5 50 23

The Spring Regatta of the EASTERN YACHT CLUB, for 1883, was sailed from Marblehead Rock over Course No. 7, 2 1/2 nautical miles, on June 30, 1883, at 11:45 A. M.

SCHOONERS.			
First Class.			
Fortuna, Prize \$350	80.46	2 59 30	2 59 30
Alice (B. Y. C.), 2d Prize \$100	71.00	3 31 10	3 23 24
Gitana	86.12	3 33 35	3 32 30
Second Class.			
Latona, Prize \$150	60.52	3 45 35	3 32 10
Sylph, 2d Prize \$75	50.00	3 51 28	3 33 14
Tempest	55.18	3 54 45	3 37 41

SLOOPS.			
First Class.			
Wenonah, Prize \$150	55.88	3 22 30	3 05 47
Maggie, 2d Prize \$75	39.64	3 38 08	3 07 34
Oriva	47.40	3 35 06	3 11 22
Hesper	47.64	3 37 54	3 15 00
Second Class.			
Shadow, Prize \$75	37.38	3 50 02	3 16 36
Lapwing, 2d Prize \$35	36.57	3 55 28	3 21 22
Clytie	35.61	3 58 38	3 23 22
Viking	37.78	4 13 22	3 40 28

A Special Regatta, open only to the NEW YORK and EASTERN YACHT CLUBS, was sailed off Marblehead August 10, 1883, for cups presented by the NEW YORK YACHT CLUB (one cup to each class), under its rules and allowances; 55 miles seaward and return.

HISTORY OF THE EASTERN YACHT CLUB.

	SCHOONERS.		
	Rac. Meas. Feet.	Act. Time H. M. S.	Cor. Time H. M. S.
First Class.			
Halcyon, wins	81.1	4 35 12	4 29 19
Fortuna	91.5	4 18 00	4 18 00
Montank	93.8	4 37 28	4 37 12
Estelle	81.8		withdrawn
Second Class.			
Clia, wins	68.8	5 08 33	4 55 19
Ladona	62.0	5 27 02	5 00 57
Social	60.3	5 11 35	5 22 50
Thora	43.5	5 51 50	5 19 44

	SLOOP.		
	Rac. Meas. Feet.	Act. Time H. M. S.	Cor. Time H. M. S.
First Class.			
Wenmah, wins	63.1	4 21 25	4 06 05
Mischief	65.1	4 21 26	4 17 17
Gracie	71.0	4 28 28	4 28 28
Julia	71.1	4 49 51	4 13 44
Second Class.			
Vixen, wins	48.0	4 57 40	4 39 29
Rover	47.3	5 05 22	4 15 40
Maggie	40.0		withdrawn

The Annual Regatta of the EASTERN YACHT CLUB for 1881 was sailed from Marblehead Rock over Course No. 6, 20½ nautical miles, on June 27.

	SCHOONERS.		
	Rac. Meas. Feet.	Act. Time H. M. S.	Cor. Time H. M. S.
First Class.			
Fortuna, Prize \$250	89.10	3 54 25	51 25
Rebecca	66.72	4 11 14	4 31 31
Second Class.			
Clia, Prize \$150	65.26	4 06 31	3 57 32
Harbinger, 2d Prize \$75	61.11	4 09 57	3 59 50
Adrienne	61.07	4 16 01	4 05 17
Sylph	50.00	4 51 31	4 39 44
SLOOP.			
First Class.			
Belouin, Prize \$150	61.43	3 39 07	3 29 35
Addie V.	60.17	4 48 22	4 36 51
Ileen	56.89	4 10 25	3 56 58
Wenmah, Prize \$75	55.88	3 57 07	3 43 00
Huron	53.24	4 08 21	3 52 50
Hesper	47.47	4 51 38	4 32 05
Second Class.			
Maggie	39.64	4 28 46	4 03 08
Hera, 2d Prize \$25	37.96	4 22 49	3 55 17
Shadow, Prize \$75	37.38	4 19 03	3 51 02
Lapwing	36.57	4 47 05	4 18 33
Clytie	35.61	4 38 50	4 09 16

The prize won by FORTUNA in the above regatta was returned, as a cup, to the Committee who offered it, to be sailed for on the Annual Cruise of the club at New Bedford, July next, and was won by HALCYON, EASTERN YACHT CLUB.

The regatta sailed at New Bedford on the cruise of the EASTERN YACHT CLUB, July 23, 1881, for cups presented by Commodore Hovey, one for first and second class schooners, and one for first and second class sloops:—

	SCHOONERS.		
	Rac. Meas. Feet.	Act. Time H. M. S.	Cor. Time H. M. S.
Fortuna	89.46	5 09 15	5 00 46
Ruth	80.16	5 39 44	5 27 13
Halcyon, wins	78.61	4 56 46	4 49 57
Rebecca	69.72	5 14 00	5 03 00
Meteor	69.47	5 35 01	5 23 24
Harbinger	61.11	5 08 38	4 53 19
SLOOP.			
Belouin, wins	61.43	4 43 18	4 28 30
Huron	53.24	4 57 07	4 34 37
Windward	49.53	5 21 51	4 56 22
Hesper	47.47	5 10 51	4 44 01
Rover	41.09	5 54 45	5 24 02
Maggie	39.64	5 08 50	4 33 10

The Annual Regatta of the EASTERN YACHT CLUB for 1885 was sailed over a triangular course of 5 miles on a side twice around, on June 30, 1885; 30 nautical miles.

	SCHOONERS.		
	Rac. Meas. Feet.	Act. Time H. M. S.	Cor. Time H. M. S.
First Class.			
Mohican	104.10	4 07 37	4 07 37
Fortuna, Prize \$200	91.50	3 38 24	3 35 01
Gitana, 2d Prize \$100	91.70	3 46 34	3 43 25
America	96.00	4 20 08	4 17 23
Phantom	87.00	3 52 45	3 46 10
Second Class.			
Rebecca	75.00	4 11 13	4 11 13
Adrienne, Prize \$75	65.72	4 09 22	4 03 49
Meta	64.21	4 12 46	4 06 12
Fearless, Prize \$125	58.44	4 13 17	4 02 15

	SLOOP.		
	Rac. Meas. Feet.	Act. Time H. M. S.	Cor. Time H. M. S.
First Class.			
Puritan, Prize \$150	89.30	3 25 15	3 25 15
Thetis	66.60	3 57 57	3 45 30
Huron	66.20	4 00 08	3 47 55
Ileen, Prize \$75	65.78	3 54 01	3 40 42

A Special Regatta of the EASTERN YACHT CLUB for first and second class sloops for prizes of \$300 and \$200 given by Commodore Hovey was sailed September 8, 1884, over a course from Marblehead Rock; 30 nautical miles.

	SCHOONERS.		
	Rac. Meas. Feet.	Act. Time H. M. S.	Cor. Time H. M. S.
Ileen	56.89	4 47 51	4 47 51
Huron	53.24	5 08 13	5 05 32
Isis	49.15	6 09 17	5 55 10
Valkyr	47.75	5 30 21	5 28 35
Oriva	47.38	5 05 21	4 57 05

	SLOOP.		
	Rac. Meas. Feet.	Act. Time H. M. S.	Cor. Time H. M. S.
Maggie	39.64	5 18 42	5 03 55
Shadow	37.38	5 40 53	5 30 11

The Annual Regatta of the EASTERN YACHT CLUB for 1886, was sailed from Marblehead Rock on June 23rd, over a triangular course of 5 miles on a side, twice around; 30 nautical miles.

	SCHOONERS.		
	Rac. Meas. Feet.	Act. Time H. M. S.	Cor. Time H. M. S.
First Class.			
Mohican	104.50	4 09 15	4 09 15
Gitana	96.25	3 54 58	3 51 11
Fortuna, Prize \$250	91.50	3 38 48	3 34 17
Second Class.			
Alice	78.60	4 29 50	4 29 50
Meta	64.21	4 45 20	4 34 40
Gevalia, Prize \$125	60.00	4 28 30	4 12 29

	SLOOP.		
	Rac. Meas. Feet.	Act. Time H. M. S.	Cor. Time H. M. S.
First Class.			
Mayflower	87.80	3 28 35	3 28 35
Priscilla	85.45	3 30 05	3 28 34
Puritan, Prize \$50	83.25	3 24 50	3 22 23
Second Class.			
Belouin, Prize 150	71.45	3 51 40	3 51 40
Huron	66.20		disabled
Stranger	66.08	3 58 08	4 00 16
Thetis	65.50	4 05 24	4 00 10

	SLOOP.		
	Rac. Meas. Feet.	Act. Time H. M. S.	Cor. Time H. M. S.
Third Class.			
Active	54.50	curr'd away tp'm'st	4 37 35
Chara, Prize \$75	54.28	4 12 00	4 12 00
Ulida	43.00	4 55 35	4 39 55
Fourth Class.			
Shona, Prize \$50	35.23	2 40 30	walk over

The Annual Regatta of the EASTERN YACHT CLUB for 1887, was sailed from Halfway Rock, off Marblehead, on June 23rd, around a triangular course, 12 nautical miles on a side; 36 nautical miles.

for 1885 was
around, on

r. Time

1. M. 8.
07 37
35 01
43 25
17 23
46 19

11 13
03 49
06 13
03 15

25 15
43 00
47 55
40 43

First and sec-
Commodore
Marblehead

r. Time.

47 51
05 32
55 10
28 35
57 05

03 55
30 11

for 1886, was
gular course

r. Time.

09 15
51 31
34 17
29 50
33 40
12 29

28 35
28 34
22 23

51 40

00 16
00 16

37 35
12 00
39 55

to over

for 1887, was
d, around a
al miles.



ORIVA.

THE SOCIETY AND CHURCHES OF AMERICA

Name	1850		1851		1852	
	Members	Value	Members	Value	Members	Value
First Class	100	1000	100	1000	100	1000
Second Class	200	2000	200	2000	200	2000
Third Class	300	3000	300	3000	300	3000
Fourth Class	400	4000	400	4000	400	4000
Miscellaneous	500	5000	500	5000	500	5000
Total	1000	10000	1000	10000	1000	10000

ORIVA.

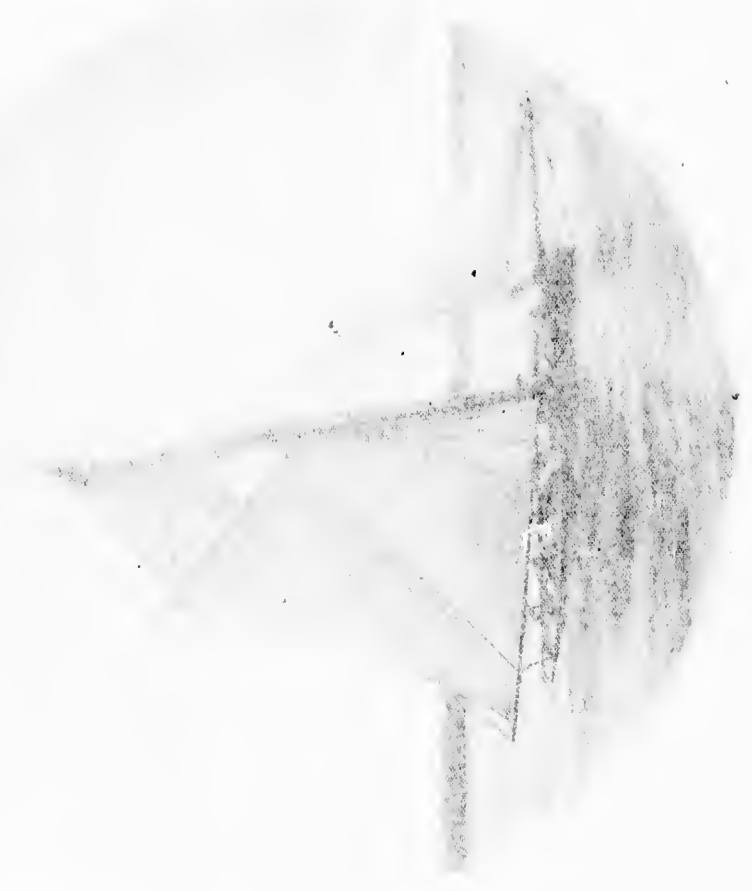

S

F

sai
con
cla

Fin

Th

Fir

THE YACHTS AND YACHTSMEN OF AMERICA.

SCHOONERS.

Class.	Rac. Meas. Feet.	Act. Time. H. M. S.	Cor. Time. H. M. S.
First Class.			
Mohican	104.50	5 31 38	5 31 28
Gitana	96.23	5 17 32	5 13 34
America	91.44	5 39 41	5 32 41
Sachem, Prize \$250	88.47	5 09 20	4 51 07
Iroquois	83.00 (est'd)	5 21 52	5 07 47
Second Class.			
Adrienne, Prize \$125			

SLOOPS.

Class.	Rac. Meas. Feet.	Act. Time. H. M. S.	Cor. Time. H. M. S.
First Class.			walk-over
Mayflower, Prize \$250	87.99	4 42 42	4 33 07
Galatea	80.87	4 56 47	4 46 30
Second Class.			
Stranger	66.87	6 52 56	5 32 03
Huron, Prize \$150	60.31	5 52 57	5 31 40
Fourth Class.			
Shadow	36.37	5 19 31	5 19 34
Shona, Prize \$50	37.23	5 34 17	5 33 01

Mayflower also took the PURITAN-Golet Cup for the year.

A Special Regatta of the EASTERN YACHT CLUB was sailed on August 11, 1888, on a triangular course of 12 miles on a side, 36 nautical miles, for the usual prizes, and for a cup of \$1,000 value, presented by the *Boston Herald* for first and second class sloops, open to all schooners over 50 feet on waterline, and all sloops of the NEW YORK YACHT CLUB and EASTERN YACHT CLUB.

SCHOONERS.

Class.	Rac. Meas. Feet.	Act. Time. H. M. S.	Cor. Time. H. M. S.
First Class.			
Resolute	88.47	5 08 42	
Sachem, Prize \$250	88.47	4 33 38	4 24 08
Troubadour	91.44	4 59 56	4 53 31
America	81.74	4 57 57	4 55 07
Iroquois, 2d Prize \$50	81.74	4 42 43	4 32 12

SLOOPS.

Class.	Rac. Meas. Feet.	Act. Time. H. M. S.	Cor. Time. H. M. S.
First Class.			
Volunteer, Prize \$250	83.20	4 19 51	4 19 51
Mayflower	87.99	5 31 58	4 39 56
Atlantic	86.31	4 28 00	4 25 53
Priscilla	85.97	4 29 25	4 26 57
Puritan, Prize \$50	81.85	4 27 43	4 23 44
Second Class.			
Titania	73.58		disabled
Bedouin	71.45		disabled
Stranger	66.87		disabled
Gracie, Prize \$50	71.02	5 11 35	4 57 22
Fanny	79.00	5 14 36	4 58 23
Huron, Prize \$100	66.31	5 11 29	4 51 40
Third Class.			
Cinderella	55.18	6 15 55	5 31 05
Vixen	48.60	6 16 41	5 41 36
Zigener (est'd), Prize \$75	45.01	6 19 36	5 42 39

Volunteer also took the "Herald" Cup.

The Annual Regatta of the EASTERN YACHT CLUB for 1888 was sailed on the 28th of June, from Halfway Rock around a triangular course 12 nautical miles on a side, 36 miles. Sixth and seventh class sloops to sail 24 miles only.

SCHOONERS.

Class.	Rac. Meas. Feet.	Act. Time. H. M. S.	Cor. Time. H. M. S.
First Class.			
Gitana	95.72	4 45 26	4 45 26
Adrienne, Prize \$250	68.74	5 07 08	4 38 38
Third Class.			
Bohemian, Prize \$50	46.75	4 49 58	4 49 58
Diana	38.00		did not finish.
First Class.			
Volunteer, Prize \$200	90.81	4 05 10	4 00 51
Puritan	85.22	4 22 04	4 12 36

SCHOONERS.

Class.	Rac. Meas. Feet.	Act. Time. H. M. S.	Cor. Time. H. M. S.
Second Class.			
Stranger, Prize \$100	68.07	4 47 00	4 17 50
Fifth and Sixth Class.			
Hesper	51.42	4 02 57	4 02 57
Haboon	46.80	3 59 41	3 59 41
Xara, Prize \$50	46.40	3 58 43	3 58 03
Seventh Class.			
Clytie, Prize \$40	36.00	4 41 37	4 27 22

Volunteer took the PURITAN-Golet Cup for the year.

A Special Regatta of the EASTERN YACHT CLUB was sailed on September 14, 1888, from Marblehead Rock, over a triangular course of 24 nautical miles for fifth and sixth class sloops, and a Subscription Regatta for yachts between 25 and 30 feet waterline, over a course of 16 nautical miles.

SLOOPS.

Class.	Rac. Meas. Feet.	Act. Time. H. M. S.	Cor. Time. H. M. S.
Fifth Class.			
Funita	50.80	5 40 46	5 40 46
Vixen	50.15	5 56 38	5 56 04
Bayadere, Prize \$100	48.80	5 38 31	5 36 10
Sixth Class.			
Chiquita	47.50	5 44 21	5 44 21
Haboon	46.80	5 49 55	5 49 17
Xara, Prize \$75	46.40	5 32 04	5 30 47
Papoose	41.90	5 50 46	5 43 08
Special Class.			
Marguerite	35.72	3 44 53	3 44 53
Saracen, Prize \$50	35.50	3 29 30	3 29 14
Elf	31.00	3 59 33	3 57 36
Mignon, 2d Prize \$25	33.00	3 35 00	3 31 23
Beetle	32.55	4 09 41	4 05 23
Atalanta	32.55		did not finish
Prince Karl	31.75	4 14 01	4 08 30
Ione	30.97		did not finish
Swordfish	29.47	4 00 02	3 51 36
Siva	29.00	4 03 28	3 53 20

A Regatta of the EASTERN YACHT CLUB for 40-footers, for a cup presented by Commodore Hovey, was sailed July 13, 1889, over a course of 19 nautical miles, from Marblehead Rock.

Class.	Rac. Meas. Feet.	Act. Time. H. M. S.	Cor. Time. H. M. S.
Gorilla	48.50	3 54 35	3 54 35
Varuna	47.00	3 45 08	3 43 16
Chiquita	46.88	3 55 34	3 53 42
Alice	47.00	4 06 48	4 04 56
Helen	46.50	3 55 27	3 52 56
Minerva, Prize	46.07	3 39 19	3 33 48
Papoose	42.60	3 41 40	3 37 20

The Annual Regatta of the EASTERN YACHT CLUB for 1889, was sailed July 15th and 16th, from Halfway Rock around a triangular course, 36½ nautical miles, and 23¼ miles for 6th, 7th, and special sloop classes.

SCHOONERS.

Class.	Rac. Meas. Feet.	Act. Time. H. M. S.	Cor. Time. H. M. S.
First Class.			
Merlin, 2d Prize	93.45	5 05 43	5 04 50
Sea Fox, 1st Prize	91.43	5 04 02	5 01 22
Mayflower	90.32	5 16 05	5 12 30
Fortuna	94.25	5 16 33	5 16 33
Second Class.			
Onone	79.60	5 20 28	5 20 28
Quickstep, Prize	79.18	5 20 00	5 08 25
Fourth Class.			
Clara, Prize	54.90	5 20 34	5 20 34
Fifth Class.			
Alga, Prize	51.83	5 35 33	5 35 33

HISTORY OF THE EASTERN YACHT CLUB.

SLOOPs.

Sixth Class.	Rac. Meas.	Act. Time.	Cor. Time.
	Feet.	H. M. S.	H. M. S.
Vereina	47.00	3 39 33	3 37 15
Chiquita	46.88	3 31 32	3 32 11
Gorilla	47.50	3 26 28	3 26 28
Minerva, Prize	46.07	3 22 18	3 19 11
Seventh Class.			
Banona	37.00	1 09 45	1 09 45
Special Class.			
Kathleen	37.59	3 59 56	3 59 56
Saracen	36.10	1 00 49	3 57 30
Hardinger, Prize	31.00	3 56 43	3 39 15

Minerva also wins cup presented by Mrs. A. Cass Canfield.

On the Annual Cruise of the EASTERN YACHT CLUB, in 1889, a prize of \$250 was presented by Capt. Bayard Thayer for schooners of the first and second classes, and a cup valued at \$250 was presented by Capt. P. D. Wheatland for the 40 foot class, to the yachts making the best average time over the various runs on the cruise, as follows:

From Halfway Rock to Isle of Shoals.	32 miles.
From Isle of Shoals to Cape of Elizabeth.	38 miles.
From Ram Island to White Head Light.	51 miles.
From Rockland to Pond Island Buoy.	32 miles.
Schooner Genoa wins the Thayer Prize.	
Sloop Papoose wins the Wheatland Cup.	

A Special Autumn Regatta for 40 foot sloops, was sailed September 5, 1889.

	Rac. Meas.	Act. Time	Cor. Time.
Vereina, Prize \$200	47.00	3 48 30	3 48 30
Alice	47.00	withdrew.	
Chiquita	46.88	3 53 12	3 53 12
Nara	46.40	4 11 12	4 10 32

The Annual Regatta of the EASTERN YACHT CLUB for 1890, was sailed on July 11th, from Halfway Rock to Harding's Bell Buoy and return; 24 nautical miles.

SCHOONERS.

	Rac. Meas.	Act. Time.	Cor. Time.
Merlin, Prize \$200	93.15	2 56 25	2 56 25
Sea Fox, 2d Prize \$100	91.13	3 05 29	3 01 33
Mayflower	90.32	3 10 22	3 08 57
Genoa	80.62	3 11 51	3 08 28

SLOOPS.

Fifth Class.			
Thelma, Prize \$75	52.30	3 45 19	3 45 49
Alga	51.83	3 52 19	3 51 46
Sixth Class.			
Gosoon, Prize \$75	47.42	3 51 30	3 59 29
Ventura	46.87	did not finish	
Minerva	46.07	3 51 58	3 51 49
Papoose	42.60	did not finish	
Seventh Class.			
Shark, Prize \$75	36.07	4 40 39	4 40 39
Hawk	36.07	4 42 43	4 42 43

A Special Race of the EASTERN YACHT CLUB was sailed September 10, 1890, over a triangular course from Marblehead Rock; 24 nautical miles.

	Rac. Meas.	Act. Time.	Cor. Time.
46 foot class.			
Millicete	52.0	3 29 26	3 29 26
Thelma	52.0	3 27 52	3 27 52
Alga, 2d Prize \$75	52.0	3 25 48	3 25 15
Ventura, Prize \$150	47.6	3 28 59	3 23 54
30 foot class.			
Shark, Prize \$75	36.10	4 20 03	4 20 03
Mignon	35.8	4 24 07	4 22 17

A Handicap Race of the EASTERN YACHT CLUB was sailed May 30, 1891, over a triangular course from Marblehead Rock; 24 nautical miles.

	Rac. Meas.	Act. Time.	Cor. Time.
	Feet.	H. M. S.	H. M. S.
Saladin	30.0	4 29 12	4 29 12
Hawk, Prize \$50; allows 5 min., 15 sec.		4 32 53	4 27 37
Elf, allows 20 min.		4 59 46	4 39 46

A Match Race of the EASTERN YACHT CLUB was sailed June 19, 1891, over a triangular course from Marblehead Rock; 24 nautical miles.

	Act. Time.
	H. M. S.
30-footers.	
Mildred, Prize \$50	4 09 00
Saladin	4 15 14

The Annual Regatta of the EASTERN YACHT CLUB for 1891, was sailed on June 29th, over a course of 32 miles, and for seventh class sloops, 22½ miles. The PRUITAN-GOELT Cup for the year was also sailed for with four-fifth measurements for the schooners.

SCHOONERS.

	Rac. Meas.	Act. Time.	Cor. Time.
First Class.			
Merlin	93.15	did not finish	
Mayflower, Prize \$200	89.13	8 10 41	8 08 09
Second Class.			
Genoa, Prize \$100	79.60	8 17 54	8 17 54
Triton	66.44	did not finish	

SLOOPS.

Fifth Class.			
Betrix	55.00	7 48 15	7 45 37
Thelma	52.30	7 51 53	7 45 45
Gossoon, Prize \$75	48.10	7 50 40	7 38 23
Seventh Class.			
Mildred, 2d Prize \$25	36.69	5 30 07	5 30 07
Hawk	36.02	5 55 58	5 55 58
Fancy, Prize \$50	36.30	5 29 20	5 28 28
Hardinger		6 20 30	

The PRUITAN-GOELT Cup is awarded for the year to GOSsoon.

At the same time and course, a Sweepstakes Race (postponed from June 19, 1891), was sailed by the sloops SALADIN, MILDRED, FANCY and HAWK. FANCY won 1st prize, \$112.50; MILDRED 2d prize, \$37.50.

A Special Race of the EASTERN YACHT CLUB for schooners and fifth class sloops, 35 miles, and seventh class sloops, 28 miles, was sailed on July 22, 1891, from Halfway Rock.

SCHOONERS.

	Rac. Meas.	Act. Time.	Cor. Time.
First Class.			
Mayflower, Prize \$100	89.13	4 53 41	4 53 41
Marguerite	83.25	5 02 30	4 57 49
Genoa	79.60	5 02 15	4 54 53

SLOOPS.

Fifth Class.			
Alborak	55.68	5 04 05	5 04 05
Betrix, Prize \$100	55.00	4 50 57	4 54 29
Owene	54.54	4 58 30	4 57 11
Sayonara	51.12	did not finish	
Barbara	53.00	5 07 26	5 02 55
Gossoon	48.10	5 18 54	5 06 52
Seventh Class.			
Mildred, Prize \$75		4 25 10	
Hawk		did not finish	
Chieftain		4 33 16	

Gossoon disqualified for fouling Minot stake boat. Sayonara parted her bobstay and Hawk her backstay.

EASTERN YACHT CLUB SQUADRON Races on the cruise in 1891:
 August 23d, first race: Marblehead to Gloucester; 8½ nautical miles. Schooners: FORTUNA, VOLUNTEER, SEA FOX, MAYFLOWER, GENONE and PEERLESS. Sloops: CINDERELLA, SAYONARA, THELMA and GOSsoon.

August 25th, second race: Isle of Shoals to Booth Bay; 63½ miles. Schooners: FORTUNA, VOLUNTEER, SEA FOX, MAYFLOWER, GENONE, PEERLESS. Sloops: CINDERELLA, SAYONARA, THELMA and GOSsoon.

August 26th, third race: Booth Bay to White Head; 23½ nautical miles. Schooners: VOLUNTEER, SEA FOX, MAYFLOWER, GENONE, PEERLESS. Sloops: CINDERELLA, SAYONARA, THELMA, GOSsoon.

August 29th, fourth race: Camden to Bass Harbor; 35½ miles. Sloops: CINDERELLA, SAYONARA, THELMA, GOSsoon. The following is the summary:

SCHOONERS.

	1st race	2d race	3d race	Total
Fortuna	4	6	6	16
Sea Fox	3	5	4	12
Volunteer	1	1	1	3
Mayflower	2	3	2	7
Genone	6	2	3	11
Peerless	4	4	5	13

SLOOPS.

	1st race	2d race	3d race	4th race	Total
Sayonara	2	2	3	2	9
Gossoon	4	3	1	3	11
Thelma	1	4	4	4	13
Cinderella	3	1	2	1	7
Volunteer, 1st prize				\$250	
Mayflower, 2d prize				100	
Genone, 3d prize				50	
Cinderella, 1st prize				250	
Sayonara, 2nd prize				100	
Gossoon, 3d prize				50	

The Autumn Regatta of the EASTERN YACHT CLUB was sailed from Halfway Rock, September 8, 1891; over a course of 35 nautical miles.

SCHOONERS.

	Rac. Meas.	Act. Time.	Cor. Time.
	Feet.	H. M. S.	H. M. S.
Volunteer	93.78	6 28 17	6 28 17
Mayflower	89.13	6 41 27	6 38 21
Genone, Prize \$400	79.60	6 36 31	6 26 02

SLOOPS.

Fifth Class.

	Rac. Meas.	Act. Time.	Cor. Time.
Alborak	55.08	did not finish	
Sayonara	54.12	6 38 26	6 36 14
Beatrix, Prize \$500	54.01	6 27 49	6 26 21
Owenee, 2d Prize \$250	54.54	6 37 30	6 36 02
Barbara	52.86	did not finish.	

Opening Race of the EASTERN YACHT CLUB for 1892, for seventh class sloops of the club, was sailed on May 30th; over a course of 17 nautical miles.

SLOOPS.

	Rac. Meas.	Act. Time.	Cor. Time.
Hawk	36.85	Did not finish, disabled.	
Fancy	36.67	3 38 08	3 38 08
Handsel, Prize \$30	32.22	3 22 58	3 16 30

Handicap Race of the EASTERN YACHT CLUB was sailed June 18,

1892, for fifth, sixth and seventh class sloops, over a triangular course, 24 miles.

No sloops of fifth or sixth class entered.

SLOOPS.

Seventh Class.	Rac. Meas.	Act. Time.	Cor. Time.
	Feet.	H. M. S.	H. M. S.
Hawk, Prize \$50	36.85	5 53 03	5 47 03
Fancy	36.67	6 20 43	6 16 43
Chepoquoit	36.05	6 05 52	6 05 52
Handsel	32.22	6 01 58	6 01 58

Annual Regatta, EASTERN YACHT CLUB, June 27, 1892, open race; course 35 miles, except seventh class, 23 miles.

SCHOONERS.

First Class.	Rac. Meas.	Act. Time.	Cor. Time.
Morlin	93.45	4 38 42	4 38 42
Mayflower	89.06	4 37 58	4 35 12
Marguerite, Prize \$100	83.75	4 34 37	4 27 54

SLOOPS.

Second Class.	Rac. Meas.	Act. Time.	Cor. Time.
Thelma	66.95	5 01 21	5 01 21
Wayward, Prize \$100	61.87	4 58 37	4 56 22

Fifth Class.

	Rac. Meas.	Act. Time.	Cor. Time.
Wasp, Prize \$75	55.27	4 40 11	4 40 11
Barbara	52.86	4 59 12	4 55 25

Seventh Class.

	Rac. Meas.	Act. Time.	Cor. Time.
Hawk	36.85	did not finish.	
Fancy	36.67	3 38 45	3 38 45
Handsel, Prize \$50	32.22	4 28 15	3 19 30

The Puritan-Gaulet Cup for the year is awarded to Wasp.

A Special Invitation Race for 24-footers (length waterline) and 25-footers, was sailed from Marblehead Rock, over a course of 15 nautical miles, on July 28, 1892. Allowances at the rate of six-tenth second per mile, for each tenth of a foot racing measure, spinnakers barred:

24-footers.

	Rac. Meas.	Act. Time.	Cor. Time.
Alpha, Prize \$50 and medal	23.70	4 19 59	4 15 56
Freak, ruled out	25.70	4 16 54	4 16 00
Catspaw, 2d Prize \$25	26.24	4 19 10	4 18 52
Reaper, 3rd Prize \$15	24.69	4 24 36	4 21 00
Vanessa	24.66	4 28 31	4 24 55
Thrush, abt	27.17	4 24 50	
Exile	26.30	4 28 16	4 28 07
Tadpole	25.57	4 45 34	4 41 32
Sirocco	26.42	4 44 54	4 44 54

25-footer.

	Rac. Meas.	Act. Time.	Cor. Time.
Pyxie, ruled out	24.06	4 50 43	4 48 37

A 32 mile Special Race of 46 sloops, August 11, 1892, of the NEW YORK and EASTERN YACHT CLUBS, for a purse of \$250 presented by Commodore Forbes.

	Rac. Meas.	Act. Time.	Cor. Time.
Wasp, wins	55.27	4 49 27	4 49 27
Harpoon*	54.86	4 55 25	4 54 45
Gloriana	54.49	lost topmast, did not finish	
* Formerly Beatrix.			

Private Sweepstakes Race same day and course:

HISTORY OF THE EASTERN YACHT CLUB.

SCHOONERS.

	Rac. Meas.		Act. Time.		Cor. Time.		Yacht.	Owner.	Class.	Rig.	Rac.	Elapsed	Cor.
	Feet.	H. M. S.	H. M. S.	H. M. S.	Feet.	H. M. S.					H. M. S.	H. M. S.	
Constellation	110.10	4 45 27	4 45 27				Volunteer	J. Malcolm Forbes	1	schooner	92.14	6 10 24	6 16 24
Mayflower, wins	89.06	4 40 41	4 28 59				Mayflower	W. A. Gardner	1	schooner	88.71	6 26 51	6 34 49
Marguerite	83.75	4 44 37	4 29 09				Marguerite	H. W. Lamb	1	schooner	83.74	6 38 10	6 32 32
Iroquois	82.00	5 01 03	4 43 07				Wasp	E. R. Coleman	5	sloop	55.27	6 15 35	6 15 35
							Harpoon	J. C. & C. F. Adams	2 1/2	sloop	54.89	6 33 11	6 32 30
							Handsel	Jas. R. Hooper	7	sloop	32.22	did not finish	

A regatta was sailed by the NEW YORK and EASTERN YACHT CLUB boats off Marblehead, August 10, 1892, for cups presented by Com. Gerry of the NEW YORK YACHT CLUB for schooners and sloops. The cup for schooners was won by MARGUERITE and that for sloops by WASP, but as it was not an EASTERN YACHT CLUB Race, it is not on their records.

Autumn Regatta, EASTERN YACHT CLUB, September 3, 1892, for schooners and fifth class sloops of the EASTERN YACHT CLUB, 35 miles (no schooners entered).

SLOOPS.

Fifth Class.

	Rac. Meas.	Act. Time.	Cor. Time.
Harpoon* wins \$75	54.89	5 01 31	5 01 31
Gloriana,	51.49	5 06 22	5 05 37
Barbara	52.89	5 10 22	5 07 19

*Formerly Beatrix.

The Annual Regatta of the EASTERN YACHT CLUB took place June 25, 1893, over a 32 mile course. The wind was from the east, but very light, the weather was fair.

The following yachts participated:

VOLUNTEER won in her class and WASP won in the sloop class, HARPOON was awarded the PRUITAN CUP.

A regatta was sailed August 28, 1893; over a 35 mile course. The wind was fresh from southwest by south.

The following yachts were entered:

Yacht.	Owner.	Class.	Rig.	Rac. Meas.	Elapsed Time.	Cor. Time.
Constellation	Bayard Thayer	1	schooner	110.10	3 50 00	3 50 00
Yankee	H. P. Whitney	1	"	107.44	did not finish	
Alewa	L. V. Clark	1	"		did not start	
Volunteer	J. M. Forbes	1	"		did not start	
Mayflower	Win. A. Gardner	1	"	88.71	4 08 16	3 55 07
Marguerite	H. W. Lamb	1	"	83.74	4 14 10	3 57 33
Mayflower won the Weld Cup.						
Harpoon	G. C. & C. F. Adams	2 1/2	sloops	54.89	4 39 13	4 39 13
Carnita	C. H. W. Foster	5	"	54.20	4 42 33	4 41 48
Harpoon was first.						
Fancy	C. F. Lyman	7	"	36.07	4 06 07	4 03 41
Handsel	Jas. R. Hooper	7	"	32.22	4 07 25	3 58 15
Chieftain	Aaron Brown	7	"	38.07	4 14 43	4 14 43
Gracie G.	M. J. Sughrue	7	"		did not finish	
Hawk	Gordon Dexter	7	"	30.85	4 07 29	4 05 05
Tomboy	T. K. Lothrop	7	"	30.06	did not finish	

Handsel was first, Fancy second.

Cor.
Time.
n. m. s.
6 16 24
6 34 43
6 32 32
6 15 35
6 32 30
t finish
op class.

erse. The

Cor.
Time.
3 50 09
not finish
not start
not start
3 55 07
3 57 23
4 39 13
4 41 48
4 03 41
3 58 15
4 14 43
not finish
4 05 05
not finish



COMMODORE J. MALCOLM FORBES, JR.
EASTERN YACHT CLUB.

BIOGRAPHICAL SKETCHES AND DESCRIPTION OF YACHTS ENROLLED IN THE CLUB.

COMMODORE J. MALCOLM FORBES has been for years a member of the well-known firm of J. M. Forbes & Co., Boston, Mass., which has been interested in shipping and mercantile affairs in all parts of the world. Commodore Forbes has been closely identified with yachting interests since his early youth, particularly in the waters of Massachusetts Bay and in the vicinity of the Island of Nauson. He was a member of the syndicate which built **PURITAN** and Chairman of the Executive Committee who raced her successfully against the cutter **GENESTA**. He afterwards became sole owner of **PURITAN** and owns her still. Commodore Forbes also owns **VOLUNTEER**, which he used as a schooner last summer and is now transforming into a sloop. He has acted as Vice-Commodore of the **EASTERN YACHT CLUB**, and as Commodore during the past two seasons.

PURITAN.

PURITAN is a centerboard sloop, owned by J. Malcolm Forbes of Boston, and launched in 1885. She was designed by Burgess and built by Lawley & Son, South Boston, Mass. She sails with the **EASTERN** and **NEW YORK YACHT CLUBS**. See Fig. 288.
Official number, 150,494.

DIMENSIONS.

Length over all,	41 feet.	Length load waterline,	31 feet.
Depth,	8 feet 8 inches.	Draft,	8 feet 2 inches.
Beam,	21 feet.		

VOLUNTEER.

A steel centerboard schooner, belonging for some years to Gen. Chas. J. Paine of Boston, Mass., but now the property of J. Malcolm Forbes, Jr. Designed by Edward Burgess and built by Pusey & Jones, Wilmington, Del., in 1887. She was originally a sloop yacht, but was altered and rebuilt and lengthened by Lawley in 1891. Hails from Boston, and sails with the fleets of the **EASTERN**, **NEW YORK**, **ATLANTIC**, **PORTLAND**, **SEAWARD**, **CORINTHIAN**, **BEVERLY**, **NEW BEDFORD** and **CORINTHIAN** (of Massachusetts) **YACHT CLUBS**. See Fig. 283.

CODE SIGNAL LETTERS, K. H. M. W.

Official number, 161,637.

DIMENSIONS.

Length over all,	43 feet.	Length load waterline,	39 feet 6 inches.
Depth,	11 feet.	Draft,	10 feet.
Beam,	21 feet 2 inches.		

Racing Record, 1891:—

VOLUNTEER was the winner of the Golet Cup, in the race sailed August 7th, her competitors being **FORTUNA**, **MERLIN**, **MAYFLOWER**, **MARGERITE** and **TROUQUOIS**. She was beaten by **MERLIN** in the Squadron Run of the **NEW YORK YACHT CLUB**, August 11th.

In the First Squadron Run of the **EASTERN YACHT CLUB**, August, 22d, **VOLUNTEER** won, defeating **FORTUNA**, **SEA FOX**, **MAYFLOWER**, **GENONE** and **PEERLESS**. Won from **FORTUNA** and **SEA FOX** on August 25th, Second Squadron Race. Beat the same yachts August 26th, Third Squadron Race. In the Autumn Regatta, September 8th, was beaten by **GENONE**, **MAYFLOWER** being third.

WILD DUCK.

An auxiliary screw schooner, owned by John M. Forbes of Boston. She was designed by Edward Burgess and built for her present owner in 1891. She is a centerboard yacht, hailing from Boston, and sailing with the **EASTERN YACHT CLUB**. See Fig. 285 and plate XLIV.

CODE SIGNAL LETTERS, K. J. P. M.

Official number, 81,333.

DIMENSIONS.

Length over all,	151 feet.	Length load waterline,	125 feet.
Draft,	8 feet.	Beam,	26 feet.

The engine was built by the Atlantic Works of East Boston, and the boilers are Belleville (St. Denis, Seine, France).

MESSERS. G. C. & C. F. ADAMS, real estate and law, respectively, are residents of Quincy, Mass., the former having been born in the year 1863 and the latter in 1866. Their father was J. Q. Adams. These gentlemen are the owners of the famous yacht **HARPOON**, better known as **BEATRIX**, under which name she first attained her present reputation. They have also owned the yachts **DANDELION**, **TUP**, **SUCKY**, **CRICKET**, **PAPPOUSE**, **BARBOON** and **GOSsoon**. Mr. C. F. Adams is the Rear Commodore of the **EASTERN YACHT CLUB**, both belonging as well to the **NEW YORK**, **BEVERLY**, **HULL**, **QUINCY** and **CORINTHIAN YACHT CLUBS**.

HARPOON.

Formerly known as **BEATRIX**, is a centerboard cutter, the property of G. C. and C. F. Adams, of Boston, Mass. She was designed by Edward Burgess and was built by Frisbee of Salem, Mass. She was built for C. A. Prince and John Bryant and was launched in 1891. Her ballast plan and rig were changed in 1892. She now hails from Cohasset, sailing with the **NEW YORK**, **EASTERN**, **BEVERLY**, **HULL**, **QUINCY** and **CORINTHIAN YACHT CLUBS**. See Fig. 285.

DIMENSIONS.

Length over all,	62 feet 2 inches.	Length load waterline,	45 feet 6 inches.
Depth,	8 feet.	Draft,	7 feet 5 inches.
Beam,	14 feet.		

Racing Record for 1891:—

EASTERN YACHT CLUB—Second in her class, in the Annual Regatta sailed June 29; **GOSsoon** first. Won prize of \$100 in the Special Race sailed July 22, beating **OWEENE**, **GOSsoon**, **ALBORAK**, etc. Again a winner in the Autumn Regatta, winning \$500 and defeating **SAYONARA** and **OWEENE**.

MASSACHUSETTS YACHT CLUB—Defeated by **OWEENE** in Special Race held July 16, for a \$250 silver cup.

CORINTHIAN (Marblehead) **YACHT CLUB**—Won Sweepstakes Race sailed July 23, beating **OWEENE** and **BARBARA**, etc. Beaten by both **OWEENE** and **BARBARA** on the 27th of August in the 54th Regatta. On the next day, August 28th, **BEATRIX** (as she was then called) won again, beating her usual competitors. This defeat was repeated on the 29th of August, when she was nearly 12 minutes ahead in a run of 24 miles.

CORINTHIAN (New York) **YACHT CLUB**—August 17th, Sweepstakes of \$100 each. **BEATRIX** won third prize, \$85, with **GLORIANA** first and **OWEENE** second.

Racing Record for 1892:—

EASTERN YACHT CLUB—Special Race, August 11th. **WASP**, **HARPOON** and **GLORIANA**, the last named breaking down, and the first named winning. In the Autumn Regatta, September 3d, **HARPOON** won from **GLORIANA** and **BARBARA**, winning prize of \$75.

NEW YORK YACHT CLUB—**HARPOON** won the Golet sloop, cutter and yawl Cup valued at \$500, defeating **GRACIE**, **WASP** and **GLORIANA**, on the 5th of August. In the Squadron Run of August 6th, **HARPOON** was second, **GLORIANA** winning. Third in the Run of August 8th, **WASP** winning, **GLORIANA** second. Made but an indifferent showing in the Morgan Cup Races of

August 8th. Beaten by WASP for Commodore Gerry's Cup, August 10th.

CORINTHIAN YACHT CLUB of New York—HAIPOON was second in the Fourth Annual Sweepstakes, sailed at Newport, August 23d. WASP won; GLOBIANA third.

ZIGUNER.

ZIGUNER is a cutter, owned by Max Aggasiz and R. L. Aggasiz, of Newport, R. I. She was designed by Burgess and built by Lawley & Son in 1887. Hails from Newport, R. I., and sails with the fleets of the EASTERN, BOSTON, BEVERLY and RHODE ISLAND YACHT CLUBS. See Fig. 287.

DIMENSIONS.			
Length over all,	52 feet 2 inches.	Length load waterline,	42 feet.
Draft,	8 feet.	Beam,	12 feet 9 inches.

EDWARD APPLETON BANGS, lawyer, Wareham, Mass. Was born in Watertown, Mass., the son of Edward and Anne Bangs. Has owned the yacht MADEIR, but is now the owner of the keel schooner KATHLEEN, partly owned by him and partly by H. H. Carter of Boston. Interested in yachting for nine years, and a member of the EASTERN, MASSACHUSETTS, BEVERLY and SIPPICAN YACHT CLUBS.

KATHLEEN.

KATHLEEN is a keel schooner, formerly called LEATHA, and is owned by Edward A. Bangs and H. H. Carter, both of Boston. Was built by Jas. T. Marsh of Baltimore, and was launched in 1874. Was formerly a centerboard yacht; hails from Boston, and sails with the EASTERN, MASSACHUSETTS, BEVERLY and SIPPICAN YACHT CLUBS. See Fig. 288.

Official number 15,991.

DIMENSIONS.			
Length over all,	70 feet.	Length load waterline,	58 feet.
Depth,	6 feet 2 inches.	Draft,	7 feet.
Beam,	17 feet 10 inches.		

Racing Record for 1892:—

MASSACHUSETTS YACHT CLUB—In the Fall Cruise of the club, KATHLEEN was second (MAGNOLIA first) with five starters.

EDGEWATER.

A screw schooner, designed by W. J. Titcomb, and built by J. H. Marquand of Newburyport, Mass. She was launched in 1889. EDGEWATER is owned by Nicholas Sheldon, hails from Providence, R. I., and belongs to the fleet of the EASTERN and MASSACHUSETTS YACHT CLUBS.

DIMENSIONS.

Length over all,	33 feet.	Length load waterline,	27 feet.
Depth,	7 feet 8 inches.	Draft,	7 feet 8 inches.
Beam,	16 feet.		

Her engines were built by Geo. E. Whitney, in 1892. F. & A. C., 2 Cy. 6½ in. and 10½ in. x 8 in. Here boilers were made by Mr. Killien in 1892, and are 3 ft. 8 in. x 5 ft.

ADELITA.

A screw schooner, designed by D. J. Lawlor and built by him at East Boston, Mass. She was launched in 1881. ADELITA is owned by Nathaniel C. Nash and hails from Boston. She belongs to the fleet of the NEW YORK, EASTERN, MASSACHUSETTS, JEFFREYS, HULL and CORINTHIAN (of Marblehead) YACHT CLUBS.

DIMENSIONS.

Length over all,	61 feet 6 inches.	Length load waterline,	58 feet 4 inches.
Draft,	5 feet 6 inches.	Beam,	12 feet 1 inch.

Her engines were built by Webb & Watson of East Boston, Mass., and are 2 Cy. 15 in. and 22½ x 14 inch. Her boilers were made by Kendall & Roberts, Cambridgeport, Mass., and are steel, vertical, tubular.

HUGH COCHRANE, a merchant of Boston, born in the same city, is the owner of the schooner GENONE. He was also at one time the owner of TIIGA. A yachtsman for fifteen years and is a member

of the EASTERN, HULL, CORINTHIAN, MASSACHUSETTS and NEW YORK YACHT CLUBS.

GENONE.

The keel schooner GENONE was designed by Edw. Burgess and built by William McKie, East Boston, Mass., in 1888, for Hugh Cochrane. She has a cabin, hails from Boston, and sails in the fleets of the HULL, CORINTHIAN, MASSACHUSETTS, NEW YORK, and EASTERN YACHT CLUBS. See Fig. 290 and plate XLVIII.

CODE SIGNAL LETTERS, K. H. O. T.

Official number, 155,185.

DIMENSIONS.

Length over all,	95 feet.	Length load waterline,	75 feet.
Depth,	12 feet.	Draft,	12 feet.
Beam,	19 feet 9 inches.		

Racing Record, 1891:—

In the Autumn Regatta of the EASTERN YACHT CLUB, GENONE raced with VOLUNTEER, MAYFLOWER, GOSHOON, BARBARA, BEATRIX and OWEENE, and won the race. In three other EASTERN Regattas GENONE came in second and third. In a Special Cup Race of the NEW YORK YACHT CLUB on August 10th, she beat FORTUNA; on August 4th and 6th she was beaten by INOQUIS and MARGUERITE, but on August 8th, while MARGUERITE won the race, GENONE came in second, beating INOQUIS.

FOAM.

FOAM is a centerboard schooner, owned by Arthur Dexter of Boston. She was designed and built by R. Palmer of Newak, Conn., and was launched in 1893. She hails from Beverly, and sails with the EASTERN and BEVERLY YACHT CLUBS. See Fig. 291.

CODE SIGNAL LETTERS, K. H. B. M.

Official number, 9,357.

DIMENSIONS.

Length over all,	88 feet 9 inches.	Length load waterline,	82 feet 4 inches.
Depth,	7 feet 4 inches.	Draft,	7 feet 3 inches.
Beam,	20 feet 9 inches.		



WILLIAM S. EATON.

having been one of the founders of the latter club.

LASSIE.

A cutter owned by Wm. S. Eaton, Jr., of Boston, Mass. Designed by Edward Burgess and built by Geo. Lawley & Son, launched in September, 1881. She hails from Marblehead, sailing with the fleet of the EASTERN and CORINTHIAN (of Marblehead) YACHT CLUBS. See Fig. 292.

DIMENSIONS.

Length over all,	29 feet.	Length load waterline,	19 feet 10 inches.
Depth,	4 feet 6 inches.	Draft,	5 feet.
Beam,	7 feet 9 inches.		

Racing Record:—

During her first two seasons she was never beaten.

MERLIN.

A centerboard schooner, owned by W. H. Forbes of Boston. She is of Burgess design and was built by Lawley & Son in 1889. Hails

from Boston, and sails with the fleets of the EASTERN, NEW YORK and NEW BEDFORD YACHT CLUBS. See plate XLV.

CODE SIGNAL LETTERS, K. H. F. K.

Official number, 92,187.

DIMENSIONS.			
Length over all,	138 feet.	Length load waterline,	80 feet 6 inches.
Depth,	10 feet 2 inches.	Draft,	9 feet 3 inches.
Beam,	23 feet 6 inches.		

Racing Record for 1891:—

NEW YORK YACHT CLUB—Second in the Squadron Run of August 6th, beating VOLUNTEER and PHANTOM. On August 8th she was second again, MAYFLOWER winning. Second in the races for Special Cups, August 10th, defeating PALMER and FORTUNA. Beat VOLUNTEER in the Run of August 11th, being first.

1892—**NEW YORK YACHT CLUB**—Second in the Run of August 4th, beating ALERT, MAYFLOWER, ATLANTIC, etc. Won the Goelet Schooner Cup, August 5th, beating IROQUOIS, ALCEA, LASCA, MAYFLOWER, etc., ten starters. This cup is valued at \$1,000. Second in the Squadron Run of August 6th, and again on August 8th. In the Morgan Cup Race, sailed August 8th, MERLIN came in third, with nineteen starters.

SARACEN.

The cutter yacht SARACEN is owned by N. L. Francis and Henry McPherson, of Boston. She is a Burgess yacht, being built by Lawley, and launched in 1888. Hails from Boston, and sails with the EASTERN, JEFFRIES and CORINTHIAN (of Massachusetts) YACHT CLUBS.

Official number, 116,416.

DIMENSIONS.			
Length over all,	34 feet.	Length load waterline,	21 feet 6 inches.
Depth,	6 feet 7 inches.	Draft,	7 feet 3 inches.
Beam,	10 feet.		

MAYFLOWER.

A centerboard schooner, having been altered from sloop rig in 1889 by Lawley. She is owned by William A. Gardner of Groton, Mass., and she hails from Boston. She was designed by Burgess and built by Lawley, being launched in 1886. She was first owned by Gen. Chas. J. Paine, who sold her in 1887 to E. D. Morgan. Later she became the property of F. T. Underhill, and finally came into the hands of Commodore Gardner. She was not an entire success at first, but after some alterations she was vastly improved, and began to show her speed. She has beaten such yachts as ATLANTIC, PURITAN and PRISCILLA, defeating these three in the Goelet Cup Race of 1886. In the trial races held at New York, prior to the selection of a cup defender, she beat these yachts again, and was chosen to race with GALATEA—the result is well known.

After the race, and in the spring of 1887, she won several other prizes, though not without various defeats. 1891 she sailed in several races, and during the season defeated such yachts as PALMER, FORTUNA, MARGUERITE, GENONE, PHANTOM, MERLIN and VOLUNTEER. She was beaten by IROQUOIS in the contest for the Goelet Cup, August 7th.

In 1892 MAYFLOWER beat MARGUERITE, CONSTELLATION, IROQUOIS etc., while she in turn was beaten by ALCEA, MARGUERITE, MERLIN and others, coming in second for the Goelet Cup, with MARGUERITE first. See plate XLI.

She sails with the BEVERLY, EASTERN and NEW YORK YACHT CLUBS.

CODE SIGNAL LETTERS, K. H. J. B.

Official number, 92,199.

DIMENSIONS.			
Length over all,	100 feet.	Length load waterline,	85 feet 7 inches.
Depth,	9 feet.	Draft,	11 feet.
Beam,	23 feet 5 inches.		

HABROON.

HABROON is owned by George A. Goddard of Boston, Mass. She is a keel sloop, a Burgess yacht, and built by Lawley in 1888. She hails from Boston, and sails with the EASTERN, BEVERLY, HULL and CORINTHIAN (of Marblehead) YACHT CLUBS. See Fig. 291.

Official number, 3,479.

DIMENSIONS.			
Length over all,	51 feet.	Length load waterline,	30 feet 7 inches.
Depth,	8 feet 8 inches.	Draft,	8 feet.
Beam,	13 feet.		

HENRY S. HOVEY, of Boston, Mass., has been a yachtsman for a long time, both at heart and in reality. His present yacht is FORTUNA, and he has also owned EDITH and PHANTOM. He was the Commodore of the EASTERN YACHT CLUB for four years, and is a member of nine yacht clubs, namely, the ATLANTIC, NEW YORK, EASTERN, BEVERLY, CORINTHIAN (of Marblehead), LARCHMONT, MASSACHUSETTS, NEW BEDFORD and SEAWANAHAKA CORINTHIAN. He was one of the founders of the EASTERN YACHT CLUB.

FORTUNA.

The keel schooner FORTUNA, belonging to Henry S. Hovey, of Boston, was designed by A. Cary Smith, and built by C. & R. Poffon, Brooklyn, N. Y. She was built for Mr. Hovey, and was launched in 1883. She has a cabin, and hails from Gloucester, Mass. She sails with the ATLANTIC, NEW YORK, LARCHMONT, NEW BEDFORD, SEAWANAHAKA CORINTHIAN, MASSACHUSETTS, CORINTHIAN (of Marblehead), EASTERN, and BEVERLY YACHT CLUBS. See plate XLIX.

CODE SIGNAL LETTERS, K. B. H. S.

Official number, 120,547.

DIMENSIONS.			
Length over all,	112 feet.	Length load waterline,	90 feet 6 inches.
Depth,	11 feet 9 inches.	Draft,	12 feet 8 inches.
Beam,	22 feet 6 inches.		

Racing Record:—

NEW YORK YACHT CLUB—In the Squadron Run of August 4, 1891, FORTUNA won from FLEUR DE LYS. Again on August 6th, she came in ahead of FLEUR DE LYS and MONTAUK. On August 13th she was beaten by CONSTELLATION, but she defeated PALMER on the Run of August 8th.

1892—**NEW YORK YACHT CLUB**—Second a few times.

ELF.

A cutter, owned by Henry Howard, of Longwood, Mass. She was built and designed by Geo. Lawley & Son for William H. Wilkinson, and was launched in 1888. She has never been altered, hails from Boston, and sails with the EASTERN and CORINTHIAN (of Marblehead) YACHT CLUBS. See Fig. 296.

Official number, 136,276.

DIMENSIONS.			
Length over all,	36 feet.	Length load waterline,	28 feet 8 inches.
Draft,	7 feet.	Beam,	11 feet.



FREDERICK GRINNELL.

FREDERICK GRINNELL, mechanical engineer, inventor and manufacturer, Providence, R. I., was born in New Bedford, August 14, 1836. He is of Huguenot and English (Puritan) descent, and is the son of Lawrence Grinnell and Rebecca S. Williams.

As a yachtsman, Mr. Grinnell has been actively interested for some seven seasons, though he has always been more or less a devotee of the sport. Has owned the schooners LYDIA, and QUEKSTER, the latter being his present craft. He is a member of the NEW YORK, NEW BEDFORD, EASTERN and RHODE ISLAND YACHT CLUBS.

QUICKSTEP.

A centerboard schooner, owned by Frederick Grinnell. Designed by Edward Burgess, and built by Henry Piepgras, City Island, N. Y. Launched in 1889. She is constructed of steel. Hails from Providence, and sails with the NEW YORK, EASTERN, RHODE ISLAND, NEW BEDFORD and NARRAGANSETT YACHT CLUBS. See Fig. 295.

Official number, 20,602.

DIMENSIONS.

Length over all,	81 feet.	Length load waterline,	65 feet.
Depth,	9 feet 4 inches.	Draft,	7 feet.
Beam,	20 feet.		

Racing Record, 1891:—

NEW YORK YACHT CLUB—Squadron Run, August 4th, a winner in her class. Again a winner in the Run of the 6th of August. Defeated VIATOR in the Squadron Run on August 8th, and beat MARGUERITE, GENONE, and HUROQUIS in the races for the Special Cups on August 10th. Moved up into the class with HUROQUIS in the Squadron Run on the 11th of August, and was the winner. Was the winner of her class in the Run of the 12th of August.

Racing Record for 1892:—

NEW YORK YACHT CLUB—QUICKSTEP was second in the Squadron Run of August 3d, with GEVALIA first. She won on August 4th, beating PEEPLESS, GEVALIA and AZALEA. Second in the Squadron Run August 6th, AZALEA won. QUICKSTEP won again on the 8th of August, beating PEEPLESS and AZALEA.

ALBORAK.

A semi-composite cutter, belonging to John B. Paine, of Boston, was designed by Mr. Paine, and built by Geo. E. Lawley & Son, So. Boston, Mass., being launched in June, 1891. She hails from Boston, and sails with the BEVERLY and CORINTHIAN (of Marblehead) YACHT CLUBS. See Fig. 298.

Official number, 106,827.

DIMENSIONS.

Length over all,	61 feet.	Length load waterline,	45 feet 9 inches.
Depth,	9 feet 3 inches.	Draft,	10 feet 2 inches.
Beam,	13 feet 9 inches.		

JUBILEE.

Was designed by John B. Paine, and was built by Geo. Lawley & Son Corporation, South Boston, Mass., being launched June 14, 1893. She is a bulb-fin centerboard cutter, and is owned by Gen. Chas. J. Paine, of Boston. She is built of steel. JUBILEE hails from Boston, and sails with the NEW YORK, ATLANTIC, PORTLAND, EASTERN, SEAWASHAKA CORINTHIAN, BEVERLY, NEW BEDFORD and CORINTHIAN (of Marblehead) YACHT CLUBS.

In the race August 10, 1893, from New London to Newport between JUBILEE and VIGILANT, the latter won by 1 min., 11 sec., JUBILEE was third in the race for the Goelet Cup, August 11, 1893, COLONIA winning.

JUBILEE be. COLONIA in the run from Newport to Vineyard Haven, but was beaten by VIGILANT 10 min., 42 sec. In the first trial race JUBILEE was second, being beaten by VIGILANT 4 min., 32 sec., but beating COLONIA and PILGRIM; and in the third trial race JUBILEE was third. (See pages 73 and 74 for details.)

DIMENSIONS.

Length over all,	123 feet.	Length load waterline,	81.47 feet.
Beam,	22 feet, 6 inches.	Draft,	14 feet.

CLYTIE.

A centerboard schooner, designed and built by C. E. Ketchum, Stamford, Conn. She was launched in 1877, and had been for some time owned by George M. Preston, though she now belongs to Henry

C. Ward. She hails from New York City. See Fig. 299.

CODE SIGNAL LETTERS, K. C. H. P.

Official Number, 125,600.

DIMENSIONS.

Length over all,	85 feet.	Length load waterline,	78 feet 3 inches.
Depth,	7 feet 7 inches.	Draft,	9 feet.
Beam,	21 feet 8 inches.		

WAYWARD.

A cutter, owned by David Sears, of Boston. Was designed by Edward Burgess and built by George Lawley & Son, in 1890. She hails from Boston, and sails with the EASTERN YACHT CLUB. See Fig. 300.

Official number, 81,273.

DIMENSIONS.

Length over all,	70 feet.	Length load waterline,	60 feet 6 inches.
Depth,	11 feet.	Draft,	11 feet.
Beam,	11 feet 3 inches.		

Racing Record:—

1891—NEW YORK YACHT CLUB—WAYWARD had two races recorded: one sailed on August 6th in the Squadron Run, she came in second (HILDEGARD first), beating WILLEAWAY and MISCHIEF; the second being in the Squadron Run of August 8th, when MISCHIEF won, with WAYWARD second and HILDEGARD third.

1892—EASTERN YACHT CLUB—In the Annual Regatta WAYWARD was first in her class, winning a prize of \$100, THETIS second. NEW YORK YACHT CLUB—WAYWARD won in the Squadron Run sailed August 6th, beating ATHLON, CLARA and VENTURA in the order named. On the 8th of August she was beaten by KATRINA, sailing out of her class.

CONSTELLATION.

A steel centerboard schooner, of Burgess design, and built by Henry Piepgras, City Island, New York, in 1889. She is owned by Bayard Thayer of Boston, and sails with the fleets of the EASTERN, NEW YORK, ATLANTIC, MASSACHUSETTS, LARCHMONT and CORINTHIAN (of New York) YACHT CLUBS. CONSTELLATION hails from Boston. See Fig. 301.

Official number, 126,571.

DIMENSIONS.

Length over all,	131 feet.	Length load waterline,	113 feet 6 inches.
Depth,	12 feet 9 inches.	Draft,	12 feet.
Beam,	23 feet 10 inches.		

Racing Record:—

1891—NEW YORK YACHT CLUB—CONSTELLATION was second in the Squadron Run on August 4th. NOBSEMAN won, but CONSTELLATION beat PALMER and INTREPID. First in the Squadron Run of August 8th, the other entries being DAUNTLESS, PALMER and FORTUNA. Won from the PALMER in the run of August 11th, and was again a winner in the run of August 12th.

1892—NEW YORK YACHT CLUB—CONSTELLATION won two seconds and two firsts in the series of Squadron Runs, being beaten by DAUNTLESS and MONTAUK, and defeating in turn RAMONA, CORONET, FORTUNA and DAUNTLESS. On August 8th she won the Morgan Schooner Cup, nineteen yachts starting and was victorious over such boats as ALCEA, MERLIN, MAYFLOWER, ATLANTIC, MARGUERITE, HUROQUIS, GENONE, etc. She was third in the race for Commodore Gerry's Cup, August 10th, MARGUERITE winning.

ALGA.

A cutter yacht. She was built by Lawley, having been designed by Burgess, and was launched in 1888. Is owned by Charles A. Long-

D.

feet 3 inches.
wt.

designed by
1890. She
CLUB. See

feet 4 inches.
feet.

two races re-
mudron Run,
LEAWAY and
in of August
1 and HILDE-

ta WAYWARD
HETIS second.
quadron Run
ENTURA in the
by KATRINA.

and built by
is owned by
the EASTERN,
ST and COMIN-
ION hails from

11 feet 4 inches.
12 feet.

as second in the
won, but Cox-
in the Squadron
TLESS, PALMER
of August 11th,
th.

ron two seconds
Runs, being
defeating in turn
ss. On August
n yachts starting
, MERLIN, MAY-
EXONE, etc. She
up, August 10th,

y been designed by
Charles A. Long-

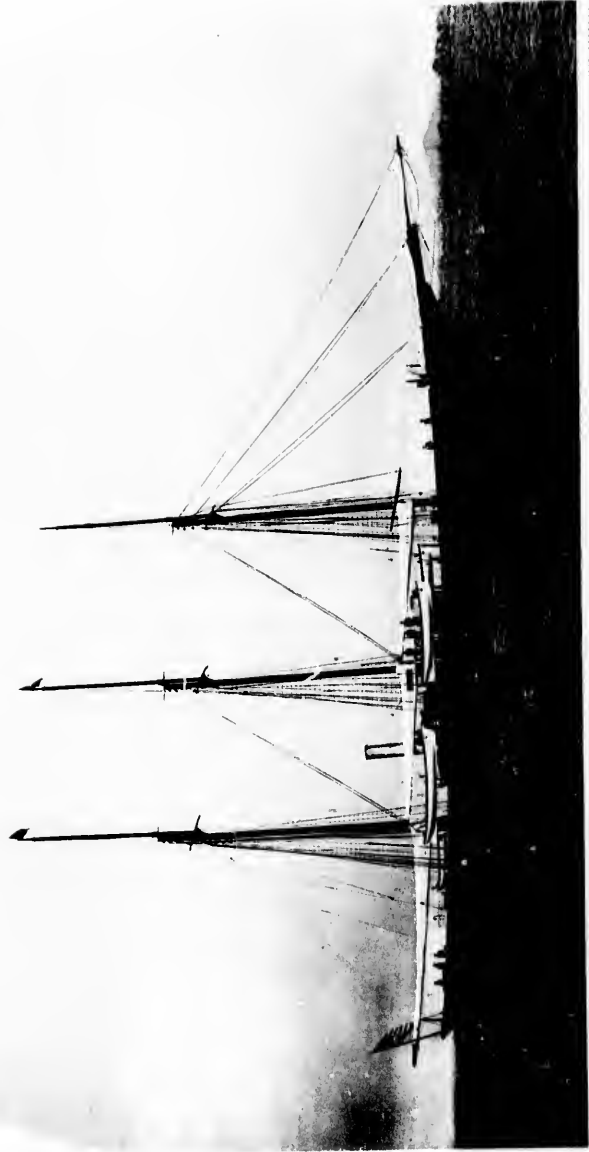

PLATE XXIII

UTOWANA.
13 Masted Schooner.

DIMENSIONS.

Overall,	80 feet,	Length load waterline,	63 feet 9 inches.
	9 feet 4 inches.	Draft,	11 feet 6 inches.
	12 feet 6 inches.		

*891:—

—Third in the Squadron Run of August
 and MIXDOLA, NAUTILUS fourth. Sec-
 ond OWENE winning, with UVERA
 HESICA, etc. Second
 August 27th, GLORIANA
 Third in the Squad-
 ron for Special Cups,
 A. Won in the
 the 12th. We

Iron Run of Au-
 THELMA winning.
 n Race, August
 ed August 26th.
 ee August 29th.
 econd, Second
 x winning.
 iled June 30th.
 Third in the Au-
 first in a Regatta of
 , sailed July 6th,
 Annual Regatta, held
 Squadron Run sailed
 AST winning.

by Manson
 field and built
 Was launched
 of the EASTERN,
 STBIAN and Cor-
 1902.

80 feet 5 inches.
 11 feet.

d in the First
 starters. Her
 faces, while in

of Beverly,
 by McQuesten
 HEN, SEAWAN-
 New York)

Foot 7 inches.
 Foot 9 inches.

UTOWANA.
 3 Masted Schooner.

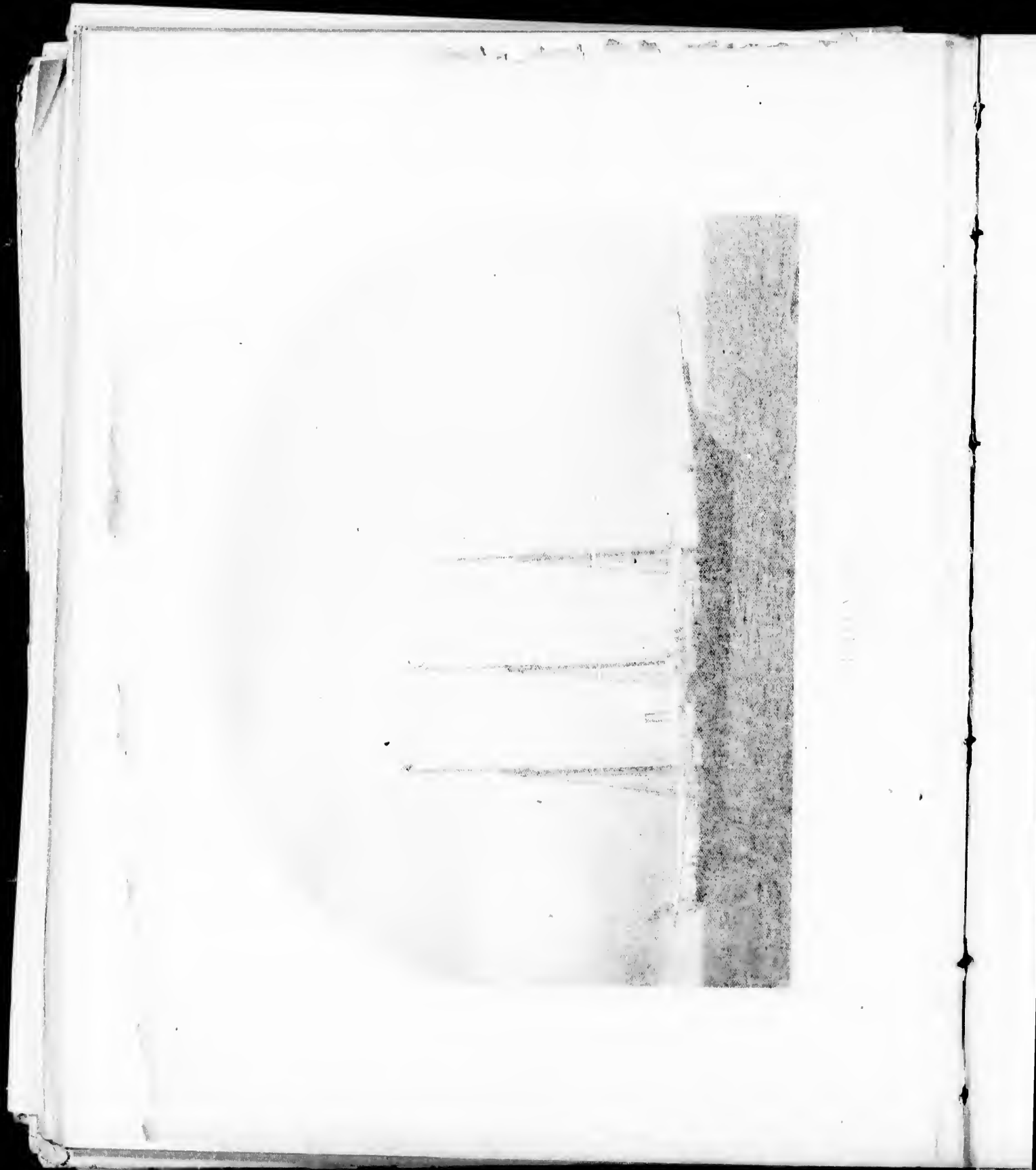

fellow of Boston, hailing from that port, and sailing with the EASTERN, NEW YORK and other YACHT CLUBS. See Fig. 297.

CODE SIGNAL LETTERS, K. H. D. L.
Official number, 106,740.

DIMENSIONS.			
Length over all,	56 feet.	Length load waterline,	45 feet.
Depth,	8 feet 4 inches.	Draft,	8 feet 9 inches.
Beam,	13 feet 6 inches.		

OWEENE.

A semi-composite keep cutter; was owned by A. B. Turner, then sold to William Otis Gay, of Boston, and is now owned by R. E. Malone of the same city. She was designed by Edward Burgess and built by Geo. Lawley & Son, South Boston, Mass., in 1890-91. She was launched in May, 1891. Hails from Boston, and sails with the EASTERN YACHT CLUB. See Fig. 303.

Official number, 155,199.

DIMENSIONS.			
Length over all,	63 feet.	Length load waterline,	45 feet 9 inches.
Depth,	9 feet 5 inches.	Draft,	11 feet.
Beam,	13 feet 4 inches.		

Racing Record, 1891:—

NEW YORK YACHT CLUB—August 4th, Squadron Run, first, defeating MINEOLA, SAYONARA and NAUTILUS. August 6th, Squadron Run, first, beating the same yachts, with the addition of MILCETE, UVIRA and JESSICA. August 8th, Squadron Run, third, being beaten by MINEOLA and NAUTILUS. On August 10th, she was beaten by SAYONARA and MINEOLA. August 12th, Squadron Run, second, beaten by SAYONARA.

EASTERN YACHT CLUB—July 23d, Special Race, OWEENE second, beaten by BEATRIX, followed by ALBORAK, SAYONARA, BARBARA and GOSsoon. September 8th, Autumn Regatta, won second prize (\$250), beaten by BEATRIX.

MASSACHUSETTS YACHT CLUB—July 16th, Special Race, first, winning silver cup valued at \$250, beating BEATRIX, GOSsoon, BARBARA and ALBORAK.

CORINTHIAN (of Marblehead) YACHT CLUB—July 1st, Regatta, won by OWEENE, beating ALBORAK and GOSsoon. July 23d, Regatta, second, won by BEATRIX. August 27th, Regatta, second, won by BARBARA, BEATRIX third. August 20th, Regatta, second, BEATRIX first. August 29th, Regatta, third, beaten by BEATRIX and ALBORAK.

CORINTHIAN (of New York) YACHT CLUB—August 17th, Sweepstakes, second, GLORIANA first, followed by ALBORAK, BARBARA, BEATRIX, JESSICA, MINEOLA, NAUTILUS, SAYONARA, and UVIRA.

SAYONARA.

The cutter yacht SAYONARA is of Burgess design, built by Lawley & Son, South Boston. She was launched in May, 1891, and is the property of Bayard Thayer of Boston. She hails from the City of Boston, and is enrolled in the EASTERN, NEW YORK, ATLANTIC, MASSACHUSETTS, LARCHMONT and CORINTHIAN (of New York) YACHT CLUBS. See plate XLII.

CODE SIGNAL LETTERS, K. J. L. S.
Official number, 116,403.

DIMENSIONS.

Length over all,	60 feet.	Length load waterline,	45 feet 9 inches.
Depth,	9 feet 4 inches.	Draft,	11 feet 6 inches.
Beam,	12 feet 6 inches.		

Racing Record, 1891:—

NEW YORK YACHT CLUB—Third in the Squadron Run of August 4th, beaten by OWEENE and MINEOLA, NAUTILUS fourth. Second in the Run of August 6th, OWEENE winning, with UVIRA third, followed by MINEOLA, NAUTILUS, JESSICA, etc. Second in the race for the Goolet Cup for sloops, August 7th, GLORIANA winning; in this race she beat BARBARA. Third in the Squadron Run of August 8th. Won in the races for Special Cups, August 10th, beating OWEENE and MINEOLA. Won in the Squadron Run of August 14th, and again on the 12th. Was beaten by GLORIANA August 13th.

EASTERN YACHT CLUB—Second in the First Squadron Run of August 22nd, beating CINDERELLA and GOSsoon, THELMA winning. Beaten by CINDERELLA in the Second Squadron Race, August 25th, and also in the Third Squadron Race, sailed August 26th. In the Fourth Squadron Race, which took place August 29th, CINDERELLA won a third time, with SAYONARA second. Second in the Autumn Regatta, September 8th, BEATRIX winning.

LARCHMONT YACHT CLUB—First in a Special Race, sailed June 30th, in which she defeated MINEOLA and JESSICA. Third in the Annual Regatta, July 4th, JESSICA winning. First in a Regatta of the AMERICAN YACHT CLUB (of New York), sailed July 6th, MINEOLA, JESSICA and NAUTILUS.

NEW ROCHELLE YACHT CLUB—First in the Annual Regatta, held July 7th, beating JESSICA.

1892—NEW YORK YACHT CLUB—Second in the Squadron Run sailed August 3rd, beating GLORIANA and LIRIS; WASP winning.

SEA FOX.

SEA FOX is an iron centerboard schooner, owned by Alanson Tucker of Boston. She was designed by A. Cass Canfield and built by the Harlan & Hollingsworth Co., Wilmington, Del. Was launched in 1888, hails from Boston and sails with the fleets of the EASTERN, NEW YORK, MASSACHUSETTS, SEAWANHAKA CORINTHIAN and CORINTHIAN (of Marblehead) YACHT CLUBS. See Fig. 302.

CODE SIGNAL LETTERS, K. F. G. C.

Official number, 116,216.

DIMENSIONS.			
Length over all,	115 feet.	Length load waterline,	89 feet 5 inches.
Depth,	12 feet.	Draft,	11 feet.
Beam,	23 feet 10 inches.		

Racing Record:—

EASTERN YACHT CLUB—In 1891 SEA FOX was third in the First Squadron Race, VOLUNTEER winning with six starters. Her showing was not so good in her other recorded races, while in 1892 no record is to be obtained of any racing.

SIONA.

SIONA is a cutter yacht, owned by Chas. H. Tweed of Beverly, Mass. She was designed by G. L. Watson, and built by McQuesten in 1884. Hails from Beverly and sails with the EASTERN, SEAWANHAKA CORINTHIAN, BEVERLY and CORINTHIAN (of New York) YACHT CLUBS. See Fig. 304.

DIMENSIONS.			
Length over all,	42 feet.	Length load waterline,	33 feet 7 inches.
Draft,	5 feet 8 inches.	Beam,	5 feet 9 inches.

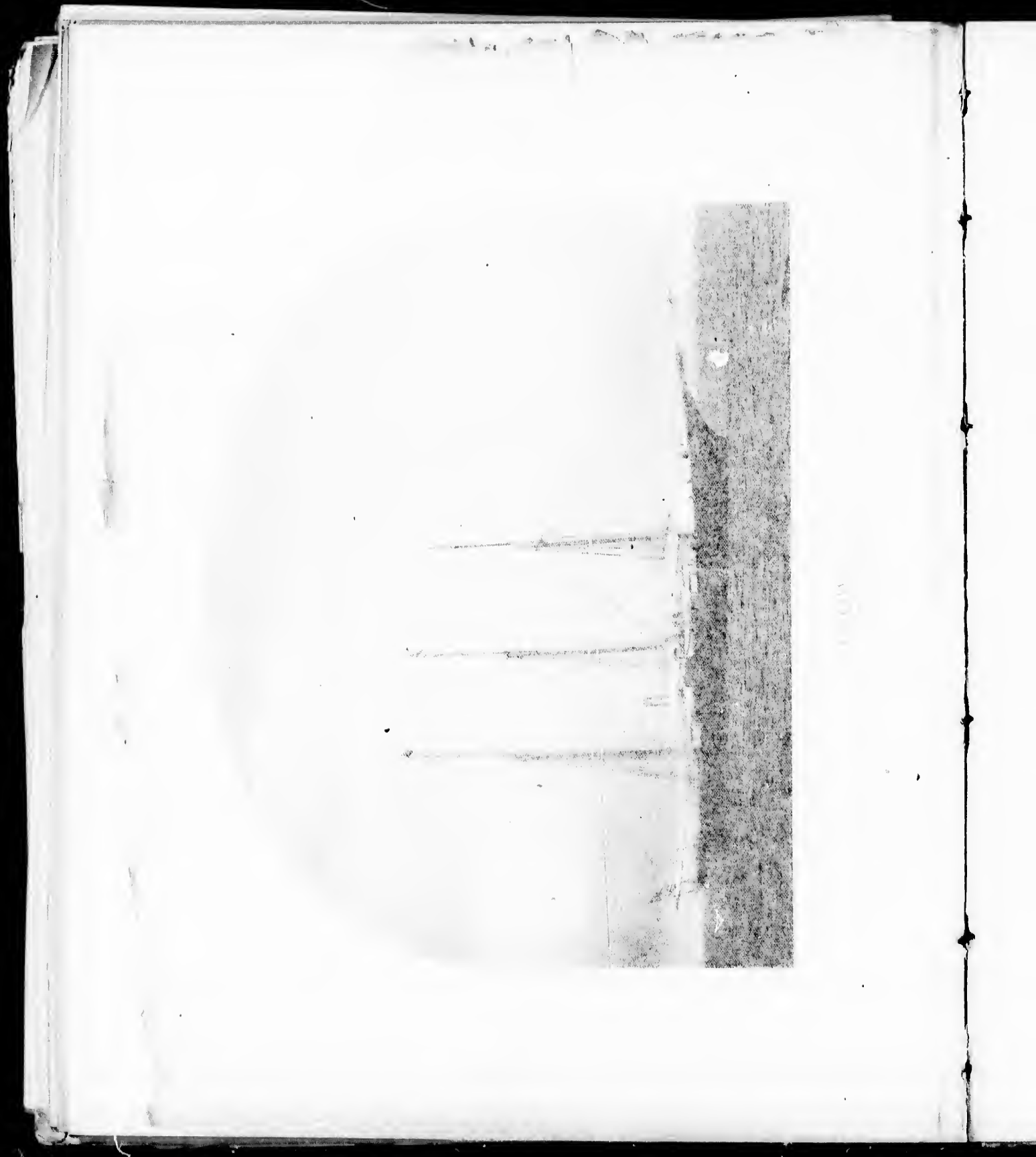

fellow of Boston, hailing from that port, and sailing with the EASTERN, NEW YORK and other YACHT CLUBS. See Fig. 297.

CODE SIGNAL LETTERS, K. H. D. L.

Official number, 106,740.

DIMENSIONS.			
Length over all,	50 feet.	Length load waterline,	45 feet.
Depth,	8 feet 6 inches.	Draft,	8 feet 9 inches.
Beam,	13 feet 6 inches.		

OWEENE.

A semi-composite keep cutter; was owned by A. B. Turner, then sold to William Otis Gay, of Boston, and is now owned by R. E. Malone of the same city. She was designed by Edward Burgess and built by Geo. Lawley & Son, South Boston, Mass., in 1890-91. She was launched in May, 1891. Hails from Boston, and sails with the EASTERN YACHT CLUB. See Fig. 303.

Official number, 155,199.

DIMENSIONS.			
Length over all,	63 feet.	Length load waterline,	45 feet 2 inches.
Depth,	9 feet 5 inches.	Draft,	11 feet.
Beam,	13 feet 4 inches.		

Racing Record, 1891:—

NEW YORK YACHT CLUB—August 4th, Squadron Run, first, defeating MINEOLA, SAYONARA and NAUTILUS. August 6th, Squadron Run, first, beating the same yachts, with the addition of MILICETE, UVIRA and JESSICA. August 8th, Squadron Run, third, being beaten by MINEOLA and NAUTILUS. On August 10th, she was beaten by SAYONARA and MINEOLA. August 12th, Squadron Run, second, beaten by SAYONARA.

EASTERN YACHT CLUB—July 23d, Special Race, OWEENE second, beaten by BEATRIX, followed by ALBORAK, SAYONARA, BARBARA and GOSsoon. September 8th, Autumn Regatta, won second prize (\$250), beaten by BEATRIX.

MASSACHUSETTS YACHT CLUB—July 16th, Special Race, first, winning silver cup valued at \$250, beating BEATRIX, GOSsoon, BARBARA and ALBORAK.

CORINTHIAN (of Marblehead) YACHT CLUB—July 1st, Regatta, won by OWEENE, beating ALBORAK and GOSsoon. July 23d, Regatta, second, won by BEATRIX. August 27th, Regatta, second, won by BARBARA, BEATRIX third. August 20th, Regatta, second, BEATRIX first. August 29th, Regatta, third, beaten by BEATRIX and ALBORAK.

CORINTHIAN (of New York) YACHT CLUB—August 17th, Sweepstakes, second, GLORIANA first, followed by ALBORAK, BARBARA, BEATRIX, JESSICA, MINEOLA, NAUTILUS, SAYONARA, and UVIRA.

SAYONARA.

The cutter yacht SAYONARA is of Burgess design, built by Lawley & Son, South Boston. She was launched in May, 1891, and is the property of Bayard Thayer of Boston. She hails from the City of Boston, and is enrolled in the EASTERN, NEW YORK, ATLANTIC, MASSACHUSETTS, LARCHMONT and CORINTHIAN (of New York) YACHT CLUBS. See plate XLII.

CODE SIGNAL LETTERS, K. J. L. X.

Official number, 116,403.

DIMENSIONS.

Length over all,	60 feet.	Length load waterline,	45 feet 9 inches.
Depth,	9 feet 4 inches.	Draft,	11 feet 6 inches.
Beam,	12 feet 0 inches.		

Racing Record, 1891:—

NEW YORK YACHT CLUB—Third in the Squadron Run of August 4th, beaten by OWEENE and MINEOLA, NAUTILUS fourth. Second in the Run of August 6th, OWEENE winning, with UVIRA third, followed by MINEOLA, NAUTILUS, JESSICA, etc. Second in the race for the Goolet Cup for sloops, August 7th, GLORIANA winning; in this race she beat BARBARA. Third in the Squadron Run of August 8th. Won in the races for Special Cups, August 10th, beating OWEENE and MINEOLA. Won in the Squadron Run of August 11th, and again on the 12th. Was beaten by GLORIANA August 13th.

EASTERN YACHT CLUB—Second in the First Squadron Run of August 22nd, beating CINDERELLA and GOSsoon, THELMA winning. Beaten by CINDERELLA in the Second Squadron Race, August 25th, and also in the Third Squadron Race, sailed August 26th. In the Fourth Squadron Race, which took place August 29th, CINDERELLA won a third time, with SAYONARA second. Second in the Autumn Regatta, September 8th, BEATRIX winning.

LARCHMONT YACHT CLUB—First in a Special Race, sailed June 30th, in which she defeated MINEOLA and JESSICA. Third in the Annual Regatta, July 4th, JESSICA winning. First in a Regatta of the AMERICAN YACHT CLUB (of New York), sailed July 6th, MINEOLA, JESSICA and NAUTILUS.

NEW ROCHELLE YACHT CLUB—First in the Annual Regatta, held July 7th, beating JESSICA.

1892—NEW YORK YACHT CLUB—Second in the Squadron Run sailed August 3rd, beating GLORIANA and LUIS; WASP winning.

SEA FOX.

SEA FOX is an iron centerboard schooner, owned by Alanson Tucker of Boston. She was designed by A. Cass Canfield and built by the Harlan & Hollingsworth Co., Wilmington, Del. Was launched in 1888, hails from Boston and sails with the fleets of the EASTERN, NEW YORK, MASSACHUSETTS, SEAWANAKA CORINTHIAN and CORINTHIAN (of Marblehead) YACHT CLUBS. See Fig. 302.

CODE SIGNAL LETTERS, K. F. G. C.

Official number, 116,216.

DIMENSIONS.			
Length over all,	113 feet.	Length load waterline,	89 feet 5 inches.
Depth,	12 feet.	Draft,	11 feet.
Beam,	23 feet 10 inches.		

Racing Record:—

EASTERN YACHT CLUB—In 1891 SEA FOX was third in the First Squadron Race, VOLUNTEER winning with six starters. Her showing was not so good in her other recorded races, while in 1892 no record is to be obtained of any racing.

SHONA.

SHONA is a cutter yacht, owned by Chas. H. Tweed of Beverly, Mass. She was designed by G. L. Watson, and built by McQuisten in 1884. Hails from Beverly and sails with the EASTERN, SEAWANAKA CORINTHIAN, BEVERLY and CORINTHIAN (of New York) YACHT CLUBS. See Fig. 304.

DIMENSIONS.

Length over all,	42 feet.	Length load waterline,	33 feet 7 inches.
Draft,	5 feet 8 inches.	Beam,	5 feet 9 inches.

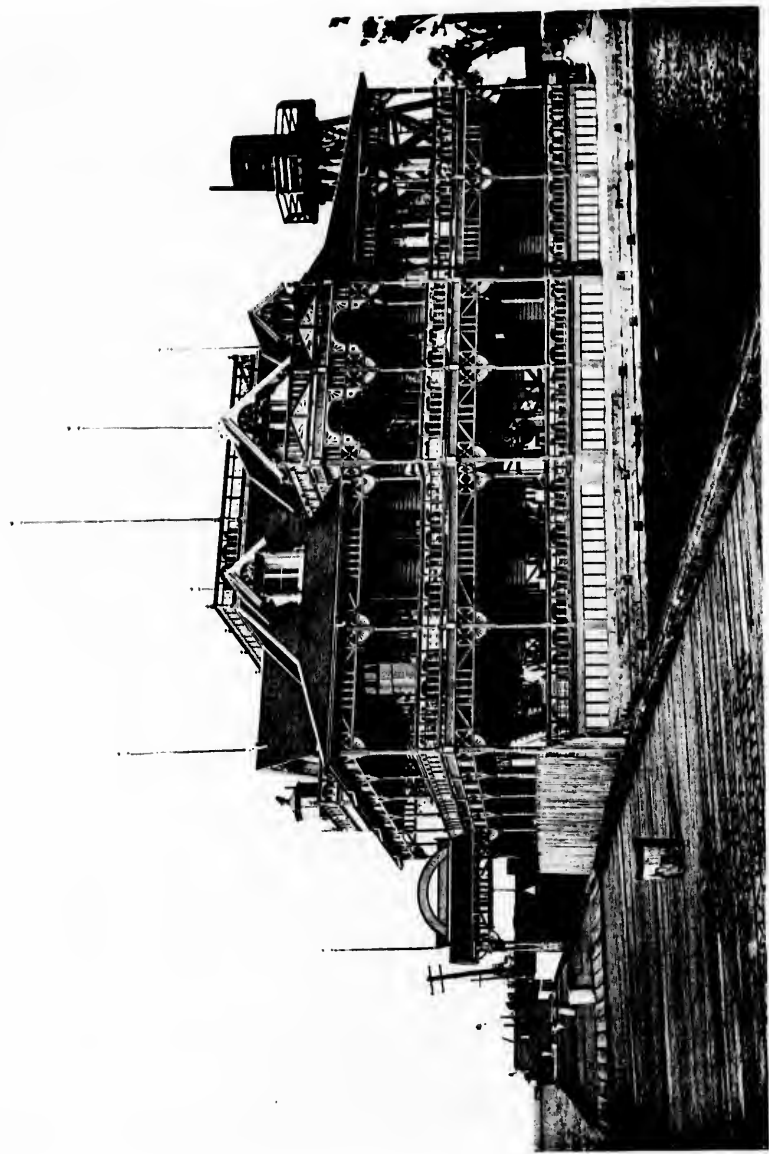

ROYAL HAMILTON YACHT CLUB HOUSE.

THE HAMILTON YACHT CLUB



The Hamilton Yacht Club
 was organized in 1846
 and has since that time
 been one of the most
 successful and popular
 clubs in the world.
 It has a membership
 of over 1000 and
 owns a fleet of over
 100 yachts.
 The club is open
 to all who are
 interested in
 yachting.
 For more information
 contact the club
 secretary.



THE BUREAU OF THE ARMY

History of the Royal Hamilton Yacht Club.

NO port on the chain of the great lakes possesses more natural advantages for the encouragement of yachting than Hamilton, Ontario, a city of 50,000 inhabitants situated on the southern shore of Hamilton (formerly called Burlington) Bay at the head or western extremity of Lake Ontario. Hamilton Bay is a completely land-locked body of water, triangular in shape, four miles long and three miles wide, separated from the lake by a narrow strip of sand and connected with it by a canal three-eighths of a mile in

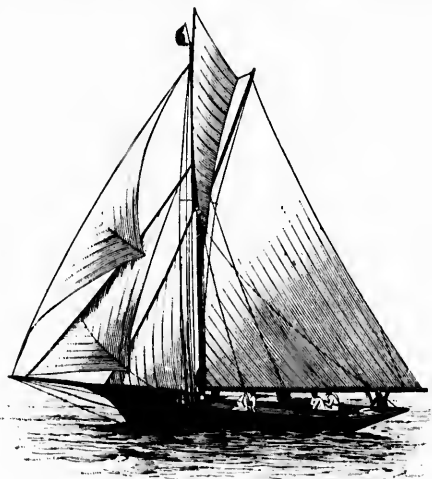

SAMOA.—FIGURE 304.

length. The shores of the bay, beautifully wooded and very picturesque, rise gradually for about two miles to a high plateau of land from which can be had one of the prettiest views in the northern country.

In the early seventies Hamilton's crack yachts were the terror of the lakes, the 60-tonner ANNIE CUTBERT and her smaller but equally invincible sisters BARNETTE and COQUETTE, old style boats of the then fashionable centerboard type, holding their laurels won from the other lake flyers year after year. These craft sailed under the colors of the BURLINGTON YACHT CLUB, an organization which did much in its day to encourage yachting on the lakes, but unfortunately was the ultimate cause of a lack of interest in the sport in Hamilton which lasted for some time. After a short career of but about seven years' extravagant management, or rather mismanagement, the club's existence terminated and gave yachting in Hamilton a set-back that was not overcome for more than a decade.

Although between the years 1876 and 1887 a number of yachts were owned in Hamilton, no club or other organization existed during that period, but in the Fall of 1887 Messrs. Emilius Jarvis and A. G. Osborne purchased the celebrated sloop WHITE WINGS, and Messrs. J. F. Monek and John Stewart the five enter CYPRISS

which had been brought out from England the year before. At this time, also, Messrs. Kilvert, Greening, Grant and Vallance built the 40-foot cutter PSYCHE, designed by the late C. P. Kunhardt, and other smaller craft appearing on the bay, it was decided to form the HAMILTON YACHT CLUB.

The first meeting was held on November 1, 1887, as a result of a notice sent out to the yachtsmen of the city, and about one hundred were present at this meeting. Mr. F. E. Kilvert acted as Chairman, and Mr. J. F. Monek was appointed Secretary pro tem. Three other meetings were held between that date and April 2, 1888, when the first annual meeting for the election of officers was held, the club at this time having a membership of 154. The officers elected at this meeting were, F. E. Kilvert, Commodore; John Stewart, Vice-Commodore; J. F. Monek, Captain; J. W. G. Watson, Secretary; G. F. Birley, Treasurer; E. Jarvis, F. S. Malloch and G. Webster, Committee. Prior to this it had been decided to erect a Club House, and taking example by the fate of its predecessor, the club erected a very modest though comfortable building on the Bay front at a cost of about \$1,000.

The club fleet at this time consisted of 20 yachts (14 centerboard

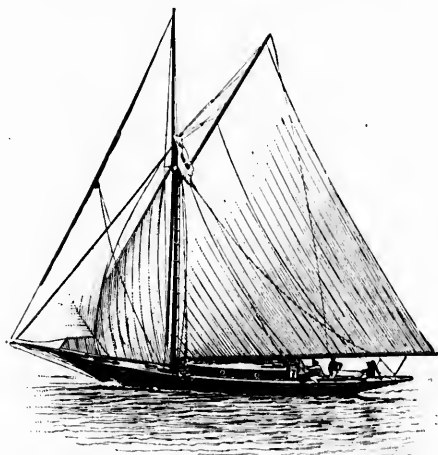

AGGIE.—FIGURE 305.

sloops, 5 cutters and 1 steam yacht), and the first club race was held on May 24, 1888, on what has ever since been the club course for local races, around a twelve-mile triangle on Hamilton Bay. In this race there were but seven starters, but during the season fourteen other races were held in addition to the Annual Regatta given under the auspices of the LAKE YACHT RACING ASSOCIATION, and in the majority of these a much larger number of sails were found at the starting line when the gun was heard.

Immediately upon its formation the club affiliated with the other clubs on Lake Ontario which form the LAKE YACHT RACING ASSO-

CLAYTON, and the First Annual Regatta was sailed over an open course on Lake Ontario on July 28, 1888, under the auspices of the Association and was open to all yachts belonging to the clubs of which the Association consisted. (See Record of Races given below.)

The Annual Regatta of the club has been sailed each year under the auspices of the LAKE YACHT RACING ASSOCIATION, the course always being an open one on Lake Ontario off Hamilton Piers. All the regattas on Lake Ontario are sailed under the rules of this Association, and the ROYAL HAMILTON YACHT CLUB has always taken an active part in the discussion and formation of these rules. It was during the Fall of 1889 when the annual meeting of the Council of the Association was held at Hamilton, that the waterline system of classification was changed to that of corrected length, and the Hamilton delegates did much to bring this about.

During the years 1889 and 1890 the club membership and fleet were considerably increased, and in October, 1890, the club decided to

this communication was an Admiralty warrant authorizing the club boats to carry the blue ensign of Her Majesty's fleet with a crown and maple leaf in the fly. The officers of the club at this time were Hon. W. E. Sanford, Commodore; S. O. Greening, Vice-Commodore; J. F. Monek, Captain; and E. H. Ambrose, Hon. Secretary; and they

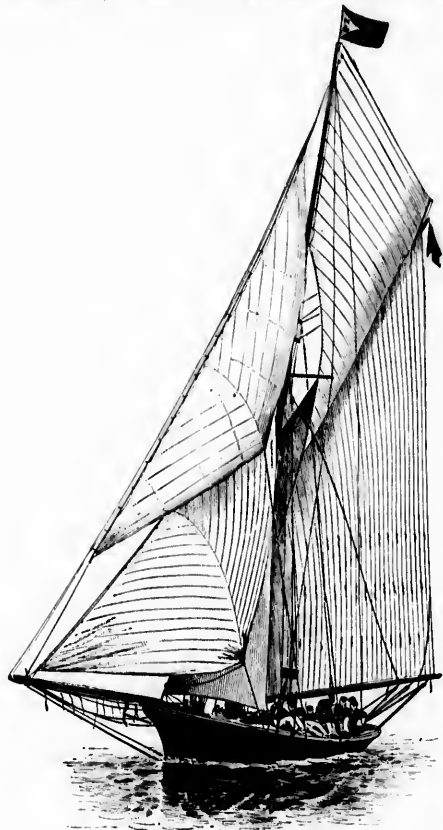

PSYCHE.—FIGURE 306.

erect a Club House at Hamilton Beach, the strip of sand which separates Hamilton Bay from Lake Ontario. About the same time a petition was sent by the Club to Her Majesty, Queen Victoria, praying that the HAMILTON YACHT CLUB might be permitted to assume the title ROYAL and carry the blue ensign of Her Majesty's fleet. In March, 1891, a communication was received from official quarters stating that Her Majesty had been pleased to grant her consent to the petition of the HAMILTON YACHT CLUB, which was thereafter to be known as the ROYAL HAMILTON YACHT CLUB, and accompanying



WHITE WINGS.—FIGURE 307.

with an enthusiastic committee immediately set about the work of erecting the Beach Club House. So heartily were they supported in this work that the building for which plans had been prepared had to be more than doubled in size, and on May 1st it was announced that the club membership had increased to over 500, and that contracts had been let for the erection of a club building to cost \$13,000, on a site adjoining the piers, a lease of which had been obtained from the Government.

From the illustration a very good idea of the Club House can be obtained. It is situated in a prominent position and from its spacious verandas a most beautiful view is had. The interior of the building is handsomely decorated and every conceivable convenience for the comfort of yachtsmen is provided.

While the club was increasing in wealth and membership its yachting strength was increasing in proportion, and at this time the club had a fleet of fifty-four yachts. A large number of races open only to the club boats are given each year in addition to the Annual Regatta, held under the auspices of the LAKE YACHT RACING ASSOCIATION, which (as has been stated) is open to all boats belonging to the clubs of which the Association consists. In addition to the prizes offered by the club, many of these races are for valuable challenge cups which have been presented to the club for annual competition, but the most coveted of these is the handsome trophy presented by Her Majesty, the Queen, in 1891, to be competed for annually by yachts belonging to the Canadian Yacht Clubs. The first race for this cup was sailed at Toronto, on July 1, 1891, when the ROYAL CANADIAN cutter VEDA beat the ROYAL HAMILTON boat WHITE WINGS by only two seconds, the latter being unfortunate enough to lose her topmast while having the race well in hand. The race in 1892 was at Hamilton, and, as in the previous year, there were seven starters, the cup being won by the ROYAL HAMILTON cutter NANCY, which beat the new Fifte lugger VEDETTE, of the ROYAL CANADIAN YACHT CLUB by over five minutes. The cup was sailed for again at Hamilton, in 1893, and was won by ZELMA. The present officers of the club are: Hon. W. E. Sanford, Commodore; F. S. Malloch, Vice-Commodore; R. A. Lucas, Rear-Commodore; W. J. Grant, Captain, and Thomas W. Lester, Hon. Secretary.

LIST OF YACHTS ENROLLED IN THE ROYAL HAMILTON YACHT CLUB.

NO.	YACHT.	OWNER.	P. O. ADDRESS.	HAULS ON LENS.	TIME ALLOWANCE	HTG.
2	Aggie	Marlatt & Armstrong	Oakville	33.81	137.42	Cutter
3	Aileen	H. Mills	Toronto	56.90	81.76	"
5	Alert	H. Sichel	Hamilton	32.03	100.31	Sloop
14	Condor	C. A. B. Brown	Toronto	42.70	117.50	Cutter
21	Vera	T. Whawry	Hamilton	"	"	"
23	Echo	James Hannah	"	29.61	172.98	Sloop
66	Sudra	L. H. Urquhart	"	20.70	172.42	"
76	Psycho	F. E. Kilvert	"	37.25	137.00	Cutter
83	Stella	G. S. Vappo	"	22.43	222.11	Sloop
92	Verve	I. W. Hendri	"	43.98	133.53	Cutter
108	Adeline	J. Morris	"	18.01	256.06	Sloop
112	Eclipse	W. Dillon	"	20.70	237.76	"
114	Heather Bell	Thompson Bros.	"	22.37	222.70	"
116	Nadley	C. A. Birge and Geo. Cook	"	24.95	232.50	"
117	Samoa	E. H. Ambrose, et al.	"	20.02	171.21	"
121	Wayo	W. H. Judd, et al.	"	28.83	177.37	"
123	Ariadne	J. Morris	"	20.10	233.62	"
125	Lotus	H. Weir	"	28.85	177.22	"
126	Zanthe	W. Johnson	"	20.80	234.81	"
127	Matid B.	W. Burnside	"	24.68	204.47	"
147	Volante	Geo. Webster	"	33.00	159.77	Cutter
167	Blush	F. S. Malloch	"	37.66	135.45	"
149	Vreda	Com. Bowdell	Toronto	47.80	162.77	"
173	Glytic	H. Weir	Hamilton	20.56	230.13	Sloop
175	Java	J. C. Quinn	Toronto	20.06	235.29	Cutter
176	Mignon	J. B. Bustin	Hamilton	18.02	Skiff
177	Medora	T. S. Stephens	"	17.00	"
179	Sofine	J. B. Young	"	15.00	"
180	Latona	H. Sichel	"	29.79	171.91	Sloop
181	Carnil	E. Jackson Sanford	"	20.08	217.05	"
190	Erma	L. V. Percival	Toronto	20.76	171.87	Cutter
188	Spray	Maw & Drauscke	Hamilton	20.07	235.20	"
222	P'U Away	Th. Stephens	"	20.81	236.72	"
219	Salola	W. J. Huzar	"	21.58	235.20	Sloop
221	Lucy	W. Johnston S. Vilk	"	21.07	231.53	"
2.6	Clipper	Alex. Thomas	"	21.77	233.81	"
220	Mona	G. H. Judd, et al.	"	21.72	231.18	Cutter
223	Oriental	Thos. Tubb	"	10.33	251.61	Sloop
4	Cruiser	H. J. McAllister	"	"
148	Katie Hall	D. Hall	Aldershot	24.95	232.50	"
156	Hustler	E. H. Bowen	Hamilton	19.20	232.06	"
225	Okieha	W. J. Wallace	"	20.70	237.20	Lugger
	Blackbird	G. T. Tuckett	"	Sloop
18	Cygnat	T. McGaw	Toronto	Cutter
61	Molly	T. E. World	"	"
227	Thistle-down	E. Jarvis	"	20.72	237.15	"
225	Trump	R. K. Duthee	"	21.62	212.50	Sloop
	Cleopatra	A. E. Gooderham	"	Stemmer
220	Lenora	J. W. Plummer	"	Yawl
80	Velette	Frank M. Gray and J. Carl Reed	"	29.82	171.87	Lugger
145	Nancy	T. Dillon	Hamilton	28.60	178.71	"

the club
rown and
time were
unmodore;
and they

the work of
ported in
epared had
announced
l that cost
\$13,000,
ained from

ouse can be
om its spu-
erior of the
convenience

ip its yacht-
me the club
pen only to
al Regatta,
OCIATION.
to the clubs
izes offered
elenge cups
ion, but the
ted by Her
y by yachts
ee for this
YAL CANA-
ITE WINGS
to lose her
in 1892 was
ren starters,
ncy, which
IAN YACHT
in at Ham-
eers of the
loch, Vice-
nt, Captain.

RECORD OF RACES.

The First Annual Regatta of the ROYAL HAMILTON YACHT CLUB was held under the auspices of the LAKE YACHT RACING ASSOCIATION on July 28, 1888. The course was on Lake Ontario off Hamilton Piers five miles to windward and return, the larger boats



VERA.—FIGURE 308.

making three circuits or 30 miles, and the smaller ones two circuits. In this regatta the following yachts started:

Second Class.—36 feet to 50 feet load waterline.

AGGIE, WHITE WINGS, VERVE, CONDOUR and CYGNET.

Third Class.—25 feet to 36 feet load waterline.

VOLANTE, PSYCHE, CYPRIUS, ALBERT, COQUETTE, BURLINGTON.

ST. ELMO, CACIQUER, MERLE, MAJEL, CRUISER and SURGE.

Fourth Class.—20 feet to 25 feet load waterline.

GREYHOUND, STELLA, MYSTERY, ACACIA, CAPRICE, ALBERT.

MISCHIEF, TRITON, NEPTUNE, VELNETTE, FLIRT and MOLLIE.

Fifth Class under 20 feet load waterline.

ALVETTA, KESTREL, DAPHNE, FLEETWING, COMET, FLIGHT,

ALLIANCE, WATER WITCH, ADELEINE and SEA GULL.

Owing to the wind falling very light, none of the races were finished, and the regatta was postponed until August 4th, the winners then being:

Second Class, WHITE WINGS 1st, AGGIE 2d.

Third Class, CYPRIUS 1st, COQUETTE 2d, PSYCHE 3d.

Fourth Class, GREYHOUND 1st, STELLA 2d, MYSTERY 3d.

Fifth Class, ALVETTA 1st, FLIGHT 2d, ADELINE 3d.

The Second Annual Regatta was sailed over the same course on August 19, 1889 in a moderate southwest wind increasing to fresh during the day. Thirty-seven yachts started in this regatta, the winners being:

Schooner Class, 75 feet load waterline, ORIOLE 1st, WASP, 2d.

50 Foot Class, WHITE WINGS 1st, VERVE (R. H. Y. C.) 2d,

VERVE (R. C. Y. C.) 3d.

35 Foot Class, MERLE 1st, VISION 2d, COQUETTE 3d.

30 Foot Class, ALBERT 1st, ECHO 2d, NADIA 3d.

25 Foot Class, VENDETTA 1st, STELLA 2d, KELPIE 3d.

20 Foot Class, CAPRICE 1st, ELLIDA 2d, AILEEN 3d.

The Third Annual Regatta was sailed over the lake course off Hamilton Piers on August 13, 1890, in a moderate to fresh east to north-east wind. Since the last Annual Regatta the system of classification had been changed from that of load waterline to corrected length. Forty-seven yachts started in this regatta, the following being the winners in their respective classes:

First Class, VREDA 1st, ORIOLE 2d, AILEEN 3d.

40 Foot Class, WHITE WINGS 1st, CONDOUR 2d, VERVE 3d,

YAMA 1st, MERLE 2d, PSYCHE 3d.

35 Foot Class, COQUETTE 1st, ALBERT 2d, CYPRIUS 3d.

30 Foot Class, NANCY 1st, NADIA 2d, ECHO 3d.

25 Foot Class, MISCHIEF 1st, MAUD B. 2d, No. 2 3d.

21 Foot Class, WIDGEON 1st, RAMBLER 2d, CAPRICE 3d.

The Fourth Annual Regatta was sailed over the club course on Lake Ontario on July 14, 1891. In point of numbers this promised to be the most successful regatta the club had held, but a violent thunder squall struck the fleet about an hour before the starting time driving several of the yachts ashore and disabling others, so that out of over 50 yachts only 30 started. After the squall the wind settled down to a moderate southwesterly breeze which held steadily throughout the race. The winners in this regatta were:

First Class, VREDA 1st, ORIOLE 2d.

46 Foot Class, YAMA 1st, VERVE (R. H. Y. C.) 2d, AGGIE 3d.

40 Foot Class, PSYCHE 1st, VERVE (R. C. Y. C.) 2d.

35 Foot Class, DENAD 1st, ALBERT 2d, VISION 3d.

30 Foot Class, ECHO 1st, SAMOA 2d, NADIA 3d.

25 Foot Class, MAUD B. 1st, NELLIE 2d, TRITON 3d.

21 Foot Class, WIDGEON 1st, CAPRICE 2d, METEOR 3d.

The Second Annual Race for the Queen's Cup was sailed on the ROYAL HAMILTON YACHT CLUB'S course on July 1, 1892, and was open to all Canadian yachts of 30 feet corrected length and under.

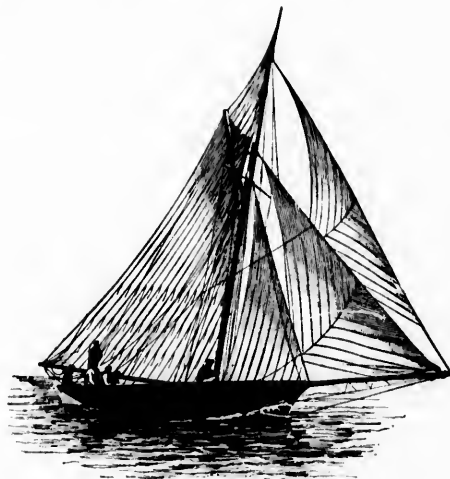

NANCY.—FIGURE 309.

The wind was light, to moderate from the southwest, freshening at the finish. The cup was won by NANCY, owned by F. S. Mulloch, Vice-Commodore of the ROYAL HAMILTON YACHT CLUB, MAUD B. of the same club second, and VEDETTE, of the ROYAL CANADIAN YACHT CLUB, third.

The Fifth Annual Regatta held by the club under the auspices of the LAKE YACHT RACING ASSOCIATION, was sailed over the same

course off Ham-
east to north-
classification
ected length.
ing being the

l.
ERVE 3d,

3d.

3d.
ANCE 3d.

course on Lake
promised to be
iolent thunder
g time driving
at out of over
settled down
ly throughout

2d, AGUE 3d.

) 2d.

l.

S 3d.

FOR 3d.

s sailed on the
1892, and was
gth and under.



est, freshening at
y F. S. Mulloch,
CLUB, MAUD B.
OYAL CANADIAN

er the auspices of
ed over the same

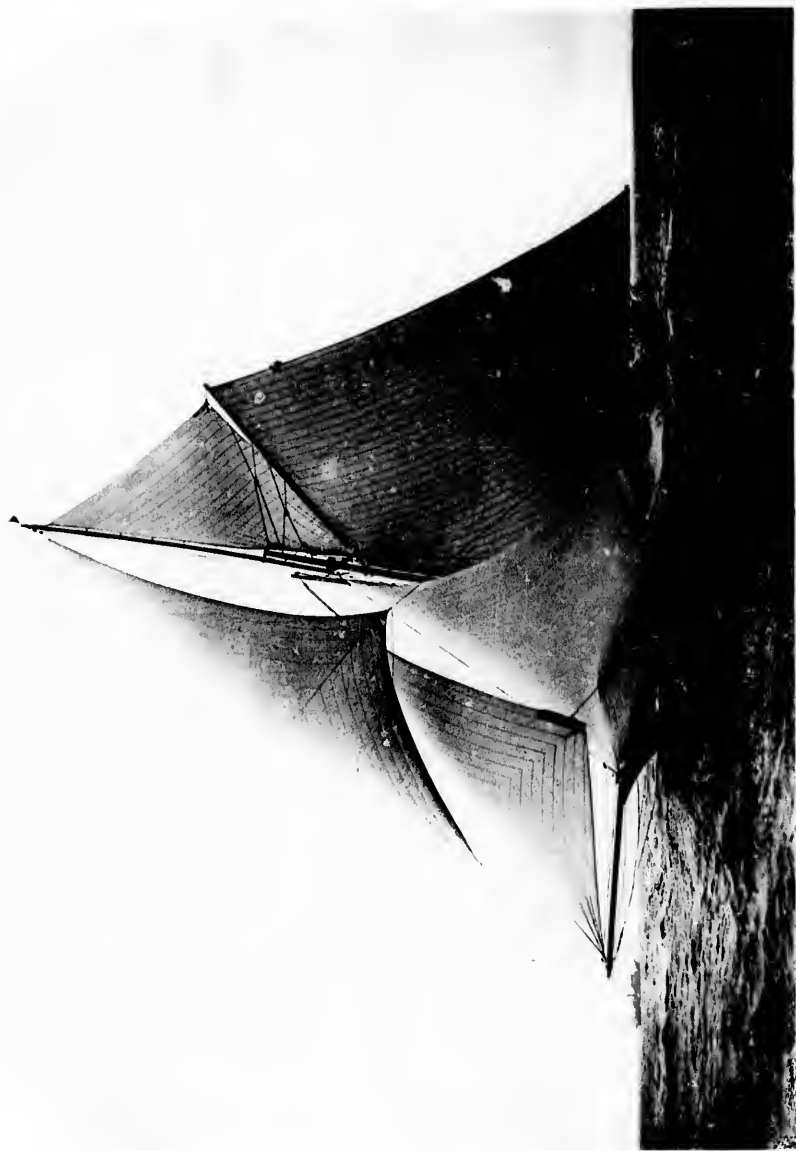

PLATE XXVII.

THE "BARB" NEGATIVE BY JOHNSON.

BARBARA.



course as the previous ones, on July 26, 1892, in a light southeast wind. Owing to the fact that the American yachts on the lake did not complete the LAKE YACHT RACING ASSOCIATION circuit, and the consequent lack of interest resulting from the contests not being of an international character, this regatta was the smallest which the club had held, there being but 26 starters. The winners in their respective classes were:

- First Class, VREDA 1st, OHIOLE 2d.
- 46 Foot Class, AGGIE 1st, WHITE WINGS, 2d.
- 40 Foot Class, ZELMA 1st, DINAH 2d, PSYCHE 3d.
- 35 Foot Class, VISION 1st, ALERT 2d.
- 30 Foot Class, ERMA 1st, VOLANTE 2d, VEDETTE 3d.
- 25 Foot Class, MACD B. first, SALOLA 2nd, NOX 3d.
- 21 Foot Class, GWENDOLINE 1st, CANUCK 2d, ILL AWAY 3d.

The records as given above are only of the Annual Regattas, open to the fleets of the yacht clubs on Lake Ontario, but in addition to these from 20 to 25 other class races are held each season, in which are entered the boats of the ROYAL HAMILTON YACHT CLUB only. The average number of starters in each of these club races is from six to eight.



VOLANTE.—FIGURE 310.

ROYAL HAMILTON RACES FOR 1893.

Regatta, May 24th.

The 25 foot class sailed over a ten mile course.

Yacht.	Owner.	Class.	Rig.	Ft. In.	Elap. Time.	Cor. Time.
Salola	W. J. Buggie	25 ft sloop	24 6	2 42 00	2 41 50	
Mona	G. K. Judd	25 ft cutter	24 0	2 41 28	2 41 28	
Maud B.	Wm. Burnside	25 ft sloop	24 6	2 53 30	2 53 27	

SALOLA won.

The 21 foot class sailed a nine mile course.

Caruli	E. J. Sanford	21 ft cutter	20 6	2 30 00	2 35 35	
Eclipse	W. Dillon	21 ft sloop	20 3	2 37 32	2 37 09	
Rustler	E. H. Bower	21 ft sloop	19 2	2 40 00	2 43 31	
Ill Away	T. S. Stephens	21 ft cutter	20 0	2 53 00	2 53 46	
Spray	Maw & Draescke	21 ft cutter	21	2 59 00	2 59 00	

CARULI won, ECLIPSE second.

A Regatta was sailed June 10th, over a ten mile course as follows:

40 Foot Class.						
Dinah	F. S. Malloch	40 ft cutter	37 8	2 50 37	2 50 37	
Psyche	F. E. Kilvert	40 ft cutter	37 3	3 10 12	3 09 50	
Alert	G. K. Judd	35 ft sloop	32	4 00 05	3 55 57	

Yacht.	Owner.	Class.	Rig.	Ft. In.	Elap. Time.	Cor. Time.
30 foot class.						
Echo	Jas. Hammond	30 ft sloop	29 6	3 16 27	3 16 05	
Nadia	J. H. Fearnside	30 ft sloop	29 8	3 22 05	3 21 19	
Nancy	Thos. Dalton	30 ft cutter	24 0	3 38 04	3 38 04	
Volante	Geo. Webster	30 ft cutter	30 0	3 50 21	3 50 21	

DINAH won in the 40 foot class, and Echo won in the 30 foot class.

A Regatta took place June 24th. The 25 foot class sailed a ten mile course, as follows:

Mona	G. K. Judd	25 ft cutter	24 0	3 11 22	3 11 22	
Maud B.	W. Burnside	25 ft sloop	24 6	2 52 12	2 52 09	
Salola	W. J. Buggie	25 ft sloop	24 6	2 57 33	2 57 31	

The 21 foot class sailed over a nine mile course.

Okelha	W. J. Wallace	21 ft lugger	19 3	2 53 00	5 53 00	
Ill Away	T. L. Stephens	21 ft cutter	20 0	3 05 04	3 04 56	
Eclipse	Wm. Dillon	21 ft sloop	20 3	2 58 06	2 57 19	
Caruli	E. J. Sanford	21 ft cutter	20 6	3 02 50	3 02 31	

MAUD B. and OKELHA won in their respective classes. ECLIPSE ruled out, CARULI took second place, ILL AWAY third.

A Regatta was sailed July 1st, over a 25 mile course, for the Queen's Cup. The entries were all of the 40 foot class.

Zelma	N. B. Dick	40 ft cutter	40 0	6 47 05	6 47 05	
Aggie	Murlitt & Armstrong	40 ft cutter	40 0	7 09 15	7 08 58	
Dinah	F. S. Malloch	40 ft cutter	37 8	7 39 05	7 35 28	

ZELMA won.

A Regatta (LAKE YACHT RACING ASSOCIATION) was sailed July 8th. The course was 24 miles for the 40 foot class, 16 miles for the 35 and 30 foot classes, and 12 miles for the 25 foot class.

Vreda	Com. Boswell	first class cutter	47 6	4 48 20	4 48 20	
Zelma	N. B. Dick	40 ft cutter	40 0	4 50 35	4 54 35	
Dinah	F. S. Malloch	40 ft cutter	37 8	4 58 45	4 55 16	
Cyprus	N. B. Dick	35 ft cutter	32 8	4 51 40	4 51 40	
Verette	Gray & Reed	30 ft lugger	30 0	4 07 15	4 06 50	
Simon	E. H. Ambrose	30 ft cutter	30 0	4 15 41	4 15 37	
Volante	Geo. Webster	30 ft cutter	30 0	4 24 45	4 24 45	
Nox	Fred A. Miller	25 ft lugger	24 0	3 40 40	3 40 13	
Salola	W. J. Buggie	25 ft sloop	24 6	3 44 15	3 44 06	
Maud H.	Wm. Burnside	25 ft sloop	24 6	3 48 16	3 48 10	

21 foot class sailed August 19.

VREDA, VEDETTE and NOX won in their respective classes.

A Regatta was sailed July 23d, over a 10 mile course as follows:

Simon	E. H. Ambrose	20 ft cutter	27 6	2 25 25	2 25 21	
Volante	Geo. Webster	20 ft cutter	29 10	2 47 00	2 47 00	
Dinah	F. S. Malloch	40 ft cutter	37 8	2 00 29	2 00 29	

DINAH won.

On July 29th, a Cruising Race to Oakville took place as follows:

Simon	E. H. Ambrose	30 ft cutter	27 6	2 07 02	2 07 02	
Nadia	J. H. Fearnside	30 ft cutter	29 4	2 07 03	2 07 03	
Volante	Geo. Webster	30 ft cutter	29 10	2 07 04	2 07 04	

SAMOA won.

On the 12th of August a Cruising Race to Pt. Dalhousie was sailed.

Nadia	J. H. Fearnside	30 ft cutter	29 4	4 09 00	3 29 00	
Volante	Geo. Webster	30 ft cutter	29 10	4 06 00	3 36 00	
Simon	E. H. Ambrose	30 ft cutter	27 6	4 16 30	3 36 30	

NADIA won.

A Regatta was sailed on the 19th of August, on which date the 21 foot class sailed the LAKE YACHT RACING ASSOCIATION Regatta.

Eclipse	W. Dillon	21 ft sloop	20 8	2 47 05	2 46 11	
Okelha	W. J. Wallace	21 ft lugger	20 0	2 48 28	2 48 25	
Ill Away	T. L. Stephens	21 ft	20 0	3 03 22	3 03 22	

Lydia						
Okelha	W. J. Wallace	21 ft lugger	19 11	2 48 21	2 46 59	
Eclipse	W. Dillon	21 ft sloop	20 8	2 47 05	2 46 55	
Ill Away	T. L. Stephens	21 ft cutter	20 0	3 03 22	3 03 22	

ECLIPSE was the winner in both events.

HISTORY OF THE ROYAL HAMILTON YACHT CLUB.

The contest for the WHITE WINGS CUP took place August 26th; course, 10 miles.

Yacht.	Owner.	Class.	Fig.	Elapsed Time.		Cor. Time.	
				H. M. S.	D. M. S.	H. M. S.	D. M. S.
Dinah	F. S. Malloch	40 ft cutter		2 10 10		2 10 10	
Psyche	F. E. Kilvert	40 ft "		2 20 20		2 20 04	
Vedette	J. C. Reed & F. M. Gray	30 ft lugger		2 22 50		2 10 00	
Salola	W. J. Buggie	25 ft sloop		2 31 05		2 20 28	
Maud B.	Wm. Burnside	25 ft "		2 32 35		2 21 05	
Volante	Geo. Webster	30 ft cutter		2 39 12		2 33 11	

DINAH won, with VEDETTE second.

The MONCK and LUCAS Cups were sailed for on the 2nd of September, as follows; course, 12 miles:

		Elapsed Time.		Cor. Time.	
		H. M. S.	D. M. S.	H. M. S.	D. M. S.
Vedette	Monck Cup	2 10 50		2 15 41	
		2 21 55		2 21 55	
Nancy	Lucas Cup	2 30 27		2 36 27	
		2 35 00		2 34 55	
		2 48 00		2 46 50	

Winner of Monck Cup, Vedette.
Winner of Lucas Cup, Volante.

BIOGRAPHICAL SKETCHES AND DESCRIPTION OF YACHTS ENROLLED IN THE CLUB.

HONORABLE WILLIAM E. SANFORD, Senator for the Dominion of Canada, Hamilton, Ontario, and Commodore of the ROYAL HAMILTON YACHT CLUB, was born in New York City, of English parentage. He is the owner of the steamer NAIAD, and has been a yachtsman all his life. He was one of the charter members of the ROYAL HAMILTON YACHT CLUB.

NAIAD.

NAIAD is a steamer, belonging to the Hon. William E. Sanford, Commodore of the ROYAL HAMILTON YACHT CLUB, of Hamilton. She was designed and built by the Polson Iron Works for her present owner, and was launched in July, 1890. She hails from Hamilton, and sails with the ROYAL HAMILTON YACHT CLUB. See plate LI.

DIMENSIONS.

Length over all,	67 feet.	Length load waterline,	50 feet.
Draft,	4 feet.	Beam,	10 feet.

Engine: Fore and aft compound condensing. $1\frac{1}{2}$ in, and 15 in. x 10 inch.

Boiler: Clyde boiler 66x84 in. 30 horse power.

FRANCIS S. MALLOCH, Vice-Commodore of the ROYAL HAMILTON YACHT CLUB, and President of the LAKE YACHT RACING ASSOCIATION, was born in Brockville, Ont., and now lives in



VICE-COMMODORE F. S. MALLOCH.

Hamilton, Ont. He is a most ardent yachtsman, and is the owner of the sloop DINAH, having also owned the yachts SPRAY, MOLLY, and NANCY. Is a member of the ROYAL HAMILTON and ROYAL CANA-

DIAN YACHT CLUBS, being one of the founders of the former Association.

DINAH.

The keel sloop DINAH, owned by Vice-Commodore Francis S. Malloch of the ROYAL HAMILTON YACHT CLUB, was designed and built by Thomas Dalton. She was launched in 1891. DINAH hails from Hamilton, and sails with the ROYAL HAMILTON and ROYAL CANADIAN YACHT CLUBS, and with the LAKE YACHT RACING ASSOCIATION. See plate LIII.

DIMENSIONS.

Length over all,	40 feet.	Length load waterline,	33 feet.
Depth,	2 feet 6 in.	Beam,	6 feet 8 in.



E. H. AMBROSE, barrister-at-law, Hamilton, Ont., was born in Hamilton of English descent. Has been interested in yachting all his life, and is the owner of the cutter SAMOA. Took a prominent part in the organization of the ROYAL HAMILTON YACHT CLUB, and was Secretary of the club at the time of organization. Was Treasurer in 1890, Secretary in 1891, and Captain in 1892.

SAMOA.

E. H. AMBROSE. A cutter, designed by Emilus Jarvis and built by A. M. Robertson & Sons, Hamilton. She was built for her designer, but in 1891 became the property of her present owner, Mr. E. H. Ambrose. She has never been altered, and sails with the ROYAL HAMILTON YACHT CLUB. See Fig. 305.

DIMENSIONS.

Length over all,	40 feet.	Length load waterline,	27 feet 6 in.
Draft,	6 feet.	Beam,	8 feet 6 in.

She made her fame as a heavy weather boat in the Kingston Regatta of 1890, when the wind blew fifty-eight miles an hour. Was the only boat in her class which went over the course, seven others giving up.

AGGIE.

A cutter yacht, owned by M. Armstrong and C. Marlatt of the ROYAL HAMILTON and ROYAL CANADIAN YACHT CLUBS. She was designed and built by James Andrews of Oakville, Ont., from which port she now hails. Was launched in 1887, and was rebuilt by Andrews in 1892. See Fig. 306.

DIMENSIONS.

Length over all,	50 feet.	Length load waterline,	37 feet.
Depth,	8 feet.	Draft,	8 feet.
Beam,	12 feet.		

Racing Record:—

AGGIE has seen a good deal of racing since 1888, and has competed with most of the crack yachts of that section. A partial schedule of her races is given below.

Aug. 4, 1888—Second, WHITE WINGS first.

July 14, 1891—Third, YAMA first.

2nd of

re.

er Asso-

ancis S.
ied and
DIXIE
ON and
YACHT

ches.

r-at-law,
Hamilton
inter-
d is the
a prom-
e ROYAL
Secretary
nization.
in 1891,

us Jarvis
was built
r present
and sails

3 inches.
4 inches.
agston Re-
our. Was
en others

att of the
She was
rom which
uilt by An-

37 feet.
8 feet.

s competed
chedule of



COMMODORE W. E. SANDFORD.

ROYAL HAMILTON YACHT CLUB.

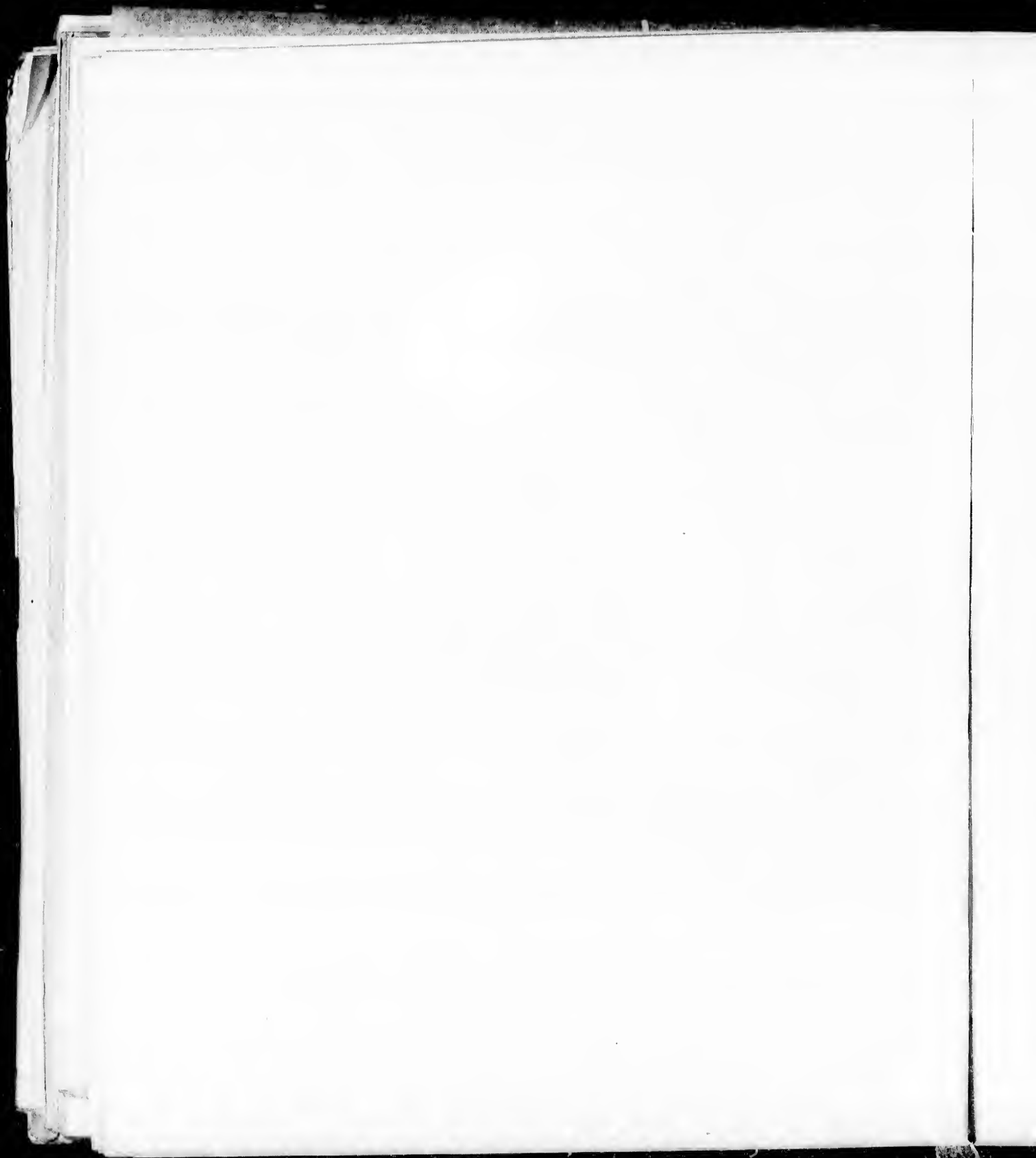

June 11, 1892—First, beating ZELMA and CONDOR.
 July 18, 1892—Second, WHITE WINGS first.
 July 22, 1892—Defeated WHITE WINGS, in Regatta of LAKE YACHT RACING ASSOCIATION.
 July 26, 1892—First, defeating WHITE WINGS.
 July 28, 1892—First, beating WHISTLEWING and CONDOR.
 Sept. 3, 1892—Third, ZELMA first, ORIOLE second, and VREDA fourth.

From this incomplete list we see that AGGIE has met and defeated VREDA, ZELMA, WHITE WINGS, CONDOR and WHISTLEWING.



W. J. GRANT.

W. J. GRANT, railway agent, Hamilton, Ont., was born in England. He is one of the owners of the keel cutter yacht PSYCHE, enrolled among the yachts of the ROYAL HAMILTON YACHT CLUB. Interested in yachting from early childhood, and the Captain of the ROYAL HAMILTON YACHT CLUB for 1893. He was connected with the organization of this club.

PSYCHE.

The cutter PSYCHE belongs to W. J. Grant and other members of the ROYAL HAMILTON YACHT CLUB. She was designed and built by C. P. Kinnhardt, and was launched in 1888. She hails from Hamilton, has a cabin, and sails with the ROYAL HAMILTON YACHT CLUB. See Fig. 307.

DIMENSIONS.	
Length over all,	44 feet.
Depth,	5 feet.
Beam,	15 feet.
Length load waterline,	32 feet.
Beam,	11 feet.



THOMAS W. LESTER.

THOMAS W. LESTER, real estate, Hamilton, Ont., was born in Indiana a "long time ago." He is of Irish ancestry. Has owned the yacht MARGUERITE and is a part owner of the cutter WHITE WINGS. Has been a yachtsman for many years, and is the Honorable Secretary of the ROYAL HAMILTON YACHT CLUB, of which he is one of the incorporators.

WHITE WINGS.

A centerboard cutter, owned by Thomas W. Lester, *et al.* of Hamilton, Ont. Her designer and

builder was Alex. Cuthbert. Her former owner was Emilius Jarvis, who sold her in 1890. Has never been altered. She sails with the ROYAL HAMILTON YACHT CLUB. See Fig. 308.

DIMENSIONS.

Length over all,	52 feet.	Length load waterline,	43 feet 5 inches.
Depth,	5 feet.	Draft,	5 feet.
Beam,	15 feet.		

Racing Record:—

WHITE WINGS has a record of 11 consecutive firsts on Lakes Ontario and Erie. Below are given some of the races in which she has sailed.

July 18, 1887—First, GARFIELD second; ROCHESTER Y. C.
 Aug. 4, 1887—Second, GARFIELD first; OSWEGO Y. C.
 July 20, 1888—First, winning prize of \$80, CYGNET second; L. Y. R. A.
 July 28, 1888—First, VERVE second; L. Y. R. A.
 Aug. 15, 1889—Second, VERVE first; L. Y. R. A.
 Aug. 27, 1889—First, winning \$60, VERVE second; OSWEGO Y. C.
 Aug. 25, 1890—First, VERVE second; OSWEGO Y. C.
 Aug. 30, 1890—First, CONDOR second; R. H. Y. C.
 July 1, 1891—Second, VREDA first; R. C. Y. C.
 July 16, 1891—Second, YAMA first; L. Y. R. A.
 July 20, 1891—Third (accident), beaten by YAMA and VERVE; L. Y. R. A.
 July 15, 1892—Third, with VREDA first and ORIOLE second; BAY OF QUINTE Y. C.
 July 18, 1892—First, AGGIE second; OSWEGO Y. C.
 July 22, 1892—Second, with AGGIE first; L. Y. R. A.

VERA.

A keel yacht, the property of Harry Lowrey, and sailing with the ROYAL HAMILTON YACHT CLUB. Length on waterline, 37.16 feet; corrected length, 41.23 feet. See Fig. 309.

VOLANTE.

A keel yacht, owned by George Webster. She is 26.75 feet on the waterline, and 29.85 feet corrected length. VOLANTE sails with the ROYAL HAMILTON YACHT CLUB.

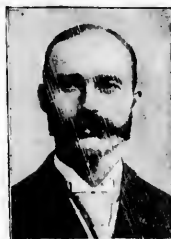

J. F. MÖNCK.

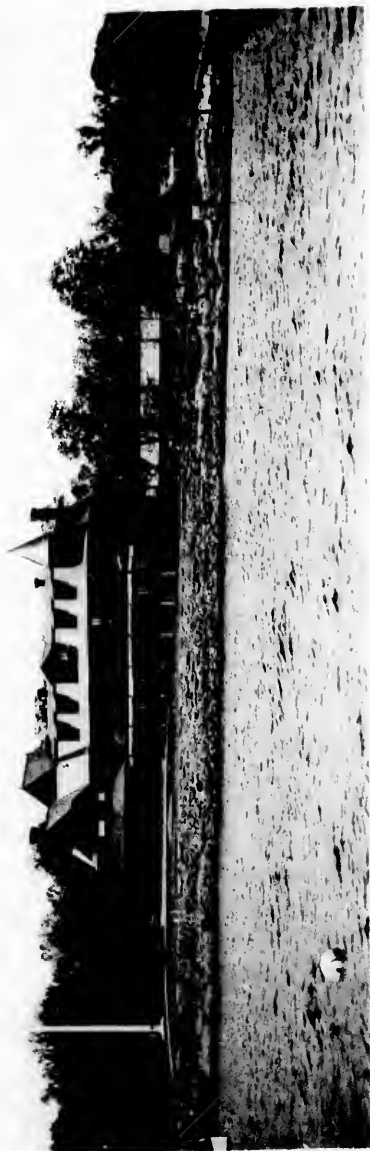

LARCHMONT YACHT CLUB HOUSE.

Announcement of the Larchmont Yacht Club.

The Larchmont Yacht Club, organized in 1881, has the honor to announce that it will hold its annual regatta on the 15th and 16th of August, 1900. The regatta will be held at the Larchmont Yacht Club, and will consist of a number of races in all classes of yachts. The prizes for the races will be as follows:—

For the 12-foot class, a silver cup, valued at \$100.00.
 For the 14-foot class, a silver cup, valued at \$100.00.
 For the 16-foot class, a silver cup, valued at \$100.00.
 For the 18-foot class, a silver cup, valued at \$100.00.
 For the 20-foot class, a silver cup, valued at \$100.00.
 For the 22-foot class, a silver cup, valued at \$100.00.
 For the 24-foot class, a silver cup, valued at \$100.00.
 For the 26-foot class, a silver cup, valued at \$100.00.
 For the 28-foot class, a silver cup, valued at \$100.00.
 For the 30-foot class, a silver cup, valued at \$100.00.



The Larchmont Yacht Club, organized in 1881, has the honor to announce that it will hold its annual regatta on the 15th and 16th of August, 1900. The regatta will be held at the Larchmont Yacht Club, and will consist of a number of races in all classes of yachts. The prizes for the races will be as follows:—

For the 12-foot class, a silver cup, valued at \$100.00.
 For the 14-foot class, a silver cup, valued at \$100.00.
 For the 16-foot class, a silver cup, valued at \$100.00.
 For the 18-foot class, a silver cup, valued at \$100.00.
 For the 20-foot class, a silver cup, valued at \$100.00.
 For the 22-foot class, a silver cup, valued at \$100.00.
 For the 24-foot class, a silver cup, valued at \$100.00.
 For the 26-foot class, a silver cup, valued at \$100.00.
 For the 28-foot class, a silver cup, valued at \$100.00.
 For the 30-foot class, a silver cup, valued at \$100.00.

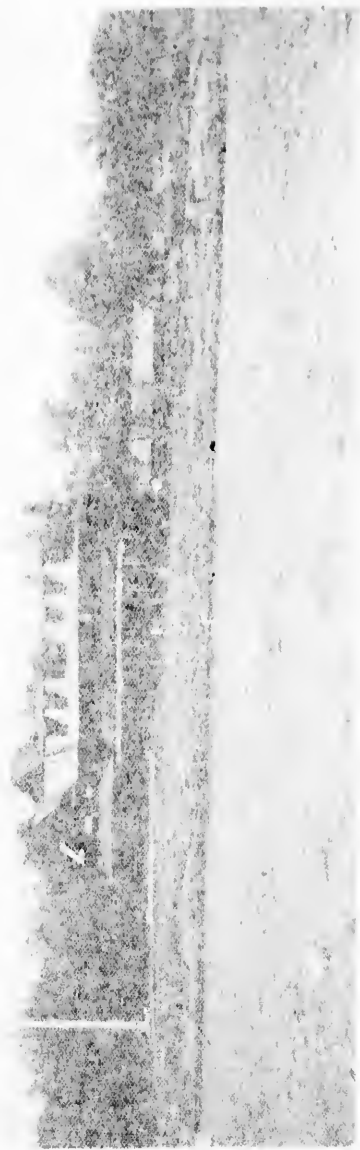

C
Wm.
Curtis
The
about
club.
a lease
This
Alley
tion
after
night
on the
The
called
from
an un
tional
bonds.
W
hours
ceived
for n
the
night
first
held
alrea
was f
the
Hon
were
ing,
repr
The
ly c
for
were
Con
Sec
A
enst
test
app
A
ber
(S
I
ren
ela
lea
de
ro

History of the Larchmont Yacht Club.

ON the 20th of June, 1880, several yachts could be seen lying at anchor in the "Horseshoe" off Larchmont Manor:—the cat-boat *VIVIN*, owned by Frank L. Anthony; the jib and mainsail thirty foot racer *CYTHIA*, owned by Wm. C. France, Jr.; *NYURN*, owned by Fred W. Flint, and *CRUISER*, owned by Wm. S. Alley.

The owners and friends of these yachts congregated on the shore about noon and after some informal talk agreed to organize a yacht club. Mr. Fred W. Flint was appointed a committee of one to secure a lease of the boat house built by the Larchmont Manor Company. This he succeeded in doing during the afternoon. Messrs. W. S. Alley and Eugene L. Bushe undertook the drafting of the Constitution and By-Laws, and after working most of the night had the same ready on the following day. The document prepared called for \$5 subscription from each member for annual dues and \$5 additional for the care of boats.

Within twenty-four hours the new club received fifty applications for membership, and on the following Saturday night, June 26th, the first regular meeting was held in the boat house already alluded to, which was formally set apart for the purpose of a Club House. Twelve members were present at the meeting, and seven others were represented "by proxy." The officers unanimously elected at this time for the remainder of 1880 were, F. C. Fleming, Commodore; W. C. France, Jr., Vice-Commodore; Fred W. Flint, Secretary and Treasurer; W. S. Alley, Measurer.

At this meeting it was decided to hold a Regatta on the 5th of the ensuing July, for a pennant offered as a prize by Mr. Alley, to be contested by jib and mainsail yachts and cat-boats, and a committee was appointed to make suitable arrangements for the event.

At the meeting held July 3d of the same year, fifteen new members were elected. The First Annual Regatta was sailed July 5, 1880. (See Record of Races.)

In 1881 the initiation fee was raised to \$10, the annual dues remaining \$5, and \$5 extra for boat owners. Not quite two years elapsed before the Club House proved too small, the result being the leasing of a house and grounds from the Flotaing estate, which bordered on the harbor. The house had eight dormitories, a dining room and other conveniences. This was acquired for \$1,500 an-

nuual rental, one-half of which the Larchmont Manor Company agreed to pay.

In another two years this prosperous and favorite club had outgrown its belongings and surroundings, and on May 1, 1884, moved into a private residence obtained from Mr. C. D. Shepard on a five year lease at \$5,000 annual rental. The property consisted of three or four acres of land and had upon it two dwelling houses and a stable, which latter was at once fitted up as a billiard room, with servants' sleeping rooms above it.

Owing to the brilliant series of regattas given by the club, and its liberal policy and hospitality, the membership was rapidly increased. In November, 1887 the club again found it necessary to increase

its quarters, and purchased from Mr. Benjamin F. Carver the beautiful site it now has, for the sum of \$400,000. The purchase money was raised by subscription to bonds, Mr. Carver taking \$25,000 of bonds at par in part payment. The title was passed on April 30, 1887, and in the Fall the club took possession and commenced such alterations as were necessary. The property consisted of nearly eleven acres on which Mr. Carver had erected a very attractive and commodious house which commanded an extended view of the Sound. Thirty thousand dollars were appropriated from the treasury for the improvements and alterations, which were conducted under the personal supervision of a board of

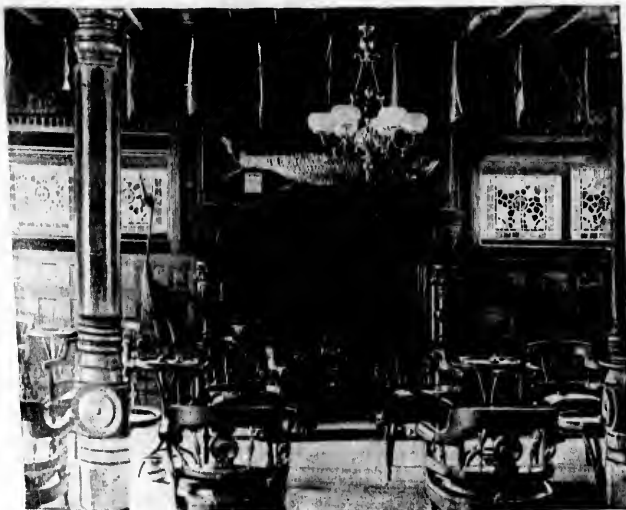

INTERIOR OF HALL IN LARCHMONT YACHT CLUB.—FIGURE 311.

trustees composed of Messrs. Augustin Monroe, Francis M. Scott, William Murray, Eugene L. Bushe and William S. Alley, with Commodore G. C. Lowery as ex-officio member of the board. Since that time over \$50,000 additional has been spent, making the total cost of the Club House and grounds very near \$200,000.

From the illustration a very good idea of the Club House can be obtained. It is situated on a prominent site commanding a most beautiful view. The interior of the Club House is artistically decorated, and every conceivable convenience for the comfort of yachtsmen is provided.

The close proximity of the club to New York lends another attractive feature and enables the yachtsman to go back and forth from the city after enjoying a delightful sail on his yacht, the distance being 18 miles and regular fare only 40 cents each way, and by commuting very much less.



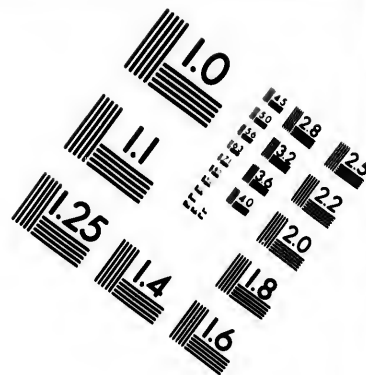
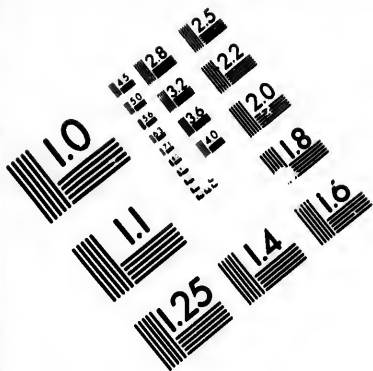

**IMAGE EVALUATION
TEST TARGET (MT-3)**

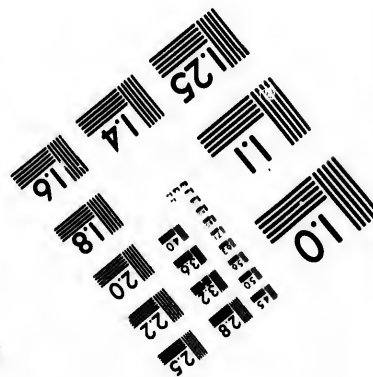
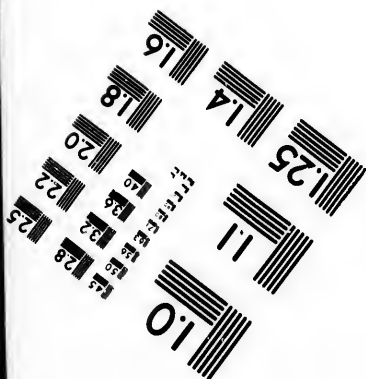
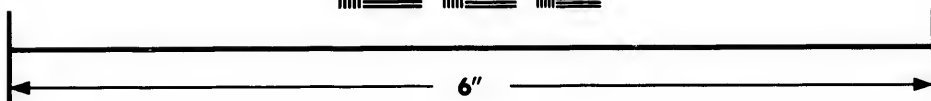
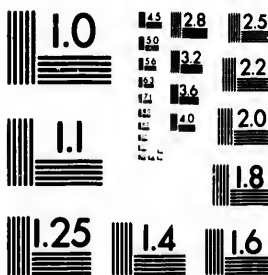

**Photographic
Sciences
Corporation**

23 WEST MAIN STREET
WEBSTER, N.Y. 14580
(716) 872-4503

14
15
16
17
18
19
20
22
25

10
11
12
13
14
15
16
17
18
19
20

Larchmont Harbor was formerly known as Delancy Cove. On the left is Flagler's Point and on the right Fleming Point. From the Café on a clear day can be seen Eaton's Neck Lighthouse, eighteen miles away toward the eastward and the Execution Light toward the westward, the latter being adopted as the great seal of the club. The float is situated directly in front of the Club House, there being eight feet of water, and a few hundred yards from it is a simple anchorage for all but the very largest yachts which anchor a little further out.

The Opening Day of the yachting season is fixed for the first Saturday of May, and the Spring Regatta takes place the first Saturday in June, the Annual Regatta being held on the Fourth of July. The Fall Regatta is sailed on the first Saturday in September, and on the Saturday next preceding October 15th, the great annual clambake brings the season to a close.

The officers for 1892 were as follows:

Commodore,	Caldwell H. Colt,	Secretary,	Chas. C. Little.
Vice-Commodore,	Joseph H. Sterling,	Treasurer,	Wm. Murray.
Rear-Commodore,	Edward J. Greenen,	Measurer,	John Hyslop.
Fleet Surgeon,	Wm. E. Bullard.		

The officers for 1893 were as follows:

Commodore,	Caldwell H. Colt,	Secretary,	Chas. C. Little.
Vice-Commodore,	Harold A. Sanderson,	Treasurer,	Wm. Murray.
Rear-Commodore,	George Work,	Measurer,	John Hyslop.
Fleet Surgeon,	Wm. E. Bullard, M. D.		

ACCORDING TO THE RULES AND REGULATIONS.

RULE I.

1. The following rules shall govern all the races of the club and any race sailed under its auspices, unless otherwise specified, by the parties sailing the race.
2. The rules shall apply to all yachts sailing in a race, whether in the same or in different classes.
3. All yachts belonging to the club, not sailing in a race, shall keep out of the way of yachts in the race, and to leeward of them.
4. Yachts entered in a race shall be amenable to these rules from the time the preparatory signal is made.
5. The decision of the Regatta Committee shall be final (Constitution, Art. 5, Sec. 2).

RULE II. — CLASSIFICATION.

1. Cabin yachts shall be classed according to the racing length, and open yachts according to their actual load waterline length.

SCHOONERS.

2. Class A. All over 90 feet, racing length.
- Class B. All over 81 feet and not over 90 feet, racing length.
- Class C. All over 71 feet and not over 81 feet, racing length.
- Class D. All over 60 feet and not over 71 feet, racing length.
- Class E. All of 60 feet, racing length, and under.

SLOOPS, CUTTERS AND YAWLS.

3. Class 1. All over 77 feet, racing length.
- Class 2. All over 69 feet and not over 77 feet, racing length.
- Class 3. All over 60 feet and not over 69 feet, racing length.
- Class 4. All over 55 feet and not over 60 feet, racing length.
- Class 5. All over 49 feet and not over 55 feet, racing length.
- Class 6. All over 43 feet and not over 49 feet, racing length.
- Class 7. All over 36 feet and not over 43 feet, racing length.
- Class 8. All over 30 feet and not over 36 feet, racing length.
- Class 9. All over 25 feet and not over 30 feet, racing length.
- Class 10. All of 25 feet and under.
- Class 11. All mainsail cabin yachts of 25 feet, racing length.
- Class 12. All mainsail cabin yachts of 25 feet and under.

OPEN YACHTS.

4. Class 13. All mainsail yachts over 23 feet, load waterline length.
 - Class 14. All mainsail yachts 20 feet and not over 23 feet, load waterline.
 - Class 15. All mainsail yachts of 20 feet and under.
 - Class 16. All jib and mainsail yachts over 23 feet.
 - Class 17. All jib and mainsail yachts 23 feet and under.
- The Regatta Committee, with the approval of the Commodore, may establish special classes for any regatta.

RULE III. — ALLOWANCE FOR RIG.

In mixed rig races, schooners shall be rated at eighty-five per cent. of their racing length, and yawls at ninety-three per cent. of their racing length, as hereinafter defined, both for classification and time allowance.

RULE IV. — MEASUREMENT.

Yachts shall be measured and rated for time allowance and classification, according to the following method:

To the square root of the sail area, add the load waterline length and divide the sum by two.

$$\frac{\sqrt{S A} + L W L}{2} = R. L.$$

The result is the measurement for time allowance, and shall be known as racing length.

The measurements shall be obtained as follows:

A base line shall be taken from a point midway between the jib topsail stay and the jib stay on the bowsprit, or between the flying

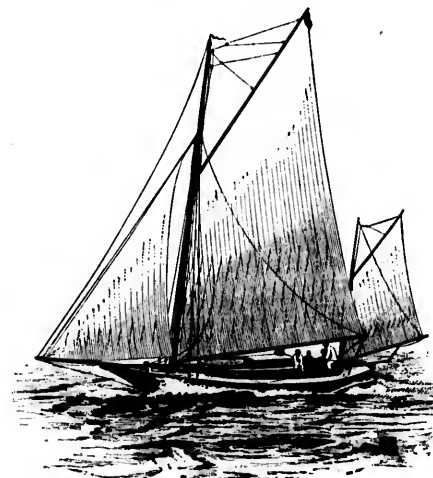

KWASIND.—FIGURE 312.

jib stay and jib topsail stay on the jibboom, in a straight line to the end of the mainboom. To this measure shall be added that length of main gaff which will remain after 80 per cent. of the topmast has been subtracted from it. The gaff, for this purpose, shall be measured from the after side of mast to the end, and the topmast from hounds to the lower side of sheave in topsail halliard block. The length of base line as above defined shall be modified in any case where the spinnaker boom measures more than the distance from the fore-side of foremast in a schooner, or mainmast in a single-masted

vessel, to the forward point of base line as previously defined. Any excess in the length of spinnaker boom beyond this point shall be added to the base line. The length to be measured for spinnaker boom shall be the extreme distance, when in use, of its outer end from the center of the fore side of the mast on which it is carried.

For yawls the base line shall be taken from the same point forward as in vessels of other rig, to the after end of the mizzen boom.

A perpendicular line to be taken along the after side of the mainmast from the under side of the sheave for gaff topsail halliard to

stationed amidships. The Measurer, at the time of making his measurement, to fix a distinctive mark at each point. In boats which carry no head sail, the forward point of measurement for the base line shall be the after side of the mast, or of the foremast if there shall be more than one mast.

In vessels which carry no topmasts, the upper point of measurement for the perpendicular shall be the center of the eye in the upper peak halliard band. In such vessels, for the purpose of measuring the base line, the distance between the center of the eye in the throat halliard band and that of the upper peak halliard shall be used

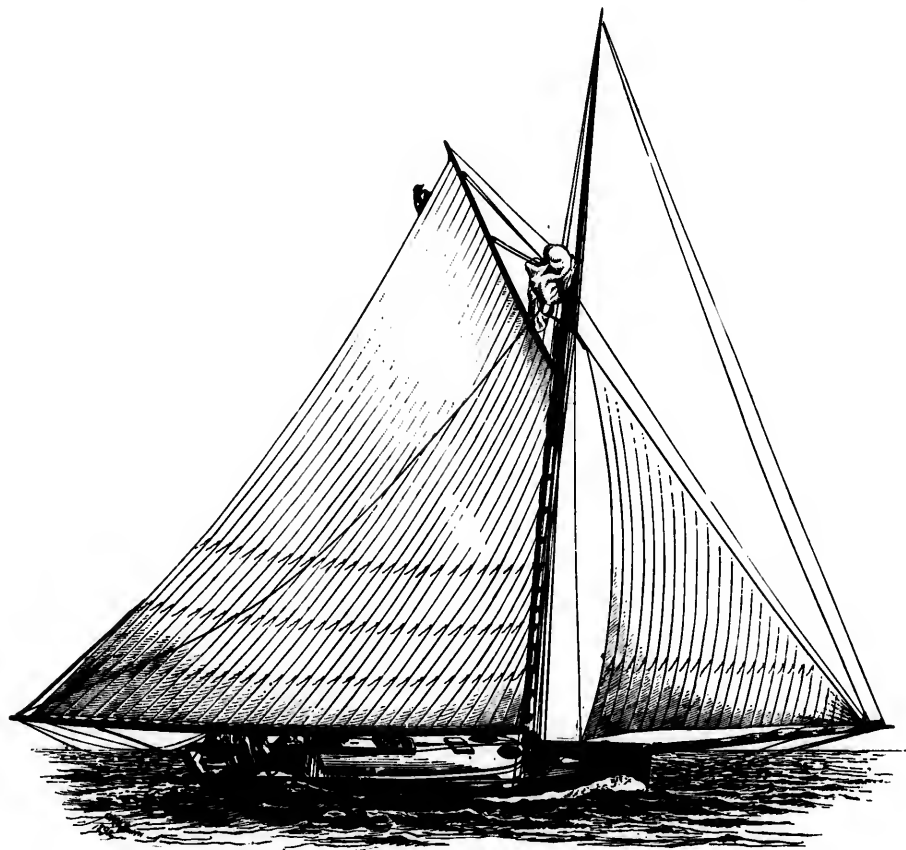

SCHEMER.—FIGURE 313.

the upper side of boom when resting on the saddle, or on the lowest part of goose-neck, the distance of which point from main deck or house-deck shall be recorded by the Measurer, together with the other points used in measurements.

To obtain the estimated area from these figures, multiply the base by the perpendicular and divide the product by two.

Length is the length on the load waterline, exclusive of any portion of the rudder or rudder-stock, and is to be ascertained when the yacht is afloat and in her ordinary trim, and with the crew, if aboard,

in the same way as is the length of the topmast, where one is carried.

Any change in these measurements shall be reported by the owners to the Measurer.

RULES AND FEES FOR MEASURING.

The owner of the yacht to be measured shall notify the Measurer, in writing, specifying the time and place where the yacht will be, such time to be not less than twenty-four hours after the delivery of the notice, and such place to be Larchmont Harbor, or some convenient part of New York Harbor.

The Measurer's fees shall be as follows: For each open yacht and each yacht of less than thirty feet in length in the load waterline, five dollars; and for all other yachts ten dollars each. These fees shall be paid by the Treasurer, and collected by him from the owner or owners of the yacht so measured.

The Measurer will make out a certificate in duplicate and will deliver both copies thereof to the Treasurer of the club, who shall deliver one to the Chairman of the Regatta Committee and shall send the other to the owner of the yacht so measured, with a bill for the amount of the Measurer's fee.

In the case of yachts entering from another club, the Regatta

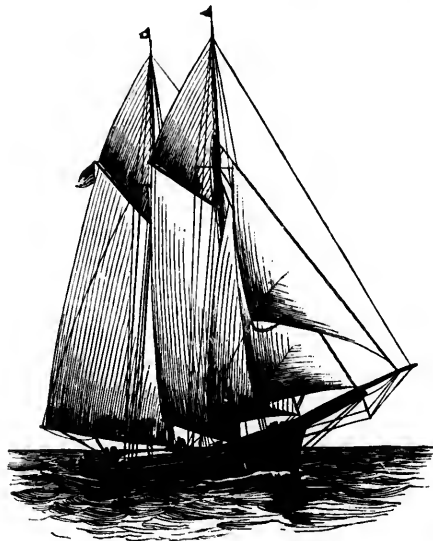

ALTAMA.—FIGURE 314.

Committee will accept a certificate of measurement signed by the official Measurer of the club from which said yacht may be entered, reserving the right, however, in all cases, with or without protest, to require such yacht to be remeasured by the Measurer of the LARCHMONT YACHT CLUB, in which case the owner of the yacht so remeasured will be required to pay the Measurer's fee.

Any yacht whose owner shall refuse to submit to such remeasurement, or shall refuse or neglect to pay the established fee therefor, shall thereafter be debarred from participating in the races and regattas of the club, unless such disqualifications shall be removed by the Regatta Committee.

PROTEST AGAINST MEASUREMENT.

If a protest shall be made relative to the measurement of any yacht which has been measured by the Measurer of this club, such yacht shall be remeasured by the Measurer, under the direction of the Regatta Committee, and the result as reported by him shall be final.

The fee for remeasurement shall be paid by the party protesting if the original measurement be confirmed, and by the owner, if the original measurement be found to be incorrect.

TIME ALLOWANCE.

Time allowance shall be calculated upon the racing length according to the table of allowances of the club, which is calculated at 60 per cent. of the theoretical allowance, based upon the principle that opportunities for speed vary as do the square roots of the lengths of

vessels of different sizes, and yachts shall be rated for difference of measurement accordingly.

Any yacht alone in her class may sail in the class next above, but in such cases the yacht shall assume and be entered as of the minimum racing length specified for the class in which she so enters, if a cabin yacht, and of the minimum load waterline length of such class, if an open yacht; but this shall not be construed as to permit a sloop, cutter or yawl to enter in a schooner class, nor any open yacht to enter in a class with cabin yachts.

FILING CERTIFICATE.

The owner of every winning yacht, except in classes A and B of schooners, and 1 and 2 of sloops, shall, within twenty-four hours of the finish of the regatta, and before the awarding of the prize, file with the Regatta Committee the names, occupations and addresses of his crew, and his certificate that they are amateurs. The owner of every winning yacht in Classes A and B of schooners, and 1 and 2 of sloops, cutters and yawls shall sign declaration that all rules have been complied with.

SPECIAL RACES.

All special races sailed under the auspices of the club shall be under the direction of the Regatta Committee, and shall be governed by the rules and regulations applicable to regattas, unless otherwise expressly provided.

ENTRIES.

All entries shall be made in writing and signed by the owner or his representative, giving name of yacht, rig and racing length, calculated according to the foregoing rule for measurement of a cabin yacht, and the actual load waterline length of an open yacht, which measurement shall be verified by the Measurer of the club before any prize shall be awarded to such yacht: and all such entries must be

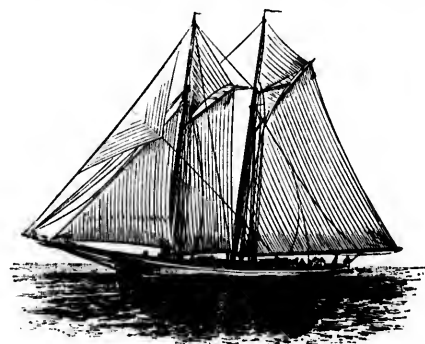

AZALEA.—FIGURE 315.

lodged with the Regatta Committee at Larchmont, not later than thirty-six hours previous to the time of starting, exclusive of Sundays, unless otherwise ordered by said Committee.

The Regatta Committee may refuse any entry, or may except any entry made after the time of closing. They may, with or without protest, disqualify any yacht, should it come to their knowledge that she has committed a breach of the rules.

At all regattas the flag officers and Regatta Committee may invite entries from such other yacht clubs as they may deem advisable.

A yacht owned wholly or in part by a member of the Regatta Committee shall not be entered for any regatta of the club.

No member or owner shall be interested in more than one yacht in any one class, except in the case of a member who has chartered his

rated for difference of
the class next above, but
entered as of the mini-
-which she so enters, if a
-line length of such class,
-ed as to permit a sloop,
-nor any open yacht to

in classes A and B of
n twenty-four hours of
g of the prize, file with
us and addresses of his
rs. The owner of every
s, and 1 and 2 of sloops,
all rules have been com-

the club shall be under
shall be governed by the
less otherwise expressly

igned by the owner or
nd racing length, calcula-
-measurement of a cabin
of an open yacht, which
r of the club before any
ll such entries must be



mount, not later than
ing, exclusive of Sun-
ttee.

try, or may except any
may, with or without
o their knowledge that

gatta Committee may
they may deem advisa-

member of the Regatta
a of the club.

n more than one yacht
r who has chartered his

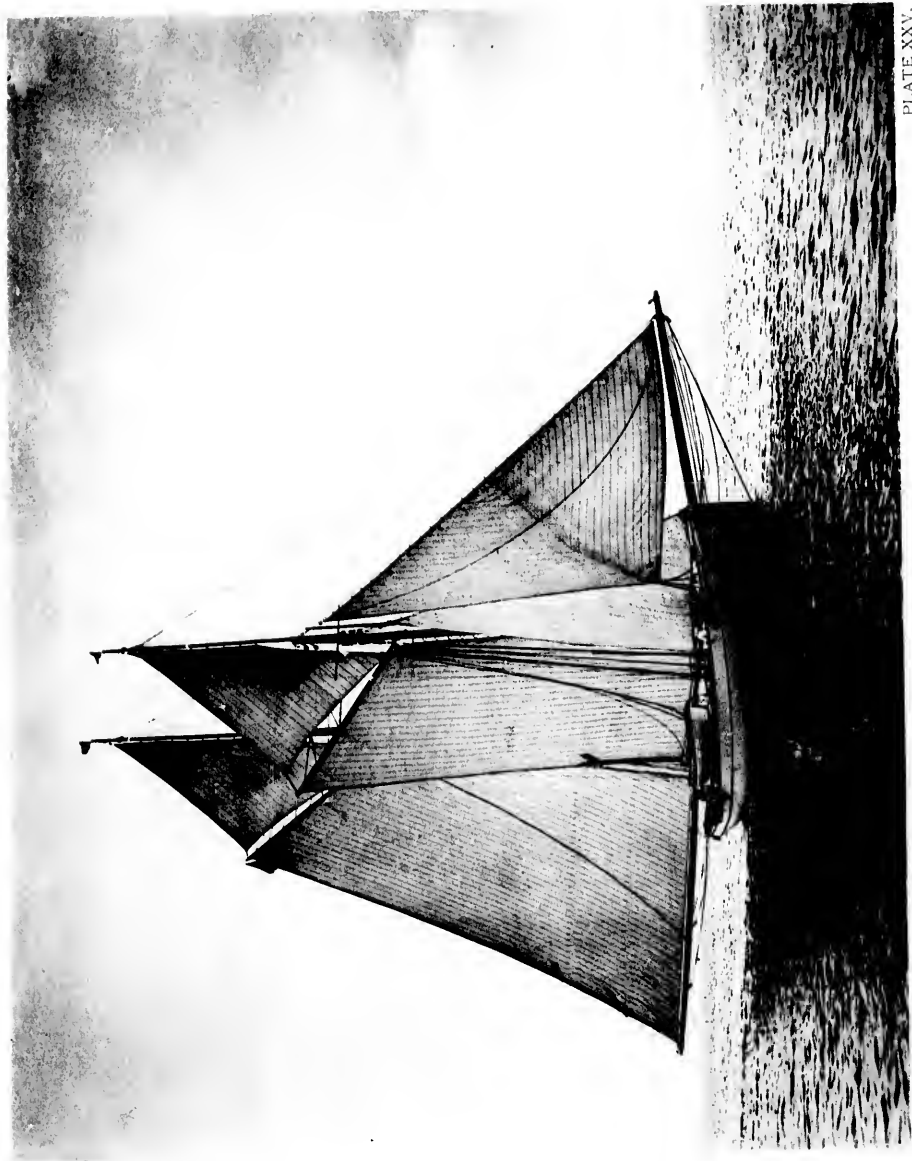

PLATE XXV.

GRAYLING.

From the north end of the island of Larchmont, ...

... bearing north by east 1/2 east, 1/2 mile ...

... bearing north by east 1/2 east, 1/2 mile ...



... bearing north by east 1/2 east, 1/2 mile ...

... bearing north by east 1/2 east, 1/2 mile ...

... bearing north by east 1/2 east, 1/2 mile ...

... bearing north by east 1/2 east, 1/2 mile ...

... bearing north by east 1/2 east, 1/2 mile ...

... bearing north by east 1/2 east, 1/2 mile ...

... bearing north by east 1/2 east, 1/2 mile ...



... bearing north by east 1/2 east, 1/2 mile ...

... bearing north by east 1/2 east, 1/2 mile ...

Larchmont,

Notch Caps
around the
h 1/4 west;

Hemp-
Point
bears
to and
by east
of the
y west
across

of Baton's
same
west, 1/4
south;

From the north end of the island of Larchmont, ...

From Larchmont to and around a stake boat ...

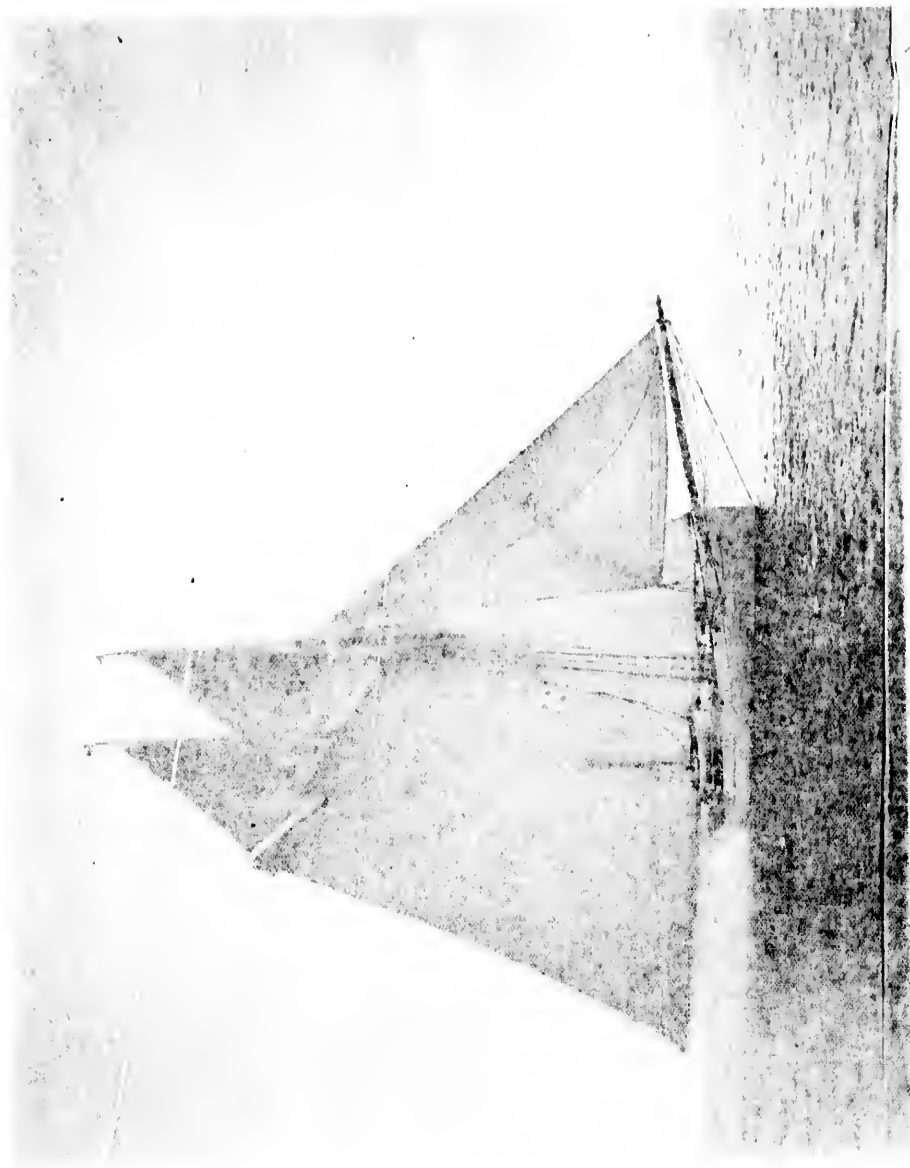

yacht for not less than thirty days to another member of the club, or any club invited to participate in the race.

WALK-OVER PRIZE.

At least two yachts must start in any one class to entitle a yacht to a prize of the full value. Should a yacht be obliged to sail alone in her class, and shall go over the course of her class, she shall be entitled to a prize of one-half the value of the regular prize, and upon same shall be inscribed "Walk-over Prize."

BOATS AND LIFE-BUOYS.

All schooners, and classes 1, 2, 3 and 4 of sloops, cutters and yawls, shall carry on deck a serviceable round-bottom boat, with oars and row-locks or tholepins lashed in, not less than 14 feet in length, except classes 3 and 4, which shall carry a boat as above not less than 12 feet in length.

All yachts shall carry on deck two serviceable cork-ring life buoys, at least 22 inches in diameter.

COURSES.

Courses Nos. 1, 2, 3 and 4 shall be sailed by the respective classes in all the regattas of this club. In Special or Match Races the Regatta Committee may select any of the following courses such selection being sent to each yacht with the notice of the race.

Course No. 1:—For Classes A, B, C, 1, 2, 3 and 4:

From Larchmont to and around a stake boat anchored in Hempstead Harbor, $2\frac{1}{2}$ nautical miles (course south southeast; from stake boat Sands' Point Lighthouse, bears west by south, and Execution Lighthouse, bears west by north $\frac{1}{4}$ north), leaving same on port hand; thence to and around a stake boat anchored $\frac{1}{2}$ of a mile west by south from Stamford Harbor Lighthouse (course northeast $\frac{1}{4}$ east), passing same on port hand; thence to and around the stake boat in Hempstead Harbor (course southwest $\frac{1}{4}$ west), passing same on starboard hand; thence to and across the finishing line at Larchmont (course north, northwest).

Distance, 27 nautical miles.

Course No. 2:—For Classes D, E, 5, 6, 7, 8 and 9:

From Larchmont to and around a stake boat anchored in Hempstead Harbor (course south southeast; from stake boat Sands' Point

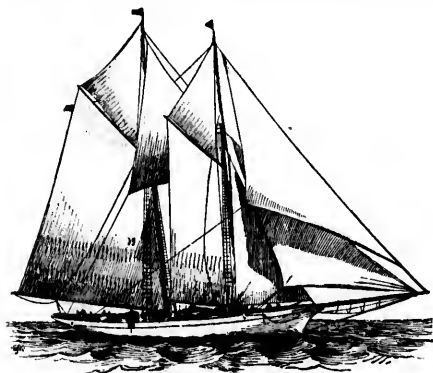

VIATOR.—FIGURE 316.

Lighthouse, bears west by south, and Execution Lighthouse, bears west by north $\frac{1}{4}$ north), passing same on the port hand; thence to and around a stake boat anchored $\frac{1}{2}$ mile southwest, $\frac{1}{4}$ south of Captains' Island Lighthouse (course northeast $\frac{1}{4}$ north), passing same on the port hand; thence to and around the stake boat anchored in Hempstead Harbor (course southwest $\frac{1}{4}$ south), passing same on the

starboard hand; thence to and across the finishing line at Larchmont, (course north northwest).

Distance, 20 nautical miles.

Course No. 3:—For Classes 13, 14, 15, 16 and 17:

From Larchmont to and around the Red Spar Buoy on Scotch Caps Reef, leaving it on the starboard hand; thence to and around the stake boat anchored in Hempstead Harbor (course south $\frac{1}{4}$ west;

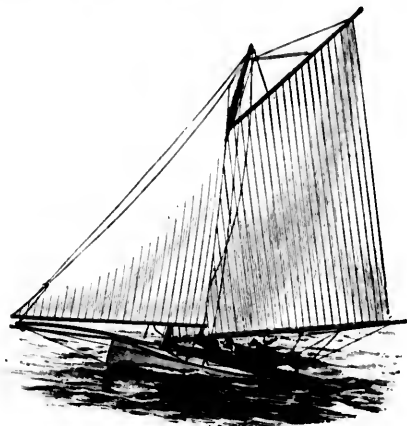

COVOTE.—FIGURE 317.

from stake boat Sands' Point Lighthouse, bears west by south, and Execution Lighthouse, bears west by north $\frac{1}{4}$ north), passing it on the starboard hand; thence to and around the Red Spar Buoy on Scotch Caps' Reef (course north $\frac{1}{4}$ east), thence to and across the finishing line at Larchmont.

Distance, 10 nautical miles.

Course No. 4:—For Classes 10, 11 and 12:

From Larchmont to and around a stake boat anchored in Hempstead Harbor (course south southeast; from stake boat Sands' Point Lighthouse, bears west by south, and Execution Lighthouse, bears west by north $\frac{1}{4}$ north), passing same on port hand; thence to and around the Black Spar Buoy off Matinecock Point (course east by east $\frac{1}{4}$ east), passing same on the port hand; thence to and around the stake boat anchored in Hempstead Harbor (course southwest by west $\frac{1}{4}$ west), passing same on the starboard hand; thence to and across the finishing line at Larchmont (north northwest)

Distance, 13 nautical miles.

Course No. 5:

From Larchmont to and around a stake boat anchored off Eaton's Neck Buoy (course east $\frac{1}{4}$ north, $15\frac{1}{2}$ nautical miles), leaving same on the port hand; thence returning direct to finish (course west, $\frac{1}{4}$ south).

Total distance, $31\frac{1}{2}$ miles,

Course No. 6:

From Larchmont to and around a stake boat anchored $\frac{1}{2}$ of a mile south by west from Stamford Lighthouse (course east northeast $\frac{1}{4}$ north, $9\frac{1}{2}$ nautical miles), leaving same on starboard hand; thence to and around a stake boat anchored off Eaton's Neck Buoy (course east southeast, 7 nautical miles) leaving same on the starboard hand; thence returning direct to finish (course west $\frac{1}{4}$ south, $15\frac{1}{2}$ nautical miles). Total distance, $32\frac{1}{2}$ nautical miles.

Course No. 7:

From Larchmont to and around a stake boat anchored $\frac{1}{2}$ a mile south by west from Sheffield Island Lighthouse (course east northeast

$\frac{1}{2}$ east, $15\frac{1}{2}$ nautical miles), leaving same on starboard hand; thence to and around a stake boat anchored off Eaton's Neck Buoy (course south $\frac{1}{2}$ east, $4\frac{1}{2}$ nautical miles), leaving same on the starboard hand; thence returning direct to finish (course west $\frac{1}{2}$ south, $15\frac{1}{2}$ nautical miles). Total distance, $35\frac{1}{2}$ nautical miles.

Course No. 8:

From Larchmont to and around a stakeboat anchored half a mile south by west, from Sheffield Island Lighthouse (course east north-east $\frac{1}{2}$ east, $15\frac{1}{2}$ nautical miles) leaving same on starboard hand; thence to and around a stake boat anchored in Hempstead Harbor (course southwest by south $\frac{1}{2}$ west, 16 nautical miles: from stakeboat Sands' Point Lighthouse, bears west by south, and Execution Lighthouse, bears west by north $\frac{1}{2}$ north); thence direct to finish (course north northwest $\frac{1}{2}$ north, $2\frac{1}{2}$ nautical miles). Total distance, $34\frac{1}{2}$ nautical miles.

Course No. 9:

From Larchmont to and around a stake boat anchored off Eaton's Neck Buoy (course east $\frac{1}{2}$ north, $15\frac{1}{2}$ nautical miles), leaving same on port hand; thence to and around a stake boat anchored $\frac{1}{4}$ of a mile



FAUNA.—FIGURE 318.

south by west from Stamford Lighthouse (course west northwest, 7 nautical miles), leaving same on port hand; thence direct to finish (course west southwest $\frac{1}{2}$ south, $9\frac{1}{2}$ nautical miles). Total distance, $32\frac{1}{2}$ miles.

Course No. 10:

From Larchmont to and around a stake boat anchored off Eaton's Neck Buoy (course east $\frac{1}{4}$ north, $15\frac{1}{2}$ nautical miles), leaving same on port hand; thence to and around a stake boat anchored $\frac{1}{4}$ of a mile west by south, from Stamford Lighthouse (course west northwest, 7 nautical miles), leaving same on port hand; thence to and around a stake boat anchored in Hempstead Harbor (course southwest $\frac{1}{2}$ west, $10\frac{1}{2}$ nautical miles; from stake boat Sands' Point Lighthouse, bears west by south, and Execution Lighthouse, bears west by north $\frac{1}{2}$ north), leaving it on starboard hand; thence direct to finish (course

north northwest $\frac{1}{4}$ north, $2\frac{1}{2}$ nautical miles). Total distance, $35\frac{1}{2}$ miles.

All courses and bearings are magnetic.

All stake boats will carry at the masthead a large blue and white striped ball.

Competing yachts must not pass between either of the Buoys on Hen and Chickens' reef, nor to the northward of the Scotch Caps Buoy for either course. The restriction regarding Scotch Caps Buoy does not apply to yachts sailing Course No. 3.

At night the stake boats will carry two red lights, one above the other, and at intervals will burn the night signal of the club, showing blue-red-blue in succession.

Should any stake boat be removed from its proper position, either by accident or design, then the Judge's steamer will, during the day, anchor a raft flying the club flag; and, if at night, the Judge's steamer will act as the turning mark, and show the two red lights, one above the other; but should it be impossible for the Judge's steamer to arrive at turning point in time to act, then the Regatta Committee may at their option order the race re-sailed.

SAILS.

The carrying of sails in regattas, except in Classes A and B of schooners, and Classes 1 and 2 of sloops, is restricted as follows:

Schooners.—Mainsail, a working maintopsail, maintopmast staysail, foresail, a working foretopsail, a forestaysail, jib, flying jib, jib topsail, spinnaker.

Cabin Sloops, Cutters and Yawls.—Mainsail, working maintopsail, forestaysail, jib, flying jib, jib topsail and spinnaker; and on yawls, a mizzen and mizzen staysail.

No extra spurs, booming out or whisker poles, excepting a spinnaker boom, shall be used in any of the above classes.

Open Jib and Mainsail Yachts.—Jib and mainsail.

Open Mainsail Yachts.—Mainsail.

A working main or foretopsail must be jib headed, and must not extend above the truck nor beyond the end of the gaff, but yachts in Classes 8, 9 and 10 may carry the topsail ordinarily used by them when cruising or sailing for pleasure, provided it does not extend beyond the end of the gaff.

A spinnaker must be triangular, and must not extend above the truck.

No two sails of the same name shall be set at the same time by any yacht, but any cabin yacht can set in the place of any sail a balloon sail of the same name.

All open yachts must keep their bowsprits down and in place, and the tacks of their jibs fast.

In Classes A and B of schooners, and Classes 1 and 2 of sloops, there shall be no restrictions whatever as to sails.

PRIVATE SIGNAL AND NUMBER.

Each yacht shall carry her *private* signal at the main peak and display her number, which will be furnished by the Committee, on both sides of the mainsail above the reef points, and must be returned to the Regatta Committee after the race.

CREWS.

Except in Classes A and B of schooners, and Classes 1 and 2 of sloops, in which there shall be no restrictions as to sailing muster, helmsman or crew, all yachts must be manned by amateurs exclusively, but any cabin yacht may carry and use her regular crew in any regatta.

All cabin yachts may carry, in addition to the Captain, one man for every five feet of length over all or fraction thereof. All open yachts may carry, in addition to the Captain, one man to every three feet of length over all or fraction thereof.

In all regattas each yacht must be steered by the owner or other amateur, except in Classes A and B of schooners, and Classes 1 and 2 of sloops.

In any Special Race the Regatta Committee shall have power to remove any and all restrictions as to crew, helmsmen and sails, but notice of same must be printed on notice of the race.

FITTINGS, BULKHEADS, BALLAST, ETC.

After the preparatory signal no ballast shall be taken on board or out of any yacht; nor shall any water be started from or taken into the tanks or other receptacles for the same on such yacht.

All ceilings and bulkheads on cabin yachts must be kept on board and in their places.

No ballast or article of weight shall be shifted on any cabin yacht.

No booming out of ballast will be allowed, and each yacht must bring back the same persons with whom it started.

RACE POSTPONED OR RESAILED.

No new entries shall be received for a race postponed or resailed. Should, however, any yacht duly entered not start—or having started withdraw, such yachts shall, in the event of the race being postponed or resailed, be entitled to start; but no new entry shall be received under any circumstances for such regatta, and no yacht disqualified in such regatta shall be entitled to start in case the same shall be re-sailed.

TIME OF RACE LIMITED.

No race in any class shall be considered made unless finished by one of the yachts in that class before one-half an hour after the time of sunset, as given in the table in the Annual Club Book, except when it is specified in the notice of race that there shall be no limit to the time in which the race shall be sailed.

Should any race not be made within the time specified, the Regatta Committee shall order the race resailed, fixing date and giving proper notice of same.

POSTPONEMENT OF RACES.

The Regatta Committee shall have power to postpone any race, should unfavorable weather, accident or other circumstance render such a course desirable.

NUMBER AND INSTRUCTIONS.

Each yacht entered for a race shall apply at the Club House on or before 9 A. M. of the morning of the race for numbers and instructions as to the course to be sailed, etc.

START AND FINISH.

All starts shall be flying.

The time at the start and finish shall be taken when the point marked by the foremast in schooners and the mainmast in single-masted vessels and yawls, crosses the line.

If this point in any yacht be across the line when the signal for starting is given, she must return and recross the line.

A yacht so returning, or one working into position from the wrong side of the line after the signal for starting is given, must keep clear of and give way to all competing yachts.

The starting and finishing line shall be an imaginary one, and drawn between two stake boats, each carrying at the masthead a large blue and white striped ball, anchored off the mouth of Larchmont Harbor. At night the northeasterly stake boat will carry one red light, and the southwesterly stake boat two red lights, one above the other; the latter will also at intervals show the Club Night Signal—blue, red and blue.

A competent person appointed by the Committee shall be placed on a stake boat at the finishing line, who shall time the yachts in the absence of the Regatta Committee, and this time shall be considered final.

The Regatta Committee will start all schooners, and Classes 1, 2 and 3 of sloops, cutters and yawls, before the other classes.

The first set of starting signals will be for schooners and Classes 1, 2 and 3 of sloops, cutters and yawls only.

The second set of starting signals will be for all other classes. The preparatory signal will be given five minutes after the "elapsed time" signal for schooners and Classes 1, 2 and 3 of sloops, cutters and yawls.

The signals for the start shall be:

A red rectangular flag with a white square in the center displayed from the forward flagstaff of the Regatta Committee's steamer, as a signal for all yachts to approach the starting line. This will remain hoisted for five minutes.

A large white ball substituted for the red flag, as a signal for all yachts to start. This will remain hoisted for ten minutes.

The club flag substituted for the white ball, as a signal that the time for crossing the line has elapsed. This will be left flying.

Attention shall be called to each of these signals by a blast of the steam whistle of Judge's steamer.

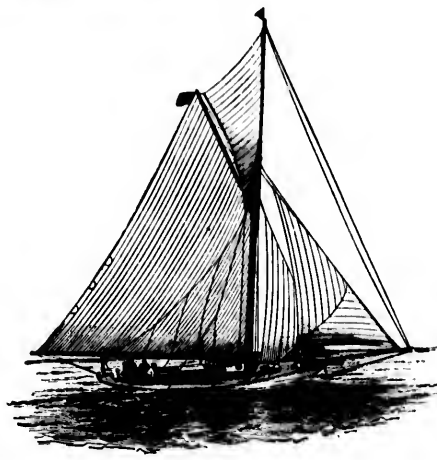

MARJORIE.—FIGURE 319.

All yachts must cross the starting line during the time the White Ball is hoisted, and any yacht that does not do so within that time shall be timed from the lowering of the White Ball.

In case the whistle should not work, the hoisting of the signals shall be deemed sufficient notice.

LIGHTS AND FOG SIGNALS.

The United States Government regulations regarding lights and fog signals shall be observed.

PROPULSION.

No means of propulsion other than sails shall be employed.

ANCHORING, ETC.

A yacht may anchor, but must weigh her anchor again and not slip. A yacht shall not warp or kedge or make fast to a buoy, pier, vessel or other object, except as provided in Section 4.

RUNNING AGROUND OR FOULING.

A yacht running aground or fouling a buoy, pier, vessel or other object, may use her anchors, warps, boats, etc., to get clear, but may not receive any assistance except from the crew of the vessel fouled.

Any anchor, warp or boat so used must be taken on board again before continuing the race.

SOUNDING.

No other means of sounding than the hand lead and line shall be employed during the race.

MAN OVERBOARD AND ACCIDENTS.

In case of accident to another vessel, or of a man falling overboard from another vessel, yachts in position to render assistance shall do so; and if, in the judgment of the Regatta Committee, a

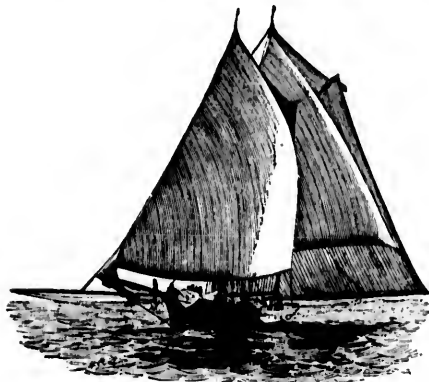

INOQUIS.—FIGURE 330.

yacht was thereby prevented from winning the race, they may order it to be resailed between such yacht or yachts and the winner.

RIGHT OF WAY.

When one yacht is approaching another yacht, so as to involve risk of fouling, one of them shall keep clear of the other as follows:

ON DIFFERENT POINTS SAILING.

A yacht free shall keep clear of the one close-hauled.

ON SAME POINT OF SAILING WITH WIND ON OPPOSITE SIDES.

When both yachts are close-hauled or both free, or both have the wind aft, and have the wind on opposite sides, the yacht with wind on the port side shall keep clear.

ON SAME POINT OF SAILING WITH WIND ON SAME SIDE.

When both yachts are free or both have the wind aft, and have the wind on the same side, the yacht to windward shall keep clear.

WIND AFT.

A yacht with the wind aft is deemed to have the wind on the side opposite to that on which she is carrying her main boom. A yacht with the wind aft shall keep clear of a yacht on any other point of sailing.

OVERTAKING.

An overtaking yacht shall, in every case as long as any overlap exists, keep clear of the yacht which is being overtaken.

DEFINITION OF OVERLAP.

An overlap is established when an overtaking yacht has no longer a free choice on which side she will pass, and continues to exist as long as the leeward yacht, by luffing, or the weather yacht by bearing away, is in danger of fouling.

ALTERING COURSE.

When of two yachts one is obliged to keep clear, the other shall not so alter her course as to involve risk of fouling.

LUFFING.

A yacht may luff as she pleases in order to prevent another from passing her to windward, providing she begins to luff before an overlap has been established.

BEARING AWAY.

A yacht shall not become entitled to her rights on a new course until she has filled away.

CONVERGING CLOSE-HAULED.

When two yachts, both close-hauled on the same tack, are converging by reason of the leeward yacht holding a better wind, and neither can claim the rights of a yacht being overtaken, then the yacht to leeward shall keep clear.

PASSING AND ROUNDING MARKS.

If an overlap exists between two yachts when both of them, without tacking, are about to pass a mark on the required side, then the outside yacht must give the inside yacht room to pass clear of the mark, but shall not be required to tack for that purpose. A yacht shall not, however, be justified in attempting to establish an overlap, and thus force a passage between another yacht and the mark after the latter yacht has altered her helm for the purpose of rounding.

DEFINITION OF MARK.

A mark is any vessel, boat, buoy or other object used to indicate the course, and does not involve a question of sea room.

OBSTRUCTION TO SEA ROOM.

When a yacht is approaching a shore, shoal, pier, rock or other obstruction, not a mark, and cannot go clear by altering her course without fouling another yacht, then this latter shall, on being hailed by the former, at once give room; and, in case one yacht is forced

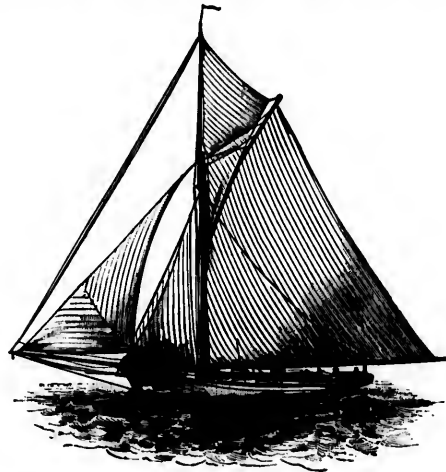

NYMPH.—FIGURE 321.

to tack or to bear away by order to give room, the other shall also tack or bear away, as the case may be, at as near the same time as it is possible without danger of fouling.

ANGER.

In construing and obeying these rules, due regard must be had to all dangers of navigation, and to any special circumstances which may exist in any particular case, rendering a departure from them

necessary in order to avoid immediate danger (U. S. Revised Statutes). But this rule shall not be construed as removing or abating the disqualification of any yacht under Rule XXIV.

DISQUALIFICATION.

A yacht touching a mark or causing a mark boat to shift her position, unless wrongfully compelled to do so by another yacht, shall be disqualified.

If a yacht, in consequence of her neglect of any of these rules, shall foul another yacht, or compel another yacht to foul any yacht, mark or obstruction, or to run aground, she shall be disqualified, and shall pay all damage; and any yacht which shall wrongfully cause

yacht should it come to their knowledge that she has committed a breach of these rules.

PROTEST.

A yacht having cause, during a race, to protest against any other yacht for a violation of these rules, may display Flag B of the Club Signal Code, which shall be known as the Protest Flag, and keep such flag flying till answered from the Judge's boat by the answering pennant. A protest must be supplemented by a written statement of the facts, which must be sent to the Regatta Committee before 6 P. M. of the day following the race, Sundays not included.

If through protest the measurement of any yacht be called in question, the Regatta Committee shall direct the Measurer to remeasure such yacht, and the result as reported by him shall be final. The Treasurer shall collect the usual fee for measuring, according to Rule 5, from the owner, if the measurement be found wrong; from the party protesting, if the measurement be found correct.

PENALTIES.

A yacht which shall be disqualified twice in one season shall be debarred from sailing in club races for the remainder of the season.

REVERSION OF PRIZES.

If the owner of any yacht, otherwise entitled to a prize, shall fail to comply with the conditions imposed on winners of prizes, such owner shall, in the absence of any reason deemed sufficient by the Regatta Committee, be held to have forfeited all claims to the prize and it shall revert to the club.

AMENDMENT.

These racing rules may be amended at any regular or special meeting of the club, the proposed amendment having been stated in the call for the meeting.

TABLE OF TIME ALLOWANCE.

The allowances in the following table are based upon the rule accepted by naval architects, that, within economic limits, opportunities for speed vary in different vessels as the square roots of their respective lengths. As strong winds are required, however, to give to larger vessels the full extent of their advantage in size, and as such a scale of allowance is not adapted to ordinary summer racing, 60 per cent. only of the allowance due to the rule is given in the table, and may be stated thus:

Time equals $6 \left\{ \frac{3600}{L} - \frac{3600}{l} \right\}$; 3600 representing the number of seconds in an hour, l the small yacht, and L the large one.

Practically the formula is $\left\{ \frac{2160}{L} - \frac{2160}{l} \right\}$; six-tenths of 3600 being 2160.

EXAMPLE.

What time will a yacht 70 feet racing length have to allow to one of 65 feet racing length, in a course of 20 nautical miles?

The time opposite 65 feet is	78.48
" " " 70 " "	88.75
Difference,	973
Number of nautical miles,	20
Allowance,	194.60
Or 31 minutes 14 3-5 seconds.	

For fractions of a foot in the measurement use the nearest tenth to be found in the table.

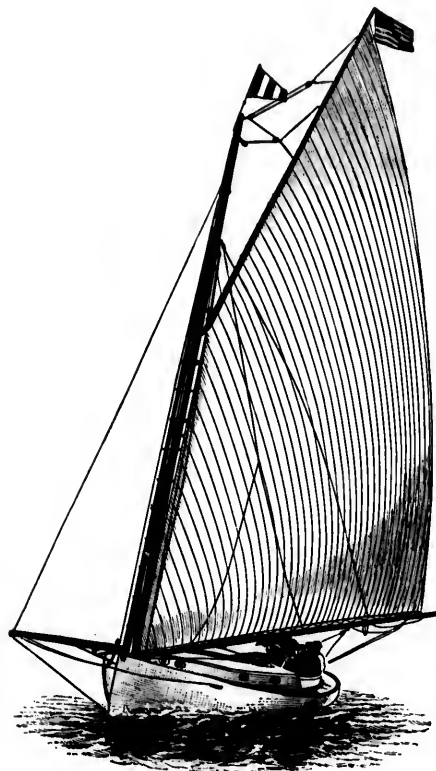

NYMPH.—FIGURE 322.

another to luff, bear away or tack in order to avoid fouling, or shall, without due cause, compel another yacht to give room, or to tack under Section 15, or shall herself fail to tack or to bear away, as required in that section, or shall in any way infringe or fail to comply with any of these rules, shall be disqualified.

DISQUALIFICATIONS WITHOUT PROTEST.

The Regatta Committee shall also, without protest, disqualify any

another from
is an over-

new course

are converg-
and neither
the yacht to

h of them,
d side, then
pass clear of
purpose. A
establish an
nd the mark
se of round-

to indicate

back or other
ing her course
being hailed
ght is forced

her shall also
same time as it

must be had
stances which
are from them

LIST OF YACHTS ENROLLED IN THE LARCHMONT YACHT CLUB

SCHOONERS.

Name.	Centerboard or Ketch.	Owner.	Length over	Length on	Beam.	Draft.
			all.	L. W. L.		
			ft. in.	ft. in.	ft. in.	ft. in.
Agnes	c b	J. Norton Winslow	61 8	53 11	16 9	5 6
Alcea	k	L. Vaughn Clark	125	90	21	13
Altauna	k	J. C. Ayer	62	53	17 10	8 6
Athantio	c b	Wilson Marshall	63 1	84 1	21 3	8 0
Azalea	c b	J. Clinch Smith	71	61 3/4	17 1/2	5 9
Clochetto	k	Eugene L. Busio	61 5	50 8	14 2	6 0
Clytie	c b	Henry C. Ward	85	78 3	21 8	9
Constellation	c b	Bayard Thayer	131	106	24 10	12
Coronilla	k	John H. Booth	64	45	15	8 6
Curlew	k	William L. Brooks	43	40 5	13 2	5
Dagmar	c b	Robert W. Inman	66 4	69 4	21	8 1
Dauntless	k	Caldwell H. Colt	123 11	116 7	25 7	12 6
Emerald	c b	J. Rogers Maxwell	112	82	21 10	10
Fenella	k	William A. Hazard	67	51 6	17	9
Fleur-de-Lys	k	George Trotter	108	81 6	22	13
Fortuna	k	Henry S. Hovey	100 4	96	22 6	12 8
Gevulia	c b	Howard W. Coates	70	54 6	19 6	7
Hillegard	k	George J. Gould	115	100	20	14
Iroquois	c b	Ralph N. Ellis	96 3	80 2	21	10
Lasca	c b	John E. Brooks	119	89 6	23	10 8
Lotus	c b	Daniel Appleton	63 10 1/2	58 11 1/2	16 8 1/2	5 6
Magic	c b	Augustus W. Mott	84 6	81 11	20 10	7 6
Oricle (Ketch)	c b	Caldwell H. Colt	54	43	15 6	3 3
Phantom	c b	Henry S. Parmelee	100 3	86	24 11	6 6
Ramona	k	H. M. Gillig	132	110 10	25 7	13
Sachem	c b	Frederick T. Adams	102 2	81	23 8	8 10
Social	k	Oscar B. Smith	66	57	16 9	8
Shamrock	c b	Willard P. Ward	80 3	70 6	19 7	8 5
Tioga	k	Seymour L. Husted, Jr.	60 11	54 1	15	9
Varuna	k	Frank K. Sturges	93 9 1/2	86 5	22 11 1/2	10 4
Viator	k	W. Gould Brokaw	76	62	19	10
Wave Crest	c b	Frank H. Lawrence	91	82	22	6
Whim	c b	Bradford B. McGregor	62 9	57 6	16	3 6

AUXILIARY SCHOONERS.

Name	Owner.	Length over	Length on	Beam.	Draft.
		all.	L. W. L.		
		ft.	ft.	ft. in.	ft. in.
Intrepid	Lloyd Phoenix	164	132	27	13 6
Towana	W. West Durant	191	155	24 8	11 6

Beam.	Draft.
ft. in.	ft. in.
16 9	5 6
23	13
17 10	8 6
23 3	8 6
17 10	5 0
14 2	6 6
21 8	9
24 10	12
15	8 6
13 2	5
21	8 3
25 7	12 0
21 10	10
17	9
22	13
22 6	12 8
19 6	7
20	14
21	10
23	10 8
16 8 1/2	5 6
20 10	7 6
15 6	3 3
24 11	6 6
25 7	13
23 8	8 10
16 9	8
19 7	8 5
15	9
22 11 1/2	10 4
19	10
22	6
16	8 6

Beam.	Draft.
ft. in.	ft. in.
15	13 6
23 8	11 6



PLATE XXVI.

WASP.

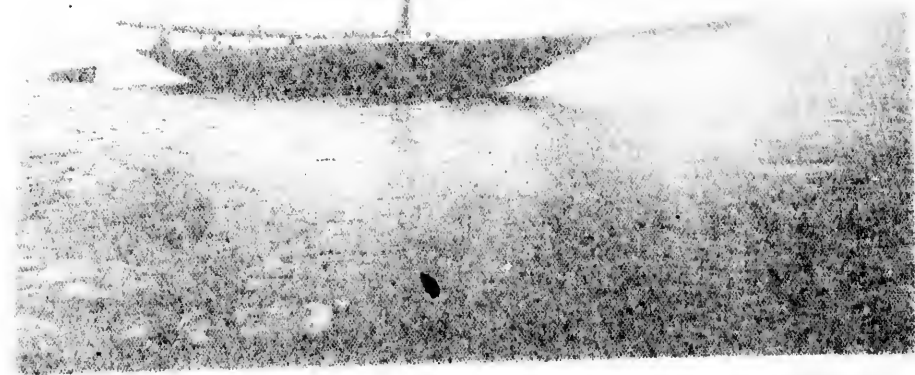

LIST OF YACHTS ENROLLED IN THE LARCHMONT YACHT CLUB, 1893.

CABIN SLOOPS, CUTTERS AND YAWLS.

Name.	Centerboard or Keel.	Owner.	Length over all.		Beam.	Draft.
			ft. in.	ft. in.		
Aeolus	k	William L. Matson	69 7	51	16 2	5 1
Addo	e b	C. B. Nickerson	21 5	25 5	12	2 6
Aliso	k	Frank S. Coru-ll	25 6	21 10	9 6	4 2
Arab	e b	F. M. Freeman	33	28 9	11	4 2
Ariel	e b	John H. Hogenun, Jr.	31 2	28	10 3	4 4
Ariel	k	Davis C. Anderson	32 6	30	10 4	3 10
Audax (Yawl)	k	Henry W. Eaton	42 6	30	10 3	6 6
Awixa	e b	William L. Brooks	38	33	12 3	2 1
Banshee	e b	Arthur H. Serlauer	48 8	36 7	13	6 3
Bantam	k	Woodbury Kane	31	25	8	5 6
Beatrice	e b	Charles A. Prince	61	45 9	16 1	7 6
Bedouin	k	Charles W. Wetmore	83	70 2 2.5	15 8	12
Bonnie Doon	e b	Arthur Gibb	42	30	13	2 3
Brenda	k	Francis M. Scott	25 2	21	8 2	4 3
Carrie	e b	Israel J. Merritt	53	46	16 2 1	4 9
Circo	k	S. Grosvenor Porter	37 6	30 8	6 2	5 6
Clara	k	John Howard Adams	63 7	53	9	9 10
Colonla	k	Archibald Rogers	128	85	24	16
Conquiesco	e b	Bryce Metcalf	31	27 5	11 6	3 6
Coyote	e b	Henry W. J. Bucknall	25 10	20 6	9 7	1 8
Cygnia	e b	Chas. Slover Allen	31 6	25 6	11 6	3 4
Cygnat	e b	James R. Murray	21 6	22	10	3 1
Cygent	e b	Daniel Edgar	38	31 6	11 1 1	5 7
Defiance	k	Horace L. Hotchkiss, Jr.	35	30	12	5
Delvyn	k	M. Roosevelt Schuyler	42	33 6	5 4	6 8
Drsilla	k	Lewis M. Rutherford	50	36 3	9 6
Duplex (Yawl) (Aux.)	e b	F. M. Wilson, M. D.	72	27 6	12	3
Eteetera (Yawl) (Aux.)	k	Louis Q. Jones	30	27	7 6	3
Eurybia	e b	Charles Fryer	47	34 4	14	6
Fanny	e b	Thomas P. Fiske	72	66	23	6
Fauna	e b	Moses Bulkley, 2d	35	29 8	12	3 9
Flash	e b	Joseph H. Sterling	36	32	12 4	4
Gavinta	k	G. Morris Edwards	60	50 1	15	6
Guenn	e b	Edward Winslow	34 6	28 6	12 6	3 2
Gulnare	e b	John E. Dwight	51	46	14 6	5
Harriet	e b	Edward J. Greacen	40	37	14	3 6
Heedless	k	Clarence L. Burger	35	30	9 6	5 6
Helen	k	Charles A. Prince	4	38 11	12 6	10 9
Huron	k	William Butler Duncann, Jr.	73 4	63 5	15 9	10 10
Heen	k	Frederick Goldard	78	65 4	10 7	11
Imperia	e b	Henry C. Eno, M. D.	46 1	41 11	15 3	4 9
Inez	e b	John H. Cole	45 4	38 2	13 6	4
Iris	k	G. W. Watson	61	51	13	9 6
Julie	e b	R. F. Downing	22 6	20	9 6	5
Kangaroo	e b	Franklin Boumes	35	28	12 9	4

LIST OF YACHTS ENROLLED IN THE LARCHMONT YACHT CLUB, 1893.

CABIN SLOOPs, CUTTERS AND YAWLS.—CONTINUED.

Name	Construction or Keel	Owner.	Length over all	Length on L. W. L.	Beam	Draft.
			ft. in.	ft. in.	ft. in.	ft. in.
Katrina	e b	George Work	36 6	60 4 1	20 4	0 3
Kwasind (Yawl)	e b	Oliver Adams	40	28 3	12	4
Luxen	k	George Hullock	30	30	10 6	5 10
Marjorie	k	H. D. W. Burt	38 2	28 3	10 6	7 2
Mayetta	e b	Horatio H. Harper	33 0 1	31	11 9	3 6
Merlin	k	George E. Sackett	30 4	25 9	7	5 6
Mineola	k	August Belmont	62	45 10	13 10	10 5
Mistral	e b	Charles T. Wills	30 6	34 8	14 6	4 6
Molesta	k	Henry E. Smith	30 4	25 9	7	6
Mona	k	Robert G. Sherman	41 8	37 5	8 1	7 0
Nanteless	k	Charles W. Wetmore	33 6	24 8	6 8	0
Navahoe	e b	Royal Phelps Carroll	120	85	23	12 7
Nirvana	k	John Moller	53 6	45	15 6	8 2
Nomad	e b	Henry B. Hayden	36 4	32	13 6	4 6
Nora	k	Gerard M. Baretto	26 1	21 6	7 11	4 8
Nymph	e b	Henry W. Harris	50	39 10	14 7	6
Oriva	k	Herman Clark	60 9	51 4	11 9	9 11
Peri	e b	Chas. McK. Leoser	42	37	14	5
Portia	k	Frank T. Robinson	27 6	29 4	11 4	6
Pyxie	k	Oswald Sanderson	36 6	23 6	7 8	6 6
Queen Mab	e b	Percy Chubb	58 3	16	11
Rajah	k	Walter C. Hubbard	41 6	33 0	8 6	7
Regina	e b	Thomas J. McCubbill	58	47 3	10 3	4 3
Richmond	e b	Frederick A. Palmer	46	42 11	18 4	4 3
Rosalind	k	J. C. Ayer	37 10	29 7	10 1	6 9
Saona	k	A. P. Ketchum	45 6	33	12	6 9
Sayonara	k	Bayard Thayer	60	45 9	12 6	10 6
Scorita	e b	J. Maxwell Williams	38	32	12 6	3 6
Surf	k	William Boyce	42 10	35 2	7 6	7 4
Susie W.	e b	Louis T. Duryen	30	24	10 6	5
Teal	e b	Oswald Sanderson	22	17 7	7 5	2 11
Thetis	e b	Paul E. Stevenson	22	61	10	9
Thistle	e b	George H. Belcher	25 6	60 6	17 6	7
Tom Boy	k	Archibald Rogers	37 9	29 6	9 8	6 9
Trochilus	k	Mayhew W. Bronson	50	41 6	15	6 6
Ventura*	k	William H. Jones	70	56	13	7 4
Vindex	k	George Bullock	62 5	56 5	17 3	8 9
Vision	e b	Dr. C. Stover Allen	31 6	26 6	11 6	3 4
Vivien	e b	Stanley Greeneen	28	29 6	9 6	2 8
Volusia	e b	J. Maxwell Williams	38	32 4	12 4	3
Vorunt	e b	Geo. G. Tyson	34 8	29 6	12 3	6
Wasp	k	Archibald Rogers	22	45 6	13	16 8
Wizard	e b	Ernest Staples	63	58	18 4	7 6
(Building)	e b	C. Oliver Iselin	128	85	26	12 4

* Sold.

LIST OF YACHTS ENROLLED IN THE LARCHMONT YACHT CLUB, 1893.

MAINSAIL (CABIN) BOATS.

	Draft.							
ft. in.		Name	Centerboard or Keel.	Owner.	Length over all.	Length on L. W. L.	Beam.	Draft.
					ft. in.	ft. in.	ft. in.	ft. in.
4	9 3	Anemone	cb	M. F. Phant	31	24 0	12	3
6	5 10	Aura	cb	William H. Simonson	33	30	11 3	3 0
6	7 2	Cinch	k	John H. Hayward	23 2	23 0	12 4	3 10
9	3 6	Cupid	cb	Frederick C. Luke	23 4	20 1	9	2 10
7	5 6	Ebène	cb	Frank M. Freeman	23 10	21 0	10 2	3
3 10	10 5	Elin	cb	C. A. Andresen	30	26 3	12	3 0
4 6	4 6	Fannie	cb	Alexander Taylor, Jr.	31	30 5	13 4	3 1
7	6	Greyhound	cb	John M. Woodbury, M. D.	24	21	9 6
8 1	7 0	Nymph	cb	Frederick W. Flint	30	26	12	3
6 6	6	Protos	cb	Stephen A. Cooper	33	26 0	13 3	2 8
23	12 7	Silence (Yawl)	cb	Leonard Jacob, Jr.	25	20	8	3 0
15 6	8 2	The Sabot	cb	William G. Read, Jr.	27 10	25 5	12 5	3
13 6	4 6	Water Lily	cb	Henry H. Andersen	20	25 6	12 0	3
7 11	4 8							
14 7	6							
11 9	9 11							
14	5							
11 4	6							
7 8	6 6							
10	11							
8 6	7							
10 3	4 3							
18 4	4 3							
10 1	6 9							
12	6 9							
12 6	10 6							
12 6	3 6							
7 8	7 4							
10 6	5							
7 5	2 11							
10	9							
17 6	7							
0 8	6 9							
15	6 6							
13	7 4							
17 3	8 9							
11 6	3 4							
9 8	2 8							
12 4	3							
12 3	6							
13	10 8							
18 4	7 8							
26	12 4							

JIB AND MAINSAIL (OPEN) BOATS.

		Name	Centerboard or Keel.	Owner.	Length over all.	Length on L. W. L.	Beam.	Draft.
					ft. in.	ft. in.	ft. in.	ft. in.
		Apache	cb	Harold S. Forwood	24 2	22 2	10	1 3
		Brunnhilda	cb	Charles T. Wills	30	23 2	12	2 0
		Chin Chin	cb	F. J. Hynes	23	23	8 0	2
		Cruiser	cb	A. Bryan Alley	20 6	20 6	9 7	1 8
		Expert	cb	Julian M. Humsey	21 7	21 7	11 2	1 8
		Fedora	cb	Edward H. Wales	23	23	9	2
		Florence	cb	Richard H. Eggleston	21 10	21 10	9	1 8
		Folly	k	George Bullock	32 6	22 6	7	0
		Katie G.	cb	William G. Read, Jr.	22 10	22 10	9	1 0
		Kitz	k	Jacob Cram	32	23	7 0	5
		Lanner	cb	James B. Kinney, M. D.	27	24	9	2
		Mignon	cb	Edward N. Dickerson	21 10	21 10	8 8	1 10
		Nadly	cb	Auguste P. Montant	27 11	27 11	11 0	1 0
		Nahil	cb	Washington E. Connor	21 2 1/2	24 2 1/2	12	1 7
		Oriental	cb	George I. Seney	21 10	21 10	9 2	1 6
		Petrel	cb	Joseph P. Knapp	21 11	21 11	9 0	1 6
		Rhet	cb	E. D. Appleton	21 10	19 0	8 2	1 11
		Trident	cb	P. H. Adee	25	21 0	9 2	2
		Vanadis	cb	William S. McCrea	20 4	20 1
		Water Wag	cb	George W. Scott	18	18	6	1

LIST OF YACHTS ENROLLED IN THE LARCHMONT YACHT CLUB, 1893.

MAINSAIL (OPEN) BOATS.

Name.	Centerboard or keel.	Owner.	Length over all ft. in.	Length of L. W. L. ft. in.	Beam. ft. in.	Draft. ft. in.
Alice	e b	George G. Murray	17	17	7 10	1 3
Blonde	e b	Alphonse Montant	31	29 7	12	2
Boojum (Yawl)	e b	Harold S. Forwood	15 8	15 6	5 2	1 2
Cuddle	e b	J. Rogers Maxwell	21	21	9	2
Caro	k	William Boyce	21 5	19 2	8	4 8
Comanche	e b	P. H. Adie	24 6	21	9	3
Coot	e b	C. C. Munroe	18 2	16 9	7 4	2 6
Dearie	e b	Arthur Gibb	21 3	18	7 8	1 8
Dodge	k	Edward M. Puleford	11	12	4	3
Giggle	e b	Joseph H. Sterling	19 2	19 2	8 7	1 6
Impulse	e b	William D. Hatch	21 3	21 3	8 4	1 6
La Perichole	e b	Charles P. Buchanan	24 11	24 11	9 6	1 10
Lestris (Yawl)	k	Harold S. Forwood	11	11 8	4 6 1/2	2
Lorraine	e b	E. Porter Mason	14 8	14 4	6 2	1 1
Louie Belle	e b	J. Maxwell Williams	18	16 8	6	10
Lucille	e b	Alphonse H. Alker	21 1 1/2	21 10	8 8	1 6
Nettle	e b	Frederic A. Potts	20 4	20 4	8 7	1 6
Next	e b	Bradford B. McGregor	19 8	19 6	9	1 6
Nozle	e b	Larchmont Yacht Club	20	20	8 6	1 8
Olga	e b	C. T. Little	20 4	20 4	9	1 10
Priscilla	e b	E. W. Dixon	19 10	19 10	9	1 8
Punch	e b	Everett Hushmore	20	20	8	11
Sally	e b	William S. Alley	22 10	22 1 1/2	9 4	1 2
Skip	e b	W. R. Moon	16	16	6	1
Tautog	e b	Charles H. Osgood	21	21	8 6	2 8
The Kid	e b	Bayard Thayer	18 7	18 7	7 10	10
Thera (Lugger)	k	John M. Woodbury, M. D.	24	24	5	3
Violet	e b	Godfrey A. S. Wilners	22 6	22 6	9 6	1 6
Vivid	e b	Frank L. Anthony	22 10	22 10	9	3 6
Zinga	e b	W. Neal Banks	21 9	18 6	8 6	2

LIST OF YACHTS ENROLLED IN THE LARCHMONT YACHT CLUB, 1893.

STEAMERS.

Name.	Owner.	Length over	Length on	Beam.	Draft.
		all.	L. W. L.		
		ft. in.	ft. in.	ft. in.	ft. in.
Alicia	Henry M. Flugler	188	160	21	11
Almy	Frederic Galatin	177 6	155 6	24	9 6
Avenel	G. Weaver Laper	134	106	18	9 6
Bellehazen	Hazen L. Hoyt	40	37	8	2 6
Bo-Peep	Edward H. Townsend	65	60	12	4
Columbia	J. H. Ludew	194 6	1 0	23	10 2 1/2
Conqueror	Frederick W. Vanderbilt	251	188	24 7	13
Cora	John A. Morris	140	123 6	23	8 4
Daisy	Edwin D. Morgan	48	47	7 6	3
Daphne	Bradford B. McGregor	47	44 4	9 2 1/2	4 6
Dolphin	W. Boerum Wetmore	42	41 4	8 6	3
Electra	Elbridge T. Gerry	174	161 6	23	10 6
Embla	John H. Hanan	102	101	20	8
Elois	William H. and George P. Butler	80	77 6	15	6 4
Evelyn	John H. Hegeman, Jr.	85	81	13	4 10
Fedalma	Edward M. Brown	122	102	20 4	6
Half-Moon	F. J. Holder	70	10 6	4 6
Helvetia	Columbus O'D. Iselin	92	80	11 6	5
Hirondelle	Caleb G. Evans	75	69	11	4 6
Ituna	August Belmont	150	135 6	19 7	13
Javelin	Charles H. Flint	97 9	91	10 2	4 9
Jean	James Renwick	100	85	17 6	7
Jessie	Charles H. Murray	63 6	79 3	11	5
Lina	Stephen W. Hoach	72	61	13 8	4 6
Loando	T. Henry French	98 6	87	16 9	7
Lorna	Jacob Cram	60 6	94	12 4	5
Lurline	W. Boerum Wetmore	65	92	17	7 6
Marguerite	Robert W. Inman	40	40	5 6	3
May	E. D. Morgan	220	204	27 8	14 6
Narwhal	Charles H. Osgood	142	126	18 4	7
Nomad	Adrian Iselin, Jr.	74	67	13	5
Nooya	Edward N. Dickerson	125 8	104	18 2 1/2	10
Gillie	Percy Chubb	54 6	51 4	8 9	3 8
Onelda	E. C. Benedict	138	121 6	20 6	8 6
Oriente	Edward R. Ludew	125	117	17	7
Pharos	Rufus M. Silvers	44	7 6	3
Reposo	Bradford B. McGregor	78	68	11 4	5 3
Shearwater	Henry R. Welcott	124	108	18	6 6
Stella	Henry E. Abley	68	56 3	15	4 6
Thyra	C. Barnum Seeley	79	66	11	5 4
Tillie	William H. Starbuck	177	157	20	9
Valiant	William K. Vanderbilt	318	253	31 2	16 6
Vedette	M. C. D. Borden	125	104	18 6	9 6
Victor	James Renwick	55	49	10	3
Vision	Clarence McKim	100	80	16	4 6
Yetam	Jacob Cram	53	50	8 8	3 6

LIST OF YACHTS ENROLLED IN THE LARCHMONT YACHT CLUB, 1893.

LAUNCHES—UNDER THIRTY-FIVE FEET WATER LINE.

Name	Owner.	Length over	Length on	Beam.	Draft.
		all.	L. W. L.		
		ft. in.	ft. in.	ft. in.	ft. in.
Aline	F. S. Salisbury	25	22 0	6 2	2
Anchoria	Henry A. Mott	35	32	7	3 6
Baltimore	Christian Ax	7 0	6 2	8	3 6
Bohemian	Charles H. Osgood	34	28	6 6	2
Cherub	George Bullock	25
Cozy	Infus M. Stivers	23	21	6 6	3
Eone	William D. Ellis	3	20	6 6	2 0
Eva H.	Charles B. Barker	25	23	8	2
Fakir	Charles H. Osgood	40	6 6	3
Florence	A. Marshall	38	35	7	4 6
Growler	Pierre Noël	30	27 3	6 6	2 4
Jill	George H. Holt	20	2	6 6	2 4
Josephine	William Buchanan	35 10	12	3 0
Kraken	H. A. Van Lew	35	28	6 6	2 4
Lurline	W. Bowen Wetmore	18 3	15 10	4 7	1 3
Marguerite	R. F. Downing	25	22 6
Niobe	William H. Caldwell	30	28	6 6	2 0
Olivo	James McLaughlin	20	16 4
Oso	Edward H. Wales	21
Republie	Louis T. Duryen	21	21	5 6	2 6
Sentinel	George L. Rounds	42	30	8 6	2 6
Siwamy	George I. Sney	26	20 6	6 9 1/2	2 1 1/2
So So	Frederic W. Flint	21	21	6	2
Sweetheart	Joseph H. Sterling	27	23	6	2 6
The Wake	Edward F. Caldwell	20	6
Trochilus	Mayhew W. Bronson	21	5 6	1 6
Tycosm	Richard H. Eggleston	32	20	6 6	2 0
Vixen	George Hullock	30
White Cup	William V. Brokaw	30	27	7 2	3

Beam.	Draft.
ft. in.	ft. in.
0 2	2
0 7	3 6
0 8	3 6
0 0	4
...
0 0	3
0 6	2 6
7	2
0 0	3
7	4 6
0 0	2 3
0 0	2 4
12	3 0
0 0	2 1
4 7	1 3
....	..
0 0	2 0
....	..
5 0	2 0
8 0	2 0
0 0	2 1
0	2
0	2 6
0	...
5 0	1 6
0 0	2 0
....
7 2	3

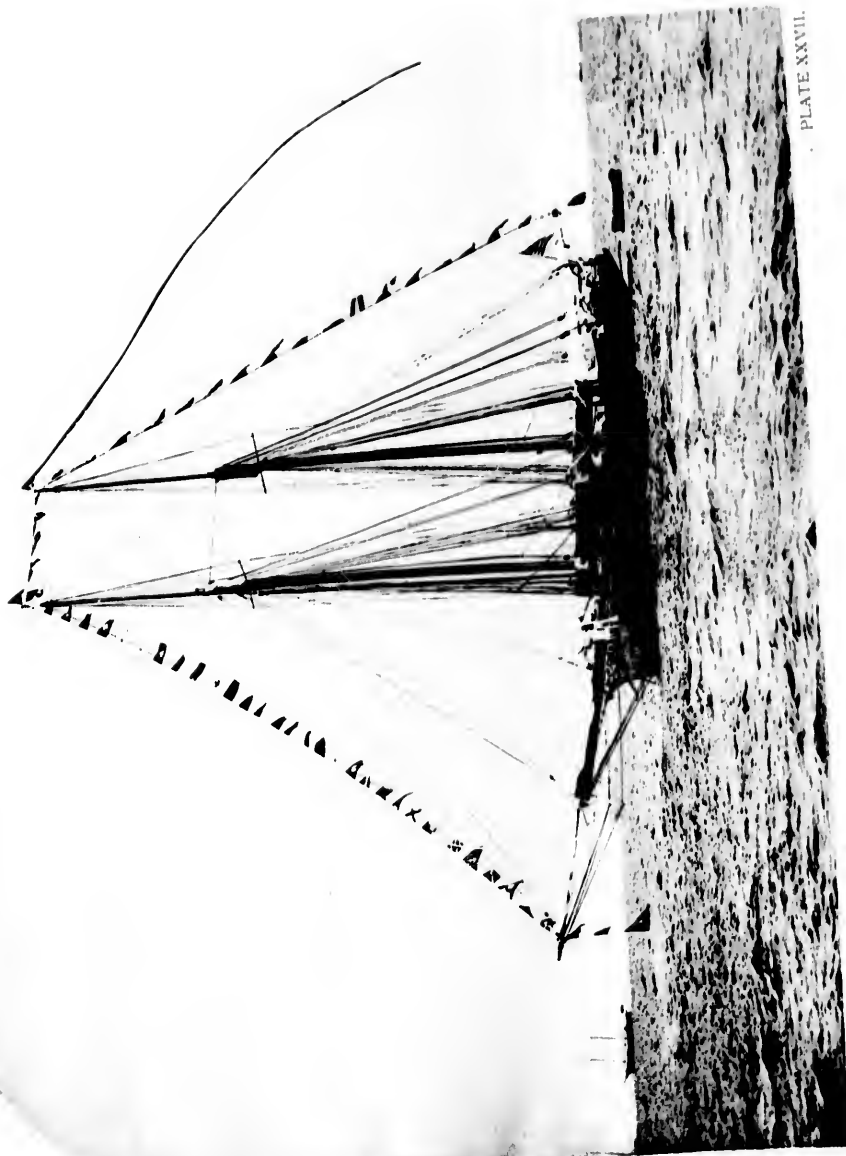
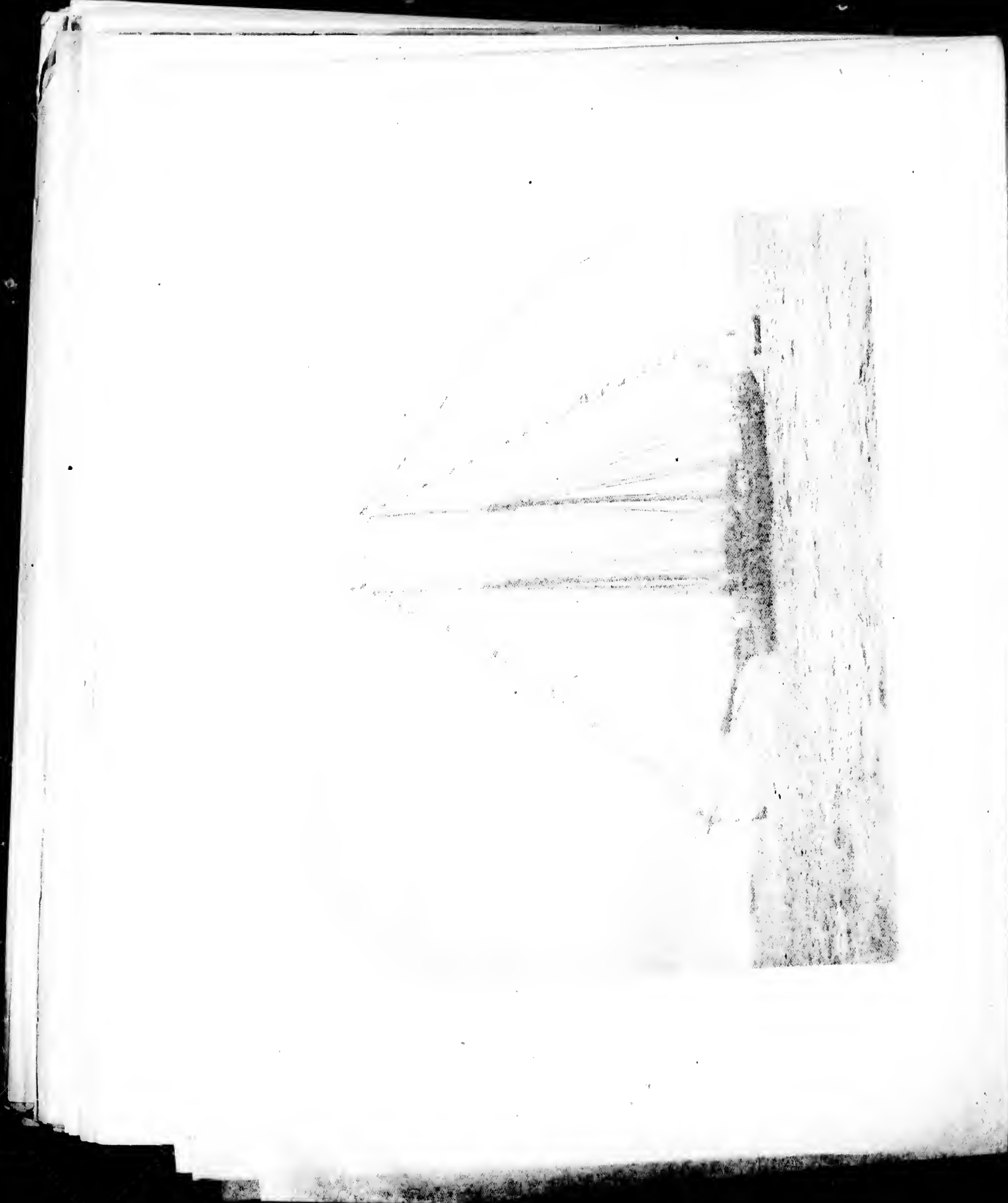

PLATE XXVII.

FROM A NEGATIVE BY HOLLE

CRUSADER.



RECORD OF RACES.

The First Annual Regatta of the LARCHMONT YACHT CLUB was sailed July 5, 1880.

The following yachts took part :

SLOOPS.		
	Sailing Measure, ft. in.	Allowance M. S.
Viva	29 6	
Reverie	25 9	4 30
Katie C.	22 11	7 51
Willis	22 10	8

CAT-RIGGED.		
	Sailing Measure, ft. in.	Allowance M. S.
Meteor	26 7	
Vivid	22 10	4 30
Cruiser	20 10	6 51
Luella	17 11	10 21

The yachts got under way a few minutes past 11 o'clock. The course was from Horseshoe Cove to and around the spar buoy off Matinecock Point, L. I., thence to and around the spar buoy off Execution Rocks and back to the place of departure, a distance of 12 nautical miles. The time allowance was one minute and twelve sec.

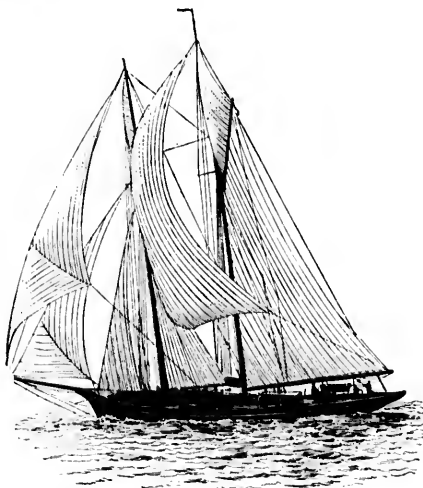

RAMONA.—FIGURE 323.

onds to the foot of mean length. The wind was southeast, fresh whole-sail breeze, and the tide was on the first quarter of the ebb. To the first mark the wind was abeam, and the set of the tide to leeward. Of the sloops, WILLIS won the race in 1 hr., 52 min., 57 sec. VIVA was second, time 1 hr., 55 min., 9 sec.; REVERIE was third, time 2 hrs., 1 min., 7 sec., and KATIE C. was last. Of the cat-rigged yachts, METEOR won in 1 hr., 59 min., 17 sec.; VIVID was second, time 2 hrs., 3 min., 30 sec.

A second Regatta was sailed July 31, 1880, the course being from a mark boat off the Cove, to and around a mark boat near the Gangway Buoy off Sands Point and return, a distance of eight miles and repeat, on the usual time allowance of six seconds per foot per mile, making one minute and thirty-seconds per foot for the course. A prize was given in each class of a silver cup, presented by James R.

Flint, a member of the club. The wind was very light and the pace was slow.

The following yachts competed :

OPEN SLOOPS.		
	Sailing Measure ft. in.	Allowance M. S.
Viva	29 6	
Katie C.	22 11	10 32
Willis	22 10	10 40

CAT-RIGGED.		
	Sailing Measure ft. in.	Allowance M. S.
Holden	27 1	
Meteor	26 7	0 18
Truant	24 3 1/2	3 40
Marie	23 5	5 52
Zoe	23	6 32
Vivid	22 10	6 18
Cruiser	20 10	10

The sloops got under way a few minutes before 2 o'clock. WILLIS won the race in 1 hr., 53 min., 10 sec.; VIVA was second, time 4 hrs., 14 min., 7 sec., and KATIE C. was third, time 4 hrs., 26 min., 58 sec.

The cat-rigged yachts started about 2 o'clock, CRUISER winning in 3 hrs., 50 min., 40 sec.; TRUANT was second, time 3 hrs., 52 min., 10 sec., and HOLDEN third, time 3 hrs., 52 min., 38 sec.

The Second Annual Regatta was sailed July 4, 1881. The yachts were divided into classes A and B; C and D; E and F, 19 yachts taking part in the race. The course for the cabin classes was to and around the buoy off Loyd's Neck and return, a distance of 25 miles; and for the open yachts to and around the Centre Island Buoy and return, a distance of 20 miles.

The wind was very fair for an hour, but died out and it looked as though the race could not be finished in the required time. At 5 o'clock, however, a squall from the northeast with rain sent the yachts flying home. The allowance for all classes was six seconds per foot per mile or 2 1/2 minutes per foot for the cabin boats and 2 minutes per foot for the open boats. In Class A, cabin yachts, FANITA won, beating WAYWARD, WENONA and CURLEW. In Class C and D WILLIS won, beating CORNELL, KATIE C., ZOE and FAIRY.

A Pennant Regatta was sailed August 20, 1881, but the contest was almost a fizzle. Three classes of yachts started, which were to sail to Matinecock Buoy, to Gangway Buoy and return, but did not return at 4:30 P. M. In the second class, FAIRY won in a twelve mile race in 2 hrs., 30 min. In the third class, TRUANT won in 2 hrs., 25 min.

The next Regatta was sailed August 27, 1881. The cabin sloops WENONA, HELENA and VENTURE competing. The race was won by HELENA, WENONA second.

The first Regatta held the following year was on June 3, 1882. In Class B, GRACIE beating ECLIPSE and FANITA.

The Third Annual Regatta was held July 4, 1882. In Class 3, cabin sloop GRACIE, 74 ft. 11 1/3 in. sailing measurement, was the only yacht which took part. She sailed over the course in 5 hrs., 31 min., 50 sec.

In Class A, cabin sloop ECLIPSE won, beating ROVER, VOLAXTE and CURLEW, sailing the course in 5 hrs., 30 min., 30 sec. There were eight classes, in which were distributed 23 yachts. The course for the large sloop Classes 3 and 3A was from a point off Larchmont to and around the buoy at the west of Execution Reef, thence up the Sound to the buoy off Centre Island, thence across the Sound to a mark off Captain's Island, returning around the Execution Buoy to the place of departure, a distance of 28 nautical miles. The finish was made in a pouring rain.

The next Regatta was sailed July 22, 1882, between WILLIS, HORNEX, ZOE, NYMPH, FAIRY and CRUISER. FAIRY won in 6 hrs., 43 min., 48 1/10 sec., CRUISER in 7 hrs., 2 min., 31 sec. The course sailed was a distance of 17 nautical miles.

The first Regatta the following year was sailed June 16, 1883.

In Class 4, open, *CHEMUN* entered and in Class 5, open, *ADA*, *ZOE*, *HORNET* and *CRUISER*. *ADA* won in 4 hrs., 47 min., 2 sec., over a distance of about 17 miles. On July 21, 1883, *ADA*, *ZOE* and *ORIENTA* competed over a course of 18 miles, *ORIENTA* winning in 4 hrs., 2 min., 15 sec.; *ADA* second in 4 hrs., 07 min., 42 sec.

The Fourth Annual Regatta was sailed July 4, 1883. In Class 3, cabin sloops, were *GRACIE* and *FANNY*. *FANNY* won in 3 hrs., 49 min., 03 sec., beating *GRACIE* 3 min., 44 sec., over a course of 17 miles. *GRACIE* and *FANNY* collided at the Centro Island Buoy. Both sides claimed a foul. The judges decided in favor of *FANNY*. The yachts were both sailed by their sailing masters. There were eight classes in which were distributed twenty yachts.

In Class 5, open sloops, *HORNET* capsized. On Aug. 18, 1883, the following yachts competed over a course of 18 miles: *FEDORA*, *ZOE*, *HORNET*, *ORIENTA* and *JEWEL*. *ORIENTA* won in 3 hrs., 37 min., 2 sec. On Aug. 25, 1883, Mr. Frank Scott, owner of *HORNET*, 22 feet 6 inches, challenged Mr. Harold Sanderson to sail his yacht *ZOE* against *HORNET* for a \$100 cup, *ZOE* being 3 inches the longer.

The course was from off Pagoda Point, Larchmont Manor, to and

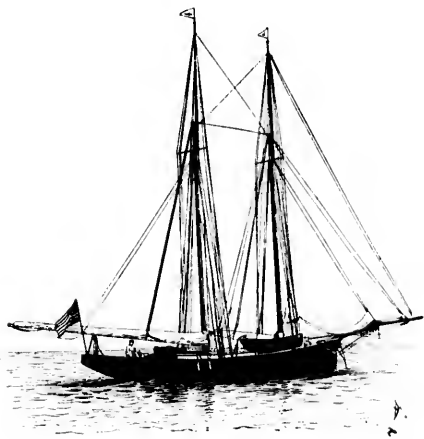

TIOGA.—FIGURE 324.

around the Gangway Buoy and return, a distance of 5 miles, to be sailed over three times on the regular time allowance of the club, *ZOE* allowing *HORNET* 21 seconds.

Mr. Sanderson gave up the race as the wind was too light. *HORNET* continued around the course and was awarded the cup.

On June 7, 1884, another Regatta was held at Larchmont.

The course was 17 miles. In Class 1, *ATHLON* and *ECLIPSE* competed, the latter winning in 4 hrs., 29 min., 4 sec. The Fifth Annual Regatta was sailed July 4, 1884. The course for Class 1, cabin sloops was about 22 miles. *ATHLON*, *ECLIPSE* and *FANITA* competed: the race was won by *FANITA* in 3 hrs., 21 min., 29 sec., *ECLIPSE* coming in second in 3 hrs., 26 min., 5 sec., *ATHLON*'s time being 3 hrs., 21 min., 39 sec.

There were six classes which contained altogether nineteen yachts. Another Regatta was held Sept. 6, 1884. *CRUISER*, cat-rigged, was the only yacht completing the course, which was about 17 miles. Time, 5 hrs., 48 min., 56 sec.

On June 6, 1885, a Regatta was held in which *FANITA* beat *ECLIPSE* over a 22 mile course in 6 hrs., 51 min., 34 sec., the time taken by *ECLIPSE* being 7 hrs., 13 min., 37 sec. There were only seven yachts which participated in the various classes. The Sixth Annual Regatta was sailed July 4, 1885. *SPERANZA* and *CLIO*, schooners, participated, the former winning over a 22 mile course in 4 hrs., 58 min., 11 sec. *ATHLON*, *ISIS*, *THISTLE*, *ECLIPSE*, *ANNIE*, *DAPHNE*, *VIXEN*, *MAGGIE* and *FANITA* competed, the last named winning in 4 hrs., 9 min., 10 sec., *VIXEN* coming in second in 4 hrs., 35 min., 15 sec. Thirty-seven yachts took part and were distributed in nine classes. There was a cracking breeze at the start, which died out towards the finish. On September 5, 1885, a Regatta was sailed over a 17 mile course, eighteen yachts finishing. In Class 8, cat-rigged, *FAIRY* beat *ADA*, *ORIENTA*, *CRUISER* and *NAHLI*. On August 22, 1885, the Oyster Boat Regatta was sailed.

Twenty cabin sloops and seven open sloops participated, the course being about 19 nautical miles. The sloops were limited to mainsails, jibs, and working gull topsails; the cut-boats to mainsails only. *LIZZIE D. BELL* won in 4 hrs., 24 min., 55 sec. *TELEPHONE* was the second boat in, but was ruled out as not being a working boat. *J. H. TRUSTY* was second, time 4 hrs., 38 min., 10 sec.

Of the open sloops, *MARY C.* won, time 4 hrs., 59 min., 46 sec., *ADDIE B.* being second, time 5 hrs., 03 min., 11 sec.

The next Regatta was held June 5, 1886, in which *CLARA*, 56.2½ feet, beat *THISTLE*, *ATHLON* and *CINDERELLA* over a 22 mile course; time, 4 hrs., 22 min., 01 sec. *NYMPH*, in Class 3, beat *YOLANDE* and *MERLIN*, but was ruled out for fouling the home stake boat at finish. Thirteen yachts contested in their respective classes.

The Seventh Annual Regatta was held July 5, 1886; forty-eight yachts participated, being distributed in eleven classes.

In Class A, *SPERANZA* and *NIRVANA* competed over a 22 mile course, the former finishing in 6 hrs., 37 min., 14 sec.; the latter not completing the course.

In Class B, *TURTON* and *LEONE* raced, the former finishing in 6 hrs., 15 min., 46 sec. In Class C, *CINDERELLA* and *CLARA* raced, the latter winning in 5 hrs., 8 min., 7 sec. *CINDERELLA*'s time being 5 hrs., 36 min., 9 sec. *DAPHNE*, in Class 1, beat *ATHLON*; time, 5 hrs., 42 min., 14 sec.; *ATHLON* 6 hrs., 6 min., 52 sec.

The Oyster Boat Regatta was sailed August 31, 1886. There were 18 cabin sloops, 14 open sloops and 5 cat-boats. *GRACE MACKAY*, 40 feet, won the Cabin Sloop Race in 3 hrs., 28 min., 47 sec. *WATSON*, 40.6 feet, came, in second in 3 hrs., 29 min., 33 sec., and *STELLA*, 35.9 feet, third, 3 hrs., 31 min., 1 sec.

In open sloops, *STRYL*, 29.6 feet, won; time, 3 hrs., 45 min., 41 sec. *JAMES A. WILLIS*, 25.9 feet, was second, time 3 hrs., 51 min., 58 sec. In the cat boats, *MAMIE*, 21.10 feet, won; time, 4 hrs. 9 min., 5 sec. *JOKE* was second, time 4 hrs., 12 min., 12 sec. A Regatta was sailed September 4, 1886, in which 10 yachts took part, being distributed in 5 classes.

In Class 2, *SANTAPOGUE* beat *NONA* over a 22 mile course, time, 4 hrs., 5 min., 59 sec. *NONO*, 4 hrs., 6 min., 6 sec. In Class 4, *GANNET* beat *REVERIE* and *ZOE*; time, 4 hrs., 18 min., 17 sec. *ZOE*, 4 hrs., 20 min., 9 sec.; *REVERIE*, 4 hrs., 22 min., 20 sec.

NEZLE, in Class 8, beat *DOROTHY*; *ORIENTA* being disabled; time, 4 hrs., 35 min., 9 sec., over a 17 mile course. *DOROTHY*; time, 4 hrs., 35 min., 9 sec.

In Class 3, *VOLUSIA*, the only entry, was disabled. The next Regatta was held October 2, 1886, over a 22 mile course. In Class C, *CLARA* beat *CINDERELLA*; time, 2 hrs., 39 min., 23 1-5 sec. *CINDERELLA*, time, 2 hrs. 40 min., 54 3-5 sec.

In Class 2, *NONA* won, beating *SANTAPOGUE*, time, 3 hrs., 10 min., 45 sec. *SANTAPOGUE*, time, 3 hrs., 11 min. *SURF* broke down and *SARA* did not finish. Towards the end of the race the wind came in puffs.

A Match Race was sailed May 30, 1887, each boat \$200, contributing

FANITA beat ECLIPSE, the time taken by the only seven yachts in the Sixth Annual Regatta, schooners, parse in 4 hrs., 58 min., 15 sec. DAPHNE, VIXEN, winning in 4 hrs., 35 min., 15 sec. sailed in nine classes. sailed out towards the 8, cut-rigged, FAIRY On August 22, 1885,

participated, the course limited to mainsails, sails to mainsails only. TELEPHONE was being a working boat, 10 sec.

hrs., 59 min., 46 sec., 1 sec.

in which CLARA, 56.24 BELLA over a 22 mile race, in Class 3, beat Yodling the home stake in their respective

July 5, 1886; forty-eight in classes.

competed over a 22 mile race, 14 sec.; the latter not

former finishing in 6 hrs., and CLARA raced, the CINDERELLA's time being at ATHLON; time, 5 hrs., 11 sec.

July 21, 1886. There were six boats. GRACE MACKAY, 28 hrs., 28 min., 47 sec., 29 min., 33 sec., and 11 sec.

3 hrs., 45 min., 41 sec. 3 hrs., 51 min., 58 sec. time, 4 hrs., 9 min., 5 sec.

A Regatta was sailed part, being distributed

a 22 mile course, time, 4 in., 6 sec. In Class 4, 18 min., 17 sec. ZOE, min., 20 sec.

TA being disabled; time, DOROTHY; time, 4 hrs.,

is disabled. The next 2 mile course. In Class min., 23-5 sec. CIN-

time, 3 hrs., 10 min., SURF broke down and the race the wind came in

h boat \$200, contributing

between SHREW, 24.11 feet, owned by H. H. Chittenden; NAHLL, 24.04½ feet, owned by Wm. E. Connor and LA PERICHOLE, 24.01½ feet, owned by C. P. Buchanan.

NAHLL beat SHREW 2 min., 48½ sec., and LA PERICHOLE 17 min., 6 sec. The course was from Larchmont to and around the buoy at Throggs' Neck and return. Time allowance 2 minutes to the foot for 20 mile race.

	Time.
	H. M. S.
Shrew	3 30 59
Nahll	3 24 10 1-2
La Perichole	3 40 16 1-2

The Spring Pennant Regatta was sailed June 4, 1887. The winners were as follows:

Class D, Titania, Prize, solid silver dish given by Commodore W. S. Alley.

Class	Yacht	Prize	Pennant
" 2	Schener	" \$65	"
" 3	Nymph	" "	"
" 4	Loriva	" "	"
" 8	Fairy, 1st	" \$25	"
" 8	Oriana, 2d	" \$20	"

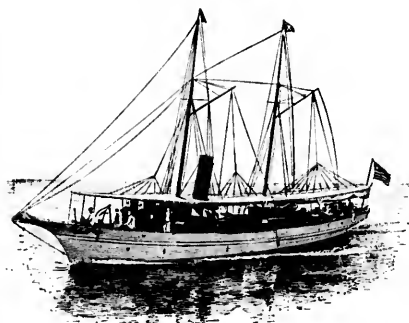

JESSIE.—FIGURE 325.

The Eighth Annual Regatta took place July 4, 1887. TROUBADOUR won a prize of \$100 in Class A, beating SPERANZA and MAGIC over a 27 nautical mile course.

	Time.
	H. M. S.
Troubadour	3 43 05
Speranza	3 51 09 1/2
Magic	3 52 57

In Class B, COMET won a \$90 prize, beating NIRVANA and SOUTHERN CROSS; time, 4 hrs., 01 min., 59 sec.

GEVALIA won a \$75 prize, beating LOTTIS and LEONA; time, 3 hrs., 35 min., 21 sec.

The sloop SHANPOCK, in Class E, was awarded a prize of \$100, TITANIA came in first, but was ruled out for carrying too many men.

CINDERELLA won a \$90 prize in Class F, beating HILDEGARD. FANITA, in Class 1, beat ADELAIDE, CONCORD, DAPHNE, ULIDIA, ROVER, ARIADNE and KELPIE. The prize was \$60; time, 3 hrs., 34 min., 20 sec., over a 21 mile course.

The other winners were as follows:

Class	Yacht	Prize
2	Rival,	\$50.
" 3	Volusia,	1st " \$50.
"	Betrix,	2d " \$45.
" 4	Arab,	" \$45.
" 5	Glenn,	" \$45.
" 6	Anmda,	" \$35.
" 9	Adele,	" \$30.
" 10	Ada,	" \$25.
" 11	Narrtoch,	" \$20.

Sixty-nine yachts were entered in the various classes. TROUBADOUR and COMET carried away their foretopmasts, while the latter also her flying jib boom.

ELEPHANT, RAJAH and STRANGER were ruled out, TERRAPIN and NARRTOCH having same corrected time, 3 hrs., 46 min., 49 sec., matched coins for the prize or race, the latter winning.

The Third Annual Oyster Boat Regatta took place August 20, 1887. Twenty-nine yachts were entered and divided into three classes. The winners were:

Class	Yacht	Prize
Class One,	CADIN SLOOPS,	
	Grace Mackay,	1st Prize \$75
	Agnes,	2d Prize \$45.

Class	Yacht	Prize
Class Two,	OPEN SLOOPS,	
	Flyaway,	1st Prize \$50.
	Jennie A. Willis,	2d Prize \$40.

Class	Yacht	Prize
Class Three,	CAT-RIGGED,	
	Uncle Dave,	1st Prize \$10.
	Sea Spray,	2d Prize \$25.

The course for all classes was 21 miles.

Time allowance, Classes 1 and 2, 1½ minute to the foot. Class 3, 1½ minute to the foot. There was a good sailing breeze.

GRACE S. MACKAY beat W. H. ROWE, LIZZIE D. BELL and JENNIE A. BENEDICT; the time was, 3 hr., 33 min., 00½ sec.

A match sail between NORA, GANNETT, REVERIE and BRENDA took place August 21, 1887, and the yachts finished in the order named; NORA beating GANNETT 3 min., and 22 sec.

The Fall Regatta was held September 3, 1887. Nineteen yachts were entered in 9 classes. MAGIC won in Class A, SPERANZA, the only contestant, failing to finish.

In Class E, SHAMROCK beat FANNY 20 minutes and 3 second.

A Special Race was sailed September 10, 1887, for two prizes offered by the club. The 1st prize, \$250, was won by SHAMROCK and the \$100 prize won by TITANIA. The distance was 35 miles, and the first time attempted was not sailed within 8 hours, and was consequently sailed over September 25, 1887, with the above result.

FANNY and MISCHIEF started the first time but not the second time; GRACIE started the last time, but did not finish.

SHAMROCK beat TITANIA by 15½ seconds; time, 4 hr., 15 min., 51½ sec.

A Special Race was sailed between ANACONDA, owned by John G. Prague, and CINDERELLA, owned by Wm. E. Iselin, September 12, 1887, for \$250 a side. The course was from Larchmont to and around Hog Island Buoy and return.

The wind was blowing very hard from east northeast. ANACONDA was unable to go over the course. CINDERELLA finished, actual time, 4 hrs., 20 min., 14 sec.

A Match Race for \$250 a side between WIZARD and VIVID was started May 30, 1888, but was resailed June 2, 1888, as the first race was not finished within eight hours. The wind on June 2nd was about south southwest, a good sailing breeze.

The course was from Larchmont to stake boat in Hempstead Harbor, thence to and around stake boat near Stamford Harbor Light-house, returning over same course; distance 27 nautical miles.

WIZARD was sailed by G. Kortright, and VIVID by Harvey Van Wyck; WIZARD won, beating VIVID 17 min., 23 sec., or making the course in 6 hrs., 53 min.

The Spring Regatta was sailed June 9, 1888.

There were twenty yachts entered, distributed in ten classes. The course was the regular club course; wind southwest south, good whole sail breeze.

In Class E, AGNES beat LEONA.

In Class 3 SHAMROCK beat FANNY and HURON. In class 6 DAPHNE beat ADELAIDE and NYMPH. In class 8 EURYBIA beat ARIEL.

In Class 9, KANGAROO beat AMAZON.

In Class 14, LORNA beat SHREW.

In Class 15, FAIRLY beat OLIVE N., and in Class 16, KID beat NARRI-OCH.

The Ninth Annual Regatta took place July 4, 1888, over the regular club courses as revised in Sailing Rules and Regulations for 1888. Thirty-seven yachts took part in 12 classes.

In Class B, schooners 79 to 91 feet load waterline, TROUBADOUR won in 3 hrs., 41 min.; time of MAGIC 3 hrs., 46 min., 58 sec.,

In Class E, schooner LOTUS won in 3 hrs., 12 min., 32 sec.; time of Agnes 3 hrs., 14 min., 57 sec.; of LEONA 3 hrs., 18 min., 36 sec.

In Class 5, sloops 47 to 54 feet load waterline, ANACONDA won; time, 3 hrs., 07 min., 52 sec.; ROAMER second, time 3 hrs., 14 min., 27 sec.; ATHLON third, time 3 hrs., 24 min.

In Class 6, sloops 41 to 47 feet load waterline, ADELAIDE won; time, 3 hrs., 11 min., 18 sec.; DAPHNE second, time 3 hrs., 12 min., 35 sec.; REGINA third, time 3 hrs., 16 min., 35 sec.

In Class 7, sloops 35 to 41 feet load waterline, PAPOOSE won; time, 3 hrs., 16 min., 20 sec.; NYMPH second, time 3 hrs., 16 min., 50 sec.; RIVAL third, time 3 hrs., 19 min., 52 sec.; BANSHEE fourth, time 3 hrs., 20 min., 54 sec.

In Class 8, sloops 30 to 35 feet load waterline, EURYDIA won; time, 2 hrs., 39 min., 20 sec.; RAJAH second, time 2 hrs., 43 min., 34 sec.; VOLVIA third, time 2 hrs., 43 min., 39 sec.; FLORA did not finish.

In Class 9, sloops 25 to 30 feet load waterline, KANGAROO won in 2 hrs., 45 min., 10 sec., beating VORANT, MOYA, GEM, AMAZON, and MERLIN in order mentioned.

In Class 10, VIXEN won in 2 hrs., 17 min., 23 sec., beating GLEAM and PILOT.

The prizes were orders for silverware given by Regatta Committee.

Special prizes were offered for yachts in Classes 3 and 4, originally built before January 1, 1883.

Individual prizes were offered for members of winning yachts in Classes 12, 13, 14, 15, or 16. The Connor Cup was offered in Class 3; class did not fill. The special prize, the Gould Cup, was won by NYMPH in 3 hrs., 12 min., 08 sec., beating ADELAIDE, whose time was 3 hrs., 13 min., 02 sec.

A Match Race was sailed the next day (July 5) between BANSHEE, 41.4 feet in length, and PAPOOSE, the latter winning in 4 hrs., 10 min., 36 sec. Time of BANSHEE, 4 hrs., 12 min., 19 sec.; she was sailed by A. Cary Smith, Capt. Watson sailing PAPOOSE. The prize was a silver cup to be paid for by the losers.

The Fourth Annual Oyster Boat Race took place August 18, 1888.

The prizes were cash subscriptions by members of the club. The breeze was stiff, rather too much for the smaller boats. 25 boats took part divided into 5 classes.

WATSON won in Class 1, time 5 hrs., 12 min., 17 sec., beating LIZZIE D. BELL and C. D. SMITH.

JENNIE BAKER won in Class 2; time, 5 hrs., 19 min., 16 sec.

LOOX won in Class 3, being the only entry; time, 5 hrs., 47 min., 08 sec.

JENNIE A. WILLIS won in Class 4; time, 5 hrs., 19 min., 15 sec.

JOKE won in Class 5, time 5 hrs., 43 min., 58 sec., beating FANNIE M. and PANTHENIA.

A Special Race was sailed August 31, 1888, for Class 7, measuring 35 to 41 feet load waterline.

CHIQUITA won in 3 hrs., 44 min., 20 sec., beating BANSHEE 1 min., 54 sec.

This race was particularly interesting, from the fact that it was the first sailed by the 40-footers, including the new type of boats.

The prize was a silver cup.

The course was 27 nautical miles. The wind was light, from west southwest at start, increasing to a good scupper breeze for the last half of the race.

The Fall Regatta was sailed September 1, 1888, twenty-three yachts taking part.

In Class E, AGNES won a prize of \$50, beating TROGA; time, 5 hrs., 47 min., 46 sec.

ANACONDA won on time allowance in Class 5, beating MISCHIEF, the prize being \$50; the actual time being, ANACONDA 5 hrs., 53 min., 28 sec., MISCHIEF 5 hrs., 47 min., 43 sec.

In Class 7, BARBOON took the 1st prize of \$50, time 4 hrs., 2 min., 14 sec., and NYMPH the 2nd prize of \$50, time 4 hrs., 30 min., 31 sec., beating BANSHEE, CROCODILE, PAPOOSE and INEZ in order named.

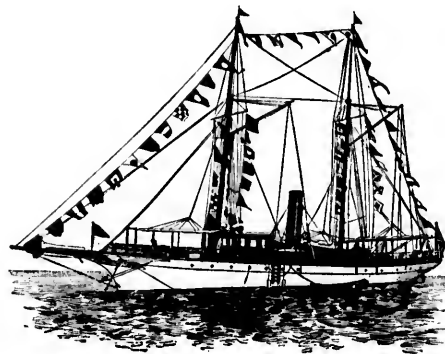

JEAN.—FIGURE 326.

In Class 8, ISEULT won a \$35 prize; time, 3 hrs., 4 min., 12 sec., beating VOLVIA and WACONDA.

In Class 9, AMAZON won a \$35 prize; time, 3 hrs., 19 min., 9 sec., beating FAUNA and VORANT.

In Class 11, LAKSHMI won a \$30 prize, time 4 hrs., 19 min., 5 sec., beating BRUNHILDE, time 4 hrs., 25 min., 54 sec., and WHITE CAP, time 5 hrs., 22 min., 15 sec.

In Class 12, SIREN won a \$25 prize, beating APACHE, belonging to Class 13.

In Class 16, LOXE beat GWENDOLINE, thus winning a \$25 prize in 3 hrs., 58 min., 10 sec.

The prizes were silver cups. The course was as provided in Sailing Rules of 1888.

A Special Race took place September 3, 1888, between NYMPH, BARBOON and BANSHEE. NYMPH won in 4 hrs., 34 min., 18 sec.; BARBOON, time 4 hrs., 38 min., and BANSHEE, time 4 hrs., 45 min., 19 sec. The prize was a silver cup. No restrictions as regards sails, sailing masters, helmsman or crew. Club topsails allowed and carried. The course was 12 miles to windward and return. A good stiff breeze and perfect day.

A Special Race for jib and mainsail yachts was sailed September 15, 1888. In the 25 and 30 foot class, ANAXO won; SUSIE S., the only competitor, capsized.

In the 23 and 25 foot class, EXPERT won, time 2 hrs., 59 min., 29 sec., beating TWILIGHT, SIREN and NAHLI in order named. The prize in each class was \$100 from the club and in case five or more started, a second prize of \$50.

A Special Race was sailed September 30, 1888, for a \$25 cash prize given by the club. BRENDA won, time 3 hrs., 19 min., 15 sec., beating GANNET, time 3 hrs., 19 min., 40 sec., and NORA, time 3 hrs., 20 min., 10 sec. The course was from Larchmont to and around

was light, from west
r breeze for the last

1888, twenty-three

TIOGA; time, 5 hrs.,

5, beating MISCHIEF.
ONDA 5 hrs., 53 min.,

, time 4 hrs., 2 min.,
hrs., 30 min., 31 sec.,
NEZ in order named.



, 3 hrs., 4 min., 12 sec.,

e, 3 hrs., 19 min., 9 sec.,

time 4 hrs., 19 min., 5
min., 54 sec., and WHITE

ating APACHE, belonging

us winning a \$25 prize in

e was as provided in Sail-

, 1888, between NYMCH,

4 hrs., 34 min., 18 sec.;

E, time 4 hrs., 45 min., 19

trictions as regards sails,

topsails allowed and car-

and return. A good stiff

hts was sailed September

LANDO won; SUSIE S., the

von, time 2 hrs., 59 min.,

HLI in order named. The

and in case five or more

, 1888, for a \$25 cash prize

hrs., 19 min., 15 sec., beat-

, and NORA, time 3 hrs.,

Larchmont to and around



FROM A NEGATIVE BY BOLLES

PLATE XXVIII.

EMBLA.

PLATE XXVIII

EMBLA.

FROM A NEGATIVE BY BOLLES

THE VALLEY OF

OF AMERICA

... ..
... ..
... ..
... ..

... ..
... ..
... ..
... ..

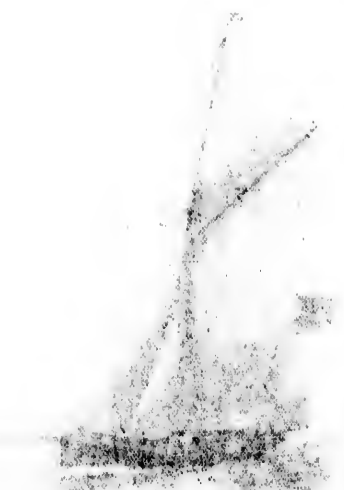

... ..
... ..
... ..
... ..

... ..
... ..
... ..
... ..

... ..
... ..
... ..
... ..

... ..
... ..
... ..
... ..

... ..
... ..
... ..
... ..

... ..
... ..
... ..
... ..

... ..
... ..
... ..
... ..

... ..
... ..
... ..
... ..

... ..
... ..
... ..
... ..

... ..
... ..
... ..
... ..

... ..
... ..
... ..
... ..

... ..
... ..
... ..
... ..

... ..
... ..
... ..
... ..

... ..
... ..
... ..
... ..



1871

Execution, thence to and around Black Buoy (Constable Buoy) and return to Larchmont, a distance of about 8 miles.

A Special Race between GANNET, NOLA and BUENDA was sailed October 7, 1888, for a \$50 cash prize (subscribed), same course as in last race. The yachts won in order named; time of GANNET 1 hr., 24 min., 13 sec.; others 1 hr., 27 min., 44 sec., and 1 hr., 32 min., 11 sec., respectively.

A Special Race was sailed May 30, 1889; the prize was a silver cup valued at \$750. The wind was about 25 to 30 miles an hour from southeast. The course was 27 nautical miles.

TITANIA, 70.06 feet load waterline, and SHAMROCK, 68.014 feet load waterline, competed. TITANIA won in 2 hrs., 49 min., 35 2-5 sec., SHAMROCK'S time being 2 hrs., 55 min., 43 1-5 sec.

A Regatta was sailed June 8, 1889, in which 14 yachts were

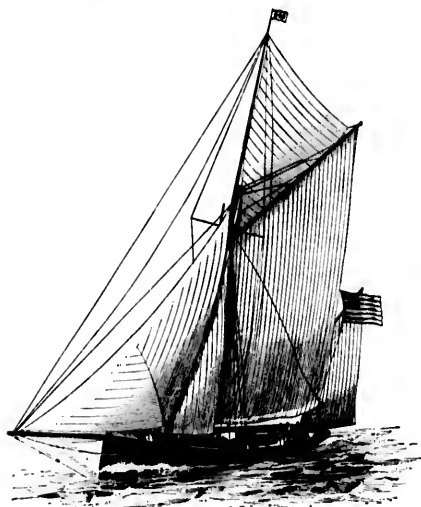

NONFARRELLIE. FIGURE 327.

entered, two of which did not start and one did not finish; there were 9 classes. Classes 5, 7, 8 and 9 sailed a distance of 20 nautical miles.

The course for classes 12, 13, 15 and 16 was 10 nautical miles. NYMPH, in Class 7, won a \$95 prize in 3 hrs., 30 min., 49 sec., beating BANSHEE, time 3 hrs., 31 min., 59 sec.

In Class 8, ERYNIA won a \$35 prize, beating VOLUSIA; time (actual), 5 hrs., 15 min., 6 sec., and 5 hrs., 17 min., 25 sec., respectively.

In Class 9, SARACEN won a \$30 prize, beating KATHLEEN, AMAZON not finishing; time (actual), 5 hrs., 16 min., 22 sec., and 5 hrs., 16 min., respectively.

In Class 15, GIGGLE won a \$25 prize in 2 hrs., 15 min., 49 sec., there being no other entry.

A Race for the Mosquito Fleet took place June 10, 1889. The prizes were two silver cups offered by the LARCHMONT YACHT CLUB. LESTRIS won in the yawl class, beating WAIF and GRAY; time (actual), 2 hrs., 2 min., 58 sec., 2 hrs., 4 min., 52 sec., and 2 hrs., 8 min., 18 sec., respectively.

BELLE, in the cat class, won, beating SURPRISE, SURE and UNIQUE not finishing.

The Tenth Annual Regatta took place July 4, 1889. 23 yachts took part in nine classes.

CLARA, in Class 5, won a prize valued at \$150, beating ANACONDA.

LOUIS, in Class 7, won a \$75 prize, beating NYMPH, MARIQUITA, BANSHEE and GORILLA; time, 5 hrs., 12 min., 20 sec. MARIQUITA won the second prize, valued at \$50; time, 5 hrs., 40 min., 26 sec.

In Class 8, ERYNIA won a prize valued at \$35, beating VOLUSIA; actual time, 6 hrs., 18 min., 8 sec., and 6 hrs., 25 min., 5 sec., respectively.

In Class 9, KATHLEEN won a \$30 prize, AMAZON and VOLANT not finishing; actual time, 6 hrs., 01 min., 15 sec. In Class 11, AWA won a \$25 prize, beating DOROTHY; time (actual), 5 hrs., 35 min., 13 sec., and 6 hrs., 54 min., 20 sec.; LAKSHMI and BRUNHILDE did not finish. In Class 13, COYOTE won a \$25 prize, beating APACHE, which did not finish; time (actual), 6 hrs., 50 min., 6 sec.

In Class 16, RIVAL won a \$25 prize, beating LONE, which did not finish, and GIGGLE, which latter yacht was upset; actual time, 6 hrs., 28 min., 8 sec.

The Gould Cup for Classes 6 and 7 was won by NYMPH.

The course sailed by Classes 5, 7, 8 and 9 was 20 miles; for classes 13, 15 and 16 the course was 10 miles; for classes 10 and 11, 13 miles.

The wind was steady at start from southwest, but in about thirty minutes changed to northwest, when the conditions became rainy and squally, which lasted about three hours, followed by light wind and calm. During the squall, yachts were shut in as if by a fog, and could not be seen from the judge's boat.

A Special Race for sloops, measuring 35 to 41 foot load waterline, was sailed on July 6, 1889, the course was ten miles to windward and back, from Larchmont to the tug DALZELL, anchored about three miles southeast of Stamford Light House.

PAPOOSE won the club prize valued at \$150, and one leg for Thayer Cup, NYMPH won the second club prize valued at \$100, beating GORILLA and MARIQUITA; time of GORILLA 7 hrs., 28 min., 45 sec., of NYMPH, 7 hrs., 28 min., 06 sec.; of MARIQUITA, 7 hrs., 32 min., 37 sec.; of PAPOOSE, 6 hrs., 23 min., 17 sec., actual time.

A Match Race was sailed August 3, 1889, between MONA and RAJAH, the latter winning in 3 hrs., 21 min., 29 sec.; time of MONA, 3 hrs., 25 min., 21 sec.

The Fifth Annual Oyster Boat Race took place August 24, 1889.

Seven boats took part in Class 1.

STELLA obtained the first prize of \$50, and GRACE S. MACKAY, the second prize of \$25; time, 4 hrs., 01 min., 42 sec., and 4 hrs., 02 min., 4 sec., respectively.

Eight boats started in Class 2. FLORENCE MAY won the first prize of \$40, and CLAUDIA N. won the second of \$25; time, 3 hrs., 56 min., 43 sec., and 4 hrs., 6 min., 19 sec., respectively.

Three boats started in Class 3.

STELLA MAY was first, prize \$40; JULIA B. was second, prize \$25; time, 4 hrs., 17 min., 32 sec.; 4 hrs., 19 min., 58 sec.; LOON was third; time 4 hrs., 32 min., 11 sec.

Nine boats sailed in Class 4.

EMMA C. was first, prize \$40; DELPHINE second, prize \$25; time, 4 hrs., 4 min., 52 sec.; 4 hrs., 6 min., 47 sec., respectively.

Five boats sailed in Class 5.

JOKE first, prize \$40; MAMIE second, prize \$25; time, 4 hrs., 43 min., 05 sec.; 4 hrs., 52 min., 49 sec., respectively.

The other boats did not finish.

The race was over a course of 20 nautical miles.

The Fall Regatta was sailed September 7, 1889. Eighteen yachts took part, in eight classes.

The course for Classes 5, 6, 7, 8 and 9 was 20 nautical miles.

For Classes 12, 13, 14, 15 and 16, 10 nautical miles, and Classes 10 and 11, 13 nautical miles.

CLARA won the first prize, Class 5, value \$75; beating ANACONDA and ELEANOR; time 2 hrs., 35 min., 19 sec.; time of ANACONDA, 2 hrs., 38 min., 07 sec.

VOLUSIA won the first prize, Class 8, value \$40, beating ALINE and CELPHIT FAX; time of VOLUSIA, 3 hrs., 07 min., 49 sec.

FAUNA won first prize, Class 9, value \$35, beating AMAZON, time (actual) 3 hrs., 26 min., 32 sec. and 3 hrs., 38 min., 16 sec., respectively.

GIGGLE won first prize, Class 16, value \$25, beating NIAMUCK and ZELDA, time, 1 hr., 56 min., 1 sec.; 1 hr., 58 min., 41 sec. and 1 hr., 59 min., 54 sec., respectively. NIAMUCK received the second prize.

AZALEA, in Class D, beat CLIO and won the first prize, valued at \$100; time, 2 hrs., 40 min., 22 sec., and 2 hrs., 50 min., 24 sec.

DONOTHY sailed the course in Class 11 and won first prize, value \$25; time (actual), 2 hrs., 48 min., 44 sec.

GIGGLE won, besides the above, individual prizes for crew.

Special Race for Class 7 sailed September 28, 1889. The course was 23 miles. LIRIS won the first prize, value \$100 and second leg for Thayer Cup.

MARIQUITA won the second prize, value \$75; time, 3 hrs., 52 min., 21 sec., GONILLA was third, time 4 hrs., 1 min., 32 sec., and BUONCHIO did not finish.

A Match Race was sailed September 29, 1889, between LIRIS, 41 ft. 6 in. and KATHLEEN, 29 ft. 10 3/4 in. Course from Larchmont to and around Hog Island Buoy No. 17, passing same on port hand to and around Matinecock Point Buoy, passing same on the starboard hand, thence to and across the finishing line off Larchmont. The

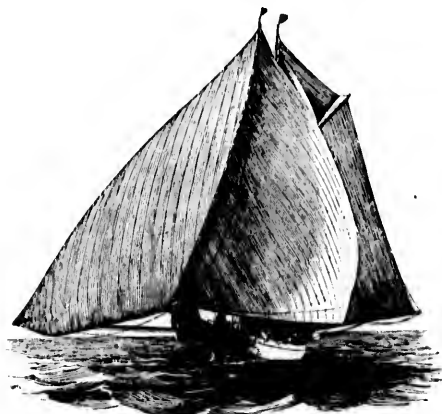

ATLANTIC.—FIGURE 328.

yachts had a fairly good breeze all the time. The time (actual) of LIRIS was 3 hrs., 54 min., 55 sec., and of KATHLEEN, 4 hrs., 25 min., 20 sec.

A Match Race was sailed September 15, 1889, between CRUISER and NIAMUCK. The course was 5 miles to windward and return. Time of CRUISER 2 hrs., 28 min., 19 sec.; of NIAMUCK 2 hrs., 44 min., 31 sec.

A Match Race was sailed May 31, 1890, although started the day before, but not completed within 7 hours.

Both yachts were handicapped after the last signal, their actual times of starting were:

	Start.	Finish.
	H. M. S.	H. M. S.
Agnes.	12 2 29	4 40 31
Azalen.	12 3 17	4 26 07

AZALEA won by 9 min., 36 sec. Time, 4 hrs., 24 min., 7 sec., and 4 hrs., 33 min., 43 sec. respectively. The race was for a prize valued at \$200, presented by the club. Captain Edward Blunt owned AZALEA, and Captain J. Norton Winslow owned AGNES. The yachts had a good sailing breeze. AZALEA lost her fore-topmast opposite Namrising Island. The course was 27 nautical miles.

The Spring Regatta was sailed June 7, 1890; 13 yachts in 5 classes started. In Class E, AGNES won prize valued at \$100, beating LEONA and ELFIN. Time, 2 hrs., 35 min., 54 sec.; 2 hrs., 54 min., 55 sec.; 3 hrs., 3 min., 18 sec., respectively.

In Class 4, CLARA (sailover) won prize, value \$75. Time, 2 hrs., 18 min., 50 sec.

In Class 5, LIRIS won first prize, value \$150.

In Class 5, MINERVA won second prize, value \$75, beating MARIQUITA and HELEN; time, 2 hrs., 30 min., 15 sec., and 2 hrs., 30 min., 54 sec.

In Class 6, KATHLEEN won prize, value \$65, beating BRUNCHO. Time (actual), 3 hrs., 1 min., 32 sec., and 3 hrs., 3 min., 56 sec.

In Class 16, GIGGLE won prize, of \$30, beating ZELDA. Time (actual), 1 hr., 54 min., 20 sec., and 1 hr., 56 min., 8 sec. The course for all classes except 16, was 20 nautical miles, for Class 16 the distance was 10 nautical miles. The yachts had a fresh whole sail breeze from the southwest.

A Match Regatta was sailed June 17, 1890, for a prize valued at \$100, between the schooner LEONA, Vice-Commodore Sterling, and ELFIN, Rear Commodore Jackson. The prize was presented by the club.

The course was from an imaginary line between the new black buoy on Hen and Chickens Reef and the flag ship, DAPHNE at anchor to the eastward, to and around Execution Reef, leaving all buoys on the port hand; thence to and around DAPHNE, anchored about 200 yards southwest of the Spar Buoy and western end of Great Captain's Island; thence to and around Execution Reef, leaving all buoys on the starboard hand; thence back to and across starting line. The wind was south, moderate and steady. Judge Francis M. Scott, Chairman Regatta Committee. LEONA won; time 4 hrs., 59 min., 49 sec. Time of ELFIN, 5 hrs., 11 min., 16 sec.; of ANACONDA, 4 hrs., 44 min., 57 sec.; of CLARA, 4 hrs., 47 min., 6 sec. This race was sailed for the cup won by CLARA in the Spring Regatta, the owner having offered the same.

In Class 5, LIRIS beat MARIQUITA and CHOCTAW, time 3 hrs., 31 min., 8 sec.; 3 hrs., 44 min., 35 sec., and 4 hrs., 02 min., 35 sec., respectively. MINERVA, 45.61 feet sailing measurement, elected to sail in Class 5, assuming the lowest limit of that class and receiving 1 min., 39 sec. from Liris. For the Gould Cup, MINERVA sailed on her actual sailing length receiving from LIRIS 3 min., 14 sec.

	Time.
Fifth Class.	H. M. S.
Liris,	3 31 08
Mariquita,	3 44 35
Choctaw,	4 02 35

Sixth Class.	
*Minerva	3 28 31
	3 27 15

*For Gould Cup.

Eleventh Annual Regatta was sailed July 4, 1890; 31 yachts started, distributed in 10 classes, VIATOR did not go the course.

	H. M. S.
Azalen.	3 53 57
Gevalia,	3 48 40
Lotus,	(actual) 4 04 00

AZALEA and GEVALIA were disqualified for carrying as members of their crew men who were neither amateurs nor members of the regular crew, and the prize was therefore awarded to LOTUS, but the owner refused to receive the same.

In Class 6, ANACONDA and CLARA sailed. The owners of ANACONDA refused to have the yacht measured and conceded the race to CLARA.

In Class 7, KATHLEEN won; time, 4 hrs., 23 min., 40 sec., beating VOLUPTA, time 4 hrs., 24 min., 39 sec., MAHOTA, VORANT and SASSAQUA. In Class 8, KANGAROO won; time, 4 hrs., 57 sec., 04 min.;

13 yachts in 5 classes
\$100, beating LEONA
rs., 54 min., 55 sec.; 3

ne \$75. Time, 2 hrs.,

ne \$75, beating MAURICE,
e., and 2 hrs., 30 min.,

\$65, beating BRONSON,
and 3 hrs., 3 min., 50

ating ZELICA. Time
min., 8 sec. The course
es, for Class 16 the dis-
a fresh whole sail breeze

00, for a prize valued at
omodore Sterling, and
e was presented by the

between the new black
flag ship DAPHNE at
ention Reef, leaving all
and around DAPHNE,
Spar Buoy and western
around Execution Reef,
ence back to and across
ate and steady. Judge
(tee. LEONA won; time
rs., 11 min., 16 sec.; of
IA, 4 hrs., 47 min., 6 sec.
IA in the Spring Regatta,

HOCTAW, time 3 hrs., 31
hrs., 02 min., 35 sec.,
asurement, elected to sail
lass and receiving 1 min.,
ERVA sailed on her actual
4 sec.

Time.
H. M. S.
3 31 08
3 44 35
4 02 35

3 28 31
3 27 15

4, 1890; 31 yachts started,
the course.

H. M. S.
3 53 57
3 48 40
4 04 00

or carrying as members of
or members of the regat-
rded to LOTUS, but the

. The owners of ANA-
d and conceded the race

, 23 min., 40 sec., beating
IOTA, VOIRANT and SAS-
4 hrs., 57 sec., 04 min.;

AMAZON did not finish. In Class 9, VIXEN won. In Class 11, AWA won; time, 4 hrs., 04 min., 46 sec.; ELFIN second, time 4 hrs., 07 min., 21 sec.; FALCON third and LAKSHMI fourth.

In the mainsail yachts, Class 14, EDNA won; walk-over.

In Class 16, NEXT won first prize by 1 min., 15 sec., and ZELICA won second prize, beating RIVAL and GIGOLE.

Sixth Annual Oyster Boat Race, sailed August 23, 1890. Twenty-one boats took part, distributed in five classes. This race was open to oyster boats, regularly engaged in the oyster business.

Time allowance 1 1/2 minute per foot. The course was 20 nautical miles. The wind was from the northeast and was fresh.

WINNERS:—Class 1		1st Prize \$50
" 1	Combination	24 " \$25
" 2	Beside B.	1st " \$10
" 3	Claudia M.	2d " \$25
" 3	Stella May	1st " \$10
" 3	Julia D.	2d " \$25
" 4	Susie C.	1st " \$10
" 4	Addie B.	2d " \$25
" 5	Shunrock	1st " \$10
" 5	Delphine	2d " \$25

Judges, Francis M. Scott and Oswald Sanderson.

Special Race for open yachts sailed August 30, 1890. This was an invitation race. Yachts to be manned by amateurs. Course, to and around Matinecock Buoy and back and repeat; 16 nautical miles. ZELICA capsized; RIVAL lost a man overboard, and after recovering him withdrew.

Wind was west northwest, fresh. The same judges as in the last race acted. PUYLLIS was the only yacht to finish; actual time, 4 hrs., 25 min., 26 sec. RIVAL did not finish.

The Fall Regatta was sailed September 6, 1890. Sixteen yachts started in six classes. The course was the regular LAUNCHMONT YACHT



PHAROS.—FIGURE 329.

Club course, as set forth in Club Book of this year. Wind was light and trifling. The winners were:

Class 4, CLARA, JESSICA elected to sail in Class 4, and with consent of owner of CLARA, sailed on the actual racing length. CLARA 12 hrs., 01 min., 00 sec.; JESSICA, 12 hrs., 48 min., 37 sec.

Class 5, MINEIVA, 7 hrs., 6 min., 40 sec., beating MARIQUITA, 7 hrs., 21 min., 39 sec., and LIRIS, 7 hrs., 6 min., 40 sec.

Class 7, KATHLEEN, 7 hrs., 34 min., 33 sec., beating VOLUSTIA, 7 hrs., 39 min., 57 sec., and SASQUA, 7 hrs., 59 min., 10 sec.

In Class 8, AMAZON beat BURNTILDE, which did not finish. Actual time, 9 hrs., 56 min., 57 sec.

In Class 11, ELFIN won, beating AURA and MINNETTE, the latter not finishing; time, 6 hrs., 26 min., 51 sec., and 6 hrs., 30 min., 24 sec., respectively.

In Class 16, PUYLLIS won, beating RIVAL and ZELICA; time, 4 hrs., 37 min., 55 sec.; 4 hrs., 42 min., 36 sec.; 4 hrs., 42 min., 50 sec., respectively.

MINEIVA elected to sail in Class 5, assuming the lowest limit of that class.

A Match Race was sailed September 7, 1890. The course was to windward and return, without time allowance. The terms were private. NORA and CADAJAH competed; time (actual), NORA, 1 hr., 35 min.; CADAJAH, 1 hr., 39 min.

A Special Race was sailed September 8, 1890, between JESSICA,

LIRIS, MARIQUITA and MINEIVA; being for yachts measuring from 40 to 50 feet racing length.

The course was 12 miles to windward and return. The wind was east by north and steady.

JESSICA carried away port spreader soon after starting, but repaired damages and proceeded.

MINEIVA won the first prize, a \$200 cup, in 4 hrs., 33 min., 02 sec., and MARIQUITA won the second prize in 4 hrs., 55 min., 51 sec. LIRIS was third, time, 5 hrs., 05 min., 38 sec., and the time of JESSICA was 5 hrs., 10 min., 42 sec.

Francis M. Scott and Commodore Lowrey acted as judges.

A Match Race was sailed September 10, 1890, which was first of a series of races, (best two in three) terms private; SEAWANAKA COLUMBIAN YACHT CLUB scale of time allowance; time allowance, Larchmont rules.

Course: LAUNCHMONT CLUB Course No. 2.

LIRIS carried away her tiller after rounding Captain's Island stake boat. The wind was northeast and strong.

The judges were Commodore Lowrey, T. C. Zerega and Thornton Smith. MINEIVA won; actual time, 2 hrs., 48 min., 25 sec.

On September 11, 1890, the second series was sailed.

The course was ten miles to windward and return; the wind was east northeast and strong, with heavy sea.

MINEIVA, time, 4 hrs., 19 min., 42 sec.; LIRIS, time, 4 hrs., 26 min., 36 sec.

An attempt was made to sail the race on the 9th, but as it was not accomplished within the required time, was declared off.

The Spring Regatta of the LAUNCHMONT YACHT CLUB was sailed June 6, 1891. The course for Classes D and 5 was 20 knots; for Classes 10 and 11, 13 knots, and for Classes 13 and 14, 10 knots. The wind was northeast and moderate. The following yachts started a few minutes after noon:

SCHOONERS.				
Class D.	Sailing Length.	Time Allowance.	Elapsed Time.	Corrected Time.
	Feet.	M. S.	H. M. S.	H. M. S.
Princess	71.47		3 21 27	3 21 27
Viator	65.02	03 32	3 04 35	3 01 03
SLOOP.				
Class 5.				
Jessica	53.45		2 46 42	2 46 42
Liris	48.83	04 30	3 06 53	3 02 17
Class 8.				
Delynn				did not start
Volusia				did not finish
Class 10.				
Smuggler	24.94		2 42 06	2 42 06
Nameless	24.87	0 02	2 47 53	2 47 51
CABLE CAT-BOATS.				
Class 11				
Aura	20.07		3 12 38	3 12 38
Nelle	26.06	5 07	3 01 08	2 59 01
Dot	25.07	7 58	3 03 04	2 55 06
Minnette	20.51	21 21	3 27 01	3 05 40
No Name			3 31 12	
OPEN YACHTS.				
Class 13.—Unofficial.				
Cruiser	25.50		2 02 42	2 02 42
Coyote	24.24	01 53	2 05 54	2 04 01
Class 14.				
Edna			1 56 57	sail over
Class 16.				
Zelica				did not start

The winners were VIATOR, JESSICA, SMUGGLER, DOT and CRUISER, in their respective classes. Judges of the race, the Regatta Committee.

HISTORY OF THE LARCHMONT YACHT CLUB.

290

A Match Race over a 20 knot course, between PRINCESS (71.47 feet) and VIATOR (65.92 feet) was sailed June 20, 1891. The wind was southeast, light at the start, and freshening at the finish. VIATOR won; time, 5 hrs., 58 min., 24 sec. The terms were private, the club presenting a cup. The corrected time of PRINCESS was 5 hrs., 50 min., 7 sec., being allowed 3 min., 32 sec. Judge, Francis M. Scott.

A Special Race between SAYONARA (54.24 feet), MINEOLA (54.20 feet) and JESSICA (50.22 feet), was sailed over a 24 knot course on June 30, 1891. The wind was from east northeast at the start and southeast at the finish, and was a good sailing breeze throughout. SAYONARA won the first prize (\$250 Cup), and MINEOLA won the second prize (\$100 Cup). SAYONARA allowed MINEOLA 02 sec., and JESSICA was allowed 4 min., 37 sec. The corrected time was, SAYO-



BO-PEEP.—FIGURE 330.

NARA, 4 hrs., 08 min., 20 sec.; MINEOLA, 4 hrs., 10 min., 2 sec., and JESSICA 4 hrs., 15 min., 31 sec. The judges were, Francis M. Scott and Otto Sarony of the Regatta Committee.

The Annual Regatta was sailed July 4, 1891, starting about 11:55 A. M. The courses were: For Classes C, D, 4, 5, 7, 8 and 9, 20 knots; for Classes 10 and 11, 13 knots, and for Classes 12, 14, 15 and 16, 20 knots.

The wind was fresh and steady from the west southwest. The following yachts started:

SCHOONERS.		Time Allowance.	Elapsed Time.	Corrected Time.
		H. M. S.	H. M. S.	H. M. S.
Class C.	Princess	scratch		
Class D.	Viator	02 50	3 08 07	3 05 17
	Tempest	05 30	3 17 46	3 42 10
	Lotus	04 42	3 29 41	3 21 02

SLOOPERS.		Time Allowance.	Elapsed Time.	Corrected Time.
		H. M. S.	H. M. S.	H. M. S.
Class 4.	Clara			did not start
Class 5.	Sayonara	scratch	2 53 27	2 53 27
	Mineola	00 30	2 53 28	2 52 58
	Jessica	04 00	2 51 17	2 43 17
	Nautilus	05 30	2 53 44	2 51 14
Class 7.	Mistral	01 00	3 30 03	3 35 03
	Saona	03 45	3 47 19	3 43 24
	Viking	01 00	did not finish	
	Kathleen	scratch	3 39 05	3 39 05
	Senorita	scratch	did not finish	
	Sasqua	02 00	3 31 17	3 32 17
Class 8.	Kangaroo	scratch	3 53 45	3 53 45
	Ariel	01 30		not timed
Class 9.	Amazon	00 30		not timed
	Iris	06 30		
	Bantam	scratch		

SLOOPERS.		Time Allowance.	Elapsed Time.	Corrected Time.
		H. M. S.	H. M. S.	H. M. S.
Class 10.	Smuggler	scratch	2 53 27	2 53 27
	Nameless	scratch	2 38 26	2 34 26
	Coyote	02 00		did not start
	Toad	15 00		did not start
	Nesle	00 45	2 41 51	2 41 06

CABIN-YACHTS.		Time Allowance.	Elapsed Time.	Corrected Time.
		H. M. S.	H. M. S.	H. M. S.
Class 11.	Nelle	01 00	2 45 02	2 44 02
	Dot	scratch	2 42 44	2 42 03
	Wonder	02 30		did not start
	Nahua	12 00		did not start
	Minnette	25 00	2 51 21	2 26 21
	Aura	scratch		disqualified
	Ellin	02 00		did not start
	Narika	25 00		

OPEN YACHTS.		Time Allowance.	Elapsed Time.	Corrected Time.
		H. M. S.	H. M. S.	H. M. S.
Class 12.	Stren			did not start
Class 14.	Tattler	scratch	2 25 35	2 25 35
	Edna	05 00		did not start
Class 15.	Ada		2 00 10	2 00 10
	Vanda			disqualified
Class 16.	Phyllis	scratch		did not start
	Zellen	02 00	2 02 05	2 02 05

This race was a handicap, the figures in the allowance column showing in minutes and seconds the handicapping of the yachts.

The schooners were classed together for the purpose of handicapping. The conditions governing the club prizes were such that to insure a first prize it was necessary that at least two yachts should start in the class; to insure a second prize it was necessary that at least four yachts should start in the class.

The special prizes for certain classes were the Connor Cup and the Gould Cup, which were open to competition only to yachts enrolled in the club, and prizes to be held by their respective winners until the next Annual Regatta. There being no entries for Class 6, the Gould Cup was not awarded.

VANDA was disqualified for carrying a larger crew than permitted by the rules.

ELFIN was disqualified for fouling DOT. The elapsed time of SAYONARA was only one second less than that of MINEOLA. The racing length of SAYONARA (54.24 feet) exceeded that of MINEOLA (54.20 feet) by 4-100 of a foot, which would entitle MINEOLA to an allowance of a little more than one second, and less than one second and a half. Under these circumstances, the Regatta Committee declined to award the Connor Cup, considering the race as practically a tie between the two yachts.

The winners were as follows:
JESSICA won a special prize for all yachts from 50 to 60 feet racing length.

WINNERS.—Schooners, Class 11.		Viator,
5th Class	Sloopers	Jessica, 1st Prize.
5th "	"	Mineola, 2d Prize.
7th "	"	Sasqua, 1st Prize.
7th "	"	Mistral, 2d Prize.
7th "	"	Kangaroo, 1st Prize.
8th "	"	Smuggler, 1st Prize.
10th "	"	Minnette, 1st Prize.
11th "	"	Dot, 2d Prize.
15th "	"	Ada, 1st Prize.
16th "	"	Zellen, 1st Prize.

Corrected
Time.
U. S. S.

27 2 33 27
28 2 34 26
did not start
did not start
31 2 41 00

45 02 2 44 02
49 43 2 49 03
did not start
did not start
51 21 2 40 21

disqualified
did not start

did not start

2 25 35 2 25 35
did not start

2 00 10 2 00 10
disqualified

did not start
2 02 05 2 02 05

errors in the allowance column
handicapping of the yachts.
for the purpose of handicap-
club prizes were such that to
at least two yachts should
ize it was necessary that at least

were the Connor Cup and the
petition only to yachts enrolled
by their respective winners until
being no entries for Class 6, the

ing a larger crew than permitted

ing Dot. The elapsed time of
s than that of MINEOLA. The
feet) exceeded that of MINEOLA
which would entitle MINEOLA to an
second, and less than one second
ances, the Regatta Committee de-
onsidering the race as practically

all yachts from 50 to 60 feet racing

Victor,
essica, 1st Prize.
ineola, 2d Prize.
asqua, 1st Prize.
Mistral, 2d Prize.
Kangaroo, 1st Prize.
Smuggler, 1st Prize.
Minnette, 1st Prize.
Dot, 2d Prize.
Ada, 1st Prize.
Zelien, 1st Prize.

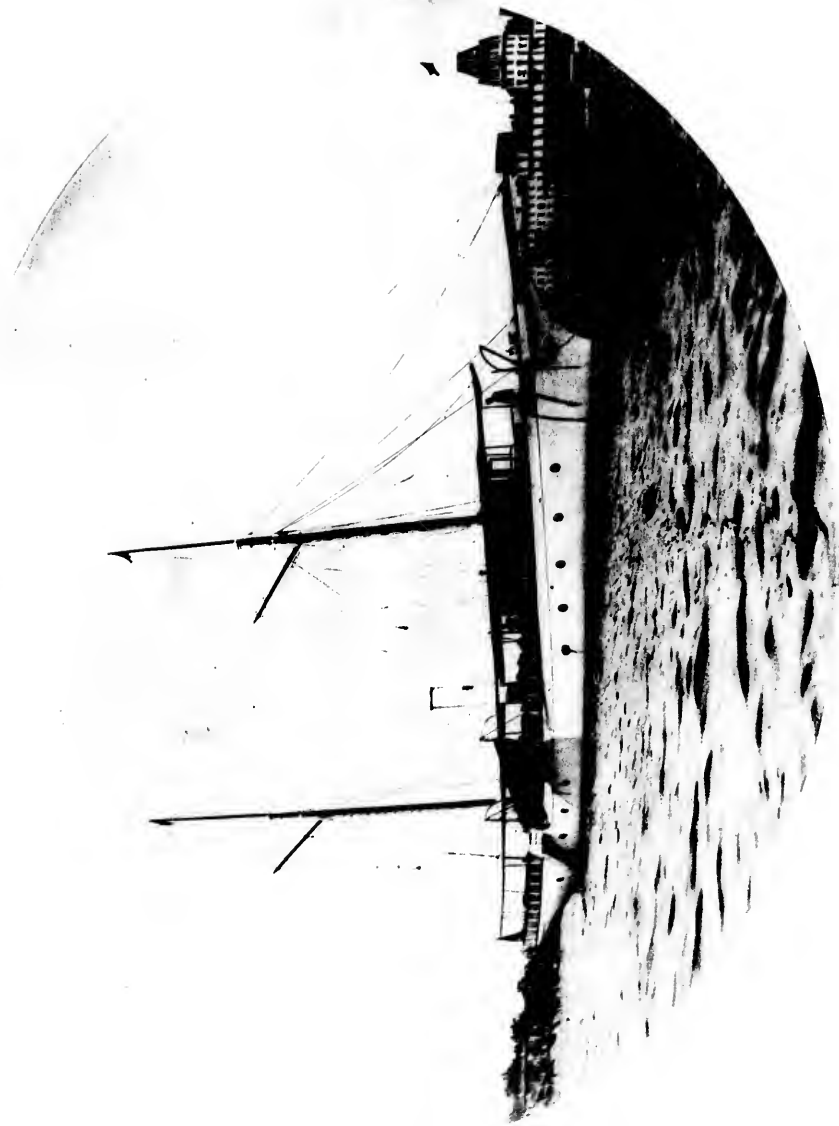

VIVIENNE.

PLATE 1000

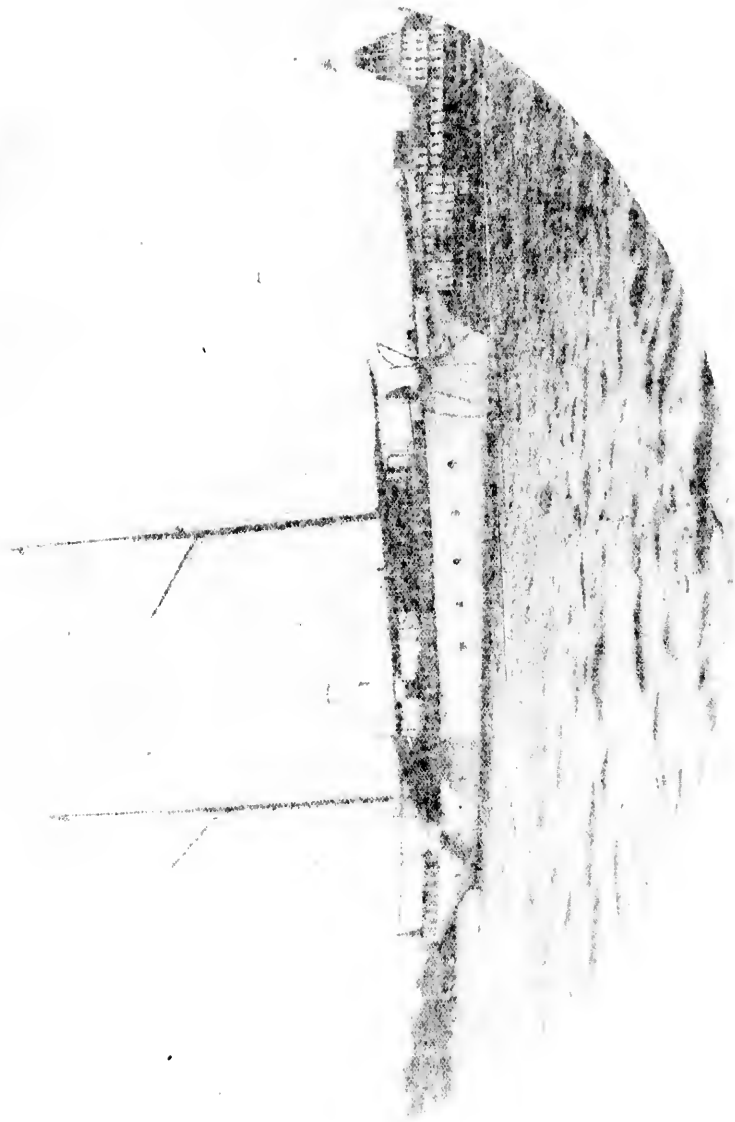

1862

The judges were: Francis M. Scott, Otto Sarony, Harold S. Forwood—Regatta Committee.

A Special Race, open to all yachts under 25 feet racing length, was sailed August 1, 1891. Only two yachts started, NAMELESS and COYOTE. The course was from Constable's Buoy to Westerly Buoy on Execution Reef and return—twice around. The wind was south southwest and blowing hard. COYOTE did not finish; NAMELESS started at 12 hrs., 26 min., 27 sec. and finished at 1 hr., 48 min., 15 sec., winning a \$50 cup presented by C. W. Wetmore.

The judge was Otto Sarony.

A Sweepstakes Race from Larchmont to Sands Point and return was sailed August 2, 1891. The wind was south southeast, light at start, at finish a calm. NAMELESS and COYOTE started. NAMELESS won, time 4 hrs., 57 min., 2 sec. (elapsed); time of COYOTE, 5 hrs., 19 min., 3 sec.

Judge, Otto Sarony.

A Special Club Cup Race from Club House to Execution Reef and return, was sailed August 23, 1891, between BRENDA and NOVA. The wind was moderate from the south southeast.

BRENDA won; time, 1 hr., 44 min., 45 sec., (elapsed). Time of NOVA, 1 hr., 47 min., 45 sec., (elapsed). Judge, Otto Sarony.

The Seventh Annual Open Oyster Boat Race was sailed over a 20 knot course on August 29, 1891, starting about 11:50 o'clock. The wind was light and from west northwest.

The following yachts entered:

		CABIN SLOOPS.			
		Sailing Length	Time Allowance	Elapsed Time.	Corrected Time.
		FEET.	H. M. S.	H. M. S.	H. M. S.
First Class.					
	Mary Ella	41.00		6 00 25	6 00 25
	Agnes	39.00	03 00	did not finish	
	Blue Rock	37.07	05 07		
	Lizzie D. Bell	37.00	00 00		
	Jennie R.,	35.06	08 15	6 01 05	5 52 50
Second Class.					
	Barthenia	33.07			
	Emma R. Martin	33.07	05 07	6 01 08	5 56 01
	Ally Bay	30.03	05 37	6 31 44	6 20 07
	Claudia M.	29.01	07 00	5 57 31	5 50 31
	Eliza D. Bird	29.00	07 30	6 23 12	6 15 42
	Jason	31.00	allows	5 57 59	5 57 59
	Emily	29.00	07 30	6 12 51	6 05 21
	Mary	29.00	07 30	did not finish	
	Julia B.	31.00	01 30	6 01 54	6 00 24
	Eva C.	32.00	03 00	6 12 50	6 09 50
	Harvey M.,	29.00	07 30	did not finish	
	Rover	33.00	01 30	" "	" "
	Frank Hopkins	32.00	03 00	" "	" "
		OPEN SLOOPS.			
Third Class.					
	Simon Banks	31.00		6 11 36	6 11 36
	Stella May	30.02	01 15	did not start	
Fourth Class.					
	Shamrock	26.06		6 05 45	6 05 45
	Jennie A. Willis	25.09	01 07	5 48 48	5 47 41
	Agitator	24.06	03 00	5 55 11	5 52 11
	Addie B.	24.06	03 00	6 05 06	6 26 00
	Nettle	24.05	03 07	did not finish	
	Carrie B.	21.06	07 30	6 14 51	6 07 21
	Minnie	27.00		did not finish	
	Loon	31.08		" "	" "
		CAT-BOATS.			
Fifth Class.					
	Joke	25.00		did not finish	
	Niagara	24.00	02 00	" "	" "
	Delphine	24.11	00 37	6 32 29	6 31 52
	Idler	23.00	02 22	6 31 29	6 29 07
	Quaker City	21.06	06 30	did not finish	
	Fanny M.	19.02	09 15	6 26 06	6 16 41

RESTRICTIONS, ETC.

The 1st, 2d, 3d and 4th classes were restricted to jib, mainsail and working gaff topsail, the 5th class was restricted to mainsail. Stationary ballast and limited crew. Time allowance 1 min., 30 sec. per foot.

SHAMROCK, AGITATOR and ADDIE B. entered protest against JENNIE A. WILLIS for carrying borrowed rig; this protest was overruled. DELPHINE entered protest that IDLER was a pleasure boat, and this protest was overruled.

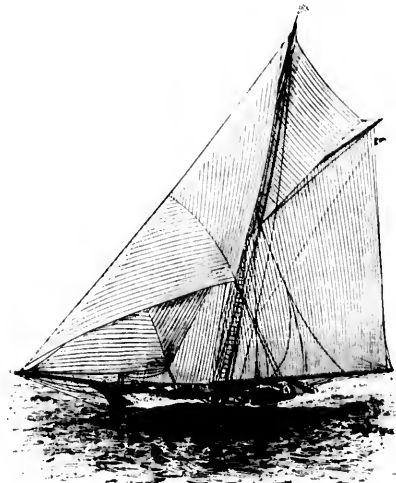

KATRINA.—FIGURE 331.

WINNERS:—1st Class, Jennie R., \$50.

1st "	Mary Ella, \$25.
2d "	Claudia M., \$40.
3d "	Emma R. Martin, \$25.
3d "	Simon Banks, \$10.
4th "	Jennie A. Willis, \$40.
4th "	Agitator, \$25.
5th "	Fannie M., \$1.0
5th "	Idler, \$25.

Match Races were sailed September 7, 1891. The courses were for 25 foot class, a distance of 13 knots, for Class 11 A, 13 knots, and for special match the Captain's Island course, 20 knots. The wind was fresh and from the north.

25 Foot Class.				
Nameless,	24.02		2 52 52	2 52 52
Needle,				
Class 11 A				
Aura,	29.97		2 50 00	2 50 00
Wonder,	20.06	05 07	2 45 59	2 49 52
Minnette,	20.51	17 04	2 52 10	2 35 44
Special Match.				
Viator,	65.92		2 43 22	2 43 22
Clara,	55.12		disabled	

NAMELESS won the \$50 Wetmore Cup, MINNETTE won the first club prize, WONDER won the second club prize and VIATOR won the Kersey Cup.

Judges, Francis M. Scott and Otto Sarony.

A Match Race was sailed over the Captain's Island course, a distance of 20 knots. The wind was light from the south. The following yachts competed:

	Time Allowance.	Elapsed Time	Corrected Time
	M. S.	H. M. S.	H. M. S.
Rebecca	allows	3 37 59	3 37 59
Viator	03 00	3 30 39	3 33 39

VIATOR wins the cup presented by the club.

The judges were Francis M. Scott and Otto Sarony.

A Match Race was sailed September 27, 1891. The course for CINDERELLA and CLARA was a distance of 20 knots and 13 knots for NAMELESS and NEEDLE. The wind was moderate, east by south.

	Sailing Length	Time Allowance.	Elapsed Time.	Corrected Time.
	Feet.	M. S.	H. M. S.	H. M. S.
Cinderella	27.80	allows	3 31 14	3 31 14
Clara	55.12	02.22	3 30 47	3 34 25
Nameless			2 49 30	
Needle			2 51 01	

CINDERELLA won cups presented by the club. The judge was Otto Sarony.

A Match Race was sailed over the Captain's Island course, a distance of 20 knots on October 3, 1891. The wind was light and from the south.

	Time Allowance.	Elapsed Time.	Corrected Time.
	M. S.	H. M. S.	H. M. S.
Rebecca	allows	6 27 51	6 27 51
Viator	03 00	6 53 39	6 50 39

REBECCA won a cup presented by the club, beating VIATOR 22 min., 48 sec.

The judge was Otto Sarony.

A Match Race was sailed over a 13 knot course on October 10, 1891. The wind was northerly and light.

The following yachts competed:

	Elapsed time.
	H. M. S.
Nameless	3 42 48
Needle	3 48 03
Alma	did not finish.

NAMELESS won the \$50 Wetmore Cup.

VIATOR and CLARA started at the same time (about 12:12) to sail a match race for a cup offered by the club, but owing to the light wind were unable to complete the race.

Judge, Francis M. Scott.

A Match Race was sailed from Larchmont to Scotch Caps Buoy and return on October 17, 1891. The sea was heavy, the wind east and very fresh.

Brenda	0 52 14
Nora	0 52 08
Nora	0 57 09
Brenda	0 59 30

NORA won both races; the start for the first race was made at a few minutes before one; for the second race a few minutes after 4 o'clock.

The judge was Auguste Munroe.

Spring Regatta, sailed June 4, 1892.

Open to yachts belonging to the NEW YORK, EASTERN, SEAWANAKA CORINTHIAN, NEW YORK CORINTHIAN, NEW HAVEN, NEW ROCHELLE and CORINTHIAN (of Marblehead) YACHT CLUBS.

Courses:

Classes B and D—From Larchmont to and around stake off Stamford; thence to stake boat off Eatons' Neck; thence returning direct to finish. Distance 32½ nautical miles.

Classes 5 and 8—From Larchmont to and around stake boat in Hempstead Harbor; thence to stake boat off Captains' Island; thence returning over the same course to finish. Distance 20 nautical miles.

Classes 10 and 11—From Larchmont to and around stake boat in Hempstead Harbor; thence to and around Black Spur Buoy off Matinecock Point; thence returning over the same course to finish. Distance 13 nautical miles.

The wind was east and fresh for one-half of the race, then moderated, blowing very light by the time the last boats finished.

	Time
	M. S.
WINNERS:—Class B—Shamrock from Atlantic,	by 20 01
" " " Fleur-de-lis,	05 26
" " " Phantom,	56 48
Class D—Viator	" Peerless, 57 21
Class 8—Tigress	" Saona, 15 52
Class 10—El Chico	" Pyxie, 12 34
Class 11—Aura	" Nellie, 14 45
" " " Oceance,	" 29 09

SCHOONERS.

	Sailing Meas.	Start.	Finish.	Elapsed Time.
	H. M. S.	H. M. S.	H. M. S.	H. M. S.
Class B:				
Atlantic,	87.31	11 45 00	5 20 47	5 35 47
Fleur-de-lis	not msd.	11 45 00	5 06 12	5 21 12
Phantom,	86.52	11 44 42	5 57 26	6 12 31
Shamrock,	73.18	11 45 00	5 00 47	5 15 46
Class C:				
Azalea,	61.36	did not start.		
Viator,	65.02	11 45 00	5 24 09	5 39 09
Peerless,	68.03	11 44 55	6 21 25	6 36 30

SLOOPS AND CUTTERS.

Class 5:				
Clara,	55.00	did not start; misunderstood instr's.		
Oriva,	not msd.	" " "	" "	" "
Wasp,	51.07	" " "	" "	" "
Gulbare,	54.03	12 03 01		

SLOOPS AND CUTTERS.

	Feet	H. M. S.	H. M. S.	H. M. S.
Class 8.				
Tigress	Jas. Wier, Jr., 41.30	11 56 16	3 14 51	3 18 29
Saona	A. P. Ketchum	not msd.	12 01 30	3 35 51
Mistral	C. T. Willis	not msd.	did not start	
Class 10.				
Pyxie	Oswald Sanderson	21.95	11 56 33	2 18 23
Toboggan	George Work	not msd.	did not start	
El Chico	J. M. Korsey	24.86	11 56 04	2 05 20
Nameless	C. W. Wetmore	34.92	did not start	
Helcia		not msd.	did not start	

CABIN-CATS.

Class 13.				
Nellie	26.65	11 55 56	2 41 55	2 45 50
Coyote	not msd.	did not start		
Edna	24.01	and not start		
Oceance	26.12	11 57 34	2 57 57	3 00 23
Aura	29.20	12 02 27	2 33 37	2 31 14

Thirteenth Annual Regatta, sailed July 4, 1892:

Open to yachts belonging to the NEW YORK, EASTERN, SEAWANAKA CORINTHIAN, NEW YORK CORINTHIAN, AMERICAN, NEW HAVEN, NEW ROCHELLE, and CORINTHIAN (of Marblehead) YACHT CLUBS.

Courses:

Classes A, B, and 2—From Larchmont to and around stake boat in Hempstead Harbor; thence to and around stake boat off Stamford; thence returning over the same course to finish. Distance 27 nautical miles.

Classes D, 5, 7, 8 and 9—From Larchmont to and around stake boat in Hempstead Harbor; thence to and around stake boat off Captain's Island; thence returning over the same course to finish. Distance 20 nautical miles.

Classes 10 and 11—From Larchmont to and around stake boat in

THE YACHTS AND YACHTSMEN OF AMERICA.

293

round stake boat in
Black Spar Buoy off
the course to finish.

race, then moder-
ated.

Time
M. S.
20 01
05 20
56 48
57 21
15 52
12 34
14 45
29 09

Finish.	Elapsed
H. M. S.	H. M. S.
5 20 47	5 35 47
5 06 12	5 21 12
5 57 26	6 12 31
5 00 47	5 15 46

5 24 09	5 39 09
6 21 25	6 36 30

misunderstood instrs.
" "

H. M. S.	H. M. S.
3 14 51	3 18 29
3 35 51	3 34 21

2 18 23	2 21 50
2 05 20	2 09 16

2 41 55	2 45 59
2 57 57	3 00 23
2 33 37	2 31 14

EASTERN, SEAWAN-
AMERICAN, NEW
Hampshire) YACHT

round stake boat in
boat off Stamford;
Distance 27 nauti-

d around stake boat
boat off Captain's
finish. Distance

round stake boat in

Hempstead Harbor; thence to and around Black Spar Buoy off
Matinecock Point; thence returning over the same course to finish.
Distance 13 nautical miles.

Classes 12, 14, 15 and 16—From Larchmont to and around the Red
Spar Buoy on Scotch Caps Reef; thence to and around stake boat in
Hempstead Harbor; thence returning over the same course to finish.
Distance, 10 nautical miles.

Wind, east north east; strong at start, moderating later in the
day.

Class	Yacht	W. S.	Walk-over	M. S.
Class A—Dumtless				
" B—Troquois from Atlantic		by	8 44	
" " " Phantom		"	18 23	
" D—Azalea	" Peerless	"	16 25	
" " " Viator			sailed wrong course	
" 5—Wasp	" Forget-me-not	"	4 58	
" 8—Kangaroo	" Petrol	"	4 55	
" 9—Kittie	" Kwasiind		sailed wrong course	
" " " Rajah			sailed wrong course	
" 10—Pyxie			walk-over	
1st.				
" 11—Marguerite	" Nellie	"	0 51	
" " " Almira		"	1 46	
" " " Traunt		"	5 31	
2d.				
" " " Nellie	" Elin	"	7 13	
" " " Aura		"	23 36	
" " " Geomee		"	8 36	
" 14—Wilmerad			walk-over	
" 16—Phoebe R.	" Zelica		did not finish	

SCHOONERS.

Class	Yacht	Sailing Measurement, Feet.	Allowance, M. S.	Start, H. M. S.	Finish, H. M. S.	Elapsed Time, H. M. S.	Corrected Time, H. M. S.
Class A.							
Dumtless		111.01	7 00	12 16 50	1 01 51	3 45 01	3 45 01
Republic			13 00	did not start			
Constellation			Allows	did not start			
Ramona		105.84	5 00	did not start			
Class B.							
Atlantic		86.31	Allows	12 18 35	3 56 20	3 37 45	3 37 45
Phantom		86.52	10 00	12 17 23	4 14 37	3 57 14	3 47 14
Troquois		82.21	Allows	12 23 20	3 51 11	3 28 51	3 28 51
Shamrock		73.18		did not start			
Marguerite		83.38		did not start			
Class D.							
Azalea		63.36		12 24 41	3 27 40	3 01 59	3 01 59
Peerless		68.63		12 19 51	3 41 25	3 21 31	3 21 31
Viator		65.92		12 10 05		sailed wrong course	

SLOOPS AND CUTTERS.

Class	Yacht	W. S.	Walk-over	M. S.
Class 2.				
Katrina				did not start
Class 5.				
Wasp		51.97	allows	12 28 51
Clara		55.00		12 00
Oriva				18 00
Gulmare		54.04		18 00
Forget-me-not				18 00
Penguin				20 00
Class 7.				
Saona		not msd.	allows	did not start
Volusia		not msd.	4 52	did not start
Class 8.				
Petrol		not msd.	3 21	12 44 04
Kangaroo		not msd.	allows	12 42 54

YAWLS.

Sailing Measurement, Feet.	Allowance, M. S.	Start, H. M. S.	Finish, H. M. S.	Elapsed Time, H. M. S.	Corrected Time, H. M. S.
Class 9.					
Kwasind	31.14	12 39 37		sailed wrong course	
Kittie	27.65	12 37 31	1 42 05	1 01 21	1 01 21
Rajah	32.75	12 38 23		sailed wrong course	
Class 10—25-footers.					
El Chico	21.76		did not start		
Pyxie	21.95	12 36 18	3 11 47	2 35 29	2 35 29

CABIN CATS.

Class	Yacht	W. S.	Walk-over	M. S.
Class 2.				
Roi				did not start
Nellie	26.65	5 01	12 36 21	3 15 27
Geomee	26.12	5 55	12 39 45	3 27 27
Aura	29.00	allows	12 14 17	3 38 17
Traunt	28.02	2 51	12 43 25	3 25 01
Myrtle				did not start
Elin	27.63	3 29	12 11 30	3 27 40
Almira	28.70	1 46	12 39 21	3 16 67
Marguerite	26.40	5 59	12 37 42	3 16 22

JOB AND MAINSAIL.

Class 12.					
Tattler				did not start	
Siren				did not start	

OPEN CATS.

Class 14.					
Wilmerad	26.06		12 41 01	2 15 25	2 03 21
Edna	24.01			did not start.	
Class 15.					
Vanda				did not start.	
Class 16:					
Ellie				did not start.	
Zelica			12 40 50	Did not finish.	
Merula				did not start.	
Spin-drift			" "	" "	
Caprice			" "	" "	
Phoebe R.			12 40 22	2 49 47	2 00 25

Cruise of the LARCHMONT YACHT CLUB. Run from Larchmont
to Black Rock, July 9, 1892. Distance 28 nautical miles.

WINNERS:—Schooners—Atlantic, 1st Prize,
" Gevalia, 2d Prize,
Sloops—Dare, 1st Prize,
" Nymph, 2d Prize.

Entries:

Schooners.	Racing length, Feet.	Start, No. n.	Finish, P. M.
Dumtless	109.85	12 00	5 35
Atlantic	86.31	12 00	5 28
Viator	65.92	12 00	6 08
Gevalia	61.91	12 00	5 48
Tioga	56.00	12 00	7 27

SLOOPS.

Dare	59.00	12 00	5 45
Thistle	68.00	12 00	7 05
Clara	55.00	12 00	5 56
Forget-me-not	51.00	12 00	7 28
Nymph	41.00	12 00	7 06
Harriet	33.00	12 00	7 15
Kwasind (Yawl).	31.00	12 00	7 37
Enterprise		12 00	7 35

HISTORY OF THE LARCHMONT YACHT CLUB.

CRUISE.

Run from Black Rock to Deering's Cove, July 10, 1892. Distance 53 nautical miles.

WINNERS:—Schooners—1st Prize, Atlantic.
 " 2d " Gevalia,
 Sloops—1st " Clara,
 " 2d " Nymph.

SCHOONERS.

Entries:	Racing Length.	Start.	Finish.
	Feet.	A. M.	P. M.
Dauntless	109.85	0 30	4.50
Atlantic	86.31	0.30	4.55
Viator	05.92	0.30	5.41
Gevalia	01.91	0.30	5.28
Tioga	50.00	0.30	5.45
Phantom	86.44	0.30	5.35
Agnes		joined fleet	
SLOOPS.			
Dare	50.00	0.30	5.20
Thistle	08.00	0.30	5.50
Clara	"	0.30	5.13
Forget-me-not	01.00	0.30	6.47
Nymph	41.00	0.30	5.48
Harriet	33.00	0.30	
Kwaswind (Yawl)	31.00	0.30	
Enterprise		0.30	0.09
Headless		joined fleet	

CRUISE.

DINGY RACE, JULY 11, 1892, at DEERING'S COVE.

Entries:

Nymph,	Awarded 1st Prize, \$10.00 in money.
Dare,	" 2d " 5.00 in money.
Viator,	Turned stake wrong.
Phantom,	Finished first, but protested for using boat with outrigger. Protest allowed.

PAIR-OARED GIGS WITH COXSWAINS.

Viator,	Awarded 1st Prize, \$20.00 in money.
Atlantic,	" 2d " 10.00 in money.
Dare,	Came in 3d.
Dauntless	" " 4th.
Tioga,	Broke an oar and retired.

SPECIAL RACE FOR PAIR-OARED GIGS WITH COXSWAINS, JULY 12, 1892.

For \$50 cup, presented by Mr. Martin, also Sweepstakes money to go to men in winning boat.

Entries:

Phantom,	Awarded 1st Prize \$25.00 in money, also Martin Cup.
Atlantic,	" 2d " 10.00 in money.
Viator,	Came in 3d.
Jessie,	" " 4th.
Tioga,	" " 5th.
Dauntless,	" " 6th.
Dare,	" " 7th.

LADIES RACE IN DINGIES BELONGING TO YACHTS OF THE CLUB, JULY 12, 1892.

Entries:

Awarded 1st Prize. Larchmont Yacht Club Pins.	
Miss Lowell	Bow
Miss Headley	Stroke
Miss Halsey	Coxswain
Awarded 2d Prize. Larchmont Yacht Club Pins.	
Miss F. Lowell	Bow
Miss G. Norris	Stroke
Miss Sayre	Coxswain
Awarded 3d Prize. Leather medals.	
Miss Jackson	Bow
Miss MacStory	Stroke
Miss Anthony	Coxswain

CRUISE.

Run from Deering's Cove to Newport, July 13, 1892. Distance 49 nautical miles. Dense fog prevailed.

WINNERS:—Schooners: 1st Prize, Atlantic.
 2d " Agnes.
 Sloops: 1st Prize, Dare,
 2d " Enterprise.

SCHOONERS.

Entries:

	Racing Length.	Start.	Finish.
	Feet.	A. M.	P. M.
Dauntless	109.85	0.00	5.29
Atlantic	86.31	0.00	5.47
Viator	65.92	0.00	withdrew
Gevalia	01.91	0.00	6.20
Tioga	50.00	0.00	8.00
Phantom	86.52	0.00	6.21
Agnes	58.44	0.00	6.18
Magie	83.00	joined fleet	
SLOOPS.			
Dare	50.00	0.00	July 14th, A. M. 12.30
Thistle	08.00	0.00	withdrew
Clara	55.00	0.00	withdrew
Forget-me-not	51.00	0.00	withdrew
Nymph	41.00	0.00	withdrew
Harriet	33.00	0.00	withdrew
Kwaswind (Yawl)	31.00	0.00	withdrew
Enterprise		0.00	11.30
Headless		0.00	withdrew
Katrina		0.00	joined fleet
Defiance	33.00	0.00	joined fleet

CRUISE.

Run from Newport to New London, July 15, 1892. Distance 38 nautical miles.

WINNERS:—Schooners—Dauntless, 1st Prize.
 Sloops—Dare, 1st Prize (walk-over).

Entries:

SCHOONERS.

Dauntless	109.85	0.00	3.10
Gevalia	01.91	0.00	3.14
Phantom	86.52	0.00	3.06

SLOOPS.

Dare	50.00	0.00	6.20
------	-------	------	------

CRUISE.

Run from New London to Deering's Cove, July 17, 1892. Distance 19 nautical miles.

WINNERS:—Schooners—Magie, 1st Prize.
 Sloops—Katrina, 1st Prize.

Entries:

SCHOONERS.

Dauntless	109.85	10.45	2.41
Phantom	86.52	10.45	2.30
Magie	83.00	10.45	2.29

SLOOPS.

Dare	50.00	10.45	3.24
Katrina		10.45	2.00

The Eighth Annual Oyster Boat Race, sailed Saturday, August 27, 1892.

Wind northeast and moderate, and very light at finish.

Course for all classes: From Larchmont to and around a stake boat anchored in Hempstead Harbor, passing same on the port hand; thence to and around a stake boat anchored off Captain's Island, passing same on the port hand; thence to and around stake boat in Hempstead Harbor, passing same on the starboard hand; thence returning direct to finish. Distance 20 nautical miles.

WINNERS.

Class 1—1st Prize,	Jennie R.,	Stamford, Conn.
2d "	Iosco,	Portchester, N. Y.
Class 2—1st Prize,	Claudia M.,	Stamford, Conn.
2d "	Amateur,	Bridgeport, Conn.
Class 3—1st Prize,	S. C. Bond,	Bridgeport, Conn.
2d "	Stella May,	Cow Bay, L. I.
Class 4—1st Prize,	Jennie A. Willis,	Cow Bay, L. I.
2d "	Agitator,	Cow Bay, L. I.
Class 5—1st Prize,	Uncle Dan,	City Island, N. Y.
2d "	Delphine,	Cow Bay, L. I.

UNCLE DAN was protested as having given wrong measurement; she was officially measured October 2, 1892, and the measurement was found to be correct. Protest not allowed.

Entries:

	L. W. L.	Allowance.	Start.	Finish.	Elapsed Time.	Corrected Time.
Class 1.						
Mary Ella	41	allows	11 48 05	0 01 16	0 15 11	0 15 11
Lizzie D. Bell	36		7 30	11 54 01	0 10 01	0 23 07
Jennie R.	35.3		8 38	11 46 16	5 21 16	5 38 00
Iosco	35.4		8 30	11 40 12	5 45 33	5 59 21
Class 2.						
Claudia M., Amateur	29.4		5 30	11 46 30	5 04 16	5 18 46
Geo. R. Martin	28		7 30	11 47 08	5 20 20	5 33 21
Ellen	30.7				did not start	
Ally Ray	30.6		3 45	11 48 30	did not finish	
Fly-Away	30.4		4 00	11 48 30	did not finish	
Bessie B.	32		1 30	11 47 55	did not finish	
Rover	32.4		1 00	11 47 47	did not finish	
Class 3.						
S. C. Bond	30.6	allows	11 48 14	5 19 12	5 30 58	5 30 58
Stella May	30.2		0 30	11 47 45	5 58 09	6 10 24
Class 4.						
Shamrock	27				did not start	
Jennie A. Willis	25.9	allows	11 50 47	4 58 10	5 07 23	5 07 23
Arrow	25.5		0 30	11 48 27	did not finish	
Agitator	21.6		2 38	11 50 00	5 33 32	5 43 32
Erlie C.	23.1		4 00		did not start	
Class 5.						
Uncle Dan	28.3	allows	11 47 08	5 38 04	5 40 56	5 40 56
Fanny M.	19.2		13 15	11 46 03	did not finish	
Delphine	25.2		4 15	11 47 39	5 47 28	5 59 49

SAILED.

Match Race—PYXIE VS. NAMELESS.

	Start.	Finish.	Time.
	A. M.	P. M.	Actual
Pyxie	11.19	1.17.40	1.58.40
Nameless	11.19	1.18.35	1.59.25

Fall Regatta, September 10, 1892.

Open to yachts belonging to the NEW YORK, EASTERN, SEAWANAKA, CORINTHIAN, AMERICAN, NEW HAVEN, NEW ROCHELLE, and CORINTHIAN (of Marblehead).

Wind northeast, strong and steady.

Courses:

Classes A, B and B Special—From Larchmont to and around stake boat anchored in Hempstead Harbor; thence to and around stake boat off Stamford; thence returning to Hempstead Harbor stake boat; thence direct to finish. Distance 27 nautical miles.

Classes D, 5, 7, and 8—From Larchmont to and around stake boat anchored in Hempstead Harbor; thence to and around stake boat off Captain's Island; thence returning to Hempstead Harbor stake boat; thence direct to finish. Distance 20 nautical miles.

Classes 9, 10 and 11—From Larchmont to and around stake boat anchored in Hempstead Harbor; thence to and around the Black Spar Buoy off Matinecock Point; thence to and around stake boat in Hempstead Harbor; thence direct to finish. Distance 13 nautical miles.

Classes 14 and 16—From Larchmont to and around the Red Star Buoy on Scotch Caps Reef; thence to and around stake boat anchored in Hempstead Harbor; thence returning to buoy on Scotch Caps Reef; thence direct to finish. Distance 10 nautical miles.

WINNERS:—Class A—	Ramona	from	Damless,	by	Time.
					M. S.
" B—	Shamrock	"	Atlantic	"	19 38
" "	"	"	Iroquois	"	1 01
" "	"	"	Atlantic	"	16 19
" "	Special	"	Iroquois	"	6 42
" D—	Azalea	"	Viator	"	5 01
" 5—	Clara	"	Walk-over	"	
" 7—	Kathleen	"	Senorita	"	11 05
" 8—	Chippewa	"	Fanna	"	7 13
" 9—	Kittie	"	Rajah	"	4 28
" "	"	"	Kwasind	"	9 23
" 10—	El-Chico	"	Pyxie	"	0 45
" "	"	"	Nemadjo	"	2 03
" "	"	"	Nameless	"	5 21

2d Pyxie

Class 11—	Nellie	"	Marguerite	"	Time.
					M. S.
" "	"	"	Nahma	"	0 44
" "	"	"	Aura	"	1 36
" "	"	"	Oceano	"	3 26
" "	"	"	Mabel, not measured	"	

Marguerite awarded 2d Prize

Class 11—	Edna	from	Wilmerad	by	Time.
					M. S.
" "	"	"	Erlie	"	8 17
" "	"	"	Sadie	"	9 23
Class 10—Phyllis					
" "	"	"	Lark	"	12 12
" "	"	"	Spin-drift	"	20 50
" "	"	"	Ione	"	21 11

Erlie awarded 2d Prize.

SCHOONERS.

	Sailing Measure-ment.	Allow-ance.	Start.	Finish.	Elapsed Time.	Corrected Time.
					H. M. S.	H. M. S.
Class A.						
Damless	111.01	allows	11 39 25	4 05 53	4 26 28	4 26 28
Ramona	105.81	2 25	11 42 10	3 51 36	4 09 26	4 07 01
Class B.						
Atlantic	86.31	allows	11 41 31	3 49 30	4 07 50	4 07 50
Iroquois	82.24	2 35	11 39 00	3 39 57	4 00 57	3 58 22
Marguerite	83.38				did not start	
Shamrock	81.00	3 23	11 42 54	3 43 38	4 00 41	3 57 21
Class B. (special.)						
Atlantic	86.31	allows	11 41 31	3 49 30	4 07 50	4 07 50
Iroquois	82.24	2 45	11 39 00	3 39 57	4 00 57	3 58 22
Shamrock	73.18	9 04	11 42 54	3 43 38	4 00 44	3 51 40
Class D.						
Viator	65.92	allows	11 38 12	2 27 02	2 48 50	2 48 50
Azalea	63.36	1 41	11 42 27	2 28 00	2 45 43	2 43 49

SLOOP.

Class 5.	Clara	55.00	11 56 55	2 41 18	2 41 23	2 44 23
Forgot-me-not					did not start	
Class 7.						
Volusia	37.53				did not start	
Kathleen	37.44	allows	11 57 38	3 10 08	3 12 30	3 12 30
Senorita	36.50	1 27	11 58 46	3 23 43	3 24 27	3 23 37
Tigress	41.30				did not start	
Class 8.						
Fanna			11 56 17	3 25 30	3 29 13	3 29 13
Chippewa	36.00		11 55 48	3 17 48	3 22 00	3 22 00

3, 1892. Distance
Finish.
P. M.
5.20
5.47
withdrew
6.20
8.00
6.21
0.18

July 14th,
A. M.
12.30
withdrew
withdrew
withdrew
withdrew
withdrew
11.30
withdrew
joined fleet
joined fleet

1892. Distance 38
3.10
3.14
3e36
0 29

7 17, 1892. Distance
2.41
2.30
2.29

1 Saturday, August
around a stake boat
on the port hand;
captain's Island, pass-
stake boat in Hemp-
1; thence returning

SPECIAL FOR YAWLS.

Class 9.	Sail Meas. Feet.	Allowance.	Start U. M. S.	Finish U. M. S.	Elap. Time U. M. S.	Act Time U. M. S.
Kwasind	31.11	1 11	11 57 47	2 19 11	2 21 27	2 20 46
Rajah	32.75	allows	11 58 13	2 11 01	5 15 51	2 15 51
Kittie	27.05	7 11	11 53 01	2 16 38	2 18 37	2 11 23

25-Footers:

Class 10.	Sail Meas. Feet.	Allowance.	Start U. M. S.	Finish U. M. S.	Elap. Time U. M. S.	Act Time U. M. S.
El Chico	21.80	0 10	11 56 48	2 07 52	2 11 01	2 10 54
Pyxie	21.05	allows	11 59 06	2 10 45	2 11 29	2 11 29
Nemadji			11 58 28	2 11 25	2 12 57	2 12 57
Nameless	21.02	0 01	11 55 40	2 12 11	2 14 22	2 16 18

CABIN-CATS.

Class 11.	Sail Meas. Feet.	Allowance.	Start U. M. S.	Finish U. M. S.	Elap. Time U. M. S.	Act Time U. M. S.
Nellie	20.05	4 08	11 55 40	2 15 27	2 19 47	2 15 39
Oenoe	20.12	4 40	12 00 30	2 21 15	2 23 39	2 18 59
Marguerite	20.10	1 28	12 01 37	2 21 55	2 20 18	2 15 50
Mabel	not meas.		11 58 40	2 21 40	2 25 50	2 25 50
Nahua	22.32	12 31	11 55 32	2 21 25	2 28 53	2 16 23
Almira	28.50	0 45	12 05 03		did not finish	
Aura	20.20	allows	12 02 56	2 20 11	2 17 15	2 17 15

OPEN-CATS.

Class 14.	Sail Meas. Feet.	Allowance.	Start U. M. S.	Finish U. M. S.	Elap. Time U. M. S.	Act Time U. M. S.
Edna	21.33	1 37	11 59 20	1 46 05	1 46 45	1 43 03
Wilfred	20.87	allows	12 00 01	1 45 05	1 45 01	1 45 01
Fairy	21.00	7 31		did not start.		

Class 16.

Phyllis	19.11	allows	11 58 48	1 42 05	1 45 17	1 45 17
Zelda	19.05	1 02	11 55 55		did not finish.	
Sadie	19.11		11 59 00	1 53 40	1 54 40	1 54 40
Ellie	19.11		11 58 21	1 49 55	1 53 31	1 53 31
It	18.00	3 03	11 59 48		withdrew.	
Martha	20 00				did not start.	
Skræbling	18 00				" "	
Lark	16.00	9 18	11 55 48	2 02 45	2 03 57	1 57 39
Caprice	11.03		11 57 09		capsized.	
Jone	18.00	3 00	11 56 41	2 06 12	2 09 28	2 06 28
Spindrift	17.11	4 23	11 55 29	2 05 52	2 10 26	2 06 13

For the Larchmont Cup of 1892, for schooners, sailed September 13, 1892. Value of cup, \$500.

This race for the Larchmont Cup of 1892 was open to schooners, irrespective of size, and allowance was based on their actual measurement. Different courses were laid out and one selected on the morning of the race, to enable the yachts to get as nearly as possible an equal amount of windward and leeward work.

Course selected was No. 2: from Larchmont to and around a stake boat anchored 3-4 of a mile, south by west, from Stamford Light-house (course east northeast, north 1-8, 9 3-4 nautical miles), leaving same on starboard hand; thence to and around a stake boat anchored off Eaton's Neck Buoy (course, east southeast, 7 nautical miles), leaving same on the starboard hand; thence returning direct to finish (course west, 15 5-8 nautical miles). Total distance 32 3-8 nautical miles.

Wind, south southeast and strong, increasing to a gale that night.

WINNERS:—Iroquois from Lasca by

			M. S.
"	"	Shamrock	1 12
"	"	"	1 44
"	"	Marguerite	2 50
"	"	Viator	10 45
"	"	Ramona	11 37
"	"	Azalea	22 27

Entries:

Lasca	93.17	7 27	11 45 00	3 14 05	3 29 05	3 21 38
Marguerite	83.38	14 21	11 44 39	3 21 26	3 36 47	3 22 26
Shamrock	73.18	23 04	11 43 10	3 28 29	3 45 10	3 22 10
Iroquois	82.24	15 14	11 45 00	3 20 40	3 35 40	3 20 26
Viator	65.92	30 16	11 45 00	3 46 27	4 01 27	3 31 11
Azalea	63.36	33 08	11 36 50	3 53 00	4 16 01	3 42 53
Ramona	105.84	allows	11 37 38	3 09 41	3 32 03	3 32 03
Atlantic	86.31	12 10			did not start.	

Private Match Race for \$150 cup, sailed September 13, 1892. This match was sailed over the same course and at the same time as the Race for the Larchmont Cup.

	Sail Meas. Feet.	Allowance.	Start U. M. S.	Finish U. M. S.	Elap. Time U. M. S.	Act Time U. M. S.
Viator	65.92	allows	11 43 00	3 46 27	4 01 27	4 01 27
Azalea	61.33	2 52	11 30 50	3 53 03	4 16 01	4 13 03

Viator wins from Azalea by 11 min., 42 sec.

Match Race sailed October 6, 1895. ATLANTIC and VIATOR. Course from Larchmont to and around stake boat off Eaton's Neck Buoy; thence to and around stake boat off Stamford Lighthouse, thence returning direct to finish. Distance 32 3-8 nautical miles.

Wind, northwest. Blowing very hard, yachts having reefed sails.

Atlantic	86.21	allows.	11 37 21	4 09 15	4 31 51	4 31 51
Viator	65.92	18 00	11 40 00	5 13 15	5 33 15	5 15 00

Viator was handicapped at start, 2 min., 31 sec.
Atlantic wins from Viator by 43 min., 18 sec.

Annual Spring Regatta June 10, 1893, for Classes A, B and special Class C. From Larchmont to and around a stake boat anchored in Hempstead Harbor, passing same on port hand; thence to and around a stake boat off Stamford Lightship, passing same on port hand; thence returning to Hempstead Harbor stake boat; thence direct to finish. Distance 27 nautical miles.

For Classes D, E, 5, 7, 8 and 9. From Larchmont to and around a stake boat anchored in Hempstead Harbor; thence to and around a stake boat off Captain's Island; thence to and around a stake boat in Hempstead Harbor; thence direct to finish. Distance 20 nautical miles.

For Classes 10 and 11. From Larchmont to and around stake boat anchored in Hempstead Harbor; thence to and around stake by Spar Buoy off Matinecock Point; thence to and around stake boat in Hempstead Harbor; thence returning direct to finish. Distance 13 nautical miles.

For Classes 12, 14 and 16. From Larchmont to and around Red Spar Buoy on Scotch Caps; thence to and around stake boat in Hempstead Harbor; thence returning to Red Spar Buoy on Scotch Caps; thence direct to finish. Distance 10 nautical miles.

Wind was southwest and light, increasing to a fair breeze.

	Sailing length. Feet.	Elapsed Time. U. M. S.	Corrected Time. U. M. S.
Class A.			
Nameless	111.04	5 37 27	5 37 27
Ramona	105.84	5 25 41	5 23 16
Class B.			
Lasca	93.17	5 18 50	5 18 50
Iroquois	82.24	5 20 56	5 14 24
Emerald	88.32		did not start
Shamrock	81.00	5 33 46	5 26 20
Class C, Special.			
Lasca	93.17	5 18 50	5 18 50
Iroquois	82.24	5 20 56	5 14 24
Shamrock	73.18	5 33 46	5 21 18
Class D.			
Azalea	63.36	4 30 50	4 28 19
Viator	65.92	4 27 18	4 27 18
Ellie		did not start.	
Class E.			
Fenella	walk-over	4 40 35	4 40 35
Class 5.			
Wasp	walk-over	54.97	3 54 12
Class 7.			
Eurytia	walk-over	40.02	4 12 31
Rajah		did not start	
Class 8.			
Marjorie		did not start	35.23
Bonnie Doon			31.66
Rosalind		did not start	36.36

ber 13, 1892. This
e same time as the

Elap. Time	Act. Time
h. m. s.	h. m. s.
4 01 27	4 01 27
4 10 03	4 13 03

2 sec.

ERIC and VIATOR,
t off Eaton's Neck
nford Lighthouse,
nautical miles.
aving reefed sails.

4 31 51	4 31 51
5 33 15	5 15 09

, 31 sec.

18 sec.

es A, B and special
o boat anchored in
ence to and around
me on port hand ;
t; thence direct to

mont to and around
ence to and around
und a stake boat in
istance 20 nautical

d around stake boat
und stake by Spar
und stake boat in
inish. Distance 13

nt to and around
and around stake
Red Spar Buoy on
nautical miles.
air breeze.

Elap. Time	Corrected Time
h. m. s.	h. m. s.

27	5 37 27
41	5 23 16

56	5 18 56
----	---------

56	5 14 24
----	---------

did not start	
46	5 26 26

56	5 18 56
----	---------

58	5 14 24
----	---------

16	5 21 18
----	---------

50	4 28 19
----	---------

48	4 27 18
----	---------

35	4 40 35
----	---------

12	3 54 12
----	---------

31	4 12 31
----	---------

53	4 07 53
----	---------

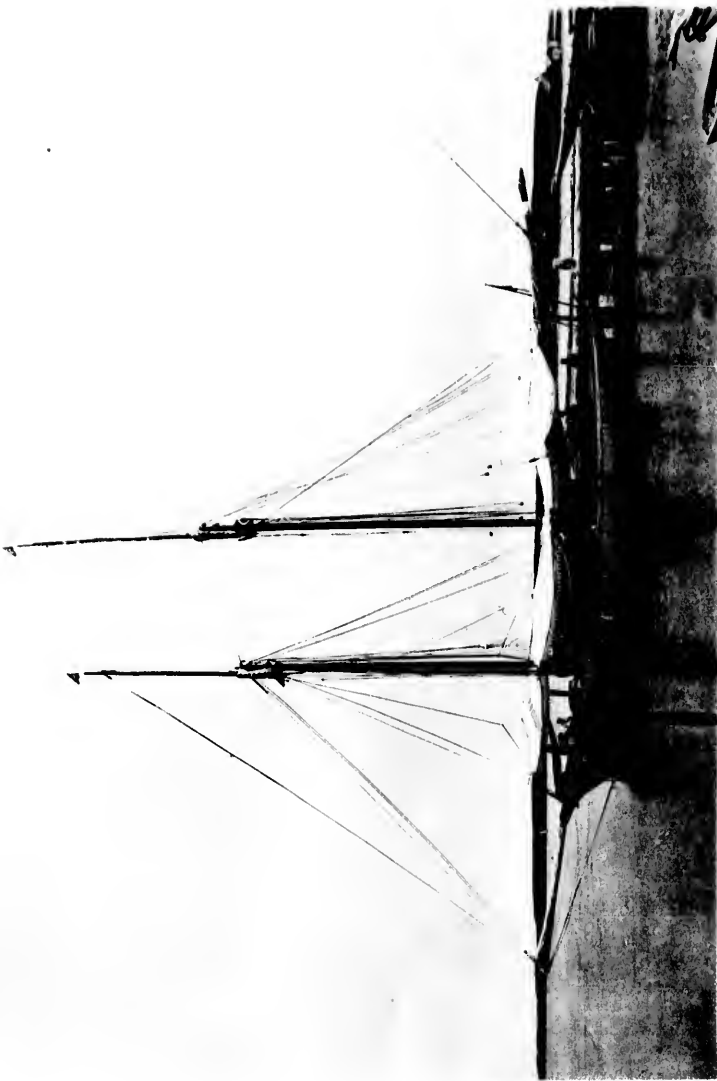
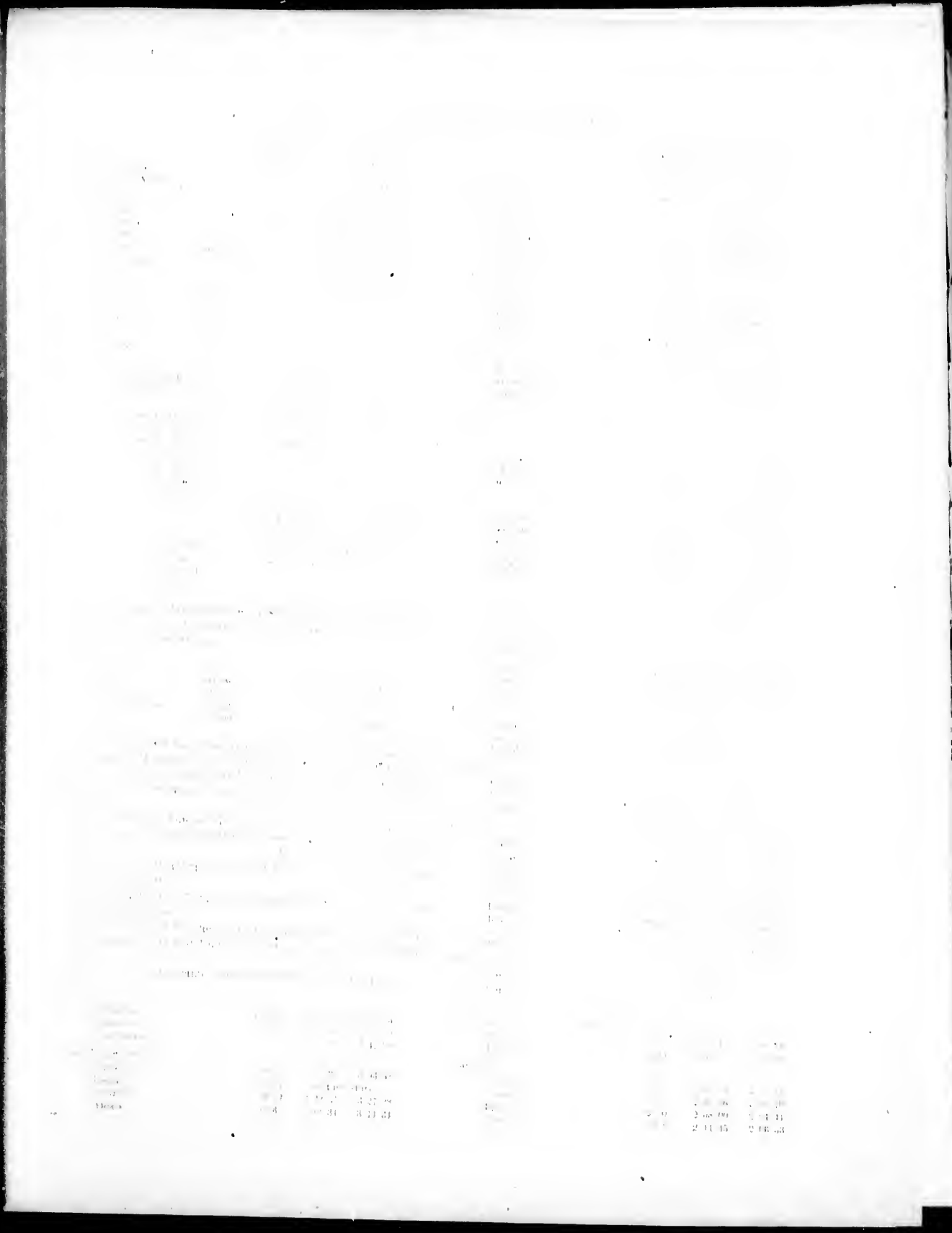

PLATE XXX

MONHEGAN.

MONHEGAN.



Scale

1000	1000
2000	2000
3000	3000
4000	4000
5000	5000
6000	6000
7000	7000
8000	8000
9000	9000
10000	10000

1000	1000
2000	2000
3000	3000
4000	4000
5000	5000
6000	6000
7000	7000
8000	8000
9000	9000
10000	10000

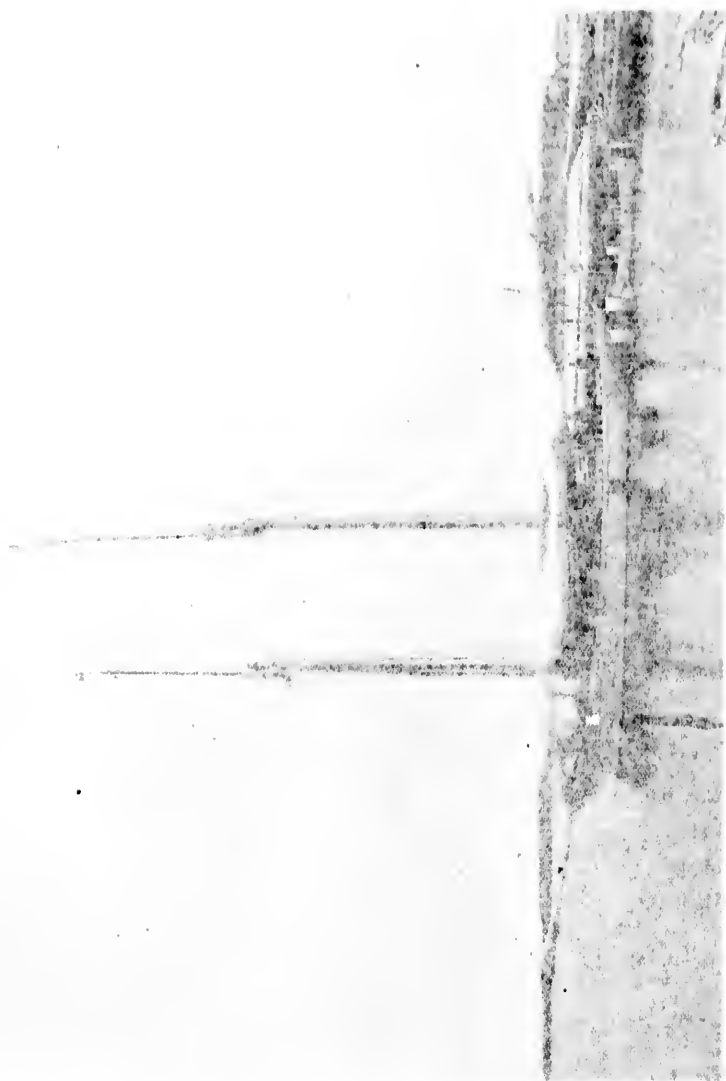

1850

	Sailing Length, Feet.	Elapsed Time, H. M. S.	Corrected Time, H. M. S.		Sailing Length, Ft. In.	Elapsed Time, H. M. S.	Corrected Time, H. M. S.		
Special Class B, Kittle (Yawl)	27.05	3 02 50	3 02 50	Class B, Atlantic	80.31	3 32 31	3 32 31		
Class 11, Aura	29.20	3 00 05	3 00 05	Class C, Comet		did not start			
Almira	28.70	2 57 45	2 57 00	Elsiemarie		disabled			
Oceano	26.12	3 00 33	3 01 33	Shamrock	73.18	did not start			
Ellin	did not start			Dagmar		did not start			
Anemone	27.92	3 07 48	3 04 44	Class D, Viator	65.92	2 11 21	2 41 21		
Class 12, Caper	walk-over	24.17	3 12 56	Azalea	63.36	disabled			
Class 14, Punch	walk-over	20.18	2 31 06	Loyal		withdrew			
Class 16, Zelia	walk-over	10.40	2 34 43	Triton	67.63	2 57 00	2 57 00		
				Sekara	assigned	2 58 40	2 54 25		
WINNERS—Class A—Ramona	from	Duuntless	by	11 11	Class 2, Katrina	50.08	3 15 27	3 15 27	
Class B—Inspiro	"	Lasca	"	4 32	Hildegarde		did not start		
		Shamrock	"	12 02	Huron	68.11	3 20 53	3 11 47	
Special Class C—Troquois	"	Lasca	"	4 32	Class 5, Wasp	walk-over	54.07	2 30 22	2 30 22
" C—Shamrock	"	"	"	0 54	Class 6, Evira		47.11	2 40 24	2 40 15
Class E—Fenella		Walk-over			Choctaw		47.23	2 55 42	2 55 42
" 5—Wasp		"			Mocushu				
" 7—Eurybia		"			Class 7, Tigress		41.30	did not start	
" 8—Bomble Doon		"			Daffodil		40.80	3 24 31	3 24 31
" 9—Kittle		"			Suona		40.70		
" 11—Almira	from	Oceano		7 32	Eurybia		40.02	3 30 12	2 29 05
		Anemone	"	7 44	Kathleen		37.11	3 31 11	3 26 14
		Aura	"	12 05	Peri			did not start	
Oceano		awarded	24	Prize	Class 8, Marjorie		35.23	3 38 38	
" 12—Caper		walk-over			Euromia			did not start	
" 15—Punch		"			Fair Wind			3 41 43	
" 16—Zelia		"			Class 9 (special), Anlax		31.00	3 35 36	3 35 36
					Kittle		20.24	3 35 50	3 31 55
					Evelyn	not meas.	4 00 19	4 00 10	
					Class 9, Freyja		31.00	3 40 14	
					Sussie W.		29.24	3 50 31	
					Wanda				
					Class 10, Pyxie		24.95	2 28 02	
					Beatrice	not meas.		did not start	
					Wahmetta	not meas.		2 41 08	
					Class 11, Aura		20.20	2 40 45	2 40 45
					Almira		28.70	2 29 51	2 29 06
					Anemone		27.92	2 31 00	2 31 02
					Mary		28.23	2 40 06	2 38 45
					Oceano		26.12	2 38 10	2 33 10
					Infanta	not meas.		did not start	
					Roi		28.95	2 31 33	2 30 57
					Nyolph		28.62	2 38 24	2 37 30
					Ellin		27.63	2 43 23	2 40 55
					Class 12, Tabitha			2 42 01	
					Caper		21.17	2 47 27	
					Class 13, Siren	withdrew	24.7		
					Myrtle		21.0	2 37 17	2 30 11
					Edna		2.44	1 51 55	1 51 29
					Class 14, Typhoon		22.9	2 25 14	2 25 11
					Violet		20.0	2 25 36	2 20 20
					Ramona		21.0	2 08 00	2 04 41
					Punch		20.2	2 11 45	2 06 53

June 10, 1893: Handicap race for \$100 cup presented by Commodore C. H. Colt, open to sloops, cutters and yawls irrespective of size, Time allowance a handicap.

Entries:

Wasp	Allows	3 54 12	3 54 12
Eurybia	21.00	4 12 31	3 48 31
Bomble Doon	20.00	4 07 53	3 38 53
Pyxie	40.00	did not finish	

The course sailed was from Larchmont to and around stake boat in Hempstead Harbor; thence to and around stake boat off Captain's Island; thence returning to and around stake boat in Hempstead Harbor; thence returning direct to finish. Distance 20 nautical miles.

The Fourteenth Annual Regatta was sailed July 4, 1893. The wind was west northwest, shifting to northwest with a good sailing breeze.

For Classes A, B, (B special) C and 2, the 27 nautical mile course was stipulated.

For Classes D, 5, 6, 7, 8, and 9 (9 special), the 20 nautical mile course was stipulated.

For Classes 10 and 11, the 13 nautical mile course was stipulated.

For Classes 12, 13 and 15, the 10 nautical mile course was stipulated.

The above were the same courses adopted on June 10, 1893.

Class A.

Duuntless	111.04	3 20 03	3 20 03
Ramona	105.84	3 15 35	3 13 10
Branhilda		3 41 08	3 41 08

Class B (special).

Emerald	88.32	3 06 38	3 03 54
Lasca	93.17	did not start	
Atlantic	86.31	3 32 31	3 27 38
Alcaza	93.65	3 14 31	3 14 34

Elapsed Time.	Corrected Time.
n. m. s.	n. m. s.
4 57 02	4 57 02
4 52 35	4 47 12
5 42 32	5 40 30
6 08 47	
5 50 32	5 50 32

5 50 11	5 44 16
5 47 44	5 47 44
6 12 40	
did not finish.	
" "	

5 26 53	
6 17 55	

did not finish.

6 32 40	
---------	--

6 39 40	
---------	--

did not finish.

7 05 12	
---------	--

6 57 10	
---------	--

7 40 17	
---------	--

6 02 20	
---------	--

did not finish

" "

joined fleet on run.

	n. m. s.
Dauntless	by 9 50
Ramona	" 9 53
Southern Cross	not meas.
Viator	by 3 28
Nonpareille	" not meas.
Atlantia	" did not finish
Nonpareille	" " "
Dauntless	" not meas.

Chairman; Otto Sarony.

from Morris Cove to New

5 00 49	5 00 49
---------	---------

5 10 08	5 05 00
---------	---------

6 01 05	6 01 05
---------	---------

46 55	5 45 07
-------	---------

30 12	6 30 12
-------	---------

36 41	6 31 03
-------	---------

37 47	
-------	--

34 35	
-------	--

27 33	
-------	--

53 07	
-------	--

07 47	
-------	--

50 37	
-------	--

43 08	
-------	--

SCHOONERS.

WINNERS:—Class A—Dauntless	from	Ramona	by	M. S.
Class B—Atlantia	"	Phantom	"	15 58
Class D—Viator	"	Geyllia	"	00 51
"	"	Southern Cross	"	not meas.
"	"	Tioga	"	not meas.
Class 2—Katrina	"	Nonpareille	"	not meas.
"	"	Wenona	"	not meas.
Class 7—Volusia	"	Peri	"	not meas.
Class 10—Pyxio	"	Walk-over	"	

Cruise (continued) July 17, 1893:

Run from New London to Newport, 36 miles.

Wind at start was light, from the westward, then dropped to a calm; the yachts drifted in through the night.

	Racing Length.	Elapsed Time.	Corrected Time.
	Feet.	n. m. s.	n. m. s.
Class A.			
Dauntless	114.04	8 41 54	8 41 54
Ramona	105.81	8 47 48	8 43 12
Class B.			
Phantom	86.52	did not finish	
Atlantia	86.31	did not finish	
Class D.			
Southern Cross	not meas.	did not start	
Gevalia	61.01	arrived following day	
Viator	65.92	did not start	
Tioga	not meas.	did not start	

SLOOP.

Class 2.			
Katrina	76.08	8 48 05	
Nonpareille	not meas.	did not cross the line;	went through the race
Class 7.			
Volusia	37.53	did not finish	
Peri	not meas.	did not finish	

WINNERS:—Class A—Dauntless	from	Ramona	by	M. S.
" B—Did not finish				1 48
" 2—Katrina			walk-over	
Steamer—Thyra		Ladoga		

VOLUSIA and PERI had a private match and were allowed to start early, but through some instructions given by an unauthorized person the boats went to Shelter Island instead of Newport. Same Regatta Committee.

Cruise (continued) July 19, 1893:

Run to Shelter Island from Newport 50 miles. The wind at start was northeast and light, but about noon shifted to south southwest and light.

SCHOONERS.

Class A.			
Dauntless	114.04	9 32 55	9 32 55
Ramona	105.84	10 25 02	10 18 38
Class B.			
Atlantia	86.31	8 27 28	8 27 28
Gevalia (moved up to Class B)	61.91	9 54 22	9 18 02

SLOOP.

Katrim (ran ashore but was towed off)	76.08			
Nonpareille	not meas.	12 07 25		
WINNERS:—Class A—Dauntless	from	Ramona	by	M. S.
" B—Atlantia	"	Gevalia	"	50 34
" 2—Nonpareille	"	Katrim	(went ashore)	

Same Regatta Committee.

Cruise (continued) July 20, 1893:

Gig and Naptha Launch Races at Shelter Island.

FOUR-OARED GIG RACE.

Dauntless	Awarded 1st Prize, value \$37.50.	Spoon oars.
Speranza	"	"
Ramona	Awarded 1st Prize, value \$37.50	Straight oars.
Katrina	Came in 2nd.	"
Phantom	" " 3rd.	"

PAIR-OARED GIGS.

Atlantia	Awarded 1st Prize, value \$22.50
Southern Cross	" 2nd " " 13.50
Nonpareille	" 3rd " " 7.00
Viator	Came in 4th
Dauntless	" 5th
Tioga	" 6th
Ramona	" 7th
Phantom	" 8th

DINGY RACE.

Ramona	Awarded 1st Prize, value \$7.50
Phantom	Came in 2nd

NAPHTHA LAUNCHES.

Ramona	Awarded 1st Prize, value \$15.00
Dauntless	Came in 2nd

OOFELDT LAUNCHES.

Atlantia	Awarded 1st Prize, value \$15.00
----------	----------------------------------

Oyster Boat Regatta sailed August 26, 1893:

Course: From Larchmont to and around stake boat in Hempstead Harbor; thence to and around stake boat off Captain's Island; thence returning to and around stake boat in Hempstead Harbor; thence direct to finish. Distance 20 Nautical miles.

Wind was very light from south southeast the first part of the race, then shifted to the southwest but remained very light.

	Sailing Length.	Elapsed Time.	Corrected Time.
	Feet.	n. m. s.	n. m. s.
Class 1.			
Christine	39.00	did not finish.	
Jennie R.	35.00	8 04 25	7 53 45
Josco	35.01	8 12 43	8 02 20
Mary F. Durria	41.85	9 19 17	9 19 17
Class 2.			
Priscilla	33.00	9 37 04	9 37 04
Lady Clare	28.05	did not finish.	
Ally-Ray	28.00	did not start.	
Claudia M.	29.04	8 23 56	8 18 30
Class 3.			
Stella May	30.03	9 14 14	9 12 37
Lola L.	31.04	7 12 55	7 12 55
S. C. Bond	30.06	9 50 19	9 58 09
Class 4.			
Shamrock	27.06	did not finish.	
Julia A.	24.08	did not start.	
Sneak	26.05	did not finish.	
Agitator	24.06	9 02 38	8 58 08
Jennie A. Willis	25.09	10 03 20	10 00 47
Class 5.			
Funny M.	19.02	9 31 03	9 31 03

WINNERS:—Class 1—Jennie R.	1st Prize.
Josco	2nd "
Class 2—Claudia M.	1st Prize.
Priscilla	2nd "
Class 3—Lola L.	1st Prize.
Stella May	2nd "
Class 4—Agitator	1st Prize.
Jennie A. Willis	2nd Prize.
Class 5—Funny M.	1st Prize.

Same Regatta Committee.

A Race for the Flint Cups was sailed August 26, 1893. This race was open to cabin-cats irrespective of size, with time allowance.

HISTORY OF THE LARCHMONT YACHT CLUB.

based on the actual sailing measurement—all boats to sail in one class for cups presented by Mr. F. W. Flint, and to be known as the Flint Cups for cabin-cuts.

The course was from Larchmont to and around stake boat in Hempstead Harbor; thence to and around Black Spar Buoy off Matinicoek Point; thence returning to stake boat in Hempstead Harbor; thence direct to finish.

The wind was very light at the start from the south southeast and remained so during one-half the race, then shifted to the southwest but did not increase in strength.

The following yachts were entered:

	Sailing length. Feet.	Elap. Time. H. M. S.	Cor. Time. H. M. S.
Nymph	28.02	5 27 05	5 26 12
Roi	28.05	5 36 31	5 36 31
Oceonee	25.70	5 30 47	5 25 27
Myrtle	27.03	5 00 03	4 56 58
Box			did not start.
Mary	29.26	" "	" "
Anemone	27.92	" "	" "
Caper	24.17	" "	" "
Almira	28.70	4 59 15	4 58 37
Wilmerad	26.87		did not finish
Zetes			did not start
Edith	27.63	" "	" "

	from	Almira	by	M. S.
WINNERS:—Myrtle			01 39	
"	"	Oceonee	28 29	
"	"	Nymph	29 14	
"	"	Roi	40 36	

Almira wins 2d Prize.

Same Regatta Committee.

A Match Race was sailed August 28, 1893, between NYMPH and ROI.

The stakes were \$100 a side. The course was from Larchmont Harbor off Flagler's Point to buoy on west end of Execution Reef; thence to and around buoy on Old Hen Rock; thence to stake boat off Flagler's Point; thence around the same course again to finish. Distance 16 nautical miles.

	Sailing length. Feet.	Elap. Time. H. M. S.	Cor. Time. H. M. S.
Nymph	28.02	2 32 25	2 31 51 2.5
Roi	28.05	2 33 57	2 33 57

Nymph wins by 2 min., 5 3-5 sec.

Annual Fall Regatta sailed September 2, 1893.

COURSES:—

For Class 2, the regular 21 nautical mile course.

For Classes D, 7, 9 and 9 (special), the 20 nautical mile course.

For Classes 10, 11 and 12, the 14 nautical mile course.

For Classes 15 and 17, the 10 nautical mile course.

The wind was northwest and strong.

SCHOONERS.

	Sailing length. Feet.	Elap. Time. H. M. S.	Cor. Time. H. M. S.
Class D,			
Peerless	68.03	2 38 14	2 38 14
Triton	67.03	2 40 52	2 40 13
Viator	65.92	2 30 14	2 28 52

Class 2.

	Sailing length. Feet.	Elap. Time. H. M. S.	Cor. Time. H. M. S.
Katrina	76.08	3 04 06	3 04 06
Bedouin	73.11	3 11 12	3 08 57
Queen Mab	69.00	2 58 08	2 52 29

Class 7.

	Sailing length. Feet.	Elap. Time. H. M. S.	Cor. Time. H. M. S.
Daffodil	40.81	3 06 28	3 06 28
Eurybia	40.02	" "	" "
Kathleen	37.44	3 08 57	3 03 57
Mary C.	not meas.	3 18 24	" "

SLOOPS.

	Sailing Length. Feet.	Elapsed Time. H. M. S.	Corrected Time. H. M. S.
Class 9,			
Susie W.	27.72	3 37 46	3 37 40
Class 10,			
Pyxie	24.95		disabled.
Folly	25.00	2 31 53	2 31 53
Nomadly	24.03		did not start.
Fanny	23.85	3 06 04	" "
Brenda		2 42 32	" "

YAWLS.

	Sailing Length. Feet.	Elapsed Time. H. M. S.	Corrected Time. H. M. S.
Special Class 9,			
Audax	30.85	2 16 06	2 16 00
Kwasind	29.87	2 19 33	2 18 16

CABIN-CATS.

	Sailing Length. Feet.	Elapsed Time. H. M. S.	Corrected Time. H. M. S.
Class 11,			
Mary	29.26	2 23 07	2 23 07
Almira	28.62	2 26 30	2 25 32
Wenonah	25.00	2 47 06	2 41 08
Class 12,			
Caper	24.17	2 27 21	" "
Water Witch			did not start.
Tabitha			2 21 41
Whim			3 27 51

Class 15.

Phyllis			did not finish
Zelion			" " start.

Class 17.

Scare-Crow	1 50 23	1 50 23	H. M. S.
------------	---------	---------	----------

WINNERS:—Class D, Viator	from	Peerless	by 0 22
	"	Triton	" 11 21

Class 2, Queen Mab	"	Katrina	" 11 37
	"	Bedouin	" 16 28

Class 7, Kathleen	"	Daffodil	" 2 31
-------------------	---	----------	--------

Class 9, Susie W.	"	walk-over.	
-------------------	---	------------	--

Special Class 9, Audax	"	Kwasind	" 2 10
------------------------	---	---------	--------

Class 10, Folly	"	Brenda	" 10 39
	"	Fanny	" 34 11

	"	Pyxie	disabled.
--	---	-------	-----------

Brenda awarded 2nd Prize.

Class 11,—Mary	"	Almira	" 2 25
	"	Wenonah	" 18 01

Class 12,—Caper	"	Tabitha	" 4 20
	"	Whim	1h. 30 sec.

Class 17,—Scare-Crow,	"	walk-over.	
-----------------------	---	------------	--

THE LARCHMONT CUP OF 1893 FOR SCHOONERS.

The Race took place September 16, 1893, over Course No. 10. The wind at the start was west southwest with rain, but at 11:50 A. M. a squall struck the yachts from the northwest, causing them to take in all light sails. The weather cleared but it continued to blow very hard during the race, and in some of the puffs the yachts were carrying their upper dead-eyes in the water.

The following yachts participated:

	Sailing length. Feet.	Elap. Time. H. M. S.	Cor. Time. H. M. S.
Dauntless	114.04	4 21 44	4 21 41
Lasea	93.17	3 53 49	3 42 38
Emerald	88.32	4 20 16	4 05 25
Ariel	81.53	4 09 01	3 50 20

Lasea won the \$500 cup from Ariel by 8 42

" Emerald " 22 47

" Dauntless " 30 06

Regatta Committee; John F. Lovejoy, Chairman; Otto Sarony, Gerard M. Barretto.

Time.	Corrected
M. S.	H. M. S.
46	3 37 46

disabled.
1 53 2 31 53
did not start.
06 04
12 32

06	2 16 06
33	2 18 16

07	2 23 07
30	2 25 32
06	2 41 08

7 21
did not start.
1 41
7 51

did not finish
" " start.

23	1 50 23
	H. M. S.
less	by 9 22
m	" 11 21
ima	" 11 37
min	" 16 28
til	" 2 31
-over.	
sind	" 2 40
da	" 10 39
y	" 34 11
e disabled.	

ra	" 2 25
onah	" 18 01
tha	" 4 20
m	1h.30 sec.
	walk-over.

CHOOSERS.

Course No. 10. The
n, but at 11:50 A. M.
causing them to take
ontinued to blow very
the yachts were carry-

Time.	Cor. Time.
M. S.	H. M. S.
1 41	4 21 41
3 49	3 42 38
0 16	4 05 25
09 01	3 50 20
	M. S.
by	8 42
"	22 47
"	39 06

rman; Otto Sarony.



THE LATE COMMODORE CALDWELL H. COLT.

LARCHMONT YACHT CLUB.

BIOGRAPHICAL SKETCHES AND DESCRIPTION OF YACHTS ENROLLED IN THE CLUB.

CALDWELL HART COLT, late Commodore of the LARCHMONT YACHT CLUB, was born in Hartford, Conn., in November 1858, and died January 21, 1894, at the Punta Gorda, Fla. He was the son of Samuel and Elizabeth Colt.

Commodore Colt was probably as well known as any yachtsman in the country, and has continually offered inducements in the shape of cups, etc., to yachtsmen to test the merits of their yachts. He has owned a number of well known boats, including *LIZZIE*, *WIZARD*, *ATALA*, *ORIOLE*, and the famous *DAUNTLESS*, formerly *L'HIRONDELLE*. He belonged to the LARCHMONT, NEW YORK, EASTERN, NEW HAVEN, ST. AUGUSTINE and other yacht clubs. Besides the honorable office he held up to the time of his death, he has held that of Vice-Commodore of the NEW YORK YACHT CLUB for one year. Commodore Colt was known as one of the most hospitable of yachtsmen, being always ready to entertain his friends and brother yachtsmen. By his death the LARCHMONT YACHT CLUB has sustained a great loss.

DAUNTLESS.

The famous keel schooner *DAUNTLESS*, owned by the late Caldwell H. Colt, Commodore of the LARCHMONT YACHT CLUB, was built by Forsyth & Morgan at Mystic, Conn., in 1866. She was originally called *L'HIRONDELLE*. *DAUNTLESS* now sails with the fleets of the LARCHMONT, NEW YORK, EASTERN, ST. AUGUSTINE, NARRAGANSETT and BISCAYNE BAY YACHT CLUBS.

For her complete racing record see pages 61 and 62.

Official number, 14,901.

CODE SIGNAL LETTERS, R. M. J. Q.

DIMENSIONS.

Length over all,	121 feet 10 inches.	Length load waterline,	116 feet 7 inches.
Depth,	10 feet.	Draft,	12 feet 0 inches.
Beam,	28 feet 7 inches.		

KWASIND.

The yawl *KWASIND* is the property of Oliver Adams; she was built for him by Read Bros., who also designed her. She was launched in May 1892, at Fall River, Mass. Her owner has been a member of the LARCHMONT YACHT CLUB since 1880. She is a centerboard yacht, has a cabin, and hails from New York. See Fig. 312.

Official number, 161,031.

DIMENSIONS.

Length over all,	44 feet.	Length load waterline,	28 feet 3 inches.
Draft,	4 feet.	Depth,	feet.
Beam,	12 feet.		



WILLIAM S. ALLEY.

WILLIAM S. ALLEY, stock broker, New York City, the son of George Bolton Alley, was born in 1853. He has been the owner of a number of yachts, among them *ADA* and *NEZLE*. The steamer *NOOYA* and the sloop *SCHEMER* have also belonged to Mr. Alley. The last, launched in 1871, was his property for ten years.

Like many of the more prominent yachtsmen of the day, Mr. Alley has interested himself in yachting since his boyhood. He was, in 1880, one of the founders of the LARCHMONT YACHT CLUB, and has always held some office in that body. He is also a member of the NEW YORK and the AMERICAN YACHT CLUBS.

SCHEMER.

SCHEMER is a centerboard sloop that was designed and built by I. F. Wilkins of Jersey City, New Jersey, and launched in 1871 for William

M. Tweed. Formerly the property of William S. Alley, but now belonging to Francis S. Brown, of Philadelphia, from which port she now hails, sailing with the PHILADELPHIA YACHT CLUB. She was altered from open to cabin sloop in 1873, partly re-built in 1882 and 1886, and was given a new stern in 1892. See Fig. 313 and plate.

Official number, 115,375.

DIMENSIONS.

Length over all,	45 feet 5 inches.	Length load waterline,	34 feet 10 inches.
Depth,	1 foot 4 inches.	Draft,	3 feet 8 inches.
Beam,	11 feet 0 inches.		

Spars: Boom, 44 feet; gaff, 26 feet 6 inches.

Racing Record:—

1891—PHILADELPHIA YACHT CLUB—*SCHEMER* won the championship pennant of her class, sailing twice alone and once with the yacht *NAROUNYA* which she defeated.

1892—PHILADELPHIA YACHT CLUB—*SCHEMER* won in the Regatta of June 4th, defeating *KATHLEEN*. On September 10th, she competed for a pennant, under the auspices of the same club. In this race she was beaten by both *YVETTE* and *NANON*.

ALTAMA.

ALTAMA is a keel schooner, formerly called *CARRIE*, and is the property of James C. Ayer. She was designed and built by Pope & Steers, Cleveland, Ohio, and launched in 1871. Hails from Boston, and sails with the NEW YORK, LARCHMONT and HULL YACHT CLUBS. See Fig. 314.

Official number, 125,366.

DIMENSIONS.

Length over all,	62 feet.	Length load waterline,	53 feet.
Depth,	6 feet 4 inches.	Draft,	8 feet 6 inches.
Beam,	17 feet 10 inches.		



EDMUND BLUNT.

EDMUND BLUNT, Brooklyn, N. Y., commission merchant, was born in Brooklyn, 1843, and is the son of Edmund Blunt and Eliza N. Sinclair. His grandfather was the author of "The American Coast Pilot" and other works. His father was on the U. S. Coast Survey. Mr. Blunt himself served in the U. S. Army, 1861-65. Has owned four yachts, *GO AND FETCH IT*, *MASCOTTE*, *SEMINOLE* and *AZALEA*, the last being his present yacht. Is a member of the NEW YORK, LARCHMONT and GREAT SOUTH BAY YACHT CLUBS.

AZALEA.

A centerboard schooner, designed and built by D. J. Lawlor, Chelsea, Mass., and launched in 1857. Built for J. M. Forbes, but at present the property of Edmund Blunt. She was altered in '73 and '79 by Smith, New Bedford. Hails from New York. See Fig. 315.

CODE SIGNAL LETTERS, K. H. B. L.

Official number, 1,914.

DIMENSIONS.

Length over all,	72 feet.	Length load waterline,	61 feet.
Depth,	5 feet 3 inches.	Draft,	6 feet.
Beam,	17 feet 7 inches.		

Now owned by J. Clinch Smith (Manning).

Racing Record for 1892:—

LARCHMONT YACHT CLUB—AZALEA won from PEERLESS and VIATOR in the Thirtieth Annual Regatta, July 4, and from VIATOR again in the Fall Regatta, September 10th. Beaten by VIATOR in a Match Race for the \$150 Cup September 13th.

SEAWASHAKA CORINTHIAN YACHT CLUB—Beat VIATOR in the Annual Regatta, sailed July 2nd.

RIVERSIDE YACHT CLUB—Annual Regatta, July 9th, beat PEERLESS.

NEW YORK YACHT CLUB—Did very little in the first part of the cruise, but was the winner in her class in the Run of August 6th, beating PEERLESS, QUICKSTEP, etc. Second in the Run of August 8th, in which QUICKSTEP won.



W. GOULD BROKAW.

W. GOULD BROKAW, of New York City, a native New Yorker, is the owner of the yacht VIATOR, and was formerly the owner of both the cat-boat FLORENCE and the schooner WILM. He has been a yachtsman, for ten years and belongs to several clubs, among them the NEW YORK, SEAWASHAKA, LARCHMONT and the AMERICAN YACHT CLUBS.

VIATOR.

A keel schooner, designed by E. Burgess, and built by Wm. Eddy, Marblehead, Mass., and launched in 1888, for a

Mr. Weyth of Boston. She became the property of W. Gould Brokaw, of New York City, in 1889. She hails from New York. See Fig. 316.

CODE SIGNAL LETTERS, K. J. G. T.

Official number, 161,585.

DIMENSIONS.

Length over all,	75 feet.	Length load waterline,	62 feet.
Depth,	6 feet.	Draft,	10 feet 6 inches.
Beam,	19 feet.		

Racing Record:—

1891—NEW YORK YACHT CLUB—Came out first in the Regatta of June 18th, beating DAUNTLESS, which was disabled. On August 8th, in a Squadron Run, she beat QUICKSTEP.

LARCHMONT YACHT CLUB—Won in the Spring Regatta, June 6th, defeating PRINCESS, which she also vanquished in a match Race held on June 20th. She won in the Annual Regatta of July 4th; and won a Match Race on September 7th, winning the Kerssey Cup. VIATOR also won another race on September 12th, beating REBECCA.

1892—LARCHMONT YACHT CLUB—Beat PEERLESS by nearly an hour in the Spring Regatta, June 4th. In the Cruising Runs of the LARCHMONT YACHT CLUB, classed with schooners of all sizes, VIATOR won no prizes. She was also beaten by AZALEA in the Fall Regatta, September 10th. Came in fifth in the race for the Larchmont Cup for schooners (seven starters). Won a \$150 Cup in a private race with AZALEA, September 13th, and was beaten by ATLANTIC in a Match Race sailed October 6th.

SEAWASHAKA CORINTHIAN YACHT CLUB—Lost to AZALEA in the Annual Regatta of July 2nd.

NEW YORK YACHT CLUB—Beat PEERLESS June 9th, in Regatta, winning Cup.

COYOTE.

A centerboard sloop yacht, owned by Henry W. G. Bucknall, of New York. She was designed by Burgess and built by George Lawley & Son in 1886. She hails from New York City, and sails with the fleet of the LARCHMONT YACHT CLUB. See Fig. 317.

DIMENSIONS.

Length over all,	25 feet, 10 inches.	Length load waterline,	20 feet, 6 inches.
Draft,	1 foot 8 inches.	Beam,	9 feet 7 inches.

FAUNA.

A centerboard sloop, owned by Moses Bulkley of New York. She was built in 1882 by John F. Munn of South Brooklyn, N. Y. FAUNA hails from New York City, and sails with the LARCHMONT YACHT CLUB. See Fig. 318.

DIMENSIONS.

Length over all,	31 feet.	Length load waterline,	25 feet 8 inches.
Draft,	3 feet 9 inches.	Beam,	12 feet 8 inches.

HENRY D. W. BURT, a native of New York City, and in the dry goods commission business in that city. Has been interested in yachting for twenty-five years, and is the owner of the keel cutter yacht MARGORIE. He is a member of the LARCHMONT YACHT CLUB.

MARGORIE.

A cutter, built by Pryor & Co. of Boston, and designed by Borden. Launched in September 1888. Formerly the property of Frank S. Benson of the ATLANTIC YACHT CLUB. She now belongs to H. D. W. Burt, of the LARCHMONT. She has never been altered, and now hails from New York. Has a cabin, and sails with the LARCHMONT YACHT CLUB. See Fig. 319.

CODE SIGNAL LETTERS, K. J. H. G.

Official number, 92,217.

DIMENSIONS.

Length over all,	38 feet 2 inches.	Length load waterline,	28 feet 3 inches.
Depth,	4 feet 9 inches.	Draft,	7 feet.
Beam,	10 feet 6 inches.		



RALPH N. ELLIS.

RALPH N. ELLIS, Rear-Commodore of the NEW YORK YACHT CLUB, is a resident of New York City. He has always taken a prominent position in yachting circles. Formerly the owner of the yacht REGINA, he is now in possession of the steel schooner IROQUOIS and is a member of the NEW YORK, SEAWASHAKA, LARCHMONT and EASTERN YACHT CLUBS.

IROQUOIS.

A centerboard steel schooner, formerly JULIA. Belongs to Ralph N. Ellis of New York City. Was designed by A. Cary Smith, and built by Harlan & Hollingsworth, Wilmington, Del., being launched in December, 1886. Hails from New York, and sails with the yachts of the NEW YORK, LARCHMONT, EASTERN and SEAWASHAKA CORINTHIAN YACHT CLUBS. IROQUOIS was chartered last summer by John Lee Carroll, Jr. See Fig. 320.

CODE SIGNAL LETTERS, K. D. N. T.

Official number, 76,658.

DIMENSIONS.

Length over all,	93 feet 3 inches.	Length load waterline,	80 feet 6 inches.
Depth,	11 feet.	Draft,	10 feet.
Beam,	21 feet.		

Racing Record:—

1891—NEW YORK YACHT CLUB—In the Squadron Run of August 4th, IROQUOIS won in her class, defeating MARGUERITE, GENONE, etc. Defeated by MARGUERITE in the Run of August 6th. Second (VOLUNTEER first) in the 11th series of races for the Gulet Cups, August 7th. Third in the Squadron Run of the 8th of August, MARGUERITE first. August 10th, Special Cups, Third. Winner in the Run of August 11th. Moved up into the third class on the 12th of August, and was beaten by MERLIN.

1892—NEW YORK YACHT CLUB—Won in the Squadron Run of Aug. 4th,

beating MARGUERITE and SHAMROCK. Second in the Squadron Run of August 6th, MARGUERITE winning. August 8th, Squadron Run. IROQUOIS first.

LARCHMONT YACHT CLUB—IROQUOIS won in the Thirteenth Annual Regatta, held July 4th, beating ATLANTIC and PRAXTOM. Beaten by SHAMROCK in the Fall Regatta, September 10th., ATLANTIC third. IROQUOIS was the winner of the Larchmont Cup of 1892 for schooners, beating LASCA, SHAMROCK, MARGUERITE, AZALEA, etc. IROQUOIS also won several thirds during the season.

F. W. FLINT, Larchmont Manor, N. Y., has been interested in yachting for twenty-three years, and is a member of the NEW YORK and SEAWANAKA YACHT CLUBS. Is also a charter member of the LARCHMONT YACHT CLUB, having been one of its founders in 1880. He has owned eight yachts, among them LURLEY, METEOR and HELENA. His present vessel is the centerboard cutter NYMPH. See Fig. 321 and cut SYMPH. Fig. 322.

NYMPH.

A centerboard cutter, designed by Edw. Burgess and built by G. Lawley & Son, So. Boston, Mass., in 1888, for F. W. Flint. Her present owner is Henry W. Harris. She sails with the fleets of the LARCHMONT, NEW YORK and SEAWANAKA CORINTHIAN YACHT CLUBS, and hails from New York.

Official number, 130,411.

DIMENSIONS.

Length over all,	50 feet.	Length load waterline,	46 feet.
Depth,	6 feet 4 inches.	Draft,	6 feet.
Beam,	14 feet 6 inches.		



HARRY M. GILLIG.

HARRY M. GILLIG, capitalist, Larchmont, N. Y., was born in California. He is the owner of the keel schooner RAMONA, formerly called RESOLUTE. Mr. Gillig is a member of the NEW YORK, LARCHMONT and CORINTHIAN (of New York) YACHT CLUBS.

RAMONA.

A keel schooner, formerly RESOLUTE, designed by David Carl, who was also her builder. She was launched in 1871, and is now the property of Harry M. Gillig, Larchmont, N. Y. She was re-built and lengthened in 1888, and sails with the NEW YORK CORINTHIAN, NEW YORK and LARCHMONT YACHT CLUBS. She hails from New York. See Fig. 323.

CODE SIGNAL LETTERS, K. J. M. Q.

Official number, 110,130.

DIMENSIONS.

Length over all,	133 feet.	Length load waterline,	110 feet 9 inches.
Depth,	8 feet 5 inches.	Draft,	12 feet 2 inches.
Beam,	25 feet 7 inches.		



FREDERICK C. GRIFFITHS.

FREDERICK C. GRIFFITHS, of New York City, has been interested in yachting for a number of years. He was at one time on the Regatta Committee of the LARCHMONT YACHT CLUB. Is in the stock business, and is a member of the Manhattan Club and of the New York Athletic Club. He belongs to four yacht clubs; the NEW YORK, LARCHMONT, STAMFORD and SEAWANAKA CORINTHIAN.

HORACE LESLIE HOTCHKISS, Jr., banker and broker, was born in 1868 at Stamford, Conn. Present residence New York City. Formerly the owner of the cat-boat Emma, now owns the

keel sloop DEFIANCE, formerly GRAPLING. DEFIANCE came into Mr. Hotchkiss' possession about three years ago. He is a member of the LARCHMONT YACHT CLUB, having joined in 1890. Has been interested in yachting since 1874.

DEFIANCE.

A keel sloop, designed and built by J. F. Mumm, So. Brooklyn, N. Y., and launched in 1878. For the past three years she has been the property of Horace L. Hotchkiss, Jr., of New York City, a member of the LARCHMONT YACHT CLUB. DEFIANCE was formerly GRAPLING. She was altered in 1881, being lengthened 5 feet. She hails from Mamaroneck, and has a cabin.

DIMENSIONS.

Length over all,	35 feet.	Length load waterline,	30 feet 6 inches.
Draft,	5 feet.	Beam,	12 feet.

SEYMOUR L. HUSTED, Jr., New York City. Born in 1851, in Brooklyn, N. Y., the son of Seymour L. and Mary J. Husted. Is the owner of the yacht TIOGA, and from 1877 to 1881 was the owner of the schooner PETREL. Has been interested in yachting for sixteen years. Is a member of the NEW YORK, LARCHMONT, SEAWANAKA, CORINTHIAN (of New York) and ATLANTIC YACHT CLUBS.

TIOGA.

A keel schooner, owned by Seymour L. Husted, Jr., having been designed and built by Joshua Brown, Salem, Mass., for General Perkins. She was launched in 1881, and became the property of Mr. Husted in 1887. She has a cabin, hails from New York, and sails with the fleets of the NEW YORK, LARCHMONT, SEAWANAKA, CORINTHIAN (of New York), and ATLANTIC YACHT CLUBS. See Fig. 324.

CODE SIGNAL LETTERS, K. F. D. V.

Official number, 145,345.

DIMENSIONS.

Length over all,	62 feet.	Length load waterline,	54 feet 11 inches.
Depth,	6 feet.	Draft,	9 feet.
Beam,	15 feet 9 inches.		



GIRARD C. LOWREY.

GIRARD C. W. LOWREY, merchant, Larchmont, N. Y. Dutch-English ancestry. Born in Newark, N. J., son of Joseph S. and Deborah P. Lowrey. Is Vice-President of the Larchmont Water Co. His father was a prominent merchant, being one of the organizers and for many years President of the Fifth Avenue Bank, New York City. Mr. Lowrey has been a yachtsman all his life, and held the office of Vice-Commodore in 1887, and Commodore from 1888-91 in the LARCHMONT YACHT CLUB. Was the owner of the yacht DAPHNE, now the property of A. W. Booth of Bayonne, N. J.

DAPHNE.

A centerboard sloop, designed by J. Rogers Maxwell, and built by A. F. Mumm, launched in 1885, for her designer. Now the property of Alfred W. Booth; was for some time owned by Girard C. W. Lowrey, of the LARCHMONT and AMERICAN YACHT CLUBS. Has a cabin and has never been altered. Hails from New York. See plate XCV.

CODE SIGNAL LETTERS, K. D. P. M.

Official number, 157,145.

DIMENSIONS.

Length over all,	51 feet.	Length load waterline,	46 feet.
Depth,	8 feet 9 inches.	Draft,	6 feet 6 inches.
Beam,	16 feet 4 inches.		



AUGUSTIN MONROE.

AUGUSTIN MONROE, member of the LARCHMONT YACHT CLUB and Chairman of the House Committee. Mr. Monroe, from his active interests in the welfare of the club has placed himself in a position to command the respect of the members, and it is needless to say that by the active members Mr. Monroe is held in the highest esteem. In fact, without the presence of his congenial nature one would question if he were in the LARCHMONT YACHT CLUB.



AUGUSTUS W. MOTT.

AUGUSTUS W. MOTT, New York City, N. Y., born in Mott Haven, New York City, the son of Jordan L. and Mariana S. Mott. Developed a taste for yachting eleven years ago. Has owned two yachts, ETHEL and MAGIC, the latter being his present yacht. In 1891 Mr. Mott was tendered the Rear-Commodorship of the AMERICAN YACHT CLUB, which he had joined in 1889. He became a member of the NEW YORK YACHT CLUB in 1890, the NEW ROCHELLE YACHT CLUB in 1890, the LARCHMONT YACHT CLUB in 1883, the late CHERRY DIAMOND YACHT CLUB in 1891 and the AMERICAN CANOE ASSOCIATION in 1890. Mr. Mott makes his yacht his home during the summer months, and few yachtsmen entertain more liberally.

MAGIC.

A centerboard schooner, owned by Augustus W. Mott, a member of the late CHERRY DIAMOND, NEW YORK, LARCHMONT, AMERICAN, and NEW ROCHELLE YACHT CLUBS, and the AMERICAN CANOE ASSOCIATION. Designed and built by R. F. Loper, Philadelphia, and launched in 1857—originally the sloop yacht MADGIE—1857-8, was lengthened 15 feet forward by Loper. In 1859-60, lengthened 12 feet aft, and rig changed to schooner. 1859-60, lengthened 15 feet amidships. Re-built in 1869-70 by David Carll at City Island. Again re-built by Smith & Terry, of Greenpoint, in 1890. Formerly owned by T. E. D. Powers, and owned by Mr. Mott since 1889. She hails from New York. See plate LV.

Official number, 90,372.

DIMENSIONS.

Length over all,	81 feet 6 inches,	Length load waterline,	70 feet.
Depth,	6 feet,	Draft,	7 feet 10 inches.
Beam,	29 feet 10 inches,		

MAGIC won the America's Cup in 1870, against a whole fleet of other yachts, beating Sir John Ashley's schooner CAMBRIA. See Chapter on America's Cup, Vol. II.

JESSIE.

JESSIE is a screw schooner, owned by Charles H. Murray, of New York City. She was designed by James E. Bayles, was built by James M. Bayles & Son, Port Jefferson, New York, and was launched in 1890. In 1893 she was lengthened 14 feet forward by her builders. JESSIE hails from New York and sails with the fleet of the LARCHMONT YACHT CLUB. See Fig. 325.

Official number, 76,869.

DIMENSIONS.

Length over all,	91 feet,	Length load waterline,	79 feet.
Depth,	5 feet 8 inches,	Draft,	5 feet.
Beam,	19 feet,		

Engine: 2 steuple condensing, 4 cylinders, (2) 7 in. and (2) 14x9 inch; 1890. L. Wright, Jr., Newark.
Boiler: James Beggs, New York City.



R. M. STIVERS.

R. M. STIVERS, carriage builder, New York City. Born in 1822; has devoted his spare time to yachting and nautical affairs generally. He was the son of James and Sarah Stivers. He has owned two yachts, COZY and the one which now belongs to him, PHAROS; the latter was launched in 1889, and has been his property for two years. He is a member of the NEW ROCHELLE and LARCHMONT YACHT CLUBS.

PHAROS.

Screw steamer, belonging to Rufus M. Stivers, a member of the LARCHMONT and NEW ROCHELLE YACHT CLUBS. Was formerly known as SCAMP. Launched in 1888, and the property of Mr. Stivers for two years. She hails from New York. See Fig. 330.

DIMENSIONS.

Length over all,	45 feet,	Length load waterline,	40 feet.
Draft,	3 feet 6 inches,	Beam,	7 feet.

Engines: Compound.

Boiler: Built by Riley & Cowley.

KATRINA.

A steel centerboard cutter, owned by George Work, of New York. Was designed by A. Cary Smith and built by Henry Piepgras, City Island, New York, and was launched in May, 1888. She was formerly owned by Hugh D. Archinloss, of New York. KATRINA now hails from New York City, and sails with the fleets of the LARCHMONT, NEW YORK, SEAWANAKA CORINTHIAN and CORINTHIAN OF NEW YORK YACHT CLUBS. See Fig. 331.

CODE SIGNAL LETTERS, K. G. H. M.

Official number, 14,473.

DIMENSIONS.

Length over all,	85 feet 9 inches,	Length load waterline,	69 feet 6 inches.
Depth,	10 feet 3 inches,	Draft,	9 feet 3 inches.
Beam,	20 feet 4 inches,		

Racing Record for 1892:—

NEW YORK YACHT CLUB—KATRINA started in seven races. She was beaten by FANNY in the Squadron Run of August 3rd, with GRACIE third. Second, beaten by HURON in the Run of August 4th, with GRACIE third again. On August 6th, KATRINA beat both GRACIE and HURON, and defeated WAYWARD on the 8th. She was third in the contest for the Morgan Sloop Cup, August 8th, being beaten by WASP and GLORIANA, while she in turn beat WAYWARD, CLARA, HARPOON, etc.

LARCHMONT YACHT CLUB—KATRINA won in a cruise on July 17th, beating DARE.

BO-PEEP.

A screw steamer, designed and built by Henry Piepgras, City Island, New York, and now owned by E. H. Townsend. She was launched in 1888. BO-PEEP hails from New York and sails with the NEW YORK and LARCHMONT YACHT CLUBS. See Fig. 330.

CODE SIGNAL LETTERS, K. F. G. H.

Official number, 3,401.

DIMENSIONS.

Length over all,	65 feet,	Length load waterline,	60 feet.
Depth,	5 feet 7 inches,	Draft,	4 feet 6 inches.
Beam,	12 feet,		

Engine: Triple expansion, 3 cylinders, 5 in., 8 in., and 13 x 8 inch. Nominal horse power 25. Built in 1888, by J. W. Sullivan.

Boiler: Water tube, 1892.



OTTO SARONY.

OTTO SARONY, photographer, New York City, New York. Was born in New York City, of Canadian and English ancestry. Mr. Sarony is associated with his father in business, and the firm has reached the acme of perfection in photography. They are artist photographers, and the name of Sarony in this connection is known as well in Europe as in America.

Mr. Sarony has been an active member of the Regatta Committee of the LARCHMONT YACHT CLUB for the last five years, and on account of his conservatism and acute sense of justice, is highly thought of. He is a member of the New York Athletic Club, and the Accomack Club of Virginia.

CLINTON BARNUM SEELEY, of New York City, born in Bridgeport, Conn., has been a yachtsman for the past ten years. He was Commodore of the New ROCHELLE YACHT CLUB, and held a similar position in the BRIDGEPORT YACHT CLUB. He has owned the cat-boat TRAMP, the sloops CUTE and PSYCHE, the schooner PRINCESS, and his present yacht is the schooner ATLANTIC. Mr. Seeley was one of the founders of the BRIDGEPORT YACHTING ASSOCIATION. He is a member of the NEW YORK, LARCHMONT, and NEW ROCHELLE YACHT CLUBS. ATLANTIC.

A centerboard schooner yacht, owned by C. B. Seeley and Wilson Marshall, of New York City. She was designed by Ellsworth, built by Mumm, and was launched in 1886. Mr. Seeley has owned her for eighteen months. She was originally sloop rigged, but was changed to schooner in 1890, and was rebuilt in 1892. She hails from New York, and sails with the NEW YORK, LARCHMONT and NEW ROCHELLE YACHT CLUBS. See Fig. 329.

CODE SIGNAL LETTERS, K. D. J. M.

Official number, 106,415.

DIMENSIONS.

Length over all,	98 feet.	Length load waterline,	81 feet.
Draft,	9 feet 6 inches.		

Racing Record for 1892:

LARCHMONT YACHT CLUB—Spring Regatta, June 4th, third, beaten by SHAMROCK and FLEUR DE LYS. Thirteenth Annual Regatta, July 4th, second, beaten by TROUQUOIS. A winner in the Squadron Cruise of July 9th, beating DAUNTLESS, VIATOR, GEVALLA, etc. The following day she defeated the same schooners, with the addition of PHANTOM. This was repeated on July 13th. Was beaten by both SHAMROCK and TROUQUOIS in the Fall Regatta, sailed September 10th. There was a Match Race October 6th, between ATLANTIC and VIATOR, in which ATLANTIC won by over 43 minutes.

NEW YORK YACHT CLUB.—Second in the Squadron Run of August 3rd, LASCA winning. Third on August 4th, beaten by LASCA and MERLIN. Entirely outsailed in the race for the Golet Cup, August 5th. Fourth on the 6th of August (Squadron Run), and the same on the following day.



HAROLD A. SANDERSON.

HAROLD ARTHUR SANDERSON, steamship manager, New York City, was born in England. He is the owner of the yawl NONPAREILLE, having also owned the sloop ZOE. A shining light among the yachtsmen of the country for fifteen years, and now Vice-Commodore of the LARCHMONT YACHT CLUB; he has also held the office of Rear-Commodore in this club. He is a member of the LARCHMONT, NEW YORK, CORINTHIAN, ROYAL NOVA SCOTIA OF HALIFAX, and the ROYAL NORTHERN OF SCOTLAND YACHT CLUBS.

NONPAREILLE.

NONPAREILLE is a keel yawl, built and designed by Camper & Nicholson, of Gosport, Hants. She was launched in June 1882, and her owner was Vice-Commodore Harold A. Sanderson of the LARCHMONT YACHT CLUB. She hails from New York, and sailed with the fleets of the LARCHMONT, NEW YORK and CORINTHIAN YACHT CLUBS, as well as the ROYAL NOVA SCOTIA YACHT CLUB of Halifax, and the ROYAL NORTHERN YACHT CLUB of Scotland up to the time she was washed ashore on the rocks at Larchmont last summer. She has recently been sold at auction. See Fig. 327.

CODE SIGNAL LETTERS, W. L. V. S.

DIMENSIONS.

Length over all,	80 feet.	Length load waterline,	67 feet 11 inches.
Depth,	10 feet 3 inches.	Draft,	11 feet 6 inches.
Beam,	15 feet 9 inches.		



OSWALD SANDERSON.

LARCHMONT YACHT CLUB, and the SEAWANAKA CORINTHIAN YACHT CLUBS.

PYXIE.

The keel sloop PYXIE, property of Oswald Sanderson, was designed by W. E. Gardner, and built by A. Wood & Son, City Island, N. Y., for her present owner. She was launched in May, 1892, and hails from New York. Her owner belongs to several clubs, the LARCHMONT, SEAWANAKA and the CORINTHIAN MOSQUITO FLEET.

DIMENSIONS.

Length over all,	36 feet 6 inches.	Length load waterline,	23 feet 9 inches.
Depth,	5 feet.	Draft,	6 feet 6 inches.
Beam,	7 feet 8 inches.		

RACING RECORD.

PYXIE has a very good racing record, since in her first season she won four firsts and two seconds out of eleven races, in two of which she was unfortunate enough to meet with accidents which left her no chance of winning. She has beaten EL CHICO and NADY; the latter with seven starters. She also beat NAMELESS in a special race on September 4th. On September 5th, in a handicap, PYXIE scratch, came in second with eleven starters. PYXIE sailed from Larchmont to Boston in 55 hours; remarkable time for so small a yacht.

JEAN.

James Renwick of New York is the owner of the screw schooner JEAN. She was designed by Edward S. Renwick and built by John F. Mumm, South Brooklyn, New York, in 1888. Was launched in June of the same year. She sails with the NEW YORK and LARCHMONT YACHT CLUBS, and hails from New York City. See Fig. 326.

CODE SIGNAL LETTERS, K. J. E. T.

Official number, 76,763.

DIMENSIONS.

Length over all,	106 feet.	Length load waterline,	95 feet.
Depth,	10 feet 8 inches.	Draft,	7 feet 6 inches.
Beam,	17 feet 6 inches.		

Engines:—Two steple engines: 4 cylinders, two 10 x 12 inch., and two 20 x 12 inch. Indicated horse power, 300. Built in 1888 by L. Wright, Jr., Newark.

Boilers:—Two vertical tubular boilers. Erie City Iron Works, Erie, Pa.

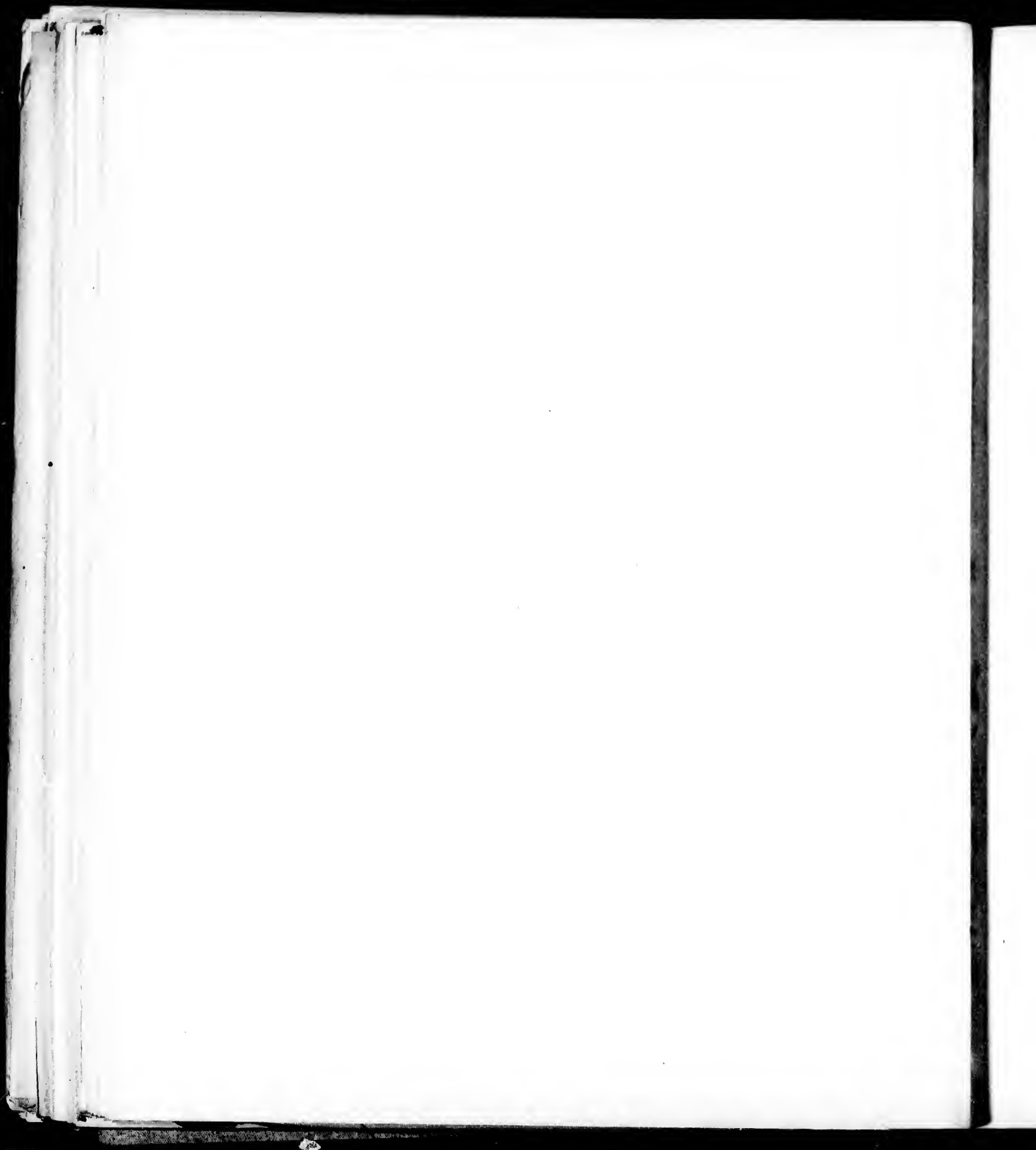



ST. LAWRENCE YACHT CLUB HOUSE.—FIGURE NO. 332.

History of the St. Lawrence Yacht Club.

THE ST. LAWRENCE YACHT CLUB was organized in the Spring of 1888, and it has attained such a measure of success under certain adverse and exceptional conditions as to make a decidedly interesting organization.

The yachtsmen of Montreal are practically restricted for home cruising and racing, to the waters of Lake St. Louis, and although there is plenty of room for a ten mile course on this sheet of water, it is unfortunately so thinly spread out over certain shoals and shallows that the limit of draft for boats intended for general use upon it cannot be more than between 30 and 40 inches. This, of course, prevents the general use of boats as large as those which make up the smaller regular classes on the coast and the lakes, and restricts the development of the sport greatly. Then too, although Montreal is connected with the sea by a 30 foot channel, with the Great Lakes by a 12 foot channel, and with the Hudson by a 7 foot channel, the position of the city, the nature of these channels and the character of her yachting waters combine to isolate her yachtsmen to a very decided degree. The stimulus of outside racing can never be looked for, and that best of object lessons, a good sound beating from a foreigner, can never be administered to local self-satisfaction and ignorance.

That, however, yachting did not make greater progress than it has done in the vicinity of Montreal during the past twenty years, was less because of the disadvantageous natural conditions, than because the artificial condition under which racing was carried on was such as to make development impossible. There was for some years a yacht club with its headquarters established upon a reach of the river below the city, but its principal yearly function was a moonlight excursion on a steamer, while its members were, generally speaking, so exhausted by their attempts to comply with the regulations as to be unable to do anything else. During the seventies a fleet of rather large skimming dishes was got together on Lake St. Louis, and a veritable racing mania set in. There were no rules, for there was no club or other body to either frame or enforce them, and as the interest was keen, everything was done to secure a victory, nothing to make for yachting in its best sense. Professional crews were employed, principally to throw sand bags, and on some occasions Alexander Cuthbert, the only Canadian that has ever distinguished himself as a professional yacht sailor and designer, was brought down to sail a fast boat in some of these bagatorial contests,—for so they may be termed—and great interest was shown in this

phase of race sailing. A fire which destroyed the whole fleet while they were in their winter quarters, a large storage shed, brought this epoch in Montreal's yachting history to a close. Few of the men who then lost their boats ever built again, and a large collection of miscellaneous brass work in the hands of "St. Onge" and the good stories told by the veterans of those stirring days, are all that is left of it.

For at least eight or ten years prior to the formation of the ST. LAWRENCE YACHT CLUB very little yachting was done on Lake St. Louis. Boat clubs grew up about the lake, a good many small cats and sloops were brought from Lake Champlain, or were put together by local builders, and at the yearly regattas of the boat clubs, Sweepstakes Races were held. There were few rules and less management, shifting ballast and unlimited crews were allowed, there was no fixity about the scale of time allowance, and dexterity in building up a wall of sand bags was the principal result obtained by such racing.

This state of things was about at its worst, when in the Spring of 1888 a caucus of men interested in yachting was held in a reading room of the Montreal Amateur Athletic Association, and as a result a call for an open meeting was issued. This meeting was duly held and there was a fairly large attendance; that is, there were twenty or thirty men present, and before the meeting closed two or three new boats were heard of. Among those present were Messrs. S. Greenshields, W. J. Wallace, Judge Davidson, Jas. Paton, G. H. Duggan, F. Scott, A. Irving, J. F. Gibsons, C. H. Levin and G. Gabler. The club was formed, a constitution and by-laws were adopted, and a set of sailing regulations, based upon those of the LAKE YACHT RACING ASSOCIATION, were adopted.

The first officers were as follows:

Commodore,	S. Greenshields.	Secretary, J. Simmons.
Vice-Commodore,	G. H. Duggan.	Treasurer, T. L. Paton.
Rear-Commodore,	C. H. Levin.	Measurers, J. F. Gibsons and F. Scott.

Within two years after the date of organization the club had secured a membership of 108, and had enrolled upon its squadron list 30 boats classed as yachts, 28 skiffs and 31 steam yachts and launches. In the matter of classification it had reduced chaos to order on a corrected length basis, and had introduced class and series racing. Shifting ballast and unlimited crews had been killed, the best measurement rule that could be found adopted, and many improvements made in general laws and regulations.

Up to the Winter of 1890, the club was simply a racing organization, but in the Fall of that year, the committee ventured on a new departure, and established a Winter club room in the city. Weekly meetings were held, and a great deal of interest in the club and in yachting generally was evoked, which, as the Spring grew near, crystallized in a scheme for building a Club House and so putting the club on a permanent basis. The club's incorporation was secured during this Winter, the constitution and sailing regulations were thoroughly revised, and with the beginning of the yachting season the construction of the Club House began and a boom in yachting set in, resulting in both a large addition to the membership of the club and to the fleet. During the Winter of 1891 and 1892 the interest abated somewhat, but it was revived during the racing season of 1892, and a most important addition was made to the club's property; a large shed for the storage of yachts—a necessity created by the climate—was erected, and a basin was excavated.

THE ST. LAWRENCE YACHT CLUB has not merely been successful as an organization, although its history leaves little to be desired in

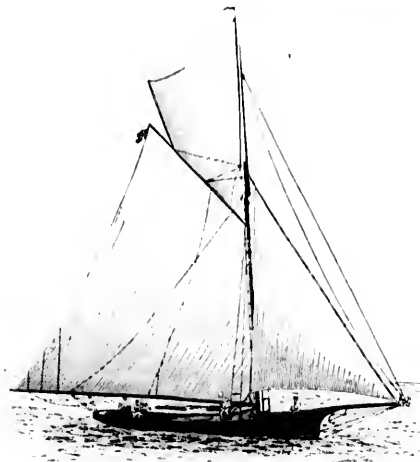

MADON.—FIGURE 334.

that respect, but it has revived the flagging interest of Montrealers in the sport and has created a healthy Corinthian racing spirit. All professional sailors are rigorously excluded from its races, and the prizes raced for are all honorary, a flag and trophy being the utmost that can be won—and more than this it has begun, at least, upon the development of a type of boat suitable to the waters at its command. The limit nature has imposed upon draft, of course, absolutely prevents development along the same lines as those which obtain in more favored localities, and the problem of obtaining speed, safety and comfort, is rendered a very difficult one. The policy of the club, to discredit and prevent the growth of racing machines by every means in its power, has, however, been fairly successful, and although the perfect boat has not as yet been seen on Lake St. Louis any more than elsewhere, still the most successful boats in the club's races are, as recent events have proved, the ablest and most generally useful of the fleet. In the past the impossibility of getting a good workman-like boat turned out by a local builder without great trouble, has greatly interfered and hampered development, but this trouble is now a thing of the past, and great progress in this respect may be looked for in the future.

The club has now 320 regular, 11 non-resident, 9 junior and 2 honorary members.

Mr. G. H. Duggan was elected Commodore for 1889, re-elected in 1890, and succeeded by A. W. Morris in 1891. Commodore Morris was also re-elected for a second year. The complete list of officers for the year 1893 was as follows:

Honorary Commodore	A. W. Morris, M. L. A. (first year this office has been filled)
Commodore	Charles H. Levin.
Vice-Commodore	W. Arthur C. Hamilton.
Harb. Commodore	R. R. Stevenson.
Hon. Secy. and Treas.	J. C. Cogswell Almon.
Measurers.	F. P. Shearwood, C. G. R. Marler, G. A. S. Hamilton.

COMMITTEE.

J. G. Monk,	A. F. Mitchell,
E. Kirk Greene,	R. Campbell Nelles,
G. H. Duggan,	John Simmons,
W. S. Clouston,	W. de M. Marler,

SAILING COMMITTEE.

G. H. Duggan,	Judge Davidson,
W. S. Clouston,	Arthur Hamilton,
W. Kavanagh,	E. Kirk Greene,
G. Gable,	W. de M. Marler,
A. W. Morris, M. L. A.,	C. H. Levin, J. C. C. Almon.

ACCORDING TO THE RULES AND REGULATIONS.

According to the sailing regulations of the club, the measurement of yachts shall be of length and sail area according to the following formula: "(Lead water line plus square root of sail area) divided by two (2) equal to racing length." Length to be measured from the forward side of stern at the lead waterline to the lead waterline at stern, wherever found, exclusive of any part of the rudder. This measurement to be taken when the yacht is afloat and in her ordinary trim, and without her crew on board. The Measurer, at the time of taking his measurements, to affix a distinctive mark at each point. The sail area to be computed as follows: In the A, 30 and 25 foot classes, by multiplying the base by perpendicular, and dividing by 2. The perpendicular shall be the length taken along the after side of mainmast from upper side of the upper hulliard block or sheave on topmast, to the upper side of boom when resting on the saddle or on the lowest part on goose-neck; but the following to be taken if greater from the upper side of mainboom to the under side of cross-trees, or, if the yacht has no cross-trees, to the under side of the main rigging (in the case of cat-boats), and those having no rigging, to the upper side of throat hulliard sheave plus four-fifths of the length of the gaff. On schooners, cutters and sloops, the base line shall be the length from a point half-way between the bee hole or point of contact of the jib-stay on bowsprit, or flying gib-stay or jibboom, or from pin of out-haul sheave, when jib is set flying, and the point of contact of the topmast stay or bowsprit, to the end of the mainboom, with one-fourth of the length of the main-gaff added thereto. On yawls, the base line shall be the length from the same point on jibboom, as for schooners, etc., to the end of mizzen-boom. On cat-boats the base line shall be the length of the boom plus one-fourth the length of gaff. Any excess of the spinnaker boom over the distance from the fore side of mast to the forward point of base line, or if the length be greater, the height from the mainboom to the under side of the cross-trees or main rigging (in the case of boats having no rigging, to the upper side of throat hulliard and sheave) shall be added to the base line. The gaff and boom to be measured from the after side of mast to the end of gaff or boom, and any extension of either to be included in measurement. In the case of rigs to which the above rules of measurements do not, in the opinion of the sailing committee, apply, sail area shall be measured as follows: to the actual area of the sails, exclusive of head sails and spinnaker, shall be added the area of the forward triangle, which shall be computed by measuring a base line from the end of bowsprit to the foremast, and a perpendicular from the deck to the highest block used to set head sails or spinnaker, and dividing the multiple of these measurements by 2. In such cases the sail area may be computed from a properly certified sail plan filed with the Measurers. In the 21 and 18 foot classes

80, re-elected in
Comodore Morris
list of officers for

ear this office has
been filled)

A. S. Hamilton.

ettes.

er.

on,
v.
er.
Abnon.

IONS.

he measurement
g to the follow-
ot of sail area)
gth to be meas-
waterline to the
ve of any part
when the yacht
at her crew on
a measurements,
sail area to be
ses, by multiply-
The perpendic-
mainmast from
topmast, to the
n the lowest part
greater from the
-trees, or, if the
main rigging (in
to the upper side
gth of the gaff.
ll be the length
of contact of the
, or from pin of
nt of contact of
boom, with one-
On yawls, the
jibboom, as for
at-boats the base
th the length of
distance from the
e if the length be
nder side of the
ng no rigging, to
be added to the
, the after side of
f either to be in-
h the above rules
iling committee,
ne actual area of
all be added the
ed by measuring
st, and a perpen-
set head sails or
asurements by 2.
properly certified
d 18 foot classes



HON. COMMODORE A. W. MORRIS.

ST. LAWRENCE YACHT CLUB.

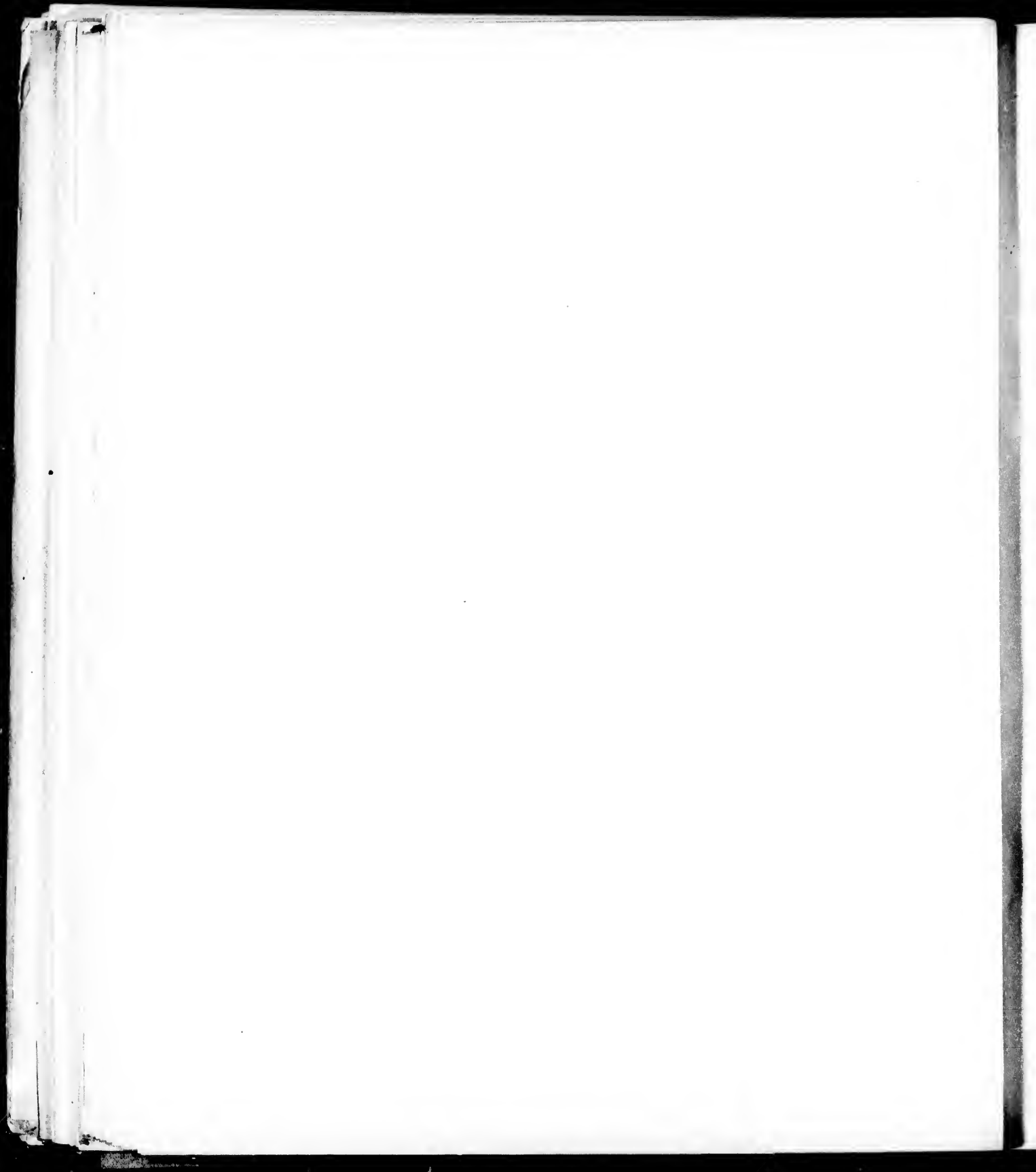

sail area shall be computed by multiplying perpendicular by base and dividing by two. The perpendicular shall be the length taken along the after side of mainmast, from upper side of halliard or sheave on topmast, to upper side of boom when resting on saddle or lowest part of goose-neck. The base line shall be from a point half way between the bee-hole or point of contact of the jib-stay or jibboom or pin of out-haul sheave, when jib is set flying, and the point of contact of the topmast stay on bowsprit to the end of mainboom, to which shall be added the excess of the gaff over 80 per cent. of the topmast, the topmast to be taken from the hounds to the highest point of measurement.

The area from these figures is to be obtained by multiplying the base by the perpendicular and dividing by two. To the square root of the area, as ascertained, add the length, and divide by two; the result is the corrected length for time allowance.

The squadrons of the club shall be divided for racing into the following classes:

Class A—All yachts of over 30 feet corrected length, as found by above formula.

30 foot Class—All yachts of over 25 and not over 30 feet corrected length.

25 foot Class—All yachts of over 21 and not over 25 feet corrected length.

21 foot Class—All yachts of over 18 and not over 21 feet corrected length.

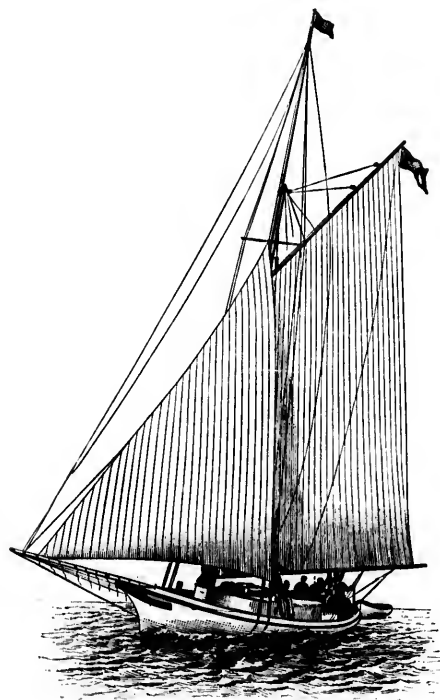

DREAM.—FIGURE 334.

18 foot Class—All yachts of 18 feet corrected length and under.

Boat Class, all boats not included under the following definition of a yacht, of which the beam is not at least one-third of the load water-

line length; or, in lieu thereof. No vessel may be enrolled as a yacht in any of these classes of which the beam is at least one-third of the load waterline length; or in lieu thereof, does not carry thirty pounds of stationary ballast for each foot of load waterline length.

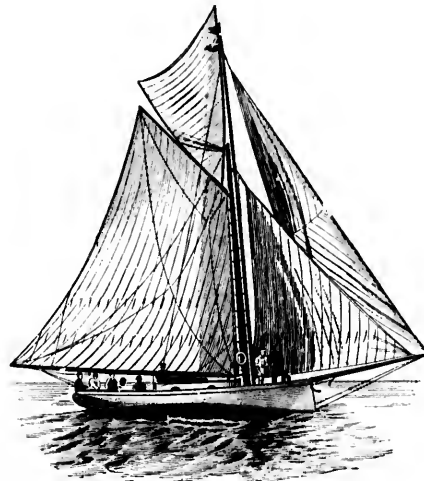

FRONIC.—FIGURE 335.

There shall be no restrictions as to sails or the manner of setting or working them.

No towing, sweeping, poling or pushing, or any mode of propulsion, except sails, shall be allowed.

No shifting of ballast or planking out shall be permitted during any race. Yachts must carry the ballast they start with throughout the race under their floors, platforms or lockers. No more than the usual anchors and chains shall be carried during a race, and these must not be used as shifting ballast or for altering the trim of a yacht; nor shall any of the spars, sails, rigging or boat's furnishings be shifted for ballasting purposes. The crew carried must be limited to one man for every five feet of corrected length, according to Rule 11, and every fraction thereof over 50 per cent. of five feet corrected length, excepting in the 18 foot class, which shall not carry more than two men.

Each yacht starting in a race must carry at least one Government standard life belt, or equivalent life-saving apparatus, for each man, allowed by the sailing regulation. Any yacht not complying with this regulation may be disqualified by the Sailing Committee.

In all sailing matches, yachts and boats competing must be sailed by *bona-fide* members of the club, and no boat-builder, rigger or professional sailor shall be allowed on board any competing yacht or boat.

In case of a man falling overboard from a competing yacht, all other boats in a position to do so, shall use their utmost endeavors to render assistance; and if it should appear that any yacht was prevented thereby from winning the race, the committee shall have power to order it to be re-sailed between any yachts so prevented and the actual winner.

The allowances of this club are based upon the rule accepted by naval architects, that within economic limits, opportunities for speed vary in different vessels as the square roots of their respective lengths.

As strong winds are required, however, to give to larger vessels the full extent of their advantage in size, and as such a scale of allowance is not adapted to ordinary summer racing, forty per cent. only of the allowance due to the rule is given in the table, and may be stated thus:



CHAPERON.—FIGURE 336.

Time equals $4 \left\{ \frac{3672}{4L} - \frac{3281}{4L} \right\}$ 3600 representing the number of seconds in an hour, L the small yacht, and L the large one.

Practically the formula is $\left\{ \frac{1491}{4L} - \frac{1191}{4L} \right\}$, four-tenths of 3600 being 1440.

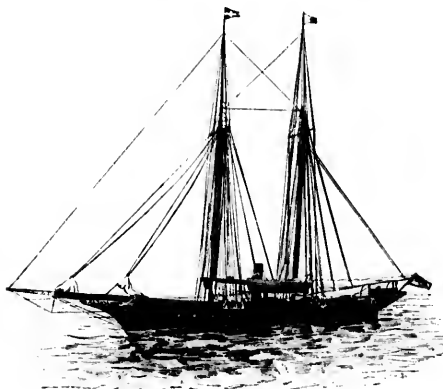

GADABOUT.—FIGURE 337.

RACING REGULATIONS FOR 1893.

The cup given by the Honorary Commodore shall be sailed for by Class A.

The cup given by the Commodore shall be sailed for by 30 foot Class.

The cup given by the Vice-Commodore shall be sailed for by 21 foot Class.

The cup given by the Rear-Commodore shall be sailed for by 18 foot Class.

Cups will be given by the club for second place, and prize pennants to the first, second and third boat in each class series race. The first prize pennant will have the club's device in black on a yellow field, the second prize pennant the club's device in blue on a red field, and the third prize pennant, the club's device in red on a blue field. Money prizes will be given to the first, second and third boat in the steam yacht race.

There must be at least two entries in a class or there will be no race. In the A and 30 foot classes no second prizes shall be given unless three or more yachts have started, or in the 25, 21 and 18 foot classes, unless four or more yachts have started.

SIR DONALD A. SMITH CHALLENGE CUP RACING RULES.

1. The cup shall be a perpetual Challenge Cup to be sailed for annually on Dominion Day, under the rules of the ST. LAWRENCE YACHT CLUB.
2. The cup may be held by the yacht winning it until the first day of June following—a satisfactory bond being given the Commit-

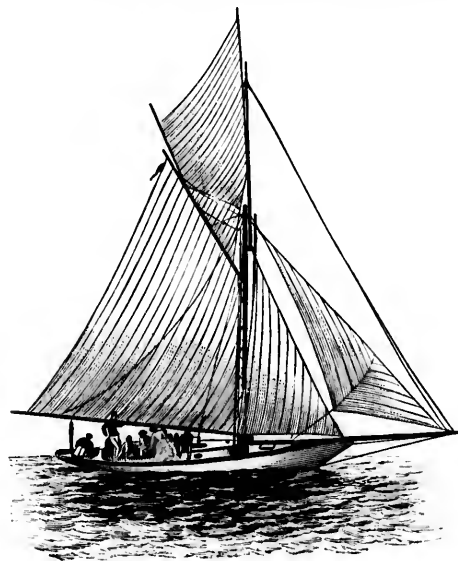

COQUETTE.—FIGURE 338.

tee for its safe return. A commemorative medal shall be given by the club to the yacht when the cup is returned to the club.

3. The races for the cup to be open to yachts of the ST. LAWRENCE YACHT CLUB of the A, 29 and 24 foot classes. Sailing length as defined by Rule III.

4. The course for the cup races to be over the ST. LAWRENCE YACHT CLUB course as decided each year.

5. All disputes shall be decided by the Sailing Committee of the club—for this purpose not less than five members shall be a quorum.

All boats sailing in the club's races, where rig does not come within the scope of the present measurement rules, shall have their sail area measured for rating as follows: To the actual area of their sails, exclusive of headsail and spinnaker, shall be added the area of forward triangle, which shall be computed by measuring a base-line from the end of bowsprit or spinnaker boom (whichever be the greater) to the foremast, and a perpendicular from the deck to the highest block used for setting the spinnaker, and dividing the multiple of these measurements by two.

d prize pennants
race. The first
yellow field, the
d field, and the
ie field. Money
out in the steam

there will be no
ll be given unless
1 18 foot classes,

RULES.

e sailed for annu-
WUENCE YACHT

it until the first
en the Commit-



shall be given by
he club.
of the ST. LAW-
s. Sailing length

e ST. LAWRENCE

Committee of the
all be a quorum.
s not come within
ave their sail area:
of their sails, ex-
ne area of forward
base-line from the
be the greater) to
m the deck to the
ividing the multi-



FROM A NEGATIVE BY BOLLES.

PLATE XXXII

AZTEC.

AZTEC.

FROM A NEGATIVE BY BOLLES.

PLATE XXXII. Aztec. (Continued)



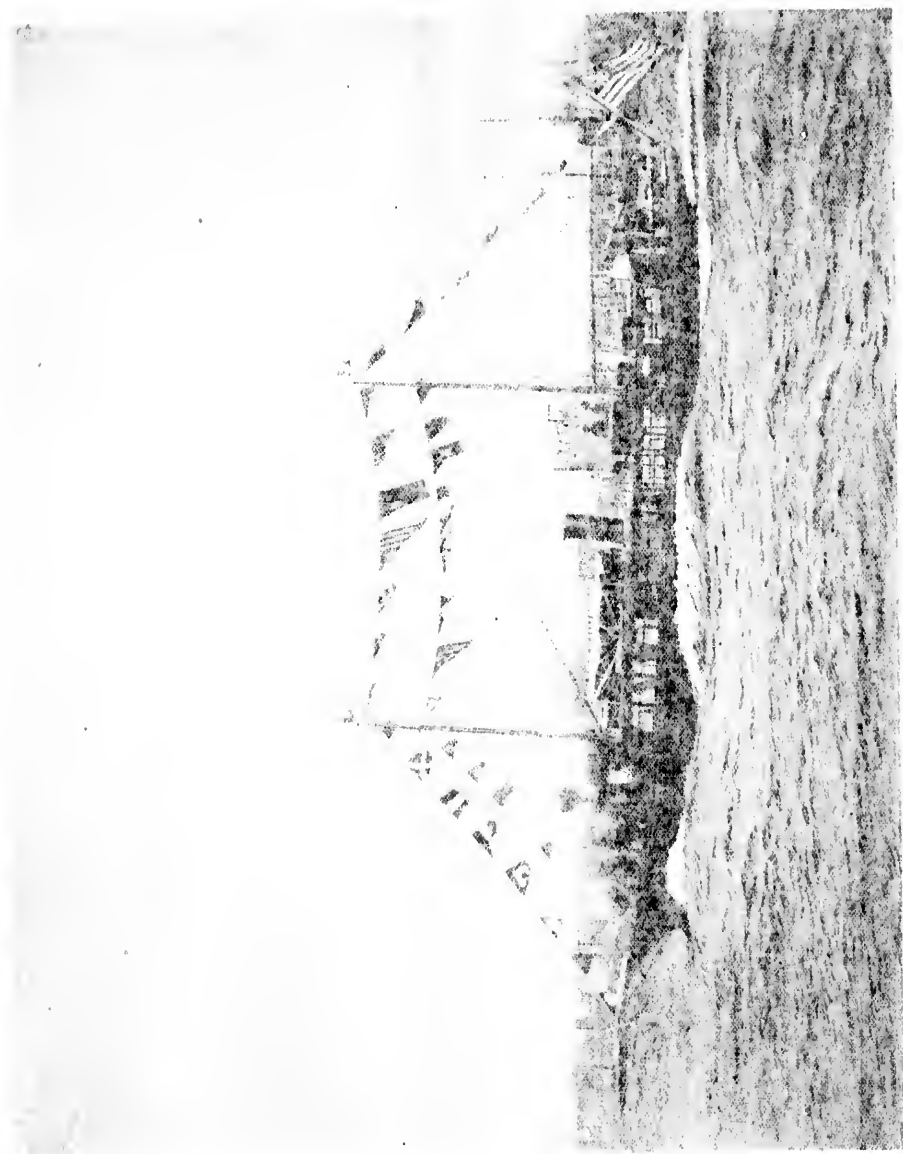

SQUADRON LIST OF THE ST. LAWRENCE YACHT CLUB.

SAIL.

Signal Letters.	Rtg.	Yacht.	owner.	Designer.	Builder.					
						L. O. A.	L. W. L.	Beam.	Spruce.	C. L.
BH	Cutter	Engle	C. H. Levin, Geo. Gabler	Builder	R. Roy	30.00	35.00	10.00	1,150	36.02
HJ	"	Viking	L. J. Smith		J. McIntyre	15.00	30.00	12.00	35.00
BS	"	White Squall	J. H. Gester	G. H. Duggan	W. C. White	23.07	27.01	11.00	1,235	31.01
HL	"	Chaparron	E. S. Clouston	A. F. Jarvis	A. M. Robertson	25.00	25.00	9.00	1,057	30.02
JH	"	Copette	Arthur Hamilton	Builder	Lebonif	35.00	25.00	9.10	1,100	28.00
PH	"	Griffin	W. H. Denyon			20.00	21.00	7.00
PJ	"	St. George	J. A. Denyon			25.00	24.00	7.00	600	24.00
SH	"	Spray	C. H. Godfrey, Frank Scott	Builder	J. Weir	20.00	21.00
WBH	"	Yampa	James MacDougal	A. F. Jarvis	A. M. Robertson	19.05	21.00
WBJ	"	Danshee	Dr. W. Johnston		Hodgson	19.05	22.00
HHW	"	Unha	R. A. Kydd		G. St. Onge	29.00	25.00	8.00	700	26.00
HHP	"	Dandy	H. G. Stanton, A. Sabiston	H. G. Stanton	P. Girard	28.00	20.00	6.00	23.75
HP	Sloop	Drean	A. W. Morris, H. M. Molson	Builder	E. S. Matthews	31.07	28.00	11.00	1,307	32.72
HW	"	Lulu	William Ryan			25.00	10.00	914	29.02
HP	"	Frolic	E. K. Green, W. A. C. Hamilton	Builder	A. F. Mann	26.08	23.07	10.00	1,100	27.70
HS	"	Ishkoolah	R. E. Stevenson	Builder	P. Douillet	28.00	21.50	10.00	1,080	28.07
HW	"	Sans Souci	Jos. Perrault	Builder	J. Weir
JS	"	Water Witch	Jas. Paton		F. T. Wood	22.00	28.00	8.00
PW	"	Minnie A.	J. A. Lavale, E. C. Frappier	Builder	A. Cutlbert	20.00	25.07	8.00	780	26.08
JW	"	Molly Bawn	Walter Kavanagh	E. Burgess	Lawley & Sons	20.00	8.00	25.02
PB	"	Mudge	T. C. Davidson, Thos. Donnelly	Builder	Edwards	20.00	21.00	824	24.00
HBP	Lugger	Debutante	E. S. Clouston		J. Weir	25.00	17.00	7.00
	Sloop	Soubrette	S. Jackson	Builder	J. Weir	22.00	16.00	8.00	17.00
FS	"	Valda	G. H. Duggan	Owner	G. St. Onge	25.00	24.00	8.00	630	24.01
SB	"	Izraelhuat	Valois Syndicate			25.00	23.11
SJ	"	Mabel	W. Lyall	Builder	J. Weir	23.00	21.00
WHP	"	Inez	T. Daoust			26.00	23.00

SQUADRON LIST OF THE ST. LAWRENCE YACHT CLUB.

SAIL.—CONTINUED.

Signal Letters.	Htg.	Yacht.	Owner.	Designer.	Builder.	L. O. A.	L. W. L.	Beam.	Sail area.	C. L.
WHB	Sloop	Elbia	A. G. Fry, A. D. Bedford		Hodgson	23.00	10.10	7.00	401	21.00
HJS	"	Merobe	R. B. Kenrick	G. H. Duggan	J. McIntyre	20.00	15.11	5.11	370	17.05
BSJ	"	Flavette	St. Lawrence Yacht Club	Builder	G. St. Onge
BSP	"	Rita	C. O. Clark	Owner	P. Douillet	27.07	22.00	10.02	1,200
DWJ	"	Osprey	C. L. Shorey			19.07
BWP	"	Intermet	W. de M. Marler	Builder	Lebent	25.10	18.00	8.08	710	19.00
BWS	"	Zoe	A. F. Biddle			21.00	19.00	6.00
DWS	"	Wasp	E. L. Bond	G. H. Duggan	Hodgson	18.00	18.00	6.00
ESH	"	Elsie	Wm. Davidson	Builder	R. A. Winsor	20.66	17. 0	6.10
BPW	"	Dug	G. H. Duggan	Owner		16.03
WHP	"	Comet	C. O. Clark			19.07	7.03	18.74
JH	"	Marguerite	F. L. Barlow			21.00	8.06
WBS	Cat	Petrel	R. Davidson			19.03	10.00	22.00
BPS	"	Bessie	J. H. Routh		J. H. Rushton	18.00	5.03
BHW	"	Wildewake	H. J. Mulson			16.63	16.63	0.00	383	7.01
BH	"	Bhanavar	H. R. Drummond	Builder	J. H. Rushton	17.00	16.00	5.00
JSH	"	Fidget	J. C. C. Abmon			17.00	5.00	175
BSW	"	Circé	Judge C. P. Davidson			25.01	22.00	9.00
WHS	"	Undine	G. H. Marler	Builder	E. S. Matthews	25.00	10.02
HB	"	Little Marchioness	R. Campbell Nelles		F. C. Smith	16.08	8.04
	"	Pearl	W. Ross			18.00	17.00	7.00
	"	Serienne	Salin J. Sewell			20.00	12.00	6.00	24.50
	"	Rowena	J. L. Barlow			22.00	19.00	8.00
WHL	Yawl	Thora	H. Simms	Builder	Edwards	10.05
HBS	"	Inez	G. F. Benson	Builder	N. Gilbert	20.00	6.00
	Fin Sloop	El Chico	E. M. Fulton *		

* Formerly owned by H. Maitland Kersey.

SQUADRON LIST OF THE ST. LAWRENCE YACHT CLUB.

STEAMERS.

	Sail area.	C. L.	Signal Letters.	Design.	Yacht.	Owner.	Designer.	Builder.	Length.	Engine.	Cy. Under.
0	401	21.00									
11	370	17.05									
12	1,390	HPJ	Schooner	Nana	H. B. Angus		P. Lamote	68.00	C	
18	700	19.00	HPB	"	Guldbout	E. M. Fulton	J. Heuyer Webb		C	
00	JHH	"	Dama	C. E. Levey			92.00	C	
00	JBP	Cabin	Vivid	J. B. Wood	Builders	Polson Iron Works	90.00	C	12x18x10
06	JHS	"	Windemere	And. Duves	Builders	Carlin Building Co.	100.00	HP	19x12
10	JBW	"	Adonis	J. B. Tressler	Builder	Robertson	60.00	TE	5x9.5
03	18.74	JHB	"	Chipmunk	G. W. Radle	Builder	J. McIntyre	50.00	C	
06	JHP	"	Ingonar	C. C. Newton			60.00	C	5x9x7
00	JHS	"	Nereid	H. J. Beaman	Builder	G. St. Onge	50.00	HP	6x9
00	22.00	JHW	"	Evelina	J. G. Laviolette, M. D.			41.00	HP	6x6
00	333	7.01	JPB	Launch	Our Club	E. A. Small			45.00	CO	8x8
00	JPH	"	Nemo Ist	H. Carbonneau	Builder	Hobbsou	40.00	C	
00	JWH	"	Undine	C. E. Levey			51.00	HP	5x8x8
00	175	JWH	"	Myra	A. L. Kent	Builder	Hobbsou	32.00	HP	4x4
00	JPS	"	Iris	J. H. Garth	Builder	P. Lamote	30.00	HP	6x6
00	JPW	"	Zela	J. Higginson			30.00	HP	5x5
04	JSH	"	Louise	G. A. Greene			30.00	CO	
00	JSP	"	Fna	W. Luffmann			30.00	CO	
00	24.50	HJB	"	Beaver	H. E. Murray			30.00	CO	6x6
00	HJP	"	Insect	W. A. Murray, M. L. Williams	Owners	D. A. Bullock, Hull	20.00	HC	21x21
00	19.05	HJS	"	La Monche	L. Hout	Builders	J. Gillies & Co.	23.00	CO	
00	HJW	"	Lancet	F. W. Campbell, M. D.	Builders	J. Gillies & Co.	21.00	CO	
00	HPB	"	Fly	J. H. Arnold			17.00	CO	
00		"	Idle Hour	A. W. Morris		Gas Engine Power Co.	31.00	Naphtha	

THE SEASON OF 1888.

The local headquarters of the club during the season of 1888 were at Valois, and the course was from off the Valois boat-house, around the Valois light, and two Buoys off the Isle Perrot shore, 10 miles in all.

An open Sweepstakes Race on the 24th of May, was the first race of the season, and was given by the club. There were nine entries, and MINNIE A., MADGE, LULU, ISHKOODAH, BLACK EAGLE, OSPREY, WATERWITCH and EDITH started. The race was won by MINNIE A.; LULU second.

A series of six yacht races was sailed for a cup presented by the Commodore, as follows:

June 23rd: Nine started in a moderate breeze. MADGE first, by 1 min., 51 sec., corrected time; MINNIE A. second; LULU third.



MOLLY BAWN.—FIGURE 320.

June 30th: Eight started; a strong northwest breeze. LULU first, by 8 minutes actual and 6 min., 30 sec., corrected time; MADGE second; MINNIE A. third. LULU's elapsed time over the course was 1 hour and 30 minutes; the best time made during the season.

July 2d: Dominion Day. Seven starters; two rounds of the course to be sailed; wind very light. LULU completed the course in 12 hrs., 8 min., 30 sec., elapsed time; the rest withdrew.

July 21st: Six starters; a strong southwest wind that died out as the sun went down. BLACK EAGLE finished first, in 2 hrs., 11 min., 45 sec. LULU won by 6 min., 44 sec., corrected time; MADGE second, by 3 min., 10 sec., corrected time; BLACK EAGLE third.

August 18th: Six starters; a strong southwest wind. MADGE won by 5 min., 30 sec., elapsed, and 8 min., 56 sec., corrected time; LULU second; BLACK EAGLE third.

September 1st: Six starters; wind light and variable. MADGE won by 6 min., 15 sec., elapsed, and 10 min., 30 sec., corrected time. OSPREY second; ISHKOODAH third.

September 18th: Sail-off between LULU and MADGE for the cup; a fresh southerly breeze.

	Start.	Finish.	Elapsed Time.	Corrected Time.
	H. M. S.	H. M. S.	H. M. S.	H. M. S.
Lulu	3 15 30	4 57 35	1 42 05	1 45 05
Madge	3 11 17	5 01 53	1 47 38	1 40 20

LULU was therefore the winner of the Cup and the champion of the year.

The places taken by the yachts competing in the cup races were as follows:

LULU, 7 starts, 4 firsts, 1 second, 1 third and 1 fifth place.

MADGE, 7 starts, 3 first and 4 second places.

MINNIE A., 4 starts, 1 second and 1 third place.

BLACK EAGLE, 5 starts, 2 third and 2 fifth places.

ISHKOODAH, 6 starts, 1 third, 2 fourth and 2 fifth places.

OSPREY, 4 starts, 1 second and 1 ninth place.

IZACOURT, 5 starts, 1 fourth, 2 sixth and 1 seventh place.

PEARL, 3 starts, 1 fourth and 1 eighth place.

MABEL, 2 starts, never finished.

WANDA, 1 start, 1 fourth place.

A series of skiff races, six in number, took place upon the same dates as did the yacht races, for a cup presented by the Committee. It was won by TARA, Mr. W. J. Wallace, which finished first in each race, but on June 30th, fouled a buoy and was ruled out of the race. KOORALI, Mr. W. H. Young, started three times, and was once third and twice second; MARGUERITE, Mr. W. S. Clonston, started twice and was twice second; ZETA, Mr. A. W. Sherwood, started three times and was once first and once fourth; and JEAN A., Mr. G. H. Labbe, started twice and was once third.

THE SEASON OF 1889.

The local headquarters of the club during the season of 1889 were at Pointe Claire. The course was triangular and 10 miles in length, the start being made from the Pointe Claire boat house.

May 24th: Commodore's Cup Race: Seven entries and six starters. The course was a special one, from Pointe Claire boat-house, around Valois light and two buoys off the Isle Perrot shore. Distance about 10 miles.

	Corrected Length.	Start.	Finish.	Elapsed Time.	Corrected Time.
	Feet.	H. M. S.	H. M. S.	H. M. S.	H. M. S.
Lulu	27.5	2 21 40	4 20	1 58 20	1 33 30
Madge	23.1	2 21 05	5 03	2 41 55	2 13 53
Minnie A.	25.7	2 20 50	4 43 15	2 12 25	1 40 01
Mabel	23.0	2 21 05	5 00 45	2 48 35	2 20 21
Osprey	19.8	2 21 07	5 11 55	2 40 28	2 10 18
Breeze	21.4	2 20 30	5 15	2 54 40	2 54 02

The first of the skiff series races for the Rear-Commodore's Cup was also sailed. There were four starters in the first and four in the second class. In the first class VREDA, Mr. G. H. Duggan, won; KOORALI, Mr. H. Young, second. In the second class, ZETA, Mr. A. W. Sherwood, won; WAVE second.

May 25th: First race of first and second class yacht series, for Vice-Commodore's Cup. The wind was light from the northwest and the course was shortened to 8½ miles. Three starters. LULU first, by 1 min., 24 sec.; MINNIE A. second; BLACK EAGLE, third.

June 22d: A heavy gale from the southwest was blowing and a big sea running. The skiff race was postponed. LULU, MINNIE A., MADGE, CHAPERON and BLACK EAGLE started. MADGE and CHAPERON were disabled and forced to give up the race, LULU was swamped at the South Buoy, but kept afloat and finished. BLACK EAGLE also got into trouble and was forced to anchor. MINNIE A. won in 1 hr., 50 min., elapsed, and 1 hr., 23 min., 37 sec., corrected time. LULU finished second, 33 min., 35 sec., elapsed, 35 min., 17 sec., corrected time; BLACK EAGLE third.

June 29th: Wind light and shifting from south to southwest. Five starters in second, four in third class yacht races. MINNIE A. won in second class race by 57 seconds; LULU second. MABEL won in third race by 11 min., 41 sec.; CHAPERON second.

Corrected Time.
M. S.
45 05
46 20

champion of

aces were as

ace.

as.

place.

in the same
Committee.
first in each
out of the
s, and was
I. Clonston.
Sherwood.
JEAN A.,

f 1889 were
s in length.

ix starters.
use, around
Distance

Corrected
Time.
M. S.
1 33 30
2 13 53
1 46 01
2 29 21
2 16 18
2 54 02

odore's Cup
four in the
ggan, won;
ETA, Mr. A.

t series, for
northwest and
LUL first, by 1

ng and a big
MINNIE A.,
and CHAPE-
as swamped
EAGLE also
won in 1 hr.,
me. LUL
c., corrected

o southwest.
MINNIE A.
MABEL won

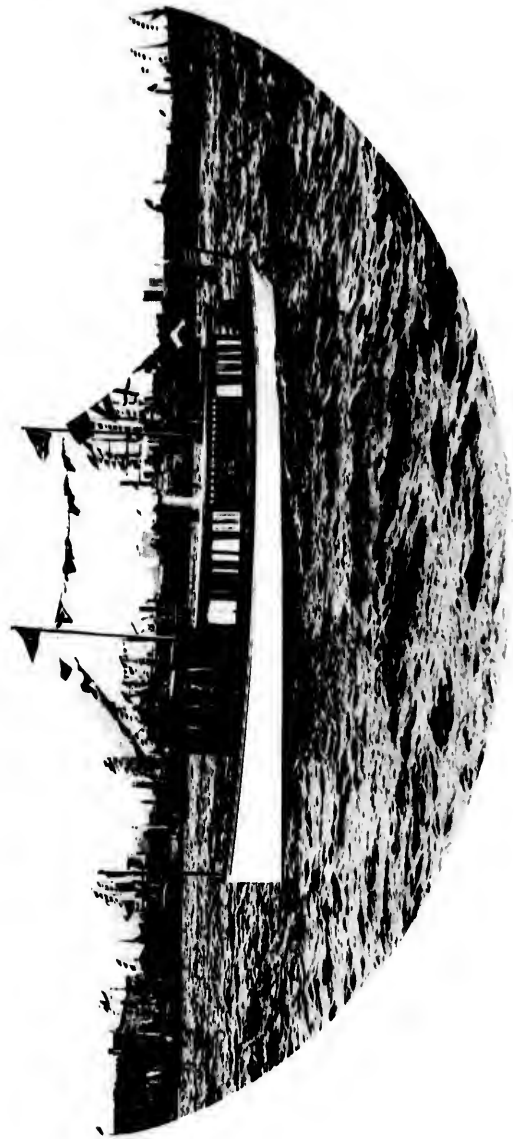

STRAE.

PLATE XXXIII

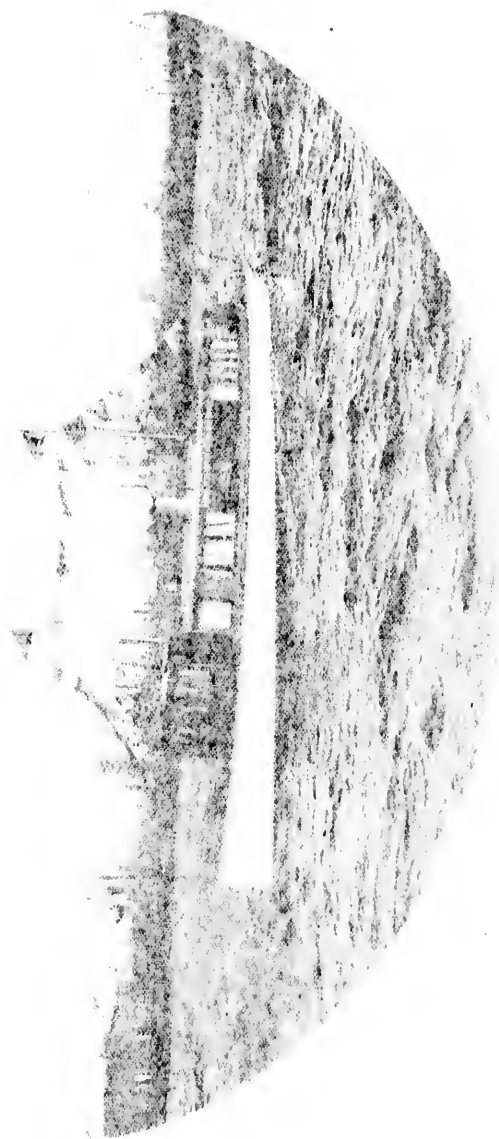

The first steam yacht race of the club was started before the sailing yachts were sent off. There were nine starters and the race was won by IVY, by 45 seconds; EMMA second.

The First Squadron Cruise of the Club commenced after the races were finished. LULU, MINNIE A. and MABEL, the steamer ISTIS and skiffs VREDA, ZETA and BULLFROG, in tow of the ISTIS, started on this cruise, and Como was reached at noon on the following day. The night was spent in camp there, and on July 1st the fleet sailed home in company.

July 6th. Wind light and variable. Five starters in second, two in third class. The 2d class race was won by LULU, by 7 min., 20 sec., MINNIE A., second; the 3d class race by MABEL; CHAPERON second. There were four starters in the 1st class skiff class, and VREDA, Mr. G. H. Duggan, won by 2 min., from YUKWA, Mr. W. J. Wallace.

July 13th. Skiff races only; wind light from the south. Five starters in first, two in second class. YUKWA won in the first class by 3 min., 30 sec. over VREDA. ZETA won in the second class.

July 20th. Wind light from the north. Four starters in 1st class skiff class. YUKWA won by 1 min., 10 sec. over VREDA.

August 31st. Skiff race postponed from June 22d; two entries and two starters. YUKWA won by 5 min.

September 14th. A tie between LULU and MINNIE A., for the Vice-Commodore's Cup and a Sweepstakes Race, were sailed between BLACK EAGLE and WHITE SQUALL, in the first, and PEARL and CHAPERON in the second class. Wind easterly, and although light at the start, it grew fresh before the race finished.

VICE-COMMODORE'S CUP—TIE.

	Start.	Finish.	Elapsed Time.	Corrected Time.
	H. M. S.	H. M. S.	H. M. S.	H. M. S.
Minnie A.	3 15 50	4 52 32	1 36 42	1 35
Lulu	3 15 15	4 51 30	1 36 15	1 36 15

Black Eagle won in her class, Pearl in hers.

A steam yacht race, in which five boats started, was won by MYRA; IRENE second and IUS third.

MINNIE A. won Vice-Commodore's Cup and the championship of the second class, by three firsts and two seconds for five starts. LULU started five times and was twice first and three times second. BLACK EAGLE started four times and was three times third and once fourth. MADGE started three times and was once third and once fourth. BREEZE started twice and was twice fifth.

MABEL won the Club Cup and the championship of the third class, by two firsts in two starts. CHAPERON started twice and was twice second.

YUKWA won the Rear-Commodore's Cup and the championship of the first class skiffs, by three firsts and one second for four starts. VREDA won one first and three seconds for four starts.

ZETA won the second class skiff series by two firsts.

THE SEASON OF 1890.

The summer station of the club was at Pointe Claire, and the course was the same as that of previous years—a triangle of about 10 miles in length.

The season was opened on May 24th with a Squadron Cruise to Beauharnois, in which VALDA, the flag ship, MABEL, MADGE, TARA, GALLAGHER, VAGABOND and PEARL took part.

June 7th. The first race of the skiff series was sailed in a strong and puffy northwest wind and a heavy sea. FREYJA was first and VAGABOND second out of five starters in the first class, and DIXIE was first out of three starters in the second.

June 7th. The second race of the skiff series was sailed in a strong northeast breeze. FREYJA was first and GALLAGHER second out of five starters in the first class, and DIXIE first out of three starters in the second.

June 21st. The first race of the yacht series was sailed in a very light air, and was a drifting match. A light breeze which sprang up

in the evening, enabled four boats to finish out of the ten which started, as follows:

	Start.	Finish.	Elapsed Time.
	H. M. S.	H. M. S.	H. M. S.
Valda	3 58	8 46	4 48
Lulu	3 58 15	8 50	4 51 45
Black Eagle	3 59	9 21 30	5 22 30
Chaperon	3 58 30	9 22	5 23 30

The customary time limit having been exceeded, the Sailing Committee ordered the race to be re-sailed.

June 28th. The opening race for the First Class Challenge Cup, presented by C. H. Levin, was sailed in a fine whole sail breeze, and resulted as follows:

	Start	Finish	Elapsed Time	Corrected Time
	H. M. S.	H. M. S.	H. M. S.	H. M. S.
Lulu	4 03 45	6 05 00	2 01 15	1 57 30
Black Eagle	4 04 45	6 01 00	1 56 15	1 57 15
Chaperon	4 03 30	6 11 00	2 07 30	
Viking	4 07 00	withdrew.		

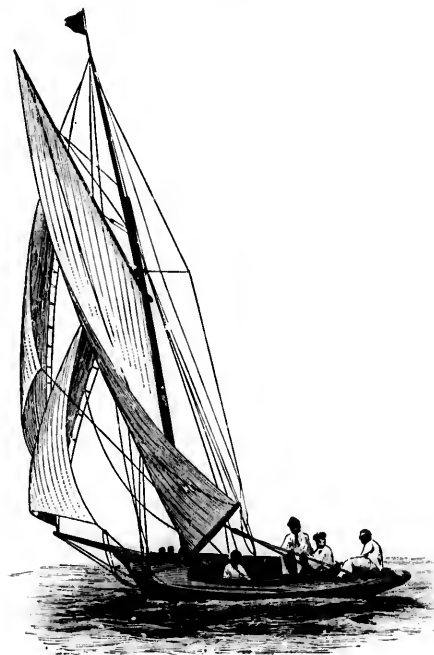

BUTTERNUT.—FIGURE 340.

The steam yacht race of this date resulted as follows:

	Start.	Finish.
	H. M. S.	H. M. S.
Ivy	4 21 45	5 13 30
Evelina	4 16 10	5 11 30
Myra	4 11 30	5 15 00
Fly		withdrew.

After the races, VALDA, CHANCE, PEARL, MINNIE A. and BAN-SHEE started on a Squadron Cruise. The night was passed at Beuharnois, and on the following day the fleet ran on to St. Anns, and from there returned to Pointe Claire, BAN-SHEE leading home.

July 1st, Dominion Day: The second race of the yacht series and third day of the skiff series, were commenced with a very light air, which became a good topsail breeze before the finish. The result was as follows:

Class 1.	Start.		Finish.		Elapsed Time.	
	H. M. S.	H. M. S.	H. M. S.	H. M. S.	H. M. S.	H. M. S.
Lulu	12 29 15	2 31 00	2 01 45			
Black Eagle	12 26 00	2 45 00	2 19 45			
Class 2.						
Minnie A.	12 26 29	2 29 30	2 13 10			
Breeze	12 26 25	2 59 00	2 32 35			
Madge	12 27 00	withdrew.				
Class 3.						
Valda	12 26 05	2 40 00	2 13 55			
Pearl	12 26 00	3 46 48	2 20 45			
Osprey	12 28 00	3 10 00	2 37 00			
Banshee	12 28 30	not taken.				

The third race of the skiff series was held on the same day, five entries: FREYJA first, TARA second, in the first class. DIXIE first in the second.

July 5th: The third race of the yacht series was sailed in a fresh breeze from the northwest, and resulted as follows:

Class 1.	Start.		Finish.		Elapsed Time.	
	H. M. S.	H. M. S.	H. M. S.	H. M. S.	H. M. S.	H. M. S.
Lulu	3 31 15	5 07 00	1 35 45			
Black Eagle	3 32 00	5 13 00	1 41 00			

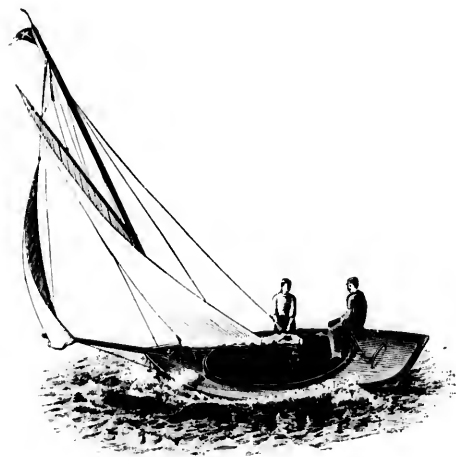

ELSIE.—FIGURE 341.

Class 2.	Start.		Finish.		Elapsed Time.	
	H. M. S.	H. M. S.	H. M. S.	H. M. S.	H. M. S.	H. M. S.
Minnie A.	3 31 20	5 23 00	1 51 40			
Breeze	3 31 40	5 30 10	1 58 30			
Class 3.						
Valda	3 31 25	5 12 10	1 40 45			
Pearl	3 35 30	5 42	2 06 30			

July 26th: LULU having been challenged by BLACK EAGLE, a match was sailed between them, for the cup presented by Mr. Levin, in a good breeze and a choppy sea. The result was as fol-

lows, the corrected time being based on the logged length of the course:

	Start.		Finish.		Elapsed Time.		Corrected Time.	
	H. M. S.	H. M. S.	H. M. S.	H. M. S.	H. M. S.	H. M. S.	H. M. S.	
Lulu	4 05	6 02	1 57	1 52 05				
Black Eagle	4 05	5 57 50	1 52 50	1 52 50				

August 23rd: LULU having been challenged by CHAPERON, a Match Race was sailed between them, for the cup presented by Mr. Levin, in a strong north wind. The result was as follows:

	Start.		Finish.		Elapsed Time.	
	H. M. S.	H. M. S.	H. M. S.	H. M. S.	H. M. S.	H. M. S.
Lulu	12 09 30	1 48 45	1 39 15			
Chaperon	12 09 00	1 51 17	1 42 17			

LULU having won three Match Races in succession, thus became owner of the Levin Challenge Cup.

August 30th: The fourth race of the yacht series was sailed in a strong westerly wind. There being only one starter from each class, the judges ordered VALDA and MINNIE A. to sail in the first class, at the same time awarding them each a first towards the class trophies. The result was as follows:

	Start.		Finish.		Elapsed Time.	
	H. M. S.	H. M. S.	H. M. S.	H. M. S.	H. M. S.	H. M. S.
Valda	4 23 15	6 31 05	2 07 50			
Minnie A.	4 22 25	6 30	2 07 35			
Chaperon	4 22 20	6 34 10	2 11 50			

VALDA therefore won a first class pennant for this race.

September 13th: The last of the yacht series races commenced with a fine sailing breeze from the west, which increased towards the finish into a gale. The race was a match between LULU and CHAPERON, the winners of the second and third class trophies having been settled by the results of the previous races. CHAPERON carrying away her board during the beat to windward, left LULU winner of the race.

The result of the racing of the year was as follows:

Class 1.	Starts	Firsts	Seconds
Lulu	3	3	0
Chaperon	2	1	1
Black Eagle	2	0	2
Class 2.			
Minnie A.	3	2	1
Breeze	2	0	2
Class 3.			
Valda*	3	3	0
Pearl	2	0	2
SKIFFS.			
Class 1.			
Freyja	3	3	0
Vagabond	2	0	1
Tara	2	0	1
Gallagher	2	0	1
Class 2.			
Dixie	3	3	0
Black Fry	2	0	2

*VALDA also won a First Class Pennant.

THE SEASON OF 1891.

The headquarters of the club were fixed at its own Club House, Dowal, and a new course for racing with the starting and finishing line off the Club House was adopted.

The season was opened on the 23rd and 24th of May, with the usual Squadron Cruise to Beauharnois, in which DREAM, BLACK EAGLE, VALDA, FROLIC and BREEZE took part.

May 25th: A Sweepstakes Race from the Club House, round the Chataugay Lights to Pointe Claire, about 8 miles, was sailed in a fresh whole sail breeze, and resulted as follows:

	Corrected		Finish.	Elapsed Time.	Corrected Time.	
	Length.	Start.			U. S. S.	U. S. S.
Dream	32.45	3 40 45	5 38 45	1 58 00	1 58 00	
Valda	21.01	3 42 45	5 49 30	2 06 45	2 01 21	
Frolic	28.15	3 42 00	6 15 45	2 34 43	2 31 13	
Black Eagle	37.07	3 43 00	did not finish			

June 13th: The first series race for the 29 and 24 foot classes was sailed in a moderate breeze, 4 of the 29-footers starting.

Valda	24.01	4 06 05	6 12 05	2 06 00	2 03 21
Chaperon	30.02	4 06 10	6 12 55	2 06 45	2 00 45
Frolic	28.45	4 06 50	6 16 10	2 09 20	2 07 57
Molly Bawn	25.92	4 05 25	6 21 20	2 15 45	2 12 00

VALDA won a first prize pennant and one leg for the Vice-Commodore's Cup by 45 seconds elapsed and 6.24 corrected time, CHAPERON winning a second prize pennant.

June 20th: Wind light from the east for the first series race for the A and 21 foot classes. There were four entries for Class A and three for the 21 foot class, resulting as follows:

Class A.			
Lulu	29.02	2 17 45	2 14 51
Dream	32.52	2 18 24	2 14 21
White Squall	31.01	2 24 37	2 24 20

LULU thus won a prize flag and one leg for the Commodore's Cup by 39 seconds elapsed time and 3.13 corrected time. DREAM won a second prize flag.

21 Foot Class.			
Thora	19.05	3 00 08	2 58 07
Ellida	21.60	3 02 33	3 02 33
Vesper	19.71	3 14 19	3 10 53

THORA therefore won a prize pennant and one leg for her Class Trophy.

June 27th: The second series races for all classes, were sailed in a strong, puffing breeze, most of the yachts starting with a reef in the mainsail.

Class A.			
Dream	32.00	1 52 15	1 49 01
Lulu	29.02	1 55 10	1 49 10
White Squall	31.01	2 11 25	2 07 23
Black Eagle	37.07	2 10 25	2 10 25

DREAM notified the Sailing Committee that they had fouled the Chataugay Buoy, but the other yachts refusing to accept the advantage which the disqualification of DREAM would confer, the committee ordered the race to be sailed over on July 18th.

29 Foot Class.					
Valda	24.01	4 2 30	6 03 45	2 1 15	1 56
Frolic	28.00	4 3 20	6 05 50	2 2 30	2 01 00
Chaperon	29.06	4 3 05	6 04 30	2 1 25	3 01 25
Molly Bawn	25.00	4 3 20	6 12 20	2 0 00	2 05 40

VALDA won a first prize pennant and one leg for the Vice-Commodore's Cup. FROLIC a second prize pennant.

21 Foot Class.					
Thora	10.5	4 03 00	6 03 03	2 00 03	1 57 50
Vesper	19.4	4 02 50	6 18 30	2 16 40	2 11 33
Frolic	21.0	4 02 00	6 22 05	2 20 05	2 20 05
Conc.	4.6	4 06 00	withdrew		

THORA won a first prize pennant and one leg for her class trophy, and made the best corrected time over the course, 4.06 better than DREAM. VESPER won a second prize pennant.

July 1st: The third series races for all classes resulted as follows:

Class A.					
Dream	32.6	11	12 49 42	1 49 42	1 46 28
Lulu	29.2	11	12 54 24	1 54 24	1 48 33
White Squall	31.1	11	1 05 33	2 05 35	2 01 15
Black Eagle	37.7	11	1 05 32	2 05 34	2 05 32

DREAM won by 2.05, scoring one leg for the Commodore's Cup. LULU won a second prize flag.

29 Foot Class.					
Valda	24.1			1 53 20	1 50 05
Molly Bawn	25.0			2 02 30	1 59 10
Chaperon	29.6			1 59 44	2 00 14
Frolic	28			2 05 20	2 03 19
Breeze	25			2 17 00	2 13 41

VALDA secured the Vice-Commodore's Cup by winning the third time, making the best corrected time of the fleet — 1.59 over DREAM. MOLLY BAWN won a second prize flag.

VESPER sailed over the course, thus scoring one leg for the 21 foot class trophy.

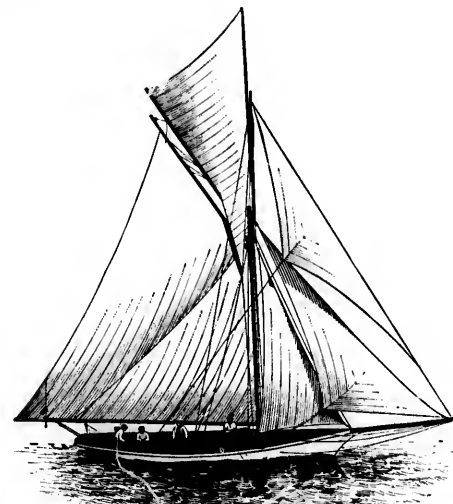

VIKING.—FIGURE 342.

In the evening, Commodore and Mrs. Morris gave a very enjoyable At Home in the Club House.

July 11th: A and 29 foot classes.

Class A.			
Lulu	29.2	2 04 36	2 02 00
Dream	32.6	2 05 29	2 05 29
Black Eagle	37.7	did not finish	

29 Foot Class.			
Chaperon	29.6	2 03 57	2 03 57
Valda	24.1	2 16 33	2 11 18
Molly Bawn	25.9	2 16 52	2 13 22

CHAPERON made the best corrected time of the fleet by 20 seconds over LULU.

July 18th: The race of June 27th for Class A was re-sailed in a strong, squally east wind, all the yachts under close reefed mainsail and jib.

Lulu	29.2	4 30 14	6 29 30	1 59 16	1 53 25
Dream	32.6	4 30	6 29 11	1 59 11	1 56 00
Black Eagle	37.7	4 28 03	6 31 19	2 04 15	2 03 13
White Squall	31.1	4 39 47	did not finish		

LULU thus won the third time and secured the Commodore's Cup, DREAM getting a second prize pennant.

July 25th: In response to an invitation from the QUEBEC YACHT CLUB, DREAM, BLACK EAGLE and FROLIC, with S.S. DAMA visited Quebec, and their crews with a number of members of the club were most hospitably entertained by that club. On July 25th, DREAM,

FROLIC and BLACK EAGLE took part in a race given by the QUEBEC YACHT CLUB, in which FROLIC came in first, BERNADETTE, (Q. Y. C.) second, DREAM third. By a ruling of the Sailing Committee of the QUEBEC YACHT CLUB, FROLIC was disqualified and the first prize awarded to BERNADETTE, and the second to DREAM. This is the first time in the history of the club that any of its yachts have competed with those of a sister club.

The result of the Series Racing of the year was as follows:

Class A.	Starts.	First.	Seconds.
Lulu, Prize, Commodore's Cup	5	3	2
Dream	5	2	3
White Squall	4	0	0
Black Eagle	4	0	0

29 Foot Class.	Starts.	First.	Seconds.
Valda, Prize, Vice-Commodore's Cup	4	3	1
Chaperon	4	1	1
Frolie	3	0	1
Molly Bawn	4	0	1

21 Foot Class.	Starts.	First.	Seconds.
Thor, 21 Foot Class Trophy	2	2	0
Vesper	3	1	1
Ellida	2	0	1
Comet	1	0	0

THE SEASON FOR 1892.

June 4th: Special Club Prize Race, sailed over an 8 mile course with a fair wind and good weather.

	Rig.	Sailing Length. Feet.	Elapsed Time. H. M. S.	Corrected Time. H. M. S.
18 Foot Class.				
Bug	sloop	18.26	1 16 20	1 13 20
Wideawake	cut	17.01	1 23 40	1 18 33
Cockroach	cut	17.01	did not finish	
Bhanavar	cut	14.03	did not finish	

Bug won.

June 11th: Series Race for Prize Pennants. Course, 11 miles; wind strong, weather bad and rainy.

Class A.	Rig.	Sailing Length. Feet.	Elapsed Time. H. M. S.	Corrected Time. H. M. S.
Viking	cut	31.65		
White Squall	cut	31.01		
Eagle	cut	36.92		

29 Foot Class.	Rig.	Sailing Length. Feet.	Elapsed Time. H. M. S.	Corrected Time. H. M. S.
Valda	sloop	21.36		
Chaperon	cut	23.07		
Molly Bawn	cut	25.92		

24 and 21 Foot Class.	Rig.	Sailing Length. Feet.	Elapsed Time. H. M. S.	Corrected Time. H. M. S.
Elsie	sloop	19.08		
Ellida	sloop	20.09		

No official time was kept as the judges' yacht drifted. The winners were VIKING, VALDA and ELSIE in their respective classes.

June 18th: Series Race for Prize Pennants. Light wind and fair weather.

Class A.	Rig.	Sailing Length. Feet.	Elapsed Time. H. M. S.	Corrected Time. H. M. S.
Viking	cut	34.65	2 20 32	2 20 32
Coquette	cut	29.05	2 29 18	2 25 18
White Squall	cut	31.01	2 35 55	2 32 58

18 Foot Class.	Rig.	Sailing Length. Feet.	Elapsed Time. H. M. S.	Corrected Time. H. M. S.
Bug	sloop	18.26	2 29 23	2 29 23
Wideawake	cut	17.01	2 38 50	2 36 43
Bhanavar	cut	14.06	2 55 23	

The winners were VIKING and Bug.

The race for the Sir Donald A. Smith Challenge Cup was sailed July 1st, in a heavy wind.

	Rig.	Sailing Length. Feet.	Elapsed Time. H. M. S.	Corrected Time. H. M. S.
A, 29 and 24 Foot Class.				
Valda	sloop	21.36	2 04 40	2 00 03
Viking	cut	34.65	2 03 35	2 00 35
Chaperon	cut	29.07	2 36 55	2 33 21
Frolie	sloop	28.45	2 37 40	2 32 13
Molly Bawn	cut	25.92	2 53 10	2 46 10
Eagle	cut	36.02		
Coquette	cut	29.05		

VALDA was the successful competitor.

July 1st: Series Race. Wind very strong, sea rough.

29 Foot Class.	Rig.	Sailing Length. Feet.	Elapsed Time. H. M. S.	Corrected Time. H. M. S.
Valda	sloop	24.36	2 27 10	2 27 10

24 and 21 Foot Class.	Rig.	Sailing Length. Feet.	Elapsed Time. H. M. S.	Corrected Time. H. M. S.
Elsie	sloop	19.08	2 31 15	2 31 15
Ellida	sloop	21.04	did not finish	
Zoe	sloop	21.00	did not finish	

18 Foot Class.	Rig.	Sailing Length. Feet.	Elapsed Time. H. M. S.	Corrected Time. H. M. S.
Wideawake	cut	17.01	did not finish	
Bhanavar	cut	14.06	did not finish	

VALDA and ELSIE were the winners in their respective classes.

July 9th: Series Race. Very light wind and fair weather.

29 Foot Class.	Rig.	Sailing Length. Feet.	Elapsed Time. H. M. S.	Corrected Time. H. M. S.
Molly Bawn	cut	25.92	2 28 17	2 24 51
Chaperon	cut	29.07	2 39 47	2 39 47
Frolie	sloop	28.00	3 07 49	3 06 34

24 and 21 Foot Class.	Rig.	Sailing Length. Feet.	Elapsed Time. H. M. S.	Corrected Time. H. M. S.
Ellida	sloop	21.04	3 00 22	3 00 22
Elsie	sloop	19.08	3 08 59	3 06 55
Butternut	cut	21.00	3 12 50	3 12 27

18 Foot Class.	Rig.	Sailing Length. Feet.	Elapsed Time. H. M. S.	Corrected Time. H. M. S.
Bug	sloop	18.26	2 36 58	2 30 58
Wideawake	cut	17.01	3 06 35	3 04 28

The winners were MOLLY BAWN, ELLIDA and Bug.

July 16: Baylis Cup Race. Strong wind, choppy sea.

A and 29 Foot Class.	Rig.	Sailing Length. Feet.	Elapsed Time. H. M. S.	Corrected Time. H. M. S.
Valda	sloop	21.36	1 33 25	1 26 11
Viking	cut	34.65	1 31 40	1 31 40
Chaperon	cut	29.07	1 38 50	1 36 16
Eagle	cut	34.02	did not finish	

VALDA was the winner.

July 23d: Series Race. Fair wind.

29 Footers.	Rig.	Sailing Length. Feet.	Elapsed Time. H. M. S.	Corrected Time. H. M. S.
Valda		24.36	2 45 20	2 40 20
Chaperon		29.07	2 42 35	2 42 35
Frolie		28.45	2 45 45	2 44 40
Molly Bawn		25.92	did not finish	

24 and 21-Footers.	Rig.	Sailing Length. Feet.	Elapsed Time. H. M. S.	Corrected Time. H. M. S.
Ellida		21.04	2 55 55	2 55 55
Elsie		19.08	3 40 10	3 38 18
Zoe		21.00	3 19 30	3 19 22
Butternut		21.00	3 47 15	3 47 07

VALDA and ELLIDA were the winners.

September 3d: Handicap Race, all classes, for club prizes. Fresh wind.

Molly Bawn	cut	25.92	2 10 30	2 12 30
Coquette	cut	29.05	2 22 55	2 18 55
Frolie	sloop	28.45	2 27 50	2 20 50
Chaperon	cut	29.07	2 30 50	2 24 50
Viking	cut	34.65	2 41 55	2 24 55
Eagle	cut	36.02	2 45 25	2 35 25
Ellida	sloop	21.04	2 50 00	2 38 00
Butternut	cut	21.00	2 49 15	2 37 15

MOLLY BAWN was the winner.

Challenge Cup was sailed

Elapsed Time H. M. S.	Corrected Time H. M. S.
2 03 40	2 00 03
2 03 35	2 00 35
2 36 55	2 33 21
2 37 40	2 32 13
2 53 10	2 46 10

sea rough.

27 10	2 27 10
-------	---------

31 15	2 31 15
did not finish	
did not finish	

did not finish
did not finish

respective classes.

fair weather.

28 17	2 24 51
39 47	2 39 47
07 49	3 06 34

00 22	3 00 22
08 59	3 06 55
13 59	3 12 27

30 58	2 30 58
06 35	3 04 28

and Brc.

choppy sea.

33 25	1 26 11
31 40	1 31 40
38 50	1 36 16
did not finish	

45 20	2 40 20
42 35	2 42 35
45 45	2 41 40
did not finish	

55 55	2 55 55
40 10	3 38 18
10 30	3 19 22
47 15	3 47 07

club prizes. Fresh

19 30	2 12 30
22 55	2 18 55
27 50	2 20 50
30 50	2 23 50
24 55	2 24 55
15 25	2 25 25
30 00	2 38 00
49 15	2 37 15

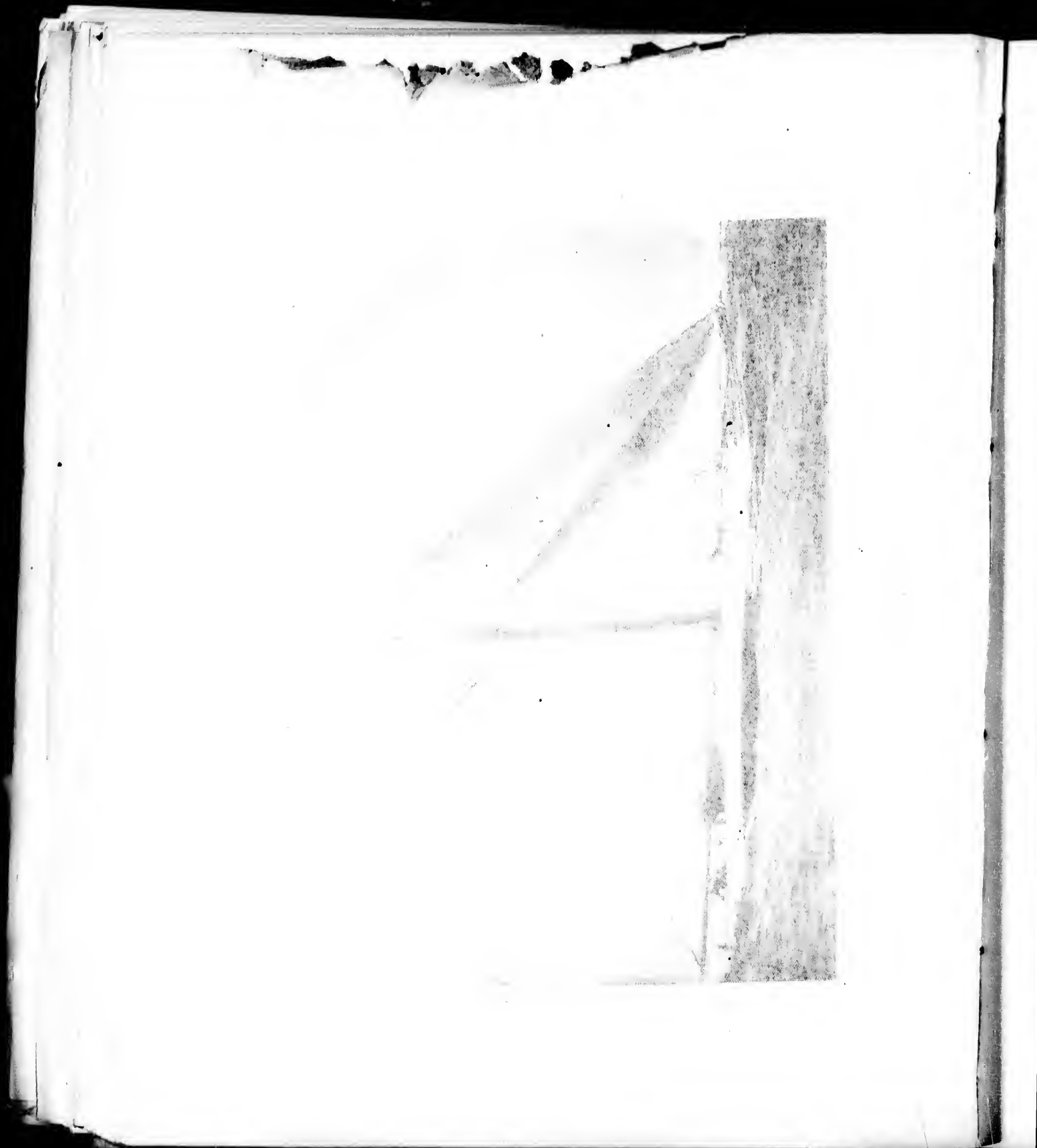

PLATE XXXIV.

FROM A NEGATIVE BY HINSON.

VENTURA.

VENTURA.



September 10: Sail-off, for 20 foot Class, for place in Series Races, and sail-off for 24 and 24 foot classes for Rear-Commodore's Cup.

	Rtg.	Length.	Sailing Elap. Time. Cor. Time.	
			H. M. S.	H. M. S.
20 Footers.				
Molly Bawn	cut	25.02	2 26 46	2 23 20
Chaperon	cutter	29.07	2 22 30	2 22 30

24 and 21-Footers.

*Elsie	sloop	10.08	2 42 22	2 40 18
Ellida	sloop	21.04	2 40 33	2 40 33

MOLLY BAWN and ELSIE were declared the winners. CHAPERON fouled buoy and was disqualified.

Handicap Race, all classes, September 17. A strong, steady wind.

Valda	sloop	21.30	2 25 49	2 21 40
Viking	cutter	31.65	2 20 12	2 20 12
Coquette	cutter	29.05	2 44 15	2 40 15
Frolic	sloop	28.45	did not finish	
Chaperon	cutter	29.07	did not finish	
Butternut	cutter	21.00	did not finish	

VALDA was the winner.

The result of the regular racing of the year, therefore, was as follows:—

WISNER'S—Class A—Viking,	Commodore's Cup.
" "	2 First prizes.
" " Coquette,	2 Second prizes.
20 Foot Class—Valda,	Vice-Commodore's Cup.
" "	3 First prizes (3 starts.)
" " "	Sir D. A. Smith Challenge Cup.
" " "	Baylis Cup.
" " Molly Bawn,	1 First prize.
" " Chaperon,	2 Second prizes.
" " Frolic,	1 Third prize.
24 and 21 Foot Class—Elsie,	Rear-Commodore's Cup.
" " "	2 First prizes.
" " "	2 Second prizes.
" " Ellida,	2 First prizes.
18 Foot Class—Bug,	H. M. Molson Cup.
" " "	2 First prizes.

THE SEASON OF 1893.

This season, marked by disasters unparalleled in the history of the club, was a late one. The usual racing and cruising on May 24th had to be abandoned, the boats not being ready, and a gale with extremely high water did great damage along the water front. Several boats were driven ashore, and the club pier, while it stood better than any other in the vicinity, was much damaged.

June 10th: The first race of the season, was sailed on June 10th, and was the first series race for A, 30, 25 and 21 foot Classes. There was a strong west wind, with heavy puffs from the north, and a broken sea. The result was as follows:

Class A. 30 foot.	Sailing Length.	Start	Finish	Elap. Time		Cor. Time.
				H. M. S.	H. M. S.	
Chaperon	30.02	4 00 05	6 10 00	2 09 55		2 09 55
Eagle	30.02	3 58 49	6 17 13	2 18 33		
White Squall	31.01	3 58 36	6 24 30	2 25 54		
25 foot Class.						
Molly Bawn	21.29	4 00 25	5 56 00	1 55 35	1 51 28	
Valda	21.51	3 59 40	5 57 50	1 58 10	1 52 34	
Frolic	28.45	3 59 30	6 05 00	2 06 24	2 04 34	
Unda	26.00	4 00 00	did not finish.			
Rita	25.00	4 00 15	6 15 40	2 13 25		
21 foot Class.						
Thora	10.05	3 50 20	6 27 40	2 28 20		

June 17th: Second Series Race, A, 30, 25 and 24 foot Classes.

Eleven boats crossed the line, but at 6:40 only half the course had been covered and the race was abandoned.

June 21th: First Series Race for 25 and 18 foot Classes. South wind with showers, freshening to a good breeze at finish.

	C. L.	Start	Finish.	Elapsed Corrected	
				Time.	Time.
Foot.	H. M. S.	H. M. S.	H. M. S.	H. M. S.	H. M. S.
Bug	15 08	3 45 50	6 55 20	3 09 30	3 05 12
Debutante	18 00	3 47 17	7 08 30	3 22 20	3 22 20
Little March-blown	17 06	3 48 53	6 59 40	3 10 17	3 09 58
Wide-awake	16 08	3 47 17	7 08 50	3 21 33	3 20 05

July 1st: Sir Donald A. Smith Cup Race.

The start was made at 11 A. M., and thirteen boats crossed the line. There was a slight draft of air from the southeast at the start, and the day was hot and fine. LULU, VALDA and CHAPERON in the order named went away from the fleet, but by 2:15 the wind was dead; only the first leg of the course had been covered and the race was abandoned.

July 8th: Third Series Race for the A, 30 and 21 foot Classes.

EAGLE, CHAPERON, VALDA, MOLLY BAWN, FROLIC, COQUETTE and RITA started. A fresh club topsail breeze was blowing and the weather was threatening. On the second leg of the course, a reach from the Valois to the Chateaugay Buoy, a thunder squall of unexampled force swept the lake. VALDA, EAGLE, CHAPERON and MOLLY BAWN were leading, and were carrying all plain sail when the squall of wind, rain and thunder struck them. EAGLE and CHAPERON instantly capsized and sank within a quarter of an hour. VALDA and MOLLY BAWN were knocked down, but got their canvas on deck in time to avert disaster. RITA and two boats that were not racing, PETEREL and BUTTERNUT, were also capsized at a moderate distance from shore. VALDA, under bare poles, ran down under EAGLE's lee and took off one of her crew but was unable to make fast to the wreck. Drifting down to leeward, she anchored, put in three reefs, worked back to EAGLE and took off two more of her crew, all that were still by her. She then ran down to CHAPERON and picked up three of her crew. She was the only boat in the fleet under control during the whole squall and its successor, which was less furious than the first. The nuptial launch LILE HORN put off from Pointe Claire and picked up the remainder of CHAPERON'S and EAGLE'S crews with the exception of C. H. Levin, the Commodore of the club, who went down with his ship. The crews of RITA, PETEREL and BUTTERNUT were rescued from the shore.

After this most unfortunate disaster all racing was postponed for one month.

August 26th: Re-sail for Sir Donald Smith's Cup. The start was at 3:40. The day was very fine and warm, and there was hardly wind enough to carry any of the boats over the line. There were twelve starters but at 6 P. M. the race was abandoned.

September 2nd: Re-sail for Sir Donald A. Smith's Cup. There was a heavy gale from the northwest. At the start it was blowing harder than it has ever done on a racing day on Lake St. Louis; and it being reported that the Chateaugay Buoy had been carried away, it was decided to sail around the Pointe Claire Buoy, a course of about seven miles to windward and return. All the boats at the start carried three reefs in the mainsail and storm jib.

The start was as follows:

Chaperon	H. M. S.	3 31 37
Molly Bawn		3 32 00
Valda		3 32 11
Lulu		3 36 25
Coquette		2 33 08
Undine		3 34 30
Dream		3 32 10

VALDA more than held CHAPERON until Valois Bay was opened. Then the wind lightening up, the sloop got into trouble changing jibs, and COQUETTE passed her. The wind let up steadily all the

time the windward work was being done, and at Pointe Claire all were carrying full lower sail, but on the run it freshened up until it was heavy work carrying spinnakers.

The time of the race was as follows:

	Start.	Finish.	Elap. Time.
	H. M. S.	H. M. S.	H. M. S.
Chaperon	3 31 37	1 17 40	1 16 03
Cosette	3 33 38	1 51 53	1 18 15
Valda	3 32 11	1 55 56	1 23 45
Molly Bawn	3 32 00	5 00 11	1 28 11
Dream	3 32 10	5 02 52	1 30 42
Endine	3 34 30	5 11 05	1 36 35

The course was not officially measured, but CHAPERON was the winner. At a meeting of the Sailing Committee held on September 9th, it was decided that under the terms on which the cup is raced for, the Sailing Committee had no power to alter the course, and the race was declared off.

September 9th. Re-sail of Second Series Race for A, 30, 25, and 21 foot Classes. There was a strong southwest wind, and single reefed mainsails were carried throughout the fleet.

	Start	Finish	Elap. Time.	Cor. Time.
	H. M. S.	H. M. S.	H. M. S.	H. M. S.
Class A.				
Chaperon	3 11 01	5 41 20	1 51 28	1 52 51
Cosette	3 46 42	5 54 31	2 07 49	2 05 35
Dream	3 48 09	5 42 20	1 54 11	1 51 11

	Start.	Finish.	Elap. Time.	Cor. Time.
	H. M. S.	H. M. S.	H. M. S.	H. M. S.

30 Foot Class.

Molly Bawn	3 47 28	5 45 12	1 57 44	1 52 03
Valda	3 48 31	5 49 33	2 01 02	1 53 53
Endine	3 47 12	6 02 25	2 15 13	2 08 32

September 16th. Third Series Race 18 foot Class. Strong equally west and south wind.

Bug	3 52 47	6 23 50	2 31 03	2 28 01
Pirate	3 52 20	6 41 55	2 49 35	2 48 35
Little Marchioness	3 53 38	6 45 25	2 51 47	2 51 47

September 23d. Re-sail for Sir Donald Smith's Cup.

Another attempt was made to sail this race in a light air. The fleet had now dwindled to six boats, and again after the time limit had expired not half the course had been sailed, and the race had to be abandoned.

September 30th. Fifth race for Sir Donald Smith's Cup.

Molly Bawn	3 31 20	5 30 50	2 08 30	2 08 30
Waterwheel	did not sail over the course.			
Burnerut	"	"	"	"
Endine	"	"	"	"

As a result of the season's racing, CHAPERON won the Honorary Commodore's Cup, by taking two straight races in the Class A series. She also won the only race that was sailed for the Sir Donald Smith Cup.

MOLLY BAWN won the 30 foot Class series, the Commodore's Cup by two straight firsts, and the Sir Donald Smith Cup by a sail over. Bug won the Series in 18 foot Class, by two straight firsts.

BIOGRAPHICAL SKETCHES AND DESCRIPTION OF YACHTS ENROLLED IN THE CLUB.



E. S. CLOUSTON.

E. S. CLOUSTON, Montreal, Quebec. He is the owner of the yachts *CHAPERON* and *DEBUTANTE*, and is a member of the *ST. LAWRENCE YACHT CLUB*. Mr. Clouston is the General Manager of the Bank of Montreal, and is a trustee of the yacht club to which he belongs.

CHAPERON.

The cutter yacht *CHAPERON*, owned by E. S. Clouston, was designed by A. J. Jarvis and built by Leboeuf. She sails with the fleet of the *ST. LAWRENCE YACHT CLUB*. See Fig. 396.

CODE SIGNAL LETTERS, H. J.

DIMENSIONS.

Length over all,	34 feet,	Length lead waterline,	25 feet 10 inches.
Beam,	10 feet,	Sail area,	1,167 square feet.



G. HERRIEK DUGGAN.

G. HERRIEK DUGGAN, Chief Engineer of the Dominion Bridge Company, Montreal, is a resident of his native city, Toronto, Ontario. He was born September 6, 1862. Has been interested in yachting about twenty years, and is the owner of the yachts *VALDA* and *BUG*. He has designed, built and owned the yachts *ESCAPADE*, *ZOE*, *VREDA* (sailing skill), *VALDA* and *BUG*, and has designed *FRIEZE*, *FANNY*, *JAMBOREE*, *HILDA*, *EDNA*, *VIKING* and *MICROBE*, all sailing in either the *TORONTO*, *ROYAL CANADIAN*, or *ST. LAWRENCE YACHT CLUBS*.

Mr. Duggan is a member of the *ST. LAWRENCE YACHT CLUB*, and has held the office of Captain in the *TORONTO YACHT CLUB*, as well as that of Vice-Commodore and Commodore in the *ST. LAWRENCE YACHT CLUB*. He was one of the founders of the *TORONTO YACHT CLUB*, and is a member of the committee of three which called together the first meeting of the *LAKE YACHT RACING ASSOCIATION*. He is also a charter member of the *ST. LAWRENCE YACHT CLUB* and was their first Vice-Commodore.

BUG.

BUG is a centerboard open cut-boat, designed by her owner, G. H. Duggan, and built by Duggan & Shearwood of Montreal, and launched in May 1892. She hails from Dorval and sails with the fleet of the *ST. LAWRENCE YACHT CLUB*.

DIMENSIONS.

Length over all,	21 feet,	Length lead waterline,	11 feet.
Beam,	7 feet,	Draft,	8 inches.

Racing Record for 1892 :—

ST. LAWRENCE YACHT CLUB—*BUG* won on June 4th, beating *WIDE-AWAKE*, *COCKROACH* and *BHANAYAR*. She again won on June 18th and also on the 9th of July. *BUG* has a record of five firsts out of five starts. See Fig. 59.

VALDA.

VALDA is a centerboard sloop, designed by her present owner, Mr. G. Herriek Duggan, and built by G. St. Onge, Lachine. She

was launched in 1890, in the month of May. She hails from Dorval and sails with the *ST. LAWRENCE YACHT CLUB*.

DIMENSIONS.

Length over all,	25 feet,	Length lead waterline,	21 feet.
Depth,		Draft,	2 feet 2 inches.
Beam,	8 feet		

Racing Record for 1891 :—

ST. LAWRENCE YACHT CLUB—Special Open Sweepstakes, May 25th. *VALDA* second, beaten by *DREAM*; four starters. A winter on June 13th, beating *CHAPERON*, *FROLIC* and *MOLLY BAWN*. Won again on the 27th of June, beating the same yachts, and a third time on the 1st of July, when *BREEZE* was also included in the list of the vanquished. On July 11th, *VALDA* was beaten by *CHAPERON* with *MOLLY BAWN* third. In a special unclassified race, sailed August 29th, she was again second, with *THORA* first; six starters.

Racing Record for 1892 :—

ST. LAWRENCE YACHT CLUB—June 11th, *VALDA* beat *CHAPERON* and *MOLLY BAWN*. In the contest for the Sir Donald A. Smith Challenge Cup, July 1st, *VALDA* won, beating *EAGLE*, *COQUETTE*, *VIKING*, *CHAPERON*, etc. Again a winner in the Series Race of July 1st. In the Baylis Cup Race, July 16th, *VALDA* was a winner, defeating three other yachts, and also won the Series Race sailed July 23d. In a Handicap Race, September 17th, *VALDA* was the first of the six starters.

VALDA has a record of 16 firsts and 3 seconds out of 19 starts.



W. ARTHUR C. HAMILTON and E. Kirk Greene, both of Montreal, Canada, are the joint owners of the sloop yacht *FROLIC*. They have been share and share alike in the ownership of the yachts *CHANCE* and *CYCLONE*, and have been yachtsmen since 1877. These gentlemen are charter members of the *ST. LAWRENCE YACHT CLUB*, and are quite active in its interests.

Mr. Hamilton the son of E. Gay Hamilton was born in Brooklyn, New York.

He was recently the Vice-Commodore of the *ST. LAWRENCE YACHT CLUB*, but is now acting as Commodore since the death of the late C. H. Levin, and has also held the offices of Treasurer and Assistant Secretary.

Mr. Greene was born in Montreal, and is the son of E. K. Greene. He is connected with a firm of wholesale furriers. Has served on one of the Committees in the *ST. LAWRENCE YACHT CLUB* for three years.

FROLIC.

FROLIC is a sloop yacht, with a lead keel through which the centerboard drops. She was designed and built by A. F. Mumm of South Brooklyn, and was launched in June, 1887. She was built for T. C. Ward of Brooklyn, who sold her to E. N. Norton, from whom she was purchased by her present owners, W. Arthur C. Hamilton and E. Kirk Greene, of Montreal, Canada. She hails from Dorval.

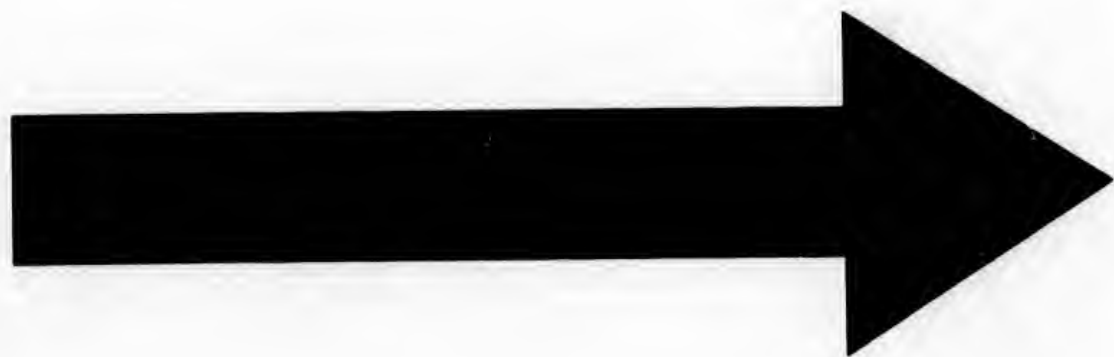

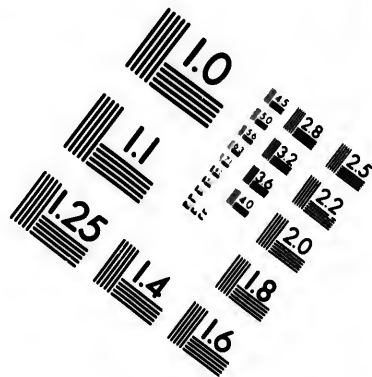
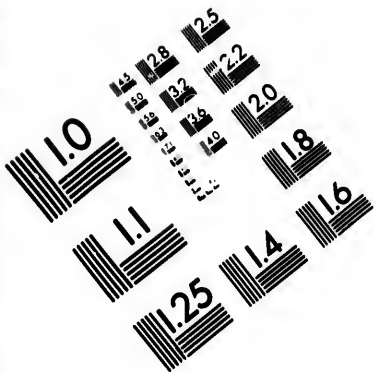

**IMAGE EVALUATION
TEST TARGET (MT-3)**

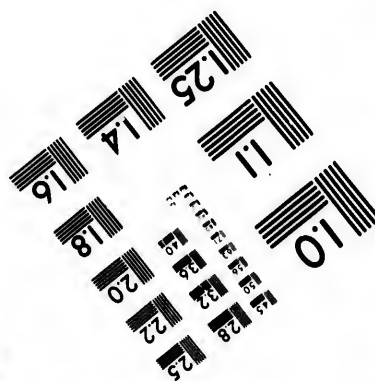
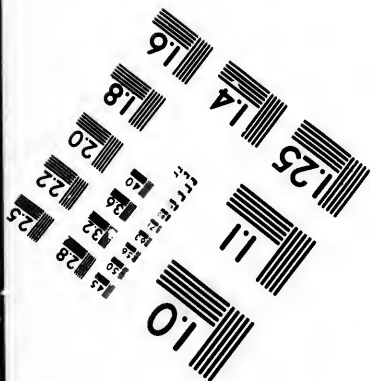
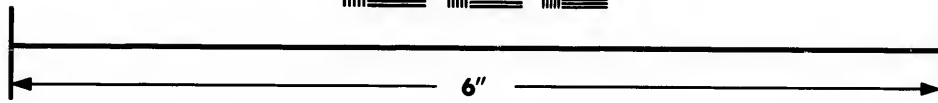
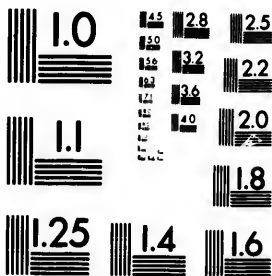

**Photographic
Sciences
Corporation**

23 WEST MAIN STREET
WEBSTER, N.Y. 14580
(716) 872-4503

1.5 28
2.0 32
2.5 36
3.0 40
3.6 45
4.5 50
5.6 56
7.1 63
9.0 72
11.2 80
14.0 90
18.0 100

10
11
12
13
14
15
16
17
18
19
20
21
22
23
24
25
26
27
28
29
30
31
32
33
34
35
36
37
38
39
40
41
42
43
44
45
46
47
48
49
50
51
52
53
54
55
56
57
58
59
60
61
62
63
64
65
66
67
68
69
70
71
72
73
74
75
76
77
78
79
80
81
82
83
84
85
86
87
88
89
90
91
92
93
94
95
96
97
98
99
100

Quebec, and is enrolled in the ST. LAWRENCE YACHT CLUB. See Fig. 335.

DIMENSIONS.			
Length over all,	28 feet.	Length load waterline,	23 feet 9 inches.
Depth,	4 feet.	Draft,	3 feet 4 inches.
Beam,	16 feet 3 inches.		
SPARS.			
Mast,	15 feet.	Staff,	18 feet 6 inches.
Boom,	27 feet.	Holst,	22 feet.
Club topsail spars,	21 and 14 feet.		



CHARLES H. LEVIN.

CHARLES H. LEVIN, late Commodore of the ST. LAWRENCE YACHT CLUB, Canada, was born in Montreal, March 23, 1853. He was the owner of the yacht EAGLE (See Fig. 333), and was a charter member of the ST. LAWRENCE YACHT CLUB. Has held many offices in the club, as follows:—1888, Rear-Commodore; 1889, Vice-Commodore; 1890, Committeeman; 1891, Vice-Commodore; 1892, Vice-Commodore; and 1893, Commodore. He was interested in yachting since 1870. Commodore Levin was a member of the firm of B. Levin & Co., wholesale furs and hats; was President of the M. A. A. Chess Club, and a member of the Metropolitan Club and the Board of Trade.

EAGLE.

The yacht EAGLE is a cutter, owned by the late Chas. H. Levin and George O. Gabler of Montreal. She was designed and built by R. Roy. She hails from Montreal and sails with the fleet of the ST. LAWRENCE YACHT CLUB.

DIMENSIONS.			
Length over all,	39 feet 3 inches.	Length load waterline,	35 feet 3 inches.
Draft,	28 inches.	Beam,	10 feet.
Sail Area,	1,450 square feet.		

A. W. MORRIS, is a member of the ST. LAWRENCE YACHT CLUB, and Honorary Commodore. He is a member of the Legislative Assembly of the Province of Quebec, and is the owner of the yacht DREAM.

DREAM.

DREAM is a centerboard sloop, owned by Hon. Com. A. W. Morris of Montreal, and H. Markland Molson. She was designed and built by E. S. Matthews of New York. She hails from Dorval, and sails with the fleet of the ST. LAWRENCE YACHT CLUB. She was formerly known as SADIE B. See Fig. 334.

DIMENSIONS.			
Length over all,	31 feet, 7 inches.	Length load waterline,	28 feet 9 inches.
Beam,	11 feet 8 inches.	Draft,	2 feet 10 inches.
Sail Area,	1,505 square feet.		

Racing Record for 1891:—

ST. LAWRENCE YACHT CLUB—DREAM won on May 25th, in the Special Open Sweepstakes, beating VALDA, FROLIC and BLACK EAGLE; beaten by LULU on June 30th. DREAM was a winner on the 27th of June, beating LULU, WHITE SQUALL, etc. She won again in the race sailed July 1st with five contestants. On the 11th of July she was defeated by LULU a second time, and still again on the 18th of July.

R. CAMPBELL NELLES, general merchant, Montreal, Canada; was born in London, Ontario, is the son of J. A. Nelles, M.D. Is the owner of the yachts ELSIE and LITTLE MARCHIONESS. Mr. Nelles has been a yachtsman for thirteen years and is a member of the ST. LAWRENCE YACHT CLUB.

ELSIE.

A centerboard sloop, designed and built by R. A. Winsor and owned by R. C. Nelles, sailing with the ST. LAWRENCE YACHT CLUB. Hails from Dorval, Quebec. See Fig. 341.

DIMENSIONS.			
Length over all,	20.00 feet.	Length load waterline,	17 feet 10 inches.
Draft,	2 feet 6 inches.	Beam,	6 feet 10 inches.

Racing Record for 1892:—

ST. LAWRENCE YACHT CLUB—ELSIE won in the Series Race of June 11th, beating ELLIDA. First on July 1st, defeating ELLIDA and ZOE. Beaten by ELLIDA on the 9th of the same month, and a second time on the 23rd. In the Sail Off for the Commodore's Cup, September 10th, ELSIE won from ELLIDA by 15 seconds.

MOLLY BAWN.

The sloop yacht MOLLY BAWN is owned by Walter Kavanagh. She was designed by Edward Burgess and built by Lawley & Son. Sails with the ST. LAWRENCE YACHT CLUB. See Fig. 339.

CODE SIGNAL LETTERS, J. W.

DIMENSIONS.			
Beam,	8 feet.	Length load waterline,	20 feet.

BUTTERNUT.

BUTTERNUT is a sloop yacht, designed and built by Lebauf. She is owned by W. de M. Marler and sails with the ST. LAWRENCE YACHT CLUB. See Fig. 340.

CODE SIGNAL LETTERS, B. W. P.

DIMENSIONS.			
Length over all,	25 feet.	Length load waterline,	18 feet.
Beam,	8 feet 8 inches.	Sail Area,	700 Square feet.

COQUETTE.

COQUETTE is a cutter yacht, owned by A. Hamilton. Was designed and built by Lebauf and now hails from Montreal, Canada. She sails with the ST. LAWRENCE YACHT CLUB. COQUETTE is 35 feet over all, 25 feet on the waterline, and 9 feet 10 inches beam. See Fig. 335.

GADAROUT.

This yacht is an auxiliary screw schooner, owned by Edward M. Fulton. She was designed by J. Beavor-Webb, and built by Aug. Cantin, Montreal, Canada. She was launched in 1892. She hails from Montreal, sailing with the fleets of the NEW YORK, LAKE CHAMPLAIN, ROYAL CANADIAN and ST. LAWRENCE YACHT CLUBS. See Fig. 337.

Official number 100,593.

CODE SIGNAL LETTERS, V. S. P. K.

DIMENSIONS.			
Length over all,	98 feet.	Length load waterline,	76 feet.
Depth,	10 feet 6 inches.	Draft,	10 feet.
Beam,	17 feet.		

Engine: Compound, 2 cylinders, 8 inch, and 16 x 12 inch. Plenty & Son.

Boiler: Return tubular. Plenty & Son, Newbury, England.

VIKING.

VIKING is a cutter yacht belonging to L. J. Smith. She hails from Montreal and sails with the ST. LAWRENCE YACHT CLUB. Was designed by G. H. Duggan and built by J. McIntyre. See Fig. 342.

DIMENSIONS.			
Length over all,	41 feet.	Length load waterline,	30 feet.
Beam,	12 feet.		

Racing Record for 1892:—

ST. LAWRENCE YACHT CLUB—In the Series Race held June 11th, VIKING won, beating WHITE SQUALL and EAGLE. She won a second time in the Series Race of June 18th from WHITE SQUALL and COQUETTE. In the contest for the Sir Donald A. Smith Challenge Cup, she was beaten by VALDA; VIKING came in ahead of CHAPERON, FROLIC, MOLLY BAWN, EAGLE and COQUETTE. Second, VALDA first, in the race for the Baylis Cup sailed July 16th. VIKING was second in the Handicap Race which took place September 17th, VALDA winning again. VIKING won the Commodore's Cup.

Race of June
ELLIDA and
month, and a
Commodore's
5 seconds.

vannagh. She
& Son. Sails

20 feet.

Leboeuf. She
r. LAWRENCE

8 feet.
10 Square feet.

on. Was de-
treat, Canada.
QUETTE is 35
1 inches beam.

by Edward M.
built by Aug.
92. She hails
LAKE CHAM-
CLUBS. See

76 feet
10 feet.

2 inch. Plenty
ngland.

th. She hails
YACHT CLUB.
McIntyre. See

30 feet.

held June 11th,
E. She won a
WHITE SQUALL.
onald A. Smith
TRING came in
S, EAGLE and
for the Baylis
n the Handicap
winning again.



HULL YACHT CLUB HOUSE.

History of the Yacht Club.

THE HISTORY OF THE YACHT CLUB, 1880, is a story of the growth and development of the club from its first meeting in 1880 to the present time. The club was organized in 1880, and its first meeting was held on the 1st of September. The club's first year was a successful one, and it was the first year that the club had a regular meeting. The club's first year was a successful one, and it was the first year that the club had a regular meeting. The club's first year was a successful one, and it was the first year that the club had a regular meeting.



Yacht Club Schooner

The club's first year was a successful one, and it was the first year that the club had a regular meeting. The club's first year was a successful one, and it was the first year that the club had a regular meeting. The club's first year was a successful one, and it was the first year that the club had a regular meeting. The club's first year was a successful one, and it was the first year that the club had a regular meeting. The club's first year was a successful one, and it was the first year that the club had a regular meeting.

2. The admission fee was made ten dollars. The first club annual regatta was held in 1881, and it was a great success. Its officers were W. B. Lambert, Commodore; Moody Merrill, Secretary; H. P. Stanwood, Treasurer; W. B. Lambert, C. A. Perkins, F. H. Johnson, Edwin Howland and G. C. Merrill. The club's first year was a successful one, and it was the first year that the club had a regular meeting. The club's first year was a successful one, and it was the first year that the club had a regular meeting. The club's first year was a successful one, and it was the first year that the club had a regular meeting.

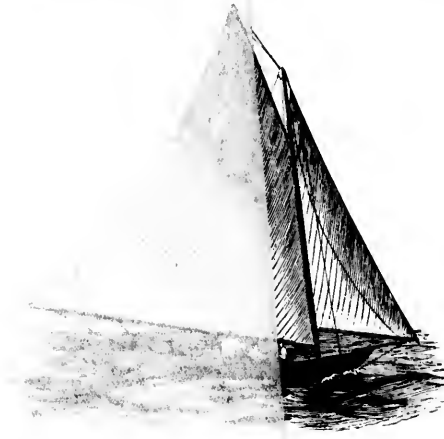

Yacht Club Cutter

The club's first year was a successful one, and it was the first year that the club had a regular meeting. The club's first year was a successful one, and it was the first year that the club had a regular meeting. The club's first year was a successful one, and it was the first year that the club had a regular meeting. The club's first year was a successful one, and it was the first year that the club had a regular meeting. The club's first year was a successful one, and it was the first year that the club had a regular meeting.

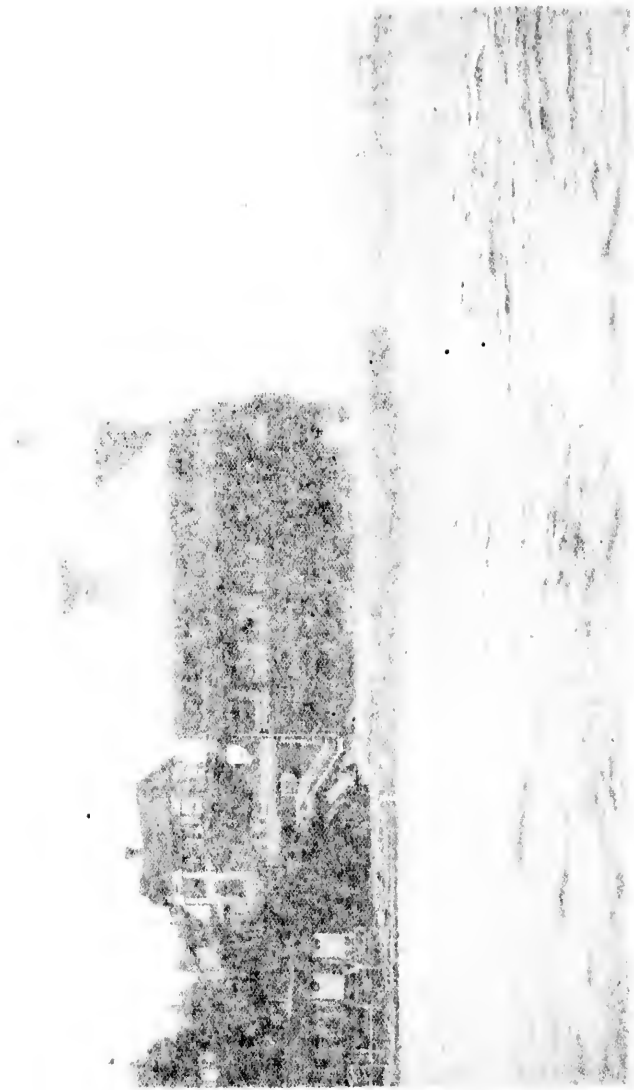

1904

History of the Hull Yacht Club.

THE HULL YACHT CLUB was formed in the early summer of 1880, by a few gentlemen, summer residents of Hull, who owned small boats, and anticipated pleasure in friendly races and the winning of an occasional prize. The original membership was thirteen, that so-called unlucky number, whereby these gentlemen proved that all sailors are not superstitious; and the success of the club, which to-day stands among the first in the country, has conclusively proved that there is luck in odd numbers. On June 25, 1880, the club was organized with the following officers: W. B. Lambert, Commodore; W. M. Merrill, Vice-Commodore; F. M. Holbrook, Secretary and Treasurer. Regatta Committee: W. B. Lambert, C. A. Perkins, W. M. Merrill, Joshua Clark and W. L. Phinney. The dues were made five dollars per annum. The flag that the club adopted was a pointed burgee with yellow field, black crossed

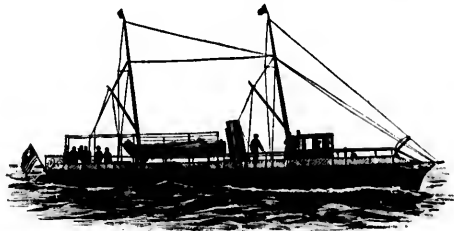

NOW THEN.—FIGURE 343.

bars, and white stars in the center of the cross. During the first season several club races were given and one open race, all of which were so successful as to attract much attention to the club; by the end of the season, which was short, the membership had doubled, and its original fleet of six yachts had increased to eighteen.

Its second year was marked by an increase of membership to one hundred and seventy-five, and of the fleet to seventy-nine. A committee was appointed, with full powers, to build a pier at the point where the present Club House stands, and this pier was the first property ever held by the club. This season was more successful than the previous one. Numerous regattas were sailed, with full entries, and several entertainments for the benefit of the club treasury were given at the village hotel—the Oregon House. The season closed with a grand ball at the Hotel Pemberton, which proved to be one of the finest given on the New England coast.

Up to 1882, the only property owned by the club was the landing pier, its meetings having been held at members' houses. A Club House had become a necessity, and early in 1882 arrangements were made with the steamboat company, owning the wharf at Hull, for the erection of a house at the end of their pier. This house provided for them what appeared to be ample accommodations. There was a large hall, surrounded on three sides by a piazza, having a stage, thereby enabling the club to give entertainments, which added largely to the club's popularity, and also somewhat to its income—committee, junior's and toilet rooms, and a number of lockers. There was a good landing with ample floats for the storage of tenders, and good water at all stages of the tide. A charter was obtained and the club incor-

porated April 20, 1882. The admission fee was made ten dollars, the annual dues remaining at five dollars. The first club annual was issued during the year. Its officers were W. B. Lambert, Commodore; C. A. Perkins, Vice-Commodore; Moody Merrill, Rear-Commodore; F. H. Monks, Secretary; H. P. Stanwood, Treasurer. Executive Committee: W. B. Lambert, C. A. Perkins, F. H. Monks, H. P. Stanwood, T. F. Patterson, Edwin Howland and G. C. Appleton. In these gentlemen was vested the entire charge of the policy and finances of the club, which rule has remained in force ever since, to the great benefit of the club. The new house gave a great impetus to the club. Thirteen club regattas were given, \$600 being offered in cash prizes, besides champion pennants, cups and other trophies. An open regatta, was also given on a larger scale than before, \$500 being offered in cash prizes. Corinthian sailing was encouraged by the offering of additional prizes to yachts manned and sailed by amateurs, and the number of entries was large. At the end of the season the membership had increased to four hundred and the fleet to one hundred and twenty-five, and the cash prizes won by its yachts during the season, in various races, amounted to over \$3,000.

From 1881 up to the present time the club has given an average of not less than eight club races each year, while its ladies' days, an-

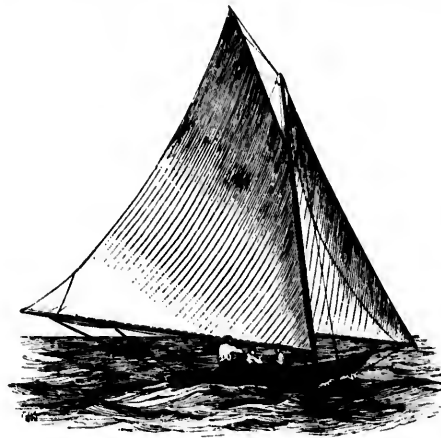

VANESSA.—FIGURE 344.

ual cruises, band concerts, and other entertainments have kept up an unflagging interest among its non-yacht-owning members.

In 1883 the club gave the greatest open regatta ever given in Eastern waters. Cash prizes amounting to \$1,000 were offered. There were one hundred and twenty-five yachts entered and ninety started. These open races became an annual feature, and were the most successful and noted races in Eastern waters for many years.

In 1888, the annual dues were raised to ten dollars.

Up to 1889 the club continued its annual open races for all classes, with an average entry list of between eighty and ninety yachts, but

notwithstanding its success in that direction, it was decided to devote the money to club races, except in the case of special classes which it seemed desirable to encourage. With this end in view, special prizes were offered in 1889 to 30 and 40 footers, in an open race over the club's outside course off Nantasket Beach.

In 1890, in addition to the regular club races, a series of cup races was given, including the HULL YACHT CLUB Subscription Cup, costing \$150, for 40 footers, and the D. Hull Rice Cup, costing \$150, for the 30 footers, with cups of smaller value for other classes.

In 1891 regular club races were given, but in 1892 the club, always ready to encourage prominent classes, gave a most successful open race for 21 footers, off Nahant, besides seven club races.

Since 1886 the club had been on the lookout for a site for a new and larger Club House; and it was not until 1889 that they secured the present location. It was late in the Fall that the purchase was concluded, and only preparatory work was done until the following year. Money was raised for the land and building by the issue of 4 per cent. bonds, that were immediately taken by members. The purchase included a house of twelve rooms, which served as a Club House during the season of 1890, while the new building was being erected, and over this cottage, the club raised for the first time, its flag,



ALPHA.—FIGURE 315.

with red field and blue bars, which had been adopted in place of the old yellow and black. The reason for this change was that no yellow bunting could be obtained that would hold its color. In the winter of 1890 the admission fee was raised to twenty dollars, and the annual dues to fifteen dollars.

The new Club House was opened in May, 1891, complete in all its departments, and the club started on a new era of prosperity. The house proper measures fifty feet on its front or water side, and is fifty-five feet deep. From the platform on which it stands, the ridge-

pole is nearly 80 feet, and from the floor of the dancing hall rises an open space of 40 feet, giving ample ventilation and a cool temperature in the hottest weather. There is a 12 foot piazza on three sides of the two upper stories and the ground floor. The house stands upon a platform 100 by 80 feet, which is surrounded on three sides by a granite sea wall. This wall and the house foundation rests on a solid ledge of rock. In the upper story is a large dancing hall, which has a 20 by 10 foot stage, a ladies' parlor and toilet rooms. On the next or street floor are the billiard room (containing three tables), public and private dining rooms, committee and reading rooms, wine rooms, butler's pantry and toilet rooms. On the next or mezzanine floor are three regulation bowling alleys, kitchen and store-rooms, and servants' quarters. On the lower floor are fifty lockers of various sizes, a laundry, boatmen's rooms, toilet room, tub and shower baths, and storage for spars. The location is unsurpassed. Water surrounds the house on three sides; from the piazzas a most beautiful view is to be had, and the club's inside race courses are in full sight. The floats extend out some 250 feet, and at the outer end there is 10 feet of water at mean low tide. The bay in front offers the best of anchorage for an unlimited number of yachts. In addition to the Club House is the cottage already spoken of, which furnishes eleven sleeping apartments.

The nearness of Hull to Boston—a distance of only eight miles down the bay, making a pleasant steamer ride of only forty minutes—a fine sheet of water for sailing, the perfect appointments of the Club House, which cannot be surpassed for a yachtsman's purpose, together with the excellent cuisine, cause many members to select the Club House for their summer quarters, and the demand for rooms cannot be met by the present accommodations. The club's land extends three hundred feet on the street, and has a water frontage of over four hundred feet, so that there is ample room for further building.

During its thirteen years of existence, the club has had but six Commodores: W. B. Lambert during 1880, '81 and '82; Wm. F. Weld in 1883; C. A. Perkins in 1884; Charles V. Whitten in 1885, '86, '87, '89 and 1890; E. H. Converse in 1888, and J. J. Souther in 1891 and 1892. Five Treasurers: F. M. Holbrook, 1880; Thos. F. Patterson, 1881; Henry P. Stanwood, from 1881 to 1885; Chas. C. Hutchinson, from 1885 to 1891; John J. Henry from 1891 to the present time. Five Secretaries: F. M. Holbrook, 1880; Thos. F. Patterson, 1881; Frank H. Monks during 1882; Peleg Aborn from 1882 to 1888; Wm. A. Cary from 1888 to the present time.

At present the club is in a most prosperous condition, with a membership of four hundred, being the club limit, a fleet of one hundred and forty yachts, its magnificent Club House and large grounds on as sightly and well situated a point for yachting as can be found, and only a small bonded indebtedness.

OFFICERS FOR 1893.

Commodore: Lewis J. Bird, Steamer SEA BIRD.
 Vice-Commodore: E. F. Linton, Sloop MISCHIEF.
 Rear-Commodore: Winthrop B. Thayer, Yawl WHITE CAP.
 Secretary: William A. Cary.
 Assistant Secretary: W. D. Shattuck.
 Treasurer: John J. Henry.
 Measurer: William E. Waterhouse.

REGATTA COMMITTEE.

For one year, Frank L. Dunne. For two years, Barclay Tilton and Herman W. Friend.

LIST OF YACHTS ENROLLED IN THE HULL YACHT CLUB, 1893.

STEAMERS.

Name.	Owner.	Length over all.	Length on Water Line.	Mast overhang.	Beam.	Draft.
		ft. in.	ft. in.	ft. in.	ft. in.	ft. in.
Adelita	N. C. Nash	93	7	..	16	7 6
El Pinella	John W. Abbot	71	30	..	13	5
Eld (Naphtha launch)	E. F. Lytton	40	35	5	4	3
Glean	Henry W. Savage	80	70	..	17 6	5 6
Gyda	Edgar Harding	71	62	..	12 5	4
Hib	S. C. Lawrence	132	121	..	23 10	8 6
Jathiel	J. B. Thomas	130	110	..	18 6	8 6
Marhan	William H. Swift	36	31	3	8	2 6
Navarch	C. F. Morrill	65	56	..	11 6	5
Norma	William Amory	59	51 6	..	10 2	4
Now Then	J. Edw. Adieks	86 4	81 2	..	10	3 2
Philomene	William Amory	80	65	..	11	6
Polly	Charles S. Eaton
Sea Bird	Lewis J. Eiel	58	50	12	15	6 6
Senator	William H. Crane	83	65	..	11 6	6
Tallman	J. B. Thomas	143	123	..	17 6	7
Vivace	H. G. Hunt	6	3 6
(Building)	R. H. White

SCHOONERS.

Name.	Centerboard or Keel.	Owner.	Length over all.	Length on Water Line.	Mast Overhang.	Beam.	Draft.
			ft. in.	ft. in.	ft. in.	ft. in.	ft. in.
Adrienne	k	H. P. Smith	71	60 9	9 5	18	9 4
Alice	k	E. J. Andrews	82	71 10	7	21 6	9 2
Bohemian	k	Harry P. Smith	53 11	46 7	..	15 3	7
Casella	k	George H. Brooks	71	61 2	..	18	..
Clyde	k	George M. Preston	85	72	..	21 8	5 5
Eyvor	k	George W. Cushman	31 10 2	10 5	1 7
Magnolia	k	E. P. Boynton	48	40	..	16	8 6
Genone	k	Hugh Cochrane	30	25 2	11	20	12
Pastime	k	Fredk. E. Whiting	45	38	..	14	8
Priscilla	k	Edgar Harding	64 3	56	6 6	17 6	9 10
Troubadour	e-b	W. L. Lockhart	95 2	88 4	..	21 2	9

LIST OF YACHTS ENROLLED IN THE HULL YACHT CLUB, 1893.

CUTTERS AND SLOOPS.

Name.	Centerboard or Keel.	Owner.	Length over	Length on	After	Beam.	Draft.
			all.	Water Line.	Overhang.		
			ft. in.	ft. in.	ft. in.	ft. in.	ft. in.
Albatross	e b	John J. Henry	38 2	39 5/4	3 4/4	11	5
Baboon	k	G. A. Goddard	51	30 8	8 3	13 3	8 0
Beatrice	e b	John Cavanaugh	32	24 4	12 10	2 10
Drynhllo	k	F. L. Wheeler	30	20 2/4	2 11	10 9	5
Camilla	e b	F. C. Welch	41	20 9	3	11	5 4
Caprice	e b	Reginald W. Bird	22 6	18 10	3 8	8	2 9
Catspaw (J. & M.)*	e b	C. A. Prince	29 0	10 10	6 10	10 6	1 6
Chaparral *	e b	Charles H. Jones	40 6	20 10	6	14 3	2 6
Composite	k	J. McIntyre	21 7	15 10	2 8	6 6	3 6
Cycla	k	E. J. Hyde	26 0	23 6	10 6	3
Echo	k	E. L. Burwell	27 6	23 0/4	3 8	10 6	6 6
Eureka (J. & M.)	e b	E. B. Rogers	25 1/4	19 10/4	3 5	10	2
Estle (J. & M.)	e b	S. N. Small	29 0	20 3	11 2
Fad	k	G. A. Goddard	29	26	4 0	6	5
Fancy	k	C. P. Lyman	42	29 6	7 6	9	7 6
Fannie	e b	Cabot J. Morse	21 6	21 6	2	2 6
Folly	e b	J. F. Sheppard	28 8	26 1	11	2 6
Gladys	k	William P. Fowle	42	31	10	7
Handsel *	fin	James R. Hooper	44 8	29 9	7 9	9 6	7 6
Harpoon	e b	C. F. Adams, 2d	61	46 9	16	7 6
Hawk	e b	Gordon Dexter	40 5	29 11	7 1	11 6	6
Helen	e b	James Mulcahy	44 19	28 9	6	14 3
Huldee (J. & M.)	e b	S. N. Small	31 6	22 8	6 10	9 9	1 11
Hoiden	e b	Gordon Dexter	21 10	19 10	9 9	1 10
June	k	J. S. Poyen	29 4/4	25 3/4	3 10	10	5 6
Jewel	e b	Lew C. Hill	21 0	18 10	2 9	6	2
Job Lot	e b	J. P. Plinney	17	16	8 6	3
Katherine	k	Owen A. Galvin	34
Kwasind	k	A. L. Finney	21	18	3	7 6	4 3
Lille	k	S. Edwin Tobey	38 0	30 6	2	13 2	8
Lulla	e b	John L. Butler	31	26	9 6	3
Nudge	e b	F. T. Wendell	24 11	23 5	1 3	10 6	3 1
Mariota	k	Charles A. Hayden, Jr.	37 8	34 3	3 5	10 2	6
Matoxeh (J. & M.)	e b	Allert Stone	22	16	2 6	8	3

* Official Club Measurement.

Draft.

ft. in.

5

8 0

2 10

5

5 4

2 0

1 0

2 0

3 0

0

5 0

2

.....

5

7 0

2 0

2 0

7

7 0

7 0

5

.....

1 11

1 10

5 0

2

8

.....

4 0

0

2

2 1

0

2

15

THE
MARGUERITE
MAGAZINE
PUBLISHED
BY
THE
MARGUERITE
MAGAZINE
COMPANY
NEW YORK
1880

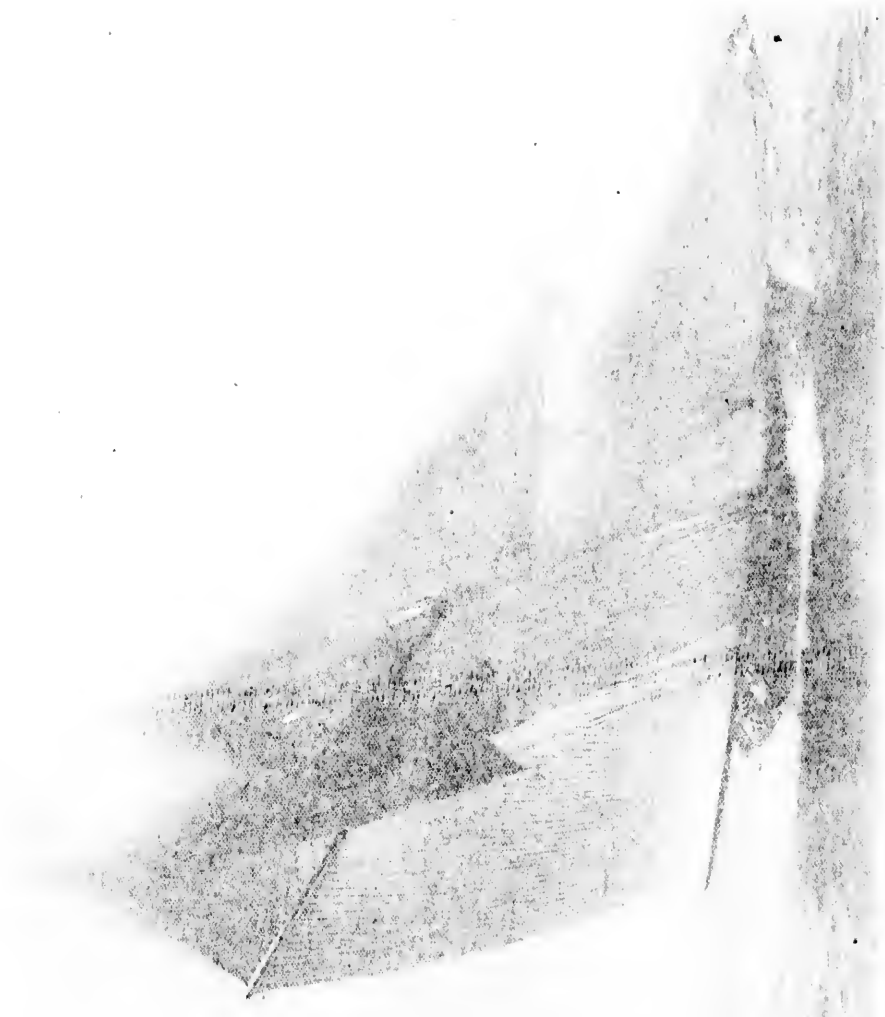

- Name.
- Mildred
 - Mischief
 - Moonlyn
 - Mystery
 - Nahm (J.)
 - Nimbus
 - Nomad
 - North Star
 - Pilgrim
 - Posy *
 - Rondina
 - Santa Maria
 - Secret *
 - Shadow
 - Silver King
 - Sigrid
 - Suse
 - Tadpole (J.)
 - The Owl
 - Thrush (J. &)
 - Undertaker
 - Ulnie
 - Estane (J. &)
 - Vaga
 - Vallalla
 - Vanessa *
 - Vandal
 - Vandal
 - Vashti
 - Wapiti (J. &)
 - Wave Crest
 - White Fawn
 - Zulu

*Official Cl

LIST OF YACHTS ENROLLED IN THE HULL YACHT CLUB, 1893.

CUTTERS AND SLOOPS—CONTINUED.

Name.	Centerboard or Keel.	Owner.	Length-over- all.	Length-on- Water Line.	Area Overhang	Beam.	Draft.
			ft. in.	ft. in.	ft. sq.	ft. in.	ft. in.
Mildred	k	N. C. Nash	40	29 11	9 6	7 6
Mischief	e b	E. F. Linton	67 5	61	19 10	5 8
Moondyne	e b	W. H. Shaw	25	21 7	1	10 0	2 6
Mystery	k	A. A. Pope, A. L. Pope	65	59 5	5 7	18 6	10
Nahema (J. & M.)	e b	A. L. Andrews, C. W. Fourdriner	29	17	3	8	1 9
Nimbus	e b	J. S. Cushing	37 2	33 7 ²	3 3	12 6	4 6
Nomad	k	H. A. Sols	38 5	31	11 6	6 1
North Star	e b	J. H. McGrady	47	41	1 1	15	4 6
Pilgrim	e b	E. W. Dixon	39 5	28 1	1 7
Posy *	e b	H. G. Hunt	25 11	22 10 ²	2 8	1 8	2 11
Rondina	k	D. C. Perival, Jr.	36 4	30 1	6 1	8 2	6 9
Santa Maria	k	J. J. Souther	28	21	7 19	4 3
Secret *	e b	E. F. Linton	21 7	22 7	11	1 8
Shadow	e b	Dr. John Bryant	37	31 1	2 9	11 1	5
Silver Klug	e b	J. P. Plimney	18	17	8 6	8
Sigurd	k	S. Halsey Lewis	27	23	1	9	5
Susie	e b	W. W. Keith	27	23 5	2 6
Tadpole (J. & M.)	fn k	W. E. Waterhouse	20	20	7 3	6 3
The Owl	e b	J. S. Cushing	15 1	15 2	11 10 ²	2 6
Thrush (J. & M.)	e b	J. Bryant	31	29	5	12	2
Undertaker	e b	F. C. Welch	19	15	7	1 8
Undine	e b	E. B. Holmes	25	22	3	10	2 8
Ustano (J. & M.)	e b	S. N. Small	25 1	21 2	3 7	10 2	2 11
Vaga	k	Cabot J. Morse	21 5	17 9	3 5	7 8	3
Valhalla	k	A. G. Van Nostrand	40	35	5	11 2	6 3
Vanessa *	fn	A. Bigelow, Jr.	29 7	26 5	1 3	6 10	5 6
Vandal	k	H. W. Friend, E. K. Friend	21 7	21 6	3 1	9 2	4 6
Vandal	e b	J. A. Stetson, H. O. Stetson	48	38 8	8	14 7	6 6
Vashti	k	John A. Stetson, Herbert O. Stetson	38	28 8	7	11	6 9
Wapiti (J. & M.)	e b	Paul F. Folsom	22	18	7
Wave Crest	e b	Winfield S. Smith	23 6	30	6	12	4
White Fawn	e b	Alonso E. Jones	25 9	25	3	12 2	2 2
Zulu	k	William Hamilton	39 6	5

*Official Club Measurement.

HISTORY OF THE HULL YACHT CLUB.

LIST OF YACHTS ENROLLED IN THE HULL YACHT CLUB, 1893.

CAT RIGS.

Name.	Centerboard or Keel.	Owner	Length over	Length on	After	Beam.	Draft.
			all.	Water Line.	Overhang.		
			ft. in.	ft. in.	ft. in.	ft. in.	ft. in.
Atala	cb	E. F. Linton	20 0 $\frac{1}{2}$	19 9 $\frac{1}{2}$	1	10	2
Chloe	cb	W. H. Crane	22 0	20 5	8 8	1 6
Cleanthe	cb	B. W. Rowell	18 0	16	2 6	1 9
Clyde	cb	Jos. T. Greene	22 0	19 6	3	9 6	2 8
Cricket	cb	W. H. Rothwell	19 3 $\frac{1}{4}$	16 1 $\frac{1}{4}$	3	7 0 $\frac{1}{2}$	1 4
Dandelion	cb	Arthur Adams	18 11	16 10	2	7 3	1 8
Don	cb	Will H. Shaw	20	17	9	1 3
Fire Fly	cb	H. L. Harding	24 6	21 6	3	10	2 5
Grace	k	J. M. Bassett	22 9	21	10	2 9
Hagedorn	cb	C. V. Souther	20	19 10	2
Hester	cb	Paul R. Blackmar	21 11	19 5	2 6
Idler *	cb	F. L. Dunne	21 7	20 9	6
Joker	cb	B. Tilton, J. B. Tilton	22 10 $\frac{1}{4}$	19 7 $\frac{1}{4}$	3 1 $\frac{1}{2}$	8 11 $\frac{1}{2}$	1 8
Koorall *	cb	Reginald C. Robblus	24 3 $\frac{1}{4}$	19 4	4 6	10	2
Mab *	cb	John Shaw	18 9	15 8	2 8	7 3
Mabel D.	cb	J. Foster Clark	19 4	16 5
Midge	cb	W. H. Thayer	20 10	19 10	7	9 6	2 2
Maggie *	cb	Harrison Gray Otis	20 4	19 5	6	9 6	2 2
Memento	cb	S. N. Small
Meta	cb	William G. South	17 6	15 3	2	6 3	1 3
Midget	cb	E. Lombard	17	1 6	6
Minnie B.	cb	Charles A. Hayden, Jr.	24 10	24 8	11 6	2 6
Montezuma	cb	George E. Carry	22 11	22 1	8 $\frac{1}{2}$	11
Myrtle	cb	R. C. Poor	24 6	20 6	10 6	2
Nlobe	cb	A. F. Schenkelsberger	22 8 $\frac{1}{2}$	19 7	2 9 $\frac{1}{2}$	9 6
Ojebec *	cb	Wm. P. Barker	20 3	19 5	5
Perl	cb	Arthur P. Hunt	20 10	18 8	1 8	9	1 10
Puritania	cb	C. B. Barnes, Jr.	21 3	18 5	8	2
Smoke	cb	Harry L. Rice, Fred J. Rice	22 3	19 6	2 3	10	1 6
Stranger	cb	B. W. Howell	18 1	16 7	7 5	1 11
Three Brothers	cb	Owen A. Galvin	21 8	21 4	2 $\frac{1}{2}$
Trump	cb	Caleb Nichols	19 1	19 1	9 4	1 6
Typhoon	cb	Chas. H. Taylor	27	23 5	9 8	2 3
Wanda	cb	Reginald C. Robblus	23 5 $\frac{1}{4}$	20 8	2 8	8 11	3
Wave	cb	W. H. Spooner	20 5	19 9	9 6	1 9
Winona	cb	G. W. T. Braman	23 6	21 6	4	12 2	2 0
(Building)	cb	H. M. Faxon	21 6	18	1 6	8 5

* Official Club Measurement.

YAWLS.

Name.	Centerboard or Keel.	Owner.	Length over	Length on	After	Beam.	Draft.
			all.	Water Line.	Overhang.		
			ft. in.	ft. in.	ft. in.	ft. in.	ft. in.
Argo	k	David Hall Rice	19	56	10	18	9
White Cup	k	Winthrop Thayer	83 6	69 6	11	20	9

ACCORDING TO RULES AND REGULATIONS.

Yachts are classified as follows:

- Class 1. Yachts 30 feet, and less than 35 feet waterline length.
 Class 2. Yachts 25 feet, and less than 30 feet waterline length.
 Class 3. Yachts 21 feet, and less than 25 feet waterline length.

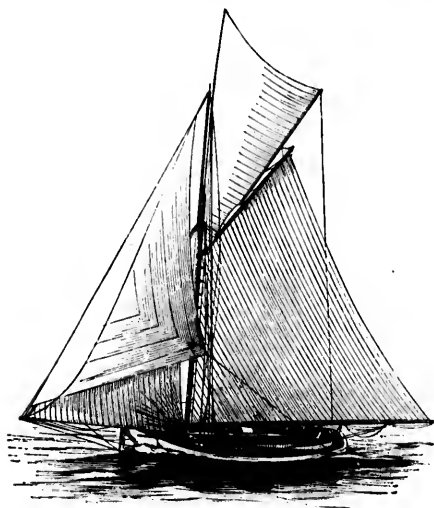

SHADOW.—FIGURE 346.

Special Class. Keel, jib and mainsail yachts less than 21 feet waterline length.

Class 4. Centerboard, jib and mainsail yachts less than 21 feet waterline length.

Class 5. Yachts 18 feet, and less than 21 feet waterline length and not included in special and 4th classes.

Class 6. Yachts less than 18 feet waterline length, and not included in special and 4th classes.

Yachts contending for prizes are allowed to carry crews as follows:

In Class 1, 9 men.

In Class 2, 8 men.

In Class 3, 7 men.

In Special and 4th Classes, 6 men.

In Classes 5 and 6, 5 men.

In Classes 1, 2 and 3, there will be no restriction in regard to sails. In all other classes, schooners may carry jib, forestay sail and mainsail; cat-boats may carry mainsail only; yawls, the same as sloops, and mizzensail. Time allowance will be based on sailing length.

$$\frac{\text{Load waterline} + \sqrt{\text{sail area}}}{2}$$

In 1882, the sailing measurement was the waterline length, with one-third of after overhang added. All starts were made from anchor, and Challenge Pennant Races were sailed Corinthian.

In 1883, the sailing measurement was the same as in 1882.

In 1884, 1885 and 1886, the sailing measurement was the waterline length with one-fifth of after overhang added. The starts were flying, the time for each class was taken from the gun for each class.

In 1887, 1888, 1889, 1890, 1891 and 1892, the starts were flying, as in 1886. In 1887, 1888, 1889, 1890 and 1891, the sailing measurement was the waterline with one-fifth of the after overhang added.

In 1892, the sailing measurement was as follows:

SAILING MEASUREMENT.

The waterline length is taken from point of immersion forward to point of immersion aft. In cases where any portion of the rudder or rudder-post projects above the water, such portion is to be included in the waterline length.

The crew need not be aboard, but if aboard must be stationed amidships.

The sail area is ascertained by taking a perpendicular along the after side of the mainmast, from the underside of gaff-topsail block or sheave on topmast to the upper side of boom, when resting on the saddle, or on the lowest part of goose-neck; the distance of which point from the main deck or house deck is recorded by the Measurer, together with the other points used in measurement. In all yachts, the forward point of measurement of the base-line is taken midway between the intersection of the bowsprit and jib topsail stay, and the center of the tack cringle of the jib or flying jib, when set. In all cases where the extreme length of the spinnaker boom exceeds the distance from the forward side of the forward mast to the forward point of measurement, such excess is added to the base line. The after point of measurement, is taken from the end of the main boom in schooners, cutters and sloops, and of the mizzen boom in yawls. The main topmast is measured from the hounds of the lower mast to the lower side of the topsail halliard block or sheave, and eighty per cent. of this length is taken from the extreme length of the main gaff measured from the inside of the jaws to the after end, the remainder of the gaff being added to the base line, as measured above. The area from these figures is obtained by multiplying the corrected base by the perpendicular, and dividing by two. To the square root of the area, as ascertained, the waterline length is added and the product divided by two. The result is the measurement for time allowance.

In measuring boats without topmasts, the perpendicular is measured to the highest point of attachment of the uppermost halliard block on the mast, and in such boats the point of attachment of the throat



THRESH.—FIGURE 347.

halliard block is the point of measurement, corresponding to the hounds. In measuring boats without headsails, the after side of the forward mast is taken as the forward point of the base line.

No change of spurs is allowed on the day of a race, except in case of accident, in which case notice of change must be given to the Re-

gatta Committee before the preparatory signal, and the new spars must be of the same length as those for which they are substituted.

The Mensor, at the time of making his measurement, is required to make a distinctive mark at each end of the waterline.

The Courses are as follows:

For First and Second Classes (starting off Club House):

No. 1. Across the line between the judges' stand and flag boat, leaving flag boat on port, through Hull Gut; thence, leaving Toddy Rocks Buoy (No. 1) and Point Alberton Buoy (No. 3) on starboard, to and around Harding's Ledge Bell Buoy, leaving it on port; thence, leaving Riley's Ledge Buoy (No. 2) on port, to and around the Graves Whistling Buoy, leaving it on port; thence, leaving Martin's Ledge Buoy (No. 4) on starboard, and Toddy Rocks Buoy (No. 1) on port; to and across judge's line, leaving the flag boat on starboard; 15 miles. Time limit, 5 hours.

No. 2. Reverse of Course No. 1, leaving each mark on the opposite hand, except at the start and finish.

Courses for Third Class:

No. 3. Across the line between the judges' stand and flag boat, leaving flag boat on port. Sheep Island on port. Pig Rocks Beacon on starboard, to and around Jack Knife Ledge Buoy (No. 1), leaving it on port; thence, leaving Pig Rocks Beacon on port, and Sheep Island on starboard, to and around flag boat (at starting line), leaving it on port, and repeat, leaving flag boat on port at finish; 11 miles. Time limit, 3½ hours.

No. 4. Across the line between the judges' stand and flag boat, leaving flag boat on port, to and around Black Can Buoy (No. 1), ¼ mile south southwest of starting line, leaving it on starboard; thence, leaving Wreck Buoy (No. 4) off Nut Island on starboard, to and around Wilson's Rock Buoy (No. 1), leaving it on port; and return, leaving Wreck Buoy (No. 4), and Black Can Buoy (No. 1) on port, to and across judge's line, leaving flag boat on port at finish; 9 miles. Time limit, 3½ hours.

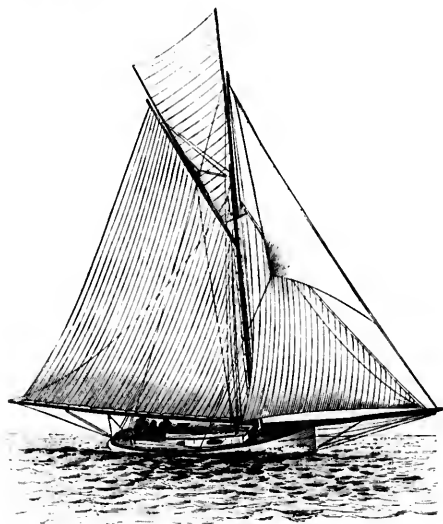

ECHO.—FIGURE 348.

No. 5. Across the line between the judges' stand and flag boat, leaving flag boat on port, to and around Black Can Buoy (No. 1), leaving it on port; thence, to and around H. Y. C. Barrel off Strawberry Hill, leaving it on starboard; thence, to and around Wreck

Buoy (No. 4), leaving it on starboard; thence, to and around Strawberry Hill Barrel, leaving it on port, to and across judges' line, leaving flag boat on port at finish; 9 miles. Time limit, 3½ hours.

Courses for Special, Fourth and Fifth Classes:

No. 6. Across the line between the judges' stand and flag boat, leaving flag boat on port, to and around H. Y. C. Barrel off Pig Rocks Beacon, leaving it on port; thence, leaving Black Can Buoy

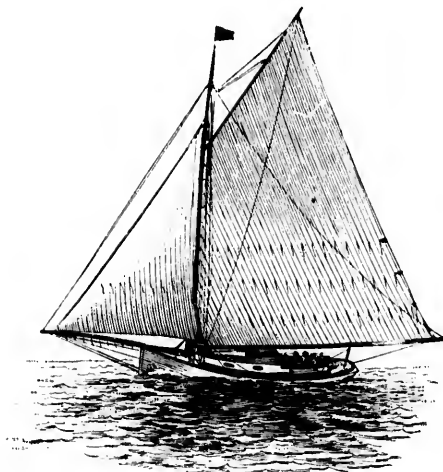

MARIPOSA.—FIGURE 349.

No. 7. Across the line between the judges' stand and flag boat, leaving flag boat on port, to and around Black Can Buoy (No. 1), leaving it on port, to and around flag boat (at starting line), leaving it on port, and repeat, leaving flag boat on port at finish; 7 miles. Time limit, 3 hours.

No. 8. Reverse of Course No. 6, leaving each mark on the opposite hand.

No. 9. Across the line between the judges' stand and flag boat, leaving flag boat on starboard, to and around H. Y. C. Barrel off Bunkin Island, leaving it on starboard, to and around H. Y. C. Barrel off Harry's Rocks, leaving it on starboard, and repeat, leaving flag boat on starboard at finish; 6 miles. Time limit, 3 hours.

No. 10. Reverse of Course No. 8, leaving each mark on the opposite hand.

No. 11. Across the line between the judges' stand and flag boat, leaving flag boat on port, to and around H. Y. C. Barrel, 1-2 mile west by south from starting line, leaving it on port, to and around H. Y. C. Barrel off Strawberry Hill, leaving it on port, to and around flag boat (at starting line), leaving it on port, and repeat, leaving flag boat on port at finish; 7 miles. Time limit, 3 hours.

No. 12. Reverse of Course No. 10, leaving each mark on the opposite hand.

Course for Sixth Class:

No. 13. Same as Course No. 8.

No. 14. Same as Course No. 9 (reverse of No. 12).

In addition to the regular prizes offered in each class, a championship prize is awarded to the yacht winning the largest number of races in her class.

In any class in which only one yacht starts, fifty per cent. of the first prize offered is awarded. No second prize is awarded in any class unless three or more yachts start, and no third prize unless four or more start.

raw-
line,
s.

boat,
Pig
Buoy

g it on
Time

posite

boat,
rel off
B. Bar-
eaving

oppo-

g boat,
2 mile
round
o and
repeat,
nit, 3

he op-

mpion-
ber of

of the
in any
ss four



PLATE XXXVI

CLERMONT.

and the
the
of
of which
prize
second
23
Po
The
second
the
LANE
\$10
I
the
all

The fir
entries.
In the
ADRIENNE
ish. ADRI
For first
was 12 mi



won the \$35
prize in 2 hrs
Of keel st
ANNIE won t
\$15 prize in 2
For second
were 13 entr
ALICE, POSY,
\$25 prize in 1
01 min., 22 s
20 sec. The
at finish; the
The second
\$25 prize in
WILFUT the
In the thi
miles. JANE
won the \$10
prize in 1 hr
of \$5 in 1 h
There were
\$20 prize in
hr., 22 min.,
min., 46 sec.

RECORD OF RACES OF THE HULL YACHT CLUB.

The first Open Regatta was given August 26, 1880; there were 88 entries.

In the Special Schooner Class (over 36 feet) CAROLINE E. and ADRIENNE started over a course of 16 miles; but the former did not finish. ADRIENNE won the \$40 prize in 4 hrs., 6 min., 18 sec.

For first class centerboard Sloops, 26 and less than 38 feet, the course was 12 miles. SHADOW, FOLLY and COMFORT competed. SHADOW

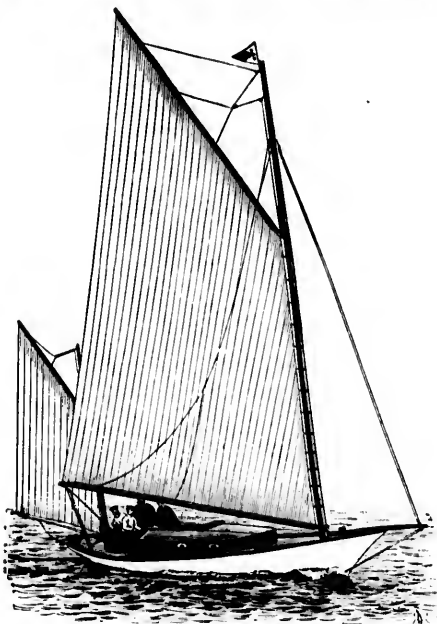

JESTER.—FIGURE 350.

won the \$35 prize in 2 hrs., 31 min., 35 sec. FOLLY won the \$15 prize in 2 hrs., 36 min., 22 sec.

Of keel sloops (same class), ANNIE, LILLIE and VIKING started. ANNIE won the \$30 prize in 2 hrs., 53 min., 32 sec. LILLIE won the \$15 prize in 2 hrs., 55 min., 08 seconds.

For second class centerboard Sloops, the course was 7 miles; there were 13 entries. MURIEL, REBIE, EXPERT, ERGUNIN, VENCIS, ALICE, POSY, EMEKA, FIONA and EDITH started. MURIEL won the \$25 prize in 1 hr., 0 min., 09 sec. REBIE won the \$15 prize in 1 hr., 01 min., 22 sec.; and EXPERT won the \$10 prize in 1 hr., 06 min., 20 sec. The wind was brisk from the southeast at start, dying away at finish; the tide was strong ebb.

The second class keel Sloops had 16 starters. FAIRY won the \$25 prize in 1 hr., 09 min., 51 sec. LENA won the \$15 prize, and WILFUL the \$10 prize.

In the third class there were 15 starters; the course was seven miles. JANET won the \$20 prize in 1 hr., 03 min., 23 sec. TOPSY won the \$10 prize in 1 hr., 05 min., 30 sec. CLARA B won the \$7 prize in 1 hr., 05 min., 51 sec., and WAVE CREST won a fourth prize of \$5 in 1 hr., 06 min., 19 sec.

There were six starters in the third class, keels. INEZ won the \$20 prize in 1 hr., 20 min., 17 sec., DELLE won the \$12 prize in 1 hr., 22 min., 01 sec., and NATALIE won the \$7 prize in 1 hr., 29 min., 46 sec.

In fourth class centerboard Sloops, there were twenty starters; the course was 7 miles. FLORA LEE was first, ROCKET second, NATIE third and CRICKET fourth.

In fourth class keels, MARY won, NONPAREIL was second, HAVETIE third; BABY did not finish.

The next race was sailed on August 7, 1880, there being a moderate breeze.

No yachts started in the First Class.

In second class, cuts, JANET won in 1 hr., 59 min., 05 sec., beating CLARA B., time 1 hr., 59 min., 57 sec., and SHEERWATER, time 2 hr., 03 min., 25 sec.

In third class, cuts, CRICKET won in 2 hr., 00 min., 07 sec.; MARY was second, time 2 hr., 00 min., 47 sec.; SHEILA third and IDLEWILD fourth.

A Race was sailed August 14, 1880. There was a light westerly wind which became quite brisk towards finish.

In second class, SHEERWATER won in 1 hr., 20 min., 40 sec.; JANET second and CLARA B. third.

In third class, CRICKET won in 1 hr., 27 min., 21 sec.; MARY second and SHEILA third.

The next race was sailed August 28th. There was a strong, out- west wind.

In second class, SHEERWATER won in 1 hr., 05 min., 12 sec., beating CLARA B. by 51 seconds.

In third Class, MARY won in 1 hr., 06 min., 03 sec., beating IDLEWILD and SHEILA.

The Third Regatta (for season) was held July 30, 1881.

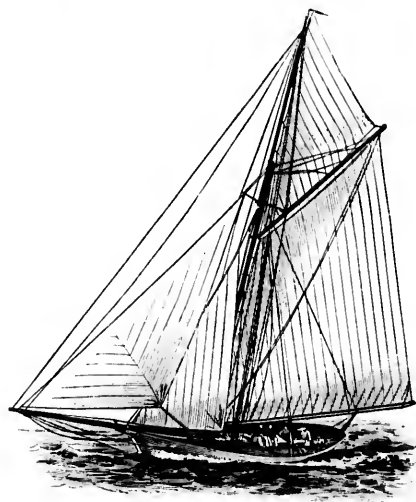

HAWK.—FIGURE 351.

The course for first class, over 21 feet, was 5½ miles. EXPERT won in 1 hr., 8 min., 51 sec., beating ALLIE, time 1 hr., 09 min., 48 sec. and VOLANTE, time 1 hr., 14 min., 19 sec.

In second class for yachts over 18 feet and under 21 feet, seven yachts started. SHEERWATER won in 1 hr., 10 min., 17 sec.; JOKER second, time 1 hr., 11 min., 0 sec., and JANET third, time 1 hr., 11 min., 13 sec.

In third class, yachts under 18 feet, FLORA LEE won in 1 hr., 9 min., 59 sec.; IDLEWILD second, CRICKET third, and SEA MEW fourth.

An Open Race was sailed August 13, 1881. The wind was light at start and fresh at finish.

In first class for sloops and schooners, 38 feet and under 60 feet, FALCON won the \$40 prize over a 16 mile course in 3 hrs., 17 min., 09 sec., beating OSPREY; time, 3 hrs., 28 min., 29 sec. OSPREY, however, received a \$20 prize.

For second class keels, 26 feet and under 38 feet, the course was 12 miles. TRANSIT won the \$30 prize in 1 hr., 55 min., 39 sec., beating ANNIE and FREDDIE. ANNIE received a \$15 prize.

Of centerboards, SHADOW won the \$30 prize in 1 hr., 39 min., 28 sec., beating FOLLY and JUNE. FOLLY received a \$15 prize.

For third class, centerboard 21 feet and less than 26 feet, the



IDLER.—FIGURE 352.

course was 7 miles; five yachts started. MYRIEL won the \$25 prize in 0 hr., 46 min., 22 sec., beating REBE, ALLIE, EXPERT and POSY. REBE received a \$15 prize and ALLIE a \$10 prize.

Of the keels, GEM won the \$25 prize in 0 hr., 50 min., 08 sec.; BANNERET second, \$15 prize; FAIRY, third \$10 prize, and RAVEN fourth.

For fourth class, centerboard, 17 feet and under 21 feet, there were 18 starters over a 7 mile course. JULIA won the \$20 prize in 0 hrs., 48 min., 17 sec., Ims second, \$12 prize; time, 0 hr., 49 min., 55 sec., PERI third, \$7 prize and THISIE fourth.

Of the keels, DELLE, won the \$20 prize, in 0 hrs., 59 min., 55 sec.; CHARLOTTE was second, winning a \$12 prize in 1 hr., 00 min., 43 sec.; FEARLESS third, winning a \$7 prize; BESSIE ADELE fourth, INEY, fifth, RUDY sixth.

In fifth class, centerboard and keels, under 18 feet, ROCKET, won the \$15 prize, with 13 starters, in 0 hrs., 56 min., 51 sec.; FLORA LEE won the second prize of \$10; IDLEWILD third prize of \$7, CRICKET won \$5 and NONPARIELE the only keel, won a \$15 prize in 0 hrs., 59 min., 31 sec.

The First Championship Race was sailed August 27th, with the wind moderate. For first class sloops of 21 feet and over there were three starters, ALLIE, DOLLY and EXPERT, who finished in the order named. ALLIE'S time was 1 hr., 17 min., 54 sec.

In the second class, cat-rigs between 18 and 21 feet, JULIA won in 1 hr., 18 min., 55 sec. JANET was second with CLARA B. third. There were in all eight starters.

The third class was for cat-rigs under 18 feet. Five yachts started. FLORA LEE won in 1 hr., 22 min., 20 sec., followed by SEA MEW, IDLEWILD, CRICKET and ELSIE W.

The Second Championship Race took place September 3rd. There was a very strong easterly breeze. In the first class for sloops, EX-

PERT won in 44 min., 49 sec., with BANNERET second. Then in the order named came TOSPY, ALLIE and DOLLY.

The second class was for cat-rigs, of which there were ten starters. MYRTLE won in 41 min., 58 sec., and SHEERWATER came second with JANET a close third. Ims was dismasted and DAVID withdrew to assist SEA MEW.

In the third class for cat-rigs, FLORA LEE won with six starters, in 44 min., 14 sec.; CRICKET was second, time 51 min., 11 sec, and JULIA was third. SEA MEW was dismasted.

THE SEASON OF 1882.

The First Challenge Pennant Regatta was sailed at Hull, June 21 h. The first class schooners over 38 feet, sailed over a 16 mile course. The start was at 3 P. M. FALCON was the only starter and made the run in 4 hrs., 46 min., 46 sec.

There were no starters in the second class.

The third class was for centerboards from 21 to 26 feet. The course sailed was 7 miles, and the gun was fired at 3:35 P. M. Five yachts started. THISIE won, time 1 hr., 17 min., 3 sec. She was followed by SEA BIRD, ALLIE, DAVID CRICKET and EXPERT.

The starting signal for the fourth class, centerboards and keels between 18 and 21 feet, was fired at 3:40 P. M.; the course was 5½ miles. There were six yachts to start among the centerboards, while CHARLOTTE was the only keel boat. The time of the latter was 1 hr., 31 min., 54 sec. The best time made by the centerboards was that of WILDFIRE, 1 hr., 23 min., 16 sec. GISELA was second and COUSAIR third.

The fourth class, yachts under 18 feet, started at 3:45 P. M. The course was 5½ miles. DANDELION won in 1 hr., 21 min., 22 sec., with CRICKET second, IDLEWILD third and ELLA MAY fourth. There were only four yachts in this class.

During this Regatta there was a dead calm until 4 o'clock when the wind freshened, east to southwest.

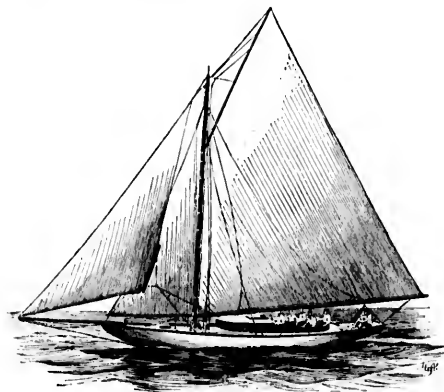

HANSEL.—FIGURE 353.

The race set for July 1st at Hull was postponed, but money was raised by subscription, and a Scrub Race was sailed. The start was at 3:38 P. M. The wind was east and a hard storm was raging. Seven yachts started and AMY won, receiving a prize of \$10; GISELA was second and she won a prize of \$5. The total result was as follows: AMY first, 41 min., 44 sec.; GISELA second, 42 min., 48 sec.; then, as named, followed JANET, COUSAIR, MYRTLE, CRICKET and JOKER.

The First Club Regatta—postponed from July 1st—was held July 8th. The wind was southwest. The first class was for schooners over 38 feet; no starters.

Special Class, schooners between 26 and 38 feet. Course 12 miles,

the start being at 2 P. M. The starters were VANITAS and ENIGMA. The former won, her time being 2 hrs., 10 min., 59 sec.

The second class was for sloops 26 to 38 feet. Course, 12 miles; the start was at 2 P. M. There were seven entries and five starters. The winner was LILLIE, time 1 hr., 37 min., 28 sec. HERA was second, 1 hr., 39 min., 17 sec.

The third class was for sloops 21 to 26 feet. Out of seven entries there were only three starters: SEA BIRD, ALLIE and GLADYS. The course was 7 miles and the start was at 3 P. M. The yachts finish in the following order: SEA BIRD, 1 hr., 2 min., 33 sec.; ALLIE and GLADYS.

Fourth class, cuts 21 to 26 feet. Seven miles; start at 3 P. M. Three entries and two starters. AMY won, time 1 hr., 3 min., 29 sec.; THIRSE second.

In the fifth class for cuts from 18 to 21 feet—course 5½ miles, start at 3:05 P. M.—there were twelve entries and nine starters. The winning boat was NIOBE, time 56 min., 21 sec. IUS was second, 57 min., 52 sec.; JANET was third and GISELA fourth.

The sixth class was for cuts under 18 feet. The distance to be sailed was 5½ miles and the start was at 3:05 P. M. Out of eight entries only three yachts started. CRICKET won, time 1 hr., 8 min., 57 sec., followed by ZIP and IDLEWILD.

A regatta was sailed on July 22nd. Wind west.

Second class for sloops 26 to 38 feet. Distance 12 miles. Three yachts started. HERA won, time 3 hrs., 18 min., 35 sec.; LOTTIE second and MERMAID third.

Third class for sloops 21 to 26 feet sailed over a course of 7 miles. There were three starters in this class. The winner was ALLIE, time 1 hr., 47 min., 42 sec. SEA BIRD was second and EXPERT third.

Fourth class, cuts 21 to 26 feet. Distance 7 miles. AMY won, time 1 hr., 50 min., 41 sec., with CLIO, the only other starter, second.

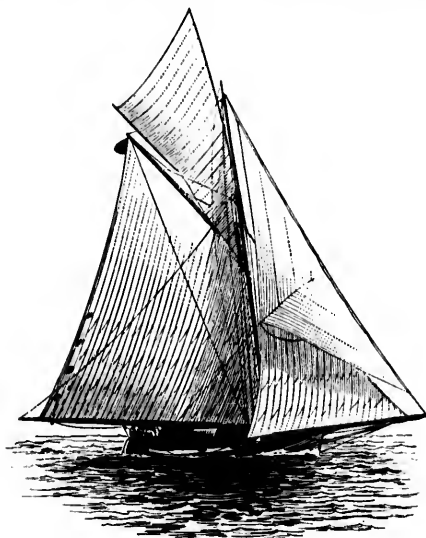

POSY.—FIGURE 354.

The fifth class, cuts 18 to 21 feet, sailed 6 miles. Ten yachts started, JOKER winning in 1 hr., 31 min., 17 sec. MYRTLE was second, 1 hr., 33 min., 1 sec., NIOBE third and JANET fourth.

The sixth class was for cuts under 18 feet. The course was 6 miles and five boats competed. The winner was DANDELION, time 1 hr., 37 min., 12 sec. IDLEWILD came second and ZIP third. Ow-

ing to numerous protests, the contest of the fifth class was declared no race.

The Second Challenge Pennant Race was sailed July 25th. The distance for both classes was 5½ miles. The challenge was sent by the owners of the yachts JOKER and IDLEWILD.



CHAPOQUOIT.—FIGURE 355.

In the fourth class there were eight starters. GISELA won, time 52 min., 21 sec., thereby winning the pennant from WILDFIRE. JOKER was second, NIOBE third and WILDFIRE fourth.

There were only two starters in the fifth class—cuts under 18 feet—DANDELION and IDLEWILD; the former won in 52 minutes, defeating her challenger.

The Sail Off for the fifth class, postponed from July 22nd, took place on August 3d. Six yachts started on the 6 mile run and JANET won in 1 hr., 36 min., 38 sec., followed by WILDFIRE and IUS. The start was at 3:25 P. M. and the wind was light and easterly.

A Sweepstakes Regatta was held August 5th. The wind was light and southwest. There were no entries in the first class.

HERA was the only starter in the second class and her time was not taken. The course was 12 miles.

The third class, sloops 21 to 26 feet, sailed 7 miles. The entry fee was \$5. SEA BIRD won in 1 hr., 57 min., 22 sec. There were only two starters.

Fourth class, entry fee \$3, distance 7 miles. Six yachts started in this class and WAVE CHEST won in 2 hrs., 50 sec. IUS was second, 2 hrs., 4 min., 31 sec., and AMY third.

The fifth class was for cuts 18 to 20 feet. The entry fee was \$3 and the course 6 miles. The four competitors came home as follows: JANET, time 1 hr., 30 min., 21 sec.; DUCIN, 1 hr., 34 min., 30 sec.; WILDFIRE and CORSAIR.

Sixth class: Entry fee \$2 distance 6 miles, was for cuts under 18 feet. Three boats started. SEA MEW won in 1 hr., 32 min., 34 sec.; IDLEWILD followed with GRETCHEN third.

The third Club Regatta was sailed August 12th. The wind was southwest and fresh.

There were no entries in the first class.

Second class, distance 12 miles, no entries. LILLIE won, time 1 hr., 16 min., 7 sec., HERA second.

Third class, 7 miles. SEA BIRD won, time 32 min., 55 sec.; ALLIE second. Two starters.

Fourth class, 7 miles, six starters. Won by JOKER, time 54 min., 49 sec.; GISELA second, 55 min., 30 sec.; NIOBE third.

There were four starters in the fifth class for the run of 6 miles. CONSAIR won, 59 min., 55 sec., followed by MYRTLE, JANET and WILDFIRE.

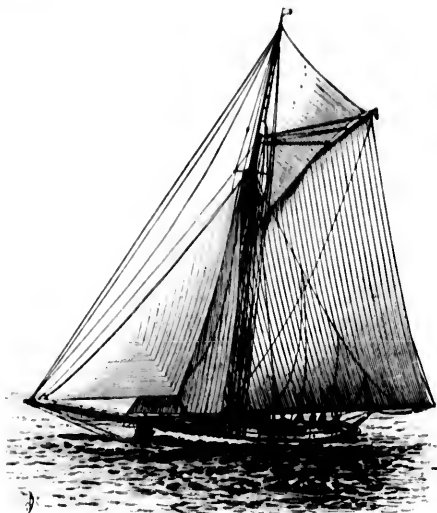

MISCHIEF.—FIGURE 355.

Sixth class, distance 6 miles, five contestants. IDLEWILD was winner in this class with CRICKET second. Winner's time, 1 hr., 3 min., 55 sec.

An Open Regatta was held August 19th. The wind was very light, north northwest.

There were no starters in the first class for schooners or sloops.

Second class, schooners 26 to 38 feet. Distance 12 miles. BESSIE and WHITE CLOUD started, the former winning in 2 hrs., 56 min., 44 sec.

Among the centerboard sloops of the same class there were five starters, NIMBUS winning in 2 hrs., 48 min., 8 sec., with MAGIC second and SHADOW third.

Ten yachts started in the keel sloops. The winner was LILLIE, time 2 hrs., 33 min., 39 sec.; HERA was second, LINA third and ZULY fourth.

Third class, centerboards 21 to 26 feet; 7 mile course. Nine boats started and SEA BIRD won in 1 hr., 16 min., 6 sec.; EXPERT was next, 1 hr., 16 min., 42 sec.; VENTS was third and ALLIE fourth.

Eleven keel yachts of the same class started, VOLANTE winning in 1 hr., 31 min., 40 sec. She was followed by RAVEN, BANNERET, JUDITH, etc., as named.

Fourth class, centerboards. There were twenty-two starters in this class. The winner was JOKER, time, 1 hr., 16 min., 14 sec.; AMY was second, 1 hr., 19 min., 58 sec.; WILDFIRE third, 1 hr., 20 min., 6 sec.; and WAVE CREST fourth, in 1 hr., 20 min., 31 sec.

Nine keel yachts also started in this class. NONPAREIL winning in 1 hr., 28 min., 38 sec., followed by CHARLOTTE, LIZZIE and VESPER, as named.

In the fifth class, centerboards, six boats started, FLORA LEE finish-

ing first, time 1 hr., 17 min., 48 sec.; DANDELION was second and GHETCHEN third. The course was 6 miles.

The Third Challenge Pennant Race took place August 24th. No competitors in the second and third classes. GEM and FAIRY won.

Fourth class; there were three starters, the distance being 5½ miles. MYRTLE won, with JOKER second, CONSAIR, who was third, was ruled out for not sailing with a Corinthian crew. The winner's time was 1 hr., 15 min., 53 sec.

CHAMPIONSHIP RACES FOR 1882.

First race sailed September 2d. There being only one starter in the second class, the race was declared off.

Third class, 7 miles, centerboard sloops 21 to 26 feet. Two starters. ALLIE won; time, 1 hr., 5 min., 16 sec., with DAVID CROCKETT second.

The fourth class was for cuts, 20 to 26 feet, to run the same distance as the previous class. Five starters; AMY winning in 1 hr., 12 min., 1 sec., followed by INIS and JOKER.

Fifth class, for cuts 18 to 20 feet; 6 mile course. Six starters; CONSAIR winning in 59 min., 11 sec.; Janet second, 1 hr., 1 min., 1 sec., and MYRTLE third.

Seven yachts started in the sixth class, cuts under 18 feet. SEA MEW was first in 1 hr., 5 min., 8 sec.; IDLEWILD second, 1 hr., 5 min., 31 sec., and DANDELION third.

Second Race September 9th:

Third class, ALLIE again defeated DAVID CROCKETT; time, 3 hrs., 7 min., 51 sec.

Fourth class, cuts 20 to 26 feet. Five contestants; won by AMY in 1 hr., 56 min., 48 sec., with INIS second and WAVE CREST third.

Seven boats started in the fifth class, cuts 18 to 20 feet. WILDFIRE was the winner; time, 1 hr., 38 min., 14 sec.; Janet second, SHEEHWATER third, and WATERWITCH fourth.

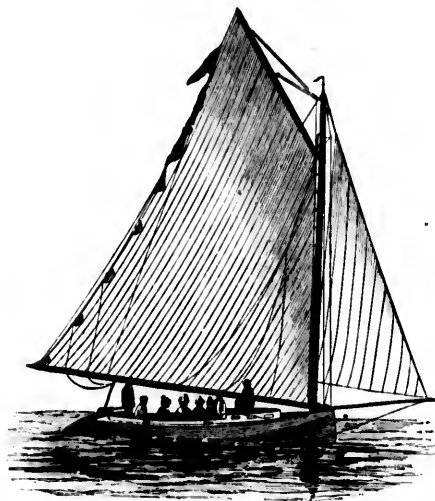

SECRET.—FIGURE 356.

Sixth class, four starters. Won by SEA MEW, 1 hr., 35 min., 34 sec., GHETCHEN second.

During these races the wind was quite fresh; northeast east.

Sail off between WILDFIRE and CONSAIR, of the fifth class, was held September 11th. WILDFIRE won in 59 min., 38 sec.

was second and

August 24th. No
and FAIRY won.
since being 54
who was third.
The winner's

one starter in

0 feet. Two
, with DAVID

the same dis-
tance in 1 hr.,

Six starters;
hr., 1 min., 1

8 feet. SEA
second. 1 hr., 5

time, 3 hrs.,

won by AMY
QUEST third.
feet. WILD-
JANET second,



35 min., 34

east.
mass, was held

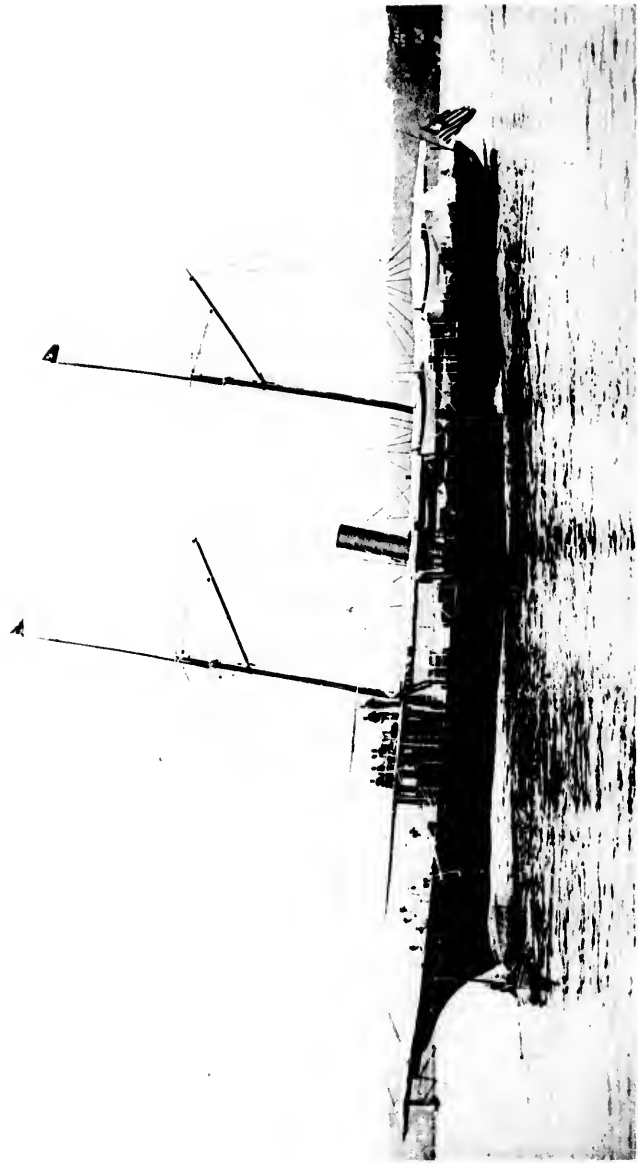

FROM A PHOTO BY STEBBINS.

PLATE XXXVII

RADHA.

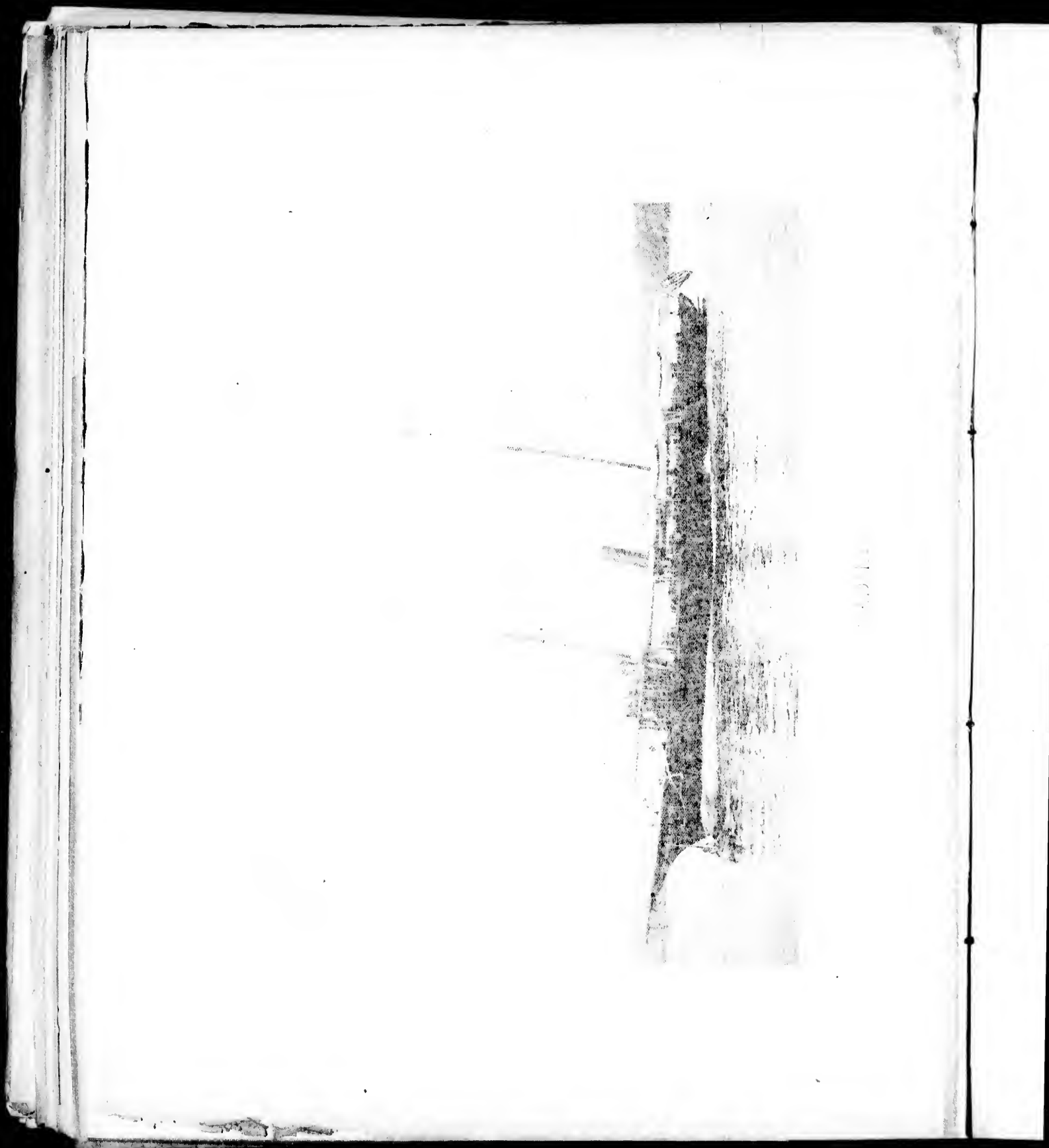

THE SEASON OF 1883.

Champion Pennant Regatta, June 23d. Wind moderate, east by south.

No starters in first class.

Second class, centerboard sloops, 26 to 38 feet. Two starters. *SHADOW*, owned by J. Bryant, won.

Second class, keel sloops 26 to 38 feet. Only one starter; *ALTAIRE*, J. H. Sherburne, owner, won pennant.

Special class, schooners 26 to 38 feet. *VANITAS*, owned by H. Hutchinson, the only starter, won pennant.

Third class, centerboard sloops 21 to 26 feet. Two starters; *SEA BIRD*, owned by G. S. Forbush, winner of pennant.

Third class, keel sloops of same measurement. No starters.

Fourth class, cut-boats 21 to 26 feet. One starter; *QUEEN MAR*, owned by W. S. Phinney, won pennant.

Fifth class, cuts 18 to 21 feet. Seven starters; *JOKER*, owned by Geo. Coffin, winner.

Sixth class, cuts under 18 feet. One starter, *DANDELION*, owned by C. F. Adams, won pennant.

First Regular Regatta, July 7th. Wind strong from the westward.

There were no starters in the first and special classes.

Second class, centerboards. Two starters; *MAGIC* won.

Second class, keels. Two starters; *TRANSIT* won.

There were no entries for the third class.

Fourth class, cut-boats 20 to 26 feet. Six starters; *QUEEN MAR* won the first prize, *AMY* the second and *GISELA* the third.

In the 5th class, cuts 18 to 20 feet, there were four starters. *MYRTLE* won the first regular and first Corinthian prize; *CON-*

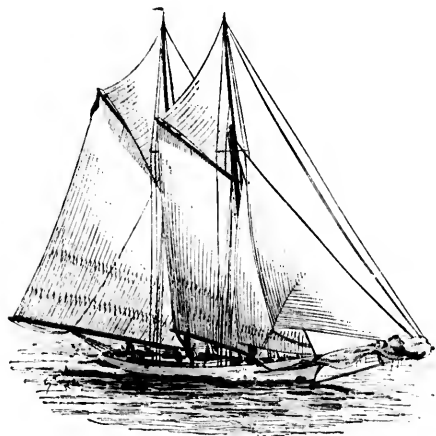

TRUOBADOUR.—FIGURE 358.

SAIR won the second regular and second Corinthian prize, while *WILDFIRE* won the third regular prize.

There were three starters in the sixth class. *SAMARIA* won the first regular and Corinthian prizes, and *ZIP* the second regular and Corinthian prizes.

Second Regular Regatta held July 21st. Wind southeast, very light and variable; dead calm at times.

First class, no entries.

Second class, two starters. *MAGIC* won regular prize.

Third class no entries.

Fourth class, cut-boats 20 to 26 feet. Eight starters; *QUEEN MAR* won first regular prize, *IMS* won second regular prize, *NIOBE* won third regular and first Corinthian prizes, and *GISELA* won the second Corinthian prize.

In the fifth class there were six starters. *WILDFIRE* won the first regular and first Corinthian prizes, *SHEERWATER* won the second regular prize, and *SPRAY* the third regular.

Sixth class, for cuts under 18 feet. There were three starters. The first regular and Corinthian prizes were won by *ZIP*, while *SAMARIA* won the second regular and Corinthian prizes.

First Championship Regatta sailed August 4th. Wind was blowing fresh from the west.

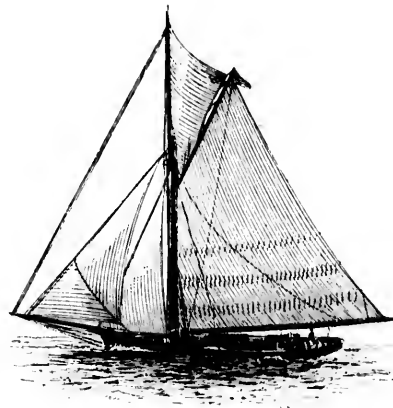

MYSTERY.—FIGURE 359.

First class, no entries.

Second class, keel sloops; two starters. *GEM* won.

Second class, centerboard sloops. Two starters; won by *NIMBUS*. Special and third classes, no entries.

There were seven starters in the fourth class, cuts 20 to 26 feet. *QUEEN MAR* was the winner.

Fifth class, five starters. Won by *MYRTLE*.

Only two boats started in the sixth class. *DANDELION* won.

The Third Regular Regatta was held on August 11th with the wind very strong from the west.

First Class, no entries.

There were two contestants in the second class, centerboard sloops; *NIMBUS* won.

TRANSIT started in the class for keel sloops, but owing to an accident did not finish.

No entries in the special and third classes.

In the fourth class there were five competitors. *NIOBE* won the first regular prize, *GISELA* won the second regular prize, *AMY* won the third regular prize and *JOKER* won the first Corinthian prize.

Six boats started in the fifth class. *KISMET* won the first regular and Corinthian prizes, *WILDFIRE* the second prizes, regular and Corinthian, and *SPRAY* secured the third regular prize.

Sixth class. Four cuts started. *DANDELION* won the first regular and Corinthian prizes, *SAMARIA* the second prizes, and *DINO* the third regular prize.

Open Regatta, August 25th.

Four starters in the first class. *MAGGIE* won prize of \$100.

Second class, centerboard sloops 26 to 38 feet. Seven yachts

started. SHADOW won \$60, MABEL won \$30 and MAGIC won \$20.

Second class, keel sloops. The race was won by HERA, who received \$60, LILLIE, second, \$30; VIKING, third, \$20.

Second class, schooners. Of the three contestants VANITAS was the winner securing a prize of \$50.

Third class, centerboards. Twelve sloops started, the winner being QUEEN MAH, prize of \$50; SEA BIRD was second, \$35; AMY third, \$25; and VENUS fourth, \$15.

Third class, keels. Ten starters; TRANSIT won \$50, GEM won \$35, KITTY \$25 and JUDITH \$15.

Fourth class, centerboards. Fourteen starters; the winners were IRENE, prize \$40, NIOBE \$30, FANCY \$20, SERAPHINE \$10 and MYRTLE \$5.

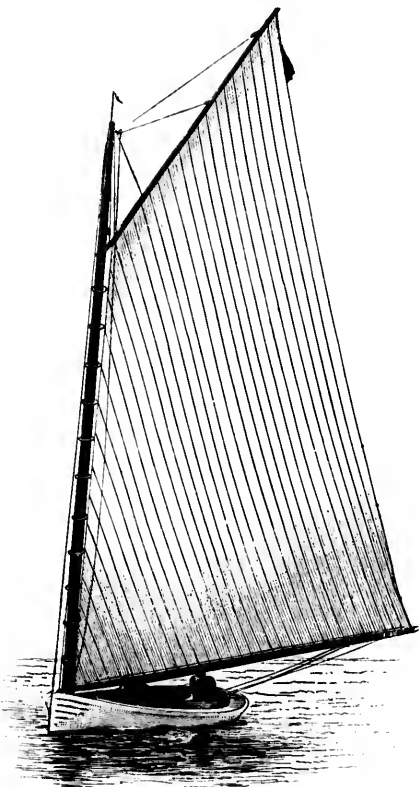

MABEL.—FIGURE 360.

Fourth class, keels. Five contestants. NONPARIEL won \$40, CHARLOTTE won \$30 and DELLE \$20.

Fifth class, thirteen starters. Prizes were awarded as follows: FLORA LEE \$35, SCAMP \$25, SPIDER \$15 and DANDELION \$10. Second Championship Regatta, September 1st.

Second class, centerboards. MABEL, the only starter, won a leg.

Second class, keels. TRANSIT, only starter, won a leg.

Third class. SEA BIRD, the only starter, won a leg.

Fourth class, five starters; QUEEN MAH won second leg and cup.

Fifth class. Six starters; CONSAIR won a leg.

Sixth class. Two starters; DANDELION won second leg and cup.

Third Championship Regatta, September 8th.

Second class, centerboards. Two starters; NIMBUS won championship prize.

Second class, keels. Three starters; LILLIE won a leg.

Third class. SEA BIRD, the only starter, won championship prize.

Fifth class. Seven starters; CONSAIR won championship prize.

Championship Sail Off, September 22nd.

Second class, keels. Three starters; LILLIE won championship prize.

THE SEASON OF 1884.

Championship Pennant Regatta was sailed June 21st. Wind, west.

Second class, keels. Two starters; TRANSIT won championship pennant.

Third class, centerboards. SEA BIRD, the only starter, won championship pennant.

Third class, keels. KITTY, the only starter, won pennant.

Fourth class, centerboards. Two starters; JOKER won championship pennant.

Fifth class, centerboards. Six starters; IMOGEN won championship pennant.

Sixth class, centerboards. MIRAGE, the only starter, won championship pennant.

Club Regatta, July 12th.

First class, centerboards over 30 feet. One starter, NIMBUS, won prize of \$25.

Second class, keels 25 to 30 feet. Four starters, TRANSIT won \$20, BANNERET won \$15.

Third class, centerboard sloops 21 to 25 feet. Three starters; SEA BIRD won \$15; DAVID CROCKETT won \$10.

Fourth class. Five starters; QUEEN MAH won \$13, AMY won \$10 and NIOBE won \$5.

Fifth class. Eight starters; VIVA won \$15, SHEERWATER won \$10, and SPRAY won \$5.

First Championship Regatta, August 2nd.

First class, keels. Two starters; LILLIE won leg in championship.

No other boats returned within the time limit. Races postponed to August 6th.

First Championship Regatta, August 6th. Wind, south-west, and light.

Second class, keels. BANNERET, the only starter, won a leg and first cash prize.

Second class, centerboards. RAMBLER, the only starter, won a leg.

Fourth class, cuts. Five starters; QUEEN MAH won a leg and first cash prize. JOKER won second cash prize and NIOBE third.

Fifth class, cut-bouts. Eight starters; SPRAY won a leg and first cash prize; VIVA won second and MYRTLE won third.

Sixth class. Four starters; MIRAGE won first regular prize and first Corinthian prize.

Annual Open Regatta, August 16th.

Second class, keels 30 to 38 feet. Three starters; HERA won \$35 and ELLA MAY won \$25.

Second class, centerboards. Three starters; MAGIC won \$35 and SHADOW won \$25.

Second class, schooners. Two starters; BESSIE won \$25.

Third class, keels. Three starters; TRANSIT won \$25, RAVEN won \$15 and ECHO won \$10.

Third class, centerboards. Five starters; SEA BIRD won \$25, FROLIC won \$15 and MOLLY won \$10.

Fourth class, keels. Seven starters; BANNERET won \$20, KITTY won \$10 and SARACEN won \$5.

Fourth class, centerboards. Thirteen starters; BLACK CLOUD won \$20, CRUISER won \$15 and QUEEN MAH won \$10.

Fifth class, less than 20 feet. Twenty-five starters; MABEL won \$15, VIVA \$10 and FLORA LEE \$5.

Second Championship Regatta, August 23d. Wind southwest, moderate.

First class, 30 feet and over. Three starters; SHADOW won a leg.
Second class, keels, 25 to 30 feet. Three starters; BANNERET won second leg and championship.

Third class, centerboards, 21 and 25 feet. The only starter, SEA BIRD, won a leg.

Third class, keels, 21 to 25 feet. Three starters; KITTY won a leg in championship.

Fourth class, centerboards. Four starters; QUEEN MAB won second leg in championship.

Fifth class, 18 to 21 feet. Seven starters; KISMET won a leg.

Sixth class, under 18 feet. Three starters; ELSIE won a leg in championship.

Championship Sail Off, September 6th:

First class. Three starters; SHADOW won second leg, first prize and championship.

Second class, centerboards. RAMBLER, the only starter, won second leg and championship.

Second class, keels. Two starters; TRANSIT won first leg in championship.

Third class, centerboards. Two starters; SEA BIRD won second leg, first prize and championship.

Third class, keels. KITTY, only starter, won second leg and championship.

Fifth class, centerboards. Eight starters; VIVA won first leg in championship, and first prize. WILDFIRE won second prize and HORNET third.

Sixth class, five starters. MIRAGE won second leg and championship.

Sail Off, Championship Series, September 13th:

Second class keels. Two starters; TRANSIT won second leg and championship.

Fifth class, centerboards. Three starters; VIVA won second leg and championship.

THE SEASON OF 1885.

Pennant Race, June 20th: Wind southeast and southwest.

Second class, keels. Three starters; BANNERET won pennant.

Third class, centerboards. MIRIEL, only starter, won pennant.

Third class, keels. Three starters; KITTY won pennant.

Fourth class. THRASHER, the only starter, won pennant.

Fifth class. Three starters; SPRAY won pennant.

Forty-ninth Club Race, July 18: Wind light, northwest.

Third class, centerboards. Three starters; QUEEN MAB won first prize.

Third class, keels. Three starters; KITTY won first prize.

Fourth class. Four starters; NIOBE won first prize and AMY second.

Fifth class. Seven starters; EMM ELL EYE won first prize and WILDFIRE second.

Sixth class. Two starters; MIRAGE won first prize.

The other boats did not return within the time limit. The re-sail was postponed to July 27th.

Re-sail, Forty-ninth Club Race, July 27th: Wind fair, southeast.

First class, keels. One starter; HERA won half of first prize, \$12.50.

Second class, centerboards. Two starters; ATALANTA won first prize, \$20.

Second class, keels. Four starters; BANNERET won first prize and LIZZIE F. DALY second.

First Championship Race, August 1st: Wind southeast.

First class, keels, 30 feet and over. HERA, the only starter, won first prize.

First class, centerboards. SIREN, the only starter, won first prize.
Second class, keels, 25 feet to 30 feet. Three starters; BANNERET won first prize.

Second class, centerboards. Two starters; ATALANTA won first prize.

Third class, keels, 22 to 25 feet. Two starters; THELGA won first prize.

Third class, centerboards. Three starters; QUEEN MAB won first prize.

Fourth class, centerboards 20 to 22 feet. Seven starters; JOKER won first prize.

Fifth class, 18 to 20 feet. Five starters; EMM ELL EYE won first prize.

Sixth class, under 18 feet. Two starters; ELSIE won first prize.

Open Regatta, August 15th: Wind east southeast, fairly strong.

First class, centerboards 31 to 40 feet. Three starters; MAGIC won \$50 and VIOLET \$25.

First class, keels. Three starters; HERA won \$50 and MAUD \$25.

Second class centerboards 21 to 31 feet. Six starters; EVA won \$40, ATALANTA won \$20.

Second class keels. Five starters; BANNERET won \$40 and CARMEN \$20.

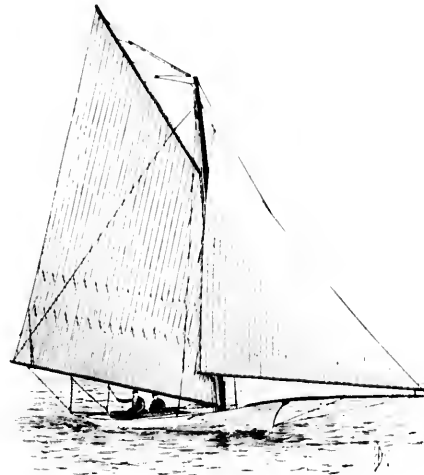

ETREKA.—FIGURE 361.

Third class, centerboards, 21 to 24 feet. Six starters; QUEEN MAB won \$35, EXPERT \$20, SEA BIRD \$15 and ALDA \$10.

Third class, keels. Six starters; KITTY won \$35, THELGA \$20, WITCH \$15 and STRANGER \$10.

Fourth class, centerboards, 19 to 21 feet. Twenty starters; EMM ELL EYE won \$30, NETTLE \$20, TARTAR \$15 and NIOBE \$10.

Fifth class, centerboards, under 19 feet. Fourteen starters; WILDFIRE won \$30, HORNET \$20, FLORA LEE \$15, KISMET \$10 and JESSIE \$5.

Ladies' Race, August 26th: Wind double reef, westerly.

Second class, centerboards, 25 to 30 feet. ATALANTA, the only starter, won prize.

Second class, keels. BANNERET, the only starter, won prize.

Third class, centerboards, 22 to 25 feet. QUEEN MAB, the only starter, won prize.

Third class, keels. Two starters; KITTY won.
Fourth class, 20 to 22 feet. Seven starters; NIOBE won prize.
Fifth class, 18 to 20 feet. Eight starters; EMM ELL EYE won.

Sixth class, under 18 feet. *MIRAGE*, the only starter, was the prize winner.

The prizes were a silver medal for each lady on the winning boat.
Second Championship Race, September 5th.

The race was started at 4:30 P. M. The wind was very light, and at five o'clock the judges called the race off on account of insufficient wind. The re-sail was appointed for September 14th.

Re-sail Second Championship Race, September 14th.

Second class, centerboards, 25 to 30 feet. Two starters; *ATALANTA* won cash prize of \$15 and the championship.

Second class, keels. Two starters; *LIZZIE F. DALY* won first leg and prize of \$15.

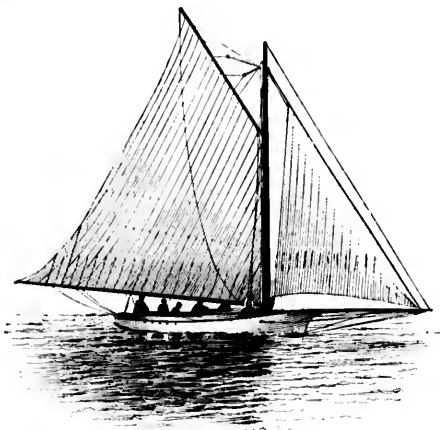

FOLLY.—FIGURE 302.

Third class, centerboards 22 to 25 feet. Three starters; *QUEEN MAU* won prize of \$12 and championship.

Third class, keels. Three starters; *KITTY* won first leg and cash prize of \$12.

Fourth class, 20 to 22 feet. Three starters; *AMY* won first leg and cash prize of \$10.

Fifth class, 18 to 20 feet. Six starters; *EMM ELL EYE* won prize of \$10 and championship.

Sixth class, under 18 feet. Two starters; *MIRAGE* won prize of \$10 and first leg in championship.

Championship Sail Off, September 19th. Wind strong, from the southwest.

First class, keels over 30 feet. *HERA*, the only starter, won championship.

Second class, keels 25 to 30 feet. Two starters; *BANNERET* won championship.

Third class, keels 22 to 25 feet. Two starters; *KITTY* won championship.

Fourth class, 20 to 22 feet. Two starters; *AMY* won championship.

Sixth class, *ELSIE*, the only starter, won championship.

THE SEASON OF 1886.

Pennant Race (sailed under Corinthian rules) June 19th. Wind, southeast, fair.

First class, centerboards over 30 feet. *NIMBUS*, the only starter, won pennant.

Second class, centerboards 25 to 30 feet. *ATALANTA*, the only starter, won pennant.

Third class, centerboards 22 to 25 feet. Two starters; *SEA BIRD* won pennant.

Fourth class, centerboards 19 to 22 feet. Four starters; *TUISIE* won pennant.

Fourth class, keels. One starter; *ZETTA* won pennant.

Fifth class, under 19 feet. *ROCKET* won pennant.

Fifty-Sixth Club Race, July 3d. Wind, southeast, light:

First class. Two starters; *MAUD* won first prize.

Second class, centerboards; *ATALANTA*, the only starter, won half of first prize.

Second class, keels. Three starters; *LIZZIE F. DALY* won first prize; *ECHO* won second prize.

Third class, centerboards. One starter; *SEA BIRD* won half the first prize.

Fourth class, keels. *ZETTA*, the only starter.

Fourth class centerboards. Ten starters; *TABBAR* won first prize, *TUISIE* won second prize.

Fifth class. Four starters; *ROCKET* won first prize, *WILDFIRE* won second prize.

First Championship Race, July 17th. Wind, southeast, light:

First class, keels. Two starters; *CARMEN* won first prize and leg.

First class, centerboards. *NIMBUS*, the only starter, won half the first prize and championship leg.

Second class, keels. Two starters; *LIZZIE F. DALY* won prize and leg.



EXILE.—FIGURE 303.

Second class, centerboards. Two starters; *RAMBLER* won prize and leg.

Third class, keels. One starter; *KITTY* won half the first prize and one leg.

Third class, centerboards. Three starters; *POSY* won prize and leg.

Fourth class, keels. Only one starter; *ZETTA*.

Fourth class, centerboards. Six starters; *TOM CAT* won prize and leg.

Fifth class. Five starters; *WILDFIRE* won prize and leg.

Open Regatta, August 14th. Wind, southwest, heavy at start:

First class. Six entries. Two starters; *SHADOW* won \$50.

ra, the only

; SEA BIRD

ers; THURSDAY

starter, won

Y won first

ron half the

n first prize,

, WILDFIRE

light:

rize and leg.

ron half the

Y won prize



k won prize

e first prize

on prize and

ron prize and

leg.

at start:

n \$50.

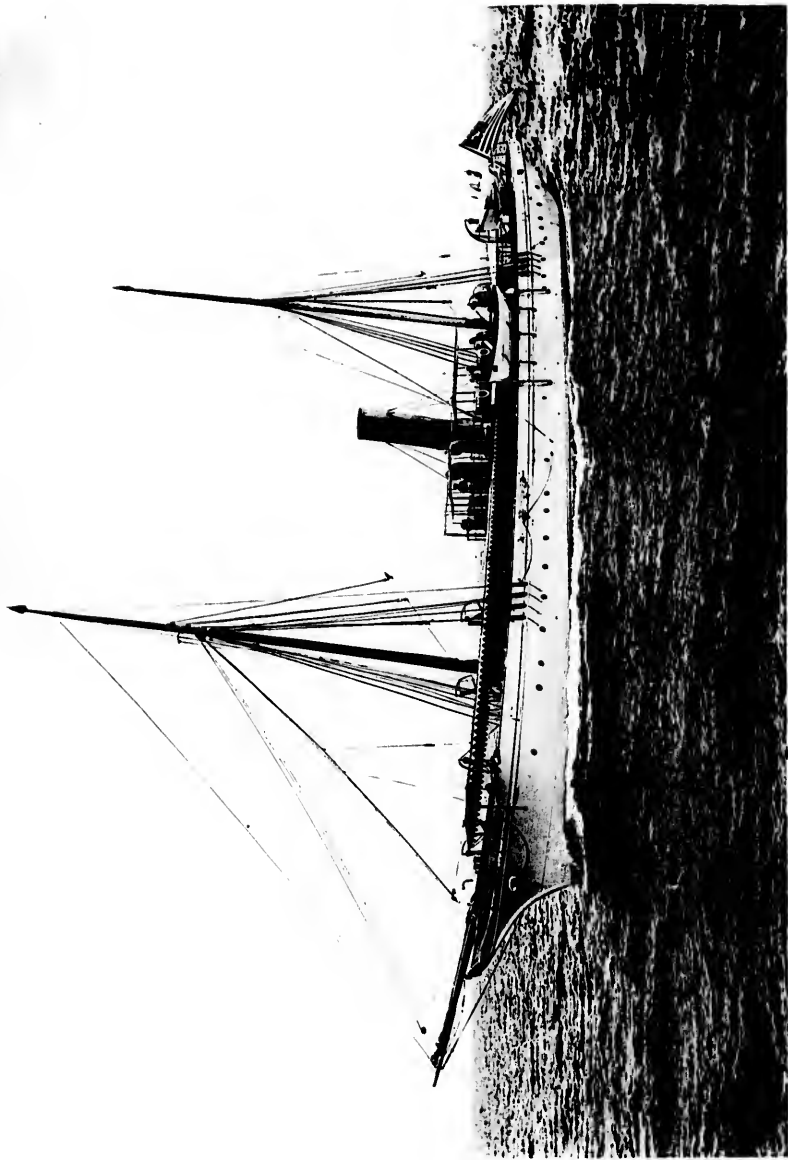

FROM A NEGATIVE BY STEBBINS

PLATE XXXVIII

CONQUEROR.

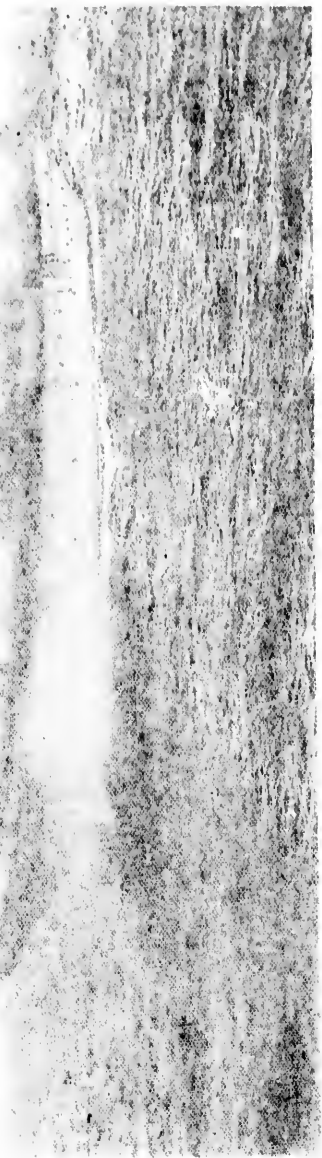

Second class, centerboards. Three starters; EVA won \$40, FOLLY won \$20.

Second class, keels. Four starters; IONE won \$40 and ECHO \$20. There were seven boats entered which did not start.

Third class, centerboards. Ten starters; POSY won \$35, NORA won \$20, LOUBETTE won \$15, TYRANT won \$10. In this class there were four boats entered which did not start.

Third class, keels. Nine entries, seven starters; KITTY won \$35, VOLANTE won \$20, CARMITA won \$15, FEARLESS won \$10.

Fourth class, nineteen entries, ten starters; TOM CAT won \$30, EMM ELL EYE won \$20, TARTAR won \$15, CRUSADER won \$10.

Fifth class, twenty-three entries and eight starters; WILDFIRE won \$30, ZOE won \$20, FLORA LEE won \$15, LARK won \$10, MISCHIEF won \$0.

Ladies Race, August 25th. Wind, northeast, strong.

First class. HERA, the only starter, won three Ladies' prizes.

Second class. Two starters; ECHO won four prizes.

Third class. One starter; M'GWIMP. This yacht won no prizes, as she had no ladies on board as required.

Fourth class. One starter; EMM ELL EYE won three prizes.

Fifth class. One starter; JOSEPHINE won two prizes.

Second Championship Race, August 28th.

First class, keels. CARMEN, the only starter, won half of prize and championship.

First class, centerboards. Two starters; NIMBUS won cash prize and championship.

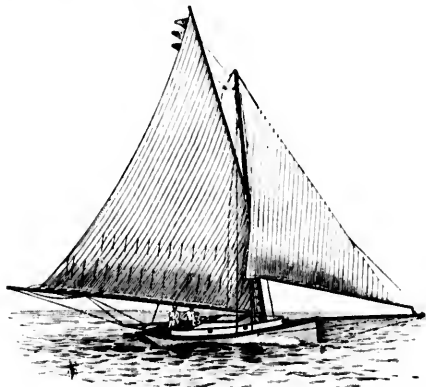

USTANE.—FIGURE 304.

Second class, keels. Two starters; ECHO won prize and leg.

Second class, centerboards. Three starters; FOLLY won prize and leg.

Third class, centerboards. Three starters; NORA won prize and leg.

Fourth class, centerboards. Three starters; TOM CAT won prize and championship.

Fifth class. Three starters; VICTOR won cash prize and leg.

Championship Sail Off, September 11th; wind west, light and steady.

Second class, keels. Two starters; LIZZIE F. DALY won championship.

Second class, centerboards. Two starters; RAMBLER won championship.

Third class, keels. One starter; KITTY won championship.

Third class, centerboards. Two starters; POSY won championship.

Fifth class. Two starters; VICTOR won championship.

THE SEASON OF 1887.

Pennant Regatta, June 18th.

Second class, centerboards. Pennant winner, ATALANTA, the only starter.

Second class, keels. Three starters; LIZZIE F. DALY won pennant.

Third class, centerboards. Six starters; MABEL won pennant.

Third class, keels. ZETTA, the only starter, won the pennant.

Fourth class. Two starters; ROCKET won the pennant.

Club Regatta July 2d.

Second class, centerboards. Three starters; ATALANTA won \$20, POSY won \$10.

Second class, keels. Five starters; KITTY won \$20, ECHO won \$10.

Third class, centerboards. Eight starters; COYOTE won \$15, MABEL won \$10.

Fourth class. Two starters; VICTOR won \$12, ROCKET won \$6.

First Championship Race, July 16th. Wind, southwest.

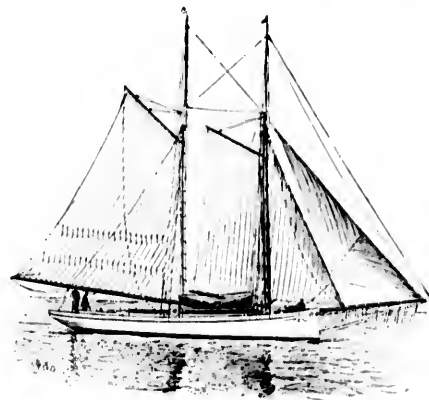

BOHEMIAS.—FIGURE 305.

First class, keels. BREEZE, the only starter, won one leg.

Second class, centerboards. Six starters; POSY won first leg, and ATALANTA won prize of \$10.

Second class, keels. Two starters; THIELGA won first leg.

Third class, centerboards. Eight starters; COYOTE won first leg, and MABEL won prize of \$10.

Third class, keels. Two starters; ZETTA won first leg.

Fourth class. Ten starters; VICTOR won a leg and ZOE won \$10.

Second Championship Race, August 6th, postponed from July 30th. Wind southwest, changing to southeast.

Second class, centerboards. Four starters; POSY won championship.

Second class, keels. Three starters; BANNERET won a leg.

Third class. EMM ELL EYE won a leg.

Open Regatta, August 27th, postponed from August 13th.

First class, centerboards. Three starters; SHADOW won \$10, RAMONA won \$20.

First class, keels. AGLAIA, the only starter, won \$10.

Second class, centerboards. Seven starters; ATALANTA won \$30, EVA won \$20, SYRINGE won \$10.

Second class, keels. Nine starters; ECHO won \$30, IONE won \$20, PRINCE KARL won \$10.

Third class, centerboards. Ten starters; BLACK CLOUD won \$25, EXPERT won \$20, POSY won \$15, SECRET won \$10, SEA BIRD won \$5.

Third class, keels. Seven starters; WITCH won \$25, KITTY won \$20, THIELGA won \$15, HALCYON won \$10, CARMITA won \$5.

Fourth class, cut-rigs. Nine starters; TARTAR won \$25, MABEL won \$20, SCAMP won \$15, NIODE won \$10.

Fifth class, cut-rigs under 18 feet. Five starters; WILDFIRE won \$25, FLORA LEE won \$20, MIRAGE won \$15, MAMIE won \$10.

Sixth class, jib and mainsail under 21 feet. Eight starters; EMM ELL EYE won \$25, COYOTE won \$20, WHITE WINGS won \$15, ZOE won \$10. The wind was brisk at start, but died almost to a calm at finish.

Championship Sail Off, September 10th:

Second class, keels. BANNERET, the only starter, won championship.

Third class, centerboards. One starter, EMM ELL EYE, who won the championship.

Fourth class, under 19 feet. Two starters; VICTOR won second leg and championship. ZOE won \$10 prize.

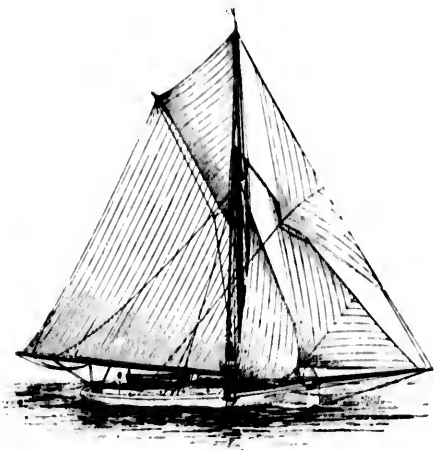

NOMAD.—FIGURE 366.

THE SEASON OF 1888.

Pennant Race, June 23d: Wind west; good breeze.

Fourth class, centerboards, 19 to 22 feet, and all keels under 22 feet. Three starters; MABEL won the pennant.

Sixth class, centerboards under 19 feet. Two starters; ROCKET won pennant.

First Championship Race, July 14th. Brisk, southerly breeze.

Third class, centerboards. Three starters; POSY won a leg.

Third class, keels. THELGA, the only starter, won a leg.

Fourth class, centerboards. Five starters; MABEL won a leg.

Fourth class, keels. One starter; VAQA won first leg.

Fifth class, jib and mainsails under 22 feet. Three starters; EMM ELL EYE won a leg.

Sixth class, centerboards under 19 feet. Three starters; ROCKET won first leg.

Sixty-ninth Regatta, July 28th:

First class, 30 feet and over. Three starters in centerboard class, only one in keel class, AGLAIA. The latter had her mast carried away, and the three centerboard boats withdrew to assist her and did not continue the race.

Third class, centerboards 22 to 25 feet. Three starters; POSY won first prize of \$15, SECRET \$15 and SECRET \$10.

Third class, keels. Two starters; THELGA won \$15, and Echo \$10.

Fourth class, centerboards 19 to 22 feet. Four starters; MYRTLE won \$12.

Fourth class, keels. VAQA, the only starter, won \$12.

Sixth class, yachts under 19 feet, no starters.

Special class, jib and mainsail under 22 feet. Two starters; COYOTE won \$12.

Second Championship Race, August 4th: Stiff breeze.

First class, one starter. SHADOW won a leg.

Third class, centerboards. Three starters; SECRET won a leg.

Third class, keels. Two starters; THELGA won second leg and championship of her class.

Fourth class, centerboards. Five starters; NIOME won a leg.

Fourth class, keels. One starter, VAQA, who won her second leg, secured the championship.

Fifth class, jib and mainsail. Four starters; EMM ELL EYE won second leg and championship.

Sixth class, centerboards. Four starters; MIRAGE won first leg.

Championship Sail Off, September 8th: Heavy sea.

First class centerboards. Two starters; ALBATROSS won \$25.

First class, keels. AGLAIA, the only starter, won championship.

Fourth class, centerboards. Two starters; NIOME won championship.

Sixth class, centerboards. One starter, MIRAGE, won championship.

Championship Sail Off September 15th:

Third class, centerboards. POSY won championship.

First class, centerboards. ALBATROSS, the only starter, won championship.

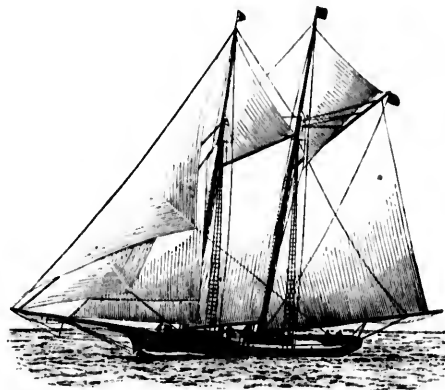

ADRESNE.—FIGURE 367.

THE SEASON OF 1889.

First Championship Race, June 22nd:

First class, centerboards. Only one starter, MAGIC, who won a leg.

Second class, centerboard. HARRINGER won a leg; one starter.

Third class, centerboards. POSY, the only starter, won a leg.

Third class, keels. Two starters; THELGA won a leg and Corinthian prize.

Fourth class, centerboards. Two starters; EUREKA won a leg.

Fifth class, centerboards. Two starters; MYRTLE won a leg.

Fifth class, keels. One starter; VAQA, won a leg.

Sixth class, under 19 feet. One starter; WILDFIRE won a leg.

Seventy-sixth Race, July 6th. Wind southeast and light.

First class, centerboards. Two starters; NIMBUS won prize of \$25.
 Second class, centerboards. One starter; HARBINGER won half of first prize, \$10.

Third class, centerboards. Two starters; POSY won first prize.
 Third class, keels. Two starters; ECHO won prize of \$15.
 Fourth class, jib and mainsails under 21 feet. Three starters; EUREKA won prize of \$12.

Fifth class, centerboards. Four starters; ATALA won first prize, \$12, MAHEL second prize, \$6, MYRTLE third prize, \$3.
 Sixth class, centerboards. ROCKET won prize of \$10.

Ladies' Race, July 20th: Wind northwest and very light.
 First class, four starters. NIMBUS won prize of marine glasses and a prize for each lady.

Second class, three starters. HARBINGER won marine glasses and ladies' prize.

Third class, centerboards. Four starters; POSY won glasses and ladies' prizes.

Third class, keels. Three starters; ECHO won marine glasses and prize for each lady.

Fourth class, jib and mainsails. Three starters; EUREKA won silver cup and ladies' prizes.

Fifth class, centerboards. Four starters; MAHEL won Corinthian prize, silver cup and a pin for each lady.

Fifth class, keels, one starter. VAGA won silver cup and ladies' prizes.

Sixth class, three starters. ROCKET won cup and ladies' prizes.
 Second Championship Race, August 17th: Wind west and moderate.

Third class, keels. Three starters; THELGA won championship; ECHO won prize.

Fourth class, three starters. EUREKA won championship; I. N. L. won second cash prize.

Fifth class, centerboards. Five starters; ATALA won a leg.

Sixth class, two starters. ROCKET won a leg.
 Open Race, August 30th:

First class, four starters. SHADOW won \$75, ALBATROSS won \$40.

Second class, centerboards. Seven starters; HARBINGER won \$60, SHARK won \$30.

Second class, keels. Six starters; KATHLEEN won \$60, ELP won \$30.

No starters in Special Class.
 Championship Sail Off, September 5th: Wind fresh, southwest.

Second class, keels. One starter; MALVENA won championship.

Fifth class, two starters. ATALA won championship.

Sixth class, two starters. ROCKET won championship.

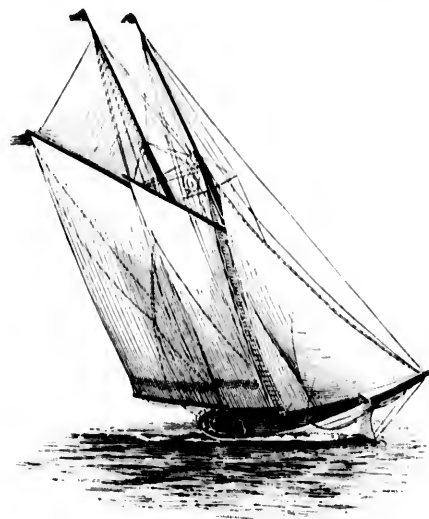

GITANA.—FIGURE 368.

First class, four starters. MAGIC won championship.
 Second class, centerboards, 25 to 30 feet. Two starters; HARBINGER won championship.

Second class, keels. MALVENA won leg in championship.
 Third class, centerboards, 21 to 25 feet. Three starters; POSY won championship; SECRET won cash prize.



CAMILLA.—FIGURE 369.

Open Race, September 7th:

Third class, centerboards, 21 to 25 feet. Ten starters; POSY and SECRET divided first and second prizes. MADGE won third prize and SEA BIRD won fourth prize.

Third class, keels. Six starters; THELGA won first prize and ECHO won second prize.

Fourth class, jib and mainsail. Ten starters; EUREKA won first prize, TOM CAT second, USTASE third and AIR fourth.

Fifth class, four starters. ASTREA won first prize.

Sixth class, eleven starters. ROCKET won first prize, FLORA LEE second, WILDFIRE third and I. N. L. fourth.

THE SEASON OF 1890.
HULL YACHT CLUB.—OPEN RACE.

June 17th: Wind southwest, fresh.

First class, jib and mainsails under 21 feet.

Yacht.	Sailing Length, Feet.	Actual Time, H. M. S.	Allow-ance, M. S.	Corrected Time, H. M. S.
Zoo	18.01	1 26	21 51.80	1 01 9
Zetta	18.09	1 20 33	21 12	1 02 1
Jack Daw	18.4	1 29 33	21 30.60	1 01 57
Ustano	20.7		22 32.40	
Diadem	18.2	1 24 10	21 46.80	59 24
Composite	16.0	1 33 33	27 09.00	1 06 23

Protest against Diadem sustained from fact that a member of crew touched buoy.

USTANE carried away mast on last round when well ahead.

ZOE wins first prize, \$10; ZETTA second prize, \$5.

Second class, cats, 19 feet and under 21 feet.

Yacht.	Sailing Length, Feet.	Actual Time, H. M. S.	Allow-ance, M. S.	Corrected Time, H. M. S.
Egeria	19.11	1 22 21	23 07.20	59 17
Tartar	19.11	1 23 13	23 07.20	1 0 6
Myrtle	19.02	did not start	23.48	
Mabel	19.10	did not start	23 11.49	
Joker	20.30	1 26 51	22 40.18	1 04 02

EGERIA wins first prize, \$10; TARTAR second prize, \$5.

Third class, cats, under 19 feet.

Yacht.	Sailing Length, Feet.	Actual Time, H. M. S.	Allow-ance, M. S.	Corrected Time, H. M. S.
Wildfire	17.30	1 29 31	25 45.8	1 03 48
I. X. L.	16.80	time not taken	26 22.2	
Mirage	17.50	1 30 26	25 33.0	1 04 53
Scamp	18.40	1 05 50	24 35.6	withdrew after first lap
Rocket	16.20	1 27 05	26 57.0	1 0 08
Flora Lee	16.10		26 10.8	carried away jaws of gaff
Mamie	18.30	1 29 40	24 42.0	1 04 58
Preak	16.00	1 32 07	27 00.0	1 04 58
Peri	18.10	1 23 11	24 07.2	59 94

PERI protested by ROCKET for measurement. Protest not allowed.

PERI wins first prize, \$10; ROCKET second prize, \$5.

FIRST CHAMPIONSHIP RACE.

June 28th: Wind southeast, fresh.

Third class, centerboards; Course No. 7, 9 miles.

Yacht.	Sailing Length, Feet.	Actual Time, H. M. S.	Allow-ance, M. S.	Corrected Time, H. M. S.
Posy	22.1½	1 51 47	31 53.4	1 19 54
Moondyne	24.80	1 53 50	29 11.0	1 24 39
Montezuma	22.10	1 56 05	31 59.0	1 24 06
Elite	24.11	withdrawn parted jibstay		

POSY wins leg in championship. MONTEZUMA wins 2d prize, \$10.

Third class, keels.

Yacht.	Sailing Length, Feet.	Actual Time, H. M. S.	Allow-ance, M. S.	Corrected Time, H. M. S.
Echo	24.00	1 54 05	29 22.2	1 24 43
Thelga	22.01	2 0 31	31 58.8	1 28 22

ECHO wins leg in championship.

Fifth class, centerboards; Course No. 12, 6 miles.

Yacht.	Sailing Length, Feet.	Actual Time, H. M. S.	Allow-ance, M. S.	Corrected Time, H. M. S.
Tartar	19.11	1 21 42	23 07.0	58 35
Myrtle	17.10	1 26 31	23 53.0	1 02 38
Madge	19.11	1 21 20	23 07.0	58 13
Mabel	19.10	1 23 04	22 11.0	59 52

MADGE wins leg in championship. TARTAR wins second prize, \$5.

Fifth class, keels.

Yacht.	Sailing Length, Feet.	Actual Time, H. M. S.	Allow-ance, M. S.	Corrected Time, H. M. S.
Vaga	18.50	1 28 24	24 32.0	1 03 52
Spray	not official	20.11	1 30 45	22 16.0
Composite	16.00	1 31 47	27 07.0	1 04 40

VAGA wins leg in championship and Corinthian prize of \$3. COMPOSITE second prize, \$5.

Fourth class, centerboard.

No starters.

Sixth class, centerboards; Course No. 12, 6 miles.

Yacht.	Sailing Length, Feet.	Actual Time, H. M. S.	Allow-ance, M. S.	Corrected Time, H. M. S.
Rocket	16.02	1 24 22	26 57.0	57 25
Wildfire	17.03	1 28 52	25 44.0	1 03 08

ROCKET wins leg in championship and Corinthian prize of \$3.

EIGHTY-FOURTH CASH PRIZE.

July 20th: Wind southwest, very fresh.

Second class, keels and centerboards; Course No. 1, 15 miles.

Yacht.	Sailing Length, Feet.	Actual Time, H. M. S.	Allow-ance, M. S.	Corrected Time, H. M. S.
Harbinger	28.10	2 50 10	43 26.0	2 12 44.0
Erin		3 15 35		

HARBINGER wins first prize, \$20.

No First Class.

No Fourth Class.

Third class, centerboards; Course No. 7, 9 miles.

Yacht.	Sailing Length, Feet.	Actual Time, H. M. S.	Allow-ance, M. S.	Corrected Time, H. M. S.
Moondyne	24.80	1 30 10	29 11.4	1 09 58.6
Montezuma	22.10	did not start		
Elite	24.11			
Secret			ruled out, started ahead of time.	
Posy	22.20			

MOONDYNE awarded 50 per cent. of first prize, \$7.50.

Third class, keels.

Yacht.	Sailing Length, Feet.	Actual Time, H. M. S.	Allow-ance, M. S.	Corrected Time, H. M. S.
Swordfish	24.04	carried away mast off Pig Rocks Beacon		
Echo	24.06	1 37 06	29 22.0	1 07 44.0

ECHO wins first prize, \$15.

Fifth class, centerboards; Course No. 12, 6 miles.

Yacht.	Sailing Length, Feet.	Actual Time, H. M. S.	Allow-ance, M. S.	Corrected Time, H. M. S.
Madge	19.11	1 09 06	23 11.0	45 55
Egeria	19.11		23 07.0	did not start.
Mabel	19.10		23 11.0	" "
Joker			" "	" "
Myrtle	19.01		" "	" "
Tartar	19.11	1 13 40	23 07.0	59 33

MADGE wins first prize, \$12.

Fifth class, keels; Course No. 12, 6 miles.

Yacht.	Sailing Length, Feet.	Actual Time, H. M. S.	Allow-ance, M. S.	Corrected Time, H. M. S.
Composite	16.00	1 20 42	27 00.0	53 33
Vaga	18.50	1 19 55	24 32.0	55 27

COMPOSITE wins first prize, \$12.

Sixth class, centerboards, under 19 feet; Course No. 12, 6 miles.

Yacht.	Sailing Length, Feet.	Actual Time, H. M. S.	Allow-ance, M. S.	Corrected Time, H. M. S.
Rocket	16.02		29 57.0	did not start.
Wildfire	17.03		25 44.0	" "
Cricket	16.80	1 25 19	26 22.0	58 57

CRICKET awarded 50 per cent. of first prize, \$5.

FIRST CHAMPIONSHIP RACE.

August 9th: Wind southeast.

First class, 30 to 35 feet; Course No. 3, 18 miles.

Yacht.	Sailing Length, Feet.	Actual Time, H. M. S.	Allow-ance, M. S.	Corrected Time, H. M. S.
Nimbus	34.40	3 36 02	42 52.2	2 53 10.0
Albatross	34.20	3 33 57	43.7	2 50 50.0

ALBATROSS wins leg in championship.

Second class, 25 to 30 feet; Course No. 3, 18 miles.

Yacht.	Sailing Length, Feet.	Actual Time, H. M. S.	Allow-ance, M. S.	Corrected Time, H. M. S.
Erin		did not start		
Harbinger	28.00	3 28 14	52 06.0	2 36 07.4
Hawk	31.40	3 23 02	47 00.6	2 36 07.4
Mignon	29.11	3 24 38	47 38.4	2 36 50.6
Mopsa	27.20	3 41 44	51 32.4	2 50 11.0

HAWK wins leg in championship.

HARBINGER wins second prize, \$10.

SECOND CHAMPIONSHIP RACE.

August 11th:

First class, 30 feet and under 35 feet; Course No. 3, 18 miles.

Yacht.	Sailing Length, Feet.	Actual Time, H. M. S.	Allow-ance, M. S.	Corrected Time, H. M. S.
Nimbus	34.40	3 31 56	42 52.2	2 49 3.8
Albatross	34.20	3 50 27	43 06.0	3 7 20.4

NIMBUS wins leg in championship.

Second class, 25 feet and under 30 feet; Course No. 3, 18 miles.

Yacht.	Sailing Length, Feet.	Actual Time, H. M. S.	Allow-ance, M. S.	Corrected Time, H. M. S.
Harbinger	28.10	3 26 21	52 06.0	2 34 14.4
Hawk	31.40	3 10 51	47 00.6	2 23 50.4
Mignon	30.11	3 18 08	47 38.4	2 30 20.6
Pilgrim	28.80	3 15 47	51 07.2	2 24 39.8

HAWK wins championship. PILGRIM wins second prize, \$10.

August 23rd: Second Championship Race for 3rd, 4th, 5th and 6th classes. Wind, east, light.

Third class, centerboards; Course No. 7, 9 miles.

Yacht.	Sailing Length, Feet.	Actual Time, H. M. S.	Allow-ance, M. S.	Corrected Time, H. M. S.
Posy	22.8½	1 53 19	31 53.4	1 21 25.6
Moondyne	24.80	1 53 51	29 11.4	1 24 39.6
Elite	24.11	1 54 10	28 56.1	1 25 13.9
Secret	22.00	1 57 29	31 30.9	1 25 59.1

POSY wins championship. MOONDYNE second prize, \$10.

miles.
Corrected
Time.
H.M.S.
12 44.0

09 58.6

and of time.
"

ing Rocks Beacon
11 07 44.0

45 55
did not start.
" "
" "
" "
" "
50 33

53 33
55 27

6 miles.
did not start.
" "
58 57

53 10.0
50 50.0

2 36 07.4
2 36 07.4
2 30 50.6
2 50 11.6

miles.
49 3.8
7 20.4

8 miles.
34 14.4
23 50.4
30 29.6
24 39.8
ce, \$10.

4th, 5th und

21 25.6
24 39.0
25 13.9
25 59.1
\$10.

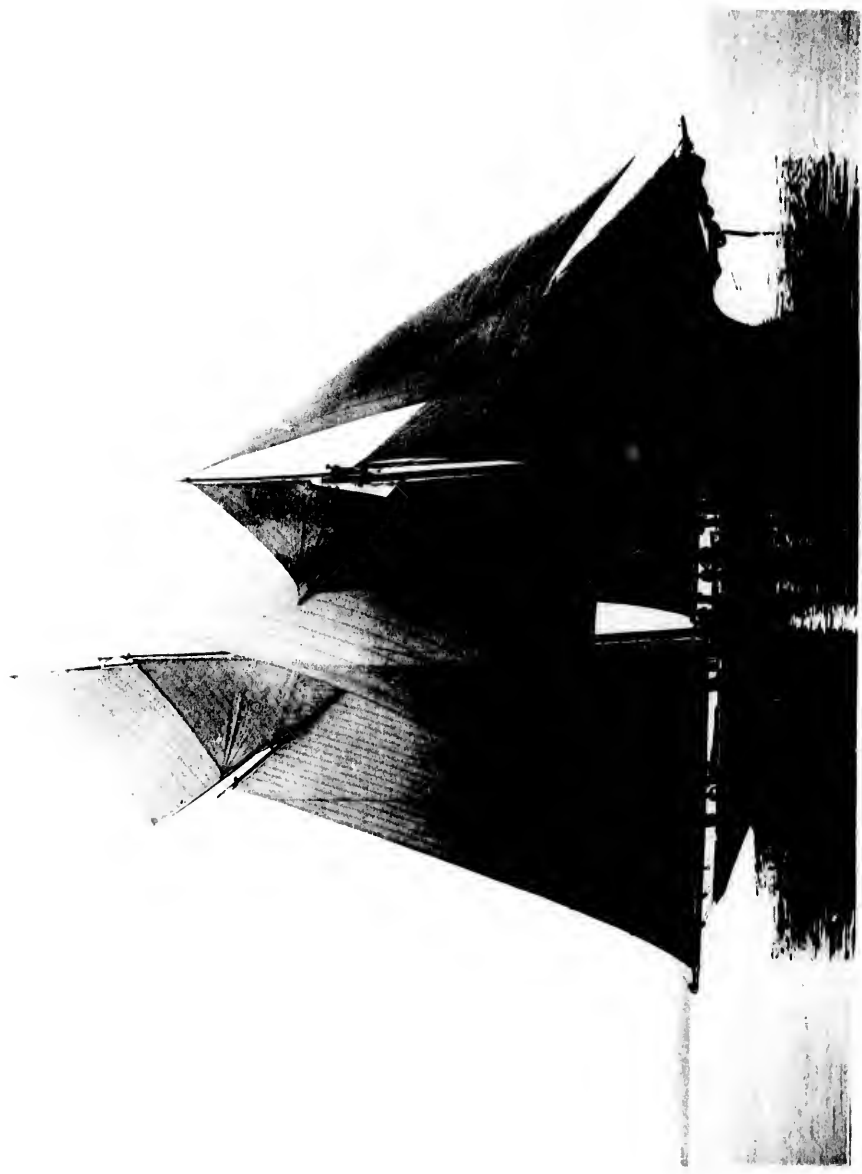
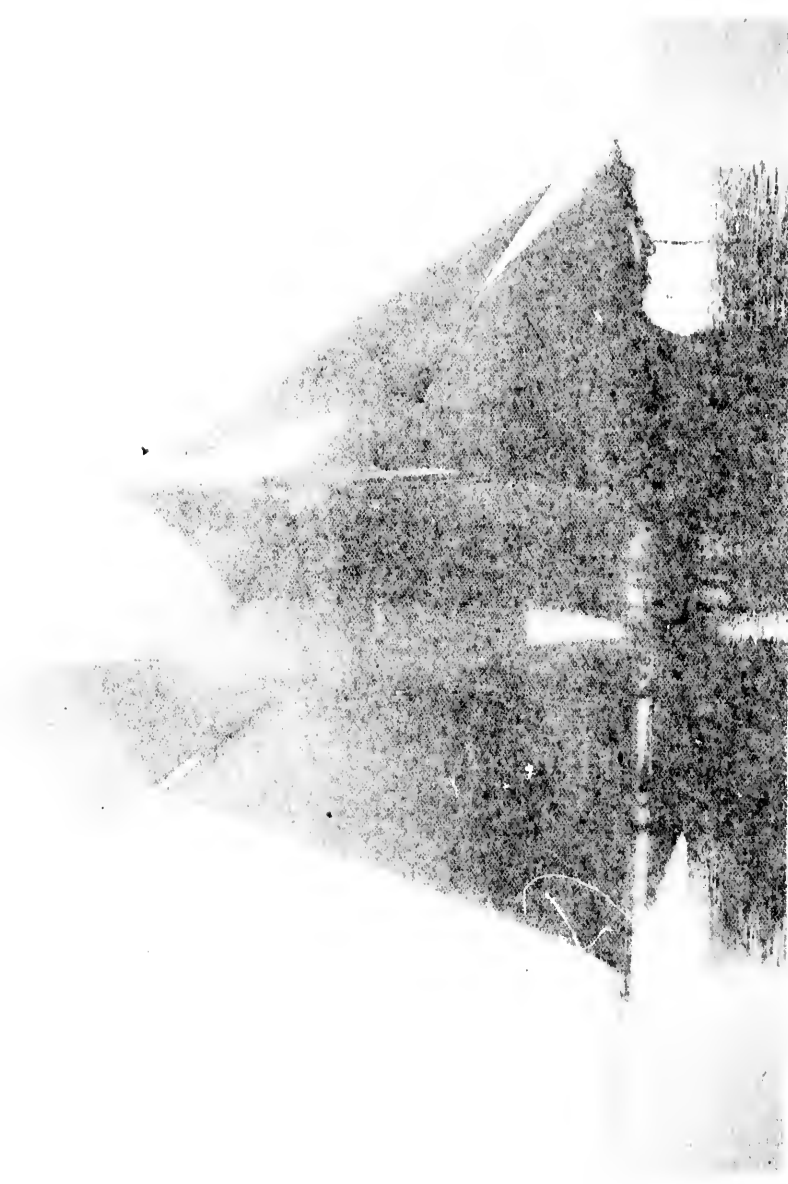

PLATE XXXIX.

ORIOLE.

Fig
MA
AN
HO
Course
R
a
m
p
and
Y
M
S
L
H
a
w
I
S
C



CHITOLE

T

Fo

Six

W

Fift

Fift

M.

2d p

At

and c

Cours

HA

wins 3c

Sept

Third

WILL

Almira

Third C

S

E

Neithe

her moon

all right.

Fourth U

M

M

Fourth cl

Co

Fifth Clas

Wi

Roc

MADGE

wins enp i

Septemb

west (gale)

THE YACHTS AND YACHTSMEN OF AMERICA.

313

Third class, keels.

Yacht.	Sailing Length. Feet.	Actual Time. U.M.S.	Allowance. M.S.	Corrected Time. U.M.S.
Echo	24.00	1 53 29	20 22.2	1 24 06.8
Swordfish	24.01	did not return.		

ECHO wins championship.

Fourth class, centerboard.

No entries.

Sixth class.

Yacht.	Sailing Length. Feet.	Actual Time. U.M.S.	Allowance. M.S.	Corrected Time. U.M.S.
Rocket	16.02	1 31 51	26 57.0	1 04 54.0
Mabel D.	16.11	1 35 45	20 05.4	1 09 39.4
Wildfire	17.03	1 28 50	25 43.8	1 03 15.2

WILDFIRE wins leg in championship; ROCKET wins 2d prize, \$5.

Fifth class, centerboards.

Yacht.	Sailing Length. Feet.	Actual Time. U.M.S.	Allowance. M.S.	Corrected Time. U.M.S.
Egeria	19.11	1 22 57	23 07.0	59 50.0
Madge	19.11	1 21 01	23 07.2	57 53.8
Mabel	19.10	1 22 16	23 11.4	59 04.6

Fifth Class, keels.

Yacht.	Sailing Length. Feet.	Actual Time. U.M.S.	Allowance. M.S.	Corrected Time. U.M.S.
Vaga	18.52	1 29 20	24 31.8	1 04 57.2
Composite	16.00	1 32 57	27 00.0	1 04 58.0
"	16.40	26 45.0		

MADGE wins championship in 5th Class centerboards; MABEL won 2d prize, \$5; VAGA wins championship and CORINTHIAN prize 3.

August 25th: Cup Race for \$150 cup, offered by David Hall Rice, and cash prizes by club. Wind west, moderate.

Course 3, 18 miles.

Yacht.	Sailing Length. Feet.	Actual Time. U.M.S.	Allowance. M.S.	Corrected Time. U.M.S.
Harbinger	27.11½	3 55 15	53 20.1	3 2 54.9
Hawk	31.30	3 56 52	47 00.6	3 9 51.4
Saladin	31.30	3 53 16	47 08.0	3 6 8.0
Pilgrim	28.80	3 51 47	51 07.2	3 3 39.8
Shadow	31.10	3 52 17	42 37.8	3 9 39.2
Albatross	3 53 50	43 06.6		

HARBINGER wins cup; PILGRIM wins 2d prize, \$30; SALADIN wins 3d prize, \$20.

September 6th: Special Cup Race. Wind east, moderate.

Third Class centerboards; Course No. 10, 10 miles.

Yacht.	Sailing Length. Feet.	Actual Time. U.M.S.	Allowance. M.S.	Corrected Time. U.M.S.
White Fawn	25.3½	2 00 55	31 45	1 29 10
Almira	24.00	2 02 07	32 21	1 29 46
Posy	22.1½	did not start.		
Secret	22.60	2 11 05	35 01	1 36 04
Moodyne	24.80	2 12 58	32 26	1 40 32
Montezuma	22.10	35 32 withdrew.		
Elite	24.11	2 05 04	32 00	1 32 55
Erin	not measured. 2 5 18			

WHITE FAWN wins cup presented by Commodore Chas. V. Whitten; Almira wins 2d prize of \$15 offered by club.

Third Class, keels 21 feet sailing length, and under 25 feet waterline.

Yacht.	Sailing Length. Feet.	Actual Time. U.M.S.	Allowance. M.S.	Corrected Time. U.M.S.
Swordfish	21.7	2 15 04	32 32	1 42 32
Echo	24.0	2 11 20	32 38	1 38 42

Neither boat rounded Seal Rocks Buoys rightly. Echo came to her moorings and furled all sails, got under weigh and rounded buoys all right. Judges decided race should be sailed over again.

Fourth Class, centerboards, 21 feet and under 25 feet.

Yacht.	Sailing Length. Feet.	Actual Time. U.M.S.	Allowance. M.S.	Corrected Time. U.M.S.
Madge	19.11	1 32 21	23 07	1 09 14
Mabel	19.10	1 32 25	23 11	1 09 14

Fourth class, keels, under 21 feet.

Yacht.	Sailing Length. Feet.	Actual Time. U.M.S.	Allowance. M.S.	Corrected Time. U.M.S.
Composite	16.4	ready to start but no competitors.		

Fifth Class, centerboards, under 19 feet.

Yacht.	Sailing Length. Feet.	Actual Time. U.M.S.	Allowance. M.S.	Corrected Time. U.M.S.
Wildfire	17.63	1 43 42	25 41	1 17 58
Rocket	16.20	1 39 13	16 57	1 12 16

MADGE wins cup in 4th class presented by J. J. Souther; ROCKET wins cup in 5th class presented by J. B. Forsyth.

September 13th, Championship Sail Off. Wind heavy from south-west (gale).

Yacht.	Sailing Length. Feet.	Actual Time. U.M.S.	Allowance. M.S.	Corrected Time. U.M.S.
First Class, Course No. 1, 15 miles.				
Albatross	31.2	3 01 22	35 55.5	2 25 26.5
Nimbus	31.1	3 08 00	35 43.5	2 32 25.5

ALBATROSS wins championship.

September 20, Championship Sail Off. Wind west moderate.

Sixth Class, Course No. 11, 6 miles.

Yacht.	Sailing Length. Feet.	Actual Time. U.M.S.	Allowance. M.S.	Corrected Time. U.M.S.
Rocket	16.02	1 28 20	26 15	1 01 23
Wildfire	17.03	25		

ROCKET wins championship.

THE SEASON OF 1891.

CASH PRIZE RACE.

June 17th. Wind, northeast, strong.

Fifth Class, keels; course 11, 6 miles.

Yacht.	Sailing Length. Feet.	Actual Time. U.M.S.	Allowance. M.S.	Corrected Time. U.M.S.
Composite	sloop 16.4	1 37 58	26 45	1 11 13

Wins 50 per cent. of 1st prize.

Fifth class, centerboards.

Yacht.	Sailing Length. Feet.	Actual Time. U.M.S.	Allowance. M.S.	Corrected Time. U.M.S.
Madge	cat 19.11	1 21 00	23 07	1 00 53
Magpie	cat 18.10	1 20 21	21 07	1 06 17
Egeria	cat 19.11	1 19 08	23 11	55 57
Niobe	cat 20.20	22 51 withdrew.		

EGERIA wins 1st prize, MADGE 2d prize, MAGPIE 3d prize.

Sixth class, centerboards.

Yacht.	Sailing Length. Feet.	Actual Time. U.M.S.	Allowance. M.S.	Corrected Time. U.M.S.
Crocket	cat 16.8	1 39 29	26 22	1 13 07
Mab	cat 16.3	1 33 33	26 51	1 05 42

MAB wins 1st regular prize and also Corinthian prizes.

NINETY-SECOND CLUB REGATTA.

June 27th. Wind, northeast at start, dying out to dead calm.

Second class.

Yacht.	Sailing Length. Feet.	Actual Time. U.M.S.	Allowance. M.S.	Corrected Time. U.M.S.
Harbinger	sloop 27.11½	43 36.7		
White Fawn	sloop 25.10	47 57.0		

No race, yachts not sailing the course.

Third class, centerboards.

Yacht.	Sailing Length. Feet.	Actual Time. U.M.S.	Allowance. M.S.	Corrected Time. U.M.S.
Montezuma	sloop 22.10	35 32		
Posy	sloop 22.81	34 48		
Moodyne	sloop 24.80	32 26		
Estane	sloop 21.11	35 47		

No race.

Third class, keels.

Yacht.	Sailing Length. Feet.	Actual Time. U.M.S.	Allowance. M.S.	Corrected Time. U.M.S.
Swordfish	sloop 21.7	32 32		

No race.

Fourth class, jib and mainsail.

Yacht.	Sailing Length. Feet.	Actual Time. U.M.S.	Allowance. M.S.	Corrected Time. U.M.S.
Eureka	20.7	32 31.4		

No race.

Fifth class, centerboards.

Yacht.	Sailing Length. Feet.	Actual Time. U.M.S.	Allowance. M.S.	Corrected Time. U.M.S.
Madge	cat 19.11	23 07.2		
Magpie	cat 19.09	23 16.2		
Mabel	cat 19.11	23 07.2		
Egeria	cat 19.11	23 07.2		

No race.

Fifth class, keels.

Yacht.	Sailing Length. Feet.	Actual Time. U.M.S.	Allowance. M.S.	Corrected Time. U.M.S.
Composite	sloop 16.4	26 45		

Sixth class.

Yacht.	Sailing Length. Feet.	Actual Time. U.M.S.	Allowance. M.S.	Corrected Time. U.M.S.
Rocket	cat 16.2	26 57		
Crocket	cat 16.8	26 22		
Mab	cat 15.9	27 27		
Ingelorn	cat	27 27		

No race.

FIRST CHAMPIONSHIP RACE.

July 11. Wind, southeast, west.

Third class, centerboard; course 8, 9 miles.

Yacht.	Sailing Length. Feet.	Actual Time. U.M.S.	Allowance. M.S.	Corrected Time. U.M.S.
Posy	sloop 22.81	1 46 49	31 19	1 15 30
Moodyne	sloop 24.8	1 45 25	39 01½	1 16 11

POSY wins leg in championship.

Third class, keels; course 8, 9 miles.

Yacht.	Sailing Length. Feet.	Actual Time. U.M.S.	Allowance. M.S.	Corrected Time. U.M.S.
Swordfish	sloop 21.7	1 42 44	29 16.8	1 13 27
Echo	sloop 24.0	1 46 30	29 22.0	1 17 17

SWORDFISH wins leg in championship and Corinthian prize.

Fourth class, jib and mainsails; Course No. 12, 6 miles.

Yacht.	Rig.	Sailing Length, Feet.	Actual Time, U. S. S.	Allowance, M. S.	Corrected Time, U. S. S.
Eureka		20.7	disabled	22 32.01	withdrew
Idler		20.6	1 11 59	22 36.06	52 22

IDLER wins leg in championship.

Fifth class, centerboards; Course No. 12, 6 miles.

Magpie	cat	19.09	1 17 21	23 16.29	51 05
Egeria	cat	19.11	1 15 48	23 07.20	53 41

EGERIA wins leg in championship and Corinthian prize.

Fifth class, keels; Course No. 12, 6 miles.

Composite	sloop	16.40	1 30 52	26 45.0	1 04 07
-----------	-------	-------	---------	---------	---------

Wins leg in championship.

Sixth class centerboards; Course No. 12, 6 miles.

Rocket	cat	16.02	1 22 58	26 57.00	56 01
Cricket	cat	16.08	1 20 19	26 22.00	59 57
Mab	cat	15.09	1 25 03	27 27.00	57 36

ROCKET wins leg in championship and Corinthian prize. TAB wins second prize.

NINETY-THIRD CLUB REGATTA FOR CASH PRIZES.

July 17: Wind southeast, light.

Second class, centerboards; Course No. 1, 15 miles.

Winger	sloop	27.113	3 02 37	43 36.07	2 19 0
White Fawn	sloop	25.10	3 02 17	47 57.00	2 11 20
Hawk	sloop	31.40	2 53 15	39 10.05	2 11 01

HAWK wins 1st prize. WHITE FAWN 2d prize.

Third class, centerboard; Course No. 7, 9 miles.

Posy	sloop	22.84	2 11 35	31 19.00	1 43 15
Moondyne	sloop	21.08	did not	29 11.01	finish
Ustane	sloop	21.01	2 29 14	32 10.05	1 57 30
Susie	sloop		2 22 24		
Erin	sloop		2 20 58		

POSY wins 1st prize. SUSIE 2d prize, ERIN 3d prize:

Third class, keels; Course No. 7, 9 miles.

Swordfish	sloop	21.70	2 13 58	29 16.08	1 41 41
Echo	sloop	21.60	2 25 48	29 22.02	1 56 25

SWORDFISH wins 1st regular and also Corinthian prize.

Fourth class, jib and mainsail; Course No. 12, 6 miles.

Eureka		21.01	1 22 44	21 55.20	1 01 30.8-10
Idler		20.06	1 23 21	22 36.06	1 0 53
True Blue			1 21 05		

TRUE BLUE wins 1st prize; EUREKA 2d prize.

Fifth class, centerboards; Course 12 miles.

Magpie	cat	19.00	1 30 51	23 57.00	1 06 53
Egeria	cat	19.11	1 29 36	23 07.20	1 06 28

Fifth class, keels.

Composite	sloop	16.40	1 51 25	26 45.00	1 24 40
-----------	-------	-------	---------	----------	---------

Sixth class, centerboards.

Rocket	cat	16.02	1 40 14	26 57.00	1 13 37
Cricket	cat	16.08	1 46 07	26 22.00	1 19 45
Mab	cat	15.09	1 38 47	27 27.00	1 11 20
Mabel D.	cat	17.00*	2 01 32	26 05.04	1 25 25

FIRST CHAMPIONSHIP RACE.

July 18th: First and second classes. Wind southeast, fresh.

First class; Course No. 3, 18 miles.

Albatross	sloop	31.2	3 21 45	42 52.20	2 41 52.8-10
-----------	-------	------	---------	----------	--------------

Wins leg in championship.

Second class; Course No. 3, 18 miles.

Harbinger	sloop	27.113	3 10 10	52 20.10	2 17 49.3-10
White Fawn	sloop	25.10	3 28 18	57 32.40	2 30 45.6-19
Hawk	sloop	31.40	3 06 50	47 09.60	2 19 49.4-10
Pilgrim	sloop	28.80	3 16 17	51 07.20	2 25 09.8-60
Erin	sloop		3 25 11	not measured.	
Mignon	sloop	30.11	3 10 23	47 38.40	2 21 44.0-10

HARBINGER wins leg in championship. HAWK wins 2d prize, \$10.

SECOND CHAMPIONSHIP RACE.

First and Second Classes. Wind southeast, moderate, hauling a little southerly.

First class; Course No. 3, 18 miles.

Yacht.	Rig.	Sailing Length, Feet.	Actual Time, U. S. S.	Allowance, M. S.	Corrected Time, U. S. S.
Hypatia	sloop	30.00	3 29 33	40 49.80	2 48 53.2-10

Wins leg in championship.

Second class; Course No. 3, 18 miles.

Harbinger	sloop	27.113	3 21 55	53 20.10	2 32 34.9-10
White Fawn	sloop	25.10	3 27 47	57 32.40	2 30 14.6-10
Hawk	sloop	31.40	3 10 41	47 09.60	2 32 43.4-10
Pilgrim	sloop	28.80	3 20 38	51 07.20	2 29 30.3-10
Mignon	sloop	30.11	3 23 34	47 38.40	2 31 56.6-10

PILGRIM wins leg in championship. WHITE FAWN wins 2d prize.

SPECIAL CUP RACE.

August 1st: Wind west southwest at start, fresh, hauling to south-west, lighter and fresh again to finish.

Third class, centerboards; Course No. 10, 10 miles.

Montezuma	sloop	22.10	did not	35 32.00	finish
Posy	sloop	22.84	2 02 52	34 48.00	1 28 04
Moondyne	sloop	21.80	2 0 05	32 26.00	1 27 39
Susie	sloop	23.11	2 04 15	34 17.00	1 30 58
Erin	sloop	27.40	2 04 02	29 40.00	1 33 22
Three Brothers	sloop	21.40	2 07 48	36 31.00	1 31 14

MOONDYNE wins cup offered by Commodore J. J. Souther; POSY 2d prize, \$10.

Third class, keels; Course No. 10, 10 miles.

Swordfish	sloop	24.70	2 02 08	32 32.00	1 29 36
Echo	sloop	21.60	2 04 49	32 38.00	1 29 11

ECHO wins cup offered by Rear-Commodore H. P. Smith.

Fourth class, jib and mainsails; Course No. 12, 6 miles.

Eureka		21.40	1 26 41	21 55.20	1 01 48.8-10
Idler		20.06	1 17 55	22 36.06	55 19.4-10

IDLER wins cup offered by H. S. Woodbury.

Fifth class, centerboards; Course No. 12, 6 miles.

Madge	cat	19.11	1 21 10	23 07.20	58 03
Magpie	cat	19.00	1 25 28	23 57.00	1 01 30.4-10
Egeria	cat	19.11	1 21 00	23 07.20	57 52.8-10
Atala	cat	19.10	1 24 22	23 11.40	1 01 10.6-10

EGERIA wins cup offered by J. D. Crosby; MADGE wins 2d prize.

Fifth class, keels; Course No. 12, 6 miles.

Composite	sloop	16.40	1 30 58	26 45.00	1 04 13
Vandal	sloop	22.10	1 29 01	21 19.02	1 07 45

COMPOSITE wins cup offered by E. L. Burwell.

Sixth class, centerboards; Course No. 12, 6 miles.

Rocket	cat	16.02	2 20 50	26 57.00	59 53
Cricket	cat	16.08	1 28 18	26 25.00	1 01 50
Mab	cat	15.09	1 27 50	27 27.00	1 0 23

ROCKET wins cup offered by E. F. Linton; MAB 2d prize, \$5.

SECOND CHAMPIONSHIP RACE.

August, 8th: Wind, north northwest at start, but changed north-east to east, very light and blustery.

Third class, centerboards; Course No. 7, 9 miles.

Posy	sloop	22.84	2 52 16	31 19.20	2 20 57
Moondyne	sloop	24.80	3 10 51	29 11.40	2 41 43
Ustane	sloop	21.11	did not finish	32 10.50	
Three Brothers	sloop	21.40	did not finish	32 52.80	
Torment	sloop		2 40 39		

POSY wins leg in championship, also 2d prize, \$10.

Third class, keels; Course No. 7, 9 miles.

Swordfish	sloop	21.70	2 56 30	29 16.80	2 27 14
Echo	sloop	21.60	3 15 24	29 22.20	2 46 20

SWORDFISH wins championship and Corinthian prize.

Fourth Class, jib and mainsail; Course No. 12, 6 miles.

True Blue		17.10	2 21 5	25 06.60	1 55 59
Idler		20.00	1 58 51	22 36.00	1 36 18

IDLER wins championship.

Fifth class, centerboards; Course No. 12, 6 miles.

Egeria	cat	19.11	2 51 6	23 07.20	2 27 50
Atala	cat	19.10	2 48 53	23 11.40	2 25 42

ATALA wins leg in championship.

THE YACHTS AND YACHTSMEN OF AMERICA.

345

Fifth class, keels; Course No. 12, 6 miles.

Yacht.	Rig.	Sailing Length, Feet.	Actual Time, H. M. S.	Allowance, M. S.	Corrected Time, H. M. S.
Composite	sloop	16.1	did not finish	in time limit	26 15

Sixth class, centerboards.

Rocket	cut	16.2	2 29 11	26 57	1 59 17
Crickot	cut	16.0		26 22	
Mab	cut	15.9		27 27	

ROCKET wins championship, and Corinthian prize, \$5.

SIXTY-EIGHTH CASH PRIZE REGATTA.

August 15th: Wind, southeast to northeast, later to northwest.

First class; Course No. 2.

Helen	sloop	39.11		30 10.3	
Nimbus	sloop	31.50		35 39.0	

Did not finish in time limit.

Second class.

Harbinger	sloop	27.114		43 26.7	
White Fawn	sloop	25.10		47 57.0	
Mignon	sloop	30.11		39 42.0	

Did not finish in time limit.

Third class, centerboards; Course No. 7, 9 miles.

Posy*	sloop	22.84		31 19.2	
Moondyne	sloop	24.80		20 11.1	
Torment	sloop	25.10	3 09 57	30 02.7	2 29 51

Did not finish in time limit. *Disabled, broken gaff.

TORMENT wins 1st prize, \$15.

Third class, keels; Course No. 7, 9 miles.

Swordfish	sloop	24.7		29 17	
Echo	sloop	24.6		29 22	
Lone	sloop	26.1		27 49	

Did not finish in time limit.

Fifth class, centerboards; Course No. 12.

Madge	cut	19.11	1 52 37	23 07.2	1 29 70
Magnio	cut	19.06	1 53 32	24 57.6	1 29 35
Egeria	cut	19.11	1 54 18	23 07.2	1 31 14
Atala	cut	19.10	1 59 02	23 11.4	1 35 51
Idler	cut	20.00	1 48 13	22 36.6	1 25 37

IDLER wins Corinthian and 1st prize, \$12. MADGE 2d prize, \$5.

MADGE 3d prize, \$3.

Fifth class, keels.

Composite	sloop	16.4		26 45	
-----------	-------	------	--	-------	--

Did not finish in time limit.

Sixth class, centerboards.

Crickot	cut	16.8	2 58 13	26 22	2 31 51
Mab	cut	15.9		27 27	

Did not finish in time limit.

CRICKOT wins 1st prize, \$10.

CUP AND CHAMPIONSHIP SAIL OFF RACE.

August 23d: Course No. 3.

First class.

Albatross		31.2		43 06.0	race
Hypatia		36.0		40 49.8	declared
Nimbus		31.5		42 46.8	off.

Second class.

Harbinger		27.11		52 20.1	race
White Fawn		25.10		57 32.1	declared
Pilgrim		28.80		51 07.2	off.
Mignon		30.11		47 38.4	
Mariposa		26.00		55 48.0	
Folly		26.70		54 43.2	

MARBLEHEAD CUP AND PENNANT RACE.

August 29th: Wind northwest, fresh.

Special class.

Bohemian	schr.	38.50	2 07 00	25 20	1 41 40
Helen	sloop	39.11	2 09 27	24 16	1 45 11

BOHEMIAN wins 1st prize. HELEN 2d prize.

First class.

Albatross	sloop	31.2	2 26 50	28 36	1 58 11
Hypatia	sloop	36.0	2 25 00	27 13	1 56 47

HYPATIA wins 1st prize. ALBATROSS 2d prize.

Yacht.	Rig.	Sailing Length, Feet.	Actual Time, H. M. S.	Allowance, M. S.	Corrected Time, H. M. S.
--------	------	-----------------------	-----------------------	------------------	--------------------------

Second class.

White Fawn	sloop	25.10	2 15 20	28 22	1 36 58
Mariposa	sloop	26.00	2 15 37	37 12	1 38 25
Harbinger	sloop	27.11	2 16 29	34 53	1 35 36
Vishki	sloop	30.00	2 17 00	32 11	1 44 19
Coronilla	sloop	30.10	2 15 23	32 13	1 44 10

HARBINGER wins 1st prize. WHITE FAWN 2d prize.

Third class.

Posy	sloop	22.80	2 21 50	41 47	1 40 03
Montezuma	sloop	22.10	2 25 48	42 38	1 43 10
Moondyne	sloop	24.80	2 17 15	38 55	1 34 50
Swordfish	sloop	24.70	2 14 30	39 02	1 35 28
Echo	sloop	24.60	2 33 43	39 10	1 41 33
Vandal	sloop	22.10	2 36 01	42 38	1 47 24
Elite	sloop	24.11	2 17 06	38 35	1 39 11
Clytie	sloop	26.10	2 32 05	45 56	1 46 09

SWORDFISH wins 1st prize. MOONDYNE 2d prize.

Fourth class.

Madge	cut	19.11	2 25 26	46 14	1 39 12
Magnio	cut	19.06	2 29 25	47 55	1 41 33

MADGE wins 1st prize. MAGNIO 2d prize.

CASH PRIZE AND CHAMPIONSHIP SAIL OFF.

September 2d: Wind east, light.

Second class; Course No. 1, 15 miles.

Harbinger	sloop	27.11	3 13 32	43 36.7	2 29 56
White Fawn	sloop	25.10	3 06 27	47 57.0	2 18 39
Mignon	sloop	30.11	3 39 11	39 12.0	2 24 02

WHITE FAWN wins 1st prize, \$20. MIGNON 2d prize, \$10.

Third class, keels; Course No. 8, 9 miles.

Swordfish	sloop	24.7	2 01 2	29 17	1 31 15
Echo	sloop	24.6	2 03 57	27 19	1 31 35
Lone	sloop	26.1	2 03 38	27 19	1 35 18

SWORDFISH wins 1st prize, \$15. ECHO 2d prize, \$10.

Third class, centerboards; Course No. 8, 9 miles.

Posy	sloop	22.8	2 02 51	31 19	1 31 32
------	-------	------	---------	-------	---------

Wins leg in championship.

Fifth class, keels; course 6 miles.

Composite		16.1	1 52 9	26 45	1 25 24
-----------	--	------	--------	-------	---------

Wins championship and 50 per cent. first prize, \$6.

Fifth class, centerboards; 6 miles.

Egeria		19.11			
--------	--	-------	--	--	--

Mr. Linton of ATALA telegraphed his inability to appear, and Mr. Ware of the EGERTIA kindly agreed to postpone the sail off in his class to a later date.

CUP AND CHAMPIONSHIP SAIL OFF RACE.

September 3d: Off Point Allerton. Wind, southeast at start, shifting to southwest.

First class; Course No. 3, 13 miles.

Albatross	sloop	31.2	4 18 29	43 06.6	3 35 22
Hypatia	sloop	36.0	4 38 00	40 49.8	3 57 22

ALBATROSS wins Rice-Harbinger Cup, value \$150, and championship

Second class; Course No. 3, 18 miles.

Harbinger	sloop	27.11	4 22 51	52 20.1	3 30 33
White Fawn	sloop	25.10		57 32.1	foiled Mignon
Pilgrim	sloop	28.80	4 06 52	51 07.2	3 15 11
Mignon	sloop	30.11	4 05 19	47 38.4	3 17 10
Folly	sloop	26.70	4 57 13	54 43.2	4 02 29

PILRIM wins cup offered by David Hall Rice, value \$150, and 2d class championship. MIGNON wins 2d prize, \$25; HARBINGER wins 3d prize, \$10.

CHAMPIONSHIP SAIL OFF.

September 11th:

Fifth class, centerboards; 6 miles.

Egeria	cut	19.11	2 01 32	23 07.2	1 38 24.08
Atala	cut	19.10	2 02 29	23 14.4	1 39 17.06

EGERTIA wins championship.

HISTORY OF THE HULL YACHT CLUB.

THE SEASON OF 1892.

June 16: Opening race. Course for fourth, special and fifth classes, 7 miles; for sixth class, 6 miles. Strong southwest wind.

Fourth Class, jib and mainsail centerboards, less than 21 feet waterline.

	Sailing Length.	Start.		Allowance.		Actual Corrected Time.		Remarks.
		H.M.S.	M.S.	H.M.S.	M.S.	H.M.S.	H.M.S.	
Alpha	23.10	3 15 00	23 22	1 23 49	1 00 27	1 00 27	1st prize \$15	
Catspaw	20.07	3 15 00	21 17	1 28 05	1 00 51			

Special Class, jib and mainsail keels less than 21 feet waterline.

Vanessa	24.03	3 15 00	23 02	1 32 31	1 00 32	1st prize \$15	
R. D.						disabled.	
Asp						did not finish.	

Fifth Class, cut-boats 18 feet and less than 21 feet waterline.

Koorali	23 01	3 20 00	23 47	1 29 35	1 05 48	1st prize \$15	
Maggie	22.01	3 20 00	21 39	1 34 06	1 10 07		

Sixth Class, cut-boats less than 18 feet waterline.

Marvel	20.03	3 25 00	22 49	1 16 38	53 48	1st prize \$10	
Mab	17.02	3 25 00	25 40	1 20 13	54 24	2d prize \$ 5	
Don	20.03	3 25 00	22 40	1 19 45	50 50		

June 25th: Special Open Sweepstakes 21-footers. Wind west, southwest, light.

Alpha, c. b.	23.10	2 32 45	23 22	1 31 45	1 08 24	1st prize \$20	
Catspaw, c. b.	20.70	2 32 45	21 17	1 32 18	1 11 01	2d prize \$15	
Vanessa, fin	24.30	2 32 45	23 02	1 31 39	1 11 36	3d prize \$10	
R. D., k.	25.40	2 32 45	22 11	1 41 20	1 19 09		

July 2nd: Race for all classes. Course for second class, 15 miles; third class, 9 miles; fourth, special and fifth classes, 7 miles; sixth class, 6 miles. Wind southwest, whole sail breeze.

Second Class.

Handsel, fin	33.40	2 30	30 40	2 47 55	2 11 06	1st prize \$25	
Chapoquoit, c. b.	37.10	2 30	32 13	2 49 10	2 16 57		

Third Class.

Gipsy	29.80	2 35	25 33	1 53 56	1 28 23	1st prize \$15	
White Fawn	30.11	2 35	24 49	1 56 32	1 32 43	2d prize \$10	
Ustane	27.30	2 35	26 46	1 59 52	1 33 06	3d prize \$ 5	
Posy	30.70	2 35	24 01	1 58 38	1 31 31		
Moodyne		2 35		1 59 41			

Fourth Class.

Alpha	23.50	3 40	23 43	1 30 28	1 00 45	1st prize \$15	
Catspaw	20.50	2 40	21 21	1 32 20	1 10 50		

Special Class.

Vanessa, fin	24.30	2 40	23 02	1 31 04	1 08 02	1st prize \$17.50	
--------------	-------	------	-------	---------	---------	-------------------	--

Fifth Class.

Maggie	22.40	2 45	21 39	1 44 10	1 19 31	1st prize \$15	
Koorali	23.40	2 45	23 47	1 44 14	1 20 27		

Sixth Class.

Mab	17.20	2 50	25 49	1 23 42	57 53	1st prize \$10	
Marvel	20.30	2 50	23 49	1 27 09	1 04 20	2d prize \$ 5	
Don	20.30	2 50	22 49	1 31 54	1 09 05		

July 16th: Race for third, fourth, fifth, sixth and special classes.

Course for third class, 9 miles; fourth, special and fifth classes, 7 miles; for sixth class, 6 miles. Fresh northwest breeze.

Third Class.

Gipsy	29.80	3 15	25 34	1 50 20	1 24 46	1st prize \$15	
Posy	30.70	3 15	24 04	1 54 15	1 30 11	2d prize \$10	
Ustane	27.30	3 15	26 46	1 57 20	1 30 43	3d prize \$ 5	
Beatrice	30.11	3 15	23 49	1 55 58	1 32 00		
White Fawn	30.11	3 15	23 49			did not finish.	

Fourth Class.

Exile	20.50	3 20	21 24	1 20 33	1 05 09		
Catspaw	20.50	3 20	21 24			disabled when in the lead.	

Special Class.

Vanessa, fin	24.30	3 20	42 02	1 21 35	58 33	1st prize \$15	
R. D., k.	25.40	3 20	32 11	1 27 19	1 05 01	2d prize \$10	

	Sailing Length.	Start.		Allowance.		Actual Corrected Time.		Remarks.
		H.M.S.	M.S.	H.M.S.	M.S.	H.M.S.	H.M.S.	
Tadpole, fin	25.40	3 20	23 11	1 27 53	1 05 42	price \$5		
Asp, fin		3 20				did not finish.		
R. D.						Lost 2d place by accident.		

Fifth Class.

Idler		3 25	23 50	1 22 36	58 40	1st prize \$15	
Koorali	23.04	3 25	23 47	1 20 35	1 02 48	2d prize \$10	
Madge	23.	3 25	24 04	1 27 58	1 03 54	3d prize \$ 5	
Maggie	22.40	3 25	24 30	1 28 30	1 04 00		
Snake		3 25		1 33 00			

Sixth Class.

Mab	17.02	3 30	25 49	1 18 38	52 40	1st prize \$10	
Primrose	17.11	3 30	05 03	1 10 00	54 50	2d prize \$ 5	
Don	20.30	3 30	22 49			did not finish.	

July 30th: Race for third, fourth, fifth, sixth and special classes. Course for third class, 9 miles; course for fourth, special and fifth classes, 7 miles; course for sixth class, 6 miles. Wind southeast, light.

Third Class.

Beatrice	30.11	3 15	23 49	1 56 37	1 32 48	1st prize \$15	
White Fawn	30.11	3 15	23 49	5 02 12	1 38 23	2d prize \$10	
Moodyne		3 15		2 12 22		3d prize \$ 5	
Gipsy	28.80	3 15				did not finish.	

Sixth Class.

Mab	17.20	3 20	25 40	1 27 49	1 02 00	1st prize \$10	
Primrose	17.11	3 20	25 02	1 28 52	1 03 50	2d prize \$ 5	
Don	20.30	3 20				did not finish.	

August 12th: Postponed from July 30th.

Fourth Class.

Alpha	23.50	3 30	23 43	1 21 10	57 27	1st prize \$15	
Catspaw	20.50	3 30	21 24	1 22 39	1 01 24		

Special Class.

Vanessa, fin	24.30	3 30	23 02	1 33 50	1 00 48	1st prize \$15	
R. D., k.	25.40	3 30	22 11	1 37 32	1 15 21		

Fifth Class.

Madge	23.00	2 35	24 04	1 29 25	1 04 21	1st prize \$15	
Koorali	23.00	2 35	24 04	1 29 30	1 05 20	2d prize \$10	
Maggie	22.40	2 35	24 39	1 30 12	1 05 33	3d prize \$ 5	
Typhoon	23.90	2 35	23 26	1 29 40	1 06 14		
Opechuo	22.20	2 35	24 48	1 31 20	1 06 32		

August 2nd: Outside races for second class. Wind, whole sail northeast.

Handsel, fin	33.40	11 30	49 06	3 24 24	2 35 18	1st prize \$25	
Chapoquoit	37.10	11 30	42 58	3 29 30	2 46 41		

August 3rd: Second race outside; same course. Southeast wind, shifting to southwest. The annual contest for the Rico Cup was included in this race (no extra entries).

Handsel, fin	33.40	11 30	49 06	4 29 20	3 40 14	1st prize \$25 and Rico Cup	
Chapoquoit, c. b.	37.10	11 30	42 58	4 31 55	3 48 57		

HANDESEL also wins championship in second class.

August 31st: Open subscription race for 21-footers, off Nahant. Course 10 miles. Wind southwest, whole sail.

Alpha, c. b.	23.50	11 00 18	33 53	1 34 33	1 00 40	1st prize \$30	
Vanessa, fin	24.30	11 00 27	32 55	1 39 52	1 06 57	2d prize \$50	
Exile, c. b.	20.50	11 00 50	30 35	1 38 28	1 07 53	3d prize \$35	
Reaper, fin	24.00	11 00 31	33 13	1 44 38	1 11 20	4th prize \$20	
Romance, c. b.	25.00	11 00 02	21 32	1 47 44	1 10 12	5th prize \$10	
R. D.	25.40	11 01 14	21 42	1 50 40	1 22 04		
Yankee Maid	22.60	11 01 07	25 00	1 57 08	1 22 08		
Catspaw						did not start.	
Thrush						" "	
Freak						" "	
Astrea						" "	

September 10th: Race for third, fourth, fifth, sixth and special classes (postponed from August 27th, on account of weather). Course for third class, 9 miles; for fourth, special and fifth classes, 7 miles; for sixth class, 7 miles. Wind southeast, fair.

Remarks

prize \$5
not finish.
Lost 2d place
by accident.

1st prize \$15
2d prize \$10
3d prize \$5

1st prize \$10
2d prize \$5
not finish.

al classes.
and fifth
east, light.

1st prize \$15
2d prize \$10
3d prize \$5
ot finish.

1st prize \$10
2d prize \$5
ot finish.

1st prize \$15

1st prize \$15

1st prize \$15
2d prize \$10
3d prize \$5

whole sail

1st prize \$25

east wind,
Cup was

1st prize \$25
d Rice Cup

F Nahant.

1st prize \$80
2d prize \$50
3d prize \$35
4th prize \$20
5th prize \$10

not start.

"

"

"

d special
(weather).
classes, 7

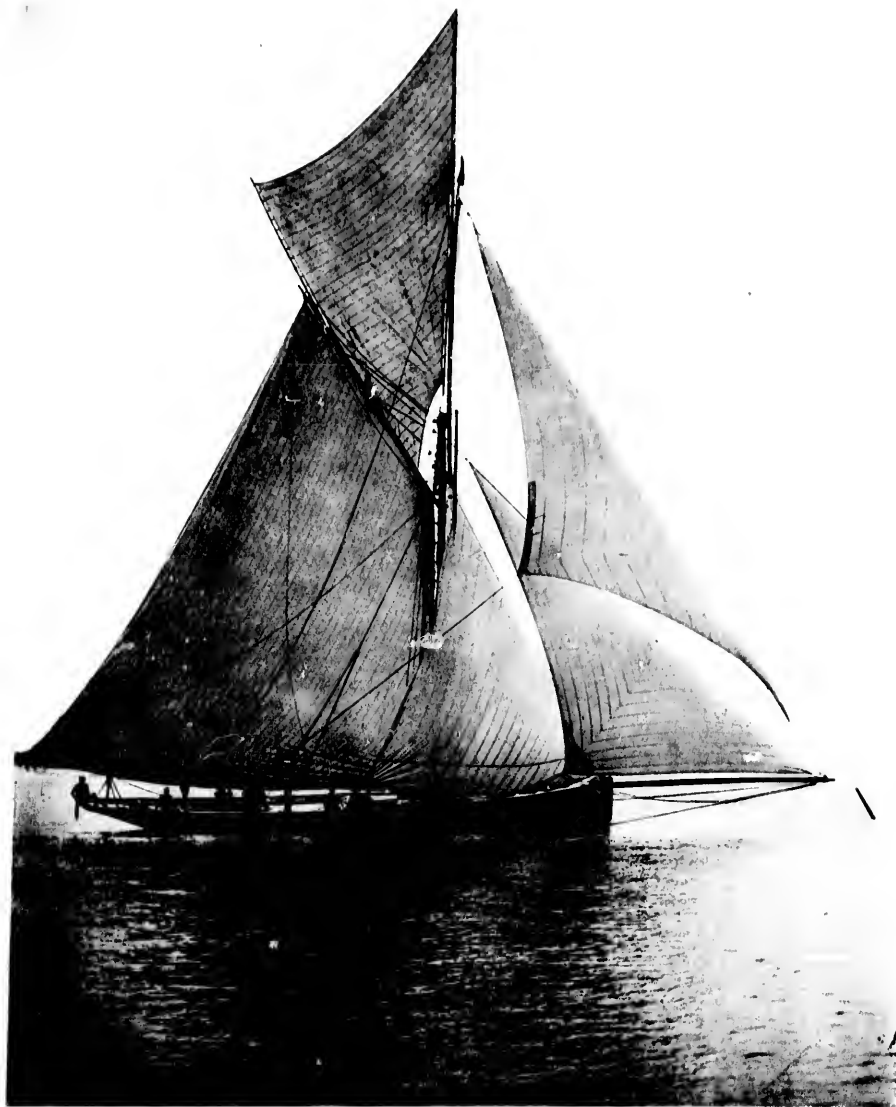

FROM A NEGATIVE BY FRUCE.

PLATE XL

AILEEN.

1911

1912

1913

1914

1915

1916

1917

1918

1919

1920

1921

1922

1923

1924

1925

1926

1927

1928

1929

1930

1931

1932

1933

1934

1935

1936

1937

1938

1939

1940

1941

1942

1943

1944

1945

1946

1947

1948

1949

1950

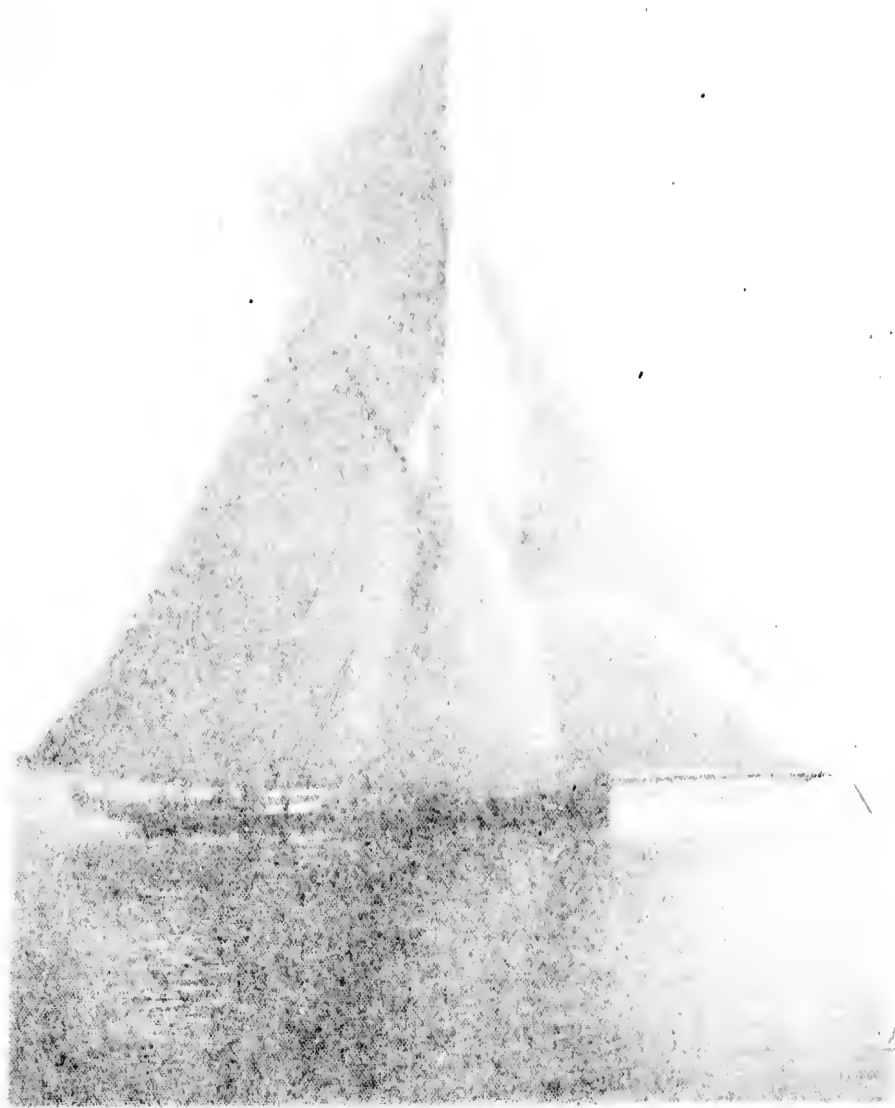

The
Ben
Cate
Wh
Poc
Sud
Gly
Asp
Fou
Thre
Spe
Van
R. U
Fift
Typ
Koo
Mag
Ope
Six
Prim
Don

Su
Fift
Thir
Bea
Gly
B
Fift
Typ
Mag
Mag
Koo
T
wins

Ju
mile
Fom

Fift

Six

T
DAS

Ju
cour
Thir

THE YACHTS AND YACHTSMEN OF AMERICA

31

Sailing Class,	Sailing Length.	Start. U. S.	Allowances. U. S.	Actual Corrected Time.		Remarks.
				U. S. S.	U. S. S.	
Third Class,						
Beatrice	30.11	3 15	23.49	2 12 10	1 48 21	1st prize \$15
Ustane	27.30	3 15	20.46	2 20 00	1 33 11	2d prize \$10
White Fawn	30.11	3 15	23.49	2 18 25	1 34 36	3d prize \$5
Posy	30.70	3 15	24.03	2 25 17	2 01 11	
Sadie	30.11	3 15		2 28 45		
Gipsy	28.80	3 15				did not finish.
Asp	8 15					" "
Fourth Class,						
Thrush, c. b.	3 20			1 45 29		1st prize \$7.50
Special Class,						
Vanessa, 10	24.30	3 20	23.02	1 47 12	1 24 10	1st prize \$15
R. D. keel	3 20					
Fifth Class,						
Typhoon	29.00	3 25	23.26	1 47 11	1 23 48	1st prize \$15
Koorali	23.40	3 25	24.01	1 51 03	1 27 59	2d prize \$10
Magpie	22.40	3 25	24.39	1 53 38	1 28 59	3d prize \$5
Opechee	22.20	3 25	24.18	1 54 30	1 29 42	
Sixth Class,						
Primrose	17.11	3 30	25.02	1 30 50	1 10 18	1st prize \$10
Don	20.30	3 30	22.50	1 40 15	1 17 25	

September 17th: Sail off. Course for Third Class, 9 miles; for Fifth Class, 7 miles. Wind northwest, fair.

Third Class, C. B.		
Beatrice	30.11	2 05
Gipsy	28.80	2 05
		25.31

BEATRICE wins championship.

Fifth Class.		
Typhoon	29.00	2 00
Madge	23.00	2 00
Magpie	22.40	2 00
Koorali	23.40	2 00
		24.01

TYPHOON wins championship; also special prize of \$15. MADGE wins 2d prize, \$10. MAGPIE withdrew, having fouled MADGE.

Beatrice, centerboard, wins Championship in 3rd Class.		
Typhoon	"	"
Mab	"	"
Alpha	"	"
Vanessa	"	"
		special

THE SEASON OF 1893.

June 15th: Northeast wind; nasty weather. Length of course; 7 miles.

Fourth class, jib and mainsail sloops.		
	Sailing length.	Elapsed Time.
	Feet.	U. S. S.
		Corrected Time.
		U. S. S.

Santa Maria		declared off
Vanessa		declared off

Fifth class, cut-boats.		
Hazelorn	20.30	48 42
Opechee	22.20	49 13

Sixth class, cut-boats.		
Dandelion	18.11	55 05

The winners were VANESSA (in sail over), HAZELORN and DANDELION.

July 1st: Strong, southeast, shifting to southwest wind. Length of course, 9 miles.

Third class, sloops.		
Hiladee	27.10	1 37 31
Gipsy	28.80	1 42 09
Moodyne	25.00	1 40 58
Beatrice	30.11	1 34 31
White Fawn	30.11	1 30 03

Sailing Class,	Sailing Length.	Elapsed Time.	Corrected Time.
Fourth class, jib and mainsails; 7 miles.			
Exile	26.50	1 20 31	59 10
Vanessa	24.30		withdrew

Fifth class, cut-boats; 7 miles.		
Aurisa	21.60	1 27 11
Magpie	22.40	1 29 25
Hazelorn	22.50	1 30 05
Opechee	22.20	1 34 38
Koorali		withdrew

Sixth class, cut-boats; 7 miles.		
Primrose	17.11	1 25 29
Don	20.30	1 32 27
Mab	17.20	withdrew
Dandelion	18.40	withdrew

Special Handicap class, cuts and sloops; 7 miles.		
Joker		1 18 09
Vanlal		1 16 16
Santa Maria		1 19 56
Wapiti		1 45 00

The winners were HILADEE, EXILE, AURISA, PRIMROSE and JOKER.

July 22d: Whole sail easterly wind and fine weather. Third class, sloops; 9 miles.

Beatrice	30.11	1 19 21
Hiladee	27.10	2 03 16
Posy	25.11	2 06 17
Moodyne		2 35 00

Fourth class, jib and mainsails; 7 miles.		
Vanessa	24.30	1 20 21

Special handicap class, sloops and cut-boats; 7 miles.		
Joker		1 19 30
Wapiti		1 30 03
Santa Maria		1 21 20
Vanlal		1 23 06
Mabel D.		1 29 21

Fifth class, cut-boats; 7 miles.		
Magpie	20.40	1 29 30
Hazelorn	20.00	1 32 11
Koorali	24.30 1/2	1 32 05
Aurisa	21.60	1 37 15
Opechee	20.30	1 38 39

Sixth class, cut-boats; 6 miles.		
Mab	17.20	1 16 20
Dandelion	18.40	1 23 22

The winners were BEATRICE, VANESSA, JOKER, MAGPIE and MAB.

August 5th: strong, southwest wind. Third class, sloops; 9 miles.

Beatrice	30.11	1 19 50
Moodyne		1 20 31
White Fawn	30.11	1 25 28
Gipsy	28.80	1 27 10

Fourth class, jib and mainsails; 7 miles.		
Vanessa	29. 7	1 10 22

Fifth class, cut-boats; 7 miles.		
Aurisa	21.60	1 08 40
Opechee	20.30	1 11 31
Magpie	20.10	1 12 01
Hazelorn	20.00	1 15 51

Sixth class, cut-boats; 7 miles.		
Mab	17.20	not taken

The winners were BEATRICE, VANESSA, AURISA and MAB.

August 28th: Wind southwest, shifting to south. Third class, sloops; 9 miles.

Beatrice	30.11	1 34 33
Hiladee	27.30	1 57 03
White Fawn	30.11	1 59 33
Gipsy	28.80	withdrew

Fourth class, jib and mainsails; $\frac{1}{2}$ miles.

	Sailing Length.	Elapsed Time.	Corrected Time.
	Feet.	H. M. S.	H. M. S.
Exile	26.5	1 30 26	1 00 02
Euhlie	27.5	1 28 54	1 10 40
Vanessa	29.7	disabled	

Fifth class, cut-boats; $\frac{1}{2}$ miles.

Maggie	20.1	1 40 32	1 15 53
Opedee	20.3	1 40 57	1 13 15
Aurisa	21.0	1 43 13	1 16 45
Hugelom	20.0	1 45 27	1 18 31

Sixth class, cut-boats; $\frac{1}{2}$ miles.

Mab	17.6	1 12 57	1 13 15
-----	------	---------	---------

September 4th: Race complimentary to the CORINTHIAN YACHT CLUB (of Marblehead), on occasion of their visit to the HULL YACHT CLUB. Wind northwest, strong. Length of course, $3\frac{1}{2}$ miles. Special Handicap Class.

	Elapsed Time.	Corrected Time.
	M. S.	M. S.
Vandal	48 08	43 08
Frances	50 51	44 41
Ariel	52 18	45 18
Santa Maria	48 52	45 52
Vanessa	47 00	47 00

The winners were BEATRICE, EXILE, MAGGIE, MAB and VANDAL.

BIOGRAPHICAL SKETCHES AND DESCRIPTION OF YACHTS ENROLLED IN THE CLUB.

LEWIS J. BIRD, Commodore of the HULL YACHT CLUB, is a native of Boston; is the son of Matthew and Sarah Bird, and he traces his ancestry back to Plymouth Rock. Is at present the owner of the yacht SEA BIRD and has owned the schooners PEERLESS and EDITH; the steam yachts CREEDMOOR and ARCOON, and others. Has been interested in yachting for forty years, a veteran in the service, and is a member of the BOSTON and HULL YACHT CLUBS.

SEA BIRD.

SEA BIRD is a screw schooner belonging to Lewis J. Bird of Boston, Mass. She was designed by the Boston Yacht Agency and was built by W. K. Pryor & Co. She was built for Commodore Bird, and was launched in May, 1892. She has a cabin, hails from Boston, and sails with the HULL and BOSTON YACHT CLUBS.

DIMENSIONS.

Length over all,	95 feet 6 inches.	Length load waterline,	78 feet.
Depth,	7 feet 6 inches.	Draft,	7 feet.
Beam,	15 feet.		

Engine: Condensing, inverted, vertical; 2 cylinders, 10 in. and 20 x 14 inches. E. S. Clark, Boston. Stroke of piston, 14 inches. Actual horse power, 200, indicated horse power, 290.

Boiler: Almy water tube, Providence, R. I.

Speed: 14 knots per hour.

NOW THEN.

The screw schooner NOW THEN was designed and built by Herreshoff in 1887. She was built for Norman L. Monroe. Since July, 1890, she has belonged to J. Edward Addicks of Boston, Mass. She has never been altered, save in the changing of her color from black to white. She hails from Boston and sails with the NEW YORK and EASTERN YACHT CLUBS. In a run of 175 miles, NOW THEN has made 23 miles per hour. See Fig. 343.

CODE SIGNAL LETTERS, K. D. S. Q.

Official Number, 430,374.

DIMENSIONS.

Length over all,	86 feet.	Length load waterline,	85 feet.
Depth,	6 feet.	Draft,	6 feet.
Beam,	10 feet.		

Engines: Triple expansion, 3 cylinders, $1\frac{1}{2}$ in., 12 in. and 19 x 10 $\frac{1}{2}$ inches. The Herreshoff M'g Co. Stroke of piston, 10 1-3 inches.

Boiler: One tubular, 1891. The Herreshoff M'g Co. indicated horse power, 375.

VANESSA.

A fin-keel sloop, owned by A. Bigelow, Jr., built in 1892, at Bristol, R. I. by the Herreshoff M'g Co. Was designed by N. G. Herreshoff. She sails with the HULL YACHT CLUB. See Fig. 344.

DIMENSIONS.

Length over all,	30 feet 6 inches.	Length load waterline,	29 feet 10 inches.
Draft,	5 feet 6 inches.	Beam,	6 feet 10 inches.

Racing Record for 1892:—

EASTERN YACHT CLUB—Fourth in a Special Invitation Race; ALPHA first, CATSPA W and REAPER.

MASSACHUSETTS YACHT CLUB—Second in the Annual Open Race sailed June 17th; ALPHA first, VANESSA beating EXILE, REAPER, KOORALI, etc.

QUINCY YACHT CLUB—VANESSA beat EXILE in the City of Quincy Regatta held July 4th. Beaten by ALPHA, August 13th.

HULL YACHT CLUB—VANESSA beat both R. D. and ASP in a Club Race held June 16th. Was third in a Special Open Sweepstakes, June 25th; ALPHA first and CATSPA W second. Won in her class July 2nd. Club Race, July 16th; she won again, defeating R. D., TADPOLE and ASP. Beat R. D. again August 12th. Was second (ALPHA first) in a race sailed August 31st, with seven starters, among them being EXILE, REAPER, etc. Won in her class, September 12th.

CORINTHIAN YACHT CLUB (of Marblehead)—Fifty-ninth Regatta, June 18th; VANESSA was second to ALPHA's first, with nine starters. Second, with REAPER first, in the Sixty-second Regatta sailed August 2nd, CATSPA W, FREAK, THRESH and PYXIE following. Fourth in the Sixty-fourth Regatta, August 18th; REAPER first, EXILE second, FREAK third. Third in the Sixty-fifth Regatta, August 19th, FREAK first, REAPER second; nine starters. Second, REAPER first in the Sixty-sixth Regatta, August 20th.

HULL CORINTHIAN YACHT CLUB—In the Club Regatta of July 23d, VANESSA was third, beaten by ALPHA and CATSPA W. Fourth, September 3d.

JACOB FRED'K BROWN, wool commissioner, Boston, Mass.; the son of Jacob B. and Anna A. Brown; born in Newburyport, Mass., August 30th, 1862. The last yacht owned by Mr. Brown was ALPHA, which he sold to E. J. Phelps of Minnetonka. He has owned several other yachts; the cats RESOLUTE and NTOBE, a part owner of the cat MABEL, and TARTAR and BANNERET. Has been a yachtsman at heart since he was eleven years old and was the owner of RESOLUTE at thirteen. A member of the HULL and QUINCY YACHT CLUBS.

ALPHA.

The centerboard jib and mainsail yacht ALPHA is the property of J. F. Brown, J. L. Deering and A. P. Hunt. She was designed and built by the Herreshoff M'g Co. for the above-named gentlemen. Was launched May, 1892. She has no cabin, hails from Hull, and sails with the fleets of the HULL, QUINCY and SAVIN HILL YACHT CLUBS. See plate LXV. and Fig. 345.

YACHT
YACHT
miles.

CANDAL.

ee; At-

en Race
E. REA-

Quincy
.

a Club
epstakes.
n in her
defeating
h. Was
th seven
i in her

Regatta,
ith nine
Regatta
XIE fol-
st 18th;
e Sixty-
nd; nine
tta, Au-

July 23d,
Fourth.

ass.; the
uryport,
own was
as owned
t owner
been a
e owner
QUINCY

perty of
ned and
btlemen.
and sails
CLUBS.



COMMODORE LOUIS J. BIRD.

HULL YACHT CLUB.

C
o
M
M

D
O

A
he

o

F
L
P
u
r

318
the
V.A

C

G.
187
for

cabi
S
SETT

L
D

T
She v
the I

L
D

The
for W
Isham
seven

Lawle
TOS. I
YACH

Len
Draf

DIMENSIONS.			
Length over all,	28 feet 4 inches.	Length load waterline,	19 feet 4 inches.
Depth,	1 foot 4 inches.	Draft,	2 feet 10 inches.
Beam,	8 feet.		

Recently sold to E. J. Phelps of the MINNETONKA YACHT CLUB.

RACING RECORD FOR 1892.

She has never been fairly beaten in a race, and the one defeat charged against her out of sixteen contests was when she was ruled out for a technical violation of the rules.

In the first race, under the auspices of the QUINCY YACHT CLUB, May 28th, ALPHA had an easy victory, beating the old 25-footer, MOONBYNE.

In the Open Race of the SOUTH BOSTON YACHT CLUB on Memorial Day, ALPHA easily beat EXILE.

On June 15th, 16th, 17th and 18th she won four straight victories. On the 16th she beat CATSPAW, VANESSA, R. D. and ASP.

In the HULL YACHT CLUB Race on June 27th, ALPHA won easily. Again she won on July 3d. On the 4th of July, even after dipping her centerboard, she beat VANESSA and SPIRT.

She won in the HULL CORINTHIAN YACHT CLUB Race on the 24th of July, beating CATSPAW, VANESSA, THURSH and EXILE.

On July 28th, in the EASTERN YACHT CLUB Race, ALPHA met BREAK for the first time, and won on corrected time. In the BEVERLY YACHT CLUB Race on July 29th, she finished 11 seconds ahead of BREAK, but was protested by the latter because, in changing jibs, she used two sets of jib halyards. The protest was allowed and ALPHA ruled out.

In the Open Race of the HULL YACHT CLUB off Nahant, August 31st, ALPHA won without difficulty. She won on September 3d in the HULL CORINTHIAN YACHT CLUB Race, beating EXILE, ROMANCE, VANESSA and ASP.

SHADOW.

Centerboard sloop owned by John Bryant, M. D., designed by N. G. Herreshoff and built by J. B. Herreshoff, at Bristol, R. I., in 1871. Has been the property of Dr. Bryant for 17 years. Owned formerly by Chas. Randal, C. Crowningshield and others. Has a cabin and hails from Cohasset. See Fig. 346.

Sails in the fleet of the ATLANTIC, BOSTON, EASTERN, MASSACHUSETTS, BEVERLY, HULL and LARCHMONT YACHT CLUBS.

Official number, 23,972.

DIMENSIONS.			
Length over all,	37 feet.	Length load waterline,	31 feet 11 inches.
Draft,	5 feet 4 inches.	Beam,	11 feet 4 inches.

THURSH.

THURSH is an open centerboard sloop, owned by Dr. John Bryant. She was built in 1892 by A. McVey of South Boston. She sails with the HULL YACHT CLUB. See Fig. 347.

DIMENSIONS.			
Length over all,	30 feet.	Draft,	2 feet.
Beam,	12 feet.		

ECHO.

The yacht ECHO is a keel sloop, built and designed by Pierce Bros. for William Preston. She is now owned by E. L. Barwell and F. N. Isham of Lynn, Mass. She has been owned by these gentlemen for seven years. Was launched in 1876 and had her keel deepened by Lawley in 1886. She hails from Hull and sails with the SOUTH BOSTON, HULL, HULL CORINTHIAN and CORINTHIAN (of Marblehead) YACHT CLUBS. See Fig. 348.

DIMENSIONS.			
Length over all,	27 feet 6 inches.	Length load waterline,	21 feet 9 inches.
Draft,	5 feet 6 inches.	Beam,	10 feet 6 inches.



WILLIAM A. CARY.

WILLIAM A. CARY, Solicitor-in-Probate, etc., Boston, Mass.; born in 1849. His birthplace was the town of Roxbury—now a part of Boston. The son of Nathan C. and Frances T. Cary. He is a direct descendant of John Cary who came from England in 1635. Mr. Cary was the owner of the yacht CUBA KET, and when her sailing master, won many prizes. Has been connected with yachting since 1868, and has the honor of being one of the nine founders of the HULL YACHT CLUB, which was organized in 1880. For many years he has served on the Regatta Committee of this club, and was the Chairman of the Building Committee which built the present Club House. He has been the secretary of the club ever since 1887. He commands Company C of the Massachusetts Naval Militia.



WILLIAM H. CRANE.

WILLIAM H. CRANE, actor, Cohasset, Mass., was born in Leicester, Mass., April 30th, 1845, the son of A. B. and Mary S. Crane. He was one year Vice-Commodore of the HULL YACHT CLUB, and is the owner of THE SENATOR, formerly MELISSA. He has also owned the schooners ENIGMA and YIP, and the steamer TANTALUS. Has been interested in yachting for fifteen years and is a member of the HULL and EASTERN YACHT CLUBS.

THE SENATOR.

The SENATOR is a screw schooner, formerly MELISSA. Designed by Edward Burgess and built by Geo. Lawley & Son, South Boston, Mass. She was launched in April 1891. She hails from Boston and sails with the HULL and EASTERN YACHT CLUBS.

Official number, 92,274.

DIMENSIONS.			
Length over all,	81 feet.	Length load waterline,	61 feet.
Depth,	6 feet 7 inches.	Draft,	6 feet.
Beam,	13 feet 9 inches.		

Engine: Vertical condensing, 3 cylinders, 8 in., 12 in., and 20 x 12 in. Fore River Engine Company.

Boiler: Army water tube, Providence, R. I.

MARIPOSA.

The centerboard sloop MARIPOSA was formerly known by the name of BOXBOY. She was built by H. C. Lambert in 1880 and is owned by A. D. Crowell. Sails with the HULL YACHT CLUB. See Fig. 349.

DIMENSIONS.			
Length over all,	28 feet 10 inches.	Length load waterline,	25 feet 4 inches.
Draft,	3 feet.	Beam,	11 feet 1 inches.

JESTER.

JESTER is a cat-yawl (centerboard) owned by Allan M. Davis of Boston, for whom she was built by W. K. Pryor & Co. in 1891, being launched in June. Her designer was Jefferson Borden. JESTER hails from Boston and sails with the SAVIN HULL and HULL CORINTHIAN YACHT CLUBS. See Fig. 350.

DIMENSIONS.			
Length over all,	31 feet.	Length load waterline,	21 feet.
Draft,	3 feet.	Beam,	9 feet 6 inches.

GORDON DEXTER of Boston, Mass., the owner of the center-board cutter **HAWK**, is a member of the **EASTERN, BEVERLY, CORINTHIAN** and **HULL YACHT CLUBS**. Few yachtsmen are better known than Mr. Dexter, and few yachts are more widely known than **HAWK**.

HAWK.

A centerboard cutter, built for her present owner, Gordon Dexter, of Boston, Mass., by Geo. Lawley & Son, and designed by Edward Burgess. She was launched in 1890, and has never been altered. She sails with the **EASTERN, HULL, BEVERLY** and **CORINTHIAN** (of Marblehead) **YACHT CLUBS**. She hails from Beverly. See Fig. 351.

Official number, 96,110.

DIMENSIONS.

Length over all,	40 feet 3 inches.	Length load waterline,	29 feet 11 inches.
Draft,	5 feet.	Beam,	11 feet.

Racing Record for 1891:—

EASTERN YACHT CLUB—**HAWK** was a winner in the Handicap Race of May 30th, defeating **FANCY** and **SALADIN**. On June 29th and July 22nd **MILDRED** defeated her, and an accident befell **HAWK** in the last race.

BEVERLY YACHT CLUB—**HAWK** won the First Marblehead Championship on August 1st; but on the 5th of September in the 118th Race she was vanquished by **FANCY**; however, **HAWK** took championship of her class.

CORINTHIAN (of Marblehead) **YACHT CLUB**—**HAWK** was first in the Forty-eighth Regatta, held on June 20th, on which date she out-sailed **FANCY** and **SALADIN**. Again in the Fifty-second Regatta of August 8th she won, beating among others her old rival, **MILDRED**, who in turn revenged herself by winning from **HAWK** on September 12th, at the Fifty-eighth Regatta.

Racing Record for 1892:—

EASTERN YACHT CLUB—**HAWK** won a prize of \$50 in the Handicap Race of June 18th, sailed under the auspices of this club, beating **NANCY, CHAPOQUOIT** and **HANSEL**.

CORINTHIAN (of Marblehead) **YACHT CLUB**—A winner in her class in the Sixty-first Regatta of this club. Beat **FANCY**, September 5th, in the Sixty-eighth Regatta of the same club.

**FRANK L. DUNNE.**

FRANK L. DUNNE of Boston, Mass., was born in Louisville, Ky. He is the owner of the open sloop yacht **IDLER**, and has in time past been the possessor of such boats as **NIobe, TARTAR, MABEL** and **ALPHA**. Has been interested in yachting for ten years. He is a member of the **MASSACHUSETTS, HULL** and **QUINCY YACHT CLUBS**.

IDLER.

A centerboard open sloop, the property of **FRANK L. DUNNE**. **Frank L. Dunne** of Boston, Mass., having belonged to him since July, 1891, the time of her launching. She was designed and built by C. C. Hanley, Monument Beach, Mass., for her present owner. She hails from Hull, Mass., and sails with the **HULL, MASSACHUSETTS** and **QUINCY YACHT CLUBS**. See Fig. 352.

DIMENSIONS.

Length over all,	21 feet 9 inches.	Length load waterline,	20 feet 3 inches.
Draft,	2 feet 6 inches.	Beam,	10 feet.

Sprs: Mast, 38 feet; Boom, 31 feet; Gaff, 20 feet.

Racing Record:

1891: **MASSACHUSETTS YACHT CLUB**—**IDLER** won four firsts this season, once she was badly beaten. She was first in the 143d Race, held September 12th, in which race she beat **CAPRICE**. In the Third Championship Race of the **QUINCY YACHT CLUB**, she defeated **VISION, SCAMP** and **HELEN**, and in the Championship Sail

Off of August 25th, she came in ahead of her only competitor **MADGE**. She was also a winner in the Open Races of the **DORCHESTER YACHT CLUB**, July 25th, on this occasion winning from **ARK** and **CAPRICE**.

1892: **HULL YACHT CLUB**—**IDLER** won in her class in the Club Race sailed July 16th, beating **KOORALI, MADGE**, etc.

**HERMAN W. FRIEND.**

HERMAN W. FRIEND of Boston, Mass., was born in Gloucester, of English descent. Has been interested in yachting for ten years, and has been the owner of three yachts, **ARAB, VAGA** and **VANDAL**, the last of which is still in his possession. He was for three years on the Membership Committee of the **HULL YACHT CLUB**, and for three years Assistant Secretary, which office he still holds. He is a member of the **MASSACHUSETTS, HULL** and **CORINTHIAN** (of Marblehead) **YACHT CLUBS**.

VANDAL.

A keel cutter, formerly known as **ADELE**, designed and built by Geo. Lawley & Son, and launched in 1888. She has belonged to **HERMAN W. FRIEND**, of Boston, Mass., for three years. Her cabin has been refitted, and she hails from Hull. She sails with the **HULL, MASSACHUSETTS** and **CORINTHIAN** (of Marblehead) **YACHT CLUBS**.

DIMENSIONS.

Length over all,	21 feet 6 inches.	Length load waterline,	22 feet.
Draft,	4 feet 6 inches.	Beam,	9 feet 2 inches.

VANDAL, under the charge of Capt. Moulton of yacht **WAYWARD**, had a very severe test in the winter of 1890, sailing from Baltimore to Boston, encountering most severe storms. The Captain was taken from the yacht exhausted. In telling the story, he always finishes by remarking that "the snow was eight feet deep in the cockpit."

HANSEL.

A fin-keel sloop belonging to **JAMES R. HOOPER** of Boston, Mass. She was designed and built by the **Herreshoff Mfg. Co.** for her present owner, and was launched in May, 1892. She has a cabin, hails from Boston, and sails with the **EASTERN** and **HULL YACHT CLUBS**. See Fig. 353.

Official number, 96,177.

DIMENSIONS.

Length over all,	41 feet 6 inches.	Length load waterline,	29 feet 6 inches.
Draft,	7 feet 9 inches.	Beam,	9 feet 6 inches.

Racing Record, 1892:—

EASTERN YACHT CLUB—**HANSEL** won 1st Prize of \$50 in the Opening Race, May 30th, racing with **HAWK** and **FANCY**. Second in the Handicap Race of June 18th, with **HAWK** first, four starters, **CHAPOQUOIT** third. First in the Annual Regatta, June 27th, winning prize of \$50, defeating **HAWK** and **FANCY**.

MASSACHUSETTS YACHT CLUB—**HANSEL** beat **CHAPOQUOIT** in the Annual Open Race, June 17th.

HULL YACHT CLUB—**HANSEL** beat **CHAPOQUOIT** in the Club Race sailed July 2d, and again on August 2d. On August 4th, she again defeated **CHAPOQUOIT**, winning the first prize, the Rice Cup, valued at \$150, and also the championship of her class.

POSY.

A centerboard sloop, formerly **FANNY**, was designed by **J. B. Herreshoff** and built by the **Herreshoff Mfg. Co.** in 1866 at Bristol, R. I. She was formerly rigged as a cat-boat, but was altered to sloop rig in 1891; has been altered several times. She is at present the property of **Russell G. Hunt** and **Fred T. Hunt**, and hails from Wey-

mouth, Mass., sailing with the HULL, BEVERLY, QUINCY, MONAQUOT and CORINTHIAN (of Marblehead) YACHT CLUBS. See Fig. 354.

DIMENSIONS.

Length over all,	20 feet.	Length load waterline,	21 feet 8 1/2 inches.
Beam,	11 feet 10 inches.	Draft,	3 feet.

Racing Record, 1891:

MASSACHUSETTS YACHT CLUB—POSY was first in the 135th Race sailed June 17th, beating WHITE FAWN, GOOD LUCK, MOONDYNE, USTANE; thirteen starters.

QUINCY YACHT CLUB—Second Championship Race, July 29th. POSY won from ERIN, WHITE FAWN and MOONDYNE. In the 102d Regatta, which took place August 29d, POSY defeated ERIN and ADOLPH. Beaten by WHITE FAWN, August 25th.

CHAS. H. JONES, manufacturer of boots and shoes, Boston and West Falmouth, Mass., was born in Ashfield, Mass. in 1855. He is the owner of the yacht CHAPOQUOT, and has also owned the yachts GWENDOLYN and ALMIRA. Has been a yachtsman for four or five years, and is a member of the HULL, CORINTHIAN, CORINTHIAN (of Marblehead), BEVERLY and NEW BEDFORD YACHT CLUBS.

CHAPOQUOT.

A cabin cut-bout, belonging to Chas. H. Jones, of Boston. She was designed and built by C. C. Hanley for her present owner, being launched in 1892. She is a centerboard yacht, and hails from West Falmouth, Mass. She sails with the CORINTHIAN (of Marblehead), HULL, CORINTHIAN, BEVERLY and NEW BEDFORD YACHT CLUBS. See Fig. 355.

DIMENSIONS.

Length over all,	42 feet.	Length load waterline,	29 feet 10 inches.
Draft,	2 feet 10 inches.	Beam,	11 feet 4 inches.

Spars: Mast, 50 feet; Boom, 45 feet; Gaff, 28 feet.

Racing Record, 1892:

EASTERN YACHT CLUB—CHAPOQUOT was second (HAWK first) in the Handicap Race of June 18th.

MASSACHUSETTS YACHT CLUB—Second, with HANDEL first, in the Annual Open Race, sailed June 17th.

BEVERLY YACHT CLUB—First in the 187th Race, July 29th. In this race she won from HAWK, HANDEL, etc., though she would probably not have been the first boat had not both the two mentioned lost the mark in the dense fog. She was beaten by FIN in the 193d Race, sailed September 5th.

NEW BEDFORD YACHT CLUB—CHAPOQUOT won in the race sailed July 20th. There were five other entries.

HULL YACHT CLUB—HANDEL beat CHAPOQUOT in the Club Race of July 2d. Then HANDEL repeated the defeat twice in succession, August 3d and 4th.

TROUBADOUR.

A centerboard schooner, the property of William L. Lockhart of Boston. She was formerly known as MARION WESTWORTH. Was designed by J. Dahl and built by D. D. Kelly & Son, Boston, being launched in 1881. Hails from Boston, and sails with the fleet of the HULL, BOSTON and MASSACHUSETTS YACHT CLUBS. See Fig. 358.

CODE SIGNAL LETTERS, K. D. Q. J.

Official number, 91,346.

DIMENSIONS.

Length over all,	97 feet 2 inches.	Length load waterline,	88 feet 4 inches.
Depth,	7 feet.	Draft,	8 feet.
Beam,	24 feet 2 inches.		

MYSTERY.

A cutter, formerly a keel sloop, owned by Henry W. Lamb of Bos-

ton, but now the property of Albert A. Pope. She was designed and built by A. E. Smith, Islip, N. Y., and was launched in 1882. She sails with the HULL YACHT CLUB, and hails from Boston. See Fig. 359.

CODE SIGNAL LETTERS, J. W. F. M.

Official number, 91,454.

DIMENSIONS.

Length over all,	61 feet 8 inches.	Length load waterline,	58 feet.
Depth,	6 feet 7 inches.	Draft,	19 feet.
Beam,	18 feet 1 inch.		



JOHN H. MCGRADY. A screw steamer, designed and built by the Bath Shipbuilding Company, and launched in 1878. She is now the property of John H. McGrady, Boston, Mass. She hails from Boston, and sails with the HULL and QUINCY YACHT CLUB.

Official number, 140,316.

DIMENSIONS.

Length over all,	50 feet.	Beam,	10 feet.
Depth,	3 feet 4 inches.	Draft,	4 feet.

Engine: Condensing, one cylinder, 6x12 inch.

Boiler: One tubular, 4 ft. 8 in. by 3 ft. 6 in. Portland Iron Works.

VERGO.



DAVID PAUL RICE. WAS designed by the late David Hall Rice, a lawyer of Boston, Mass., and was built by Moses Adams, being launched in 1892 at Essex, Mass. She was the property of Mr. Rice up to the time of his death, and sailed with the HULL and MASSACHUSETTS YACHT CLUBS of which Mr. Rice was a member. Her owner since 1875, he was actively interested in yachting and endeavored to enhance yacht designing and interest in yachting at every opportunity. He was a man who was respected by all who knew him. For Argo see Fig. 57.

DIMENSIONS.

Length over all,	79 feet.	Length load waterline,	75 feet.
Depth,	8 feet 6 inches.	Draft,	9 feet.
Beam,	16 feet 6 inches.	Main mast,	65 feet 13 inches.

MABEL.

A cut-boat, built and designed in 1875 by Pierce Bros., South Boston, for Commodore Roberts, of the SOUTH BOSTON YACHT CLUB, who sailed her until 1884, when she became the property of Mr. Geo. R. Howe. Mr. F. L. Dunne purchased her in 1886, and it was during the year 1888 that she made the great record of 13 firsts and 2 seconds out of 15 starts.

In 1890, Mr. H. L. Rice of Quincy, Mass., became her owner. She was sold in 1889 to E. A. Sumner, of New York City. She was perhaps, for fifteen years, the fastest of her type and size in Boston waters. She is a centerboard, and now hails from Boston, Mass., sailing with the INDIAN HARBOR YACHT CLUB. See Fig. 360.

DIMENSIONS.

Length over all,	22 feet 4 inches.	Length load waterline,	19 feet 3 1/2 inches.
Draft,	2 feet.	Beam,	9 feet 4 inches.

Spars: Mast, 30 feet; Boom, 29 feet; Gaff, 17 feet.

RACING RECORD.

In 1886 MABEL won six firsts and was disabled once in seven races. In May, 1887, she took six firsts, eight seconds and one fourth, sailing against jib and mainsail boats. In 1888 she took thirteen firsts and two seconds in fifteen races.

EDWIN B. ROGERS, manufacturer of shoes, Newton, Mass., was born in Cape Cod in 1839. His present yacht is EUREKA, and he has also been the owner of ARIADNE, WAVE CREST and ELITE, the last of which, with EUREKA, was built for his use. Has taken an active interest in yachting for twenty years, and is a member of the HULL, WINTHROP—formerly GREAT HEAD—and HULL CORINTHIAN YACHT CLUBS.

EUREKA.

A centerboard open sloop, designed by Jefferson Borden and built by W. K. Pryor & Co., South Boston, Mass., being launched in 1889. She hails from Boston, and sails with the fleets of the HULL, WINTHROP and HULL CORINTHIAN YACHT CLUBS. Owned by Edwin B. Rogers. See Fig. 361.

DIMENSIONS.

Length over all,	25 feet.	Length load waterline,	19 feet 6 inches.
Depth,	30 inches.	Draft,	18 inches.
Beam,	10 feet.		

Mast, 32 feet; Boom, 26 feet; Gaff, 19 feet; Bowsprit, 23 feet. Racing Record, 1891:—

BUNKER HILL YACHT CLUB—Fourth in the race, June 21st, with six starters. Again fourth in a similar race of the same club held on July 12th, with four starters. QUINCY YACHT CLUB, Championship Race, June 27th: second, three starters, ERIN winning. She has an easy rate of 8 miles an hour.

FOLLY.

A centerboard sloop owned by Joel P. Sheppard who built her in 1874. She hails from East Braintree, Mass., and sails with the HULL YACHT CLUB. See Fig. 362.

DIMENSIONS.

Length over all,	28 feet, 8 inches.	Length load waterline,	26 feet, 4 inches.
Draft,	2 feet 6 inches.	Beam,	11 feet.

EXILE.

A centerboard open sloop, owned by J. S. Small of Dorchester, Mass. She was designed by him, and built by Charles Jenkins, Harwich Port, Mass. She hails from Boston and sails with the DORCHESTER, MASSACHUSETTS, QUINCY, CORINTHIAN (of Marblehead) and MOSQUITO FLEET YACHT CLUBS. See Fig. 363.

DIMENSIONS.

Length over all,	29 feet 1 1/2 inches.	Length load waterline,	29 feet 0 inches.
Draft,	1 foot 6 inches.	Beam,	11 feet.

Spars: Mast, 37 feet; Boom, 32 feet; Gaff, 21 feet; Bowsprit, 14 feet.

Racing Record for 1892:

MASSACHUSETTS YACHT CLUB—EXILE won from CAPRICE in the 147th Race, sailed at Dorchester, September 14th.

BEVERLY YACHT CLUB—EXILE was third in the 187th Race held July 29th. FREAK first, CATSPAW second, with thirteen starters.

HULL YACHT CLUB—Beat CATSPAW in the Club Race of July 16th. Third in the Subscription Race of August 31st with seven starters.

CORINTHIAN YACHT CLUB (of Marblehead)—Second in the Sixty-fourth Regatta, August 18th. Ten starters; REAPER first by a little over two minutes. First in the Sixty-eighth Regatta, September 5th, beating REAPER and FREAK.

HULL CORINTHIAN YACHT CLUB—Second (ALPHA first) in the Open Race sailed September 3rd, with five starters.

So far EXILE had been entered in five regattas and taken first prize in each one.

Four of these were for cash prizes, and the other was a log for the Championship Cup of the DORCHESTER YACHT CLUB. Among the crack yachts she defeated in these events are VENESSA, THURSH and ROMANCE.

At the Open Regatta of the CAPE ANN YACHT CLUB, July 8th, EXILE beat her nearest competitor over half an hour.



SAMUEL N. SMALL.

SAMUEL N. SMALL, yacht designer, Boston, Mass., was born in Harwich, Mass.; the son of Samuel and Mary B. Small. Has been the owner of the yachts MEMENTO, STAR, TRANSIT, and his present yacht, the sloop USTANE. Was the designer of USTANE, MEMENTO and TRANSIT. For four years Mr. Small has taken a deep interest in yachting and is a member of the HULL, SAVIN HILL, CORINTHIAN, MOSQUITO FLEET and CAPE COD YACHT CLUBS.

USTANE.

USTANE is a centerboard sloop owned by her designer, Samuel N. Small, of Boston, Mass. She was built by Boyles, East Boston, Mass. She was launched in August, 1889, and hails from Boston. She sails with the HULL, CORINTHIAN, MOSQUITO FLEET, SAVIN HILL and CAPE COD YACHT CLUBS. See Fig. 364.

DIMENSIONS.

Length over all,	25 feet.	Length load waterline,	21 feet.
Depth,	4 feet 10 inches.	Draft,	3 feet 10 inches.
Beam,	11 feet 4 inches.		

HENRY P. SMITH, Rear-Commodore of the HULL YACHT CLUB in 1892, is a merchant in the City of Boston, Mass. He was born in Salem, Mass., December 6, 1854. The owner of the schooner BOHEMIAN and also of the yacht CLOWA. He has held the office of Rear-Commodore of the HULL YACHT CLUB for two years, and has been interested in yachting for fifteen years. He is a member of other clubs as well as the one in which he holds his office, viz., the CORINTHIAN (of Marblehead), MASSACHUSETTS (of Boston) and the HULL CORINTHIAN.

BOHEMIAN.

Keel schooner, formerly called CAROLINE; designed by D. J. Lawler and built by W. L. Dolbeare, Boston, Mass. Built for a Mr. Norton, but now the property of Rear-Commodore Henry P. Smith of the HULL YACHT CLUB. BOHEMIAN was launched in 1880 and has been owned by Rear-Commodore Smith for three years. She has a cabin and hails from Boston. See Fig. 365.

CODE SIGNAL LETTERS, K. D. C. G.

Official number, 125,811.

DIMENSIONS.

Length over all,	53 feet 2 inches.	Length load waterline,	46 feet 3 inches.
Depth,	7 feet.	Draft,	7 feet 6 inches.
Beam,	15 feet 3 inches.		

the Sixty-
first by a
cutta, Sep-

t) in the

taken first

eg for the
mong the
arsit and

July 8th,

designer,
Harwich,
Mary B.
the yachts
his pres-
Was the
nd TRAN-
has taken
s a mem-
L, COIN-
CAPE COD

Samuel N.
st Boston.
m Boston.
ET, SAVIN

et,
et 10 inches.

L. YACHT
Mass. He
mer of the
e has held
B for two
s. He is a
s his office.
(of Boston)

D. J. Law-
for a Mr.
y P. Smith
t 1880 and
s. She has

et 3 inches.
et 5 inches.

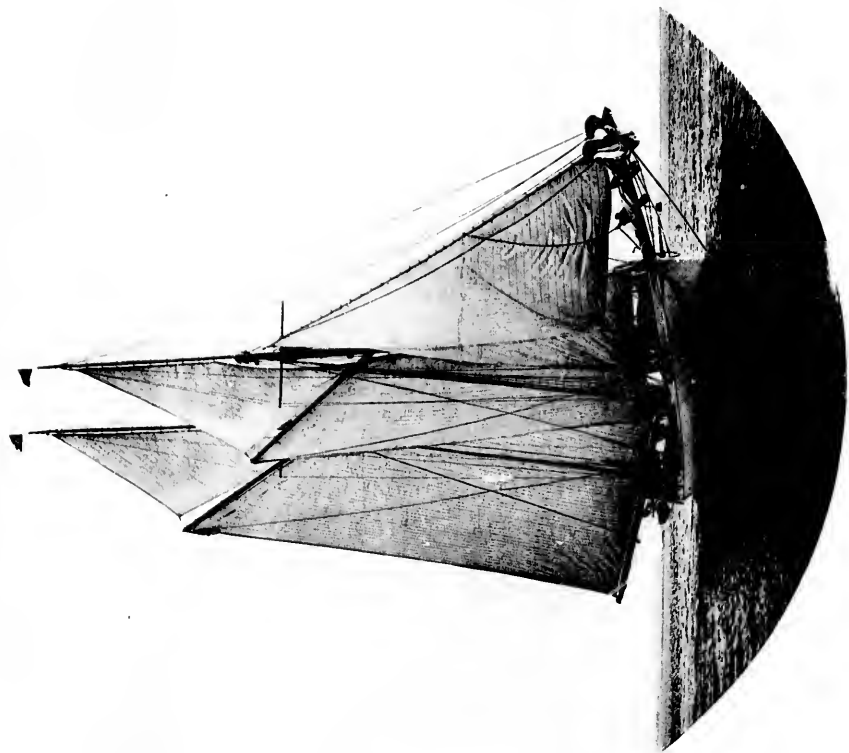

MAYFLOWER

PLATE XII

1. 1847
 2. 1848
 3. 1849
 4. 1850
 5. 1851
 6. 1852
 7. 1853
 8. 1854
 9. 1855
 10. 1856
 11. 1857
 12. 1858
 13. 1859
 14. 1860
 15. 1861
 16. 1862
 17. 1863
 18. 1864
 19. 1865
 20. 1866
 21. 1867
 22. 1868
 23. 1869
 24. 1870
 25. 1871
 26. 1872
 27. 1873
 28. 1874
 29. 1875
 30. 1876
 31. 1877
 32. 1878
 33. 1879
 34. 1880
 35. 1881
 36. 1882
 37. 1883
 38. 1884
 39. 1885
 40. 1886
 41. 1887
 42. 1888
 43. 1889
 44. 1890
 45. 1891
 46. 1892
 47. 1893
 48. 1894
 49. 1895
 50. 1896
 51. 1897
 52. 1898
 53. 1899
 54. 1900

333

chs.
 box.

-sea.
 was
 NEW
 CBS.

ty.
 ol-
 has
 only,
 or

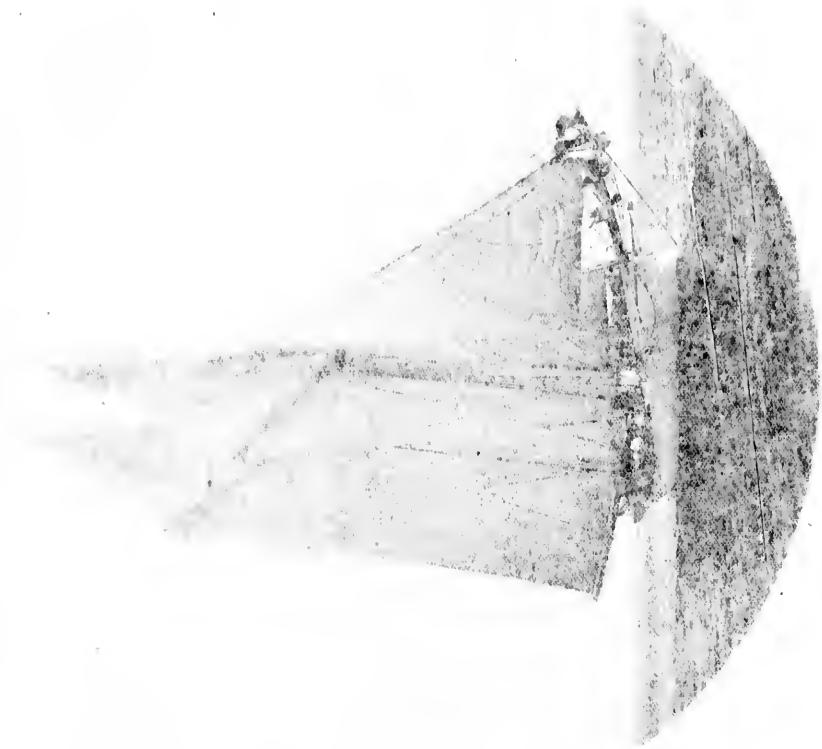

NOMAD.

NOMAD is a keel sloop, the property of Henry A. Sails of Boston, Mass. She was designed by A. Cary Smith of New York, and built by Pierce Bros. of South Boston, Mass. Was built for Henry Tudor, being launched in 1882, and afterwards became the property of W. O. Gay. She was formerly called TUL and she was re-built in 1892 by Geo. Lawley & Son. She hails from Boston and sails with the HULL and MASSACHUSETTS YACHT CLUBS. See Fig. 366.

Official number, 130,539.

DIMENSIONS.

Length over all,	40 feet,	Length load waterline,	35 feet,
Depth,	5 feet 3 inches,	Draft,	6 feet,
Beam,	11 feet,		

ADRIENNE.

ADRIENNE is a keel schooner, owned by J. J. Souther and Clarence Y. Souther, of Boston. She was designed and built by Lawley in 1883, and sails with the HULL, ATLANTIC and CORINTHIAN (of Marblehead) YACHT CLUBS. See Fig. 367.

Official number, 106,180.

DIMENSIONS.

Length over all,	71 feet,	Length load waterline,	67 feet 9 inches,
Depth,	9 feet 2 inches,	Draft,	10 feet,
Beam,	18 feet,		

CAMILLA.

CAMILLA is a centerboard cutter, designed by Edward Burgess and built by Lawley. Launched in 1890. She was originally built for William Amory, and has belonged to her present owner, Mr. Francis C. Welch, only two years. She had her lead lowered ten inches in 1893. She hails from Boston and sails with the BOSTON, HULL, EASTERN and HULL CORINTHIAN YACHT CLUBS. See Fig. 369.

Official Number, 126,724.

DIMENSIONS.

Length over all,	30 feet 6 inches,	Length load waterline,	28 feet 10 inches,
Depth,	5 feet 6 inches,	Draft,	6 feet 11 inches,
Beam,	11 feet,		

GIFANA.

GIFANA is a keel schooner, built by D. J. Lawlor of Chelsea, Mass., in 1882, and owned by Geo. W. Weld of Boston. She was lengthened by W. B. Smith in 1886. She sails with the HULL, NEW YORK, EASTERN, NEW BEDFORD and MASSACHUSETTS YACHT CLUBS. See Fig. 368.

CODE SIGNAL LETTERS, K, C, S, D.

Official number, 85,338.

DIMENSIONS.

Length over all,	44 feet,	Length load waterline,	39 feet,
Depth,	11 feet 2 inches,	Draft,	11 feet 6 inches,
Beam,	19 feet 11 inches,		

MISCHEFF.

A centerboard sloop, owned by E. H. Linton of New York City. She was designed by A. Cary Smith, and built by the Harlan & Hollingsworth Co. in 1879. She is constructed of iron. MISCHIEFF was lately owned by George Work; she now hails from New York City, and sails with the fleets of the HULL, QUINCY and MONSIEUR YACHT CLUBS. See Fig. 369.

CODE SIGNAL LETTERS, K, C, S, D.

Official number, 91,154.

DIMENSIONS.

Length over all,	62 feet 5 inches,	Length load waterline,	61 feet,
Depth,	5 feet 9 inches,	Draft,	5 feet 8 inches,
Beam,	19 feet 10 inches,		

SUFEE.

A centerboard cut-boat, designed by D. S. Stone and built by Herreshoff & Stone in 1864. In 1888 she was re-built, and is now owned by E. H. Linton, hailing from Canarsie. She sails with the HULL YACHT CLUB. See Fig. 357.

DIMENSIONS.

Length over all,	22 feet 6 inches,	Length load waterline,	22 feet 6 inches,
Draft,	1 foot 8 inches,	Beam,	11 feet,

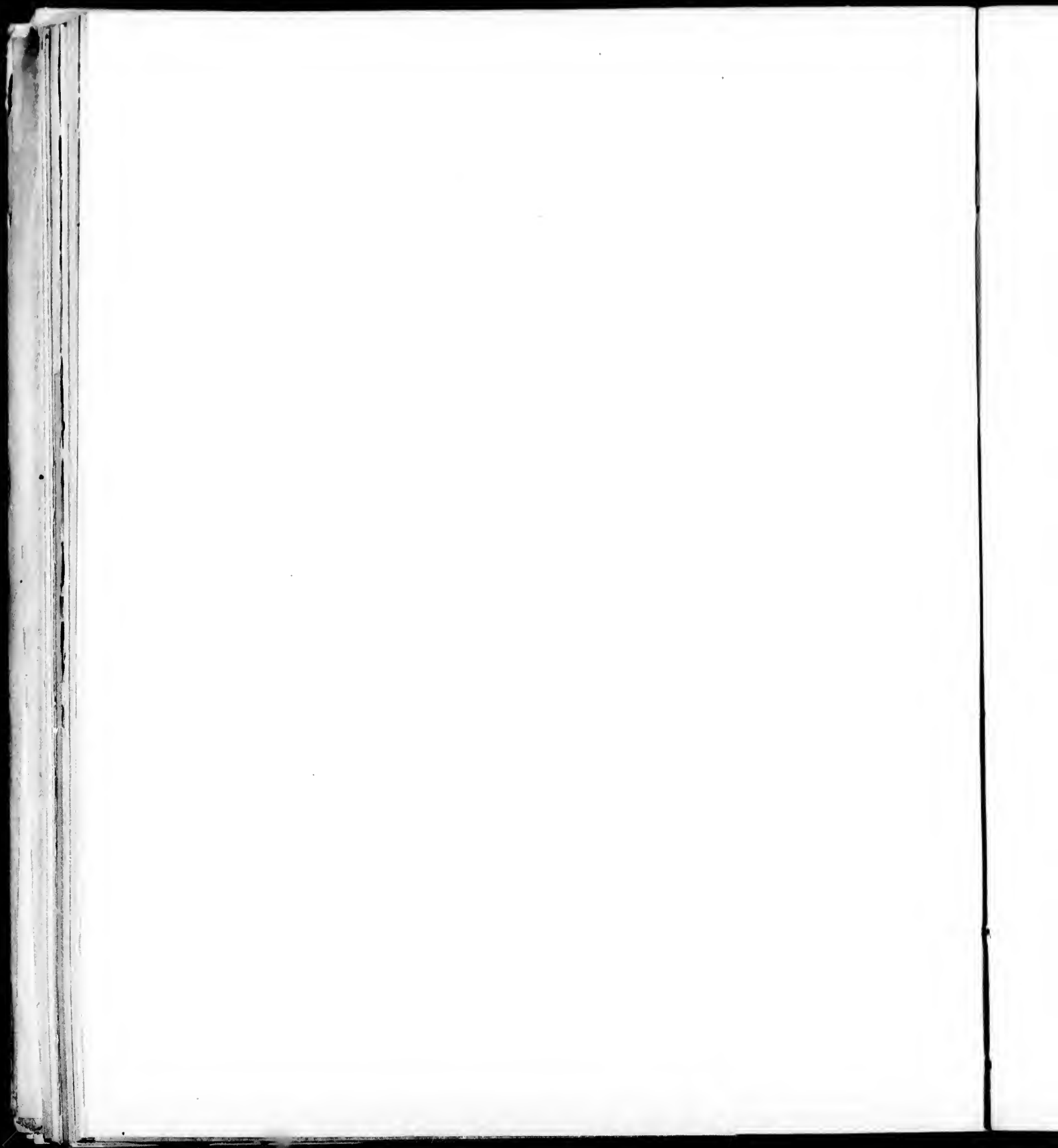



ROYAL NOVA SCOTIA YACHT SQUADRON HOUSE.

History of the Royal Nova Scotia Yacht Squadron.

THE ROYAL NOVA SCOTIA YACHT SQUADRON had its beginning in a meeting of yachtsmen, called by circular, and held at the office of Mr. F. C. Sumichrast, in Halifax, Nova Scotia, on the 25th day of November, 1875. Ten gentlemen attended. This meeting adjourned until Tuesday, 7th of December, 1875, when fourteen of the original members were present. It was resolved "That a yacht club be and is hereby formed, to be called the NOVA SCOTIA YACHT SQUADRON, to have its station at Halifax, and to have for its objects the promotion of yacht building and sailing in the Province, and the making the members proficient in seamanship." The number of original members was limited to thirty-five. A committee was appointed to draw up a constitution.

The first officers of the squadron were elected as follows:

Commodore,	His Excellency the Earl of Dufferin, Governor General of Canada.
Vice-Commodore,	F. M. Passow.
Rear-Commodore,	S. A. White.
Honorary Secretary,	F. C. Sumichrast.
Honorary Treasurer,	Jas. W. Stairs.

Committee of Management.

Lt. Col. H. W. Clerke,	D. Cronan,
A. C. Edwards,	H. St. G. Twining,
	S. Tupper.

The annual subscription was made \$10, with an entrance fee of \$5.

On the 14th of August 1880, permission was granted by Her Majesty to the squadron to use the prefix of "Royal," and in November of the same year by permission of the Lords of the Admiralty, members were permitted to fly the blue ensign of Her Majesty's fleet.

Although the matter was discussed at various intervals, it was not

until 1890 that the squadron was enabled to acquire ground and erect a Club House for the use of its members, when, through the energy of Commodore A. C. Edwards and an active Committee, the membership was increased from one hundred and fifty to two hundred, and a sufficient sum of money was raised for the purchasing of an extensive water front and grounds, and the erection of a small but pretty Club House, and a large and commodious boat-house with landing stages, etc.

The squadron premises are situated on the western shore of the harbor, adjoining Point Pleasant Park, and from the balcony of the Club House yachts while racing can be followed with a glass over the entire length of all the courses. The harbor is specially adapted to yachting; there is no current, the rise and fall of the tide being only about five feet.

The yachts enrolled in the club list, though not large, afford excellent sport to their owners in the summer, which are held during each season. The prevailing wind is south-west, strong and steady.

The fixtures usually comprise ten races in which, almost without exception, competing yachts are sailed and manned by amateurs.

The officers for 1893 were as follows:

Commodore,	James Fraser.
Vice-Commodore,	Jas. W. Stairs.
Rear-Commodore,	John E. Butler.
Secretary,	H. M. Wylie.
Honorary Treasurer,	A. E. Jones.

ACCORDING TO THE SAILING RULES AND REGULATIONS.

START.

The yachts shall start from moorings, anchors, or under way, as directed by the Sailing Committee. A quarter of an hour before the time of starting, one of the following flags of the Commercial Code

shall be hoisted as a preparative flag for the yachts of each successive race; in case of a start from anchors or moorings, to take up their stations for the start with headsails down, or all sails down, as the Sailing Committee may direct; or, in case the start be a flying one, to approach the starting line, viz:—

B of Commercial Code for the yachts of 1st race.

C " " " " 2nd "

D " " " " 3rd "

E " " " " 4th "

and so on.

Five minutes before the start the preparative flag shall be lowered, a Blue Peter hoisted, and a gun fired, after which the yachts in the race shall be amenable to the rules. At the expiration of five minutes exactly, the Blue Peter shall be hauled down and a second gun fired as a signal to start.

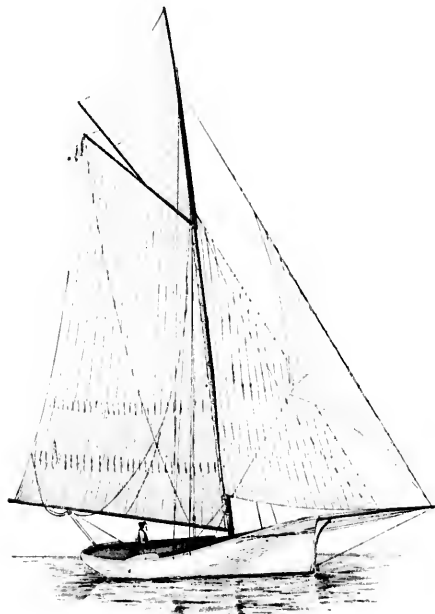

ESMR.—FIGURE 370.

If the start is to be made from anchors or moorings, lots shall be drawn for stations, and springs shall be allowed on the same bridle or anchor chain or warp as the bow-fasts, but are not to be carried to a buoy, pier, other vessel, or fixed object.

If any yacht lets go or parts her bridle before the signal to start, or if she drags any moorings or anchor to which she is made fast for the purpose of starting, she shall be liable to be disqualified, unless such parting or dragging be explained to the satisfaction of the Committee, or unless she has returned, after the signal to start, within the line of starting buoys, so as not to obtain any advantage by the accident.

In a flying start, if any yacht, or any part of her hull, spars or equipment be on or across the line before the signal to start is made, she must return and re-cross the line. A yacht so returning, or one working into position from the wrong side of the line after the signal to start has been made, must keep clear of all competing yachts.

Should the gun miss fire, the lowering of the Blue Peter shall be the signal to start; but the Sailing Committee or Officer of the Day shall be at liberty, in the event of either gun missing fire, to have a single blast of the steam whistle on board the Squadron Steamer blown, should there be one engaged; otherwise the flag signals shall be deemed sufficient.

FLYING START.

Flying starts shall be pure and simple, with no restriction of time as to crossing the line, and no allowance for delay.

RECALL NUMBERS.

Each sailing yacht entered on the squadron list shall, at the beginning of the season, be given a recall number, which will be printed in the club book. In starting a race, should any yacht cross the line before the signal for the start has been made, her distinguishing number shall be exhibited as soon as possible, as a recall, and kept displayed until the said yacht shall either have returned and re-crossed the line to the satisfaction of the officers in charge, or have given up the race. The numbers to be in white on a black ground, and the figures not less than 2 ft., 6 in., in height.

ENTRIES FOR RACES RE-SEAILED.

Should any yacht duly entered for a race not start, or having started should she give up, or be disabled during the race, such yacht shall, in the event of the race being re-sailed, be entitled to start; but no new entries shall be received under any circumstances whatever for a postponed race.

DISTINGUISHING FLAGS.

Each yacht must fly (on the leech of her mainsail, within two feet of the gaff) a distinguishing flag different from that of any other yacht, to be described in the Squadron List, and shall sail all matches under the same. Notice of any alteration in a yacht's flag shall be immediately sent to the Secretary.

Yachts are permitted to fly distinguishing flags of any shape, but the minimum size in each class shall be:—

Under 5 Rating,	1 ft., 6 in., by 1 ft.
5 to 10 Rating,	1 ft., 9 in., by 1 ft., 2 in.
Over 10 Rating,	2 ft., 3 in., by 1 ft., 9 in.

These sizes to be for rectangular flags; flags of any other shape to contain a like area of bunting.

SAIL OVER.

When a prize has been offered for competition, any yacht duly entered, may claim to sail over the course, and shall be entitled to the prize, subject, however, to the By-laws.

CENTERBOARD YACHTS.

Yachts fitted with centerboards shall not be allowed to raise their centerboards during the race for the purpose of crossing a shoal.

DECLARATION OF WINNER.

Every yacht sailing in a race shall have on board a member of a recognized Yacht Club, who, before the prize is awarded, shall sign a declaration that the yacht under his charge has strictly conformed to all the sailing regulations.

SAILS.

There shall be no restrictions as to sails, or the manner of setting and working them.

HANDS.

There shall be no limit to the number of paid hands, and no restrictions as to the number of friends, or to their working. Any number of hands may join or leave a yacht up to the signal to start (viz., the

shall be
the Day
have a
steamer
shall be

of time

begim-
ited in
the line
ishing
d kept
and re-
or have
ground,

having
e, such
itled to
stances

wo feet
yacht,
s under
be im-
pe, but

hape to

luly en-
t to the

se their
al.

ber of a
ll sign a
rmed to

f setting

o restric-
number
viz., the

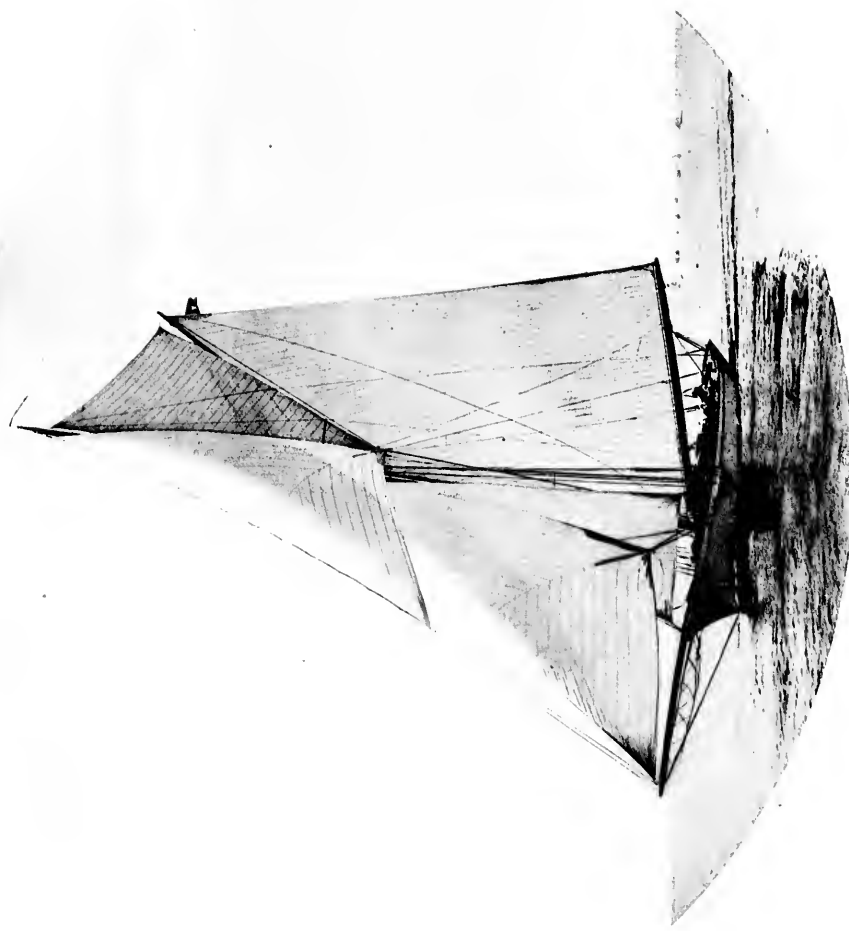

SAYONARA.

PLATE XLII.

When
the
hall

When
follow
A
way
When
When
When

When
to
to
to
to
to

When
to
to
to
to

When
to
to
to
to

When
to
to
to
to



second gun).
to any person

No more
a race, and
the trim of
shall not be

Each yac
yachts sha
life belt for

When t
risk of coll
as follows,

A yacht
which is cl

A yacht
the way of

When b
yacht whi

of the oth

When l
yacht whi

which is t

A yach
other.

When
two yach
is close t
give the
weather
shall be
to give n
overtaki
establish
yacht n
the pur

When
sea roo
or yach
structio
always
actuall

A y
taken
yacht
course
sidere
boom.
has dr

If
buoy,
foul c
not a
ward
owne
five,
time

second gun), but not afterwards, except in case of accident or injury to any person on board.

ANCHORS AND CHAINS.

No more than the usual anchors and chains shall be carried during a race, and these must not be used as shifting ballast, or for altering the trim of the yacht, and all ballast shall be properly stowed, and shall not be shifted or trimmed in any way whatever during a race.

LIFE BUOYS.

Each yacht shall carry at least two life buoys ready for use. Open yachts shall carry at least one life buoy for every two persons, or a life belt for each person on board, ready for use.

YACHTS MEETING.

When two yachts are approaching one another so as to involve risk of collision, one of them shall keep out of the way of the other, as follows, viz.:

A yacht which is running free shall keep out of the way of a yacht which is close-hauled.

A yacht which is close-hauled on the port tack shall keep out of the way of a yacht which is close-hauled on the starboard tack.

When both are running free with the wind on different sides, the yacht which has the wind on the port side shall keep out of the way of the other.

When both are running free with the wind on the same side, the yacht which is to windward shall keep out of the way of the yacht which is to leeward.

A yacht which has the wind aft, shall keep out of the way of the other.

ROUNDING MARKS, ETC.

When rounding any buoy or vessel used to mark out the course, if two yachts are not clear of each other at the time the leading yacht is close to, and actually rounding the mark, the outside yacht must give the other room to pass clear of it, whether it be the lee or weather yacht which is in danger of fouling the mark. No yacht shall be considered clear of another yacht, unless so much ahead as to give a free choice to the other on which side she will pass. An overtaking yacht shall not, however, be justified in attempting to establish an overlap, and thus force a passage between the leading yacht and the mark after the latter yacht has altered her helm for the purpose of rounding.

OBSTRUCTIONS TO SEA ROOM.

When passing a pier, shoal, rock, vessel, or other obstruction to sea room, should yachts not be clear of each other, the outside yacht or yachts must give room to the yacht in danger of fouling such obstruction, whether she be the weather or leeward yacht; provided always that an overlap has been established before an obstruction is actually reached.

LUFFING AND BEARING AWAY.

A yacht overtaking any other shall keep out of the way of the overtaken yacht, and a yacht may luff as she pleases to prevent another yacht passing to windward, but must never bear away out of her course to hinder the other passing to leeward, the lee side to be considered that on which the leading yacht of the two carries her main boom. The overtaking vessel, if to leeward, must not luff until she has drawn clear ahead of the yacht she has overtaken.

APPROACHING SHORE.

If two yachts are standing towards a shore or shoal, or towards any buoy, boat or vessel, and the yacht to leeward is likely to run aground or foul of such buoy, or boat, or vessel (a mark vessel excepted), and is not able to tack without coming into collision with the yacht to windward, the latter shall at once tack, on being hailed to do so by the owner of the leeward yacht, or the person acting as his representative, who shall be bound to see that his own vessel tacks at the same time.

RUNNING AGROUND, ETC.

Any yacht running on shore, or foul of a buoy, vessel, or other obstruction, may use her own anchors, boats, warps, &c., to get off, but may not receive any assistance except from the crew of the vessel fouled. Any anchor, boat or warp used must be taken on board again before she continues the race.

FOULING YACHTS, MARKS, ETC.

Each yacht must go fairly around the course, and must not touch any buoy, boat or vessel used to mark it out, but shall not be disqualified if wrongfully compelled to do so by another yacht. Any yacht causing a mark vessel to in any way shift her position to avoid being fouled by such yacht, shall be disqualified. If a yacht, in consequence of her neglect of any of these rules, shall foul another yacht, or compel other yachts to foul, she shall forfeit all claim to the prize, and shall pay all damages.

MEANS OF PROPULSION.

No towing, sweeping, poling, or pushing, or any mode of propulsion except sails, shall be allowed.

ANCHORING.

A yacht may anchor during a race, but must weigh her anchor again and not slip. No yacht shall during a race make fast to any buoy, stage or pier, or send an anchor out in a boat, except for the purposes described in the Rules.

FOUNDING.

No other means of sounding than the lead and line allowed.

MAN OVERBOARD.

In case of a man falling overboard from, or any dangerous accident to, a competing yacht, all other yachts in a position to do so shall use their utmost endeavors to render assistance. In such case the race shall be considered off, and a signal be made as follows: the flag denoting the race hoisted under the Blue Peter, or in case of fog or darkness three guns fired, and in addition to either of these signals, four long blasts from the Squadron Steamer, if she be present at the race.

PROTESTS.

Should the owner of any yacht, or the person acting as his representative, consider that he has a fair ground of complaint against another for foul sailing, or any violation of these rules, he must, if it arise during the race, signify the same on first passing the finishing point, by showing an ensign conspicuously in the main rigging. The protest shall be made in writing, and under such regulations (if any) as the Sailing Committee may have determined, within twenty-four hours, not including Sunday, of the arrival of the protesting yacht, and shall be heard by the Sailing Committee, and decided after such inquiries as they may consider necessary. They shall also, without a protest, disqualify any yacht, should it come to their knowledge that she has committed a breach of the rules.

REMOVAL OF MARK.

Should any flag vessel or other mark be removed from its proper position, either by accident or design, the race shall be sailed over again, or not, at the discretion of the Sailing Committee.

DISQUALIFICATION OF YACHTS.

Any yacht disobeying or infringing any of these rules, which shall apply to all yachts whether sailing in the same or different races, shall be disqualified from receiving any prize she would otherwise have won, and her owner shall be liable for all damages arising therefrom.

In the event of any yacht being disqualified, the next in order shall be awarded the prize.

DISQUALIFICATION OF OWNER.

Should a flagrant breach of these rules be proven against any yacht, her owner, or sailing master, or both, may be disqualified by

the Sailing Committee for one season from sailing in any race held under the rules of the squadron.

LIMIT OF TIME.

The Sailing Committee shall, at the beginning of each season, limit the time of finishing each race and insert the same in the fixtures of the year.

In the event of a race not being completed within the time prescribed by the Sailing Committee, it shall be considered as "no race," and may be resailed, subject to by-laws.

If any yacht finish within the time limit, all succeeding yachts shall be entitled to be timed and the prizes awarded.

CLASSIFICATION.

The classification of yachts shall be as follows:

5th class, not exceeding	1½ rating.
4th " exceeding 1½ rating and not exceeding 3 "	"
3d " " 3 " " "	5 "
2d " " 5 " " "	10 "
1st " " 10	

TIME ALLOWANCE.

Time shall be allowed on arrival for difference in rating or tenths of rating, according to the annexed scale increased or decreased in proportion to the length of different courses.

In yachts under 10 rating the sail areas and total sail areas shall be computed by ratings and tenths of ratings.

SHORTENING COURSE.

If it be necessary during a race to shorten the course, the signal flag denoting the race, hoisted under the White Peter, or in case of fog or darkness two guns fired shall show that the race is to finish with the round about to be completed, and the time allowance shall be reduced in proportion.

PLACE OF MARKS.

As distance is an important element in the calculation of time allowance, the marks and flag boats should be placed so as to mark as accurately as possible the length of the course for which time is allowed.

SEA ROOM.

The Sailing Committee should be particularly careful to provide ample room between the points marking the starting line.

COURSES.

Signal K. Come. Code. Course I, A. Starting off Squadron Wharf to inner Automatic Buoy (red) leaving it on port hand, thence to mark boat anchored east, ¾ north, distance 6 miles, thence to outer Automatic Buoy (black), thence to inner Automatic Buoy, leaving these marks on starboard hand and finish off Squadron Wharf. 32 miles.

Signal W. Come. Code. Course I, B. Starting off Squadron Wharf to inner Automatic Buoy (red) thence to outer Automatic Buoy (black), thence to mark boat anchored north by east, ¾ east, distance 6 miles, leaving these marks on port hand, thence to inner Automatic Buoy leaving it on starboard hand and finish off Squadron Wharf. 32 miles.

Course No. 2. Starting off Squadron Wharf to Litchfield Buoy, thence to inner Automatic Buoy (red), thence to Thrump Cap Buoy, leaving these marks on port hand, thence to Litchfield Buoy, leaving it on starboard hand, and finish off Squadron Wharf. 15 4-10 miles.

Course No. 3. Starting off Squadron Wharf to Flag Buoy in Dartmouth Cove, leaving it on starboard hand, thence to outer Flag Buoy off Squadron Wharf, leaving it on port hand, thence to Ives

Knoll Buoy, leaving it on starboard hand, thence to Mars Rock Buoy, leaving it on starboard hand and finish off Squadron Wharf. 11 miles.

Course No. 4. Starting off Squadron Wharf to Flag Buoy in Dartmouth Cove, leaving it on starboard hand, thence passing to westward of George's Island, to Point Pleasant Buoy, thence to Buoy off Woodside Refinery, thence to outer Flag Buoy off Squadron Wharf, leaving these marks on port hand, thence to Point Pleasant Buoy, leaving it on starboard hand, and finish off Squadron Wharf. 9 2-10 miles.

Course No. 5. Starting off Squadron Wharf to Flag Buoy in Dartmouth Cove, thence to Point Pleasant Buoy, thence to Ives

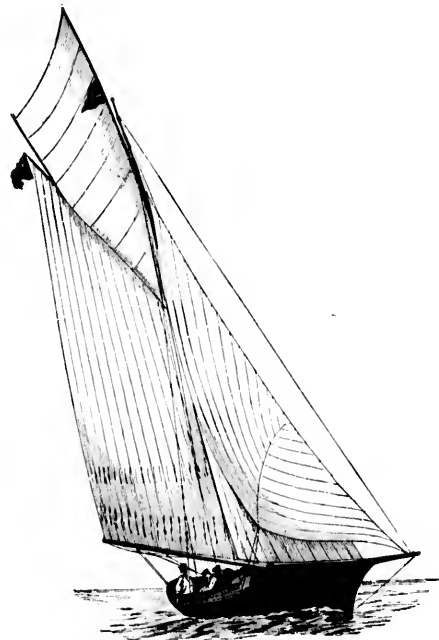

YACHT.—FIGURE 371.

Knoll Buoy, leaving these marks on port hand, and finish off Squadron Wharf. 5 8-10 miles.

STARTING AND FINISHING LINE.

Passing between the outer Flag Buoy and the Squadron Wharf, the two flagstaves (the inner one is used for making starting signals and hoisting ensign, and the outer one has Squadron Burgee hoisted on it) in one, mark the line.

Yachts in starting or during a race must not pass to the westward of the inner Flag Buoy.

The Flag Buoys off Squadron Wharf and Woodside Refinery Wharf and in Dartmouth Cove carry a flag, striped red, white, red white, red horizontally.

[AS ADOPTED BY THE YACHT RACING ASSOCIATION.]

SCALE OF ALLOWANCES FOR DIFFERENCES OF RATING.

Rating.	Allowance in Seconds per Knot.	Rating	Allowance in Seconds per Knot.
1	00.00	26	172.45
2	40.79	27	173.85
3	71.06	28	175.18
4	87.20	29	176.45
5	100.00	30	177.67
6	108.34	31	178.85
7	116.00	32	180.00
8	122.54	33	181.11
9	128.05	34	182.18
10	132.90	35	183.21
11	137.23	36	184.21
12	141.12	37	185.17
13	144.62	38	186.10
14	147.78	39	187.00
15	150.65	40	187.87
16	153.28	41	188.71
17	155.72	42	189.53
18	158.02	43	190.33
19	160.10	44	191.11
20	162.24	45	191.87
21	164.18	46	192.61
22	166.02	47	193.33
23	167.76	48	194.03
24	169.41	49	194.72
25	170.97	50	195.40

TIME SCALE FOR DIFFERENCES OF RATING, ADVANCING BY TENTHS.

Rating by Tenths.	Time in Seconds per Knot.	Rating by Tenths.	Time in Seconds per Knot.
1.1	6.71	5.0	104.85
1.2	12.85	5.1	105.73
1.3	18.40	5.2	106.60
1.4	23.47	5.3	107.53
1.5	28.13	5.4	108.34
1.6	32.44	5.5	109.14
1.7	36.44	6.0	109.93
1.8	40.18	6.1	110.71
1.9	43.50	6.2	111.49
2.0	46.79	6.3	112.26
2.1	49.78	6.4	113.03
2.2	52.62	6.5	113.80
2.3	55.31	6.6	114.50
2.4	57.87	6.7	115.30
2.5	60.31	6.8	116.08
2.6	62.64	6.9	116.78
2.7	64.87	7.0	117.45
2.8	67.01	7.1	118.11
2.9	69.07	7.2	118.76
3.0	71.06	7.3	119.40
3.1	72.98	7.4	120.03
3.2	74.83	7.5	120.66
3.3	76.61	7.6	121.30
3.4	78.30	7.7	121.93
3.5	79.94	7.8	122.54
3.6	81.53	7.9	123.14
3.7	83.06	8.0	123.70
3.8	84.53	8.1	124.27
3.9	85.94	8.2	124.84
4.0	87.29	8.3	125.40
4.1	88.61	8.4	125.96
4.2	89.89	8.5	126.50
4.3	91.11	8.6	127.05
4.4	92.29	8.7	127.57
4.5	93.44	8.8	128.05
4.6	94.57	8.9	128.54
4.7	95.69	9.0	129.02
4.8	96.80	9.1	129.52
4.9	97.91	9.2	130.00
5.0	99.00	9.3	130.50
5.1	100.05	9.4	131.00
5.2	101.07	9.5	131.48
5.3	102.06	9.6	131.96
5.4	103.02	9.7	132.43
5.5	103.95	9.8	132.90
		9.9	
		10.0	

LIST OF YACHTS ENROLLED IN THE ROYAL NOVA SCOTIA YACHT SQUADRON.

Official No.	Hearing No.	Name.	Tig.	Owner.	Port.	Length L. W. L.			Reg. Tonnage.	Squadron Rating.
						ft. in.	ft. in.	ft. in.		
....	12	Albatross	Schooner	F. K. Warren, and Geo. Musgrave	Halifax	32 6	11 7	4 7 $\frac{1}{4}$	8.	5.98
74,868	..	Arrow	Steamer	Roderick McDonald	"	42 5	9 4	10.2
98,108	..	Barronetta	Screw Schooner	Gen. Willoughby Weston	New York	121 7	20 1	114.
90,740	21	Clara	Cutter	Robt. A. Osborn	"	51	9 1	8 0	21.
94,891	..	Dama	Screw Schooner	C. E. Lovey	Quebec	91 8	13 2	55.
14,901	12	Damitless	Schooner	Caldwell H. Colt	New York	116 7	26 7	12 6	120.40
92,680	..	Eldra	Screw Schooner	Thomas Fraser, <i>et al.</i>	New Glasgow	69 3	11 3	7	39.1
80,800	10	Esme	Sloop	J. J. Hudolf	Lunenburg	26	8 4	4 4	5.42	4.0
96,788	11	Eticmo	Sloop	J. E. Butler	Halifax	28	8 9	4 9	3.85	2.6
89,844	13	Galtea	Cutter	Lieut. H. N. Henn	Glasgow	87	15	14 0	87.
....	..	Galvant	Steamer	W. H. Brookfield and Walter Mitchell	Halifax	25	6	3
81,165	1	Hebe	Cutter	G. E. Franklyn, Jr.	"	25 4	8 2 $\frac{1}{4}$	4 2 $\frac{1}{4}$	4.	4.8
92,561	2	Hildred	Sloop	H. T. Jones	"	23 4	8	4	3.45	3.2
90,729	3	Lenore	Cutter	A. F. Buckley	"	27 1	7 11	4 1	4.58	3.6
....	..	Lurline	Launch	F. D. Corbett	"	10	5 4	2 3
85,830	4	Mentor	Cutter	H. R. Kennedy	"	20 9	6 10 $\frac{1}{2}$	3 4	2.8	2.25
....	6	Nautilus	Sloop	A. F. Buckley	"	19 3	1.3
....	23	Nonpareille	Yawl	H. A. Sanderson	New York	68	16	10 3	7.2
81,168	15	Nymphes	Yawl	F. D. Corbett	Halifax	31 4	9 6	3 8	5.67
155,205	16	Orithya	Schooner	W. M. Walker	Bayville, L. I.	55	16 4	9	30.8	...
89,838	7	Psyche	Cutter	F. H. Bell and T. C. James	Halifax	24 2	7 8	3 7	4.9	3.
110,478	17	Ruth	Schooner	Henry Marquand	New York	93 4	23 3	8 1	171.3
....	..	Ruth	Steamer	A. T. Stikeman	Montreal	25 5	7 4
92,626	20	Saint Kilda	Schooner	James W. King	Lunenburg	35 4	6 9	6.51	6.26
90,414	18	Stranger	Cutter	George H. Warren	Liverpool, G. B.	65 1 $\frac{1}{2}$	13 6	9	42.	48.2
92,577	9	Thotis	Cutter	A. A. McKay	Halifax	21 7	6 8	5 6	3.77	2.34
96,697	..	Ulala	Steamer	Hon. W. J. Stairs and J. F. Stairs	"	49 4	9	5 2	13.70
97,626	19	Uvra	Cutter	F. P. Sands, Rhode Island Yacht Club	Newport	42	11 4	8 6	16.	22.
....	..	Wenonah	Cutter	Gen. Willoughby Weston	New York	60 9	14	10	37.04
....	21	Widgeon	Yawl	Capt. C. E. Capel	Wivenhoe	20 5	8 8
....	5	Wym	Cutter	William Young	Halifax	26	7 4	6	5.75	3.6
96,888	8	Yousa	Cutter	H. M. Wydo	"	26	7 4	6	5.75	3.4
94,076	..	Zoliska	Screw Schooner	W. M. Black	"	51	8 5	4 2	12.

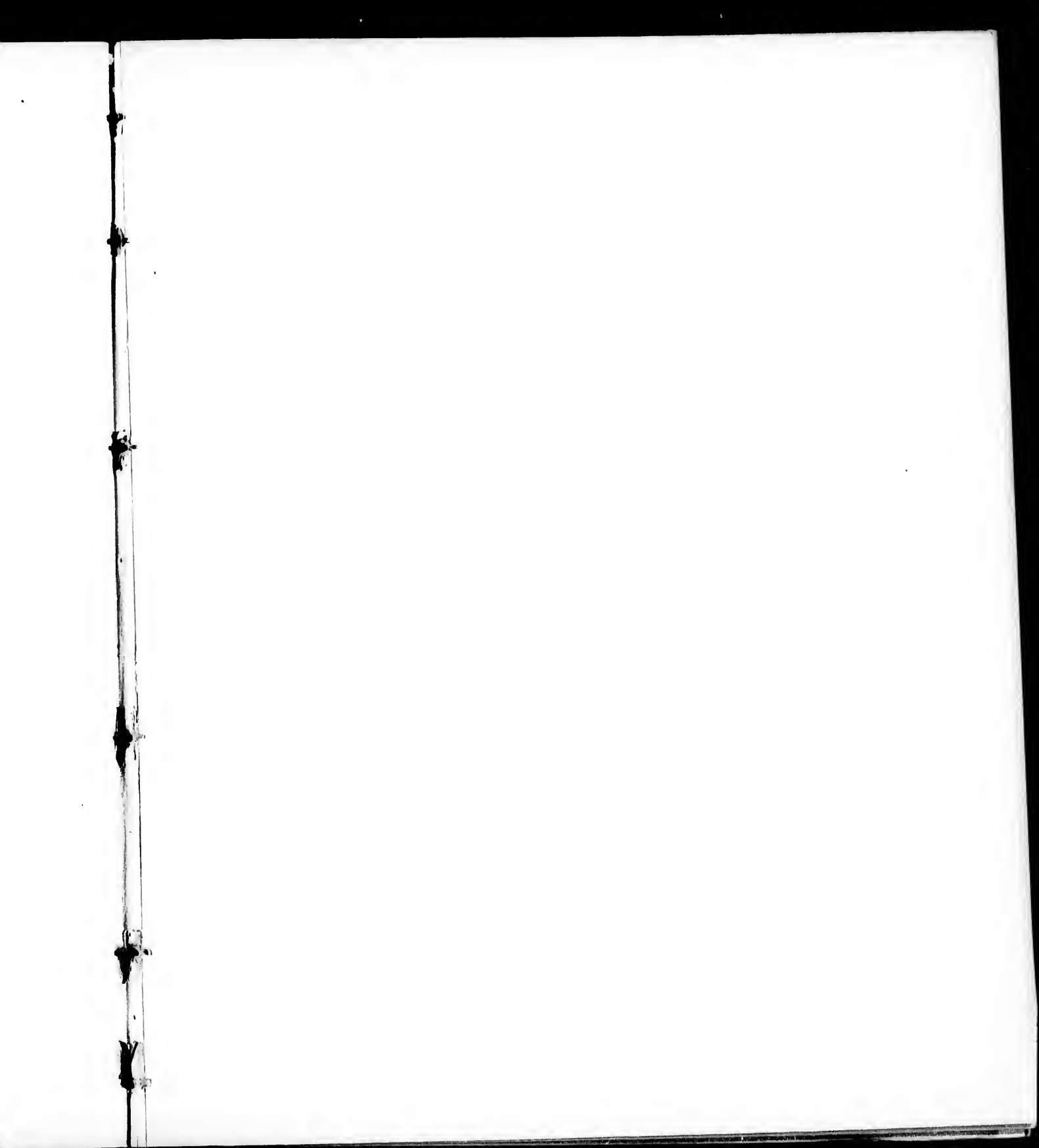

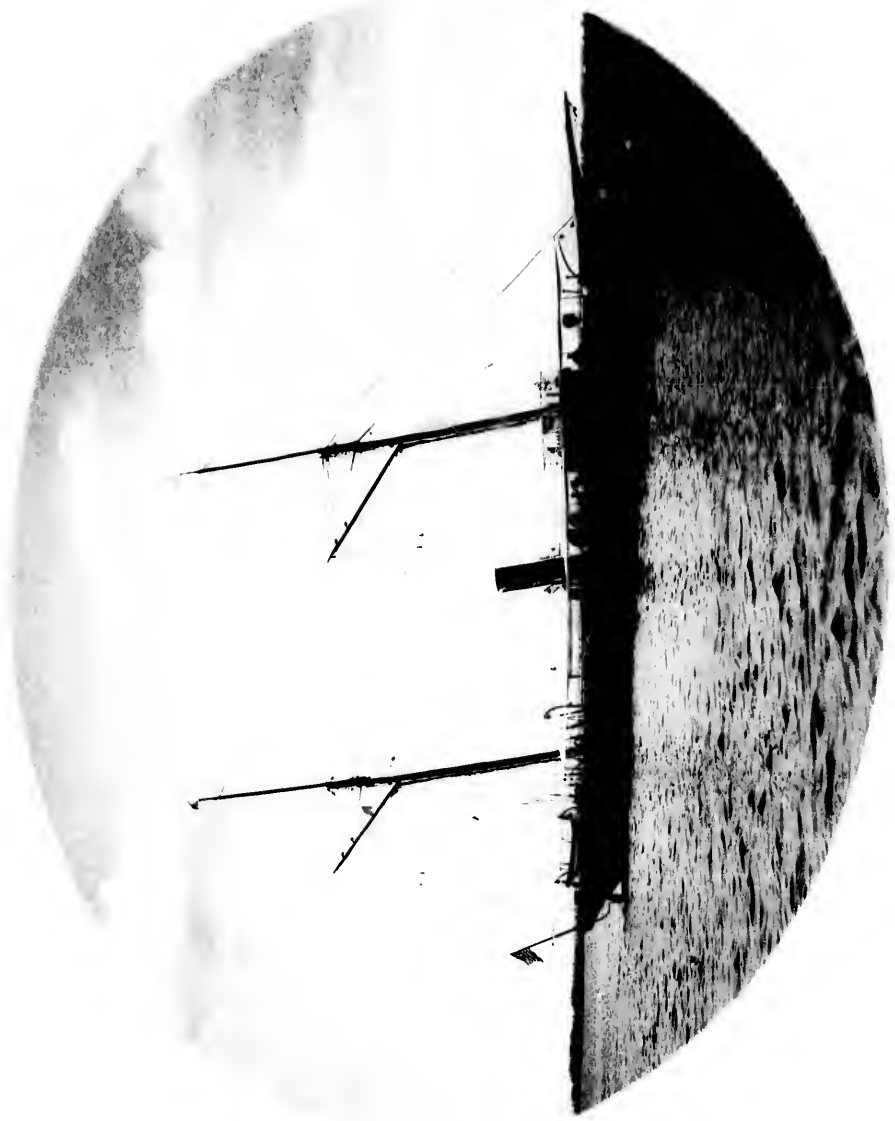

ONEIDA.

1851.

[Faint, illegible text, likely bleed-through from the reverse side of the page. The text is too light to transcribe accurately.]

368
 ally,
 et al.,
 rd Cup,
 n. Lord
 . Capt.
 . Ruth
 . Com.,
 . Jans-
 odore,
 Cham-
 odore,
 rd Cup,
 up,
 Banks
 e Cup,
 . Cup,
 Race,
 "



1876 : June :
July :
Aug. :

1877 : June
Sept.

1878 : June

July

Aug.

Aug.

Aug.

Sept.

Sept.

1879 : June

Jul

Aug

Aug

Sept

Se

1880 : J

RACING RECORDS.

- 1876: June 24th, 1 PSYCHE, sloop, J. E. Butler.
2 CURIE, sloop, J. Fraser.
July 21st, 1 PETREL, sloop, G. A. Black, sailed over.
Aug. 24th, 1 CURIE, sloop, J. Fraser.
2 KATE, sloop, W. H. Brookfield.
3 PSYCHE, sloop, J. E. Butler.
- 1877: June 23d, 1 HEBE, sloop, J. E. Butler, (Mayor Richey's prize).
Sept. 8th, 1 HEBE, sloop, J. E. Butler.
2 CURIE, sloop, J. Fraser.
3 MYSTERY, sloop, F. C. Sumichrast.
- 1878: June 21st, 1 HEBE, sloop, J. E. Butler.
2 ALBATROSS, schooner, D. Cronin.
3 MYSTERY, sloop, F. C. Sumichrast.
July 13th, 1 SEAFOAM, schooner, Captain Larcom, R.A. Mr. Sumichrast's prizes.
1 PSYCHE, sloop, G. E. Capel Curé.
2 CURIE, sloop, J. Fraser.
Aug. 10th, 1 PSYCHE, sloop, Lt. G. E. Capel Curé, 20th Regt. Mr. Sumichrast's prize.
Aug. 24th, 1 SEAFOAM, schooner, Captain Larcom, R.A.
1 HEBE, sloop, J. E. Butler.
2 KESTREL, yawl, S. A. White.
Aug. 31st, 1 MUTA, sloop, Lt. E. R. Hussey, R. E.
Sept. 1th, 2 PSYCHE, sloop, Lt. G. E. Capel Curé, 20th Regt.
1 MUTA, sloop, Lt. E. R. Hussey, R. E.
Sept. 21st, 1 HEBE, sloop, J. E. Butler, R. A. and R. E. handicap prizes.
2 SPRAY, sloop, H. St. G. Twining.
- 1879: June 21st, 1 PSYCHE, sloop, W. H. Brookfield.
2 PHANTOM, sloop, W. H. Troop, Mr. Sumichrast's prize.
1 HEBE, sloop, J. E. Butler.
1 MUTA, sloop, Lt. H. L. M. Dunlop, R. A.
2 LILY, sloop, W. H. Weeks, M.D., Mr. Sumichrast's prize.
July 19th, 1 PHANTOM, sloop, W. H. Troop.
1 MUTA, sloop, Lt. H. L. M. Dunlop, R. A.
Aug. 23d, 1 SEAFOAM, schooner, Lt. C. C. Carter, R. E. Mayor Tobin's prize).
2 HEBE, sloop, J. E. Butler.
Aug. 30th, 1 PSYCHE, sloop, W. H. Brookfield, Mr. Sumichrast's prize.
2 SEAFOAM, schooner, Lt. C. C. Carter, R. E.
1 LILY, sloop, W. H. Weeks, M.D.
Sept. 13th, 1 PETREL, sloop, A. C. Edwards; Messrs. Hussey, Stairs and Sumichrast's prize.
1 PSYCHE, sloop, W. H. Brookfield.
2 VOLANTE, schooner, F. Rudolph.
1 ISA, centerboard sloop, F. S. West.
2 MUTA, sloop, Lt. H. L. M. Dunlop, R. A.
Sept. 20th, 1 HEBE, sloop, J. E. Butler, Officers R.A. & R.E. prizes, handicap.
2 ISA, centerboard sloop, F. S. West, Officers R.A. & R.E. prize, handicap.
- 1880: June 25th, 1 DAPHNE, sloop, A. E. Jones.
2 MUTA, sloop, Lt. H. L. M. Dunlop, R. A.
July 3d, 1 PSYCHE, sloop, F. S. West, Lt. Governor's Challenge Cup.
1 PASTIME, schooner, W. H. Brookfield.
1 DAPHNE, sloop, A. E. Jones.
2 FIONA, sloop, Rev. R. Morrison.
- July 3d, 1 ISA, sloop, H. E. Gates.
July 10th, 1 PASTIME, schooner, W. H. Brookfield.
2 OI-KAZE, cutter, F. C. Sumichrast.
Aug. 18th, 1 PASTIME, schooner, W. H. Brookfield, Chester Regatta.
Aug. 28th, 1 OI-KAZE, cutter, F. C. Sumichrast.
1 EAGLET, sloop, Lt. D. G. Princep, R. A.
2 MUTA, sloop, Lt. H. L. M. Dunlop, R. A.
- Sept. 4th, 1 PASTIME, schooner, W. H. Brookfield, Messrs. Richey and Daly, M. P.'s prize.
1 OI-KAZE, cutter, F. C. Sumichrast.
1 PSYCHE, sloop, F. S. West.
1 MUTA, sloop, Lt. H. L. M. Dunlop, R. A.
- Sept. 11th, 1 PSYCHE, sloop, F. S. West, Mayor Tobin's prize.
1 OI-KAZE, cutter, F. C. Sumichrast.
1 MUTA, sloop, Lt. H. L. M. Dunlop, R. A.
Sept. 11th, 1 OI-KAZE, cutter, F. C. Sumichrast, Mr. Cornelius' prize.
1 OI-KAZE, cutter, F. C. Sumichrast, Mr. W. H. Troop's prize.
2 PSYCHE, sloop, F. S. West, Mr. Sumichrast's prize.
3 EAGLET, centerboard sloop, Lt. D. G. Princep, R. A. Mr. Sumichrast's prize.
- 1881: June 18th, 1 ESME, sloop, J. E. Butler.
2 ISA, centerboard sloop, H. E. Gates.
2 MUTA, sloop, J. Symons.
July 2d, 1 ISA, centerboard sloop, H. E. Gates, Sweepstakes.
July 8th, 1 PSYCHE, sloop, Capt. Trott, Messrs. Richey & Daly, M. P.'s prize.
July 30th, 1 ESME, sloop, J. E. Butler, Mayor Tobin's prize.
Aug. 10th, 1 ESME, sloop, J. E. Butler, Lord Lorne's Challenge Cup.
Aug. 13th, 1 KESTREL, yawl, S. A. White, Lieut.-Governor's Challenge Cup.
Aug. 22d, 1 HEBE, sloop, A. H. Zwicker, Messrs. Carter and West's prize.
2 NYMPHAEA, yawl, C. E. Brown, Chester Regatta prize.
Sept. 10th, 1 ESME, sloop, J. E. Butler.
2 KESTREL, yawl, S. A. White.
1 OI-KAZE, cutter, F. C. Sumichrast, Sweepstakes.
1 PHANTOM, sloop, F. Stairs.
2 SAUCY ELLA, sloop, F. Rudolph.
- 1882: June 24th, 1 MARIQUITA, yawl, W. J. Wallace.
July 1st, 1 PSYCHE, sloop, Capt. S. Trott, Lieut.-Governor's Challenge Cup.
2 OI-KAZE, cutter, Lt. W. A. Channiey, 19th Regt.
3 PHANTOM, sloop, F. Stairs and first prize of June 24th.
4 MARIQUITA, yawl, W. J. Wallace.
July 15th, 1 PSYCHE, cutter, Capt. S. Trott, Lord Lorne's Challenge Cup.
July 29th, 1 PHANTOM, sloop, F. Stairs, Capt. Trott's prize.
1 MARIQUITA, yawl, W. J. Wallace, Mr. Sumichrast's prize.
Aug. 14th, 1 PASTIME, schooner, W. H. Brookfield, Halifax to Chester.
Aug. 16th, 1 PASTIME, schooner, W. H. Brookfield, Chester Regatta.
Aug. 18th, 1 PASTIME, schooner, W. H. Brookfield, Chester to Halifax.
Aug. 19th, 1 VELEXAR, cutter, F. C. Sumichrast, sweepstakes.

- Sept. 1st. 1 PSYCHE, cutter, Capt. S. Trott, Mayor Fraser's prize.
2 EME, sloop, J. E. Butler.
2 ISABEL, sloop, Lt. G. H. F. Mathison, 19th Regt.
1 LILY, sloop, W. H. Weeks, M.D.
2 VELENAR, cutter, F. C. Sumichrast, dead heat.
2 MASCOT, centerboard sloop, H. M. Wylde, dead heat.
- Sept. 6th. 1 OI-KAZE, cutter, Lt. W. A. Chauncey, 19th Regt., Mayor Fraser's Regatta Cup.
2 PHANTOM, sloop, F. Stairs.
1 VELENAR, cutter, F. C. Sumichrast, sweepstakes.
2 MARIQUITA, centerboard yawl, W. J. Wallace, sweepstakes.
- Sept. 23d. 1 VELENAR, cutter, F. C. Sumichrast.
2 MARIQUITA, centerboard yawl, W. J. Wallace.
- Sept. 30th. 1 OI-KAZE, cutter, Lt. W. A. Chauncey, 19th Regt.
2 PHANTOM, sloop, F. Stairs, Mr. Chauncey's prize.
- 1883 :
- June 23d. 1 PHANTOM, sloop, F. Stairs, Mr. Hancock's prize.
1 MENTOR, sloop, A. Stone.
- July 14th. 1 KESTREL, yawl, S. A. White, Mayor Fraser's prize.
2 DAPHNE, sloop, A. E. Jones.
1 MENTOR, sloop, A. Stone.
- Aug. 4th. 1 KESTREL, yawl, S. A. White, Capt. Trott's prize.
- Aug. 11th. 1 MARIQUITA, yawl, W. J. Wallace.
2 MENTOR, sloop, A. Stone.
3 VELENAR, cutter, F. C. Sumichrast.
- Aug. 25th. 1 MENTOR, sloop, A. Stone.
2 VELENAR, cutter, F. C. Sumichrast.
3 MARIQUITA, yawl, W. J. Wallace.
- Sept. 1st. 1 MENTOR, sloop, A. Stone, Archibald Challenge Cup.
2 PHANTOM, sloop, F. Stairs.
1 LILY, sloop, W. H. Weeks.
2 VELENAR, cutter, F. C. Sumichrast.
- Sept. 15th. 1 PETREL, sloop, Lt. G. C. S. Hancock, 19th Regt. Lord Lorne's Challenge Cup.
2 DAPHNE, sloop, A. E. Jones.
1 MENTOR, sloop, A. Stone.
- 1884 :
- June 23d. 1 PSYCHE, cutter, Capt. S. Trott, prize by F. S. West, Vice-Commodore.
2 CIRCE, sloop, J. C. C. Almon, prize by F. C. Sumichrast, Rear-Commodore.
- July 12th. 1 MENTOR, sloop, C. R. Fletcher Archibald Challenge Cup.
2 DAPHNE, sloop, A. E. Jones.
- July 19th. 1 DAPHNE, sloop, A. E. Jones, Lord Lorne's Challenge Cup.
2 MENTOR, sloop, C. R. Fletcher.
- Aug. 23rd. 1 PSYCHE, cutter, Lt. L. G. Russell, Lieut-Governor's Challenge Cup.
2 CIRCE, sloop, J. C. C. Almon.
- Sept. 6. 1 PSYCHE, cutter, Lt. L. G. Russell, Mayor Mackintosh's Cup.
2 KESTREL, yawl, H. St. G. Twining.
1 MENTOR, sloop, C. R. Fletcher.
2 CIRCE, sloop, J. C. C. Almon.
- Sept. 13th. 1 PSYCHE, cutter, Lt. L. G. Russell, W. Hedley, Hon. Treasurer's prize.
2 MENTOR, sloop, C. R. Fletcher, A. C. Edwards, Secretary's prize.
- 1885 :
- June 27th. 1 PHANTOM, sloop, H. M. Wylde, prize by A. G. Jones, Vice-Commodore.
- June 27th. 2 DAPHNE, sloop, J. Peters, prize by James Fraser, Rear-Commodore.
- July 11th. 1 MENTOR, sloop, C. R. Fletcher, Archibald Cup.
2 PHANTOM, sloop, H. M. Wylde.
3 KESTREL, sloop, H. St. George Twining.
- July 18th. 1 MENTOR, sloop, C. R. Fletcher, Lorne Cup.
2 E. M., sloop, W. Marshall Black.
- Aug. 22d. 1 PHANTOM, sloop, H. M. Wylde, Lieut.-Governor Richey's Cup.
2 MINNEHAWA, sloop, Lieut. Arkwright.
3 DAPHNE, sloop, J. Peters.
- Aug. 29th. 2 MINNEHAWA, sloop, Lieut. Arkwright, prize by Lieut. Hancock, late Vice-Commodore.
2 MENTOR, sloop, C. R. Fletcher.
3 PHANTOM, sloop, H. M. Wylde.
- Sept. 5th. 1 MENTOR, sloop, C. R. Fletcher.
2 DAPHNE, sloop, J. Peters.
- Sept. 29th. 1 KESTREL, sloop, H. St. George Twining, Mayor Mackintosh's prize.
- 1886 :
- June 26th. 1 PSYCHE, cutter, Capt. L. G. Russell, Archibald Cup.
2 CIRCE, sloop, J. C. C. Almon, winning on time allowance.
- July 10th. 1 HEBE, cutter, Capt. S. Trott, Mayor Mackintosh's Cup.
2 MENTOR, sloop, C. R. Fletcher, winning on time allowance. (PSYCHE was awarded 2d prize but did not accept it.)
- July 24th. 1 WENONAH, schooner, James Stairs, *et al.* Lorne Cup.
2 HEBE, cutter, Capt. S. Trott.
- Aug. 7th. 1 HEBE, cutter, Capt. S. Trott, Lieut.-Governor Richey's Cup.
2 PSYCHE, cutter, Capt. L. G. Russell.
- Aug. 21st. 1 HEBE, cutter, Capt. S. Trott, Lord Alex. Russell's Cup.
2 PSYCHE, cutter, Capt. L. G. Russell.
- Sept. 4th. 1 HEBE, cutter, Capt. S. Trott, Lord Lansdowne's Cup.
2 PSYCHE, cutter, Captain L. G. Russell.
1 MENTOR, sloop, G. H. Berg, Captain L. G. Russell's Cup.
- Sept. 18th. 1 PSYCHE, cutter, Captain L. G. Russell, Match Race.
2 MENTOR, cutter, G. H. Berg, Match Race.
- Sept. 25th. 1 WENONAH, schooner, James Stairs, *et al.*, Match Race.
2 PASTIME, schooner, W. M. Black, Match Race.
- 1887 :
- June 11th. 1 HEBE, cutter, Capt. S. Trott, Archibald Cup.
2 WENONAH, schooner, F. S. West, *et al.*
3 DAPHNE, sloop, F. H. Bell, *et al.*
- July 6th. 1 LEXORE, sloop, H. C. McLeod, Lorne Cup.
2 WENONAH, sloop, James Fraser, *et al.*
3 HILDRED, sloop, W. G. Jones.
- Aug. 6th. 1 WENONAH, schooner, A. E. Jones, *et al.*, Lord Alexander Russell's Cup.
2 HEBE, cutter, Captain S. Trott.
3 HILDRED, sloop, W. G. Jones.

- Aug. 19th, 1 GALATEA, cutter, Lieut. Henn. R. N. S. Y. S. Cup.
 2 DAUNTLESS, schooner, C. H. Colt, R. N. S. Y. S. Cup.
 1 STRANGER, cutter, George Warren, Sheraton Prize.
 1 WENONAH, schooner, W. H. Troop, et al., American Citizen's Cup.
 2 ST. KILDA, schooner, H. M. Jost et al., Squadron prize, \$50.
- Aug. 20th, 1 GALATEA, cutter, Lieut. Henn. Queen's Jubilee Cup.
 2 DAUNTLESS, schooner, C. H. Colt, American Citizen's Cup.

Jubilee Regatta:

- Aug. 21th, 1 WENONAH, schooner, James Stairs et al., Captain Leonard Russell's Cup.
 2 LENORE, sloop, H. C. McLeod.
 Sept. 3rd, 1 LENORE, sloop, H. C. McLeod, Lansdowne Cup.
 2 PSYCHE, cutter, Captain L. Russell.
 3 HILDRED, sloop, W. G. Jones.
 Sept. 10th, 1 LENORE, sloop, H. C. McLeod, Lieut.-Governor Richey's Cup.
 2 HILDRED, sloop, W. G. Jones.
 Aug. 17th, 1 WENONAH, schooner, F. S. West et al., Mayor O'Mullin's Cup.

1888:

- July 14th, 1 DAPHNE, sloop, T. C. James et al., Archibald Cup.
 2 HILDRED, sloop, W. G. Jones.
 3 LENORE, sloop, H. C. McLeod.
 Aug. 11th, 1 ESME, sloop, J. Rudolf, Jr., Lorne Cup.
 2 WENONAH, schooner, James Fraser et al.
 3 DAPHNE, sloop, F. H. Bell et al.
 July 21st, 1 WENONAH, schooner, A. E. Jones et al., Lieut.-Governor Richey's Cup.
 2 DAPHNE, sloop, T. C. James et al.
 3 HILDRED, sloop, W. G. Jones.
 Aug. 4th, 1 LENORE, sloop, H. C. McLeod, Lord Alex. Russell's Cup.
 2 HILDRED, sloop, W. G. Jones.
 3 DAPHNE, sloop, F. H. Bell et al.
 Aug. 18th, 1 HILDRED, sloop, W. G. Jones, Capt. Leonard Russell's Cup.
 Sept. 15th, 1 LENORE, sloop, H. C. McLeod, Capt. Chauncey's Cup.

1889:

- June 15th, 1 DAPHNE, sloop, F. H. Bell et al., Lord Alexander Russell's Cup.
 2 WENONAH, schooner, James Fraser et al.
 3 HILDRED, sloop, W. G. Jones.
 June 29th, 1 LENORE, sloop, H. C. McLeod, Capt. Leonard Russell's Cup.
 2 MENTOR, cutter, C. M. Jack.
 3 PSYCHE, cutter, G. E. Weston, et al.
 July 13th, 1 MENTOR, cutter, C. M. Jack, Sweepstakes.
 2 HILDRED, sloop, W. G. Jones, Sweepstakes.
 July 24th, 1 LENORE, sloop, H. C. McLeod, Capt. Chauncey's Cup.
 2 PSYCHE, cutter, G. E. Weston, et al.
 3 THETIS, cutter, W. M. Black.
 Aug. 10th, 1 LENORE, sloop, H. C. McLeod, Richey Cup, finally.
 2 WENONAH, schooner, James Stairs, et al.
 3 DAPHNE, sloop, Thomas C. James et al.

- Aug. 26th, 1 ESME, sloop, J. Rudolf, Lorne Cup, finally.
 2 WENONAH, schooner, A. E. Jones et al.
 3 ST. KILDA, schooner, Jas. King et al.
- Sept. 7th, 1 WENONAH, schooner, W. H. Troop, et al., Lansdowne Cup.
 2 PSYCHE, cutter, G. E. Weston et al.
 3 LENORE, sloop, H. C. McLeod.
- Sept. 23st, 1 LENORE, sloop, H. C. McLeod, Archibald Cup.
 2 DAPHNE, sloop, F. H. Bell et al.
 3 MISSEHAVA, sloop, A. T. Stikeman.

1890:

- June 14th, 1 MISSEHAVA, sloop, A. T. Stikeman, Lord Alex. Russell's Cup.
 2 DAPHNE, sloop, F. H. Bell et al.
 3 HILDRED, sloop, G. E. Fraueklyn, Jr.
- July 5th, 1 UYIRA, cutter, Jas. Fraser, Vice-Com., Capt. Leonard Russell's Cup.
 2 WENONAH, schooner, A. E. Jones et al.
 3 CALYPSO, sloop, Lt. H. V. Kent, R. E.
- July 12th, 1 CALYPSO, sloop, Lt. H. V. Kent, R. E., Ruth Cup.
 2 ETEENNE, sloop, J. E. Butler.
 3 WENONAH, schooner, A. C. Edwards, Com., et al.
- Aug. 9th, 1 CALYPSO, sloop, Lt. H. V. Kent, R. E.
 2 MENTOR, cutter, Guy and Carl Stayner.
 2 HILDRED, sloop, G. E. Fraueklyn, Jr.
- Aug. 16th, 1 CALYPSO, sloop, Lt. H. V. Kent, R. E.
 2 PSYCHE, cutter, G. E. Weston.
 3 ETEENNE, sloop, J. E. Butler.
- Aug. 23rd, 1 WENONAH, schooner, A. E. Jones, et al., Lansdowne Cup.
 2 CALYPSO, sloop, Lt. H. V. Kent, R. E.
 3 HILDRED, sloop, G. E. Fraueklyn, Jr.
- Aug. 30th, 1 UYIRA, cutter, Jas. Fraser, Vice-Commodore, United Banks' Cup.
 2 ETEENNE, sloop, J. E. Butler.
- Sept. 6th, 1 MENTOR, cutter, Guy and Carl Stayner, Chauncey Cup.
 2 CALYPSO, sloop, Lt. H. V. Kent, R. E.
- Sept. 20th, 1 UYIRA, cutter, Jas. Fraser, Vice-Commodore, Archibald Cup.
 2 ETEENNE, sloop, J. E. Butler.
 3 CALYPSO, sloop, Lt. H. V. Kent, R. E.

1891:

- June 6th, 1 LENORE, cutter, H. C. McLeod, Archibald Cup, final win.
 2 YOLLA, cutter, H. M. Wyble.
 3 PSYCHE, cutter, T. C. James et al.
- June 13th, 1 YOLLA, cutter, H. M. Wyble, Chauncey Cup.
 2 LENORE, cutter, H. C. McLeod.
- June, 27th, 1 YOLLA, cutter, H. M. Wyble, United Banks Cup.
 2 ETEENNE, sloop, J. E. Butler.
 3 PSYCHE, cutter, F. H. Bell et al.
- July 4th, 3 raters: 1 ETEENNE, sloop, J. E. Butler.
 " " 2 NAUTILUS, sloop, F. H. Murray.
- July 18th, 1 YOLLA, cutter, H. M. Wyble, Lansdowne Cup.
 2 LENORE, cutter, H. C. McLeod.
 3 HEBE, cutter, G. E. Fraueklyn, Jr.
- July 23rd, 1 YOLLA, cutter, H. M. Wyble, WENONAH, Cup.
 Aug. 1st, 1 LENORE, cutter, H. C. McLeod, Match Race.
 2 YOLLA, cutter, H. M. Wyble, " "
 3 HEBE, cutter, G. E. Fraueklyn, Jr., " "

HISTORY OF THE ROYAL NOVA SCOTIA YACHT SQUADRON.

- Aug. 8th. 1 YOULA, cutter, H. M. Wyld, Ladies' race
 2 LENORE, cutter, H. C. McLeod, " "
 3 HEBE, cutter, G. E. Francklyn, Jr., " "
- Aug. 14th. 1 YOULA, cutter, H. M. Wyld, Match race.
 At Chester, 2 LENORE, cutter, H. C. McLeod, " "
 N. S. 3 ESME, sloop, J. J. Rudolf, " "
- Aug. 22nd. 1 YOULA, cutter, H. M. Wyld, Ruth Cup.
 2 ETEENNE, sloop, J. E. Butler.
 3 PSYCHE, cutter, F. H. Bell et al.
- Aug. 29th. 1 LENORE, cutter, H. C. McLeod, Capt. Leonard Russell's Cup.
 2 YOULA, cutter, H. M. Wyld.
 3 WENONAH, schooner, Jas. W. Stairs, et al.
- Sept. 5th. 1 YOULA, cutter, H. M. Wyld, Lord Alex. Russell's Cup.
 2 HEBE, cutter, G. E. Francklyn, Jr.
 3 NAUTILUS, sloop, F. H. Murray.
- Sept. 12th. 1 ETEENNE, sloop, J. E. Butler, Handicap.
 2 PSYCHE, cutter, F. H. Bell et al.
- 1892:
 June 11th. 1 ETEENNE, sloop, J. E. Butler, Lansdowne Cup.
 2 YOULA, cutter, H. M. Wyld.
 3 MINNEHABA, sloop, F. K. Warren.
- June 25th. 1 YOULA, cutter, H. M. Wyld, United Banks Cup.
 2 LENORE, cutter, F. H. Murray.
 3 PSYCHE, cutter, F. H. Bell and T. C. James.
- July 9th. 1 ETEENNE, sloop, J. E. Butler.
 3 races. 2 MINNEHABA, sloop, F. K. Warren.
- July 9th. 1 LENORE, cutter, F. H. Murray.
 Match race. 2 YOULA, cutter, H. M. Wyld.
- July 16th. 1 YOULA, cutter, H. M. Wyld.
 Match race. 2 LENORE, cutter, F. H. Murray.
 3 HEBE, cutter, G. E. Francklyn, Jr.
- July 30th. 1 YOULA, cutter, H. M. Wyld, WENONAH Cup.
 2 WYM, cutter, Wm. Young.
 3 LENORE, cutter, F. H. Murray.
- Aug. 6th. 1 WYM, cutter, Wm. Young, Ladies' prizes.
 2 LENORE, cutter, F. H. Murray, " "
- Aug. 20th. 1 WYM, cutter, Wm. Young, Ruth Cup.
 2 LENORE, cutter, F. H. Murray.
 3 YOULA, cutter, H. M. Wyld.
- Sept. 13th. 1 WYM, cutter, Wm. Young, Lord Alex. Russell's Cup.
 2 YOULA, cutter, H. M. Wyld.
 3 LENORE, cutter, F. H. Murray.
- Aug. 31st. 1 YOULA, cutter, H. M. Wyld, Chauncey Cup.
 final win.
 2 LENORE, cutter, F. H. Murray.
- Sept. 3rd. 1 YOULA, cutter, H. M. Wyld.
 Handicap. 2 ETEENNE, sloop, J. E. Butler.
 3 LENORE, cutter, F. H. Murray.
- Sept. 10th. 1 YOULA, cutter, H. M. Wyld, Capt. L. G. Russell's Cup.
 2 WYM, cutter, Wm. Young.
 3 MENTOR, cutter, R. R. Kennedy, Class prize.
- Sept. 14th. 1 WYM, cutter, Wm. Young.
 Match Race. 2 LENORE, cutter, F. H. Murray.

CHALLENGE CUPS.

Archibald Challenge Cup. Presented to the Squadron by Hon. A. B. Archibald, Lieut.-Governor of Nova Scotia, February 12, 1880.
 Conditions: A perpetual Challenge Cup, to be competed for annually by yachts of the ROYAL NOVA SCOTIA YACHT CLUB.

WINNERS.

1880, July 3d. PSYCHE, sloop, F. S. West.
 1881, August 13th. KESTREL, yawl, S. A. White.
 1882, July 1st. PSYCHE, cutter, Capt. S. Trott.
 1883, Sept. 1st. MENTOR, sloop, A. Stone.
 1884, July 12th. MENTOR, sloop, C. R. Fletcher.
 On July 9, 1884, the following new conditions, with the consent of the donor, were adopted, to come into force in the following year, viz.:-

A challenge cup for annual competition, to become the property of a member winning twice, not necessarily in consecutive years, nor in same yacht, previous winnings not to count.

WINNERS.

1885, July 11th. MENTOR, sloop, C. R. Fletcher.
 1886, June 26th. PSYCHE, cutter, Capt. L. G. Russell.
 1887, June 11th. HEBE, cutter, Capt. S. Trott.
 1888, July 14th. DAPHNE, sloop, T. C. James, F. H. Bell, J. A. McDonald.
 1889, Sept. 21st. LENORE, sloop, H. C. McLeod.

Lansdowne Challenge Cup. Presented to the Squadron by His Excellency the Marquis of Lansdowne, Governor General of Canada, Commodore, January 27, 1886.

CONDITIONS.

A Challenge Cup for annual competition to become the property of a member winning it twice, not necessarily in consecutive years, nor in same yacht.

WINNERS.

1886, Sept. 4th. HEBE, cutter, Captain S. Trott.
 1887, Sept. 3d. LENORE, sloop, H. C. McLeod.
 1888. Not raced for.
 1889, Sept. 7th. WENONAH, schooner, Vice-Commodore Jas. Fraser, A. E. Jones, J. W. Stairs, F. S. West, W. H. Troop.

1890, August 23d. WENONAH, schooner, Commodore A. E. Edwards, A. E. Jones, J. W. Stairs, F. S. West, W. H. Troop.

1891, July 18th. YOULA, cutter, H. M. Wyld.
 1892, June 11th. ETEENNE, sloop, J. E. Butler.
 Lord Alex. Russell's Cup. Presented to the Squadron by General Lord Alex. Russell, April 25, 1886.

CONDITIONS.

A cup for annual competition to become the property of a member winning it twice, not necessarily in consecutive years, nor in the same yacht.

WINNERS.

1886, Aug. 21st. HEBE, cutter, Captain S. Trott.
 1887, Aug. 6th. WENONAH, schooner, James Fraser, A. E. Jones, James Stairs, W. H. Troop, F. S. West.
 1888, Aug. 4th. LENORE, sloop, H. C. McLeod.
 1889, June 15th. DAPHNE, J. A. McDonald, T. C. James, F. H. Bell.
 1890, June 14th. MINNEHABA, A. T. Stikeman.
 1891, Sept. 5th. YOULA, cutter, H. M. Wyld.
 1892, Sept. 13th. WYM, cutter, William Young.
 Capt. Leonard Russell's cup. Presented to the Squadron by Capt. Leonard Russell, April 22, 1887.

CONDITIONS.

A cup, for annual competition, to become the property of a member winning it twice, not necessarily in consecutive years nor in same yacht, winnings in first four years not to count.

ent of
y year,
erty of
nor in

Bell, J.

on by His
of Canada.

property of
ve years, nor

ommodore Jas.
Stairs, F. S.

dore A. E. Ed-
V. Stairs, F. S.

r.
udron by General

erty of a member
years, nor in the

Trott.
ames Fraser, A. E.
I. Troop, F. S. West.
eod.
ld, T. C. James, F.

keman.
Nylde.
Young.
the Squadron by Capt.

the property of a mem-
entive years nor in same
nt.

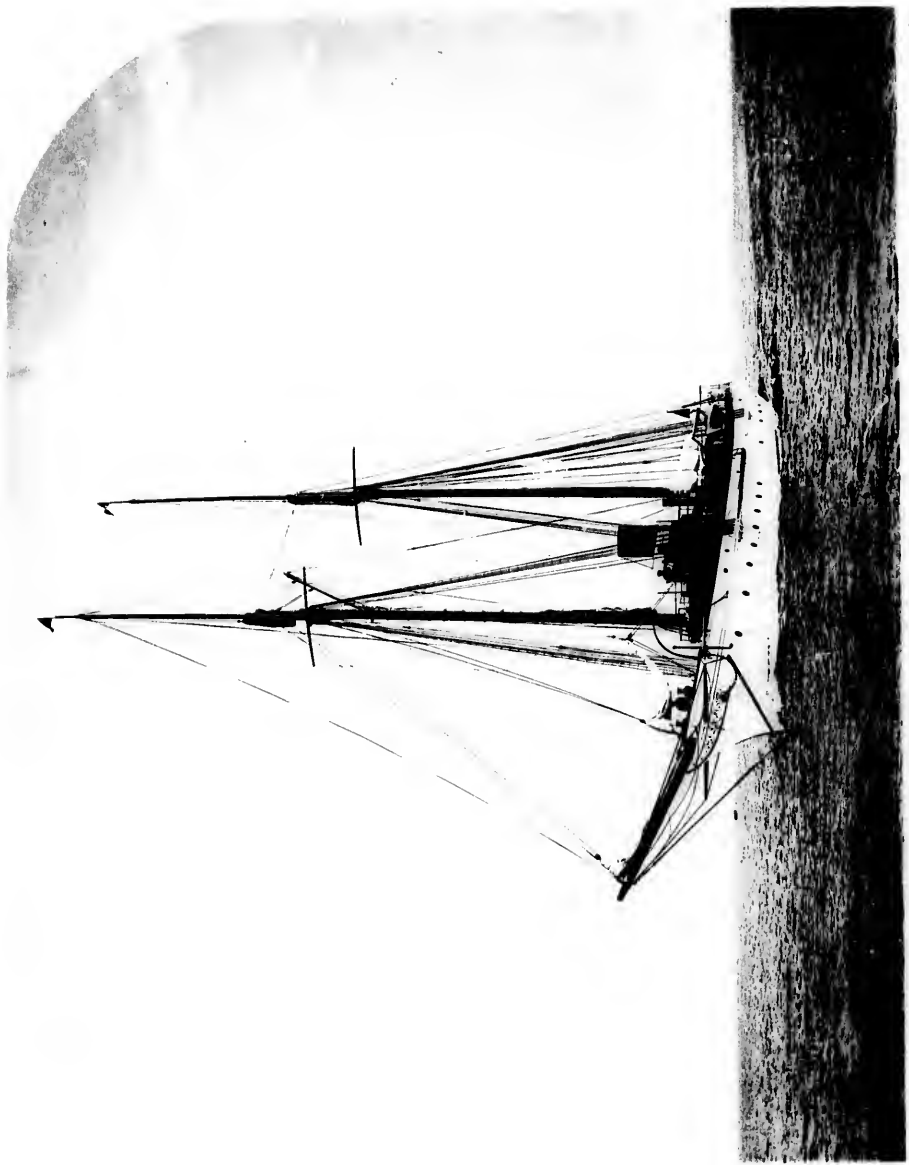
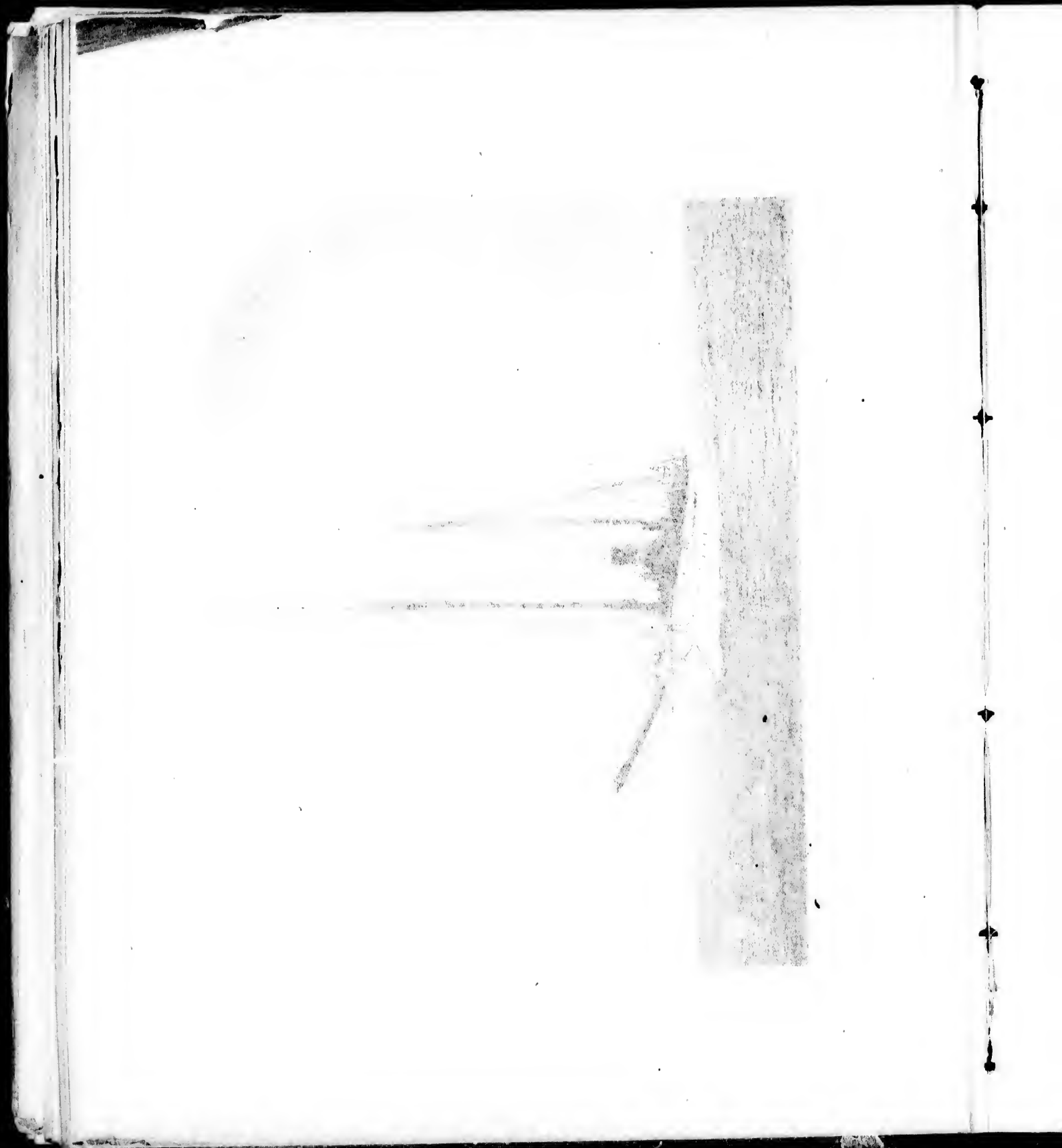

PLATE XLIV.

WILD DUCK.

WILD DUCK.



WINNERS.

1887: Aug. 27th, WENONAH, schooner, James Fraser, A. E. Jones, James Stairs, W. H. Troop, F. S. West.

1888: Aug. 18th, HILDRED, sloop, W. G. Jones.
1889: June 29th, LENORE, sloop, H. C. McLeod.
1890: July 5th, UYIRA, cutter, Vice-Com. Jas. Fraser.
1891: Aug. 29th, LENORE, cutter, H. C. McLeod.
1892: Sept. 10th, YOUA, cutter, H. M. Wylde.

Chauncey Challenge Cup. Presented to the Squadron by Capt. W. A. Chauncey, 1st York Regt., September 5th, 1888.

CONDITIONS.

A perpetual Challenge Cup for annual competition for three years, after which to become the property of a member winning it twice, not necessarily in consecutive years nor in same yacht, winnings in first three years not to count.

WINNERS.

1888: Sept. 15th, LENORE, sloop, H. C. McLeod.
1889: July 24th, LENORE, sloop, H. C. McLeod.
1890: Sept. 6th, MENTOR, cutter, C. Stayner.
1891: June 13th, YOUA, cutter, H. M. Wylde.
1892: Aug. 31st, YOUA, cutter, H. M. Wylde (final win).

Challenge Cup. Presented to the Squadron by distinguished gentlemen of the United States, for competition by yachts of R. N. S. Y. S. Won by schooner yacht WENONAH. Owners, Messrs. James Fraser, A. E. Jones, James Stairs, W. H. Troop, F. S. West, on August 19, 1887, (Jubilee Regatta), and by them presented to the Squadron, January 16, 1890, under the following conditions, viz:—

CONDITIONS.

A perpetual Challenge Cup, to be competed for annually over a course not less than twenty nautical miles in length, between 1st July and 1st October. Open to yachts duly enrolled in any recognized yacht club. The winner to hold this cup for eleven months, giving a bond to the trustees to the amount of \$1,000, after which the cup to be returned to the trustees.

WINNERS.

1890: July 24th, Race not finished on account of fog.
1891: July 23rd, YOUA, cutter, H. M. Wylde.
1892: July 30th, YOUA, cutter, H. M. Wylde.

Ruth Cup. Presented to the Squadron by Mr. Henry Marquand, owner of schooner yacht RUTH, New York Yacht Club, July 4, 1890.

CONDITIONS.

A cup for annual competition to become the property of a member winning it twice after the first year, not necessarily in consecutive years nor in same yacht.

WINNERS.

1890: July 12th, CALYPSO, sloop, Lt. H. V. Kent, R. E.
1891: Aug. 23d, YOUA, cutter, H. M. Wylde.
1892: Aug. 20th, WYM, cutter, William Young.

United Banks Cup. Presented to the Squadron by the surviving members of the Bankers' Regattas and United Banks' Football Club, August 15, 1890.

CONDITIONS.

A cup for annual competition to become the property of a member winning it three times, not necessarily in consecutive years nor in same yacht.

Start: "Bermudian," time allowance to be taken at the start.

WINNERS.

1890, Aug. 30th, UYIRA, cutter, Vice-Com. Jas. Fraser.
1891, June 25th, YOUA, cutter, H. M. Wylde.
1892, June 25th, YOUA, cutter, H. M. Wylde.

The first race of the season of 1893 was sailed on June 10th, the prize being the cup presented by Lord Alexander Russell. The day was rainy and foggy, with a southerly wind. The course was from the Squadron Wharf to Dartmouth Cove, thence to the flag buoy, off the Squadron Wharf, thence to Yves' Knoll Buoy, thence to Mars Rock Buoy and finish off Squadron Wharf. The times were:

Elapsed Time. Corrected Time.

	H. M. S.	H. M. S.
Wym	2 31 00	2 31 00
Lenore	2 31 30	2 31 30
Youa	2 38 20	2 37 11
Mentor		Did not finish.

Yachts all disqualified for non-observance of sailing rules.

YOUA was delayed by an accident to her rigging. The second race, for the Lord Russell Cup and Squadron prizes, was sailed on June 17th, the course being: Starting off Squadron Wharf to Flag Buoy in Dartmouth Cove, leaving it on starboard hand, thence passing it to westward of George's Island, to Point Pleasant Buoy, thence to the buoy off Woodside refinery, thence to enter Flag Buoy off Squadron Wharf, leaving these marks on the port hand, thence to Point Pleasant Buoy, leaving it on starboard hand, and finish off Squadron Wharf, 9 2-10 miles. Time limit, 4 hours. The times at finish were:

Elapsed Time. Corrected Time.

	H. M. S.	H. M. S.
Youa	1 51 33	1 51 20
Wym	1 57 15	1 57 15
Lenore	1 59 13	1 59 13
Etienne	2 13 20	2 11 22
Mentor	2 37 20	2 33 19

WYM won.

Race No. 3, was to take place on June 24th but on account of light wind the yachts could not finish, so the race was sailed over on August 19th.

Race No. 4 took place July 1st, over a course of 20.8 miles. The wind was from the southwest. Weather was fine.

Name	Rig.	Sailing Length.		Elapsed Time.		Corrected Time.	
		ft.	in.	H. M. S.	H. M. S.	H. M. S.	H. M. S.
Youa	cutter	26.00	4.02	4.02	4.02	4.02	4.02
Valkyrie	schooner	28.01	5.02	4.47	4.47	4.37	4.37
Lenore	cutter					did not finish	
Albatross	schooner					did not finish	

YOUA won the WENONAH Challenge Cup.

Race No. 5, handicap, was sailed on the 8th of July, over a course of 11 miles. The weather was fair and the wind was from the southwest.

Valkyrie	schooner	28.01	2.22	2.00	1.59.00
Mentor	cutter	26.00	2.30	2.50	2.00.50
Hebe	cutter	25.01	2.15	1.10	2.02.10
Etienne	sloop	26.00	2.21	50	2.07.50
Lenore	cutter	27.00	2.11	50	2.08.20
Youa	cutter	26.00	2.09	20	2.09.20
Albatross	schooner	32.06	2.11	05	2.11.05
Meda	sloop	26.00	2.11	40	2.11.40
Hildred	sloop				did not start

Race No. 6 took place July 15th. The weather was fair and the wind light from the southwest. The course was 9.2 miles.

Youa	cutter	26.00	2.00	04	1.57.04
Lenore	cutter	27.00	2.05	10	2.03.10
Etienne	sloop	26.00	2.19	45	2.15.30
Hebe	cutter	25.01	2.17	10	2.17.10
Valkyrie	schooner	28.01	2.27	10	2.17.55
Hildred	sloop	26.00	2.28	52	2.25.00
Meda	sloop	26.00	2.57	20	2.57.20
Irene	schooner	25.00			did not start
Mentor	cutter	29.00			did not start

1st prize *YOULA*, United Banks Cup, (final win) and \$10.
2d prize, *LENORE*, \$10.
3rd prize, *ETIENNE*, \$5.
Race No. 7, July 29th. The wind was south and the weather cloudy. The course was 9.2 miles.

Name	Rig	Sailing Length.	Elapsed Time.	Corrected Time.
Valkyrie	schooner	28 01	3 17 20	2 42 00
Thetis	cutter	21 07	3 41 31	3 40 00
Mentor	cutter	20 00	3 43 25	3 41 00
Hildred	sloop	20 00	3 43 45	3 43 45
Irene	schooner	25 00	did not finish	
Etienne	sloop	20 00	did not start	

1st prize, *VALKYRIE*, \$10.

3d prize, *THETIS*, \$5.

Re-sail of race No. 3 took place on August 19th, with a light, north-east wind, and clear weather. The course was 15.4 miles.

<i>Yonla</i>	cutter	20 00	5 05 15	5 04 25
<i>Lenore</i>	"	27 00	5 09 30	5 09 30
<i>Valkyrie</i>	schooner	28 01	6 30 00	6 21 20
<i>Etienne</i>	sloop	20 00	did not start.	
<i>Albatross</i>	schooner	32 00	"	"
<i>Hildred</i>	sloop	23 01	"	"

First prize, *YOULA*, RUTH Cup and \$10, (final win). Second prize *LENORE*, \$10. Third prize, *VALKYRIE*, \$5.

Race No. 8, was a Ladies' Race sailed on the 26th of August, with a strong squally, north wind. Course 5.8 miles.



A. C. EDWARDS.

ESME is a keel sloop, and is owned by J. J. Rudolf. She was built by J. E. Butler, and sails with the ROYAL NOVA SCOTIA YACHT SQUADRON, hailing from Lunenburg. See Fig. 371.

CODE SIGNAL LETTERS, P. D. K.

Official number, 80,860. Squadron number, 9.

DIMENSIONS.

Depth,	4 feet 4 inches.	Length low waterline,	20 feet.
Beam,	8 feet 4 inches.		

RACING RECORD.

ESME raced many times in the ROYAL NOVA SCOTIA YACHT SQUADRON between 1881 and 1891. Her record for the ten years has been four firsts in '81, winning a cup; a second in '82, one first '88 (cup), one in '89 (cup), and one third in 1891.

YOULA.

YOULA is a cutter yacht, designed by William Fife, Jr.; framed by Fife, Fairlie, Scotland and finished by H. Stanton, Pieteron, Ontario. She was launched in June, 1891, for her owner, H. M. Wythe of Halifax. Sails with the ROYAL NOVA SCOTIA YACHT SQUADRON and hails from Halifax. See Fig. 372.

Name	Rig	Sailing Length.	Elapsed Time.	Corrected Time.
<i>Wym</i>	cutter	20 00	1 10 40	1 10 40
<i>Yonla</i>	"	20 00	1 13 50	1 13 31
<i>Lenore</i>	"	27 00	1 17 32	1 17 32
<i>Valkyrie</i>	schooner	28 04	1 18 58	1 14 30

Winners, *WYM* first, *YOULA* second, *VALKYRIE* third. Prizes presented by the ladies.

Race No. 9, Handicap Race sailed September 2d. Wind east with rain and fog. Course 11 miles.

<i>Lenore</i>	cutter	27 00	2 03 50	2 00 50
<i>Yonla</i>	"	20 00	2 18 45	2 18 45
<i>Valkyrie</i>	schooner	28 04	2 19 28	2 00 28
<i>Wym</i>	cutter	20 00	did not finish	

LENORE, first prize, \$12; *VALKYRIE* second, \$8; *YOULA* third, \$5.

Race No. 10, sailed September 9th. Wind southwest, strong with squalls. Course 15.4 miles.

<i>Lenore</i>	cutter	27 0	2 00 47	1 50 52
<i>Yonla</i>	"	20 0	2 01 00	1 54 54
<i>Valkyrie</i>	schooner	28 4	2 12 27	2 00 57
<i>Meda</i>	sloop	25 0	2 43 20	2 35 08

First prize, *LENORE*, Lansdowne Cup and \$10; 2d prize, *YOULA*, \$10; 3d prize, *VALKYRIE*, \$5.

Race No. 11, was a handicap open to 4 and 5 raters, and took place September 27th. Light south wind with rain. Course 9.2 miles.

<i>Mentor</i>	cutter	20 00	2 40 03	2 31 03
<i>Irene</i>	schooner	25 00	2 47 18	2 32 18
<i>Etienne</i>	sloop	20 00	2 39 42	2 37 42
<i>Valkyrie</i>	schooner	28 04	2 39 05	2 39 05
<i>Meda</i>	sloop	20 00	did not finish.	

First prize, *MENTOR*, A. C. Edwards' Cup and \$10; 2d prize, *IRENE*, \$10; 3rd prize, *ETIENNE*, \$5.

BIOGRAPHICAL SKETCHES AND DESCRIPTION OF YACHTS ENROLLED IN THE CLUB.

A. C. EDWARDS, ex-Commodore of the ROYAL NOVA SCOTIA YACHT SQUADRON. Mr. Edwards has been an enthusiastic yachtsman for years, and is held in the highest esteem by the various members of the club of which he had the honor of being the commanding officer at one time. At present Mr. James Fraser is the Commodore, and looks after the best interests of the club.

ESME.

ESME is a keel sloop, and is owned by J. J. Rudolf. She was built by J. E. Butler, and sails with the ROYAL NOVA SCOTIA YACHT SQUADRON, hailing from Lunenburg. See Fig. 371.

CODE SIGNAL LETTERS, P. D. K.

Official number, 80,860. Squadron number, 9.

DIMENSIONS.

Depth,	4 feet 4 inches.	Length low waterline,	20 feet.
Beam,	8 feet 4 inches.		

RACING RECORD.

ESME raced many times in the ROYAL NOVA SCOTIA YACHT SQUADRON between 1881 and 1891. Her record for the ten years has been four firsts in '81, winning a cup; a second in '82, one first '88 (cup), one in '89 (cup), and one third in 1891.

YOULA.

YOULA is a cutter yacht, designed by William Fife, Jr.; framed by Fife, Fairlie, Scotland and finished by H. Stanton, Pieteron, Ontario. She was launched in June, 1891, for her owner, H. M. Wythe of Halifax. Sails with the ROYAL NOVA SCOTIA YACHT SQUADRON and hails from Halifax. See Fig. 372.

Official number, 96,808.

DIMENSIONS.

Length over all,	37 feet.	Length low waterline,	20 feet.
Depth,	4 feet.	Draft,	6 feet 7 inches.
Beam,	7 feet 4 inches.		

RACING RECORD.

The races given below are those which *YOULA* has sailed under the auspices of the ROYAL NOVA SCOTIA YACHT SQUADRON.

1891 :—July 6th, second; defeated by *LENORE*, with *PSYCHE* third. June 13th, won Chauncey Cup, *LENORE* second. June 27th, first, *ETIENNE* second; won United Banks Cup. July 18th, won Lansdowne Cup, *LENORE* being second and *HEBE* third.

July 23d, won WENONAH CUP.

Aug. 1st, beaten by *LENORE*, *HEBE* third.

Aug. 8th, first, *LENORE* second, followed by *HEBE*.

Aug. 14th, first, *LENORE* second and *ESME* third.

Aug. 22d, won the RUTH Cup beating *ETIENNE* and *PSYCHE*.

Aug. 29th, beaten by *LENORE*, with *WENONAH* third.

Sept. 5th, first, winning Lord Alex. Russell's Cup, competing with *HEBE* and *NAUTILUS*.

1892 :— June 11th, second, *ETIENNE* first, *MISSEMAHA* third.

June 25th, first, winning United Banks Cup; *LENORE* second, *PSYCHE* third.

July 9th, second, beaten by *LENORE*.

July 16, first, *LENORE* second, *HEBE* third.

July 30th, won WENONAH Cup, beating *WYM* and *LENORE*.

Aug. 20th, *WYM* first, *LENORE* second, *YOULA* third.

Aug. 13th, beaten by *WYM*, *LENORE* third.

Aug. 31st, won Chauncey Cup, defeating *LENORE*.

Sept. 3d, first, with *ETIENNE* second and *LENORE* third.

Sept. 10th, first, beating *WYM* and *MENTOR*.

Elapsed Time.	Corrected Time.
13 56	13 38
14 30	14 10
15 50	15 31
17 32	17 32
18 58	18 30

third. Prizes pre-

ber 2d. Wind east

03 50	2 00 50
18 45	2 18 45
19 28	2 00 28
	did not finish

8; YOULA third, \$5.

nthwest, strong with

00 47	1 50 52
01 00	1 50 54
12 27	2 00 57
43 20	2 35 08

0; 2d prize, YOULA,

nters, and took place

Course 9.2 miles.

40 03	2 31 03
47 18	2 32 18
39 42	2 37 42
39 05	2 39 05
	did not finish.

and \$10; 2d prize,

B.

line, 20 feet.
6 feet 7 inches.

has sailed under the
CADRON.

, with PSYCHE third.

RE second.

n United Banks Cup.

RE being second and

ird.

el by HEBE.

ESME third.

ating ETIENNE and

ENONAH third.

assell's Cup, compet-

ENNEHANA third.

s Cup; LENORE sec-

third.

ing WYM and LENORE.

, YOULA third.

third.

ing LENORE.

and LENORE third.

EXTOR.

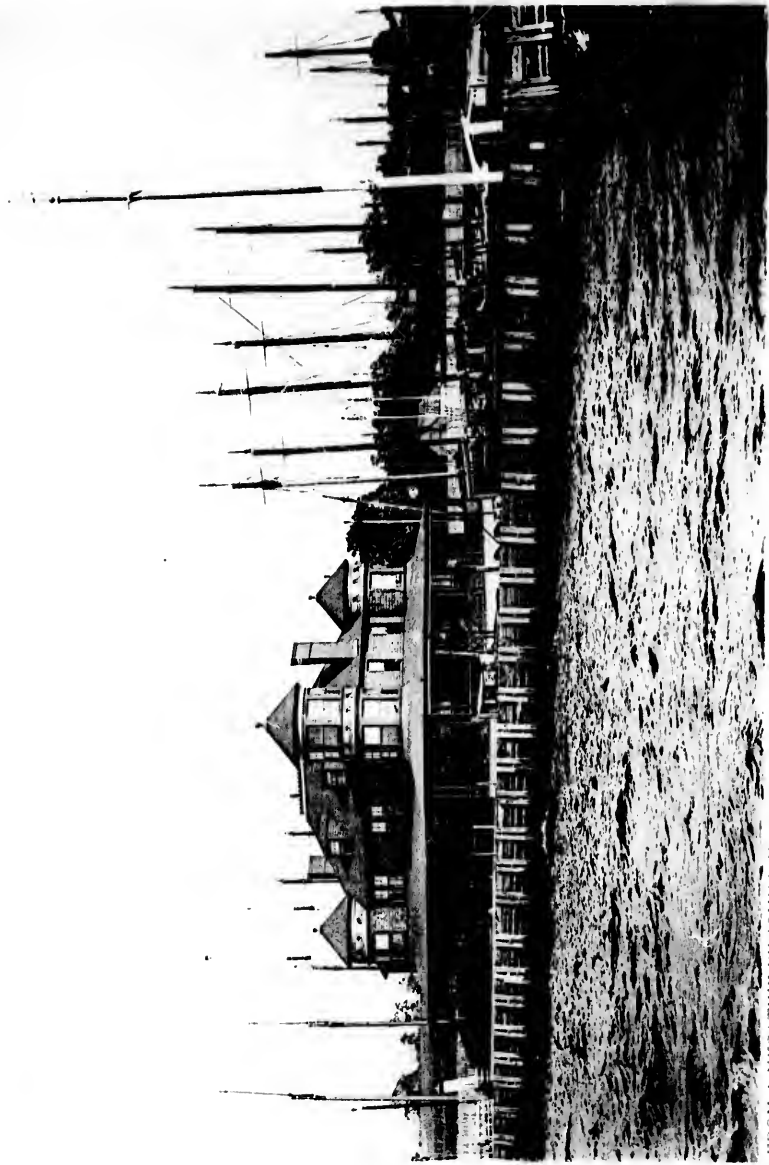

FROM A NEGATIVE BY JOHNSON.

ATLANTIC YACHT CLUB HOUSE.

20

4 1 2 3 4 5 6 7 8 9

d
y
r
c
h
s
y
r
e
r
i
s



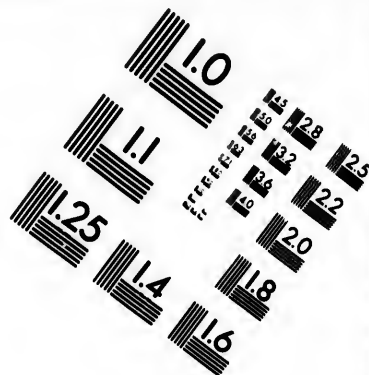
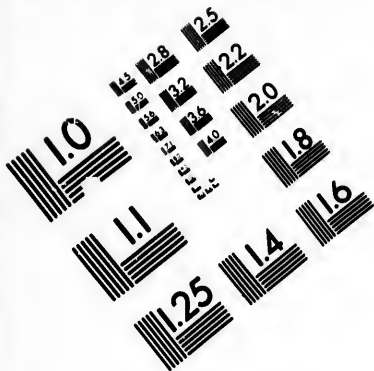

**IMAGE EVALUATION
TEST TARGET (MT-3)**

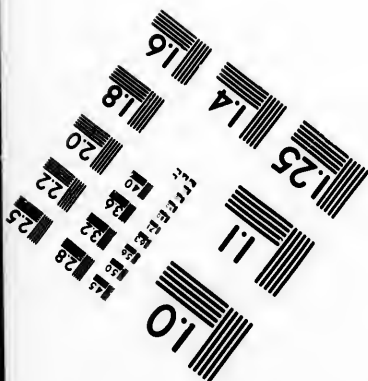
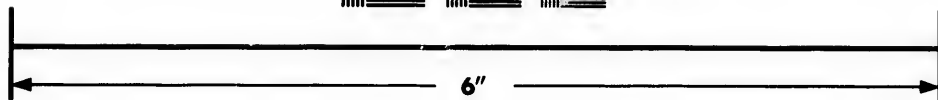
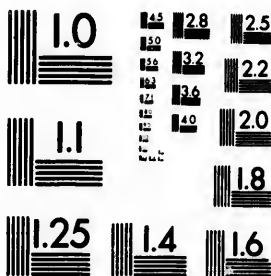

**Photographic
Sciences
Corporation**

23 WEST MAIN STREET
WEBSTER, N.Y. 14580
(716) 872-4503

18
20
22
25
E6
E6
E6
E6
E6
E6

10
E6
E6
E6

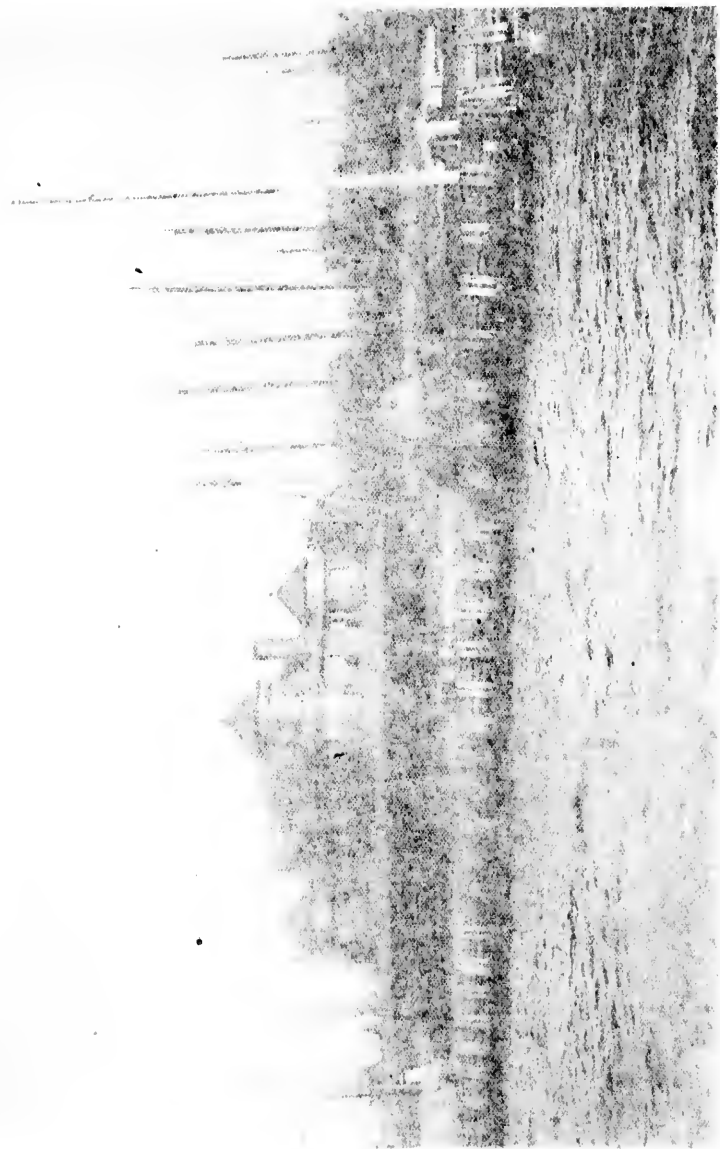

History of the Atlantic Yacht Club.

IT was in the Summer of 1865 that some members of the BROOKLYN YACHT CLUB who had become dissatisfied with the management of that club, began to discuss among themselves a plan for a similar organization which should be more of a yacht club, more select in its membership, and have a higher standard of seamanship; a club which should not be controlled by non-yacht-owners, and in whose races its yachts should be sailed by member against member, and not by professionals.

The regatta of the BROOKLYN YACHT CLUB that Summer was in some respects unfortunate, and rather increased the dissatisfaction, which culminated after an excursion and dinner given to the club by the since notorious AMERICUS CLUB, at Indian Harbor, on July 4, 1865. This dissatisfaction crystallized into action when, on an evening in November of that year, about ten of its members met at the house of Mr. Henry A. Gouge, on Washington street, Brooklyn, to consult as to the formation of a new yacht club, in which the general management should be by the yacht owners, all professional sailors be excluded, and the membership be restricted to those who could fraternize in social life on terms of equality, and where those of the highest standard of character would not feel out of place with their surroundings. At this meeting a preliminary paper was prepared and signed by those present, most of whom were afterwards named as directors for the first year. Mr. Henry A. Gouge, Mr. Chas. P. Low and Mr. William Peet were appointed a committee to obtain a charter under the general Act of the State for such corporations passed by the Legislature that year. Afterwards, at the residence of Mr. William M. Brasher, the name ATLANTIC was selected, and the club signal followed almost as a matter of course, being the first letter "A."

The committee obtained the charter, which, at a subsequent meeting, was accepted. At the same meeting a Constitution, By-Laws and Sailing Regulations were adopted and officers elected for that year (1866) as follows:

Commodore, T. C. Lyman; Secretary, Christopher Lippitt; Treasurer, J. Rogers Maxwell; Measurer, Edward Harvey; Chaplains, Rev. James Eells, D. D. and the Rev. A. A. Willetts, D. D., and the ATLANTIC YACHT CLUB became a fact in the yachting world.

The First Regatta was held on the 11th day of June, 1866. The yachts that sailed were:

First Class.		SLOOPS.
	Owner.	Length Feet.
Psyche	F. B. Taylor	45.0
Annie Laurie	C. P. Low	44.0
Black Hawk	J. R. Maxwell	37.0
Lois	T. C. Lyman	37.0
Dolphin	T. W. Sheridan	35.0
Frolic	C. T. Lippitt	32.0
Second Class.		
Agnes	Edward Harvey	43.0
Lizzie	W. H. Langley	33.0
Alida	Philip Brasher	30.0
Nameless	Sheppard Homans	28.0
Hector	William Peet	26.0
Aurelia	H. A. Gouge	23.0
Imp	H. W. Hubbel, Jr.	24.3
Zaidee	C. T. Litchfield	24.0

Judges: Wm. McMonies, Hon. Lucien Birdseye, John T. Moore.
The race was sailed without any time allowance, and the yachts passed the home stake boat as follows:

	Time.
	H. M. S.
Hector	4 40 00
Agnes	4 41 50
Psyche	4 46 00
Black Hawk	4 51 00
Lois	4 57 00
Annie Laurie	5 02 00
Frolic	5 02 11

The time of the others was not taken. Prizes were awarded to HECTOR and PSYCHE. HECTOR and NAMELESS this year, on a First Cruise of the yachts of the club, carried the Atlantic Flag through Long Island Sound as far as Newport and Bristol, R. I., and since that time the fleet has never failed to make a summer cruise, generally going to Newport, and often as far as New Bedford and Martha's Vineyard.

For the year 1867 the officers of the previous year were re-elected, with the exception of Mr. Lippitt, who declined a re-election, and William Peet was chosen Secretary.

The Second Regatta was held the 18th of June, 1867.

First Class (cabin sloops).

	Owner.	Length Feet.
White Wings	Sheppard Homans	55
Addie V	William Voorhis	51
Alarm	T. W. Sheridan	45
Psyche	F. W. Taylor	45
Agnes	Edw. Harvey	43
Dolphin	J. R. Waller	35
Lois	T. C. Lyman	37
Galatea	Geo. H. Grannis	30

Second Class (open sloops).

Sabes	H. C. Walton	33
Leopard	T. C. Fowler	31
Martha	William M. Brasher	28
Carrie	J. R. Maxwell	27
Hector	William Peet	26
Aurelia	H. A. Gouge	23
Imp	H. W. Hubbel, Jr.	23
Harry Schell	H. S. Schell	23

The winners were ADDIE V. and CARRIE.

This year the club commenced Championship Regattas to be sailed upon challenge, but for no prize except a championship endorsed by a champion pennant. This race was first sailed on the 21st of September, 1867, and the course was from off the Elysian Fields, Hoboken, to a stake boat off Yonkers and back. ADDIE V. won the championship of the first class, and FANNIE in the second class.

A Second Championship Regatta was sailed October 9, 1867, with the course in the lower bay. The same yachts were victorious and retained the pennants. In this race HECTOR and HARRY SCHELL raced for the championship of a special class but the latter capsized, and HECTOR, far ahead, turned back and picked up the crew and sailed for home.

The officers for the year 1868 were: Commodore, Sheppard Homans; Vice-Commodore, William Voorhis; Rear-Commodore, William Peet; Secretary, George H. Grannis; Treasurer, H. H. Hoggins; Measurer, H. A. Gouge.

The Third Annual Regatta was sailed on the 17th of June, 1868

SCHOONERS.

Name.	Owner.	Tons.	Length.
Mystic	J. T. Sparkman	40	56.4
Algo	Jas. E. Gregory	18	38.4

SLOOPS.

First Class.

White Wings	Sheppard Homans	30	
Addie V.	William Voorhis	35	
Alarm	T. W. Sheridan	30	39.8
Clytie	J. B. Herreshoff	13	34
Psyche	F. H. Taylor	18	
Qui Vive	Thomas Clapham	18	34.6
Agnes	Edward Harvey	20	34.6
Niagara	John W. Rich	16	39.9
Mariquita	T. B. Henry	18	
Athens	Geo. H. Seeley		38.5
Fannie	J. R. Halsey		
Galatea	S. V. & D. T. Lovett	12	

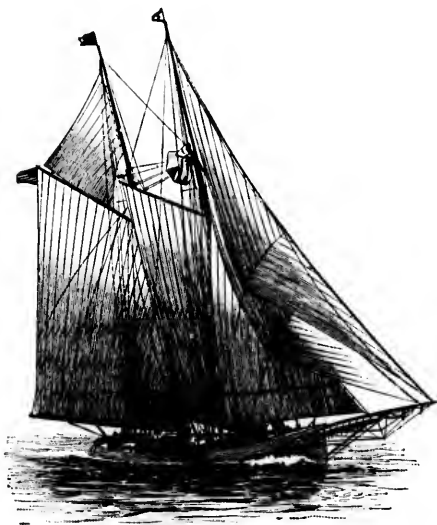

UNA.—FIGURE 372.

SLOOPS.

Second Class.

Salus	H. C. Walton	35
Peerless	J. R. Maxwell	30
Hermit	Leslie Wetmore	30
Martha	William M. Brasher	28
Marion	H. H. Hogins	26
Lavine	S. F. Speir	26
Hector	William Peet	26
Florence	H. S. Schell	24

The wind was too light to allow a race but it was sailed the next day, and the schooner *MYSTIC*, first class sloop *CLYTIE* and the second class sloop *MARTHA* took prizes.

In the Championship Pennant Regatta held in the Fall, *LOIS* (schooner), *GRACIE* (first class sloop), *CLYTIE*, (second class sloop), *WHITE CAP* (third class sloop), and *LAVINE* (open sloop) took the championship pennants in their respective classes.

The officers elected in 1869, were:

Commodore, William Voorhis,	Vice-Commodore, T. W. Sheridan.
Rear-Commodore, J. Rogers Maxwell,	Secretary, Robert A. Gramis.
Treasurer, H. H. Hogins,	Measurer, H. A. Gouge.

The Annual Regatta was sailed June 8th:

SCHOONERS.

Name.	Owner.
Mystic	J. T. Sparkman.

SLOOPS.

First Class.

Madeleine	Jacob Voorhis.
Gracie	William Voorhis.
Addie V.	John Voorhis.
Carrie	William B. Nichols.

Second Class.

Sadie	J. B. Herreshoff.
Daphne	J. R. Maxwell.
Alarm	T. W. Sheridan.
Qui Vive	Thomas Clapham.
Fannie	J. B. Halsey.

Third Class.

Anna	W. A. Cummings
Niagara	J. W. Rich
Richard Kell	S. M. Simpson
White Cap	Ludlow Livingston
Constance	J. & L. T. Griffith
Nimbus	William Peet.
Salus	H. C. Walton.
Cyrene	W. H. Langley

SLOOPS.

Fourth Class.

Crusade	Leslie Wetmore
Florence	H. S. Schell
Coquette	W. C. Brett
Minnie	Edw. Arnold
Flyaway	Van Brugh Livingston

Prizes were won by *MADELEINE*, *GRACIE*, *SADIE*, *CYRENE* and *COQUETTE* in their respective classes.

It was this year that Henry A. Mott of New London, Conn., offered prizes to the club, to be sailed for in a regatta held in New London Harbor, July 30th, during the cruise of the club. This regatta was a great success, as nearly all the yachts on the cruise entered, and the prizes were awarded by F. L. Allen and John A. Tibbits, judges, and Hon. Augustin Brandegee, the umpire, to the schooner *LOIS* and sloops *GRACIE* and *ANNA*, in their respective classes. The club was handsomely entertained by Mr. Mott at his place on the Thames River, and he presented the prizes, handsome silver goblets, to the winners.

The Championship Pennant Regatta was sailed on September 29th, and the pennants were won by *MADELEINE*, *SADIE* and *ANNA*.

In 1870 the Commodore, Rear-Commodore, Treasurer and Measurer were re-elected. William Peet was elected Vice-Commodore; John B. Morgan, Recording Secretary; Leslie Wetmore, Corresponding Secretary.

The Annual Regatta took place June 2, 1870:

SCHOONERS.

Calypto	W. S. Hatch
Lois	T. C. Lyman
Madeleine	Jacob Voorhis
Tidal Wave	William Voorhis

SLOOPS.

First Class.

Addie V.	W. H. Langley
Gracie	Johnson and Krebs

Second Class.

Name.	Owner.
Alarm	T. W. Sheridan
Daphne	J. R. Maxwell
Orion	George A. Thayer
Qui Vive	Thomas Clapham
Richard Kelly	S. M. Simpson

Third Class.

Name.	Owner.
Anna B.	W. A. Cummings
Jennie	H. L. Foote
Nimbus	William Peet
Storm King	Peter Voorhis
White Cap	Ludlow Livingston

OPEN SLOOPS.

Fourth Class.

Name.	Owner.
Apollo	W. S. Fry
Copette	W. C. Brett
Flyaway	V. B. Livingston
Jennie	W. Southwick
Viking	L. Wetmore
Vivid	J. M. Sawyer

The prizes were won in their respective classes by TIDAL WAVE, GRACIE, ORION, WHITE CAP and VIVID.

The Championship Pennant Regatta was won by the schooners MADELEINE, MYSTIC and LOIS.

This year, as in 1869, the club was invited on the Fourth of July to an entertainment given by Commodore William Voorhis, at Nyack-on-the-Hudson. There was also a regatta on this occasion. The course was from Nyack to Stony Point and return, and fifteen yachts entered in two classes. MADELEINE and WHITE CAP were the winners in this event.

The Championship Pennant Regatta was sailed September 12th and was won by sloop DAPHNE in the second class, WHITE CAP in the third, and FLYAWAY in the fourth.

At the annual meeting of 1871, Mr. William Peet, yacht NIMBUS, was elected Commodore; Mr. J. Rogers Maxwell, yacht PEERLESS, Vice-Commodore; Mr. John A. Monsell, yacht LOIS, Rear-Commodore; the other officers were re-elected.

The Sixth Annual Regatta was sailed June 16, 1871:

SCHOONERS.	
Agnes	Edward Harvey
Lois	Rear-Com. Monsell
SLOOPS.	
First class.	
Addie V.	W. H. Langley
Gracie	Johnson and Krebs
Peerless	Vice-Com. Maxwell
SLOOPS.	
Second Class.	
Daphne	E. M. Wood
Nancy	S. M. Simpson
Orion	George A. Thayer
Qui Vive	Thomas Clapham
Vixen	L. Livingston
SLOOPS.	
Third Class.	
Nimbus	Com. Wm. Peet.
Viking	Ledie Wetmore.
SLOOPS.	
Fourth Class.	
Apollo (br'k down)	Thos. Fry
Flyaway	V. B. Livingston

Prizes won by AGNES, ADDIE V., VIXEN and FLYAWAY.

The stake boat by some mismanagement was removed before the third class could reach it, and no race was made in that class. It

was ordered to be sailed again on the Fourth of July when the club was to spend the day in Glen Cove Harbor.

Accordingly, it was then sailed from Glen Cove across the Sound to a buoy off Shippan Point and return. The entries and time were:

Name.	Owner.	Time.
Nimbus	Com. Peet	4 31 30
Ida	J. C. Greenleaf	5 25 15
Josephine	S. V. Lowell	4 21 30

NIMBUS won the prize.

During the Annual Cruise on the 5th of August a regatta was sailed from Greenport, open to all cabin yachts not enrolled in any yacht club east of Throgg's Neck.

So much had been heard by the club in the different harbors on Long Island Sound of the wonderful speed made by yachts belonging there, that to test the comparative speed of their yachts with the

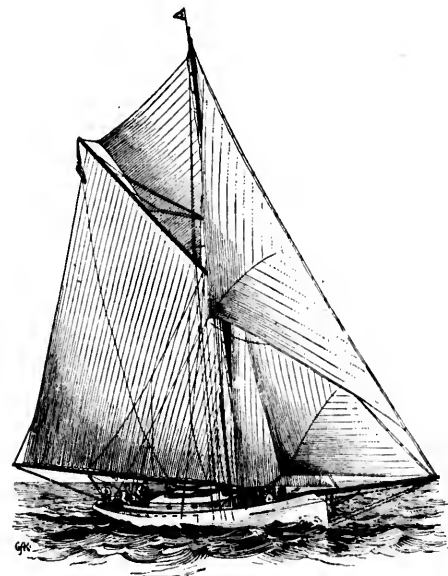

AGLAIA.—FIGURE 373.

club yachts, the club appropriated \$1,000 and bought eight prizes in silver and sent them to Greenport for exhibition and then published the notice of the regatta. Entries were free to all, and yachts of the ATLANTIC YACHT CLUB were forbidden to set any but the ordinary working sails.

The race was to be sailed under the Rules and Sailing Regulations of the club, and two prizes were offered to each class, one to the first yacht and the other to the one beating by time allowance.

The judges selected were Hon. Henry A. Reeves, S. Wells Phillips, of Greenport, and Edwin Arnold of the club.

There were twenty-six entries divided into schooners and three classes of sloops, of which fourteen were outsiders, and twelve were in the club. Prizes were taken by the schooner LOIS; sloops PEERLESS, ORION and ANNA in their respective classes. The winners were all in the yacht club, and won without, as well as with, the time allow-

ance, taking both prizes. The regatta was a delight to the citizens of Greenport and Sag Harbor as well as to the Yacht Club. After the regatta the club continued its summer cruise and visited Newport, New Bedford and Martha's Vineyard.



LENA.—FIGURE 374.

The Championship Pennant Regatta was held September 26th, and the pennants were won by PEERLESS, DAPHNE and JOSEPHINE.

The officers for 1871 were all re-elected for the year 1872. The Seventh Annual Regatta took place June 18th, 1872. The entries were:

SCHOONERS.	
	Owner.
Resolute	A. S. Hatch
Tidal Wave	William Voorhis
Peerless	Vice-Com. Maxwell

SLOOPS.	
First Class.	
Gracie	S. F. Colgate
Addie V.	W. H. Langley
Orion	J. W. Cooper
Vixen	L. Livingston
Second Class.	
Qui Vive	Thomas Clapham
Anna	W. A. Cummings
Nimbus	Commodore Peet
Josephine	S. V. Lowell
Third Class.	
Flyaway	V. B. Livingston
Undine	C. E. Willis

PEERLESS, VIXEN, ANNA and UNDINE won in their respective classes.

The Club this year accepted the invitation of the SEAWANUAKA YACHT CLUB to spend the Fourth of July in Oyster Bay.

THE SEASON OF 1873.

The year opened with the first Anniversary Dinner of the club, given on January 15th, at Delmonico's, in New York City. At the Annual Meeting, Commodore Peet declined re-election, and the offi-

cers chosen were: Commodore, J. Rogers Maxwell, PEERLESS; Vice-Commodore, John A. Monsell, EDDIE; Rear-Commodore, Henry A. Gouge, DAPHNE. The other officers remained the same as in the previous year, except that William B. Davonport was elected Corresponding Secretary and Christopher T. Lippitt, Measurer.

The Annual Regatta was sailed June 10th and the entries were:

SCHOONERS.			
	Owner.	Length. Feet.	Time. H. M. S.
Foam	Sheppard Homans	78.0	4 58
Triton	George A. Thayer	65.6	4 03
Myslie	W. G. Creamer	65.3½	
Peerless	Commodore Maxwell	64.5	4 50
Agnes	L. A. Fish	57.0	4 48

SLOOPS.			
First Class.			
Vision	J. J. Alexandre	60.6	4 50
Orion	J. W. Cooper	48.4	
Vixen	L. Livingston	48.4	4 52
Second Class.			
Anna	W. A. Cummings	39.7	4 27.6
Alert	H. Vail	39.0	4 27.3
Nimbus	William Peet	35.3	4 30.0
Ida	D. Crocker	33.7	4 54.0
Barbara Freitchie	J. H. Rhodes	24.4	
Third Class.			
Fly Away	V. B. Livingston	32.6	4 15
Undine	C. E. Willis	29.0	4 14

Prizes won by PEERLESS, VIXEN, ALERT and UNDINE, in their respective classes.

This year the club again accepted an invitation to spend the Fourth of July with the SEAWANUAKA YACHT CLUB, in Oyster Bay Harbor, and a race was sailed by the yachts in both fleets for a prize offered by the entertaining club to the visitors. In this race VIXEN, Ludlow Livingston owner, was the winner.

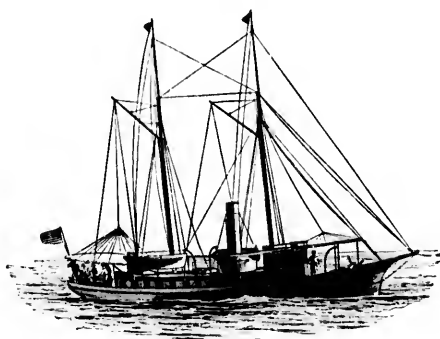

EMU.—FIGURE 375.

Soon after this race Ludlow Livingston died, and his heirs receiving the prize, gave it to the ATLANTIC YACHT CLUB to be known as the Livingston Memorial and to be sailed for at each Annual Regatta as a yearly prize. It was to be awarded to the first yacht belonging to the class in which VIXEN would have sailed, had she been present, irrespective of any time allowance. The club accepted the gift, and it has been sailed for and won at each Annual Regatta since that time.

THE SEASON OF 1874.

At the annual election, all the officers of the past year were

ell, PEERLESS; Vice-
Commodore, Henry
ed the same as in the
t was elected Corre-
Measurer.

the entries were:

Length.	Time.
ft.	h. m. s.
0	4 58
1	4 53
1 1/2	4 50
2	4 48

4 50

4 52

4 27.6

4 27.3

4 30.0

4 54.0

4 15

4 14

UNDINE, in their

spend the Fourth
ster Bay Harbor,
prize offered by
VIXEN, Ludlow



nd his heirs
CLUB to be
for at each
to the first
sailed, had
The club
each Annual

year were



ATLANTIC YACHT CLUB SQUADRON.

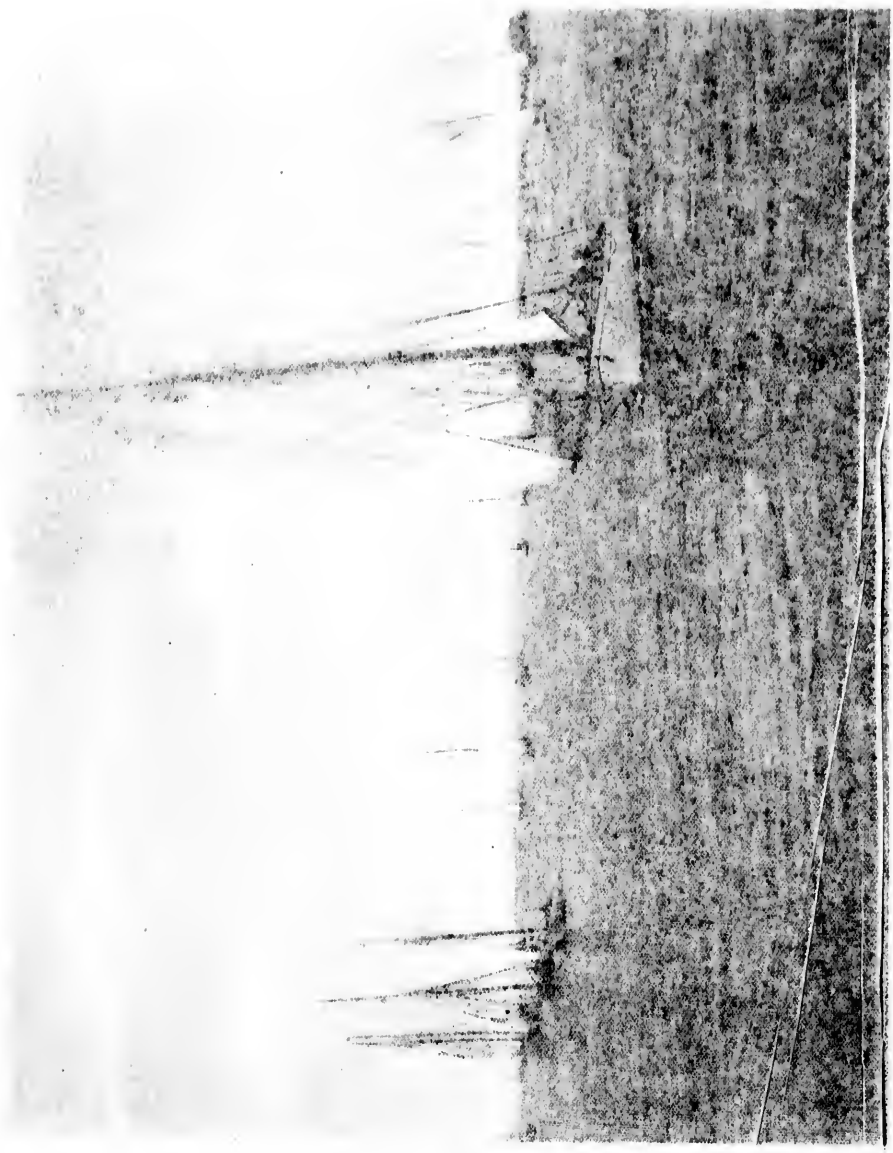

re-elected, with the exception that F. H. Stott was chosen to take the office of Rear-Commodore in the place of Henry A. Gouge who declined a re-election.

The Champion Pennant Regatta took place September 16th in New York Bay.

Ninth Annual Regatta, sailed June 10th. Entries as follows

SCHOONERS.	
Owner.	
Triton	George A. Thayer.
Peerless	Commodore Maxwell
Agnes	L. A. Fish

Owner.	
Lapwing	I. H. Morgan
Vanita	M. Carrington
Aola	Geo. B. Moffat
Thayer	H. H. Hogins

First Class.

SLOOPS.	
Orion	J. W. Cooper
Tony M.	Vice-Commodore Monsell
Kaiser Wilhelm	Greenleaf & Norris
Anna	W. A. Cummings
Recreation	George A. Weber
Kato	E. Z. Lawrence
Ida	D. Crocker
Barbara Freitchio	J. H. Rhodes

Second Class.

Flyaway	V. B. Livingston
---------	------------------

The wind was light, and the race not being made in the required time no prizes were awarded.

The officers elected for 1875, were:

Commodore, George A. Thayer.	Vice-Commodore, Latham A. Fish.
Rear-Commodore, William Cooper.	Recording Sec'y, John B. Morgan.
Cor. Secretary, H. H. Hogins.	Treasurer, S. W. Knowles.
Messenger, C. T. Lippitt.	

Tenth Annual Regatta was held as follows:

SCHOONERS.		
Ariel	W. L. Swan	72.0
Triton	Com. Thayer	4 54 00 65.6
Peerless	J. R. Maxwell	5 10 00 65.4
Vision	Geo. H. Seeley	5 07 00 60.4
Agnes	Vice-Com. Fish	4 55 00 57.9

First Class.

SLOOPS.		
Undine	W. C. Fowler	5 02 00 52.9
Orion	Rear-Com. Cooper	50.6
Madcap	J. R. Busk	45.0
Marion	R. H. Huntley	44.6

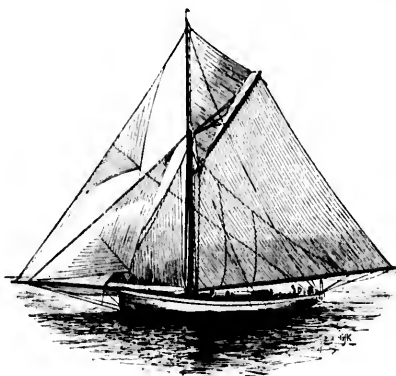

GULNARE.—FIGURE 376.

Second Class.

Kaiser Wilhelm	W. E. Greenleaf	4 18 00	40.3
Genia	Sheppard Homans	4 22 00	40.0
Josephine	S. V. Lowell		33.0
Barbara Freitchio	J. H. Rhodes		24.0
Marguerite	C. T. Pierce		23.0

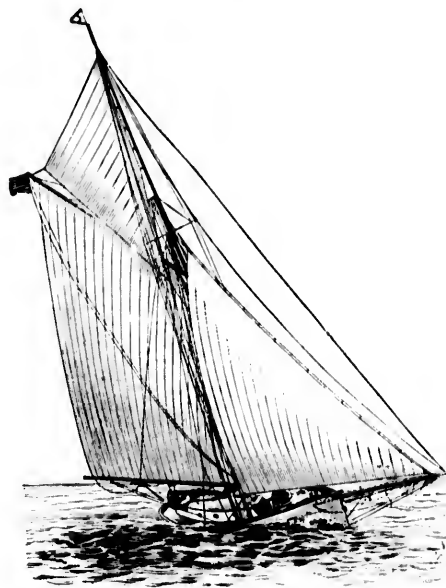

ARAB.—FIGURE 377.

YANITA wins the pennant.

Prizes were won by TRITON, UNDIANE and KAISER WILHELM. UNDIANE also won the Livingston Memorial.

This year, May 30th having been by law set apart as a holiday in memory of those killed in the late War of the Rebellion and called Decoration Day, the ATLANTIC YACHT CLUB adopted it as the opening day of its Yacht Season by an excursion of the fleet and an invitation to all its members to enjoy the day's trip. This custom has since been kept up by the club yearly and it has been followed by most of the other yacht clubs.

At the annual meeting in March 1876, the same officers were re-elected, except that S. V. Lowell was elected Corresponding Secretary, Mr. Hogins declining a re-election. But at the next meeting Mr. Lowell resigned and Mr. J. L. Marcellus was elected to the office.

The Eleventh Annual Regatta was sailed on June 11th. The entries were:

SCHOONERS.		
Ariel	W. L. Swan	73.0
Peerless	J. R. Maxwell	6 02 20 70.9
Triton	Com. Thayer	5 46 28 65.6
Agnes	Vice-Com. Fish	5 32 35 57.9

First Class.

SLOOPS.		
Undine	Brasher & Fowler	5 45 24 52.9
Orion	Wm. Cooper	5 59 59 50.6
Sadie	W. E. Greenleaf	6 02 15 48.9
Madcap	J. R. Busk	5 42 46 45.0

SLOOP.			
Second Class.	Owner.	Time.	Length.
		U. S. C.	Allowance.
Kaiser Wilhelm	W. H. Field	5 00 37	30.0
Nimbus	L. H. Bigelow	4 58 31	35.3
Curlew	G. Kortwright	4 48 23	29.3
Barbara Freitchie	J. H. Rhodes		21.3

Prizes were won by TRITON, MADCAP and NIMBUS. UNDINE being first yacht of her class, won the Livingston Memorial Prize. CURLEW not having been sailed by a member of the club, as required by the rules, was ruled out.

The Fall Championship Pennant Regatta was sailed September 30th, over a course in the lower Bay. The entries were:

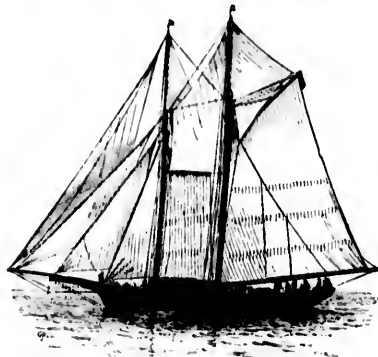

CAVALIER.—FIGURE 378.

SCHOONERS.		
Triton	Com. Thayer	3 20 47
Peerless	J. R. Maxwell	3 32 00
Agnes	Vice-Commodore Fish	3 28 27

SLOOPS.		
First Class.		
Dolphin	J. M. Cooper	not timed
Orion	Rear-Com. Cooper	3 31 50
Madcap	J. R. Busk	3 39 55
Nautic	W. H. Huntley	3 30 40
Sadie	Norris & Greenleaf	3 38 16

Second Class.		
Myra	C. F. Major	
Nimbus	L. H. Bigelow	

Too dark to take time but NIMBUS crossed the line first.

Championship Pennants were won by TRITON, NIAUTIC and NIMBUS.

A Championship Pennant Regatta for cat-boats was held in the bay on the 11th of September, and was won by WIND (Wm. Peet) and VANITA (W. E. Greenleaf), in their respective classes.

THE SEASON OF 1877.

The annual election resulted as follows: Commodore, George A. Thayer; Vice-Commodore, William Cooper; Rear-Commodore, Wm. Hildreth Field; Recording Secretary, John B. Morgan; Corresponding Secretary, John L. Marcellus; Treasurer, Wm. H. H. Beebe; Measurer, C. T. Lippitt.

On May 22nd a Pennant Regatta for cat-boats was sailed. The entries were:

Barbara Freitchie	J. H. Rhodes	24.7
Louise	S. W. Knowles	4 20 22 23.43½
Nomad	H. H. Hoggins	4 14 28 23.0
Wind	William Peet	4 25 10 22.3
Lapwing	John B. Morgan	4 30 33 20.4

NOMAD won the pennant.

The Annual Regatta was held June 11th, as follows:

SCHOONERS.		
	Owner.	Length.
		Allowance.
Triton	Com. Thayer	65.1½
Peerless	J. R. Maxwell	70.0
Agnes	W. H. Vermilye	59.5½

SLOOPS.		
First Class.		
Nautic	R. H. Huntley	61.0
Orion	Vice-Com. Cooper	50.6½

Second Class.		
Kaiser Wilhelm	Rear-Com. Field	41.8
Lizzie L.	J. G. Johnson	41.5½
Genia	T. P. Fiske	40.8
Hope	F. C. Swan	38.8½
Nimbus	L. H. Bigelow	31.7½
Mab	Richard Arnold	25.8

No race was made in the schooners or first class sloops, but the GENIA took the prize in her class.

The Summer Championship Pennant Regatta was won by HOPE beating GENIA by one second, and NIMBUS by 23 seconds. The Fall Champion Pennant Regatta took place on the 27th of September and was won by PEERLESS, ORION and GENIA in their respective classes. On the 29th of the same month a Championship Regatta for open boats was sailed in New York Bay the pennant being won by WIND (William Peet), beating COMINSE and LOUISE.

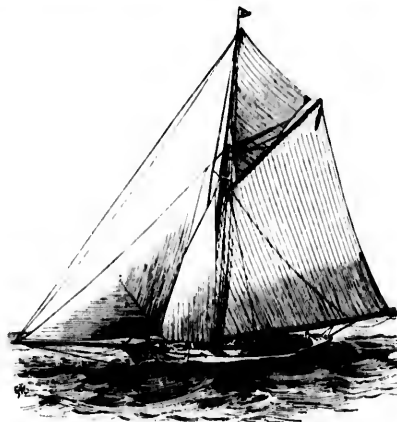

CHISPA.—FIGURE 379.

THE SEASON OF 1878.

The annual election was held on March 11th, the flag officers and secretaries being re-elected. Richard C. Field was elected Treasurer and George B. Moffatt, Measurer.

The Thirteenth Annual Regatta was appointed for the 17th of June. The entries were as follows:

SCHOONERS.		
Triton	Com. Thayer	7 48 54
Peerless	J. R. Maxwell	7 56 15

SLOOPS.		
First Class.		
Dolphin	J. W. Cooper	8 08 33
Orion	Vice-Com. Cooper	8 09 10
Sadie	H. E. Cole	8 18 54
Undine	H. Bryant	8 16 35

	Owner.	Time. H. M. S.
Second Class.		
Genia	T. P. Fisk	7 21 45
Hope	F. C. Swan	7 01 04
Imperia	C. T. Pierce	6 21 20
Kaiser Wilhelm	Rear-Com. Field	6 30 49
Lizzie L.	J. G. Johnson	7 22 50
Sheila	A. Norton	6 31 28
Third Class.		
Alma	W. Lummis	5 42 43
Intrepid	N. B. Lawton	5 05 18
Mab	R. Arnold	5 56 18
Nimbus	L. H. Bigelow	5 09 04
Nomad	H. H. Hogins	5 27 18

TRITON, DOLPHIN, IMPERIA and INTREPID won the prizes in their classes, and IMPERIA won the Livingston Memorial Prize.

	Time. H. M. S.
SLOOPS.	
First Class.	
Dolphin	6 16 32
Sadie	6 16 01
Second Class.	
Winsome	5 31 02
Genia	not timed.
Third Class.	
Nimbus	1 24 55

Pennants were won by AGNES, SADIE, WINSOME and NIMBUS in their respective classes.

The annual elections of 1870, resulted as follows:

Commodore, Latham A. Fish.	Vice-Commodore, William Cooper
Rear-Commodore, Augustus Norton.	Reg. Secretary, F. T. Peck.
Cor. Secretary, J. L. Marcus.	Messenger, R. C. Field.
Treasurer, H. C. Winttingham.	

On June 7th the Annual Regatta was sailed, as follows

SCHOONERS.		Time.	Length.
		H. M. S.	Milwaukee.
Agnes	Com. Fish	9 35 40	59.5
Triton	Geo. A. Thayer	7 08 01	64.4
Peerless	J. R. Maxwell	6 29 30	70.2
Vision	Geo. H. Seeley		66.5
SLOOPS.			
First Class.			
Orion	Vice-Com. Wm. Cooper		51.4
Dolphin	Jacob W. Cooper	7 17 27	46.4
Regina	W. A. W. Stewart	6 50 41	48.0
Sadie	H. C. Coles	7 11 30	49.4
Undine	Henry Bogart		52.3

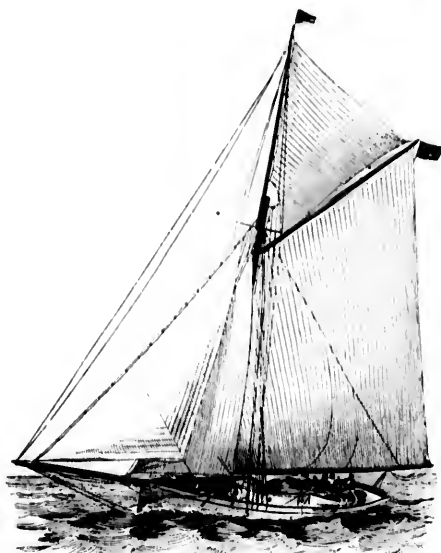

ROVER.—FIGURE 380.

This year, during the Annual Cruise, on the 8th of August, the club held a regatta open to all sloop yachts not enrolled in a yacht club, and also open to those enrolled in any club east of Throgg's Neck. All entries were divided into three classes, over 45 feet, over 35 feet and over 25 feet. There were three entries in the first class, five in the second class and ten in the third class. Prizes were won by THISTLE (Boston), JOSIE (Groton, Conn.), FLORA (New London), in their respective classes.

The Fall Champion Pennant Regatta for open yachts was held September 18th, the course being in New York Bay. This regatta was won by PILOT over CORINNE and TURANT over GENIE.

The Fall Championship Pennant Regatta was sailed September 26th and the course was from Bay Ridge down the lower bay and return. The entries were:

SCHOONERS.		
Peerless		5 51 00
Triton		5 28 00
Agnes		5 37 00

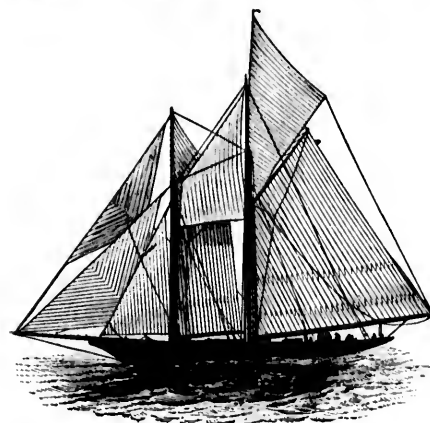

EMERALD.—FIGURE 381.

Second Class.			
Winsome	Rear-Com. Norton	5 39 57	49.7
Genia	T. P. Fiske	6 11 28	40.4
Kaiser Wilhelm	W. H. Field	6 15 12	41.5
Lizzie L.	J. G. Johnson	6 01 49	43.9
Pirate	W. A. Howell	5 49 10	45.0
Schemer	C. Smith Lee	5 45 17	38.7
Third Class.			
Alma	William Lummis	5 21 40	37.4
Mab	R. Arnold		25.0
Nimbus	L. H. Bigelow	4 16 15	35.0
Nomad	H. H. Hogins		30.0

but the

by HOPE
The Fall
September
respective
up Regatta
being won

flag officers
ected Treas-
the 17th of

	Owner.	Time.	D.M.S.	Allowance.
Fourth Class.				
Corriane	W. W. Beebe	5 28 67	38.0	
Pilot	R. S. Church	5 14 00	24.0	
Fifth Class, Open.				
Aloyon	Geo. P. Mackay	5 44 45	20.7	
Gertie	J. W. Rhodes		23.1	
Wind	William Peet	5 17 15	22.0	
Traut	H. C. Wintringham		19.0	

The winners were PEERLESS, REGINA, WINSOME, PILOT and WIND in their respective classes.

During the Summer a race was arranged between the EASTERN and ATLANTIC YACHT CLUBS, to be sailed at New London. This regatta

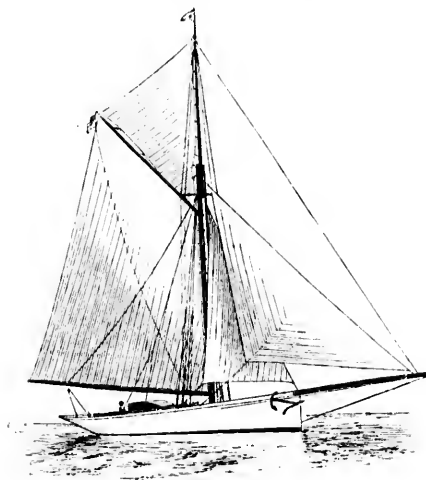

MOYA.—FIGURE 382.

was sailed June 28th from the Pequot House to the Manhasset House, Shelter Island.

The entries were:

SCHOONERS.

First Class.	Com. Boardman	Eastern Yacht Club
Foam	Lloyd Phoenix	" "
Intrepid	W. R. Vermilye	" "
Atlanta	Rear-Com. Hoovey	Eastern " "

Second Class.	Com. Fish	Atlantic Yacht Club
Agnes	J. M. Forbes	Eastern " "
Azalea	J. Rogers Maxwell	Atlantic " "

SLOOPS.

Winsome	Rear-Com. Norton	Atlantic Yacht Club
Enterprise	F. E. Peabody	Eastern " "
Regina	F. M. Hall	Atlantic " "
Schemer	C. P. Underhill	" " "

PHANTOM, AGNES and REGINA were the prize winners.

A race was sailed on July 10th for the Club Championship Pennant between WIND, (William Peet) and TRAUT (Chas. Pryer). The course was off the Club House in New York Bay, and WIND was the winner. This race was for the championship of the cat-head class.

The Annual Championship Pennant Regatta was sailed September

17th over the usual course from Bay Ridge. PEERLESS, DOLPHIN and LIZZIE L. were the pennant winners.

Annual election of 1880, resulted as follows:

Commodore, Latham A. Fish, Vice-Com. H. H. Hogins
Rear-Com. W. R. Vermilye.

The other officers were re-elected.

This year the Atlantic Harbor Company was incorporated by members of the ATLANTIC YACHT CLUB. They purchased a tract of land at the foot of 55th and 56th streets, built out docks, and fitted up the old farm house for a Club House, and since that time it has been so used by the club until 1891 when a large Club House was built on the water front of the Harbor Company's Basin.

The Fifteenth Annual Regatta was held June 9th, as follows:

SCHOONERS.

Class A.	Owner.	Length.	D.M.S.
Clytie	Anson P. Stokes	81.8	not timed.
Crusader	J. Rogers Maxwell	89.6	10 06 00
Class B.			
Mystic	A. Norton	65.3 $\frac{1}{2}$	not timed
Triton	Geo. A. Thayer	61.4 $\frac{1}{2}$	9 40 10
Vision	Geo. H. Seeley	58.6	not timed.
Agnes	Com. Fish	57.0	9 41 22
Sunshine	William Peet	47.11	not timed.

SLOOPS.

Class C.			
Fanny	H. Bryant		8 45 07
Gracie	C. R. Flint		not timed.
Mischief	J. R. Busk	61.9	" "
Vision	J. J. Alexander		" "
Coming	S. Peabody		8 28 19
Onward	William Shipman		not timed.

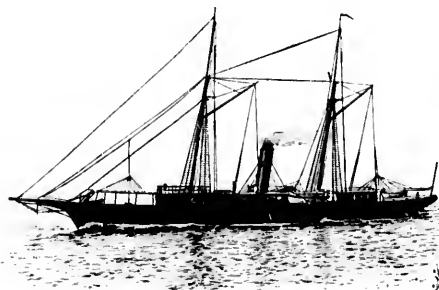

KANAPHA.—FIGURE 383.

Class D.			
Dolphin	J. W. Cooper	49.1 $\frac{1}{2}$	not timed.
Sadie	W. A. Cole	49.1 $\frac{1}{4}$	" "
Fanita	J. G. Prague		" "
Regina	W. A. W. Stewart	48.0	8 24 50
Class E.			
Stella	H. H. Hogins	45.2	7 55 35
Lizzie L.	J. G. Johnson	43.9	6 41 30
Pirate	T. A. Howell	45.0	7 18 28
Listless	Wm. Lummis		
Class F.			
Genia	T. P. Fiske	40.3	7 37 40
Schemer	C. Smith Leo	38.7	7 18 10
Caprice	D. Williams		7 53 11
Elephant	F. M. Johnson		6 44 16
Flying Cloud	J. G. Suydam		7 44 51

s, DOLPHIN

Hogins

ted by mem-
tract of land
locks, and
ce that time
Club House
asin.
follows:

11. M. S.
not timed.
10 06 00

not timed
9 40 10
not timed.
9 41 22
not timed.

8 45 07
not timed.
" "
" "
8 28 19
not timed.



not timed.
" "
" "
8 24 50

7 55 25
6 41 30
7 18 28

7 37 40
7 18 10
7 53 11
6 44 16
7 44 51

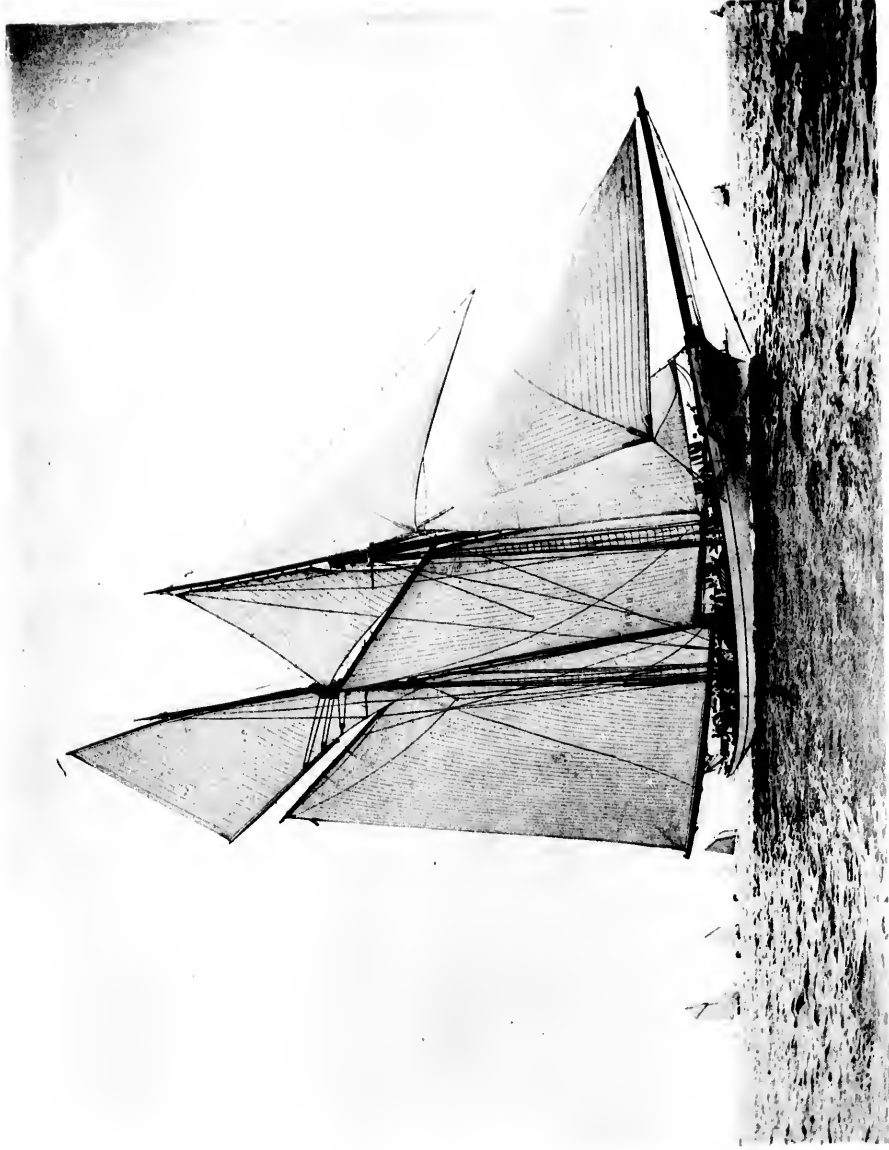

PLATE XLV.

FROM A NEGATIVE BY CHILD

MERLIN.

MERLIN.

311
von by
Spring
; such
yacht
re;
Rear-
urch;
R. C.
fleet
h the



Class G. Pilot
Corinne

Prizes won by C
ELEPHANT and Co
REGINA also won
her class.

The officers ele
Fish; Vice-Comm
A. Howell; Recor
Secretary, J. Law
George B. Moffatt
The Sixteenth
were:

First Class,
Atalanta
Crusader
Clytie
Second Class,
Triton
Lotus
Agnes
Sunshine
Madcap

First Class,
Gracie
Mischie
Coming

Second C

Third Cl

The
cover th

Class G.	Pilot	Owner.	Length for Allowance.	Time. H.M.S.
	R. S. Church,		2.48	7 18 22
	Corinne	W. W. Debe	23.1	7 10 02

Prizes won by CRUSADER, TRITON, COMING, REGINA, LIZZIE L., ELEPHANT and CORINNE.

REGINA also won the Livingston Memorial Prize, being the first of her class.

THE SEASON OF 1881.

The officers elected for the year were: Commodore, Latham A. Fish; Vice-Commodore, W. R. Vermilye; Rear-Commodore, Thomas A. Howell; Recording Secretary, William W. Debe; Corresponding Secretary, J. Lawrence Marcellus; Treasurer, R. C. Field; Measurer, George R. Moffatt.

The Sixteenth Annual Regatta came off June 11th. The entries were:

SCHOONERS.				
First Class.				
Atalanta	Vice-Com. Vermilye	90.1	not timed.	
Crusader	J. Rogers Maxwell	87.7	11 13 52	
Clytie	Anson P. Stokes	81.2	not timed.	
Second Class.				
Triton	Geo. A. Thayer	60.10	11 01 25	
Lotus	W. A. Cole	60.30		
Agnes	Com. Fish	57.50		
Sunshine	William Peet	47.11		
Madeap	F. D. Shaw	45.00		
SLOOP.				
First Class.				
Gracie	C. R. Flint	75.20	10 02 42	
Mischief	J. R. Bisk	61.00	9 49 00	
Coming	S. Peabody	59.11		

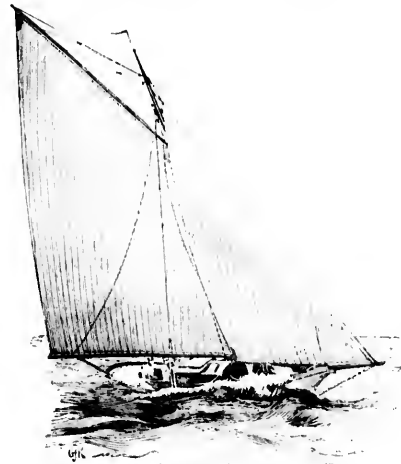

SMUGGLER. FIGURE 381.

SMUGGLER. FIGURE 381.				
Second Class.				
Regina	W. A. W. Stewart	19.	10 20 25	
Pirate	Rear-Com. Howell	15.		
Third Class.				
Lizzie L.	J. G. Johnson	43.9	9 18 38	
Kelpie	J. N. Winslow	42.0		
Genia	T. P. Fiske	39.0		
Caprice (yaw)	D. Williams	37.7		

The wind was light; only one yacht of each class was able to cover the course and the prizes so won were awarded to CRUSADER,

TRITON, MISCHIEF, REGINA and LIZZIE L. REGINA also took the Livingston Memorial Prize.

July 6th a regatta was held for the smaller boats of the club that did not compete in the Annual Regatta.

OPEN SLOOP.		
Pilot	Owner.	Length for Allowance.
Corinne	J. B. Morgan	21.8
	H. B. Howell	23.1
CAT-BOATS.		
Hoyden	N. D. Lawton	21.0
Cruiser	A. A. Alley	20.1

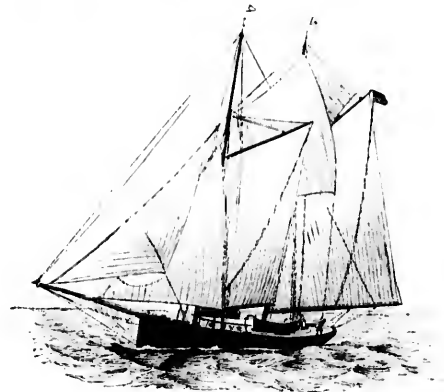

VIDETTE.—FIGURE 385.

The wind was again so light that the boats could not make the course and no prizes were awarded.

During the Summer, while on the Annual Cruise, the club held a regatta at New Bedford on July 22nd, open to yachts of the NEW BEDFORD and SEAWASHAKA YACHT CLUBS. There were twenty entries and the yachts PEERLESS, FAXITA, HESPER and NIXIE won in their respective classes.

THE SEASON OF 1882.

The annual election resulted as follows: Commodore, W. R. Vermilye; Vice-Commodore, Thomas A. Howell; Rear-Commodore, J. B. Morgan; Recording Secretary, William Peet, Jr.; Corresponding Secretary, J. Lawrence Marcellus; Treasurer, R. C. Field; Measurer, George R. Moffatt.

The Seventeenth Annual Regatta took place June 13th. The entries were:

SCHOONERS.			
Class A.		Time.	Length for H.M.S. Allowance.
	Atalanta	4 46 55	90.1
	Crusader	4 46 40	87.7
	Clytie	4 53 20	81.2
Class B.			
	Triton	5 01 17	61.1½
	Agnes	5 06 28	57.5½
	Sunshine		47.11
	Madeap		
SLOOP.			
Class C.			
	Gracie	4 59 20	75.20
	Coming		59.11
	Sagitta		56.90

won by Spring t such yacht re: Rear-arch; R. C. fleet h the

Class D.

	Time.	Length for Allowance.
Eclipse	5 06 10	52.3
Christmo	5 21 00	48.0
Viola		47.3
Pirate	5 11 06	45.2
Lizzie L.	4 50 30	43.9
Rover	5 11 40	41.1
Linda	5 37 48	45.6

Class E.

Kelpie	4 53 15	42.00
Genia	5 01 40	40.30
Wave	4 38 58	39.11
Emma T.	5 13 33	33.70
Clarita		35.70
Elephant	4 33 41	35.00
Caprice	5 15 00	31.70

Class F.

Pilot	4 29 00	24.8
Corinne	4 20 47	23.1

Prizes were won by CRUSADER, AGNES, GRACIE, LIZZIE L., ELEPHANT and CORINNE. ECLIPSE, the first in of her class, won the Livingston Memorial Prize.

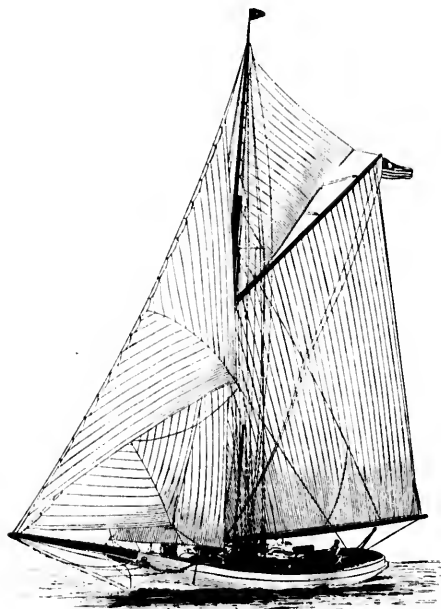

CONCORD.—FIGURE 398.

THE SEASON OF 1883.

The following officers were elected at the annual meeting: Commodore, W. R. Vermilye; Vice-Commodore, Thomas A. Howell; Rear-Commodore, F. Wayland; Recording Secretary, Frank C. Swan; Corresponding Secretary, J. Lawrence Marcellus; Treasurer, R. C. Field; Measurer, J. J. Pierrepont.

The Eighteenth Annual Regatta occurred on the 19th of June. The following were the entries:

SCHOONERS.

Class A.

	Time	Length for Allowance.
Atalanta	6 52 31	60.4
Crusader	7 14 13	87.7
Grayling	7 20 09	86.3
Clytie	7 30 28	81.2

Class B.

Haze	8 23 30	61.30
Sunshine		47.11

SLOOPS.

Class C.

Gracie	7 30 16	75.2
Mischief	7 04 53	64.0

Class D.

Roamer	6 57 42	50.64
Enterprise	7 30 35	47.54
Fanita	6 00 00	47.5
Viola		47.3
Rover		47.2
Stella	6 30 36	45.2
Lizzie L.	7 00 17	43.0

Class E.

Crocodile	5 38 58	41.0
Wave	7 47 24	40.3

Class F.

Daisy	7 14 21	34.0
Romeyn	7 30 35	34.2
Ilderan	6 39 10	32.0

Class G.

Lois	4 51 12	29.0
Amazon	4 53 05	27.0
Gleam	4 41 04	24.0

Class H.

Fly	5 24 43	26.2
Pilot	5 15 51	26.8

The prize winners were ATALANTA, MISCHIEF, FANITA, CROCODILE, ILDERAN, GLEAM and PILOT, in their respective classes; FANITA won the Livingston Memorial Prize.

The Annual Championship Pennant Regatta was held on the 15th of September, but owing to an entire lack of wind no race was sailed.

THE SEASON OF 1884.

The officers elected were Commodore, H. H. Hogins, AGNES; Vice-Commodore, George B. Moffatt, ENTERPRISE; Rear-Commodore, H. C. Wintringham, NOMAD; Recording Secretary, F. C. Swan; Corresponding Secretary, J. Lawrence Marcellus; Treasurer, R. C. Field; Measurer, J. J. Pierrepont.

The Annual Regatta was held on June 10th. Entries as follows:

SCHOONERS.

Class A.

Grayling	6 16 04	87.74
Crusader	6 27 56	87.70
Clytie	6 54 17	81.12

Class B.

Triton	6 40 27	64.4
Agnes	7 02 50	57.5
Haze		66.0
Leona		

SLOOPS.

Class C.

Fanny	6 16 11	
Mischief	6 11 10	64.0
Gracie	6 52 13	75.2
Thistle	6 28 17	53.0
Athlon	6 17 07	55.0

Class D.

Stella		45.2
Roamer	6 41 53	50.6
Enterprise	7 03 40	47.54
Linda		
Fanita	6 26 23	47.5

	Time.	Length.
Class E.	U.S.S. Allowance.	
Crocodile	5 55 48	41.9
Elephant		35.0
Phantom		
Amolha		40.1
Uma	6 29 40	
Class F.		
Daisy	4 49 31	31.0
Viking	5 27 21	
Nomad	4 54 14	
Romeyn	4 25 11	
Ilderan	4 51 42	32.0
Class G.		
Venture	5 24 02	28.11
Amazon	5 15 27	27.10

Prizes were won by GRAYLING, TRITON, MISCHIEF, PANITA, CROCODILE, ROMEYN and AMAZON. The Livingston Memorial Prize was won by PANITA.

In the Fall Championship Pennant Regatta, held September 3rd for class E., ILDERAN after challenging ROMEYN, was beaten after a good race.

THE SEASON OF 1885.

At the annual election the following officers were elected: Commodore, H. H. Hugins; Vice-Commodore, John C. Barron; Rear-Commodore, William Ziegler; Recording Secretary, Frank E. Swan; Corresponding Secretary, J. Lawrence Marcellus; Treasurer, R. C. Field; Measurer, J. J. Pierrepont.

The Twentieth Annual Regatta was sailed on the 9th of June with the following entries:

SCHOONERS.		
Class A.		
Republic	5 07 07	
Grayling	4 29 45	
Class B.		
Haze	5 49 43	
Agnes	5 21 50	
Vedette		
Leona		
Class C.		
Gracie	4 48 47	
Mischief	4 39 26	
Thetis	4 36 15	
Athlon	4 57 40	
Class D.		
Daphne	5 18 57	
Enterprise	5 24 44	
Panita	5 22 35	
Rover	5 44 33	
Class E.		
Crocodile	4 24 18	
Phantom	4 42 39	
Class F.		
Romeyn	3 36 38	
Nomad	3 18 59	
Ilderan	3 17 01	

The prizes were won by GRAYLING, AGNES, MISCHIEF, DAPHNE, CROCODILE and ILDERAN. DAPHNE also won the Livingston Memorial Prize.

The Fall Championship Pennant Regatta was held September 18th. This contest was between the old rivals ROMEYN and ILDERAN. ROMEYN won, keeping the pennant.

THE SEASON OF 1886.

The club began this year with a dinner at the Hotel Brunswick, January 15th, this being the twentieth anniversary of the founding of the club. On this occasion the club proposed to build a

yacht to compete with others for the right to protect the Cup won by AMERICA. For this purpose over \$20,000 was raised and that Spring the yacht ATLANTIC was built. Her success, however, was not such as to commend her to the Committee upon Selection and the yacht MAYFLOWER was chosen. The officers elected for this year were:

Commodore, H. H. Hugins; Vice-Commodore, F. C. Swan; Rear-Commodore, E. C. Sterling; Recording Secretary, Robert S. Church; Corresponding Secretary, J. Lawrence Marcellus; Treasurer, R. C. Field; Measurer, William Carey Sanger.

This year the club had ninety-nine sail yachts enrolled in its fleet and two hundred and sixteen members.

The Twenty-first Annual Regatta was held on June 15th, with the following yachts entered:

Special Class.	Time.
U.S.S.	
Priscilla	5 57 03
Puritan	did not finish
Atlantic	4 08 51
Class A.	
Tidal Wave	did not finish
Montauk	7 30 38
Republic	not timed
Grayling	7 21 43
Class B.	
Haze	not timed
Agnes	8 08 02
Vedette	
Wyvern	
Leona	8 45 15
Class C.	
Gracie	7 13 59
Thetis	7 12 17
Class D.	
Cinderella	7 30 43
Vivid	8 24 20
Clara	7 11 12
Thistle	8 05 02
Athlon	7 25 27
Bertie	did not finish
Roumer	7 26 48
Class E.	
Concord	
Daphne	8 10 45
Adelaide	7 43 16
Rover	8 26 21
Stella	not timed
Penguin	7 26 41
Nirvana	did not finish
Class F.	
Crocodile	6 52 44
Rival	6 56 54
Class G.	
Nomad	6 40 31
Daisy	6 42 25
Viking	
Ilderan	5 52 07
Class H.	
Arab	6 14 41
Curlew	
Louise	
Merlin	6 36 00
Class K.	
Hyppatia	6 27 14

The winners were: PRISCILLA, GRAYLING, AGNES, THETIS, CLARA, PENGUIN, CROCODILE, ILDERAN and ARAB. PENGUIN also won the Livingston Memorial Prize.

THE SEASON OF 1887.

At the annual election the following officers were elected: Commodore, F. C. Swan; Vice-Commodore, John Cartledge; Rear-Commodore, N. D. Lawton; Recording Secretary, Paul H. Jeannot;

Corresponding Secretary, J. Lawrence Marcellus; Treasurer, R. C. Field; Measurer, George W. McNulty.

This year the club had one hundred and twenty-six yachts enrolled and two hundred and forty-eight members.

The Twenty-second Annual Regatta took place on June 7th, as follows:

Class A.	Yacht	Time.
Class B.	Yacht	U. M. S.
	Magie	
	Clio	
	Southern Cross	
	Gevalia	6 13 50
	Agnes	6 31 42
	Leona	
Class C.		
	Galatea	5 30 27
	Priscilla	5 06 50
	Atlantic	5 23 31
Class D.		
	Shamrock	5 19 32
	Gracie	5 45 56
	Titania	5 30 33
	Stranger	
	Pocahontas	
	Fanny	5 30 52
Class E.		
	Huron	5 52 33
	Hildegarde	5 50 22
Class F.		
	Cinderella	5 23 14
	Athlon	5 48 01
	Bertie	
	Roamer	5 30 14
Class G.		
	Concord	
	Adelaide	5 39 34
	Rover	5 55 10
	Vixen	6 03 06
	Enterprise	5 49 54
	Stella	
	Ariadne	5 58 01
	Nirvana	6 00 06
Class H.		
	Rival	4 53 58
	Wayward	
Class I.		
	Minstral	5 11 44
	Viking	
	Ilderan	5 12 32
Class J.		
	Curlew	
	Arab	3 36 20
	Hypatia	3 45 40
	Louise	
	Kangaroo	3 32 15
	Nyssa	
Class K.		
	Merlin	
	Gleam	3 52 26
Class L.		
	Siren	3 41 15
	Pilot	4 07 09
Class M.		
	Marjorie	4 00 05
	Mosquito	4 12 02

The prize winners were GEVALIA, ATLANTIC, SHAMROCK, HURON, CINDERELLA, ADELAIDE, RIVAL, MISTRAL, GLEAM, SIREN, MARJORIE. The Livingston Memorial Prize was won by ADELAIDE.

THE SEASON OF 1888.

The officers elected for the year were: Commodore, J. Lawrence Marcellus; Vice-Commodore, Jefferson Hogan; Rear-Commo-

dore Howard W. Contes; Recording Secretary, Paul H. Jannot; Corresponding Secretary, Lucius M. Sheldon; Treasurer, R. C. Field; Measurer, George W. McNulty. The fleet numbered 121 yachts, and there were 253 members.

The Annual Regatta was sailed on the 12th of June.

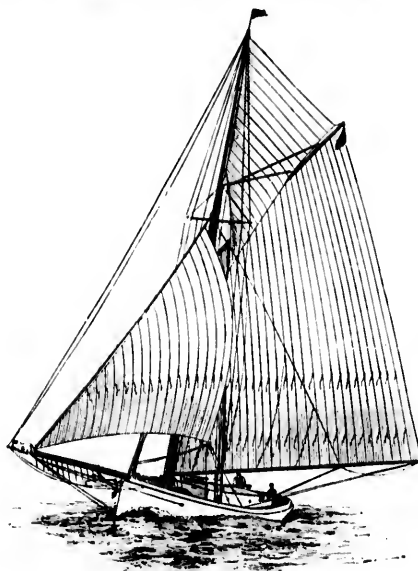

NIMBOY.—FIGURE 387.

Class.	SCHOONERS.	Time.
		U. M. S.
First Class.		
	Grayling	7 50 37
	Palmer	8 06 18
	Miranda	8 06 30
Second Class.		
	Gevalia	8 07 44
	Azalea	
	Haze	8 15 05
	SLOOPS.	
Second Class.		
	Shamrock	7 58 24
	Fanny	7 55 03
	Huron	8 03 13
Third Class.		
	Hildegarde	8 00 26
	Thistle	8 14 30
Fourth Class.		
	Anacon	7 28 40
	Roamer	7 41 20
Fifth Class.		
	Stella	7 53 02
	Enterprise	7 50 12
	Nirvana	7 52 18
	Anamuth	8 12 45
Sixth Class.		
	Banshee	7 12 15
	Papoose	7 05 18
	Rival	7 26 16
	Ariadne	7 32 52
	Phantom	7 24 18

t; Cor-
Field;
ts, and

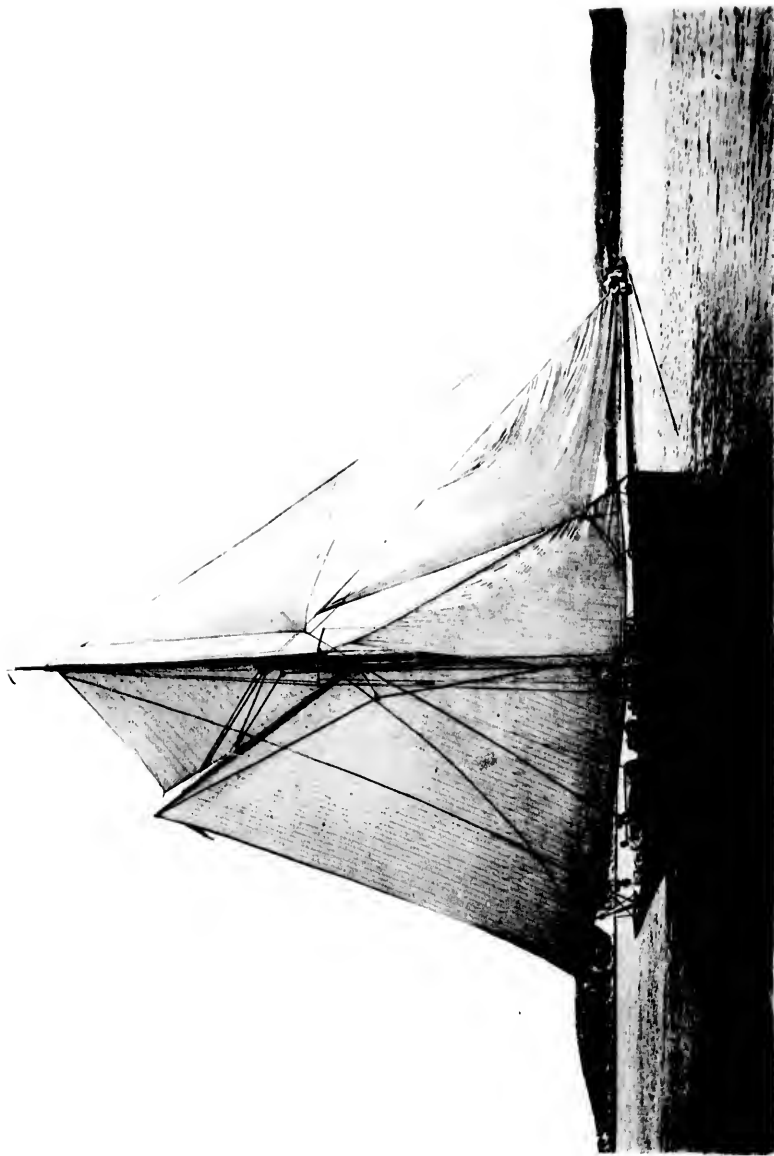
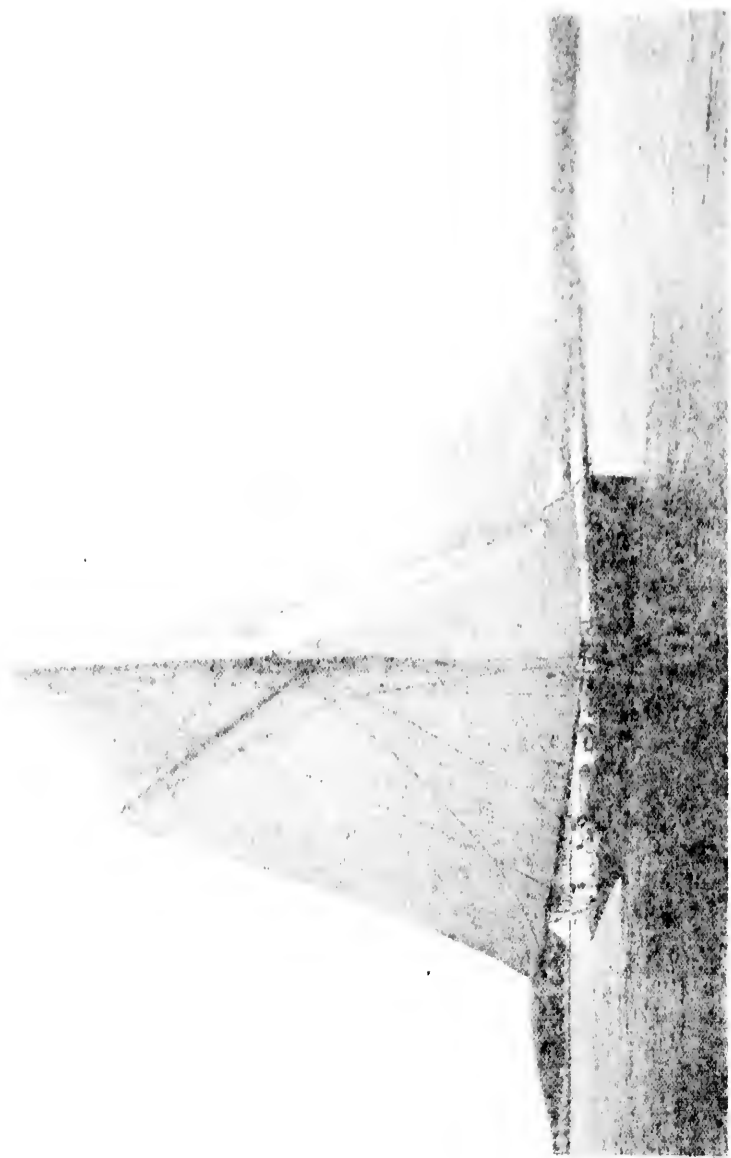

PLATE XLVI

CLARA.



Seventh Class
For
Dob
Bib
Mist

Eighth Class
Hys
Kin
Gen
Len
My

Ninth Class
Gle
Proh

Tenth Class
Bij
Mar
Cit

Prizes were
HILGARD
PARIA, GLE
orial Prize.

A Champ
being:

Gle
Proh
Is-

Won by G

The offic
Hogan; Vice
P. Fiske; Re
tary, George
H. J. Gielow

The First
the fleet ge
ladies to sa
the winning
The schoon
CONNA, Str

The Ann
were entere
squall of w
the wind in
was so ligh
clared off;
only seven
made were:

First Class
Ch

Second Cla
C

Third Clas
A

Fourth Cl
F
A

Fifth Clas
C
A

Sixth Clas
M
N

	Time.
Seventh Class.	
Eurybia	7 21 53
Daisy	7 31 03
Hibern	7 29 30
Mistral	7 42 45
Eighth Class.	
Hypatia	4 41 22
Kangaroo	4 49 16
Gem	4 57 08
Lena	5 10 45
Myra	5 11 38
Ninth Class.	
Glenn	5 06 42
Frolic	5 16 11
Tenth Class.	
Bijou	5 06 57
Margjorie	5 29 41
Idi	5 51 20

Prizes were won by GRAYLING, GEVALIA, FANNY, SHAMROCK, HILDEGARDE, ANACONDA, ENTERPRISE, PAPOOSE, EURYBIA, HYPATIA, GLEAM and BIJOU. ENTERPRISE won the Livingston Memorial Prize.

A Champion Pennant Race took place August 4th, the entries being:

Glenn	2 42 55
Frolic	2 43 05
Idi	2 31 34

Won by GLEAM.

THE SEASON OF 1889.

The officers elected for this year were: Commodore, Jefferson Hogan; Vice-Commodore, E. B. Havens; Rear-Commodore, Thomas P. Fiske; Recording Secretary, P. H. Jeannot; Corresponding Secretary, George F. Barlow; Treasurer, H. C. Wintringham; Measurer, H. J. Gielow.

The First Regatta of the club was held on Ladies' Day, June 3d, and the fleet generally participated in it impromptu and invited all the ladies to sail. The prizes were silver breast pins for each lady on the winning boats, and the race was a triangle off the Club House. The schooners CAVALIER, AZALEA and sloops HILDEGARDE, ANACONDA, STELLA, POLLY, DAISY, GEM, IRIS and MARGJORIE.

The Annual Regatta was appointed for June 11th and the yachts were entered but the day was unpropitious. It opened with a heavy squall of wind and rain at about 10 A. M., and when it had passed the wind had gone. The fleet could not start till noon; the wind was so light that the race was not made in ten hours and was declared off; it was ordered to be resailed on the 21st, on which day only seventeen yachts started. The day was favorable and the times made were:

SCHOONERS.	
First Class.	
Grayling	4 31 30
Second Class.	
Cavalier	6 16 20
Third Class.	
Azalea	5 50 27
FOURTH CLASS.	
Hildegard	5 12 11
Adlon	did not finish
Fifth Class.	
Clara	5 08 21
Anacanda	5 15 29
Sixth Class.	
Minerva	
Nymph	had no race

	Time.
Seventh Class.	
Mistral	5 15 41
Hypatia	5 17 41
Beatrice	did not finish
Nomad	did not finish
Hibern	did not finish
Eighth Class.	
Wona	4 16 32
Frolic	4 21 41
Manette	did not finish

Prizes were taken by GRAYLING, CAVALIER, AZALEA and HILDEGARDE by default, and by CLARA, MISTRAL and WONA.

THE SEASON OF 1890.

At the annual election the result was as follows:

Commodore, N. D. Lawton; Vice-Commodore, E. B. Havens; Rear-Commodore, W. L. Arnold; Recording Secretary, Frank L. St. John; Corresponding Secretary, George H. Church; Treasurer, H. C. Wintringham; Measurer, Henry J. Gielow. The club had this year one hundred and twenty-four yachts and two hundred and thirty-nine members.

The Twenty-Fifth Annual Regatta was sailed on the 17th of June with the following entries:

SLOOPS.	
First Class, 61 to 70 feet.	
Shamrock	5 47 14
Katrina	5 18 08
Fanny	did not finish.
Second Class, 46 to 53 feet.	
Clara	4 51 35
Anacanda	4 57 50
Third Class, 40 to 46 feet.	
Nepenthe	5 36 55
Stella	time not taken
Fourth Class, 35 to 40 feet.	
Minerva	4 28 41
Chispa	4 33 29
Choctaw	4 37 01
Fifth Class, 30 to 35 feet.	
Shona	4 42 56
Volusia	4 52 41
Hypatia	4 52 53
Polly	4 53 57
Agloha	5 10 27
Eurybia	did not finish
Sixth Class, 25 to 30 feet.	
Kathleen	3 39 40
Pelican	did not finish
Seventh Class, under 25 feet.	
Frolic	4 05 50
	4 18 07

CAT-BOATS.

Bijou	3 53 12
Siren	4 00 05

MINERVA having tacked a wrong course was ruled out and the prizes were won by SHAMROCK, CLARA, NEPENTHE, CHISPA, SHONA, KATHLEEN, FROLIC and BIJOU. NEPENTHE won the Livingston Memorial Prize.

THE SEASON OF 1891.

The officers elected for the year were: Commodore, N. D. Lawton; Vice-Commodore, David Banks; Rear Commodore, James Wier, Jr.; Secretary, George H. Church; Treasurer, H. C. Wintringham; Measurer, Henry J. Gielow.

There were 170 yachts enrolled in the club this year and the membership was 277.

The Twenty-sixth Annual Regatta of the ATLANTIC YACHT CLUB was sailed June 16, 1891. The weather was clear, the sea calm, and a light wind prevailed throughout the race. The yachts started a little before 11 o'clock, A. M. The following were the participants:

SCHOONERS.		Act. Time.	Cor. Time.
		H. M. S.	H. M. S.
Class 2.	Marguerite	4 59 05	4 59 05
Class 3.	Gevalia	5 34 48	5 34 48
SLOOPS			
Class 2.	Shamrock	4 50 41	4 50 41
Class 3.	Hildegarde	5 09 00	5 00 00
Class 4.	Anaconda	4 32 30	4 32 30
	Clara	4 34 06	4 29 16
Class 5.	Mineola	4 29 27	not measured
	Gloriana	4 21 10	4 21 10
	Nautilus	4 39 50	4 38 13
	Jessica	4 41 16	4 35 43
Class 7.	Indra	4 45 35	not measured
	Tigress	3 58 57	3 58 57
	Eurybia		
	Polly	4 15 15	4 13 12
	Saona	4 23 05	4 17 51
	Portia		
	Kathleen	4 18 02	
Class 9.	Smuggler	2 54 25	2 54 25
CATS.			
Class 11.	C. O. D.	3 03 05	3 00 51
	Marguerite	2 57 08	3 53 41
	Bijou	2 50 43	2 56 43

Winners; MARGUERITE, GEVALIA, SHAMROCK, HILDEGARDE and SMUGGLER, these having a walk-over in their classes. CLARA, GLORIANA, TIGRESS and BLOU won in their respective classes.

A Special Race was sailed June 23, 1891. The weather was clear, the sea smooth, and the wind light and baffling. The following yachts started shortly after noon:

SLOOPS.			
Class 5.	Gloriana	5 04 17	5 04 17
	Sayonara	5 10 35	not measured
	Mineola	5 14 03	" "
	Nautilus	5 19 35	5 17 50
	Jessica	5 23 43	5 16 49
Class 7.	Tigress	4 51 48	4 51 48
	Polly	5 07 21	5 05 10
	Saona	5 18 38	5 13 13
	Kathleen	5 11 21	5 04 26
Class 11.	Smuggler	3 57 22	3 57 22
	Nameless	4 10 52	4 19 52
	Beth	4 26 40	not measured

GLORIANA, TIGRESS and SMUGGLER won in their respective classes. The Regatta Committee was H. B. Howell, H. J. Gielow and H. A. Gouge.

THE SEASON OF 1892.

This year the fleet numbered 173 and there were 313 names on the list of members. The officers chosen for the year were as follows: Commodore, David Banks; Vice-Commodore, William L. Moore; Rear-Commodore, James Weir, Jr.; Secretary, George H. Church; Treasurer, H. C. Wintringham; Measurer, Henry J. Gielow.



TIGRESS.—FIGURE 388.

The Annual Regatta came off June 14th. The wind was lighter than would have been preferred by the larger classes but the day was perfect. The judges were H. J. Gielow, G. W. McNulty and G. B. Frisbie. The start was effected at 10:30 with the tide flood and a light breeze. The entries and times made were:

SCHOONERS.	Elapsed Time.
	H. M. S.
Ninety foot class.	
Shamrock	5 49 00
Marguerite	5 44 11
Seventy foot class.	
Peerless	not timed
Fifty-three foot class.	
Clara	5 09 26
Forty-six foot class.	
Wasp	4 46 50
Gulnare	5 50 11
Daphne	not timed
Thirty-five foot class.	
Tigress	4 00 40
Daffodil	4 22 37
Saona	4 14 18

Twenty-five foot class.	Elapsed Time.
El Chico	3 44 02
Freya	3 53 25
Wabnetta	3 53 03

CAT-BOATS.	Elapsed Time.
Acorn	3 43 20
Marguerite	3 37 03
Ocumee	3 48 32
Wilmerad	3 47 06

Prizes were won by SHAMROCK, CLARA, WASP, TIGRESS, EL CHICO and MARGUERITE, in their respective classes.

The Annual Cruise began on July 23d. Among the yachts were WATER WITCH, KANAPIA, TIGRESS, ATHLON, RIVAL, UNA, NEAIRA, ORIENTA, GULNARE, PENGUIN; etc. The start was made from Cold Spring Harbor. In the afternoon Black Rock was reached, the leading yachts anchoring as follows:

Tigress	3 35 00
Athlon	3 39 00
Gulnare	3 40 30
Penguin	3 57 30
Concord	4 00 33
Water Witch	4 05 30
Notus	4 21 35
Daphne	4 36 15

The others came in later. Sunday was spent at Black Rock services being held on board KANAPIA. About 10 o'clock A. M. the yachts that had not gone on ahead set out for Morris Cove where they were entertained by the Pequot Association. The wind was very light, however, and the progress consequently slow. The foremost yachts anchored as follows:

Athlon	3 19 00
Water Witch	3 20 55
Tigress	3 35 00
Penguin	3 45 00
Gulnare	3 47 15
Una	3 55 00

Early the next morning the start was made for the run to New London, the longest of the cruise. At the start there was a good breeze, and throughout the day the wind, although not steady, was better than on the preceding days. After a long race through all the day, between GULNARE, WATER WITCH and ATHLON, the first named yacht won, there being, however, but thirty-five seconds between the three. Just a little behind were PENGUIN and TIGRESS.

At 10 o'clock the next day they started for Shelter Island. ATHLON was the first to anchor followed by TIGRESS, WATER WITCH, GULNARE, CONCORD, UNA, etc., in the order named. At sunset the fleet disbanded, thus terminating, although the shortest, one of the most enjoyable cruises of the ATLANTIC YACHT CLUB.

RECORD FOR 1893.

The regatta which was to be held on the 13th of June, 1893, was a failure, as the wind was so light that none of the boats could cover the distance in the prescribed time, so the race was declared off.

The cruise of the ATLANTIC YACHT SQUADRON commenced July 15, 1893. The run was from Cold Spring Harbor to Black Rock.

The yachts were favored with a fine sailing breeze part of the way, but the wind became quite light.

The following yachts participated and arrived at Black Rock as follows:

	Cold Spring Light.	Black Rock Harbor.	Elapsed Time.
	H.M.S.	H.M.S.	H.M.S.
Grayling	10 38 06	1 18 20	2 40 14
Water Witch	10 25 30	1 29 00	3 03 30
Daphne	10 24 19	1 32 10	3 08 00
Moccasin	10 27 10	1 32 40	3 05 30
Choctaw	10 25 50	1 39 10	3 10 20
Loyal	10 33 25	1 37 10	3 04 15
Siren	10 25 40	1 38 15	3 12 45
Tigress	10 25 32	1 39 15	3 13 43
Awa	10 29 00	1 40 00	3 11 00
Rival	10 28 05	1 40 10	3 12 05
Una	10 28 06	1 42 45	3 11 39
Penguin	10 26 25	1 47 50	3 21 25
Roamer	10 32 00	1 48 30	3 16 30
Lydia	10 29 20	1 51 15	3 21 55
Rover	10 28 45	2 05 05	3 36 20
Athene	10 28 28	1 55 00	3 26 32
Saona	10 30 00	2 06 15	3 36 15

The fleet then proceeded to New London, and arrived on July 17th very late, which interfered with the entertainments which were to be given.

The next race took place on the 18th, from New London Light, to Bug Light in Gardiner's Bay. Two cups were offered, one by Vice-Commodore Sanford, for the 40-footers, CHOCTAW, MOCCASIN and AWA, and the other by James Weir, Jr., for PENGUIN, ATHENE, ROAMER and RIVAL.

The following table gives details of the race:

FOR VICE-COMMODORE SANFORD'S CUP.

	New London Light.	Bug Light Gardiner's Bay.	Elapsed Time.
	H.M.S.	H.M.S.	H.M.S.
Awa	12 05 00	4 18 20	4 13 20
Moccasin	12 05 00	4 25 20	4 20 20
Choctaw	12 05 00	not timed	

FOR JAMES WEIR, JR.'S CUP.

Rival	12 03 40	4 15 20	4 11 40
Penguin	12 02 18	4 19 55	4 17 37
Roamer	12 02 22	4 28 36	4 26 14
Athene	12 00 38	4 31 20	disqual.

AWA won Vice-Commodore Sanford's Cup, RIVAL winning the Weir Cup, having done some very fine work.

The members after the cruise gave their attention entirely to the International Race for which the club hired the steamer GAYHEAD for the series of races, that the members and their friends might be properly entertained.

The officers for 1893 were as follows:

Commodore, David Banks,	Vice-Commodore, P. G. Sanford.
Rear-Commodore, Alex. P. Ketchum,	Secretary, Geo. H. Church.
Treasurer, H. C. Wintringham,	Measurer, Henry J. Gielow.

ATLANTIC YACHT CLUB FLEET, 1893.

SCHOONERS.

NAME.	OWNER.	LENGTH OVER ALL.	LENGTH L. W. L.	BEAM.	DRAFT.	C. B. OR K.
Agnes	J. Norton Winslow	59.8	55.3	16.9	5.6	e b
Ariel	G. H. B. Hill	169.	79.6	21.9	19.	e b
Cavalier	Jefferson Hogan	77.10	65.10	20.	10.	k
Columbia	J. T. Perkins	107.11	96.	25.1	8.3	e b
Comet	William H. Langley	91.	71.1	20.	6.1	e b
Constellation	Bayard Thayer	131.	106.	21.10	12.	e b
Coronet	John D. Wing	153.	125.	27.	12.6	k
Crusader	Wendell Goodwin, F. F. Swift	97.8	81.	21.6	8.3	e b
Emerald	J. Rogers Maxwell	112.	82.	21.10	10.	e b
Estelle	J. J. Dougherty	91.6	80.	22.0	7.	e b
Fearless	H. H. Hoagus	65.7	57.5	16.	7.	e b
Fenella	W. A. Hazard	67.	53.6	16.6	9.	k
Fortuna	Henry S. Hovey	109.4	96.3	22.6	12.8	k
Grayling	Latham A. Fish	91.10	83.5	23.	6.9	e b
Gevalia	H. W. Cones	69.	58.6	19.	7.	e b
Hermes	J. Crocker White	37.9	31.2	12.2	6.5	k
Hildegard	George J. Gould	112.	100.	20.	11.	k
Lasca	J. E. Brooks	119.	89.7	23.	10.8	e b
Loyal	B. F. Sutton	79.	69.	19.	7.6	e b
Lydia	H. W. Banks	50.6	44.6	16.	5.	e b
Marguerite	R. S. Palmer	96.11	79.11	21.	11.	e b
Nirvana	George I. Tyson	80.4	71.9	20.3	9.	k
Palmer	Rutherford Stuyvesant	118.4	104.4	21.2	9.0	e b
Romance	A. L. C. Macconnell	75.	60.	18.	8.	e b
Signal	J. Maerue	45.	40.	13.10	4.	e b
Shamrock	W. P. Ward	82.	69.3	20.	8.5	e b
Southern Cross	H. H. Chittenden	73.	65.	18.6	6.2	e b
Sachen	F. T. Adams	105.	88.5	23.5	8.6	e b
Tempest	E. A. Campbell	71.6	62.6	17.6	9.	k
Toga	Seymour L. Husted, Jr.	61.11	51.	15.	9.	k
Tricudo	D. D. Tompkins	46.8	39.	13.8	6.	k
Uma	J. P. Arkerman	71.9	68.	17.8	7.2	k
Vesta	J. J. Dougherty	123.6	110.2	25.9	9.8	e b
Vidette	H. F. Munn	59.6	50.	11.	5.	e b & k
Volunteer	Charles J. Palne	104.	80.9	23.2	10.	e b
Water Witch	David Banks	81.	79.6	22.6	8.	e b

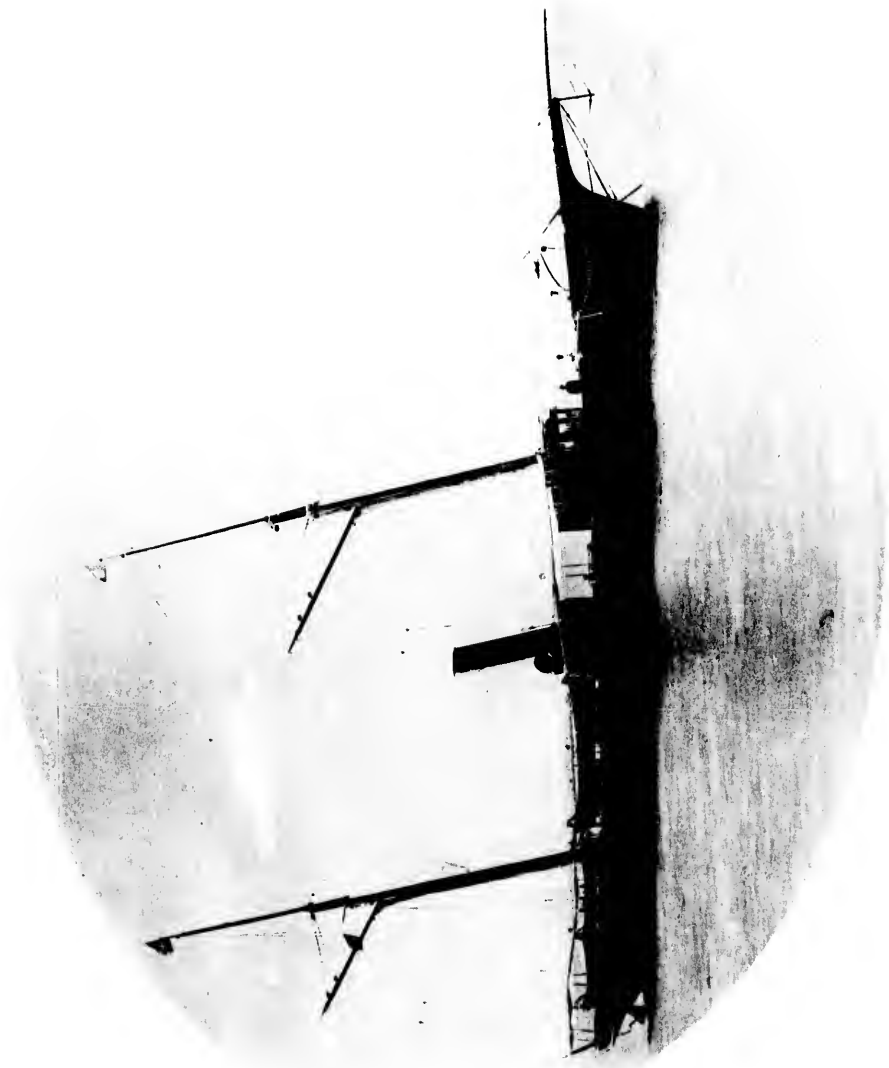

UTOWANA. (U.S. Fish Com.)

PLATE XLVII

PLATE XLVII

PLATE XLVII

PLATE XLVII



PLATE XLVII



ATLANTIC YACHT CLUB FLEET, 1893.

SLOOPS, CUTTERS, ETC.

NAME.	OWNER.	LENGTH OVER ALL.	LENGTH L. W. L.	BEAM.	DRAFT.	C. B. OR K.
Adele	J. Jay Allen	30.	25.	11.0	3.0	e b
Aglala	E. J. Bergen	38.1	33.	12.	7.0	k
Anaconda	John G. Prugue	99.	51.	18.0	5.5	e b
Annie	J. M. Tappen	19.0	11.0	16.4	4.0	e b
Athens	Charles A. Rich	99.	49.	17.5	5.0	e b
Athlon	Elwin B. Havens	61.7	51.8	17.4	7.4	e b
Awa	C. E. Cameron	52.	39.9	15.	9.	e b
Beatrice	Theodoro Dunham, E. K. Dunham	42.	32.0	10.4	7.	k
Belouin	C. W. Wetmore	81.	70.2	15.8	12.	k
Chispa	F. L. St. John	50.	39.7	13.3	9.1	k
Choctaw	T. L. Arnold	53.	39.8	11.	6.2	e b
Clara	R. A. Osborn	61.2	51.	9.1	9.10	k
Concord	H. C. Roome	51.	45.	17.	e b
Coquette	Thomas Leeming	21.	20.	7.	4.	k
Corsair	Melville B. Fuller, Henry C. Fuller	32.	43.4	16.7	4.9	e b
Duro	H. G. Well	70.	57.1	17.2	7.	e b
Dullodil	J. R. Whiting	14.	31.8	13.0	5.4	e b
Daphne	A. W. Booth	51.	40.	16.4	6.6	e b
De-dree	F. E. Camp	40.	12.0	e b
Enterprise	H. H. Hodins	50.85 ₂	11.25 ₂	15.8	7.3	k
Eurybia	Charles Fryer	47.	31.10 ₂	14.	6.	e b
Fanny	Thomas B. Fiske	72.	65.	21.	5.9	e b
Freyja	T. W. Davis	21.8
Gem	John Bliss	29.2	25.2	10.	6.0	k
Gracie	J. P. Earle	79.10	69.10	21.6	8.	e b
Guide	Benjamin Aborn	38.	29.11	12.	6.	e b
Gulnare	J. E. Dwight	73.	46.	15.2	5.	e b
Hildegardo	J. C. Bergen	69.5	60.0	19.2	5.5	e b
Hydriad	G. H. Brown	40.	30.	12.8	6.	e b
Ilderan	Walter Southwick	39.9	31.11	13.4	3.10	e b
Ileika	E. H. Converse	41.	31.	14.	3.6	e b
Iris	Edward N. Norton	27.	21.0	10.	3.3	e b
Iola	J. F. Ackerman	58.	40.	15.	4.6	e b

ATLANTIC YACHT CLUB FLEET, 1893.

SLOOPS, CUTTERS, ETC.—CONTINUED.

NAME.	OWNER.	LENGTH OVER ALL.	LENGTH L. W. L.	BEAM.	DRAFT.	C. H. OR K.
Jewel	H. A. Hilton-Harper	35.	30.1	11.	3.	e b
Louisa	Thomas H. Hull	30.6	25.6	12.	2.6	e b
Laxen	H. L. Goodwin	39.8	29.6	10.3	6.	k
Mad Cap	T. W. Sheridan	50.	41.5	16.	6.2	e b
Mignon	T. H. Hostetter	37.	31.	11	6.3	k
Mimosa	August Belmont	62.	45.10	13.10	10.5	k
Moccasin	J. P. Cruger	51.	39.8	13.6	6.4	e b
Monetto	Fred M. Smith	32.9	29.0	8.8	2.6	e b
Moya	Fraser M. Moffat	31.	28.	9.7	5.4	k
Montecito (Yawl)	Alexander Malthand	68.3	51.	15.	9.	k
Namodesa	C. W. Wetmore	30.	25.	6.	5.	k
Nautilus	W. D. Dickey	62.	45.10	13.5	10.2	k
Netbia (Yawl)	W. W. Kenyon	52.3	40.	11.	2.8	e b
Notus	J. B. Craft	24.5	21.7	10.	4.6	k
Orion	C. W. Cooper, G. C. Cooper	51.6	49.2	15.1	4.9	e b
Penguin	George E. Brighton	48.6	41.	15.8	6.	e b
Proteus (Yawl)	S. A. Cooper	31.	29.0	13.6	3.8	e b
Rajah	Walter C. Hubbard	41.6	31.6	8.6	7.	k
Rival	P. G. Sanford	40.7	39.3	14.8	6.2	e b
Rommel	S. D. McElroy	52.3	48.10	16.6	4.6	e b
Rose-Marie	J. Henry Work	35.	30.	13.	4.	e b
Rover	J. S. Manning	49.8	41.8	13.8	6.	e b
Saona	Alexander P. Ketchum	45.6	31.	12.	6.9	k
Sayonara	Rayard Thayer	62.	45.9	12.6	10.6	k
Smuggler	Charles W. Morgan	34.	24.	7.	5.3	k
Swallow	Herman Livingston	76.	54.8	12.	5.3	e b
Swannnon	J. D. Barrett	50.	40.6	16.	6.6	e b
Tigress	James Weil, Jr.	45	31.0	13.7	5.	e b
Vixen	J. C. Richardson	51.4	44.6	16.	7.9	k
Vorant	George G. Tyson	34.6	29.6	12.4	5.8	k
Venture	Henry Griswold	30.2	27.2	11.	4.	e b
Wabossa	J. F. Ackerman	30.	26.	10.	5.	k

ATLANTIC YACHT CLUB FLEET, 1893.

CAT-RIGGED YACHTS.

NAME.	OWNER.	LENGTH OVER ALL.	LENGTH L. W. L.	BEAM.	DEPTH.	C. B. OR K.
Acorn	P. H. Jeannot	21.10	24.0	11.3	2.9	e b
Calypso	Henry G. Peabody	25.	22.	8.	4.6	k
Curo	William Boyce	21.5	19.2	8.	1.8	k
Curlow	A. K. Buxton	25.	21.8	9.1	2.8	e b
Cygnet	P. H. Jeannot	24.	22.	9.	2.	e b
Elaine	A. P. Ketchum	22	22.4	9.	2.6	e b
Enid	H. V. H. Nash	27.3	26.	12.8	3.3	e b
Gazetta	David Banks, Jr.	23.10	22.1	10.0
Gunhilde	E. H. Jewett	31.2	31.	12.6	4.	e b
Hero	J. J. Phelps	23.7	20.3	9.3	2.	k
Iris	Elbridge T. Gerry	26.5 ⁶	25.11	12.	2.4	e b
Kathleen	Rev. Lindsay Parker	17.	17.	7.	1.9	e b
Marguerite	F. H. Simmons	24.10	24.5	11.	2.4	e b
Mendota	J. Carlidge, Jr.	24.	21.	8.6	3.	e b
Myrtle	J. H. Maxwell, Jr.	25.	24.	e b
Novlee	Atlantic Yacht Club	20.	20.	8.2	e b
Nydia	William G. Sage	26.	23.	8.2	3.	k
Oronce	C. T. Pierce	20.	24.6	10.6	2.6	e t
Parole	J. H. Rhodes	22.6	22.3	1.8	e b
Peggy	Charles K. Konyon	20.1	20.	8.4	2.2	e b
Playmate	Paul Babcock	26.	11.	e b
Rattler	T. A. Howell	20.2	20.2	9.	1.6	e b
Romp	George A. Thayer	20.	27.6	11.4	3.	k
Stranger	Atlantic Yacht Club	20.	18.	8.6	2.	e b
Spray	J. F. Munn	20.	25.	11.	3.	e b
Talitha	N. D. Lawton	20.	21.	8.	2.6	e b
The Bird	William Peet, Jr.	18.6	15.13 ⁴	7.3	1.4	k
The Kid	Bayard Thayer	18.7	18.7	7.1 ⁰	.1	k
Wanda	Charles A. Rich	20.	20.	8.6	1.6	k
Westmaoe	M. C. D. Horden	24.9	22.3	10.1	2.6	e b
White Cap	John H. Lord	27.8	23.1	10.	2.1	e b
Ysoldi	S. L. Blood	19.	17.	7.6	1.4	e b

HISTORY OF THE ATLANTIC YACHT CLUB.

ATLANTIC YACHT CLUB FLEET, 1893.

STEAM YACHTS.

NAME.	OWNER.	LENGTH OVER ALL.	LENGTH L. W. L.	DEAM.	DRAFT.
Almy	Frederick Gallatin	177.0	155.6	21.	0.0
Anita	William Dupont	112.	101.0	15.9	0.0
Aquila	George A. Thayer	101.	85.	15.	7.
Atlantic	Atlantic Yacht Club	25.	22.	5.8	1.0
Au Revoir	William Dupont	108.	100.
Camilla	M. C. D. Borden	60.	52.2	0.	3.3
Calmnet	C. G. Emery	83.9	70.8	11.	4.
Compass	E. H. Bennett	78.	67.	11.0
Daisy	E. D. Morgan	48.	7.6	2.8
Electra	E. T. Gerry	174.	161.6	23.	10.6
Emu	E. A. Du Vivier	85.6	77.	15.	6.
Fishelm	E. M. Brown	107.	95.	20.3	7.8
Glance	J. S. Spencer	60.	58.	8.	2.6
Intrepid	Capt. Lloyd Phoenix	164.	132.	27.	13.6
Ituna	A. Belmont	137.0	19.7	11.3
Jacquemintot	J. J. Phelps	21.	19.	5.	1.6
Judy	T. H. Hostetter	102.3	86.	11.6	5.0
Junior	Robert Graves	25.	5.8	1.0
Kumpha	William L. Moore	185.	165.	23.8	10.0
Lagonda	William L. Moore	140.	119.	19.6	7.6
Magnot	T. A. Howell	63.	60.	12.	4.6
Marguerite	William M. Harriman	90.	78.6	15.4	5.4
Marietta	H. B. Moore	113.2	95.	16.	6.
May	E. D. Morgan	229.	203.8	27.8	14.5
Myra	W. W. Kenyon	76.	65.	10.4	4.
Minerva	W. S. Chamberlain	35.
Neutra	S. H. Austin	130.	115.2	20.	7.6
Normandie	A. L. Goodrich	60.	50.	10.0	4.6
Norklyn	J. L. Marcellus	60.	57.	8.	3.
Nixie	J. M. Foote	40.	40.	7.6	3.
Nydia	R. V. Pierce	96.6	82.6	15.10	6.
Orrmoore	Alexander E. Orr	55.	51.	12.6	4.6
Oriente	Edward H. Ludew	121.	117.	17.	7.
Secret	J. A. Aspinwall	48.	8.	3.
Stranger	J. C. Hoagland	167.	173.	28.8	10.6
Sambel	R. Stuyvesant	61.	61.	15.	11.10
Stella	George V. Brower	30.
Tantalus	Guy Loomis	52.	46.	10.	4.
Thyra	J. A. Aspinwall	79.	66.	11.	5.4
Trophy	E. H. Bennett	90.	90.	14.	5.3
Vesta	H. A. Laughlin	98.	89.4	15.9	5.10
Vidette	M. C. D. Borden	-
Water Witch	David Banks	21.	4.6	2.6
Zampa	A. J. Cammeyer	40.

DRAFT.

9.8
6.9
7.
1.9
.....
3.3
4.
.....
2.8
10.4
6.
7.8
2.6
11.6
11.3
1.6
5.9
1.9
10.6
7.6
4.6
5.4
6.
14.5
4.
.....
7.6
4.6
3.
3.
6.
4.6
7.
3.
10.6
1.10
.....
4.
5.4
5.3
5.10
.....
2.6
.....

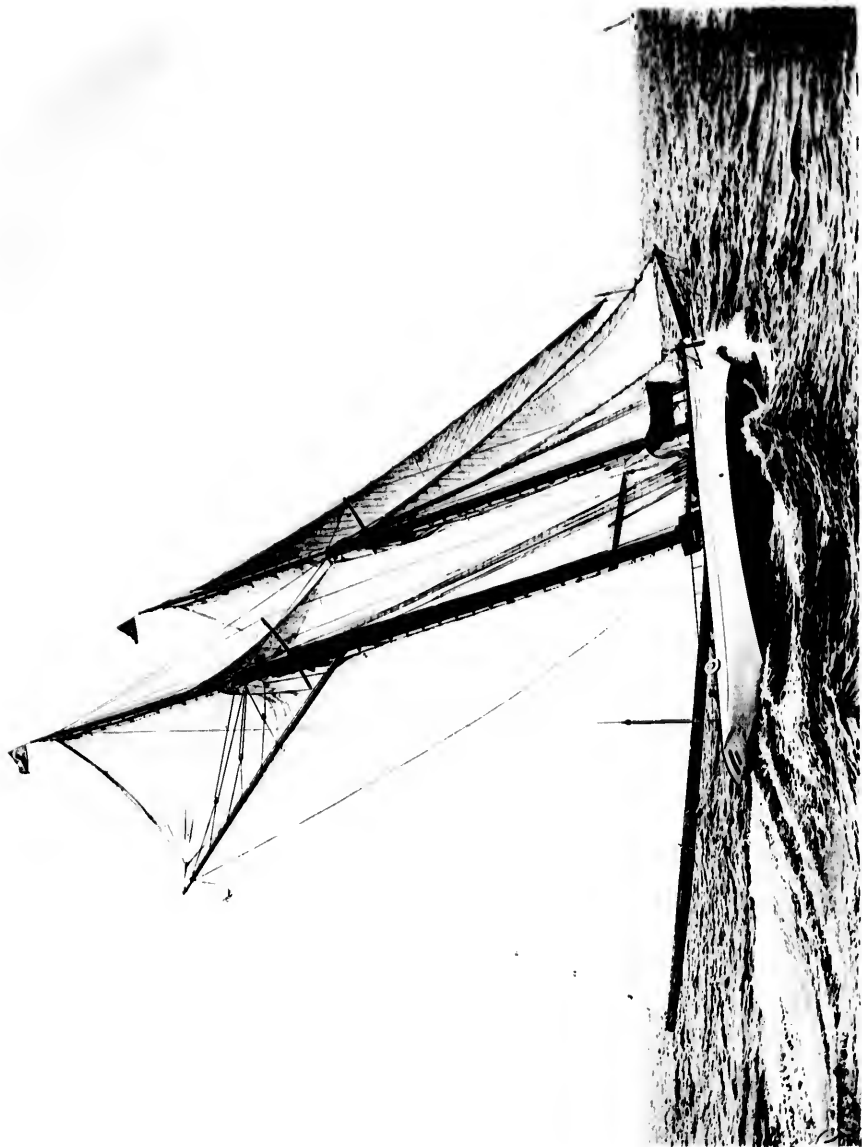

FROM A NEGATIVE BY STEBBIN.

H. L. V. C. R.

OENONE.

rew, if aboard,
king his meas-

be considered

be taken from
on bowsprit or
head, the dis-
peak hulliard

the owners, as

be adopted by

as,

th the Chair-

-eight hours

Sunday shall

ittee of boats en-

belonging to a

week prior

ally paid.

measurement,

asurer of the

entered for

a period of

tin, at least

allowance of

accordance

b, jibtopsail,

maker,

-jib, jibtop-

re than one

hoist above

m.

peak,

yacht en-

reef points,

ntely after

ed against

bulkheads

ime of the

of the day

n into the

is rule, be

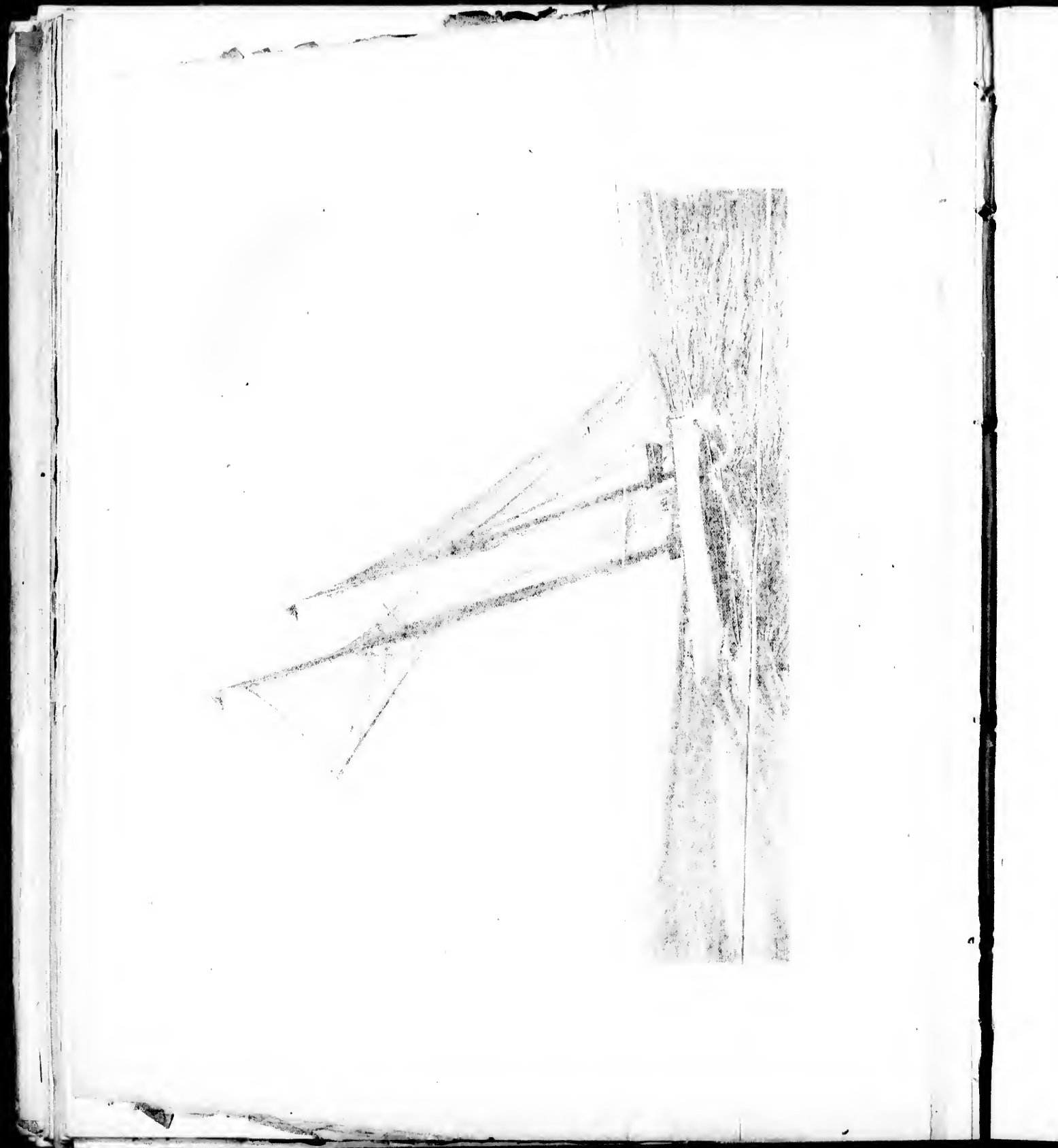

ACCORDING TO THE RULES AND REGULATIONS:

CLASSIFICATION.

For Club Races, yachts shall be divided into classes according to load waterline, length to be determined in the manner specified in the rules providing for measurement for time allowance, which classification shall be as follows:

SCHOONERS.

- Class 1.—All over 90 feet, load waterline.
 Class 2.—All over 70 feet and not over 90 feet, load waterline.
 Class 3.—All of 70 feet and under, load waterline.

SLOOPS, CUTTERS AND YAWLS.

- Class 1.—All over 70 feet, load waterline.
 Class 2.—All over 61 feet and not over 70 feet, load waterline.
 Class 3.—All over 53 feet and not over 61 feet, load waterline.
 Class 4.—All over 46 feet and not over 53 feet, load waterline.
 Class 5.—All over 40 feet and not over 46 feet, load waterline.
 Class 6.—All over 35 feet and not over 40 feet, load waterline.
 Class 7.—All over 30 feet and not over 35 feet, load waterline.
 Class 8.—All over 25 feet and not over 30 feet, load waterline.
 Class 9.—All of 25 feet and under, load waterline.
 Class 10.—All open sloops.
 Class 11.—All cut-rigged yachts.

Any yacht which shall have been launched prior to the first day of May 1888, exceeding the higher limit in any class by not over the fraction of a foot, shall be included in that class.

The rules also provide for special 25 foot rating class.

SPECIAL ALLOWANCE.

1. For cruising trim: Yachts entering to sail in cruising trim shall be rated for time allowance at ninety-four (94) per cent. of their racing length. Yachts so entered must sail in ordinary cruising trim, and carry their complete cruising outfit, subject to approval as such by the Regatta Committee.

2. For rig: In mixed rig races, schooners shall be rated at eighty-five (85) per cent. of their racing length, and yawls at ninety-four (94) per cent. of their racing length.

MEASUREMENT FOR TIME ALLOWANCE.

Yachts shall be rated for time allowance according to the following system: To the square root of the sail area add the load waterline length and divide the sum by two. The result is the measurement for time allowance.

The measurement shall be obtained as follows: A base line to be taken from a point midway between the jib topsail stay and jibstay on bowsprit, or flying jibstay on jib boom in a straight line to the end of the main boom, with the excess of the length of main gaff, measured from after side of mast to end, over 80 per cent. of the length of main topmast measured from hounds to lower side of sheave of topsail halliard block.

The length of base line, as above defined, shall be modified in any case where the spinnaker boom measures, when shipped in place at mast, from swivel socket to end of pole, more than the distance from the fore side of foremast in a schooner, or mainmast in a single-masted vessel, to the forward point of base line, as previously defined. Any excess in the length of spinnaker boom beyond the point shall be added to the base line. For yawls the base line to be taken from the same point to end of the mizzen boom.

A perpendicular line to be taken along the after side of the mainmast from the under side of the sheave for gaff topsail halliard to the upper side of boom resting on the saddle or on the lowest part of goose-neck, the distance of which point from main deck or house deck to be recorded by the measurer together with the other points used in measurements.

To obtain the estimated area from these figures, multiply the base by one-half the perpendicular.

Length is the length on the load waterline, exclusive of any portion of the rudder or rudder stock, and it is to be ascertained when the

yacht is afloat and in her ordinary trim, and with the crew, if aboard, stationed amidships, the Measurer at the time of making his measurement to fix a distinctive mark at each point.

On yachts that carry no topmast, the masthead shall be considered in place of the topmast.

On cat-boats the measurement of the base line shall be taken from the after side of the mast in place of point specified on bowsprit or jib boom. On boats that have no clearly defined masthead, the distance between the throat halliard band or eye and upper peak halliard band or eye shall be taken for length of masthead.

Any change in these measurements to be reported by the owners, as customary, to the Measurer.

Allowances shall be calculated according to the table adopted by the club.

There are also special rules for the 25 foot rating class.

ENTRIES.

Entries for a regatta must be in writing, and filed with the Chairman of the Regatta Committee, not later than forty-eight hours prior to 9 o'clock A. M. of the day of the regatta. If Sunday shall intervene, no part of it shall be included.

Entries may be received by the Regatta Committee of boats enrolled in such clubs as they may deem advisable.

Every yacht entering for a regatta or race must, if belonging to a member, have been enrolled in the fleet at least one week prior thereto, and all the dues of the owners must have been fully paid.

Entries from other clubs must specify the yacht's measurement, according to the rules of this club, certified to by the Measurer of the club from which she is entered, or by her owner.

No yacht which has been chartered to a person shall be entered for a race, unless she has been chartered, in good faith, for a period of not less than two months.

The Regatta Committee shall post on the club bulletin, at least twenty-four hours prior to the regatta, the tabulated allowance of time to be given by the yachts entered in the regatta, in accordance with the system of allowance adopted by the club.

SAILS.

Yachts in races may carry the following sails:

Schooners:—Mainsail, foresail, forestaysail, jib, flying-jib, jibtopsail, fore and main gaff topsails, main topmast staysail and spinnaker.

Sloops and cutters:—Mainsail, forestaysail, jib, flying-jib, jibtopsail, gaff topsail and spinnaker.

Open Sloops:—Jib and mainsail.

Cat-boats:—Mainsail.

No topsail shall hoist above the truck, nor extend more than one foot beyond the peak of the sail above which it is set.

Spinnakers shall be triangular in shape, and shall not hoist above the truck, nor extend beyond the end of the spinnaker boom.

FLAGS AND NUMBERS.

Each competing yacht shall fly the private signal at the peak.

Distinguishing numbers or flags will be assigned each yacht entered, and must be fastened to the mainsail above the reef points, and must be returned to the Regatta Committee immediately after the race, or the cost of replacing the same will be charged against the person neglecting to do so.

BALLAST, FITTINGS, TRIM.

Yachts shall, during a race, keep their floors down and bulkheads standing.

Trimming by dead weight shall be allowed up to the time of the starting signal but not during the race.

Ballast shall not be taken in or discharged after 9 P. M. of the day before the race, and no water shall be started from or taken into the tanks after that hour.

A race postponed or re-sailed shall, so far as regards this rule, be considered a new race.

BOATS AND BUOYS.

All yachts of over 53 feet load waterline length in races shall carry on deck a serviceable round bottom boat, with oars and rowlocks or tholepins lashed in, 14 feet or over in length; on boats over 40 feet load waterline length and not over 53 feet load waterline length, one 12 feet or over in length.

All yachts in races shall carry on deck, aft of the main companion-way, two serviceable cork ring life-buoys, each at least 27 inches in diameter from outside to outside, ready for immediate use.

CREWS.

In all races yachts over 53 feet load waterline length shall be unlimited and unrestricted as to the crews they may carry. Yachts of 53 feet load waterline length and under, in addition to the helmsman, may carry as crew one man for every five feet or fraction thereof of racing length, of which crew one man for every ten feet of racing length may be a professional, the rest must be amateurs. Yachts of thirty feet load waterline length and under must be steered by a member of this club or by some other amateur. All yachts must carry throughout the race the crew on board at the start.

POSTPONEMENT.

The Regatta Committee shall have power to postpone any race, should, in their judgment, unfavorable weather render such a course desirable.

Should any yacht duly entered for a race not start, or, having started, should she withdraw or be disabled, such yacht shall be entitled to start in the event of the race being re-sailed.

No new entries shall be received under any circumstances for a postponed race.

COURSES.

For all classes of schooners and sloops in classes 1, 2, and 3: From the starting line, between Buoy No. 11 and a stake boat anchored to southward and eastward thereof, to and around southwest Spit Buoys Nos. 12 and 10, passing to the west of same; thence to and around the Scotland Light Ship, keeping the same on the starboard hand; thence to and around a tug boat or turning mark, anchored five miles south southwest of said Light Ship, keeping it on the starboard hand; thence returning to Scotland Light Ship, keeping it on the port hand; thence to Buoys Nos. 10 and 12, going around same; keeping them on the starboard hand; thence to home stake boat, going to the southward and westward of beacon on Romer Shoal. Keep to the northward and eastward of Bell Buoy off the point of the Hook both going and returning.

For sloops in classes 4 and 5: From said starting line, between Buoy No. 11 and a stake boat, to and around a stake boat near Buoy No. 6 off the northern point of Sandy Hook, passing to the west of the same; thence to and around the Scotland Light Ship, keeping it on the starboard hand; thence to and around a tug-boat, or turning mark, anchored five miles south southwest of said Light Ship, keeping it on the starboard hand; thence home, going to southward and westward of beacon on Romer Shoal. Keep to the northward and eastward of Bell Buoy off the point of the Hook, both going and returning.

For classes 6 and 7: From said starting line between Buoy No. 11 and a stake boat, to and around a stake boat near said Buoy No. 6, keeping the same on the port hand; thence to and around the Scotland Light Ship, keeping it on the starboard hand; thence home, passing to westward of beacon on Romer Shoal. Keep to the northward and eastward of Bell Buoy off the point of the Hook, both going and returning.

For classes 8, 9, 10, and 11: From said starting line between Buoy No. 11 and a stake boat, to and around a stake boat near said Buoy No. 6, keeping the same on the port hand; thence home, passing to westward of beacon on Romer Shoal.

The starting line will be an imaginary one between Buoy No. 11 and a stake boat anchored southward and eastward of the Buoy.

The finish for all classes will be at Buoy No. 11, and all yachts must cross the line between said buoy and a stake boat anchored to southward and eastward of buoy.

All yachts must pass to the eastward of Buoy No. 9 on west bank, both going and returning.

START AND FINISH.

All starts shall be flying.

The signal shall be given from the Club Boat.

Preparatory signals: There shall be a whistle blown, and the ATLANTIC YACHT CLUB signal shall be lowered for all yachts to approach the starting line.

Starting Signals: Five minutes after the preparatory signal, a whistle shall be blown and a white ball hoisted on the flag-staff for all yachts over 53 feet load waterline length to start.

Five minutes later a whistle shall be blown, and a second white ball hoisted on the flag-staff for all other yachts to start. Five minutes will be allowed each yacht to cross the line after the signal for the start of the class.

Any yacht which does not cross the starting line within the time allowed for the class will be timed from the expiration of that time.

Each yacht must cross the starting line after the proper starting signal for the class in which she is entered.

The second and third whistles shall be blown on time, and in case of any mistake the hoisting of the signals on the flag-staff shall take the place of the whistle.

The time at the start and finish shall be taken when the point marked by the foremast in schooners, and the mainmast in single-masted vessels and yawls, crosses the line.

If this point in any yacht be across the line when the proper starting signal for such yacht is given, she must return, and re-cross the line.

A yacht so returning, or one working into position from the wrong side of the line, after the starting signal for any class has been given, must keep clear of and give way to all competing yachts.

STAKE BOATS AND MARK BOATS.

All stake boats will fly the ATLANTIC YACHT CLUB signal, and after dark will show a white light suspended over a red light.

A competent person shall be placed on the stake boat at the finishing line, whose duty it shall be, in the absence of the Regatta Committee, to take the time of the yachts.

Should any stake boat, buoy, or other mark, be absent or moved from its proper position during a race, the race may be re-sailed or not, at the option of the Regatta Committee.

TIME OF RACE.

There shall be no limit to the time in which a race is to be sailed.

YACHTS NOT IN RACES.

All yachts not racing must keep to leeward and out of the way of racing yachts.

LIGHTS AND FOG SIGNALS.

Yachts shall during a race observe the Government regulations regarding lights and fog signals.

PROPULSION.

No means of propulsion, except sails, shall be employed during a race.

PRIZES.

In each class in which any yacht starts and completes the course, and complies with all the rules and regulations of the club, a prize shall be awarded.

DECLARATION.

Before the owner of a winning yacht can receive the prize, he, or in his absence the member representing him on the yacht, shall sign a declaration that all the rules were complied with.

SPECIAL RULES FOR 35 FOOT RATING CLASS.

The yachts shall be governed by the regular measurement and sailing rules of the club, except:

The altitude shall be measured to the highest block carrying any halliard.

In case of sails of any design differing from the ordinary jib and mainsail, so that in the opinion of the Measurer of the club, the rule does not measure the full area of the sails, any such excess shall be measured at its actual area and added.

The mast must be at least one-fifth the length of waterline from the fore end of waterline.

The spinnaker boom shall not exceed the sailing length of the yacht.

The crew shall not exceed three men in addition to the helmsman; they must all be amateurs and no other person shall be allowed on board.

TABLE OF TIME ALLOWANCE.

The allowances in this table are based upon the rule accepted by naval architects, that within economic limits, opportunities for speed vary in different vessels as the square roots of their respective lengths. As strong winds are required, however, to give to larger vessels the full extent of their advantage in size, and as such a scale of allowance is not adapted to ordinary summer racing, 50 per cent. only of the allowance due to the rule is given in the table and may be stated thus:

Time equals $.5 \left\{ \frac{3600}{L} - \frac{3600}{L} \right\}$; 3600 representing the number of seconds in an hour, L the small yacht, and L the large one.

Practically the formula is $\left\{ \frac{1800}{L} - \frac{1800}{L} \right\}$; five-tenths of 3,600 being 1,800.

RULES AND REGULATIONS FOR PENNANT REGATTAS.

There may be a regatta in the Fall of the year, to be called the Annual Pennant Regatta, in which event it shall take place in September, and be subject to these rules and regulations and such special rules and regulations as may be prescribed by the proper authority, as hereinafter provided.

The classification shall be the same as in the Annual Regatta in June preceding.

The time allowance shall be the same as in the Annual Regatta in June preceding.

Every yacht enrolled in the fleet shall be considered as entered for these Regattas in her proper class, unless especially entered under the provisions of the Regatta and Sailing Regulations.

If there should be only one yacht of any class enrolled in the fleet, such class shall be vacant until another yacht of the same class shall be enrolled; and if the pennant of such class shall be in possession of the single yacht, it may so remain until demanded by the club; or if it should be in possession of the club, it shall so remain until another yacht of such class shall be enrolled therein, when it may be competed for under these rules.

These regattas, except as provided in Rule IX, shall be under the charge of the Commodore who shall make such special rules and

regulations as he deems best, provided they do not conflict with the rules and regulations of the club. He shall select the day and course, and appoint three competent judges (who shall not be yacht owners) to superintend the regatta. He shall notify the Secretary, who shall immediately notify all members of the regatta. The Commodore shall receive the decision of the judges and award the pennants to the winning yachts.

Any yacht winning the pennant shall be entitled to hold the same unchallenged for thirty (30) days, after which time she may be challenged by any yacht of her class, as follows:

Such yacht shall give a written challenge to the owner of the yacht holding the pennant, either personally or by leaving the same on board his yacht with the sailing master, and shall immediately give written notice thereof with a copy of challenge to the Commodore, who shall appoint the time of such race, not earlier than ten (10) days nor later than fifteen (15) days thereafter, and indorse the same on, and transmit the papers to the Secretary, who shall give the same notices as in the Annual Pennant Regatta. The Commodore shall have the same authority in reference thereto as in the Annual Pennant Regatta, except as otherwise restricted in this rule.

Such races shall be over same course as that over which the pennant was won and with the same allowances. Any other yacht of the class may enter the race therefor, by giving at least 72 hours before the appointed hour of starting a written notice thereof to the Commodore, to the judges and to the yachts challenged and challenging.

If at any time, from any cause, the pennant of either class shall be in the possession of the club, any yacht of the class to which such pennant belongs may challenge for it as follows: By serving the challenge on the Commodore, who shall, through the Secretary, immediately notify all yachts of that class that such challenge has been filed.

If no yacht of that class shall within ten days thereafter serve notice of acceptance of such challenge on the Commodore, he shall award the pennant to the yacht challenging, and give notice of such award at the next meeting of the club.

If a notice of acceptance shall be served by one or more yachts, the Commodore shall appoint the day, course and judges, and the Secretary shall give notice as provided in the Rules.

If the Commodore's yacht should at any time hold a pennant, or if he should challenge for one, his duties, as provided in these rules, shall devolve upon the Vice-Commodore, or the next in rank, whose yacht shall not be one competing in a race resulting from the challenge. This rule shall not, however, interfere with the exercise of the Commodore's duties, so far as they pertain to the Annual Pennant Regatta.

The yachting season for the purposes of these regattas or races shall commence with May 30th and end on the last day of October, and no race shall be appointed except in the season.

The regatta and sailing regulations of the club shall apply in Challenge Regattas, Pennant Regattas, Matches and Races, except as otherwise provided in these special rules and regulations.

All violations of these rules shall be reported to the club or to the Commodore, and may be punished by the club.

BIOGRAPHICAL SKETCHES AND DESCRIPTION OF YACHTS ENROLLED IN THE CLUB.

DAVID BANKS, Commodore of the ATLANTIC YACHT CLUB, an enthusiastic yachtsman, has been active in developing the best interests of the club of which he has the honor of being the commanding officer.

In 1892 Commodore Banks had charge of Station No. 11 of the NEW YORK YACHT CLUB at New London, where he owns a palatial summer resort and where it is his custom to give entertainments to visiting yachtsmen.

His present yacht is WATER WITCH, the flag ship of the ATLANTIC YACHT SQUADRON.

Commodore Banks has just been re-elected to office which demonstrates the high estimation in which he is held by the members of the club.

WATER WITCH.

WATER WITCH is a centerboard schooner, owned by Commodore David Banks of the ATLANTIC YACHT CLUB. Was designed and built by D. O. Richmond, Mystic, Conn., and launched in 1881. Hails from New York. See plate LVII.

CODE SIGNAL LETTERS, K. C. D. V.

Official number, 80,828.

DIMENSIONS.

Length over all,	88 feet.	Length load waterline,	78 feet 1 inch.
Depth,	9 feet.	Draft,	7 feet 6 inches.
Beam,	22 feet 6 inches.		



J. FRED ACKERMAN.

J. FRED ACKERMAN, born and living in the city of Brooklyn, N. Y., carries on a wholesale paper and importing business; is a member of the ATLANTIC and BAY HEAD YACHT CLUBS, being a charter member of the latter which was organized in 1889 at Barnegat Bay.

The owner of the yacht USA, which was launched in 1849, and re-built in 1883 as a keel schooner. He has also owned the sloops MONTAGU, ULQUIOT, IOLA and the cutter WAROSSA. Has been an enthusiastic yachtsman for thirty years. Mr. Ackerman has been Major in the 13th Regiment, N. G. S. N. Y.

USA.

A keel schooner of 39 tons, owned by J. Fred Ackerman of Brooklyn; designed and built by George Steers, Williamsburgh, N. Y., and launched in 1849. She was altered in 1854 and 1879, re-built in 1882 as a keel schooner and afterwards lengthened and re-built in 1893. Has a cabin and hails from New York. See Fig. 369.

USA is an historic yacht, having taken part in the early races of the NEW YORK YACHT CLUB.

Official number, 25,017.

DIMENSIONS.

Length over all,	85 feet.	Length load waterline,	68 feet.
Depth,	6 feet 2 inches.	Draft,	8 feet 6 inches.
Beam,	17 feet 8 inches.		

RACING RECORD.

Sailed her First Race June 2, 1867; then owned by James M. Waterbury; 39 tons. This was a regatta of the NEW YORK YACHT CLUB, and USA won.

Many have thought that the famous PURITAN was modeled after USA.

On October 12, 1847, there was a Corinthian race. In this race USA again won.

Was beaten by ULTRA, October 31, 1848.

June 3, 1852, Annual Regatta: USA beat ULTRA, CORNELIA and SYBIL.

June 21, 1858, USA (then owned by W. B. Duncan), took part in the famous race around Long Island, when Mr. Jas. G. Bennett so immortalized himself by taking the short course through Plum Gut. In this race she lost.

RICHARD W. BAINBRIDGE was born in Brooklyn, N. Y., in the year 1856. He still lives in that city and is an extensive manufacturer of paper goods. Has been a yachtsman for twenty years and is at the present time the owner of the sloop yacht MABELLE. Was formerly a member of the ATLANTIC YACHT CLUB.

MABELLE.

A centerboard sloop, belonging to Richard W. Bainbridge, Brooklyn, N. Y., hails from New York City. Re-built in 1892 by William King.

DIMENSIONS.

Length over all,	32 feet.	Length load waterline,	26 feet 6 inches.
Depth,	5 feet.	Draft,	3 feet.
Beam,	11 feet 6 inches.		

AGLATA.

A cutter, formerly MAUD; owned by Edw. J. Bergen of Brooklyn, N. Y. Built and designed by Wood Bros. of East Boston, and launched in 1885. She hails from New York and sails with the ATLANTIC and NEW ROCHELLE YACHT CLUBS. See Fig. 370.

Official number, 106,841.

DIMENSIONS.

Length over all,	38 feet 1 inch.	Length load waterline,	32 feet 9 inches.
Depth,	6 feet 2 inches.	Draft,	7 feet 6 inches.
Beam,	12 feet.		

J. R. COLLINS, Brooklyn, N. Y., was born in the north of Ireland in the year 1863, of English and Irish extraction. He is an importer, and is quite a yachtsman as well. Has always as he expresses it, "owned some sort of a boat," and is now the possessor of the yacht LENA. Has been interested in yachting for eighteen or twenty years. Was for some years the Secretary of the old NEREBD BOAT CLUB, now merged into the CRESCENT. He is a member of the ATLANTIC and NEW ROCHELLE YACHT CLUBS.

LENA.

The sloop LENA is the property of James R. Collins and was designed by Edward Burgess and built by Wood Bros. of East Boston, Mass. Was formerly the property of W. S. Vallean of New York. The rig and interior have been altered to some degree. She was launched in 1878 and she hails from New York. Has been owned by Mr. Collins for two years. See Fig. 137.

Official number, 140,365.

DIMENSIONS.

Length over all,	32 feet.	Length load waterline,	27 feet.
Depth,	6 feet.	Draft,	6 feet 6 inches.
Beam,	11 feet.		

EMU.

Steam yacht, designed by Hines and built by S. Pine, Greenpoint, N. Y., 1880. Former owner, C. Fletcher, Providence, R. I.; now owned by Edward A. Du Vivier, New York City; his property since 1890. She has never been altered and hails from New York. She is a screw schooner. Her owner belongs to the NEW YORK, SEAWANAIKA, LARCHMONT, ATLANTIC and NEW ROCHELLE YACHT CLUBS. See Fig. 372.

Official number, 135,446.

DIMENSIONS.

Length over all,	85 feet.	Length load waterline,	77 feet 6 inches.
Depth,	6 feet.	Draft,	6 feet.
Beam,	15 feet.		

CORNELIA

took part in
Bennett so
Plum Gut.

N. Y., in
an extensive
for twenty
yacht MA-
T CLUB.

idge, Brook-
892 by Wil-

et 6 inches.
et.

of Brooklyn,
Boston, and
with the Ar-
70.

et 9 inches.
et 6 inches.

north of Ire-
tion. He is
ays as he ex-
ssessor of the
en or twenty
ERREID BOAT
r of the Ar-

us and was
ros. of East
ean of New
egree. She
Has been

et.
et 6 inches.

Greenpoint,
R. I. ; now
operty since
New York
NEW YORK,
ELLE YACHT

et 6 inches.
et.



COMMODORE DAVID BANKS,

ATLANTIC YACHT CLUB.

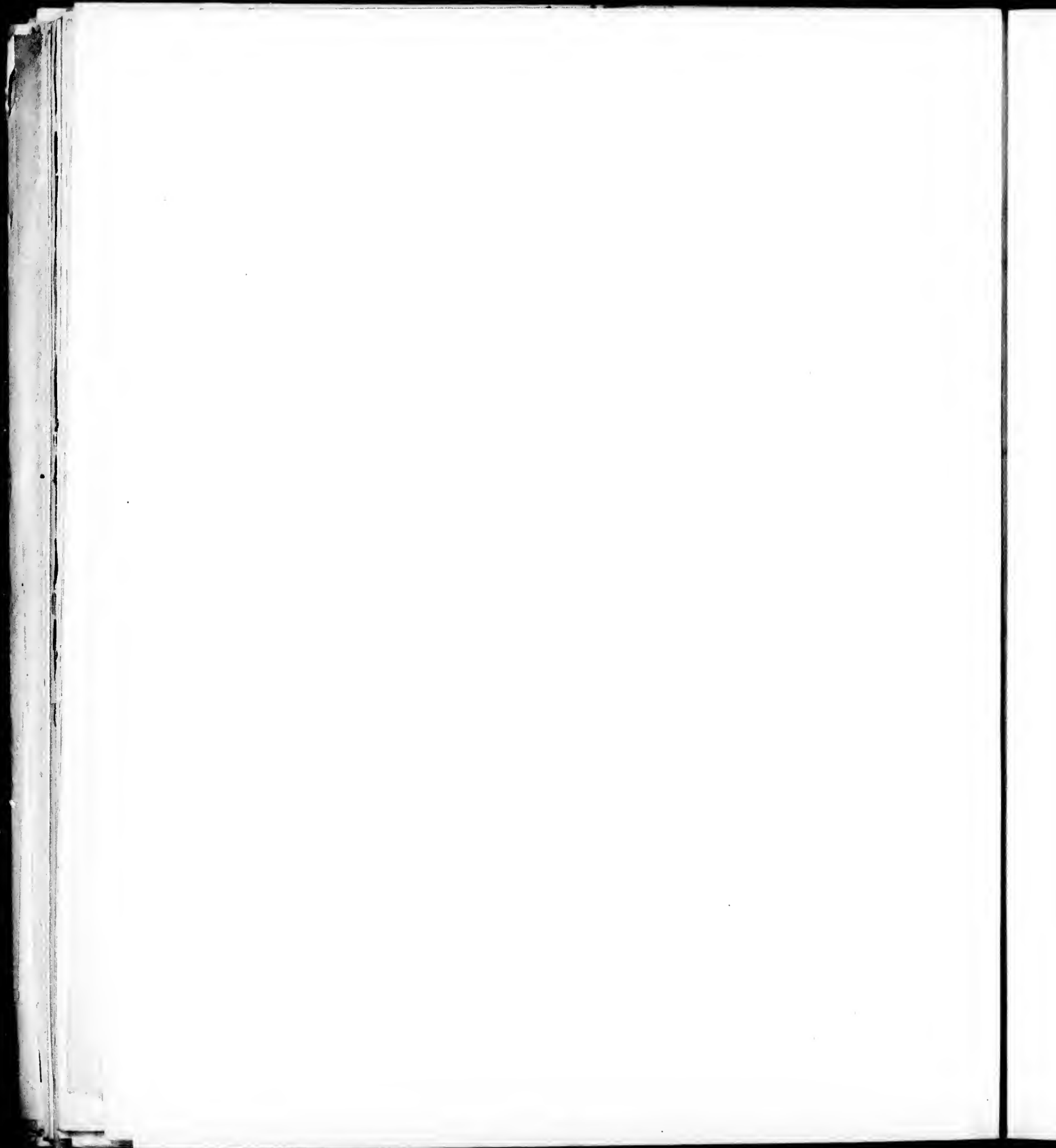

Engines : Two condensing, 10 x 10 inch.
Boiler : One, 8 x 5 ft. 4 inches, upright tubular, built by R. I. Locomotive Co., '87.

ARAB.

ARAB is a centerboard sloop designed by Philip Ellsworth and built by J. F. Mumm at South Brooklyn, in 1886. She hails from New York City and is owned by Frank M. Freeman, formerly the property of Edmund Fish. Sails with the SEAWASHAKA CORYTHIAN and LARCHMONT YACHT CLUBS. See Fig. 314.

DIMENSIONS.			
Length over all,	33 feet.	Length load waterline,	29 feet.
Draft,	4 feet 6 inches.	Beam,	11 feet.

MELVILLE B. FULLER of New York City, N. Y., was born in Brooklyn in the year 1868, the son of H. C. and K. E. Fuller; is a broker and the owner of the centerboard sloop yacht **CORSAIR**. Has been interested in yachting for the last five years and is a member of the ATLANTIC, KNICKERBOCKER and INDIAN HARBOR YACHT CLUBS.

CORSAIR.

A centerboard sloop designed and built by Jackson & Matthews, Greenport, N. Y., and launched in 1880; now the property of Melville B. Fuller, of New York City. Has belonged to him for four years. She was re-built at Northport, L. I., in 1891. **CORSAIR** hails from New York.

Official number, 125,814.

DIMENSIONS.			
Length over all,	32 feet.	Depth,	6 feet.
Draft,	5 feet 6 inches.	Beam,	17 feet.



HENRY A. GOUGE.

HENRY ALBERT GOUGE, of New York City, born in Hartford Conn.; of Huguenot descent, the son of Alfred and Eliza Gouge. Is a ventilating and heating engineer. Has owned the yacht **ALARM** and others. For forty years a yachtsman and a veteran in the service; a member of the NEW ROCHELLE and ATLANTIC YACHT CLUBS and an incorporator of the latter club. Was Rear-Commodore of the ATLANTIC YACHT CLUB and on the Board of Trustees of the NEW ROCHELLE YACHT CLUB.

CAVALIER.

A keel schooner, owned by Jefferson Hogan. Designed and built by Joshua Bedell, Glenwood, N. Y. Launched in 1888. Hails from New York, and sails with the ATLANTIC and NEW ROCHELLE YACHT CLUBS. See Fig. 375.

CODE SIGNAL LETTERS, K. P. C. J.

Official number, 126,469.

DIMENSIONS.			
Length over all,	77 feet 10 inches.	Length load waterline,	65 feet 10 inches.
Depth,	9 feet 3 inches.	Draft,	9 feet.
Beam,	20 feet.		

GULNARE.

A centerboard sloop, owned by John E. Dwight and designed and built for him by Louis Towns, Mariners' Harbor, N. Y., in August 1891. She has a cabin and hails from New York. She is in the fleet of the ATLANTIC, LARCHMONT and NEW BEDFORD YACHT CLUBS. See Fig. 373.

CODE SIGNAL LETTERS, K. T. S. P.

Official number, 86,166.

DIMENSIONS.			
Length over all,	51 feet.	Length load waterline,	46 feet.
Depth,	6 feet.	Draft,	5 feet 6 inches.
Beam,	14 feet 3 inches.		



ALEX. P. KETCHUM.

ALEXANDER P. KETCHUM, New York City, N. Y., Rear-Commodore of the ATLANTIC YACHT CLUB. Born in New Haven, Conn., May 11, 1839; the eldest son of Edgar and Elizabeth Ketchum. His father was a noted lawyer of New York City, and was for many years in that city, United States registrar in bankruptcy. Mr. A. P. Ketchum graduated in 1858 from what is now called the College of the City of New York. In 1862 he went to South Carolina, as civil aid to Gen. Rufus Saxton, the

Military Governor of that State.

He is a lawyer of some prominence in New York City, and not alone is he considered an authority on questions pertaining to law, but he is invariably among the leading spirits of any business in which he may be interested. He has held many offices of honor and responsibility; Collector of Internal Revenue, 1869-71; Gen'l Appraiser of the Port, 1874, which position he held until the administration of Cleveland; Chief United States Appraiser, 1883, and a Lieutenant of the United States Volunteers in the early part of the war. Left the Army in 1867 when Brevet-Colonel and Acting Asst. Adjutant-General on the staff of Major General O. O. Howard. He has also been an active member of the Grand Army of the Republic since its organization; he is a member of the Bar Association of the Republican Club of New York, the Numismatic and Archaeological Society of New York and was chairman of the Harlem Branch of the Young Men's Christian Association for a number of years.

The owner of the sloop **SAONA** and the cat-boat **ELAINE**. A member of six yacht clubs: the ATLANTIC, LARCHMONT, NEW ROCHELLE, RIVERSIDE, NEW YORK and RHODE ISLAND. He has been a most enthusiastic yachtsman—as he puts it—"since I was born, so far as I know."

ELAINE.

Centerboard cat **ELAINE**, belonging to Alexander P. Ketchum, was formerly **LENA B.** She was built at Osterville, Cape Cod, and launched in 1884. Has been the property of Mr. Ketchum since 1887. **ELAINE** hails from Barrington, R. I.; she has a cabin and has never been altered.

DIMENSIONS.			
Length over all,	21 feet.	Length load waterline,	21 feet.
Draft,	2 feet 9 inches.	Beam,	9 feet.

SAONA.

Keel sloop designed by Henry J. Gielow and built by H. C. Wingham, South Brooklyn, N. Y. Launched in April 1891, for A. P. Ketchum, who is still her owner. She hails from New York, has a cabin and sails with the RHODE ISLAND, ATLANTIC, LARCHMONT, NEW ROCHELLE and RIVERSIDE YACHT CLUBS. See plate LVI.

Official number, 116,408.

DIMENSIONS.			
Length over all,	45 feet 6 inches.	Length load waterline,	31 feet.
Depth,	7 feet 1 inch.	Draft,	6 feet 9 inches.
Beam,	12 feet.		

COMET.

COMET is a centerboard schooner; she was designed by Philip Ellsworth and built by A. E. Smith, Islip, Long Island, N. Y., in 1874. Was launched in April. Is now owned by W. H. Langley of New York. She hails from New York and sails with the fleet of the Ar-

ATLANTIC YACHT CLUB. She was re-built and altered in 1892 by C. & R. Poillon. See plate LVIII.

Official number, 125,362.

DIMENSIONS.			
Length over all,	80 feet 6 inches.	Length load waterline,	71 feet 11 inches.
Depth,	5 feet 4 inches.	Draft,	6 feet 10 inches.
Beam,	22 feet.		



NEWBURY D. LAWTON.

NEWBURY D. LAWTON, a lawyer of New York City, was born in 1852. He is the owner of the yacht TABITHA and has owned many others, among them RIPPLE, INTREPID, HOYDEN, ARAB, CHISPA, etc. He has been interested in yachting for twenty-five years. He was Commodore of the ATLANTIC YACHT CLUB in 1890-91 and also Vice-Commodore of the LARCHMONT YACHT CLUB. He has also held several other prominent positions, such as Flag Officer, etc. He has designed several yachts, and built INTREPID, ARAB, GLEAM and CHISPA. He is a member of the ATLANTIC, NEW YORK, RIVERSIDE and NEW ROCHELLE YACHT CLUBS.

CHISPA.

A keel sloop, which was the property of ex-Commodore N. B. Lawton until quite recently. She was designed by Burgess, built by Mumm, and was launched in 1889. She was built for Mr. Lawton. CHISPA has never been altered, has a cabin and hails from New York City. Now owned by F. L. St. John. See Fig. 376.

CODE SIGNAL LETTERS, K. J. D. W.

Official number, 126,709.

DIMENSIONS.			
Length over all,	56 feet.	Length load waterline,	50 feet 9 inches.
Depth,	8 feet 6 inches.	Draft,	9 feet.
Beam,	13 feet 4 inches.		

THOMAS LEEMING, importer, living in the city of Brooklyn, N. Y., was born in Burnley, England. A member of the ATLANTIC YACHT CLUB and the owner of the yacht COQUETTE.

COQUETTE.

The keel cutter COQUETTE was built and designed by Thos. Bond and was launched in 1881. She was built in Birkenhead, England, and has for six years been the property of Thos. Leeming and Harvey T. Lewis. She hails from Brooklyn, N. Y., and sails with the fleet of the ATLANTIC YACHT CLUB.

DIMENSIONS.			
Length over all,	23 feet 9 inches.	Length load waterline,	19 feet 6 inches.
Depth,	6 feet.	Draft,	4 feet.
Beam,	6 feet.		

JAMES S. MANNING, machinery merchant, New York City. He was born in Boston, the son of Alfred and Elizabeth Manning. He is the owner of the yacht ROVER and has owned a number of smaller boats. He has taken more or less of an interest in yachting for several years, and belongs to the NEW YORK, ATLANTIC and JAMAICA BAY YACHT CLUBS. Mr. Manning was instrumental in the organization of the JAMAICA BAY YACHT CLUB.

ROVER.

The centerboard sloop ROVER is the property of James S. Manning, New York City. She was designed by A. Cary Smith and built by H. Piepgras, Greenpoint, N. Y., being launched in 1880. She has been in the possession of Mr. Manning for two years but was formerly owned by C. O. Iselin and Frank C. Stern. Her stern was lengthened in 1881 by Bayles. She has a cabin, hails from New

York and sails with the JAMAICA BAY, ATLANTIC and NEW YORK YACHT CLUBS. See Fig. 377.

CODE SIGNAL LETTERS, K. J. P. P.

Official number, 110,899.

DIMENSIONS.			
Length over all,	49 feet 8 inches.	Length load waterline,	44 feet 8 inches.
Depth,	6 feet 3 inches.	Draft,	6 feet 3 inches.
Beam,	15 feet 8 inches.		

Spars: Mast, 50 feet; Top, 30 feet; Boom, 49 feet; Gaff, 27 feet.

EMERALD.

EMERALD is a steel centerboard schooner owned by J. Rogers Maxwell of New York City. She was built by S. L. Moore & Sons Co., Elizabeth, N. J., having been designed by H. C. Wintringham. Was launched in May 1893, hails from New York City and sails with the ATLANTIC, CORINTHIAN (of New York), LARCHMONT and NEW ROCHELLE YACHT CLUBS. See Fig. 378.

DIMENSIONS.

Length over all,	112 feet.	Length load waterline,	82 feet.
Draft,	10 feet.	Beam,	21 feet 10 inches.

MOYA.

Cutter, formerly belonging to W. E. Bond and Geo. E. Church, now owned by W. L. & F. M. Moffat, designed by Edward Burgess and built by Geo. Lawley & Son, in 1881, for Edward Burgess. MOYA has a cabin below-deck (no deck-house), has never been altered and hails from New York. Sails with the fleets of the RIVERSIDE and ATLANTIC YACHT CLUBS. See Fig. 379.

DIMENSIONS.

Length over all,	33 feet.	Length load waterline,	27 feet 10 inches.
Depth,	5 feet 4 inches.	Draft,	5 feet 4 inches.
Beam,	9 feet 7 inches.		

REV. WILLIAM L. MOORE, born in New York and a resident of that city, is the owner of two screw schooners, KANAPHA and LAGONDA. Has been interested in yachting for three years. Was elected Vice-Commodore of the ATLANTIC YACHT CLUB in 1891.

KANAPHA.

An iron screw schooner formerly CORSAIR; belonging to Rev. William L. Moore, the Vice-Commodore of the ATLANTIC YACHT CLUB. KANAPHA was designed and built by W. Cramp & Son of Philadelphia and was launched in 1880. Bought by her present owner in 1891. Formerly owned by J. Pierpont Morgan. She hails from New York. See Fig. 380.

CODE SIGNAL LETTERS, K. C. M. H.

Official number, 125,834.

DIMENSIONS.			
Length over all,	180 feet.	Length load waterline,	165 feet.
Depth,	11 feet 6 inches.	Draft,	10 feet 6 inches.
Beam,	21 feet 8 inches.		

Engines: Compound inverted, two cylinders, 24 in. and 44 x 24 inch. Boilers: Two Scotch steel, 1891.

LAGONDA.

A screw schooner designed by R. Steuler and built by J. F. Mumm, Brooklyn, N. Y., for J. C. Hoagland. She was launched in 1884, was sold to S. H. Austin, Jr., and in 1890 became the property of Rev. William L. Moore, a member of the ATLANTIC YACHT CLUB. She hails from New York. Was altered in '88, having her stern lengthened by Mumm. She is now chartered to Richard Stevens.

CODE SIGNAL LETTERS, K. C. M. H.

Official number, 140,700.

DIMENSIONS.			
Length over all,	139 feet.	Length load waterline,	118 feet.
Depth,	10 feet.	Draft,	7 feet 6 inches.
Beam,	19 feet 6 inches.		

Engine : Compound inverted, 16 in. and 28 x 16 inch.

Boiler : One Scotch steel, 9 ft. x 9 ft. 6 in. Her record is 14.7 knots an hour. **LAGONDA** won one race in 1886, making 11.3 knots.

C. W. MORGAN, grocers' specialties, the son of James Franklin Morgan, is a native New Yorker, and is still a resident of New York City. He is a member of the ATLANTIC YACHT CLUB, and is the owner of the yacht **SMUGGLER**, launched in 1891.

SMUGGLER.

SMUGGLER (cutter), was designed by William Gardner and built by Thos. R. Webber, New Rochelle, N. Y., in 1891 for Louis Bourry. She is now the property of Chas. W. Morgan, New York City. She has never been altered, has a cabin and hails from New York. See Fig. 380.

DIMENSIONS.

Length over all,	31 feet.	Length load waterline,	24 feet.
Draft,	5 feet 4 inches.	Beam,	7 feet.

RACING RECORD FOR 1891.

SMUGGLER beat **NAMELESS** a number of times; in a Special Race (ATLANTIC YACHT CLUB), on June 23d; in the Spring Regatta of the LARCHMONT YACHT CLUB and also in the Annual Regatta of the same club, July 4th; and in one of the races of the SEAWANAHKA YACHT CLUB, June 20th. **NAMELESS** won the other race on July 2d.

In the Third Annual Regatta of the MARINE and FIELD YACHT CLUB, **SMUGGLER** defeated **FORSYTHE**. She also beat **NEEDLE** and **BETH** this season.

ELAINE.

The cabin cat **ELAINE** was the property of F. M. Freeman, Greenwich, Conn., and is now owned by C. W. Morgan. She was designed and built by Thos. D. Stoddard, Newport, R. I., and was launched in 1888. She was built for Mr. Freeman and has never been altered. **ELAINE** formerly hailed from Belle Haven.

DIMENSIONS.

Length over all,	21 feet 10 inches.	Length load waterline,	20 feet 6 inches.
Depth,	3 feet 4 inches.	Draft,	3 feet.
Beam,	10 feet 2 inches.		

Spars : Mast, 30 feet; Boom, 27 feet and Gaff, 14 feet.

VIDETTE.

VIDETTE is a centerboard schooner owned by Herbert F. Munn of New York City. She was designed and built by Thos. Clapham, Roslyn, N. Y., being launched in 1885. In 1887 she was altered by J. F. Mumm. Her owner is a member of the ATLANTIC YACHT CLUB and with this club the yacht sails. She hails from New York City. See Fig. 382.

DIMENSIONS.

Length over all,	50 feet 6 inches.	Length load waterline,	54 feet.
Depth,	4 feet 6 inches.	Draft,	5 feet.
Beam,	14 feet.		



WILLIAM PEET.

WILLIAM PEET, lawyer, Brooklyn, N. Y., was born in New York City. His parents were Frederick T. and Elizabeth Peet, both of Bridgeport, Conn., and he is a descendant of John Peet who settled in Connecticut in 1604, coming from Seven Oaks, England. Mr. Peet graduated from Yale College in 1847.

Has been a yachtsman since 1860 and has owned many yachts, among them **ROANOKE**, **HECTOR**, **NIMBUS**, **WIND** and the schooner **SUNSHINE**. Mr. Peet now belongs to the ATLANTIC YACHT CLUB, and in this club he

has held every office except that of Treasurer. He has also been

a member of the MANHATTAN, BROOKLYN and LARCHMONT YACHT CLUBS, and was one of the charter members of the ATLANTIC YACHT CLUB.

CONCORD.

A centerboard sloop owned by H. C. Roome of New York City. She was designed by Davidson and built by Crocker & Davidson, New London, Conn., being launched in 1880. She was slightly altered in 1884. She hails from New York, and sails with the ATLANTIC YACHT CLUB. See Fig. 383.

CODE SIGNAL LETTERS, K. C. M. S.

Official number, 126,222.

DIMENSIONS.

Length over all,	56 feet 3 inches.	Length load waterline,	49 feet 2 inches.
Depth,	5 feet.	Draft,	5 feet 6 inches.
Beam,	17 feet 3 inches.		

SIMPOY.

A keel sloop designed by J. B. Smith and built by J. Hathaway, New Bedford, Mass. Launched in 1886. Was the property H. H. Salmon of New York City for two years, now owned by John H. Lidgerwood. She hails from New York and sails with the ATLANTIC and INDIAN HARBOR YACHT CLUBS. See Fig. 384.

Official number, 130,302.

DIMENSIONS.

Length over all,	39 feet.	Length load waterline,	31 feet.
Depth,	5 feet.	Draft,	6 feet.
Beam,	13 feet 8 inches.		



JAMES WEIR, JR.

JAMES WEIR, JR., of Brooklyn, N. Y., was born in 1843, in England of Scotch-English ancestry. The son of James and Ann Weir. He is a member of the Board of Education, and has been more or less actively connected with yachting for the past ten years. He has been the owner of three yachts, **HYPATIA**, 30 feet; **HYPATIA**, 35 feet and **TIGRESS**, which is his present boat. Com. Weir has frequently given cups to be competed for, as he wishes to encourage the sport of yachting. He

belongs to the ATLANTIC and AMERICAN YACHT CLUBS, and in the latter named club held the office of Rear-Commodore for two years.

TIGRESS.

A centerboard cutter, the property of James Weir, Jr., Brooklyn, N. Y. Designed by Philip Ellsworth and built by Geo. Lawley & Son, Boston, Mass. Launched in 1890, for Owen Ferguson. Has never been altered, hails from New York and sails with the AMERICAN YACHT CLUB. See Fig. 385.

DIMENSIONS.

Length over all,	46 feet 6 inches.	Length load waterline,	31 feet 9 inches.
Draft,	5 feet 2 inches.	Beam,	13 feet 6 inches.

Racing Record:—

1891—ATLANTIC YACHT CLUB—Won in the Twenty-sixth Annual Regatta, June 16th; and also in a Special Race held on June 23d. MARINE AND FIELD YACHT CLUB—Winner in the Third Annual Regatta held June 17th. By winning in these races **TIGRESS** took prizes from **SAONA**, **KATHLEEN**, **EURYBIA** and **AGLAVA**, as well as others not mentioned.

1892—LARCHMONT YACHT CLUB—Won from **SAONA** in the Spring Regatta, sailed June 4th.

MARINE AND FIELD YACHT CLUB—Won from **SAONA** June 11th.

SHEETER ISLAND YACHT CLUB—Won from **SYBYL** in the SIXTH Open Regatta, August 13th.

ATLANTIC YACHT CLUB—Won from **SAONA** and **DAFFODIL** in the Twenty-seventh Annual Regatta, sailed June 14th.



COMMODORE J. C. MILLER.
MIRAMICHI YACHT CLUB.

History of the Miramichi Yacht Club.

THE Miramichi River, known to fame as having had upon its banks one of the notable forest and village conflagrations of the world, is a capital water for yachtsmen. Ten or fifteen miles below the principal towns, Chatham and Newcastle, which are reached by ships drawing 22 feet, the river widens to five miles, and to ten and fifteen miles near the mouth. This broad basin is protected by a number of low islands of sand formation, through which, besides the ship channel, there are channels navigable by small yachts. The entire bay, opening into the Gulf of St. Lawrence

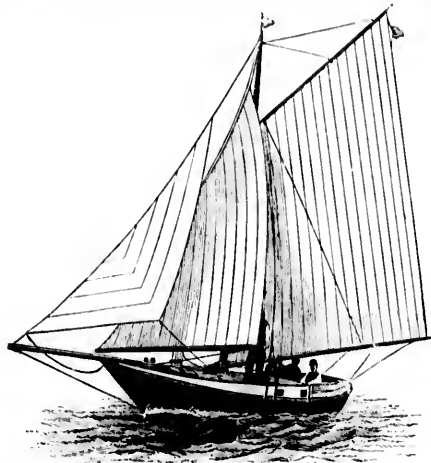

MAUDE.—FIGURE 389.

and the land locked inner bay could not be surpassed for small yacht sailing.

In 1886 Mr. J. C. Miller of Millerton, Mr. J. L. Stewart of Chatham and a few others agreed to form a yacht club, and a meeting was held at New Castle on Monday afternoon, April 5th, and adjourned to the 12th, when the MIRAMICHI YACHT CLUB was organized with a membership of thirty, the following officers being elected unanimously: J. C. Miller, Commodore; J. L. Stewart, Vice-Commodore; F. Kennedy, Secretary and Treasurer; T. Crimmen, Measurer. A constitution and by-laws were adopted, and a committee appointed on flags, uniforms, club book, etc.

The opening event was fixed for the Queen's birthday, May 24th. A picnic at Sheldrake Island, eight miles below Chatham, (where still stand the ruins of the first leper hospital ever built in North America) was arranged for. The day opened bright and clear, and the yachts, gayly dressed in bunting, the sailing yachts in tow of the steamers, formed a procession at Newcastle and went down to the Island, affording a beautiful spectacle to the people on the banks of the river. A passenger steamer, provided for the purpose by Col. Call, a member of the club, took the ladies and friends of the clubmen. The picnic was a great success. The yachts stood on and off between

the Island and Point Aux Car, taking the ladies out for sails, everybody enjoying the day. A fresh following wind sent the yachts racing homeward towards night. A small yacht, with too much sail for her ballast, capsized during the afternoon but no one was injured.

The only accident that has endangered life since that incident was the sinking of Vice-Commodore Stewart's Flotony off Chatham in 1890. She was knocked over by a squall, filled and sank in twenty feet of water. Her crew of five clung to the topmast until picked up by the judges' steamer.

No Club House has been erected. The yachtsmen live all up and down the river, from Black Brook to Millerton, and no location would suit a majority.

Picnics, cruises to points down river, races, etc., have been held every season, and the club is vigorous and destined to long life.

The officers of the MIRAMICHI YACHT CLUB for 1892 were as follows: Commodore, J. C. Miller; Vice-Commodore, J. L. Stewart; Rear-Commodore, John McKane; Secretary and Treasurer, J. R.

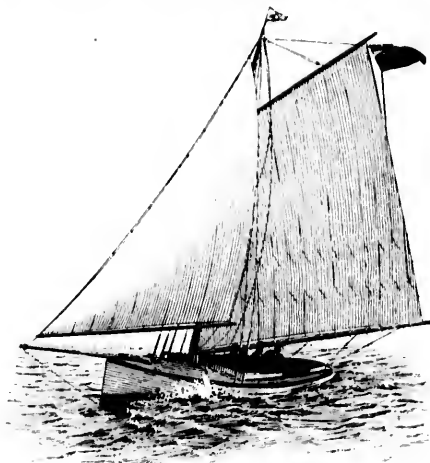

KILBRIDE.—FIGURE 390.

Lawler; Measurer, Thomas Crimmen. The Commodore, Vice-Commodore and Measurer have been unanimously re-elected every year.

The yachting season opens May 24th, and closes about October 15th. The competitors were at first divided into two classes, but the smaller class has not shown up in races of late, all the interest being centered in the larger one. The officers for 1893 are:

Commodore, J. C. Miller. Vice-Commodore, J. L. Stewart.
Rear-Commodore, John McKane. Secretary and Treasurer, George Watt.
Measurer, Thomas Crimmen.

The club is not large, either in men or yachts, but it is comprised of true yachtsmen, who sail, win or lose, for the fun of it, and never wrangle over details.

YACHTS ENROLLED IN THE MIRAMICHI YACHT CLUB.

SAILING YACHTS.

NAME.	OWNER.	KEEL OR C. B.	RIG.	LENGTH OVER ALL.	LENGTH ON W. L.	BEAM.	DRAFT
Honoy	C. J. Hatcher	c b	Sloop	22	18.	7.	1.3
Kilbride	J. C. Miller	c b	"	25	22.6	7.	1.6
Annie	J. L. Stewart	k	"	16	15.7	4.9	1.4
Arrow	G. Watt	c b	"	22	21.	5.7	1.4
Kiltloch	Jas. Miller	k	Cutter	28	22.6	6.8	4.6
Yum-Yum	H. A. Mulheud	c b	Sloop	21	19.1	6.1	1.6
Ila	M. Moss	k	"	14	13.6	3.9	1.0
Squirrel	T. Crimmen	c b	"	17	15.	5.	1.3
Fedora	J. L. Stewart	k	Cutter	27	23.8	8.	4.0
Poo-Bah	H. A. Mulheud	c b	"	17	16.2	5.	1.3
Mackerel	Geo. Watt	k	"	17	16.	5.	1.6
Fisherman	Robt. Loggie	c b	"	27	25.	9.6	2.0
Welcome Home	F. Loggie	c b	"	25	23.	8.	2.0
Calypso	W. H. Gould	k	"	28	23.8	9.6	4.0
Maud	J. C. Miller	k	"	35	24.	7.6	4.2
Orlana	J. L. Stewart	c b	"	32	24.	7.2	2.6

STEAM YACHTS.

NAME.	OWNER.	SIDE WHEEL OR SCREW.	LENGTH ON W. L.	LENGTH OVER ALL.	BEAM W. L.	BEAM OVER ALL.	DRAFT.
Laura	J. C. Miller	Screw	51	57	8.9	10.0	4.10
Bessie	T. W. Crocker	"	35	38	6.6	7.6	3.0
Mindoo	E. Hutchison	"	39	45	8.6	9.6	4.9
Derby	T. C. Miller	Side Wheel	50	53	7.0	7.6	2.0
Carric	Dr. Cates	Screw	27½	31	4.9	5.8	2.3
Gracie	Jas. Robinson	"	27½	31	4.9	6.0	2.3
Lily	J. W. Miller	"	27½	31	4.9	6.0	2.3
Thistle	Jas. Yeoman	"	20	20½	4.6	4.6	2.0
Marion	J. W. Miller	"	42	48	8.0	3.6
Saretha	E. Hutchison	"	50	55	10.0	4.0

RECORD OF RACES.

The next event to take place after the picnic to Sheldrake Island on the 24th of May 1886, was a Squadron Run held on Dominion Day, July 1st, of the same year. The squadron sailed to Smith's landing where a picnic party had gathered, and spent the day between there and Sheldrake Island.

July 29th the squadron had a grand run to Sheldrake Island, FEDORA carrying Vice-Commodore Stewart's flag, leading all the way. They anchored for lunch, and had a hard beat homeward, in which KILBRIDE showed her superiority in windward work.

The First Race was held August 12th. Course, Chatham to Newcastle and return, 10 miles. The wind was light and varying. KITTOCH and KITROCK had a tight tussle for first place, the former winning by four seconds only. The following is a summary:

class, and a silver cup given by Col. Call and Mr. P. A. Noonan to yachts of the second class. The course was from Newcastle to Chatham and return. It was a breezy day, with frequent squalls, and kites were carried at considerable risk to spars and rigging. The first half of the race was a run, the other half a beat. KITROCK carried away her jib, replacing it with a smaller one; FEDORA'S main-sheet traveler gave way and ANNIE was knocked out of a good chance of winning by fouling her topsail in an attempt to lower it. The yachts of the second class, which started fifteen minutes before those of the first, reached the mark boat off Chatham just as they were overtaken by the big ones, and the crowd on the banks evidently enjoyed the scene hugely, the fourteen boats all turning the mark together. The result was as follows:

	Elap. Time.	Cor. Time.
	U. S. S.	U. S. S.
First Class.		
Kilbride	1 43 56	1 28 27
Fedora	1 46 40	1 32 40
Yum-Yum	1 47 49	1 27 30
Blondy	1 48 33	1 28 47
Kittoch	1 48 52	1 33 09
Arrow	1 58 38	1 39 43
Dauntless		not timed
Second Class.		
Pooh-bah	2 02 24	1 35 47
Ida	2 04 54	1 33 00
Annie	2 09 10	1 42 40

YUM-YUM and IDA, the two smallest boats in each class, won the cups.

The Spring event of 1887 was on the 24th of May, when the squadron ran down to Sheldrake Island and beat back, spending the day on the river.

The First Race of the year was on June 2d. The entries were as follows:

First Class.	Second Class.
Kilbride	Pooh-bah
Kittoch	Albion
Fedora	Ida

The forenoon was dull, and there was a dead calm with rain, but while the yachts were getting into position a breeze sprang up, and with topsails and spinnakers set, off went the line of boats. FEDORA had an accident in the setting of her spinnaker which prevented her from doing anything of notice during the race. The real race was between KILBRIDE and KITTOCK. The latter got a slight lead on the way up, but the Commodore managed to make a better turn at the mark boat, and thus gained on his rival. Again, KITROCK forged ahead, carrying her club topsail, until, when about half way down, KILBRIDE got a favorable slant of wind and reached well forward, continuing to gain and finishing first by a good lead.

POOH-BAH took the lead in her class, and went up the course fully as fast as the larger boats. She continued to increase her lead, and finished a long distance ahead of the other two.

The next race was on August 18th, the course being the usual one from Newcastle to Chatham and return. The second class started in a dead calm, but ten minutes later when the first class started, a light breeze blew up and all the racers, nine in number, were soon in a bunch. The little boats ran about as well as the larger ones in the race that followed. TERRON took the lead of the smaller yachts though ANNIE passed them all and rounded the mark third, with only KILBRIDE and KITTOCK before her. On the return, BEAR made a great spurt and passed ANNIE, but in the last mile both ANNIE and TERRON gained on BEAR, and as a final result ANNIE won. In the first class yachts, the real race was as usual, between KILBRIDE and KITTOCK, though ARROW and BLOODY sailed quite an exciting contest on their own account. KILBRIDE won. The following is the summary.

DRAFT
1.3
1.4
1.4
4.8
1.8
1.0
1.3
4.0
1.3
1.6
2.0
2.0
4.0
4.2
2.6



KITTOCK.—FIGURE 391.

DRAFT
4.10
3.0
4.9
2.0
2.3
2.3
2.3
2.0
3.6
4.0

	Elap. Time.	Cor. Time.
	U. S. S.	U. S. S.
First Class.		
Kilbride	2 50 11	2 30 34
Kittoch	2 50 47	2 30 38
Yum-Yum	2 57 37	2 31 24
Fisherman	3 00 09	2 41 46
Arrow	3 14 25	2 49 43
Fedora	3 12 27	2 51 15
Blondy		not timed
Second Class:		
Annie	3 43 22	3 06 21
Twilight	3 58 45	
Spy		not timed

KILBRIDE and ANNIE were the winners.

The Second Regatta was sailed on September 15th. The prizes were a silver cup given by Commodore Miller to yachts of the first

	Corrected Time.	
	U. S. S.	
First Class.		
Kilbride	2	36 31
Kittoch	2	38 56
Arrow	2	52 00
Blondy	2	55 51
Second Class.		
Annie	3	23 40
Bear	3	23 50
Terror	3	28 40
Twilight	3	54 25
Daisy	3	43 20

The last race of the season was September 13th over the usual course. There was a light westerly wind, which just before the start freshened into a brisk nor'wester, with the frequent squalls which characterize such wind on this river. At the start DAISSY and POO-BAH both made a mistake in the course, and they were called back; ANNIE also went back, thinking she too had been summoned, thereby losing her splendid lead. ANNIE'S rudder unshipped soon after her second crossing of the line and she went ashore. BEAR and DAISSY came into collision, forcing the former to repair to the wharf to have her bowsprit mended, after which she resumed the race. The ultimate result of the race, after many mishaps and amid some wild excitement, is given below:



MARION.—FIGURE 392.

	Elapsed Time.		Corrected Time.	
	U. S. S.	U. S. S.	U. S. S.	U. S. S.
First Class.				
Kilbride	1	59 00	1	43 31
Kittoch	2	04 05	1	48 16
Fisherman	2	04 50	1	52 50
Fedora	2	19 40	2	05 45
Arrow	2	30 20	2	11 20
Second Class.				
Bear	2	49 45	2	22 03
Poo-bah	2	41 55	2	14 13
Annie			lost rudder	
Terror			swamped	
Daisy			did not finish	

The season of 1888 was started in the usual way—a day up and down the river, with a picnic at Sheldrake Island. However, the affair was held on Beantbear's Island. There was just wind enough for easy sailing, and the day was thoroughly enjoyed by all.

The First Race of 1888 was sailed June 8th. The day promised very badly, but later the sun came out and it turned out to be an ideal day. There were five starters, all of the larger class. The summary was as follows:

Kilbride	1	52 35	1	52 35
Kittoch	1	58 24	1	58 04
Fedora	2	06 45	2	03 14
Blondy	2	18 47	2	14 30
Coventry	2	42 55	2	35 14

KILBRIDE won.

July 1st was a gala day. The yachts went up and down the river with parties of ladies on board, and officers from the military camp, which was this year held in Chatham.

The next race was sailed July 9th. The first half of the race was to windward. The contestants were KILBRIDE, KITTOCH, FISHERMAN and BLONDY in the first class, and ANNIE and MACKEREL in the second class. KILBRIDE and MACKEREL were the winners in their respective classes. The actual time of the former was 1 hr., 49 min.

The next race was held August 20th. The day was clear and cool with a very strong nor'wester blowing. There were five starters in the first class, and only two in the second. There were one or two accidents, but no one was hurt, and the final results were as follows:

	Elap. Time.		Cor. Time.	
	U. S. S.	U. S. S.	U. S. S.	U. S. S.
First Class.				
Kilbride	1	41 57	1	41 57
Kittoch	1	45 10	1	44 50
Fedora	1	48 35	1	45 04
Blondy	1	49 55	1	45 38
Arrow	2	16 03	2	12 20
Second Class.				
Poo-bah	2	05 09	2	05 09
Mackerel	2	30 06	2	30 06

The winners were KILBRIDE and POO-BAH. KILBRIDE'S time was the fastest ever made over the course.

The season closed October 18th with a race for first class yachts from Black Brook to Oak Point and back, ten miles. The prize was a Championship Pennant given by Vice-Commodore Stewart. The day was fine with a brisk westerly wind. The following is a summary:

Welcome Home	1	53 31	1	50 28
Kilbride	1	53 42	1	50 52
Kittoch	1	55 02	1	51 07
Fisherman	1	53 18	1	53 18

WELCOME HOME won the bunting.

The 1889 season was opened by a general meet of the Squadron on May 24th. The wind was light and it was all the yachts could do to stem the tide.

The First Race was sailed June 13th. The wind was so fresh that at a bend in the river mainbooms had to be jibed and spinnakers shifted. FISHERMAN was ahead at the rounding mark, but had bad luck in rounding it, and the other boats caught up with her. The following table shows the final results:

Kittoch	1	55 09	1	51 14
Fisherman	1	59 40	1	59 40
Kilbride	2	05 50	2	02 47
Fedora	2	10 52	2	01 16
Blondy			not timed	

KITTOCH won.

The next race day was August 23d, when the same yachts, with the exception of FISHERMAN, competed again. KILBRIDE was an easy winner in the time of 2 hrs., 11 min., 20 sec.

The race of September 12th was made notable by the sinking of one of the yachts. They left Newcastle with a light breeze, which soon increased to a pretty stiff one. When off Chatham, FEDORA was knocked over by an unexpected squall, the wind having been perfectly steady till then. She refused to answer her helm and before sheets could be eased she sank, only her maintopmast showing above water. Vice-Commodore Stewart went down with her while engaged in casting off the mainsheet, but the crew went up the rigging. The skipper rose and had a hard fight for safety, but finally reached the topmast, where the crew were clinging, and the judges' steamer soon picked them up. The summary of the race was as follows:

Kilbride	1	59 33	1	59 33
Blondy	2	08 22	2	01 33
Kittoch	2	04 42	2	03 50
Fedora			capsized and sank	

KILBRIDE was the winner.

and down the river
the military camp.

f of the race was
TITTOCH, FISHER
and MACKEREL in
re the winners in
former was 1 hr.,

was clear and cool
ere five starters in
e were one or two
s were as follows:

Cor. Time.
H.M.S.

1 41 57
1 44 50
1 45 04
1 45 38
2 12 29

2 05 09
2 36 06

KILBRIDE'S time was

r first class yachts
niles. The prize
 Commodore Stewart.
The following is a

1 50 28
1 50 53
1 51 07
1 53 18

of the Squadron on
yachts could do to

d was so fresh that
bed and spinnakers
mark, but had had
up with her. The

1 51 14
1 59 40
2 02 47
2 04 16
not timed

o same yachts, with
KILBRIDE was an

e by the sinking of
light breeze, which
atham, FEDORA was
d having been per-
er helm and before
mast showing above
h her while engaged
nt up the rigging.
, but finally reached
the judges' steamer
was as follows:

3 1 59 33
2 2 03 33
2 2 03 50
zed and sank

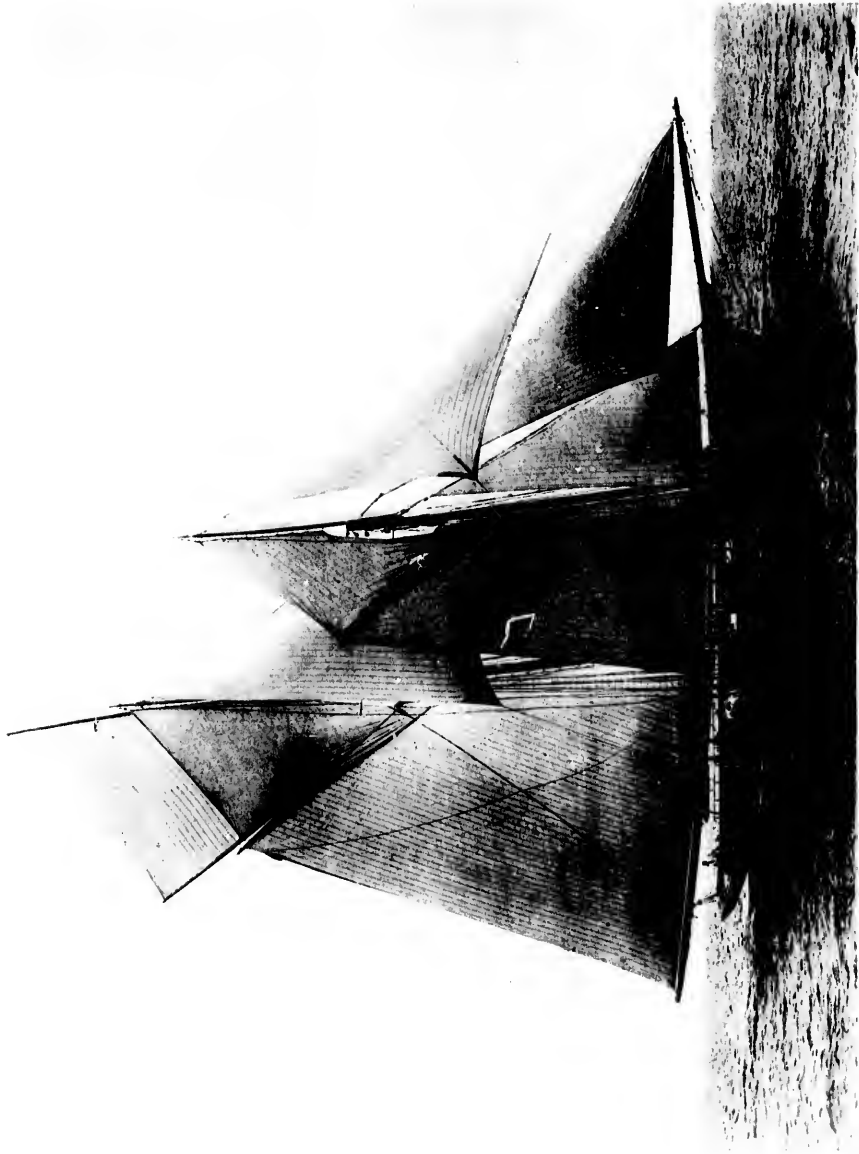

FROM A PHOTO BY PEABODY

PLATE XLIX

FORTUNA.

FORTUNA.

THE UNIVERSITY OF CHICAGO

1911

THE UNIVERSITY OF CHICAGO
LIBRARY

1911

1911

1911

1911

1911

1911

1911

1911

1911

1911

1911

1911

1911

1911

1911

1911

1911

1911

1911

1911

1911

1911

1911

1911

1911

1911

1911

1911

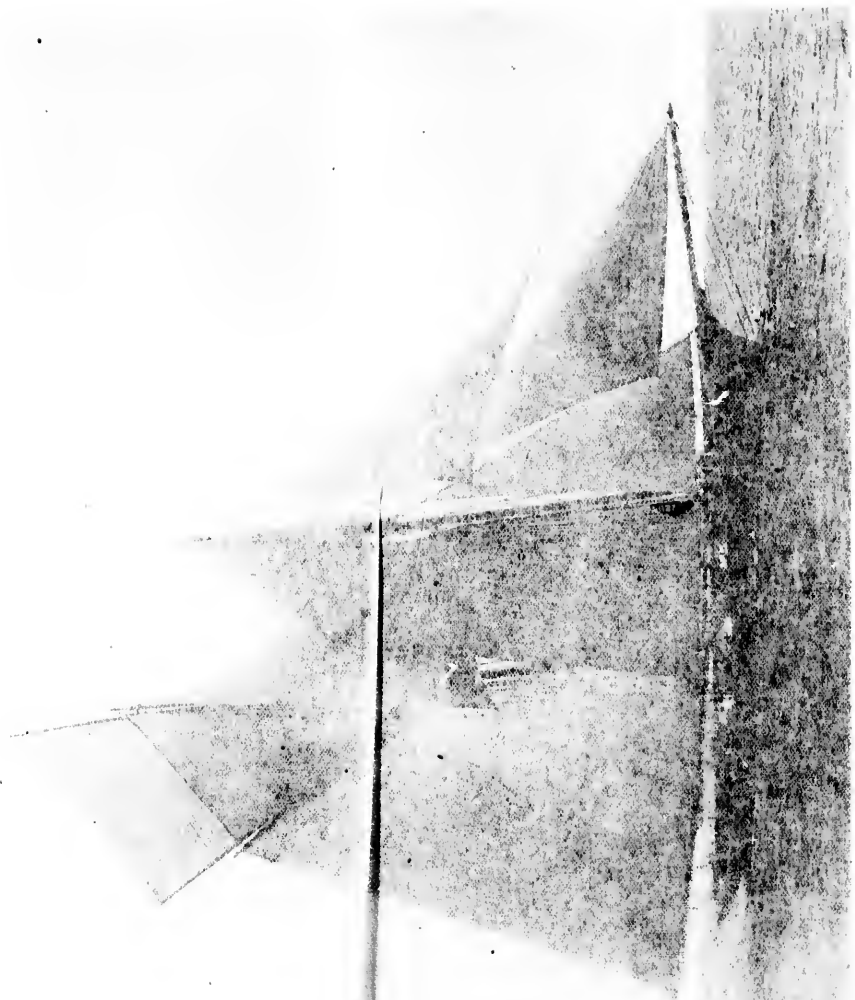

The season of 1890 was opened by a race on the 19th of June. It was sailed in a light wind and a drizzling rain and FEDORA was faster than she was before, but was still not fast enough for her company. The record of the race is:

	Elap. Time.		Cor. Time.
	H. M. S.	H. M. S.	
Kittoch	2 07 25	2 04 40	
Kilbride	2 06 45	2 05 17	
Fedora	2 27 30	allows	
Blondy	2 21 40	2 14 58	

KITTOCH won flag and a silver cup.

On July 17th there was a race that had been especially got up for a visiting boat, J. BELL, sailed by John Bell, a veteran yachtsman whose luck was even greater than his skill. There was a light following wind, and in the first half of the race the visitor ran right away

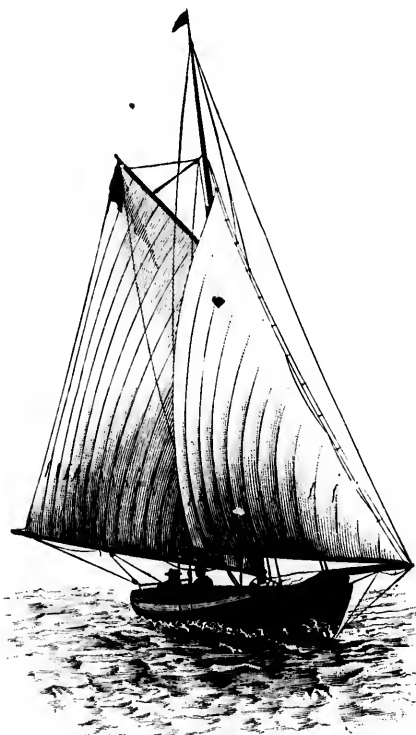

FEDORA.—FIGURE 293.

from the home boats. They, however, were confident of catching her on the beat back, but no sooner had she turned the mark than the wind shifted and with spinnaker re-set, she went gayly home, an easy winner. The record is:

J. Bell	1 45 35	allows
Kittoch	1 59 34	1 56 30
Blondy	2 04 53	1 57 52
Starling	2 04 30	2 00 12
Kilbride	2 03 14	2 02 27
Fedora	2 00 25	2 00 11

August 28th the Second Race for the Stewart Championship Pennant was sailed over the Black Brook, Oak Point Course. There was only

a light wind at the start, and this soon died out, so that the return leg was more of a drift match. There were four yachts which finished as follows:

	Finish.	
	H. M. S.	H. M. S.
Kilbride	2 45 24	
Kittoch	2 51 31	
Fedora	2 56 01	

The new boat NEGRAC, from down river who had a great reputation as a flyer, had to be towed in as she had proved very slow in windward work.

The season closed September 25th with a race for the McLimont flag. There were only three starters, KILBRIDE, KITTOCH and FEDORA. KITTOCH won.

May 24, 1891 found the squadron together, gayly dressed in bunting, the steam yachts with parties of ladies on board. All hands then repaired to Middle Island, where they had dinner, and then spent the rest of the day in cruising up and down river.

July 1st, Dominion Day. A race was sailed over a triangular course off Chatham. A new first class yacht, CALYPSO, had been added to the fleet and great things were expected of her. The prizes were flags and cash offered by the Celebration Committee. The race was uneventful though several fouls were avoided with great difficulty at the first mark boat. The official time is as follows:

	START.	HUTCHINSON'S.	ENGLAND'S.
Kittoch	2 20 30	2 31 30	3 07 50
Kilbride	2 20 48	2 32 30	3 10 10
Calypso	2 21 00	2 32 30	3 10 50
Fedora	2 21 07	2 32 30	3 13 40
Lottie	2 20 05	2 32 30	not timed
Arrow	2 20 20	2 32 25	not timed
CANADA WHARF.			
Kittoch	3 11 45	3 33 22	4 06 10
Kilbride	3 12 25	3 33 20	4 03 50
Calypso	3 03 20	3 34 40	4 07 00
Fedora	3 16 10	3 38 18	4 12 50
		Finish.	Elap. Time.
Kittoch	4 09 10	4 19 40	1 59 10
Kilbride	4 06 30	4 16 20	1 55 32
Calypso	4 10 00	4 19 15	1 58 45
Fedora	4 17 05	4 26 50	2 05 43

KILBRIDE was the winner with CALYPSO second.

August 20th a race was sailed from Chatham to Newcastle and back. The following is the result:

Kittoch	2 42 11
Kilbride	2 42 33
Calypso	2 45 52
Blondy	3 01 11

KITTOCH was the winner.

The last race of the season was sailed in a light wind September 17th, for the Stewart Pennant. The summary of the race is as follows:

Kilbride	3 27 51
Calypso	3 30 10
Kittoch	3 32 55
Fedora	3 35 00
Negrac	did not finish
Blondy	did not finish

The club had a breezy day for the opening event of 1892, May 24th. The day was spent as the other opening days, cruising up and down the river, with ladies on board the steam yachts.

On July 1st the squadron met at Newcastle to celebrate Dominion Day. A new yacht, MAUD, owned by Commodore Miller made her appearance. The afternoon was spent sailing between the town and Bearbear's Island.

On September 1st a regatta of the club took place. The official times taken by the judges—Dr. Pedolin and Mr. A. A. Davidson, were as follows:

	Sailing Length. Feet.	Start		Finish.	
		U. M. S.	H. M. S.	U. M. S.	H. M. S.
Calypso	25.2	12 00	40	2 10	00
Maude	23.0	12 01	22	2 13	33
Kittoch	21.0	12 03	00	2 10	33
Kilbride	22.9	12 01	00	2 24	43
	Actual Time.	Corrected Time.			
	U. M. S.	H. M. S.		H. M. S.	
Calypso	2 00 20	2 00 20		2 00 20	
Maude	2 12 11	2 00 41		2 00 41	
Kittoch	2 14 33	2 10 27		2 10 27	
Kilbride	2 20 03	2 16 40		2 16 40	

It will be seen by the above tables that the race was a very close one, for though CALYPSO sailed the race 2 min., 51 sec., faster than the lead keel cutter, she had only 21 seconds to spare on corrected time. She was sailed by Mr. J. L. Stewart, KILBRIDE by Mr. James Carter, MAUDE by Commodore Miller, no professionals having a hand in it.

The last race of the season took place October 6th. The morning was wet and cold, the wind was northwest, with the tide running up. The summary was as follows:

	Start.	Finish.	Elap. Time.
	U. M. S.	U. M. S.	H. M. S.
Maude	1 56 15	3 12 05	1 16 05
Kittoch	1 56 15	3 13 57	1 17 42
Calypso	1 56 15	3 11 05	1 15 40

The time was fast and the race a close and pretty one. There was not enough sea on to make it wet on board, and nobody felt cold after the starting signal had sounded. KITTOCH went down river after the race for a cruise.

The club has had two or three cruises to Bay du Vin Island, Neguac, and other points in the inner and outer bay each year, being absent two or three days on each cruise.

Two new yachts were added to the club's fleet in 1893; one of them is owned by Vice-Commodore Stewart.

RACING RECORD FOR 1893.

A Regatta was sailed June 15th. The course was off Chatham 5 miles in length, twice around. Half windward work. The wind was from the east and squally, sea heavy, and weather thick and cold. The following yachts took part:

	Sailing Length.	Elap. Time.	Corrected Time.	
			H. M. S.	H. M. S.
	FT.			
Maude	cutter	23.9	2 10 10	2 14 20
Kittoch	cutter	21.9	2 10 35	2 15 24
Calypso	sloop	25.3	2 25 45	2 25 45
Oriana	sloop	23.0	2 43 40	2 41 50
Kilbride	sloop	22.0	2 40 30	2 40 30
Blondy	sloop	19.3	3 12 45	3 05 00
Starling	sloop	25.3	did not finish	

MAUDE won, KITTOCH was second. ORIANA a new yacht, had too much sail for the wind, and lay down and wallowed.

The next regatta took place on July 13th over a ten mile course.

The wind was from the east and moderate weather was fine.

The following yachts took part:

Wym	cutter	24.9	1 56 24	1 54 03
Learing	sloop	27.0	2 11 38	2 11 38
Maude			2 18 30	2 15 01
Oriana			2 19 15	2 15 46
Kittoch			2 23 24	2 17 25
Kilbride			2 28 02	2 23 20
Starling			2 30 00	2 28 10
Calypso			did not finish	

WYM won; she belongs to the Nova Scotia Yacht Squadron; Five design.

The next race took place on August 24th over a ten mile course from Black Rock to Oak Point and back. The wind was from the southwest and light. The weather was fine.

The following yachts participated:

	Corrected Time.	Elapsed Time.
	H. M. S.	H. M. S.
Learing	2 04 57	2 04 57
Calypso	2 19 06	2 17 18
Maude	2 19 50	2 16 27
Kittoch	2 22 41	2 16 43
Arlana	2 31 59	2 28 30

LEARING won; MAUDE second.

A Regatta was held September 16th over a 6 mile course. The wind was from the southwest and was strong and squally. Rain fell during the race.

The following yachts competed:

Learing	56 40	56 40
Oriana	1 00 00	57 55
Maude	1 01 25	59 20
Kittoch	1 07 05	1 03 30
Kilbride	1 07 15	1 04 20

ORIANA claimed the race and asked for re-measurement, LEARNING

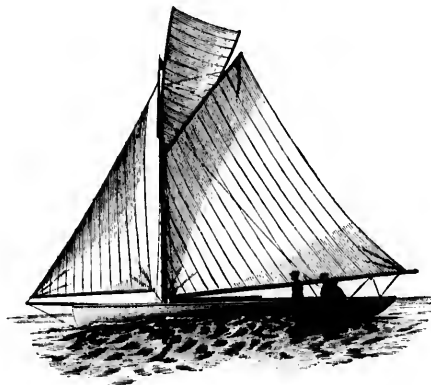

ORIANA.—FIGURE 304.

having shipped a lot of extra ballast. LEARNING left after discharging the extra ballast, without measuring. ORIANA's claim to the race not yet decided.

ORIANA's sail plan had been reduced, improving her sailing, and her trim and balance of sail had been improved.

A Regatta was held October 9th over a 13 mile course. The wind was southwest, fresh to moderate with squalls. The weather was fine at start, but rain fell near finish.

The following yachts entered:

Oriana	2 21 45	2 17 38
Learing	2 20 30	2 20 30
Maude	2 32 20	2 27 48

ORIANA closed the season with a decided victory, having been timed up until her speed was developed.

No race was sailed with the reefs in, and spinnakers were barred all the season.

BIOGRAPHICAL SKETCHES AND DESCRIPTION OF YACHTS ENROLLED IN THE CLUB.

J. C. MILLER, manufacturer, Commodore of the MIRAMICHI YACHT CLUB, Millerton, Miramichi, New Brunswick, Canada. Was born in Picton, Ontario, in 1839; of Scotch descent, the son of James and Eliza Miller. He is the owner of the yacht MAUDE, having owned JAMES and KILBRIDE and has been a yachtsman since boyhood. Has designed five sailing and six steam yachts. He is a charter member of the MIRAMICHI YACHT CLUB.

MAUDE.

A cutter, owned by J. C. Miller of Millerton, Miramichi, New Brunswick, and Commodore of the MIRAMICHI YACHT CLUB. She was designed by James and J. C. Miller and was built by James Henderson, being launched in 1892. She hails from Millerton, and sails with the MIRAMICHI YACHT CLUB. See Fig. 386.

DIMENSIONS.			
Length over all,	35 feet,	Length load waterline,	23 feet.
Depth,	4 feet 8 inches,	Draft,	4 feet.
Beam,	7 feet 8 inches,		

Spars: Mast, 26 feet; Boom, 25 feet; Gaff, 15 feet, 6 inches.



JAMES MILLER.

JAMES MILLER, manufacturer, Weldford, New Brunswick, Canada. He was born in Picton, Ontario, in 1846, and is the son of James and Eliza Miller. Has been a yachtsman for thirty years, and has owned three yachts, JOHN C., BLONDY and his present boat KITTOCH. He was the designer of the last named yacht, and has also designed a number of sailing canoes. Is a charter member of the MIRAMICHI YACHT CLUB.

KITTOCH.

A cutter, designed by J. C. and James Miller and built by James Henderson for her present owner, James Miller of Weldford, New Brunswick, Can. Was launched in 1886 and hails from Newcastle, Miramichi, N. B. KITTOCH sails with the MIRAMICHI YACHT CLUB. See Fig. 388.

DIMENSIONS.			
Length over all,	27 feet 6 inches,	Length load waterline,	23 feet.
Depth,	5 feet,	Draft,	5 feet.
Beam,	6 feet 9 inches,		

Spars: Mast, 20 feet; Boom, 23 feet 6 inches; Gaff, 16 feet, Top-mast, 13 feet.



JOHN W. MILLER.

JOHN W. MILLER, manufacturer, Millerton, New Brunswick, Canada. Was born in Upton, Quebec, the son of John C. and Eliza Miller. He is at present the owner of the steamer MVRION, and has owned the yachts MELBOURNE and LILY. Has been interested in yachting for twelve years and is a member of the MIRAMICHI YACHT CLUB.

MARION.

A steam yacht, owned by John W. Miller of Millerton, New Brunswick, Canada. She was designed by J. C. Miller and built by James Henderson in 1890 for her present owner. She has a clipper bow with a long overhanging stern, and has ample accommodations. She sails with the MIRAMICHI YACHT CLUB. See Fig. 389.

DIMENSIONS.			
Length over all,	48 feet,	Length load waterline,	40 feet 6 inches.
Depth,	4 feet 6 inches,	Draft,	4 feet.
Beam,	7 feet 9 inches,		

Engine: Compound, two cylinders, 51 and 11 by 6 inches. Miramichi foundry. Thornycroft propeller, 36 inches in diameter, 3 blades.

Boiler: Roberts water tube, Doty of Toronto. Horse power, 10 normal, 30 actual. A speed of 12 miles per hour.



J. L. STEWART.

J. L. STEWART, Vice-Commodore of the MIRAMICHI YACHT CLUB, Chatham, N. B., was born in Advocate, Nova Scotia, April 5, 1843; of Scotch descent, the son of Charles E. and Caroline M. Stewart. Commodore Stewart is best known in the literary line as editor, publisher and lecturer. Is at present the owner of the yachts FEDORA and ORIANA, though ANNE and BLONDY have also belonged to him. Has been interested in yachting since boyhood and actively interested since the year 1886 when he became Vice-Commodore of the MIRAMICHI YACHT CLUB, a position which he has held ever since.

Commodore Stewart was an organizer of the MIRAMICHI YACHT CLUB and is a most enthusiastic and hearty yachtsman. He is also Grand Master of I. O. O. F. of the Maritime Provinces of Canada.

FEDORA.

FEDORA is a cutter, owned by J. L. Stewart of the MIRAMICHI YACHT CLUB. Formerly the property of P. A. Noonan, a member of the same club. She hails from Chatham, N. B. See Fig. 390.

DIMENSIONS.

Length over all,	27 feet,	Length load waterline,	1 feet 8 inches.
Beam,	8 feet,	Draft,	4 feet.

ORIANA.

ORIANA is owned by J. L. Stewart. She is a centerboard craft, sailing with the MIRAMICHI YACHT CLUB. See Fig. 391.

DIMENSIONS.

Length over all,	32 feet.
Length load waterline,	24 feet.
Beam,	7 feet 2 inches.
Draft,	2 feet 6 inches.



E. D. STREET.

E. D. STREET, member of the MIRAMICHI YACHT CLUB. Mr. Street has always taken a live interest in the advancement of yachting at Chatham, and looks forward to seeing the club of which he is a member, become conspicuous as a yachting organization.



W. R. GOULD.

W. R. GOULD, jeweller, Chatham, N. B., was born in Shediac, N. B., December 25, 1858; formerly part owner of the sloop BLONDY, and now half owner with D. W. Ward, of the yacht CALYPSO. A yachtsman for six years and a member of the MIRAMICHI YACHT CLUB.

D. W. WARD, merchant, Chatham, N. B., was born in March 1850; of English descent. Interested in yachting for five years, and half owner of the yacht



D. W. WARD.

CALYPSO. He was lately part owner of the sloop **BLONDY**. A member of the **MIRAMICHI YACHT CLUB**.

CALYPSO.

CALYPSO is a cabin keel sloop, owned by D. W. Ward and W. R. Gould of Chatham, N. B. She was built by Thos. Currie in the Spring of 1890 for sale. She hails from Chatham, N. B., and sails with the fleet of the **MIRAMICHI YACHT CLUB**.

DIMENSIONS.

Length over all, 27 feet 6 inches.
Depth, 5 feet.
Beam, 9 feet 6 inches.

Length load water line, 23 feet.
Draft, 4 feet.

Spars : Mast, 35 feet ; Boom, 28 feet ; Bowsprit, 18 feet.



GEORGE WATT.

GEORGE WATT, ship chandler, Chatham, N. B., was born at Newcastle, N. B., in 1852. He is the son of Patrick and Barbara Watt and is of Scotch descent. Is at present the owner of the yacht **SPARROW**, and is a member of the **MIRAMICHI YACHT CLUB**. Has been a yachtsman for ten years and has held the offices of Secretary and Treasurer of the **MIRAMICHI YACHT CLUB** for five years.

et.

ddler, Chat-
nt News-
the son of
and is of
the owner
a member
LEN. Has
rs and has
and Treas-
e LEN for



COMMODORE B. F. SUTTON.

BROOKLYN YACHT CLUB.



BROOKLYN YACHT CLUB HOUSE.

History of the Brooklyn Yacht Club.

THIS well known yacht club grew out of what was first known as the UNION BOAT CLUB, a sailing club organized May 3, 1852. Its officers were William T. Lee, President; D. S. Bourdett, Secretary; Rutger Clarkson, Treasurer; John M. Sawyer, Measurer, the other members were Zebulon Powell and William M. Baxter. The fleet was not very extensive, consisting of but three boats, SARA, ESTER and UNION. The club book, issued in 1852, was entirely in manuscript form, and the following extracts from the regulations may prove interesting, setting forth as they do, the primitive style of by-laws adopted in the early stages of this club:

“Every member on subscribing to the Constitution shall pay an initiation fee of \$18.50 monthly, thereafter.

“The coxswain shall have entire control and management of the boat when on board, and all his orders shall be promptly obeyed; the members shall be subject to the commands of the President while on shore, or in his absence to that of the coxswain. Any member refusing to obey orders shall be fined 25 cents for each offense.

“Each member shall serve alternately as coxswain one week, in the order in which his name stands on the Secretary's book.

“The boats shall not be taken out by any member between the hours of 10 A.M. and 5 P.M. on club days, except by leaving notice of this intention on the bulletin of the club at their room, but can do so without such notice at half past seven A.M. and half past six P.M. on club days, provided another person accompanies him.

“The crew shall be responsible for any loss or injury done to the boat or fixtures while out, and shall pay by monthly instalments of \$3 until the whole is paid for.

“The boat shall not be loaned, let, or run in any race without the consent of all members.”

So much for the UNION BOAT CLUB. In September 1857, however, steps were taken towards the organization of a yacht club. This preparatory meeting took place in Sol Smalley's house, at the foot of Smith street.

At a meeting held April 19, 1858, things seem to have assumed a more definite shape, and Messrs. Cooper, Haight and Sawyer were appointed to draw up a set of by-laws. On the 23d of the same month, this committee reported to the club, and the by-laws were adopted.

At this meeting the first officers were elected as follows:

Commodore, Elias Pitcher; Vice-Commodore, G. L. Haight; Secretary, G. A. Cooper; Treasurer, Henry S. Wood; Measurer, J. M. Sawyer.

On June 11, 1858, Messrs. Dimon and Cooper were appointed a committee on securing a Club House, with full power to act.

The original headquarters and anchorage of the club was in the basin at Hamilton Avenue and Gowanus Canal, where the Brooklyn Sawmill Company now is. This Club House was retained until the erection of the Locust Grove Club House in 1871.

The Commodores, from 1859, have been as follows:—1859, G. L. Haight; 1860, G. L. Haight; 1861, G. L. Haight; 1862, John Jones; 1863, John Jones; 1864, G. L. Haight; 1865, '66, '67, George Kidd; 1872, Jacob Voorhis; 1876, John S. Dickerson; 1877, John S. Dickerson; 1881, Sam'l L. Blood (Pres.); 1882, Henry W. Turner; 1883, John H. Dimon; 1884, John H. Dimon; 1884, R. C. Hopkins (D. res'g'd); 1885, Franklin Beams (Com.); 1886, Jas. White; 1887, John T. Barnard; 1888, John T. Barnard; 1889, R. C. Hopkins; 1890, B. F. Sutton; 1891, '92, '93, B. F. Sutton.

In 1861 the name BROOKLYN YACHT CLUB was adopted, and the

first club book issued. The fleet then consisted of 17 yachts, and the membership numbered 104, of whom only nineteen are now living, as follows:—Alexander Balmanno, Benj. F. Collin, Edwin Courtlandt, John H. Dimon, Jas. D. Fowler, Thomas C. Fowler, Gilbert L. Haight, Edwin Hillyer, Chas. H. Jewett, William T. Lee, William M. Mead, Peter W. Ostrander, Dan'l B. Phillips, John M. Sawyer, Henry Smedley, Edward Storer, Edwin Underhill.

The list of flag officers for this year, 1861, was as follows:



FAY.—FIGURE 395.

Commodore, George L. Haight; Vice-Commodore, E. Courtlandt; Secretary, William T. Lee; Assistant Secretary, William M. Ringwood; Treasurer, John Ellerby; Measurer, J. M. Sawyer.

In addition to the Club House on Gowanus Bay, the club had also a room at Court street, Brooklyn.

Among the rules and regulations of this club book of 1861 are to be noted the following:

“No yacht less than 16 feet in length shall be admitted into this club.

“Yachts entering any regatta to be sailed by length are required to be measured twelve hours before starting. All yachts to be measured from the longest part of the stem to the longest part of the stern.

“Yachts entering any regatta where measurement of sails is decided on, are required to have their sails measured twelve hours before starting, and no change shall be made in the dimensions of sails between the time of measurement and the end of the regatta, except by reefing; and no sail shall be set during a race, except such as shall be duly measured.

“The allowance of time for boats when measured by length, shall be two minutes per foot.

“The allowance of time for boats, when measured by canvas, shall be one and a quarter seconds per square foot of canvas.

“A prize shall be awarded to any yacht, except the distance shall have been performed in six hours by the winning boat of any class. In case the distance shall not have been performed in six hours by the winning boat of any class, the regatta is to be repeated on the first day agreed upon.”

Following is a list of the yachts which were enrolled in the club in 1863.

Name.	Owner.	Tons.	Feet.
Bonita	John Morse	40	
Argo	J. H. Dimon	20	
Restless	John Jones	20	
Midnight	J. R. Waller	20	
Zigzag	G. L. Haight	17	
Early Bird	G. A. Cooper	16	
Win. Minor	William Roberts	30	
Rainbow	E. Pitcher	30	
Orient	G. D. Fowler	30	
Wild Wave	W. W. Mead	20	
Whistler	T. C. Fowler	20	
Limet	J. L. DeNayelles	20	
Surprise	C. T. Lippitt	20	
Favorita	J. McClenahan	28	
Sophia	John Morse	28	
Canted	J. J. Jova	28	
Commodore	E. Courtlandt	28	
Isabel	J. Ellerby	28	
Nonpareil	L. Faneher	28	
A. Carrington	J. B. Leggett	28	
H. Smedley	J. H. Dimon	27	
Montauk	Collin and Wood	27	
Laura	K. M. Whiting	27	
Nancy	S. Longman	27	
Niagara	J. W. Ritch	26	
A. Partridge	William Petrie	26	
Sinda	J. J. Jova	26	
	S. Smedley	26	
	H. Smedley	26	
Arcthusa	J. M. Dagual	25	
Sadie	George Atkins	24	
Echo	M. M. VanDyke		
Augusta	J. M. Taylor	33	
Chasseur	J. R. Waller	27	
Hector	William Post	26	
Refugee	M. M. VanDyke		

While the BROOKLYN YACHT CLUB was among the first organizations of the kind in the country, still it did not assume a prominent position until the year 1864, it being incorporated that year. It was Jacob Voorhis, Jr., owner of the yacht MADELEINE who did most toward the building up of this club, he bringing many of the NEW YORK YACHT CLUB men into the club with him, and in many ways rendering valuable assistance to the younger organization. The regatta held the 27th of June 1871, was its first event of any importance, though frequent regattas had taken place previously. In this race MADELEINE received the prize, though Mr. Osgood, the owner of COLUMBIA, claimed the race for his yacht.

During the summer of 1865 some members became more or less dissatisfied with the management of the club, and decided to organize a new club. This was accomplished the next November, still, the affairs of the BROOKLYN YACHT CLUB went on as usual.

The LOCKST GROVE CLUB HOUSE was built in 1871, and for this purpose bonds were issued. About 1884 this house was abandoned, and the club moved to quarters at Bensonhurst Pier, Bath Beach. For two years they remained here, but moved again in 1886, this time to their present quarters, secured from Captain Stillwell. The principal reason for this last move was that there was no harbor to speak of at the Pier.

Between 1875 and 1885 very little interest in yachting matters was manifested by the members of the BROOKLYN YACHT CLUB, but at the beginning of 1885, the club began to look up again as a yachting organization. The new life and active interest which became apparent at this time, may, with all justice, be largely attributed to the efforts and example of Commodore Franklin Beams. There had been no racing for several years, and so far from being a yacht club, the BROOKLYN YACHT CLUB had come to be such in name only, the entire interests of the organization being given to social affairs.

As stated, in 1885 things changed, and from that time the BROOKLYN YACHT CLUB has steadily increased its fleet and membership, and is once more becoming the prominent yachting organization that it should be, both by reason of its seniority and by reason of its erstwhile activity.

THE SEASON OF 1885.

The Annual Regatta was sailed June 27th. The start was made at 12 o'clock noon. There was a light southeast breeze. The yachts were divided into seven classes, the summary being as follows:

	Elap. Time.	Cor. Time.
	H.M.S.	H.M.S.
Class B.		
Ripple	2 44 35	2 44 35
Class C.		
Gracie	2 11 51	2 11 54
Surprise	2 20 46	2 19 14
Fern	2 21 37	2 12 53
Class 1.		
Sea Robin	2 56 30	2 56 30
Mamie	3 24 16	3 24 15
Vida		did not finish
Class 2.		
Mignon	2 46 15	2 46 15
Zeta	3 22 11	3 20 27
Class 3.		
Wacondah	2 51 07	2 51 07
Carrie May	2 20 32	2 26 20
Widgeon	2 31 27	2 28 00
Class 4.		
Genevieve		

The winners in their respective classes were: RIPPLE, GRACIE, SEA ROBIN, MIGNON, CARRIE MAY and GENEVIEVE.

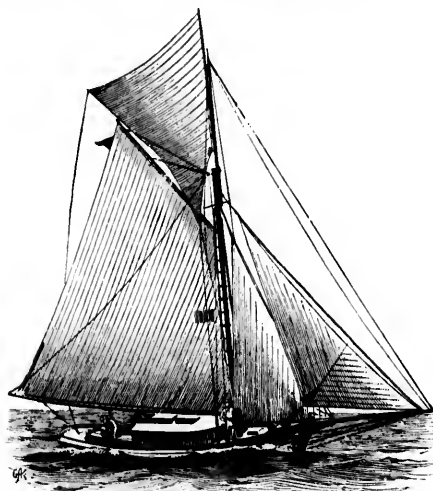

ILEIKA.—FIGURE 396.

THE SEASON OF 1886.

A meeting was held June 9th and an initiation fee of \$10 was decided on. This fee has since remained, and is still the same amount.

The Annual Regatta was held on July 14th. Summary:

	Elap. Time.	Cor. Time.
	H.M.S.	H.M.S.
Class A.		
Elfin	2 28 31	2 28 31
Psyche	2 51 12	2 48 11
Class B.		
Ripple	3 12 16	3 12 16
Class C.		
Faustina	2 13 16	2 13 16
Surprise	2 20 17	2 27 54
Class 1.		
Mascot	3 26 11	3 24 12
Vida	3 25 16	3 25 01
Class 3.		
Carrie May	2 44 35	2 43 30
Wacondah	2 49 51	2 48 20
Elephant	2 58 36	2 58 30
Class 4.		
Ottie	3 35 53	3 35 53
Hattie S.		did not go over the course

The winners were:

Class A. ELFIN won club prize, and also Sawyer prize for cut-bouts under 20 feet.

Class B. No prize awarded, RIPPLE having no competitor.

Class C. FAUSTINA.

Class 1. MASCOT.

Class 3. The boats crossed the finish line as named, but as both CARRIE MAY and WACONDAN were sailed by professional sailors and not by owners or members of the club, the prize was given to ELEPHANT.

Class 4. OTTIE wins.

The club tried to have Gravesend Bay dredged late in this year but their efforts were unavailing and nothing ever came of the undertaking.

THE SEASON OF 1887.

The season opened on May 30th with a parade of the fleet, and later a luncheon and hop at the Club House. No records can be found of the regatta this year.

THE SEASON OF 1888.

The Annual Regatta took place in the lower bay, September 3d. A flying start was made about 12 o'clock. The sea was lumpy and the wind strong and fresh from the southeast. The following is a summary:

Class A.		
Carrie	1 26 10	1 26 10
Elfin	1 33 05	1 33 42
Sunbeam	1 41 30	1 40 42
Class B.		
Ninon	2 29 59	2 29 59
Josephine	1 53 12	1 55 18
Homing	2 01 13	1 56 40
Class C.		
Faustina	1 46 36	1 43 36
Elfe	2 07 24	2 06 08
Class 1.		
Seminole	2 27 48	2 27 01
Vida	2 11 32	2 13 21
Priscilla G.	2 49 57	2 46 57
Class 2.		
Kangaroo	2 09 22	2 09 22
Class 3.		
Carrie May	2 03 38	2 03 38
Class 4.		
Elsie	3 06 08	2 56 49
Roamer	2 25 31	2 25 31

The prize winners were: CARRIE, JOSEPHINE, FAUSTINA, VIDA.

and ROAMER. No prizes were awarded in the second and third classes.

The season was closed with a clambake October 21st.

SEASON OF 1889

This year the club secured a parlor floor on Lawrence street, Brooklyn, which was termed the "city headquarters." This floor was kept until 1891.

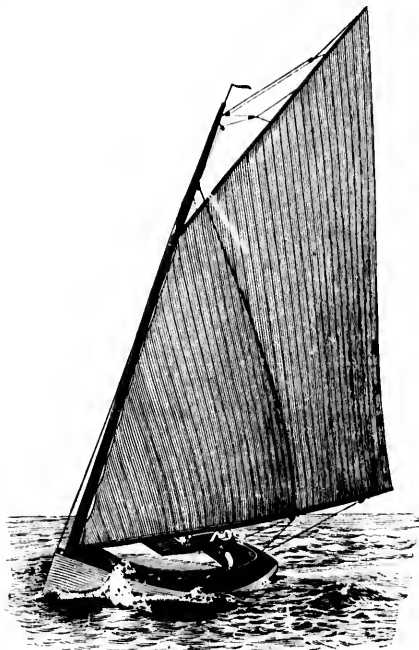

ACORN.—FIGURE 307.

They also united with the NEW YORK YACHT RACING ASSOCIATION this year, with Commodore R. C. Hopkins, Daniel O. Reilly and William Cagger as delegates, but the club resigned from this Association in April, only, however, to enter it again in 1890.

The season was opened on Memorial Day with the usual lunch and hop at the Club House.

The Annual Regatta was sailed June 15th as follows:

Class A.			
Carrie	2 04 59	2 04 48	
Alma	2 06 33	2 06 33	
Class B.			
Siren	not timed.		
Homing	" "		
Manhattan	4 14 03	4 13 08	
Josephine	4 43 14	4 43 14	
Panchito	4 40 47	4 40 25	
Class I.			
Ninon	not timed.		
Rhoda	" "		
Vida	4 56 43	4 53 57	
Irene	not timed.		

The winners were CARRIE, JOSEPHINE and VIDA, in their respective classes.

A Fall Regatta took place September 2nd of which there is no record.

The season was closed on October 20th by a dinner at Stillwell's.

SEASON OF 1890.

The Annual Spring Regatta was sailed June 14th. The starting signal was given at 12:35 P. M. Summary as follows:

	Corrected Time.
	U. S. S.
Class B.	
Carrie	2 00 53
Mabel	2 35 20
Grace	2 37 47
Gertrude	2 15 50
Grimalkin	2 14 20
Alma	2 20 12
Class C.	
Homing	2 19 10
Manhattan	2 14 45
Siren	did not finish.
Panchito	3 33 20
Class D.	
Bijou	3 03 05
Class E.	
Ermine	2 36 53
Isolde	did not finish.
Class F.	
Faustina	2 10 24
Alice	2 32 15
Class L.	
Irene	did not finish.
Troquois	2 37 36
Seminole	did not finish.
Vida	2 46 21
Ninon	did not finish.
Class 3.	
Mull	4 23 10
Killdee	4 10 25

The winners were: CARRIE, MANHATTAN, BIJOU, ERMINE, FAUSTINA, TROQUOIS and KILLDEE. The Regatta Committee consisted of Messrs. Willis Holly, W. A. Taylor and A. S. Richshoffer.

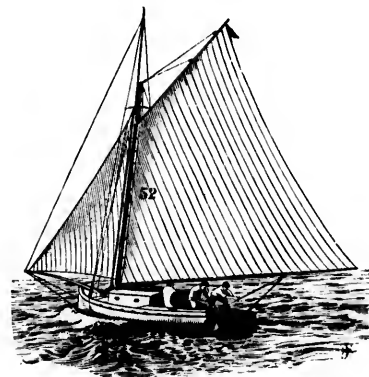

IOLA.—FIGURE 308.

Three silver cups were presented to the club this season by Mr. J. H. Sawyer, one for cabin sloops 30 feet and over, one for cabin sloops under 30 feet and the third for mainsail boats.

A Fall Regatta took place on Labor Day, but only classes B. and C. finished within time limit. The winners in these classes were:

which there is no

er at Stillwell's.

1. Tho starting

rs:

ected Time.

H. M. S.

2 09 53

2 35 20

2 37 47

2 15 50

2 14 20

2 20 12

2 19 10

2 14 45

id not finish.

3 33 20

3 03 05

2 36 53

id not finish.

2 19 24

2 32 15

id not finish.

2 37 36

id not finish.

2 46 21

id not finish.

4 23 10

4 10 25

ERMINE, FAUS-
ttee consisted of
offer.

season by Mr. J.
for cabin sloops

y classes B. and
lasses were:



FROM A NEGATIVE BY CHILD.

PLATE L.

HARPOON.
(Formerly Beatrix).



PLATE 401

Class B: ALMA won club prize of \$15.
 Class C. MANHATTAN won club prize of \$15 and special prize of \$25.

SEASON OF 1891.

The Annual Regatta was sailed June 20, 1891. A start was made at 12:05 P. M. There was a fair breeze. Summary:

Class	Yacht	Elapsed Time.
Class 1.		11. M. S.
	Iroquois	3 05 20
	Ida	2 45 37
	Seminole	3 28 00
Class 3.	Mull	4 05 24
	Bess	3 43 30
	Rosie	
	Mary A.	
Class C.	Rona	2 53 00
	Pancheto	
	Neoming	2 53 00
Class E.	Dr. Glenna	3 24 03
	Emmie	3 31 30
Class G.	Eloise	not timed
	Alice	3 52 50
Mainsail Boats.	Edda D.	2 48 20
	Grace	3 00 01
	Alma	2 44 00
	B. Q.	2 41 40

WINNERS:—Class 1, IDA.
 Class 3, BESS.
 Class E, DR. GLENNA.
 Class G, ALICE.



ALEUS.—FIGURE 399.

July 11th, race for a silver cup offered by Rear-Commodore Lyons

This race resulted as follows:

First, B. Q., J. E. Egerts.
 Second, ALMA. J. S. Hale.
 Third, EDDA D., J. C. Rummill.
 There were two other entries.

August 1st, Special Race for mainsail boats (classes A and B) wa-

sailed for the Champion-hip Pennant offered by Willard Graham. CARRIE won; EDDA D. second, B. Q. third

THE SEASON OF 1892.

The season started with a big dinner at the Montauk Club. There were over 200 guests present, among them being many prominent and well known yachtsmen.

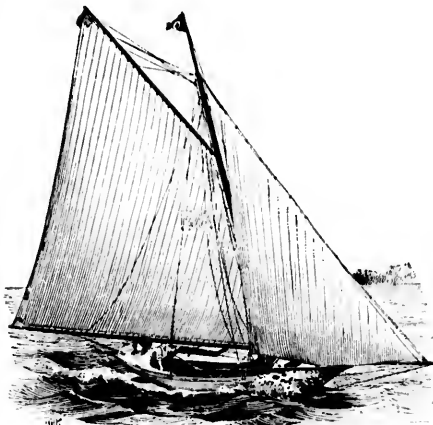

WAHNETA.—FIGURE 400.

The Annual Regatta was sailed June 25th, over the usual club courses. It was a clear day with light wind and smooth sea. Summary as follows:

SLOOPs.

Class	Course	Yacht	Time 1	Time 2	Time 3
Class 3.	18 m'ts.	Mull	40.00	3 43 09	3 43 09
		Mary A.	35.07	3 53 18	3 48 18
		Fair Wind	35.01	3 52 26	3 47 07
		Bess	31.08	3 45 43	3 39 54
		Heika		3 43 05	disqualified

SLOOPs AND YAWLS.

Class	Course	Yacht	Time 1	Time 2	Time 3
Class 2.	14 1/2 miles.	Water Lily	29.03	3 48 52	3 48 52
		Seneca	26.01	3 52 07	3 47 43
Class 1.	12 miles	Mary	27.04	3 12 00	3 12 00
		Seminole	24.03	3 21 05	2 20 29
		Tropic	21.06	3 27 18	3 19 37

MAINSAILs.

Class	Course	Yacht	Time 1	Time 2	Time 3
Class D.	14 1/2 miles.	Truant	28.01	3 15 55	3 15 55
		Dolphin	28.00	3 03 42	3 02 47
		Spray	26.09	3 09 32	3 08 51
Class C.	12 miles.	Pancheto	22.07	3 29 10	3 29 10
		Mabel	22.08	3 04 27	3 04 19
		Homing	21.10	3 04 20	3 03 19
Class B.	10 miles.	B. Q.	20.07	2 56 33	2 56 33
		Sappho	19.03	3 10 14	3 08 15
		Edda D.	19.01	2 57 18	2 55 04

OPEN SLOOPs.

Class	Course	Yacht	Time 1	Time 2	Time 3
Class E.	10 miles.	Emmie	not measured	3 03 50	3 00 50
		Waif	not measured		

The winners were: BESS, SENECA, MARY, DOLPHIN, HOMING and EDDA D., in their respective classes.

July 30, 1892: A Special Race took place for the Mærao first and second prizes. The yachts sailed over the triangular course in Gravesend Bay. Good day, though wind was light.

	Sailing Length.	Elapsed Time.	Corrected Time.
B. Q.	20.07	1 56 34	1 56 34
Sappho	19.03	2 04 00	2 03 49
Daphne	19.03		
Edla D.	19.01	1 55 48	1 54 28
Eddies	18.02		

EDDA D. was the winner.

A Special Race for the pennants offered by the Vice-Commodore was held September 18th. Good weather and smooth sea.

Class	Sailing Length.	Elapsed Time.	Corrected Time.
Class 3.			
Mull	40.00	2 15 41	2 15 41
Mary A.	35.03	2 21 01	disqualified
Bess	34.08	2 09 10	2 03 20
Class 1.			
Water Lily	29.03	did not go over course	
Ida	23 11	2 51 51	disqualified
Golden Hope	not measured	2 27 18	disqualified
Pastime	not measured	did not go over course	
Class C.			
Homing	21.10	2 38 03	2 37 33
Juanita	22.02	2 42 28	2 42 28
Truant	28.01	2 20 12	2 20 12
Class B.			
Sappho	19.03	2 51 01	2 51 01
Daphne	19.03	did not go over course	
Edla D.	19.01	2 39 43	2 38 23

The winners were: BESS, HOMING and EDDA D. In Class C, TRUANT won a special prize.

The Regatta Committee were: Messrs. W. A. Taylor, E. W. Kearney and W. F. Miller.

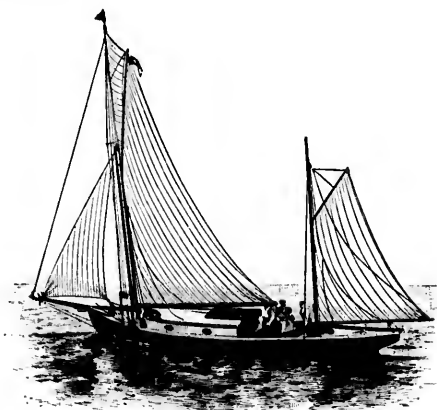

SENECA.—FIGURE 401.

June 12th: An Invitation Regatta was sailed by the BROOKLYN YACHT CLUB in the lower bay. The wind averaged a ten miles an hour, steady northwest. The weather was fine. The prizes were as follows.

Class A, \$15; Class B, \$20; Class C, \$25; Class D, \$30; Class E, \$25; Class 1, \$20; Class 2, \$25.

Sloops, cutters and yawls: 25 foot class, \$20; 30 foot class, \$25; 35 foot class, \$30; 40 foot class, \$35; 50 foot class, \$40.

Schooners: 50 foot class, \$40; 60 foot class, \$50; 70 foot class, \$75.

Class A, mainsails; Course, 9 miles.

	Sailing Length.	Elapsed Time.	Corrected Time.
Norman	19.11	2 08 02	2 07 56
Isabel	not meas.	2 12 58	
Sappho	19.3	2 09 25	2 08 02
Edla D.	10.1	2 06 19	2 04 45
Mist	19.7	2 06 33	2 05 40
Paul & Stella	not meas.	2 20 24	
Ariel	not meas.	2 18 15	

Class B, mainsails; Course, 11 miles.

Rosamond	not meas.	2 33 29	2 33 29
Defiance	21.9		did not finish

Class 1, jib and mainsails; Course, 11 miles.

Alice	23.4	2 33 47	2 33 47
Silvey	not meas.		did not finish

Class D, mainsails; Course, 15 miles.

Juanita	22.2	3 01 48	3 01 19
Water Witch	21.9	3 03 50	3 02 40

Class E, mainsails; Course, 17 miles.

Lakshmi	32.2	3 25 07	3 27 29
Aura	not meas.	3 23 42	
Truant	28.1	0 00 00	
Spray	26.0	3 14 14	3 08 37
Acorn	27.6	3 03 31	2 50 11
Marguerite	25.11	3 02 08	2 55 08

25 foot class, sloops; Course, 15 miles.

Freyja	27.8	2 50 38	3 01 17
Christine	29.0	3 00 04	3 12 34

30 foot class, sloops; Course, 17 miles.

Forsyth	32.11	3 40 28	3 53 51
Kittie (yawl)	28.11	3 22 07	3 20 58
Vixen	29.00	3 43 58	3 43 36
Golden Hope	29.80	3 26 18	3 26 11

35 foot class, sloops; Course, 19 miles.

Heika	39.5	3 27 12	3 31 30
Phantom	36.6	3 29 04	3 29 53
Saona	40.8	3 29 43	3 35 14
Mary A.	35.7	3 37 38	3 37 19
Bess	34.8	3 37 24	3 35 53

40 foot class, sloops; Course, 20 miles.

Choctaw	not meas.	3 35 00	
Mignon	not meas.	3 28 17	

70 foot class, schooners; Course, 32 miles.

Loyal		4 26 25	
-------	--	---------	--

50 foot class, schooners; Course, 23 miles.

Signal		not timed	
--------	--	-----------	--

The winners in their respective classes were EDDA D., ROSAMOND, ALICE, JUANITA, MARGUERITE, FREYJA, KITTIE, PHANTOM, MIGNON and LOYAL.

In this regatta the following yacht clubs were represented: BROOKLYN, AUDUBON, NEW UTRECHT, NEWARK, PAVONIA, NEW ROCHELLE, ATLANTIC, COLUMBIA and NEW JERSEY.

After the election of the enthusiastic yachtsman Commodore B. F. Sutton, in 1890, the club received a fresh impetus, and owing to his skilful management, greater interest was manifested by the members, and the club regattas became more attractive and interesting.

The members have taken such pride in their Commodore that at the last election when he wanted to resign, having been elected President of the NEW YORK YACHT RACING ASSOCIATION, they would not listen to it. So the Commodore still holds office and has added a new and beautiful schooner yacht to the fleet, and intends so long as he remains Commodore to advance the best interests of the club in every possible manner.

The list of flag officers for the year 1893 was as follows:

Commodore, B. Frank Sutton; Vice-Commodore, William T. Murphy; Rear-Commodore, George L. Robinson; Secretary, William Cagger; Treasurer, Willard Graham; Measurer, H. W. Kilbourne.

ed Corrected
e. Time.
s. H. M. s.
02 2 07 36
56
23 2 08 02
10 2 04 45
38 2 05 40
24
15

10 2 33 20
did not finish

17 2 33 47
did not finish

8 3 01 19
9 3 02 40

7 3 27 29

2

4 3 08 37

1 2 50 11

3 2 55 06

3 3 01 17

4 3 12 34

3 53 51

3 20 53

3 43 36

3 26 11

3 31 30

3 20 53

3 35 14

3 37 19

3 35 53

DA D., ROSAMOND,
PHANTOM, MIGNON

vere represented ;
, PAVONIA, NEW

Commodore B. F.
and owing to his
by the members,
interesting.

Commodore that at
ing been elected
SSOCIATION, they
olds office and has
lect, and intends
the best interests

llows :
ore, William T.
ecretary, William
W. Kilbourne.

YACHTS ENROLLED IN THE BROOKLYN YACHT CLUB.

MAINSAIL YACHTS.

Enrolment Number.	NAME.	Centerboard or Keel.	OWNER.	Length over all.	Length Waterline.	Extreme Beam.	Draft.
111	Acorn	e b	W. Martin	28.0	26.11 $\frac{1}{2}$	11.0	2.1
116	Addle	e b	E. S. Anderson	18.0	18.0	8.0	1.5
53	Amaranth	e b	W. F. Everett	17.0	17.0	8.0	1.0
137	Arrow	e b	J. H. Sawyer	22.0	22.0	10.9	...
121	Bohemian	e b	C. J. Earl	18.0	16.0	7.3	2.0
50	B. Q.	e b	J. C. Keerton	20.0 $\frac{1}{2}$	20.4 $\frac{1}{2}$	9.0	1.3
22	Buster	e b	L. J. Bohringer	26.0	21.6	13.0	2.6
4	Carrie	e b	Chas. H. Oliver	10.10 $\frac{1}{2}$	10.16 $\frac{1}{2}$	8.9 $\frac{1}{2}$	1.7
15	Chief	e b	Anthony Barrett	28.0	31.0	16.0	3.0
102	Dolphin	e b	G. L. Robinson	26.0	25.10	11.3	2.6
79	Edda D.	e b	R. W. Hummel	18.33 $\frac{1}{2}$	18.33 $\frac{1}{2}$
90	Eddies	e b	E. C. Fitzgerald, E. Salt	20.0	19.1	8.9	2.0
130	Eloise	e b	C. H. Gruef	22.0	18.6
...	Gertrude	e b	W. J. G. Bourns	23.1	20.4 $\frac{1}{2}$	7.10	...
131	Gracie H.	k	G. W. Brown	23.7	19.0	10.0	3.0
62	Grimalkin	e b	S. W. Ballou	21.11	19.5	8.2	1.6
3	Homing	e b	E. F. Drayton	21.0	21.8	9.3	...
100	Josephine	e b	W. J. G. Bourns	25.0	22.11	10.1	...
46	Juanita	e b	C. F. Larzelere	22.4	22.4 $\frac{1}{2}$	9.6	3.0
78	Lakshmi	e b	H. E. Kane	34.0	29.10	13.6	3.0
128	Lochinvar	e b	J. F. Sablin	18.0	18.0	8.4	1.4
19	Nau	e b	E. G. Davis	27.3	23.6	12.0	3.0
107	Paul and Stella	e b	James Riley	18.0	16.8 $\frac{1}{2}$
120	Rosamond	e b	G. H. Wheeler	25.4	21.9	8.6	...
57	Sappho	e b	Gen. H. Lyons	23.6	19.4 $\frac{1}{2}$	8.0	2.0
44	Sophia	e b	Jacob Endris	23.0	21.3	9.7	...
113	Spray	e b	J. F. Mumm	29.0	25.4
97	Truant	e b	(G. B. Townsend, F. L. Townsend, H. W. Sherry, M. D.)	29.03 $\frac{1}{2}$	26.6
132	Tudine	e b	Clinton H. James	21.10
131	Wanda	e b	J. R. Falco	24.10 $\frac{1}{2}$	21.0	11.0	2.0

LIST OF YACHTS ENROLLED IN THE BROOKLYN YACHT CLUB.

SLOOPS, CUTTERS AND YAWLS.

Enrollment Number	NAME.	Centerboard or Keel.	OWNER.	Length over all.	Length waterline.	Extreme Beam.	Draft.
68	Almee	k	B. G. Austin
120	Allris	e b	J. A. Constant	36.0	31.0	15.0	3.5
110	Alper (Yawl)	k	W. E. Doggett	27.0	21.11	0.6	5.0
95	Angler	e b	P. Mahony	28.6	25.0	10.6	0.6
5	Bess	e b	M. J. Hanly, W. T. Murphy	37.2	32.3	12.4	2.6
55	Callisto	e b	John Cottler	31.7	27.7	13.9	3.3
7	Clree	k	Thos. H. Browne	40.6	37.6	12.6	4.0
30	Chlef	e b	J. T. Barnard	50.10	44.6	13.11	4.10
104	Dorothy	e b	Peter H. Steele	31.0	27.0
108	Drift (Yawl)	e b	A. A. Knox
135	Fair Wind	e b	J. G. Meehan	35.0	30.5
41	Gipsy	k	North McLean	26.6	21.8	8.9	4.8
42	Golden Hope	e b	Franklin Prentiss	37.0	25.0	11.0	3.0
93	Hanna	e b	Martin Green
91	Ida	e b	Frank McCarthy	25.4	23.5	10.0	2.6
125	Ida Belle (Sharpie)	e b	N. T. Houghton, W. T. Miller
100	Ileika	e b	E. H. Converse	42.4	35.10	14.0	3.0
30	Iroquois	e b	E. H. Chandler	27.0	24.25 $\frac{1}{2}$	16.0	2.6
115	Jennie	e b	W. H. Growfago	25.0	21.0	9.6	2.6
20	Kangaroo	e b	H. R. M. Cook	34.6	27.0	12.6	4.0
94	Kestrel	e b	H. E. Pierce	29.6	23.6	2.0
118	Lorna	k	W. E. Spencer, M. D.	33.9	29.0	9.0	4.0
86	Magnel (Yawl)	e b	F. E. Fitch	30.6	28.6	0.6	3.0
99	Mary	e b	A. Tracy	27.2	23.0
80	Mary A.	e b	J. J. Lyons	36.8	31.1	13.3
121	Nalud	e b	W. S. Lewis	20.0	20.0	9.6	2.10
61	Seminole	e b	J. Brown, Jr.	23.6	21.6	0.8	2.6
8	Seneca (Yawl)	e b	J. P. Tribken	38.8	33.3	8.4	2.9
92	Tropic (Yawl)	e b	E. M. Rewey	28.0 $\frac{1}{2}$	25.10	8.0	1.3
129	Vida	e b	W. Schumacher	23.6 $\frac{1}{2}$	21.3	0.1	2.6
103	Vixen	e b	Louis Wunder	27.4	25.7	10.7	2.7
16	Wacondah	e b	Henry Doscher	34.11	31.0	12.6	3.0
81	Water Lily	e b	W. D. Anderson, Jr.	29.10	26.7	12.6	3.6
110	Whiteaway	e b	H. H. Morton, M. D.	23.6	20.0	0.0	2.6

YACHTS ENROLLED IN THE BROOKLYN YACHT CLUB.

JIB AND MAINSAIL YACHTS.

Draft.	Enrollment Number.	NAME.	Centerboard or Keel.	OWNER.	Length over all.	Length Waterline.	Extreme Beam.	Draft.
...	...	Alce	c b	John Cottler	25.5 $\frac{1}{2}$	22.0 $\frac{1}{2}$	8.10	1.0
3.5	59	Fannie	c b	Albert Cluman	18.4	15.4	8.3	1.0
5.0	4	Faustina	fin k	R. C. Hopkins	21.5	21.4	10.0	2.3
3.0	74	Iselle	c b	F. W. Bobbett	18.0	16.4	6.0	1.0
2.0	117	Silvey	c b	P. H. Brunner	21.0	19.11 $\frac{1}{2}$...	1.0
3.3	112	Walt	c b	W. E. Hart	15.6	16.6	7.0	1.6
4.0								
4.10								
....								
....								
....								
4.8								
5.0								
....								
2.8								
....								
....								
3.0								
2.6								
2.6								
4.0								
2.0								
4.0								
3.0								
....								
....								
2.10								
2.8								
2.0								
1.3								
2.6								
2.7								
3.0								
3.0								
2.6								

SCHOONERS.

Draft.	Enrollment Number.	NAME.	Centerboard or Keel.	OWNER.	Length over all.	Length Waterline.	Extreme Beam.	Draft.
....								
....								
3.0								
2.6	56	Loyal	c b	B. F. Sutton	82.0	61.0	19.0	7.6
2.6	89	Signal	c b	J. Macrae	40.0	36.0	13.0	3.0
4.0	67	Studio	c b	M. E. Tobin	48.0	45.0	15.0	4.0
2.0								
4.0								
3.0								
....								
....								
2.10								
2.8								
2.0								
1.3								
2.6								
2.7								
3.0								
3.0								
2.6								

STEAMERS AND LAUNCHES.

Draft.	Enrollment Number.	NAME.	OWNER.	Length over all.	Length Waterline.	Extreme Beam.	Draft.
....							
....							
2.0	114	Adela	F. J. Herpers	55.0	49.0	13.0
1.3	68	Laura E.	J. J. Boeke	70.0	12.0	4.6
2.6	106	J. Y. McKane	J. Y. McKane	60.0
2.7	47	Wavo Crest	H. B. Ogden	39.0	7.6	2.0
3.0							
3.0							
2.6							

BIOGRAPHICAL SKETCHES AND DESCRIPTION OF YACHTS ENROLLED IN THE CLUB.

BENJAMIN F. SUTTON, wholesale rubber merchant; Commodore of the **BROOKLYN YACHT CLUB** since 1891 and President of the **NEW YORK YACHT RACING ASSOCIATION**. Commodore Sutton is a great favorite amongst yachtsmen owing to the enthusiastic manner in which he enters into the advancement of the sport of yachting. Is a member of a number of yacht clubs and is the owner of the schooner yacht **LOYAL**, which was built in strict accordance with his views, combining, as it does, comfort and speed.

LOYAL.

LOYAL is a centerboard schooner owned by Commodore B. Frank Sutton of the **BROOKLYN YACHT CLUB**. She was designed by Henry J. Gielow and built by C. & R. Poillon, Brooklyn, N. Y. She was launched in May, 1893. Hails from New York and sails with the **BROOKLYN** and **ATLANTIC YACHT CLUBS**. See plate LIX.

DIMENSIONS.

Length over all,	70 feet.	Length load waterline,	60 feet.
Draft,	7 feet 6 inches.	Beam,	10 feet.

EDWARD TRACY BIRDSALL, M. E., Consulting Electrical Engineer of New York City, was born in Maryland in the year 1863. Has been interested in yachting for fourteen years, and is a member of the **KNICKERBOCKER** and **BROOKLYN YACHT CLUBS** and of the late **CORINTHIAN NAVY**. He has also held the office of Measurer in the Brooklyn Club. The canoe **FOX** was designed by him, and he has owned several sail yachts, viz., the cut **PHANTOM**, the sloop **ARYAN**, and his present yacht **FAY**. Mr. Birdsall is also a member of the New York Athletic Club.

FAY.

FAY is a keel cutter, owned by E. T. Birdsall of New York City. Was formerly **MAMIE**. Designed and built by E. L. Williams, South Boston and launched in July, 1884. For some time the property of H. H. Durycn, and has belonged to Mr. Birdsall for one year. She hails from New Rochelle and sails with the **KNICKERBOCKER** and **BROOKLYN YACHT CLUBS**. She has a cabin. See Fig. 392.

DIMENSIONS.

Length over all,	25 feet.	Length load waterline,	21 feet.
Depth,	5 feet.	Draft,	5 feet.
Beam,	6 feet.		

ILEIKA.

The centerboard sloop **ILEIKA** was designed and built by Frank E. Wicks, Amityville, N. Y., for Everett H. Converse of New York City, N. Y. She was launched in June, 1890. She has a cabin, hails from New York and has never been altered. Her owner is a member of three clubs—the **ATLANTIC**, **BROOKLYN** and **GREAT SOUTH BAY YACHT CLUBS**. See Fig. 393.

Official number, 100,496.

DIMENSIONS.

Length over all,	41 feet.	Length load waterline,	36 feet 10 inches.
Depth,	4 feet.	Draft,	3 feet 8 inches.
Beam,	11 feet.		

Racing Record for 1892:—

NEW YORK YACHT RACING ASSOCIATION—**ILEIKA** was the winner in her class in the Fourth Annual Regatta, sailed September 5th. On this occasion she defeated **AVOLON**.

**OWAIN L. HUGHES.**

OWAIN L. HUGHES, of New York City. Born in London, England, in the year 1849, of Welsh ancestry; the son of Thomas and Ann Hughes. Mr. Hughes is a well-known yacht broker, having been engaged in that special line of business for fourteen years; he is a member of the **BROOKLYN YACHT CLUB**.

ACORN.

ACORN is a centerboard sloop owned by W. Martin, Esq. She is enrolled in the **BROOKLYN YACHT CLUB** under the number 111 and sails with the fleet of that club.

DIMENSIONS.

Length over all,	24 feet.	Length load waterline,	20 feet 11 inches.
Extreme beam,	11 feet.	Draft,	2 feet 4 inches.

IDA.

IDA is a centerboard sloop owned by Frank McCarthy of Brooklyn, N. Y. She sails with the **BROOKLYN YACHT CLUB** and hails from the city of Brooklyn. See Fig. 395.

DIMENSIONS.

Length over all,	25 feet 4 inches.	Length load waterline,	21 feet 5 inches.
Draft,	2 feet 6 inches.	Beam,	10 feet.

**R. K. McMURRAY.**

R. K. McMURRAY, shipping merchant. New York City, was born in Brooklyn, of Scotch-Irish descent, the son of Joseph McMurray. He has been a yachtsman since 1856, and has held the offices of Vice-Commodore of the **BROOKLYN YACHT CLUB** and Commodore of the Yachting Department of the Staten Island Athletic Club. He is also a member of the **NEW YORK YACHT CLUB**. His present yacht is the sloop **ÆOLUS**, though he has also been the owner of the cuts **WHISTLING THUNDER**, **SUPERIOR** and **EXCELSIOR** and the sloop **PATIENCE**.

ÆOLUS.

ÆOLUS is a centerboard cabin sloop, owned by R. K. McMurray of New York City. Designed by A. Seuler and built by Samuel Ayers of New York. Launched in 1880. She hails from New York, sailing with the **NEW YORK** and **BROOKLYN YACHT CLUBS**. See Fig. 396.

Official number, 105,909.

DIMENSIONS.

Length over all,	48 feet 10 inches.	Length load waterline,	40 feet 10 inches.
Depth,	4 feet.	Draft,	5 feet.
Beam,	15 feet 4 inches.		

Spars. Mast, 47 feet; Topmast, 32 feet; Boom, 47 feet; Gaff, 27 feet; Foot jib, 31 feet.



FRANK A. PERRET.

FRANK A. PERRET, electrical engineer, now living in Brooklyn, N. Y., was born in Hartford, Conn., of American-Swiss descent, in 1867. Is the son of Charles and Mary E. Perret. Has owned the mainsail boats ADLE and PADDY and the sloop YEDA, as well as his present yacht, the sloop WAHNETA. He has been interested in yachting five years and belongs to the BROOKLYN YACHT CLUB. Mr. Perret is connected with the Elektron Mfg Co. of Springfield, Mass.

WAHNETA.

A centerboard sloop belonging to Frank A. Perret of Brooklyn, N. Y. She was designed and built for Mr. Perret by H. C. Witheringham of South Brooklyn. Was launched June 1, 1892. She has a lead keel and bronzo centerboard; hails from New York City and sails with the fleet of the BROOKLYN YACHT CLUB. See Fig. 397.

DIMENSIONS.			
Length over all.	31 feet.	Length load waterline.	21 feet.
Depth.	4 feet.	Beam.	8 feet 5 inches.

Racing Record for 1892:—

ATLANTIC YACHT CLUB—WAHNETA came in second in her class in the Twenty-seventh Annual Regatta sailed June 10th; EL CILLO was first.

NEW YORK YACHT RACING ASSOCIATION—WAHNETA won in her class beating the nine other starters in the Fourth Annual Regatta held September 5th.

SENECA.

SENECA is a centerboard sloop yawl designed and built by Post & Co., Brooklyn, N. Y., and launched in May 1885. She is owned by John P. Tribben and sails with the BROOKLYN YACHT CLUB, hailing from New York City. She was lengthened 5 feet on the deck in 1890. See Fig. 398.

DIMENSIONS.			
Length over all.	38 feet 7 $\frac{1}{4}$ inches.	Length load waterline.	30 feet 2 $\frac{1}{4}$ inches.
Depth.	3 feet 6 inches.	Beam.	2 feet 9 inches.
Beam.	8 feet 4 $\frac{1}{2}$ inches.		

of New York
don, England, in
necetry; the son
es. Mr. Hughes
ker, having been
line of business
a member of the

ed sloop owned by
s enrolled in the
under the num-

23 feet 11 inches.
2 feet 4 inches.

arthy of Brooklyn,
n and hails from

21 feet 5 inches.
10 feet.

shipping merchant,
was born in Brook-
escent, the son of
e has been a yachts-
as held the offices
of the BROOKLYN
Commodore of the
of the Staten Is-
e is also a member of
CLUB. His present
LTS, though he has
of the cats WHIS-
PERIOR and EXCEL-

R. K. McMurray of
ilt by Samuel Ayers
om New York, sail-
r CLUBS. See Fig.

49 feet 10 inches.
5 feet.

m, 47 feet; Gaff, 27



COMMODORE GEORGE W. GARDNER.

CLEVELAND YACHT CLUB.

History of the Cleveland Yacht Club.

THE CLEVELAND YACHT CLUB dates its existence back to 1878, when the following yachts, *UNIQUE*, *CHIMES*, *SILVERSPRAY*, *GISSY*, *MASTER HARRY*, *ORPHAN BOY*, *TRIO*, *TOBSY*, *CARRIE*, *MORAN* and *NOMAD* afforded it all the excitement and sport to be wished for: An agreement was made and carried out to have a regatta September 19, 1879.

YACHT CLUB to the other lake organizations is concerned, it must be dated from the time when Messrs. Gardner and Rice became members.

April 5, 1879, George W. Gardner was elected Commodore of the club, a position he has held by unanimous vote ever since. He is one of the foremost yachtsmen on fresh water to-day. With him as leader, the club increased rapidly in membership and in size of fleet. The club now numbered in its fleet besides those already mentioned, *HARRY BURKE*, *PHANTOM*, *JANE ANDERSON*, *CAMILLA*, *ORANESTY*, and the steam yacht and flag ship *ROSALINE*, owned by Commodore Gardner. This year saw the beginning of the "free for all Fourth of July Races" which argued well for Lake Erie yachting. For years there met off Cleveland Harbor the fleetest yachts from Buffalo, Erie, Detroit, Sandusky and Toledo.

In 1880 such boats as the *IDLER* and *CORA* of Chicago, *IVES* of Detroit, *FASCION* of Put-in-Bay, *CONSAR* of Erie and *CRUXER* of Buffalo, contended for the Gardner Challenge Cup, presented by

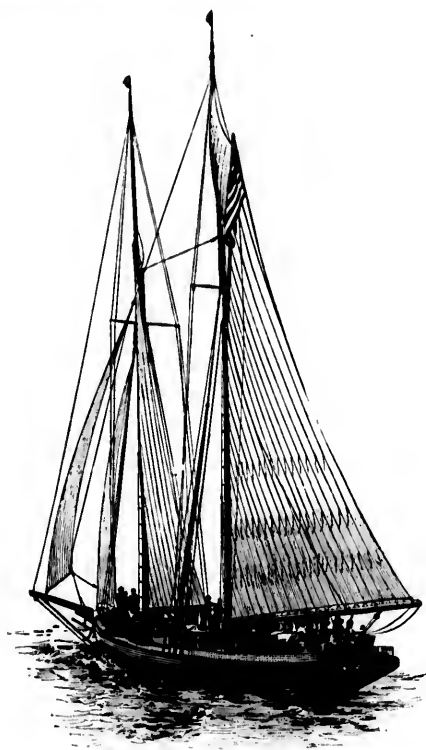

WASP.—FIGURE 402.

On the Saturday following the regatta, September 21st, the CLEVELAND YACHTING ASSOCIATION was organized, and officers elected, as follows: Commodore, F. H. Smead; Vice-Commodore, W. P. Francis; Rear-Commodore, H. Gerlach; Secretary, C. P. Smith; Treasurer, H. G. Phelps; Measurer, R. F. Bell. Executive Committee: C. P. Smith, R. E. Patterson, B. Lyman, R. E. Gill, Jr., S. Law. Soon after Geo. W. Gardner and Percy W. Rice became members of the club. As far as the relative existence of the CLEVELAND

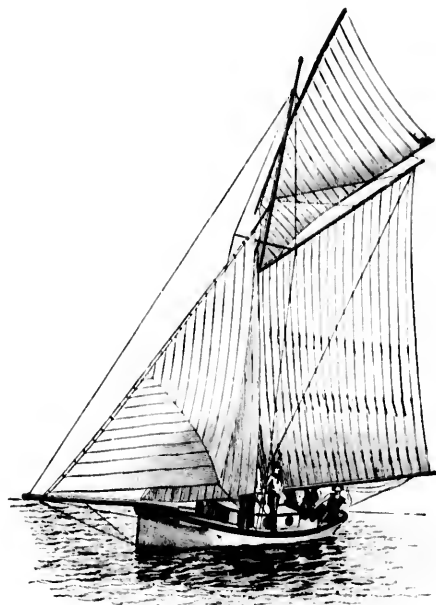

PETREL.—FIGURE 403.

Commodore Gardner, to become the property of the yacht (above 35 feet water line) winning it three successive times. In 1881 he presented the CLEVELAND YACHTING ASSOCIATION Cup, to be sailed for under the same conditions, by class above 25 feet and under 35 feet

water line. The spoils went to the victors *CYGNET* and *CONSAIR*, but not to stay. The races were bound to bring out other boats. The peerless *FANCHON* of Put-in-Bay came to the annual races, and three successive times she led her class around the course and thereby became the owner of the first yacht championship emblem of Lake Erie ever presented. The large attendance and enthusiasm manifested at these races was only the forerunner, however, of the important events to follow.

On January 17, 1885, a joint meeting of the CLEVELAND YACHTING ASSOCIATION and the CLEVELAND CANOE CLUB was held, and the nucleus of the INTER-LAKE YACHTING ASSOCIATION was formed. It was decided to have an Open Regatta at Put-in-Bay in July, and invite every yacht on fresh water. Commodore Gardner was elected President. No prettier sight was ever seen on any body of water than the one at Put-in-Bay on that July morning, when over fifty yachts worked out from under Gibraltar to wrestle for the supremacy.

Cleveland, Detroit, Toledo, Sandusky, Chicago, Erie, Hamilton and Toronto, on Lake Ontario, were represented at the meeting. Geo. W. Gardner was elected Commodore and J. S. Williams Secretary. The CLEVELAND CLUB can pride itself upon the great work it accomplished during these years.

On October 3, 1888, it was decided to change the name CLEVELAND YACHTING ASSOCIATION to the CLEVELAND YACHT CLUB, and to become an incorporated body. The Secretary of the Treasury had granted the club a lease of the Marine Hospital Lake front for the building of a Club House. Messrs. G. W. Luettmeyer, Percy W. Rice and John



MOTT B.—FIGURE 404.

G. White, are deserving of credit for the arduous labors incident to this work. For the purpose of getting some shelter from the Government breakwater, and also to get in front of Lake View Park, an attempt was made to get a lease of 600 feet west of Erie street. After four years of hard labor on the part of Commodore Gardner, a lease was at last obtained, but the conditions were of such a nature that the club could not risk putting up a \$20,000 structure on that part of the lake front, and the lease was not accepted.

The year 1893 proved to be a banner year in the history of the club.

The necessary funds for the construction of the new Club House were raised, and the Cleveland lake front, hitherto a stretch of railroad tracks, old shanties and piles, was beautified by a handsome Club House.

The club has a membership of 130 active and 6 honorary members; the fleet is made up as follows: 22 sail yachts, 4 steam yachts, and 3 naphtha launches.

In looking back over the years of organized yachting in Cleveland, the following facts are brought prominently to view:

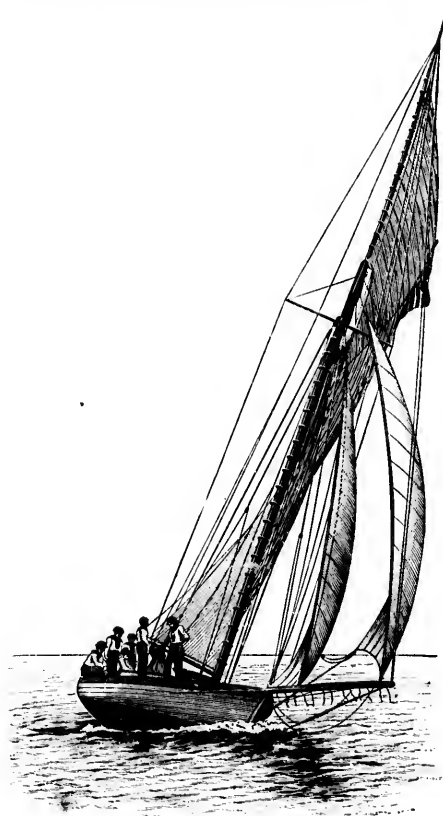

ROVER.—FIGURE 405.

The CLEVELAND YACHT CLUB is one of the oldest yacht clubs in continuous existence on fresh water.

It was the first club on the lakes to adopt the sail area measurement rule.

No member of the CLEVELAND YACHT CLUB ever lost his life from drowning.

Its fleet is made up of a weatherly type of craft ship in every particular, built and fitted out to make long trips and in any kind of weather.

For organizing and promoting the LAKE ERIE YACHTING ASSOCIATION it is certainly entitled to a place in the history of the country's yachting.

The officers for 1893 were: Commodore, George W. Gardner; Vice-Commodore, P. W. Rice; Rear-Commodore, W. R. Huntington; Secretary and Treasurer, J. O. Gardner.

YACHTS ENROLLED IN THE CLEVELAND YACHT CLUB.

SAILING YACHTS.

NAME.	OWNERS.	C. H. OR KEEL.	RO.	L. W. L.	BEAM.	DRAFT.
Wasp	G. W. Gardner <i>et al.</i>	cb	Schooner	70.1	9.4	7.1
	P. W. Bice <i>et al.</i>	k	Cutter	41.
Marietta	J. W. Steele	cb	Sloop	31.1	11.0	5.0
Susie	H. D. Moran	cb	Schooner	31.8	10.0	5.1
Restless	P. G. Oyler's <i>et al.</i>	cb	Sloop	31.3	12.1	5.7
Grayling	H. Gerlach	k	Cutter	31.1	9.6	4.9
Edna	Geo. Parish	cb	Sloop	28.0	9.5	3.3
Compeer	F. Pollard <i>et al.</i>	k	Cutter	27.1	9.0	6.0
Rover	J. Kerbel <i>et al.</i>	k	"	26.5	10.0	3.7
Ida	W. C. Sly <i>et al.</i>	cb	Yawl	26.2	10.0	7.11
Mona	Hadcliffe Bros	k	Cutter	25.3
Bessie	W. C. Sly	k	"	25.1	8.0	5.5
Eole	A. McEachron <i>et al.</i>	k	"	24.8	4.9	5.2
Petrel	C. Christie <i>et al.</i>	k	"	22.1	7.0	3.8
Whim	E. Overbeke <i>et al.</i>	cb	Sloop	22.0	7.0	2.5
Uniqno	E. W. Hubler and G. W. Luetsmeyer	cb	Cutter	21.0	5.0	4.6
Argo	C. W. Kelly <i>et al.</i>	cb	"	20.0	6.4	3.10
Ida K.	H. Kratze	cb	"	19.7
Mott B.	J. O. Gardner	cb	Sloop	19.2

STEAM YACHTS AND LAUNCHES.

NAME.	OWNERS.	RO.	L. W. L.	BEAM.	DRAFT.
Say When	W. J. White	Steam Schooner	115.0	11.5	9.4
Eugene	Win. DeMooy	Naphtha
Dearest	W. R. Huntington	"	25.0
Douglass	C. S. H. Chisholm	"	25.0
Walden	J. H. Wade, Jr.	Steam Schooner	160.6	20.7	12.0
Cremche	H. M. Hanna	"	165.0	25.2	14.0

RULE OF MEASUREMENT.

The measurements of yachts shall be the length and sail area, according to the formula: $L. W. L. + \frac{1}{4}$ Sail Area.

On schooners, cutters and sloops, a perpendicular line to be taken along the after side of the mainmast from the under side of the gaff-topsail block or sheave on topmast or uppermost block or sheave at masthead to the upper side of the boom, when resting on the saddle or on the lowest part of the goose-neck, the distance of which point from the main deck or deck-house to be recorded by the Measurer, together with the other points used in measurements.

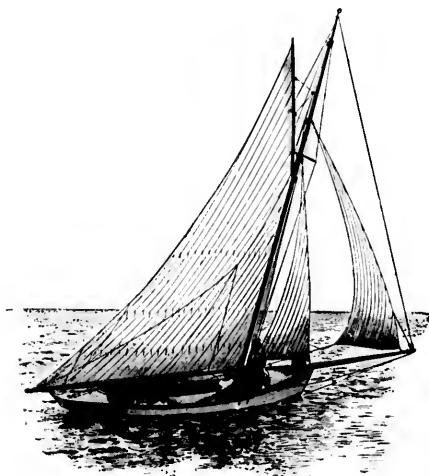

UNIQUE.—FIGURE 406.

A base-line to be taken from the bee-hol or point of contact of the jibstay or bowsprit, or flying jibstay on jibboom, in a straight line to the end of the main boom, with the difference between 50 per cent. of the length of topmast and gaff added thereto.

The excess in length of the spinnaker boom covers the difference from the forward point of measurement to the forward side of the spar to be added to the base-line, and if the spinnaker boom be arranged to ship on deck or in the rigging or has any lengthening device whatever the distance or length of same be included in the measurement. Sprits on spinnakers are limited to two feet in length. In case of a cat-boat a spinnaker boom shall be allowed equal to the boat's waterline length.

To obtain area from these figures the usual formula for obtaining the area in square feet of a triangle is to be followed, namely: Base multiplied by the perpendicular and divided by two.

Length to be measured from forward side of stem at the waterline to the waterline at stern, wherever found. This measurement to be taken when the yacht is afloat and in her ordinary trim, and with the crew, if aboard, stationed amidships. The Measurer at the time of taking his measurement, to affix a distinctive mark at each point. To the square root of the area, add the length as ascertained, divide the sum by two, and the result is the measurement for time allowance.

Any change in these measurements to be reported by the owners, as customary, to the Measurer.

RULE FOR ASCERTAINING ALLOWANCES.

To find the time one yacht allows another: Subtract the time opposite the length of larger yacht from the time opposite the length of smaller yacht, and multiply the remainder by the length of course, and the result is the allowance in seconds.

RECORD OF RACES.

Sept. 19, 1879.	1st prize	UNIQUE, Champion of fleet.
	2d "	CHIMES.
July 4, 1880, 1st Class—	1st prize	CYGNET.
	2d "	IVES.
	2d Class—1st "	FANCHON.
	2d "	IDA.
	3d Class—1st "	PENNY PRESS.
	2d "	UNIQUE.
Sept. 13, 1880.	1st "	UNIQUE, Champion of fleet.
	2d "	ROVER.
July 4, 1881, 1st Class—	1st "	CYGNET.
	2d "	CAPOL.
	2d Class—1st "	CONSAR.
	2d "	IDA.
	3d Class—1st "	UNIQUE.
	2d "	PENNY PRESS.
Sept. 10, 1881.	1st "	ROVER, Champion of fleet.
	2d "	UNIQUE.
July 5, 1882.	1st "	CONSAR.
	2d "	SIREN.
Sept. 19, 1882.	1st "	SIREN, Champion of fleet.
	2d "	ROVER.
July 4, 1883, 1st Class—	1st "	CYGNET.
	2d "	IVES.
	2d Class—1st "	FANCHON.

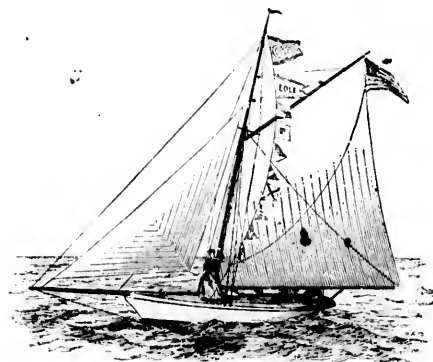

EOLIE.—FIGURE 407.

	2d "	SCUD.
	3d "	ALERT.
Sept. 10, 1883	1st "	LULU, Champion of fleet.
	2d "	IDA.
	3d "	CRUCE.
July, 1884, 1st Class—	1st "	IVES.
	2d Class—1st "	FANCHON.
	2d "	LULU.
	3d "	SCUD.
	3d Class—1st "	LADY IDA.
	2d "	FREDDIE.
	3d "	TRIO.

ADVANCES.

er: Subtract the time
time opposite the length
by the length of course,

QUE, Champion of fleet.

RES.

NET.

S.

ANCHON.

SNY PRESS.

QUE.

, Champion of fleet.

VER.

NET.

OL.

TS.

QUE.

QUE.

SNY PRESS.

ve Champion of fleet.

ISSAID.

REN.

REN, Champion of fleet.

VER.

NET.

ES.

ANCHON.

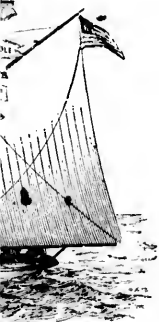

7.

CLD.

ALERT.

ALERT, Champion of fleet.

DA.

PRICE.

YES.

ANCHON.

CLD.

CLD.

CLD.

LADY IDA.

REDDIE.

TRIO.



PLATE LI

NAIAD.



Sept. 10, 1884.	1st "	LULU, Champion of fleet.
	2d "	DAISY.
	3d "	IDA.
July 16, 1885.	1st "	PANCHON.
	2d "	KATE GRAHAM.
	3d "	SCUD.
Sept. 10, 1885.	1st "	COM. GARDNER, Champion of fleet.
	2d "	ROVER.
Sept. 8, 1886.	1st "	GERTIE, Champion of fleet.
	2d "	ROVER.
Sept. 12, 1887, 1st Class—	1st "	IDA, Champion of fleet.
	2d "	ALERT.
	2d Class—1st "	PETREL.
	2d "	UNIQUE (No. 2).
Sept. 22d, 1888.	1st "	UNIQUE (No. 2), Champion of fleet.
	2d "	IDA.
	3d "	SYLVIA.
	1st Class—1st "	ALERT, Champion of fleet.
Sept. 10, 1889.	2d "	SYLVIA.
	3d "	RESTLESS.
	2d Class—1st "	UNIQUE (No. 2).
	2d "	ARAB.
Sept. 10, 1890.	3d "	PETREL.
	1st "	UNIQUE (No. 2), Champion of fleet, 3 hrs., 20 min., 40 sec.
	2d "	RESTLESS, 3 hrs., 27 min., 45 sec.
	3d "	EOLE, 3 hrs., 34 min., 46 sec.

UNIQUE not having left the stake boat on the left side, the fleet prize was awarded to RESTLESS, and the prize in the second class was given EOLE who, however, would not accept it.

The Regatta of the CLEVELAND YACHT CLUB for 1891 was sailed seven miles to windward and return on September 10th. The sea was moderate, the wind from the northeast, light at start, and fresh at finish. The following yachts started, shortly before 12 o'clock:

Class A, 25 feet and under.

Argo	did not finish
Eole	4 13 24 3 56 30
Arab	4 10 27 3 52 23
Ida K.	did not finish

Class B, over 25 feet.

Grayling	4 31 25	4 31 25
Rover	4 00 10	4 00 10
Compeer	4 00 05	4 00 05
Hessie	did not finish	
Restless	3 50 20	3 50 20

ARAB won first prize in Class A and EOLE won second prize. In Class B, RESTLESS won the first prize.

Regatta Committee: E. Oberbeke, C. Keuse and H. Lyman.

On August 16 and 17, 1893, an Open Regatta was held at Cleveland under the auspices of the CLEVELAND YACHT CLUB.

A triangular course, with six mile sides, was buoyed out on the lake abreast of the city, the yacht SAY WHEE was tendered by her owner for the use of the officials, and the following gentlemen were appointed to attend to all arrangements: Judges, C. B. Lockwood, of Sandusky; Commodore, Joseph Nicholson, of Detroit, and J. Dezelinski, of Buffalo. Time keepers, W. J. Akers, W. J. White and Col. Geo. H. Worthington. Regatta Committee, Messrs. Phil. P. Wright, W. B. Huntington, Edward Oberbeke, Charles W. Kelly, Herman Lyman and Henry Gerlach.

The principal entries were: IDA K., C. H. Keuse; CARMENCITA, G. T. Bliss; WEST WIND, F. L. Bennett; ALICE ENRIGHT, Arthur Pettie; SHAMROCK, H. C. Kendall; MERLE, E. B. Hower; FANCION, G. W. Bliss; MINN, D. C. Cleary; METEOR, B. E. Lyman; MARIETTA, R. C. Moody; IOLANTHE, A. M. McEachren; IRIS, Charles L. Parnellee; LOUISE, F. W. Caulkins; LULU B., Aleck I. McCloud; PETREL, C. H. Christie; COMPEER, C. Richter; RESTLESS, F. G. Oberbeke; MOTT B., J. O. Gardner; FLEETWING, J. McCormick; SURPRISE, Charles Boston; ARGO, John Barth; SUNBEAM, George W. Kolbe. Naphtha launches, DEAREST, W. B. Huntington; NELLIE, John Weber; EUGENE, William DeMooy.

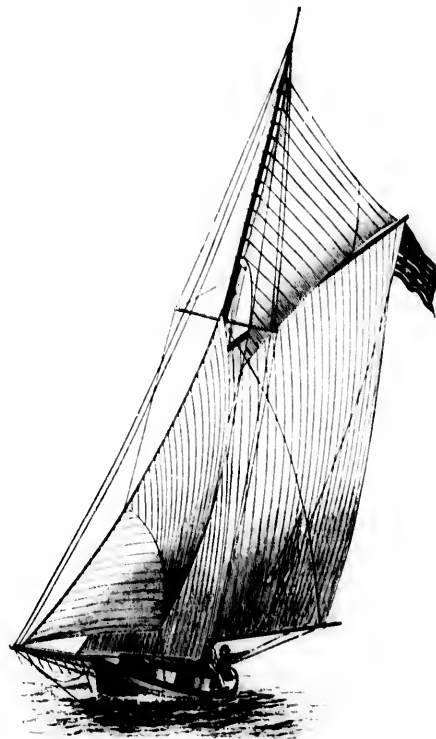

RESTLESS.—FIGURE 408.

Tuesday was clear and warm, but with a light northeast breeze. The start of Class D, was made at 10:31, and for Class E, at 10:40, the course for each class being six miles to windward and return.

LOUISE led over the course, but in the light air she was beaten by two of the smaller class, starting later. The full times were: Class D, 25 to 32 feet.

	Start.	Finish.	Elapsed Time.	Corrected Time.
	H. M. S.	H. M. S.	H. M. S.	H. M. S.
Louise	10 32 06	1 58 06	3 26 03	3 21 21
Surprise	10 33 41	2 01 43	3 30 42	3 30 42
Iris	10 33 41		did not finish	
Carmencita	10 34 15		did not finish	
Iolanthie	10 39 03		did not finish	

	Start.	Finish.	Actual Time.	Corrected Time.
	H. M. S.	H. M. S.	H. M. S.	H. M. S.
Class E. 25 feet and under.				
Argo	10 42 11	2 00 25	3 13 14	3 18 11
Ida K.	10 43 34	2 07 35	3 25 01	3 21 33
Petrel	10 43 12	broke gaff	withdrew	
Molt B.	10 45 11		not timed	

There was a thick fog on Wednesday morning, but the sun broke through it in time for a start at 11 A. M., though there was no wind for sailing. The only two entries in Class A. were WASP and MINX, neither trying to start in the light wind. The Naphtha Race was called at noon, with five starters, the course being the complete 18 mile triangle. The times were as follows:

Eugene	12 02 08	2 49 30	2 47 22	2 18 50
Douglas C.	12 02 08	3 01 10	2 59 02	2 16 06
Nellie	12 02 08	3 05 05	3 02 57	3 02 57
Dearest	12 02 08	3 05 11	3 00 52	2 26 56
Le Voyageur	12 02 08	3 12 00	3 03 03	2 20 07

DEAREST the favorite, met with several mishaps, having been in constant use in the service of the committee for two days up to the time of the start. The allowances were under the Isherwood table. The first attempt to start the launches was spoiled by the conduct of some men in a sail boat, who refused to remove her from the starting line at the request of the committee.

The wind sprung up about noon, and at 12:18:30 Class B. was sent away, the following yachts crossing the line: MERLE, of Buffalo, F. B. Hower; MARIETTA of Fairport, R. C. Moody; SUNBEAM, of Cleveland, G. W. Colby; ALICE ENRIGHT, of Detroit, Arthur Pettie; LULA B., of Detroit, F. Senter. MERLE won easily, the elapsed time being:

Merle	4 00 07
Alice Enright	4 08 19
Lulu B.	5 09 51

Class C. was started at 12:28:30. The entries were: COMPEER, of Cleveland, C. Richter; RESTLESS, of Cleveland, F. G. Oberbeke

FLEETWING, of Cleveland, James McCormack; WESTWIND, of Buffalo, F. L. Bennett; SHAMROCK, of Detroit, H. C. Kendall; FANCHON, of Toledo, G. W. Bills; METEOR, of Cleveland, B. E. Lyman; GRAYLING, of Cleveland, H. Gerlach.

The times for the class were:

	Start.	Finish.	Actual Time.	Corrected Time.
	H. M. S.	H. M. S.	H. M. S.	H. M. S.
Shamrock	12 39 20	4 51 00	4 12 40	4 10 10
Meteor	12 31 26	4 54 10	4 20 44	4 20 28
Restless	12 31 48	5 04 38	4 33 50	4 31 20
West Wind	12 30 17	5 11 47	4 41 39	4 30 40
Fanchon	12 32 02	5 10 27	4 44 25	4 41 25
Compeer	12 35 15	5 37 20	3 59 05	
Fleetwing	12 35 32			
Grayling	12 34 06			

Sept. 10, 1892.	1st Class—1st Prize	RESTLESS Champion of fleet 2 hrs., 55 min., 45 sec.
	2d "	GRAYLING, 3 hrs., 04 min., 27 sec.
2d Class—1st Prize	MONA, 3 hrs., 21 min., 49 sec.	
	2d "	BESSIE, 3 hrs., 45 min., 11 sec.
3rd Class—1st "	UNIQUE, (No. 2), 3 hrs., 18 min., 15 sec.	
	2d "	ARGO, 3 hrs., 24 min., 31 sec.
	3d "	IDA K., 3 hrs., 28 min., 18 sec.

The owner of ARGO, having fouled the stake boat, requested that IDA K. be awarded the second prize, which was accordingly done.

The Annual Regatta which was to have taken place September 4, 1893, over a 14 mile course, had to be postponed until the 27th, as there was no wind. No record sent.

BIOGRAPHICAL SKETCHES AND DESCRIPTION OF YACHTS ENROLLED IN THE CLUB.

GEORGE W. GARDNER, Commodore of the CLEVELAND YACHT CLUB, Cleveland, Ohio, was born in Pittsfield, Mass., in 1834; the son of James Gardner. Commodore Gardner was Mayor of Cleveland in 1885-86 and 1889-90, and has held other municipal and State positions. He has retained his office of Commodore for nearly twenty years, having been one of the founders of the CLEVELAND YACHT CLUB. Has owned the yachts ROWENA, ROSALINE, MARIETTA, and his present boat is the schooner WASP, he being the managing owner.

WASP.

A centerboard schooner, owned by Geo. W. Gardner, Geo. H. Worthington and E. E. Beeman, M.D., Commodore Gardner of the CLEVELAND YACHT CLUB, being her managing owner. She was launched in 1882, having been designed by John Prindiville and built by John Townsend of Chicago. Altered from sloop in 1887, then rebuilt in 1892. Commodore Gardner has been interested in WASP for seven years. She hails from Cleveland and sails with the CLEVELAND YACHT CLUB. See Fig. 399.

CODE SIGNAL LETTERS, K. D. S. R.

Official number, 80,915.

DIMENSIONS.

Length over all,	78 feet,	Length load waterline,	70 feet.
Depth,	7 feet 2 inches,	Draft,	6 feet 8 inches.
Beam,	19 feet 10 inches.		

WASP is claimed to have shown a speed record of 15 miles.



E. E. BEEMAN, M.D.

E. E. BEEMAN, M.D., physician and manufacturer, Cleveland, Ohio, was born in the State of Ohio in the year 1840, of English ancestry; the son of Dr. J. Beeman. Is a member of the Cleveland City Council and part owner of the yacht WASP. Many years a yachtsman and one of the directors of the CLEVELAND YACHT CLUB.

PETREL.

PETREL is a keel sloop belonging to C. Christie of Cleveland. She was designed and built by L. Jackson in 1884, and was lengthened in 1888. Hails from Cleveland and is enrolled in the fleet of the CLEVELAND YACHT CLUB. See Fig. 400.

DIMENSIONS.

Length over all,	25 feet.	Length load waterline,	21 feet 6 inches.
Draft,	4 feet 8 inches.	Beam,	7 feet.



GEORGE H. GARDNER.

GEOURGE H. GARDNER, printer, Cleveland, Ohio; was born in Cleveland, and has been a yachtsman all his life. Is Commodore of the WESTERN CANOE ASSOCIATION and a member of the CLEVELAND YACHT CLUB.

JAMES O. GARDNER, photographer, Cleveland, Ohio, is a native of Cleveland and the owner of the yacht MOTT B. Is a member of the CLEVELAND YACHT CLUB, holding the offices of Secretary and Treasurer.

MOTT B.



JAMES O. GARDNER.

A fin-keel sloop, designed and built by William Gardner for her present owner J. O. Gardner, and launched in July, 1892. She hails from Cleveland and sails with the CLEVELAND YACHT CLUB. See Fig. 101.

DIMENSIONS.

Length over all, 24 feet 6 inches.
Length load waterline, 18 feet.
Depth, 2 feet 6 inches, (without fin keel).
Draft, 4 feet, (with keel).
Beam, 5 feet 6 inches.



WM. R. HUNTINGTON.

WILLIAM R. HUNTINGTON, wholesale hardware and coal operator, Cleveland, Ohio, was born in Cleveland, September 3, 1857, the son of John and Jane Huntington. Mr. Huntington is the Fish and Game Commissioner for the State of Ohio, and has also held the office of Deputy County Treasurer and was Vice-Commodore of the CLEVELAND YACHT CLUB in 1892. He is also an honorary member of the OHIO YACHT CLUB. He has just built a new yacht.

ROVER.

ROVER is a centerboard sloop, the property of J. Kerbel of Cleveland, Ohio. She was built by Lyman Bros. in 1878. She is among the yachts enrolled in the CLEVELAND YACHT CLUB and her home port is Cleveland. See Fig. 402.

DIMENSIONS.

Length over all, 30 feet. Length load waterline, 20 feet 3 inches.
Draft, 3 feet 6 inches, Beam, 10 feet 7 inches.

UNIQUE.

UNIQUE is a cutter yacht, owned by E. W. Radder and G. W.

Luettmeyer of Cleveland, Ohio. She was designed by C. W. Kelly and built by P. Loshlin in 1887 for her present owners. She hails from Cleveland and sails with the CLEVELAND YACHT CLUB. See Fig. 401.

DIMENSIONS.

Length over all, 25 feet. Length load waterline, 20 feet.
Depth, 4 feet 6 inches. Draft, 4 feet 10 inches.
Beam, 5 feet.

Spars: Mast, 17 feet; Topmast, 8 feet; Boom, 25 feet; Gaff, 15 feet; Rowsprit, 12 feet.

UNIQUE has a record of four firsts and one second in the Annual Cleveland Races.

FOLE.

A cutter yacht owned by Messrs. R. Richter, A. McEachren and L. G. Sears, of Cleveland, Ohio. She was designed by C. W. Kelly and built by R. Richter, being launched in April, 1886. She hails from Cleveland and sails with the CLEVELAND YACHT CLUB. See Fig. 404.

DIMENSIONS.

Length over all, 28 feet. Length load waterline, 21 feet 8 inches.
Draft, 5 feet 8 inches, Beam, 5 feet.

GEOURGE H. WORTHINGTON, Cleveland, Ohio, was born in Toronto, Ontario, the son of John and Mary Worthington. He is one of the owners of the schooner WASE and is a member of the CLEVELAND YACHT CLUB. He has been a yachtsman for many years.

Mr. Worthington leads an active business life. He is Secretary and Treasurer of the Cleveland Stone Co., Secretary and Treasurer of the Besman Chemical Co. and Vice-President of the American Washboard Co.

RESTLESS.

RESTLESS is a centerboard sloop owned by Phil P. Wright, F. G. Oberbeke and others, of Cleveland, Ohio. She was designed and built by Joseph McCormack of Cleveland, and was launched in the Spring of 1889. She hails from Cleveland and sails with the CLEVELAND YACHT CLUB. See Fig. 405.

DIMENSIONS.

Length over all, 33 feet. Length load waterline, 31 feet.
Depth, 7 feet. Draft, 5 feet 6 inches.
Beam, 12 feet 4 inches.

Racing Record:—

1891—CLEVELAND YACHT CLUB—RESTLESS won the first prize in the regatta sailed September 10th, beating GRAYLING, COMPEER, ROVER and BESSIE.

1892—CLEVELAND YACHT CLUB—RESTLESS was fourth in the Open Regatta of August 17th, with eight starters.

STWIND, of Buf-
Kendall; FAN-
D. B. E. Lyman:

Corrected
Time.
U. S. S.
4 10 10
4 20 28
4 31 20
4 30 40
4 41 25

Champion of fleet
min., 45 sec.
3 hrs., 04 min.,

hrs., 21 min., 49

hrs., 45 min., 11

(No. 2), 3 hrs.,
15 sec.

hrs., 24 min., 31

hrs., 28 min., 18

requested that Ida
ngly done.

place September
until the 27th,

15 miles.

D., physician and
Cleveland, Ohio,
of Ohio in the year
ry; the son of Dr.
ber of the Clevel-
part owner of the
ours a yachtsman
ors of the CLEVEL-

up belonging to C.
She was designed
ed in 1888. Hails
CLEVELAND YACHT

21 feet 6 inches.
7 feet.



COMMODORE THOMAS SULLY.

SOUTHERN YACHT CLUB.



SOUTHERN YACHT CLUB HOUSE.

History of the Southern Yacht Club.

ON July 21, 1849, several yachtsmen from New Orleans met at Montgomery's Hotel, Pass Christian, Mississippi Sound, a summer resort about fifty-five miles from New Orleans, and decided to organize a yacht club, which they named the SOUTHERN YACHT CLUB.

The following officers were elected: President, James W. Behan; Vice-Presidents, Thomas Kershaw, W. L. Balfour, Thomas Byrne, James Campbell, George Urquhart; Secretary, James O. Nixon.

The club entered at once upon a very active and successful season, having five regattas.

The following yachts were enrolled in the club:

First Class.	Owner.	Length. Ft. In
Mischief	Mobile Yacht Club	35 11 ¹ / ₂
R. R. Rhodes	J. G. Robertson	31 8 ¹ / ₂
Kate	R. Stewart	28 1
Vision	J. N. Tescarine	35 1

Second Class.	Owner.	Length Feet
Sea Serpent	J. G. Robertson	27 11 ¹ / ₂
Wave	J. O. Nixon	25 0 ¹ / ₄
Cordie	Thos. Byrne	24 10
Stingaree	Stingaree Club	23 0 ¹ / ₂
Undine	A. F. Saunders	23 5 ¹ / ₂
Maraposa	H. T. Sherman	23 2
Heim	H. P. Ensign	21 2 ¹ / ₂
Third Class.		
Doubleton	J. G. Robertson	21 7
Crouker	R. Mott	21 1 ¹ / ₂
Scila	McAllister, Druihlet & Nixon	18 2
Crescent	N. D. Vance	13 2 ¹ / ₂
Yacht	S. N. Cullum	17 10
Star	James I. Day	16 10 ¹ / ₂
Minnie	B. A. Whitney	16 4 ¹ / ₂
Motel	Dan Hickok	19 10 ¹ / ₂

In addition to these, outside yachts were allowed to sail in the Club Regattas, provided they were sailed by members and a double entrance fee paid.



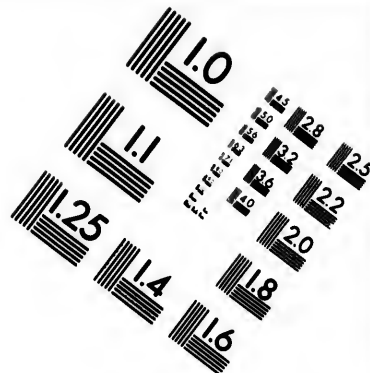
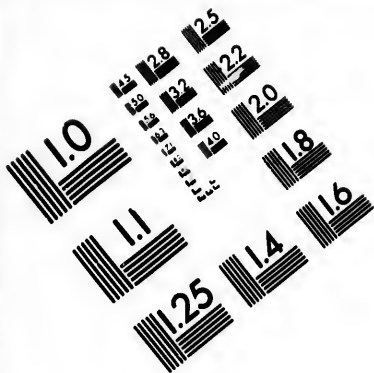

**IMAGE EVALUATION
TEST TARGET (MT-3)**

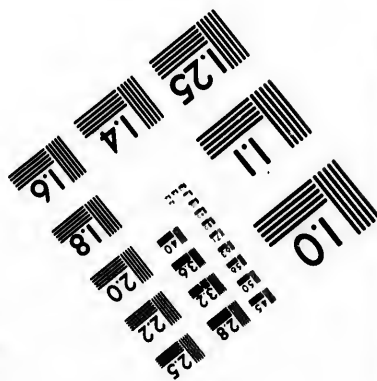
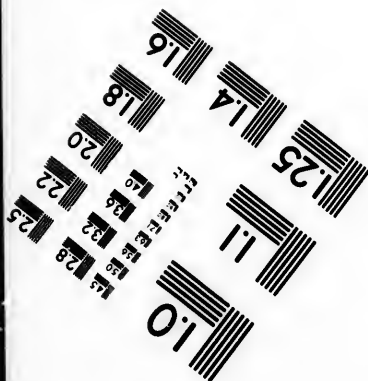
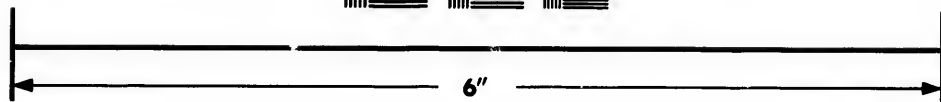
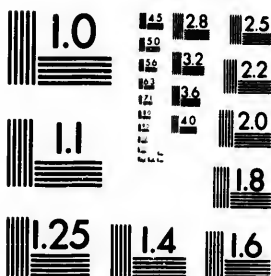

**Photographic
Sciences
Corporation**

23 WEST MAIN STREET
WEBSTER, N.Y. 14580
(716) 872-4503

18
20
22
25

10
11

THE FIRST REGATTA.

The First Regatta was held on August 6, 1849. There were eighteen entries, the sloops *UNDINE*, *ELIZA*, *RIDDLE* and *CORALIE* winning in the order named. A Second Regatta was sailed August 20th, there being sixteen entries and the prize winners were the sloops *JOHN PIERCE*, *CORALIE* and *YACHT*.

A Third Regatta was sailed September 30th, fourteen yachts started and the prizes were won by *HEIRN*, *PILGRIM* and *LAURA*.

A Fourth Regatta was sailed on September 17th, nine yachts contesting, *PILGRIM*, *RIGOLETTE* and *LAURA* winning the respective prizes.

The Fifth and last Regatta sailed in 1849, took place September 18th, for a Challenge Cup which was won by *PILGRIM*, four yachts having competed.

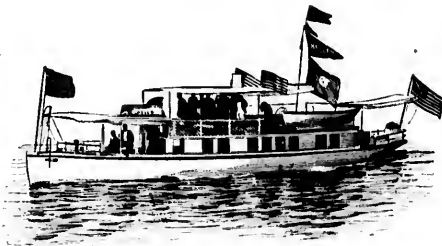

HELEN.—FIGURE 409.

All starts were from anchorage, and the following time allowance for the purpose of equalizing the different boats governed the entries.

Yachts measuring	15 to 20 feet keel,	allowed	45 sec. per foot.
" "	20 to 25 " "	" "	40 " "
" "	25 to 30 " "	" "	35 " "
" "	30 to 35 " "	" "	30 " "
" "	35 to 40 " "	" "	25 " "

Eight regattas were held during the season of 1850, the first took place July 4th, over a course from the New Canal on Lake Pontchartrain (the present location of the SOUTHERN YACHT CLUB HOUSE), and ending at the New Wharf at Pass Christian, a distance of 55 miles; the run was made in 6 hrs., 50 min. Six yachts started in the first class:

SCHOONERS.

	Entered By.
Crocodile	J. Prague
SLOOPS.	
Roger Stewart	W. DeForrest Holly
Mischief	J. G. Robertson
Stingaree	Stingaree Club
Undine	A. L. Saunders
Mischief	Mobile Yacht Club

ROGER STEWART won the first, and MISCHIEF the second prize.

In the second class the sloop *KATIE*, entered by R. Stewart, won the first, and the sloop *SEA SERPENT*, entered by J. G. Robertson, the second prize.

On July 8th, the races were continued, there being twelve entries in the third class. The sloops *R. R. RHODES*, *SEA SERPENT*, and *DOUBLOON* won in their respective classes, and were all entered by J. G. Robertson.

The next regatta with twelve boats starting, was sailed July 22d, which was followed by regattas on August 5th and 19th, when nine boat started: in the last regatta of the season, held on September 24th, 1850, ten boats started.

In 1851 the club showed considerable life, opening on July 7th

with a regatta, in which there were six entries, the next regatta being sailed July 15th, with five entries, and followed by a race between two yachts on July 27th. In August, six regattas took place under the auspices of the club at Pass Christian, and were sailed on the 17th, 18th, 19th, 20th, 21st and 23d, the members taking an active interest in the same.

Racing was continued yearly up to 1860, the yachts increasing in size. *COQUETTE*, the largest yacht of the old fleet being owned by Commodore J. G. Robertson until the war broke out.

The officers elected for 1860, were as follows: Commodore, J. T. Szymanski; 1st Vice-Commodore, Sid. Storey; 2d Vice-Commodore, A. G. Green; 3d Vice-Commodore, J. W. Balfour; Secretary and Treasurer, J. O. Nixon. At the meeting of the club when the above named officers were elected, it was resolved that the Annual Regatta be sailed at the Lake End of the New Canal, on Friday, the 27th of June. This regatta did not come off, however, as the members' time and attention were taken up with preparations for the civil war which shortly followed, and yachting regattas were suspended.

After the war, such of the old members as remained held regattas as best they could, until May 14, 1878, when at Hawkins' Club-room, Varieties Alley, they re-organized the club and elected the following officers:

Commodore, Emile F. O'Brien; Vice-Commodore, J. E. Austin; 2d Vice-Commodore, Arthur Claiborn; Treasurer, Henry Denegre; Secretary, Owen Jamison. By unanimous consent it was decided to build a Club House at West End, Lake Pontchartrain, and a Building Committee was appointed by the Commodore, consisting of Arthur Claiborn, Chairman; W. J. Hare, J. B. McConnell, J. Wintz, and Fendel Horn.

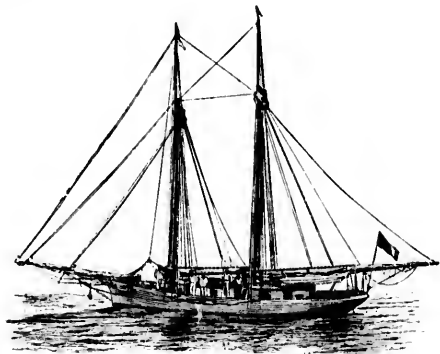

FOLLY.—FIGURE 410.

On June 24, 1872, a Corinthian Regatta was held at West End, the following yachts participating:

	SLOOPS.	
First Class.		
Germine	sailed by	W. T. Boardman
Nathalie C.	" "	G. V. McNeil
Limnas	" "	Emile J. O'Brien
Gov. Claiborn	" "	A. Claiborn
Second Class.		
Xiphias	" "	J. E. Austin
Restless	" "	J. Henry Bohan
Third Class.		
Mary A.	" "	A. A. Maginnis
Edith	" "	E. B. Hopkins
Juanita	" "	Joe McNeil
Loulou	" "	E. Harris
Maggie	" "	R. Brewster

o next regatta being
by a race between
as took place under
were sailed on the
ers taking an active

yachts increasing in
fleet being owned by
e out.

: Commodore, J. T.
2d Vice-Commodore,
four; Secretary and
club when the above
the Annual Regatta
Friday, the 27th of
as the members' timo
or the civil war which
suspended.

remained held regattas
Hawkins' Club-room
elected the following

Comodore, J. E. Austin ;
rurer, Henry Denegre ;
sent it was decided to
artrain, and a Building
consisting of Arthur
Connell, J. Wintz, and

was held at West End.

Fourth Class.
Olivia Sailed by J. B. McConnell
Brenda " " G. Dudley
Nord " " L. H. Fairchild

The winners were NATHALIE C., NIPHAS, JUANITA, and OLIVIA, in their respective classes.

On June 24th, a Professional Regatta was sailed, all the entries being the same as in the last, except MINNIE in the 4th class. The winners were NATHALIE C., sailed by J. Collins; NIPHAS, sailed by R. B. Clemens; MAGGIE, sailed by A. Brewster; and MINNIE, sailed by C. Speller.

There were no more races this season owing to the yellow fever epidemic.

The Yacht Club House was commenced August 12, 1878, and was completed the following winter. The house is situated at West End, Lake Pontchartrain, La., built on piling over the water. It is a commodious structure, having ample room for entertaining the guests of the members, and all other conveniences, having cost, equipped and furnished, about \$12,000. The members were very proud of their handsome headquarters.

Second Class. OPEN SLOOPS.
Niphias Sailed by H. T. Howard
Puck " " A. J. Mitchell

Third Class.
Gipsy " " H. A. Maginnis
Maggie " " J. Henry Bohan
Mary A. " " L. H. Fairchild
Juanita " " Joe McNeil

Fourth Class.
Olivia " " Sam Gautier
Brenda " " Jedd Waterman
Clara F. " " A. K. Belknap

The winners, in their respective classes were NO NAME, SUSIE S., NIPHAS, JUANITA and OLIVIA.

Regattas were also held from the Club House May 28th, June 11th, and at Bay St. Louis, Pass Christian and Biloxi, Mississippi Sound.

On April 1, 1880, the following officers were elected: E. J. O'Brien, Commodore; A. A. Maginnis, Vice-Commodore; Edwin Harris, Rear-Commodore; A. H. Harris, Secretary; J. B. McConnell, Measurer. 468 members on the roll and 3 honorary members.

STANDING COMMITTEES APPOINTED FOR SEASON OF 1880 AND 1881.

House Committee: H. D. Hopkins, Chairman; J. B. Lalland, Arthur Claiborn, H. W. Brown, John Lawson.

Finance Committee: T. L. Airy, F. T. Howard, A. Frelsen.

Regatta Committee: William Walsh, Bertrand Beer, C. H. Smith.

Measurement Committee: C. L. DeFuentes, Joe McNeil, H. O. Benedict.

Prize Committee: A. Brewster, P. B. Canfield, Wm. Lynd.

This year the City Council by ordinance gave to the club that body of water between the Northwest Levee and the main land, as a harbor. The club had the harbor dredged and built two islands; they then bought a strip of land running alongside of the harbor, and on this land and the island the members built their boat houses.

At the Interstate Regatta it was agreed that if two foreign boats entered \$1,200 would be appropriated as a prize, and if three or more foreign boats entered \$1,500 would be appropriated.

A Regatta was held April 16, 1880. In the Sweepstakes Race the sloop ALBERTINE was the winner. A Regatta was held May 25th and the following yachts took part:

First Class. Sailing Master.
Lady Emma J. Carney
Albertine A. Brewster
Puck and Luck Antoine Ryan
Cydus Edwin Harris
Startle B. R. Clemens

LADY EMMA WON.
At the Regatta which took place May 28th the following yachts participated:

Second Class. Marsh Fowler
Niphias Carlos Speller
Puck John Clemens
Phantom John Carney
No Name

PHANTOM WON.

Third Class.
Juanita Bob Dollbear
Gipsy Tom Ryan
Maggie Martin Greun

GIPSY WON.

The next Regatta was sailed June 7th the following yachts starting:

Cydus Edwin Harris
Lady Emma Sam Gautier
Albertine A. Brewster
Startle E. J. O'Brien

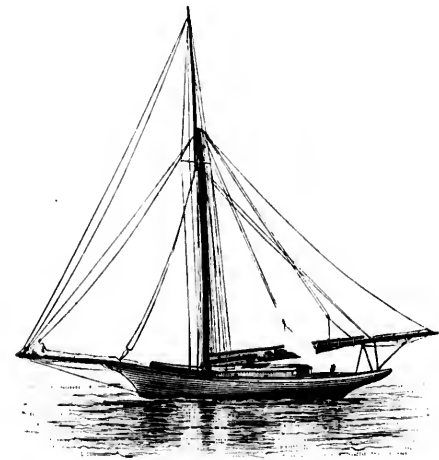

LADY SARAH.—FIGURE 411.

The yachting season of 1879 was a very successful one as renewed life was given, and the club had a membership of over six hundred. The officers elected at the annual meeting were: Commodore, Emile J. O'Brien; Vice-Commodore, H. Raveshide; 2nd Vice-Commodore, E. L. Israel; Secretary, Owen Jamison; and Treasurer, J. B. McConnell.

A Corinthian Regatta was sailed May 25, 1879, and the following yachts participated:

	CABIN SLOOPS.	
Zoe	sailed by	G. W. Nott
Zephine	" "	E. M. Vallette
No Name	" "	R. Brewster
La Belle	" "	C. B. Keep.

	OPEN SLOOPS.	
First Class.		Emile J. O'Brien
Susie S.	sailed by	J. B. McConnell
Pluck and Luck	" "	G. V. McNeil
Lady Emma	" "	Edwin Harris
Cydus	" "	A. Brewster
Linnas	" "	

W. T. Boardman
G. V. McNeil
Emile J. O'Brien
A. Claiborn

J. E. Austin
J. Henry Bohan

A. A. Maginnis
E. B. Hopkins
Joe McNeil
E. Harris
R. Brewster

The race was declared off on account of the ALBERTINE fouling the CYDNUS at the eastward stake boat. CYDNUS and STARTLE fouled each other near the home stake and LADY EMMA fouled the eastward stake boat. All bets and pools were declared off.

At the regatta held June 16th in the second class boats, NO NAME (RUBY) was the winner, and in the third class GIPSY won. On June 30th, the race for the Challenge Cup took place and ALBERTINE won. In the cabin sloops the following yachts started:

	Owner.
Linwood	A. A. Maginnis
Zoe	E. J. O'Brien
Claborn	A. Claiborne
La Belle	R. B. McCutchen.

LA BELLE was the winner.

On April 7, 1881, the following officers were elected:

A. A. McGinnis, Commodore; Edwin Harris, Vice-Commodore; Harry T. Howard, Rear-Commodore; Arthur H. Harris, Secretary; and J. B. McConnell, Measurer.

The Interstate Regatta was ordered to take place June 30th. The following were the entries:

	Owner.
Silence	Capt. Ira Smith, (N. Y.)
Lady Emma	E. L. Israel
Pluck and Luck	J. B. McConnell
Albertine	Alex. Brewster
Cydnus	E. H. Harris
No Name	Paul DeFuentes
Daisy	R. L. Robinson

A regatta was sailed May 24, 1881 and the following yachts participated.

First Class.	Owner.	Sailing Master.
Lady Emma	E. L. Israel	John Barney
Cydnus	Edwin Harris	Edwin Harris
Albertine	A. Brewster	A. Brewster

ALBERTINE was the winner.

CABIN YACHTS.

Linwood	A. A. McGinnis	A. A. McGinnis
Zoe	E. J. O'Brien	E. J. O'Brien
Gov. Claborn	A. Claiborn	A. Claiborn

The yacht GOV. CLAIBORN was disqualified for violation of the Sailing Rules, and ZOE was declared the winner.

A race was sailed May 26th, JUANITA, MAY and GIPSY competing. JUANITA was the winner. On May 27, 1881, RUBY and PHANTOM raced. The former won. A regatta was sailed on the 31st of May. In the first class were ALBERTINE, and CYDNUS. ALBERTINE won. In the second class PHANTOM and RUBY competed. RUBY won.

At the regatta sailed June 23d, the cabin yachts LINWOOD and ZOE started. ZOE was the winner. In the fourth class MAY, GIPSY, and JUANITA started, and GIPSY won. A race was sailed between MEPHISTO, A. Brewster, and PLUCK-AND-LUCK, John Carney, on June 25th MEPHISTO won.

The Challenge Cup Race was attempted on June 28th, CYDNUS, GIPSY, ALBERTINE and PLUCK-AND-LUCK starting, but as it was growing quite dark before the match was finished, the race was postponed to July 9th.

The Interstate Regatta, the entries of which have been previously given, was sailed as appointed, on June 30th. LADY EMMA was the winner.

The postponed race for the Challenge Cup was again declared off on account of the darkness, on July 9th. It was therefore postponed to July 21st, but at that time there was only one entry and consequently no race.

A Sweepstakes Race was sailed August 11, 1881. CYDNUS was sailed by E. J. O'Brien, and SILENCE by Alex. Brewster. SILENCE won the first prize, and CYDNUS won the second.

These were the officers elected for 1882: A. A. Maginnis, Commodore; Edwin Harris, Vice-Commodore; H. T. Howard, Rear-Commodore; A. H. Harris, Secretary; and J. B. McConnell, Measurer. The First Regatta this year was sailed June 6th, the following yachts participating: The catamarans NIP-AND-TUCK, ULLMAN and BOONMAN, and the cabin sloops EVELYN, LA BELLE, and REAVA. The winners were NIP-AND-TUCK and REAVA.

At the Regatta June 27, 1882, these yachts started:

Gipsy	sailed by	S. Gautier
Pluck-and-Luck	" "	John Carney
Mephisto	" "	A. Brewster
Ruby	" "	J. B. McConnell

PLUCK-AND-LUCK won.

At the Regatta, held June 29th, LADY EMMA won from SILENCE in the first class; and in the class for cabin boats LA BELLE won

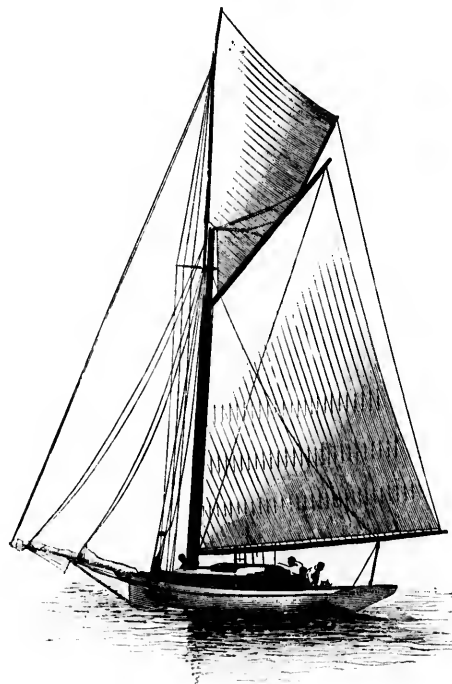

MONTAUK.--FIGURE 412.

from LINWOOD, ZOE and EVELYN. A Sweepstakes Race was sailed July 1, 1882, between LADY EMMA and SILENCE. LADY EMMA won the first prize and SILENCE the second.

The officers of the past year were re-elected for 1883.

A regatta was sailed June 19, 1883, and the following yachts started.

First Class.	Third Class.	Cabin Boats.	Cat-Rig.
Hattie	May	La Belle	Sappho
Silence	Anita	Zoe	Mamie B
		Linwood	Evelyn

SILENCE, ANITA, LA BELLE, and SAPHO were the winners.

A race for the Challenge Cup was sailed June 26th, SILENCE captured between the north and east stake, and the race for the Challenge Cup was declared off for the year.

Maginnis, Commo-
ward, Rear-Com-
Connell, Measurer.
o following yachts
ALMAN and BOARD-
nd REAVA. The

ed :
Gautier
in Carney
Brewster
B. McConnell

on from SILENCE
s LA BELLE won



s Race was sailed
LADY EMMA won

83.
following yachts

at-Rig.
appho
lante B
velyn
ie winners.
th, SILENCE cap-
for the Challenge



NANCY.

PLATE I. II.

THE YACHTS AND YACHTING

The Yacht Club of New York City, which was organized in 1843, is the oldest and largest of the yacht clubs in the United States. It has a membership of over 1,000 and owns a fleet of over 100 yachts. The club is located in the city of New York and has a clubhouse on the East River. The club is known for its regattas and races, and it is a member of the International Yacht Union.

The Yacht Club of New York City is a member of the International Yacht Union, which is a world-wide organization of yacht clubs. The club is also a member of the New York State Yacht Association, which is a state-wide organization of yacht clubs. The club is known for its regattas and races, and it is a member of the International Yacht Union.

The Yacht Club of New York City is a member of the International Yacht Union, which is a world-wide organization of yacht clubs. The club is also a member of the New York State Yacht Association, which is a state-wide organization of yacht clubs. The club is known for its regattas and races, and it is a member of the International Yacht Union.

The Yacht Club of New York City is a member of the International Yacht Union, which is a world-wide organization of yacht clubs. The club is also a member of the New York State Yacht Association, which is a state-wide organization of yacht clubs. The club is known for its regattas and races, and it is a member of the International Yacht Union.

The Yacht Club of New York City is a member of the International Yacht Union, which is a world-wide organization of yacht clubs. The club is also a member of the New York State Yacht Association, which is a state-wide organization of yacht clubs. The club is known for its regattas and races, and it is a member of the International Yacht Union.

The Yacht Club of New York City is a member of the International Yacht Union, which is a world-wide organization of yacht clubs. The club is also a member of the New York State Yacht Association, which is a state-wide organization of yacht clubs. The club is known for its regattas and races, and it is a member of the International Yacht Union.

R;
S;
ar-
R.

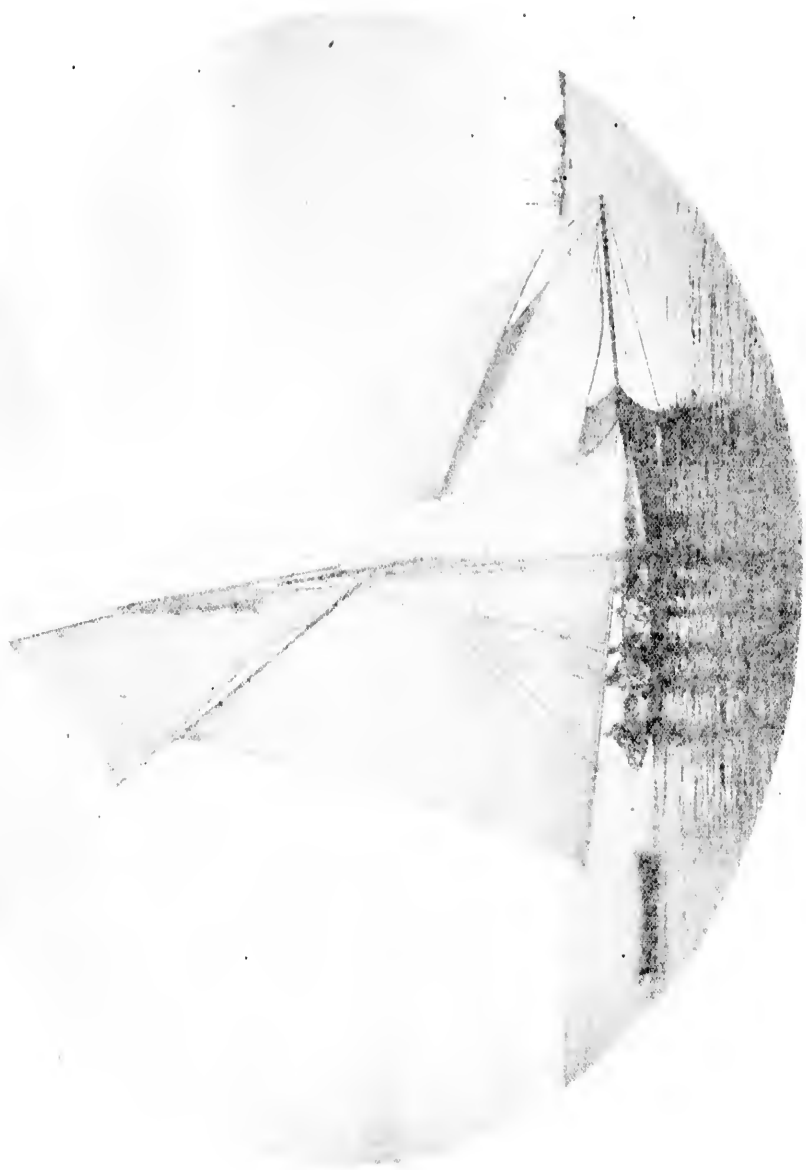

I
y
d
w
th
th
A
do
se
sh
me
S
S
S
C
T
ele
reg
pic
own
A

The following officers were elected for 1884: C. T. Howard, Commodore; E. J. O'Brien, Vice-Commodore; Alex. Brewster, Rear-Commodore; H. P. Hopkins, Secretary, and J. B. McConnell, Measurer. At a special meeting of the club held May 27, 1884, Mr. C. T. Howard resigned as Commodore, and Mr. E. J. O'Brien was elected to take the office with Mr. H. D. Hopkins as Vice-Commodore.

At another special meeting of the club held June 15, 1884, the SOUTHERN YACHT CLUB was dissolved, a new charter was adopted, and the old officers were re-elected, with Mr. E. J. O'Brien as Commodore, and Mr. H. D. Hopkins as Vice-Commodore.

A regatta was sailed on June 26, 1884, with the following boats starting:

Schooners.	Cabin Boats.	
F. W. Elmer	Linwood	
Cellina	Zoe	
Thunderbolt	Violet S.	
	La Belle	
	CAT-BOATS.	
Contland	Dora D.	M. S.
Carrie V.	Elvira	Katie
Evelyn	Minnie S.	

F. W. ELMER, ZOE and DORA D. were the winners.

There being no entries for the Challenge Cup Race on June 24th, the race was declared off for the year.

The officers elected for 1885 were as follows: E. J. O'Brien, Commodore; A. Brewster, Vice-Commodore; Chas. D. Schmidt, Rear-Commodore; H. P. Hopkins, Secretary; J. B. McConnell, Measurer.

A regatta was sailed June 21, 1885. The following yachts started:

Cabin Boats.	Schooners.	Cat-Boats.
Annie M.	Rosa Astredo	Carrie V.
Zoe	Viola	Evelyn
Katie	Mascot	May
Violet S.		Juanita

ANNIE M., VIOLA, and CARRIE V. were the winners. The Challenge Cup was also sailed for and won by MEFISTO.

The officers elected for 1886 were the same as those of the previous year, except that Mr. Joseph Mareneovitch was elected Rear-Commodore in the place of Mr. Chas. D. Schmidt.

A regatta was sailed June 29th, and these yachts won: MEFISTO won the Challenge Cup, ANON won the cabin boat prize, GIPSY won the sloop prize, HOPE won the schooner prize, and CARRIE V. won the cat-boat prize.

The officers elected for 1887 were: E. J. O'Brien, Commodore; Alex. Brewster, Vice-Commodore; C. P. Richardson, Rear-Commodore; Frank M. Hall, Secretary; Hugh M. Brown, Measurer. The schooner FROLIC having been bought by the members of the club, she was presented to the club as a pleasure schooner, at the regular meeting.

A Regatta was sailed June 28th, the following yachts winning:

Sloop MEFISTO won the Challenge Cup.
Sloop SUSIE B. won the cabin boat prize.
Schooner FROLIC won the schooner prize.
Sloop YOLANDE won the sloop prize.
Cat-boat DORA D. won the cat-boat prize.

The same officers, with the exception of the Commodore, were re-elected for the year 1888. The Commodore was R. S. Day. At the regular meeting, it was resolved that all races sailed under the auspices of the club should be Corinthian races, unless agreed to by owners after a written application being served upon the Commodore.

At a regatta sailed May 17, 1888, the following yachts started:

Schooners.	Sloops.	Cat-boats.
Emma Hand	Edith	Carrie V.
Excelsior	Zoe	La Belle
Camille	Susie B.	Mayflower
Civeno		Dora D.
H. T. Howard		Evelyn
F. W. Elmer		

H. T. HOWARD, MAYFLOWER and SUSIE B. were the prize winners. The next regatta was sailed June 5th, and the following yachts took part.

Schooners.	Cabin Boats.	Open Boats.	Cat-Boats.
Viola	Stella	Lady Sarah	Minnie O
Frolie	Zoe		Dora D.
	Susie B.		Pansy
			St. John
			Fatua

VIOLA, SUSIE B., LADY SARAH and FATUA were the winners.

The race for the Challenge Cup was sailed June 28th; SUSIE B., STELLA, ZOE and EDITH L. started. EDITH L. won the cup. SUSIE B. not having complied with the terms and conditions of the race, using her racing sails instead of her cruising sails, as agreed upon, was ruled out.

THE SEASON OF 1889.

All the officers of the club were re-elected. The Annual Regatta was sailed June 4th, these yachts starting:

Schooners.	Cabin Sloops.	1st Class Sloops.	2d Class Sloops.	Cat-Boats.
Pickwick	Edus	Minnie	Lady Sarah	Carrie V
Hope	Stella	Chie	Lucille	Eden
Viola	Edith			Evelyn
Louisa B.	Zo			St. John
				Pansy
				La Belle

HOPE, STELLA, LADY SARAH and EDEN were the winners. There was no race for the first class sloops.

The next regatta was sailed June 6th. The yachts which started were:

Cabin Sloops.	1st Class Sloops.
Stella	Minnie
Edith	Chie
Zoe	
Edus	

STELLA and MINNIE were the winners.

A race was sailed June 13th between STELLA, ZOE and EDITH. ZOE won. On July 4th a race was sailed between ZOE, STELLA and MINNIE, in which STELLA came in first.

The Fall Regatta was sailed September 7th, and the following yachts started:

Sloops	Cat-Boats.
Nepenthe	Eden
Stella	St. John
Susie B.	Evelyn
Zoe	Pansy
Minnie	

SUSIE B. and EDEN were the winners. STELLA was dismantled.

THE SEASON OF 1890.

The same officers were re-elected. The Annual Regatta was sailed June 3d. The following yachts started:

Cabin Sloops.	Working Schooners.	Open Sloops.	Cat-Boats.
Minnie	Elmer	Gitana	Minnie S.
Zoe	Grogier Cerino	Isabel	C. V. Servazin
	Chasseur		St. John
	Gerdes Bros.		Juanita
	Dr. Franklin		

ZOE, GITANA, GERDES BROS. and ST. JOHN, were the winners.

A Second Regatta was sailed June 26th. The following were the yachts taking part:

Sloops	Cat-Boats
Zoe	St. John
Minnie	Mayflower
	Evelyn
	C. E. Servazin
	Minnie
	Carrie V.

ZOE won the Challenge Cup Race. EVELYN won the race for cut-boats.

THE SEASON OF 1891.

The officers elected were: Commodore, R. S. Day; Vice-Commodore, A. Brewster; Rear-Commodore, C. P. Richardson; Secretary, F. M. Hall; Measurer, H. W. Brown.

The Annual Regatta was sailed June 2d, and the following yachts started.

Schooners.	Working Schooners	Sloops.
Folly	Mabel E. Judlin	P. B. Canfield
Hope	Annie H.	Bella S.
Susie H.	Schacaluga	
Viola	Menard Bros.	
Gertie	Fred. Gross	
	Chasseur	
	Elmer	

HOPE won the first, and FOLLY the second prize in the schooner class. MABEL E. JUDLIN won the first and CHASSEUR the second prize in the working schooner class. P. B. CANFIELD won the sloop prize.

Cut-boats.	Luggers.
Mayflower	R. Romano
St. John	Josephine
Lurie	Happy Joe
No Name	
C. E. Servazin	
Minnie S.	

MAYFLOWER, ST. JOHN and MINNIE S. won the first, second and third prizes, respectively. In the luggers, R. ROMANO won the first prize, and HAPPY JOE the second.

The Challenge Cup Race was sailed June 25th between STELLA, NEREUS and ZOE. STELLA won.

THE SEASON OF 1892.

The officers elected were: Commodore, W. A. Gordon; Vice-Commodore, Alex. Brewster; Rear-Commodore, R. S. Day; Secretary, F. M. Hall; Measurer, H. W. Brown.

The Annual Regatta was sailed June 7th, the start being made about 3:15 o'clock. The wind was from the southwest with a velocity of five miles per hour. The following yachts started:

SCHOONERS.			
	Owner.	Sailing Master.	Length.
Folly	Day & Lyons	M. S. Bringier	50.
Hope	Cobb & Kelly	P. J. Kelly	
Gertie	C. A. Lindaur	C. A. Lindaur	
Viola	S. F. Heaslip	C. F. Heaslip	
Elapsed Time.	Allowed Time.	Corrected Time.	
U. M. S.	M. S.	U. M. S.	
3 47 27	6 47	3 44 27	
3 39 27	5 42	3 32 40	
3 42 15	8 52	3 33 23	
3 34 51	8 58	3 15 53	
SLOOPS.			
Boat.	Owner.	Sailing Master.	
Montauk	P. Labouisse	Sam. Gautier	
Nepenthe	C. P. Richardson	A. Brewster	
	5 02		
3 20 32		3 20 32	
30 to 40 feet.			
Nereus	C. K. Hall	C. K. Hall	
Zoe	H. W. Brown	W. A. Gordon	
3 43 12		3 43 12	
3 34 40	6 26	3 28 14	
20 to 30 feet.			
Lady Emma	N. E. Baumgarten	N. E. Baumgarten	
Silence	P. Labouisse	Ed. Gautier	
Nyanza	Stone, Ranlett & Co.	F. Leavy	
Gypsy	J. W. Glenny	J. W. Glenny	

Elapsed Time.	Allowance.	Corrected Time.
U. M. S.	M. S.	U. M. S.
3 46 44	17	3 46 44
3 34 14	5 15	3 28 59
3 30 20	8 20	3 30 57

WORKING SCHOONERS.

Boat.	Owner.	Sailing Master.
Menard Bros.	A. Menard	Henry Scott
Electricity	John Lusch	F. Caspolicch
Queen of the Fleet	W. N. Johnson	T. Somers
Elmer	Jos. Christian	Jos. Christian
Bella Falconada	F. Bouanno	F. Bouanno
Coquette	H. L. Carson	J. Malloott
Philomena S.	J. M. Gierles	J. Barringer
Elizabeth D.	G. H. Dunbar	
	6 23	
3 34 00	12 13	3 25 47
3 37 48	13 40	3 24 02
3 47 14	19 37	3 27 23
	23 43	

CAT-BOATS.

Boat.	Owner.	Sailing Master.
Mayflower	Fred Smith	Fred Smith
St. John	C. J. Norcross	C. Michel
Minnie S.	C. Speller	L. Carlos
Celia H.	M. Aborlich	M. Aborlich
Royal Fleet	F. Bennich	L. C. Johnson
	3 15	
	10 45	
	11 05	
	20 33	3 22 07

The judges certify that the following boats won in their respective classes: VIOLA, NEPENTHE, ZOE and NYANZA, and that in the working schooner class, QUEEN OF THE FLEET won the first prize and ELECTRICITY the second prize. In the cat-boat class, ROYAL FLEET and MAYFLOWER won the first and second prizes, respectively.

The judges were: A. K. Miller, Richard Francis and E. L. Cope. The timers were: H. Bonnabel, A. M. Ancoim and Wm. Lynd, Jr.

The next regatta was sailed August 18th, the following yachts starting:

SCHOONERS.

Boat.	Owner.	Sailing Master.
Folly	L. Lyons	E. J. O'Brien
Adrienne	W. A. Gordon	W. A. Gordon
Gertie	C. Lindauer	C. Lindauer
Louisa B.	Peter Blaise	H. Dressel
Gertie Bros.	A. P. Williams	F. Malloche
Viola	Sam Heaslip	Sam Heaslip

CABIN SLOOPS.

Boat.	Owner.	Sailing Master.
Nepenthe	C. P. Richardson	Alex. Brewster
Montauk	P. Labouisse	D. Emile
Agnes	C. B. Penrose	C. H. Penrose
Zoe	H. B. Brown	C. P. Richardson
Volante	A. Fourchy	A. Fourchy

OPEN SLOOPS.

Boat.	Owner.	Sailing Master.
Lady Emma	E. Baumgarten	E. Baumgarten
Nyanza	D. L. Ferris	Sam. Gautier

VIOLA, NEPENTHE, and NYANZA were the winners in their respective classes.

The Annual Regatta of the SOUTHERN YACHT CLUB was held May 13, 1893, over a triangular course of 15 miles. Wind west north-west. Weather fair. Steam and Naphtha launches.

	Sailing Length.	Elapsed Time.	Corrected Time.
Sunbeam	35.03	1 13 54	1 13 54
Dora	30.00		
Chita	24.45	1 36 23	1 21 07
Idyle	27.01	1 28 50	1 16 50
Bijou	31.03	1 33 57	1 25 57
Cupid	22.05	1 34 19	1 17 49
Nancy	22.03	1 30 17	1 14 55

THE YACHTS AND YACHTSMEN OF AMERICA.

SCHOONERS			
	Sailing Length.	Elapsed Time.	Corrected Time.
	Ft.	U. S. S.	U. S. S.
Folly	50.00	3 26 31	3 26 51
Hope	42.03	3 46 57	3 41 00
Adrienne	40.35	3 08 27	3 08 00
Gertie	41.25	3 33 13	3 29 46
Nerius	39.08	3 40 10	3 40 10

SLOOPS.			
	Sailing Length.	Elapsed Time.	Corrected Time.
	Ft.	U. S. S.	U. S. S.
First Class, 40 to 50 feet.			
Nepenthe	50.63	5 19 18	5 19 18
Second Class, 30 feet and under 40 feet.			
Agnes	34.65	3 11 10	3 03 23
Florence	38.20	3 24 52	3 20 28
Montauk	43.45	2 56 40	2 56 40
Volante	33.00	3 27 15	3 18 17

Third Class, 25 and under 30 feet.			
	Sailing Length.	Elapsed Time.	Corrected Time.
	Ft.	U. S. S.	U. S. S.
Lady Emma	33.09	3 08 35	3 08 35
Mephisto	30.77	3 00 37	2 57 07

Fifth Class, 20 and under 22 feet.			
	Sailing Length.	Elapsed Time.	Corrected Time.
	Ft.	U. S. S.	U. S. S.
Augusta	not recorded.	Judges decided Augusta out of race.	
Lufklummer	28.08	3 11 00	3 11 00
Nyanza	26.00	3 01 33	2 58 00

Sixth Class, 18 and under 20 feet.			
	Sailing Length.	Elapsed Time.	Corrected Time.
	Ft.	U. S. S.	U. S. S.
Tonty	25.18	3 41 07	3 41 07
Bella S.	22.37	3 43 28	3 38 02
Nettie		disabled	

CAT-BOATS.			
	Sailing Length.	Elapsed Time.	Corrected Time.
	Ft.	U. S. S.	U. S. S.
Barton B.	22.01	3 30 05	3 25 50
Flavia	19.02	3 31 27	3 18 53
Alice	19.00	3 36 50	3 21 22
C. E. Servazin	10.00	3 27 27	3 21 53
Mayflower	28.00	3 16 50	3 16 59
St. John	26.00	3 34 23	3 31 11
Fannie		did not start	

A race for the Sully Cup for schooner yachts was sailed on May 20, 1893, without time allowance. The wind was from the northeast and the weather fair. Course, 44 miles.

The following yachts participated:

Folly	50.00	11 32 52
Hope	42.03	dropped out.
Adrienne	40.35	11 41 02
Gertie	41.25	dropped out.
Nerius	39.08	" "
H. P. Howard		" "

FOLLY won.

Judges: R. L. Robertson, Ed. L. Cope, Samuel Gautier. Timers: H. Bonnabel, F. W. Gustine, and H. L. Burton.

A race for the Walker Cup for open sloops was sailed on June 17, 1893. Wind north by east, and blowing at the rate of four knots an hour. Weather fair. Course, 15 miles.

Silence	33.08	3 58 42	3 58 42
Lady Emma	33.68		
Mephisto	30.72	3 22 52	3 19 03
Caprice	26.00		
Nyanza	26.06	3 32 50	3 23 18
Lufklummer	25.00		
Tonty	24.03		
Barton B.	23.01		

MEPHISTO won.

Judges: R. L. Robertson, R. S. Day, E. L. Cope. Timers: H. Bonnabel, A. M. Ancoin, N. L. Barton.

A race for the Littell Cup was sailed on August 12, 1893, over a 15 mile course. Wind southwest and weather clear. The following yachts took part:

	Rig	Sailing Length.	Elapsed Time.	Corrected Time.
		Feet.	U. S. S.	U. S. S.
Nepenthe	sloop	50.63	2 21 41	2 21 41
Adrienne	schooner	40.35	3 49 31	3 49 31
Gertie	"	41.25		
Agnes	sloop	34.65	3 32 34	3 19 20
Unprico	"	26.00	1 08 10	
Prosto	"		4 18 02	
Lufklummer	"		3 22 55	3 22 55
Nymphase	"		4 11 10	
Lady Emma	"	33.68		

Judges: R. L. Robertson, Emile O'Brien and E. L. Cope.

A race for the Brewster Cup was sailed September 9, 1893, over a 15 mile course. Wind west, one-half south, shifting to north at close of race. Weather fair. The following yachts were entered:

Nepenthe	30.63	3 55 31	3 55 31
Agnes	34.65	4 19 46	4 03 32

Judges: E. L. Cope and Emile O'Brien. Timers: James G. Ames, H. L. Burton and H. P. Lewphir.

After each regatta the club gives a promenade concert with refreshments at the Club House, for members' families and guests. Members' families and the different orphan asylums have the use of the club rooms for picnics. In the main hall is a piano where children can dance, and there is a lower gallery with stationary tables and seats where they can enjoy their lunch. There is an efficient janitor or club keeper on hand, and every one is always made as comfortable as possible.

Every season, about the first of July, the club's fleet goes on a cruise of about two weeks to the islands of the gulf where they meet several yachtsmen who were members before the war. There is only one of the original members alive, and that is Commodore Harry Rosehide, who is now a life member. He is seventy-five years of age, has good health, and still takes a great interest in yachting.

The club has now a regular annual meeting and election of officers on the first Thursday of April, and a semi-annual meeting on the first Thursday of December.

The affairs of the club are managed by a Governing Committee composed of five members with the Commodore, Secretary and Treasurer.

The complete list of officers for 1892 is as follows:

Commodore, W. A. Gordon; Vice-Commodore, Alexander Brewster; Rear-Commodore, R. S. Day; Secretary, Frank M. Hall; Measurer, Hugh W. Brown; Fleet Captain, C. P. Richardson; Fleet Surgeon, Dr. John B. Elliot.

Governing Committee: Chairman, C. L. DeFuentes; G. W. Booth, T. W. Campbell, C. K. Hall, L. O'Donnell.

Membership Committee: Chairman, M. S. Bringier; L. R. Garcia, Wm. Lynd, Jr., Blain Jamison, Emil Dupre.

Regatta Committee: Chairman, E. J. O'Brien, H. R. Lewis, A. M. Delavallade, R. M. Russell, L. C. Wilt.

Measurement Committee: Chairman, R. D. Scriven; P. S. Anderson, A. Gerdes, J. G. Canoe, J. A. Menge.

The officers for 1893 were:

Commodore, Thos. Sully; Vice-Commodore, Alexander Brewster; Rear-Commodore, L. O'Donnell; Treasurer, H. W. Brown; Secretary, F. M. Hall.

Governing Committee: James Rea, Wm. Lynd, Jr., M. E. Baumgarder, C. T. Yenni, H. O. Benedict.

Membership Committee: E. R. Van Wickle, E. L. Pinac, L. R. Garcia, J. M. Huger, Jr., M. J. Farrell.

Time.
44
50
57

Sailing Master.
Bry Scott
Caspolich
Someral
Christian
Bouanno
Mailloft
Barringer

17
09
22

Smith
Michel
Carlos
Aborleh
C. Johnson

their respective
d that in the
first prize and
ROYAL FLEET
actively.
and E. L. Cope.
m. Lynd, Jr.
following yachts

O'Brien
A. Gordon
Andauer
Dressel
Malloche
Heaslip

Sailing Master.
Brewster
Emile
Penrose
Richardson
Mourchy

Baumgarder
Gautier
their respec-

It was held
and west north-

Corrected
Time.
1 13 54

1 21 07
1 16 50
1 25 57
1 17 49
1 14 55

YACHTS ENROLLED IN THE SOUTHERN YACHT CLUB.

STEAMERS.

NAME.	REG.	OWNERS.	Custom House Tonnage.		Extreme Length.	Waterline.	Beam.	Depth of Hold.	Draft.
			Gross.	Net.					
Cora	Screw Schooner	John A. Morris	173.37	88.31	140.0	123.6	23.0	12.0	8.4
Judy	"	Frank T. Howard	44.90	27.30	102.3	86.0	11.8	7.0	6.0
Helen	"	Thomas Sully	0.0	4.7	81.5	55.0	10.3	4.6	4.0

KAYAK LAUNCHES.

NAME.	OWNERS.
Hijou	Kerchoff Bros.
Chitta	Richardson & Co.
Reckless	
Cupid	

SCHOONERS.

NAME.	C. H. OR K.	OWNERS.	Custom House Tonnage.		Extreme Length.	Waterline.	Beam.	Depth of Hold.	Draft.
			Gross.	Net.					
Adrienne	e b	Gordon & Lawrence	81.0	45.0	17.0	6.0	4.6
Folly	e b	H. S. Day	18.30	57.0	40.0	15.6	2.6
Viola		S. Hendip
Gerdes Mrs.		A. P. Williams
Maulo M.		Mengo Bros.
Gertie		C. A. Lindauer
Elizabeth		G. H. Dunbar
Louis B.		Peter Blaise
Hope	e b	Shaw & Betty	11.50	11.01	42.0	13.0	4.1	3.0
H. T. Howard		Harry T. Howard

SLOOPS.

NAME.	C. H. OR K.	OWNERS.	Custom House Tonnage.		Extreme Length.	Waterline.	Beam.	Depth of Hold.	Draft.
			Gross.	Net.					
Nerius	e b	C. K. Hall	7.42	7.06	35.0	13.0	3.0	3.4
Nepenthe	e b	C. P. Richardson	58.0	45.0	17.0	4.0
Montauk		Peter Labouisse
Stella		Beste, Bourje & Jos. Cunee
Silence	e b	Peter Labouisse	27.3	27.1	11.3	3.0	2.9
Susie B.	e b	W. P. Richardson	35.0	31.6	13.4	3.4	2.4
Zoe	e b	Hugh W. Brown	30.0	13.0	3.0
Edith L.		Peter Labouisse
Florence		L. O'Donnell
Lady Emma	e b	Baumgarten & Martinez	27.6	27.9	11.2	2.3	3.0
Mephisto		
Pluck & Luck	e b	Pierre Pontz	25.0	25.0	8.6	2.9	1.0
Ieva	e b	Harry T. Howard	28.0	28.0	11.4	3.0	1.4
Nynaza		Stoee, Huulett & Ferris
Barton B.		H. O. Benedict
Gypsy		Glenny Bros.
Hattie		D. A. DePass
Omega		H. B. Lewis

CAT-BOATS.

NAME.	OWNERS.
St. John	J. W. Glenny <i>et al.</i>
Little Commodore	B. S. Leathers

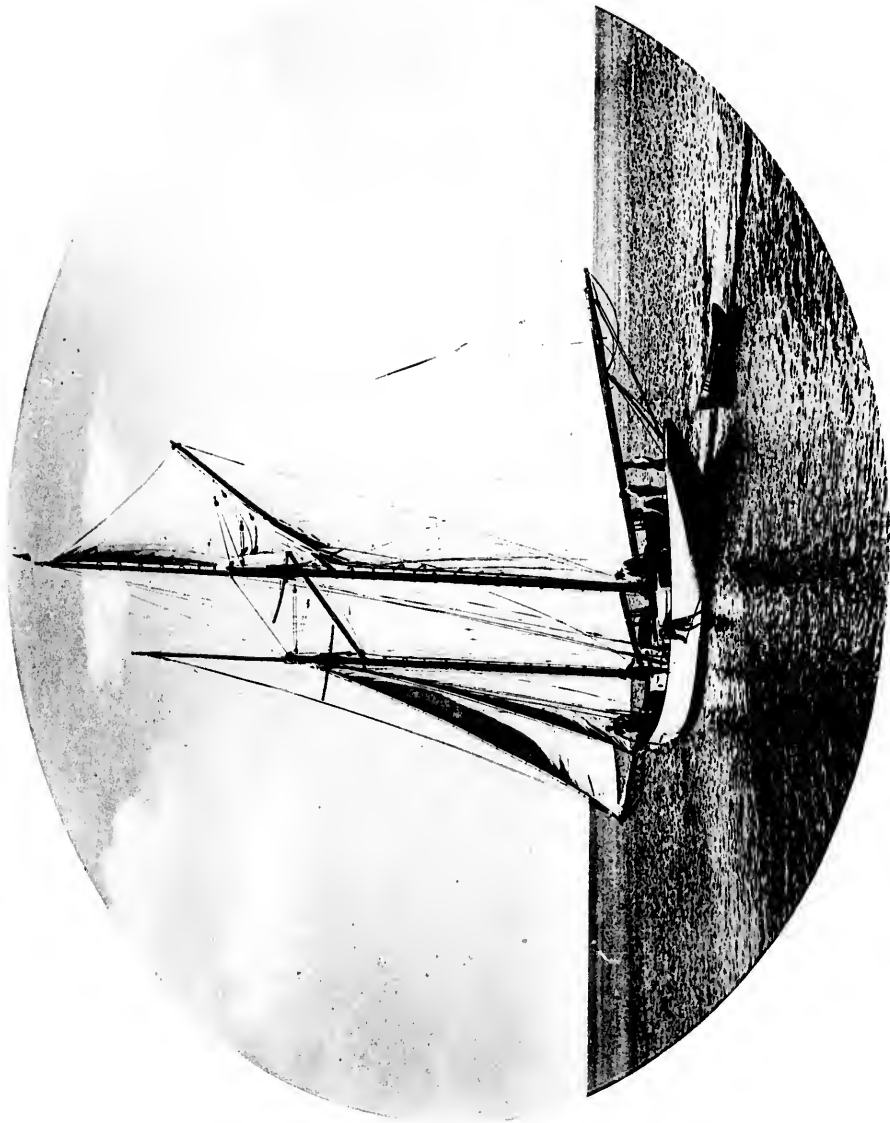

ADRIENNE.

PLATE LXXXI

[Faint, mostly illegible text at the top of the page, possibly a title or introductory paragraph.]

Thomas ...
 [Faint text block, possibly a name and title.]



[Faint text block, possibly a name and title, located to the right of the small portrait.]



[Large block of faint text at the bottom of the page, containing several paragraphs and possibly a list or index.]

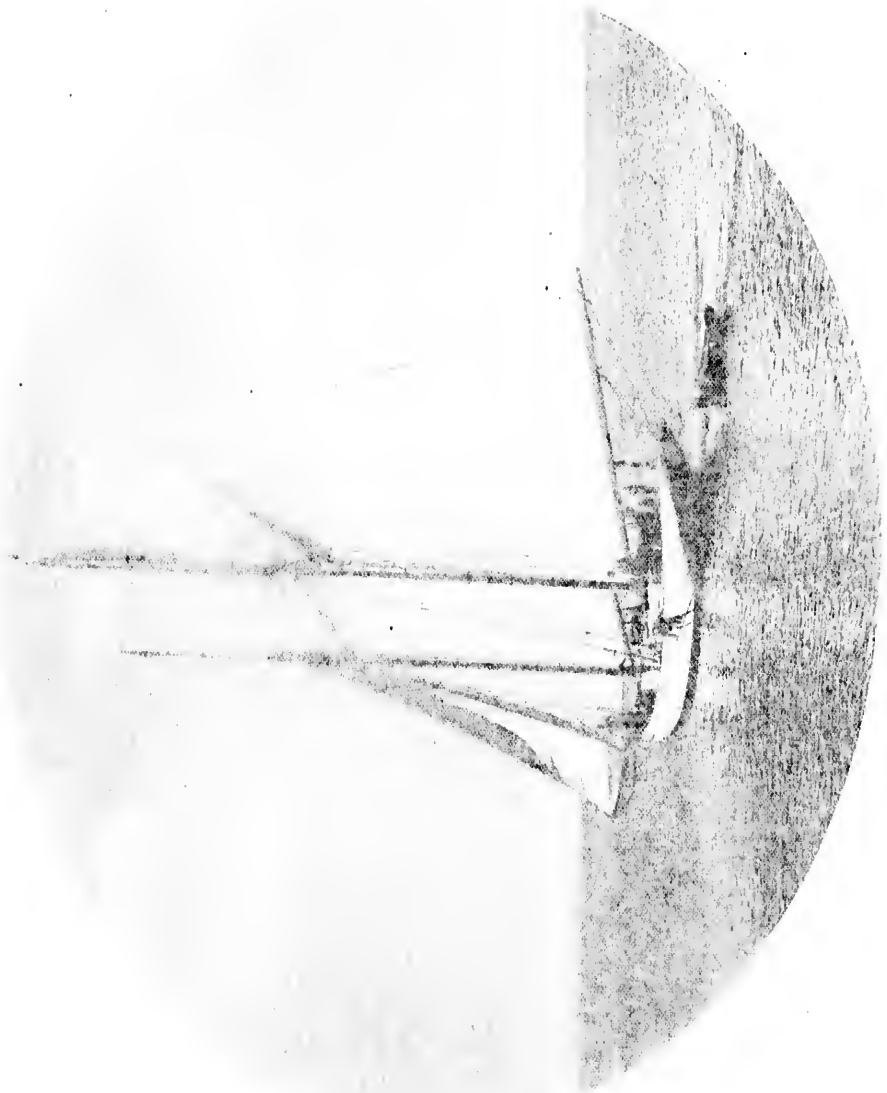

1812

BIOGRAPHICAL SKETCHES AND DESCRIPTION OF YACHTS ENROLLED IN THE CLUB.

THOMAS SULLY, architect, New Orleans, La., Commodore of the SOUTHERN YACHT CLUB, was born in Mississippi City, Miss., November 24, 1853, the son of G. W. Sully. He has owned the yachts **HELEN** (his present vessel) and the miphtha launch **RECKLESS**. He was captain of the fleet of the club in 1891. Has been interested in yachting for twenty years.

HELEN.

HELEN, owned by Thomas Sully of New Orleans, is a screw schooner. Was designed by Andre Fourchy and built by Fourchy Bros., New Orleans. Was launched in July, 1890, for her present owner. She hails from New Orleans and sails with the SOUTHERN YACHT CLUB. See Fig. 406.

DIMENSIONS.

Length over all,	92 feet.	Length load waterline,	55 feet.
Depth,	7 feet.	Draft,	4 feet 6 inches.
Beam,	10 feet.		

Engine: Horizontal compound, two cylinders, 6 and 10 in. x 9 inch. Chester Foundry and Machine Co., Chester, Pa.

Boiler: Roberts water tube, 5 x 4 x 4 feet.

**ROBERT S. DAY.**

ROBERT S. DAY, formerly Rear-Commodore of the SOUTHERN YACHT CLUB, born in Stonington, Conn., August 3, 1855. Now living in New Orleans, La. Of good old Puritan sea-faring stock; the son of James Ingersoll Day. Was for four years Commodore of the SOUTHERN YACHT CLUB. Is at present the owner of the reconstructed schooner **FOLLY** and has a part interest in the **ZOE**, besides being the owner of a number of smaller craft.

Rear-Commodore Day is a prosperous cotton merchant of New Orleans, and is a man who is thoroughly interested in all that pertains to this ever increasing pastime—yachting—having given to it during the past seventeen years much of his time and attention.

FOLLY.

The centerboard schooner **FOLLY** is the property of Robert S. Day, formerly Rear-Commodore of the SOUTHERN YACHT CLUB. She was designed and built by W. Cogan, New Orleans, La., and was launched in 1881. Formerly **PICKWICK**. Re-built in 1890 by John Thulan. She hails from New Orleans. See Fig. 407.

Official number, 150,216.

DIMENSIONS.

Length over all,	57 feet.	Length load waterline,	49 feet 9 inches.
Depth,	5 feet 2 inches.	Draft,	3 feet 6 inches.
Beam,	15 feet 6 inches.		

W. A. GORDON, ex-Commodore of the SOUTHERN YACHT CLUB, is a commission merchant of New Orleans, La. The son of George H. and Margaret Gordon, born Jan. 4, 1858. His present yacht is the schooner **ADRIENNE**, but he has also been interested in the sloop **ZOE** and the schooner **FOLLY**. The Commodore is one of

the shining lights of the SOUTHERN YACHT CLUB and he has been a devoted yachtsman for fifteen years.

ADRIENNE.

ADRIENNE is a centerboard schooner belonging to ex-Commodore W. A. Gordon and Westley E. Lawrence, of New Orleans, La. She was designed and built by Stewart & Binney for her present owners, and was launched in 1892 at Essex, Mass. She has a cabin, hails from

**EX-COMMODORE W. A. GORDON.**

New Orleans and sails with the SOUTHERN YACHT CLUB. See plate LXXXI.

Official number, 106,957.

DIMENSIONS.

Length over all,	61 feet.	Length load waterline,	45 feet.
Depth,	6 feet.	Draft,	4 feet 6 inches.
Beam,	17 feet.		

MONTACK.

MONTACK is a centerboard cutter owned by Peter Labouisse of New Orleans, La. She was formerly called **GEORGE C.** Was designed and built by William G. M. Reed, Brooklyn, N. Y., and was launched in 1887. Re-built and lengthened in 1891. **MONTACK** hails from New Orleans and sails with the SOUTHERN YACHT CLUB. See Fig. 409.

Official number, 85,967.

DIMENSIONS.

Length over all,	45 feet.	Length load waterline,	39 feet 11 inches.
Depth,	4 feet 5 inches.	Draft,	2 feet 6 inches.
Beam,	14 feet 5 inches.		



COMMODORE JOHN T. MOTT,

OSWEGO YACHT CLUB.

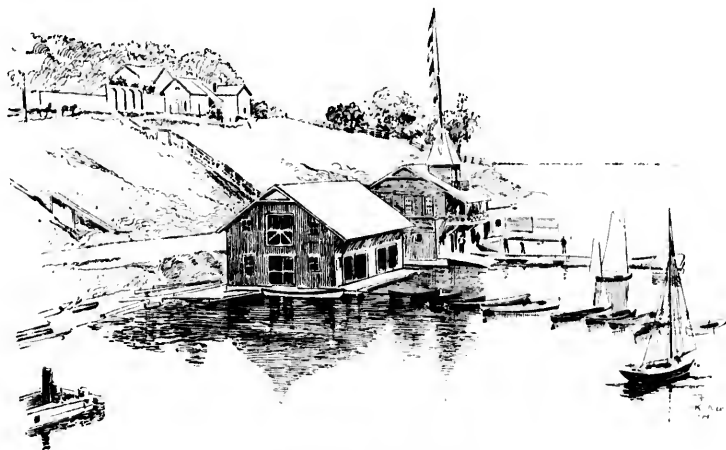

OSWEGO YACHT CLUB HOUSE.

History of the Oswego Yacht Club.

ON April 14, 1881, a number of gentlemen interested in yachting and boating met in the Doolittle House for the purpose of centering the interest in aquatic sports in a club. A committee was appointed to select a site and obtain plans and estimates of the cost of a boat house.

A Committee on Permanent Organization was also appointed.

Before the meeting adjourned it was decided to meet again in a week, to hear the reports of the Committees on Site and Permanent Organization.

At the meeting of April 21st, the Committee on Site reported that Mr. A. G. Cook had offered to allow the club to build a house on his property on the lake front, between 3d and 4th streets, the house to remain until he should wish to build there himself, when he would give the club a site further up the shore.

It was decided to accept Mr. Cook's kind offer.

At this meeting the Constitution for the club was drawn up, the Committee on Permanent Organization was accepted, and the following were elected officers for the first year: President, L. C. Kenyon; Vice-President, J. D. Higgins; Secretary, Frank Penfield; Treasurer, Delos S. Radcliffe; Directors, John T. Mott, W. B. Phelps, Jr., and D. M. Irwin.

Already fifty-five gentlemen had agreed to become members of the club, and at a subsequent meeting it was decided that the Executive Committee be empowered to contract for a house when the membership should reach seventy.

It was only a few days before the club had more than the number necessary to determine the question of its existence, and the Executive Committee contracted for a house to cost about \$700.

At a meeting of the club, held July 6th, the initiation fee for that season was fixed at ten dollars, and three months dues at a dollar a month added.

At this meeting Mr. A. G. Cook who had so generously offered a site for the Club House, was made its first honorary member.

In September, 1882, the organization which had heretofore been known as the OSWEGO BOAT CLUB became the OSWEGO YACHT CLUB, and in the following February was incorporated as such. The titles of the President and Vice-President were changed to Commodore and Vice-Commodore, the same gentlemen continuing in office.

At the meeting of December 19, 1882, the club decided upon a uniform and pennant for flag officers. A committee was appointed to draft new by-laws and to arrange for the publication of the first club book. It was also decided to adopt the Rogers' Code of Signals.

At the meeting of January 26, 1884, Commodore John T. Mott announced that he would present to the club a champion pennant, to be sailed for by the yachts of the club at the annual cruises and regattas.

In the Spring of 1885, the quarters of the club having become too small, it was decided to build in addition another house for the reception of row boats and dingies with a loft for lockers and the storage of spars, sails, etc.

In the Spring of 1889 the main house was repaired, and most beautifully decorated inside, thus making the club property very complete and attractive.

The anchorage of the club is off the Club House in the new harbor and is at all times safe. At a distance of six hundred feet from the shore there is sufficient depth of water for the largest yachts.

The club has now 179 members, with a fleet of 12 sailing yachts and 5 steam yachts.

The principal events of the club have been the Opening Cruise, the Annual Regatta, and Ladies' Day. These days are not fixed.

The officers of the OSWEGO YACHT CLUB for 1893 were: Commodore, John T. Mott; Vice-Commodore, Geo. B. Sloan, Jr.; Fleet Captain, J. M. Schuler; Secretary-Treasurer, W. B. Couch; Measurer, W. P. Judson; Fleet Surgeon, J. W. Eddy, M. D.; Directors, Allen Ames, J. D. Henderson, G. H. Sayward.

LIST OF YACHTS ENROLLED IN THE OSWEGO YACHT CLUB, 1893.

SAILING YACHTS.

NAME.	Centerboard or Keel.	OWNERS.	PORT.	Corrected or Sailing Length.	L. Y. R. A. No.	Extreme Length.	L. W. L.	Beam.	Draft.	Htg.	Where Built.	Builder's Name.	When Built.
Aileen	k	Robert Miles	Toronto	50.00	3	72 4	64 0	14 7	7 5	Cutter	Toronto, Ont.	M. Simpson	1882
Chestnut	k	C. P. H. Vary	Sodus Point	280	18 0	13 6	4 6	3 0	Sloop	Newark, N. Y.	C. P. H. Vary	1888
Cinderella	e b	Rufus K. Dryer	Charlotte	57.00	217	63 3	52 0	16 0½	6 8	Cutter	Pottery Bench, N. Y.	H. Plejgras	1886
Cygnat	e b	T. H. McGaw	Toronto	47.03	18	50 0	42 0	15 6	4 0	Sloop	Pamunapo, N. J.	P. McGlehan	1870
Gem	e b	John Parsons	Oswego	20.46	25 0	23 0	7 5	2 5	Yawl	Oswego, N. Y.	J. Smith	1880*
Katie Gray	e b	W. H. Phelps, Jr.	"	33.35	46	31 0	31 0	11 0	3 2	Sloop	Cobourg, Ont.	A. Cuthbert	1875*
Marjorie	k	H. D. W. Burt	New York	38 2	28 6	10 6	7 2	Cutter	So. Boston, Mass.	W. K. Pryor & Co.	1888
Onward	e b	H. K. Dryer, et al.	Charlotte	160	50 0	32 0	16 0	6 0	Sloop	Islip, N. Y.	A. E. Smith	1875
Papoose	k	John T. Mott	Oswego	42.47	172	44 0	37 0	12 1	7 9	Cutter	So. Boston, Mass.	G. Lawley & Son	1887
Ripple	k	T. H. Pritchard, Geo. Weldon	Charlotte	78	34 0	27 0	0 10	6 0	Cutter	Rochester, N. Y.	G. H. Nowell	1861
Volante	e b	J. M. Schuler, D. S. Radcliffe	Oswego	21.63	95	35 0	19 11	7 0	4 0	Yawl	Oswego, N. Y.	H. Morgan	1889
Yama	k	Allen Ames	"	32.90	155	50 0	36 0	9 2	9 0	Cutter	So. Brooklyn, N. Y.	H. C. Wintringham	1890

* Rebuilt 1891. + Rebuilt 1889.

STEAM YACHTS.

NAME.	OWNERS.	PORT.	Custom House Number.	Extreme Length.	L. W. L.	Beam.	Draft.	Where Built.	Builder's Name.	When Built.
Alba	W. H. Cogswell	Oswego	20.10	71 3	9 9	6 0	Oswego, N. Y.	Gable & Macfarlane	1885
Fiscen	W. H. Cogswell	"	78 8	78 0	9 9	3 3	City Island, N. Y.	A. H. Wood & Son	1893
Gffana	Geo. B. Slonn, Jr.	"	46 0	8 1	3 0	Auburn, N. Y.	Kingston & Co.	1889
Mascot	J. C. Smith	"	48 0	44 0	7 6	6 0	Alexandria Bay, N. Y.	A. C. Duclou	1893
Ruth	Switz Condé	"	28.31	80 0	72 7	13 6	4 6	Gutnden, N. J.	Ilyerly, Hillman & Straker	1882
Sigma	F. W. Chamberlain	Sodus Point	4.05	36 0	32 6	7 0	3 6	Alexandria Bay, N. Y.	A. C. Duclou	1889

RECORD OF SAILING EVENTS.

The First Annual Regatta of the club was sailed September 14, 1881. The course for the yachts in the first class was from the judges' boat anchored in the mouth of the harbor, two and a half miles east to a buoy and return, then two and a half miles north to a buoy and return, then two and a half miles west to a buoy and return, making a fifteen mile race.

The course for the yachts in the second class was two and a half miles east to a buoy and return, then two and a half miles north to a buoy and return finishing, making a ten mile race.

The wind was fresh from the northeast. The prizes in the first class were \$100, \$60 and \$30, ELLA taking first prize, EMMA second prize and FASCINATION third. The prizes in the second class were \$40, \$30, \$20 and \$10, and they were distributed to the yachts in the following order: FLORENCE, ADELAIDE, MIST and MAGIC.

The First Opening Cruise of the club occurred in June, 1882, the following yachts participating: ELLA, CRICKET, FASCINATION, VINEX, RHODA and LAURA. The wind at the start was fresh from the south and afterward hauled to the west, making considerable sea. After a few hours of unpleasant sailing with the wind ahead, the yachts arrived at their destination, Fair Haven, in the following order: ELLA, LAURA, CRICKET, RHODA, FASCINATION and VINEX. The yachts did not return together.

The First Regatta for the season 1882 was sailed July Fourth. The course for the first class was from an imaginary line drawn from the Club House pier to the new pier, thence to and around a buoy two and a half miles east, northeast, thence to and around a buoy north of the Club House outside of and near the new pier, thence to and around a buoy two and a half miles north, thence to and around a buoy near the new pier, thence to and around a buoy two and a half miles west and back to the starting line. The wind was light from the southeast. The time allowance was twenty seconds per ton.

The official record of the race is as follows:

	Start.	Finish.	Elapsed	Corrected
	H. M. S.	H. M. S.	H. M. S.	H. M. S.
Fascination	1 15 40		did not finish.	
Laura	1 14 35	4 41 05	3 26 30	3 27 00
Cricket	1 15 30	4 42 00	3 26 30	3 26 30
Ella	1 10 15	5 16 50	4 15 00	4 03 25

The Second Annual Regatta of the club was sailed August 22, 1882. The wind was from the north at the start, blowing at the rate of eight miles an hour and continued quite steady during the entire race. Never in the history of yachting on Lake Ontario had there been a fleet comprising so many fast yachts together at one time. The start was a flying one from an imaginary line drawn from the Club House pier to the new pier, thence to and around a buoy two and a half miles east, northeast. Thence to and around a buoy north of the Club House outside of and near the new pier, thence to and around a buoy two and a half miles north, thence to and around a buoy near the new pier, thence to and around a buoy two and a half miles west, thence to and around a buoy near the new pier, thence to and around a buoy two and a half miles north and returning to the starting line.

At the start GRACIE and GARFIELD came into collision and as a result GARFIELD was ruled out of the race.

The yachts that sailed in the race, and their official times, are as follows:

Cygnat	11 06 30	3 57 40	4 51 10	4 51 10
Garfield	11 07 05	3 30 30	4 29 25	4 25 15
Ella	11 04 45	3 51 00	4 49 05	4 42 00
Gracie	11 06 55	3 49 10	4 42 15	4 31 50
Laura	11 05 50	3 58 00	4 52 10	4 41 45
Katie Gray	11 06 25	3 29 30	4 23 05	4 12 15
Cricket	11 09 10	4 09 45	5 00 35	4 49 20

After the race, prizes amounting to \$200 were awarded as follows: KATIE GRAY first, GRACIE second, LAURA third, ELLA fourth.

The Third Annual Regatta of the club, was sailed August 28th, in a stiff breeze from the southeast. The course was the same as in the Second Annual Regatta, being about twenty miles. ELLA sprung a leak after rounding the North Buoy the first time and did not finish. The following is the record of the race:

Katie Gray	11 02 50	2 04 24	3 01 34	3 00 44
Cricket	11 01 00	2 06 20	3 05 20	3 03 34
Laura	11 02 41	2 10 32	3 07 51	3 07 51
Ella	14 02 28		did not finish	
Fascination	11 03 36		did not finish	

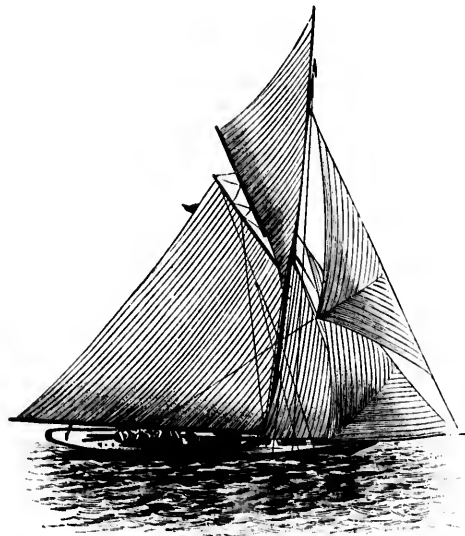

YAMPA.—FIGURE 413.

The official time was as follows:

	Start.	Finish.	Elapsed	Corrected
	H. M. S.	H. M. S.	H. M. S.	H. M. S.
First Class.				
Fascination	1 30 07	5 22 25	3 42 25	3 42 25
Ella	1 30 07	4 26 37	2 47 30	2 50 30
Emma	1 40 00	4 32 40	2 52 40	2 52 40
Lottie Blair	1 38 50		did not finish	
Second Class.				
Florence	1 59 20	4 09 00	2 09 40	2 10 00
Susie	1 59 10		did not finish	
Adelaide	1 59 00	4 20 20	2 21 40	2 21 40
Idler	1 59 00	4 30 30	2 40 30	2 40 30
Magio	1 59 05	4 20 00	2 29 55	2 29 35
Rival	1 58 30	4 45 45	2 47 15	2 47 15
Mist	1 58 20	4 24 45	2 26 25	2 26 45
Isabel	1 58 30		did not finish	

Yacht's Name.	When Built.
son	1882
Vary	1888
grus	1886
Jehan	1870
h	1880*
Albert	1875*
Pryor & Co.	1884
Smith	1875
ley & Son	1887
Rewell	1890
gan	1890
Vintringham	1890

Yacht's Name.	When Built.
Macfarlane	1885
ood & Son	1893
m & Co.	1889
nelson	1893
Hillman & er	1882
acion	1889

THE SEASON OF 1884.

The season was inaugurated with the Opening Cruise, including a race for the Champion Pennant presented by Commodore John T. Mott. The race was from Oswego to Fair Haven, but the cruise was to extend to Big Sodus Bay, fifteen miles further up the lake. During the race the wind was from the westward and there was a dense fog. The following boats participated: CRICKET, CYGNET, ELLA, LAURA and KATIE GRAY, getting away in the order named. The yachts arrived at Fair Haven in the order named: ELLA, CRICKET, CYGNET, KATIE GRAY, LAURA. On the next morning the cruise was continued to Big Sodus, there being a fine sailing breeze. The yachts returned on the day following.

The Fourth Annual Regatta was started July 30, 1884, but on account of lack of wind, the yachts could not finish in the required time and the race was postponed till the next day. The start was a flying one across an imaginary line, drawn from a point on the new pier opposite the Club House to a buoy inside of and near the pier, thence to and around a buoy three and one-half miles west northwest, thence to and around a buoy three and one-half miles northeast, three-fourths east, thence to the starting buoy. The yachts in the first class

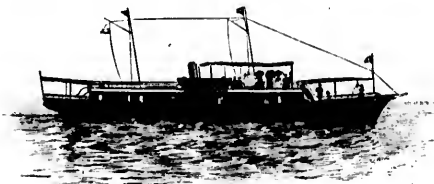

AIDA.—FIGURE 414.

sailed over the course three times, making a thirty mile race. The second class yachts sailed over the course twice, or twenty miles.

This was the first race of the LAKE YACHT RACING ASSOCIATION formed in the Spring of 1884 by the yacht clubs of Lake Ontario, under whose auspices all the regattas have since been sailed. The wind at the start was from the southwest and blowing a gale. About two o'clock a severe squall came down the lake accompanied by rain. Several yachts were blown to leeward of the harbor and had to be towed back.

The yachts competing, and the sailing times were as follows:

	Start.	Finish.	Elapsed Time.	Corrected Time.
	H. M. S.	H. M. S.	H. M. S.	H. M. S.
First Class.				
Aileen	9 30 20	2 28 10	4 51 50	4 51 50
Verve	9 35 25	3 38 00	6 02 35	5 41 35
Gartfeld	9 31 30		did not finish	
Second Class.				
Iolanthe	9 51 30	1 49 10	3 57 40	3 57 40
Katie Gray	9 52 20	2 44 00	4 51 40	4 47 23
Laura (Kingston)	9 51 05	3 09 05	5 15 00	5 13 24
Laura (Oswego)	9 51 05		did not finish	
Fascination	9 52 15		" "	
Gracie	9 52 50		" "	
Zeta	9 57 32		" "	
Cricket	9 54 50		" "	

KATIE GRAY won the Champion Pennant, being the only boat of the OSWEGO YACHT CLUB that covered the entire course

THE SEASON OF 1885.

Was inaugurated by the Opening Cruise on Decoration Day, the point of destination and the termination of the Pennant Race was

Big Sodus. The yachts got away about 9:30 in the morning in the following order: FASCINATION, FANNIE F., LAURA, CRICKET, ELLA, KATIE GRAY, ETHEL. ETHEL was the first to finish; time 3 hrs., 5 min., 32 sec. Then came LAURA, time 3 hrs., 11 min., 32 sec. Next came KATIE GRAY; time 3 hrs., 13 min., 58 sec. Then came FASCINATION, time 3 hrs., 17 min., 49 sec. CRICKET carried away her topmast, and ELLA had trouble with her board, both having to be towed. The time of FANNIE F. was not taken. The yachts returned during the following day.

The Fifth Annual Regatta was sailed August 4th, and was somewhat uninteresting for lack of wind, the yachts barely finishing within the required time, which was seven hours for the first class and five hours for the second class. Although nine o'clock was the time fixed for the start, owing to the fog and lack of wind it was eleven o'clock when the boats got away. The first class yachts sailed over a ten mile course three times and the second class over the same course twice. The wind was light from the northeast at the start but afterward changed to the northwest, but did not increase much in force.

The official record is as follows:

	Start.	Finish.	Elapsed Time.	Corrected Time.
	H. M. S.	H. M. S.	H. M. S.	H. M. S.
First Class.				
Atalanta	11 01 38	5 35 00	6 33 22	6 33 22
Aileen	11 03 30	7 19 00	8 05 40	7 58 24
Cygnat	11 03 30		did not turn last buoy	
Ethel	11 01 50		" "	
Gartfeld	11 00 20		time not taken	
Verve	11 03 30		did not finish	
Second Class.				
Laura (Kingston)	11 18 00	4 28 09	5 10 09	5 08 41
Iolanthe	11 17 45	4 38 45	5 21 00	5 21 00
Katie Gray	11 17 20	4 55 00	5 37 40	5 34 09
Laura (Oswego)	10 18 00		did not finish	
Fascination	11 18 00		did not finish	
Cricket	11 18 00		did not finish	
Fannie F.	11 18 00		did not finish	

The prizes were, for the first class \$150, \$75 and \$50, and for the second class \$100, \$50 and \$25.

ETHEL was the first boat of the club to finish the 20 mile course, and according to the conditions of this race, was awarded the Champion Pennant.

The Opening Cruise of 1886, which was started a few minutes past eight o'clock July 3d, was not a success as a sailing event, as the wind died away shortly after the start, and the yachts were towed to their destination, Charlotte. The pennant, accordingly, was still retained by ETHEL. Eight yachts participated in the cruise: AMADNE, KATIE GRAY, ELLA, CRICKET, CYGNET and LAURA. The yachts arrived at Charlotte the next morning at eight o'clock, and there being no wind were towed home the following morning.

The Sixth Annual Regatta of the club was sailed August 5, 1886. The start was a flying one across an imaginary line drawn from a point on the new pier opposite the Club House, marked by a flag, to a buoy outside of and near the pier, thence to and around a buoy bearing three and one-third miles west northwest, thence to and around a buoy bearing three and one-third miles northeast three-fourths east, thence to and around the starting buoy bearing three and one-third miles south one-half east.

First class yachts sailed over the course three times, making a thirty mile race.

Second class yachts sailed twice around the course, or twenty miles.

The prizes were for the first class \$100, \$60 and \$40. For the second class the prizes were \$75, \$50 and \$25. Five minutes were allowed for crossing the line, but every yacht in the race was handi-

the morning in the
LAURA, CRICKET,
first to finish; time
3 hrs., 11 min., 32
min., 58 sec. Then

CRICKET carried
board, both having
taken. The yachts

th, and was some-
s barely finishing
s for the first class
ne o'clock was the
ack of wind it was
first class yachts
econd class over the
e northeast at the
at did not increase

Sec.	Corrected
Time.	Time.
H. M. S.	H. M. S.

22	6 33 22
----	---------

40	7 58 24
----	---------

last buoy

"

"

"

"

"

"

"

"

"

"

"

"

"

"

"

"

"

"

"

"

"

"

"

"

"

"

"

"

"

"

"

"

"

"

"

"

"

"

"

"

"

"

"

"

"

"

"

"

"

"

"

"

"

"

"

"

"

00	5 08 41
----	---------

00	5 21 00
----	---------

40	5 34 00
----	---------

h

h

h

h

h

h

h

h

h

h

h

h

h

h

h

h

h

h

h

h

h

h

h

h

h

h

h

h

h

h

h

h

h

h

h

h

h

h

h

h

h

h

h

h

h

h

h

h

l \$50, and for the

the 20 mile course,
warded the Cham-

a few minutes past
ling event, as the
d the yachts were
t, accordingly, was
ed in the cruise:
SER and LAURA
; at eight o'clock,
owing morning.

ed August 5, 1886.
ne drawn from a
arked by a flag, to
nd around a buoy
st, thence to and
e northeast three-
uoy bearing three

times, making a

course, or twenty

d \$40. For the
e minutes were al-
e race was handi-

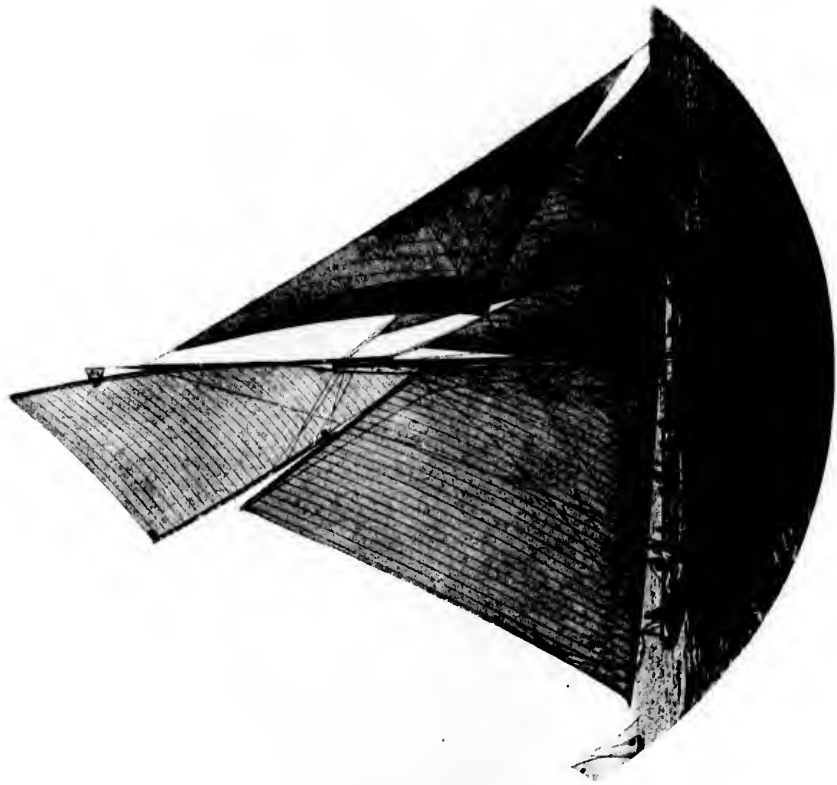

DINAH.

PLATE III.

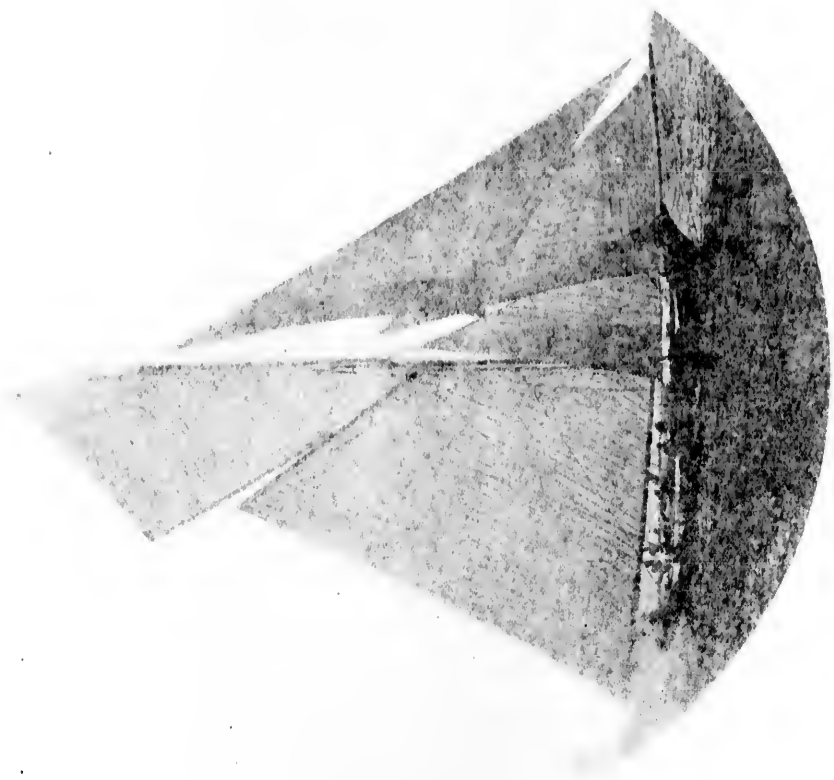

capped. The wind was stiff from the northwest with quite a sea running and it was all the yachts could do to carry lower canvas. During the night the west buoy had been carried away. This fact was not discovered until the leading yachts had lost some time trying to find it. The official time was as follows:

	Start.	Finish.	Elapsed.	Corrected.
	H. M. S.	H. M. S.	H. M. S.	H. M. S.
First Class.				
Atalanta	9 05 00	3 37 30	6 32 30	6 32 30
Aileen	9 05 00	3 51 30	6 46 30	6 46 57
Cygnat	9 05 00	4 08 10	7 03 10	6 47 27
Ethel	9 05 00	4 13 00	7 08 00	6 49 46
White Wings	9 05 00	4 18 00	7 23 45	6 56 31

	Start.	Finish.	Elapsed.	Corrected.
	H. M. S.	H. M. S.	H. M. S.	H. M. S.
Second Class.				
Iolanthe	9 20 00	3 46 20	5 26 20	5 26 20
Katie Gray	9 20 00	3 23 28	6 03 28	5 53 14
Mollie	9 20 00	3 30 40	6 10 10	5 07 10
Cricket	not timed			
Fascination	not timed			

The Opening Cruise for the season of 1887 was sailed May 28th to Big Sodus, where the ROCHESTER YACHT CLUB had arranged to meet the OSWEGO YACHT CLUB. There was a fine sailing breeze blowing from the northeast, which afterwards became very light, ARIADNE accompanied the yachts but as she was not an enrolled yacht her time was not taken. The sailing yachts were also accompanied by the steam yachts RUTH and AIDA.

The time of the cruise was as follows:

	H. M. S.	H. M. S.	H. M. S.	H. M. S.
Merle	1 22 30	5 13 00	3 51 30	3 50 27
Ella	1 23 24	5 13 30	3 51 06	3 51 06
Katie Gray	1 22 00	5 35 00	4 13 00	4 05 37
Laura	1 25 28	5 39 30	4 14 02	4 09 53
Cricket	1 22 10	5 41 00	4 19 50	4 08 42
Fascination	1 25 17	6 24 00	4 55 43	4 48 45



PHANTOM.—FIGURE 415.

The feature of the following day was a review of the yachts at 2 o'clock P. M., and a prettier sight was never seen on Big Sodus Bay. The yachts all returned on the next day, no time being taken. An event of considerable importance was the cruise of the club to Macdonald's Cove on July 2, 1887, which assumed the appearance of an international affair when they had all arrived, there being in the neighborhood of thirty yachts there from all over the lake. For lack of wind most of the yachts of the club towed over and back. The OSWEGO YACHT CLUB was represented by the steam yachts RUTH and AIDA, and the sail yachts MERLE, CRICKET, ELLA, KATIE GRAY, FASCINATION and LAURA.

The Seventh Annual Regatta was sailed August 1, 1887, with a good breeze from the south. The course was five miles to leeward and return. The Class A, and first class yachts sailed over the course three times, and the second class yachts twice. Shortly after the start, VERA carried away the jaws of her gaff and returned to the harbor. The finish between OUDER and ATALANTA was very exciting. After sailing thirty miles it was only a question of which should get to windward at the home buoy, but OUDER took the buoy by a hair. The contest between ALLES and ARIADNE was also very close. The prizes were as follows: Class A, \$75, and \$40; First class \$75, \$40, and \$20. Second class \$75, \$40, and \$20.

The time of the race was as follows:

	Start.	Finish.	Elapsed.	Corrected.
	H. M. S.	H. M. S.	H. M. S.	H. M. S.
Class A.				
Oude	9 01 00	1 17 25	4 18 25	4 11 22
Ariadne	9 04 05	1 30 50	4 32 45	4 33 05
Atalanta	9 05 00	1 17 30	4 12 30	4 12 38
Aileen	9 05 00	1 34 10	4 29 10	4 23 45

	Start.	Finish.	Elapsed.	Corrected.
	H. M. S.	H. M. S.	H. M. S.	H. M. S.
First Class.				
Ethel	9 13 00	2 29 38	5 16 38	5 15 09
White Wings	9 15 00	2 11 16	4 56 16	4 56 16
Garfield	9 13 18	2 13 54	5 00 36	4 51 52
Verve	9 15 00	did not finish		

	Start.	Finish.	Elapsed.	Corrected.
	H. M. S.	H. M. S.	H. M. S.	H. M. S.
Second Class.				
Iolanthe	9 20 38	4 30 58	5 10 20	5 10 07
Merle	9 21 14	4 27 52	5 06 38	5 06 08
Cyprus	9 21 50	4 06 05	5 41 15	5 38 17
Laura (K'g'n)	9 25 00	4 01 51	5 36 51	5 39 00
Vedette	9 25 00	4 37 27	5 12 27	5 56 43
Mollie	9 25 00	not timed		

The first sailing event of the season of 1888 was the Opening Cruise to Big Sodus on May 30th. The following yachts participated in the cruise: MERLE, CRICKET, ELLA and KATIE GRAY, also the steam yachts AIDA (the flag ship) and RUTH. The ROCHESTER YACHT CLUB was also found there. At four o'clock in the afternoon Commodore Macfarlane signaled the fleet to pass in review. The yachts passed the flag ship in the following order: MERLE, CRICKET, ELLA, and KATIE GRAY followed by the ROCHESTER fleet. The yachts maneuvered for almost an hour, after which they started for home at their own time.

The Eighth Annual Regatta was sailed July 20, 1888, the first and second classes sailing over the course three times, and the third class twice. The wind was fresh from the west. The only boat in the first class was ATALANTA but she was allowed to sail over the course and take the prize. The club offered the following prize: First class \$90, and \$50. Second class \$80 and \$40. Third class \$80, \$40 and \$20.

The yachts competing, and their times were as follows:

	Start.	Finish.	Elapsed.	Corrected.
	H. M. S.	H. M. S.	H. M. S.	H. M. S.
First Class.				
Atalanta	9 01 55	3 07 30	6 02 35	6 02 35
Second Class.				
White Wings	9 04 30	3 10 15	6 09 35	6 07 48
Cygnat	9 01 30	3 50 35	6 49 05	6 49 05
Madge	9 01 45	did not finish		
Third Class.				
Iolanthe	9 13 45	4 19 25	5 05 40	5 01 51
Merle	9 12 30	4 10 00	5 57 30	5 57 30

The Ninth Annual Regatta of the OSWEGO YACHT CLUB was sailed August 27, 1889, with a good breeze from the south, the start being made for the fifty foot class yachts at 10 o'clock, for the thirty-six and thirty foot classes at 10:10, and for the Special Class at 10:20. The course was five miles to leeward and return; three times around for the fifty foot class yachts, twice around for the thirty-six and thirty foot class, and once for the Special Race yachts, this class being for small boats of twenty-five feet waterline and under.

The prizes offered were as follows:

Seventy-five foot class \$60 and \$45; fifty foot class, \$60, \$45, and \$25; thirty-six foot class \$50, \$40, and \$20; thirty foot class \$30, \$15, and \$10. Special Race class \$20, \$10, and \$5. The seventy-five foot class did not fill. The struggle for second place in the thirty-six foot class between VISION and KATIE GRAY was the feature of the race, VISION succeeding in winning it by seventeen seconds.

The official time was as follows:

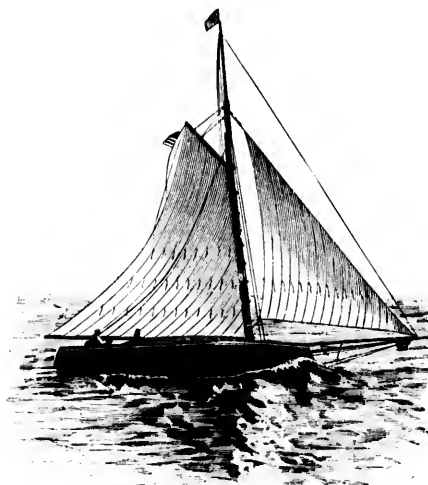

KATIE GRAY.—FIGURE 416.

	Start.	Finish.	Elapsed	Corrected
	H. M. S.	H. M. S.	Time.	Time.
	H. M. S.	H. M. S.	H. M. S.	H. M. S.
50 foot Class.				
White Wings	10 02 55	3 12 01	5 09 45	5 09 45
Verve (Chicago)	10 04 20	3 27 45	5 23 20	5 20 52
Verve (Toronto)	10 01 40	3 33 35	5 31 15	5 22 49
Madge	10 03 05	3 54 45	5 51 14	5 48 39
36 foot Class.				
Merle	10 13 35	1 25 20	3 11 45	3 11 45
Vision	10 10 40	1 39 20	3 28 45	3 25 06
Katie Gray	10 10 35	1 41 35	3 31 00	3 25 23

In the 30 foot class CYPRUS won, AMELIA being distanced. In the Special Race, VOLANTE, MAGIC, CORA, NADIA and FLEDA started. NADIA and FLEDA dropped out and the others finished in the following order: VOLANTE, MAGIC and CORA.

KATIE GRAY won the Champion Pennant of the club.

The Tenth Annual Regatta was sailed August 25, 1890, with a very light wind from the west; in fact, almost a calm during part of the race. The course was 5 miles to windward and return, the two largest classes sailing over the course three times, the next two classes twice and the smallest yachts once. The special feature of the race was the wonderful sailing of the 40-footer YAMA. She not only outsailed the boats in her own class, but on the completion of the second round was 11 minutes ahead of ORIOLE, the winner of the largest class. Perhaps the prettiest sight during the race was the finish between KATIE GRAY and GRACIE. The contest had been very close during the day between these two boats, but when they crossed the finish line it was difficult for the watchers on the pier to decide which crossed first, but KATIE GRAY won on corrected time. The prizes were for the Special Class \$50 and \$20; for the 40 foot class, \$40 and \$20; 35 foot class \$30 and \$15; 30 foot class \$30 and

\$15; 25 foot class, \$20 and \$10. No time was allowed for crossing the line.

The official record of the race is as follows:

	Start.	Finish.	Elapsed	Corrected
	H. M. S.	H. M. S.	Time.	Time.
	H. M. S.	H. M. S.	H. M. S.	H. M. S.
First Class.				
Oriole	10 00 00	5 05 30	7 05 30	7 05 30
Vrecha	10 00 00		not timed	
46 foot Class.				
White Wings	10 00 00	5 10 00	7 10 00	7 10 00
Verve (Toronto)	10 00 00	5 21 00	7 21 00	7 13 00
Condor	10 00 00		not timed	
Verve (Hamilton)	10 00 00		disabled	
40 foot Class.				
Yama	10 00 00	2 30 50	4 30 50	4 30 50
Merle	10 00 00		did not finish	
35 foot Class.				
Katie Gray	10 10 00	4 50 50	6 40 50	6 37 50
Gracie	10 10 00	4 50 45	6 40 45	6 40 05
Vision	10 10 00	4 59 00	6 49 00	6 40 00
Majel	10 10 00		did not finish	
30 foot Class.				
Nancy	10 10 00	3 47 05	5 37 05	5 34 46
Samoa	10 10 00	3 50 00	5 40 00	5 40 00
Nadia	10 10 00		not timed	
Norma	10 10 00	4 11 05	6 01 05	5 58 46
Amelia	10 10 00		did not finish	
25 foot Class.				
Maud B.	10 10 00	12 37 00	2 27 00	2 27 00
Romola	10 10 00	12 55 00	2 45 00	2 43 00

YAMA took the Champion Pennant.

The Opening Cruise of 1891 occurred May 29th, the start being made at 3 o'clock in the afternoon. The destination was Big Sodus Bay. The following yachts participated: CRICKET, YAMA, KATIE GRAY, MIDGET and VELNETTE. The OSWEGO YACHT CLUB there met the ROCHESTER YACHT CLUB twelve or thirteen yachts strong, and an enjoyable time was had on the next day. The yachts returned at will.

The Eleventh Annual Regatta of the club was sailed July 23, 1891, in a strong south wind, making it necessary for many of the yachts to use double reefed canvas. The course was 5 miles to leeward and return. The 46, 40, 35 and 30 foot class yachts sailed over the course twice, but the 25 foot class only once. The 46 and 40 foot classes were started at 10 o'clock and the 35, 30 and 25 foot classes at 10:10; no time being allowed for crossing the line and the time taken from the firing of the gun. The prizes offered were: \$50 and \$20 for the Special Class, and the same for the 46-footers; \$40 and \$20 for the 35-footers, with the same prizes for the 30-footers, and \$20 and \$10 for the 25-footers.

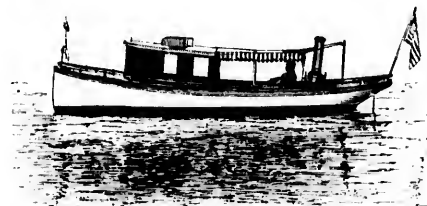

THETIS.—FIGURE 417.

YAMA won the Champion Pennant.

YAMA in the 46 foot class and LAURA of the 40-footers had no competition but were allowed prizes.

The record of the race by classes is as follows:

46 foot Class.				
Yama	10 00 00	2 06 04	4 06 04	4 06 04

THE YACHTS AND YACHTSMEN OF AMERICA.

139

allowed for crossing

Corrected
Time.
H. M. S.

7 05 30

7 10 00
7 13 00

4 30 50
ish

6 37 50
6 40 05
6 40 00
ish

5 34 46
5 40 06

5 58 46
ish

2 27 00
2 43 00

th, the start being
estination was Big
: CRICKET, YAMA.
WEGO YACHT CLUB
or thirteen yachts
at day. The yachts

sailed July 23, 1891.
many of the yachts
miles to leeward and
ats sailed over the
The 46 and 40 foot
and 25 foot classes
e line and the time
ered were: \$50 and
46-footers; \$40 and
the 30-footers, and



40-footers had no

4 06 04

	Start. H. M. S.	Finish. H. M. S.	Elapsed Time. H. M. S.	Corrected Time. H. M. S.
Forty Foot Class.				
Laura	10 00 00	2 40 32	4 40 32	4 40 32
Thirty-Five Foot Class.				
Katie Gray	10 10 00	3 08 43	4 58 43	4 56 49
Gracie	10 10 00	3 14 14	5 04 14	5 01 11
Thirty Foot Class.				
Samoa	10 10 00	2 57 03	4 47 03	4 47 03
Erma	10 10 00	3 08 07	4 58 07	4 57 40
Nadia	10 10 00	3 20 53	5 10 53	5 09 49
Lotus	10 10 00		did not finish.	
Twenty-Five Foot Class.				
Maud B.	10 10 00	1 00 15	2 50 15	2 49 57
Kelpie	10 10 00	1 08 18	2 58 18	2 58 18
Grace L.	10 10 00	2 12 27	4 02 27	3 57 50

The Opening Cruise of 1892 was ordered for May 28th to 30th, inclusive, and the point of destination was Big Sodus. The sail to Big Sodus was a race for the Champion Pennant. Three boats started, the time being as follows:

	Oswego H. M. S.	Big Sodus H. M. S.	Elapsed Time. H. M. S.	Corrected Time. H. M. S.
Yama	1 06 48	8 23 00	7 17 15	7 12 44
Papoose	1 06 55	8 35 00	7 29 05	7 29 05
Katie Gray	1 07 01		was towed to Big Sodus.	

At the start the wind was fresh from the northwest but in a short time it had died away leaving the yachts without steerage way, but after waiting awhile a land breeze sprung up which carried them to Big Sodus. The yachts in this cruise as well as in all the cruises of the club, were accompanied by a steamer for the conveyance of the members of the club and their friends.

The Twelfth Annual Regatta of the club was sailed July 18, 1892. The wind was fresh from the west and the racers carried all their light sails. The course was five miles to windward and return, the first and forty-six foot classes sailing over the course three times, the forty, thirty-five and thirty foot classes twice, while the twenty-five foot class went around the course but once. The race was started at

ten o'clock for the three largest classes and ten minutes later for the smaller classes. Just before the starting gun was fired YAMA and VREDA came into collision carrying away VREDA's bowsprit and YAMA's chain plates, leaving YAMA with only one weakened port shroud with which to sail the race. Thus crippled and making some water, she sailed a most exciting race with ZELMA, now being astern and now being ahead, till on the run to the home buoy with the wind astern she drew away from her competitor and won the race by a minute and thirty-two seconds.

The prizes were as follows: For the first class \$50 and \$20; forty-six foot class the same amounts; forty-foot class \$10 and \$20; thirty-five foot class \$30 and \$15; thirty foot class like amounts; twenty-five foot class \$20 and \$10.

The official record is as follows, no time being allowed for crossing the line.

	Start. H. M. S.	Finish. H. M. S.	Elapsed Time. H. M. S.	Corrected Time. H. M. S.
First Class.				
Oriole	10 00 00	3 21 29	5 21 29	5 21 29
Cinderella	10 00 00	3 10 03	5 10 03	5 01 43
Vreda	10 00 00		disabled	
Forty-Six Foot Class.				
White Wings	10 00 00	4 09 45	6 09 45	6 09 45
Aggie	10 00 00	4 23 55	6 23 55	6 19 04
Forty Foot Class.				
Yama	10 00 00	1 36 45	3 36 45	3 36 38
Zelma	10 00 00	1 38 10	3 38 10	3 38 10
Thirty-Five Foot Class.				
Cyprus	10 00 00	3 30 18	5 20 18	5 20 18
Katie Gray	10 10 00		did not finish	
Thirty Foot Class.				
Vedette	10 10 00	2 28 15	4 18 15	4 18 15
Erma	10 10 00	2 45 45	4 35 45	4 34 41
Norma	10 10 00	2 47 40	4 37 40	4 35 59
Twenty-Five Foot Class.				
Nox	10 10 00	12 28 43	2 18 43	2 17 58
Salola	10 10 00	12 17 58	2 37 58	2 37 51
Kelpie	10 10 00	12 54 30	2 41 30	2 44 30

No races were held by the club during the season of 1893.

BIOGRAPHICAL SKETCHES AND DESCRIPTION OF YACHTS ENROLLED IN THE CLUB.

JOHN T. MOTT, Commodore of the Oswego Yacht Club; the son of Thos. S. Mott and Sarah B. DeWolf, was born in Hamilton, N. Y., Oct. 11, 1848. His present yacht is PAPPOOSE and he has also owned MOLLY, MOTT, VIXEN and CHICKER. Has been closely connected with yachting since 1862, is a charter member of the Oswego Yacht Club and has served in that club in the following capacities: Director, 1881, '86, '88, '89; President, 1882; Commodore, 1882, '83, '84, '85, '87 and '93. Was also tendered the office of Commodore in 1886 but declined the honor.

The Commodore was also one of the moving spirits in the organization of the LAKE YACHT RACING ASSOCIATION, composed of American and Canadian yacht clubs whose home stations are on Lake Ontario. Was Vice-President of this association in 1884 and 1889, and President in 1885 and 1891. He is President of the First National Bank of Oswego, the Oswego Water Works Co. and the Oswego Gas Light Co. Is a member of the OSWEGO and ROYAL CANADIAN YACHT CLUBS.

PAPPOOSE.

A cutter belonging to John T. Mott, Commodore of the OSWEGO YACHT CLUB, designed by Burgess and built by Lawley & Son, for C. F. and G. C. Adams. Was launched in June, 1887. She was sold by Adams Bros. to Bayard Thayer, by him to Davenport Galbraith of Erie, Pa., finally passing into the hands of her present owner in December, 1891. She hails from Oswego and sails with the OSWEGO and ROYAL HAMILTON YACHT CLUBS. See plate LXII.

Official number, 150,515.

DIMENSIONS.			
Length over all,	41 feet,	Length load waterline,	37 feet.
Draft,	7 feet 9 inches,	Beam,	12 feet 1 inch.

Racing Record for 1891:—

MICHIGAN YACHT CLUB—PAPPOOSE beat CITY OF THE STRAITS in a Match Race for \$1,000, over a course of 20 miles.



ALLEN AMES.

ALLEN AMES, manufacturer of engines and boilers, Oswego, N. Y.; was born in Mexico, N. Y., October 23, 1859. Mr. Ames is the owner of the famous cutter YAMA, and has also owned the yachts MAGIC, LAURA and MERLE. A yachtsman for sixteen years and a charter member of the OSWEGO YACHT CLUB (1881). He has held the offices of Fleet Captain, Vice-Commodore and Commodore of the OSWEGO YACHT CLUB.

YAMA.

YAMA is a cutter yacht, owned by Allen Ames of Oswego. She was designed by William Fife, Jr., and was built by H. C. Wintringham of South Brooklyn in 1890. She hails from Oswego and sails with the OSWEGO YACHT CLUB. See Fig. 410.

Official number, 27,643.

L. Y. R. A. number, 155.

DIMENSIONS.			
Length over all,	52 feet,	Length load waterline,	36 feet.
Depth,	7 feet 8 inches,	Draft,	9 feet.
Beam,	9 feet 3 inches,		

RACING RECORD.

YAMA has proved herself a wonderful craft ever since her first race. Following is a list of some of the races in which she has taken part.

OSWEGO YACHT CLUB—In the Tenth Annual Regatta sailed August 25, 1890, YAMA was first, defeating the well-known MERLE. On the 23d of July, 1891, YAMA was first again. May 28, 1892,

YAMA outsailed PAPPOOSE; while in the Annual Regatta sailed July 18th, after sustaining injuries from an unfortunate collision with VREDA, YAMA pluckily sailed the race and won by less than two minutes from ZELMA. This latter yacht, by the way, was expressly built to defeat the unconquerable YAMA.

ROYAL HAMILTON YACHT CLUB—YAMA was first in the Third Annual Regatta, sailed August 13, 1890, beating MERLE and PSYCHE. In the Fourth Annual Regatta held July 14, 1891, she defeated VERVE and AGGIE.

Through the season of 1892 YAMA had to her credit, out of fourteen races, thirteen firsts and one third.



W. BIRDSALL COUCH.

W. BIRDSALL COUCH, born and now living in Oswego, N. Y.; is the Assistant Treasurer of the Oswego County Savings Bank. Has been interested in yachting all his life and is a member of the OSWEGO YACHT CLUB, having held the office of Secretary and Treasurer of that organization for one year.

RUTH.

RUTH (formerly BRUNETTE), is a screw schooner belonging to Switz Condé. She was designed by Hillmann and built by Byerly, Hillmann & Streaker, Camden, N. J. in 1892. Hails from Oswego, N. Y., and sails with the OSWEGO YACHT CLUB. See plate LX.

Official number, 3,190.

DIMENSIONS.			
Length over all,	80 feet,	Length load waterline,	72 feet 7 inches.
Depth,	5 feet 6 inches,	Draft,	4 feet 10 inches.
Beam,	13 feet 6 inches,		

Engine: Inverted cylinder 12 x 12 inch. Scoble & Levy, Philadelphia.

Boiler: 5 ft. 6 in. x 8 ft. 6 in. Duplaine.

AIDA.

AIDA is a screw steamer owned by J. D. Macfarlane and others. She hails from Oswego, N. Y., and sails with the fleet of the OSWEGO YACHT CLUB. Was built by Goble & Macfarlane in 1885. See Fig. 411.

Official number, 106,424.

DIMENSIONS.			
Length over all,	71 feet 3 inches,	Beam,	9 feet 9 inches.
Depth,	5 feet 4 inches,		

Nominal horse power, 70.



ELLIOTT B. MOTT.

ELLIOTT B. MOTT, Oswego, N. Y. Born in Oswego, April 30, 1861. A manufacturer of malt. Has owned three yachts, CRICKET, ETHEL and VOLANTE, and has been interested in yachting for fifteen years. A founder of the OSWEGO YACHT CLUB, March, 1881; still a member of that club, as well as the ROYAL CANADIAN YACHT CLUB. Has held the office of Treasurer for two years. The yacht VOLANTE was designed by Mr. Mott.

PIANTOM.

A centerboard sloop, altered from standing keel cut-rig in 1876. Designed by Captain Chas. Howard and built by Jas. Burke, being

launched in 1873 for Hillmann, Babcock and Miller. In 1876 she became the property of Mr. John P. Phelps, her present owner, of Oswego, N. Y. PHANTOM is an open sloop, now hailing from Oswego and sailing with the OSWEGO YACHT CLUB. See Fig. 412.

DIMENSIONS.			
Length over all,	21 feet.	Length load waterline,	22 feet.
Depth,	3 feet.	Draft,	2 feet.
Beam,	7 feet 9 inches.		

Spars: Mast, 32 feet; Jibboom, 9 feet; Mainboom, 21 feet; Gaff, 12 feet.



WILLIAM B. PHELPS, JR.

WILLIAM B. PHELPS, JR., freight and passenger agent, also coal and insurance, Oswego, N. Y. Born in Buffalo, April 21, 1859, the son of Wm. B. Phelps and Caroline M. Stone. His father was Superintendent of the D. L. & W. R. R. for twenty-five years. Mr. Phelps is Master of Masonic Lodge "Frontier City," No. 422. He is the owner of the fast sloop KATIE GRAY, and has cared for yachting—to use his own words, "ever since old enough to run away from school." Was one of the founders of the OSWEGO YACHT CLUB (1881), and has held the office of Commodore for one year and Vice-Commodore for four years.

KATIE GRAY.

A centerboard sloop, owned by William B. Phelps, Jr., of Oswego, N. Y. Designed and built by A. Cuthbert for Messrs. Benson & Campbell, and launched in 1875. Owned by Mr. Phelps since 1882. Re-built in 1877 and 1880 by Cuthbert and in 1889 by Goble & Macfarlane. Hails from Oswego and is enrolled among the yachts of the OSWEGO YACHT CLUB. See Fig. 413.

DIMENSIONS.			
Length over all,	32 feet 9 inches.	Length load waterline,	31 feet 9 inches.
Depth,	4 feet 6 inches.	Draft,	3 feet 2 inches.
Beam,	11 feet.		

RACING RECORD.

The racing record of KATIE GRAY extends from the year 1875 to the present time. She has won many prizes—cups, pennants, championships and cash prizes. During these years she started in no less than 39 races, making a record of 20 firsts, 12 seconds, 6 thirds and 1 fourth. Some of her races are given below.

August 22, 1882: first, beating GRACIE and LAURA.

August 28, 1883: first, CRICKET second, LAURA third.

In the Spring of 1884 she won the pennant offered by the LAKE YACHT RACING ASSOCIATION.

August 4, 1885: came in third, LAURA first, IOLANTHE second.

August 5, 1886: again third, with MOLLIE first and IOLANTHE second. She seems to have had a couple of "off" years, but things soon changed.

In 1887 she was again third, MERLE winning.

In 1889 she won the Championship Pennant.

August 25, 1890: first, beating GRACIE and VISION.

July 20, 1891: first, (LAKE YACHT RACING ASSOCIATION) DUNAR second.

July 23, 1891: first with GRACIE second.

July 18, 1892: first, beating the well-known ZEEMA.

Most of these races were sailed in the OSWEGO YACHT CLUB, though she also raced with the ROYAL HAMILTON and ROYAL CANADIAN YACHT CLUBS, besides the LAKE YACHT RACING ASSOCIATION.



G. H. SAYWARD.

G. H. SAYWARD, manufacturer, Oswego, N. Y., has been an enthusiastic yachtsman all his life. For two years a Director of the OSWEGO YACHT CLUB. At present the owner of the naphtha launch THETIS, and formerly the owner of the steam yacht JIANTVA. A member of the OSWEGO YACHT CLUB.

THETIS.

A naphtha launch, built and designed by the Gas Engine and Power Co., New York, for Mr. G. H. Sayward of Oswego, N. Y., and launched in May, 1891. Recently sold to Mr. William Bock of Montreal, Canada. THETIS has a cabin and hails from Oswego. See Fig. 414.

DIMENSIONS.			
Length over all,	25 feet.	Length load waterline,	23 feet.
Draft,	2 feet.	Beam,	6 feet.

Engine: Built by the Gas Engine and Power Co.; 4 horse power. Record said to be 8 miles.



JOHN M. SCHULER.

of Oswego in 1889.

L. Y. R. A. number, 95.

DIMENSIONS.			
Length over all,	35 feet.	Length load waterline,	19 feet 11 inches.
Draft,	4 feet.	Beam,	7 feet.

CLIAS A. WORTS, real-estate, Boston, Mass. Born in Oswego, N. Y., the son of Mannister and Mary J. Worts. A member of the OSWEGO, ROCHESTER, KINGSTON, TORONTO and BAY OF QUINTE YACHT CLUBS and a charter member of the first two. Has held the following positions: Chairman of the Regatta Committee, Director and Secretary of the OSWEGO YACHT CLUB and Secretary of the ROCHESTER YACHT CLUB. The owner of the sloop ETHEL. Has been interested in yachting for eleven years.

al Regatta sailed
fortunate collision
and won by less
light, by the way,
YAMA.

n the Third An-
ting MERLE and
d July 14, 1891.

edit, out of four-

UCH, born and
Oswego, N. Y.; is
r of the Oswego
Has been inter-
life and is a mem-
ber CLUB, having
ary and Treasurer
one year.

NETTE), is a screw
Switz Condé. She
mann and built by
1892. Hails from
CLUB. See plate

72 feet 7 inches.
4 feet 10 inches.

fic & Levy, Phila-

arlane and others.
cet of the Oswego
in 1885. See Fig.

9 feet 9 inches.

P, Oswego, N. Y.
April 30, 1861.
mult. Has owned
ETHEL and Vo-
interested in yacht-
A founder of the
B. March, 1881;
club, as well as
N. YACHT CLUB.
Treasurer for two
ANTE was designed

l cent-rig in 1876.
las. Burke, being



NEW HAVEN YACHT CLUB HOUSE.

NEW HAVEN YACHT CLUB HOUSE.

NEW HAVEN
CONNECTICUT
MAY 1914

The New Haven Yacht Club



THE NEW HAVEN YACHT CLUB
HAS THE HONOR OF INVITING YOU
TO THE ANNUAL REGATTA
TO BE HELD AT NEW HAVEN
CONNECTICUT
ON MAY 15-16-17-18-19-20-21-22-23-24-25-26-27-28-29-30-31
1914



History of the New Haven Yacht Club.

ONE Saturday during the month of August, in the year 1881, four small yachts assembled on the south side of Long Wharf, New Haven, for the purpose of engaging in a friendly cruise. *FLORA*, the largest of the four, measured 37 feet over all; *EXPLORER*, 31 feet; *VIXEN*, 28 feet, and *GRAPPLING*, 30 feet. The last named was a cat-rigged yacht, while the other three were sloop-rigged, after the usual American pattern. Edwin S. Perry, on *FLORA*, was made Commodore for the trip. The small fleet sailed east, and these four yachts became the nucleus of the NEW HAVEN YACHT CLUB. As they sailed from port to port

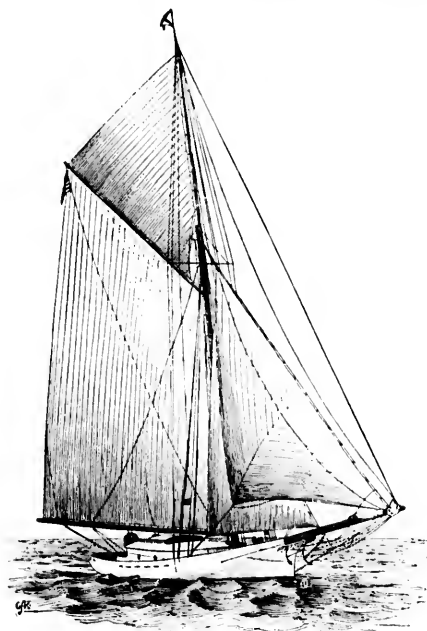

CARRIE W.—FIGURE 418.

the yacht getting in first was permitted to fly the pennant, thus advertising the fact; and before the cruise was over, much to the gratification of their owners, all the yachts had flown the pennant.

On their return the question of organizing a yacht club was discussed, and while a few objected, the majority approved. There had not been in New Haven any great interest shown in yachting matters for some years. Occasionally, however, a sharpie race would be planned, but this was only of interest to those who favored that type of boat. A few of the more enthusiastic yacht-men did get up a race from time to time and had quite a large number of entries, but this was more for the pleasure of sailing and as a kind of

"feeler," as there were no prizes offered. However, as a result of all this, a few gentlemen assembled together in the month of November, 1881, and organized the NEW HAVEN YACHT CLUB; the club was not incorporated, however, until the following March. The first officers of the club were as follows:

Commodore, H. D. Billard; Vice-Commodore, J. G. Beecher; Fleet Captain, G. E. Dudley; Secretary, F. P. Tyler; Treasurer, A. W. Adams.

The charter members of the club were as follows:

E. S. Perry, J. N. Macauley, Allen Seaman, W. W. Price, C. W. Rawson, E. P. Avery, James P. Kennedy, J. G. Beecher, A. W. Adams, H. D. Billard, F. H. Baldwin, H. W. Vail, L. A. Elliott, E. B. Lee, F. P. Tyler, M. White, Geo. E. Dudley, C. R. Waterhouse, C. R. Waterhouse, Jr., R. J. Hamilton.

The club occupied rooms at this time over the Yale National Bank, corner of State and Chapel streets. May 30, 1882, being the first Opening Sail since the club was incorporated, much interest was

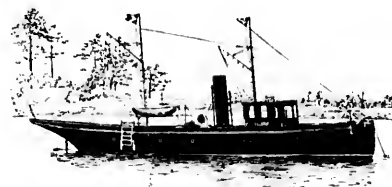

WAMPANOAG.—FIGURE 419.

manifested, and such was the enthusiasm that the regatta which was sailed a couple of weeks later furnished much talk for some time afterward about the merits of the several boats entered. The result was a Match Race between *VIXEN* and *CERES*, the former belonging to the NEW HAVEN YACHT CLUB, and the latter hailing from Portchester (belonging to no club); in this race *VIXEN* was defeated. The Fall Race was sailed in a very hard blow and furnished a topic for discussion throughout the winter.

The east and cruises of the club have always been looked forward to with a great deal of interest, and the Cruise of 1882 being the first since the organization of the club, is still spoken of as one of rare enjoyment and good-fellowship, which none but yachtsmen can appreciate.

The year 1883 was opened with a boom in the NEW HAVEN YACHT CLUB. The old officers were re-elected. The Opening Sail and Spring Race went off as usual and evoked no little rivalry between the contestants. The Summer Cruise received a set-back owing to the loss of a whole crew of the yacht *MYSTERY* off the Hen and Chickens reef, the year being consequently clouded with feelings of sadness. Up to this time there was no Club House, and frequent meetings were held to determine what should be done in the matter of taking steps for a speedy development of some scheme whereby the

club should own a Club House. The result was that a committee was appointed consisting of the following gentlemen: Joseph Porter, G. E. Dudley, C. W. Seranton, H. D. Billard, Jas. Gallagher, Jr. and C. M. Peck. After much consideration the result of their labors was the handsome Club House at the foot of Franklyn street.

To Mr. Joseph Porter belongs the credit for the active and financial part of the work, and the NEW HAVEN YACHT CLUB appreciates that fact and will ever hold him in remembrance. The Club House has been much admired by yacht-men from all over the country and the club makes it a point to entertain visiting yachtmen. Mr. C. W. Seranton was the Commodore at this time, and his smiling face was always a welcome addition to any party. The club cruise was made more interesting by the Commodore offering a cup to be sailed for on the cruise. The cup was won by VIXEN, her nearest competitor

The year 1886 opened with unabated interest. At the annual election the following were made officers for the year: H. D. Billard, Commodore; George E. Dudley, Vice-Commodore; Chas. M. Peck, Rear-Commodore.



RAJAH.—FIGURE 420.

itor being her old antagonist CERES. The race was sailed in Buzzard Bay, over the NEW BEDFORD YACHT CLUB Course.

The year 1885 was opened with more than usual interest. The Club House was thronged most of the time and impatient yachtmen could hardly wait for the ice to melt before setting out. The election of officers, which is always attended with much interest, resulted in J. G. Beecher being elected Commodore. The most notable event of the year was the Block Island Race given by the club, in which thirteen yachts entered and finished. The yachts were divided into three classes, with prizes of \$100 to each class. The result was that it created a great deal of unusual comment in this section of the yachting world. In the first class the prize was won by ARIADNE. WAYWARD won in the second class, and SPRANGER in the third. In the club it was at all times the theme for conversation.



AMATEUR.—FIGURE 421.

The season which opened so auspiciously was doomed to be shrouded in gloom before its close through the death of Commodore Billard. By his death the club lost a most valuable and enthusiastic

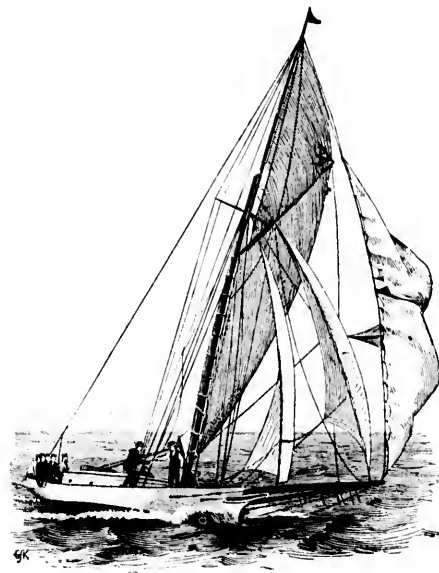

UNDINE.—FIGURE 422.

member as well as one of the founders of the organization. The circumstances which led to his final illness, and which were indirectly the cause of the same, were particularly painful to the club.

While on a cruise an explosion occurred in the cabin of his yacht which caused what might have been a serious fire. In his efforts to extinguish the flames he was severely burned and was conveyed to his home immediately on the arrival of the yacht in port. From this dated a lingering and painful illness, which early in the Fall termi-

ated, perhaps, than others, but they have been none the less successful. In 1888 the club elected H. A. Seymour as Commodore, and a better man could not have been chosen. He has ably filled the position and has always taken the lead in everything which pertained to the welfare of the club.

This office was held by him until the beginning of the present season, at which time, owing to an inability to devote the time which he considered necessary to the office, he was forced to decline a re-nomination and undoubtedly unanimous re-election.

His administration was marked with unbounded success and perfect harmony in the club, and the regattas and cruises sailed with the Commodore's pennant at the mast-head of his yacht were always looked forward to and participated in with the greatest enthusiasm and pleasure.

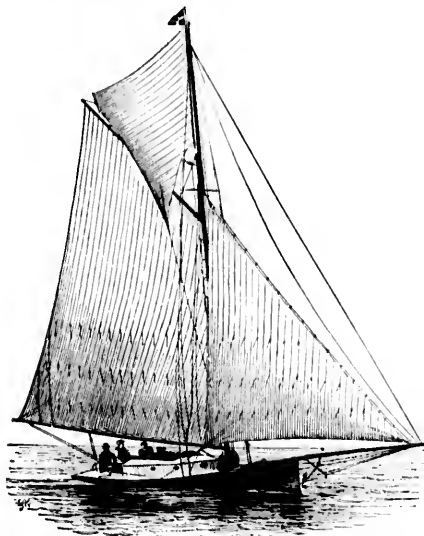

STRANGER.—FIGURE 423.

nated in his death. On the announcement of this fact a special meeting was called and appropriate resolutions adopted. At this meeting a committee was appointed to take charge of the funeral and secure suitable floral tributes. The funeral services were attended by the club in a body, and for thirty days from the date of his death

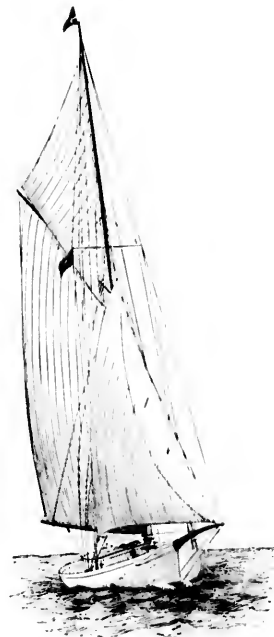

MARGHERITE.—FIGURE 425.

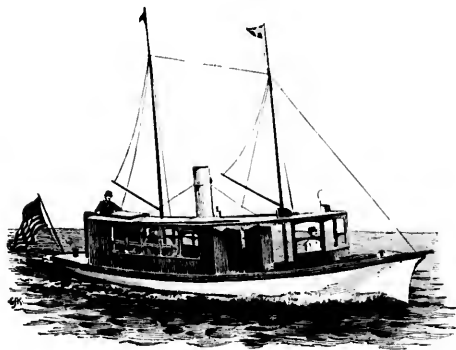

CERES.—FIGURE 424.

the Club House was draped in deep mourning, and the flags on the house and yachts kept at half-mast.

The years have followed each other with continued measure of success for the club. Some years have been a little more enthusias-

The season of 1893 opened with every appearance of being an extremely successful one in the club. The officers elected at the annual meeting in March were:

Henry S. Parmelee, Commodore; H. S. Holcomb, Vice-Commodore; Jesse D. Welch, Rear-Commodore; W. W. Hawkes, M. D., Fleet Surgeon; W. A. Chamberlain, Secretary; George R. Chamberlain, Treasurer.

Early in April the club was called on once more to mourn the death of one of its most enthusiastic and oldest members and the recently elected Secretary, Mr. W. A. Chamberlain. He had faithfully executed his duties in this office since 1889, and was just in the prime of life when called away.

annual elec-
H. D. Billard,
Thas. M. Peck,

doomed to be
of Commodore
and enthusiastic

ization. The
which were indi-
l to the club.

FLEET OF THE NEW HAVEN YACHT CLUB.

NAME.	HULL.	OWNER.	Length over all.		Extreme Beam.		Draft.
			ft. in.	ft. in.	ft. in.	ft. in.	
Flora	Sloop	T. F. Hammer	36 7	34 2	14 0	4 4	
Marguerite	"	H. F. and C. M. Peck	40 6	35 7	14 6	4 0	
Viola	"	C. N. Wayland	48 6	45 1	14 0	4 0	
Stranger	"	J. N. Macaulay	28 6	27 0	11 7	
Wild Pigeon	"	Frank Wheeler	46 3	37 7	14 0	4 5	
Sea Belle	Cutter	H. A. Seymour	35 7	30 6	10 0	6 3	
Thula	Sloop	W. H. Zink	36 5	31 0	11 0	2 5	
Dare Devil	"	C. C. Andel	27 3	27 3	12 0	2 8	
Venus	"	George M. Graves	29 11	29 11	12 0	
Concord	"	H. C. Honne	56 3	49 2	17 3	5 6	
Narwhal	Steamer	C. Henry Osgood	143 0	120 0	18 4	7 6	
Violetta	Sloop	H. G. Shepard	25 3	22 3	11 0	1 2	
Darling	Steamer	D. H. Warner	105 0	88 0	16 0	4 6	
Idlewild	Naphtha	F. H. Denton	28 0	5 3	2 0	
Retriever	Cat	W. G. Shepard	21 0	18 0	7 0	1 4	
Awa	Sloop	Chas. H. Warner	34 0	29 0	10 6	0 7	
Gipsy	"	W. E. Jacobs	27 7	24 0	9 9	
Isabel	Naphtha	J. T. Pohlman	25 0	5 8	
Carrie W.	Sloop	Eugene E. Baker	38 0	34 0	3 0	
Phantom	Schooner	Henry S. Parmelee	101 0	85 0	24 11	6 6	
Juanita	Naphtha	Wm. H. Lockwood	30 0	27 0	7 0	1 10	
Trio	Sloop	Wm. M. Chase	22 10	20 5	9 3	1 10	
Hival	"	P. G. Sanford	40 7	38 3	14 6	6 1	
Victor	Naphtha	Geo. E. Nettleton	18 0	6 0	1 6	
Ceres	Steamer	Jas. H. Parish	40 0	33 0	8 0	3 0	
Diana	Schooner	T. W. Hinman	59 11	53 0	14 6	7 8	
Plover	Naphtha	Wm. H. Andrews	25 0	22 0	5 8	2 0	
Crystal Wave	Steamer	W. S. Brantledge	28 0	8 0	2	
All So	Sloop	C. N. Holcomb	19 6	6 6	2 0	
White Star	Steamer	W. S. Brantledge	45 0	40 0	11 0	3 0	
Kismet	Schooner	Jas. Cockroft	44 3	39 1	12 10	4 5	
Cygnets	Naphtha	C. P. Pratt	35 0	7 0	2 8	
Lou	Steamer	W. E. Oulber	40 0	8 0	3 0	
Idle May	Yawl	Jesse D. Welch	31 0	24 0	11 0	1 0	
Mercury	Naphtha	Myron R. Durham	21 0	4 10	2 0	
Sapphire	Steamer	Anzi L. Barber	135 0	115	19 0	9 0	
Manola	Naphtha	Thos. H. Pratt	
Xenia	Sloop	Le Grand Cannon	28 0	24 0	10 0	4 0	
Alice G.	"	Alex. S. Gilson	
Susie B.	"	L. D. Benton	52 0	13 0	6 0	
Eudora	Steamer	W. W. Horton	33 0	6 0	3 0	
Gael	Sloop	Daniel Prentice	33 0	28 0	10 6	5 2	
Neva	"	Eugene D. Flisk	33 0	29 0	11 7	3 6	
Jessie	Steamer	Henry A. Bishop	28 0	7 6	2 6	
Thelma	Schooner	H. S. Holcomb	60 0	18 0	6 3	
Agnes	Sloop	F. E. Morgan	42 0	38 0	14 6	3 0	
Beatrice	"	R. N. Burwell	32 6	22 6	10 4	3 6	
Myra	Naphtha	T. H. Pickering	41 0	38 0	6 7	3 3	
Speranza	Schooner	O. D. Wilkison	98 0	84 0	21 0	9 8	
Wanda	Sloop	W. F. Knapp	31 6	30 0	12 0	3 0	
Dauntless	Schooner	Caldwell H. Colt	123 10	110 7	26 7	12 0	
Gossip	Cat	Arthur H. Day	28 5	25 2	11 2	2 0	
Ariel	Sloop	F. C. Cannon	28 0	22 0	
Uganda	"	R. E. Griswold	34 9	29 0	11 5½	5 0	
Metusa	"	Maurice M. Whilaker	42 0	34 5	11 0	
Castanea	Cat	A. V. Beecher and Jas. M. Coneter	29 0	25 11½	11 0	3 0	
Iona	Sloop	Geo. F. Eaton	29 6	25 3	10 0	6 0	

reme Down. Drift.

ft. in.	ft. in.
14 0	6 4
14 6	4 0
14 0	4 0
11 7
14 0	4 6
10 0	6 3
11 0	2 6
13 0	2 6
13 6
17 3	6 6
18 4	7 6
11 0	1 2
16 0	4 6
6 3	2 0
7 0	1 4
10 6	6 7
9 9
6 6
....	3 0
24 11	6 6
7 0	1 10
9 3	1 10
13 6	6 1
6 0	1 6
6 0	3 0
14 6	7 6
5 8	2 0
6 0	2
6 6	2 0
11 0	3 0
12 10	4 5
7 0	2 6
8 0	3 0
11 0	1 0
4 10	2 0
19 6	9 0
....
10 0	4 0
....
13 0	6 0
6 0	3 0
10 6	5 2
11 7	3 8
7 6	2 6
18 0	6 3
14 6	3 6
10 4	3 6
6 7	3 3
21 6	9 8
12 0	3 0
20 7	12 6
11 2	2 6
....
11 6½	5 0
11 0
11 0	3 0
10 0	6 0

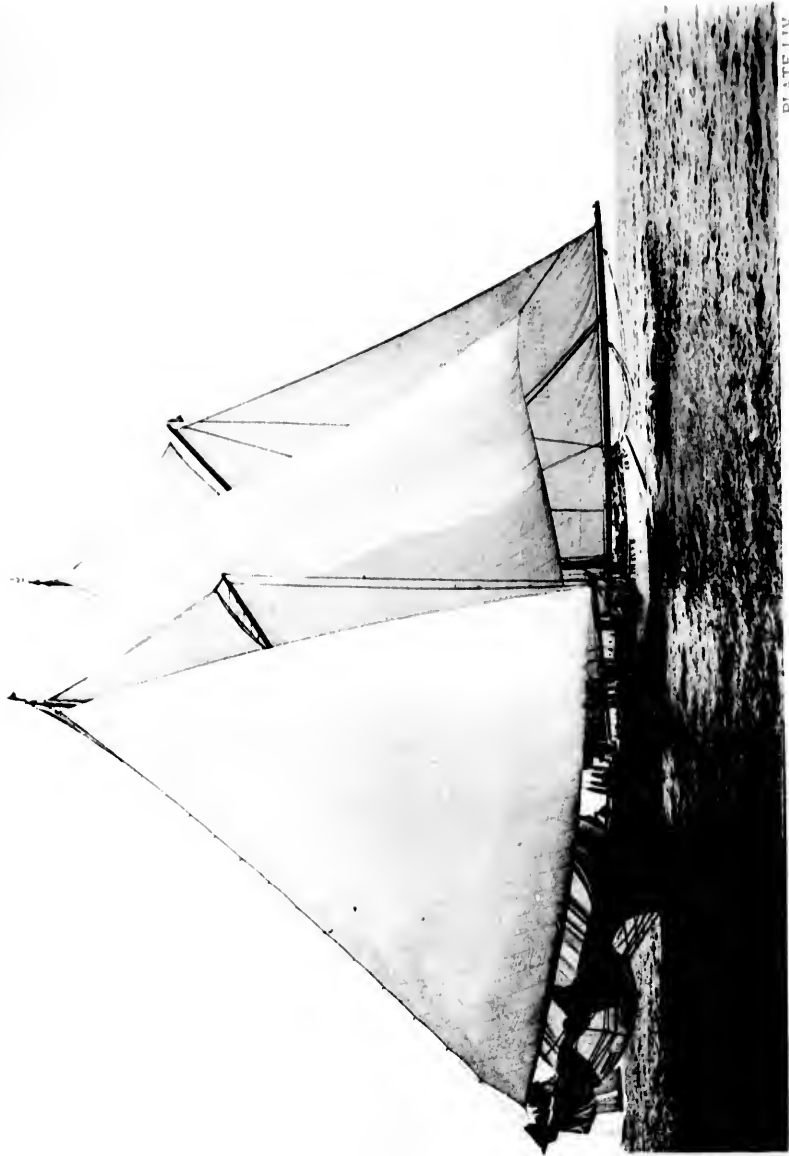

PLATE LIV.

DAUNTLESS.



PLATE I

LIST OF THE WINNING YACHTS FROM 1887.

Spring Regatta of 1887, sailed June 24th.

- Class B, sloop THISTLE.
- Class C, sloop MARGUERITE.
- Class D, sloop VIXEN.
- Class D, (open) sloop DARE DEVIL.

Fall Regatta, sailed October 6, 1887.

- Class B, sloop WILD PIGEON.
- Class C, sloop MARGUERITE.
- Class D, sloop STRANGER.
- Class D, (open) sloop VENUS.

Spring Regatta, sailed June 12, 1888.

- Class 2, sloop FLORA.
- Class 3, sloop WANDA.
- Class 4, sloop STRANGER.

Mystic Island Race, sailed while on the Annual Cruise for cash prizes; five miles to windward and return.

- Class 2, sloop MARGUERITE.
- Class 3, sloop SEA BELLE.

Fall Regatta, sailed September 22, 1888.

- Class 2, sloop MARGUERITE.
- Class 3, sloop THALIA.
- Class 4, sloop STRANGER.

Special Race, September 29, 1888. Sailed to wind up the season, for cash prizes—no classification or time allowance.

- 1st Prize, sloop MARGUERITE.
- 2d Prize, sloop FLORA.
- 3d Prize, (open) sloop DARE DEVIL.

Spring Regatta, June 18, 1889.

- Class 2, sloop FLORA.
- Class 3, sloop SEA BELLE.
- Class 4, sloop STRANGER.

Fall Regatta, sailed September 30, 1889.

- Class 2, sloop FLORA.
- Class 3, sloop SEA BELLE.
- Class 4, sloop ACME.

Spring Regatta, sailed 1890.

- The following were the winners:
- Class 2, sloop RIVAL.

- Class 3, sloop WANDA.
- Class 4, sloop STRANGER.

Fall Regatta, sailed 1890.

- Class 2, sloop RIVAL.
- Class 3, sloop WANDA.
- Class 4, sloop STRANGER.

Spring Regatta, sailed 1891.

- Class 2, sloop RIVAL.
- Class 3, sloop WANDA.
- Class 4, sloop STRANGER.

Fall Regatta, sailed 1891.

- Class 2, sloop RIVAL.
- Class 3, sloop STRANGER (sailing in class above her own).
- Class 4, open jib and mainsail, champion.

Spring Regatta, sailed 1892.

- Class 3, RIVAL.
- Class 4, STRANGER.
- Class 6, VIDETTE.
- Class 7, COMMODORE.

No Fall Regatta was sailed in 1892.

The Twelfth Annual Regatta of the NEW HAVEN YACHT CLUB on June 22, 1893, was started in a light southeast breeze, the wind coming in later quite fresh from the northeast. The course was off Pardee's Bar Buoy, around the buoy at the mouth of the Housatonic River. The times were:

	Elap. Time.		Cor. Time.	
	H. M. S.	H. M. S.	H. M. S.	H. M. S.
Nymph	5 01	41	5 01	41
Sea Belle	6 10	53	6 00	41
Ione			not timed	
Stranger	5 39	44	5 22	14
Vidette			not timed	
Venus	5 15	48	5 03	22
Castanea	5 29	10	5 28	20
Gossip	5 18	12	5 18	12

NYPH won the special prize of a cup in Division C for the best corrected time. In Class 3 SEA BELLE won the Warner Cup, which she has held for three consecutive years, and won her class prize in money. STRANGER won in her class and GOSSIP in hers.

The Regatta Committee included D. M. Goodridge, John I. Goodrich and S. D. Baker, and the judges were M. H. Bacon of New London, James Gallagher, Jr., and C. M. Peck.

BIOGRAPHICAL SKETCHES AND DESCRIPTION OF YACHTS ENROLLED IN THE CLUB.

HENRY S. PARMELEE, New Haven, Conn., Commodore **NEW HAVEN YACHT CLUB**, was born April 9, 1844, in Twinsbury Ohio. He is the son of Spencer T. and Zerah A. Parmelee, and his ancestors for nine generations have lived in Connecticut. Mr. Parmelee is the President of the Mathuslek Piano Mfg Co. Has been a yachtsman since 1889 and has owned the yacht **PHANTOM** since that time. He is a member of the **NEW YORK, NEW HAVEN, LARCHMONT and CORINTHIAS (Phila.) YACHT CLUBS**.

PHANTOM.

The centerboard schooner **PHANTOM** belongs to Henry S. Parmelee, New Haven, Conn. She was designed and built by J. D. Van Dusen, New York City, in 1865 and was rebuilt by Palmer in 1879. She has been the property of Mr. Parmelee since 1889. She hails from New Haven, Conn. See plate LXIII.

CODE SIGNAL LETTERS, K, J, F, B.

Official number, 19,812.

DIMENSIONS.

Length over all,	19 feet 3 inches.	Length load waterline,	18 feet.
Depth,	7 feet.	Draft,	6 feet 6 inches.
Beam,	21 feet 11 inches.		

CARRIE W.

CARRIE W. is a centerboard sloop, built and designed by A. W. Vail and launched in 1875. She belongs to Eugene E. Baker of New Haven, Conn. Hails from New Haven and sails with the **NEW HAVEN YACHT CLUB**. See Fig. 419.

Official number, 125,069.

DIMENSIONS.

Length over all,	29 feet 6 inches.	Length load waterline,	27 feet.
Depth,	3 feet.	Draft,	3 feet.
Beam,	11 feet.		



J. G. BEECHER.

J. G. BEECHER, member of the **NEW HAVEN YACHT CLUB**, as also one of the founders of the club. Mr. Beecher was the former owner of **RAJAH** (now owned by W. C. Hubbard), has always been an active member, continually endeavoring to advance the best interests of the club.

RAJAH.

The cutter yacht **RAJAH**, formerly owned by J. G. Beecher, but now the property of W. C. Hubbard, a member of the **ATLANTIC and SEAWANAKA CORINTHIAS YACHT CLUBS**. Was designed by A. C. Smith and built by J. J. Driscoll of Greenpoint, N. Y. See Fig. 421.

CODE SIGNAL LETTERS, K, J, G, L.

Official number, 110,897.

DIMENSIONS.

Length over all,	41 feet 6 inches.	Length load waterline,	31 feet 6 inches.
Depth,	6 feet 5 inches.	Draft,	7 feet.
Beam,	8 feet 6 inches.		

RECORD OF RACES.

LARCHMONT YACHT CLUB—In the race sailed July 4th **RAJAH** was disqualified. On September 10th she was second in her class.

RIVERSIDE YACHT CLUB—**RAJAH** came in second in a race sailed July 9th.



ARTHUR B. BENJAMIN.

ARTHUR BEDELL BENJAMIN, born in New York City, 1854. A lineal descendant of the John Benjamin who came over from England with Gov. Winthrop in 1630. His grandfather, Col. Aaron Benjamin, was an officer of the Revolutionary Army from 1775 until the close of the war and also commanded the fortification at New London during the greater part of the war of 1812. His father, Hon. Frederick A. Benjamin, of Stratford, Conn., was one of the old merchants of New York City, and was a member of the Connecticut State Senate of 1862 and of the Electoral College of 1864. His mother was Elizabeth Bedell, the daughter of the Rev. Gregory Townsend Bedell, who at one time was widely known as the rector of St. Andrew's Church of Philadelphia.

Mr. Benjamin developed a taste for nautical affairs in boyhood and was, at an early age, a skilful pilot on the Housatonic River upon which Stratford, the summer home of the Benjamins, is situated. In 1886, being a competent navigator, he was granted a navigator's certificate for steam vessels. He has designed and built several yachts, the last one being the steam yacht **WAMPANOAG**. He is a member of the **NEW YORK and NEW HAVEN YACHT CLUBS**, and also of the **Calumet Club of New York**.

WAMPANOAG.

The screw steamer **WAMPANOAG**, now owned by Hugh L. Wiloughby, was designed by A. Bedell Benjamin for his own use, and built by Samuel Pine, Greenpoint, N. Y. She was launched in July, 1887. Has been slightly altered, having a small auxiliary schooner rig replaced by a larger one. Is a flush-decked steamer, cabins below. Hailing from New York. See Fig. 420.

CODE SIGNAL LETTERS, K, D, T, Q.

Official number, 81,155.

DIMENSIONS.

Length over all,	67 feet.	Length load waterline,	58 feet.
Depth,	8 feet 6 inches.	Draft,	5 feet.
Beam,	12 feet.		

Spars: Small auxiliary rig, merely for steadiness in sea-way.

Engine: Triple expansion, three cylinders, 6 $\frac{1}{2}$, 10 $\frac{1}{2}$ and 16 in. x 10 in. Stroke of piston, 10 in.

Boiler: One upright steel tubular; McEntee & Rodie.

ROBERT N. BURRELL of New Haven, Conn., was born in that city August 3, 1860. His people were all Americans. Has been the owner of two yachts—**DAPHNE** and the one which he now owns, **BEATRIX**. Has been interested in yachting for ten years and is a member of the **NEW HAVEN YACHT CLUB**.

BEATRIX.

BEATRIX was built by S. H. Thatcher and designed by Stewart & Binney. She was built for her present owner, Robert N. Burrell, and launched in July, 1892. She is a centerboard yacht, has a cabin and hails from New Haven, Conn.

DIMENSIONS.

Length over all,	32 feet 6 inches.	Length load waterline,	22 feet 6 inches.
Depth,	4 feet.	Draft,	3 feet 6 inches.
Beam,	10 feet 4 inches.		

CLUB.

DELL, BENJAMIN,
York City, 1854. A
f the John Benjamin
a England with Gov.
b. His grandfather,
in, was an officer of
Army from 1775 until
e and also commanded
New London during
the war of 1812. His
rick A. Benjamin, of
as one of the old mer-
ork City, and was a
and of the Electoral
edell, the daughter of
one time was widely
Philadelphia.
al affairs in boyhood
the Housatonic River
e Benjamins, is situa-
was granted a navi-
signed and built sev-
t WAMPANOAG. He
EN YACHT CLUBS, and

d by Hugh L. Wil-
for his own use, and
was launched in July,
ll auxiliary schooner
steamer, cabins be-

r. q.

l waterline. 58 feet.
5 feet.

ness in sea-way.

1, 10 $\frac{1}{2}$ and 16 in. x

& Rodie.

nn., was born in that
all Americans. Has
e one which he now
ig for ten years and

designed by Stew-
ner, Robert N. Bur-
rboard yacht, has a

ne, 22 feet 6 inches
3 feet 6 inches.



COMMODORE S. PARMELEE,

NEW HAVEN YACHT CLUB.



FRANCIS BURRITT.

TEAL, WHISTLER, RIPPLE, WHISPER, GO SOFTLY, QUICK STEP, PROFESSIONAL, AMATEUR (see Fig. 422), **CHAMPION, RIVAL, COMMODORE** and others. The last one is his present yacht. He is also the owner of the fast sloop **CORINTHIAN**.

Few yachtsmen have done more to advance yachting and racing on Long Island Sound than Commodore Burritt.

COMMODORE.

An open sloop, the property of Commodore Francis Burritt, South Norwalk, Conn. Designed by Francis Burritt and built by H. B. Robbins, Bridgeport, Conn. She was launched in April, 1892. She sails with the **INDIAN HARBOR YACHT CLUB** and hails from South Norwalk. See plate LXIV.

DIMENSIONS.

Length over all,	27 feet.	Length load waterline,	27 feet.
Draft,	2 feet.	Beam,	12 feet.



GEORGE E. DUDLEY.

GEORGE E. DUDLEY, merchant, New Haven, Conn. Born in Cheshire, Conn., May 20, 1852, of English descent. A member of the **NEW HAVEN YACHT CLUB** and the **PEQUOD ASSOCIATION**. Has held many positions of honor—Fleet Captain, Rear-Commodore, Vice-Commodore and Treasurer, and is at present a member of the Board of Trustees. A charter member of the **NEW HAVEN YACHT CLUB**, and its first Fleet Captain. Has been the owner of three yachts, **GRAPPLING, ZEIDYER** and **JEWEL**.

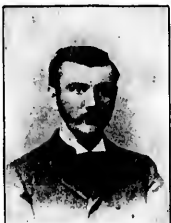

MYRON R. DURHAM.

MYRON R. DURHAM, merchant, New Haven, Conn., was born in that same city, December 25, 1864. Joined the **NEW HAVEN YACHT CLUB** in 1894, and held the position of Fleet Captain under Commodore Seymour in 1893-'90. Elected Rear-Commodore in 1890. Has served twice on the Board of Trustees, and is at present Chairman of the Board. Is also the Fleet Captain for the present year. He owned half of the sloop **WANDA**, 1888, and bought the sloop **ACME** in 1890.

GEORGE M. GRAVES, yacht builder, New Haven, Conn. Birth-place, Guilford, Conn., son of George A. and Elizabeth E. Graves. Since 1882 has been an active member and a yacht owner in the **NEW HAVEN YACHT CLUB**. He is the owner of the sloop **VENUS**. Mr. Graves has taken an active interest in yachting since 1855.

YENUS.

A centerboard sloop, formerly **MARIOTA**, was designed and built by E. A. Willis, for Van Ward Bros., and was launched in 1887. She has belonged to Mr. G. M. Graves of New Haven, Conn. for the last

four years. Has no cabin, and hails from New Haven, Conn., her owner being a member of the yacht club of that city.

DIMENSIONS.

Length over all,	30 feet 11 inches.	Length load waterline,	31 feet 11 inches.
Depth,	3 feet 6 inches.	Draft,	2 feet 2 inches.
Beam,	12 feet 6 inches.		

Spar: Mast 40 feet; Boom 36 feet; Gaff 18 feet.

YNDISE.

A centerboard sloop, formerly owned by H. S. Holcomb, now the property of T. E. and C. E. Secor of the **NEW HAVEN YACHT CLUB**. Originally **YNDISE**, then **THERESA** and now **YNDISE**. Designed and built by J. W. Guider, and launched in 1882. Given extra ribs by S. Ayers of South Brooklyn in 1890. She hails from New Haven, and sails with the **NEW HAVEN YACHT CLUB**. See Fig. 423.

Official number, 257.

DIMENSIONS.

Length over all,	31 feet.	Length load waterline,	31 feet 4 inches.
Beam,	12 feet.	Draft,	2 feet 9 inches.

STRANGER.

A centerboard sloop, owned by John X. Macaulay, of New Haven, Conn. Was designed by Harry Smolley, built by Frank Bates, South Brooklyn, N. Y., and launched in 1881. Hails from New Haven, and sails with the **NEW HAVEN YACHT CLUB**. See Fig. 424.

DIMENSIONS.

Length over all,	28 feet.	Length load waterline,	28 feet.
Depth,	2 feet 6 inches.	Draft,	2 feet.
Beam,	11 feet 6 inches.		

Racing Record, 1891:—

NEW HAVEN YACHT CLUB—STRANGER won in the regatta held July 8th; and again on the 9th of September, sailing in the class above her, and defeating **SEA BELLE, PHYLLIS** and **VIGLETTE**.

Racing Record for 1892:—

NEW HAVEN YACHT CLUB—STRANGER won in the Annual Regatta sailed June 27th, beating **YNDISE** and **SEA BELLE**.



EDWARD F. MANSFIELD.

EDWARD F. MANSFIELD, merchant, New Haven, Ct., was born in that city, and like all his ancestry since 1649, has made it his home. He was born in the year 1848. While he is not a yacht owner at present, Mr. Mansfield has been an active member of the **NEW HAVEN YACHT CLUB** since its infancy, and has used his best efforts to raise it to its present plane. He has been Fleet Captain of the club for one year, and has served on the Board of Trustees for seven years.



JAMES H. PARISH.

JAMES HEALD PARISH, manufacturer, and Ex-Rear-Commodore of the **NEW HAVEN YACHT CLUB**, was born in Springfield, Mass., March 21, 1854. The son of Ariel and Anna W. Parish. For some years he has been an enthusiastic yachtsman, and has done a great deal to promote this sport. Beginning his aquatic career with a small open sloop constructed by himself, becoming familiar with boat handling in all its details, he has since been the owner of various yachts. For several years he sailed the sloop **CERES**, winning many prizes. At present he is the owner

and skipper of the 40 foot steam launch which bears the same name.

He is one of the charter members of the NEW HAVEN YACHT CLUB, and has held several offices. Few yachtsmen who cruise along the eastern coast are better known or more popular than Mr. Parish.

CEHES.

A screw launch designed and built by Ralph B. Hill, of Guilford, Conn., and was launched in the Summer of 1888. She was bought in 1890 by James H. Parish, of New Haven, Conn., a member of the yacht club of that city. Was formerly UNKNOWN. Her bow was lengthened two feet in 1891 by Thatchler & Son. She hails from New Haven. See Fig. 424.

DIMENSIONS.

Length over all,	38 feet 6 inches.	Length load waterline,	33 feet.
Depth,	3 feet.	Draft,	3 feet.
Beam,	8 feet.		

Spars: Mainmast, 24 feet; foremast, 21 feet.

Engines: Compound Steeple Condensing; 2 cylinders, 4 1/2 in. and 8x6 in. George Whitney, Boston, 1890.

Boilers: Serpentine water tube, 1892. C. W. Foster, New Haven. 10 horse power.



CHARLES M. PECK.

CHARLES M. PECK, of New Haven, Conn., has been a yachting man all his life. When fifteen years old his love of yachting had enabled him to learn the rudiments of sailing and handling a yacht. In the Spring of 1882, he joined the NEW HAVEN YACHT CLUB, and since that time he has given much of his time and attention to this subject. He became the owner of MARGUERITE, which he still owns, and which he has sailed in many of the regattas of the NEW HAVEN CLUB. In 1886 he was elected Rear-Commodore and was unanimously chosen as the Commodore of the club at its next annual meeting. The following year he declined a re-nomination. His yacht has won many prizes and the Ex-Commodore many friends, during their stay in the NEW HAVEN YACHT CLUB.

MARGUERITE.

A centerboard sloop owned by H. E. and Chas. M. Peck of New Haven, Conn. Was designed and built by Norton Bros. and launched in 1880. She was lengthened in 1888. She hails from New Haven, her owners being members of the NEW HAVEN YACHT CLUB. See Fig. 425.

DIMENSIONS.

Length over all,	40 feet 5 inches.	Length load waterline,	31 feet 5 inches.
Depth,	4 feet 6 inches.	Draft,	4 feet.
Beam,	14 feet 6 inches.		

H. A. SEYMOUR, ex-Commodore of the NEW HAVEN YACHT CLUB, is a resident of Washington, D. C., and was born in Bristol, Conn. Business, attorney-at-law. For ten years interested in yachting. Formerly the owner of the yacht HILDA, now the owner of SEA BELLE. He was Commodore for four years and for one year Vice-Commodore of the NEW HAVEN YACHT CLUB.

SEA BELLE.

A keel sloop, the property of H. A. Seymour, of Washington, D. C., ex-Commodore of the NEW HAVEN YACHT CLUB. She was



EX-COMMODORE H. A. SEYMOUR.

designed and built by Thomas Creamer and launched in 1882. The Commodore has owned the yacht since 1883. In this same year she was lengthened and raised. She hails from New Haven, Conn.

DIMENSIONS.

Length over all,	37 feet.	Length load waterline,	30 feet 10 inches.
Depth,	6 feet.	Draft,	6 feet 10 inches.
Beam,	10 feet.		

NEW HAVEN YACHT
Club, and was born in
ten years interested
in HILDA, now the
four years and for
YACHT CLUB.

of Washington, D.
Club. She was



it.
launched in 1882. The
in this same year she
New Haven, Conn.

line, 30 feet 10 inches,
8 feet 10 inches.



COMMODORE T. B. JANNEY,
MINNETONKA YACHT CLUB.



MINNETONKA YACHT CLUB HOUSE.

History of the Minnetonka Yacht Club.

NO one who sees beautiful Lake Minnetonka, situated in the far northwestern State of Minnesota would look upon it as a place where yachting could be either popular or practicable, but as a matter of fact the keen lover of yachting will here find a sturdy progressive spirit and enterprise so necessary to a successful development of this sport—and scattered among Minnetonka's bays and inlets a fleet of boats which in speed, beauty, and general attractiveness is second to none in this country. Here a most flourishing yacht club was organized on the 11th of August, 1882, having a membership at the present time of over three hundred and a beautiful Club House. The fleet consists of over sixty yachts, ranging in length from 16 to 23 feet keel, (the latter being the limit) and they represent the most intelligent and advanced ideas among modern boat builders. There is scarcely a name among the successful designers of small boats for the last twenty-five years which cannot be found upon the books of this club as having designed one or more boats for its members. The membership is composed largely of gentlemen residing in Minneapolis who make their summer home on the lake, and embraces many prominent men, representing all the leading professions and business interests of the northwest. The lawyer and the banker, the doctor and the wholesale merchant, the miller and the minister, meet at this favored spot to contest for the beautiful prizes which every year are the victor's reward. Among the many fast boats famous in other waters before they were brought to their present home, not one can be said to be a "sure winner." It has been the experience of the club ever since its organization, that the champion of one year found herself confronted the succeeding year with competitors more dangerous than any she had thus far encountered. A progressive spirit characterizes the members, and it is doubtless not too much to say, that should any one craft carry off the honors for a number of years in succession, the entire energies of the club would be bent towards

finding another boat which would prove herself to be just a little faster. The following is the list of yachtsmen who held office in 1892: Commodore, Chas. B. Eastis; Vice-Commodore, Bradford C. Hurd; Fleet Captain, Geo. A. Morse; Secretary, Robert G. Gale; Treasurer, Cavour S. Langdon; Measurer, Bradford C. Hurd, Jr.

Regatta Committee: Chairman, C. N. Smith, F. B. Bailey, Geo. A. Dole.

House Committee: Wm. Peet, Jr., B. C. Hurd, G. A. Morse.

Directors: H. J. Burton, C. B. Eastis, E. J. Phelps, Wm. Peet Jr., T. B. Janney, B. C. Hurd, G. A. Morse, C. S. Langdon, C. N. Smith.

In 1893 the following yachtsmen were elected to office: Commodore, T. B. Janney; Vice-Commodore, Wm. Peet, Jr.; Fleet Captain, W. A. Ramsey; Secretary, Robert G. Gale; Treasurer, Cavour S. Langdon; Measurer, Bradford C. Hurd, Jr.

Regatta Committee: Chairman, F. B. Bailey, C. H. Sweeney, W. B. Angir.

House Committee: Wm. Peet, Jr., F. J. Hopkins, C. N. Smith.

Directors: T. B. Janney, C. B. Eastis, W. K. Morison, C. S. Langdon, Wm. Peet, Jr., J. T. Wyman, C. N. Smith, F. B. Long and W. A. Ramsey.

On the 15th day of April, 1889, the club was incorporated, and the name, purpose, plan and location in the amended articles of incorporation is as follows:

The name of this corporation shall be the MINNETONKA YACHT CLUB. Its general purpose shall be the promotion of a larger interest in yachting, the social enjoyment of its members and the mutual improvement of their skill in the art of seamanship. Its plan of operation shall be to encourage sailing, and to erect and maintain a boat house and docks on Lake Minnetonka, in Hennepin County, Minnesota; its principal offices shall be at Minneapolis, Hennepin County, Minnesota.

LIST OF YACHTS ENROLLED IN THE MINNETONKA YACHT CLUB.

SLOOPS.

YACHT.	OWNER.	DESIGNER.	BUILDER.	LENGTH.	BEAM.	SAIL AREA.
				ft. in.	ft. in.	sq. ft.
Advertiser	J. L. Stack	Arthur Dyer	Arthur Dyer	501
Alpha	E. J. Phelps	N. G. Herreshoff	Herreshoff Mfg. Co.	21	7 6	737
Aurelia	C. S. Langdon	J. B. Brooks	J. B. Brooks	21	9 9	740
Aurora	T. E. Gaty	J. B. Brooks	J. B. Brooks	22 2½	9 8	785
Bird	Wm. Peet, Jr.	N. G. Herreshoff	Herreshoff Mfg. Co.	18 2	7 3	430
C. L. C.	Geo. Cook, Chas. Champion, Louis Long	F. B. Long	F. B. Long	22 10	8 3	733
Cella II.	W. W. Hay	J. B. Brooks	J. B. Brooks	14 1	7 0	405
Dolphin	W. H. Dunwoody	H. C. McLeod	J. B. Brooks	22	8 8	688
Eleanor	H. E. Selden	Wallin & Gorman	Wallin & Gorman	21 13¼	8 7	713
Electric	F. S. Warren	Kelsey	Kelsey	472
Elytra	E. L. Bidwell	J. B. Brooks	W. W. Parker	21 7	9 2½	733
Idler	Geo. A. and W. D. Morse	Thos. Chapham	Thos. Chapham	18 6	7 2	470
Ino	W. D. Gregory	J. B. Brooks	T. H. Wise	19 10	8 10	480
Kite	W. H. Dunwoody, Wm. Peet, Jr.	N. G. Herreshoff	Herreshoff Mfg. Co.	22 9	8 1¼	840
Marehloness	C. A. Hovey	G. V. Johnson	G. V. Johnson	20 1½	8 7½	629
Mary Leo	J. H. Marshall	W. W. Parker	W. W. Parker	22 10½	8 8	772
Mermaid	H. C. Jefferson	Kelsey	Riddle & Penfield	20 3	9 0½	701
Modesty	Egerton	Chapman	Chapman	20	9	550
Mystic	F. F. Casseday, H. M. Lawrence	Thos. Chapham	Thos. Chapham	21	8	567
Oriole	Walter S. Milnor	R. C. Moore	R. C. Moore	20 11	11	687
Pearl	G. McC. Reeve	C. D. Smith	Thatcher & Brooks	19 11½	9 1	637
Peerless	Carl Puckett	Geo. Graves	Geo. Graves	19 11	8 10	567
Phyllis	Robt. G. Gale	J. B. Brooks	J. B. Brooks	18 11	8 2	780
Siren	T. A. Sammis	J. B. Brooks	J. B. Brooks	22 7	10 1	804
Swallow	Mark Ewing	J. B. Brooks	W. W. Parker	18 8	8	590
Varuna	E. J. Phelps	H. C. McLeod	H. W. Riddle	23	11 6	983
Verve	Geo. H. Duzgett	Chapman	Chapman	19 11	9	564
Volante	H. J. Burton	Edward Burgess	Lawley & Son	20 8½	9 3½	671
Vreda	Wm. Donaldson	Edward Burgess	Lawley & Son	20 10	10	700
Wacouta	C. Z. Brown	H. C. Moore	B. C. Moore	21	10 3	670
Water Witch	F. H. Anson, L. S. Gillette	Arthur Dyer	Arthur Dyer	21 6	8	575
White Wings	B. C. Hurd, Jr.	R. C. Moore	H. C. Moore	22 2	9 0½	740

LIST OF YACHTS ENROLLED IN THE MINNETONKA YACHT CLUB.

CAT-BOATS.

YACHT.	OWNER.	DESIGNER.	BUILDER.	LENGTH.	BEAM.	SAIL AREA.
				ft. in.	ft. in.	sq. ft.
Ariadne	E. C. Gale	J. B. Brooks	J. B. Brooks	11 10	11 10	304
Atalanta	T. B. Janney	J. B. Brooks	J. B. Brooks	17 2	8 23 ₄	304
Bonita	C. T. Thompson	Johnson & Moore	Johnson & Moore	23	9 4 ₀	530
Calypso	J. A. Oldenburg	Hereschoff Mfg. Co.	Hereschoff Mfg. Co.	21 3	10 8 ₀	543
Catherine	H. K. Sible	J. B. Brooks	J. B. Brooks	16 6	7 2	280
Columbia	W. A. Ramsey	R. C. Moore	J. B. Brooks	1 5	9 10 ₀	518
Curlew	Eustis & Young	R. C. Moore	R. C. Moore	20 11	9 0 ₀	560
Elizabeth	F. M. Laraway	J. B. Brooks	J. B. Brooks	20 8 ₀	9 2 ₀	438
Fanchon	W. G. Crocker	Joseph Dingle	Joseph Dingle	20 4	8 9	535
Helen	F. J. Hopkins	R. C. Moore	R. C. Moore	21 4	9 3	497
Ida	Geo. A. Brackett	Jake Smith	Jake Smith	19 3	9 3	465
Idlewild	Dole & Morse	J. B. Brooks	Thatcher & Brooks	22 9	9 3	560
Kestrel	Boy Wyman	Thos. Chappin	Thos. Chappin	23 2	9	511
Kismet	Willis S. Williams	Arthur Dyer	Arthur Dyer	16	8	321
Mollie	E. A. Sumner	G. V. Johnson	G. V. Johnson	17 4	8	390
Nautilus	J. C. Elliot	T. H. Wise	T. H. Wise	20 5	8	471
Princess	Carman N. Smith	A. Cary Smith	W. W. Parker	16	7 6	255
Silver Bell	C. N. Chadborn	Johnson & Moore	Johnson & Moore	21 9	8 6	457
Ventura	W. S. Benton	R. C. Moore	R. C. Moore	20 4	9 3	451
Wave	J. A. Camp	Capt. Dyer	Capt. Dyer	20 11	9 6	532
Winona	L. H. Brooks	R. C. Moore	R. C. Moore	19 10	9 6	492
Zoraya	C. S. Hulbert	R. C. Moore	R. C. Moore	17	7	329
				20	9 5	501

SPECIAL CLASS.

YACHT.	OWNER.	DESIGNER.	BUILDER.	LENGTH.	BEAM.	SAIL AREA.
				ft. in.	ft. in.	sq. ft.
Coquette	L. B. Newell	J. B. Brooks	J. B. Brooks	16	7 6	329
Coquina	W. G. Hollis	Hereschoff	Hereschoff Mfg. Co.	16	5 6	180
Countess	F. P. Wilson	A. Westlake	A. Westlake	16	8	330
Fleetwing	Geo. F. Barnard	A. Westlake	A. Westlake	15 3	5 4	181
Hermes	Ward C. Burton	Capt. Dyer	Arthur Dyer	16	7	321
Kelpie	A. M. Keith	J. B. Brooks	J. B. Brooks	15 6	314
King Bird	A. E. McMullen	Arthur Dyer	Arthur Dyer	16	5 2	329
Lark	W. W. Parker	W. W. Parker	W. W. Parker	16	5 2	329
Pauline	Paul Blackmar	J. B. Brooks	J. B. Brooks	15 10	7 7	331
Ruth N.	H. J. Neiler	P. McGeehan & Son	P. McGeehan & Son	25	11 6	680
Snark	C. H. Sweeney	Capt. Dyer	Capt. Dyer	16	8	329
The Kid	Wm. M. Tenney	J. B. Brooks	J. B. Brooks	15	311

ACCORDING TO THE RULES AND REGULATIONS.
MANAGEMENT OF RACES.

All races and all boats sailing therein shall be under the direction of the Regatta Committee, or of officers appointed by them. All matters shall be subject to their approval and control, and all doubts, questions and disputes which may arise be subject to their decision. Their decision shall be based on these rules so far as they apply, but as no rules can be devised capable of meeting every incident and accident of sailing, the Regatta Committee should keep in view the ordinary customs of the sea, and discourage all attempts to win a race by other means than fair sailing, superior speed and skill.

POSTPONEMENT OF RACES.

The Regatta Committee, or officers in charge for the day, shall have power to postpone any race.

CLASSIFICATION.

Boats shall be classified according to length. There shall be five classes, as follows:

First Class.—Jib and mainsail boats 20 feet to 23 feet.

Second Class.—Jib and mainsail boats 16 feet, 6 inches and under 20 feet.

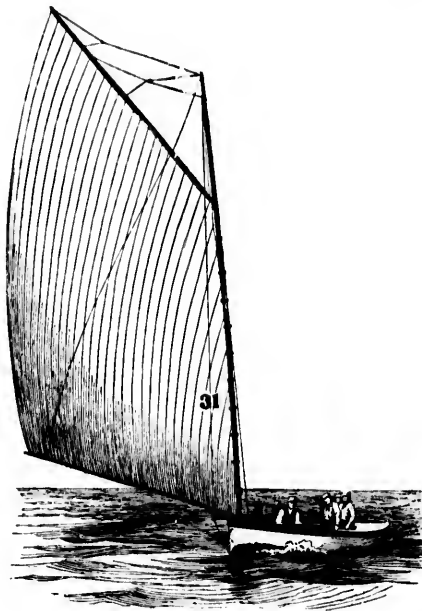

ATALANTA.—FIGURE 426.

Third Class.—Cat-rigged boats 20 feet to 23 feet.

Fourth Class.—Cat-rigged boats over 16 feet and under 20 feet.

Fifth Class.—Boats of any rig 14 feet and not over 16 feet.

EXCEPTION.

(a) Boats known as Cutumarrans, Canoes, St. Lawrence Skiffs, and the like shall not be classified with boats of other types or compete with them, but this shall not affect the standing of any boat enrolled in the club book of 1892.

(b) At least three yachts must be entered to constitute a class for the season, but thereafter a yacht duly entered shall not be deprived

of a prize in any race by reason of the failure of her competitors to sail the race.

Length shall be taken three inches above the waterline. The waterline shall be determined by ballasting the boat to her usual trim when the crew is not on board, with not less than two pounds of ballast for each square foot of mainsail. The inside ballast to be placed as directed by the Measurer, who shall keep in view the usual racing trim of the boat. No boat shall be so ballasted in any race as to make her classified length respectively more or less than the extreme limits of her class when the crew is not on board.

TIME ALLOWANCE.

(a) Time shall be allowed for difference in sailing lengths according to the table adopted and now used by the club.

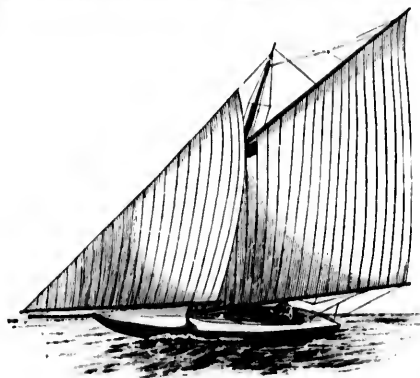

OSAWA.—FIGURE 427.

(b) The sailing length of a boat shall be the square root of its sail area.

EXCEPTION.

(1) It shall not be computed as less than the minimum length of its class.

(c) Before entering a race the owner shall furnish the Regatta Committee with a certificate of measurement, giving the measurement for length and for sailing length, signed by the official Measurer of the club. The Measurer's fee for such certificate shall be one dollar.

(g) The mainsail shall be measured as follows:

Hoist the sail and set the peak and luff up taut and let go the topping lift so that the weight of the boom comes on the leach of the sail. Take the length of the sail on the foot, luff, head and leach, measuring from the outside of cringles, also the diagonal line from throat to clew of sail.

(h) The jib shall be measured as follows: Hoist the sail up taut, take the length of the sail on the luff, leach and foot.

From the measurement so taken a sail plan would be made and the area calculated as follows: See diagram page 405.

To find the area of mainsail multiply A by B and C by D, add the products together and divide by two.

To find the area of jib, multiply E by F and divide by two.

(i) For sails of any shape that cannot be measured by the above formula, the Measurer shall make a plan and refer the case to the Regatta Committee.

(j) An owner wishing to change the sails of his boat may do so upon giving two days notice to the Regatta Committee and obtaining a new certificate of measurement, but this rule shall not disqualify a yacht compelled to change any sail by reason of any unavoidable damage or accident, which could not be repaired before the next race,

provided that notice of such change shall be given to the Regatta Committee before the race is started.

(k) The Measurer shall make official marks upon the boom, gaff and jib boom at the points to which he measured the sails. If the sails are stretched beyond the official marks without notice to the Regatta Committee such boats shall be disqualified.

ENTRIES.

Entries shall be made in such form as the Regatta Committee may direct. Such entry shall designate the class in which the yacht

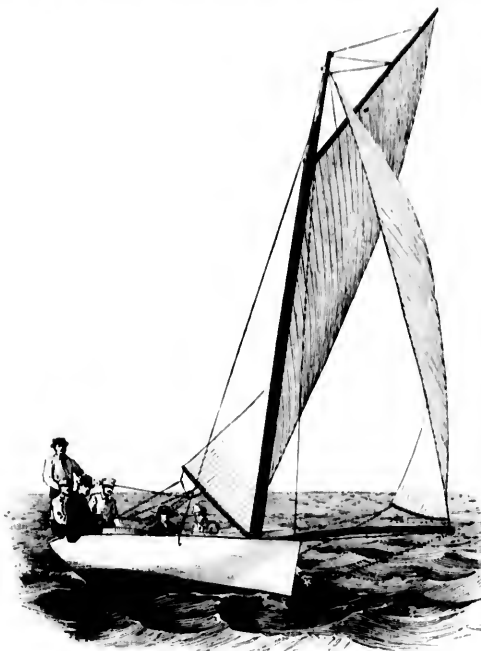

VOLANTE.—FIGURE 128.

intends to sail, and such yachts shall not compete in any other class until after a new entry has been made. Each boat entered for a race must be the property of a member or members of this club.

DISTINGUISHING NUMBERS.

Each boat to be eligible shall carry distinguishing numbers throughout the race, which shall be fastened on each side of the sail, above the reef points. The numbers to be furnished by and obtained from the Regatta Committee.

INSTRUCTIONS.

(a) Each boat, before a race, should obtain printed instructions at the Club House, as to the conditions of the race, the course to be sailed, marks, etc. Nothing shall be considered a mark unless specially named in these instructions.

(b) The Regatta Committee may amend or change the instructions at any time before the race, provided notice thereof is posted at the Club House before the preparatory signal.

MEMBERS ON BOARD.

Every boat competing in a race shall be steered by a member of the club.

CREW.

(a) A cut-rigged boat may carry any number of men, provided their aggregate weight does not exceed two pounds for each square foot of mainsail.

(b) A boat of any other rig may carry any number of men, provided their aggregate weight does not exceed one and three-quarter pounds for each square foot of total sail area.

BALLAST.

Ballast shall not be changed in any way whatever during a race, and no out-riggers to windward will be allowed.

START AND FINISH.

(a) All boats shall be amenable to these rules from the signal given five minutes before the time for crossing the starting line, if the start is a flying one, otherwise they shall be amenable to the rules from the time of crossing the starting line. The time and manner of the start shall be determined by the Regatta Committee and the finish shall be taken when the mast crosses the given line; but if this point in any boat be across the line before the signal for the start in her class is given, she must return and re-cross the line.

(b) A boat so returning, or working into position from the wrong side of the line, after the signal for the start has been given must keep clear of and give way to all competing boats.



SILVER BELLE.—FIGURE 129.

(c) When the time for each boat is taken at the start, a difference in corrected time of three seconds or less shall be considered a tie, and the race shall be ordered re-sailed as between such boats.

TIME OF RACE.

In case any boat in any class sailing in a race sails the course at the rate of $3\frac{3}{4}$ knots per hour, actual time, it shall be a race for all classes, otherwise it shall be declared no race, and shall be sailed again on some day to be named by the Regatta Committee.

ANCHORAGE.

A boat may anchor or come to moorings during a race but must weigh anchor on resuming her course.

REMOVAL OF STAKE BOAT, ETC.

Should any stake boat, buoy, or other mark be removed from its proper position, either by accident or design, the race shall be sailed over again, or not, at the option of the Regatta Committee.

RUNNING AGROUND, ETC.

Any boat aground, or foul of a buoy, vessel or other obstruction, may use any means, including anchors, boats, oars, poles, warps, etc., to get off. In no other case shall any means except sails be used to propel the boat.

ACCIDENTS.

In case of accident to another boat, or to a member of the crew by falling overboard or otherwise, all boats in a position to do so shall use their utmost endeavors to render assistance, and if it should ap-

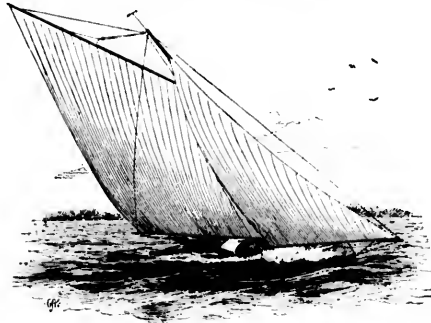

DOLPHIN.—FIGURE 430.

pear that any boat was thereby prevented from winning the race, the Regatta Committee shall have power to order the race to be re-sailed between such boat and the actual winner.

CHAMPION FLAGS.

(a.) There shall be a champion flag for each class to be given the yacht winning the greatest number of regularly scheduled club races during the season in her respective class, the annual cruise being excepted, such yacht to be declared the champion in its class for the season.

(b.) When the scheduled races for the season are over, if it be found that there is no winner in any class, but that two or more yachts are tied for first place, then these winners shall sail off the ties between them before the close of the season, on dates fixed by the Regatta Committee.

PRIZES IN ALL RACES.

In all races a prize shall be given in each class to the winners, and a second prize in each class, in which three or more yachts start.

The yachting season to be from May 30th to October 1st, inclusive.

TABLE OF TIME ALLOWANCE.

The allowances in the table adopted are based upon the rule accepted by naval architects that, within economic limits, opportunities for speed vary in different vessels as the square roots of their respective lengths. As strong winds are required, however, to give to larger vessels the full extent of their advantage in size, and as such a scale of allowance is not adapted to ordinary summer racing, fifty per cent. only of the allowance due to the rule is given in the table, and may be stated thus:

Time equals $\frac{3600}{L} \sqrt{\frac{360}{L}}$ representing the number of seconds in one hour, L the small yacht, and L the large one.

Practically the formula is $\frac{1800}{L} \sqrt{\frac{180}{L}}$ five-tenths of 3600 being 1,800

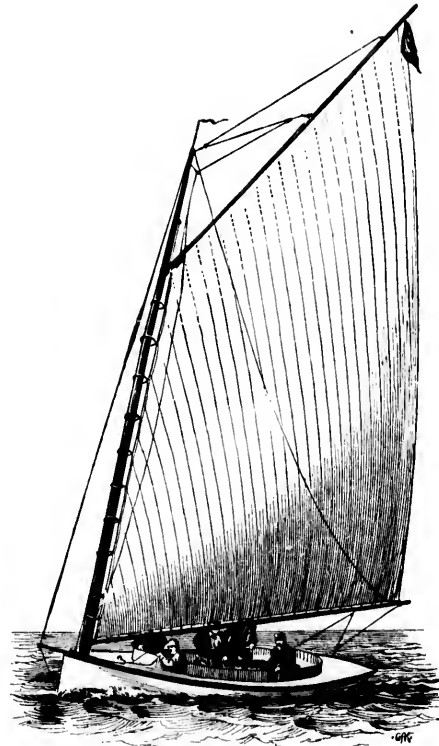

CUTLEW.—FIGURE 431.

PRIZE WINNERS FOR 1891.

SLOOPS.

First Class.

	VARUNA.	AURELIA.	VOLANTE.	BOUNCER.	BUTH S.
First club race, May 30th	1 52 44	1 55 45	1 55 11	2 12 41	
Second club race, June 13th	1 56 21	1 54 11			1 45 40
First cup race, July 7th	2 05 27	2 00 27	2 00 57	2 07 31	1 50 28
Second cup race, July 18th	2 08 32	2 05 44	1 58 49	2 11 11	
Third cup race, Aug. 1st	1 57 45	2 17 09	2 03 31	1 49 51	
Third club race, Aug. 22d	1 50 25	1 57 21	1 57 51		
Fourth club race, Aug. 29th	1 41 28	1 45 24		1 42 21	1 42 03

WHITE WINGS.

	SIREN.
1	1
2	2
3	2 05 10
4	2 19 09
5	2 07 20
6	2 05 10
7	1 42 03

Second Class.

	BIRD.	IDLER.
	H. M. S.	H. M. S.
First club race, May 30th		1 46 55
Second club race, June 13th	1 43 25	1 53 55
First cup race, July 7th	2 01 40	2 00 25
Second cup race, July 18th	1 56 51	2 06 11
Third cup race, Aug. 1st		1 46 13
Third club race, Aug. 23d	1 46 08	1 51 29
Fourth club race, Aug. 29th	1 37 53	

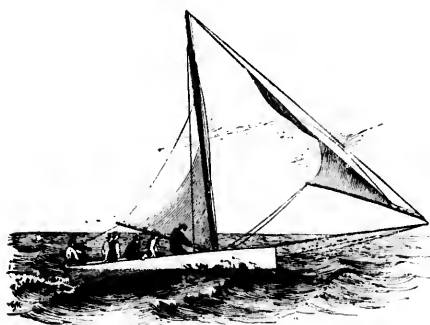

WHITE WINGS.—FIGURE 432.

CAT-BOATS.

	ATALANTA.	IDA.	CURLEW.
First club race, May 30th	1 50 36		2 03 42
Second club race, June 13th	2 02 02	1 58 44	2 02 13
First cup race, July 7th	1 57 02	2 03 11	2 08 20
Second cup race, July 18th	2 16 01	2 13 53	2 17 46
Third cup race, Aug. 1st	1 48 14	1 55 40	1 56 27
Third club race, Aug. 23d		1 51 59	2 03 40
Fourth club race, Aug. 29th		1 43 40	1 43 27

*IDA won the race with ATALANTA.

Special Class.

	THE KID.	HERMES.	KING BIRD.
First club race, May 30th	2 16 00	2 23 50	
Second club race, June 13th		2 21 28	
First cup race, July 7th			2 17 20
Second cup race, July 18th	2 28 15	2 36 17	
Third cup race, Aug. 1st	2 10 01		
Third club race, Aug. 23d			
Fourth club race, Aug. 29th			

FIRST CLUB RACE, MINNETONKA YACHT CLUB.

Sailed May 30, 1892.

SLOOPS.

Name.	Sailing Length, Feet.	Sail Area, Sq. Ft.	Allowance, 10 miles.	Actual Time, H. M. S.	Corrected Time, H. M. S.
First Class.					
1 Varuna	29.1	846	28	2 01 50	2 00 53
2 Siren	27.8	770	1.15	1 57 02	1 55 45
3 Aurelia	27.5	753	2.04	2 12 20	2 09 51
8 Dolphin	25.0	670	3.48	1 59 19	1 55 18
11 Bouncer	22.7	517	7.49	2 06 37	2 00 10
12 Oriole				2 12 42	2 12 42
16 Volante	25.9	670	3.48	1 58 22	1 54 07
Second Class.					
25 Bird	21.0	444	10.19	1 59 25	1 48 32
33 Idler	21.0	440	10.19	2 07 02	1 57 49

CATS.

	Sailing Length, Feet.	Sail Area, Sq. Ft.	Allowance, 10 miles.	Actual Time, H. M. S.	Corrected Time, H. M. S.
First Class.					
31 Atalanta				2 05 29	1 57 58
32 Ida				2 06 13	1 59 56
33 Bonita				2 01 23	2 00 44
31 Princess				2 12 48	2 03 27
37 Curlew				2 11 42	2 02 21
41 Ventura				2 08 47	2 00 35
44 Mollie				2 10 18	2 00 11
Special Class.					
65 Hermes				2 25 00	2 02 50
69 Kestrel				2 21 43	2 10 01

A yacht sailing in a higher class not allowed a greater allowance than the following:

	M. S.
Entering sloops, first class	4.23
Entering sloops, second class	7.17
Entering cats, first class	4.23
Entering cats, second class	8.49

First Cup Race, sailed June 11, 1892;

SLOOPS.

First Class.					
1 Varuna	29.1	846	28	1 56 33	1 55 30
2 Siren	27.8	770	1.43	1 57 07	1 55 52
3 Aurelia	27.5	753	2.04	2 01 29	1 59 10
7 White Wings	26.4	696	3.15	1 57 37	1 54 23
16 Volante	25.9	670	3.48	1 50 53	1 52 38
Second Class.					
25 Bird	21.0	441	10.19	1 56 06	1 45 13
30 Celia R.				2 14 59	2 05 29

CATS.

First Class.					
31 Atalanta				2 08 51	2 01 22
32 Ida				2 07 51	2 01 00
31 Princess				2 12 47	2 03 26
Special Class.					
60 The Kid				2 16 08	1 59 40
53 Kestrel				2 25 59	2 11 17
70 King Bird				2 22 51	2 06 59

Club Race sailed July 2, 1892:

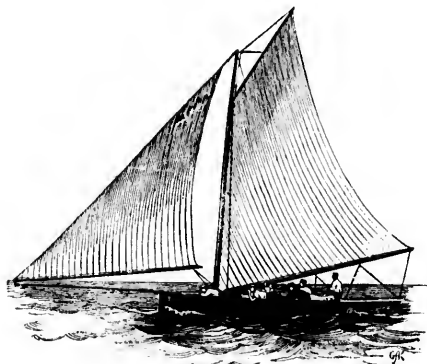

MERMAID.—FIGURE 433

SLOOPS.

Second Class.					
18 Bird	20.7	430	10.53	2 00 23	1 49 30
16 Idler	21.8	476	9.13	2 12 31	2 03 18
19 Electric	21.7	472	9.21	2 22 41	2 13 20

Re-sailed as to first class sloops and cats, on September 3, 1892:

the number of sec-

000 being 1,800



OUNCEL RUTH S.

2 12 41	1 45 49
2 07 31	1 56 28
2 11 11	
49 51	
42 21	1 42 03

Club Race sailed July 9, 1892.

	SLOOPS.				
	Sailing Length. Feet.	Sail Carried. Sq. Ft.	Allow-ance. 10 miles.	Actual Time. H. M. S.	Corrected Time. H. M. S.
First Class.					
5 Aurelia	27.2	740	2 20	2 12 14	2 09 45
4 Aurora	28.0	785	1 30	2 09 20	2 07 50
10 Waconta	26.6	706	3 07	2 19 50	2 16 52
6 White Wings	26.5	705	3 14	2 12 00	2 08 46
7 Dolphin	26.2	688	3 34	2 05 41	2 02 07
9 Bouncer	23.8	567	6 27	2 13 42	2 07 15
1 Oriole	29.7	883		2 13 49	2 13 49
8 Volante	25.9	671	3 51	2 06 25	2 02 31
Second Class.					
18 Bird	20.7	430	10 53	2 04 54	1 54 01
16 Idler	21.8	476	9 13	2 13 40	2 04 27
17 Celia R.	21.6	465	9 30	2 24 44	2 15 14

	CATS.				
	Sailing Length. Feet.	Sail Carried. Sq. Ft.	Allow-ance. 10 miles.	Actual Time. H. M. S.	Corrected Time. H. M. S.
First Class.					
32 Atalanta	23.0	530	7 31	2 21 06	2 13 35
31 Ida	23.5	566	6 51	2 10 57	2 13 06
36 Princess	23.0	565	7 31	2 17 38	2 10 07
37 Curlew	20.8	438	10 44	2 23 46	2 13 12
44 Zoraya	21.6	503	9 30	2 29 27	2 10 57
34 Ventura	22.5	532	8 12	2 14 49	2 06 37
35 Mollie	21.2	471	10 67	2 28 22	2 18 15
Special Class.					
67 Hermes	15.1	181	22 10	2 41 48	2 19 38
65 King Bird	17.7	314	15 52	2 27 37	2 11 45
53 Kestrel	18.5	291	14 42	2 41 28	2 26 46
70 Coquina	17.6		10 28	2 29 58	2 13 30

Second Cup Race sailed July 23, 1892:

	SLOOPS.				
	Sailing Length. Feet.	Sail Carried. Sq. Ft.	Allow-ance. 10 miles.	Actual Time. H. M. S.	Corrected Time. H. M. S.
First Class.					
2 Varuna	30.0	903	16	1 57 05	1 57 21
3 Siren	28.4	808	1 15	1 58 22	1 57 07
5 Aurelia	27.2	740	2 29	2 04 57	2 03 18
4 Aurora	28.0	785	1 39	2 00 16	1 59 37
6 White Wings	26.5	705	3 14	2 00 17	1 57 03
7 Dolphin	26.2	688	3 34	1 54 53	1 51 19
9 Bouncer	23.8	567	6 27	2 03 56	1 57 20
1 Oriole	29.7	883		2 02 31	2 02 31
8 Volante	25.9	671	3 54	2 00 52	1 56 58

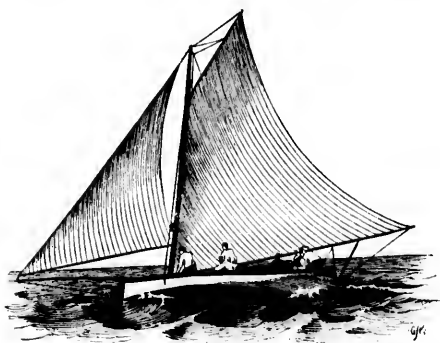

AURELIA.—FIGURE 434.

	SLOOPS.				
	Sailing Length. Feet.	Sail Carried. Sq. Ft.	Allow-ance. 10 miles.	Actual Time. H. M. S.	Corrected Time. H. M. S.
Second Class.					
22 Phyllis				1 58 56	
18 Bird	20.7	430	10 53	1 54 24	1 43 21
16 Idler	21.8	476	9 13	2 07 26	1 58 13

	CATS.				
	Sailing Length. Feet.	Sail Carried. Sq. Ft.	Allow-ance. 10 miles.	Actual Time. H. M. S.	Corrected Time. H. M. S.
First Class.					
32 Atalanta	23.0	530	7 31	2 02 24	1 54 53
31 Ida	23.5	566	6 51	2 06 20	1 56 29
33 Bonita	22.9	563	7 39	2 21 26	2 12 47
36 Princess	23.0	565	7 31	2 10 04	2 02 33
37 Curlew	20.8	438	10 44	2 07 34	1 56 50
34 Ventura	22.5	532	8 12	2 08 33	2 00 20
35 Mollie	22.2	534	8 98	2 21 57	2 13 19

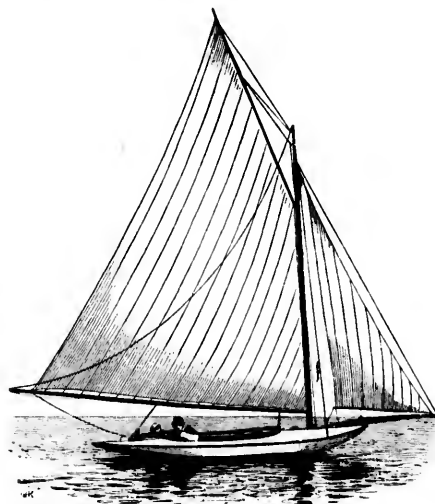

IDLER.—FIGURE 435.

	CATS.				
	Sailing Length. Feet.	Sail Carried. Sq. Ft.	Allow-ance. 10 miles.	Actual Time. H. M. S.	Corrected Time. H. M. S.
Special Class.					
67 Hermes	15.1	181	22 10	2 24 26	2 02 16
68 The Kid	17.6	311	16 28	2 19 26	2 02 58
65 King Bird	17.9	314	15 52	2 19 18	2 03 26
53 Kestrel	18.5	291	14 42	2 11 21	2 07 42

Annual Cruise sailed June 30, 1893.

	SLOOPS.				
	Sailing Length. Feet.	Sail Carried. Sq. Ft.	Allow-ance. 10 miles.	Actual Time. H. M. S.	Corrected Time. H. M. S.
First Class.					
3 Siren	28.4	808	1 15	2 48 04	2 46 49
4 Aurora	28.0	785	1 39	2 21 39	2 20 00
6 White Wings	26.5	705	3 14	2 36 14	2 33 00
9 Bouncer	23.8	567	6 27	2 48 13	2 41 46
1 Oriole	29.7	883		2 20 10	2 20 10
8 Volante	25.9	671	3 54	2 20 21	2 18 27
13 Pearl	25.6	657	4 15	3 01 35	2 57 20
Second Class.					
31 Peerless				2 48 30	
22 Phyllis				2 48 23	
11 Bird	20.7	430	10 53	2 40 37	2 29 44
16 Idler	21.8	476	9 13	2 46 10	2 36 57
17 Celia R.	21.6	465	9 30	3 10 25	3 00 55
CATS.					
First Class.					
32 Atalanta	23.0	530	7 31	3 02 34	2 55 03
31 Ida	23.5	566	6 51	2 54 15	2 47 24
36 Princess	23.0	565	7 31	2 53 40	2 46 09
37 Curlew	20.8	438	10 44	2 55 00	2 44 16
34 Ventura	22.5	532	8 12	3 10 43	3 02 31
35 Mollie	21.2	521	8 55	3 08 40	2 59 45
46 Della S.	25.6	732	4 15	3 11 37	3 07 12

ual ie. t. s.	Corrected Time. H. M. S.
---------------------	--------------------------------

24	1 54 53
20	1 59 29
26	2 13 47
04	2 02 33
34	1 56 50
33	2 00 20
57	2 13 19



2 02 16
2 02 58
2 03 26
2 07 42

2 46 49
2 20 00
2 33 00
2 41 46
2 20 19
2 16 27
2 57 20

2 29 44
2 36 57
3 00 55

2 55 03
2 47 24
2 46 09
2 44 16
3 02 31
2 59 45
3 07 12

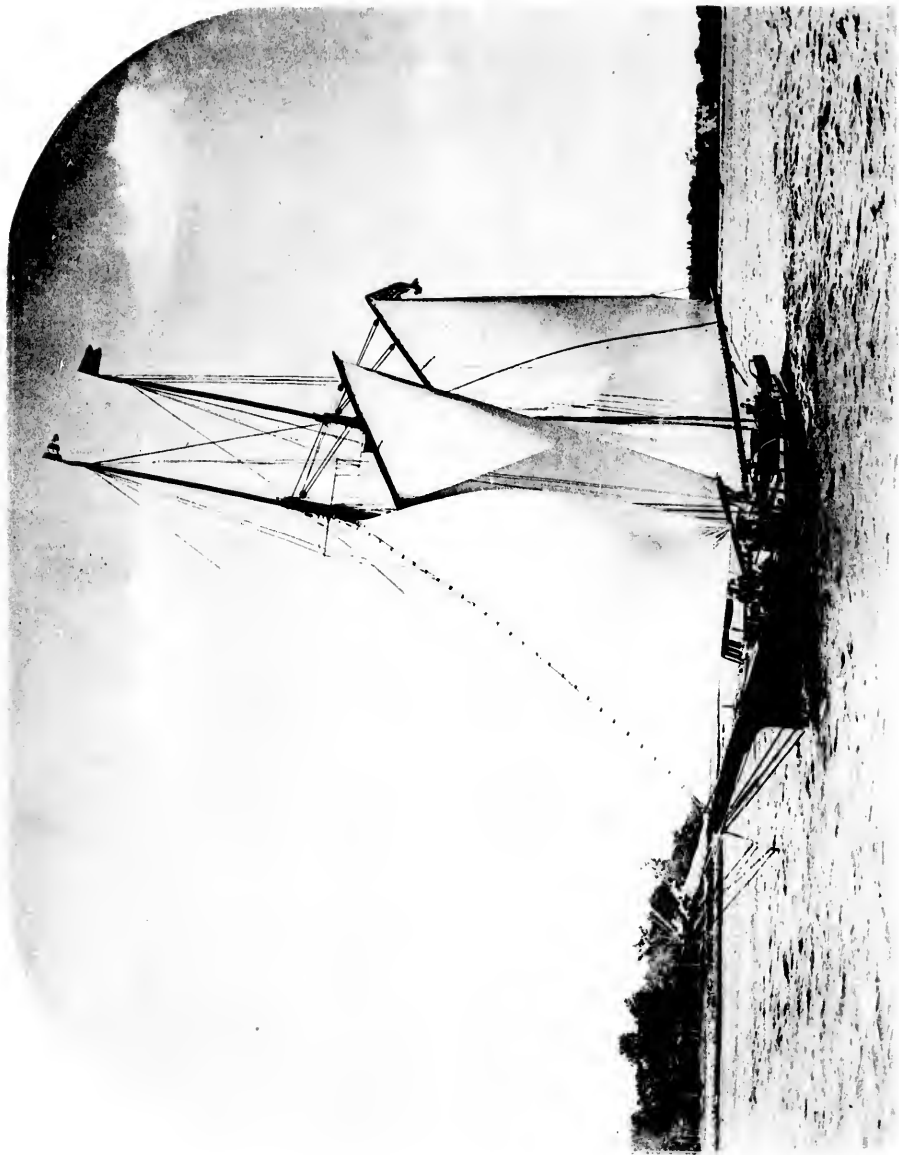
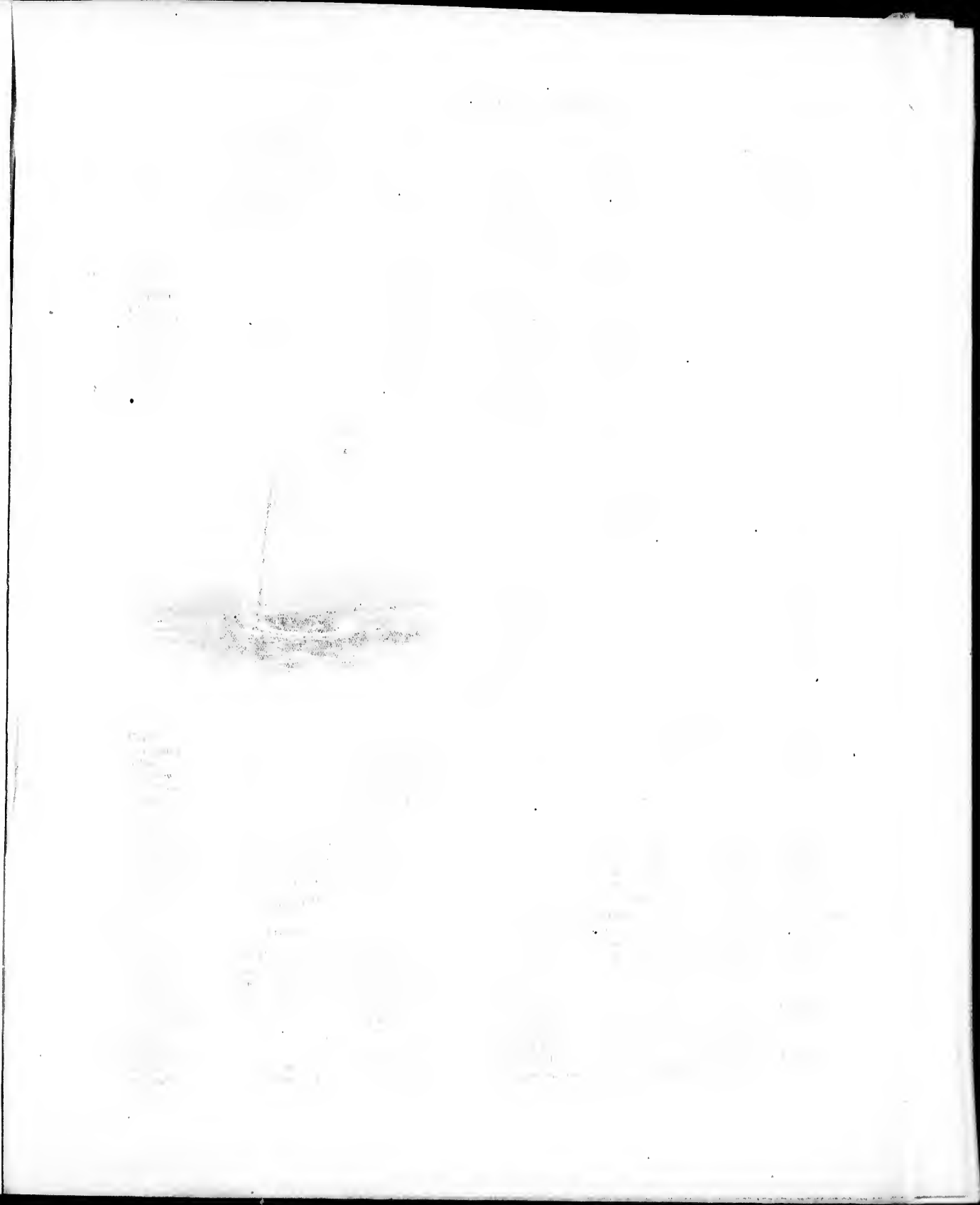

PLATE LV.

MAGIC.

MAGIC.





	Sailing Length.		Allow- ance.	Actual Time.		Corrected Time.	
	Feet.	Sq. Ft.		H. M. S.	H. M. S.	H. M. S.	H. M. S.
Special Class.							
60 The Kid	17.0	311	16 25	8 24 27	2 47 50		
65 King Bird	17.0	314	15 52	3 03 41	2 47 49		
68 Calypso	18.1	329	15 28	2 53 25	2 37 57		

Club Race, sailed August 13, 1892.

SLOOPS.							
First Class.							
2 Varuna	30.0	903	16	2 27 58	2 28 04		
8 Siren	28.4	808	1 15	2 27 55	2 26 40		
5 Aurelia	27.2	740	2 20	2 19 51	2 17 22		
4 Aurora	28.0	785	1 39	2 16 42	2 15 03		
8 White Wings	20.5	705	3 14	2 20 01	2 16 50		
9 Bouncer	23.8	567	6 27	2 28 31	2 22 04		
1 Oriole	29.7	883		2 33 36	2 33 36		
8 Volante	25.9	671	3 54	2 23 19	2 19 25		
18 Pearl	25.6	657	4 15	2 34 43	2 30 28		
Second Class.							
16 Idler	21.8	476	9 13	2 26 47	2 17 31		

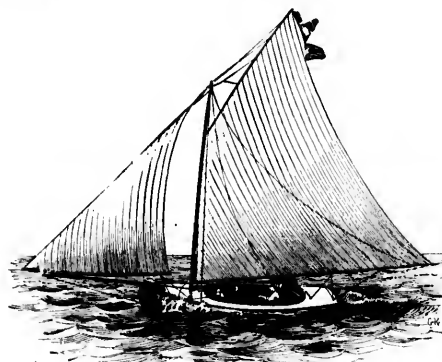

BIRD.—FIGURE 436.

CATS.							
First Class.							
32 Atalanta	23.0	530	2 31	2 29 29	2 21 58		
31 Ida	23.5	566	6 51	2 32 23	2 25 32		
37 Curlew	20.8	437	10 44	2 37 34	2 26 50		
34 Ventura	22.5	532	8 12	2 28 20	2 20 17		
35 Mollie	22.0	521	8 55	3 35 34	2 26 39		
Special Class.							
67 Hermes	15.1	181	22 10	2 46 47	2 24 37		
60 The Kid	17.6	311	16 28	2 52 42	2 36 14		
65 King Bird	17.0	314	15 52	2 52 15	2 36 23		
53 Kestrel	18.5	321	14 42	2 52 30	2 37 48		
70 Coquina	17.6	170	16 28	2 55 23	2 36 26		

Single Handed Race. Challenge by H. J. Burton. Sailed August 25, 1892.

SLOOPS.							
First Class.							
5 Aurelia	27.2	740	2 29	2 29 00	2 20 31		
4 Aurora	28.0	785	1 39	2 20 22	2 27 13		
7 Dolphin	26.2	688	3 34	2 41 55	2 38 01		
9 Bouncer	23.8	567	6 20	2 41 25	2 34 58		
8 Volante	25.0	671		2 38 53	2 38 53		
Advertiser				2 51 40			
Second Class.							
22 Phyllis				2 38 21			
16 Idler	21.18	476	9 13	2 56 05	2 46 52		
17 Celta R.	21.16	465	0 30	2 49 38	2 40 08		

CATS.							
First Class.							
31 Ida	23.5	566	6 51	2 41 55	2 35 04		
35 Mollie	21.2		8 55	2 41 40	2 35 45		
Special Class.							
67 Hermes			21 39	2 50 19	2 28 40		

Third Cup Race, sailed August 27, 1892.

SLOOPS.							
First Class.							
2 Varuna	30.0	903	16	3 52 28	1 52 51		
3 Siren	28.4	808	1 15	3 57 14	1 55 59		
6 White Wings	26.5	705	3 14	1 51 41	1 51 50		
9 Bouncer	23.8	567	6 27	1 58 40	1 52 13		
8 Volante	25.9	671	3 51	1 52 16	1 48 22		
13 Pearl	25.6	657	4 15	2 05 16	2 01 01		
Second Class.							
22 Phyllis				1 56 51			
30 Advertiser	23.0	501	7 31	1 56 08	1 48 37		

CATS.							
First Class.							
32 Atalanta	23.0	530	7 31	1 56 47	1 49 16		
31 Ida	23.5	566	6 51	1 58 55	1 52 04		
33 Bonita	22.9	563	7 39	2 12 35	2 04 56		
36 Princess	22.7	537	7 55	2 00 25	1 53 30		
37 Curlew	20.8	438	10 44	2 02 30	1 51 46		
14 Zoraya	21.6	503	9 30	2 00 45	1 51 15		
35 Mollie	21.7	502	9 21	2 06 36	1 57 13		
Special Class.							
60 The Kid	20.4	417	11 23	2 10 06	1 58 43		
65 King Bird	17.9	314	15 52	2 13 37	1 57 45		
53 Kestrel	18.5	321	11 42	2 10 11	1 55 49		
24 Swallow				2 11 13			

Club Race re-sailed as to first class sloops and cats. Sailed September 3, 1892.

SLOOPS.							
First Class.							
3 Siren	28.4	808	1 15	1 54 26	1 53 11		
4 Aurora	28.0	785	1 39	1 55 26	1 53 41		
7 Dolphin	26.2	688	3 31	1 53 03	1 50 19		
9 Bouncer	23.8	567	6 27	2 03 07	1 56 01		
1 Oriole	29.7	883		1 50 43	1 57 43		
8 Volante	25.9	671	3 51	1 57 25	1 53 11		

CATS.							
First Class.							
32 Atalanta	23.0	530	7 31	2 02 14	1 54 43		
31 Ida	23.5	566	6 51	2 03 57	1 57 06		
37 Curlew	25.8	438	10 41	2 09 47	1 60 03		
44 Zoraya	21.6	503	9 25	2 09 17	1 59 47		
34 Ventura	22.5	532	8 12	1 59 49	1 51 37		

TIE RACE. Champion for first class sloops and cats. Cup for special class. Sailed September 10, 1892.

CATS.							
First Class.							
7 Dolphin	26.0	678	3 48	1 55 27	1 51 39		
8 Volante	25.9	671	3 54	1 57 47	1 53 53		
Special Class.							
60 The Kid				2 23 48			
53 Kestrel	18.5	321	11 42	2 13 33	1 58 51		

The prize winners in 1892 were therefore as follows:

HISTORY OF THE MINNETONKA YACHT CLUB.

First class.

SLOOPS.

	DOLPHIN.	VOLANTE.	AURORA.	AURELIA.
	H. M. S.	H. M. S.	H. M. S.	H. M. S.
Club race, May 30th	1 55 18	1 54 07		2 09 51
Cup race, June 11th		1 52 38		1 59 10
Club race, July 9th	2 02 07	2 02 31	2 07 50	2 09 45
Cup race, July 23d	1 51 19	1 50 58	1 50 37	2 03 18
Club race, Aug. 13th		2 19 25	2 15 03	2 17 22
Cup race, Aug. 27th		1 48 22		
Club race, Sept. 3d	1 50 19	1 53 11	1 53 41	
Tie race, Sept. 10th	1 51 39	1 53 53		

Second Class.

	BIRD.	IDLER.
Club race, May 30th	1 18 32	1 57 49
Cup race, June 11th	1 45 13	
Club race, July 2d	1 49 30	2 03 18
Club race, July 9th	1 54 01	2 04 27
Cup race, July 23d	1 43 21	1 58 13
Club race, Aug. 13th		2 17 34
Cup race, Aug. 27th		

CAT BOATS.

	ATALANTA.	IDA.	VENTURA.
Club race, May 30th	1 57 58	1 59 56	2 00 35
Cup race, June 11th	2 01 23	2 01 00	
Club race, July 9th	2 13 35	2 13 06	2 06 37
Cup race, July 23d	1 54 53	1 59 29	2 00 26
Club race, Aug. 13th	2 21 58	2 25 32	2 20 17
Cup race, Aug. 27th	1 49 16	2 52 04	
Club race, Sept. 3d	1 54 43	1 57 06	1 51 37
Tie race, Sept. 10th	1 52 13		1 53 15

Special Class.

	HERMES.	KESTREL.	KING BIRD.	THE KID.
Club race, May 30th	2 02 50	2 10 01		
Cup race, June 11th		2 11 17	2 06 59	1 59 40
Club race, July 9th	2 10 38	2 26 46	2 11 45	
Cup race, July 23d	2 02 10	2 07 42	2 03 26	2 02 58
Club race, Aug. 13th	2 24 37	2 37 48	2 36 23	2 36 14
Cup race, Aug. 27th		1 55 49	1 57 45	1 58 43
Tie cup race, Sept. 10th		1 58 51		2 23 48

The First Race of the season of 1893 of the MINNETONKA YACHT CLUB was sailed on June 17th over a 10 mile course, for first class sloops. The following yachts participated:

	Sailing Length.	Elapsed Time.	Corrected Time.
	Ft.	H. M. S.	H. M. S.
Onawa	20.	1 46 11	1 34 09
Kite	25.0	1 51 51	1 40 29
Siren	21.4	1 57 54	1 56 39
Advertiser		2 06 05	1 57 27
Dagmar		2 01 39	1 58 33
Aurelia		2 01 47	1 58 58
Ida		2 02 10	1 59 48
Waconta	26.6	2 10 08	2 07 01
Aurora	28.0	2 01 40	2 00 07
Mystic	23.8	2 07 17	2 00 50
C. L. C.	27.8	2 03 20	2 01 47
Water Witch	22.7	2 10 38	2 11 43

SLOOPS.

Second Class; Course, 10 miles.

Idler	21.8	2 31 58	1 51 43
-------	------	---------	---------

CATS.

Third Class; Course, 10 miles.

Atalanta	23.	2 03 09	1 55 38
Curlew	22.6	2 09 26	2 01 23
Columbia	21.3	2 12 54	2 02 57
Mabel	21.7	2 14 21	2 06 27

Fourth Class; Course, 10 miles.

Kestrel	18.1	2 15 08	2 00 03
Coquette		2 20 49	2 04 57
King Bird	17.7	2 22 51	2 22 51

Fifth Class.

Coquina	14.0	2 28 43	2 03 35
---------	------	---------	---------

ONAWA, IDLER, ATALANTA and KESTREL were the winners in their respective classes.

The Second Race of the season was sailed July 1st, over a ten mile course, for 1st class sloops. The following boats took part.

	Sailing Length.	Elapsed Time.	Corrected Time.
	Feet.	H. M. S.	H. M. S.
Aurora	28.0	2 08 20	2 06 50
Aurelia		2 04 05	2 01 05
Mystic	23.8	2 13 08	2 06 41
Ida		2 06 26	2 06 26
C. L. C.	27.8	2 05 13	2 03 22
Alpha	26.2	1 49 27	1 46 93
Kite	25.6	1 50 23	1 46 08
Apukwa	24.9	1 51 35	1 46 31
Dagmar		1 56 59	1 56 59

SLOOPS.

Second Class; Course 10 miles.

Idler	21.8	2 07 38	1 58 25
-------	------	---------	---------

CATS.

Third Class.

Bonita	23.7	2 17 04	2 10 29
Curlew	22.6	2 09 28	2 01 24
Columbus	21.3	2 23 03	2 13 06

Fourth Class; Course 10 miles.

Kestrel	18.1	2 17 27	2 01 50
Cupid	16.	2 47 16	2 27 19

Fifth Class.

The Kid	15.	1 12 14	1 02 16
Hermes	14.	1 15 51	1 03 19
Coquina	11.	1 13 53	1 01 16

Winners: KITE, IDLER, CURLEW and COQUINA, in the irrespective classes.

The Third Race of the season was sailed July 4th, for first class sloops over a 10 mile course.

	Sailing Length.	Elapsed Time.	Corrected Time.
	Ft.	H. M. S.	H. M. S.
Aurora	28.	2 20 38	2 27 50
Aurelia		2 23 48	
White Wings	26.5	2 20 46	2 23 32
Mystic	23.8	2 30 42	2 24 15
Ida		2 27 50	
Water Witch	22.7	2 31 52	2 28 57
C. L. C.	27.8	2 22 05	2 20 14
Alpha	26.2	2 06 30	2 03 45
Kite	25.6	2 15 00	2 10 45
Apukwa	24.9	2 23 57	2 18 53
Dagmar		2 19 59	

SLOOPS.

Second Class.

Idler	21.8	2 31 40	2 22 27
-------	------	---------	---------

CATS.

Third Class.

Mabel	21.7	2 30 52	2 22 51
Curlew	22.6	2 34 49	2 26 45
Columbus	21.3	2 44 14	2 34 17
Pearl		2 31 17	2 21 56

Fourth Class.

Kestrel	18.1	2 42 28	2 27 00
King Bird	17.7	2 58 04	2 41 48
Coquette		2 41 39	2 25 47
Cupid	10.	2 50 27	2 30 30
Phyllis		2 38 03	2 27 55

Fifth Class.

Coquina	14.	2 58 53	2 33 45
---------	-----	---------	---------

The winners were ALPHA, IDLER, PEARL and KESTREL in their respective classes.

The fourth race for first class sloops was sailed July 15th, over a ten mile course. The following yachts were entered:

the winners in
over a ten mile
part.

Corrected
Time.
U. M. S.
2 06 50
2 04 05
2 06 41
2 00 26
2 03 22
1 46 33
1 46 08
1 46 31
1 56 59

1 58 25

2 10 20
2 01 24
2 13 06

2 01 59
2 27 19

1 02 16
1 03 19
1 01 16

the irrespective

for first class

2 27 50

2 23 32
2 24 15

2 23 57
2 20 14
2 03 45
2 10 45
2 18 53

2 22 27

2 22 51
2 26 45
2 24 17
2 21 56

2 27 00
2 41 48
2 25 47
2 30 30
2 27 55

2 33 45

STREL in their

y 15th, over a

SLOOP.

	Sailing Length.	Actual Time.	Corrected Time.
	Feet.	U. M. S.	H. M. S.
Aurora	28.0	2 12 08	2 10 20
Aurelia	27.3	2 08 51	2 06 32
Mystic	23.8	2 35 10	2 29 13
Ida	26.1	2 10 23	2 07 02
Water Witch	22.7	2 13 30	2 05 41
C. L. C.	27.8	2 03 21	2 01 30
Kite	25.0	2 01 09	1 56 54
Onawa	20.0	1 52 05	1 40 03
Apukwa	24.7	2 15 01	2 09 42
Second Class, Omega	24.2	2 32 35	2 27 20

Third Class.

	Sailing Length.	Actual Time.	Corrected Time.
Mable		2 24 32	2 15 37
Curlew	22.0	2 25 33	2 17 20
Columbus	22.4	2 25 19	2 16 58

Fourth Class.

	Sailing Length.	Actual Time.	Corrected Time.
Kestrel	18.3	2 20 33	2 11 28
King Bird	18.0	2 31 25	2 15 45
Coquette	17.0	2 37 37	2 21 45

Fifth Class.

	Sailing Length.	Actual Time.	Corrected Time.
The Kid	16.0	2 41 18	2 22 21
Hermes	14.0	2 57 43	2 32 35
Coquina	14.0	2 52 23	2 27 15

Winners: ONAWA, OMEGA, MABEL, KESTREL and THE KID.



PEARL.--FIGURE 437.

The Fifth Race of the season was sailed August 15th:

SLOOPS.			
Class	Sailing Length.	Actual Time.	Corrected Time.
First Class.			
Siren	21.4	1 51 46	1 44 58
Aurora	25.8	1 57 45	1 53 44
Mystic	23.8	2 05 10	1 58 49
Water Witch	22.7	2 00 07	1 53 12
C. L. C.	27.8	1 55 41	1 53 50
Alpha	20.8	1 47 19	1 43 45
Kite	27.3	1 40 53	1 38 31
Onawa	20.0	1 41 23	1 39 21
Apukwa	24.7	1 59 44	1 54 25
Shark	25.8	2 10 00	2 05 59

SLOOPS.

	Sailing Length.	Actual Time.	Corrected Time.
	Feet.	U. M. S.	H. M. S.
Second Class, Idler	21.0	2 10 27	2 00 02
Gohar,	21.0	2 10 07	2 00 37
Omega	21.2		1 57 47

Third Class.

	Sailing Length.	Actual Time.	Corrected Time.
Atlanta	23.0	1 57 08	1 49 37
Mabel	22.7	2 01 41	1 54 46
Columbus	22.4	2 05 25	1 57 04
Vreha	22.7	2 08 00	2 00 11
Pearl	21.7	2 05 57	1 56 30

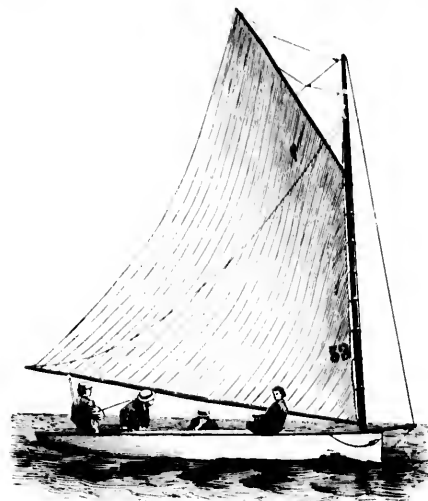

KESTREL.--FIGURE 438.

	Sailing Length.	Actual Time.	Corrected Time.
Aurora	23.8	1 58 25	1 50 38
Ida	22.2	1 59 39	1 51 01
Fourth Class, Kestrel	18.3	2 11 32	1 56 27
Cupid	16.0	2 22 59	2 13 02
Fifth Class, The Kid	16.0	2 25 45	2 05 48

The Sixth Race of the season was sailed August 19th.

SLOOPS.

SLOOPS.			
Class	Sailing Length.	Actual Time.	Corrected Time.
First Class.			
Orion	20.7	1 48 53	1 48 53
Siren	21.4	1 58 03	1 48 15
Aurora	25.8	1 36 31	1 32 30
Volante	25.0	1 33 27	1 29 12
Mystic	23.8	1 40 20	1 43 02
Water Witch	22.7	1 46 41	1 38 36
C. L. C.	27.8	1 33 47	1 31 56
Alpha	20.8	1 32 56	1 30 11
Kite	27.3	1 32 21	1 30 59
Apukwa	24.7	1 34 08	1 28 48
Dagmar	26.6	1 46 11	1 42 10
Mischief	22.2	1 43 51	1 35 43
Second Class, Idler	21.0	1 50 55	1 40 30
Bird	20.7	1 42 45	1 31 52
Phyllis	25.2	1 35 00	1 30 07
Ino	21.9	2 21 06	2 15 02
Omega	24.2	1 42 30	1 36 31

HISTORY OF THE MINNETONKA YACHT CLUB.

	CATS.		
	Sailing Length.	Elapsed Time.	Corrected Time.
Third Class.			
Atalanta	23.0	1 46 54	1 39 30
Ventura	22.0	1 45 20	1 38 00
Mabel	22.7	1 48 12	1 40 17
Princess	23.2	1 53 44	
Curlew	22.0	1 47 01	1 38 57
Idlewild		2 00 20	
Columbus	22.4	1 47 22	1 39 11
Vreda	21.0	2 03 05	1 53 40
Ida	22.2	1 48 00	1 39 22
Daphne	20.8	1 45 55	1 35 11
Fourth Class			
Kestrel	18.3	1 50 08	1 35 03
King Bird	18.0	1 45 45	1 30 05
Cupid	10.0	2 20 03	2 00 06
Lakv	17.0	2 14 16	1 58 33
Fifth Class.			
The Kid	10.0	1 56 06	1 36 09
Hermes	14.8	1 50 17	1 27 21
Comtesse		2 15 15	1 53 21

The winners were: **APUKWA, PHYLLIS, DAPHNE, KING BIRD and HERMES.**

The Seventh Race of the season took place August 26th. The following boats participated:

SLOOPS.			
First Class.			
Mystic	21.8	1 40 25	1 30 58
Water Witch	22.7	1 30 35	1 31 40
C. L. C.	27.3	1 38 20	1 35 58
Kite	27.3	1 20 33	1 21 11
Omawa	20.0	1 20 42	1 17 40
Apukwa	24.7	1 30 31	1 34 12
Mischief	22.2	1 32 24	1 23 40
Second Class.			
Omega	24.2	1 43 39	1 37 43

CATS.			
Third Class.			
Atalanta	23.0	1 43 21	1 35 50
Bonita	23.7	1 52 09	1 45 34
Mabel	22.7	1 48 06	1 40 11
Curlew	22.6	1 40 37	1 41 33
Vreda	21.0	1 52 10	1 41 45
Aurelia	22.8	1 38 04	1 30 17
Ida	22.2	1 43 23	1 34 45
Daphne	20.8	1 42 40	1 32 02
Fourth Class.			
Kestrel	18.3	1 55 16	1 40 11
Kingbird	18.0	1 51 41	1 36 01
Cupid	16.3	1 55 35	1 30 19
Fifth Class.			
The Kid	17.6	1 56 43	1 40 15
Hermes	14.8	2 03 40	1 40 50

The winners were **ONAWA, OMEGA, AURELIA, KING BIRD and THE KID.**

The Eighth Race of the season was held under the auspices of the **MINNETONKA YACHT CLUB**, September 2d. The following yachts were entered:

SLOOPS.			
First Class.	Sailing Length.	Elapsed Time.	Corrected Time.
Water Witch	22.7	2 32 24	2 24 29
C. L. C.	27.3	2 20 12	2 17 50
Alpha	20.8	2 17 06	2 14 12
Kite	27.3	2 17 30	2 15 04
Omawa	20.0	2 10 38	2 07 30
Mischief	22.2	2 20 44	2 17 06
Second Class.			
Phyllis	25.2	2 30 45	2 25 52
Omega	24.2	2 41 11	2 35 15

CATS.			
Third Class.			
Atalanta	23.0	2 49 17	2 40 46
Columbus	21.3	2 41 43	2 31 46
Aurelia	22.8	2 37 30	2 29 43
Daphne	20.8	2 40 55	2 30 11
Aurora	23.0	2 40 26	2 40 07

SLOOPS.			
Fourth Class.			
Kestrel	18.3	2 55 34	2 40 29
King Bird	18.0	3 01 40	2 46 50
Coquette	17.0	2 55 16	2 30 24
Cupid	10.3	2 42 32	2 23 16

CATS.			
Fifth Class.			
The Kid	17.6	3 02 47	2 46 19
Hermes	14.8	2 45 45	2 22 49

Winners: **ONAWA, PHYLLIS, AURELIA, CUPID and HERMES.**

The last race of the season of 1893 was sailed September 9th. The following yachts took part:

SLOOPS.			
First Class.			
Alpha	26.8	1 40 48	1 40 54
Apukwa	24.7	1 47 03	1 41 44
Third Class.			
Atalanta	23.0	1 57 20	1 49 49
Aurelia	22.8	1 58 44	1 50 57
Fourth Class.			
Kestrel	18.3	2 12 02	1 56 57
Coquette	17.0	2 14 27	1 58 35
Cupid	10.3	2 18 16	1 50 00
Fifth Class.			
Hermes	14.8	2 22 06	1 50 10

The winners were: **APUKWA, ATALANTA, KESTREL and HERMES** in their respective classes.

BIOGRAPHICAL SKETCHES AND DESCRIPTION OF YACHTS ENROLLED IN THE CLUB.



T. B. JANNEY.

T. B. JANNEY, Commodore of the **MINNETONKA YACHT CLUB**, was born in 1838 in the State of Ohio, the son of Phineas M. and Frances S. Janney. Is now a resident of Minneapolis, Minn., and is a wholesale iron and hardware merchant. Is the owner of the fast eat-boat **ATLANTA**.

Commodore Janney has been a yachtman since boyhood, and has been a member of the Board of Directors of the **MINNETONKA YACHT CLUB** for four years.

ATLANTA.

ATLANTA is a centerboard open cut belonging to T. B. Janney, Commodore of the **MINNETONKA YACHT CLUB**. She was launched in June, 1888, being designed and built by J. B. Brooks. She hails from Lake Minnetonka and sails with the **MINNETONKA YACHT CLUB** fleet. See Fig. 426.

DIMENSIONS.

Length over all, 25 feet. Length load waterline, 23 feet.
Draft, 2 feet 4 inches. Beam, 9 feet 4 inches.

Racing Record for 1892:—

MINNETONKA YACHT CLUB—**ATLANTA** won in the First Club Race sailed May 30th, with seven starters. Beaten by **IDA** in the First Cup Race, June 11th. Sixth in the Club Race of July 9th. A winner in the second Cup Race, held July 3d, defeating **CURLEW**, **IDA**, **VENTURA**, etc. Fourth in the Annual Cruise, July 30th. Second in the Club Race sailed Aug. 13th, **VENTURA** winning. Again a winner in the race of August 27th, with seven starters. Beaten by **VENTURA** in the Club Race of September 3d. Beat **VENTURA** September 19th, winning championship.

ATLANTA won the silver cup in 1891 and 1892, offered by the **MINNETONKA YACHT CLUB**, and in 1889 she won the championship and a cup in the **EXCELSIOR YACHT CLUB**, then sailing as a sloop.

HAZEN J. BURTON, the President of the Plymouth Clothing House, Minneapolis and St. Paul, living in Minneapolis, Minn., was born in Boston, Mass. He has been a yachtsman for seven years and is a member of the **MINNETONKA YACHT CLUB**. In this club he has held several offices, having been Vice-Commodore for two years and Commodore for one year. He is the owner of the yacht **VOLANTE**, which was designed by Burgess about the same time as **VOLUNTEER**.

VOLANTE.

A centerboard sloop, designed by Edward Burgess and built by Geo. F. Lawley & Son in 1889. Her lines were designed at the same time as those of the celebrated **VOLUNTEER**, hence the similarity in the name. She was built for her present owner, Mr. H. J. Burton. See Fig. 428.

DIMENSIONS.

Length over all, 20 feet 10 inches. Length load waterline, 20 feet 6 inches.
Depth, 1 foot 8 inches. Draft, (center'd down) 5 feet 6 inches.
Beam, 9 feet 6 inches.

ONAWA.

ONAWA, the champion 21-footer of Lake Minnetonka, was designed and built by Arthur Dyer. She was specially built to defeat **KITE** and **ALPHA**, the undisputed champions of the Lake. In her first race she won from **ALPHA** and in the second race she beat **KITE** by

nearly 17 minutes corrected time. She is very light, strongly constructed, and is covered with light canvas, both hull and deck, for the purpose of additional protection.

She is owned by Mr. Ward Burton of Minneapolis, Minn., and sails with the **MINNETONKA YACHT CLUB**. See Fig. 427.

SILVER BELL.

SILVER BELL is an open cut, built by Roy Moore, Wayzata, Minn., for C. N. Chadbourne. She has never been altered, hails from Wayzata and sails with the fleet of the **MINNETONKA YACHT CLUB**. See Fig. 429.

DIMENSIONS.

Length load waterline, 20 feet 1 inch. Beam, 8 feet.



WILLIAM H. DUNWOODY.

WILLIAM H. DUNWOODY, merchant, Minneapolis, Minn., was born in Chester County, Pa. His parents were James and Hannah Dunwoody. He has been a yachtsman for three years, and is a member of the **MINNETONKA YACHT CLUB**. The owner of the yacht **DOLPHIN**.

DOLPHIN.

A centerboard sloop, designed and built by H. C. McLeod for William H. Dunwoody, her present owner. She was launched in the Spring of 1891 and sails with the **MINNETONKA**



EX-COMMODORE CHAS. B. EUSTIS.

YACHT CLUB. She won the championship of her class in 1892, in the races of the **MINNETONKA YACHT CLUB**. She has no cabin. See Fig. 430.

DIMENSIONS.			
Length over all,	22 feet 11 inches.	Draft,	2 feet.
Beam,	8 feet 8 inches.	Sail area,	670 square feet.

CHAS. B. EUSTIS, ex-Commodore of the MINNETONKA YACHT CLUB, Minneapolis, Minn., was born in Dixfield, Maine, in 1849; is the son of C. L. and D. J. Eustis. The owner of the yacht CURLEW. Was one of the original members of the MINNETONKA YACHT CLUB, assisted in its formation and has always been one of its most active members. At different times has filled nearly every office of the club and has scarcely missed a race since the club was organized. The Commodore has taken a most active interest in yachting and kindred matters ever since the founding of the MINNETONKA YACHT CLUB.

CURLEW.

An open centerboard cut, the property of Chas. B. Eustis, ex-Commodore of the MINNETONKA YACHT CLUB and H. W. Young, Minneapolis, Minn. Was designed and built by J. B. Brooks for her present owners and was launched in 1886. She sails with the MINNETONKA YACHT CLUB. See Fig. 431.

DIMENSIONS.		
Length over all,	21 feet.	Length load waterline,
Beam,	9 feet 3 inches.	20 feet 8 inches.



ROBT. G. GALE.

ROBT. G. GALE, Secretary of the MINNETONKA YACHT CLUB, is a man greatly admired by the members of the club of which he has the honor of being Secretary; as he not only faithfully discharges the trust he accepted, but at every opportunity advances the best interests of the club as also the sport of yachting. Members like Mr. Gale are a credit to any yacht club.

WHITE WINGS.

An open sloop belonging to B. C. Hurd, Jr., of the MINNETONKA YACHT CLUB. She is a centerboard yacht, designed and built by R. C. Moore, Wayzata, Minn. Was launched in June, 1888. She sails with the MINNETONKA YACHT CLUB. See Fig. 432.

DIMENSIONS.			
Length over all,	22 feet 2 inches.	Length load waterline,	22 feet 2 inches.
Draft,	2 feet.	Beam,	9 feet 4 inches.

Racing Record for 1892:—

MINNETONKA YACHT CLUB—WHITE WINGS raced several times with this club last season, winning second place three times and third place once.

MERMAID.

MERMAID is an open sloop belonging to R. C. Jefferson, Esq. She was built by Riddle C. Penfield and designed by Kelsey. She has a sail area of 761 square feet and sails with the fleet of the MINNETONKA YACHT CLUB. See Fig. 433.

DIMENSIONS.			
Length over all,	20 feet 3 inches.	Beam,	9 feet 6½ inches.

AURELIA.

A centerboard yacht belonging to Cavour S. Langdon, Minneapolis, Minn., the Treasurer of the MINNETONKA YACHT CLUB. Designed and built by J. B. Brooks for Mr. Langdon, and launched in June, 1890. AURELIA has no cabin. See Fig. 434.

DIMENSIONS.			
Length over all,	25 feet.	Length load waterline,	25 feet.
Draft,	1 foot 7 inches.	Beam,	9 feet 9 inches.

Spars: Boom, 25 ft. 7 in.; Gaff, 17 ft. 6½ in.; Jiu-boom, 18 ft. 2 in.

IDLER.

IDLER, a cut-hoat owned by George A. Morse and W. D. Morse. She hails from Lake Minnetonka, Minn., and sails with the MINNETONKA YACHT CLUB. IDLER was designed and built by Thomas Clapham of Roslyn, L. I. See Fig. 435.

DIMENSIONS.			
Length over all,	18 feet.	Beam,	7 feet 2 inches.

Racing Record for 1892:—

MINNETONKA YACHT CLUB—IDLER started in seven races, winning one first, five seconds and one third. In these races she defeated ELECTRIC, CELIA R., PHYLLIS and PEEBLESS, while she was beaten by BIRD, CELIA R. and PHYLLIS.



WILLIAM PEET, JR.

WILLIAM PEET, JR., Minneapolis, Minn., was born in Brooklyn, N. Y.; the son of William Peet of New York City. By profession a lawyer. Has been interested in yachting for twenty-five years, in fact, from boyhood. At present the owner of BIRD. He is a member of the MINNETONKA and ATLANTIC YACHT CLUBS. For the past nine years his yachting has been in the West on Lake Minnetonka.

BIRD.

The sloop BIRD is owned by William Peet, Jr. She was designed and built by the Herreshoff Mfg Co., Bristol, R. I., and was launched in 1890. She was built specially for her present owner. Has never been altered, except in rig; has no cabin and hails from Lake Minnetonka, Minn. See Fig. 436.

DIMENSIONS.			
Length over all,	19 feet.	Length load waterline,	16 feet.
Draft,	1 foot 2 inches.	Beam,	7 feet 6 inches.

RACING RECORD.

Number of races started, 22. Number of first prizes, 17. Of the five races lost three were caused by break-downs during the race, when in the lead; and the other two were caused by break-downs before the start, causing a handicap of 4½ and 6 minutes, respectively.



EDMUND J. PHELPS.

EDMUND J. PHELPS, banker and manufacturer, Minneapolis, Minn., born in Brecksville, Ohio, 1845. The son of Joseph E. and Ursula Wright Phelps. He is the owner of the two yachts, ALPHA and VARUNA, and formerly owned PRINCESS. Has taken an interest in nautical affairs since 1881. A member of the MINNETONKA YACHT CLUB and has held the offices of Commodore and Vice-Commodore.

Mr. Phelps was elected President of the Board of Trade in 1884-85, and Commissioner from Minnesota to Russia in the Spring of '92 with Steamship MISSOURI, and has held and does still hold various other local positions of prominence.

VARENA.

The centerboard sloop VARENA is the property of Edmund J. Phelps, Minneapolis, Minn. Designed by H. C. McLeod and built by R. W. Riddle for her present owner. She was launched in 1889 and hails from Lake Minnetonka.

DIMENSIONS.			
Length over all,	21 feet.	Length load waterline,	21 feet.
Draft,	1 foot 7 inches.	Beam,	11 feet.

PEARL.

PEARL is an open sloop, designed by Krit Smith and built by John B. Brooks, Wayzata, Minn. She was launched in 1871 and is at present the property C. McC. Reeve. She has never been altered and sails with the fleet of the MINNETONKA YACHT CLUB. See Fig. 437.

DIMENSIONS.			
Length over all,	20 feet.	Length load waterline,	20 feet.
Beam,	9 feet 4 inches.		

Wyman. Mr. Wyman is a manufacturer and banker. He was President of the Board of Trade of Minneapolis for two terms, is a member of the Business Men's Union, President of the Metropolitan Bank of Minneapolis, member of the firm of Smith & Wyman and Vice-President of the Board of Trustees of Hamlin University. He is the owner of the yacht KESTREL and is a member of the MINNETONKA YACHT CLUB, having joined the club four years ago.

KESTREL.

The centerboard yacht KESTREL belongs to James T. Wyman. She was designed and built by Dyer Bros., and was launched in the Fall of 1891. Has belonged to Mr. Wyman for one year. She hails from Lake Minnetonka. See Fig. 438.

DIMENSIONS.

Length over all,	19 feet 6 inches.	Length load waterline,	17 feet.
Depth,	1 foot 6 inches.	Draft,	1 foot 6 inches.
Beam,	7 feet.		

Spars: Boom, 21 ft. 6 in.; Mast, 14 ft. 4 in.; Mast, 14 ft. 4 in.

KESTREL has made ten miles (twice around a triangular five-mile course) in 1 hour and 55 minutes.

JAMES T. WYMAN of Minneapolis, Minn. was born in Millsbridge, Maine, October 15, 1849. Of Puritan ancestry, his forefathers having come from England in 1640. The son of John and Clarinda

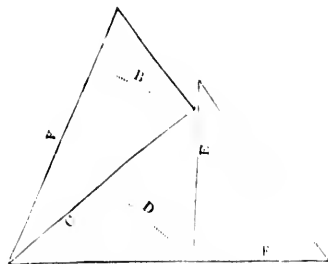

20 feet.
9 feet 9 inches.

boom, 18 ft. 2 in.

and W. D. Morse,
with the MINNE-
built by Thomas

7 feet 2 inches.

ten races, winning
races she defeated
ss, while she was

Jr., Minneapolis,
in Brooklyn, N.
Peet of New York
lawyer. Has been
for twenty-five
hood. At present
e is a member of
ATLANTIC YACHT
t nine years his
he West on Lake

She was designed
R. I., and was
r present owner.
and hails from

10 feet.
7 feet 8 inches.

sizes, 17. Of the
during the race,
by break-downs
ates, respectively.

PS, banker and
neapolis, Minn.,
no, 1845. The
Ursula Wright
of the two yachts,
l formerly owned
n interest in nau-
A member of
T CLUB and has
odore and Vice-

ed President of
84-85, and Com-
92 with Steam-
ous other local



ADMIRAL AUGUST BELMONT.
CORINTHIAN YACHT CLUB (of N. Y.)

History of the Corinthian Yacht Club.

STATION—TOMPKINSVILLE, STATEN ISLAND.

REMEMBERING the time honored maxim "let by-gones be by-gones," we shall refrain from comment on the details or merits of the domestic storm in an older club, which led to the foundation of the CORINTHIAN of New York, and gave birth to an association of practical yachtsmen which, although limited in point of numbers to one hundred members, has during its short career attained a position of no small weight in the nautical world. It has already initiated and developed improvements in many directions which are calculated to exercise a permanently beneficial influence on the future of amateur seamanship in the United States.

As an example we may mention the rules promoted by this club, regulating the classification of yachts for racing purposes by "sailing length," instead of "load waterline," thus bringing boats into competition in accordance with a formula which gives weight not to one alone, but to several of the structural elements bearing upon speed, and tends to check in some degree the ingenuity of professional yacht designers who have as a class for years past taxed their own brains to produce untaxable types of racing boats, which under the "waterline," rule were entitled to compete with smaller and weaker craft, overpowering their nominal equals with as much ease as an ocean liner outstrips a mercantile tramp.

Credit must be given to the CORINTHIAN of New York as having been one of the first influential bodies which attempted to deal with this obvious injustice, and it is due, in no small degree, to the able advocacy of the Secretary, Mr. M. Roosevelt Schuyler, that this much needed reform has thus been adopted by most of the leading clubs on this side of the Atlantic.

The first business meeting of the promoters was held July 16, 1886, when several well known yachtsmen whose names appear on the minutes, were present in person, and who may therefore claim to have been the official founders of the new organization, although many others bringing the number of the original members up to forty-three, had given in their names and intimated their readiness to join.

M. Roosevelt Schuyler occupied the chair and Chas. Stewart Davidson was requested to act as Secretary. The following were also present: Sidney DeKay, E. B. Clarke, William H. Plummer, E. M. Padelford, W. A. K. Stuart, S. M. Roosevelt, Arthur Padelford and J. Leslie Cotton.

The objects of the new club were defined and put on record under

four headings, and the programme thus formulated, has with merely verbal alterations continued to be the rule of conduct, controlling its management upon every occasion. Strict fidelity to the leading principles he laid down has led to the achievement of a remarkable measure of well merited success, which would never have been attained or striven for had the association been started with no more serious purpose than indulgence in yacht sailing as an amusement. Messrs. M. Roosevelt Schuyler, Chas. Stewart Davidson and William Plummer were appointed a Committee of Organization, and were

instructed to prepare articles of association, keeping the following four points in view as the objects of the club:

1. The maintenance of a suitable and convenient landing place on the shores of New York Bay.

2. To assist and promote the designing and measurement of yachts by their owners.

3. To determine from time to time, questions affecting allowances for racing purposes, between yachts of different sizes and rigs, by fair and careful experiments.

4. To assist in maintaining a high standard of honor and integrity in relation to yachting events.

The committee was also instructed to take the necessary steps to acquire for the club the premises and basin at Tompkinsville, Staten Island, previously occupied by the SEAWANAHKA CLUB, and to report on designs for a distinguishing burgee and pennants for the flag officers.

The committee went to work with energy and were ready to report on the various matters entrusted to them in time for the first general meeting of the club, which was held upon the 22d of July, 1886, when their report was adopted and the following officers appointed to hold office for a year:

Admiral, E. M. Padelford; Secretary, Chas. Stewart Davidson; Measurer, E. B. Clarke.

The premises secured at Tompkinsville for the use of the club are particularly suitable for its purposes, consisting of a picturesque frame building, two stories high, built like an ancient lake-dwelling on piles, at some distance from the real shore of Staten Island. The lower story contains bath-rooms, lavatories, a large reading-room and living apartments for the store-keepers. Above there is a commodious veranda, commanding a magnificent view of the harbor, and a large model room which, in one respect at least, is unique and promises at no distant date to rival in interest, if not in size, the famous collection of the NEW YORK YACHT CLUB.

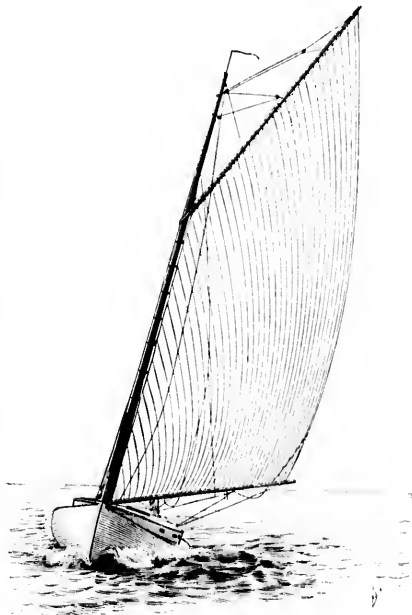

SUPERIOR.—FIGURE 133.

Every yacht-owning member is bound to deposit here a model of each yacht belonging to him, constructed on a scale of three-eighths of an inch to the foot. This uniform scale enables a visitor or student to see at a glance the relative dimensions of the various racers and cruisers, which may at any time have been on the club list

Immediately adjacent thereto is a private basin belonging to the club, giving a safe landing place at the Club House door for large craft, with winter quarters. A large piece of grass covered land enables the owners of cut-boats and small sloops to lay them up literally "in clover" when out of commission and is a source of

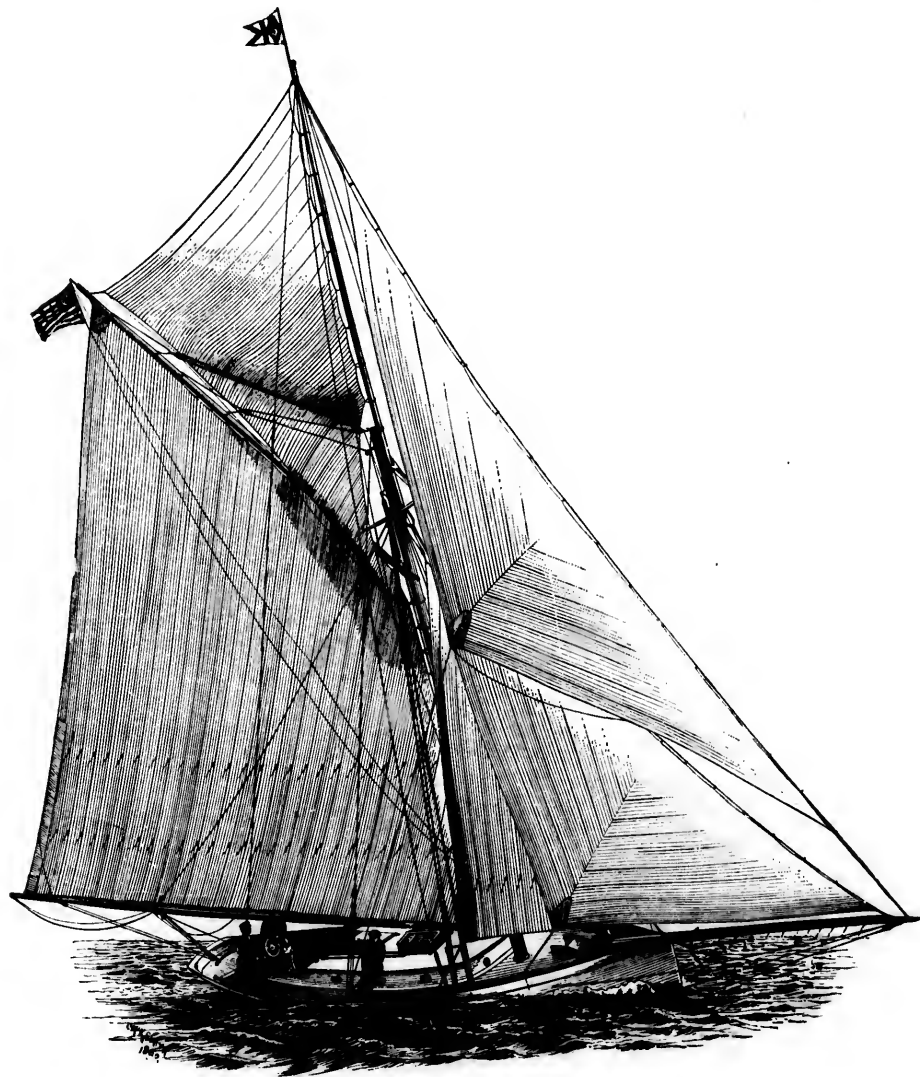

SYDNEY.—FIGURE 440.

and lends a novel feature of great practical utility to this nautical museum which cannot be claimed for any similar collection.

On the south and east of the Club House, boats of light draft can anchor close to the shore, while off the north, vessels of greater tonnage ride in safety in all weathers within two cables' length of the premises.

considerable revenue to the club in storage rents.

When we add that this snug haven can be reached from the city in 35 minutes, it will be readily admitted that the Island home of the NEW YORK CORINTHIANS offers singular advantages to its nautical owners.

At a business meeting held March 9, 1887, it was resolved that the

Admiral be requested to appoint a committee of examiners who shall publish the terms, time and place of examination for Masters' certificates.

The second annual general meeting was held May 1, 1881, when M. Roosevelt Schuyler was appointed Secretary, a position with which he remained identified up to the year 1892, when he became Fleet Captain, and another original member, Mr. George A. Cormack then assumed the secretarial duties.



AMELIA VICTORIA.—FIGURE 411.

For the year 1893 the officers are as follows: Admiral, August Belmont; Fleet Captain, M. Roosevelt Schuyler; Secretary, George A. Cormack; Measurer, John Hyslop.

Committee on Seamanship and Navigation: Chester W. Chapin, S. Grosvenor Porter, Chas. A. Stevenson.

Committee on Measurement and Naval Architecture: John Hyslop, J. Beavor Webb, J. C. Soley, U. S. N., W. Gardner.

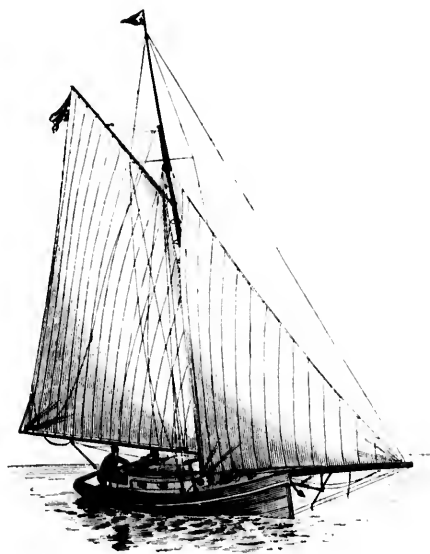

CYONET.—FIGURE 442.

Sailing Committee: The Admiral, the Secretary, William H. Plummer, W. G. Hall, E. B. Clarke, Chas. Stewart Davidson.

The Committee on Examination for Masters' Certificates: Com. Henry Erben, U. S. N.; Capt. Theo. F. Kane, U. S. N.

ACCORDING TO THE RULES AND REGULATIONS.

All yacht-owning members shall, within three months of becoming members of the club, deposit with the Secretary a model to a scale of three-eighths of an inch to one foot of each yacht owned by them, as also one or more photographs or other representations thereof, if practicable, when under sail. Also, full particulars, in writing, of time and place of building and material alterations, builder's name, size, rig, measurement, private signals and other details for preservation and insertion in the Club Annual.

All yacht-owning members are expected, within two years of their becoming such, to qualify for and obtain the Certificate as Master hereinafter provided for, and no yacht owner shall be appointed Fleet Captain who does not hold such certificate.

There shall be no exclusion of any yacht, otherwise unqualified, by reason of model or design, in any race under the club auspices, nor any discrimination against or in favor of any model or design.

The term, Masters' Certificate, as used in these By-Laws shall be held to refer to:

1st. A similar certificate to the Yachting Masters' Certificate now issued upon examination by the appropriate authority of the United

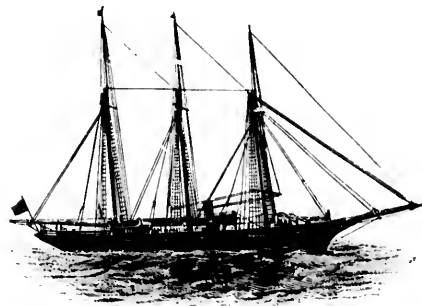

INTREPID.—FIGURE 443.

Kingdom, if, and when provision for issuing the same shall be made by the appropriate authorities of the United States; or, 2d. The aforesaid English Yachting Masters' Certificate; or, 3d. A certificate to be issued upon appropriate examination by an Examining Board of three persons skilled in navigation and seamanship, to be appointed by the Admiral, as occasion therefor may arise, no one of which shall be a member of the club, and of which one at least shall be an officer of the United States Navy of a grade not lower than Lieutenant.

Yachts shall be divided into classes, according to their sailing length, as follows:

SCHOONERS.

- Class 1.—All over 80 feet, sailing length.
- Class 2.—All under 80 feet, sailing length.

SLOOPS.

- Class 1.—All over 60 feet, sailing length.
- Class 2.—All over 50 feet, and not over 60 feet, sailing length.
- Class 3.—All over 40 feet, and not over 50 feet, sailing length.
- Class 4.—All over 30 feet, and not over 40 feet, sailing length.
- Class 5.—All over 25 feet, and not over 30 feet, sailing length.
- Class 6.—All over 20 feet, and not over 25 feet, sailing length.
- Class 7.—All under 20 feet, sailing length.

Any yacht may enter into a race with a higher class than that in which she belongs by assuming the minimum measurement of the class entered.

In mixed races, schooners and yawls may enter at one-third and one-quarter less than their actual measurement respectively, but shall not be classified by this reduced rating.

Yachts shall be rated for time allowance according to the following measurement: To the square-root of the sail-area add the waterline length, and divide by two:—

$$\frac{\sqrt{s} + l}{2}$$

These measurements shall be obtained as follows:

A base line is to be taken from a point midway between the jib topsail stay and the jib stay on bowsprit or flying jibstay on jibboom, in a straight line to the end of the main boom, with the excess of the length of the gaff, measured from the after-side of mast to end; over 80 per cent. of the topmast measured from hounds to lower side of sheave of topsail halliard block. Any excess in length of spinnaker boom beyond the distance between the forward point of measurement and the foreside of mainmast (foreside of foremast in schooners), to be added to the base line.

For yawls, the base line to be taken from the same point to the end of the mizzen-boom.

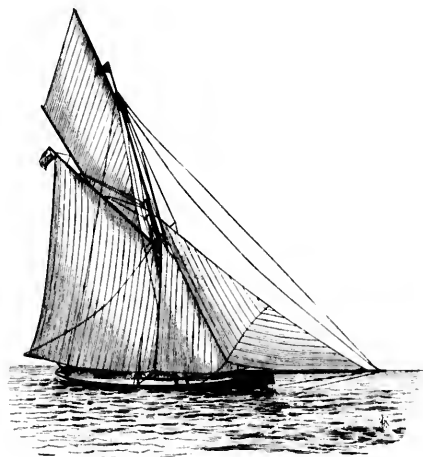

DELVYN.—FIGURE 444.

A perpendicular to be taken along the afterside of the mainmast from the underside of the gaff-topsail block or sheave on topmast, to the upper side of boom when the latter is resting on the saddle, the distance of such point from the main-deck or house-deck, to be recorded by the Measurer, together with all other points used in measurements.

To obtain the estimated sail-area from these figures, multiply the base by the perpendicular and divide by two.

The length shall be measured from the forward side of stem at the waterline, to the end of the waterline at stern wherever found exclusive of any part of the rudder or rudder-post. This measurement shall be taken when the yacht is afloat and in her ordinary trim, and with the crew (if aboard) stationed amidships.

Allowance shall be figured according to the table adopted by the club.

Each yacht entered for a race must be the *bona fide* property of the person or persons in whose name she is entered, who must be a member or members of a recognized yacht club; and no member shall be interested in more than one yacht competing for the same prize.

There shall be no restrictions as to sails, or the manner of setting or working them.

During a race, every yacht over seventy feet on load waterline shall carry a serviceable boat not less than twelve feet in length. Every yacht measuring less than seventy feet, and more than forty-five feet,

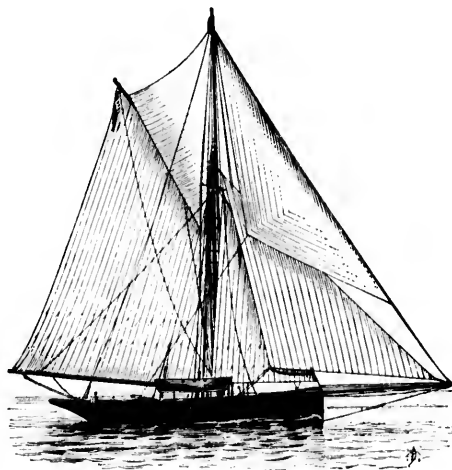

WENONAH.—FIGURE 445.

shall carry a serviceable boat not less than ten feet in length. These boats shall not be carried below deck, and must have oars lashed in them ready for immediate use. Each yacht shall also carry two serviceable life-buoys, ready for immediate use, within reach of the helmsman.

Crews are limited to one man for each full six feet of sailing length, and one for any fractional excess. Of the crew not more than one-half may be professionals, and the helmsman must be amateur. The judgment of the Sailing Committee shall be final in regard to the definition of amateur.

All starts shall be flying. No allowance shall be made for delay in starting.

When yachts are ordered to sail in cruising trim, the following rules are to be strictly observed:

1. No doors, tables, cabin skylights, or other cabin or deck fittings (davits excepted) shall be removed from their places before or during a race.
2. No sails or other gear shall be put into the main cabin in yachts exceeding forty-five feet load waterline.
3. Anchors and chains suitable to the size of the yacht shall be carried, one anchor at the usual place on the bow, which anchor shall not be unshackled from the chain before or during the race.

to adopted by the

side property of the
no must be a mem-
o member shall be
no same prize.
manner of setting or

oad waterline shall
in length. Every
than forty-five feet,



in length. These
ave oars lashed in
also carry two ser-
thin reach of the

of sailing length,
not more than one-
be amateur. The
l in regard to the

be made for delay

im, the following

in or deck fittings
s before or during

in cabin in yachts

the yacht shall be
which anchor shall
the race.



FROM A NEGATIVE BY BOLLIES.

PLATE LVI.

SAONA.

SAONA.

1
2
3
4
5
6
7
8
9
10
11
12
13
14
15
16
17
18
19
20
21
22
23
24
25
26
27
28
29
30
31
32
33
34
35
36
37
38
39
40
41
42
43
44
45
46
47
48
49
50
51
52
53
54
55
56
57
58
59
60
61
62
63
64
65
66
67
68
69
70
71
72
73
74
75
76
77
78
79
80
81
82
83
84
85
86
87
88
89
90
91
92
93
94
95
96
97
98
99
100

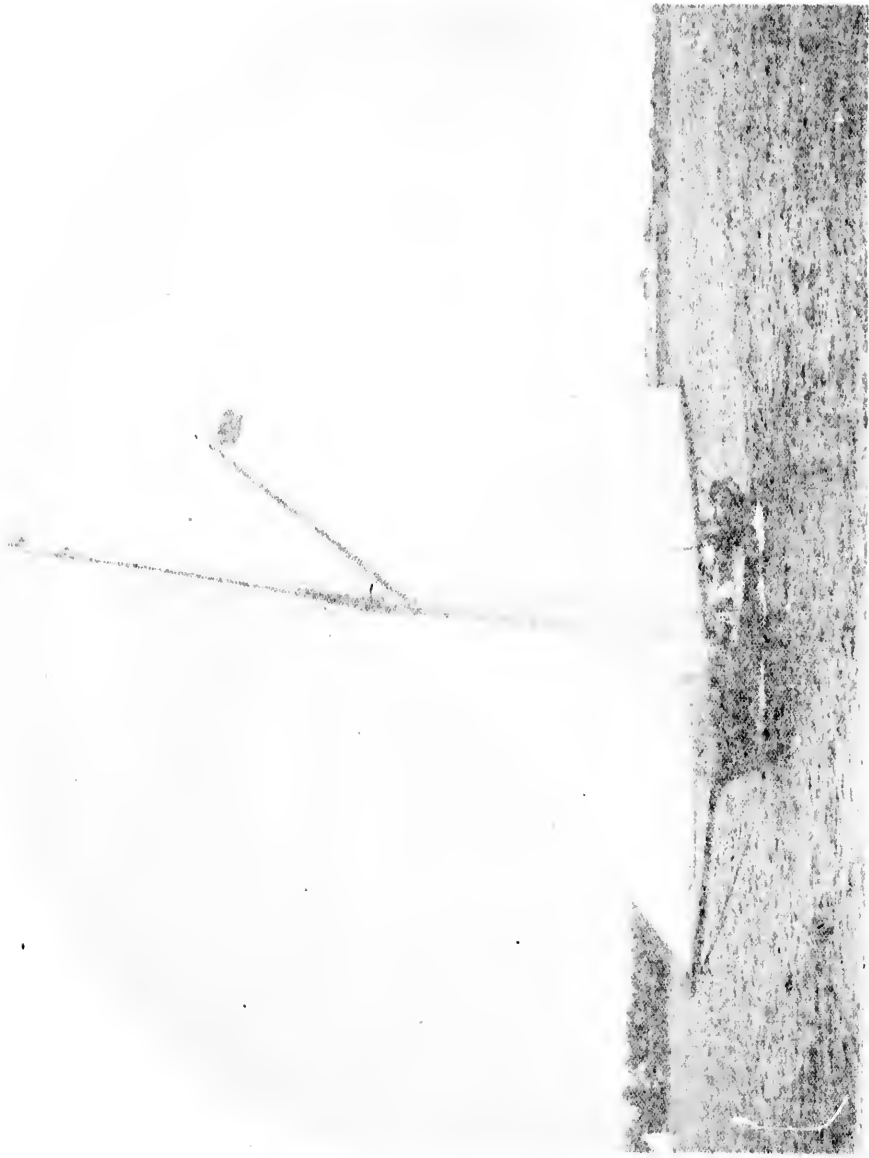

N
Alc
Alc
An
Bec
Bon
Car
Circ
Cin
Con
Cru
Cyr
Cyn
Delv
Dir
Dol
Flou
Gala
Gann
Glori
Guerr
Gunt
Harr
Horn
Idler
Introp
Javel
Jesic
Kittor
Laksh
Linta
Lotos
Miscol

THE YACHTS AND YACHTSMEN OF AMERICA.

471

LIST OF YACHTS ENROLLED IN THE CORINTHIAN YACHT CLUB.

NAME.	OWNER.	PORT.	REG.	KEEL OR C. B.	L. W. L.	DEAM.	DRAFT.
					ft.	ft. in.	ft. in.
Aida	W. P. Douglas	New York	Steamer	k	90.00	12 05	4 05
Alert	J. N. Loring	"	Schooner	k	90.00	23 06	13 01
Amelia Victoria	Walter Luttgen	"	Steam Launch	k	27.05	7 00	2 05
Bedouin	Archibald Rogers	"	Cutter	k	70.01	15 08	12 00
Bonita	J. F. Greenough	"	Yawl	k	18.10	5 00	3 05
Caro	Wm. Boyce	"	Cat	k	19.02	8 01	4 08
Circe	S. Grosvenor Porter	"	Cutter	k	30.08	6 02	5 08
Clara	Robert Osborn	"	Cutter	k	53.00	9 00	9 10
Constellation	Bayard Thayer	Boston	Schooner	e b	106.03	24 09	12 00
Cruiser	A. Bryan Alley	New York	Ship	e b	20 05	9 01	1 08
Cygnat	J. B. Murray	"	Ship	e b	24.05	11 01	2 06
Cynthia	Geo. Wark	"	Cat	k	33.06	5 01	6 08
Delvyn	M. Roosevelt Schuyler	"	Cutter	k	38.00	12 00	5 00
Diana	J. C. Soley	Boston	Schooner	e b	12.00	3 05	3 05
Dodge	E. M. Padelford	New York	Cat	k	86.00	22 00	13 00
Fleur-de-Lys	Geo. Trotter	"	Schooner	k	28.05	15 00	13 05
Galatea	Lieut. Wm. Henn	Glasgow	Cutter	k	45.25	11 00	10 07
Gannet	E. D. Morgan	New York	Cat	e b	38.06	12 00	5 02
Gloriana	E. D. Morgan	"	Ship	e b	30.00	12 05	4 00
Guinn	Edwin Winslow	"	Catamaran	k	38.00	14 00	5 00
Gunbilde	W. G. Deidrichsen	"	Cutter	k	34.00	11 00	2 05
Harriet	Stanley Greene	"	Cat	e b	65.00	15 00	10 06
Hermes	F. Roosevelt	"	Sloop	k	12 00	4 00	1 00
Huron	Wm. B. Duncan	"	Steamer	k	101.07	24 01	12 00
Idler	J. F. Greenough	"	Cutter	k	91 00	10 06	4 09
Intrepid	Lloyd Plunka	"	Cat	k	46.00	10 06	10 06
Javelin	E. D. Morgan	"	Cat	k	57.25	8 00	7 00
Jessie	W. O. B. Macdonough	"	Screw schooner	k	22.10	13 06	3 06
Kitten	E. B. Clarke	"	Steamer	k	72.00	14 00	4 06
Lakshmi	Wm. Osborn	"	Cutter	k	42.00	8 00	4 06
Linta	Walter Luttgen	"	Cat	k	45.83	13 10	10 05
Lotos	F. Roosevelt	"	Cutter	k			
Mineola	Aug. Belmont	"	Cutter	k			

d
rk
rd

LIST OF YACHTS ENROLLED IN THE CORINTHIAN YACHT CLUB.

NAME.	OWNER.	PORT.	RIG.	KEEL OR C. R.	L. W. L.	BEAM.	DRAFT.
					ft.	ft. in.	ft. in.
Mischief	Geo. Work	New York	Sloop	c b	61.00	19 10	5 08
Mignon	E. N. Dickerson.	"	Sloop	c b	21.10	8 08	1 10
Minerva	J. L. Carroll, Jr.	"	Cutter	k	39.87	10 08	9 00
Miranda	Geo. H. B. Hill	"	Schooner	k	96.35	18 00	13 06
Moustique	R. L. La Montagne	"	Cat	c b	19.00	7 00	1 00
Nadine	Edwin M. Felt	"	Cat	c b	10.00	7 00	1 00
Nonparello	H. A. Sanderson	"	Yawl	k	67.95	15 00	11 06
Peerless	J. Murray Mitchell	"	Schooner	c b	62.00	10 00	6 02
Peri	C. McK. Leoser	"	Sloop	c b	36.10	14 02	5 03
Petrel	W. C. Hall	"	Sloop	k	28.06	8 00	4 01
Ramona	Harry Gillig	"	Schooner	k	110.00	25 07	12 02
Sapphire	A. L. Barber	"	Steamer	k	119.00	19 04	9 00
Sayonara	Bayard Thayer	Boston	Cutter	k	45.75	12 05	10 05
Shona	Chas. H. Tweed	New York	Cutter	k	32.07	5 07	6 00
Sibyl	J. Berre King	"	Sloop	c b	35.00	14 00	5 00
Speedwell	Archibald Rogers	"	Steamer	k	41.00	6 00	2 08
Stranger	Geo. H. Warren	Liverpool	Cutter	k	66.00	13 06	11 00
Sultana	Trenor L. Park	New York	Bark Aux. Steamer	k	155.00	27 05	14 05
Thera	J. M. Woodbury	"	Lugger	k	24.00	5 00	2 00
Thetis	Paul E. Stevenson	"	Sloop	c b	64.00	19 00	8 00
Tioga	Seymour L. Husted	"	Schooner	k	54.00	15 05	9 00
Titania	C. O. Iselin	"	Sloop	c b	69.00	20 00	8 00
Toboggan	Geo. Work	"	Sloop	c b	33.04	10 00	18 00
Trophy	A. L. Barber	"	Steamer	k	90.00	14 00	4 06
Ulidia	James Stillman	"	Cutter	k	41.11	7 02	8 00
Utowana	Wm. West Durant	"	3 Masted Schooner	k	156.00	27 08	14 00
Vision	James W. Fryer	"	Schooner	c b	57.05	17 00	6 00
Vision	Alfred J. Weston	"	Sloop	c b	63.00	20 02	6 01
Wanda	James Stillman	"	Steamer	k	127.00	18 00	10 02
Wasp	Archibald Rogers	"	Cutter	k	45.06	13 00	10 06
Water Lily	Frederick Roosevelt	"	Sloop	c b	27.01	10 01	1 06
Wave Crest	E. N. Dickerson	"	Schooner	k	84.03	23 00	7 00
Wenonah	Willoughby Weston	"	Cutter	k	60.00	14 00	10 00
Yampa	Chester W. Chapin	"	Schooner	k	110.00	27 00	13 07
Zena	J. W. Fryer	"	Cutter	k	26.06	6 02	5 00

RECORD OF RACES.

First Annual Regatta June 14, 1887. The first of a brilliant series of races and regattas held under the auspices of the CORINTHIAN YACHT CLUB of New York came off in the lower bay on the above date. The start was effected by signal at 11:35 A. M. A gentle breeze blew from the north. After a luffing match between GALATEA, steered by her owner, Lieut. Henn, R. N., and ATLANTIC, steered by Mr. Fish, in which the former got the best position, GALATEA led over the line closely followed by ATLANTIC, ULIDIA, CINDERELLA, FANITA, STRANGER, HURON, CYNTHIA, KANGAROO, DELVYN, CORINNE; CULPRIT-FAY, BEATRICE and GLEAM. The feature of this regatta was the contest between GALATEA and ATLANTIC, which in a light wind ended in a victory for the latter, but the race was scarcely more than a drifting match for all classes. Official time:

DRAFT.	ft. in.	Yacht	Elapsed.		Corrected.	
			U. S.	S.	U. S.	S.
		Atlantic	8 15 31		8 14 27	
		Galatea	8 23 03		8 23 03	
		Stranger	8 20 48			
		Cinderella	8 20 08		8 13 21	
		Huron	8 43 20		8 43 20	
		Vision			not timed	
		Fanita			not timed	
		Culprit-Fay	4 17 07		4 15 01	
		Beatrice	4 20 30		4 20 10	
			4 40 55		4 43 37	
		Delvyn	4 52 45		allows	
		Kangaroo	3 13 50		3 11 44	
		Alexander F.	3 15 15		3 14 58	
		Petrel	3 43 45		3 42 05	
		Corinne	3 10 35		allows	
		Henn	3 30 30			

Results: ATLANTIC beat GALATEA by 8 min., 36 sec.; CINDERELLA beat HURON by 23 min., 59 sec.; CULPRIT-FAY beat BEATRICE by 11 min., 9 sec. The other winners walked over.

The Second Annual Regatta was held June 19, 1889, starting from abreast of Fort Wadsworth at 11:30 A. M. The wind was light and baffling, and the day would have resulted in an utter failure had not the Sailing Committee exercised a wise discretion in omitting the Sandy Hook and Scotland Lightships as marks in the first and second class courses, and letting all the competitors make for the finish after rounding Buoy No. 5, off the point of Sandy Hook. MINERVA led across the line at the start, steered by Mr. Lovejoy followed in the order named by ULIDIA, BANSHIEE, CLARA, FORSYTH, DELVYN, TOM-BOY, ACRY, DOROTHY and GUNHILDE.

KATHLEEN came last, handicapped 8 min., 30 sec.

The prizes were won by CLARA, MINERVA, KATHLEEN, GUNHILDE and DOROTHY after an uneventful day made up of drifts and flukes.

The Annual Regatta of 1890 came off June 18th in the lower bay in a spunking breeze, and brought together a splendid fleet of fast forries, including all the crack boats afloat in that then popular class.

MINERVA soon worked her way into a leading position, and was a long way ahead, going like a steamer, when her bob-stay gave up, compelling her to abandon the contest and return to her moorings, leaving the three remaining flyers to fight it out between them on even terms. The official result of one of the best day's sport ever witnessed in New York Bay is herewith appended:

Start, flying at 11:33 A. M.

Choctaw	5 08 30	not meas.
Tomahawk	5 08 17	not meas.
Mariquita	5 12 47	5 12 02
Kathleen	4 32 00	allows
Shona	4 40 28	4 35 31
Christine	3 47 30	
Petrel	3 47 15	
Nadine	3 56 20	
Gunhilde	3 57 09	
Lakshmi	3 59 42	

CLARA and PLYMATE had no competitors in their respective classes.

Annual Regatta, June 22, 1891, came off as usual in the lower bay, in favorable weather, and was remarkable as affording the Herreshoff's new wonder, GLORIANA, an opportunity to score the second of her long list of victories. The official record shows the increasing popularity of the Club Races, although the prizes offered were nothing more than pewter mugs.

Official Record:

Yacht	Elapsed.		Corrected.	
	U. S.	S.	U. S.	S.
Gloriana	3 30 49		3 30 49	
Sayonara	3 42 50		not meas.	
Jessica	3 41 46		3 40 04	
Liris	3 58 49		3 58 49	
Mariquita	4 01 01		3 59 39	
Uetra	3 56 33		3 55 13	
Delvyn	4 17 52		3 15 55	
Kathleen	3 12 05		3 12 05	
Chippewa	3 23 01		3 21 18	
Beth	3 35 45		3 35 45	
Saufigler			no competitor	
Lakshmi			"	
Sea Gull	3 04 12		3 04 12	
Donnybrook	3 08 21		3 04 18	

Annual Regatta, June 25, 1892. The attendance on this occasion was unusually poor, as regards both numbers and quality. The wind was light and fluky until towards evening when a stiff breeze blew the competing craft towards home in spunking style and brought a pleasant day's sailing to a happy termination with the following results:

Alert	7 11 27	
Yampa	7 04 10	winner
Delvyn	5 10 40	
Petrel	5 24 10	winner
Dawn	5 11 02	
Nadine	5 22 22	
Superior	5 10 00	winner

First Annual Sweepstakes (40 to 50 feet sailing length) off Newport Harbor, August 19, 1889. Course, equilateral triangle, 25 miles. Start and finish at Brenton's Reef Lightship.

Alice	3 33 52	3 29 56
Chiquita		withdrew and paid forfeit
Giocilla	3 30 28	3 28 56 third
Helen	3 33 32	3 20 30
Liris	3 29 21	3 29 21
Mariquita	3 34 51	3 33 33
Minerva	3 23 00	3 18 52 first
Papoose	3 34 26	3 25 41 second
Tomahawk	3 31 51	3 30 33

Second Annual Sweepstakes, August 11, 1890. Same course and particulars as year previous.

Choctaw	3 32 41	3 30 21
Gossoon	3 17 01	3 15 35 second
Liris	3 18 55	3 18 55 third
Mariquita		disqualified for fouling first mark
Minerva	3 19 17	3 15 31 first
Mocasin		disabed
Tomahawk		declared out at \$25
Ventura	3 31 36	3 29 00

Third Annual Sweepstakes, August 17, 1891. Same course and particulars as year previous.

Barbara	4 10 54	4 13 02
Beatrice	4 13 00	4 10 31 third
Gloriana	4 08 15	4 05 18 first
Jessica*	4 25 50	4 18 23
Minola	4 21 49	4 18 51
Oweene	4 09 06	4 00 39
Sayonara	4 18 20	4 15 16

Light south southwest wind.

*handicapped 4 min., 18 sec. at start

Fourth Annual Sweepstakes, August 22, 1892.

Wasp	3 18 49	winner
Harpoon	3 57 44	
Gloriana	4 02 33	

Sailed in a fine breeze.

This Annual Sweepstakes sailed off Newport under the auspices of the CORINTHIAN YACHT CLUB (of New York) was inaugurated in 1889, and is now regarded among the most important yachting events of the season. The purses are contributed by the competitors, and the amounts annually distributed have been by far the most valuable hitherto sailed for in American waters. The number of entries has been exceptionally large each year, and the competitors numerous until 1892, when the advent of WASP, coupled with the certainty of meeting GLORIANA, caused many owners to absent themselves and their boats, rather than court certain defeat.

These races are timed to synchronize with the termination of that great nautical outing, the Cruise of the NEW YORK YACHT CLUB, and take place at Newport in the height of the season, and they may fairly be regarded as determining the holder of the Blue Ribbon of the sea.

A Special Schooner Race was sailed June 17, 1893. The club made a special effort to secure entries but only five yachts were at the Scotland Lightship, YAMPA, DAUNTLESS, RAMONA and CORONET of the larger class and LASCA of the smaller. As the latter had no opponent she did not start. There was a strong northeast breeze with rain and a good roll of the sea, conditions which would have made a contest between LASCA, EMERALD and INDIAN a sight worth seeing after the dreary flukes of the week. The Regatta Committee Messrs. Eben Clark, Chas. Stewart Davidson, Geo. A. Cormack and W. C. Hall were present on the flag ship ITUNA, while on the steam yacht SAPPHIRE were Fleet Captain Schuyler, a few guests and the press.

The course was described most carefully in the printed instructions

and the tug SCANDINAVIAN set the first mark, northeast by east, 10 nautical miles, making a beat, and then steamed off at right angles for the second leg, five miles.

The start was from the gun, YAMPA leading over the line setting the pace, DAUNTLESS, RAMONA and CORONET following in order. The last was under working sails only, but the others carried working topsails after crossing. All went well for a time; the four crossed on the starboard tack and stood for the Long Island shore, making a fine sight. After they came about, YAMPA, still well in the lead, started off for SCANDINAVIAN, now vanishing on her way to the outer mark. Seeing YAMPA's course, both DAUNTLESS and CORONET followed, the trio going wide off the first mark. DAUNTLESS was the first to discover the mistake, turning and making for the correct mark, which RAMONA was now near, she rounding at 2:16:25 and DAUNTLESS at 2:31:48. YAMPA and CORONET turned about later on and made for the mark, but on reaching it turned from the wrong side and finally abandoned the race. RAMONA turned the outer mark at 2:42 and the first mark on the return at 3:09:15, with DAUNTLESS at 2:32:56. Spinnakers were set before a falling breeze, and the finish was made at 4:11:17; the full times being:

	Start.	Finish.	Elapsed		Corrected
			Time.	Time.	
	H. M. S.	H. M. S.	H. M. S.	H. M. S.	
Ramona	12 15 00	4 11 17	3 56 17	3 53 33	
Dauntless	12 15 00	3 35 15	4 20 15	4 20 15	
Yampa	12 15 00	did not finish			
Coronet	12 15 00	did not finish			

RAMONA won a silver mug, and a Corinthian pewter mug was given to each amateur in the crew and \$100 was divided among her captain and crew.

The Annual Newport Sweepstakes of the CORINTHIAN YACHT CLUB was set for Monday, August 21, 1893, but as a heavy northeast gale was blowing along the coast, the race was postponed and afterwards declared off.

BIOGRAPHICAL SKETCHES AND LIST OF YACHTS ENROLLED IN THE CLUB.

AUGUST BELMONT, Admiral of the CORINTHIAN YACHT CLUB (of New York), born February 18, 1854; second son of the great financier August Belmont, who was born in Alzey, Germany, and died in 1890. The present August Belmont continues the great banking-house which his father left as a memorial to the name of Belmont. Admiral Belmont is highly esteemed and respected by all who know him, both in business and social circles. He is a member of various yacht clubs, namely: NEW YORK, CORINTHIAN, SEAWANAKA, ATLANTIC and LARCHMONT, as also of the following social clubs: Union, Manhattan and Knickerbocker and was President of the New York Athletic Club during the past year.

Admiral Belmont is the owner of the cutter yacht MINEOLA, as also of the steam yacht ITUNA, which is the flag ship of the CORINTHIAN YACHT CLUB (of New York). On account of his activity in advancing the best interest of the club and the sport of yachting, he has just been re-elected to office.

MINEOLA.

MINEOLA is a semi-composite cutter yacht owned by Admiral August Belmont. She is a Burgess model and was built by Lawley, being launched in March 1891. She hails from New York City and sails with the NEW YORK, ATLANTIC, LARCHMONT, SEAWANAKA, CORINTHIAN and CORINTHIAN (of New York) YACHT CLUBS. See plate LXVII.

CODE SIGNAL LETTERS, K. J. P. D.

Official number, 92,313.

DIMENSIONS.			
Length over all,	62 feet.	Length load waterline,	45 feet 10 inches.
Depth,	9 feet 6 inches.	Draft,	10 feet 5 inches.
Beam,	13 feet 10 inches.		

Racing Record:—

1891—NEW YORK YACHT CLUB—Won second prize in the Squadron Run of August 4th. OWEENE winning. First in the Run of August 8th, beating OWEENE, SAYONARA, NAUTILUS, etc. Second on August 10th, in Special Cup Races. Second in the Squadron Run of August 12th. SAYONARA winning.

SEAWANAKA CORINTHIAN YACHT CLUB—First in the Special Race of July 2d, defeating JESSICA and SAYONARA.

LARCHMONT YACHT CLUB—Second in the Special Race of June 30th, SAYONARA first. Second in the Annual Regatta sailed July 4th.



HON. PERRY BELMONT.

had been appointed by President Cleveland.

HON. PERRY BELMONT, born December 28, 1851, in New York. Eldest son of the late August Belmont; his mother was the daughter of Commodore Matthew Perry. Graduated at Harvard with honors, admitted to the Bar in 1876 and after practicing law for four years, at the age of thirty, represented in Congress the First District of the State of New York. Was elected four times; was Chairman of the Committee of Foreign Affairs. In 1888 resigned his seat to accept the Mission to Spain to which he

Mr. Belmont is an enthusiastic yachtsman, and has done much to advance interest in yachting. His present yacht is *SATANELLA*, formerly *GOLDEN FLEECE*. He is one of the syndicate owning the Cup Defender, *VIGILANT*. He is a member of the *NEW YORK* and *CORINTHIAN* (of New York) *YACHT CLUBS*.

SATANELLA.

SATANELLA, belonging to Perry Belmont of New York City, is an auxiliary screw schooner, formerly known as *GOLDEN FLEECE*. Was built and designed by John S. White & Co. of East Cowes, England, and was launched in 1880. She was originally built for W. H. Roberts. She hails from New York and sails with the *NEW YORK* and *CORINTHIAN* (S. I.) *YACHT CLUBS*. See plate LXIX.

CODE SIGNAL LETTERS, T. J. W. S.

DIMENSIONS.			
Length over all,	17 6 feet,	Length load waterline,	133 feet 6 inches.
Depth,	13 feet,	Draft,	14 feet 6 inches.
Beam,	22 feet 6 inches.		

Engine : Compound, two cylinders, 13 x 12 inch. and 22 x 13 inch.
G. E. Bellis, Birmingham, England.
Boiler : Bellis return tubular (1880). Nominal horse power, 20.

SUPERIOR.

A centerboard cabin cut-boat built and designed by William Whitney, Monument Beach, Mass., and launched in 1887. In August, 1891, she became the property of Stephen H. Brown of New York City. She hails from Tompkinsville, Staten Island, and sails with the *CORINTHIAN* (of New York) *YACHT CLUB*. See Fig. 439.

DIMENSIONS.

Length over all,	21 feet 3 inches.	Length load waterline,	21 feet 9 inches.
Depth,	1 foot 8 inches.	Draft,	30 inches.
Beam,	11 feet 3 inches.		



CHARLES S. DAVIDSON.

CHARLES STEWART DAVIDSON, lawyer, New York City. Lineally descended from the Puritans, on both sides; born in New York City, son of Edward F. Davidson and Charlotte S. White. His father was appointed Consul-General of the Argentine Republic to the United States, while his grandfather was United States Minister to the Argentine Republic.

Mr. Davidson is a member of the Bar Association of New York. Has no yacht at the present time, though he was the owner of the five-tonner *ALICE*, in England, '74-'76, and has had various boats at different times. Has been a yachtsman for twenty years, though his business has prevented his taking an active part in this sport for the last ten years. He was the first Secretary of the *CORINTHIAN YACHT CLUB* (1886), and was Sailing-Master of the same club from 1889 to '93. Has also been connected with certain English yacht clubs, being an honorary member of the *ISLE OF PIRBECK YACHT CLUB*, having served on their Sailing Committee in 1874 and '75. Is a member of the *CORINTHIAN YACHT CLUB* (of New York), and was one of the founders of this organization July, 1886, and was also a founder of the *ISLE OF PIRBECK YACHT CLUB* of England in 1873.



CLAY M. GREENE.

New York), of which he is still a member.

CLAY M. GREENE, dramatic author, New York City, was born in the State of California, the son of William Greene and Anne E. Fish. On his mother's side, he traces his ancestry all the way to the time of MAYFLOWER. His father was the first President of the Board of Aldermen of San Francisco in 1850, while Mr. Greene is President of the Lambs Club of New York. Has owned the yacht *PERVTE* and has been a yachtsman for some twenty-three years, having assisted in the foundation of the *CORINTHIAN YACHT CLUB* (of New York), of which he is still a member.



J. BERRE KING.

SHYLL.

The sloop *SHYLL* is a centerboard craft and was designed by Edward Burgess for her late owner, J. Berre King. She was built by J. P. Smith and was launched at Nyack, N. Y., in 1889. She hails from New York, has a cabin and sails with the *CORINTHIAN* and *NEW YORK YACHT CLUBS*. Has lately been sold to Mr. Allen. See Fig. 440.

DIMENSIONS.

Length over all,	42 feet.	Length load waterline,	35 feet.
Depth,	5 feet 6 inches.	Draft,	6 feet.
Beam,	11 feet.		

AMELIA VICTORIA.

AMELIA VICTORIA is a launch belonging to Walter Luttgen. She was designed and built by the Gas Engine and Power Company, who also furnished her engines and boiler. Was launched in 1889 and hails from Linden, New Jersey. She sails with the *CORINTHIAN YACHT CLUB* (of New York). See Fig. 441.

DIMENSIONS.

Length over all,	30 feet.	Length load waterline,	27 feet 6 inches.
Draft,	2 feet 5 inches.	Beam,	7 feet.

LINTA.

A screw schooner designed and built by Chas. L. Seabury & Co., Nyack, N. Y., for her present owner, Mr. Walter Luttgen. She was launched in June 1892. She hails from New York City and sails with the *CORINTHIAN* (of New York), *SEAWARD*, *CORINTHIAN YACHT CLUBS* and *CORINTHIAN NAVY*. See plate LXVII.

DIMENSIONS.

Length over all,	55 feet.	Length load waterline,	76 feet.
Depth,	6 feet.	Draft,	5 feet 6 inches.
Beam,	14 feet.		

Engine: Compound condensing, two cylinders, 10 and 17½ x 10 inch.
Boiler: Seabury patent safety water tube. Electric plant by Riker Electric Motor Co.



JAMES B. MURRAY.

JAMES B. MURRAY, lawyer, New York City, is the son of Bronson Murray. He is the owner of the yacht *CYGNET* and has identified himself with yachting interests for seven years. Is a member of the *CORINTHIAN* (of New York), *LARCHMONT* and *SEAWANAHAKA CORINTHIAN YACHT CLUBS*, and also the University, Delta Phi, Reform and City Clubs.

CYGNET.

CYGNET is a centerboard sloop yacht owned by James B. Murray of New York City. She was built in the Spring of 1886, by Mann of South Brooklyn, N. Y. *CYGNET* has never been altered. She hails from New York City and sails with the *CORINTHIAN* (of New York), *LARCHMONT* and *SEAWANAHAKA CORINTHIAN YACHT CLUBS*. She ran from New York City to Newport in twenty-two hours, and from the Connecticut River to Whitestone Station between sunrise and dark. She has never been raced by her present owner. See Fig. 442.

DIMENSIONS.

Length over all,	24 feet 6 inches.	Length load waterline,	22 feet.
Draft,	3 feet 1 inch.	Beam,	10 feet.

INTREPID.

An auxiliary three-masted screw schooner owned by Lloyd Phoenix of New York City. Was designed by J. Beaver-Webb and built by Neale & Levy Co., Philadelphia, Pa. Was launched in October 1892. *INTREPID* is constructed of steel, hails from New York and sails with the *CORINTHIAN* (of New York), *EASTERN*, *NEW YORK*, *LARCHMONT* and *SEAWANAHAKA CORINTHIAN YACHT CLUBS*. See Fig. 443.

DIMENSIONS.

Length over all,	153 feet 6 inches.	Length load waterline,	132 feet.
Draft,	13 feet 6 inches.	Beam,	27 feet 2 inches.

Engine: Vertical, inverted cylinder, direct acting, triple expansion; three cylinders, 9 $\frac{1}{2}$, 14 and 23 $\frac{1}{2}$ x 19 inches. Indicated horse power, 250. Neale & Levy, 1892.

Boiler: Return tubular, Neale & Levy, 1892.

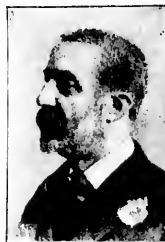

WILLIAM H. PLUMMER.

WILLIAM H. PLUMMER, New York City. He is the son of William H. and Mary C. Plummer, and is in the dry-goods line. Has been a yachtsman for forty years and is a member of the *CORINTHIAN* (of New York), *CORINTHIAN* (of Philadelphia) and the *SEAWANAHAKA CORINTHIAN YACHT CLUBS*. He is a charter member of the first two clubs mentioned.

M. ROOSEVELT SCHUYLER of New York City, a lineal descendant of Phillip Peters Van Schuyler; was



educated at the United States Naval Academy and served in the United States Naval Service and in the Mercantile Marine Service. Has been a yachtsman all his life and has held the position of Flag-Officer of the *SEAWANAHAKA YACHT CLUB*, Secretary of the *CORINTHIAN YACHT CLUB* (of New York), and is now the Fleet Captain of the latter club, of which he was a charter member. In addition to these two clubs, he also belongs to the *M. ROOSEVELT SCHUYLER NEW YORK* and *LARCHMONT YACHT CLUBS*. His present yacht is *DELYVN*, though he was at one time the owner of *YOLANDE*.

Mr. Schuyler has written several important articles on yachts and yachting, and is considered an authority on these subjects.

DELYVN.

DELYVN is a cutter belonging to M. Roosevelt Schuyler of New York City. She was designed and built by Fife & Son of Fairlee, Scotland and launched in 1884. She sails with the *CORINTHIAN* (of New York), *LARCHMONT* and *NEW YORK YACHT CLUBS*, hailing from New York City. See Fig. 444.

DIMENSIONS.

Length over all,	42 feet.	Length load waterline,	31 feet 4 inches.
Depth,	6 feet 6 inches.	Draft,	6 feet 8 inches.
Beam,	15 feet 4 inches.		

GENERAL WILLOUGHBY WESTON of New York City, is the son of Henry Weston and Susan Cullen Van Rensselaer. He was Brigadier-General and Inspector-General of New Jersey, 1881-87. He has always been an active yachtsman and has owned *ULIDIA* and *WENONAH*, the latter being his present yacht. He was one of the founders of the *HUDSON RIVER ICE YACHT CLUB*, and is a member of the *NEW YORK* and *CORINTHIAN* (of New York) *YACHT CLUBS*.

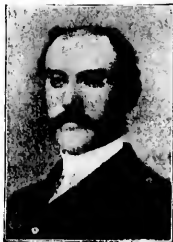
**WENONAH.**

WENONAH is a keel cutter (composite), belonging to Gen'l Willoughby Weston of New York City. *WENONAH* was designed by John Harvey and built by Henry Piepgras for James Stillman. She was launched in 1882. She hails from New York City.

DR. JOHN M. WOODBURY, York. See Fig. 445.

CODE SIGNAL LETTERS, J. W. N. B.

Official number, 80,928.

DIMENSIONS.

Length over all,	72 feet 1 inches.	Length load waterline,	60 feet 9 inches.
Depth,	10 feet 2 inches.	Draft,	10 feet 4 inches.
Beam,	14 feet.		

Spars: Bowsprit, 36 ft.; Mainmast, 61 ft. 6 in.; Topmast, 40 ft.; Boom, 57 ft. 8 in.; Gaff, 36 ft.

Racing Record for 1891:—

Started in five races and won four first prizes.

United States Naval Acad-
emy in the United States
and in the Mercantile Ma-
rines has been a yachtsman all
his life. He held the position of Flag-
rank in the HAWAIIAN YACHT CLUB,
the CORINTHIAN YACHT CLUB
(New York), and is now the
honorary member of the latter club, of which
he is also a member. In addition to
these, he also belongs to the
HONOLULU and LARCHMONT YACHT CLUBS,
and although he was at one time

an author of articles on yachts and
other nautical subjects.

Roosevelt Schuyler of New
York, of the firm of
R. H. P. & Son of Fairlee,
is a member of the CORINTHIAN (of
New York) and the HAWAIIAN YACHT CLUBS, hailing

waterline, 31 feet 6 inches.
6 feet 8 inches.

of New York City, is
Callen Van Rensselaer,
Governor of New Jersey,
a yachtsman and has owned
the present yacht. He was
a member of the HUDSON RIVER
YACHT CLUB, and is a member of the
CORINTHIAN (of New
York) and the HAWAIIAN YACHT CLUBS.

WENONAH.

keel cutter (composite),
designed by Willoughby Weston of
New York. WENONAH was designed
and built by Henry
C. Stillman. She was
launched in 1885. She hails from New
York.

waterline, 30 feet 9 inches.
10 feet 4 inches.

6 in.; Topmast, 40 ft.;

os.

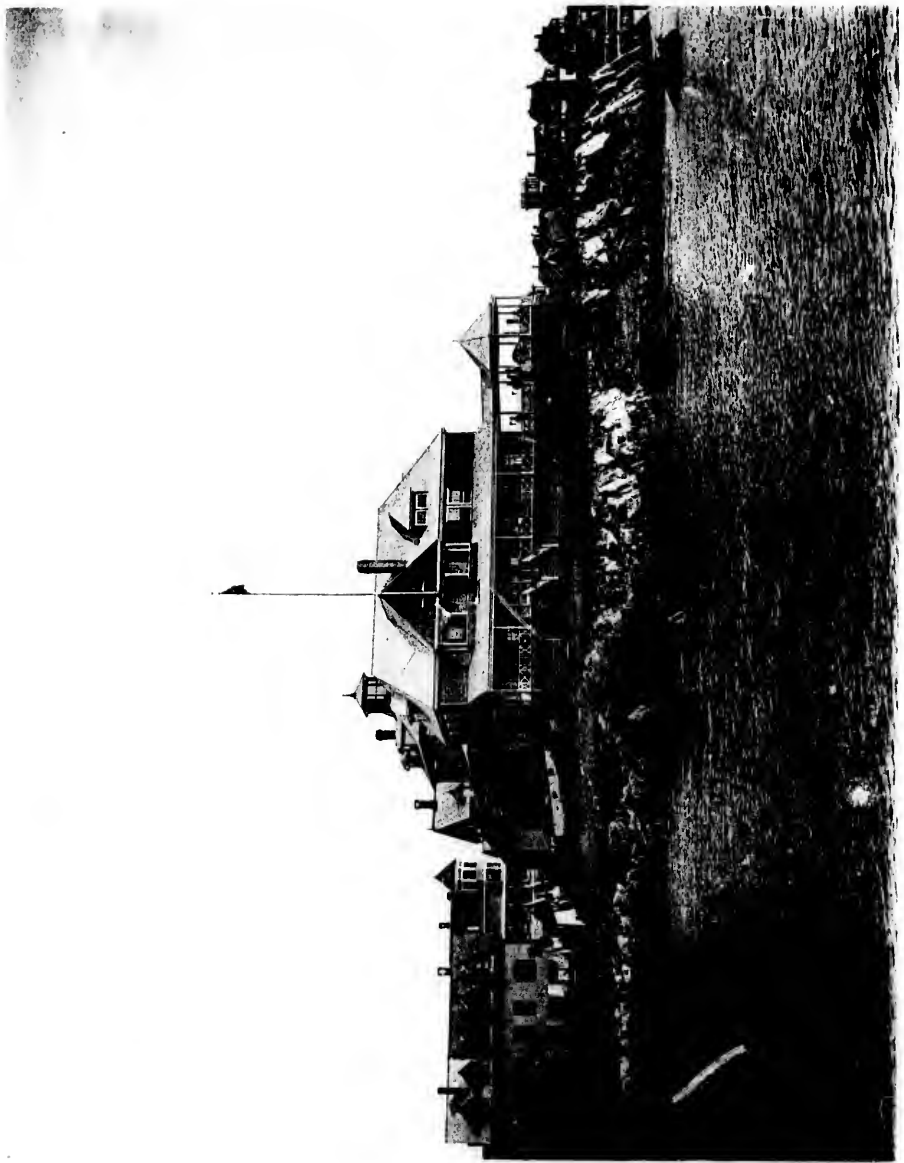

FROM A NEGATIVE BY STEBBINS

CORINTHIAN YACHT CLUB HOUSE.

MARBLEHEAD

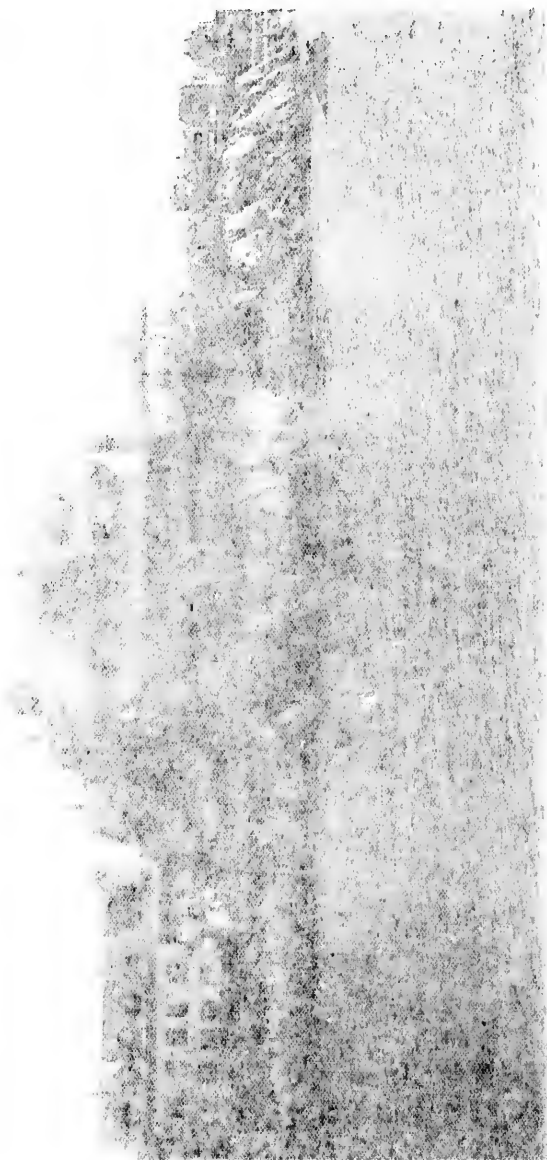

History of the Corinthian Yacht Club.

STATION—MARBLEHEAD, MASS.

DURING the first week of July, 1885, Mr. Russell Whitecomb and his brother Lawrence Whitecomb suggested to Irving S. Palmer and Mr. J. B. Rhodes a plan to form a new yacht club at Marblehead Neck, a beautiful Summer resort about 18 miles from Boston, Mass. All these gentlemen being Summer residents and amateur yachtsmen, gave the matter much thought. As the EASTERN YACHT CLUB was composed of middle-aged and elderly gentlemen they thought that there was room for another club of younger spirits, especially as the EASTERN CLUB only enrolled

The next season, 1886, the club purchased a house and a barn paying therefor \$450 for the season. The two buildings were fitted up, one for the general use of the members, the other furnished with beds, etc., to accommodate those who wanted to stop over night. The barn was used for the storage of spars, sails, oars, etc. The next year, 1887, the members voted to improve and occupy the same quarters and many interesting races took place during the season, notably the Open Regatta July 30th, with fifty-eight starters.

During the Winter of '87 and '88 a very successful Minstrel Entertainment was given at the Boston Theater, by members of the club and their friends which netted a handsome sum to the treasury. At a meeting in October, 1887, the club voted to purchase for \$6,500, the property near the entrance to the harbor known as Sparhawk's Point, a beautiful location containing about 18,000 feet of land. This valuable property was secured, the club paying part cash, and Mr. Crowninshield loaning the balance. January 17, 1888, the club was incorporated and a committee appointed to raise funds to build a new Club House on the recently purchased land. Bonds were issued and

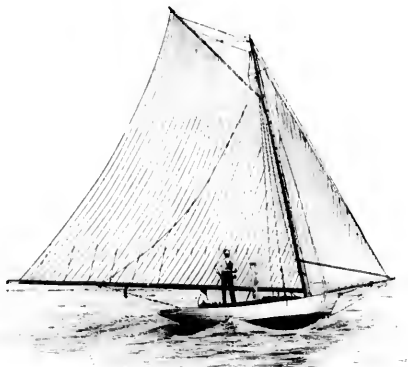

SIROCCO.—FIGURE 416.

boats of thirty feet and upward waterline measurement, and the proposed new club was intended to be composed of yachts under thirty feet and over sixteen feet waterline, thus supplementing the EASTERN YACHT CLUB. The judgment of these gentlemen was well sustained, for the meeting they called at the hall on Marblehead Neck, July 7, 1885, brought out a large attendance of those interested, and Mr. I. S. Palmer were chosen Chairman. Three or four of these preliminary meetings were held and matters of organization were talked over and the adoption of the Rhodes motion that the new club be called the CORINTHIAN YACHT CLUB was the result. The following officers were chosen for the first year:

Commodore, Benj. W. Crowninshield; Vice-Commodore, Irving S. Palmer; Treasurer, J. B. Rhodes; Secretary, Everett Palmer; Measurer, C. H. W. Foster.

Regatta Committee: Daniel Appleton, I. S. Palmer, A. S. Brown, Russell M. Whitecomb, B. W. Crowninshield.

Membership Committee: King Upton, Isaac C. Mills, Jr., Lawrence Whitecomb.

The membership of the club the first year was sixty-five, forty-five being yacht owners. All the meetings were held in the public hall at Marblehead Neck. Much enthusiasm was shown and resulted in the club having five good races during the Summer.

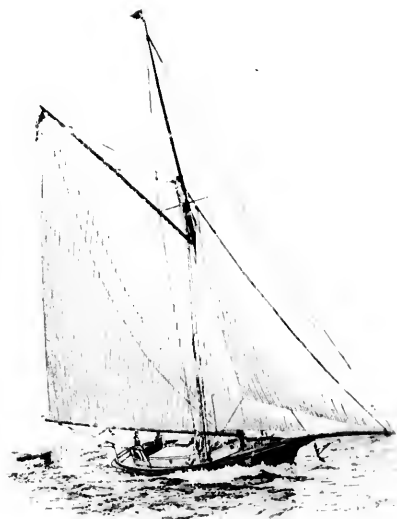

WHISTLER.—FIGURE 417.

placed with the members and a large commodious house furnished in comfortable style was completed, July 11, 1888. Members and ladies with them were entertained with a band concert, refreshments, etc.

Nine events took place this season. Seven Races, one Sail Off and one Ladies' Sail, all very successful. The greatest event of the year

was the open race with sixty starters. Fifty-six yachts sailed the different courses and returned to have their time taken.

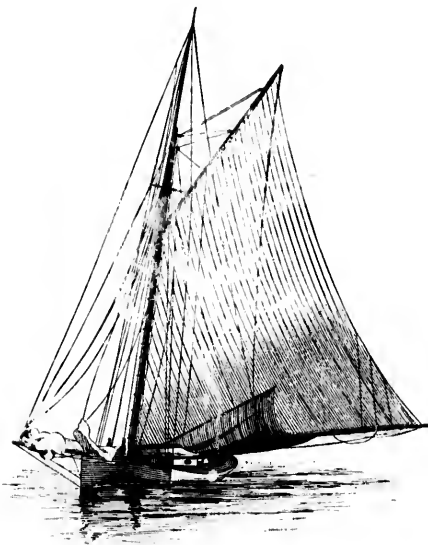

LORITA.—FIGURE 448.

It was during this year that the late Mr. W. F. Weld contributed and gave the club a cup for 40-footers, called the Weld Cup. This was won by CHUQUITA in a Special Race, sailed September 15, 1888. During the season of 1889 the races continued to be very interesting. The Midsummer Series inaugurated this year were participated in by such boats as MINERVA, TOMAHAWK, CHUQUITA, ALICE, GORILLA, ZARA and PAPPOOSE. KATHLEEN, SHARK, SARACEN, HARDINGER and SWORDFISH making things lively in the lower classes.

The Summer of 1890 witnessed continued activity with many new boats, interest centered on the Midsummer Series.

August 19th of this year (1890) saw one of the closest races on record. MINERVA winning from GOSBOON by two seconds, corrected time over a 24 mile course. These races were now a feature with the club, and each year brought to Marblehead the fastest boats in the 40 and 46 foot classes.

March 11, 1891, the club adopted the design submitted by Com. Crowninshield—Pegasus, the flying horse, the emblem of the City of Corinth together with the Club motto: *Et Certare Paros et Respondere Parati*. The membership increased so rapidly that it was found necessary to enlarge the Club House, and a Committee was appointed to attend to it. They added to the northerly and three stories and a basement containing a restaurant, dining-room, laundry, kitchen, etc.

ALBORAK, BARBARA, OWEENE, BEATRIX (afterwards HAI POON) and MINEOLA made the Midsummer Series very interesting. During the Summer the club had its First Cruise. Eight yachts completing a sail to Bar Harbor and return.

On January 17, 1892, Benj. W. Crowninshield, the first Commodore of the club died at Rome where he had gone for his health. He had always taken a great interest in the affairs of the club and his memory will be long cherished by his associates.

Ten regattas were sailed during the season of 1892. Four Club Regattas, two Open Races, three Midsummer Series and one open to all classes. The Championship Cups were won by HAWK, SUSIE, FREAK and KOORALI. The Midsummer Series Cup was won by REAPER.

The club membership has been steadily increasing from sixty-five members in 1885 when the annual dues were \$5, to five hundred members in 1893, and the annual dues \$15, with an admission fee of \$10. \$500 of the club notes have been cancelled each year and the club is in a strong financial condition.

At a meeting of the CORINTHIAN YACHT CLUB, of Marblehead, at the Parker House, Boston, on January 17, 1893, the following officers were elected:

Commodore, W. P. Fowle; Vice-Commodore, J. P. Loud; Rear-Commodore, D. C. Percival, Jr.; Secretary, Everett Paine; Treasurer, J. B. Rhodes; Measurer, J. W. Dunlop.

Regatta Committee: Henry Taggard, G. W. Mansfield, J. B. Paine, H. P. Benson, A. G. Wood.

Board of Judges: Daniel Appleton, G. W. Mansfield, W. N. Merriam, D. H. Follett, Jr.; D. W. Lano.

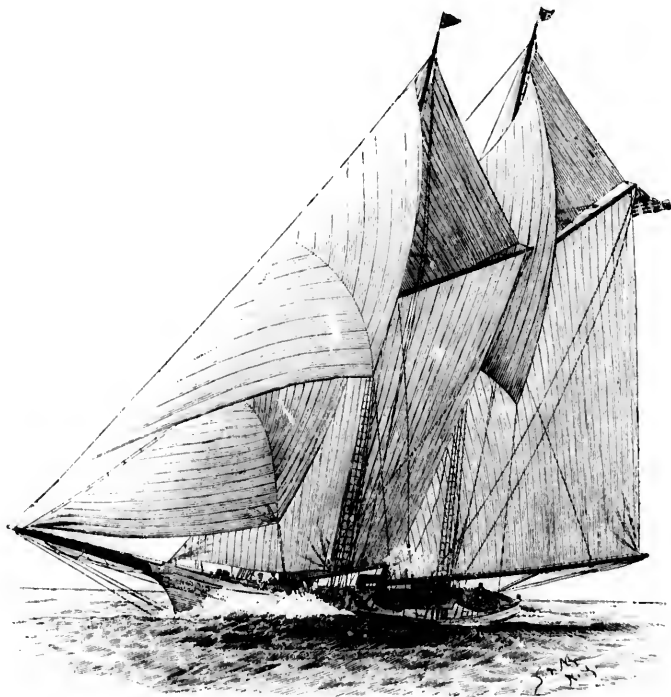

AMERICA.—FIGURE 449.

(From a Photo. by Johnson.)

wards Ha1
very interest-
Cruise. Eight

st Commodore
alth. He had
and his mem-

2. Four Club
ries and one
on by HAWK,
Cup was won

rom sixty-five
o five hundred
an admission
each year and

Marblehead, at
the following

Loud; Rear-
Paine; Treas-

nsfield, J. B.

, W. N. Mer-

LIST OF YACHTS ENROLLED IN THE CORINTHIAN YACHT CLUB, 1893.

STEAM YACHTS.

NAME.	OWNER.	PORT.	LENGTH OVER ALL.		BEAM.	DRAFT
			ft. in.	ft. in.		
Adella	N. C. Nash	Boston	33 0	87 0	16 0	7 1/8
Annie S.	Fred Pope	"	110 0	95 0	16 0	7 0/8
Corona	E. C. Taft	"	95 0	79 0	12 0	6 11
Ella	N. L. Stebbins	"	61 0	55 0	11 0	5 0/8
Gadabout	Kling Upton	"	83 0	55 0	10 0	4 0/8
Gleam	H. W. Savage	"	80 0	70 0	11 0	5 0/8
Gyda	Edgar Harding	"	71 0	62 0	12 5	5 0/8
Hannel	C. H. W. Foster	"	97 0	85 0	14 6	7 1/8
Hermes	I. S. Palmer	Marblehead	41 0	35 6	8 0	3 0/8
Imp	J. H. Sutton	Lawrence	22 0	20 0	5 0	2 0/8
Jackal	S. Cunningham	Nahant	35 0	31 0	7 6	2 1/8
Jathiel	J. B. Thomas	Salem	131 0	110 0	18 6	8 1/8
Marina	C. H. Merrill	Boston	53 6	45 0	10 0	4 1/8
Polly	C. S. Eaton	"	68 0	60 0	9 0	5 1/8
Radom	F. H. McQuesten	Marblehead	75 0	83 6	12 9	6 1/8
Signal	W. L. Wellman	Boston	28 0	25 6	6 0	2 1/8
Talisman	J. B. Thomas	Salem	143 0	123 0	17 6	7 1/8

LIST OF YACHTS ENROLLED IN THE CORINTHIAN YACHT CLUB, 1893.

THIRTY FEET WATERLINE AND OVER.

NAME.	OWNER.	PORT.	HIG.	C. D. OR KEEL.	LENGTH		BEAM.	DRAFT
					OVER ALL.	L. W. L.		
					ft. in.	ft. in.	ft. in.	ft. in.
Adrienne	H. P. Smith	Boston	Schooner	k	71 00	50 00	18 00	9 00
Alborak	John B. Palmo	Nahant	Cutter	k	63 00	46 00	14 02	10 02
Allee	Henry C. Hutman	Salem	"	k	32 11	30 00	10 00	5 01
Alice	C. S. Andrews	Boston	Schooner	k	82 00	74 11	20 06	9 09
Baboon	Geo. A. Goddard	Beverly	Cutter	k	50 00	30 05	13 06	8 03
Barbara	C. H. W. Foster	Marblehead	"	k	63 00	45 09	13 00	11 08
Betty	Geo. S. Osborne	Salem	Sloop	e b	36 02	31 10	10 08	3 10
Bohemian	H. P. Smith	Boston	Schooner	k	83 02	46 03	15 03	7 05
Bonito	Geo. A. Ballantine	Beverly	Sloop	e b	41 00	34 00	13 02	4 06
Carmita	C. H. W. Foster	Marblehead	Cutter	k f	70 00	45 00	12 08	11 00
Chiquita	A. Hemonway	Boston	"	e b	49 06	39 06	13 08	7 06
Clytie	Rollins & Neff	"	Sloop	e b	37 00	33 07	12 06	4 00
Crest	Horace H. Pearson	"	Schooner	k	38 02	33 00	9 10	6 04
Edith	H. B. Stearns	Marblehead	Cutter	k	49 06	40 08	10 00	7 06
Fanilla	Thos. H. Shepherd	Boston	Sloop	e b	50 00	44 00	17 00	5 00
Fortuna	H. S. Hovey	Gloucester	Schooner	k	100 05	53 00	22 07	12 00
Galatea	Leut Wm. Henn	Glasgow	Cutter	k	102 00	87 00	15 00	11 06
Gorilla	Odin B. Roberts	Boston	"	e b	54 00	39 11	15 03	7 00
Gossoon	Chas. A. Morse, Jr.	"	"	k	55 00	39 09	12 00	9 03
Griselda	James W. Hill	"	Schooner	e b	53 00	48 00	16 09	6 00
Gwendolen	J. J. Lonnax	Lynn	Sloop	k	38 00	32 00	12 00	7 00
Gundred	Henry Vaughan	Boston	Schooner	k	54 00	45 00	14 01	7 06
Harpoon	C. F. Adams	"	Cutter	e b	63 00	45 09	16 00	7 06
Hilda	C. P. Curtis	Swampscott	"	k	35 09	31 05	11 00	6 11
Inthe	C. L. Davenport	Boston	Schooner	k	52 00	49 01	11 10	8 00
King Philip	H. B. Torrey	"	Cutter	k	42 00	36 00	10 60	8 00
Kitty	John M. Ward	"	Schooner	k	55 00	50 00	10 00	7 00
Madeup	J. H. Booth	"	"	k	47 07	42 02	12 00	7 06
Magnolia	E. P. Boynton	"	"	k	48 00	40 05	15 00
Mystery	Albert L. Pope	"	Cutter	k	61 08	58 00	18 01	10 00
Nebula	Clarence W. Jones	"	"	k	43 00	35 00	12 00	7 06
Nellie G.	G. W. Mansfield	Salem	Schooner	k	48 00	43 00	13 00	6 09
Nimbus	J. S. Cushing	Boston	Sloop	e b	37 02	33 07	12 06	5 00
Norna	Geo. B. Upham	"	Cutter	k	35 00	33 00	7 10	6 00
Enone	H. Cochrane	"	Schooner	k	62 03	75 00	19 06	12 00
Pilgrim	Stewart & Binney	"	Cutter	k f	120 00	85 00	23 00	22 00
Priscilla	W. T. Lambert	"	Schooner	k	61 06	58 08	17 06	9 06
Hamona	M. S. Bray	"	Sloop	e b	36 02	33 03	4 06
Rondina	D. C. Perelval, Jr.	"	Cutter	k	38 00	30 00	8 02	6 05
Sekara	N. L. Francis	"	Schooner	k	67 03	50 00	15 00	9 00
Sea Fox	Alanson Tucker	"	"	e b	115 00	89 05	23 10	11 00
Stranger	Geo. H. Warren	Liverpool	Cutter	k	79 00	65 00	13 00	10 06
Yaululla	A. G. Van Nostrand	Boston	Sloop	k	45 00	35 00	14 02	6 03
Vandal	J. A. Stetson	"	Cutter	e b	47 00	33 08	14 07	6 06
Ventura	T. W. King	"	"	e b	51 00	39 09	12 00	7 06
Wave Crest	J. Gross	"	Sloop	e b	39 04	33 06	12 04	4 00
White Cap	Winthrop Thayer	"	Yawl	k	85 00	66 00	20 07	9 00
Whistler	Alfred M. Blinn	"	Sloop	e b	35 00	32 00	12 11	4 06
(Building)	C. J. Palmo	Nahant	Cutter	124 00	85 00	23 09	14 00

LIST OF YACHTS ENROLLED IN THE CORINTHIAN YACHT CLUB, 1903.

FIRST CLASS.—TWENTY-FIVE FEET WATERLINE AND LESS THAN THIRTY FEET.

NAME.	OWNER.	PORT.	RIG.	C. B. OR KEEL.	LENGTH OVER ALL.	L. W. L.	BEAM.	DRAFT.
Atalanta	G. W. Keats	Boston	Sloop	e b	11.10.	11.10.	11.10.	11.10.
Beetle	W. M. Jameson	"	Cutter	k	35.05	27.05	11.11	3.05
Brynild	W. D. Smith	"	Sloop	k	29.01	20.08	7.10	6.00
Chapognoit	Chas. H. Jones	W. Falmouth	J. & M.	e b	40.05	29.10	11.05	5.00
Countess	H. L. Sewall	Beverly Farms	Sloop	k	33.00	29.05	12.05	5.05
Daisy	Lindsay Loring	Boston	Cutter	k	32.00	25.00	8.05	6.00
Edna	Benjamin P. Hale	"	"	k	31.05	24.05	11.00	6.03
Elf	Henry Howard	"	"	k	35.00	28.01	11.00	6.05
Elsa	John M. Gordon	"	Sloop	k	29.08	20.01	10.00	5.08
Falka	Geo. D. Holes	Marblehead	Cutter	e b	31.05	28.07	10.08	5.00
Fancy	C. F. Lyman	Newport	"	k	42.00	29.05	9.00	7.05
Gladya	Wm. P. Fowle	Marblehead	"	k	42.00	30.00	11.00	7.05
Hawk	Gordon Dexter	Beverly	"	e b	42.00	29.00	11.00	5.00
Hawatha	Geo. F. Chapin	Boston	"	k	33.00	27.10	10.08	5.11
Ionian	S. E. Bullard	"	"	k	30.00	27.00	8.00	4.05
Kelpie	Wm. Bassett, Jr.	Lynn	"	k	32.00	25.05	9.00	4.05
Lena	Herbert P. Cook	Boston	Sloop	k	29.05	20.01	10.00	4.05
Leona	H. F. P. Wilkns	Marblehead	"	k	30.00	20.10	11.00	3.05
Levana	E. J. Andrews	Swampscott	Cutter	k	33.00	28.11	9.00	5.00
Lorita	John L. Butler	Boston	Sloop	e b	31.00	26.00	9.05	3.00
Marjorie	E. H. Wiggins	"	Cutter	k	32.00	26.05	9.00	4.05
Mattie	Geo. E. McQuesten	Marblehead	Cut	e b	25.11	25.10	11.08	3.00
Maud	Fred. H. Estes	Boston	Sloop	k	32.01	28.04	11.02	5.05
Mildred	N. C. Nash	"	Cutter	k	42.05	29.11	9.00	7.05
Owl	J. S. Cushing	"	Sloop	e b	25.01	25.02	11.09	2.05
Saladin	J. P. and C. E. Loud	Marblehead	Cutter	k	42.00	29.00	10.00	8.00
Saracen	Wm. Whitman, Jr.	Boston	"	k	38.03	29.07	10.00	7.00
Vanitas	C. B. Morrill	"	Schooner	k	31.02	27.03	11.05	5.00
Vashti	John A. Stetson	"	Cutter	k	36.00	29.00	11.00	6.00
Vixen	C. P. Armstrong	"	Sloop	e b	31.05	28.06	11.00	3.00
Whisper	W. F. Blake	Salem	Schooner	k	20.00	27.00	10.00	4.00
Winoos	H. D. Ward	Gloucester	Sloop	e b	31.00	27.05	10.08	5.00

DRAFT

11. 10.

9 06

10 02

5 00

9 09

8 03

11 08

3 10

7 05

4 08

11 00

7 00

4 00

6 04

7 06

5 00

12 00

11 05

7 00

9 03

6 00

7 00

7 06

7 00

6 11

8 00

8 00

7 00

7 06

10 00

10 00

7 06

6 00

5 00

6 00

12 00

22 00

9 05

4 05

6 05

9 05

11 00

10 05

6 03

6 06

7 00

4 00

9 00

4 00

14 00

LIST OF YACHTS ENROLLED IN THE CORINTHIAN YACHT CLUB, 1893.

SECOND CLASS.—TWENTY-ONE FEET WATERLINE AND LESS THAN TWENTY-FIVE FEET.

NAME.	OWNER.	PORT.	RIG.	C. B. OR KEEL.	LENGTH	L. W. L.	BEAM.	DRAFT.
					OVER ALL.	ft. in.	ft. in.	ft. in.
Albertina	Samuel Hayward	Boston	Cutter	k	30 00	25 00	8 00	5 11
Alycane	J. A. Barley, Jr.	"	Sloop	k	26 05	23 05	10 04	1 00
Aneto	H. B. Stearns	Marblehead	Yawl	k	21 00	21 00	7 00	4 05
Annie	J. B. Rhodes	"	Cutter	k	26 00	21 10	7 04	4 05
Irenda	Everett Paine	"	"	k	30 01	22 05	8 05	5 10
Calyppo	Henry G. Peabody	"	Cat	k	25 00	22 00	8 00	4 05
Dorothy	H. W. Perry	"	Sloop	k	24 07	22 00	7 01	4 05
Echo	E. L. Durwell	Hull	"	k	27 00	24 05	11 00	5 00
Grimalkin	George H. Howe	Cobasset	Cat	e b	25 04	22 05	10 00	3 05
Gypsy	H. Gutterson	Boston	Cutter	k	27 05	23 00	8 05	5 00
Hazard	Daniel H. Pierce	Newburyport	Sloop	e b	26 07	22 05	10 05	3 02
Ione	J. S. Poyen	Boston	"	k	29 03	25 07	10 00	5 03
Keewaydin	J. A. Burnham, Jr.	Beverly	Cutter	k	30 00	24 00	8 10	0 05
Madge	M. R. Wendell, Jr.	Boston	Sloop	e b	24 10	23 05	10 05	2 01
Marena	W. O. Taylor	Marblehead	Sloop	e b	27 00	23 03
Marguerite	F. Skinner, Jr.	Boston	Cutter	k	26 05	23 08	9 00	4 00
Modoc	W. C. and A. P. Loring	Beverly	"	k	27 00	22 00	7 00	5 00
Moondyne	A. J. Shaw	Weymouth	Sloop	e b	24 10	24 08	11 00	2 00
Nydia	G. H. L. Coulthurst	Salem	"	e b	25 02	21 04	10 05	2 03
Petrel	S. A. Goodhue	"	"	k	27 00	23 02	8 10	4 01
Princess	C. J. Holfe	Swampscott	"	e b	28 00	25 00	10 00	3 00
Queen Mab	C. L. Perrin	Boston	Cat	e b	24 07	21 05	10 03	2 00
Ruth	J. P. Browning	Salem	Sloop	k	23 05	21 05	10 00	5 00
Siva	Wm. H. Young	Boston	"	k	30 02	25 01
Sunbeam	Wm. L. Wellmao	"	"	k	26 07	21 05	10 00	5 00
Susie	Wm. W. Keith	Marblehead	"	e b	26 03	23 02
Trudette	M. L. Scull	Beverly	"	k	29 04	24 00	9 00	4 08
Wanderer	A. M. Merriam	Manchester	"	e b	25 00	22 10	10 00	2 10

LIST OF YACHTS ENROLLED IN THE CORINTHIAN YACHT CLUB, 1893.

THIRD CLASS.—KEEL YACHTS LESS THAN TWENTY-ONE FEET WATERLINE.

NAME.	OWNER.	PORT.	RIG.	LENGTH OVER ALL.	L. W. L.	DECK.	DRAFT.
Carl	C. H. W. Foster	Marblehead	J. and M.	20 00	21 10	11 10	11 10
Composite	Robert McIntyre	Boston	Sloop	22 00	23 10	7 10	4 00
Francis	G. H. Wheeler	Marblehead	Cutter	26 00	26 10	6 00	1 00
Freak	A. L. Cochrane	Beverly	J. and M.	20 00	20 10	7 00	1 00
Gigi	P. H. Kemble	Boston	Yawl	28 00	17 10	6 00	1 00
Jo	Ingersoll Amory	Nahant	Cat	19 00	17 00	6 00	2 00
Juno	Charles W. Parker	Marblehead	Cutter	21 00	20 10	7 00	4 00
Kathleen	H. S. Peabody	"	Sloop	26 00	19 00	7 00	4 00
Kraken	Percy Chase	"	"	29 00	20 00	8 00	5 00
Kwasind	C. E. Finney	Boston	Cutter	21 00	18 00	7 00	4 00
Lassie	W. S. Eaton, Jr.	"	"	28 00	19 00	7 00	4 00
Lotis	Geo. Burroughs	Marblehead	"	25 00	20 10	8 00	5 00
Matilda	G. C. Clement	Haverhill	Yawl	20 00	17 00	6 00	3 10
Mosen	F. E. Peabody	Marblehead	Cutter	20 01	19 00	7 00	5 10
Nancy	Endicott Sultonstall	Beverly	"	21 00	20 10	7 00	4 00
Nixie	A. L. Cochrane	"	Sloop	23 07	20 01	8 01	4 00
Ospray	H. P. Hufelinson	Marblehead	"	21 00	18 00	7 00	3 00
Reaper	H. P. Benson	"	Cutter	28 00	20 10	6 00	6 00
Santa Maria	J. J. Souther	"	Sloop	16 02	16 01	4 00	2 00
Snell	L. C. Whiting	"	Cutter	28 00	20 10	8 00	4 00
Susan	Henry Taggard	"	Cutter	28 00	20 10	8 00	4 00
Thais	E. W. Richardson	Brooklyn	Sloop	21 04	17 00	7 08	3 00
Vaga	Cabot J. Morse	Boston	"	21 00	20 11	9 02	4 00
Vandal	H. W. and E. K. Friend	"	Cutter	21 00	20 10	6 00	6 00
Vanessa	A. Higelow, Jr.	"	J. and M.	25 00	20 00	9 04	3 00
Wave	F. B. Thomas	Salem	Sloop	25 00	20 10	7 00	4 00
(Building)	Theodore Jones	Marblehead	Cutter	25 00	20 10	7 00	4 00

DRAFT.

ft. in.

5 11

4 00

4 00

4 00

5 10

4 00

4 00

5 00

3 00

5 00

3 02

5 00

6 00

2 01

....

4 00

5 00

2 00

2 00

4 01

3 00

2 00

5 00

....

5 00

....

4 08

....

4 08

2 10



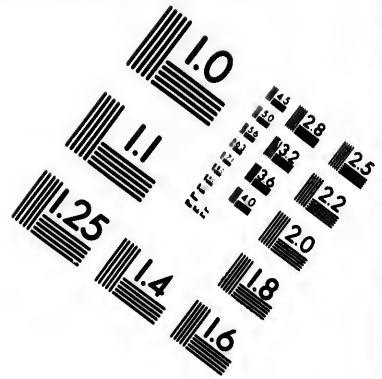
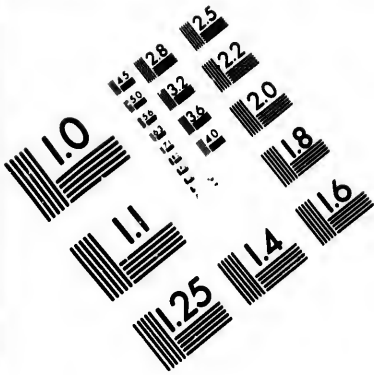

**IMAGE EVALUATION
TEST TARGET (MT-3)**

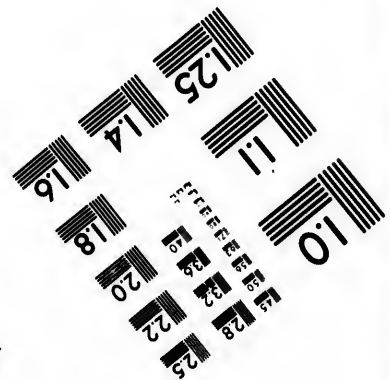
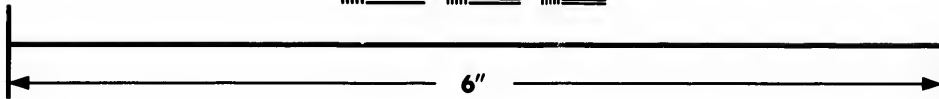
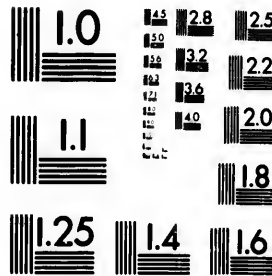

**Photographic
Sciences
Corporation**

23 WEST MAIN STREET
WEBSTER, N.Y. 14580
(716) 872-4503

1.5
1.8
2.0
2.2
2.5
2.8
3.2
3.6
4.0
4.5
5.0
5.6
6.3
7.1
8.0
9.0
10.0
11.2
12.5
14.0
16.0
18.0
20.0
22.5
25.0
28.0
32.0
36.0
40.0
45.0
50.0
56.0
63.0
71.0
80.0
90.0
100.0

1.5
1.8
2.0
2.2
2.5
2.8
3.2
3.6
4.0
4.5
5.0
5.6
6.3
7.1
8.0
9.0
10.0
11.2
12.5
14.0
16.0
18.0
20.0
22.5
25.0
28.0
32.0
36.0
40.0
45.0
50.0
56.0
63.0
71.0
80.0
90.0
100.0

LIST OF YACHTS ENROLLED IN THE CORINTHIAN YACHT CLUB, 1893.

FOURTH CLASS.—CENTERBOARD YACHTS LESS THAN TWENTY-ONE FEET WATERLINE.

NAME.	OWNER.	PORT.	RIG.	LENGTH OVER ALL.		BEAM.		DRAFT.	
				ft. in.	ft. in.	ft. in.	ft. in.		
Alceto	George H. Howe	Cohasset	Cat	18 00	15 09	2 00		
Aurelia	H. M. Faxon	Quincy	"	21 05	18 00	8 05	1 05		
Delphino	Charles M. Barker	Marblehead	Sloop	22 09	20 03	9 10		
Dolphin	Boyal Robbins	Swampscott	Cat	18 07	10 11	7 06	2 05		
Drift	Cabot J. Morse	Hull	"	22 00	19 00		
Edith	Fred M. Wood	Marblehead	"	21 07	18 05	8 10	1 10		
Exile	J. F. Small	Boston	Sloop	30 00	20 06	11 01	1 05		
Frolic	Samuel J. Brown	Marblehead	Cat	22 00	20 08		
Gaddy	A. Hemenway	Boston	J. and M.	25 06	20 10	10 06	1 03		
Gripp	A. B. Partelow	Marblehead	Sloop	24 09	20 06	10 00		
Hagedorn	C. V. Souther	Boston	Sprit	18 00	17 10	0 04	1 05		
Imogen	M. R. Wendel, Jr.	"	Cat	21 06	19 10	10 00	2 00		
Josephine	D. H. Follett, Jr.	Marblehead	Sloop	21 00	18 01	8 00		
Koonul	R. C. Robbins	Beverly	Cat	25 00	20 06	10 00	2 04		
Mudge	Wm. H. Thayer	Hull	"	20 04	18 10	9 00	2 02		
Majel	J. P. and C. E. Loud	Boston	"	23 02	20 02	9 03	1 10		
Marjorie	Jos. Sargent, Jr.	Magnolia	Sloop	23 06	19 01	0 06	3 01		
Marvel	H. M. Faxon	Quincy	Cat	19 00	16 05	9 03	1 00		
Nereon	A. P. Loring	Beverly	"	23 02	20 01	9 00	3 02		
Noupareil	F. D. Cochrane	"	"	19 10	16 11	8 00	2 00		
Psyche	P. T. Lowell	Boston	"	20 01	17 10	8 00	1 05		
Smoke	H. L. Rice	Quincy	"	22 02	19 01	10 02		
Sport	D. H. Pierce	Newburyport	J. and M.	30 00	10 09	11 04	1 08		
Teal	C. C. Patterson	Marblehead	"	22 00	17 01	7 04	2 09		
Tom Cat	W. C. Loring	Beverly	Cat	19 05	19 00	10 00	2 02		
Typhoon	John I. Taylor	Marblehead	"	27 00	20 09	9 08	2 03		
Wanda	R. C. Robbins	Swampscott	"	23 07	20 09	8 11	2 11		
Yawata	George H. Stone	Brooklyu	"	22 01	20 04	9 08	2 05		

REAM.	DRAFT.
ft. in.	ft. in.
.....	2 00
8 05	1 06
9 00
7 06	2 06
.....
8 10	1 10
11 01	1 06
.....
10 06	1 03
10 00
0 04	1 06
10 00	2 06
8 00
10 00	2 04
0 00	2 02
0 03	1 10
0 06	3 06
0 03	1 00
0 00	3 02
8 00	2 00
8 00	1 05
10 02
11 04	1 08
7 04	2 09
10 00	2 02
0 08	2 03
8 11	2 11
0 08	2 05

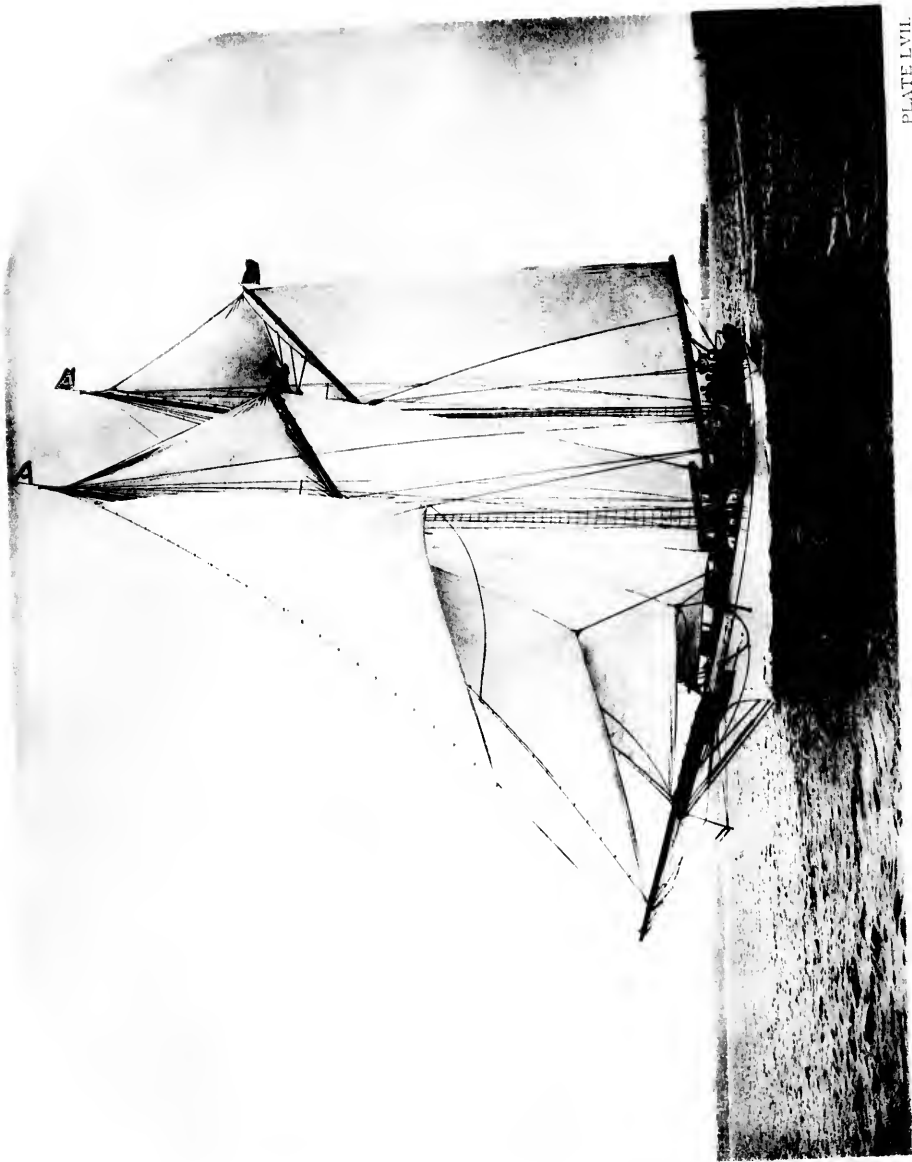

PLATE LVII.

WATER WITCH.

PLATE LVIII.

WATER WITCH.

THE WATER WITCH AND VARIOUS KINDS OF WITCHES

Faint, illegible text at the top of the page, likely a title or introductory paragraph.



Faint text block located below the first boat illustration, possibly a caption or description.



Faint text at the bottom of the page, likely a concluding note or a detailed caption.



Y
as f
C
C
A
tho
elig
C
C

n
b
w
r
n
a

ACCORDING TO RACING RULES.

Yachts shall be divided into classes according to waterline length as follows:

Class 1.—Yachts 25 feet and less than 30 feet.

Class 2.—Yachts 21 feet and less than 25 feet.

Any yacht enrolled in the club list January 8, 1890, exceeding the upper limit of the second class by not more than a foot, shall be eligible to sail in the second class until sold out of the club.

Class 3.—Keel yachts 16 feet and less than 21 feet.

Class 4.—Centerboard yachts 16 feet and less than 21 feet.

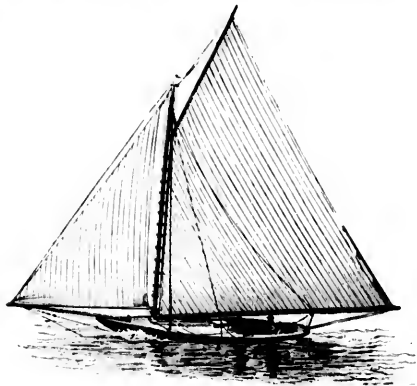

FREAK.—FIGURE 450.

If a yacht has no competitor in her own class, she may enter at her usual rating the class of the next lower number in which there may be a starting yacht.

The waterline length shall be taken from point of immersion forward, to point of immersion aft. In cases where any portion of the rudder or rudder-post projects above the water, such portion shall not be included in the waterline length.

The crew need not be aboard, but if aboard must be stationed amidships.

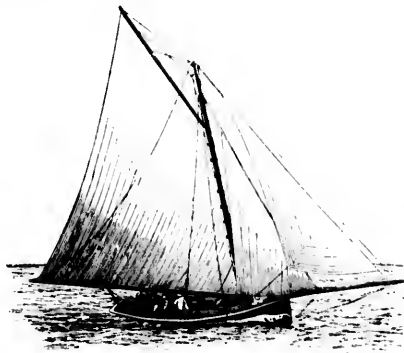

NIXIE.—FIGURE 451.

The sail area is to be ascertained by taking a perpendicular along the after side of the main mast, from the under side of gaff topsail block or sheave on topmast, to the upper side of boom, when resting on the saddle, or on the lowest part of goose-neck; the distance of

which point from the main deck or house deck is to be recorded by the Measurer, together with the other points used in measurement. In all yachts, the forward point of measurement of the base line shall be midway between the intersection of the bowsprit and jib topsail stay, and the center of the tack cringle of the jib or flying jib, when set. In all cases where the extreme length of the spinnaker boom exceeds the distance from the forward side of the forward mast to the forward point of measurement, such excess shall be added to the base line. The after point of measurement shall be the end of the main boom in schooners, cutters and sloops, and of the mizzen boom in yawls. The main topmast shall be measured from the hounds of the lower mast to the lower side of the topsail halliard block or sheave, and eighty per cent. of this length shall be taken from the extreme length of the main gaff measured from the inside of the jaws, to the after end, the remainder of the gaff being added to the base line, as measured above. The area from these figures is obtained by multiplying the corrected base by the perpendicular, and dividing by two. To the square root of the area, as ascertained, add the waterline length, and divide the product by two. The result is the measurement for time allowance.

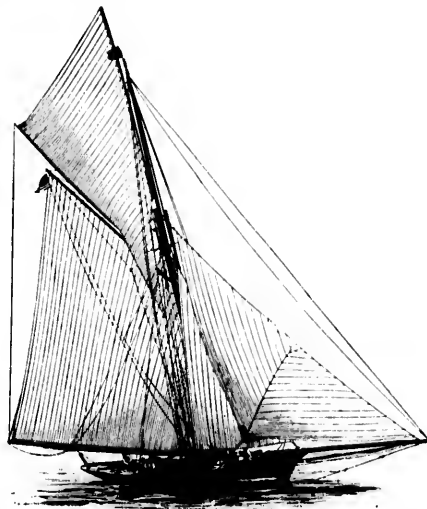

TOMAHAWK.—FIGURE 452.

In measuring boats without topmasts, the perpendicular is to be measured to the highest point of attachment of the uppermost halliard block on the mast, and in such boats the point of attachment of the throat halliard block shall be the point of measurement, corresponding to the hounds. In measuring boats without head sails, the after side of the forward mast is to be taken as the forward point of the base line.

No change of spars shall be made on the day of the race, except in case of accident, in which case notice of the change shall be given to the Regatta Committee before the preparatory signal, and the new spars shall be of the same length as those for which they are substituted.

The Measurer, at the time of making his measurement, shall make a distinctive mark at each end of the waterline.

Allowances shall be figured according to the tables prepared by N. G. Herreshoff.

For yachts in first and second classes there shall be no restrictions

in regard to sails, except that when a spinnaker is carried the pole must be set on the mast.

Yachts in the third and fourth classes shall be restricted to working sails, as follows:

For sloops and cutters: Jib, forestaysail and mainsail.

For schooners: Mainsail, foresail, forestaysail and jib.

For cats: Mainsail only.

In all races the wheel or tiller of each yacht shall be held only by an amateur who must be a member of this club or a member of the club from which the yacht is entered.

Yachts in the first class may carry six men; yachts in the second class, five men; yachts in the third and fourth classes, four men. No one shall join or leave a yacht after the start, except in case of an accident, or an injury to some person on board. None but amateurs shall be allowed on board any yacht when contending for prizes, except that yachts in the first class may carry two paid men, and in the other classes one paid man.

An amateur, for the purposes of this rule, shall be defined to be one who has never received money, or equivalent compensation, for sailing or assisting to sail a boat since this club was organized.

No water shall be started from or taken into the tanks after the signal to start has been made. No more than the usual anchors and chains shall be carried during a race, which must not be used as shifting ballast, or for altering the trim of the yacht. No ballast

All starts shall be flying. If any part of a yacht be on or across the line when the signal for her class to start is given, she must return and re-cross, keeping clear of all competing yachts.

Yachts may anchor during a race but must weigh anchor again on starting.

No means of propulsion, except sails, shall be allowed.

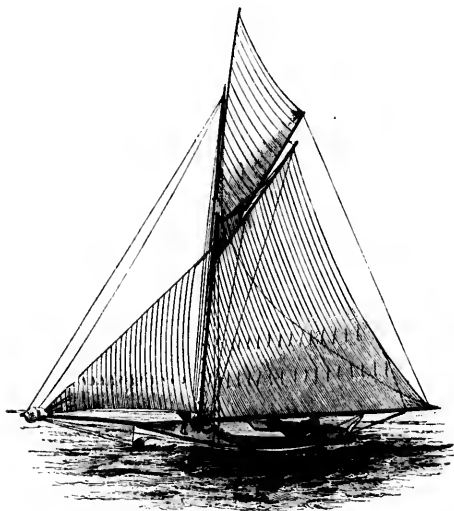

TREDTTE.—FIGURE 453.

shall be shipped or unshipped on the day of the race in either the first or second classes. Shifting ballast shall not be allowed in any race governed by the rules of this club, under penalty of the boat and the owner of the boat, and any other boat belonging to him, being debarred from further entry or participation in a race given by this club.

Yachts of the first and second classes must carry two, and yachts of the smaller classes one serviceable life buoy within easy reach of the helmsman.

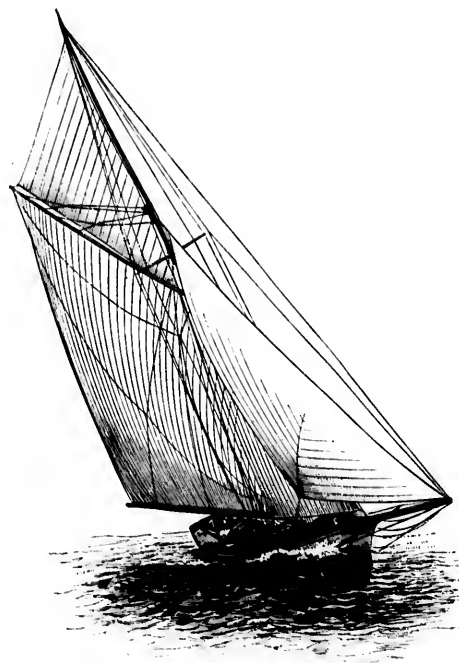

VENTURA.—FIGURE 454.

COURSES.

Course A. From starting line, leaving Spindle on Tom Moore's, Tinker's Island and Bell Buoy (off Pig Rocks) on starboard, Graves' Whistling Buoy and EASTERN YACHT CLUB, turning buoy on port, to finish line. Distance 24 miles.

Course B. From starting line, the reverse of Course A, leaving all marks on the opposite hand, to finish line. Distance 24 miles.

Course 1. From judges' line, leaving Black Buoys 3 and 1 on starboard, Cat Island on port, Half-way Rock and Bell Buoy on the outer breaker off Pig Rocks on starboard; Tinker's Island, Tom Moore's Rocks and Buoys 1 and 3 on port, to judges' line. Distance 10 miles.

Course 2. Reverse of Course 1.

Course 3. From judges' line, leaving Buoy 3, Mid-Channel Rock Buoy 4 (W. S. W. Eagle Island), Half-way Rock and Bell Buoy on the outer breaker off Pig Rocks on starboard; Tinker's Island, Tom Moore's Rocks and Buoys 1 and 3 on port, to judges' line. Distance 11 miles.

Course 4. Reverse of course 3.

Course 5. From judges' line, leaving Buoy 3 on starboard, Cat

Island Rock on port, buoy on Gooseberry Ledge on port, Bowditch Ledge Beacon on port, buoy on Eagle Bar on port, to judges' line. Distance $6\frac{1}{2}$ miles.

Course 6. Reverse of Course 5.

Course 7. From judges' line, leaving Buoy 3, Mid-Channel Rock Buoy 4 (W. S. W. of Eagle Island), Half-way Rock and Cat Island on starboard. Buoys 1 and 3 on port to judges' line. Distance $6\frac{1}{2}$ miles.

Course 8. Reverse of Course 7.

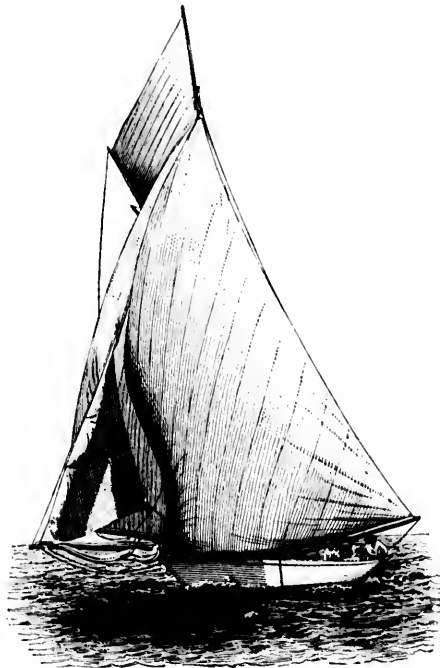

SALADIN.—FIGURE 455.

RECORD OF RACES.

August 1, 1885:

	Length Ft. In.	Actual Time.	Corrected Time.
		H. M. S.	H. M. S.
Engenin	25 06	2 04 20	1 31 08
Witch	22 10	2 08 22	1 33 47
Expert	23 03	2 08 56	1 34 51

CENTERBOARDS.

Second Class.			
Dash	20 01	1 26 09	1 05 06
Psyche	17 06	1 35 01	1 11 43
Tulip		withdrew	

KEELS.

Second Class.			
Unique	10 10	1 20 30	1 08 18
Vera	10 09	1 38 42	1 17 25
Mona	18 10	1 44 27	1 22 20
Caprice	17 10	1 48 59	1 25 58

SECOND CHAMPION.

August 12, 1885:

	Racing Length, Ft. In.	Actual Time, H. M. S.	Corrected Time, H. M. S.
Expert	23 03	2 18 55	1 23 20
Ralph	28 10	2 31 44	2 05 20

KEELS.

First Class.			
Witch	22 10	2 12 15	1 37 40
Kolus	28 03	2 24 38	1 55 50
Fal	21 11	2 38 00	2 02 15

CENTERBOARDS.

Second Class.			
Psyche	17 06	1 20 42	1 06 22
Dash	20 01	1 28 33	1 07 29

KEELS.

Second Class.			
Wraith	18 08	1 28 07	1 05 56
Unique	10 10	1 31 00	1 12 45

THIRD CHAMPIONSHIP.

KEELS.

August 22, 1885.

First Class.			
Witch	22 10	2 10 50	1 42 22
Thelga	22 01	withdrew	

CENTERBOARDS.

First Class.			
Expert	23 03	2 17 49	1 43 44
Engenin	25 05	2 18 11	1 46 34
Ralph	28 10	withdrew	

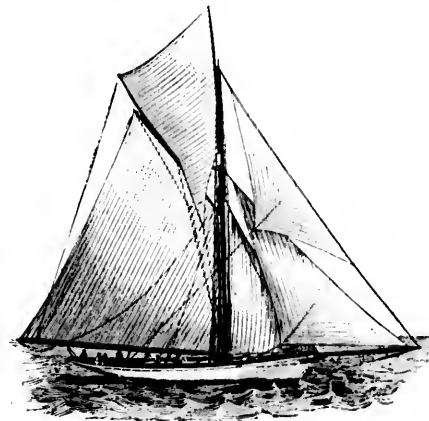

THELMA.—FIGURE 456.

Second class, keels.

Wraith	18 08	1 21 10	1 02 05
Carmith	20 11	1 25 58	1 05 33
Vera	19 09	1 30 28	1 09 08
Unique	19 10	1 31 50	1 10 25
Mona	18 10	1 32 57	1 10 50

Second class, centerboards.

Niobe (Prot)	20 02	1 18 05	57 05
Delphine	20 10	1 21 32	1 01 15
Dash	20 01	1 22 36	1 01 32
Psyche	17 06	1 26 45	1 01 25

HISTORY OF THE CORINTHIAN YACHT CLUB

Championship Sail Off, September 2, 1885.

	Racing Length. Ft. In.	Actual Time. H. M. S.	Corrected Time. H. M. S.
Second Class, centerboards.			
Dash	20 01	1 14 53	1 09 40
Delphine	20 10	1 17 03	1 11 34
Fall Matches, September 12, 1885.			
First Class, centerboards.			
Atlanta	28 08	1 45 13	1 44 03
Leona	27 07	1 50 20	1 54 09
First Class, keels.			
Bessie	28 00	1 53 04	1 51 44
Mavis	27 01	2 16 24	2 13 54
Aeolus	28 03	withdrew	

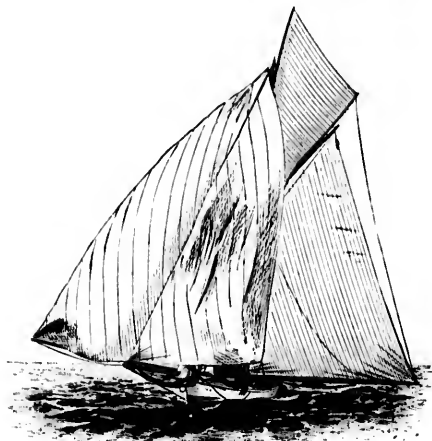

GOSSOON.—FIGURE 457.

Second Class, centerboards.			
Expert	23 03	2 05 45	1 58 54
Second Class, keels.			
Thelga	22 01	1 50 52	1 51 53
Witch	23 10	disabled	
Third Class, centerboards.			
Joker	20 03	1 03 53	57 56
Peri	19 00	1 05 21	58 23
Dash	20 01	1 04 51	58 44
Comus	19 01	1 05 36	58 41
Helen	18 06	1 11 00	1 03 40
Third Class, keels.			
Carmita	20 11	1 00 25	1 01 59
Vera	19 09	1 11 16	1 04 55
Mona	18 10	1 13 26	1 00 18
Alma	16 00	1 26 30	1 16 35

CLUB CHAMPIONS.

1885:	First Class, k.	WITCH.
	First " c.b.	EXPERT.
	Second " k.	WRAITH.
	Second " c.b.	DASH.
1886:	First Class,	ATLANTA.
	Second "	LONETTE.
	Third "	VERA.
1887:	First Class, k.	TRUDETTE.
	First " c.b.	ATLANTA.

CLUB CHAMPIONS.

	Second Class k.	WITCH.
	Second " c.b.	EXPERT.
	Third " k.	VERA.
	Third " c.b.	BANSHEE.
1888:	First Class, k.	SAMSEN.
	First " c.b.	ATLANTA.
	Second " k.	SWORDFISH.
	Second " c.b.	SPRIT.
	Third " k.	MOSCA.
	Third " c.b.	MYRTLE.
1889:	First Class,	SAMSEN.
	Second "	MOONDYNE.
	Third "	SWORDFISH.
	Fourth "	MYRTLE.
	Fifth "	MOSCA.
	Sixth "	JOSEPHINE.
1890:	First Class,	SALADIN.
	Second "	SUSIE.
	Third "	WANDA.
	Fourth "	HONNET.
	Fifth "	JOSEPHINE.

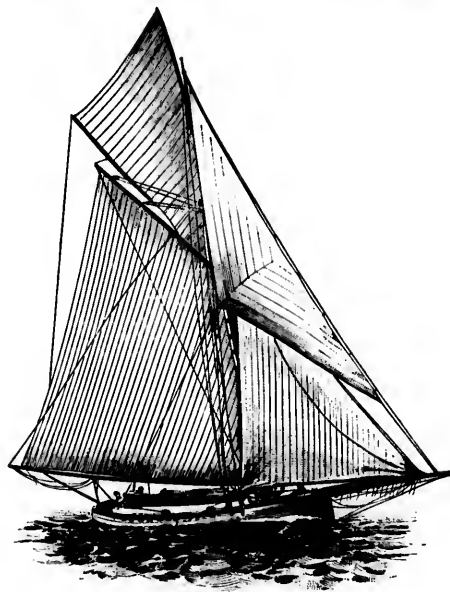

CLYTIE.—FIGURE 458.

1891:	First Class,	MILDRED.
	Second "	SUSIE.
	Third "	HONNET.
	Fourth "	MADGE.
1892:	First Class,	HAWK.
	Second "	SUSIE.

	CLUB CHAMPIONS.	FREAK.
Third Class.		KOONBALL.
Fourth " "		
	MIDSUMMER SERIES.	
1889—Cups won by	MINERVA, SARACEN, MIGNON and SWORDFISH.	
1890—Cups " "	MINERVA and SALADIN.	
1891—Cup " "	BEATRIX.	
1892—Cup " "	REAPER.	



BRENDA.—FIGURE 459.

The Forty-Eighth Regatta, Sweepstakes Race, of the CORINTHIAN YACHT CLUB of Marblehead, was sailed June 20, 1891. The course for first class was 10 miles, for third and fourth classes 6½ miles. The weather was cloudy, the sea smooth, and there was a light, easterly breeze. The following yachts started:

	Sailing Length, Feet.	Elapsed Time, H. M. S.	Corrected Time, H. M. S.
First Class.			
Hawk	36.5	2 53 30	2 53 07
Fancy	35.8	3 00 22	2 59 30
Saladin	36.1	3 11 44	3 11 44
Third Class.			
Kraken	25.6	1 48 50	1 48 50
Fourth Class.			
Wanda	22.6	1 43 45	1 41 17
Josephine		1 53 05	

HAWK, KRAKEN and WANDA won in their respective classes.

The Forty-Ninth Regatta, Sweepstakes Race, was sailed over a 24 mile course, July 1, 1891. The sea was smooth and there was a fresh breeze from the south southeast. The following yachts started:

Oweene	54.4	4 00 50	3 58 51
Alborak	55.7	4 13 47	4 13 47
Gossoon		4 28 39	4 19 35

The Fiftieth Regatta, Sweepstakes Race, was sailed over a 24 mile course, July 23, 1891. The weather was fine, the sea moderate, and there was a fresh breeze from the south southeast.

Beatrix	53.5	3 20 30	3 19 36
Oweene	54.4	3 23 54	3 23 54
Sayonara	54.4	3 24 43	3 24 43
Barbara	53.4	3 30 02	3 28 59
Gossoon		disabled	

BEATRIX won, beating OWEENE 4 min., 28 sec.

The Fifty-First Regatta was sailed July 25, 1891. The course for the first and second classes was 10 miles, for the third and fourth classes 6½ miles. The weather was cloudy with rain squalls, the sea calm, and the wind was very variable from southeast to south. The following yachts took part:

	Sailing Length, Feet.	Elapsed Time, H. M. S.	Corrected Time, H. M. S.
First Class.			
Saladin	36.1	2 02 35	2 02 35
Mildred	36.0	2 05 04	2 05 04
Second Class.			
Ione		2 18 46	2 18 46
Susie	28.4	2 30 30	2 26 13
Aleyone	29.8	did not finish	
Third Class.			
Hornet	25.5	1 49 43	1 49 40
Kraken	25.6	1 50 41	1 50 41
Fourth Class.			
Madge	22.2	1 40 43	1 36 50
Memento	26.1	1 48 21	1 48 21
Wanda	22.6	1 52 24	1 49 41
Delphine	23.0	1 53 42	1 52 27

SALADIN, IONE, HORNET and MADGE won in their respective classes.

The Fifty-Second Regatta was sailed August 8, 1891. The course for first, second and cruising classes was 10 miles, for third and fourth classes 6½ miles. The sea was calm and the wind light from the eastward. The following yachts participated:



CALYPSO.—FIGURE 460.

First Class.			
Hawk	36.5	2 13 05	2 12 42
Saladin	36.1	2 13 30	2 13 30
Mildred	36.0	2 14 50	2 14 41
Mignon	35.8	2 19 40	2 18 46
Second Class.			
Ione		2 44 25	2 44 25
Susie	28.6	3 03 20	2 50 21
Cruising Class.			
Veto		3 19 40	3 19 40
Gretchen		3 45 30	3 39 30
Triad		3 53 00	3 33 00
Kelpie		3 52 00	3 37 00
Third Class.			
Hornet	25.5	2 20 00	2 19 50

Fourth Class.	Sailing Length.	Elapsed Time.	Corrected Time.
Name.	Feet.	U. S. S.	U. S. S.
Madge	22.2	2 18 30	2 15 31
Memento	26.1	2 19 00	2 17 00
Wanda	22.0	2 31 35	2 29 08

The winners were HAWK, IONE, VETO, HORNET and MADGE in their respective classes.

The Fifty-Third Regatta was sailed August 22, 1891. The course for first, second and cruising classes was 10 miles; for third and fourth classes 6½ miles. The wind was moderate from the south-east.

First Class.	Sailing Length.	Elapsed Time.	Corrected Time.
Mildred	30.0	2 13 30	2 13 20
Saladin	37.0	2 20 25	2 20 25
Second Class.			
Susie	28.6	3 21 10	3 11 56
Ione		3 41 10	3 35 52
Moodyne		3 44 13	
Aleyone	29.8	3 45 00	3 36 55
Cruising Class.			
Triad		3 43 18	3 10 18
Countess		3 33 58	3 24 58
Lorita		3 48 25	3 28 25
Gretchen		3 44 00	3 29 00
White Wing		3 38 43	3 38 43
Third Class.			
Hornet	25.5	1 38 30	1 38 26
Kraken	25.6	1 44 10	1 44 10
Fourth Class.			
Madge	22.2	1 41 50	1 38 50
Memento	26.1	1 45 25	1 45 25
Tom Cat	24.1	1 48 25	1 47 00
Wanda	22.0	1 59 30	1 57 02
Nerena	21.7	2 09 00	2 05 34
Delphine	23.0	2 25 00	2 22 45

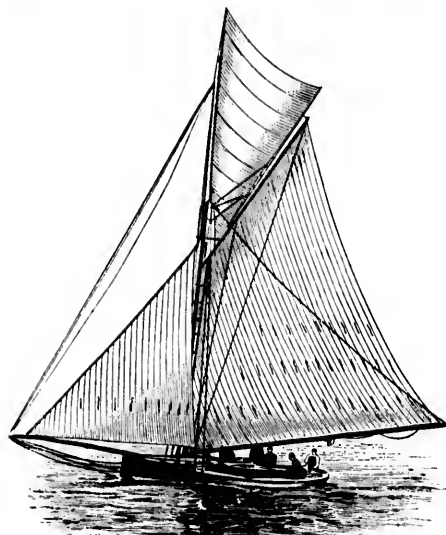

IONE.—FIGURE 461.

The winners were MILDRED, SUSIE, TRIAD, HORNET and MADGE in their respective classes.

The Fifty-Fourth Regatta was sailed over a 24 mile triangular

course. The weather was rainy, cold and foggy, the sea smooth, and the wind light from the southeast. The following yachts started:

Name.	Sailing Length.	Elapsed Time.	Corrected Time.
	Feet.	U. S. S.	U. S. S.
Barbara	53.4	4 10 02	4 08 30
Oweene	54.4	4 40 53	4 08 24
Beatrix	53.5	4 16 52	4 13 21
Alborak	55.7	4 19 17	4 18 19
Mineola	51.3	4 21 51	4 19 22

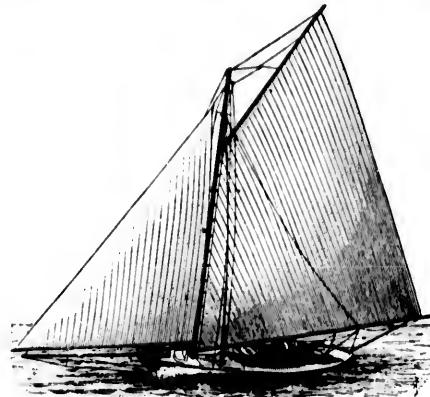

CATSPAW.—FIGURE 462.

BARBARA won, beating OWEENE 1 min., 54 sec.

The Fifty-fifth Regatta Midsummer Series was sailed over a 24 mile triangular course August 28, 1891. The weather was rainy and squally, there was a heavy swell and the wind was southwest to south-east.

Beatrix	53.5	3 41 01	3 39 31
Oweene	54.4	3 43 09	3 41 38
Alborak	55.7	3 47 12	3 47 12
Mineola	51.3	disabled	
Barbara	53.4	disabled	

BEATRIX won, beating OWEENE 2 min., 7 sec.

The Fifty-sixth Regatta Midsummer Series was sailed over a 24 mile triangular course, August 27, 1891. The weather was clear and the wind was strong and puffy from the northwest. The following yachts started:

Beatrix	53.5	3 33 03	3 32 03
Alborak	55.7	3 44 34	3 44 34
Oweene	54.4	3 45 55	3 44 54
Barbara	53.4	3 48 16	3 40 12
Mineola	51.3	3 48 55	3 47 54

BEATRIX won and received the cup given for the series.

The Fifty-seventh Regatta was sailed September 7, 1891. The course, for first, second and special classes was 10 miles, for third and fourth classes 6½ miles. The weather was rainy and foggy and the wind strong from the northeast. The following yachts participated:

First Class.	Sailing Length.	Elapsed Time.	Corrected Time.
Mildred	30.0	1 31 55	1 31 46
Mignon	35.8	1 36 12	1 35 20
Saladin	36.1	1 37 03	1 37 03
Fancy	35.9	1 40 04	1 39 12
Hawk	30.5	withdrew	
Second Class.			
Susie	28.6	2 11 40	2 07 44
Ione		2 08 41	2 08 41

smooth, and
is started:
Corrected
Time.
H. M. S.
4 00 30
4 08 21
4 13 21
4 18 19
4 19 22

Third Class.	Sailing Length, Feet.	Elapsed Time, H. M. S.	Corrected Time, H. M. S.
Name. Mosca		1 25 00	1 25 00
Special Class.			
Babou		1 30 59	1 34 11
Tonahawk		1 30 10	1 30 16

MILDRED, SUSIE, MOSCA and BABOU won in their respective classes.

The Fifty-eighth Regatta was sailed over a 10 mile course, for a Sail Off on September 12, 1891. The wind was fresh from the south-east.

First Class.	Sailing Length, Feet.	Elapsed Time, H. M. S.	Corrected Time, H. M. S.
Mildred	30.7	1 53 10	1 51 50
Hawk	30.5	1 57 30	1 50 04
Second Class.			
Susie	28.6	2 20 15	2 23 19
Tom		2 27 17	2 27 17

MILDRED and SUSIE won.

The following yachts won Club Championship.

First Class, MILDRED; Second class, SUSIE; Third Class, HORNET; Fourth class, MADGE.

Regatta Committee: G. C. Adams, chairman; G. A. Stewart, Secretary; W. P. Fowle; W. W. Keith; G. W. Mansfield.

THE SEASON OF 1892.

The Fifty-ninth Regatta of the CORINTHIAN YACHT CLUB of Marblehead, for the 21-footers, both jib and mainsail and cats, in two classes, was sailed on June 18, 1892, off Marblehead in a light and variable east wind, the course being from off the Club House around the Bell Buoy off the Pigs, around Halfway Rock and home, 10 miles. Nine new boats and one old one started in the sloop class at 2:05 and



COUNTESS.—FIGURE 463.

five boats in the cat class at 2:10. There was a little roll to the sea through the race, the wind being very pultry and uneven. The first mark was timed unofficially:

Alpha	2 40 50
Vanessa	2 42 25
Catspaw	2 43 30
Exile	2 44 25
Reaper	2 44 30
Thrush	2 44 33
Sirocco	2 46 15
Gadfly	2 47 10

The second mark was timed:

Name.	Sailing Length, Feet.	Elapsed Time, H. M. S.	Corrected Time, H. M. S.
Alpha		4 00 30	4 00 30
Vanessa		4 02 45	4 02 45
Catspaw		4 04 45	4 04 45
Reaper		4 07 25	4 07 25
Exile		4 13 15	4 13 15
Sirocco		4 15 10	4 15 10
Gadfly		4 31 10	4 31 10
Thrush		4 27 20	4 27 20



MOONSHINE.—FIGURE 461.

The full lines were:

Class A, 21-footers.

Alpha	23.05	2 45 35	2 42 12
Vanessa	21.03	2 49 15	2 17 50
Catspaw	20.06	2 50 35	2 50 35
Reaper	24.03	2 55 30	2 53 05
Exile		2 59 15	not meas.
Sirocco	20.06	3 07 25	3 07 25
Gadfly	25.01	3 14 30	3 13 18
Thrush		3 22 15	not meas.
Astraco	21.05		did not finish
Forlorn Hope			did not finish
Mocking Bird			did not finish

CATS.

Class B, 21 foot.

Maggie	22.04	3 22 25	
Koorali		3 30 00	not meas.
Madge	22.09		disabled
Arab	21.08		withdrew
Dolphine			withdrew

ALPHA won in Class A, and MAGGIE in Class B.

Class A.—Sloops and cutter-rigged yachts not over 21 feet waterline. Prizes; first, \$30; second, \$20; third, \$15; fourth, \$10; fifth, \$5. Class B.—Cat-rigged yachts not over 21 foot waterline. Prizes, first, \$25; second, \$15; third, \$10; fourth, \$5.

Regatta Committee: W. P. Fowle, Chairman; G. W. Mansfield, Secretary; John B. Paine, Everett Paine and Henry Taggard.

The Sixtieth Regatta of the CORINTHIAN YACHT CLUB, was sailed over club courses off Marblehead, July 4, 1892, the wind being very

ed over a 24
was rainy and
rest to south-

3 39 31
3 41 58
3 47 19
ed
ed

ed over a 24
was clear and
the following

3 32 02
3 44 34
3 44 54
3 46 12
3 47 54

1891. The
for third and
ggy and the
participated:

1 31 40
1 35 20
1 37 03
1 39 12
ew

3 07 44
3 08 41

strong from northwest, all of the small numbers of starters being reefed down. In the third class the new Paine fin-keel FREAK sailed her first race, but withdrew after picking up a lobster pot on her fin, a similar mishap befalling REAPER. The official times were.

	Length feet.	Elapsed Time. H. M. S.	Corrected Time. H. M. S.
Third Class.			
Reaper	24.3	1 47 58	
Sirocco	20.6	1 52 41	
Koorali		1 38 50	
Freak		did not finish	
Special Class A.			
Modoc		1 38 09	
Special Class B.			
Carl		1 21 55	1 21 55
Bob		1 32 50	1 33 50
Janet		1 37 20	1 34 20
Nancy		1 39 01	1 36 00
Sculpin		1 54 50	1 40 50
Voga		disabled	

REAPER, MODOC and CARL won in their respective classes.

The race of the CORINTHIAN YACHT CLUB on Saturday, July 20th, fared even worse than the two preceding ones, the wind falling and allowing none of the fleet to finish. The race was open to the 21 foot



ANETO.—FIGURE 405.

class and the 25-footers. PYXIE alone representing the latter. The race was finally postponed to Tuesday.

The Sixty-first Regatta of the CORINTHIAN YACHT CLUB of Marblehead was sailed on Saturday, July 23, 1892, in a light southwest wind, there being a good lot of starters, the principal ones being FREAK, PAINE fin-keel, REAPER, HERRESHOFF fin-keel, and SIROCCO, the Stewart and Binney cutter. TADPOLE was too late at the line to start in the race. The times were:

	Length feet.	Elapsed Time. H. M. S.	Corrected Time. H. M. S.
First Class.			
Hawk		2 01 45	2 01 45
Second Class.			
Susie		2 15 45	2 13 48
Yone		2 14 40	2 14 40

	Sail Length Feet.	Elapsed Time. H. M. S.	Corrected Time. H. M. S.
Third Class.			
Freak	25.08	2 09 05	2 08 14
Reaper	24.01	2 12 23	2 00 58
Sirocco	20.00	2 16 43	2 16 43
Fourth Class.			
Typhoon		1 33 25	
Koorali		1 41 00	
Class A.			
Countess		1 34 00	1 34 00
Cat Bird	20 00	2 01 35	1 41 35
Class B.			
Bob	18 00	1 59 05	1 41 05
Nancy	14 00	1 55 40	1 41 40
Jane	13 00	1 56 30	1 42 30
Josephine	3 00	1 52 06	1 40 00
Edith		1 50 50	1 50 50
Voga	6 00	1 50 15	53 15

HAWK sailed over. SUSIE, FREAK and TYPHOON each won first prizes of \$10; COUNTESS won \$15; BOB won \$10 and NANCY \$7.

TYPHOON is also a Stewart and Binney boat. The judges were Messrs. Appleton and Jones.

The Sixty-second Regatta of the CORINTHIAN YACHT CLUB of Saturday, July 30, 1892, postponed for want of wind, was re-sailed, at 2:10 P. M. The course for the 21 foot and 25 foot classes was around Pig Rocks and Half Way Rock. The wind was east northeast. After beating out of the harbor the yachts ran for Pig Rocks, where the order was VANESSA, THRUSH, REAPER, FREAK, CATSPAW and PYXIE.

After the beat to Half Way Rock the times were:

Reaper	4 06 10
Freak	4 07 30
Thrush	4 08 45
Catspaw	4 09 05
Vanessa	4 09 40
Pyxie	not timed

REAPER held her lead off the wind and won, while VANESSA was second on allowance. In the cat class there were three starters, TYPHOON, KOORALI and MAGPIE, the former leading all the way. The times were:

	Length Feet.	Elapsed Time. H. M. S.	Corrected Time. H. M. S.
Class A.			
Reaper	24.00	2 34 15	2 30 53
Vanessa	24.00	2 39 52	2 36 30
Catspaw	20.04	2 37 50	2 37 00
Freak	25.10	2 38 43	2 37 23
Thrush	27.02	2 38 03	2 38 03
Pyxie	24.11	2 50 20	2 57 01
Class B.			
Typhoon	23.09	1 40 42	1 40 42
Magpie	22.04	1 44 14	1 43 06
Koorali	23.01	1 44 38	1 43 07

REAPER won \$30, VANESSA \$20, CATSPAW \$15, FREAK \$10, THRUSH \$5, TYPHOON \$25, and MAGPIE \$15.

The Sixty-third Regatta of the CORINTHIAN YACHT CLUB, was sailed on August 13, 1892, in a light south southeast wind, the times being:

	Handicap. M.	Elapsed Time. H. M. S.	Corrected Time. H. M. S.
Special Class.			
Jane	15	2 42 10	2 27 10
Bob	20	2 47 22	2 27 22
Bath Bun	20	2 51 06	2 31 06
Nancy	15	2 48 42	2 33 42
Kraken		2 34 57	2 34 57
Thais	20	2 55 26	2 35 26
Oimara	15	2 50 28	2 35 28
Edith	5	2 42 20	2 37 20
Shingle	30	3 08 45	2 38 45

ad Corrected
Time.
H.M.S.

5 2 08 14
3 2 09 58
3 2 10 43

1 34 00
1 41 35

1 41 05
1 41 40
1 42 30
1 49 06
1 50 50
53 15

each won first
NANCY #7.
the judges were

YACHT CLUB of
, was re-sailed,
oot classes was
east northeast.
g Rocks, where
AK, CATSPA

4 06 10
4 07 30
4 08 45
4 09 05
4 09 40
not timed

VANESSA was
three starters.
g all the way.

2 30 33
2 36 30
2 37 00
2 37 23
2 38 03
2 57 01

1 40 42
1 43 06
1 43 07

K #10, THRUSH

IT CLUB, was
ind, the times

2 27 10
2 27 22
2 31 06
2 33 42
2 34 57
2 35 20
2 35 28
2 37 26
2 38 45



PLATE LVIII.

COMET.

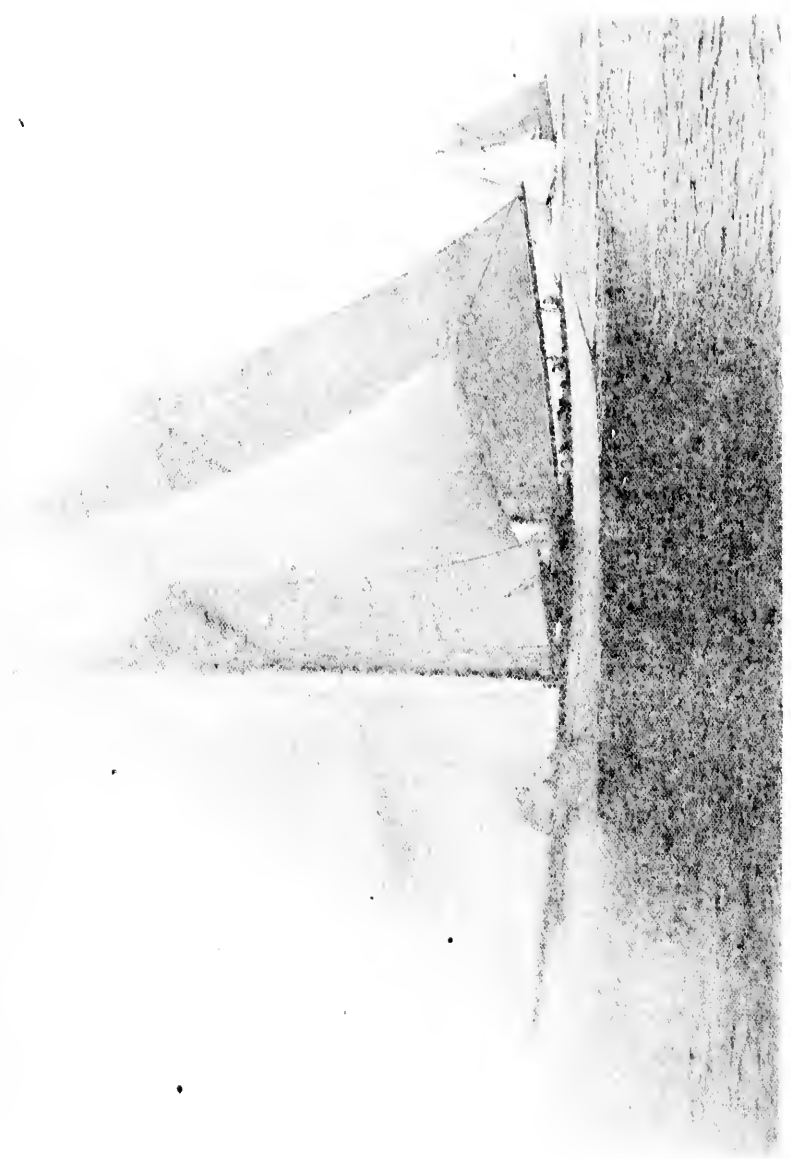

1000

T
S
V
S

T
F
C

THE YACHTS AND YACHTSMEN OF AMERICA.

	Length Feet.	Elapsed Time.		Corrected Time.	
		H. M. S.	H. M. S.	H. M. S.	H. M. S.
Second Class.					
Susie					
Iono		3 07 24			
Third Class.		3 12 22			
Freak					
Reaper		2 46 50	2 46 50		
Fourth Class.		2 57 37	2 57 04		
Koorali					
			no race		

Class B.	Elapsed Time.		Corrected Time.	
	H. M. S.	H. M. S.	H. M. S.	H. M. S.
Bob				
Oimara	1 38 10	1 35 10		
Jane	1 40 10	1 35 10		
Nancy	1 36 41	1 36 41		
Bath Bun	1 37 00	1 27 00		
Krakan	1 45 20	1 29 20		
Tadpole	1 33 58	1 33 58		
		disabled		

SUSIE won in her class. FREAK in hers and KOORALI in hers. ORINDA led the cruiser class, but KELPIE beat her on handicap. BOB and OIMARA tied in the smaller class. The judges were Messrs. Daniel Appleton and G. W. Mansfield.

KOORALI did not finish within the time limit.
JANE and FREAK won in their respective classes.
Midsummer Series for 21-footers. First Race, August 18th. Course No. 3, distance 11 miles; weather moderate, fair, wind southeast.

Catspaw	26.04	1 53 20	1 59 25
Tadpole	25.05	disabled	
Vanessa	24.00	1 55 13	1 51 50
Koorali	23.04	withdrew	
Reaper	24.00	1 52 29	1 49 47
Exile	26.06	1 50 58	1 50 08
Freak	25.10	1 52 39	1 51 11
Sirocco	20.05	2 05 14	2 04 25
Typhoon	23.09	2 06 46	2 02 45
Thrush	27.02	1 54 32	1 51 32

Winners: Class 1, first prize, REAPER; second prize, EXILE; third prize, FREAK; fourth prize, VANESSA. Judges, Daniel Appleton, Geo. W. Mansfield.

Second Race, August 19th. Course No. 3; distance 11 miles; strong wind, heavy sea, wind southeast.

Freak	1 50 08	1 48 40
Catspaw	2 03 37	2 02 47
Thrush	1 54 57	1 54 57
Vanessa	1 55 12	1 51 50
Exile	1 52 45	1 52 01
Koorali	2 08 51	2 01 17
Reaper	1 52 28	1 48 46
Typhoon		disabled
Tadpole	2 03 10	2 01 12

Winners: Class 1, first prize, FREAK; second prize, REAPER; third prize, VANESSA; fourth prize, EXILE.

Third race, August 20th: Course No. 3; distance 11 miles. weather cloudy, strong sea; wind north northeast, strong.

Sirocco	2 15 17	2 15 12
Freak	2 07 31	2 06 50
Vanessa	2 06 25	2 03 27
Reaper	2 05 12	2 02 14
Exile	2 12 00	2 12 02

Winners: Class 1, first prize, REAPER; second prize, VANESSA; third prize, FREAK; fourth prize, EXILE. In addition to prizes as above, REAPER wins \$100 cup for best two out of three.

The CORINTHIAN YACHT CLUB sailed its Sixty-seventh Regatta, the Third Championship, with a special handicap for cruisers, on Saturday, September 3, 1893, in a strong southeast wind. The times were:

Second Class.		
Susie	2 01 48	1 59 48
Iono	2 38 40	2 38 40
Third Class.		
Freak	1 52 13	1 52 13
Reaper	1 59 23	1 57 00
Fourth Class.		
Koorali	1 30 58	1 30 38
Typhoon		disabled
Class A.		
Kelpie	1 30 40	1 18 40
Orinda	1 26 44	1 26 44
Lorita	1 39 59	1 30 59
Modoo	1 44 40	1 32 40

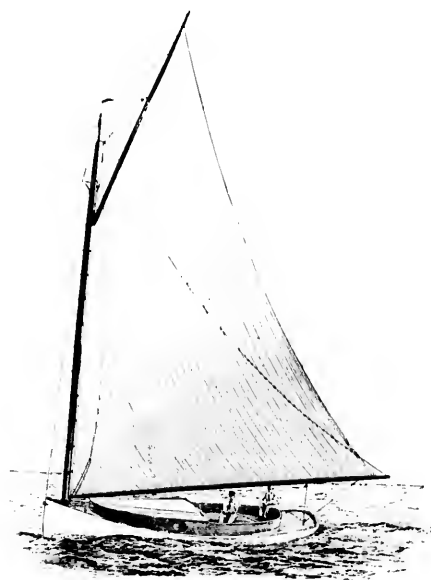

TRIAD.—FIGURE 400.

The Sixty-Eighth Regatta, Labor Day, September 5, 1892, included an Open Race in the morning and a sail for the ladies in the afternoon, with a concert and illumination in the evening. The wind in the morning was light, northwest. The times of the race were:

First Class.		
Hawk	3 27 41	3 27 41
Fancy	3 39 13	3 38 41
Second Class.		
Susie	4 05 14	4 03 09
White Fawn	3 55 01	3 55 01
Ustane	4 07 43	4 01 14
Moodyne		withdrew
Gladys		withdrew
Emma		withdrew
Third Class.		
Exile	3 46 50	3 46 50
Reaper	3 50 51	3 47 53
Freak	3 48 58	3 48 14

Fourth Class.	Elap. Time.		Cor. Time.	
	h. m. s.	h. m. s.	h. m. s.	h. m. s.
Typhoon	1 45 43	1 45 43		
Tom Cat	2 09 01	2 07 53		

CRUISERS.

Class A.				
Orinda	2 09 05	1 59 05		
Countess	1 44 25	1 39 25		
Alyone	2 37 12	2 29 12		
Vandal	2 54 08	2 30 08		
Clytio	2 10 37	2 10 37		
Gypsy	2 37 00	2 13 00		

Class B.				
Mosca	2 30 46	2 17 46		
Josephine	2 46 00	2 27 00		
Oimara	2 48 33	2 22 33		
Nancy	2 48 08	2 30 04		
Bob	2 43 34	2 28 34		
Jano	2 43 41	2 25 41		

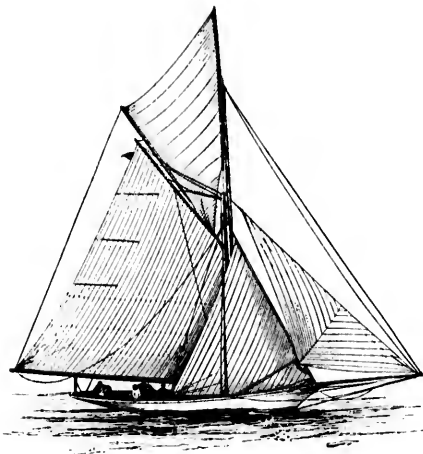

MILDRED.—FIGURE 467.

HAWK, SUSIE, EXILE, COUNTESS, TYPHOON and MOSCA won in their respective classes.

THE SEASON OF 1893.

The Sixty-Ninth Regatta was the opening event of the season and was held June 17th.

It consisted of a handicap race for cruisers and a race for the four knockabout boats, PINTA, NINA JANE and FRANCES, the first pair being just completed for the EASTERN YACHT CLUB by Emmons, of Swampscott, from designs by Waterhouse & Chesebrough. The day was unpleasant, rainy, with a strong northeast wind and a very rough sea, but seven yachts started and sailed a fine race, the two new boats making a dead heat. The 30 foot cruiser class brought out FANCY, Mr. Burgess' last and best 30-footer, RONDINA, his first 30-footer, and the other the little cutter KELPIE. The course was from the judges' line, leaving Black Buoys 3 and 1 on starboard, Cat Island on port, Halfway Rock and Bell Buoy on the outer breakers off Pig Rocks on starboard, Tinker's Island, Tom Moore's Rocks and Black Buoys 1 and 3 on port to judge's line. Distance, 10 miles.

The course for the smaller boats was No. 6, a beat to the Bowditch Ledge Beacon, leaving Eagle Bar Buoy on starboard, thence a reach

to Gooseberry Ledge Buoy, and a run home around the end of Cat Island; 6½ miles.

Neither KELPIE nor RONDINA were ready at the gun, and FANCY waited for a time, the small boats meanwhile, starting, the twins with wholesail and the others with single reefs. NINA and PINTA sailed a close race, finishing exactly together, with JANE some distance astern in third place. FANCY finally started with topmast hoisted, one reef in mainsail, and No. 2 jib. RONDINA was handicapped 2 minutes and KELPIE nearly 4 minutes. Once away FANCY quickly dropped the pair, beating them very badly, though the two made a good race with each other. The full times were:

	Handicap	Elapsed	Corrected
	Time.	Time.	Time.
	m.	h. m. s.	h. m. s.
Class A, 21 to 35 foot waterline.			
Fancy		1 58 30	1 58 30
Kelpie	15	2 35 32	2 20 32
Rondina	07	2 43 18	2 35 18

Class B, 16 to 21 foot waterline.

Nina	1 30 42
Pinta	1 30 42
Jane	1 35 53
Frances	1 36 59

Prizes: FANCY won the first prize, \$25; KELPIE second, \$15. NINA and PINTA, first and second prizes, \$15 and \$10 between them and JANE \$5 as third.

The judges were Geo. W. Mansfield and Dexter H. Follett, Jr.

The Seventieth Regatta was held on July Fourth, 1893, the courses being: For second and third classes from judge's line, leaving Buoy 3, Mid-channel Rocks, Buoy 4, (west southwest Eagle Island), Halfway Rock and Bell Buoy on outer breakers off Pig Rocks on starboard, Tinker's Island, Tom Moore's Rocks and Buoys 1 and 3 on port to finish, 11 miles; and for fourth and special classes from judge's line leaving Buoy 3, Mid-channel Rock and Cat Island on starboard, Buoys 1 and 3 on port to finish, 6½ miles. The following yachts participated:

	Length.	Elapsed	Corrected
	Feet.	Time.	Time.
		h. m. s.	h. m. s.
Second Class.			
Susie	28.00	2 13 33	
Madge		2 16 43	
Third Class.			
Reaper	24.00	2 04 58	2 02 44
Freak	25.10	2 02 16	2 02 16
Fourth Class.			
Koorall	23.04	1 38 53	1 38 33
Madge	22.00	1 45 33	1 44 40
Typhoon	23.00	1 48 15	1 48 16
Class A, special.			
Gladys		1 31 22	1 31 22
Bryhill		1 49 57	1 32 57
Marena		1 40 43	1 32 43
Keewaydin		1 37 04	1 32 04
Iris		1 52 28	1 40 28
Modoc		1 59 51	1 44 51
Class B, special.			
Nina		1 59 58	1 49 58
Carl		1 53 59	1 41 59
Kraken		1 44 45	1 44 45
Betsy		1 55 45	1 47 43
Delphine		1 51 26	1 45 26
Pinta		2 02 28	1 52 28
Frances		2 09 45	1 48 45
Don		2 13 00	1 58 00
Jane		1 55 37	1 47 37
Teal		1 06 08	1 51 08

The winners were: Second Class SUSIE, \$10; Third Class, FREAK,

THE YACHTS AND YACHTSMEN OF AMERICA.

495

the end of Cat

n, and FANCY
the twins with
PINTA sailed a
distance astern
used, one reef in
mutes and KEL-
opped the pair,
good race with

Corrected
Time.
H. M. S.
1 58 30
2 20 32
2 35 18

second, \$15.
between them

Follett, Jr.
33, the courses
leaving Buoy
Island), Half-
Rocks on star-
oys 1 and 3 on
s from judge's
on starboard,
ing yachts par-

Corrected
Time.
H. M. S.

3 02 44
2 02 16

1 38 33
1 44 40
1 48 16

1 31 22
1 32 57
1 33 43
1 32 04
1 40 28
1 44 51

1 40 58
1 41 50
1 44 45
1 47 43
1 45 26
1 52 28
1 48 45
1 58 00
1 47 57
1 51 08

Class, FREAK,

#10; Fourth Class, KOORALI, \$10; Special Class A, GLADYS, \$10, KEEWAYDIN, \$7, and MARENA, \$5; Special Class B, CARL, \$10, KRAKEN, \$7, and DELPHINE, \$5.

The Seventy-first Regatta was sailed July 15th, being the First Championship Race. The wind was strong southwest, with a sea; and all the boats were reefed. The times were:

	Elap. Time.	Cor. Time.
	H. M. S.	H. M. S.
Second Class.		
Susie	2 38 28	2 38 28
Ariel		disabled
Third Class.		
Reaper	2 23 37	2 20 23
Freak	2 23 24	2 23 24
Fourth Class.		
Koorali	1 14 10	1 11 10
Special Class A.		
Kelpie	1 21 31	1 14 31
Keewaydin	1 13 07	1 13 07

CRUISERS.

	Elap. Time.	Cor. Time.
	H. M. S.	H. M. S.
Special Class B.		
Moses	1 29 40	1 29 40
Teal	1 33 30	1 21 30
Edith	1 21 13	1 13 13
Kraken	1 19 00	1 19 00
Bonita	1 17 22	1 10 22

KNOCKABOUTS.

	Elap. Time.	Cor. Time.
	H. M. S.	H. M. S.
Betsy	1 17 52	1 11 52
Nina	1 18 01	1 14 01
Pinta	1 13 38	1 00 38
Susan	1 13 07	1 09 07
Otatsu	1 20 39	1 17 39
Frances	1 18 40	1 12 40
Jane	1 10 55	1 10 55
Bob	1 24 27	1 24 27
Carl	1 15 06	1 15 06

ARIEL parted her peak halliards and withdrew. FREAK parted her jib tack just as she neared the finish line a short distance astern of REAPER. The winners were: Second class, SUSIE, \$10 and a leg in the championship; third class, REAPER, \$10 and a leg; fourth class, KOORALI, \$10 and a leg; Special Class A, KEEWAYDIN, \$15 and a leg; Special Class B, BONITA, \$10 and a leg; EDITH \$7 and KRAKEN \$7.

The Second Championship Race was held July 29th, being sailed in connection with a special invitation race for the 21-footers, which, however, brought out only the two flus, REAPER and FREAK. There was a strong southwest wind in the morning, but by 2 P. M. it had fallen, and reefs were shaken out just after the start. The times were:

	Length	Elap. Time.	Cor. Time.
	Feet.	H. M. S.	H. M. S.
Second Class; 21 to 25 feet waterline, start 2:10.			
Susie	28.00	2 10 15	
Ariel		2 21 33	
Third Class; 16 to 21 feet waterline, keels, start 2:15.			
Freak	25.10	2 03 04	2 03 04
Reaper	24.00	2 06 08	2 04 06
Fourth Class; 16 to 21 feet waterline, start 2:20.			

	Length	Elapsed	Corrected
	feet.	Time.	Time.
		H. M. S.	H. M. S.
Koorali	23.04	1 29 40	
Bonita		1 42 46	
Cruising, Class A, 21 to 35 feet waterline, start 2:21.			
Allowance,			
M. S.			
Keewaydin	8.00	1 20 15	1 12 15
Gladys		1 23 55	1 23 55
Marena	11.00	1 36 39	1 25 30
Cruising Class B, 16 to 21 feet waterline, start 2:30.			
Carl	7.00	1 27 52	1 20 52
Jane	6.00	1 28 15	1 22 15
Otatsu	6.00	1 31 50	1 25 50
Susan		1 28 30	1 28 30
Frances	10.00	1 39 54	1 29 54
Edith	8.00	1 41 02	1 33 02
Betsy	6.00	1 39 32	1 33 32
Nina	8.00	1 42 42	1 34 42
Teal	15.00	2 00 56	1 45 56
Kraken		1 47 04	1 47 04

The winners were: Second class, SUSIE, first prize, \$10; third class, FREAK, first prize, \$25; Class A, KEEWAYDIN, first prize, \$15. Class B, knockabouts: CARL, first prize, \$10; JANE, second prize, \$7; OTATSU, third prize, \$5. Others, EDITH, first prize, \$16; TEAL, second prize, \$7.

KOORALI, cat, wins a leg of the championship; BONITA, jib and mainsail, sailed with her.

The Third Championship Regatta was sailed August 26th, the times being:

	Elap. Time.	Cor. Time.
	H. M. S.	H. M. S.
Second Class.		
Susie	2 07 15	2 07 15
Ariel	2 10 37	2 07 39
Third Class.		
Reaper	2 03 47	2 01 45
Freak	2 06 50	2 06 50
Gigi		withdrew
Fourth Class.		
Madge	1 43 24	1 43 24
Koorali	1 34 30	1 34 28
Special Class A.		
Verena	1 37 19	1 25 19
Hawk	1 26 00	1 26 00
Keewaydin	1 37 01	1 32 01
Special Class B.		
Betsy	2 49 11	2 43 11
Susan	2 42 04	2 41 31
Otatsu	2 24 00	2 21 00
Teal	2 39 57	2 21 57
Frances	3 10 44	3 00 44
Don	2 41 09	2 20 09
Edith	2 44 58	2 13 58
Pinta		withdrew
Jane	2 22 28	2 22 28
Kraken	1 39 04	1 39 04
Nina		withdrew
Carl	2 41 07	2 40 37

The winners were: Second class, SUSIE; third class, REAPER; fourth class, KOORALI; Special Class A., VERENA first, HAWK second; Special Class B., KRAKEN first, Edith second and JANE third.

BIOGRAPHICAL SKETCHES AND DESCRIPTION OF YACHTS ENROLLED IN THE CLUB.

WILLIAM P. FOWLE, Commodore of the **CORINTHIAN YACHT CLUB** (of Marblehead). Commodore Fowle is a lawyer by profession and has won distinction from the able manner in which he has conducted the various prominent cases which have been intrusted to him. One of the greatest honors conferred upon him was his election as Commodore of this club, after the death of the former distinguished yachtsman, the late Benjamin W. Crowninshield, out of respect for whom the club refused to elect a new Commodore until the term of his office had expired. Commodore Fowle is an enthusiastic yachtsman, and during his term of office has done all in his power to advance the best interests of the club. He was the former owner of **SIROCCO**, a description and illustration of which is given in these pages.

SIROCCO.

A keel sloop, formerly owned by William P. Fowle of Boston. Was designed by Stewart & Binney and built by Geo. Lawley & Son Corporation in 1892, being launched in April. She sails with the **CORINTHIAN** (of Marblehead) and **HULL YACHT CLUBS**, hailing from Boston. See Fig. 446.

DIMENSIONS.			
Length over all,	31 feet.	Length load waterline,	20 feet 0 inches.
Draft,	6 feet.	Beam,	8 feet.

WHISTLER.

A centerboard cutter, designed and built by M. Delano at Fair Haven, Mass., and launched in 1870. Her present owner is Alfred M. Blinn of Boston, Mass. She sails with the **BOSTON, MASSACHUSETTS, HULL** and **CORINTHIAN** (of Marblehead) **YACHT CLUBS**. See Fig. 447.

DIMENSIONS.			
Length over all,	35 feet 5 inches.	Length load waterline,	32 feet 2 inches.
Depth,	4 feet 5 inches.	Draft,	4 feet 6 inches.
Beam,	12 feet 11½ inches.		



JOHN LAWTON BUTLER.
CLUBS.

JOHN LAWTON BUTLER, lawyer, Boston, Mass., was born July 10, 1871, in Somerville, Mass. He is the son of John H. Butler and Laura N. Bull. His father has been a member of the lower house of the Legislature for several years, also of the Executive Council, and has held other positions of trust. Mr. Butler has owned two yachts, **POGY** and his present boat, **LORITA**. He has been interested in yachting for three years and is a member of the **HULL, BOSTON** and **CORINTHIAN** (of Marblehead) **YACHT CLUBS**.

LORITA.

This yacht is a centerboard sloop owned by John L. Butler of New York City. She was designed and built by Pierce Bros., and was launched about 1885. She was originally built for John E. Spring, and her present owner has had her for two years. She was altered two years ago from cut to sloop rig. Formerly known as **JULIA**. She has a cabin, hails from Marblehead and sails with the fleets of the **CORINTHIAN** (of Marblehead), **HULL** and **BOSTON YACHT CLUBS**. See Fig. 448.

DIMENSIONS.			
Length over all,	30 feet.	Length load waterline,	26 feet.
Draft,	3 feet.	Beam,	9 feet 0 inches.

FREAK.

A keel sloop, (open) designed by John B. Paine and built by Wm. B. Smith, at South Boston, Mass.; hails from Nahant, Mass. Until

recently owned by Mr. Paime; now the property of Alex. Cochrane. See Fig. 450.

DIMENSIONS.			
Length over all,	30 feet.	Draft,	7 feet 6 inches.
Beam,	7 feet 8 inches.		

Racing Record for 1892:—

BEVERLY YACHT CLUB—187th Race, July 29th; **FREAK** won, beating **ALPHA, CATSPAW, EXILE, VANESSA, REAPER, PYXIE** and other well-known yachts of that class.

CORINTHIAN (of Marblehead) **YACHT CLUB**—Sixty-first Regatta, July 23d; **FREAK** won, beating **REAPER** and **SIROCCO**. In the Sixty-second Regatta, August 2d, **FREAK** was fourth, **REAPER** winning; however, **FREAK** defeated **REAPER** on August 13th.



LATE COMMODORE BENJAMIN W. CROWNINSHIELD.

In the Sixty-fourth Regatta, sailed August 18th, **FREAK** was third, **REAPER** winning, there being ten contestants. On August 19th **FREAK** won, defeating **REAPER, VANESSA**, etc.—nine starters. Third in the Sixty-sixth Regatta, August 20th, **REAPER** being the winner. On September 3d, there was a race between **FREAK** and **REAPER** in which the latter won. On September 5th, both **EXILE** and **REAPER** defeated **FREAK**.

BENJAMIN W. CROWNINSHIELD, late Commodore of the **CORINTHIAN** (of Marblehead) **YACHT CLUB**; born in Boston, Mass., in the year 1818, died January 7, 1892, a citizen of Marblehead, Mass. The son of F. B. and Sarah G. Crowninshield. A member

UB.

of Alex. Cochrane.

7 feet 6 inches.

FREAK won, beat-
REAPER, PYXIE and

-Sixty-first Regatta.
and SINOCO. In the
was fourth, REAPER
EN on August 13th.



NINSHIELD.

18th, FREAK was
testants. On An-
ANESSA, etc.—nine
August 20th, REA-
here was a race be-
won. On Septem-
EAK.

Commodore of the
; born in Boston.
zen of Marblehead.
shield. A member



COMMODORE W. P. FOWLE,
CORINTHIAN YACHT CLUB, (MARBLEHEAD).

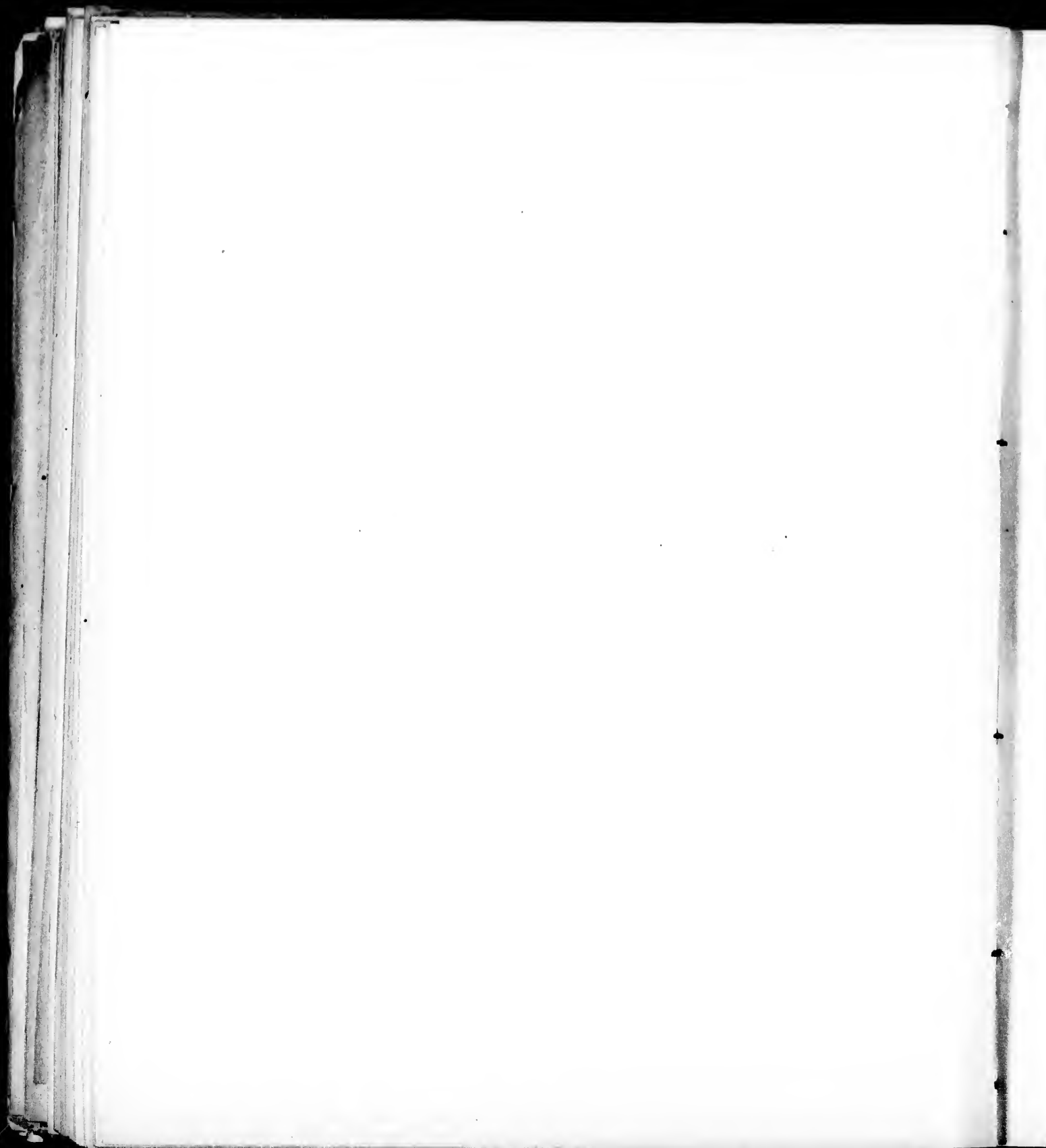

of the EASTERN YACHT CLUB, '79; the CORINTHIAN YACHT CLUB, '81 and the NEW BEDFORD YACHT CLUB, '79. One of the originators of the CORINTHIAN YACHT CLUB, he has the honor of having been its Commodore since its organization.

It is scarcely to be wondered at that Commodore Crowninshield should have so sincere a love for the sea, descended as he is from Norwegian ancestry, and having a grandfather who was twice Secretary of the Navy under Jefferson. His father was Speaker of the Massachusetts House of Representatives. The late Commodore was the owner of the yacht TOMAHAWK and formerly owned EFFIE. He was President of the Realty Co. of Kittery, Me. From 1878 he was a most enthusiastic yachtsman until the time of his death.

TOMAHAWK.

TOMAHAWK is a keel cutter constructed of iron. She was designed by Edward Burgess and built by Henry Piepgras, City Island, N. Y. Was launched in 1889 and is now the property of the late B. W. Crowninshield. She hails from Marblehead and sails with the fleet of the CORINTHIAN (of Marblehead) YACHT CLUB. See Fig. 452.

DIMENSIONS.			
Length over all,	52 feet.	Length load waterline,	39 feet 6 inches.
Depth,	9 feet 6 inches.	Draft,	10 feet.
Beam,	12 feet.		

Official number, 145,524.

Gross tonnage, 27.14; Net tonnage, 25.79.

WITCH.

The cutter WITCH was the property of the late B. W. Crowninshield, Commodore of the CORINTHIAN (of Marblehead) YACHT CLUB. She was designed and built for him by William Eddy, of Marblehead, Mass. She has a cabin and hails from Marblehead.

DIMENSIONS.			
Length over all,	21 feet.	Length load waterline,	21 feet.
Depth,	5 feet.	Draft,	5 feet.
Beam,	8 feet.		

NIXIE.

NIXIE is a keel cutter designed by Edward Burgess and built by W. Smith, for A. L. Cochrane. She hails from Beverly, Mass., and sails with the fleets of the BEVERLY and CORINTHIAN (of Marblehead) YACHT CLUBS. See Fig. 451.

DIMENSIONS.			
Length over all,	23 feet 7 inches.	Length load waterline,	20 feet 2 inches.
Beam,	7 feet 11 inches.	Draft,	4 feet 6 inches.

THUDETTE.

A keel sloop built by Higgins and Gifford, and launched in 1887. Owned by L. M. Haskins and hailing from Rockport, Mass. She sails with the CORINTHIAN (of Marblehead) YACHT CLUB. See Fig. 453.

DIMENSIONS.			
Length over all,	29 feet 3 inches.	Length load waterline,	21 feet 10 inches.
Draft,	3 feet 8 inches.	Beam,	9 feet.

VENTURA.

VENTURA is a centerboard cutter yacht owned by Theo. W. King. She was designed by Burgess and was built by Lawley & Son; launched in the Spring of 1890. Hails from Dorchester, Mass. and sails with the CORINTHIAN (of Marblehead) and MASSACHUSETTS YACHT CLUBS. See Fig. 454.

Official number, 161,635.

DIMENSIONS.			
Length over all,	52 feet.	Length load waterline,	39 feet 10 inches.
Depth,	7 feet 5 inches.	Draft,	7 feet.
Beam,	12 feet 6 inches.		

Racing Record for 1892:—

MASSACHUSETTS YACHT CLUB—VENTURA won on September 3d, 4th, and 5th, in the Fall Cruise, beating KING PHILIP, CURTAL, etc.

SALADIN.

A cutter yacht owned by J. P. & C. E. Loud, of Boston, Mass. Was designed by Burgess and built by Geo. Lawley & Son in 1890.

She hails from Boston and sails with the CORINTHIAN (of Marblehead) and EASTERN YACHT CLUBS. See Fig. 455.

Official number, 146,404.

DIMENSIONS.			
Length over all,	47 feet.	Length load waterline,	29 feet 9 inches.
Depth,	6 feet 5 inches.	Draft,	7 feet.
Beam,	10 feet.		

THELMA.

A keel cutter designed by Edward Burgess and built by Geo. Lawley & Son, South Boston, Mass. She was launched in 1890; is the property of Frank B. McQuesten of Boston, from which port the yacht hails. She sails with the BOSTON, EASTERN and CORINTHIAN (of Marblehead) YACHT CLUBS. See Fig. 456.

Official number, 145,541.

DIMENSIONS.			
Length over all,	62 feet.	Length load waterline,	45 feet 6 inches.
Depth,	8 feet 7 inches.	Draft,	9 feet 6 inches.
Beam,	13 feet 4 inches.		

Racing Record for 1891:—

EASTERN YACHT CLUB—THELMA won in the First Squadron Race, sailed August 23d, defeating SAVONARA and CINDERELLA.

GUSSEON.

A cutter yacht owned by Charles A. Morse, Jr., of Boston. Was designed by Burgess and built by Lawley & Son of Boston, and launched in 1890. Hails from Boston and sails with the CORINTHIAN (of Marblehead), EASTERN and MASSACHUSETTS YACHT CLUBS. See Fig. 457.

DIMENSIONS.			
Length over all,	53 feet.	Length load waterline,	39 feet 10 inches.
Draft,	9 feet.	Beam,	12 feet.

CLATIE.

The centerboard sloop yacht CLATIE was designed by N. G. Herreshoff and built by J. B. Herreshoff, Bristol, R. I., and launched in 1867. She hails from Boston and is owned by Robert W. Neff and W. R. Rollins. She sails with the CORINTHIAN (of Marblehead), BOSTON and QUINCY YACHT CLUBS. See Fig. 458.

Official number, 5,418.

DIMENSIONS.			
Length over all,	37 feet 2 inches.	Length load waterline,	31 feet 2 inches.
Depth,	5 feet.	Draft,	4 feet 6 inches.
Beam,	12 feet 7 inches.		

BRENDA.

BRENDA is a cutter yacht owned by Everett Paine of Marblehead, Mass. She was designed and built for her present owner by William Eddy, and was launched in 1888. She hails from Marblehead and sails with the CORINTHIAN (of Marblehead) YACHT CLUB. See Fig. 459.

DIMENSIONS.

Length over all,	30 feet 1 inch.
Length load waterline,	22 feet 6 inches.
Depth,	5 feet 8 inches.
Draft,	5 feet 10 inches.
Beam,	8 feet 6 inches.



EVERETT PAINE.



HENRY G. PEABODY.

HENRY G. PEABODY, a distinguished marine artist of Boston, Mass., was born in St. Louis, Mo., of English descent; the son of Charles Peabody. He is the present owner of CALYPSO and has in time past been the owner of VENTURA. He has been interested in yachting for twenty-two years and is a member of the ATLANTIC YACHT CLUB (of Brooklyn), and the CORINTHIAN YACHT CLUB (of Marblehead).

CALYPSO.

The cabin cat CALYPSO was designed and built by Hutchings & Pryor, South Boston, Mass., and launched in 1885. She has been

for four years the property of Henry G. Peabody, Boston, Mass. She sails with the ATLANTIC (of Brooklyn) and CORINTHIAN (of Marblehead) YACHT CLUBS. She was formerly known as the VANGUARD. See Fig. 460.

DIMENSIONS.	
Length over all,	25 feet.
Depth,	4 feet 6 inches.
Length load waterline,	22 feet.
Beam,	8 feet.

IONE is a keel sloop owned by J. S. Poyen of Boston. Was designed and built by G. W. Tappan, Newburyport, Mass., and was launched in 1884. She hails from Boston and sails with the CORINTHIAN (of Marblehead) YACHT CLUB. See Fig. 461.

DIMENSIONS.	
Length over all,	29 feet 4 inches.
Depth,	5 feet 6 inches.
Length load waterline,	25 feet 3 3/4 inches.
Beam,	10 feet.

Racing Record:—

1891—CORINTHIAN (of Marblehead) YACHT CLUB—First in the Fifty-first Regatta, sailed July 25th, beating SUSIE and ALCYONE. First in the Fifty-second Regatta, August 8th, defeating SUSIE. On the 2d of August she was defeated by SUSIE, coming in second, MOONDYNE and ALCYONE following. Beaten by SUSIE in the Fifty-seventh Regatta, which took place September 7th, and again beaten on September 12th, being second both times.

1892—CORINTHIAN (of Marblehead) YACHT CLUB—Second in the Sixty-third Regatta, July 23d. In the Sixty-third Regatta, August 13th and in the Sixty-seventh Regatta, September 3d she was second, SUSIE winning.

CATSPAW.

CATSPAW is a centerboard open sloop yacht owned by C. A. Prince. She hails from Hull, Mass., and sails with the CORINTHIAN (of Marblehead) YACHT CLUB. See Fig. 462.

DIMENSIONS.	
Length over all,	29.55 feet.
Depth,	10 feet 4 inches.
Length load waterline,	19.85 feet.

Racing Record for 1892:—

EASTERN YACHT CLUB—Special Invitation Race, July 28th, CATSPAW was second, ALPHA first, beating REAPER, VANESSA, EXILE, TADPOLE, SIBOCO, PYXIE, KOORALI, etc.

MASSACHUSETTS YACHT CLUB—In the 146th Race, sailed July 15th, CATSPAW won, beating EXILE, etc.

BEVERLY YACHT CLUB—July 29th, 187th Race, CATSPAW came in second, FREAK first, with thirteen entries.

HULL YACHT CLUB—Second, ALPHA winning, beating VANESSA and R. D.

CORINTHIAN (of Marblehead) YACHT CLUB—Third in the Fifty-ninth Regatta, June 18th, nine starters.

HULL CORINTHIAN YACHT CLUB—Second in the Club Regatta, July 23d, ALPHA first, six starters.

COUNTESS.

COUNTESS is a keel sloop owned by Rufus L. Sewall of Boston. She was designed and built by Lawley & Son of Boston, and was launched in 1882. Hails from Boston and sails with the CORINTHIAN (of Marblehead) YACHT CLUB. See Fig. 463.

DIMENSIONS.	
Length over all,	33 feet.
Depth,	5 feet 6 inches.
Length load waterline,	29 feet 3 inches.
Beam,	12 feet.

Racing Record:—

1891—CORINTHIAN (of Massachusetts) YACHT CLUB—Second in the Fifty-third Regatta, August 22d; TRIAD won.

1892—CORINTHIAN (of Marblehead) YACHT CLUB—She won in the Sixty-first Regatta, defeating CAT-BIRD; winning again in the Sixty-eighth Regatta sailed September 5th, when she beat ORINDA, GIPSY, CLYDIE, ALCYONE and VANDAL.

AMERICA.

A keel schooner yacht. She was designed and built for Commodore John C. Stevens by George Steers in 1851. This same year she went to England and took part in a contest for the Queen's Cup,

which she won, sailing against a whole fleet of the crack yachts of the day. This cup is now known as the AMERICA'S CUP, a just honor to the yacht who won it primarily. See Fig. 449.

AMERICA was later known as CAMILLA, and still later as MEMPHIS. During the war of the Secession she was a blockade runner in the Confederate service. She was finally sunk in the St. John's River, Florida, but was raised after the termination of the war, and had the honor of again sailing for the trophy she originally won. This was in the race against CANTHRA, AMERICA being fourth. See was bought in '71 by Gen. Benjamin F. Butler, and she is now owned by Paul F. Butler.

She has been several times altered, and now hails from Gloucester, Mass., sailing with the fleets of the BOSTON, MASSACHUSETTS and CORINTHIAN (of Marblehead) YACHT CLUBS. Her present dimensions are as follows:

DIMENSIONS.	
Length over all,	108 feet.
Depth,	9 feet.
Beam,	22 feet 8 inches.
Length load waterline,	96 feet.
Draft,	11 feet 6 inches.

For fuller particulars, see Chapter on AMERICA'S CUP, Vol. II.

A. J. SHAW, Braintree, Mass., was born in that place, his ancestors try being, as he expresses it, "Yankee straight from way back." His parents were Joseph and Harriet Shaw, and he is engaged in manufacturing. Is the owner of the cut MOONDYNE, and has been a yachtsman as long as his memory carries him back, and is a member of the HULL, QUINCY, CORINTHIAN (of Marblehead) and MONAQUOT YACHT CLUBS.

MOONDYNE.

MOONDYNE is a centerboard cut-bout designed and built by Nathan Smalley, Harwichport, Mass., for his own use. Launched in 1886, and owned since the Spring of '87 by A. J. Shaw of Boston, Mass. Her cabin house was lengthened in 1889 and lead was added to her keel in 1890. She hails from Quincy, Mass., and is enrolled among the yachts of the MONAQUOT, QUINCY, CORINTHIAN (of Marblehead) and HULL YACHT CLUBS. See Fig. 464.

DIMENSIONS.	
Length over all,	21 feet 8 inches.
Depth,	5 feet.
Beam,	10 feet 6 inches.
Length load waterline,	24 feet 7 inches.
Draft,	2 feet 10 inches.

Spars: Mast, 38 feet; Boom, 35 feet; Gaff, 25 feet; Bowsprit, 10 feet.

ANETO.

ANETO is a keel sloop yawl owned by H. B. Stearns of Boston, from which port she hails. Was designed by H. W. Eaton and built by W. P. Stephens, Staten Island, N. Y., and launched in 1883. Sails with the CORINTHIAN (of Marblehead) YACHT CLUB. See Fig. 465.

DIMENSIONS.	
Length over all,	21 feet 8 inches.
Draft,	4 feet 6 inches.
Length load waterline,	21 feet.
Beam,	7 feet.

TRIAD.

TRIAD is a centerboard cut-bout, owned by Henry Taggard. Formerly the property of Theo. W. Jones. She sails with the CORINTHIAN (of Marblehead) YACHT CLUB, hailing from Marblehead. Was built by H. S. Crosby & Bro. in 1878, at Oaterville, Mass. See Fig. 466.

DIMENSIONS.	
Length over all,	25 feet 10 inches.
Draft,	2 feet 10 inches.
Length load waterline,	22 feet 10 inches.
Beam,	10 feet.

MILDRED.

MILDRED is a cutter-rigged yacht owned by W. H. Wilkinson of Boston. She was designed by W. H. Wilkinson and was built by Geo. Lawley & Son in 1890. Hails from Boston, Mass., and sails with the CORINTHIAN (of Marblehead), BEVERLY, MASSACHUSETTS and BOSTON YACHT CLUBS. See Fig. 467.

Official number, 92,297.

DIMENSIONS.	
Length over all,	42 feet 8 inches.
Depth,	7 feet 3 inches.
Beam,	9 feet 5 inches.
Length load waterline,	29 feet 11 inches.
Draft,	7 feet 0 inches.

of the crack yachts of
the C. Y. C., a just honor

9.
still later as MEMPHIS,
weekade runner in the
the St. John's River,
of the war, and had
originally won. This
ing fourth. See was
she is now owned by

ails from Gloucester,
MASSACHUSETTS and
Her present dimen-

prime, 96 feet
11 feet 6 inches.

A's C. Y. C., Vol. 11.

at place, his ances-
s straight from way
haw, and he is en-
at MOONDYNE, and
lea him back, and is
N (of Marblehead)

igned and built by
use. Launched in
J. Shaw of Boston,
and lead was added
ass., and is enrolled
Y, CORINTHIAN (of
404.

no, 24 feet 7 inches,
2 feet 10 inches.

25 feet; Bowsprit,

Stearns of Boston,
W. Eaton and built
launched in 1883.
YACHT CLUB. See

waterline, 21 feet.
7 feet.

y Taggard. Form-
with the CORIN-
from Marblehead.
ervillo, Mass. See

22 feet 10 inches.
10 feet.

. H. Wilkinson of
on and was built
n, Mass., and sails
ERLY, MASSACHU-

23 feet 11 inches.
7 feet 6 inches.



COMMODORE WILMOT D. PORCHER,
CAROLINA YACHT CLUB.

History of the Carolina Yacht Club.

STATION—COOPER RIVER, CHARLESTON HARBOR, S. C.

THE CAROLINA YACHT CLUB* was organized in the Spring of 1883, with a full line of officers, a Constitution and By-Laws, Rules of Discipline, Signal Code, etc. Prior to that time much interest had been taken in water sports, and many regattas, including rowing as well as sailing races, had been held, the spirit being enlivened and enhanced by a jolly sort of rivalry which existed between the sister cities of Savannah and Charleston.

This rivalry had inspired a succession of challenges and counter challenges, resulting always in valiant battles for supremacy, followed by delightful social festivities.

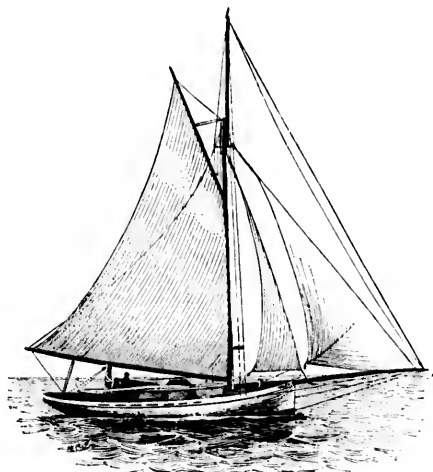

KATHINKA.—FIGURE 408.

But the noble sport of yachting *per se* was practically enjoyed by a comparative few congenial spirits, who loved salt water as they loved nothing else.

There exist no waters more enticing to a devotee of sport than the waters of that vicinity. The broad expanse of the land-locked bay, fringed with semi-tropical foliage, and opening to the sea with its ever rolling swell, or through winding lagoons behind the fertile and picturesque sea-islands to indefinite reaches as far as Cape Romain's unsurpassed fishing grounds on the north; to the south by smooth water streams swarming with fish and enlivening game birds, and birds of brilliant plumage and cheery song; on waters that wash the shores of hundreds of old time plantations, and many a sleepy hamlet nestling in semi-tropical foliage and flowers. The surpassing loveliness of the early morning along these quiet reaches, moored under the shelter of towering pines, which rise serenely out of their soft

*Written by ex-Com. C. H. GLIDDEN.

beds of lustrous green; the glittering waters alive with leaping fish sparkling in the dawn, all about the hum of awakening life, the gleam of gorgeous flowers, the flash of the startled red-bird, the crisp freshness of the scented air through the cane-brake, rustling the long fountain-like leaves of the palmetto, while over all comes in through the dense growth of vine and brake the deep toned booming of the surf a mile away. Now the steward comes along with an eye-opener, and inspired by the fresh air and the free life, the yachtsmen take a header over the taff-rail into the briny, and so disporting, watch the sweet white cranes and the dainty gannets, or the merry king fisher, while "all nature's children feel the matin spring of life reviving with reviving day." And the summer nights peculiar to this climate—the atmosphere is so clear that the star light keeps us on deck indefinitely. The distant call and echo of the mocking bird and swish of the whip-poor-will, the strident croak of the old bull-frog in the rice fields, all join in the chorus of the yachtsmen's banjo songs. *Dolce far niente* idealized.

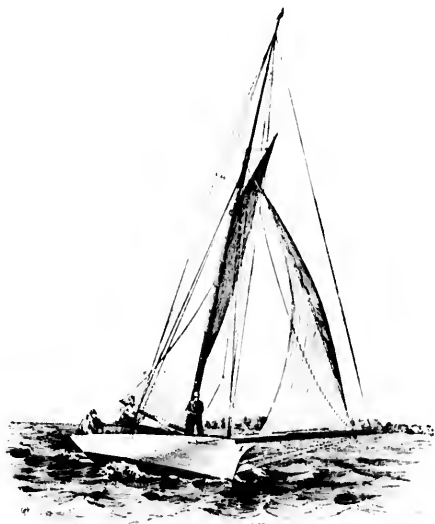

FLIRT.—FIGURE 409.

Game, including deer, which abound on these sea islands, quail, woodcock, snipe, rice birds, etc., (in their season) give plenty of work for the trigger, and the table is supplied with fish, shrimps, oysters, soft shells and terrapin galore.

Fogs or calms never vex the sailor's soul in these waters; they are almost literally unknown.

The force of the trade winds is so perfectly regular that one may sail for hours under the smooth water lee of a broad marsh with club

and jib-topsail aloft and lee rail awash, not varying an inch for miles.

Again under way, the yachtsman may round some grassy bend, flushing a host of wild fowl, dropping a few by pulling the trigger, and startling to life an unwary gator, who, with noiseless spring takes a header and is lost in the congenial slime of the water reeds and rushes. Now in the distance can be discerned under the shelter of a palmetto hammock a few shy pelicans and long-legged cranes leisurely feeding. Wafted by fitful breezes, the yachtsman sails along these serpentine water ways, past lovely Beaufort, where they "pipe all hands to quarters—a petticoat on the Beach." Tarrying

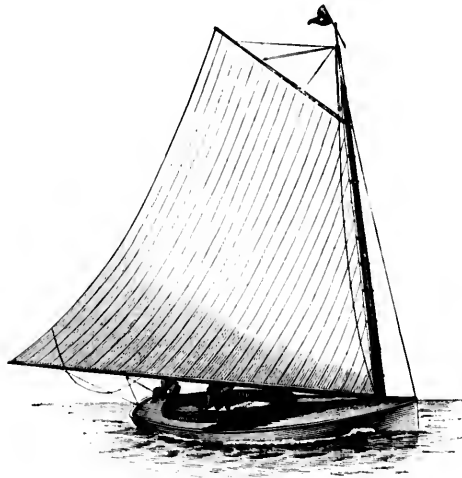

CHALLENGE.—FIGURE 470.

during the day on Broad River to join the score of negro boats for a cast at the game old "drum," hoping, usually in vain, to land a hundred pounder as the negro experts easily do, and so on to the Savannah, where they are sure of a cordial welcome.

These peculiar enticements were appreciated by a comparative few; most of the boating being done in small boats whose sailors as a rule were decidedly of the tyro type; but the spirit was here, bred in the bone, and it came out strong whenever a race was suggested, whether premeditated or impromptu. The *motif* was generally to show which dare-devil could do the most foolhardy thing in a boat.

One grand Interstate Regatta came off during those halcyon days. A fine breeze from the southwest gave the boats a free sheet, and they went off, first, second third and fourth classes, with two minutes between the guns. To be sure a heavy black squall was making up in the northeast which everybody knew would be down upon them before the boats could reach Sumpter, but nobody minded a little thing like that. They simply battened down and kept an eye to windward, just when every rag was pulling for all it was worth—and more—and the boys were in high glee, suddenly a dead calm, and then, down came the storm—it was nothing less—and spars began to crack. They were all jealously watching a certain boat that the Savannah boys had been plugging on the night before. The Carolina yachtsmen were hunting her and she held on to her canvas. Ah, there go her sticks, hurrah! and lucky for her too, as she was an open boat. Hello! COQUETTE is over. MADCAP'S boom is busted, FREELANCE'S top sail split, and UNDXE is going off in a cloud. It never occurred to anybody to shorten sail—voluntarily. In less than

ten minutes there was not a boat in the race except the big able ELEANOR and the tight little WILDBIRD. The former, regardless of rules, essayed to cross the bows of WILDBIRD, but the shave was too close. Her skipper had the right of way, and he knew it. A collision meant destruction in such a sea, but that was not the consideration just then, he was out for blood and ignored the bluff. The result was to throw the big sloop about under the lee, splitting her jib halliard block and putting her in irons. By the time she was off again WILDBIRD was many lengths to the good and, getting close under the lee of Sullivan Island, was enabled to run a few points off the wind—she never could have carried herself close hauled in such a gale and sea—for the outer buoy. Even the Revenue Cutter was averse to meeting the storm outside Sumpter, and busied herself picking up the shipwrecked mariners of Savannah and Charleston, as did the crews of most of the excursion steamers. It was a tough race and a hot one; nothing could be seen of WILDBIRD but her sails and a smother of foam; but the small boat won on time allowance by six minutes.

Similar events led to much discussion and a determination to reform such methods. A few of the devoted, W. Lawton Mikell; W. D. Porcher, F. Y. Porcher, F. T. Jones, H. M. Tucker, H. C. Cheves, C. H. Glidden, W. Robertson, W. B. Means, Henry Carere, Douglas Kirkpatrick, J. P. deSaussure and F. J. Jones, assembled together one night and proceeded to organize a club designed to effect a revolution. It took time to accomplish this, as boating, or at least racing, was a wild sport in those days, and there was plenty of kicking over the traces and taking the bit in the teeth in spite of rules. But getting disqualified for such pranks served,

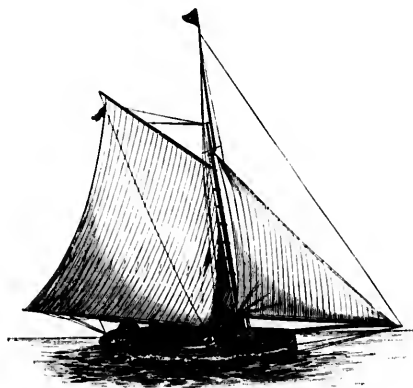

POLLY.—FIGURE 471.

after a while, to have a salutary effect, and more potent still, the presence of their friends, the enemy from sister ports evoked, that characteristic inborn courtesy that never fails these boys. But racing under written rules was at first rather embarrassing. Not to be allowed to scrape around buoys or collide with the stake boat or to push one another astern by the bowsprit was rather hard lines.

Well, the club was formed in 1883. General order No. 1 was promptly issued and duly promulgated, published and commented upon by the local papers. The first event was a Grand Review off South Battery. This was a novelty, and as it was a free show all the town turned out. It was really a beautiful sight, although the number of boats was somewhat limited. But anything like order, with guns and flag signals, and the nautical exchange of courtesies immediately enlisted the interest of the young ladies. Their enthu-

except the big able
the former, regardless of
run, but the shave was
y, and he knew it. A
t that was not the con-
sidered the bluff. The
or the lee, splitting her
By the time she was off
ood and, getting close
to run a few points off
t close hauled in such
e Revenue Cutter was
and busied herself pick-
and Charleston, as did

It was a tough race
and but her sails and
time allowance by six

l a determination to
l. W. Lawton Mikell;
H. M. Tucker, H. C.
Means, Henry Carere,
. J. Jones, assembled
e a club designed to
ish this, as boating,
days, and there was
the bit in the teeth
such pranks served,

siasm was promptly responded to by voting them all honorary mem-
bers. This naturally led to a Ladies' Day, which was the next event
formally announced with a flourish of trumpets through General
order No. 2.

It is only the truth to say that to APPODRE's influence was mainly
due the brilliant success of that opening season.

Then came the races. The course was always followed by a
club steamer and by the Revenue Cutter, which generally served as a
judges' boat. During the season the club also gave numerous garden
parties and maroons as well as races.

During the season of 1884, the Commodore was invited by a rela-
tive to join him on a cruise along the Eastern Coast, from Newport to

she being splendidly handled, many a hard fought battle ensued.
As new boats were added also to the SAVANNAH fleet the interest was
kept up. But by good luck—not to mention seamanship—the
Charleston boats have invariably carried off the honors.

In 1891, the superbly equipped *MANITO*, by William Gardner,
astonished the natives.

None of these boats exceed forty-two feet over all, five feet draft
being all that is practicable for cruising on these waters.

In the year 1891, an Inter-State Challenge Cup, the joint property
of the SAVANNAH and CAROLINA CLUBS, was purchased and a set of
rules adopted to govern all contests for its possession. Only one
race has been sailed for this cup, at Beaufort in 1891: *MANITO* and
KATRINKA promptly pushed to the front, and it was nip and tuck
between them, the former winning on allowance by 1 min., 42 sec.

The Annual Regatta was sailed Jun. 13, 1892, course 18 knots.
Wind, good breeze from east southeast, weather clear. The follow-
ing yachts started:

	Elapsed Time.	Corrected Time.
	H. M. S.	H. M. S.
<i>Katrinka</i>	2 50 06	2 50 06
<i>Manito</i>	2 53 54	2 49 54
<i>Flirt</i>	3 08 52	3 02 07
<i>Wildbird</i>		

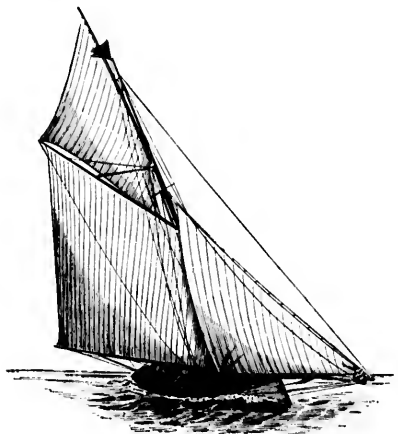

NAOMI.—FIGURE 472.

Bar Harbor. He was requested to transfer his pennant and club flag
to the yacht *LATONA* for the time and take official command.

During the Squadron Cruise of the NEW YORK and EASTERN
CLUBS that year, the beautiful schooner bearing the novel colors of
of the CAROLINA CLUB joined the squadron at Vineyard Haven, and
the flag was received with all the honors. The exchange of courtes-
ies that followed was peculiarly cordial, and the flag ship was invited
to join in all their subsequent events. Thus the club flag became
well known to our Northern friends, and our present Commodore
(from 1891) has enhanced its prestige on recent visits.

During the year 1884, the SAVANNAH and CHARLESTON CLUBS
accepted the invitation of the BEAUFORT CLUB, and in their neutral
waters enjoyed a grand race. Most of the Savannah boats were dis-
abled in a heavy squall and the race was finally won by *WILDBIRD*
in a drifting match with *FLIRT*, both going over the line stern first.
This was followed by a ball at the Sea Island Hotel and a general ex-
change of courtesies which did much to enhance the yachting inter-
ests of the three cities.

In the Spring of 1885, the jib and mainsail *VIKING* by McGeihan,
created much interest in the second class, her young Captain carrying
off all the prizes (which he promptly invested in more boats), and
arousing much interest in that class.

The next season the cabin sloop *KATRINKA*, by McGeihan, was added
to the fleet. Her advent gave a fresh impetus to the sport, and



MANITO.—FIGURE 473.

The race was won by *MANITO*.

An Inter-State Championship and Challenge Cup Race was held
July 7, 1892. Course, Beaufort to Middle Ground Buoy and return.
Wind, brisk from southwest. Weather fine, and sea moderate.

<i>Flirt</i>	3 06 40
<i>Manito</i>	3 02 08
<i>Katrinka</i>	3 03 50
<i>Ocean Queen</i>	3 08 56
<i>Glance</i>	
<i>El Diva</i>	

MANITO won, *FLIRT* being second. Judges, Commodore Kensey,
Andrew Symonds, Commodore Walker.

re potent still, the
ports evoked, that
se boys. But race-
assing. Not to be
e stake boat or to
her hard lines.

order No. 1 was
l and commented
Grand Review off
is a free show all
ght, although the
ything like order,
ange of courtesies
es. Their enthu-

On July 23, 1892, there was a race sailed for the Lowndes' Cup and Commodore's Pennant; the course being on Cooper River. Weather, clear and pleasant, sea smooth. The following yachts started:

Name.	Elapsed	Corrected
	Time.	Time.
	U. S. S.	U. S. S.
Manito	3 06 32	3 04 10
Wildbird	3 32 26	3 23 03
Katrinka	2 50 11	2 50 11
Flirt	3 00 57	3 00 25

The race was won by KATRINKA, FLIRT coming in second.

One of the most notable yachts at the present time is FLIRT, recently rebuilt and thoroughly modernized in hull and rig, making her one of the handsomest in the fleet. The improvement to WILD BIRD and KATRINKA are deserving of notice, the latter having been given a long, overhanging stern which adds greatly to her beauty and power; JENNY S., also recently altered; WISONA, which has been entirely rebuilt, down to the keel and given a roomy cabin thoroughly equipped for cruising along shore; NAOMI, CHALLENGE, POLLY and a number of others are open sloops, and last and most beautiful at

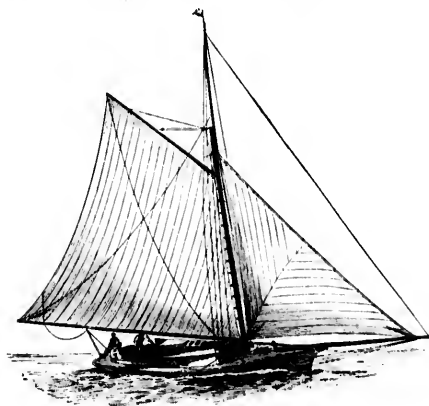

WILDBIRD.—FIGURE 474.

least, the graceful MANITO, designed by William Gardner for the former Vice-Commodore, C. T. Lowndes and now owned by the present spirited Vice-Commodore.

MANITO is an example of the latest development in centerboard cutters, and her equipment combines all the desirable features of the nautical evolution.

A cabin sloop is now being built for one of our sporting members and the first Vice-Commodore is exercising his nautical brain over a *fin de siècle* production which it is hoped will be materialized. Of launches, the club has several, the largest and handsomest being that of their Fleet Captain, DIANA. She is an expensive and beautiful cabin yacht and adds much to the picturesque effect of all displays on the water.

The career of the club has been one of constant growth, the membership being now 200. The club rooms at Commercial Docks are well situated, the view embracing many points of interest in the Harbor, and from their broad gallery old ocean's waves can be seen tossing

in the sunshine. The rooms are quite extensive, consisting of a ladies' reception room, a billiard room, buffet, gymnasium and general parlors, all of which are thoroughly and appropriately equipped and adorned with pictures and other artistic effects, and where the latest daily and illustrated papers and periodicals are to be found.

The rooms are frequently graced by the fair sex and their influence sheds a refinement and charm about the place that is fully appreciated. The social attractions of the club are so well appreciated, in fact, that the club flag is kept at mast head the year round.

The yachting season is by no means confined to the Summer months. For many years Ex-Com. C. H. Glidden and other yachtsmen have kept their boats in commission the year round, moored off South Battery in winter, ever ready for a spin, and Com. Glidden says one of the liveliest days of his life was spent on a sail to Cain-Hoy on WANDO river during Christmas week, with a jolly party of moonrunners.

The club's usual Saturday evening rendezvous is at Kiawah river, Stono, 18 miles from home, where game and fish abound and also immunity from civilization.

In spite of the numerous contests that have been fought in all weather between the boats of the club, their relative merits in point of speed are ever a debatable quantity, and this fact always serves to foster the interest.

Naturally, the homo races are mainly interesting to the friends of respective yachts and each has its devoted partisans ready to bicker and bet and quarrel over it all; but the moment a race with Savannah, which they love (take that in both applications), is started, they are all, brothers; it then becomes perfectly immaterial which Charleston boat wins, so long as she wins. It is to be hoped those Savannah boys find compensation for all the gloves and flowers and bon bons so ruefully lost. After the aquatic contest is over, however, the only rivalry is in striving to make the vanquished forget his defeat and admit he has been led gaily to it.

Com. Glidden says he has lived all along shore from the glorious coast of Maine to the sands of Florida, but he never saw more pluck in boating, as in other things, than he has seen on Charleston water. He says: "The boys all swim and dive like ducks, though I have never yet seen a white feather, and I have seen them in many an emergency, and the Lord knows we have had our share here, with cyclones, earthquakes, epidemics, political riots and fires. While pluck is an essential with the sailor, recklessness is ruin sooner or later, and to tame these wild spirits for mutual protection was a task. But the club has been blessed with a succession of conservative flag officers, and the result of discipline is apparent now-a-days. Its events are conducted with utmost decorum and smoothness, the ladies participating in them all with enthusiasm, many of them decked in regulation costume for the occasion.

"From such modest beginnings the CAROLINA YACHT CLUB has thrived particularly to its present devoted and popular Commodore, grown to be one of the most spirited organizations in the South, combining as it does all the social advantages of a gentleman's club with the fascinating interest of the noblest of sports."

The officers for 1893 were as follows: Commodore, W. D. Porcher; Vice-Commodore, E. A. Simons; Secretary, C. E. Prioleau; Treasurer, W. D. Middleton.

The racing events, reviews, and Ladies' Days of the season of 1893 have all been unusually brilliant, the result of which will be to add several fine racing yachts to the club next year.

ensive, consisting of a
gymnasium and gen-
appropriately equipped
effects, and where the
als are to be found.

sex and their influence
that is fully appreci-
so well appreciated, in
year round.

lined to the Summer
den and other yachts-
year round, moored off
in, and Com. Glidden
ent on a sail to Cain-
with a jolly party of

is at Kiawah river,
fish abound and also

been fought in all
ative merits in point
fact always serves to

ng to the friends of
ans ready to bicker
t a race with Savan-
ons), is started, they
material which Char-
be hoped those Su-
oves and flowers and
ontest is over, how-
e vanquished forget

o from the glorious
ever saw more pluck
on Charleston water.
ecks, though I have
a them in many an
ur share here, with
and fires. Whilo
s is ruin sooner or
l protection was a
ession of conserva-
pparent now-a-days.
nd smoothness, the
any of them decked

YACHT CLUB has.
pular Commodore.
in the South, com-
ttleman's club with

re, W. D. Porcher;
rioleau; Treasurer.

the season of 1893
ch will be to add

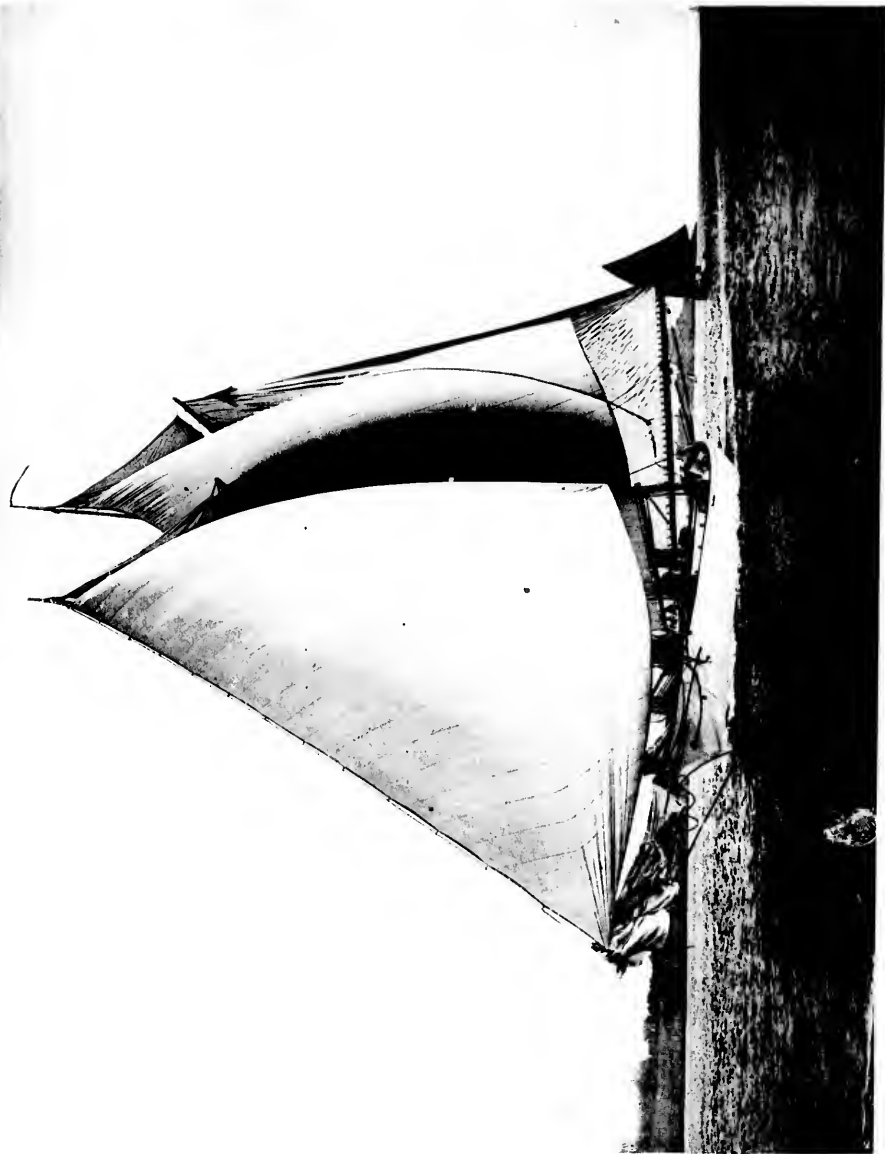

FROM A NEGATIVE BY BOLLES

PLATE LIX

LOYAL.

FROM A NEGATIVE BY BOLLIES

PLATE LIX

LOYAL

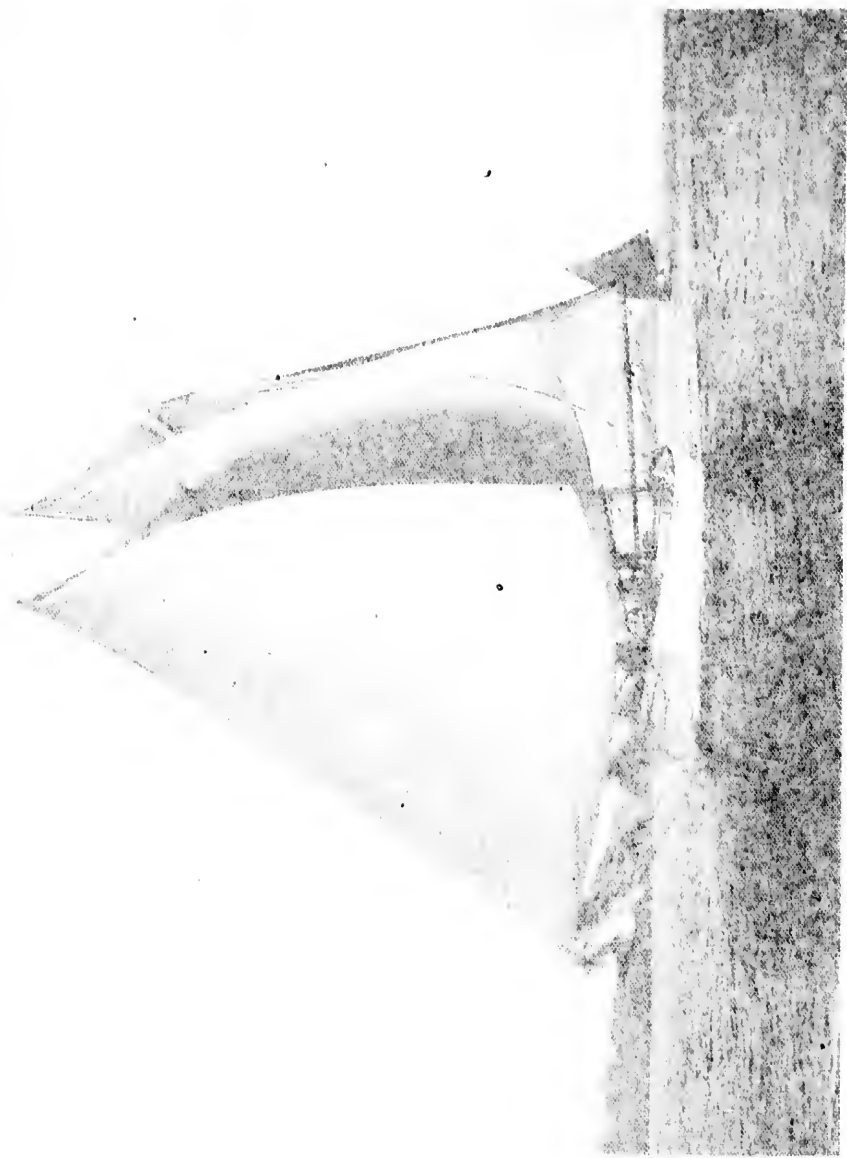

LIST OF YACHTS ENROLLED IN THE CAROLINA YACHT CLUB.

NAMK.	HT.	OWSER.	LENGTH OVER ALL	L. W. L.	BEAM	DRAFT
			ft. in.	ft. in.	ft. in.	ft. in.
Caprice	Sloop	I. M. Holt	19 00	18 00	6 07	1 04
Challenge	Cat	Irving Heyward	22 04	20 00	8 00	1 07
Coleffe	Sloop	Julian Mitchell	26 00	24 00	7 00	2 00
Diana	Naphtha Launch	Andrew Simonds	30 00	35 00	8 01	3 00
Eleanor	Sloop	Thomas Young	30 00	36 00	13 00	4 00
Flirt	"	W. B. & Heyward, H. W. Conner, Jr	34 00	30 00	10 00	2 18
Hustle	Naphtha Launch	F. Y. Porcher	25 00	21 00	5 00	1 06
Jennie S.	Sloop	A. M. Huger	32 00	26 00	10 04	1 03
Katinka	"	F. Y. Porcher, W. D. Porcher	42 00	32 10	12 09	3 06
Manito	"	Ed. A. Simons	42 02	30 00	11 08	4 04
Marguerite	Steam Launch	H. P. Williams	25 00	21 00	5 00	2 00
Messenger	Naphtha Launch	L. D. Simonds	25 00	21 00	5 00	2 00
Naomi	Sloop	W. D. Middleton, J. S. Harleston	25 05	25 05	10 08	1 04
Polly	"	A. M. Manigault	28 00	25 08	9 02	2 05
Unknown	"	H. C. Cheves	25 00	23 00	8 00	3 06
Vive	"	L. J. Alsina	29 05	24 08	9 00	2 05
Wildbird	"	A. T. Smythe	30 08	27 00	10 06	2 00
Winona	"	Jno. W. Lewis	35 00	27 00	9 00	2 18

BIOGRAPHICAL SKETCHES AND DESCRIPTION OF YACHTS ENROLLED IN THE CLUB.

WILMOT D. PORCHER, Commodore of the CAROLINA (South) YACHT CLUB, lives in Charleston, S. C., being a native of that city; of Huguenot blood, the son of Francis J. and Louisa Porcher. Commodore Porcher is a rice merchant, and he has owned several yachts, namely, CICALISE, NATALISHRA, AU BEVOIR and his present yacht, KATRINKA. He has been a yachtsman since 1870, and was one of the founders of the CAROLINA YACHT CLUB of Charleston. In this club he has held many offices—Secretary, Vice-Commodore, and his present honorable office, that of Commodore.

KATRINKA.

A centerboard sloop, designed and built by P. McGiehan, Pamrapo, N. J., launched in the Spring of 1886. Built for her present owners—Messrs. W. D. and F. Y. Porcher. She hails from Charleston and has a cabin. Her owners were among the incorporators of the CAROLINA (SOUTH) YACHT CLUB. See Fig. 468.

DIMENSIONS.			
Length over all,	37 feet.	Length load waterline,	32 feet 10 inches.
Depth,	6 feet 10 inches.	Draft,	3 feet 4 inches.
Beam,	12 feet 0 1/2 inches.		

Spars:—Mast, 41 ft.; Topmast, 18 ft. 6 in.; Boom, 35 feet; Gaff, 21 ft. 9 in.; Bowsprit, 30 ft.

Racing Record:

- 1886—CAROLINA YACHT CLUB—Annual Regatta, second. Challenge Pennant Race, first.
 1887—ISLE OF HOPE YACHT CLUB—Regatta, first.
 CAROLINA YACHT CLUB—Annual Regatta, first; Challenge Pennant Race, second, carried away her topmast, lost race by 3 seconds.
 1888—CAROLINA YACHT CLUB—Annual Regatta, second, disqualified. Floral Fair Special Regatta, first. ISLE OF HOPE YACHT CLUB, Regatta, first.
 1889—CAROLINA YACHT CLUB—First Annual Regatta, first. Special Regatta, fourth. Special Regatta, Fourth of July, second. Challenge Pennant, second. Savannah, Ga. Annual Regatta, ran aground while leading the fleet, second.
 1890—CAROLINA YACHT CLUB—Annual Regatta, second. Savannah, Ga. Annual Regatta, second.
 1891—CAROLINA YACHT CLUB—Annual Regatta, second. Inter-State Cup Race, second. Special Race, first.

KATRINKA is claimed while towing a small boat to have covered 16 miles in 1 hr., 29 min.



HENRY W. CONNER, JR., lawyer, Charleston, S. C. Was born in Charleston, and is the owner, with W. B. S. Haywood, of the yacht FLIRT, a centerboard sloop sailing with the CAROLINA (S.) YACHT CLUB, of which both her owners are members. Mr. Conner has been interested in yachting for the past five years.

FLIRT.

A centerboard sloop, built by E. Marks, and launched in 1870, formerly the property of H. M. Tucker, now belonging to W. B. S. Haywood and H. W. Conner, Jr., of Charleston, S. C. Was lengthened 2 1/2 feet on the stern in 1888. Sails with the CAROLINA (SOUTH) YACHT CLUB. See Fig. 469.

DIMENSIONS.			
Length over all,	34 feet.	Length load waterline,	30 feet.
Depth,	3 feet.	Draft,	2 feet 8 inches.
Beam,	10 feet 0 inches.		

Racing Record:

- 1891—CAROLINA (SOUTH) YACHT CLUB—FLIRT won two seconds and one third in the regattas of this club. Third in the Annual

Regatta of June 13th, second in the Inter-State Championship and Challenge Cup Race, and second in the run for the Lowndes Cup and Commodore's Pennant, July 23rd.

CHALLENGE.

An open cat, belonging to Irving Heyward, a member of the CAROLINA YACHT CLUB, with which club she sails. See Fig. 470.

DIMENSIONS.

Length over all,	22 feet 4 inches.	Length load waterline,	20 feet.
Draft,	1 foot 7 inches.	Beam,	8 feet 9 inches.



C. H. GLIDDEN.

C. H. GLIDDEN, Ex-Commodore of the CAROLINA YACHT CLUB. Commodore Glidden has been closely identified with the CAROLINA YACHT CLUB for years and was one of the Committee of Reform in its earliest stages. He is an enthusiastic yachtsman and devoted to the sport. As a writer Commodore Glidden wields an able pen, as he commands a voluminous vocabulary.

Much of the club's success is due to the interest he has manifested in it.



E. H. SIMONS.

E. H. SIMONS, Vice-Commodore of the CAROLINA YACHT CLUB. Com. Simons was elected to office on account of his popularity and for the well known interest he takes in advancing the sport of yachting. He is always ready to perform the functions of his office.

POLLY.

A sloop yacht belonging to A. M. Manigault of the CAROLINA YACHT CLUB, and sails with the fleet of that club. See Fig. 471.

DIMENSIONS.

Length over all,	28 feet.	Length load waterline,	25 feet 8 inches.
Beam,	9 feet 2 inches.	Draft,	2 feet 5 inches.

NAOMI.

A centerboard sloop formerly owned by William Crafts, but now the property of Messrs. Middleton and Harleston. She was built by P. McGiehan, Pamrapo, N. J., hails from Charleston, S. C., was launched in 1885, and sails with the fleet of the CAROLINA YACHT CLUB. See Fig. 472.

DIMENSIONS.

Length over all,	25 feet 5 inches.	Length load waterline,	25 feet 6 inches.
Beam,	10 feet 8 inches.	Draft,	1 foot 6 inches.

MANTTO.

A centerboard cutter designed by William Gardner and built by Wood & Son, City Island, N. Y., now the property of Edward A. Simons, Vice-Commodore of the CAROLINA YACHT CLUB. She was launched in April, 1891, hails from Charleston and sails with the fleet of the CAROLINA YACHT CLUB. See Fig. 473.

DIMENSIONS.

Length over all,	42 feet 2 inches.	Length load waterline,	30 feet.
Beam,	11 feet 8 inches.	Draft,	4 feet 4 inches.

WILD BIRD.

A centerboard sloop built by P. McGiehan, now the property of A. T. Smythe. She hails from Charleston and sails with the fleet of the CAROLINA YACHT CLUB. Was launched in 1887. See Fig. 474.

DIMENSIONS.

Length over all,	30 feet 8 inches.	Length load waterline,	27 feet 6 inches.
Beam,	10 feet 6 inches.	Draft,	2 feet 6 inches.

hampionship
the Lowndes

of the Can-
g. 470.

feet.
feet 5 inches.

Commodore of
CLUB. Com-
pletely identified
CLUB for years
of Reform
an enthusias-
to the sport.
len wields an
voluminous

is due to the
it.

Commodore of
CLUB. Com.
on account of
well known
ng the sport
ready to per-
ce.

A. M. Mani-
IT CLUB, and
t club. See

feet 8 inches.
feet 5 inches.

fts, but now
was built by
, S. C., was
LINA YACHT

feet 6 inches.
foot 6 inches.

and built by
Edward A.
n. She was
hills with the

feet.
feet 4 inches.

roperty of A.
the fleet of
see Fig. 474.

feet 6 inches.
feet 6 inches.



AMERICAN YACHT CLUB HOUSE.

MILTON POINT, RYE, N. Y.

The Atlantic Yacht Club

1880



Date

1880

1880

1880

1880

1880

1880

1880

1880

1880

1880

1880

1880

1880

1880

1880

1880

1880

1880

1880

1880

1880

1880

1880

1880

1880

1880

1880

1880

1880

1880

1880



50;

100.

150.

200.

250.

300.

350.

400.

450.

500.

550.

600.

650.

700.

750.

800.

850.

900.

950.

1000.

1050.

1100.

1150.

1200.

1250.

1300.

1350.

1400.

1450.

1500.

1550.

1600.

1650.

1700.

1750.

1800.

1850.

1900.

1950.

2000.

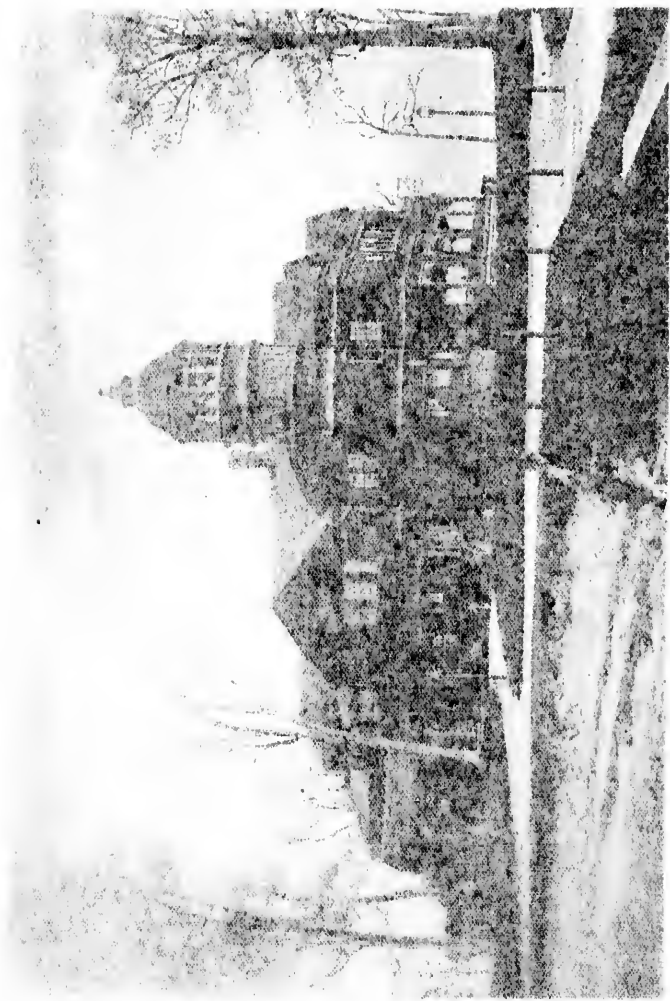

AMERICAN YACHT CLUB HOUSE

The American Yacht Club.

STATION—MILTON POINT, RYE, N. Y.

THE AMERICAN YACHT CLUB was organized May 17, 1883, and was duly incorporated on the 19th of same month. Incorporators were: Geo. S. Scott, Cornelius F. Timpson, Jay Gould, Henry A. Taylor, James B. Houston, Washington E. Connor, William B. Dowd, William P. Clyde, George J. Gould, Rufus

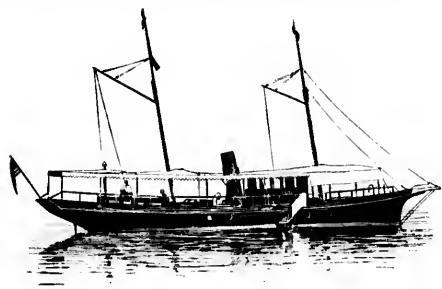

THYRA.—FIGURE 475.

Hatch, Alfred de Cordova, Christopher Meyer, Thomas C. Platt, Jesse R. Grant and Frank R. Lawrence.

The object of the club is to promote social recreation in yachting and encourage yacht building, especially with regard to the development of steam yachting.

The annual meeting and election of officers for the succeeding year is held in the City of New York, on the second Tuesday in February in each year.

The initiation fee for membership is \$100 and yearly dues \$40. The club now numbers about 250 members.

The first Board of Trustees, elected May 31, 1883, consisted of: George S. Scott, Cornelius F. Timpson, Henry A. Taylor, George J. Gould, James B. Houston, Frank R. Lawrence, Wm. B. Dowd.

On June 5, 1883, a Constitution and By-Laws by which the club could be governed were adopted. On the same day Geo. S. Scott was elected Rear-Commodore. No other flag officers were elected until the following year.

The first club rooms of the club were established at No. 80 Madison avenue, where a grand opening was held on the evening of March 1, 1884.

At the first annual meeting held at the club rooms on March 31, 1884, the following officers were elected to serve for the ensuing year:

Commodore,	George S. Scott,	steam yacht	VIKING.
Vice-Commodore,	Alfred de Cordova	" "	PROMISE.
Rear-Commodore,	Cornelius F. Timpson	" "	JULIA.

TRUSTEES.

Jabez A. Bostwick,	steam yacht	ORIENTA.
Joseph C. Hoagland,	" "	LAGONDA.
Henry A. Taylor,	" "	SPHINX.
Alfred de Cordova,	" "	PROMISE.
Cornelius F. Timpson,	" "	JULIA.
William B. Dowd.		
Frank R. Lawrence.		

During the Summer of 1884, what was known as the Greeley Relief Expedition was sent out by the United States Government to search for the Greeley Expedition Party in the Arctic Regions. The chief officers of this expedition were all members of the AMERICAN YACHT CLUB, and through the efforts and influences of the club the interest and efficiency of the expedition were promoted in many ways. On April 23, 1884, a Committee of the club presented to Lieut. W. H. Emory on the deck of the ship BEAR of which he was in command, a full set of No. 5 flags and an AMERICAN YACHT CLUB flag.

On April 28th, similar presentations were made to Commodore Wm. S. Schley on his ship THETIS and on May 9th to Commodore G. W. Coffin on his ship ALERT.

These ships which composed the expedition sailed respectively on the days named, each with an AMERICAN YACHT CLUB flag floating from its mizzen top. Those flags also waved over the dead and dying of Captain Greeley's party when they were discovered and rescued.

The first Regatta Committee consisted of Geo. W. Hall, Chas. H. Haswell, Thomas Manning and the First Annual Regatta and Cruise began on August 7, 1884.

The course was from the anchorages off the Larchmont Club House to the flag staff at Fort Trumbull in New London Harbor, distance by charts 82.25 knots, or 95.6 miles.

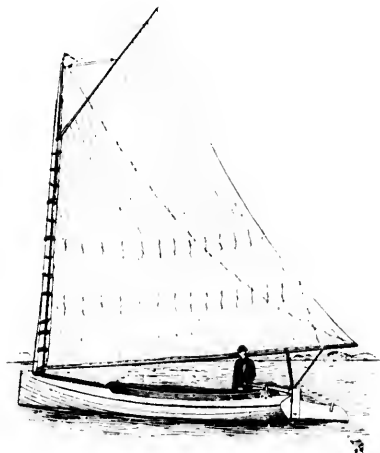

NAHLL.—FIGURE 476.

The names of yachts and times of starting of each were as follows:

First Class.	Start.
Utwana	10 22 50
Atalanta	11 21 35
Yosemite	11 21 15
W. E. Connor	
Geo. J. Gould	
John Roach	

Second Class.

		Start.
		H. M. S.
Petrel	E. M. Field	10 19 30
Sophia	C. H. Osgood	10 20 00
Camilla	F. Brandreth	10 21 00
Natalie	C. F. Timpson	10 21 30
Rival	J. M. Seymour	10 22 00
Sphinx	H. A. Taylor	10 23 30
Promise	A. De Corlova	10 24 30
Vedette	Wm. Bliss	10 24 45

A large club steamer accompanied the fleet, and in order that the members and guests on board of her might better witness the run of yachts, the smaller or second class yachts were started one

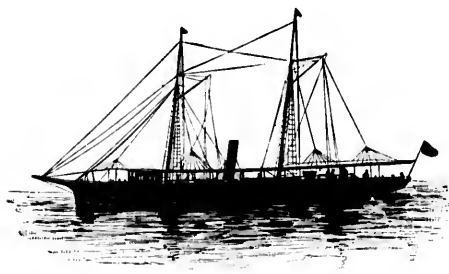

ISOLENE.—FIGURE 477.

hour in advance of those of the first class, thus affording the opportunity for club boats to progressively overtake yachts of the second class, and enable members to note their relative positions.

The time of arrival of each yacht with running and net time was as follows:

	Finished.	Elapsed.	Corrected.
	H. M. S.	H. M. S.	H. M. S.
First Class.			
Atalanta	4 09 15	4 48 45	4 34 35
Yosemite	4 43 20	5 23 05	5 23 50
Utowana	5 00 00	6 37 30	5 52 26
Second Class.			
Vedette	4 43 00	6 15 15	
Sophia	4 45 20	6 25 20	6 25 20
Rival	4 49 20	6 27 20	4 57 31
Promise	5 23 30	6 58 00	5 50 05
Camilla	6 13 00	7 53 00	6 47 01
Sphinx	8 10 00	9 46 30	9 03 47
Petrel	8 30 00	10 10 30	0 27 47

During the evening of the 7th a fine display of fireworks was given in New London Harbor from the decks of the yachts.

The prizes to be awarded were: 1st. To the winning yacht in each class, with time allowances; 2d. To the winning yacht in each class without time allowance.

The prizes were therefore awarded as follows:

One to ATALANTA for the least time in her class with time allowance, and one for the least time without allowance. One to RIVAL for the least time in her class with time allowance, and one to SOPHIA for the least time without allowance.

VEDETTE having run inside of Saratis Ledge, and her time in consequence being protested against, she was ruled out.

The wind during the entire course was fresh ahead, and the light "ebb" at the start, and the "flood" at the end were about balanced in their effects for or against early arrivals.

The Committee were Geo. W. Hall, Chairman, Chas. H. Haswell and Thos. Manning.

In October, 1884, the club removed its quarters to No. 574 Fifth Avenue.

At the second annual meeting and election, held March 31, 1885, the following officers were elected:

Commodore, Alfred De Cordova; Vice-Commodore, Joseph C. Hoagland; Rear-Commodore, Washington E. Connor.

Regatta Committee: Geo. W. Hall, Chairman, Chas. H. T. Collins, Thos. Manning, Richard G. Murphy, John P. Lockwood.

The Second Annual Cruise and Regatta of the club took place on the 16th, 17th and 18th of July, 1885. Yachts were ordered to rendezvous at the anchorage off Larchmont on the 15th; on the 16th the race from there to New London was sailed over the same course as the previous year. On the morning of the 17th, a race between the steam launches and small boats belonging to the yachts of the club took place in New London Harbor, and in the evening of the same day a grand display of fireworks was given from the yachts. On the morning of the 18th, the fleet sailed for Shelter Island and thence to New York.

The fleet of yachts was accompanied on this cruise by a large iron steamboat, with music and all conveniences for the entertainment and comfort of club members and guests.

The prizes for this regatta were awarded by the Regatta Committee on September 21st, as follows:

No. 1. Commodore's Cup, to yacht ATALANTA; Geo. J. Gould.

No. 2. Kinney Cup, to yacht 246; Wm. Cramp.

No. 3. Emery Time Allowance Cup for second class yachts, to yacht RIVAL; J. H. Baker.

No. 4. Emery Time Allowance Cup for third class yachts, to yacht VIOLA; J. P. Kennely.

No. 5. Isherwood Time Allowance Cup, to yacht 246; Wm. Cramp.

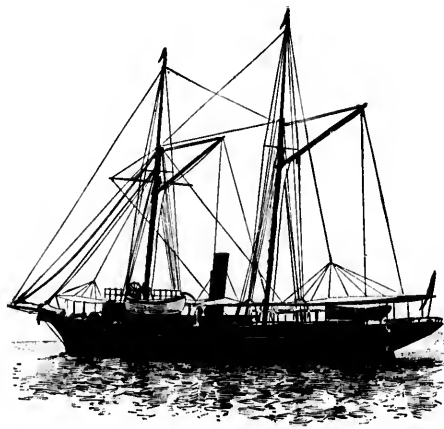

NOOYA.—FIGURE 478.

No. 6. Lundborg Time Allowance Cup, to yacht UTOWANA; W. E. Connor.

No. 7. Bateman Challenge Cup for cutters, to yacht RIVAL; J. H. Baker.

The Chairman of the Regatta Committee was George W. Hall.

At the third annual meeting and election held January 13, 1886, the following named officers were elected:

Commodore	Joseph C. Hoagland; steam yacht LAGONDA.
Vice-Commodore	Arthur E. Bateman; " " LOANDA.
Rear-Commodore	Charles H. Osgood; " " TILLIE.

Regatta Committee: George W. Hall, Chairman; Thos. Manning, Thos. L. Scoville, Edward S. Innet, Ezra S. Connor.

The Annual Cruise and Regatta of the club was held on the 15th, 16th and 17th of July over the regular club course from Larchmont to New London.

The prizes were awarded as follows:

Commodore's Cup	To yacht	ATALANTA.
Haswell Time Allowance Cup	"	INANDA.
Emory Time Allowance Cup (1st class)	"	YOSEMITE.
" " " (2d class)	"	LAGONDA.
" " " (3d class)	"	NERIED.
Alley Cup. Naphtha Launch Race	"	ORIENTA, Launch.

Commodore, Archibald Watt; Vice-Commodore, Charles H. Osgood; Rear-Commodore, Frank R. Lawrence.

Regatta Committee: George W. Hall, Chairman; J. Howard Wainwright, Wm. S. Alley, Ezra S. Connor, Walter J. Pierce.

This year three Special Races were sailed under the auspices of the club, July 4th, 6th and 18th.

Ninth annual meeting, February 9, 1892.

Commodore	Frank R. Lawrence	Steam Yacht	THYRA.
Vice-Commodore	John P. Kennedy	" "	VIOLA.
Rear-Commodore	Sheldon C. Reynolds	" "	SIGMA.

Regatta Committee: George W. Hall, Chairman; Ezra S. Connor, Wm. S. Alley, J. Howard Wainwright, Stephen W. Roach.

Tenth annual meeting, February 11, 1893. The following were elected:

Commodore	Frank R. Lawrence	Schooner Yacht	WAVE CRIST.
Vice-Commodore	John H. Flagler	Steam Yacht	SOLENE.
Rear-Commodore	G. Weaver Loper	" "	AVENEL.

Secretary, Thos. L. Scoville; Treasurer, Geo. W. Hall; Fleet Surgeon, Chas. I. Pardee, M. D.; Measurer, Chas. H. Haswell; Consulting Engineer, George W. Magee, U. S. N.

Regatta Committee: George W. Hall, Chairman, Stephen W. Roach, William S. Alley, Isaiah Paxson, John R. Hegeman, Jr.

ACCORDING TO THE SAILING REGULATIONS.

Allowances of time shall be such as the yacht owners and Regatta Committee shall recommend.

No owner shall be interested in more than one yacht competing for the same prize.

No prize shall be given in any class, unless two or more yachts of that class start in the race.

No sails shall be hoisted in a race unless specially ordered, and then only such sails as may be specified.

During a race every yacht must carry its full complement of serviceable boats, anchors, chains, etc., as per United States Inspection Laws and Requirements.

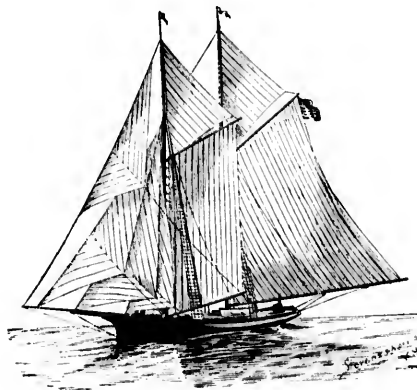

ATALANTA.—FIGURE 479.

The fourth annual meeting and election was held January 18, 1887. The following named officers were elected:

Commodore	William H. Starbuck	Steam Yacht	TILLIE.
Vice-Commodore	Arthur E. Bateman	" "	METEOR.
Rear-Commodore	Charles H. Osgood	" "	NARWHAL.

Regatta Committee: George W. Hall, chairman; Thos. Manning, Thos. L. Scoville, Edward S. Innet, Ezra S. Connor.

In the Spring of this year the club purchased a beautiful site for a Club House, consisting of about fifteen acres of ground, at Milton Point, on Long Island Sound, Town of Rye, N. Y.

On this fine Club House was constructed and no expense has been spared in beautifying the grounds.

At the fifth annual election, held January 17, 1888, the following officers were elected:

Commodore	William H. Starbuck	Steam Yacht	TILLIE.
Vice-Commodore	John R. Andrews	" "	NORA.
Rear-Commodore	Charles H. Osgood	" "	NARWHAL.

Regatta Committee: George W. Hall, Chairman; Edward S. Innet, Thomas S. Scoville, Ezra S. Connor, William Weber.

Regatta was held July 8, 1889.

The seventh annual election, January 21, 1890.

Commodore	William H. Starbuck	Steam Yacht	TILLIE.
Vice-Commodore	Charles H. Osgood	" "	NARWHAL.
Rear-Commodore	Frank R. Lawrence	Schooner	SIREN.

Regatta Committee: George W. Hall, Chairman; Thomas L. Scoville, Wm. S. Alley, Ezra S. Connor, J. Howard Wainwright.

The Annual Regattas were held July 5th and 7th.

The eighth annual meeting and election was held January 20, 1891.

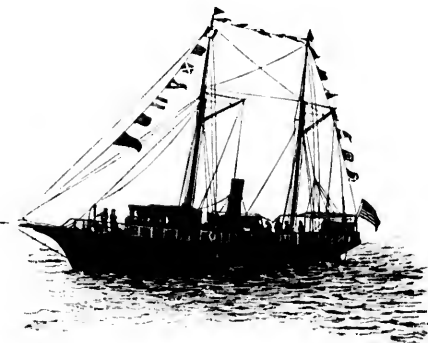

THERESA.—FIGURE 480.

Owners of yachts shall forfeit their membership in the club and their right to any prize if the amount of steam carried shall be in excess of that allowed by the Inspector's Certificate.

The owner, or a member of the club, must be on board of any yacht sailing for a prize, who shall be responsible to the club for her obedience to these rules.

No vessels will be allowed to compete as yachts unless designed and used exclusively for pleasure purposes. Each must carry masts, gaffs

and sails, of dimensions proportionate to the size of the yacht. Sails must be on board and in place.

Vessels not recognized as yachts under this rule can be classified separately at the discretion of the Regatta Committee.

AMERICAN YACHT CLUB INTERNATIONAL CHALLENGE CUP.

Any organized yacht club of a foreign country, incorporated, patented or licensed by the Legislature, Admiralty, or other executive department, having for its Annual Regatta an ocean water course on the sea or on arms of the sea, or one which combines both, shall be always entitled, through one or more of its members, to the right of sailing a match for this cup with a yacht propelled by steam, with or

In case the parties cannot mutually agree upon the terms of the match, then the challenging party shall have the right to contest for the cup in one trial sailed over the usual course of the Annual Regatta of the club holding the cup, subject to its rules and sailing regulations.

Accompanying the six months' notice there must be a Custom House certificate of measurement.

No vessel which has been defeated in a match for this cup can be

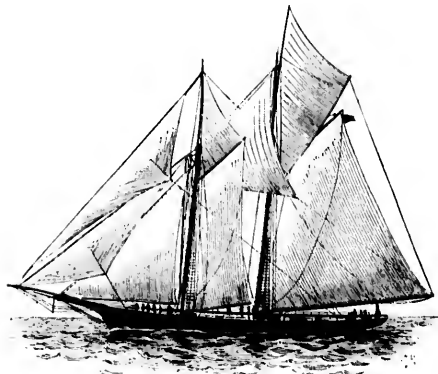

INTREPID.—FIGURE 481.

without the aid of sails, constructed in the foreign country aforesaid, against any one or two yachts constructed in the country of the club holding the cup.

The challenging party shall give six months' notice, naming the day for the proposed race, which day shall not be later than seven months from the date of the notice.

The parties intending to sail for the cup may, by mutual consent, make any arrangement satisfactory to both as to the date, course, time allowance, number of trials, and any other conditions of the match, in which case also, the six months notice shall be waived.

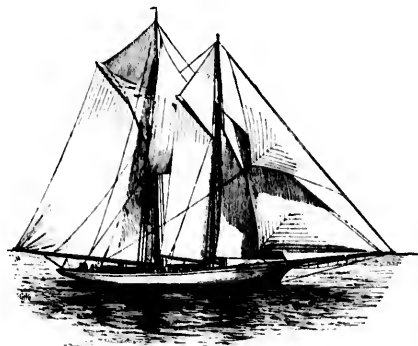

SHAMROCK.—FIGURE 482.

again selected by any club for its representative until after a contest for it by some other vessel.

Vessels intending to compete for this cup must proceed on their own bottom to the port where the contest is to take place.

Should the club holding the cup be for any cause dissolved, the cup shall be handed over to any yacht club of the same nationality it may select, which comes under the foregoing rules, and in case there should not exist any such club, then the cup shall be returned to its original owners, the AMERICAN YACHT CLUB, or in accordance with its directions.

It is to be distinctly understood that the cup is to be the property of the club, and not of the owners of vessels winning it in a match, and that the condition of keeping it open to be sailed for by organized yacht clubs of all foreign countries upon the terms above stated, shall forever attach to it, thus making it perpetually a Challenge Cup for friendly competition among nations.

LIST OF YACHTS ENROLLED IN THE AMERICAN YACHT CLUB, 1893.

STEAM YACHTS.

NAME.	OWNER.	PORT.	Length over	Length on	Beam.	Depth.	Mast, Yawl	Tons.		Horse-Power.	International
			all.	Load				Grass.	Net.		
			ft.	ft.	ft.	ft.	ft. in.				Letters.
Allela	H. M. Flagler	New York	184.0	160.0	24.0	13.6	10 08	301.80	195.80	950
Atalanta	George J. Gould	"	248.23	228.75	20.5	16.0	11 03	565.47	281.25	1,821	KBJW
Avenel	G. Weaver Loper	"	143.8	100.6	18.0	11.0	9 03	116.65	66.23	375	KFGM
Claris	W. C. Carnegie	Pittsburgh, Pa.	40.0	36.0	8.3	3.6	2 06
Columbia	J. H. Ladew	New York	194.6	180.0	21.0	14.3	10 00 ₂	1,840	JWCH
Conqueror	F. W. Vanderbilt	"	201.0	188.0	24.7	13.5	13 00	386.18	174.50
Cosette	F. L. Osgood	Norwich, Conn.	97.0	81.1	12.6	7.8	5 06	42.68	21.30	150	KULP
Evelyn	J. H. Hageman, Jr.	New York	85.0	72.0	13.1	7.0	5 11	61.00	28.11	300	KLGG
Galvota	John R. Dos Passos	"	77.2	14.7	51.19	30.24
Golden Rod	Archibald Watt	"	100.0	136.6	21.6	14.1	11 03	194.48	97.25	430	KTGP
Hirondelle	Calch G. Evans	"	75.0	69.0	11.0	4 06
Idler	W. C. McMillan	Detroit, Mich.	126.0	95.0	15.6	7.6	5 00	57.29	41.40	320
Impatient	W. M. Slingerly	Philadelphia, Pa.
Isolene	J. H. Flagler	New York	134.0	110.0	16.2	6.7	6 04	62.09	45.13	240	JVTR
Lancet	P. J. McCourt	"	40.0	38.0	7.6	4.0	2 06	5.09	28
Lina	S. W. Roach	Perth Amboy	73.0	70.0	13.6	5.0	4 08	31.65	20.53	40
Loando	T. H. French	New York	98.6	90.4	16.6	5.2	6 08	42.96	27.16	KUGF
Madge	Chas. Ward	Charleston, W. Va.	30.0	28.0	6.6	0.30	0 22
Manatee	H. C. Diston	Philadelphia, Pa.	82.0	75.5	15.6	7.7	6 00	41.44	23.35	160
Narwhal	C. H. Osgood	New London, Conn.	145.0	130.0	18.4	11.0	7 06	137.37	68.61	KWPF
Onelda	E. C. Benedict	New York	138.0	126.5	20.5	10.5	8 06	141.38	71.20	430	KJND
Oriente	E. R. Ladew	"	125.0	117.0	17.0	8.5	7 00	95.90	54.14	348	JWGB
Puzzle	A. B. Claffin	"	96.0	85.0	16.0	6.2	4 06	54.51	30.58	KDLP
Romola	J. Pulitzer	"	180.4	173.7	20.1	15.7	13 05	451.24	240.24	110	KJMC
Shearwater	H. R. Wolcott	"	134.0	108.0	18.0	8.7	6 06	109.01	55.02	KGTQ
Sigma	S. C. Reynolds	Toledo, O.	154.0	130.0	21.0	10.3	8 00	158.58	100.26
Sindbad	H. Osborn	New York	42.0	39.0	8.8	3.9	3 02	6.79
Sparkle	W. M. Slingerly	Philadelphia, Pa.	60.0	54.0	13.3	6.0	1 06	26.40	13.20
Susquehanna	J. Stiekney	New York	170.0	152.0	22.0	13.0	9 10	223.32	116.06	300	KJVP
Theresa	G. Siedenbery	"	95.6	78.0	15.6	9.0	6 00	61.35	33.13	KLEH
Tillie	W. H. Starbuck	"	177.0	158.0	19.0	11.0	9 00	241.32	100.66
Vamoose	W. R. Hearst	San Francisco, Cal.	112.6	109.4	12.4	6 11
Veto	George Law	New York	115.0	98.0	17.2	7.5	5 08	75.00	52.00	170	KHOV
Viola	Frank Willis Hawley	"	73.0	63.0	12.6	6.6	0 09	23.43	11.72	80	KDHR

LIST OF YACHTS ENROLLED IN THE AMERICAN YACHT CLUB, 1893.

SAILING YACHTS.

NAME.	Rtg.	OWNER.	PORT.	Length.		Beam.	Hold.	Draft.	Tons.		International Code Signal Letters.
				ft.	in.				Gross.	Net.	
Atlanta	Schooner	F. W. Savin	New York	90.0	86.7	23 5	7 11	7 3	86.00	81.70
Columbia	"	J. T. Perkins	Brooklyn	107.11	90.0	25 1	8 3	6 0	106.35	KCFH
Hildegarde	"	George J. Gould	New York	112.0	104.0	20 0	11 9	13 0	18.4	SVMQ
Her Highness	"	Richard Mansfield	"	66.0	62.0	17 0	7 0	HJHJ
Intrepid	"	T. L. Watt	"	113.8	101.7	24 1	11 2	12 2	117.57	111.70	JSVT
Julie	Sloop	H. F. Downing	Rye	22.6	9 4
Kingfisher	Cat	C. H. Osgood	Norwich, Conn.	28.0	12.0	4 0
Magie	Schooner	A. W. Mott	New York	84.6	78.10	20 10	6 0	7 10	46.77	44.43
Mistral	Sloop	Chas. T. Willis	"	39.0	31.8	14 6	4 6
Nahli	"	W. E. Conner	"	24.8	24.7	11 10	1 7
Nahma	"	W. I. Quintard	"	36.0	30.6	10 0	6 3
Osprey	Schooner	Archibald Watt	"	59.9	51.0	10 0	6 6	7 2	30.35	29.01
Peri	Sloop	C. McK. Leoser	"	41.7	36.10	14 2	5 6	5 3
Poningo	"	S. Wainwright	Milton Harbor	21.0	19.6	10 0
Sahib	"	W. S. Alley	New York	23.0	21.0	10 6	2 0
Siren	Schooner	J. K. Emmet	"	82.7	73.9	19 2	5 3	6 1	44.88	42.04
Tantog	Cat	C. H. Osgood	Norwich, Conn.	21.0	19.3	8 6	2 0
Viola	Sloop	C. N. Wayland	New York	50.0	44.0	14 0	5 0	4 0	17.02	10.17
Wanderer	Cat	C. H. Osgood	Norwich, Conn.	20.0	9.0	3 0
Wave Crest	Schooner	F. H. Lawrence	New York	91.0	84.3	23 0	7 0	7 0	61.82	60.63	KCFM
Wizard	Sloop	Ernest Staples	"	63.0	58.0	18 4	7 2	6 5	35.54	33.76
Zelica	Cat	H. A. Sherman	Rye	19.0	19.0	8 10	2 0

NAPHTHA YACHTS.

NAME.	OWNER.	PORT.	LENGTH.
Adroit	Clement Gould	New York	40 feet
Ameriean Yacht Club	Ameriean Yacht Club	Milton Point, N. Y.	30 "
Aphrodite	J. Walter Thompson	New London, Conn.	35 "
Dorothy	William P. Hall	Greenwich, Conn.	40 "
Fakir	Chas. H. Osgood	Norwich, Conn.	40 "
Isolene	J. H. Flagler	New York	25 "
Marguerite	H. F. Downing	Rye, N. Y.	25 "
Mariana	Jordan L. Mott	Milton Point, N. Y.	30 "
Maspeth	John N. Myer	Brooklyn, N. Y.	25 "
Mattie W.	J. W. Grindle, M. D.	New York	31 ft. 2 in.
Myra	T. R. Pickering	Portland, Conn.	35 feet
Onaida	E. C. Benedict	New York	26 "
Rita	George Lowther	Riverside, Conn.	40 "
Sirocco	C. N. Wayland	New York	22 "
Tiiania	O. E. Cromwell	Rye, N. Y.	31 "
White Cap	W. V. Brokaw	New York	30 "

Tons.	Net.	International Call Letters
81.70	
....	KCFH
....	SVMQ
....	HRH
111.70	JSVT
....	
....	
44.43	
....	
....	
....	
59.03	
....	
....	
....	
42.64	
....	
10.17	
....	
60.63	KCFM
33.76	
....	



COMMODORE FRANK R. LAWRENCE,

AMERICAN YACHT CLUB.

BIOGRAPHICAL SKETCHES AND DESCRIPTION OF YACHTS ENROLLED IN THE CLUB.

FRANK R. LAWRENCE, Commodore of the AMERICAN YACHT CLUB. Commodore Lawrence has held the office of Commodore for several years, being elected to office on account of the continued activity he has manifested in the advancement of the best interests of the AMERICAN YACHT CLUB. He has been the owner of several steam and sail yachts and has also chartered different yachts from time to time. The flag ship of the club during the season of '93 was WAVE CREST.

The Commodore is a lawyer of prominence, having an extensive practice. His high position as a leader of the Masonic Order makes him well known all over the United States and Europe.

THYRA.

A screw schooner owned by Rev. John A. Aspinwall of New York City, formerly the property of Commodore Frank R. Lawrence of the AMERICAN YACHT CLUB. Was designed by C. D. Miller and built by J. Buckhout, Poughkeepsie, N. Y., and was launched in 1887. Hails from New York City and sails with the fleets of the AMERICAN, SHELTER ISLAND and ATLANTIC YACHT CLUBS. See Fig. 475.

Official number, 145,469.

DIMENSIONS.			
Length over all,	76 feet.	Length load waterline,	66 feet.
Depth,	7 feet 1 inch.	Draft,	5 feet 4 inches.
Beam,	11 feet.		

Engine : Compound inverted, two cylinders, 8 and 14 x 14 inch. Herreshoff M'g Co.

Boiler : Square, built by Herreshoff in 1890.

WASHINGTON E. CONNOR, New York City; born in New York City. Retired from active business in 1886. Has been interested in yachting for fourteen years, and has been for nine years a trustee of the AMERICAN YACHT CLUB. Was Rear-Commodore of the AMERICAN and BOSTON YACHT CLUBS in 1884. Has owned SPHINX, UTOWANA and his present yacht NAHLI. He recently sold UTOWANA to E. C. Benedict, and she is now known as ONEIDA. Mr. Connor was largely instrumental in the organization of the AMERICAN YACHT CLUB. Is a member of the LAUCHMONT, AMERICAN and BOSTON YACHT CLUBS.

NAHLI.

A centerboard sloop owned by Washington E. Connor, New York City. NAHLI was built by C. A. Willis, Port Washington, N. Y., and launched in 1886. She hails from New York and sails with the fleets of the BOSTON, LAUCHMONT and AMERICAN YACHT CLUBS. See Fig. 476.

DIMENSIONS.			
Length over all,	24 feet 7 1/2 inches.	Length load waterline,	24 feet 7 inches.
Draft,	1 foot 7 inches.	Beam,	11 feet.



JOHN H. FLAGLER.

JOHN H. FLAGLER, capitalist, New York City; Vice-Commodore of the AMERICAN YACHT CLUB. Owner of the steam-yacht ISOLENE and has also owned the yacht-launch of the same name, the former being his present yacht. Has been a yacht'sman for twenty years and is a member of the NEW YORK and AMERICAN YACHT CLUBS.

ISOLENE.

ISOLENE was formerly called GLEAM. She is a composite screw schooner, designed and built by the Herreshoffs, and launched in 1880. Was

completely rebuilt in 1892. For the past five years has been the property of John H. Flagler, New York City. She sails with the New York and AMERICAN YACHT CLUBS, hailing from New York. See Fig. 477.

CODE SIGNAL LETTERS, J. V. T. R.

Official number, 85,613.

DIMENSIONS.			
Length over all,	134 feet.	Length load waterline,	116 feet.
Depth,	6 feet 2 inches.	Draft,	6 feet 4 inches.
Beam,	17 feet.		

Engine : Compound Herreshoff, two cylinders, 10 1/2 and 18 x 18 inch. Indicated horse power, 200.

Boiler : One tubular boiler, designed by present owner, built by Herreshoff.

Speed of 19 miles per hour.

NOOYA.

NOOYA is a steel screw schooner, formerly LA FOLLETTE but originally NOOYA. Was altered and partly rebuilt in 1885 by Poillon Bros. She was built by Laird Bros., Birkenhead, England, and was launched in 1870. She belongs to E. Livingston, hails from New York and sails with the fleets of the AMERICAN (of Rye) YACHT CLUB and the ROYAL NOVA SCOTIA YACHT SQUADRON. See Fig. 478.

DIMENSIONS.			
Length over all,	127 feet.	Length load waterline,	104 feet 3 inches.
Beam,	18 feet 2 1/2 inches.	Depth,	9 feet 8 inches.
Draft,	10 feet.		

Engines : Compound inverted, two cylinders, 19 and 33 x 14 1/2 inch. Seardon Bros., England.

Boilers : Horizontal Return Tubular, 92. National Boiler Works, East Boston, Mass.

AVENEL.

The screw schooner AVENEL, formerly NAHOB, the property of John H. Hanan, New York City, a member of the ATLANTIC, LAUCHMONT and NEW YORK YACHT CLUBS. She was designed and built by Thomas Durand, Brooklyn, N. Y., in 1888. Was sold to E. M. Fulton, Jr., then to G. W. Loper. Now hails from New York. See plate LXXIX.

CODE SIGNAL LETTERS, K. F. G. M.

Official number, 130,408.

DIMENSIONS.			
Length over all,	121 feet.	Length load waterline,	105 feet.
Depth,	10 feet 5 inches.	Draft,	7 feet 6 inches.
Beam,	18 feet.		

Engine : Quadruple expansion condensing, four cylinders, 8, 12, 16 and 24 x 18 inch. Wells Engine Co.

Boiler : Pipe, Ward, West Virginia.

ATALANTA.

ATALANTA is a centerboard schooner owned by F. W. Savin of New York City. She was built by David Carl, City Island, N. Y., in 1873. Hails from New York City and sails with the fleet of the AMERICAN YACHT CLUB. See Fig. 479.

Official number, 105,389.

DIMENSIONS.			
Length over all,	93 feet 6 inches.	Length load waterline,	86 feet 7 inches.
Depth,	7 feet 8 inches.	Draft,	8 feet 6 inches.
Beam,	23 feet 5 inches.		

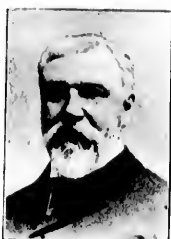

THOMAS L. SCOVILLE.

THOMAS L. SCOVILLE, merchant in brass goods. Secretary of the AMERICAN YACHT CLUB. Mr. Scoville is a man highly respected by the members of the club of which he has the honor of being Secretary. He superintends and discharges the duties of the office with efficiency and does all he can to advance the best interests of the club.



GUSTAVUS SIEDENBERGH.

GUSTAVUS SIEDENBERGH, manufacturer, New York City, was born in Germany of German parentage, the son of William Siedenbergh. He has been the owner of the steam yacht *VOLANTE* and is the present owner of the steam yacht *THERESA*. He has been interested in yachting for about four years. Is a member of the AMERICAN YACHT CLUB.

THERESA.

Screw schooner; the property of G. Siedenbergh, New York City; was designed by Henry I. Gielow and was built by C. R. Poillon, Brooklyn, N. Y. Launched February 20, 1892. She has a flush deck; state rooms and two saloons. Hails from New York. See Fig. 480.

CODE SIGNAL LETTERS, K. L. F. R.

Official number, 145,617.

DIMENSIONS.

Length over all,	93 feet.	Length load waterline,	82 feet.
Depth,	9 feet.	Draft,	6 feet.
Beam,	15 feet.		

Engines: High pressure, Wheeler; surface, condensing, two cylinders, 9 $\frac{1}{2}$ and 18 x 14 inch. Built by G. J. Sullivan, New York.



JOSEPH STICKNEY.

Boiler: Roberts, water tube.

SUSQUEHANNA.

SUSQUEHANNA is a steel screw schooner, designed and built by the Harlan & Hollingsworth Co., Wilmington, Del., and launched in 1887. Owned by Joseph Stickney of New York City. Hailing from New York and sailing with the AMERICAN YACHT CLUB. See plate LXXVIII.

CODE SIGNAL LETTERS, K. D. V. P.

Official number, 116,170.

DIMENSIONS.

Length over all,	150 feet.	Length load waterline,	151 feet.
Depth,	11 feet 4 inches.	Draft,	9 feet.
Beam,	21 feet 7 inches.		

Engine: Triple expansion, vertical, direct acting, three cylinders, 17, 28 and 42 x 22 inch. Indicated horse power, 800.



ARCHIBALD WATT.

Boiler: One tubular. Both engine and boiler built by Harlan & Hollingsworth Co.

GOLDEN ROD.

GOLDEN ROD is a screw schooner, formerly known as *METEOR*. Designed by J. E. Moulton and built by J. E. Smith, Nyack, N. Y., in 1882. Is owned by Archibald Watt of New York City; hails from New York and sails with the AMERICAN YACHT CLUB. See plate LXXX.

CODE SIGNAL LETTERS, K. T. G. P.

Official number, 91,521.

DIMENSIONS.

Length over all,	151 feet 6 inches.	Length load waterline,	136 feet 6 inches.
Depth,	14 feet 4 inches.	Draft,	11 feet.
Beam,	22 feet.		

Engine: Condensing vertical triple expansion, three cylinders, 15, 22 $\frac{1}{2}$ and 37 $\frac{1}{2}$ x 26 inch. Nominal horse power, 350. Built by Cross, Bath, Maine, in 1885.

Boiler: Coil boiler, built by Ward of Virginia in 1890.

INTREPID.

A keel schooner, owned by Thomas Watt, of New York City. Was designed by A. Cary Smith, and built by C. & R. Poillon of Brooklyn. Launched in March, 1878. For some time the property of Lloyd Phoenix. Was given new rail, bulwarks, etc., in 1887; new keel in 1888; poop cabin in 1888; and a new deck in 1890. Hails from New York and sails with the yachts of the AMERICAN YACHT CLUB. See Fig. 481.

CODE SIGNAL LETTERS, J. S. V. T.

Official number, 100,214.

DIMENSIONS.

Length over all,	113 feet 5 inches.	Length load waterline,	101 feet 7 inches.
Depth,	11 feet 2 inches.	Draft,	12 feet 2 inches.
Beam,	21 feet 1 inch.		

SHAMROCK.

Formerly a sloop. She was designed by J. Rogers Maxwell and was built by Mumm & Wintringham in 1887. She was altered to a schooner rig in 1892 by Wintringham. Is now owned by Willard P. Ward, of New York, from which port she hails. See plate LXXVII and Fig. 482.

CODE SIGNAL LETTERS, K. D. R. L.

Official number, 116,151.

DIMENSIONS.

Length over all,	82 feet.	Length load waterline,	68 feet 5 inches.
Depth,	7 feet 8 inches.	Draft,	8 feet 6 inches.
Beam,	20 feet 2 inches.		

Racing Record:

1891—ATLANTIC YACHT CLUB—SHAMROCK won in her class in the Twenty-Sixth Annual Regatta, sailed June 16.

1892—NEW YORK YACHT CLUB—Beat MARGUERITE, Regatta June 9th. Second in the Squadron Run of August 3d, MARGUERITE first, beating IROQUOIS and OENONE. Third in the run of August 4th.

ATLANTIC YACHT CLUB—Beat MARGUERITE in the Twenty-Seventh Annual Regatta, June 14th.

LARCHMONT YACHT CLUB—Won in Fall Regatta, September 10th, beating IROQUOIS and ATLANTIC. Third in the contest for the Larchmont Schooner Cup, September 13th.

One tubular. Both engine
built by Harlan & Hollings-

GOLDEN ROD.

ROD is a screw schooner, form-
erly known as MERRON. Designed by
and built by J. E. Smith,
N. Y., in 1882. Is owned by
Yacht Club of New York City; hails
from New York and sails with the AMER-
ICAN YACHT CLUB. See plate LXXX.
S. K. T. G. P.
101,521.

and waterline, 136 feet 6 inches.
11 feet.

expansion, three cylinders,
horse power, 350. Built by

Virginia in 1890.

tt, of New York City. Was
J. & R. Poillon of Brooklyn.
time the property of Lloyd
etc., in 1887; new keel in
in 1890. Hails from New
AMERICAN YACHT CLUB. See
S. Y. T.
314.

waterline, 101 feet 7 inches.
12 feet 2 inches.

y J. Rogers Maxwell and
1887. She was altered to a
is now owned by Willard
hails. See plate LXXVII
D. R. L.
51.

waterline, 68 feet 5 inches.
8 feet 6 inches.

won in her class in the
June 16.

MARGUERITE. Regatta June
August 3d. MARGUERITE
Third in the run of Au-

in the Twenty-Seventh

Regatta, September 10th,
d in the contest for the
10th.



COMMODORE C. H. SHACKFORD,
AMERICAN YACHT CLUB, (SEWBURYPORT).

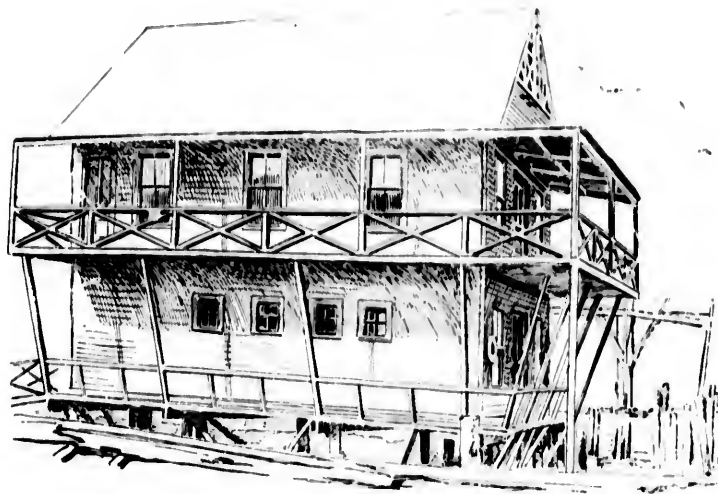

AMERICAN YACHT CLUB HOUSE.

History of the American Yacht Club.

STATION—NEWBURYPORT, MASS.

ON the evening of March 17, 1885, a party of fifteen enthusiastic yachtsmen assembled at the "Brown Square" hotel for the purpose of organizing a yacht club. After some discussion, Mr. E. P. Pride was elected Chairman and Mr. W. C. Thompson Secretary of the meeting. A committee was appointed to draw up a Constitution and By-Laws, after which the meeting was adjourned, subject to a call of the Chairman.

The party re-assembled on March 27th and held the first meeting, organizing and adopting a Constitution and By-Laws. The following officers were elected: Commodore, E. P. Pride; Vice-Commodore, D. B. Pierce; Fleet Captain, Joseph Perkins; Secretary, W. J. Creasey; Treasurer, W. C. Thompson; Measurer, John A. Pearson. At this meeting the initiation fee was placed at the sum of \$1, and yearly dues \$3. In April following, eleven new members were voted in, and the admission fee was raised to \$2, the yearly dues remaining as before.

At one meeting held in March, 1886, twenty new members were accepted. The annual meetings of the club were held the first Monday in March, but in January, 1889, it was decided that the same be changed to the first Monday in January. In December, 1886, the dues were raised to \$4 in consideration of the advanced privileges to be derived.

At the time of organization this club had a strong head tide to stem. The rooms procured for quarters, after being put into shape for the club, had to be surrendered, on account of being too closely connected with a religious society; but the members rallied with true yachtsmen's spirit, and procured a suite of rooms on State street, consisting of a meeting room, billiard and card-room, parlor, banquet

hall and cook room, making very pleasant winter quarters. During the winter, the members entertain select assemblies with whist parties and have occasional suppers.

In November, 1886, the club gave a grand ball in aid of the East-port sufferers which netted something like \$300. On March 18, 1889, the club was admitted to the NEW ENGLAND YACHT RACING ASSOCIATION, and held its membership until the disbandment of the said association, in May, 1891. In 1887, the club was presented with a valuable set of charts of the whole Eastern Coast by Honorable E. F. Stone.

The officers elected in 1886 were: Commodore, E. P. Pride; Vice-Commodore, D. B. Pierce; Fleet Captain, Chas. Willis; Secretary, W. J. Creasey; Treasurer, W. C. Thompson; Measurer, William Bowen.

	1887.	1888.	1889.
Commodore	Irvin Besse	Irvin Besse	E. G. Woodwell
Vice-Commodore	E. P. Price	E. G. Woodwell	E. T. Choute
Fleet Captain	D. B. Pierce	D. B. Pierce	C. H. Shackford
Secretary	F. B. Fanning	F. B. Fanning	E. N. Follandsbec
Treasurer	E. G. Woodwell	B. F. Gorrish	B. F. Gorrish
Measurer	L. W. Redgrass	W. T. Lamt	H. T. Mooly
	1890.	1891.	1892.
Commodore	E. G. Woodwell	W. H. Noyes	Irvin Besse
Vice-Commodore	Irvin Besse	C. H. Shackford	C. H. Shackford
Fleet Captain	C. H. Shackford	D. B. Pierce	N. D. Rodgrass
Secretary	E. N. Follandsbec	E. N. Follandsbec	E. N. Follandsbec
Treasurer	E. H. Colby	E. H. Colby	H. W. Bayley
Measurer	G. W. Marquand	G. W. Marquand	S. H. Goodwin

Commodore	1891.	C. H. Shackford
Vice-Commodore		N. D. Rodgrass
Fleet Captain		P. J. Lowell
Secretary		E. N. Follandsee
Treasurer		H. W. Bayley
Measurer		C. E. Stone

In 1890, owing to the increase in membership, it became quite evident that the club would need a Club House to properly meet the demands during the Summer. During the administration of Commodore E. G. Woodwell, the club became incorporated on May 20, 1890; at the same time the initiation fee was raised to \$5 and the yearly dues to \$5. Bonds were issued and the club erected a Club House on the bank of the Merrimac River, pleasantly situated overlooking the harbor and commanding an ocean view of more than 15 miles around. A large "floating stage" supplies the wants of the yachtsmen, and there is good anchorage for 150 or 200 feet in front and to the southeastward of the house. Since the Club House was erected, the membership has steadily increased and is to-day in the neighborhood of 110, with the club in a very prosperous condition. It has won for itself a record among the clubs of the Eastern shore, and is second to none in its hospitality toward visiting yachtsmen.

This club has held some very interesting and successful races; a record of which is given below:

RECORD OF RACES.

1885.

On June 17, a Pennant Race was held which proved a success in every way. The winners were **BESSIE ETHEL** in first class; **J. S. POYEN, JR.** in second class; **PERT** in third class.

The first Grand Open Regatta was sailed October 1, 1885, and was quite interesting. The day was all that could be desired; the river front was lined with spectators. The winners in each class were as follows:

First class: **TORMENT** first prize; **VICI** second prize.
 Second class: **BANNERET** first prize; **J. S. POYEN, JR.** second prize.
 Third class: **WHITE CLOUD** first prize; **JUNO** second prize.
 Fourth class: **PERT** first prize; **IVORY SOAP** second prize.

1886.

The races this year were not so successful, only two being sailed out of the scheduled list. The first was held on June 17th, and was won by the following:

First class: **GRACIE G.** first prize.
 Second class: **FREAK** first prize.

On August 22d, only five yachts started: **WHITE CLOUD**, **DOT**, **FREAK**, **ARIAEL** and **TEASER**. There was such a heavy sea on the bar that **WHITE CLOUD** was the only boat to cross and sail over the course. She was declared the winner.

1887.

This year the club held a series of five races, awarding four prizes, the boats making the best percentage taking the prizes in order. The First Race was sailed June 11th. The winners were:

THORN first, **BUDGE** second, **WHITE CLOUD** third, **TEASER** fourth.
 The Second Race was held July 9th, resulting as follows:
WHITE CLOUD first, **THORN** second, **BUDGE** third, **FREAK** fourth, **TEASER** fifth.

The Third Race was held on August 8th, these being the winners:
WHITE CLOUD first, **THORN** second, **BUDGE** third, **TEASER** fourth, **FREAK** fifth.

The Fourth Race was sailed on August 19th, and was won by:
WHITE CLOUD first, **THORN** second, **BUDGE** third, **FREAK** fourth, **TEASER** fifth.

The Fifth and last Race was held on September 4th, and the winners in this race were:

BUDGE first, **THORN** second, **TEASER** third, **WHITE CLOUD** fourth.
 The prizes for the series were awarded as follows:
 First prize, **THORN**, silver cup valued at \$40.
 Second prize, **BUDGE**, silver cup valued at \$25.
 Third prize, **WHITE CLOUD**, butter dish valued at \$12.
 Fourth prize, **TEASER**, silver vase valued at \$9.

1888.

A series of three Club Races and one Open Regatta were held this year. The winners in the First Race, sailed June 17, were:

WHITE CLOUD first, **HAZARD** second, **BUDGE** third, **TEASER** fourth.

The Second Race was sailed on July 14th, resulting as follows:
HAZARD first, **WHITE CLOUD** second, **BUDGE** third, **PUZZLER** fourth.

A Third Race was sailed July 28th, in a heavy gale. **WHITE CLOUD** broke a boom on the start, thereby disabling her. The prizes were awarded as follows:

HAZARD first prize; **BUDGE** second prize; **PUZZLER** third prize.

The Grand Open Regatta of '88 was in every respect even more of a success than the first, with yachts from neighboring cities to the number of fifty or more, and about forty starters. The results were:

First class: **MIGNON** first, **HAZARD** second.
 Second class: **WHITE CLOUD** first, **CLIMAX** second, **BUDGE** third.
 Third class: **ALPINE** first, **PERT** second, **ELF** third.

1889.

A series of three races was held this season; the first on June 17th. The winners were:

First class: **HAZARD** first, **WHITE CLOUD** second, **VEXER** third.
 Second class: **GEM** first, **HUSTLER** second, **ACME** third.

The Second Race was sailed July 8th. The winners were:

First class: **BUDGE** first, **VEXER** second, **HAZARD** third.

Second class: **GEM** first, **CUCKOO** second.

The Third Race was sailed July 20th. The following yachts won:

First class: **HAZARD** first, **BUDGE** second, **VEXER** third.

Second class: **GEM** first, **CUCKOO** second.

The prizes were awarded as follows: **HAZARD** first, and **BUDGE** second in first class; **GEM** took first prize, and **CUCKOO** second prize in second class. The third Open Regatta was sailed August 19th; the following yachts took prizes:

First class: **HAZARD** first, **BLACK CLOUD** second.

Second class: **CLIMAX** first, **LARK** second, **WHITE CLOUD** third.

Third class: **MADCAP** first, **VOMA** second, **ME TOO** third.

1890.

Three races were sailed, the first on July 26th.

HAZARD first, **ALPINE** second.

The second: **HAZARD** first; **GLEAM** second; **VEXER** third.

The third: **ALPINE** first; **PERT** second; **HUSTLER** third.

The first prize was given to **HAZARD**, the second to **Alpine**.

The Fourth Annual Regatta took place August 18th.

First Class: **HAZARD** took first prize, **SADIE B.** second prize.

Second Class: **GLEAM** took first prize; **VEXER** second, and **GOOD LUCK** third.

Third Class: **ALPINE** took first prize, **SASSACUSS** second and **CRICKET** third.

1891.

The only race sailed this year was the Fifth Open Regatta, which was held August 10th. The prize winners were:

First Class: **HAZARD** first; **BLACK CLOUD** second; **ARGUSTA** third.

Second Class: **MAUD S.** first; **GLEAM** second; **MAVIS** third.

Third Class: **ALPINE** first; **PERT** second; **WYMYMA** third.

THE YACHTS AND YACHTSMEN OF AMERICA.

515

SEASON OF 1892.

A series of three races, the Sixth Annual Regatta, together with a grand illumination in the evening was the programme for this year. The Open Regatta which will be given in detail was sailed September 1st, and was called Newburyport Day. There was never a better day for racing. A double reef breeze continued throughout the day, and the scene was exciting in the extreme. The river front was crowded with spectators, thousands of them, all of whom agree that it was the greatest yacht race ever seen near Newburyport.

The First Race of the season was sailed on July 16th: The wind blew hard from the northwest, and all the boats were reefed down for wet business. A flying start was made at 2:30. There were only two starters in the first class, SPURT and GLEAM.

	Length Feet.	Actual Time. H. M. S.	Corrected Time. H. M. S.
Spurt	19.11	1 35 11	0 58 12
Gleam	19.08	1 39 36	1 12 21

Distance sailed was seven miles.
There were three starters in the second class.

Wizard	14.6	1 06 0	0 41 04
Port	16.6	1 04 30	0 42 26
Elf		did not finish	

Elf in rounding the stake boat nearly filled with water, and did not finish. This class sailed five miles.

The Second Race of the series was sailed on July 30th. SPURT was the only first class boat to start, as GLEAM did not put in an appearance. The actual time was 2 hours, 13 minutes, 45 seconds, while the corrected time was 1 hour, 56 minutes, 14 seconds. This race gave SPURT first place in her class, having won two out of the three races. Distance, seven miles.

There were four entries in the second class, but WIZARD did not start, owing to an accident at the start, which prevented her from having any chance of winning.

Port	16.06	1 32 23	1 10 18
Sassacus	16.00	1 37 10	1 14 34
Sunday	15.00	1 38 00	1 14 24

The third race was sailed on August 13th. Only the second class boats started, as the contest for the supremacy of the first class had already been awarded to SPURT.

Wizard	14.60	1 35 55	1 11 43
Scout	13.11	2 02 55	1 38 01
Port	16.60	2 19 53	1 56 57
Sunday	15.00	2 29 13	2 05 37

WIZARD was given the prize in this class. Distance sailed, five miles.

The Open Regatta was sailed September 1st. The gun was fired for the flying start at 3:00 P. M. for the first class. The yachts crossed the line in the following order: WAPITI, HAZARD, AUGUSTA, ANNIE E., ADDIE L., MIRELLA. The official record:—

	Length waterline. Ft. In.	Actual Time. H. M. S.	Corrected Time. H. M. S.
Hazard	22 8	2 08 43	1 26 57
Annie E.	25 1	2 30 25	1 52 03
Mirella	29 0	2 26 45	1 55 02
Addie L.	25 3	2 27 34	1 49 24
Augusta	22 8 1/2	2 11 15	1 29 29
Wapiti	23 3	2 07 42	1 26 48

Winners: WAPITI, first prize; HAZARD, second prize; and AUGUSTA, third prize.

The gun for the start of the second class was fired at 3:10 P. M. The yachts crossed the line in the following order: TYRANT, PUZZLER, DOLPHIN, VEXER, SPURT, BUDGE.

Official record is as follows:—

	Waterline Length. Ft. In.	Elapsed Time. H. M. S.	Corrected Time. H. M. S.
Tyrant	15 06	1 42 23	1 07 08
Budge	18 06	1 11 02	1 07 22
Spurt	19 11	1 32 42	58 01
Puzzler	19 04	1 58 22	1 12 54
Vexer	19 09	1 10 14	1 05 20

Distance, nine miles. Winners: SPURT, first; VEXER, second; and TYRANT, third.

The starting gun for the third class was fired at 3:20. The official record of the race is as follows:—

Golu	15 06	1 48 19	1 07 41
Wizard	14 06	1 47 13	1 03 39
Rodie	15 06	1 11 49	1 03 11
Argo	15 03	1 54 19	1 09 03
Sassacus	16 02	1 50 43	1 10 17
Port	16 06	1 46 30	1 06 39
Elf	16 11	1 43 35	1 01 26

RODIE, WIZARD and ELF came in first, second and third, respectively. Distance, seven miles. This race was sailed waterline measurement, with allowance.

THE SEASON OF 1893.

The Seventh Annual Open Regatta, was sailed on August 2d, in a reefing breeze from northwest, a very fine race resulting. A number of yachts came over from South Boston, several of them taking part. The times were:—

First Class, 23 to 29 feet waterline.

Wapiti	23 03	2 21 17	1 40 23
Cirrus	29 07	2 23 26	1 48 03
Augusta	23 00	2 35 37	1 54 21
Triant	26 00	2 33 20	1 55 08
Viola	23 00	2 37 00	1 55 50
Annie E.	25 02	2 38 47	2 00 31
Eulalie	28 00	withdrew	

Second Class, 18 to 23 feet waterline.

Spurt	19 11	1 43 52	1 09 11
Vexer	19 10	1 49 15	1 14 28
Good Luck	21 08	1 48 32	1 16 03
Live Yankee	18 00	1 51 12	1 13 46
Ustane	21 00	1 52 26	1 19 00
Promenade	19 00	1 57 45	1 21 49
Puzzler	19 04	withdrew	
Vivian	23 00	withdrew	

Third Class, 14 to 18 feet waterline.

Rodie	15 01	1 39 42	1 02 00
Wizard	14 04	1 42 01	1 02 59
Alpine	15 06	1 41 42	1 03 41
Flirt	16 06	1 44 07	1 08 42
Weasel	15 06	1 45 47	1 08 46
Golu	15 00	1 48 45	1 09 54
Port	17 03	1 44 35	1 10 17
Trifle	14 00	1 56 31	1 16 15
Fawn	15 00	1 56 26	1 17 35

DORIES.

Fourth Class, under 16 feet waterline.

	Length Feet.	Elapsed Time. H.M.S.
Gondola	11 00	1 06 02
Sadie	16 00	1 08 25
Kansas Coon	16 00	1 09 51
Bee	14 00	1 17 38
Marvel	14 00	1 25 41
Centric	14 05	1 30 00
Gertrude	15 00	withdrew
Pointer	15 00	"
Recreation	14 00	"
Elsie	13 00	"
Witch	15 00	"
Mary L.		"

WAPITI was first in Class 1, with CIRRUS second; SPURT was first in Class 2, with GOOD LUCK second; RODIE was first in Class 3, with WIZARD second; and GONDOLA was first in Class 4, with SADIE second.

The owner of VEXER reported that he had left one of the river buoys on the wrong side. The judges were N. D. Rodgrass, M. Kimball, J. H. Higgins, W. J. Creasey, J. W. Seavers and G. Noyes.

The club held three races for the club prizes, the third race being sailed September 30th over the inside course. A strong northeasterly wind gave the boats all they wanted.

The contest lay between LIVE YANKEE owned by H. T. Moody and SPURT owned by D. B. Pierce.

GLEAM carried away her main boom while getting ready for the start, and was forced to abandon the contest. SPURT won by seven minutes and took first prize, having taken the best two out of the three races sailed. LIVE YANKEE was given second prize.

BIOGRAPHICAL SKETCHES AND DESCRIPTION OF YACHTS ENROLLED IN THE CLUB.

CHARLES H. SHACKFORD, Commodore of the AMERICAN YACHT CLUB (of Massachusetts), was born in Newburyport, March 20, 1857. He is the son of David and Lydia C. Shackford. Has been a yachtsman for twenty years and has owned the yachts SUNDAY, PUZZLER, HUSTLER, MASCOT, LYDIA PINKHAM and his present yacht, the cut-boat NEXT. He has held the offices of Fleet Captain and Vice-Commodore. Commodore Shackford was one of the founders of the AMERICAN YACHT CLUB, March 27, 1885, at Newburyport, Mass.

NEXT.

NEXT is a centerboard open cut-boat, owned by Charles H. Shackford, Commodore of the AMERICAN YACHT CLUB (of Massachusetts). She was designed and built by Wm. G. Bowen and launched in 1889. Formerly belonging to ex-Commodore E. G. Woodwell. She hails from Newburyport and sails with the fleet of the AMERICAN YACHT CLUB (of Massachusetts).

DIMENSIONS.

Length over all,	15 feet	Length load waterline,	15 feet.
Depth,	20 inches.	Draft,	1 foot.
Beam,	4 feet 9 inches.		



EDMUND N. FOLLANDBEE

Spars : Boom, 15 feet ; Gaff, 7 feet.

EDMUND N. FOLLANDBEE, Secretary of the AMERICAN YACHT CLUB (of Massachusetts) for five years and still holding that office. A merchant of Newburyport, Mass., his native place. He was born February 16, 1864, the son of Edmund F. and Abbe C. Follandsbee. Has been the owner of the yacht TRAINER, and has been interested in yachting for ten years or more.

THE YACHTS AND YACHTSMEN OF AMERICA.

517

cond; SPURT was
DIE was first in
first in Class 4.

t one of the river
D. Rodgrass, M.
ers and G. Noyes.
e third race being
strong northeast-

by H. T. Moody

ting ready for the
URT won by seven
est two out of the
d prize.

erline, 15 feet.
1 foot.

t; Gaff, 7 feet.

ANDSBEE, Sec-
AMERICAN YACHT
s) for five years
ice. A merchant
his native place.
16, 1864, the son
e C. Follandsbee.
he yacht TEASER,
in yachting for

LIST OF YACHTS ENROLLED IN THE AMERICAN YACHT CLUB, 1892.

NAME.	OWNER.	C. D. OR KEEL.	RIG.	LENGTH OVER ALL.		L. W. L.	BEAM.	DRAFT.
				ft. in.	ft. in.			
Hazard	Pierce & Moody	cb	Sloop	26 07	22 08	10 5	3 2	
Puzler	Bulch & Hubbard	cb	"	22 04	19 06	9 6	2 6	
Ell W. Hoyt	A. W. Greenleaf	cb	"	22 00	20 01	10 6	2 6	
Maudie	F. Rodgrass	cb	"	21 00	18 06	5 4	1 8	
Glenn	P. J. Lowell	cb	"	27 00	19 00	10 3	1 8	
Tyrant	W. H. Hitchcock	cb	"	24 10	19 06	10 0	2 0	
Truant	N. D. Rodgrass	cb	Cat	31 00	25 00	11 0	3 6	
Trille	Irvin Besse	cb	Sloop	15 05	13 11	6 6	1 3	
Voxer	G. W. Murphy	cb	"	21 04	19 10	9 6	2 6	
Alice	W. S. Wilson	cb	"	20 06	16 08	6 0	1 0	
Pert	F. P. Knight	cb	"	26 00	16 04	6 0	2 0	
Spurt	H. B. Pierce	cb	"	30 00	19 06	11 3	1 8	
Wizard	C. E. Cartwright	cb	"	19 02	14 06	8 2	1 3	
Hodie	G. W. Rodgrass	cb	"	22 00	15 03	8 1	2 2	
Alice	H. W. Allen	k	"	31 00	26 06	10 3 1-3	5 0	
Edna	B. P. Hale	k	"	31 06	25 06	11 0	6 3	
Addie L.	G. H. Philbrick	k	"	31 00	25 06	11 4	4 0	
Zannah	G. P. Stone	cb	Cat	16 00	15 00	7 6	1 0	
Vesha	W. H. Noyes		Steam Launch	26 00	32 00	8 0	3 0	
Senza	J. A. Brown		"	24 00	25 00	6 0	2 0	
Elf	E. W. M. Bayley	cb	Sloop	19 00	15 00	7 0	2 0	
Next	C. H. Shuckford	cb	"	16 00	15 00	6 0	1 0	
Sunday	E. G. Woodwell	cb	"	17 00	15 00	6 6	1 3	
Kier	L. W. Rodgrass	cb	"	16 01	15 00	6 0	1 0	
Bess	H. T. Moody	cb	"	19 06	17 00	9 6	1 5	



STAMFORD YACHT CLUB HOUSE.



History of the Stamford Yacht Club.

ONE evening during the month of September 1890, while at anchor off Stamford, and about to man FENELLA'S gig, the unpleasantness of being obliged to go up a long and twisting channel before arriving at a point where one could find a suitable landing, came rather forcibly to the mind of Commodore William A. Lottimer, and the idea came to him that there was no

Twelve gentlemen were appointed an Executive Committee, empowered to draft a Constitution and By-Laws, and to procure a Club House, or a site for the erection of one, on the shores of Stamford Harbor.

This committee, of which Mr. Jas. D. Smith, an ex-Commodore of the NEW YORK YACHT CLUB was chosen Chairman, attended to the work assigned to them in a most diligent manner. In December they reported a Constitution, which was adopted; and in the March following notified the club that they had purchased land on Shippan Point upon which to erect a Club House.

On April 28, 1891, a contract was made with A. W. Barrett, of Bridgeport, Conn., to erect the club building according to plans and specifications prepared by his townsman Mr. Warren R. Briggs, and upon July 25th the house was opened to members, being fully

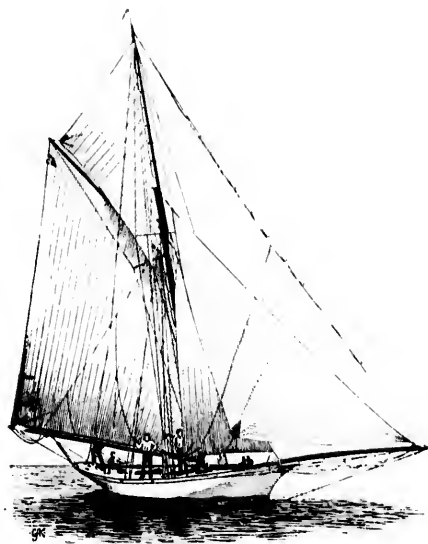

KATHLEEN. — FIGURE 483.

reason why Stamford could not and should not have a yacht club, not only for the benefit of the yacht owners, but also for others who might enjoy spending an afternoon or evening with their families down by the water.

So, on the evening of October 16, 1890, a few gentlemen met by invitation at the residence of Mr. William A. Lottimer, Richmond Hill, Stamford, Conn., for the purpose of organizing a yacht club. At this meeting it was voted to name the club, the STAMFORD YACHT CLUB, and the following officers were elected.

Commodore, William A. Lottimer; Vice-Commodore, Samuel Fessenden; Rear-Commodore, Schuyler Merritt; Secretary, C. C. Clark; Treasurer, H. P. Geib; Directors: W. M. Smith, J. D. Smith; W. L. Brooks, A. M. Hurlbutt, H. K. McIlarg, A. C. Hall, W. W. Skiddy, Albert Swords.



SAGITTA. — FIGURE 484.

ready for occupancy. During the year past additional property has been purchased, and many improvements made both to the buildings and to the grounds, so that to-day the STAMFORD YACHT CLUB possesses one of the most comfortable and best equipped Club Houses to be found on the shores of Long Island Sound.

A special feature of the club is that it gives the same facilities to

the families of members as it does to members themselves, allowing them to participate in all its sports and pleasures, yachting, bathing, tennis, concerts, receptions, etc. As a result, the Club House has become a leading feature in the social life of the town and has proved a marvelous success. A restaurant conducted in the best manner adds materially to the sociability of the club.

Although yet no regatta has been given, seventeen yachts and sailboats are owned by members of the club, and some of these boats have come off with honors in the regattas of other clubs.

In connection with the club, Commodore Lottimer organized a four-in-hand club, which parades with its dozen or more coaches and brakes, at the opening and closing of the yacht club.

Initiation fee and dues are \$50 each, for resident members, and half this amount for non-residents. Resident membership is limited to 125, and is practically full.

The officers of the STAMFORD YACHT CLUB for the years 1892 and 1893 were:

Commodore, William A. Lottimer; Vice-Commodore, Samuel Fessenden; Rear-Commodore, Schuyler Merritt; Treasurer, John V. Hecker; Secretary, Chas. H. Leeds; Fleet Surgeon, Henry P. Geib; Measurer, I. Frank Wardwell; Directors, Jas. D. Smith, Augustus M. Hurlbutt, William W. Skiddy, Albert C. Hall, Walter M. Smith, Henry K. McHarg, Edward C. Hoyt, Jas. D. Raymond, William L. Brooks, Austin H. Watson.

RECORD OF RACES SEASON OF 1893.

The First Race sailed by the STAMFORD YACHT CLUB took place on August 26, 1893, the prize being a handsome silver cup costing \$200, offered by the club for sloops and cutters of 36 to 43 feet sailing length by the Seawanhaka rule. The entries were:

				Sailing Length.
Daffodil	J. R. Whiting,	Stamford	Yacht Club	40.09½
Alecco	Wm. A. Hamilton,	Riverside	" "	40.09
Eurybia	Chas. Pryor,	Horseshoe Harbor	" "	40.02½
Kathleen	P. M. Hoyt,	Stamford	" "	37.05½

The course was from Cow's Buoy, off Shippan Point, to Matinneck Point, then to Eaton's Neck, and back to the starting line, 25 miles nautical.

The wind was very light, southwest, but the three boats made a very close race over the whole course, being together all the time, KATHLEEN in the lead. At the finish she managed to work over the line just as the wind fell, leaving the other two to drift for over an hour before finishing. KATHLEEN was sailed by Mr. Whitlock, her original owner, and his old crew of 1889. The Regatta Committee included Messrs. Archibald N. Smith, Edward E. Brughorhoff and Geo. F. Hoyt.

UN took place on
up costing \$200.
to 43 feet sailing

	Sailing Length.
Club	40.00 $\frac{1}{4}$
"	40.00
"	40.02 $\frac{1}{4}$
"	37.05 $\frac{1}{4}$

int, to Matinno-
starting line, 25

ree boats made a
her all the time,
to work over the
drift for over an
r. Whitlock, her
gatta Committee
Brugherhoff and

LIST OF YACHTS ENROLLED IN THE STAMFORD YACHT CLUB.

STEAMERS.

NAME.	OWNER.
Oriente	E. R. and J. H. Ludew
Frolic	Fred Bremer
Lina	S. W. Houch

SCHOONERS.

Kismet	Jas. Cochroft
Curlew	W. L. Brooks
Idlewild	C. C. Clark

SLOOPS.

Pocahontas	J. D. Smith
Sagitta	H. K. McHarg
Penelia	W. A. Lottimer
Eclipse	Samuel Fossenden
Duffodil	J. R. Whiting
Kathleen	S. Merritt and F. M. Hoyt
Kelpie	A. F. Delaheld
Nahai	Fred M. Hoyt
Gertrude	John W. Ward

CAT-BOATS.

Mabel	Dr. A. H. Scofield
La Pericholo	C. P. Itchanna

BIOGRAPHICAL SKETCHES AND DESCRIPTION OF YACHTS ENROLLED IN THE CLUB.

WILLIAM A. LOTTIMER, Commodore of the STAMFORD YACHT CLUB; living in New York City, born in Brooklyn, N. Y., 1850. Ancestors, English-Scotch; the son of Jane Eley and William Lottimer. Business, dry-goods. The owner of the yacht FENELLA. Commodore Lottimer was one of the organizers of the STAMFORD YACHT CLUB in 1890, and since that time he has always held the office of Commodore. He has taken an active part in yachting for five years.

FENELLA.

A centerboard sloop designed and built by Alonzo Smith, Boston, Mass., for Messrs. Haight and Holly. Launched in 1873 and rebuilt in 1884. Has been the property of Wm. A. Lottimer, Commodore of the STAMFORD YACHT CLUB, since the Fall of 1887. She has been altered in her cabin and cabin house. Hails from New York. See plate LXXXIV.

CODE SIGNAL LETTERS, K. G. W. C.

Official number, 120,127.

DIMENSIONS.

Length over all,	51 feet 6 inches.	Length load waterline,	45 feet 6 inches.
Depth,	6 feet.	Draft,	5 feet.
Beam,	16 feet 6 inches.		

FREDERICK M. HOYT, Stamford, Conn., was born in Stamford, September 15, 1873. He is the owner of NEMAD and KATHLEEN. He has been interested in yachting since 1887. A member of the SEAWANAKA CORINTHIAN and STAMFORD YACHT CLUBS.

KATHLEEN.

A cutter, designed by William Gardner, built by Samuel Ayers, South Brooklyn, N. Y., and launched in April, 1889. She has never been altered, and was formerly owned by William Whitlock. She hails from Stamford and sails with the SEAWANAKA CORINTHIAN and STAMFORD YACHT CLUBS. Is now the property of F. M. Hoyt of Stamford Conn., who has owned her for two years. See Fig. 483.

CODE SIGNAL LETTERS, K. J. L. B.

Official number, 161,013.

DIMENSIONS.

Length over all	43 feet 2 inches.	Length load waterline	39 feet 11 inches
Depth	6 feet 2 inches.	Draft	7 feet.
Beam	10 feet 6 inches.		

Spars: Mast 30 feet; Bowsprit, 23 feet; Gaff, 23 feet; Boom, 36 feet; Topmast, 24 feet; Spinnaker Boom, 30 feet.

RACING RECORD.

The KATHLEEN has to her record three thirds and one first out of four starts. In the ATLANTIC YACHT CLUB she was twice beaten by

TIGRESS, in each of which races she came in third, there being four and seven other starters, respectively. Then she came in third, with SASQUA first and six starters, while in the Annual Races of the CORINTHIAN YACHT CLUB (of New York) she beat DELVYN.



CHARLES H. LEEDS.

CHARLES H. LEEDS, Stamford,

Conn., was born in New York City, January 9, 1834. He is the son of Samuel and Mary W. Leeds, and is the eighth generation from Richard Leeds who settled in Dorchester, Mass., 1636. One maternal great-grandfather was Colonel in the Revolution while another was a Judge on the Massachusetts Bench for many years.

Mr. Leeds graduated from Yale in 1854, and was thirty years in the straw goods manufacturing line, but in 1887 retired from all active business. He is Treasurer of the STAMFORD YACHT CLUB and has also held the office of Secretary. He holds many prominent social and business positions in Stamford.

SAGITTA.

SAGITTA is a centerboard sloop owned by Henry K. Mellarg of New York City. She sails with the STAMFORD YACHT CLUB, hailing from New York. Was designed and built by A. M. Smith in 1878. See Fig. 484.

CODE SIGNAL LETTERS, K. C. F. D.

Official number, 115,613.

DIMENSIONS.

Length over all,	69 feet 6 inches.	Length load waterline,	53 feet 5 inches.
Depth,	5 feet 6 inches.	Draft,	6 feet.
Beam,	18 feet 2 inches.		



WALTER M. SMITH.

WALTER M. SMITH, New York

City, was born February 13, 1837, in Exeter, N. H., of English descent. Son of John and Esther M. Smith. Business, dry-goods. Mr. Smith says he "has loved the sea ever since he was able to feel an affection for anything." When a boy, he was an enthusiastic boatman and in his later life, he has given as much of his time as possible to this sport. He was one of the founders of the STAMFORD YACHT CLUB and has been a member of the House Committee, and on the Board of Directors

ever since its organization.

B.

, there being four
came in third, with
annual Races of the
at DELVYS.

REEDS, Stamford,
in New York City.
is the son of Sam-
s, and is the eighth
and Leeds who settled
1836. One maternal
Colonel in the Rev-
er was a Judge on
ch for many years.
ed from Yale in
years in the straw
ine, but in 1887 he
no business. He is
also held the office
and business posi-

ary K. Mellarg of
YACHT CLUB, hailing
M. Smith in 1878.

53 feet 5 inches.
6 feet.

SMITH, New York
born February 13,
H. of English de-
ed Esther M. Smith.

Mr. Smith says
sea ever since he
affection for any-
he was an enthu-
in his later life, he
of his time as pos-
He was one of the
STAMFORD YACHT CLUB
member of the House
Board of Directors



COMMODORE W. A. LOTTIMER.

STAMFORD YACHT CLUB.

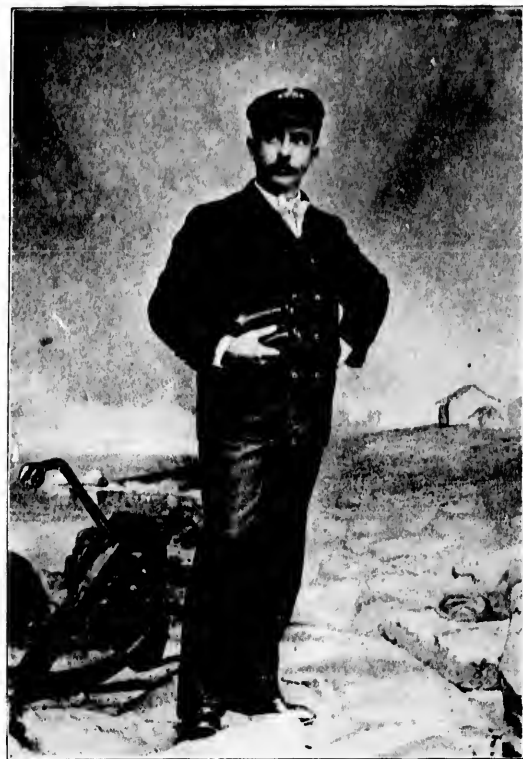

COMMODORE F. B. HOWER,
BUFFALO YACHT CLUB.

History of the Buffalo Yacht Club.

EARLY in the month of August, 1860, a small body of yachtsmen assembled one evening for the purpose of organizing a yacht club. Among those present at this first meeting were James W. Booth, who acted as Chairman, Henry C. Tucker, who acted as Secretary, and Messrs. W. H. Forbush, H. C. Tucker, Seymour Bennett and Jas. W. Booth, who were appointed a Committee to draft a Constitution and By-Laws, and report as to the expediency of forming a permanent yacht club at a subsequent meeting. The meeting then adjourned.

The first Monday in April of each year was designated as the date for the annual meeting, at which meeting the officers were to be elected and a Regatta Committee of three members appointed by the Commodore. This Constitution was adopted by the unanimous vote of those present and the meeting then proceeded to elect officers for the ensuing year.

The following were the officers elected: Commodore, John S. Newkirk; Vice-Commodore, Walter H. Forbush; Secretary, James W. Booth; Treasurer, Henry C. Tucker. Their terms of office to expire on the first Monday in April, 1861. The Commodore appointed Messrs. Beck, Forbush and Johns as Regatta Committee.

On motion of Mr. Bennett it was decided to hold the First Annual Regatta of the club on the 23d of August following, and a committee of five in addition to the Commodore was appointed to obtain subscriptions to make up prizes. The meeting then adjourned.

And so the BUFFALO YACHT CLUB was born.

The next meeting of the club was held August 13, 1860, at the of-

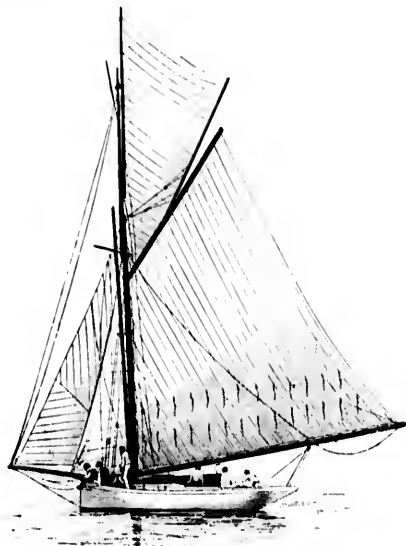

MERLE.—FIGURE 485.

The next meeting was held on Friday evening, August 10, 1860, in the office of Henry C. Tucker, the names of those present being as follows: Jas. W. Booth, Henry C. Tucker, John S. Newkirk, Walter H. Forbush, Charles C. Beck, Alfred Johns, Seymour Bennett, Isaac Preston, Charles F. Nagle and William S. Sizer.

The meeting was called to order by Mr. Booth, as Chairman, Mr. Tucker acting as Secretary, and the Committee appointed then submitted a Constitution and By-Laws, the first article of which read as follows: "This club shall be known and designated as the BUFFALO YACHT CLUB." Article second provided that the officers should consist of a Commodore, Vice-Commodore, Secretary and Treasurer.

The remainder of the Constitution was short and to the point, the whole being contained in fifteen articles. Article ten provided that the initiation fee should be \$3 and the dues \$2 per annum.

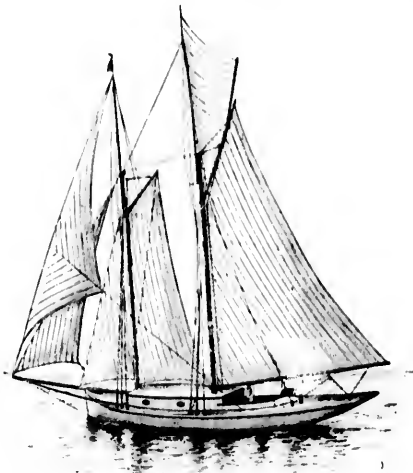

WEST WIND.—FIGURE 486.

fice of W. H. Forbush, at which the Regatta Committee reported a set of rules and regulations, which was accepted and ordered printed.

The regatta came off as per schedule, the winning boats being as follows:

First class: First prize, *UNCLE SAM*, J. S. Newkirk owner; second prize, *YOUNG REPUBLIC*, J. W. Booth owner.

Second class: First prize, *BANNER*, C. C. Beck, owner; second prize, *YOUNG AMERICA*, Alfred Johns, owner.

The judges of the regatta were R. P. Gardner, Sammel Heals and J. P. Wolfe.

No mention is made of the number or sizes of the yachts owned by the members, but that some of the members owned more than one yacht is evident from the fact that on motion of Mr. Beck it was decided that no member could enter more than one yacht in the regatta.

There is no doubt but what the majority of the boats owned in the club at this time, and for some years after, were mostly open boats, although some of them were of pretty large size.

At the next annual meeting, held April 1, 1861, the same officers were re-elected with the exception of the Treasurer, that office being consolidated with the Secretary, and Mr. J. W. Booth being elected as Secretary-Treasurer.

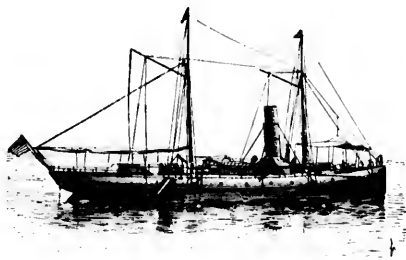

WHISPER.—FIGURE 487.

The next meeting was held June 25, 1861, at which arrangements were made to hold a regatta on the 17th of July following.

Toward the latter part of the sixties a number of the members built a sloop about 70 feet in length, on a scale of magnificence hitherto unknown in the annals of Buffalo yachting.

Figurehead, trail-board and transom were all elaborately carved and gilded, and the fittings throughout were the finest then obtainable in the market. Everything was finished outside in the highest style of the ship-builder's art, but luckily for the owners there was no finishing done in the cabin.

Unfortunately, this magnificent sloop was modeled according to the ideas then prevailing on the lakes in regard to fast sailing grain carriers. She was long, narrow and deep, with plenty of good flat bottom "for to stand upon," and of course had a centerboard. Being very narrow in proportion to her length, not carrying any ballast, and having large and heavily sparred rig, she promptly capsized on her trial trip, and came near drowning her owners and a large number of their friends who were on board at the time. She was rescued, righted, and towed into the Erie Basin, but she had so thoroughly frightened her owners that they would have nothing more to do with her, so she was dismantled and laid there for several years.

In 1872 some adventurous individuals purchased and re-fitted her. This time she did a little better, she didn't capsize until her second trip. After this performance she was voted to be no good as a pleasure yacht and was subsequently sold and fitted out as a small wrecking schooner.

She was called PHANTOM, and was probably the largest and most expensive boat ever owned in the club. Outside of this episode the proceedings of the club are surrounded in the fog of oblivion for a period of about eighteen years. The club existed, regattas were sailed, but the committees had a free and easy way of making their reports verbally instead of reducing them to writing and filing them with the records.

The minutes of all meetings subsequent to those already noted up to September 2, 1878, were destroyed by fire.

On the evening of that date a meeting of yacht owners was held in the office of Mr. B. F. Ball at which Mr. Ball officiated as Chairman and Mr. H. N. Vedder acted as Secretary.

The desultory manner in which the club had hitherto been zig-zagging on its course was severely criticized and condemned, and a committee consisting of the following five members, viz: W. A. Robinson, Henry P. Doyle, F. E. Nettleton, H. N. Vedder and Geo. D. Smith, was appointed to draft a new Constitution and By-Laws and report at the next meeting.

The next meeting was held September 9th, in the same place at which there were twenty-four members present. The Committee on Constitution and By-Laws presented a new Constitution for consideration which added a Measurer to the list of officers. It also stipulated that the Commodore and Vice-Commodore should be yacht owners and that the Regatta Committee should be elected instead of appointed. The dues were fixed at \$3 per annum and the initiation fee eliminated, the date of the annual meeting changed to the first Tuesday in February, and an elaborate set of sailing rules and regulations appended with a proviso that any question not covered by said rules and regulations should be settled according to those of the NEW YORK YACHT CLUB.

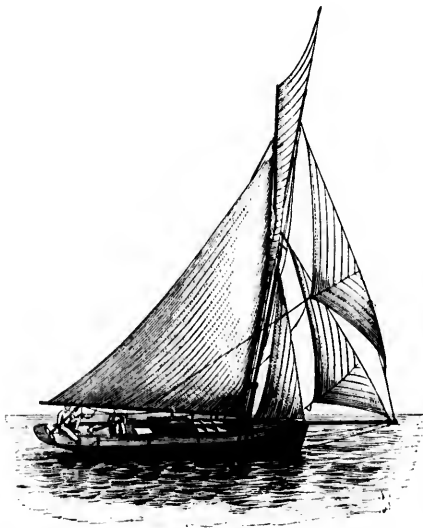

EMBLESS.—FIGURE 488.

The report of the committee was adopted and the following officers were elected to serve under the new Constitution until the annual meeting in February. Commodore, John S. Provoost; Vice-Commodore, John Bowen; Secretary and Treasurer, H. N. Vedder; Measurer, E. W. Craig; Regatta Committee, Clarence Bryant, W. E. Nettleton and W. A. Robinson.

On motion it was decided to hold a regatta on September 17th, in which the following boats were entered:

	Length	W. L.	Beam.
	Feet.	Feet.	Feet.
First Class.			
Fleetwing, schooner	27.0		11.0
Arrow, sloop	25.0		10.0
Mystic, schooner	30.0		10.2
Corsair, schooner	30.0		10.4
Second Class.			
Telephone, sloop	19.0		7.2
Annie Argo, schooner	21.0		8.0
Adele, schooner	26.0		6.0

The rule of measurement adopted was length multiplied by beam to be the sailing length.



SYLVIA.—FIGURE 489.

The course sailed over was seven and one-half miles and the time allowed was three-quarters minute per foot. The first class boats started ten minutes after the second class and the fleet arrived home in the following order: FLEETWING, ANNIE ARGO, MYSTIC, ARROW, COUSAIR, TELEPHONE. FLEETWING took first prize in the first class, the second prize going to the sloop ARROW.

First prize of second class to ANNIE ARGO and second prize to TELEPHONE. The judges of the regatta were Capt. F. B. Bruce, Capt. Frank Perew and Capt. L. B. Fortier.

The club boomed steadily and in a short time had about seventy-five members. At the next annual meeting February 4, 1879, a President and Vice-President were added to the list of officers, and the following officers were elected for the ensuing year: President, Philo G. Cook; Vice-President, Frank E. Nettleton; Commodore, John S. Provoost; Vice-Commodore, John Bowen; Secretary, Henry N. Vedder; Treasurer, W. A. Robinson; Measurer, E. W. Craig; Regatta Committee, W. E. Riggs, J. Clark White, E. Benedict.

This Regatta Committee proved somewhat derelict in their duties as no written reports of regattas were filed, although several regattas were sailed including a grand Union Regatta some time in August of

that year. The CLEVELAND and TOLEDO YACHT CLUBS were invited to participate in the regatta and they accepted the invitation, but the exact date of holding the regatta and the results are unknown.

During the year the club adopted a new Constitution and By-Laws, sailing rules and regulations, and printed a club book.

At the next annual meeting held on the evening of February 7, 1880, the following officers were elected for the ensuing year.

Commodore, Clarence L. Bryant; Vice-Commodore, C. M. Cordell; Secretary, Philo G. Cook; Treasurer, John S. Provoost; Measurer, A. H. Chilcott. Regatta Committee, J. J. Williams, T. P. Frank, Edw. P. Fields.

C. P. Kuhnhardt, late editor of *Forest and Stream*, was elected an honorary member at this meeting. The club also appointed three delegates to attend the first meeting of the YACHTING ASSOCIATION to be held in New York.

At a meeting held April 4, 1880, it was decided to incorporate the club, the officers and trustees included in the certificate of incorporation being C. L. Bryant, J. S. Provoost, Philo G. Cook, H. N. Vedder, J. J. Williams, C. M. Cordell and E. P. Fields.

The certificate of incorporation was filed April 15, 1880.

At this meeting it was also decided to issue stock for the purpose of building a Club House, and the House Committee was authorized to procure plans and specifications and proceed with the construction of the Club House as soon as a sufficient amount of stock could be disposed of.

The Constitution of the NATIONAL YACHTING ASSOCIATION was also adopted by the club, and C. P. Kuhnhardt was appointed a permanent delegate to represent the club at the meetings of that body.



MARGARET.—FIGURE 490.

The new Club House was finished and opened some time between the 1st and 16th of August. With the brand new Club House, a fleet of sixteen yachts, and a membership of seventy-five, the club seemed to be bowling along with a fair breeze on the high tide of prosperity.

The first check came at a meeting held February 3, 1881, when the Secretary reported thirty members in arrears for dues.

This was the annual meeting but for some reason not stated the election was postponed until the ensuing May.

At the next meeting, held March 3d, fifteen of the members were dropped from the roll for non-payment of dues. May 5th, the fol-

lowing officers were elected: Commodore, Laban B. Fortier; Vice-Commodore, Clarence L. Bryant; Measurer, Thos. P. Frank.

The Constitution under which the club was running at this time provided for a Board of Directors, and on motion, the election of the remaining officers, Regatta Committee and Directors, was postponed until the next meeting which was held on July 7th.

At this meeting Mr. John S. Provoost was elected Treasurer, E. P. Fields, Secretary; Regatta Committee, E. P. Fields, Chas. Battey.



CYPRESS.—FIGURE 401.

At this meeting the Board of Directors was abolished. The interest of the members in the club now seemed to flag, there being no meeting held from July 7, 1881, until February 2, 1882, and the club seemed to be getting into financial difficulties. The Commodore and Vice-Commodore had not attended a single meeting throughout the year. No mention is made of any regattas having been sailed, and the year of 1881 seemed to be one of general stagnation.

May 6, 1882, the Annual Election was held and the following officers were elected: Commodore, John S. Provoost; Vice-Commodore, Thos. P. Frank; Secretary, E. P. Fields; Treasurer, C. Lee Abell, Measurer, Arthur Allen.

Regatta Committee, C. M. Cordell, Chas. Battey and E. P. Fields.

During the ensuing season considerable ill feeling was engendered in the club. This feeling increased in bitterness until the club became divided into two factions, the one representing all that was progressive and sportsmanlike in the pastime of yachting, while the other element clung to old traditions and seemed to consider that the highest aim of a yachtsman consisted of getting aloft on something and taking frequent observations through a glass, darkly or otherwise.

A regular meeting held August 3, 1882, marks an epoch in the history of the club, as at this meeting arrangements for a regatta were perfected, to be held on August 5th. At this regatta the sloop Arrow reached the turning buoy first, and it was claimed by the other boats sailing in the race, that her crew picked up the buoy and sailed off with it.

While the remainder of the fleet were vainly hunting for the buoy, Arrow was making good time for the second mark, and after gaining a long lead on the fleet, threw the first buoy overboard. Arrow of

course won the race, but the Regatta Committee refused to hand over the prizes and the affair culminated in the withdrawal from the club of a number of the members and the formation of a second club called the BUFFALO CITY YACHT CLUB, with Geo. W. Smith of the sloop Arrow as Commodore.

This club enjoyed a short and merry existence. It was composed almost entirely of the owners of Arrow and their adherents, and the Commodore being a saloon keeper, the club's demise may be attributed to excessive stimulation.

The resignation of so many members and the expulsion of a good many more for non-payment of dues, reduced those remaining to a state of apathy. No meetings were held and no regattas were sailed. The members sailed on their individual Saturday afternoon and Sunday cruises as usual; they lounged around the Club House on Summer evenings and talked yacht, but no effort was made to extricate the club from the financial fog which enveloped it.

The old officers were allowed to hold over from one year to another and so matters went on till one evening the members were astonished to see the Club House starting off on a cruise of its own on a mud scow with the sheriff at the helm.

It would naturally be supposed that the loss of the house would prove a fatal blow to the club, but the effect was entirely the reverse. The fact that the seceding faction had contributed toward the erection of the house and had been careful to keep the few members remaining well informed of the circumstance, may have had something to do with it. It may have been with a feeling of relief that the boys saw the domicile which had created and fostered so much dissension, disappear around a bend in the Buffalo river.

Instead of giving up the ship, the boys nailed their colors to the masthead, shook hands all around and then went to work.



DIANA.—FIGURE 402.

The period of stagnation had lasted from August, 1882, until November, 1884, during which time no meetings had been held.

On the 25th of November, 1884, a meeting was held at the Tiff House, at which in the absence of the Commodore, H. N. Vedder acted as Chairman, and E. P. Field as Secretary. This meeting was principally devoted to engendering enthusiasm, and every member present was appointed an Individual Committee for the purpose of securing new members.

Eleven new members were elected at the next annual meeting held February 19, 1885, together with the following officers: Commodore, H. N. Vedder; Vice-Commodore, L. G. Northrop; Secretary, E. P. Field; Treasurer, F. L. Bennett; Measurer, M. C. Provoost. Regatta Committee, H. B. Boyle, J. F. Ellsworth, C. Lee Abell.

The initiation fee was fixed at \$1; and the annual dues at \$1.

During the year 1885 the club steadily progressed in membership and several new yachts were added to the fleet.

Committee refused to hand over
the withdrawal from the club
the formation of a second club
with Geo. W. Smith of the

ry existence. It was composed
ow and their adherents, and the
club's demise may be attributed

ers and the expulsion of a good
reduced those remaining to a
eld and no rogatus were sailed.
l Saturday afternoon and Sun-
ound the Club House on Sun-
o effort was made to extricate
veloped it.

over from one year to another
the members were astonished
a cruise of its own on a mud

the loss of the house would
effect was entirely the reverse.
contributed toward the erec-
l to keep the few members re-
nce, may have had something
feeling of relief that the boys
fostered so much discussion,
river.

boys nailed their colors to the
men went to work.

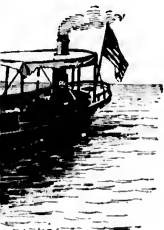

192.

n August, 1882, until No-
vember had been held.

Meeting was held at the Tuff.
Theodore, H. N. Vedder acted
as Secretary. This meeting was prin-
cipally for the purpose of securing
the purpose of securing

Next annual meeting held
Following officers: Commo-
dore, G. Northrop; Secretary,
M. G. Provoost.
Measurer, C. Lee Abell.
Annual dues at \$1.

progressed in membership
meet.

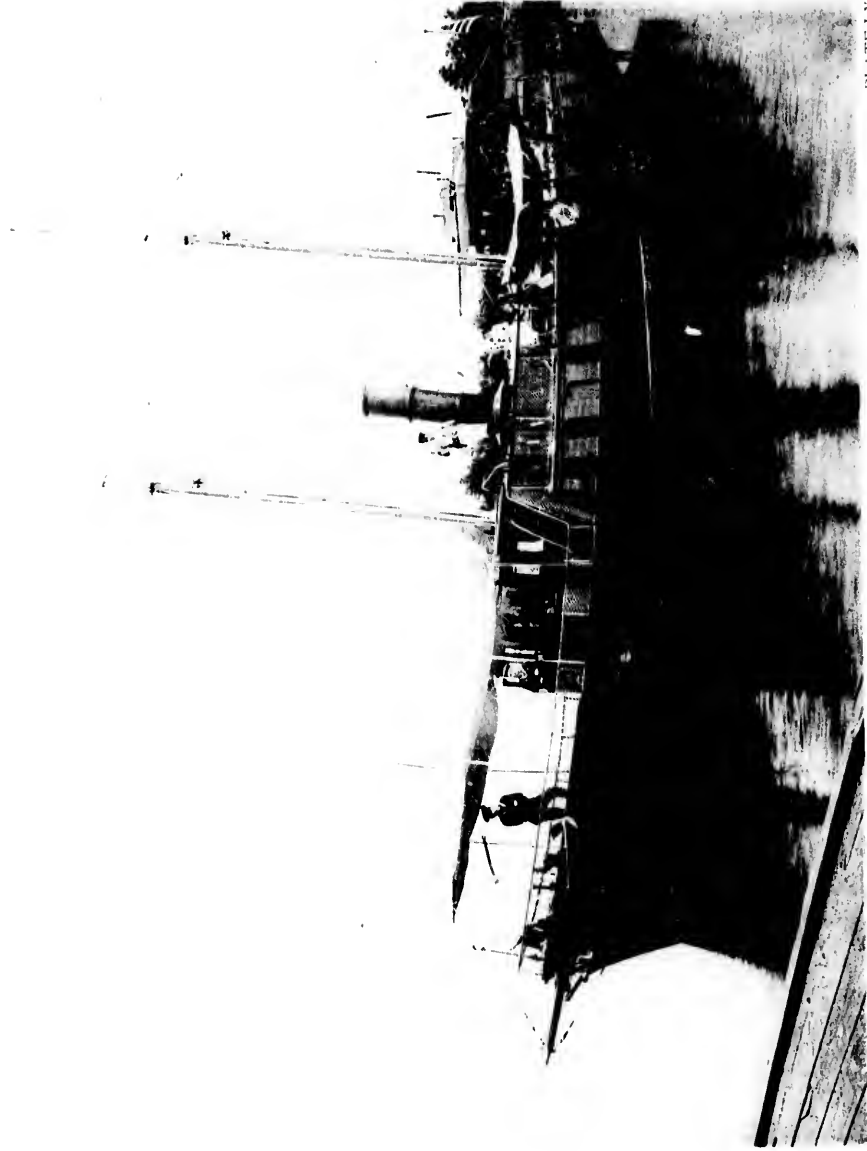

PLATE LX

RUTH.

PLATE LX

RUTH.

THE GARDEN AND THE HOUSEHOLD

... the garden ...
... the house ...
... the garden ...
... the house ...

... the garden ...
... the house ...
... the garden ...
... the house ...



... the garden ...
... the house ...
... the garden ...
... the house ...

... the garden ...
... the house ...
... the garden ...
... the house ...

... the garden ...
... the house ...
... the garden ...
... the house ...

... the garden ...
... the house ...
... the garden ...
... the house ...

... the garden ...
... the house ...
... the garden ...
... the house ...

... the garden ...
... the house ...
... the garden ...
... the house ...

... the garden ...
... the house ...
... the garden ...
... the house ...

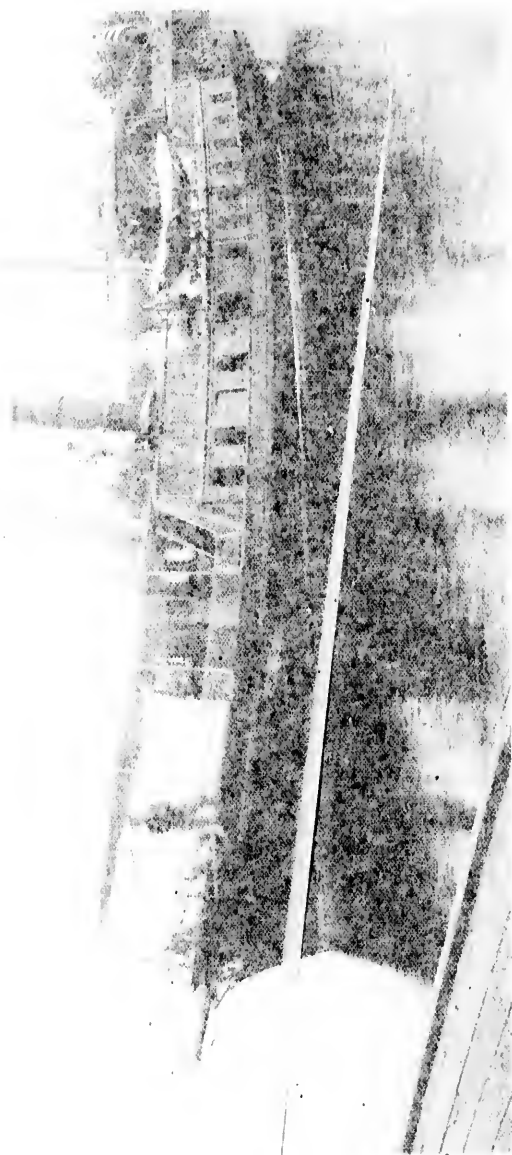

The next annual meeting was held January 6, 1886, at which the following officers were elected: Commodore, Harry D. Williams; Vice-Commodore, L. G. Northrop, Secretary, M. C. Provost; Treasurer, E. C. Roberts; Measurer, J. H. Swanson.

Regatta Committee, John Willoughby, Chas. Greiner and Mr. Tomlie. Trustees, H. D. Williams, C. B. Hill, J. H. Swanson, H. N. Vedder and L. G. Northrop. The year of 1886 was one of unexampled activity, and marks another epoch in the history of the club.

The good old Constitution which had passed through so many revisions, was again revised and a new club book printed.

In this year also the first deep draft cutter in the fleet was enrolled by R. W. Chisholm and H. E. Parrish. A large number of new members were elected, and steps were taken toward the erection of a new Club House.



ALCYONE.—FIGURE 493.

The Annual Cruise of the club to Port Dover, in August, was a great success, the residents of Port Dover providing a regatta supplemented with a grand ball in the evening.

In September the club entertained the Port Dover yachtsmen, holding a regatta on September 25th, followed in the evening by a banquet.

The next annual meeting was held January 6, 1887, at which the following officers were elected:

Commodore, H. D. Williams; Vice-Commodore, R. W. Chisholm; Secretary, M. C. Provost; Assistant Secretary, H. L. Chisholm; Treasurer, W. C. Cowles; Measurer, J. H. Swanson.

At this meeting the Constitution was amended, so that the Commodore appointed a Regatta Committee for each regatta, said committee to be dissolved after the regatta for which they had been appointed. A Fleet Surgeon and Chaplain were added to the list of officers; Dr. H. Mickle being elected Surgeon, and Rev. C. F. J. Wrigley as Chaplain.

The club steadily progressed during the year, fifteen meetings being held and a large number of new members elected.

A Building Committee was appointed, plans for a new Club House adopted, and a site was obtained from the State at the foot of Porter avenue, at some distance from the shore.

The foundation for the new Club House was built during the Summer.

A very successful regatta was held on the Fourth of July, in which a large number of visiting yachtsmen participated, followed by a banquet in the evening at the Yacht House.

The next annual meeting of the club was held on January 17, 1888, and the following officers were elected:

Commodore, H. D. Williams; Vice-Commodore, A. S. Chisholm; Secretary, H. L. Chisholm; Assistant Secretary, E. L. French; Treasurer, W. C. Cowles; Measurer, J. A. Tempest; Surgeon, Dr. H. Mickle; Chaplain, Rev. C. F. J. Wrigley.

The year 1888 was one of unusual activity and progress, the Club House being opened early in the Spring.

The initiation fee was raised to \$5 and the annual dues were also raised to \$5. During the year 4 honorary, 16 life and 18 active members were elected, making a total number of 101 at the end of the year, exclusive of 26 names dropped from the roll for non-payment of dues.

Nine yachts had been added to the fleet and four sold during the time. The fleet, at the end of the season, consisted of two cabin sloops, three open sloops, three cabin cutters, one cabin schooner, one open schooner, one open yawl, two naphtha launches, one steam launch, making a total of fourteen yachts, seven of which were centerboard boats and four keels.

The cutter yacht had been steadily gaining in favor in the club during this year. The skimming dish type receiving a fatal blow by the sailing rules being amended to prohibit the shifting of ballast during the race.

The Fourth of July was a brilliant success, \$300 in prizes was offered to be divided as follows:

First Class.

All sailing yachts, 30 feet and over sailing length. First prize, \$100; second prize, \$60; third prize, \$25.

Second Class.

All yachts under 30 feet and over 18 feet sailing length. First prize, \$50; second prize, \$25; third prize, \$10.

The following yachts were entered:

Name.		L. W. L. Feet.	Port.
White Wings	sloop	43.0	Hamilton, Ont.
Vera	cutter	34.0	Port Dover and Buffalo
Alarm	schooner	30.4	Buffalo
Viking	sloop	26.0	"
Emma	sloop	29.0	"
Glanet	sloop	30.0	"
Sylvia	cutter	36.9	"
My Bell	schooner	36.0	"
Jewett	schooner	32.0	"
Dandy	schooner	34.0	"
Cypress	cutter	36.0	Hamilton, Ont.
Second Class.			
Caprice	sloop	18	Toronto, Ont.
Mignonette	"	25	Buffalo
Twilight	"	26	"
Swallow	"	18	"
Corsair	schooner	21	"
Kowen	yawl	18	"
Betha	sloop	18	"
St. Julian	"	25	"
Mabel	"	25	Port Dover, Ont.

The regatta was started at 2 P. M. and a fresh breeze from the southwest whiel. increased to a gale; the course was triangular, about

fifteen miles in length, including the finishing leg down to the Club House.

CYPRESS lost a topmast gybing around the first buoy but cleared away the wreck and continued. The wind and sea became so heavy that a large number of the boats dropped out. ALAM pulling out her chain plates, and GANET pulling all the iron work off her mast-head.

The winners were:

	Elapsed Time.	Corrected Time.
	U. M. S.	U. M. S.
First Class.		
White Wings	2 10 45	2 10 45
Cypress	2 20 50	2 11 50
Emma	2 28 34	2 13 51
Sylvia	2 25 22	2 11 31
Second Class.		
Caprice		2 10 05
Koween		3 20 52
Retha		3 25 30

RETHA stopped to pick up the crew of a capsized sail-boat thereby losing second place to KOWEEN.

Instead of sailing the race over again they divided second prize equally. The visiting yachtsmen were royally entertained at the

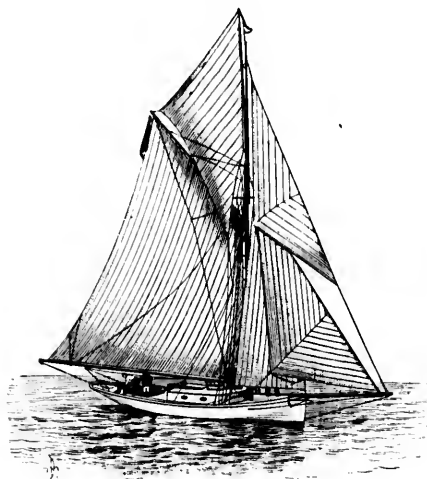

CRICKET.—FIGURE 494.

Club House, and although the Canadian boats carried off nearly all the prizes, everybody voted the regatta to be a great success.

The Annual Cruise to Port Dover was well attended, the good people of Port Dover overflowing with hospitality as usual.

After participating in the regatta at Port Dover, the yacht SYLVIA continued on to Cleveland, and the yacht EMMA to Toledo, they having been sold to parties residing in those cities.

The season of 1888 closed with the club in a very prosperous condition.

The beginning of the year 1889 was very disastrous. The winter being mild, no ice was formed on the lake, and on the night of January 9, the inhabitants of Buffalo experienced one of the severest gales which ever swept over Lake Erie.

The water rose ten feet above the normal level, and the rough sea swept through the lower story of the Club House, carrying everything before it. The morning of the 10th presented a varied picture to those who struggled down to the beach against the still howling gale.

The first floor and the entire four sides of the first story of the Club House were entirely swept away, leaving nothing but a skeleton standing on the pile foundation.

All the furniture belonging to the club, the contents of the lockers, and a large number of spars and sails stored in the Club House for the winter were swept away. Nothing was saved from the wreck, the most of it going over the Falls.

At the annual meeting held on the evening of January 10th, there was little cause for rejoicing, but the boys went right along and elected the following officers: Commodore, H. D. Williams; Vice-Commodore, E. F. Bishop; Secretary, H. L. Chisholm; Assistant Secretary, F. D. Wood; Treasurer, W. C. Cowles; Measurer, J. A. Tempest; Assistant Measurer, H. L. Campbell; Surgeon, Dr. Mickle, Chaplain, Rev. C. F. J. Wrigley.

Regatta Committee, T. H. Davies, E. C. Strong, and A. S. Chisholm.

The remainder of the winter was spent in trying to decide what to do with the Club House. After vainly endeavoring to obtain a site on the shore, the club finally decided to rehabilitate the house in its present position, having received assurance from the oldest inhabitant that the sea of January 9th had been the highest water since 1844.

During the season of 1889 two new cutters were built by members of the club from designs by C. P. Kuhlhardt, being about the last work done by him in that line before his departure on the ill-fated CONSERVA.

One of these cutters, ALCYONE, proved so fast that it spoiled the racing for the season of '89, she winning first prize in all the races in which she entered that year.

The proceeding became so regular that the other boats did not care to enter, and many of the races provided for did not take place for want of entries.

The fleet consisted of so many different types, it was sought to establish a rule of measurement which would prove satisfactory to all parties, and the club wrestled with the problem all Summer, finally adopting the square root of the sail area as the sailing length and classifying the yachts accordingly.

The season of 1882 closed satisfactorily, but could scarcely be called brilliant.

The next annual meeting was held January 9, 1890, and the officers elected were as follows: Commodore, D. P. Dobbins; Vice-Commodore, C. P. Forbush; Secretary, H. L. Campbell; Assistant Secretary, F. D. Wood; Treasurer, W. C. Cowles; Measurer, W. H. Boughton; Fleet Surgeons, Dr. H. Mickle and Dr. E. P. Hussey; Chaplain, Rev. C. F. J. Wrigley.

Regatta Committee, E. F. Bishop, F. W. Caulkins and Chas. Graves.

The club was reported to be out of debt, and in a very satisfactory condition. Everything pointed to a very successful year for 1890, but on January 13th, a gale exceeding in severity, if possible, that of the preceding year, tore out the whole lower story of the Club House for the second time.

Fortunately, the furniture had been removed and everything portable had been taken away, so that the loss was not so great as that of the preceding year, but still the blow was a severe one.

Having lost confidence in the judgment of "the oldest inhabitant," who had assured the club that such phenomenal storms would only occur at rare intervals, the club spent the Spring and Summer of 1890 in trying to obtain permission from the Park Commissioners to place the Club House on shore beyond the reach of any future storms.

Failing in this, the club was undecided what course to pursue. It seemed to be a useless and rather expensive piece of business to be building a new Club House every year for the seas to batter down, so the repairing of the Club House was laid over until another year. The season of 1890 was very dull indeed.

Having no Club House the members had no place to congregate and talk yacht, except when two or three would meet by chance on the street corner.

The Commodore was absent from the city most of the time, the Vice-Commodore resigned his office early in the season, and the Regatta Committee proved to be entirely indifferent to their duties. As a consequence, but one or two regattas were sailed which were dead failures for want of interest.

The Annual Cruise was omitted entirely.

The season of 1891 opened differently. The annual meeting was postponed until March 11th, when the following officers were elected: Commodore, Frank B. Hower; Vice-Commodore, Allan S. Chisholm; Secretary, Henry L. Campbell; Treasurer, W. C. Cowles; Measurer, R. H. Gunnell.

Regatta Committee, Geo. M. Hunt, J. DeZielinski and W. J. Prouse.

Directors, H. D. Williams, J. S. Thompson, E. P. Hussey, L. G. Northrop.

Fleet Surgeons, Dr. H. Mickle and Dr. E. P. Hussey.

The office of Chaplain was abolished.

Commodore Hower although young in years, was an old and enthusiastic yachtsman, having been one of the organizers of the CLEVELAND YACHTING ASSOCIATION, and on assuming the duties of his office, he took energetic measures to place the club on a sound and prosperous footing.

The Constitution was revised and the entire management of the club's affairs vested in a Board of Directors which held meetings every week.

The famous Burgess yacht MERLE was purchased by the Commodore from Toronto parties and added to the fleet.

The club purchased a large sloop for the use of members who were not yacht owners and also to serve as a training boat for novices. A competent man was placed in charge.

A large number of new members were elected and a number of old ones who had become indifferent and allowed their dues to pile up in arrears, were summarily dropped from the roll.

The elements having kindly refrained from inflicting any more damage on the Club House during the winter, it was repaired and opened early in the Spring of 1891 and a junior placed in charge, a luxury which the club had hitherto not indulged in.

The opening of the Club House was made the occasion of a general jollification in which pipes and tobacco, cigars, music, singing, eatables, and the festive punch bowl, played a prominent part.

These jollifications were continued through the season, being held once a month and proved very enjoyable to the members and their friends.

The Regatta Committee early in the season, was instructed to "hustle" and they followed out their instructions faithfully. The following regattas being sailed:

Measurement, square root of sail area only.

CLASSIFICATION.

Class A, 35 feet to 50 feet; Class 1, 27 feet to 35 feet; Class 2, 21 feet to 27 feet.

Class A.	Length. Feet.
Cypress	44.2
Merle	42.8
May Belle	36.5
Old Chum	36.4
West Wind	32.6

Class 1.	Length. Feet.
Aleyone	33.1
Tigress	29.1
Louise	27.8

Class 2.	Length. Feet.
Fannie F.	27.0
Erebliss	21.0

Opening Cruise May 30th.

June 6th, Pennant Regatta; 15 log miles. Wind fresh, southwest.

Class A.	Corrected Time. H. M. S.
Merle	2 19 42
West Wind	2 29 50

Seven log miles. Wind fresh, southwest.

Class 2.	Corrected Time. H. M. S.
Erebliss	2 54 35
Fannie F.	2 56 41

June 20th, Sweepstake Race to Point Abino; 12 log miles.

Class A.	Corrected Time. H. M. S.
Cypress	2 38 30
Merle	2 35 30
West Wind	2 16 48

Class 1.	Corrected Time. H. M. S.
Louise	2 24 48
Tigress	2 44 21

Class 2.	Corrected Time. H. M. S.
Erebliss	2 44 30

June 27th, Challenge Race between yachts Tigress and Louise. Course 10 miles. Wind southwest.

Class 1.	Actual Time. H. M. S.
Louise	1 45 02
Tigress	1 56 25

Louise winner by 11 minutes, 23 seconds.

July 8th, Race for Special Pennant presented by Mrs. H. Stocker to yachts of Class 1. Course 10 miles. Wind west.

Class 1.	Corrected Time. H. M. S.
Tigress	2 06 30
Louise	1 58 55
Aleyone	1 57 04

Class 1.	Corrected Time. H. M. S.
Tigress	2 06 30
Louise	1 58 55
Aleyone	1 57 04

July 21st, Club Course changed to read Class A 14 standard miles; Class 1, 10 standard miles; Class 2, 5 standard miles.

July 25th, Second Pennant Regatta for Class 2 and first one for Class 1. Wind light, southwest.

Class 1.	Corrected Time. H. M. S.
Tigress	dropped out before finish. 1 43 12
Louise	Actual Time. H. M. S. 1 57 04

Class 2.	Corrected Time. H. M. S.
Erebliss	2 04 02

and the rough
House, carrying
presented a varied
against the still

first story of the
ing but a skeleton

ts of the lockers,
Club House for
from the wreck,

January 10th, there
right along and
Williams; Vice-
holm; Assistant
Measurer, J. A.
eon, Dr. Mickle,

and A. S. Chis-

o decide what to
g to obtain a site
the house in its
he oldest inhabi-
tial water since

re built by mem-
being about the
rture on the ill-

nt it spoiled the
n all the races in

er bouts did not
id not take place

was sought to es-
atisfactory to all
Summer, finally
illing length and

scarcely be called

890, and the offi-
Dobbins; Vice-
pbell; Assistant
; Measurer, W.
r. E. P. Hussey;

kings and Chas.

very satisfactory
l year for 1890,
possible, that of
ory of the Club

everything port-
o great as that of
e.

dest inhabitant,"
orms would only
Summer of 1890
ssioners to place
ture storms.

September 12th: Second Pennant Regatta for Class 1, wind light from south to east.

	Actual Time.
Louise	n. m. s.
Alycane	dropped out
Tigress	4 00 40
	dropped out

October 30, Second Pennant Regatta for Class A. Third Pennant Regatta for Class 1 and 2; also Special Race for the Zielinski Cup to Class 2. Madam De Zielinski's Cup presented to the BUFFALO YACHT CLUB to be sailed for annually by yachts of second class, and to become the property of such yacht as won it in two successive races. Hazy weather, light wind.

	Actual Time.
	n. m. s.
Class A.	
Merle	3 08 15
Class 1.	
Louise	2 46 00
Alycane	2 30 30
Class 2.	
Erchless	2 31 15
Marion	dropped out
Iris	dropped out

The Annual Cruise to Port Dover, commenced August 15th, and was a very enjoyable affair. Nearly all the yachts participated in the cruise, and a regatta was held August 19th by the residents of Port Dover, which was a great success.

The famous PARROUSE, then owned in Erie, Pa., participated with a number of other boats from the same place.

The regatta was followed by a grand ball in the evening which was attended by guests from all the large towns and cities in Western Canada. The members of the club enjoyed themselves so thoroughly on this occasion, that they remained there the whole week.

At the close of the season which was one of the most successful the club had ever known, rooms were rented down town and the club kept open house all winter.

The annual meeting of 1892, was held on January 6th, and the following officers were elected:

Commodore, F. B. Hower; Vice-Commodore, A. S. Chisholm; Recording Secretary, F. W. Canlkins; Corresponding Secretary, H. L. Campbell; Treasurer, W. C. Cowles; Measurer, Howard A. Baker; Fleet Surgeons, Drs. Mickle and Hussey. Directors, H. D. Williams, J. S. Thompson, L. G. Northrop, F. L. Bennett.

Regatta Committee, E. P. Sears, H. J. Pulsifer, J. De Zielinski.

The reports of the committee showed the club to be in a very prosperous condition, both in regard to membership and finances.

During the winter several meetings were held by delegates from the BUFFALO, CLEVELAND, DETROIT and OHIO YACHT CLUBS, with a view of organizing a Lake Racing Association similar to the one on Lake Ontario.

Nothing definite was accomplished, but during the season an experimental regatta was held at Cleveland, which was attended by several Buffalo boats. The great distance intervening between the ports on Lake Erie, interfered so seriously with the project that the subject was dropped.

The rules of measurement and classification in use by the LAKE YACHT RACING ASSOCIATION, on Lake Ontario, were adopted by the club for the season of '92, as it was pretty clearly demonstrated that if the members wished to do very much racing outside of their own port they would have to go to Lake Ontario to do it.

The following were the regattas sailed during the season of '92.

CLASSIFICATION.

40 foot class, 35 to 40 feet; 35 foot class, 30 to 35 feet; 30 foot class, 25 to 30 feet; 25 foot class, 20 to 25 feet; 20 foot class, 15 to 20 feet.

Club course, 40 foot class 14.75 nautical miles; 35 foot class, 13.75 nautical miles. 30 foot class, 12.25 nautical miles. 25 foot class, 8.5 nautical miles. 20 foot class 6.75 nautical miles.

Opening Cruise May 28th.

June 11th: First Pennant Regatta for all classes, wind southwest by west.

	Corrected Time.
	n. m. s.
40 Foot Class.	
Merle	dropped out
35 Foot Class.	
Westwind	did not finish
Crocket	did not finish
30 Foot Class.	
Louise	2 22 08
Alycane	2 42 35
25 Foot Class.	
Erchless	2 48 38
Winona	dropped out

June 25th: First Ladies' Day. July 9th, second Ladies' Day.

July 30th: Sweepstake Race to Point Abino; wind southeast.

	Actual Time.
	n. m. s.
Louise	1 32 15
Kathleen	1 30 00

August 5th: Third Ladies' Day.

August 16th and 17th Open Regatta with the CLEVELAND YACHT CLUB. September 15th, Special Race for silk burgee presented by Mrs. F. B. Hower to yachts of 30 foot class. Clear, wind west by south, 10 miles.

	Corrected Time.
	n. m. s.
Alycane	2 02 50
Kathleen	1 50 48

September 24th: Second Pennant Regatta for 30 foot and 25 foot classes. First Pennant Regatta for 40 foot class. Clear weather; light sea; wind west; 10 miles.

	Actual Time.
	n. m. s.
40 Foot Class.	
Merle	2 43 41
Cypress	dropped out
30 Foot Class.	
Alycane	2 09 57
Kathleen	dropped out
Louise	dropped out
	Corrected Time.
	n. m. s.
25 Foot Class.	
Hinnoo	2 10 52
Iris	2 36 27
Erchless	2 19 33
Winona	dropped out

October 8th: Race for Madam De Zielinski's Cup for second class, according to measurement of 1891; Course, 8.5 nautical miles. Wind southwest; squall, very heavy sea. HINNOO and IRIS dropped out.

Erchless	2 44 11	2 47 39
----------	---------	---------

October 22: Third Pennant Regatta for 30 and 25 foot class. Second for 40 foot class.

35 feet; 30 foot
not class, 16 to 20

5 foot class, 13.75
25 foot class, 8.5

s, wind southwest

Corrected
Time,
H. M. S.

dropped out

did not finish
did not finish

2 23 08
2 42 35

2 48 38
dropped out

Ladies' Day,
and southeast.

Actual
Time,
H. M. S.
1 32 15
1 30 00

CLEVELAND YACHT
rarge presented by
ear, wind west by

Corrected
Time,
H. M. S.
2 02 50
1 50 48

30 foot and 25 foot
Clear weather:

Actual Time,
H. M. S.

2 43 41
dropped out

2 09 57
dropped out
dropped out
Corrected Time,
H. M. S.

2 10 52
2 36 27
2 19 33

dropped out

for second class,
autical miles. Wind
ts dropped out.

11 2 47 39
and 25 foot class.

Reg.	Sailing		Corrected Time, H. M. S.	Length H. M. S.	Actual Time, H. M. S.	Corrected Time, H. M. S.
	Length, H. M. S.	Time, H. M. S.				
30 Foot Class.						
Kathleen			2 15 00			
25 Foot Class.						
Hinpo			2 46 20			
35 Foot Class.						
Hinpo	sloop	34 1	1 13 20	1 13 30		
Winona	sloop	22 6	1 17 15	1 13 47		

Hinpo won.

Runs failed to come to time,
October 15th: Closing Cruise to Point Abino.

The Annual Cruise to Port Dover was omitted, the club attending the Cleveland Regatta instead. The social relations between the members of the club were developed to a greater extent during this season than at any time heretofore, Ladies' Days being made a special feature.

The afternoons of these days were devoted to short spins with the lady guests of the club. In the evening of each day a large steamer was chartered, and a short moonlight excursion up the lake and down the river was taken, followed by a hop and supper at the Redell House on Grand Island. These excursions were well attended, bringing out a large proportion of the members and ladies.

SEASON OF 1893.

The First Regatta was held July 4, 1893, over a 12½ mile course for Class 1, over a 4½ mile course for Class 2, and over a 5½ mile course for Class 3. The wind was from the southwest and the weather was clear.

The following yachts participated:

40 Foot Class.						
Merle	sloop	38 4	2 41 45	2 40 48		
Crocket	cutler	35 0	did not finish			
Cypress	sloop	30 1	did not finish			
MERLE won.						
30 Foot Class.						
Kathleen	sloop	27 2	1 33 10	1 31 52		
Aleyone	cutler	29 8	1 38 15	1 38 15		
KATHLEEN won.						
25 Foot Class.						
Winona	sloop	22 6	1 52 00	1 50 40		
Hinpo	sloop	24 1	1 58 15	1 58 15		
WINONA won.						

The next regatta was held August 12th, over a 6 mile course. The wind was from the northwest and the weather was cloudy.

The following yachts started:

40 Foot Class.						
Merle	sloop	38 4	1 02 30	1 00 02		
Cygnat	cutler	48 1	1 01 15	1 01 15		
Cypress	sloop	39 10	1 11 30	1 09 30		
Westwind	schoomer	35 15	1 16 00	1 10 23		
MERLE won.						
30 Foot Class.						
Kathleen	sloop	27 2	1 02 15	1 01 05		
Aleyone	cutler	29 8	1 07 45	1 07 45		
KATHLEEN won.						

The season closed with the Club Cruise to Point Abino, which was fully attended and thoroughly enjoyed by those participating. Altogether the season of '92 was highly prosperous and gratifying to the officers and directors of the club.

Early in the season the project of a new Club House had been broached. The subject was more or less agitated during the year and before the annual meeting of 1893 had assumed definite shape. The annual meeting of 1893 was held on January 11th, and the following officers were elected:

Commodore, F. B. Hower; Vice-Commodore, Allan S. Chisholm; Secretary, Howard A. Baker; Treasurer, W. T. Cowles; Measurer, F. L. Bennett; Fleet Surgeons, Drs. Mickle and Hussey.

Directors: H. D. Williams, J. S. Thompson, L. G. Northrop, Henry M. Birge, and the five officers.

Regatta Committee: E. P. Sears, H. D. Pulsifer, and J. W. Prose.

At the annual meeting a Building Committee was appointed consisting of Commodore Hower, H. L. Campbell and J. S. Thompson.

Plans were prepared by Architect H. L. Campbell for the new Club House, which cost about \$10,000.

The site of the new Club House is at the foot of Porter avenue, and located a little nearer the shore than the old Club House.

The first floor contains a large locker room, and a number of large lockers about 4x6 feet in size for use by yacht owners. Also a gentlemen's toilet room, shower bath, junior's room, store room, and a large space for storing dings and other boats.

The second floor has a café, ladies' parlor, with toilet room, billiard room, smoking room, and manager's office.

The front and rear verandas on this story are 12 feet wide and are connected across the ends by open balconies 6 feet wide.

The third floor has a dancing room 40 feet square, open balcony 12x20 feet in front, kitchen, living room for the steward and pantry.

The attic is used for the storing of sails. A deck 11 feet square is located on the roof, from the center of which housing topmasts are placed.

It is expected that a number of new and valuable yachts will be added to the fleet during the season of '91, as a large number of new members have been added to the roll and the officers and members look forward to a season of unusual activity.

THE FLEET OF THE BUFFALO YACHT CLUB, 1893.

CUTTERS.

NAME.	OWNER.	PORT.	C. B. or Keel.	Length over all.	Length L. W. L.		Racing Length.	Extreme Beam.	Draft.	Racing No.
					ft. in.	ft.				
Alcyon	Ed. Strong	Buffalo	k	31	21 0	20 0	8 0	5 0	5	
Cricket	J. S. Thompson	"	"	38	31 0	31 0	10 0	7 0	3	
Evhless	Chisholm Bros.	"	"	23	18 0	20 10	5 9	4 0	2	
Margaret	G. S. Huddle	"	"	30	22 0	25 0	6 2	5 0	7	
Iris	E. W. Wilkeson	"	"	23	18 7	21 80	6 3	5 11	15	
Buffalo Gal	E. W. Wilkeson	"	"	42	28 0	8 1	7 0	17	
Cygnet	Dr. A. M. Ewing	"	"	60	42 1	15 6	6 0	4	
Albatross	Geo. B. Drake	"	"	31 54	16	

SLOOP.

NAME.	OWNER.	PORT.	C. B. or Keel.	Length over all.	Length L. W. L.		Racing Length.	Extreme Beam.	Draft.	Racing No.
					ft. in.	ft. in.				
Morie	F. B. Hower	Buffalo	e b	49 0	31 0	38 31	12 8	5 0	1	
Cypress	G. W. Muiridge	"	e b	42 0	32 0	12 4	3 0	11	
Fanny F.	J. S. Thompson	"	e b	27 0	21 0	8 9	2 0	12	
Kathleen	W. C. Cowles, et al.	"	e b	32 0	21 0	27 15	10 7	1 6	8	
Marion	H. A. Baker	"	e b	21 4	20 0	21 80	8 0	1 3	13	
Hippus	G. B. Hinkley, et al.	"	e b	28 3	25 0	21 80	7 0	1 4	9	
Dorothy	W. H. Boughton	"	e b	20 0	18 0	4 6	1 8	14	
Winona	W. L. Bakesdee	"	e b	21 0	22 10	22 0	9 2	2 2	10	
Volante	R. D. Hoffman	"	k	25 0	21 0	10 0	4 6	13	

SCHOONERS AND CATS.

NAME.	OWNER.	PORT.	C. B. or Keel.	RIG.	Length over all.	Length L. W. L.		Racing Length.	Extreme Beam.	Draft.	Racing No.
						ft. in.	ft. in.				
May Belle	David Bekley	Buffalo	k	Schooner	39 0	36 0	10 0	6	26	
West Wind	F. L. Bennett	"	e b	"	41 0	32 0	31 10	11 30	4	6	
Serena	Dr. E. P. Hussey	"	e b	Cat	42 2	21 2	32 0	9 0	4	19	

STEAMERS.

NAME.	OWNER.	PORT.	KIND OF ENGINE.	Length over all.	Length L. W. L.		Extreme Beam.	Draft.	RIG.
					ft. in.	ft. in.			
Nydia	Dr. H. V. Pierce	Buffalo	93 6	82 6	15 7	9 2	Schooner	
Whisper	H. M. and G. K. Birge	"	Tandem Compound, Inverted	77 2	69 7	12 2	5 5	"	
Fire Fly	Ed. Strong	"	Oil, Shipman's	22 6	23 4	6 8	2 8	Launch	
Diann	Dr. Lee South	"	Naphtha	25 0	21 0	6 0	2 6	"	

BIOGRAPHICAL SKETCHES AND LIST OF YACHTS ENROLLED IN THE CLUB.

FRANK B. HOWER, Commodore of the **BUFFALO YACHT CLUB**, was born in Cleveland, Ohio, in 1858; his ancestry are American. Commodore Hower is in the steamboat supply business. He has been interested in yachting for the past twenty years and is at present the owner of the yacht **MERLE**.

Commodore Hower is an enthusiastic yachtsman, taking great pride in the club of which he has the honor of being Commodore. He is also an honorary member of the **CLEVELAND YACHT CLUB**.

MERLE

A centerboard cutter designed by Burgess, built by Lawley & Son, and launched in 1887. Owned for two years by Frank B. Hower. She has never been altered, hails from Buffalo and sails with the **BUFFALO** and **CLEVELAND YACHT CLUBS**. Not strictly a centerboard, being a compromise. See plate LXXXII, also Fig. 485.

DIMENSIONS.

Length over all	40 feet.	Length load waterline	31 feet.
Depth	5 feet 9 inches.	Draft	5 feet 1 1/2 inches.
Beam	12 feet 8 inches.		

Racing Record:—

1891—**BUFFALO YACHT CLUB**—Club Pennant Regatta, June 6th; defeated **WESTWIND**, though beaten by her on June 20th. Also won the pennant for Class A in the regatta of August 3d.

1892—**BUFFALO YACHT CLUB**—**MERLE** won in the First Pennant Regatta sailed September 24th.

CLEVELAND YACHT CLUB—The winner in her class (two starters) in the Open Regatta of August 17th. Among the yachts defeated on this occasion was **ALICE ENRIGHT**.

**HOWARD A. BAKER.**

HOWARD A. BAKER, Secretary of the **BUFFALO YACHT CLUB**. Mr. Baker was elected to office on account of the interest he has continually manifested in the success of the club. He is an enthusiast in the sport of yachting and fulfills the trust he has undertaken in an efficient manner. His business being that of a ship-chandler naturally tends to direct his thoughts to yachting and naval architecture.

**FRED L. BENNETT.**

FRED L. BENNETT, an attorney and counsellor-at-law of Buffalo, N. Y.; born 1862 in Evans, Erie County, N. Y.; son of Judson O. and Nancy Bennett and grandson of Hon. Joseph Bennett, one of the pioneers of Erie County, now in his ninetieth year. He is a member of the **BUFFALO YACHT CLUB** and was its Treasurer in 1884 and '85. For the past three years has been one of the Directors of the club and is now a Director and the Measurer. He is the owner of the schooner yacht **WESTWIND** and has always

taken an active interest in yachting.

WESTWIND.

WESTWIND—formerly called **EDGAR B. JEWETT**—is a centerboard schooner and is the property of Fred L. Bennett of Buffalo, N. Y. She was designed and built by Chas. Beck, being launched in 1885; and in September, 1889 her present owner bought her from C. B. Hill. In 1891 she was lengthened, raised and thoroughly rebuilt.

She is both keel and centerboard. She hails from Buffalo and sails with the **BUFFALO YACHT CLUB**. See Fig. 486.

DIMENSIONS.

Length over all	41 feet.	Length load waterline	31 feet.
Depth	5 feet.	Draft	5 feet 9 inches.
Beam	11 feet 11 inches.		

Racing Record for 1891:—

BUFFALO YACHT CLUB—Beaten by **MERLE** in the race for the Club Pennant on June 6th. Won on June 20th, Sweepstakes Race, defeating **MERLE** and **CYPRUS**.

WHISPER.

WHISPER is a screw schooner built by Clark & Newman, New York. She was launched in 1883. **WHISPER** is owned by George K. and Henry M. Birge of Buffalo, N. Y., and she is enrolled in the fleet of the **BUFFALO YACHT CLUB**. She was rebuilt in 1883 by William Liessenden. She has a centerboard. See Fig. 487.

CODE SIGNAL LETTERS, K. L. N. Y.

Official number, 80,921.

DIMENSIONS.

Length over all	37 feet 2 inches.	Length load waterline	29 feet 7 inches.
Depth	4 feet 5 inches.	Draft	6 feet.
Beam	12 feet 2 inches.		

Engine: Vertical steuple compound, two cylinders, 9 1/2 and 17 x 14 inch. Hartford Engine Co.

Boiler: Vertical tubular, 9 ft. x 7 ft. 3 inch. Drummond.

**HENRY L. CAMPBELL.**

HENRY L. CAMPBELL, resident of Buffalo, and a member of the **BUFFALO YACHT CLUB**. Mr. Campbell has taken interest in the sport of yachting for a number of years and takes much pride in the growth and development of the club to which he belongs.

ALLAN S. CHISHOLM, Vice-Commodore of the **BUFFALO YACHT CLUB**, manufacturer, Buffalo, N. Y.; was born in Oakville, Ontario, in 1866. Has owned the yachts **HOPPER**, **SYLVIA**, **PEERLESS**, and is now one of the owners

of the cutter **ERCHLESS**. Has held his office of Vice-Commodore for four years and is a member of the **BUFFALO** and **ROYAL CANADIAN YACHT CLUBS**.

ERCHLESS.

ERCHLESS is a cutter yacht, owned by Chisholm Bros. of Buffalo, N. Y. She was designed by C. P. Kunhardt and built by James Andrews, being launched in 1889. She hails from Oakville, Ontario, and sails with the **ROYAL CANADIAN** and **BUFFALO YACHT CLUBS**. **ERCHLESS** is a fine cruising yacht and her racing record speaks for itself as to her speedy qualities. See Fig. 488.

DIMENSIONS.

Length over all	23 feet.	Length load waterline	18 feet.
Depth	5 feet.	Draft	4 feet 9 inches.
Beam	5 feet 9 inches.		

RACING RECORD.

In 1890 and 1891 **ERCHLESS** won the pennant for the 25-foot class, in the **BUFFALO YACHT CLUB**, and the Do Zielinski Challenge Cup in 1891 and 1892, which being two years in succession, makes her owner of the same. She has won, besides, many other races and prizes.

SYLVIA.

SYLVIA is a cutter yacht, owned by Chisholm Bros. of Buffalo, N.

Draft.	Racing No.
ft. in.	
5 00	5
7 00	3
1 00	2
5 08	7
5 11	15
7 00	17
6 10	4
....	16

Draft.	Racing No.
ft. in.	
5 0	1
3 0	11
2 0	12
1 6	8
1 3	13
1 4	9
1 8	14
12 2	10
4 6	15

Draft.	Racing No.
ft.	ft.
6	20
4	6
4	19

Rig.	
Schooner	
"	
Launch	
"	

V. She was enrolled in the BUFFALO YACHT CLUB in 1886. See Fig. 489.

DIMENSIONS.			
Length over all,	38 feet 6 inches.	Length load waterline,	32 feet 6 inches.
Depth,	5 feet 4 inches.	Draft,	6 feet.
Beam,	9 feet 6 inches.		

GEOURGE S. HUBBELL, Buffalo, N. Y., was born in Troy, N. Y., in the year 1864; is the son of Nathan and Caroline F. Hubbell. He is a civil engineer and is the owner of the yacht MARGARET. Has been more or less connected with yachting for the past ten years. He is the Sanitary Engineer of the Board of Health of Buffalo. For three years a member of the BUFFALO YACHT CLUB.

MARGARET.

MARGARET is a keel cutter, formerly LOUISE, was designed by C. P. Kunhardt and Edward Burgess, and built by W. Hingston & Son, Buffalo, N. Y. She was built for F. W. Caulkins, and was launched in April 1889. Was partly re-built in 1890 and in 1892 passed into the hands of her present owner, George S. Hubbell of Buffalo. She hails from Buffalo and sails with the BUFFALO YACHT CLUB. See Fig. 490.



LEWIS G. NORTHROP.

LEWIS G. NORTHROP, Agent of the Chicago & Northwestern R.R. Co., Buffalo, N. Y.; was born in Centre Village, Broome County, N. Y., May 26, 1863. Has taken an active interest in yachting for thirteen years. Was part owner of EMMA and PETREL, and has owned the yachts TELEPHONE and TURK. Has held the offices of Vice-Commodore, Fleet Captain and Measurer of the BUFFALO YACHT CLUB.

DIANA.

The launch DIANA belongs to Lee H. Smith and V. Mott Pierce of Buffalo, N. Y. She was designed by George Nottter for R. V. Pierce, and was launched in 1889. The Shipman engine which she formerly had, has been changed for a gas engine. She has a cabin and sails with the BUFFALO YACHT CLUB. See Fig. 492.

DIMENSIONS.			
Length over all,	35 feet.	Length load waterline,	32 feet.
Depth,	2 feet.	Draft,	3 feet.
Beam,	8 feet 2 inches.		

Engine: Gas Engine and Power Co. Eight horse power.
Speed is claimed to be 10 miles per hour.



CHISHOLM BROTHERS.

DIMENSIONS.			
Length over all,	30 feet.	Length load waterline,	22 feet.
Depth,	4 feet 6 inches.	Draft,	5 feet 8 inches.
Beam,	6 feet 2 inches.		

Racing Record:—

1891—BUFFALO YACHT CLUB—On June 20th, in the Sweepstakes Race, LOUISE, as she was then called, defeated TIGRESS, and repeated the victory on the 27th of the same month in a Challenge Race. She was then twice beaten by ALCYONE in a race for a Special Pennant, July 18th, and in the Regatta of October 3d.

1892—CLEVELAND YACHT CLUB—LOUISE won in her class in the Open Regatta of August 16th, with five starters.

CYPRESS.

CYPRESS is a centerboard sloop owned by Geo. W. Muiridge & Son of Buffalo, N. Y. Was designed and built by Frank Bailey and was launched in February, 1891. She hails from Buffalo and sails with the BUFFALO YACHT CLUB. See Fig. 491.

DIMENSIONS.			
Length over all,	42 feet 3 inches.	Length load waterline,	32 feet 6 inches.
Draft,	3 feet 8 inches.	Beam,	12 feet 4 inches.

ALCYONE.

A cutter yacht, the property of E. C. Strong and Frank B. Gallagher of Buffalo, N. Y. She was designed by C. P. Kunhardt and was built by W. Hingston & Son, Buffalo. ALCYONE was launched in 1889. She hails from Buffalo and sails with the BUFFALO YACHT CLUB. See Fig. 493.

DIMENSIONS.			
Length over all,	31 feet.	Length load waterline,	24 feet.
Draft,	5 feet.	Beam,	8 feet.

J.S. THOMPSON, lumber merchant of Tonawanda, N. Y., which town was his birthplace. Is the owner of the keel yacht CRICKET and a member of the BUFFALO and ROYAL CANADIAN YACHT CLUBS.

CRICKET.

A keel cutter, designed and built by Wood Bros., East Boston, Mass. for J. F. Mott. She was launched in 1882 and was re built in 1888, being lengthened 7 feet. For two years she has been the property of J. S. Thompson, Tonawanda, N. Y. She has a cabin, hails from Buffalo and sails with the BUFFALO YACHT CLUB. See Fig. 494. CODE SIGNAL LETTERS, K. D. L. Q. Official number, 123, 363.

DIMENSIONS.			
Length over all,	38 feet.	Length load waterline,	31 feet.
Depth,	5 feet.	Draft,	7 feet.
Beam,	10 feet.		

TROP, Agent of the
Western R.R. Co.,
born in Centre Vil-
, N. Y., May 26,
active interest in
years. Was part
PETREL, and has
PHONE and TRK.
Vice-Commodore,
asurer of the Buf-

nd V. Mott Pierce
Notter for R. V.
engine which she
She has a cabin
fig. 492.

terline, 32 feet.
3 feet.

orse power.

l Frank B. Galla-
P. Kunhardt and
ONE was launched
BUFFALO YACHT

erline, 24 feet.
8 feet.

da, N. Y., which
f the keel yacht
ROYAL CANADIAN

os., East Boston,
nd was re built in
as been the prop-
has a cabin, hails
YACHT CLUB. See
number. 123, 363.

erline, 33 feet.
7 feet.

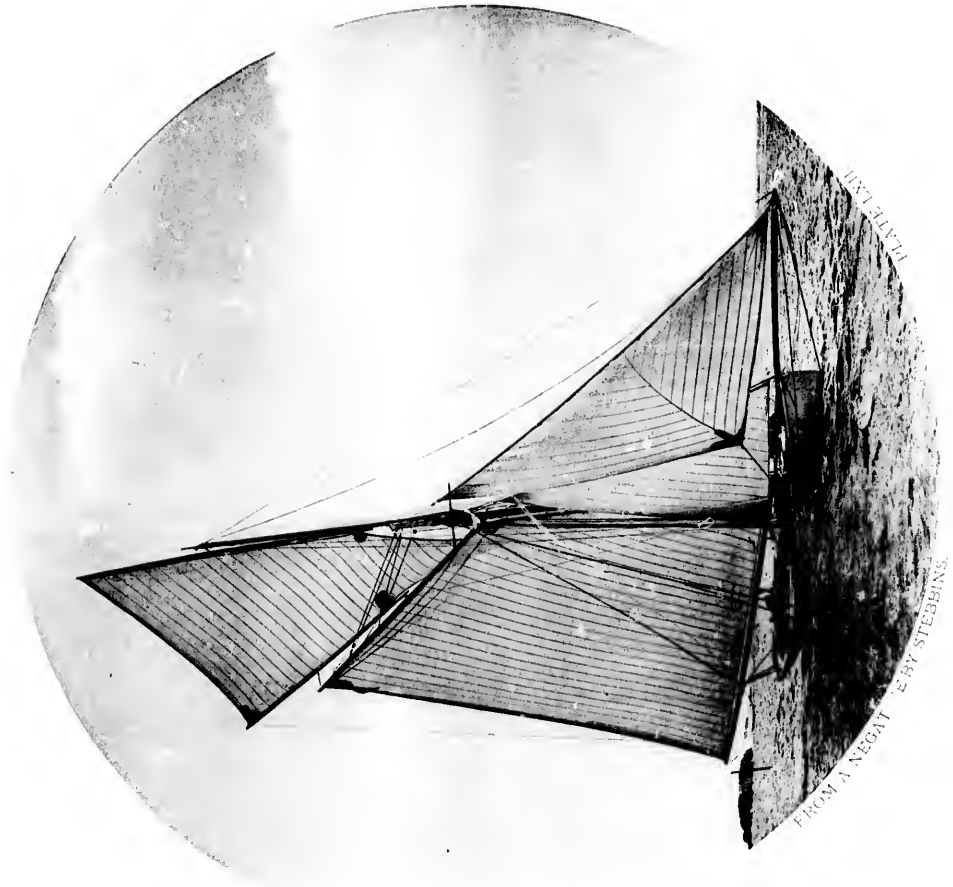

FROM A NEGATIVE BY STEBBINS

PAPCOSE.

BY STEPHENS

PAPPOSE.

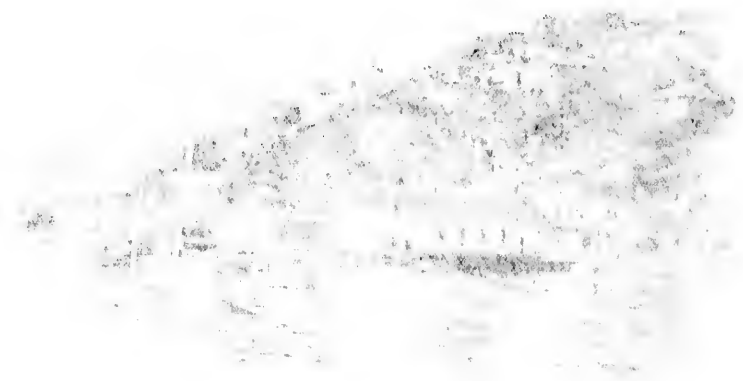

W

...ndly e
...nne in
...le. It w
...prevailin
...approved
...y way
...out reg
...beaten. M
...which were
...But when
...rally. The
...ground. M
...W. H. Day

In Arroyo
...rmission P
...was sailed
...sailed R. J.
...y Dr. J. C.
...Howard, is
...members of
...Secretary

Page 1

Page 2

Page 3

Page 4

Page 5

Page 6

Page 7

Page 8

Page 9

Page 10

Page 11

Page 12

Page 13

Page 14

Page 15

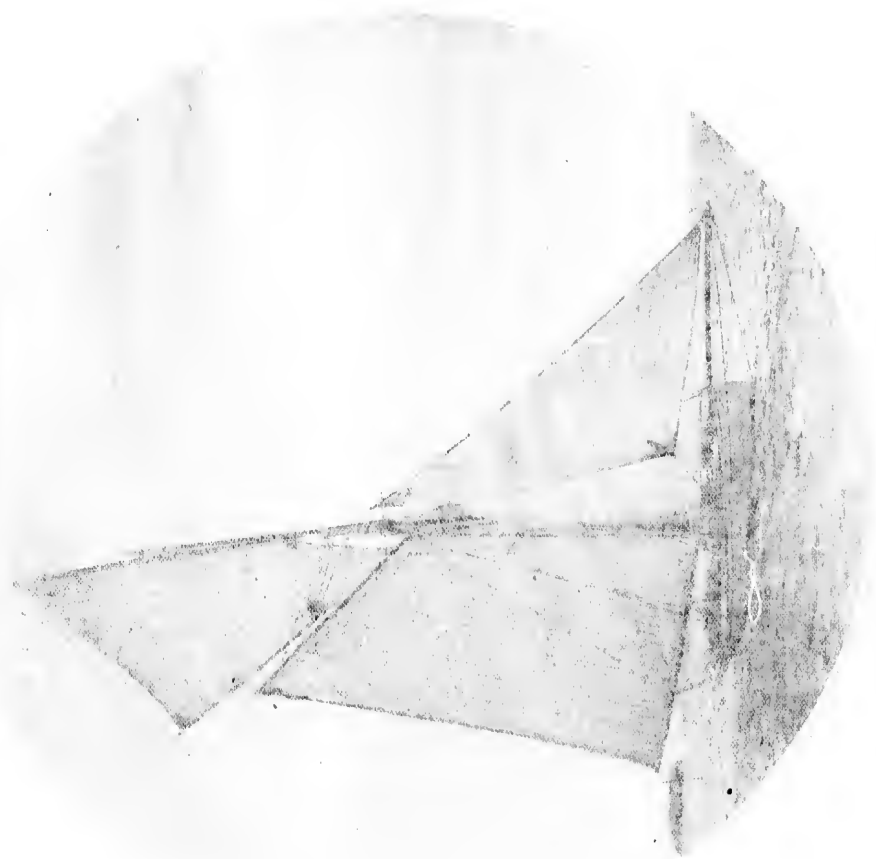



SAN FRANCISCO YACHT CLUB HOUSE.

History of the San Francisco Yacht Club.

STATION—SAUSALITO, CAL.

WHEN yachting first commenced in the Bay of San Francisco* in the "fifties," the boats used were mainly small sloops and plungers or cut-boats which had been brought there from the East on ships' decks. The boats were usually of the "skimming dish" type so prevalent in New York waters in those days, of very tight draft, wide beam and with large sails. It was soon found that the sails had to be cut down to fit the prevailing strong winds, and then in course of time the boats were improved and the new ones built were deeper and more able craft in every way. It was not until about 1868 that there was any real talk about organizing a yacht club to which the few real yachts could belong. Most of the boats which had been in the races were those which were commonly in trade, as small carriers' or boatsmen's craft. But about that date there was a movement inaugurated to form a club. The club was organized and a Club House was built on Long Bridge, Mission Bay, C. H. Platt being elected Commodore with W. H. Davis as Secretary.

In August 1869, the first real yacht regatta ever sailed in San Francisco Bay was held. In that race the winning yacht *EMERALD* was sailed by her owner, John L. Eckley; *PERLESS*, owned by Commodore R. L. Ogden, was sailed by Captain Edwin Moody; *MINKIE*, by Dr. J. C. Tucker, *LOTUS*, by Charles G. Yale, *RAVEN*, by Henry Howard, and *VIRGIN* by Mr. Williams. Commodore Platt took the members out to see the race on his yacht *AMELIA*.

*See San Francisco News Letter.

Then Commodore Ogden succeeded Commodore Platt in office and Henry G. Langley became Secretary. After this First Regatta, yachting was fairly inaugurated and club life commenced. The fleet was not large, and many supposed when they joined the club that the yachts were "free for all;" but this was a mistake, and by and by they began to cease using the Club House and the other members stopped coming too. The railroad company wanted the wharf where the Club House was and the organization dropped out of sight for a while.

About 1874 a re-organization was perfected, new officers were elected and the club prospered. R. L. Ogden was elected Commodore and after him Commodore C. H. Harrison, the latter gentleman holding the office for a number of years. When the club was re-organized, Charles G. Yale was elected Secretary and held the office continuously for some sixteen years. Franklin Bangs, Henry Underhill, Solon Williams and Charles Kellogg in turn served as Treasurer. The re-organized club had no headquarters and after a time it was decided to build. The question of location brought about a disagreement, which resulted in the founding of the *PACIFIC YACHT CLUB* and both clubs built houses at the points where they now stand. The *SAN FRANCISCO YACHT CLUB* made a mistake in its earlier history by having too many life members a mistake, by the way, which was repeated by the *PACIFICS* with equally disastrous results. Both clubs had to re-organize and stop the life membership plan.

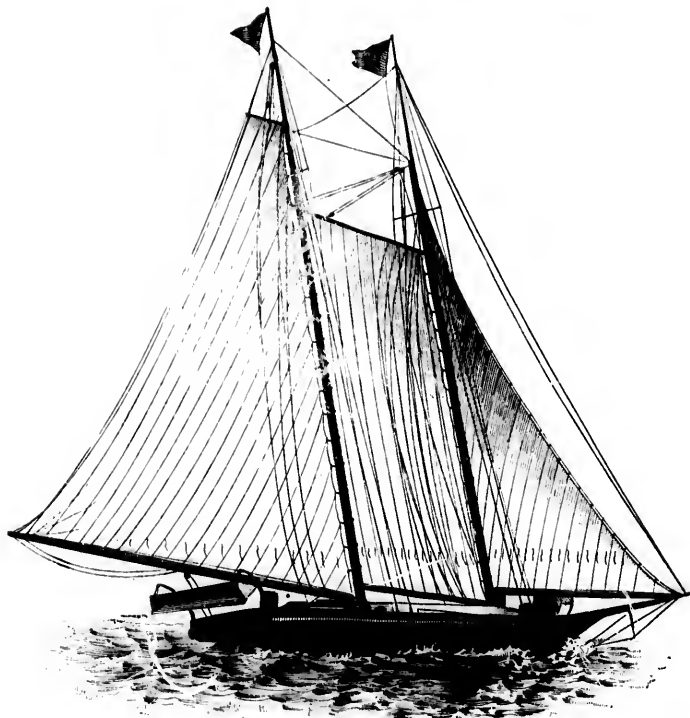

CHISPA.—FIGURE 495.

The SAN FRANCISCO YACHT CLUB has always had a reputation among the yacht clubs of this country as one in which the members knew how to sail their own boats and did sail them. It was never a merely ornamental organization formed for the members to frequent



LA PALOMA.—FIGURE 496.

the Club House, but all hands entered the regattas, went on the cruises and did actual sailing. The brass button and uniform feature never made much of a show with the boys who gave the club its reputation. They were yacht-sailors and all the officers were yacht-owners and yacht-sailors.

There are now very few of the original members left on the roll of the present club, though there are some who still retain their membership. Several of the older members have been elected to honorary membership in consideration of earlier services to the club.

This club as the pioneer of the yachting organizations of the bay, started the regattas and cruises, measured and laid out the courses for racing, got up the tables of distances and signal code, and all that which the more recent clubs follow. It was in this club that the Mosquito Regattas originated, in which all sorts of small sailing craft entered; fishermen, whitehalls, ships, boats, etc. These were very popular annual races for many years.

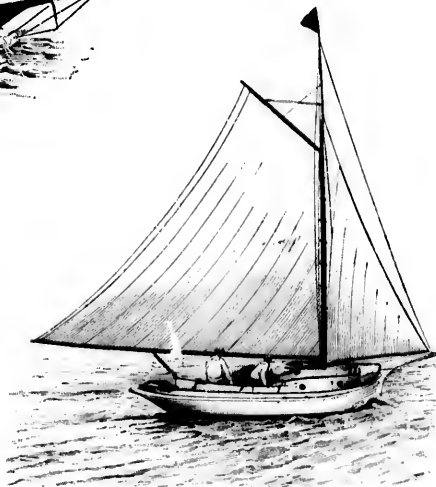

GRACIE.—FIGURE 497.

Most of the old members of this club will remember the famous clambake at Sausalito. All the yachts were placed at the members disposal, and Commodore Harrison had charge of a steambot which towed to Sausalito to the clambake. It was a great day, but when the hills came in they swamped the club. The blow was one from which the club did not recover, and it was entirely due to this that it languished for several years until new blood came in. The Club House has always been rather expensive to maintain, and some years

all hands entered the cruises and did not miss a button and made much of a show to the club its reputation-sailors and all owners and yacht-

few of the original roll of the present some who still Several of the elected to honor- consideration of earlier

member of the yacht- the buy, started the measured and laid being, got up the signal code, and the recent clubs fol- club that the Mos- ted, in which all aft entered; fisher- boats, etc. These tal races for many

it has been a hard rub to pull through. But within the past three or four years the club has again got a new lease of life and is now a most prosperous organization.

The present home of the club is at Sansalito. The Club House is easily accessible, being but a short walk from the ferry landing. It is very comfortably fitted up. There is a large room for small boats, a large assembly room, off which is a ladies' retiring room and the directors' room, a wine room and buffet, and the gallery. The walls are adorned with pictures of yachts and vessels of historic interest. Steps lead from the porch and from the boat house to a commodious float; and if necessary, yachts can come alongside the wharf. The club entertains lavishly, and its affairs are always well attended.

The fleet is large, among the vessels being the schooner *CHISPA*, belonging to Commodore I. Gutte; *LURENE*, belonging to the J. D. and A. B. Spreckels; *JESSIE*, belonging to ex-Commodore J. Macdonough; William Lacey's *PENELOPE*; ex-Commodore Wm. N. McCarthy's *RAMONA*; C. Chittenden's *WHITE WINGS*; E. W. Newhall's *VIRGINIA*; C. S. and A. H. Wieland and Captain Harry White's *AGGIE*. The yawls are *FROLIC*, belonging to ex-Commodore C. H. Harrison; *EMERALD*, belonging to W. Letts Oliver, and W. H. Shelley's *SEVEN BELLS*. The sloops are L. B. Thomas and E. A. Engelberg's *SAPPHO*; Hancock Manning's *LA PALOMA*; J. W. Pew's *TUCANT*; C. H. Merrell's *HELPLESS*; Dr. Thos. H. Hill's *GRACE*;

logg; Measurer, Capt. Matthew Turner. Directors: I. Gutte, yacht *CHISPA*; Jno. W. Pew, Harry A. Bowen, launch *CLAUDE*; G. F. Davidson, cutter *POLLY*; E. C. Bartlett, launch *GYPSY*.

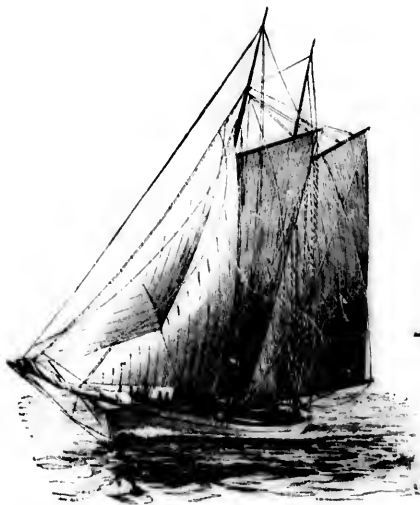

JESSIE.—FIGURE 408.

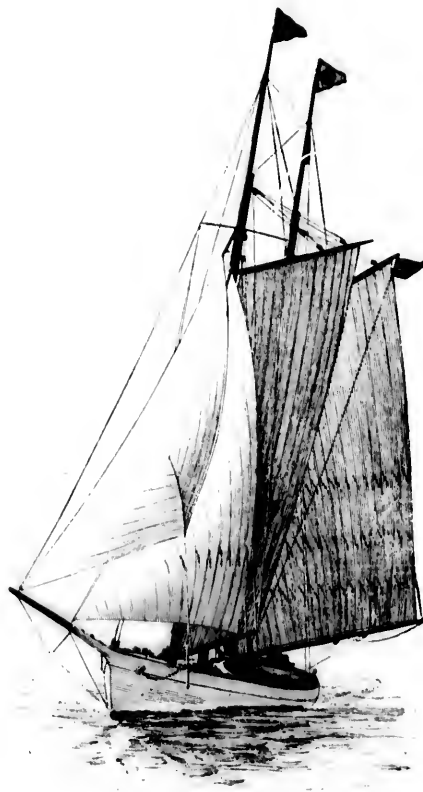

RAMONA.—FIGURE 409.

1892.

Commodore, I. Gutte, schooner *CHISPA*; Vice-Commodore, K. A. Eddy; Secretary, Geo. W. Reed; Financial Secretary, C. H. Merrell; Treasurer, Chas. L. Barrett; Measurer, Matthew Turner.

1893.

Commodore, I. Gutte, schooner *CHISPA*; Vice-Commodore, E. Engelberg; Secretary, Geo. W. Reed; Treasurer, C. L. Barrett; Measurer, Capt. M. Turner.

E. A. Von Schraidt's *CYCLONE*; Davidson Bros.' *POLLY*, *PILGRIM* and *MEXIE*. The launches are E. C. Bartlett's *GYPSY*; B. W. Stickney's *NEMO*; John Lee's *BOB*; *EDWINNA* and several others.

The officers and directors elected for the year 1891 were as follows: Commodore, Wm. N. McCarthy, yacht *RAMONA*; Vice-Commodore, L. B. Thomas, yacht *SAPPHO*; Secretary, Fred B. Chandler; Financial Secretary, Geo. W. Reed; Treasurer, Chas. W. Kel-

member the famous at the members steamboat which at day, but when low was one from due to this that e in. The Club, and some years

PROGRAMME FOR THE YEAR 1893.

Saturday, May 6th. (Opening Day).	Open Reception to CORINTHIAN YACHT CLUB and ESCINAL BOAT CLUB. Dancing at Club House from 2:30 to 6 P. M. In the evening, entertainment of visiting yachts- men.
May 7th.	Cruise in squadron, by signals from flag ship (Members' Day).
May 13th-14th	Cruise to Mare Island and return.
May 30th	Channel Cruise (C. Y. C. Regatta).
June 3d	Hop at Club House, Sausalito.
June 3d-10th	Cruise to Drake's Bay and return.
June 21th-25th	Cruise to Mare Island and return.



EMERALD.—FIGURE 500.

July 1st-4th
July 22d
July 29th-30th

Aug. 12th
Aug. 19th-20th
Aug. 26th-27th
Sept. 9th

Up River Cruise.
Hop at Club House, Sausalito.
Fishing and Chowder Cruise. (Members'
Day).
Hop at Club House, Sausalito.
Cruise in squadron, by signals from flag ship.
Full Moon Cruise.
Channel Cruise. Rendezvous for the night at
Pinnacle Rock.

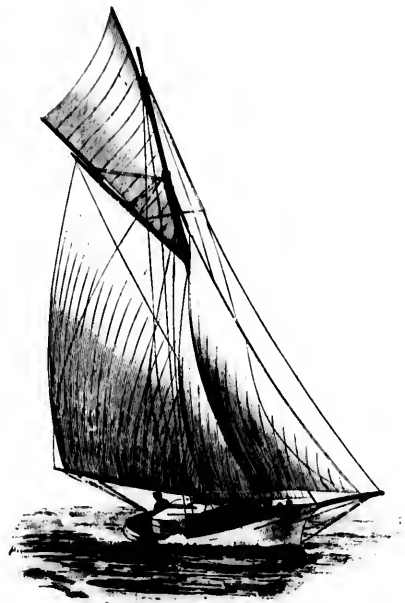

SAPPHO.—FIGURE 501.

Sept. 10th
Sept. 16th
Sept. 23d-24th
Oct. 14th
Oct 21st

Sail in squadron, by signals from flag ship.
Hop at Club House, Sausalito.
Cruise to Martinez and return.
Tilbury (C. Y. C. Closing Day).
Closing Day.

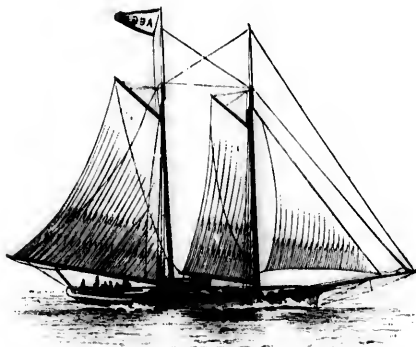

AGGIE.—FIGURE 502.

OFFICERS
OF THE
SAN FRANCISCO
YACHT CLUB.



- No. 1—Commodore I. Gutte.
- No. 2—Director Wm. N. McCarthy.
- No. 3—Director Morn M. Barrett.
- No. 4—Dr. T. R. Hill.
- No. 5—Treasurer Chas. L. Barrett.
- No. 6—Director E. C. Bartlett.
- No. 7—Mensurer Matthew Turner.
- No. 8—Secretary Geo. W. Reed.
- No. 9—Director Ben. W. Stickney.
- No. 10—Financial Sec'y Chas. H. Morrell.
- No. 11—Director ex-Cem. J. MacDonough.

als from flag ship.
consulito.
return.
ing Day).

BIOGRAPHICAL SKETCHES AND DESCRIPTION OF YACHTS ENROLLED IN THE CLUB.

I. GUTTE, Commodore of the **SAN FRANCISCO YACHT CLUB**. Commodore Gutte is the owner of the Bermudian-rigged schooner yacht **CHISPA**, a very fast yacht. The Commodore is always surrounded by friends owing to his congenial nature and liberality in entertaining brother yachtsmen. He has guided the affairs of the club in a manner which does credit to his enthusiasm and good judgment.

CHISPA.

CHISPA is a centerboard schooner belonging to Isadore Gutte, Commodore of the **SAN FRANCISCO YACHT CLUB**. Was designed and built by Matthew Turner and launched in July, 1879. She is one of the oldest and fastest yachts in the Bay and she has never been beaten. She hails from San Francisco and is also enrolled in the fleet of the **PACIFIC YACHT CLUB**. See Fig. 495.

DIMENSIONS.

Length over all,	61 feet 6 inches.	Length load waterline,	55 feet 6 inches.
Draft,	5 feet 6 inches.	Beam,	18 feet 6 inches.

JESSIE.

JESSIE is a keel schooner belonging to Joseph Macdonough, ex Commodore of the **SAN FRANCISCO YACHT CLUB**. She hails from San Francisco and sails with the fleet of the **PACIFIC YACHT CLUB**. See Fig. 498.

DIMENSIONS.

Length over all,	88 feet.	Length load waterline,	74 feet 6 inches.
Beam,	24 feet.	Draft,	10 feet 7 1/2 inches.

WILLIAM LETTS OLIVER, mining engineer, Oakland, Cal., was born at Valparaiso, Chili. Is the owner of the schooner **WAVE** and has also owned the yawl **EMERALD** and the cutter **POLLY**. Interested in yachting for twenty-five years and for three years Commodore of the **SAN FRANCISCO YACHT CLUB**. He is a member of the **SAN FRANCISCO** and **CORINTHIAN** (of California) **YACHT CLUBS**.

WAVE.

WAVE is a keel schooner owned by William L. Oliver of Oakland, Cal. Was designed and built by George Farmer, Oakland, and was launched in 1888. She hails from Oakland and sails with the **SAN FRANCISCO** and **CORINTHIAN** (of California) **YACHT CLUBS**.

DIMENSIONS.

Length over all,	31 feet.	Length load waterline,	30 feet.
Depth,	4 feet 11 inches.	Draft,	4 feet 6 inches.
Beam,	11 feet.		

LA PALOMA.

LA PALOMA is a sloop owned by Hancock Banning, one of the owners of **SANTA CATALINA ISLAND**. She was built in San Pedro and in 1889 went to San Diego to meet the famous yachts of the **SAN FRANCISCO** and **PACIFIC YACHT CLUBS**, and was there classed with such boats as **ANNIE** and **SAPHO**, both of which she beat, the former by fourteen and the latter by twenty minutes. Before the advent to the **SAN FRANCISCO YACHT CLUB** of **LA PALOMA**, **ANNIE** had borne the championship pennant for ten years. A short time ago the **SAN FRANCISCO YACHT CLUB** presented **LA PALOMA** with its championship whip, which the latter still flies as a challenge to all comers. See Fig. 496.

GRACIE.

GRACIE is a 27-foot yacht belonging to Dr. T. H. Hill, the former owner of the 25-foot sloop **NEVER SINK**. **GRACIE** made a cruise up the Sacramento River, starting on June 11th and returning on the 19th, going up as far as Walnut Grove. See Fig. 497.

RAMONA.

RAMONA is a new yacht belonging to Wm. N. McCarthy. She has been on a cruise as far south as San Diego, has a cabin, four large state-rooms, a galley and forward bunks for the crew. The panels of the cabin and galley wall are decorated with fine miniature oil paintings by French masters. See Fig. 499.

DIMENSIONS.

Length over all,	66.6 feet.	Draft,	8 feet 6 inches.
Beam,	15 feet.		

**GEORGE W. REED.**

GEORGE W. REED, Custom-House broker, San Francisco, Cal., was born in Sacramento, Cal., of American descent for eight generations back. The son of La Fayette and Frances E. Reed. Has been a yachtsman for seven years, and has for four years held the office of Secretary of the **SAN FRANCISCO YACHT CLUB**. Mr. Reed is a well-known amateur photographer and is otherwise accomplished.

SAPHO.

SAPHO is owned by L. B. Thomas and E. A. Engelberg. She was designed and built by W. Stone of San Francisco, and was launched in January 1882. Sails with the **SAN FRANCISCO YACHT CLUB**. She has made the run from San Francisco to San Diego in three days and five hours, the quickest run recorded of any yacht. She is a centerboard sloop, having been altered from a yawl in 1890. See Fig. 501.

DIMENSIONS.

Length over all,	47 feet.	Length load waterline,	40 feet 6 inches.
Draft,	8 feet.	Beam,	15 feet.

AGGIE.

AGGIE is a centerboard schooner, designed and built by W. G. Hull, Port Ludlow, Washington. She is at present the property of Charles S. and A. G. Wieland, hails from San Francisco and sails with the fleets of the **PACIFIC** and **SAN FRANCISCO YACHT CLUBS**. Was launched in 1880. See Fig. 502.

Official number, 106,151.

Gross tonnage, 52.31; Net tonnage, 49.70.

DIMENSIONS.

Length over all,	77 feet 9 inches.	Length load waterline,	63 feet 10 inches.
Depth,	31 feet 3 inches.	Draft,	6 feet.
Beam,	6 feet 9 inches.		

Racing Record for 1893:—

PACIFIC YACHT CLUB—**AGGIE** was second in the race sailed by this club September 9th.

CLUB.

r. T. H. Hill, the former
FRACIE made a cruise up
h and returning on the
e Fig. 497.

N. McCarthy. She has
has a cabin, four large
the crew. The panels of
fine miniature oil paint-

8 feet 6 inches.

. REED, Custom-House
San Francisco, Cal., was
ento, Cal., of American
generations back. The
ce and Frances E. Reed.
htsman for seven years,
years held the office of
SAN FRANCISCO YACHT
d is a well-known ama-
er and is otherwise accom-

A. Engelberg. She was
eiseo, and was launched
RANCISCO YACHT CLUB.
to San Diego in three
ed of any yacht. She is
n a yawl in 1890. See

terline, 40 feet 6 inches,
15 feet.

ed and built by W. G.
present the property of
San Francisco and sails
RANCISCO YACHT CLUBS.

51.

age, 49.70.

atorline, 69 feet 10 inches,
8 feet.

the race sailed by this



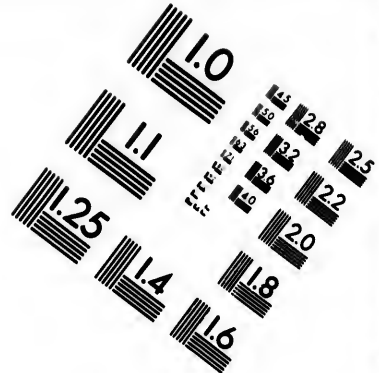
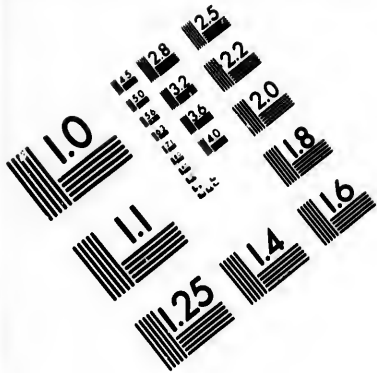

**IMAGE EVALUATION
TEST TARGET (MT-3)**

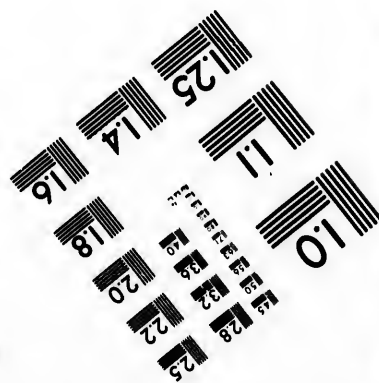
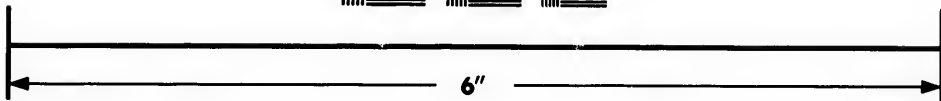
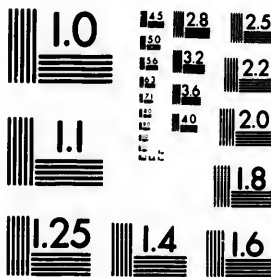

**Photographic
Sciences
Corporation**

23 WEST MAIN STREET
WEBSTER, N.Y. 14580
(716) 872-4503



FROM A NEGATIVE BY CHILD.

PLATE LXIII.

PHANTOM.



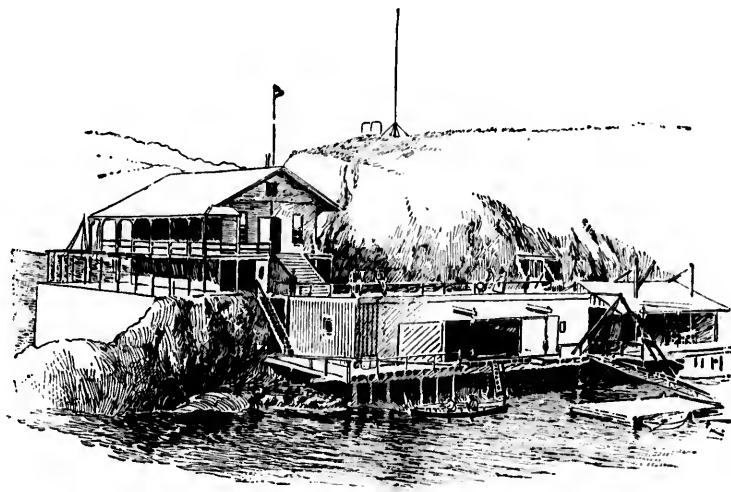

CORINTHIAN YACHT CLUB HOUSE.

History of the Corinthian Yacht Club.

STATION—TIBURON, MARION CO., CAL.

FOR many years prior to March 16, 1886, yachting in San Francisco Bay had been at a standstill among the small boats, not owing to the scarcity of boats, but principally to the way their owners were treated on a club cruise.

This treatment consisted principally in the issue of elaborate invitations to accompany the larger boats on their club cruises, etc., and before the trip was half over the larger boats had returned home and left the smaller boats to reach their destination as best they could.

About this time, T. F. Tracy, L. B. Chapman, K. H. Catton, C. W. Stangroom, S. H. Williams, Ward Battles, W. C. Moody, George E. Billings, T. H. Pennell, all interested in the advancement of small boat yachting, agreed to organize a yacht club for small boats, and a communication was addressed to those who might be interested in this advancement of the sport.

Answers came in rapidly and a meeting was called for Tuesday evening, March 16, 1886, which brought out over fifty names. At this meeting it was decided to form a permanent organization for the advancement of yachting in San Francisco Bay, and that Committees be appointed to draw up Constitution and By-Laws, and report on a suitable site for club headquarters.

Mr. T. F. Tracy, Jr., was elected Chairman pro tem. He appointed the following Committee on Constitution and By-Laws: Messrs. Moody, Chapman and Upton. Committee on Location: Messrs. Battles, McLaren and Williams, with instructions to report at

the next meeting. At this meeting it was resolved that no further names be added to the roll until the club was permanently organized.

On March 31, 1886, the first regular meeting of the club was held with about forty members present. The Committee on location were as yet undecided where to build, and further time was granted them. The Committee on Constitution and By-Laws had labored about fifteen nights drawing up rules for the government of the club, and at this meeting they were accepted.

The following officers were elected to serve for the ensuing year: Commodore, W. C. Moody; Vice-Commodore, L. B. Chapman; Recording Secretary, George E. Billings; Financial Secretary, T. F. Tracy, Jr.; Treasurer, F. D. Spaulding; Mensurer, S. H. Williams; Directors, W. A. Wilson, W. B. Upham; Sailing Committee, Ward Battles, K. H. Catton, Geo. F. Byrbee.

At the next meeting of the club, April 15, 1886, twenty-six new names were added to the roll.

On January 27, 1887, the next meeting of any importance was called. The Committee on Location reported favorably on going to Point Tiburon where an acre of ground had been leased from T. B. Valentine for a period of five years at a nominal total of \$12 per annum.

On this ground a Club House was built, costing in the vicinity of \$1,500, \$400 of which was kindly donated by James Mervin Donahue, now deceased.

On April 30, 1887, the Club House was opened for the reception

of members and their friends, and after an afternoon spent in dancing and refreshments, a sail in squadron was indulged in.

The First Annual Regatta of the club was held June 18, 1887.

As time rolled on, the club had grown to such proportions that the facilities for housing boats, etc., were not sufficient for the increasing membership, and a boat house was built on the ground in front of the Club House which gave ample room for stowing all rowing boats of the club.

Again in 1891, the increase in membership rendered an increase of space necessary, so an addition was built to the Club House. The club now numbered among its members 175.

The Club House is situated on a narrow strip of land in Marion County, projecting into the Bay, on the end of which are built the Club and Boat Houses. It is easily accessible to San Francisco, being only thirty minutes ride on the boats of the S. F. & N. P. R. R. Co.

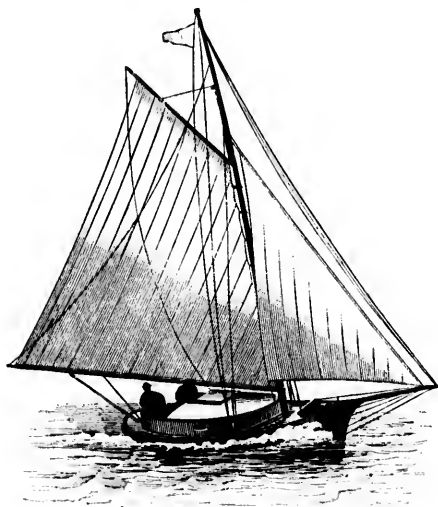

CERES.—FIGURE 503.

which make half hourly trips. In front of the boat house is a large float with water ten feet deep around it, allowing the largest yacht of the fleet to come alongside, and fill up with supplies, etc.

The ground the Club House is on being only leased, and the lease now running from month to month, the club does not feel like making any vast improvements in addition to the present quarters. A Committee on Location is now looking up a suitable site for the building of new club and boat houses.

Seawanhaka rules now govern all races, and the club owes its success principally to the fact that only boats under 45 feet length over all are admitted.

The club, besides having numerous ways of amusing its guests, makes it a point to have an annual dinner and from 75 to 125 of its members sit at the same table.

LIST OF OFFICERS, '87-'93.

	1887.	1888.
Commodore,	W. C. Moody,	L. B. Chapman,
Vice-Commodore,	L. B. Chapman,	G. E. Harrold,
Financial Sec'y,	T. F. Tracy,	
Recording Sec'y,	G. E. Billings,	G. McC. Taylor,
Treasurer,	F. D. Spaulding,	E. E. Shotwell,
Measurer,	S. H. Williams,	E. J. Stone.

	1889	1890.
Commodore,	Geo. E. Billings,	Geo. E. Billings,
Vice-Commodore,	W. P. Harrold,	W. P. Harrold,
Secretary,	H. C. Klopenstein,	T. F. Tracy,
Treasurer,	F. D. Spaulding,	F. D. Spaulding,
Measurer,	A. O. Eckmann,	A. O. Eckmann,
Port Captain,		C. E. Miller.
	1891.	1892.
Commodore,	J. H. Johnson,	W. A. Stringer,
Vice-Commodore,	H. L. Jones,	J. W. Pew,
Secretary,	T. F. Tracy,	E. S. Emmons,
Treasurer,	F. E. Spaulding,	W. F. Dixey,
Measurer,	C. R. Wilson,	H. Gorter,
Port Captain,	C. E. Miller,	H. E. Pennell.
	1893.	
Commodore,	J. W. Pew,	
Vice-Commodore,	M. A. Newell,	
Secretary,	F. E. Baker.	
Treasurer,	W. F. Dixey.	
Measurer,	H. Gorter.	
Port Captain,	H. E. Pennell.	

RACING RECORD, SEASON OF 1892.

The club sailed the First Regatta under the Seawanhaka rules on the Pacific coast on May 30th. The summary is as follows:

		L. W. L.	Seawanhaka
		ft. in.	sailing length.
			feet.
Elia	sloop	38 11	40.2
Petrel	schooner	37 11	30.8
Linda	sloop-keel	37 04	36.8
Thetis	sloop	34 04	33.6
Freda	sloop	28 08	31.4
Truant	cat	25 00	24.8
Lapwing	sloop	21 06½	24.5
May	sloop	22 00	23.8
Norma	sloop	24 06	24.3
Fawn	sloop	24 10½	24.4
Ceres	sloop	19 02	21.5

Schooners are measured at 85 per cent. and yawls at 93 per cent. of sailing length.

The wind was west by north, moderate, and the courses were from Meigs' Wharf, past Presidio Shoal Buoy, past Blossom Rock Buoy, around a mark boat 2½ miles distant, and then home by the Presidio Shoal Buoy for the larger yachts, 12 miles, and directly home for the smaller, 9 miles. The times were:

	Start.	Finish.	Elapsed.	Corrected.
	h. m. s.	h. m. s.	h. m. s.	h. m. s.
First Class.				
Elia	12 45 42	3 40 35	3 54 54	3 54 54
Petrel	12 55 00	withdrew		
Linda	12 49 15	withdrew		
Second Class.				
Thetis	13 33 45	3 47 03	3 13 18	3 13 18
Freda	13 35 44	withdrew		
Truant	13 32 00	3 46 55	3 14 45	3 08 55
Third Class.				
Lapwing	12 18 00	3 27 19	3 09 19	3 09 19
May	12 25 00	3 26 07	3 01 07	3 00 18
Norma	12 18 10	3 36 37	3 18 18	3 18 04
Fawn	12 21 22	3 11 12	2 49 50	2 49 43
Fourth Class.				
Ceres	12 05 26	3 34 25	3 30 56	3 30 50

ELIA was disqualified, being sailed by a professional.

The judges were C. H. Crocker, H. J. Kelly and A. D. Cross.

The winners were TRUANT, FAWN and CERES.

The Fall Regatta was sailed September 25th. Course, 11½ miles; wind light and fluky.

First Class.

	Rig.	Elapsed H. M. S.	Corrected H. M. S.
Elia	sloop	withdrew	
Freda	sloop	2 27 12	2 25 09
Thetis	sloop	2 28 57	2 28 57
Clara	sloop	2 32 30	not meas.
Truant	cut	2 35 51	2 31 05
Petrel	schooner	did not start	
Folly	cutter		withdrew
Linda	sloop	2 13 15	disqualified

LINDA was disqualified for not having been sailed by a member of the club.

Second Class; 10 miles.

	Start. H. M. S.	Finish. H. M. S.	Elapsed H. M. S.	Corrected H. M. S.
Volante	1 16 15	4 03 35	2 47 20	2 40 19
Fawn	1 20 30	withdrew		
Lapwing	1 23 41	4 03 53	2 41 12	2 41 12
May	1 16 08	withdrew		
Muggama Chuddee	1 16 25	4 02 04	2 45 39	2 35 20½

Second Class.

	Rig.	Sail Length. Feet.	Prize.	Cor. Time. H. M. S.
Dawn	sloop	36.7	1st "	2 11 11
Thetis	"	33.8	2d "	2 13 31

Third Class.

Fawn	"	26.8	1st "	1 52 35
May	"	21.9	2d "	1 59 17

Fourth Class.

Ceres	"	21.6	1st "	2 21 40
Cornelia	"	20.1	2d "	2 40 31

The Annual Regatta for 1893 was held on Decoration Day in a strong breeze and sea, the times being:

	Rig	Length. Feet.	Elapsed H. M. S.	Corrected H. M. S.
Elia	sloop	40.50	2 14 10	2 13 10
Linda	sloop	30.33	2 29 10	2 28 20
Petrel	schooner	31.22	2 32 21	2 21 18
Thetis	sloop	33.82	2 16 31	2 11 18
Dawn	sloop	36.36	2 11 50	2 11 50
Freda	sloop	30.76	2 21 11	2 10 00
Truant	cut	28.95	2 29 20	2 22 00
Folly	cutter	28.51	did not finish	
Duke	sloop	28.53	did not finish	
Volante	sloop	21.49	2 00 35	2 04 10
May	sloop	21.90	2 01 15	1 59 17
Fawn	sloop	26.81	1 32 35	1 52 35
Ceres	sloop	21.60	2 21 40	2 21 40
Cisne	sloop	21.41	did not finish	
Cornelia	sloop	20.44	2 42 33	2 40 31
Dart	sloop	11.29	did not finish	
Edna	sloop	36.95	did not finish	

The winners were: ELIA first, PETREL second; DAWN first; THETIS, second; FAWN first, MAY second; CERES first, CORNELIA second.

ELIA was formerly owned by Fulton G. Berry and was built at San Quentin, Cal., by the State prisoners. CLARA is an old New York boat and was brought out here by Jabez Howes. DAWN was built by one of the crack builders, W. F. Stone, about nine years ago for an oyster boat, and was purchased two months ago by the present owner, who has made extensive alterations in her, making her one of the finest boats in the fleet. FOLLY is one of the New York cutter models and has formerly shown remarkable speed when properly handled. TRUANT is a Cape Cod model and has heretofore been very fast, and is yet, in smooth water and light winds. DUKE was built by White, a well-known Pacific coast builder. DART was built by F. R. Cook, owner, and is somewhat after the GLORIANA type. EDNA, CERES, THETIS, CISNE, FAWN, VOLANTE, CUPID and MAY were all built by Wm. F. Stone. LINDA was built by M. Turner, and has since her launch, shown poor speed, except in heavy weather and head seas. In this last race the start was on a flood tide, turning to ebb at about forty minutes after starting. At turn of the tide wind freshened and considerable sea. Smaller boats were very wet. All carried full sail except CERES, who reefed, thereby handily winning the race in her class.

The club now numbers 27 boats and 186 active and 4 honorary members, 9 launches and 19 row boats. On the ways now and shortly to be added to the fleet are three boats, one an auxiliary steam and sail schooner, 49 feet long, another a 36 foot cutter made from Eastern designs, another a 45 foot launch, all of the most modern design.

*See Forest and Stream, June 22, 1893.

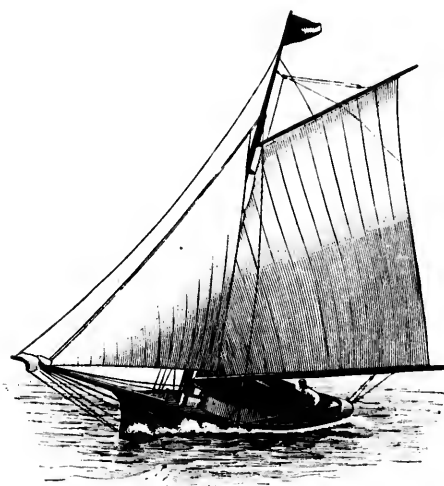

CYRETTA.—FIGURE 564.

Seawanahaka rules for measurement and time allowance. The winners were FREEDA and MUGGAMA CHUDDEE.

RACES, SEASON OF 1893.

A regatta was held May 30, 1893. The wind was from the west and moderate. The following yachts participated:

	Rig.	Sailing Length. Feet.	Corrected Time, H. M. S.
First Class.			
Elia	sloop	40.6	1st prize 2 13 10
Petrel	schooner	31.2	2d " 2 16 21

1890.

W. A. Billings
W. P. Harrold
F. Tracy,
D. Spaulding,
O. Eckmann,
E. Miller.

1892.

W. A. Stringer,
W. Pew,
S. Enmons,
W. F. Dixey,
G. Gorter,
E. E. Pennell.

Seawanahaka rules on follows:

Seawanahaka sailing length. Feet.
40.2
30.8
36.8
31.6
31.4
24.8
24.5
23.8
24.3
24.4
21.5

at 93 per cent.

Courses were from
som Rock Buoy,
e by the Presidio
tly home for the

Corrected.
H. M. S.

3 54 54

3 13 18

3 08 55

3 09 19

3 00 18

3 18 04

2 49 43

3 39 59

A. D. Cross.

course, 11½ miles;

LIST OF YACHTS ENROLLED IN THE CORINTHIAN YACHT CLUB.

NAME.	OWNER.	C. B. ON KEEL.	RIG.	LENGTH	L. W. L.	BEAM.	DRAFT.
				OVER ALL.	ft. in.	ft. in.	ft. in.
				ft. in.	ft. in.	ft. in.	ft. in.
Petrel	H. L. Fames	k	Schooner	43 11	27 11	10 06	6 00
Wavo	W. L. Oliver
Frog	k	Schooner	27 00	26 06	6 06	2 00
Orea	H. E. Pennell	e b	"	29 02	27 06	5 10	1 0'
Iris
Xara	Hruco Palmer
Fou Follet	H. H. Gorter
Folly
Ripple	Capt. C. Goodall	e b	Yawl	41 04	35 03	12 04	6 06
Hover
Linda	J. H. Johnson	k	Schooner	41 00	37 04	12 00	6 00
Ella	F. F. Ames	e b	Sloop	41 00	38 11	16 00	4 00
Clara	J. H. Burdell	e b	"	44 10	39 00	16 00	3 00
Hoss	F. A. Bartlett	e b	"
Thetis	F. R. Cook	e b	"	34 00 $\frac{1}{2}$	31 00 $\frac{1}{2}$	13 00	3 00
Truant	J. W. Pew	e b	"	28 06	25 01	10 11 $\frac{1}{2}$	2 00
Freda	A. I. Lyons	e b	"	22 10	20 00 $\frac{1}{2}$	12 00	4 03
Cupid	H. Doon	e b	"	26 00 $\frac{1}{2}$	21 10	11 04	2 00
May	M. A. Newell	e b	"	26 06	22 00	10 06	2 00
Lapwing	C. J. O'Koll	e b	"	23 00 $\frac{1}{2}$	21 00 $\frac{1}{2}$	10 06	2 00
Volante	W. A. Stringer	e b	"	25 04 $\frac{1}{2}$	21 06	10 03	2 00
Fawn	H. H. Pent	e b	"	28 06	24 10	10 04	3 00
Duke	T. H. Whitejaw
Norma
Sea Fox	A. M. Clay	k	Sloop	22 06	18 10 $\frac{1}{2}$	6 04 $\frac{1}{2}$	4 10
Hambler	Chas. G. Taylor	e b	"	19 00	18 06	7 00	2 00
Ceres	F. Thornton	e b	"	22 00	10 02	8 00	6 00
Cisue	Chas. R. Wilson	e b	"	22 06	10 02	8 00	3 00
Cornelia	L. E. Hart	e b	"	22 00
Muggama Chuddee	Wm. Brooks	e b	O. Yawl	22 00	17 03	7 00	4 02
Caprice	G. A. Story	e b	"	18 07
Mascot	G. A. Pope, <i>et al.</i>	Launch (gas)
Wallele	C. H. Crocker	"
.....	A. S. Moore	"
Chaquitta	F. Happersberger	"
Emma	R. Tittle	"
Spark	J. L. Hawks	"

And about 25 Row Boats.



COMMODORE EDWARD OGDEN,

RIVERTON YACHT CLUB.

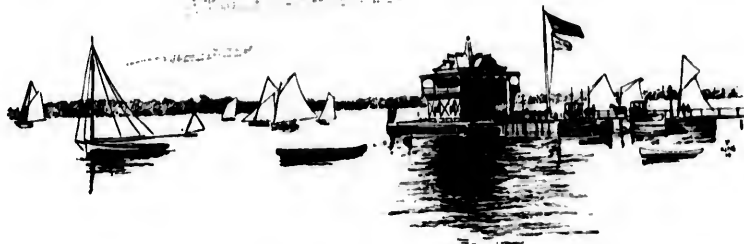

RIVERTON YACHT CLUB HOUSE.

History of the Riverton Yacht Club.

STATION—RIVERTON, N. J.

ON the evening of July 1, 1865, a party of Riverton gentlemen met for the purpose of organizing a yacht club. Mr. L. D. Senat was called to the Chair and Mr. Edward H. Ogden was appointed Secretary. Messrs. L. D. Senat and J. G. Morris were then appointed a committee to prepare a Constitution and By-Laws.

After considerable discussion it was decided to hold a regatta on the coming Fourth of July. This preliminary meeting then adjourned to meet at the call of the Chair.

The next meeting of the embryo club was held in Riverton, July 11, 1866, and, as the sentiment seemed to be unanimous that the regatta held on July 4th of the preceding year was a grand success, support for the new organization was not lacking, for the thirty-five gentlemen present were quite eager to enroll their names as members.

It was then resolved that the name of the new organization be THE RIVERTON YACHT CLUB. After adopting a Constitution and By-Laws the following gentlemen were elected to fill the several offices of the club for the ensuing year.

Commodore, Casper W. Morris; Vice-Commodore, Jacob G. Morris; Secretary and Treasurer, Edward H. Ogden; Measurer, Harry C. Biddle.

According to the By-Laws at that time: The prizes given by the club shall consist of plate, flags, etc., but under no circumstances shall matches be made for money. And according to the Sailing Regulations of that time, every yacht starting or entering for prizes, must be *bona fide*, the property of the owner or owners of such yacht.

All yachts under 34 feet, sailing in any regatta, are to . . . carry no light sails.

No . . . taking in ballast after the yachts have started in any race. Each boat to bring back the same persons as on board at the time of starting. All yachts to keep ceiling, seats and fixtures on board during a race, and no out-riggers of any description to be used.

No booming of jibs except from stay and bow-sprit to be kept down. No yacht to be sailed in a race, except a member of the club be on board.

The regulations as to sails at the present time are: There shall be

no restriction in regard to the size, shape, rig or handling of sails. The present regulations as to time allowance are as follows: Time shall be allowed for difference in length only, and such allowance shall be ten seconds to the inch per 20 miles; measurement to be greatest length wherever found.

Each year found the club in a more prosperous condition, as it had become the custom to give an excursion of the squadron each year in addition to the regattas; the excursion being attended by the members and their families and friends, and it was soon perceived that the blending of the pleasures of yachting with those of social enjoyments that ladies could indulge in, immensely increased the popularity of the club, and in a very short time there was something like 100 members on the roll.

Early in 1879 the growing sentiment in favor of having a Club House that could be called the club's own property, developed in a strong desire on the part of the members to build. Immediately the question that always presents itself on such occasions arose: "Where shall we procure the funds?" But that question was speedily settled by appointing Messrs. Walter G. Wilson, H. H. Ellison, Henry Bower, F. P. Ogden, W. E. Farrell, Chas. W. Davis and Chas. Cornelius, a committee of seven, to raise the necessary funds.

The exertions of these gentlemen soon bore fruit, for with the hearty co-operation of the Building Committee, Messrs. William F. Dreer, J. C. W. Frishmuth and William P. Ellison, the club was enabled to build and complete by June, 1880, on the outer end of the Riverton pier, a Club House that is quite a landmark to those yachtsmen cruising on the majestic Delaware by night as well as by day, for the United States Signal Service maintains a range light in the tower, and on many occasions the first view of that light has been the signal for all the boys to join in that familiar old refrain "Home Again."

In the following year, March 9, 1881, the club was incorporated, having for its object the encouraging of yachting and other athletic sports. In a short time the indebtedness had been entirely liquidated, and there was quite a balance in the treasury, notwithstanding the fact that the Club House cost \$2,500 for the building alone, while the use of the ground was kindly donated by the pier owners, subject to a few restrictions.

From year to year there were excursions and regattas, there being little to mar the pleasure of the club, except when, as in the words of one of their own members, "we were compelled to bow our heads in humble resignation to that unfathomable action of Divine Providence that would take from our scene some beloved member." Prominent among those thus taken away was the late Secretary and Treasurer, F. Perot Ogden, who was first in advocating any measure beneficial to the club, and a tireless worker in its behalf.

After the death of Mr. Ogden, January 17, 1887, interest in the club lagged somewhat, but in the Spring of 1890 interest was revived by a number of steam and naphtha craft being purchased by the members.

The year 1892 witnessed an innovation, namely, a Water Carnival. This Carnival came off in a blaze of light on Saturday evening, August 13, 1892. The Club House, as well as all the dwellings along the river bank, were handsomely illuminated with lanterns of various colors and hues, forming unique figures, while the large schooners and yachts anchored off shore were similarly illuminated. The smaller boats with their many dazzling and colored lights, forming figures of fairy houses, sails, wigwags, anchors and many others, formed in tows of ten or twelve with power launches to tow them; so when the numerous lines of boats were being towed through the various evolutions in unison with each other, and to the accompaniment of the music of the band, it recalled the fairyland tales of childhood and suggested scenes of enchantment such as only the skillful writer can graphically describe. It is expected that the Carnival of 1893 will be conducted on a still grander scale. The club on these occasions gives handsome prizes to the best illuminated boats.

The officers of the club since 1866 have been as follows:

	1867.	1868.
Commodore,	Casper W. Morris,	Casper W. Morris,
Vice-Commodore,	Jacob G. Morris,	Sam'l Grant Jr.
Sec'y and Treasurer,	Edw. H. Ogden,	Robt. K. Nelf, Jr.
Measurer,	Henry C. Biddle,	Henry C. Biddle.
	1875.	
Commodore,	Edw. H. Ogden,	
Vice-Commodore,	D. Leeds Miller,	
Secretary,	Fred. K. Moore,	
Measurer,	L. C. Cook,	
Treasurer,	F. Perot Ogden.	

The same officers acted in 1876 as in 1875, and in 1877 the only change was in electing Henry L. Gregg Vice-Commodore. In 1878 William F. Dreer was made Measurer—no other changes. In 1879 Charles W. Davis was made Measurer. In 1880 William F. Dreer was appointed Vice-Commodore, Robert Wells, Jr., Measurer, and Mr. Ogden acted as Secretary and Treasurer. In 1881 the officers were the same as in the previous year, also in 1882. The only change in 1883 was in L. C. Cook being elected Measurer. These same officers served in 1884 and 1885, while in 1886 Chas. W. Davis was made Measurer, the other officers remaining as before. Charles C. Rianhard was made Secretary in 1887, and John C. S. Davis was appointed Treasurer. There was no change in 1888 except that Walter F. Fell was made Secretary. In 1889 Chas. W. Davis became Secretary again, and in 1890 Chas. A. Wright took this office. There was no change made in 1891 or in 1892. The officers for 1893 were: Commodore, Edward H. Ogden; Vice-Commodore, Chas. M. Biddle; Treasurer, John C. S. Davis; Secretary, Charles A. Wright; Measurer, Chas. W. Davis.

Regatta Committee; Chas. W. Davis, William R. Ellison and Norman Ellison.

RACES OF 1888.

A regatta of the RIVERTON YACHT CLUB came off July 4, 1888. The wind was fresh, south southwest, with the tide flood. There were five starters in the first class; OLGA won the first prize and NETTLE won the second. In the third class CURLEW won with two

starters. The judges were Capt. Lyon, H. H. Bower, and J. C. W. Frishmuth.

A regatta was sailed July 4, 1891, over a course of 10 miles. The wind was southwest, the weather fair, and the sea smooth.

	Mailing Length, Ft. In.	Elapsed Time, H. M. S.	Corrected Time, H. M. S.
First Class.			
Nettle	26 11½	1 43 26	1 42 26
Coronet	26 10½		withdrew
Josephine	26 04½	2 11 40	2 14 10
Olga	26 02¾	1 43 45	1 43 00
Second Class.			
Active	18 08½	2 05 30	2 05 30
Curlew	16 08½	2 02 50	2 00 50

POWER LAUNCHES.

Andalusia, Ofeldt	1 29 00	1 29 00
Amerique, Naptha	1 34 11	1 24 11
Tillie, Ofeldt	1 33 01	1 21 01
Camera, Oil		withdrew

NETTLE won the first prize and OLGA the second prize in the first class. ACTIVE won the first prize in the second class, as CURLEW rounded the buoy on the wrong side. ANDALUSIA won the first and TILLIE the second prize in the Power Launch Class. The time allowance to launches was formulated for the occasion by the Regatta Committee, the size, build and horse power of the launch being taken into consideration.

The Annual Fall Regatta was sailed September 12, 1891; the weather was fair and there was a moderate easterly wind.

SLOOPs.

	Length, Ft. In.	Start, H. M. S.	Finish, H. M. S.
First Class.			
Narina	35 00	4 36 05	6 43 25
Majorie	31 08	4 36 40	6 53 05
Nannie	32 10	4 33 10	6 55 15
Ethel	29 04	4 35 30	7 03 00
Killdee	24 00	4 47 05	disabled

CATS.

Second Class.			
Olga	26 02¾	4 43 30	5 54 00
Nettle	26 11½	4 50 40	6 06 45
Josephine	26 04½	4 48 23	disabled
Third Class.			
Geo. DeB. Keim	22 08	4 47 20	5 57 45
Bonnie Jean	18 08½	4 46 50	6 03 15

NARINA, OLGA and GEO. DEB. KEIM were the winners in their respective classes. The Regatta Committee was W. R. Ellison, C. W. Davis and Chas. A. Wright.

A joint regatta was sailed by the yachts of the RIVERTON, PHILADELPHIA and CORINTHIAN YACHT CLUBS on June 30, 1892, on the Delaware River, the course being 10 miles, and the wind fresh from the southwest. The times were:

SCHOONERS.

	Elapsed Time, H. M. S.
Lydia	1 51 55
SLOOPs.	
First Class.	
Narounya	1 38 43
Schemer	1 42 47
Second Class.	
Narina	1 10 51
Majorie	2 22 30
Mermanid	2 23 11
J. S. M.	withdrew

L. Bower, and J. C. W.

course of 10 miles. The
sea smooth.

Elapsed Time. H. M. S.	Corrected Time. H. M. S.
1 42 20	1 42 20
withdrew	
2 11 40	2 14 10
1 43 45	1 43 00
2 05 30	2 05 30
2 02 50	2 00 50

1 20 00	1 20 00
1 04 11	1 24 11
1 33 01	1 21 01
withdrew	

second prize in the first
and class, as CRILEW
ESIA won the first and
eh Class. The time
occasion by the Regatta
he lunch being taken

ember 12, 1891; the
erly wind.

Start. H. M. S.	Finish. H. M. S.
1 36 05	0 43 25
1 36 40	0 53 05
1 32 10	0 55 15
1 35 30	7 03 00
1 37 05	disabled

43 30	5 54 00
50 40	6 06 45
48 29	disabled

47 20	5 57 45
46 50	6 03 15

the winners in their
as W. R. Ellison, C.

RIVERTON, PHILA-
me 30, 1892, on the
the wind fresh from

Elapsed Time.
H. M. S.
1 51 55

1 38 43
1 42 47

1 10 51
2 22 30
2 23 11
withdrew

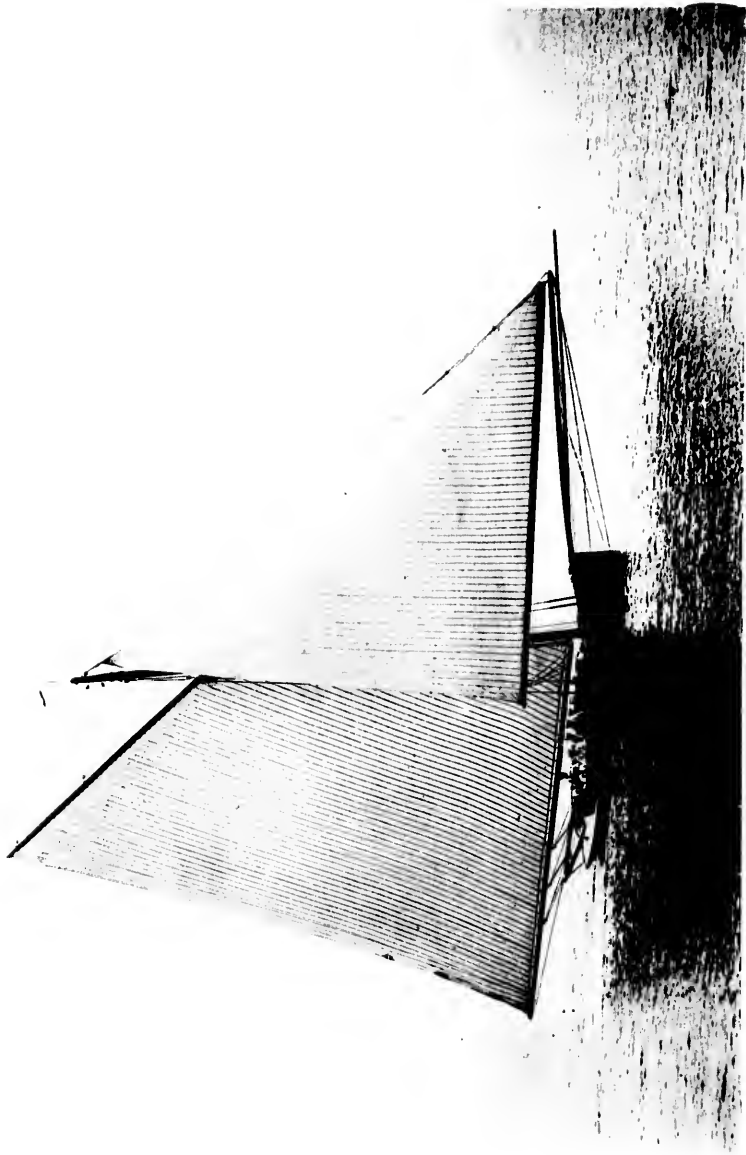

PLATE LXIV.

COMMODORE.



CONNOR-114

THE YACHTS AND YACHTSMEN OF AMERICA.

547

OPEN YACHTS.		Elapsed Time.	First Class.		Sailing Length.	Elapsed Time.	Corrected Time.
Class A.		U. S. M. S.			Feet.	U. S. M. S.	U. S. M. S.
Coronet		1 54 35	Killdee	center sloop		2 05 16	waived time allowance
Mohican		1 56 18	Marjorie			2 05 47	
Olga		1 58 38					
Spray		2 12 40	Second Class.				
G. DeB. Keim		capsized.	Olga	cat	20.024	2 02 55	2 02 10
Nettle		disabled.	Nettle	cat	20.114	2 05 42	2 05 42
			Third Class..				
Class B.	OPEN BOATS.		Bonnie Jean	cat	18.06	2 16 45	waived time allowance
Keystone		2 24 20	Frolic	cat	17.11	2 22 01	
Bonnie Jean		disqualified.	Sea Gull	cat	18.00	2 23 14	
	NAPHTHA LAUNCHES.						
Camera		1 09 35	*11		15	2 30 21	
Tillie		1 10 08	3		15	2 31 44	
Amerique		1 11 37	14		15	2 31 22	
			12		15	2 31 29	
			13		15	2 35 21	

The winners were LYDIA, NAROUNYA, NARINA, CORONET, KEYSTONE and CAMERA.

RACES OF 1893.

A Joint Regatta was held July 4, 1893, over a 10 mile course, for 1st, 2d and 3d classes. A 6 mile course for Mosquito boats, and a 15 mile course for launches.

The wind was from the northwest and the weather was mild. The following yachts took part:

MOSQUITO BOATS.	
*11	15
3	15
14	15
12	15
13	15

*Known only by numbers.

Eight other Mosquitos started in the above race.

LAUNCHES.

Fleur de Lis	1 56 18
Awba	withdrawn

Balance of season's racing was in two series, for points. A. G. Cook winning both; N. Ellison second in both.

BIOGRAPHICAL SKETCHES AND DESCRIPTION OF YACHTS ENROLLED IN THE CLUB.

EDWARD H. OGDEN, Commodore of the RIVERTON YACHT CLUB, a prosperous merchant of Philadelphia, was born in Philadelphia. In the midst of all the Commodore's business affairs, that ordinarily require all of one's attention, he has found time for forty-five years to keep himself closely in touch with yachting. He has owned EGERIA and is at present the owner of NETTLE. He was one of the founders of the RIVERTON YACHT CLUB in 1865, and his interest in the welfare of the club is proved by the fact that his fellow members appointed him Secretary and Treasurer of the club for nine years; and then gave him the office of Commodore, which honor he has retained for no less than eighteen years. Commodore Ogden has done much to advance interest in yachting and all pertaining thereto.



CHARLES A. WRIGHT.

Spars: Mast, 25 feet; Boom, 30 feet; Gaff, 10 feet.

NETTLE.

A centerboard sloop owned by Edward H. Ogden, Commodore of the RIVERTON YACHT CLUB. She was designed and built by Wignall of Philadelphia for her present owner, and was launched in 1875. She hails from Riverton, N. J. and sails with the RIVERTON YACHT CLUB.

DIMENSIONS.

Length over all, 27 feet. Depth, 4 feet 6 inches.
Draft, 2 feet. Beam, 11 feet.

LIST OF YACHTS ENROLLED IN THE RIVERTON YACHT CLUB.

NAPHTHA YACHTS.

NAME.	OWNER.	LENGTH OVER ALL.	EXTREME BEAM.	HORSE-POWER.
		ft. in.	ft. in.	
Sylvia	Edw. H. Goldhawk	40 00	8 00	10

NAPHTHA LAUNCHES.

La Carolina	H. Yale Dolan	30 00	8 00	6
Amerique	Chas. A. Wright	30 00	5 00	4

STEAM LAUNCHES.

Tillie	G. W. B. Roberts	25 00	5 06	5
Camora	F. G. Stuart	25 00	5 00	4

SCHOONERS.

NAME.	OWNER.	LENGTH OVER ALL.	EXTREME BEAM.
		ft. in.	ft. in.
Nautilus	E. B. Showell, John C. S. Davis	23 00	17 00

SLOOPS.

Kildee	W. Seymour Runk, Samuel S. Burgen	34 00	12 00
Narina	W. Barklio Heury	35 03	10 01
Marjorie	John P. Edwards	31 08	11 06
Cora	Jacob G. Morris	35 06	12 02

CAT-RIGGED YACHTS.

Nettle	Chas. M. Biddle, J. C. W. Frishmuth, J. C. S. Davis, C. W. Davis, William P. Ellison, E. H. Ogden, Thos. Roberts, Chas. A. Wright, E. B. Showell, J. G. Mellivan	26 11	10 10½			
	Cronet			H. Yale Dolan	26 11	10 11
	Nannie			E. H. Fittler, Jr.	26 04	10 09
	Josephine			D. A. Waters	26 04	11 01
	Olga			William H. Hower, A. W. Hansel	26 03	10 10
Berchwood	H. Yale Dolan	24 10	12 00			
Geo. De B. Keim	Geo. De B. Keim	22 00	8 00			
Spray	L. C. Cook	21 02	7 02			
Petrel	J. G. Marsh	18 02	8 10			
Undine	Jacob G. Morris	10 03	6 00			
Bonnie Jean	W. S. Grant, Jr.	18 06	8 03			

TOWN.

DEAN.



COMMODORE E. M. WALBRIDGE.

ROCHESTER YACHT CLUB.

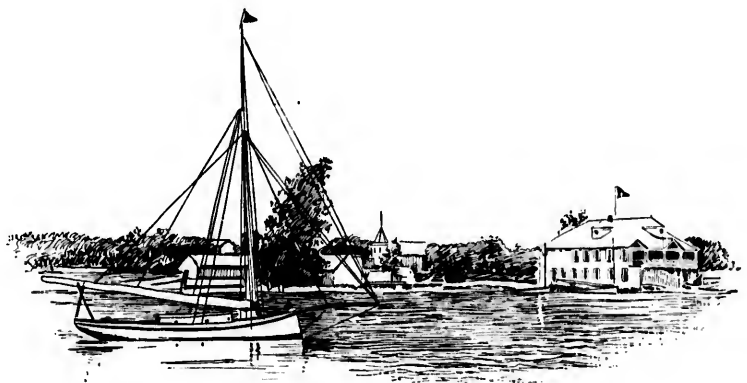

ROCHESTER YACHT CLUB HOUSE.

History of the Rochester Yacht Club.

STATION—CHARLOTTE HARBOR, N. Y.

YACHTING has taken a firm hold upon the citizens of Rochester within the past few years and the fleet of the ROCHESTER CLUB has become well known in every port along Lake Ontario. The small boats of twenty years ago have given place to some of the speediest and most graceful yachts on the lake, and the development of the sport in this city has attracted to it many of the leading men, both business and professional. Rochester is situated on the Genesee river, about 5½ miles from Lake Ontario, and the yacht club is at a disadvantage as compared with the other clubs on the lake on account of the distance from the water. At the lake is Ontario Beach, the summer resort of Western New York, and the Genesee river empties here making the harbor. The first attempt to establish a permanent yachting organization in this city was made in the early part of April 1874. At that time a few choice spirits met in the rooms of the Genesee Sportsmen's Club, in the Reynolds Arcade and formed the nucleus of what afterward became the Genesee Yacht Club. It was not until the following August, however, that they adopted their Constitution and By-Laws and elected the officers. At this time the club had a membership of forty-five and the fleet of eighteen yachts was composed of URCHE, sloop, H. C. Phillips; MAUD, sloop, A. D. McMaster; HANSWAGLER, schooner, J. A. Hoekstra, *et al.*; TEASER, sloop, G. W. Waekerman; ALDINE, sloop, Charles A. Davis; RAMBLER, sloop, George H. Newell; ISLAND QUEEN, sloop, Henry Walter; SETH GREEN, sloop, Seth Green; TITANIA, schooner, J. W. Bissell; RUSS COATES, sloop, W. C. Ellis; FLEETWING, sloop, L. U. Dodge; PEERLESS, sloop, S. J. Lovercraft; FEARLESS, sloop, F. A. Mandeville; REBECCA, sloop, W. A. Stace; OLD CROW, sloop, W. C. Ellis; ATLANTA, sloop, A. D. McMaster; RIVER BELLE, sloop, E. U. Willard; MODOC, sloop, J. G. Cramer.

Of this fleet TITANIA was the largest boat and, although not very fast, was a good cruiser and is now serving in the carrying trade as a coaster. SETH GREEN was the prize winner of the fleet, but it was very generally conceded that this was more on account of the masterly way in which the boat was sailed than any merit the craft

itself possessed. The boat was always under the personal management of the veteran yachtsman whose name she bore, and in competition with the embryo sailors who manned the other yachts he had no trouble in securing first prize in any race he cared to enter, and there is no doubt that it was owing to this monotonous taking of prizes on the part of SETH GREEN which contributed largely to the final dissolution of the club.

The officers of the club were divided into two classes, naval and civil. The personnel of the naval officers for the first year was: Commodore, Joseph C. Tone; Vice-Commodore, L. U. Dodge; Rear-Commodore, W. A. Stace; Measurer, E. U. Willard; Regatta Committee, E. Angevine, S. H. Lowe, J. A. Hoekstra.

The civil officers for the same year were President, Charles A. Davis; Vice-Presidents, E. Angevine, S. H. Lowe, J. A. Hoekstra; Recording Secretary, H. C. Phillips; Corresponding Secretary, E. U. Willard; Treasurer, R. P. Randall.

Of the yachts composing the first fleet of this club only two are now in commission. They are REBECCA (now known as GREYHOUND) and the famous SETH GREEN. Of the others all, with a few exceptions, have suffered the usual fate attending a well-worn toy that has outlived its usefulness. The exceptions are TITANIA, which is now in the coasting trade, SETH GREEN which may be seen during the summer on Irondequoit Bay, N. Y., and RAMBLER.

The members of the GENESSEE YACHT CLUB were not slow to improve their opportunity for securing a season of sport, and under the able direction of their officers a number of interesting regattas were arranged.

During the season of 1874 the club contented itself with a local race which proved very successful and encouraged them to greater efforts next season. In 1875 in addition to the usual Club Regatta, an International Regatta was held, which occurred on September 14th and 15th, off Ontario Beach, Charlotte, N. Y. These were "red letter" days for the club, for in addition to the regular yacht races a number of other attractions not usually found on these occasions were to be seen on their programme.

For the first day's sail a race for the second class yachts was held at 10:30 A. M. over a course of twelve miles, the prizes being in cash and aggregating \$85.

The Annual Regatta occurred at 1 P. M. over the same course and the entries were restricted to club yachts. The prizes in this class consisted of a number of suitable articles and were valued at \$40. Immediately after this event there was a four-oared shell race over a course of three miles in the river, and the prizes offered were valued at \$50. This last race closed the sports for the first day, and a full day it must have been.

The second day was, however, fully as interesting and included a race for first class yachts at 10:30 over a course of twenty-four miles, the prizes being in cash and amounting to \$150. This was followed at 4.00 P. M. by a single scull race over a course of two miles, for

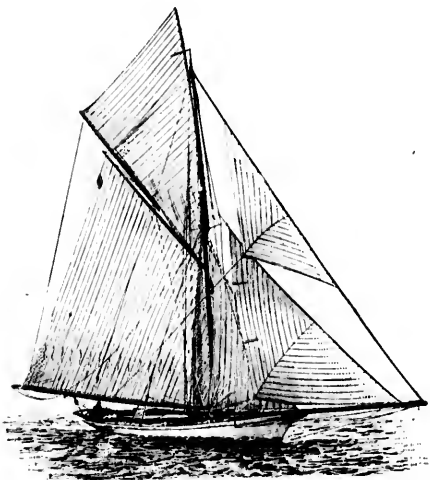

CHOCTAW.—FIGURE 505.

which two prizes valued at \$35 was given. At 5:00 P. M. there was a swimming match from the east to the west pier and return for a prize of \$8, and the day closed with a free for all skiff race over a mile course for a cash prize.

The record of this pioneer club was a brilliant one and it was successful to the close of its existence. It gave way to the ROCHESTER YACHT CLUB in 1876, an organization which was started and run on entirely different lines from its successful predecessor and managed by an entirely new set of officers. After a sky-rocket career of a couple of years this club retired with a large amount of liabilities and an unenviable record. Owing to this failure little interest was taken in yachting in the vicinity of Rochester for some time. To be sure, a few of those who had been interested in the sport from its first establishment continued to sail each season but no effort was made to organize a club until the winter of 1886.

During the summer of 1885 the managers of the Hotel Ontario, as an additional attraction for their resort, arranged a regatta to be sailed over the old course of the GENESSEE YACHT CLUB for which invitations were sent to all the yacht clubs on the lake asking them to participate. The result was the gathering of a large fleet at Ontario Beach and a most successful regatta.

It was largely the result of this enterprise that a meeting was held at the old Clinton Hotel, December 13, 1886, to establish a new yacht club. This was largely attended, and several old salts of former years were present to help the movement along. The result of this informal meeting was the organization of the present ROCHESTER YACHT CLUB, which has succeeded far beyond the fondest anticipations of its founders. The club was incorporated April 14, 1887, the incorporators being George H. Nowell, Matthew Cartwright, Edward N. Walbridge, Charles A. Worts, Edmund Ocmupaugh, William N. Oothout, Harvey S. Tomer, George P. Goulding and C. A. Phillips, who were also the executive committee for the first year.

The other officers for the same year were, Commodore, George H. Nowell; Vice-Commodore, Matthew Cartwright; Captain, Edward N. Walbridge, Secretary, Charles A. Worts, Treasurer, Edmund Ocmupaugh; Measurer, John J. Leary, Fleet Surgeon, Wm. S. Hall, M. D.

Soon after its organization the club made application for membership in the LAKE YACHT RACING ASSOCIATION and was admitted in the Spring of 1887. In July, 1887, the first regatta of the ROCHESTER YACHT CLUB, under the auspices of the LAKE YACHT RACING ASSOCIATION was given, and was a decided success, many of the representative yachts of the different clubs on the lake taking part. Since that time the club has given its Annual Regatta each year under the auspices of this Association. In the Spring of 1889, the members realized the necessity of having a home, and in the early Summer a large and commodious Club House was built at Ontario Beach on the west side of the Genesee river, a few hundred feet from Lake Ontario, and rooms were secured in the city at 607 Ellwanger & Barry Building.

During the first few years the initiation fee was \$10, and the yearly dues were \$6 which were raised to \$10 and in the Spring of 1892 they were increased to \$12 a year. Dues for non-resident members were \$6 a year.

During the Summer of 1892 the club built a marine railway capable of hauling out the largest boats of the fleet and with ample side tracks for laying up during the winter. The officers for the year of 1893 were as follows: Commodore, Edward N. Walbridge; Vice-Commodore, Arthur T. Hagan; Fleet Captain, Joseph W. Robbins; Secretary, Thomas B. Pritchard; Corresponding Secretary, Charles S. Davis; Treasurer, William H. Briggs; Measurer, James Pillow; Fleet Surgeon, W. J. Herriman, M. D. Directors, Rufus K. Dryer, Julius R. White, Charles M. Everst, Isaac W. Butts. Delegates to LAKE YACHT RACING ASSOCIATION, Edward N. Walbridge, Matthew Cartwright and J. E. Burroughs.

It is rapidly becoming the largest club on the lake, only two others now having a larger membership, and should its growth of the past years continue it will soon lead the list.

The evolution in yacht designing and building which has occurred during the past few years can be seen among the yachts of the Rochester fleet as much as in the fleets of the Eastern clubs. We have only to glance at the first fleet of which SETH GREEN was the pride and then at the present fleet with VELNETTE, MAJEL, MADGE, RIPPLE, CINDERELLA, CHOCTAW and NOX, to be convinced that the members of the club are not slow to adopt any new feature that would increase the speed or stability of the craft.

LIST OF YACHTS ENROLLED IN THE ROCHESTER YACHT CLUB.

SAILING YACHTS.

NAME.	Lake Yacht Association No.	Type. Htg.	Designer.	Racing Length.	Overall.		Builder. Where Built.	When Built.	Owner.	Port.
					Waterline.	Beam.				
				ft.	ft.	ft.				
Alta	158	e b Cutter	Follett & Schutte	12.14	25.00 3.00	10.00 2.31	Follett & Schutte Rochester, N. Y.	1888	J. J. Schutte	Charlotte, N. Y.
Arcella	8	k Cutter	Schirek Bros.	29.04	31.42 5.20	20.00 6.00	Schirek Bros. Rochester, N. Y.	1888	Schirek Bros.	Charlotte, N. Y.
Armidia	7	k Cutter	J. O. Doyle	31.28	33.00 4.00	28.80 4.50	J. O. Doyle Charlotte, N. Y.	1885	Rives, Cummis, Bennett, et al.	Charlotte, N. Y.
Cherokee	159	e b Cat	J. O. Doyle	13.81	15.50 1.90	8.00 1.00	J. O. Doyle Charlotte, N. Y.	1887	James Pillow	Charlotte, N. Y.
Chestnut	200	k Sloop	C. P. H. Vary	15.50	18.50 4.50	13.00 3.00	C. P. H. Vary Newark, N. Y.	1888	C. P. H. Vary	Sodus Bay, N. Y.
Choclaw	212	e b Cutter	E. Burgess	53.00 6.50	39.80 6.00	G. Lawley & Son Boston, Mass.	1880	E. N. Walbridge, et al.	Charlotte, N. Y.
Cinderella	217	e b Cutter	A. E. Smith	63.00 7.00	52.00 6.80	Henry Piepgrus Pottery Bench, N. Y.	1886	R. K. Dryer	Charlotte, N. Y.
Cupid	210	e b Cat	A. M. Bennett	12.10	13.00 1.50	12.67 .42	Wm. Long Rochester, N. Y.	1892	A. M. Bennett	Charlotte, N. Y.
Dot	214	e b Cat	E. W. DeLano	14.00 1.33	13.92 .50	E. W. DeLano Rochester, N. Y.	1891	W. C. Whittlesay	Charlotte, N. Y.
Gonza	165	k Sloop	E. Burgess	22.67 3.75	19.60 4.33	J. J. Leary Charlotte, N. Y.	1891	J. J. Leary	Charlotte, N. Y.
Lady Eva	48	e b Sloop	26.00 3.00	21.00 2.00	Whitney Sodus Bay, N. Y.	1882	Cartwright & Goulding	Charlotte, N. Y.
Madge	56	k Cutter	G. L. Watson	43.94	46.08 6.00	30.00 8.00	G. L. Watson Gowan, Scotland	1873	Gro. P. Goulding	Charlotte, N. Y.
Majel	57	k Cutter	E. Burgess	30.78	30.30 4.70	9.00 6.30	Wm. B. Salth Boston, Mass.	1887	Stuekie, Cramer & Le-Claire	Charlotte, N. Y.
Mayflower	236	e b Sloop	28.80	32.00 4.00	10.67 2.75 Stratford, Conn.	1880	J. A. Jackson	Cousus Lake, N. Y.
Modjeska	64	k Cutter	34.22	31.50 4.00	10.00 5.00	Hazeltine Cleveland, O.	1885	O. S. Spunkling	Charlotte, N. Y.
Nox	213	k Lug	Wm. Fife, Jr.	24.90	Wm. W. Miller Rochester, N. Y.	1892	Miller Bros. & Meerslink	Charlotte, N. Y.
Onward	100	e b Cutter	A. E. Salth	54.20	58.00 6.00	17.00 5.00	A. E. Salth Islip, N. Y.	1875	White, Davis, Dryer & Hagen	Charlotte, N. Y.

LIST OF YACHTS ENROLLED IN THE ROCHESTER YACHT CLUB.

SAILING YACHTS.—CONTINUED.

NAME.	Lake Yacht Association No.	Type. Hbr.	Designer.	Racing Length.	Overall.			Builder. Where Built.	When Built.	Owner.	Port.
					Waterline. Depth.	Beam. Draft.	ft. ft. ft.				
Priscilla	29	e b Cut, with jib	E. W. DeLano	16.00 1.23	4.83 15.81	7.75	E. W. DeLano Rochester, N. Y.	1892	E. W. DeLano	Charlotte, N. Y.
Hipple	78	k Cutter	Geo. H. Newell	34.00 5.50	27.12 6.00	9.81	Geo. H. Newell Rochester, N. Y.	1889	Geo. H. Newell	Charlotte, N. Y.
Itomola	123	k Cutter	N. H. Compton	21.73	27.00 4.67	18.70 4.50	6.83	N. H. Compton Rochester, N. Y.	1890	Norton, Hardigg & Nugent	Charlotte, N. Y.
Soubrette	166	k Cut	E. Burgess	19.68	23.00 3.75	19 25 4.33	7 12	N. H. Compton Charlotte, N. Y.	1891	Bennett & Hives	Charlotte, N. Y.
Endine	163	e b Sloop	J. W. Robbins	15.69	17.75 1 25	15.58 .75	4.63	W. C. Harris Rochester, N. Y.	1890	J. W. Robbins	Charlotte, N. Y.
Yellette	90	k Cutter	E. L. Williams	27.58	27.00 4.92	23 08 5.00	8.00	E. L. Williams S. Boston, Mass.	1887	T. B. Pritchard and M. H. Miller	Charlotte, N. Y.
Verve	90	k Cutter	G. L. Watson	44.98	48.00 6.50	41.80 8.00	7.80	McQuستن	1881	J. W. Hendrie	Hamilton, Ont.
Wenona	164	k Cut	E. Burgess	19.81	23 60 3.75	19.43 4.40	7.50	N. H. Compton Charlotte, N. Y.	1891	Clark & Hoss	Charlotte, N. Y.
Why Not	215	e b Sharpie cut	W. J. Herriman	22.67	4.81	W. J. Herriman Rochester, N. Y.	1892	W. J. Herriman	Charlotte, N. Y.
Yarle	211	e b Standing Lug	N. H. Compton	12.58	13.42 1.50	13.17 .67	5.40	N. H. Compton Charlotte, N. Y.	1892	Edward H. Leary	Charlotte, N. Y.

STEAM YACHTS.

NAME.	Engine.	Designer.	Length.		Beam. Draft.	Builder. Where Built.	When Built.	Owner.	Port.
			Waterline. Depth.	ft. ft.					
Cygnet	Steam	Codrigton & Son	35.00	30.00	7.00 3.00	Codrigton & Son Geneva, N. Y.	1888	Shipman Engine Co.	Charlotte, N. Y.
Harlem	Naphtha	Gas Engine & Power Co.	25.00 2.42	22.00	5.67 1.75	Gas Engine & Power Co. New York City	1888	A. T. Hagen	Charlotte, N. Y.
Lulu May	Naphtha	Kuhnhardt	31.00 4.00	25.00	6.50 2.50	Gas Engine & Power Co. New York City	1890	F. B. Graves	Charlotte, N. Y.
Mary Stuart	Steam	C. S. Codrigton	28.16 2.75	23.00	6.00 2.50	Codrigton & Son Geneva, N. Y.	1887	Alfred G. Wright	Rochester, N. Y.
Siesta	Steam	Herrshoff Mfg. Co.	38.00 8.60	32.00	17.00 5.60	Herrshoff Mfg. Co. Bristol, R. I.	1882	J. A. Davis	Alexandria, Bay, N. Y.
The Margaret	Naphtha	Gas Engine & Power Co.	30.50 3.42	27.33	6.50 2.53	Gas Engine & Power Co. New York City	1891	L. J. & W. M. DeLand	Fairport, N. Y.

RECORD OF RACES.

July, 1887, Annual Regatta held under the auspices of the LAKE YACHT RACING ASSOCIATION.

	Start	Finish	Actual Time.
	H. M. S.	H. M. S.	H. M. S.
Class A.			
Atalanta	10 01 45	2 01 11	3 59 20
Orion	10 02 51	2 11 47	4 06 13
Allen	10 02 58	2 42 04	4 33 23
Ariadne	10 03 44	2 45 57	4 33 44
First Class.			
White Wings	10 16 28	2 39 03	4 22 35
Garfield	10 16 14	3 01 41	4 44 03
Ethel	10 19 42	3 21 16	5 03 04
Verve	10 18 42	3 39 47	5 12 38

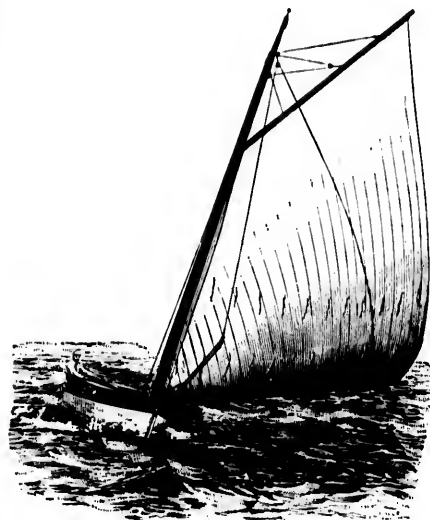

SOUBRETTE.—FIGURE 506.

Second Class.

Merle	10 35 03	1 45 26	3 00 23
Laura	10 36 50	1 58 19	3 20 23
Fascination	10 38 30	2 35 33	3 52 31
Cyprus	10 36 32	2 20 10	3 37 54
Gem	10 33 33	2 41 28	3 58 19
Fannie F.	10 38 07	2 37 33	3 48 05
Florence	10 38 42	2 52 32	3 59 02
Mollie	10 36 45	2 16 01	3 21 28

Third Class.

Mary E.	10 48 45	1 31 28	2 21 43
Velnetto	10 47 10	1 32 15	1 44 30
Grace	10 47 30	1 28 42	1 59 34
Jeannette	10 48 32	1 55 59	2 13 04
Lottie	10 47 04	1 52 21	1 59 43

EMITH started but did not finish.

July 23, 1888, Annual Regatta held under the auspices of the LAKE YACHT RACING ASSOCIATION.

Second Class.

Corrected Length.	Start	Finish	Actual Time.	
Feet.	H. M. S.	H. M. S.	H. M. S.	
Cygnat	48.10	9 53 07	3 18 07	5 25 00
White Wings	46.40	9 51 00	2 53 43	5 00 50
Madge	44.16	9 51 15	lost topmast and gun	
Verve	39.00	did not start.		

Prizes \$75 and \$35. Course 30 miles, twice to and around buoy 7 1/2 miles to windward.

Third Class.

Merle	38.32	10 07 55	2 03 40	3 55 15
Iolanthe	37.23	10 07 00	2 03 50	3 55 42
Copette	31.50	10 06 40	2 20 40	4 18 50

Prizes \$50 and \$25. Twice to and around buoy 5 miles to windward.

Modjeska	33.92	10 06 50	lost babstny, no time	
Fascination	33.43	10 07 46	time not taken.	
Ariadne	31.34		" "	
Lola	30.41	10 10 00	" "	
Gem	29.79	10 09 15	disabled, not timed	
Amella	29.73	10 08 40	3 10 03	4 50 52
Edith	28.81		time not taken.	

Course 20 miles, twice to and around buoy 5 miles to windward. Prizes \$50 and \$25.

Fourth Class.

Molly	27.58	10 21 00	12 33 00	2 11 34
Mary E.	27.47	10 21 12	12 45 25	2 21 08
Velnetto	27.46	10 22 17	12 31 25	2 09 03
Florence	26.37	10 22 17	1 17 07	2 53 48
Grace	23.20	10 25 00	disabled, not timed.	
Lottie	19.35	10 25 00	1 37 45	3 03 55

Course 10 miles, once to and around a buoy 5 miles to windward. Prizes \$20 and \$10.

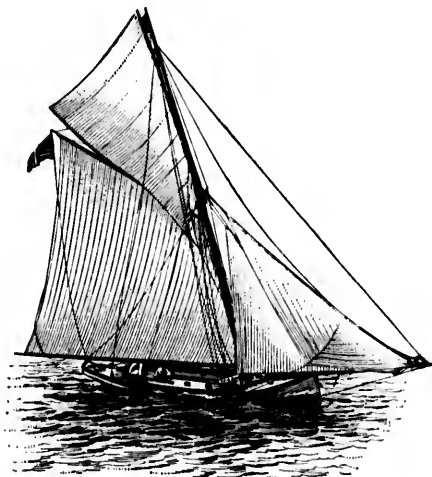

ARMIDA.—FIGURE 507.

August 23, 1888. Series of Races for the Wolters' Cup. Awarded to yacht making best record.

Madge	44.16	2 48 35	4 25 50	1 35 15
Amella	29.73	2 40 17	5 56 11	2 54 59
Velnetto	27.46	2 49 35	5 59 17	2 55 15

Course 15 miles. Weather fair.

There is no official record for the three other races in this series but the cup was awarded to MADGE.

Port.

Charlotte, N. Y.

Charlotte, N. Y.

Charlotte, N. Y.

Itochester, N. Y.

Alexandria Bay,
N. Y.

Fairport, N. Y.

Charlotte, N. Y.

Charlotte, N. Y.

Charlotte, N. Y.

Charlotte, N. Y.

Charlotte, N. Y.

Charlotte, N. Y.

Hamilton, Ont.

Charlotte, N. Y.

Charlotte, N. Y.

Charlotte, N. Y.

HISTORY OF THE ROCHESTER YACHT CLUB.

August 15, 1889. Annual Regatta held under the auspices of the LAKE YACHT RACING ASSOCIATION.

	Corrected	Start	Finish	Actual
	Length.			Time.
	Feet.	H. M. S.	H. M. S.	H. M. S.
Second Class.				
Verve No. 1.	44.29	10 43 00	2 18 54	2 33 54
White Wings	46.40	10 43 30	2 18 30	3 35 00
Verve No. 2	39.80	10 47 25	2 29 24	3 35 12

MADGE entered but withdrew.

Course 21 miles. Prizes \$75 and \$50.

Third Class.				
	Corrected	Start	Finish	Actual
	Length.			Time.
	Feet.	H. M. S.	H. M. S.	H. M. S.
Merle	38.32	10 54 20	1 17 21	2 22 09
Deerhound	30.41	10 53 10	1 21 38	2 01 28
Vision	35.00	10 58 10	1 49 28	2 46 34

Course 16 miles. Prizes \$50 and \$25.

Fourth Class.				
	Corrected	Start	Finish	Actual
	Length.			Time.
	Feet.	H. M. S.	H. M. S.	H. M. S.
Cyprus	32.80	11 03 11	1 43 45	2 39 34
Amelia	29.35	11 03 33	2 05 05	2 57 43

MAGEL dropped out.

Course 16 miles. Prizes \$40 and \$20.

Fifth Class.				
	Corrected	Start	Finish	Actual
	Length.			Time.
	Feet.	H. M. S.	H. M. S.	H. M. S.
Velnetto	27.00	11 13 55	2 10 00	3 05 05
Mary E.	21.80	11 15 00	2 59 35	3 32 16

EDNA, LADY EVA and NEPTUNE dropped out.

Course 16 miles. Prizes \$25 and \$15.

Club Race June 19, 1890.

Majel	30.78	2 29 00	6 21 45	3 50 10
Velnetto	27.01	2 20 00	6 50 15	4 24 02
Fascination	33.58	2 20 00	6 50 15	4 30 15
Edith	32.00	2 20 00	7 13 25	4 53 40
Edna	28.83	2 20 00	7 40 00	5 21 24

Course 7 miles to windward and return. Weather fair. Suitable prizes.

The Walters Cup won by MADGE was presented to the club by her owners to be awarded each season to the yacht making the best record in two races.

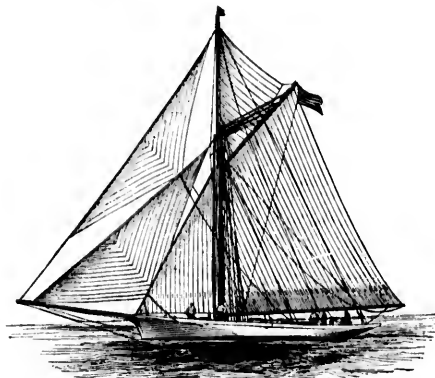

CINDERELLA.—FIGURE 508.

July 31, 1890. Club Race for MADGE Cup.

Velnetto	27.04	3 00 00	4 47 38	1 43 12
Majel	30.78	3 00 00	4 48 40	1 40 40
Ripple	31.28	3 00 00	4 50 24	1 48 54
Edith	32.00	3 00 00	4 50 20	1 50 04
Fascination	33.58	3 00 00	4 53 02	1 53 02
Armidia	31.28	3 00 00	5 07 00	2 03 30

Course, 5 miles to leeward and return. Weather cloudy and cold.

	Corrected	Start	Finish	Actual
	Length.			Time.
	Feet.	H. M. S.	H. M. S.	H. M. S.
Velnetto	27.84	2 45 30	4 58 30	2 13 00
Edith	32.00	2 45 30	5 01 30	2 16 00
Amelia	29.76	2 45 30	5 08 05	2 22 35
Ripple	31.28	2 45 30	5 21 00	2 35 30
Majel	30.78	2 45 30	not timed.	

The cup was won by VELNETTE for the season of 1890.

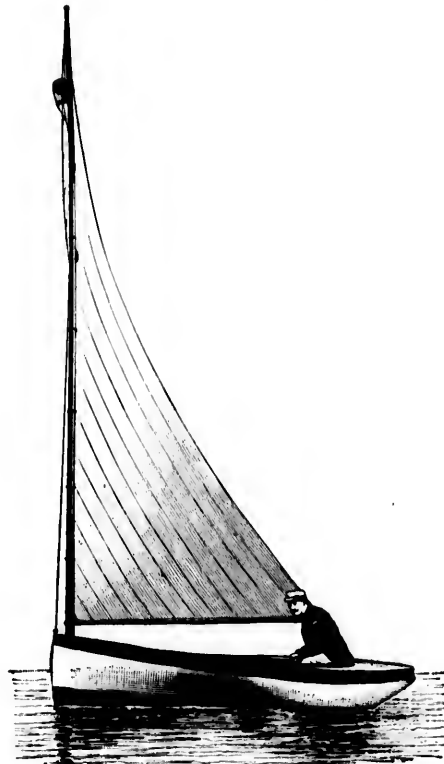

YARLE.—FIGURE 509.

August 28, 1890. Annual Regatta held under the auspices of the LAKE YACHT RACING ASSOCIATION.

First Class.

Vreda	10 30 00	4 31 56	5 51 54
Alleen	10 30 00	4 37 09	6 04 09
Oriole	10 30 00	1 23 35	6 04 49

Prizes \$50 and \$25. Course 30 miles. Three times to and around a buoy 5 miles to windward.

Second Class.

White Wings	45.74	10 40 00	4 55 50	6 15 50
Verve No. 1	44.17	10 40 00	6 20 27	7 38 34
Verve No. 2	40.01	10 40 00	6 49 05	8 01 42

CONDOR started but did not finish.

ther cloudy and cold.

Finish Actual
Time.

. M. S. P. M. S.

54 30 2 13 00

01 30 2 16 00

08 05 2 22 33

21 00 2 35 30

not timed.

f 1890.

er the auspices of the

81 50 5 51 54

37 09 6 04 09

23 35 6 04 49

times to and around

53 50 6 15 50

20 27 7 38 34

49 05 8 01 42

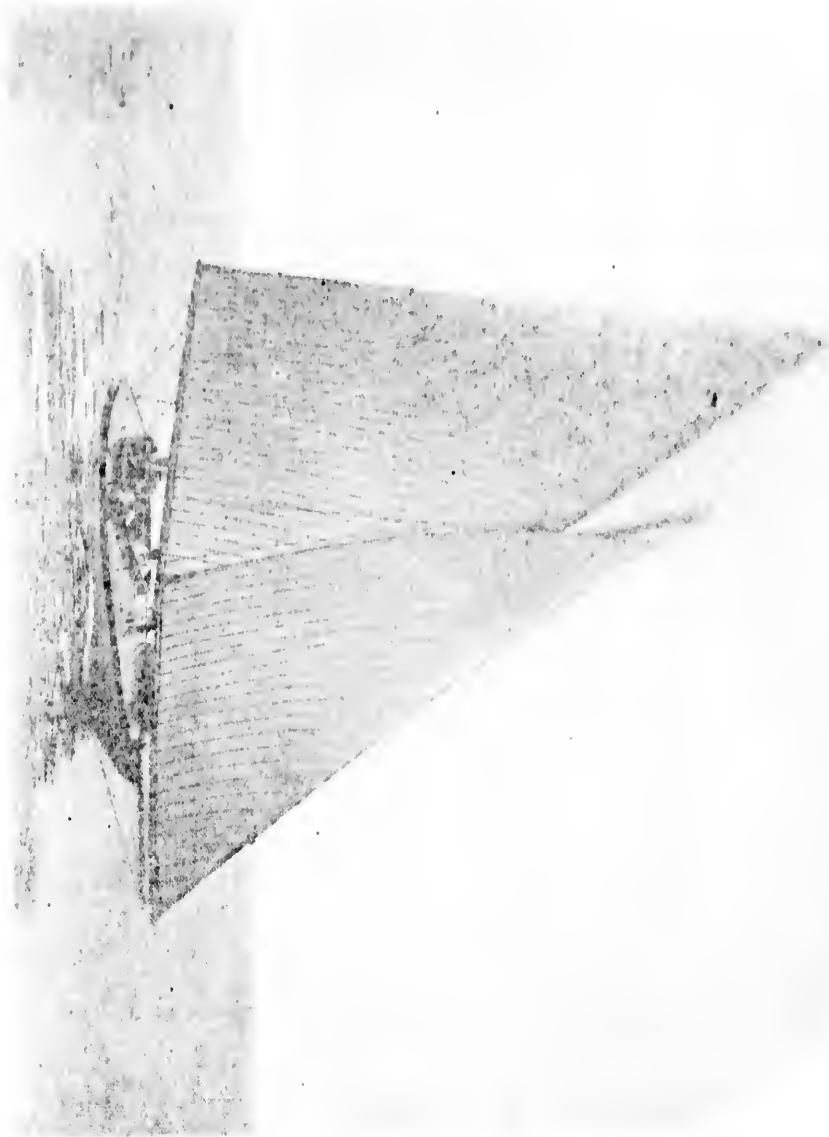

SHIP OF CLUB

... ..

Course	Start	End	Time
1st	1 14 20	1 8 30	00 50
2nd	2 15 00	2 00 00	00 45
3rd	3 15 00	3 00 00	00 45
4th	4 15 00	4 00 00	00 45

... ..



... ..

0 20 00	8 24 50	8 17 50
02 40	13 00 00	12 53 00
04 40	17 45 00	17 38 00

... ..

06 40	22 30 00	22 23 00
08 40	27 15 00	27 08 00

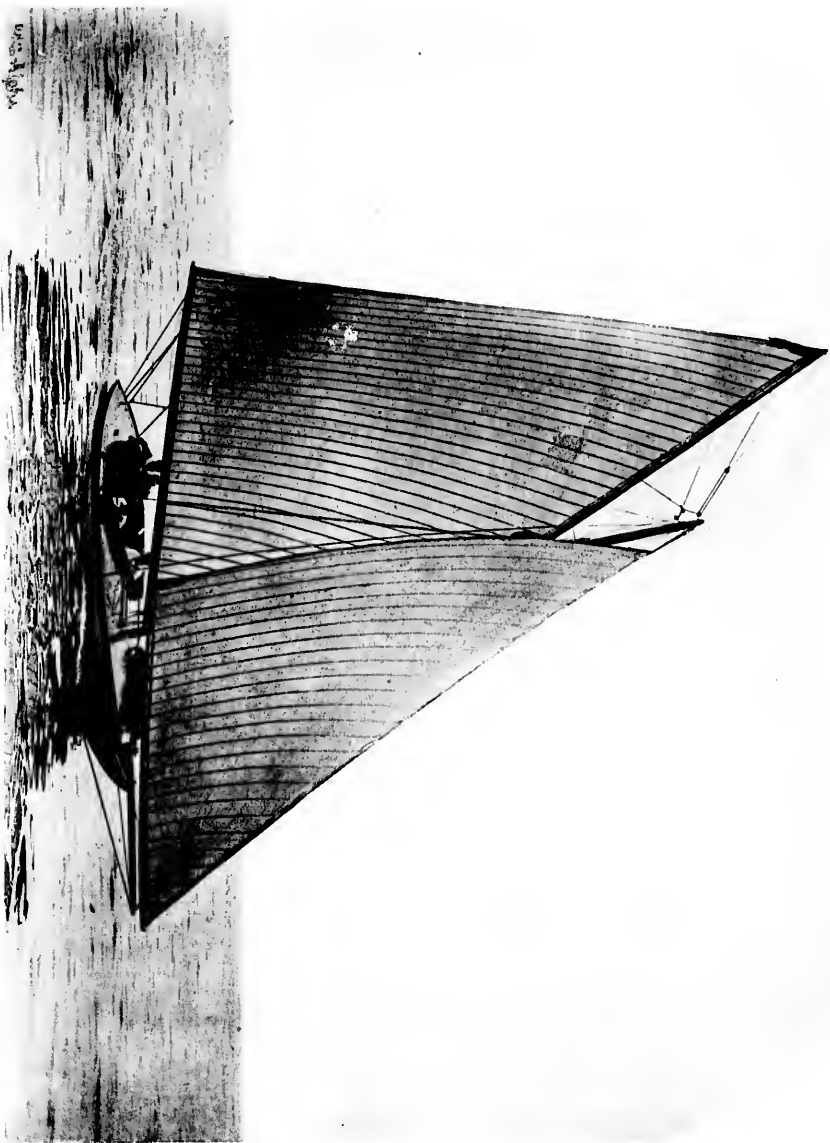

USS Alpha
FROM A NEGATIVE BY STEBBINS

ALPHA.

PLATE LXV.

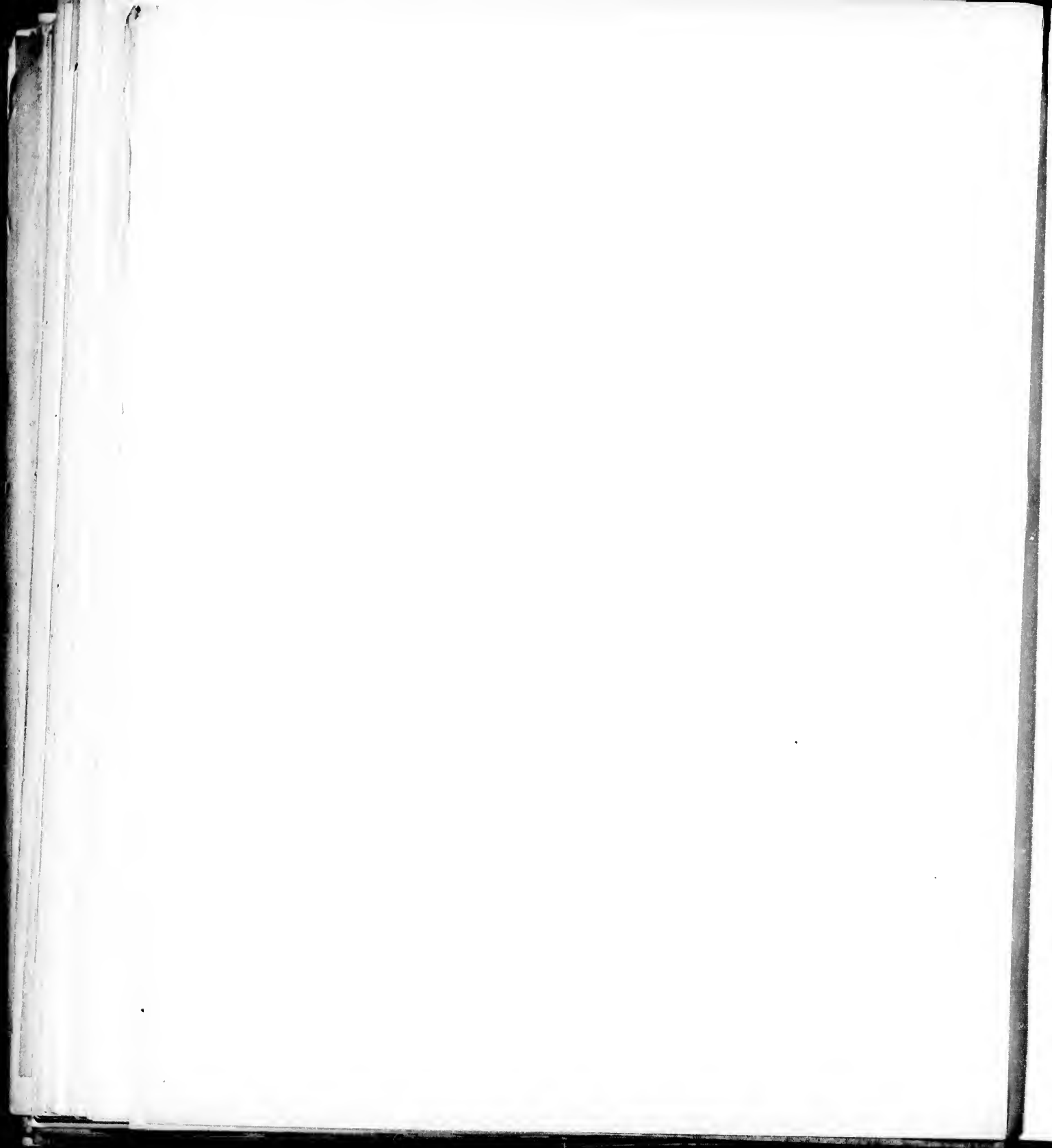

THE YACHTS AND YACHTSMEN OF AMERICA.

550

Same course as first class. Prizes \$50, \$30 and \$20.

Third Class.

Yama	Cor. Length.	Start.	Finish.	Actual Time.
	Feet.	H. M.	H. M. S.	H. M. S.
	10 50		2 40 25	3 50 25

Course 20 miles, twice to and around buoy 5 miles to windward.

Prize \$50.
Fourth Class.

Vision	35.00	11 00	Actual Time.	
			H. M. S.	H. M. S.
Gracie	34 70	11 00	3 45 18	4 44 56
Ehth	32.00	11 00	4 21 26	5 17 50

Course, same as third class. Prizes \$15, \$25, \$15.



MAJEL.—FIGURE 510.

Second Class.	Start.	Finish.	Actual Time.
	H. M. S.	H. M. S.	H. M. S.
Vreba	11 10	4 35 30	5 25 30
Onward	11 10	disabled	not timed
Third Class.			
Yama	11 20	5 08 11	5 40 38
Vervo	11 20	5 17 15	6 25 32
White Wings, sprung masthead	11 20	5 55 23	6 35 32
Aggie	11 20	time not taken	
Vera	11 20	time not taken	
Fourth Class.			
Katie Gray	11 40	3 56 04	4 04 42
Dinah	11 40	4 09 31	4 29 31
Gracie	11 40	4 11 34	4 31 30
Alert	11 40	disabled	not timed
Fifth Class.			
Nadia	11 50	4 29 28	4 38 31
Samoa	11 50	4 29 28	4 39 28
Lotus	11 50	4 43 13	4 51 35
Amelia	11 50	5 00 43	5 10 39
Erma	11 50	disabled	not timed
Sixth Class.			
Maud B.	12 00	2 16 17	2 16 01
Ocho	12 00	2 27 16	2 27 02
Kelpie	12 00	2 27 09	2 27 00
Romola	12 00	2 38 21	2 34 40
Undine	12 00	2 58 59	2 45 29
Restless	12 00	3 17 36	3 14 29
Alta	12 00	3 43 45	3 37 47
Conza	12 00	3 51 10	3 45 09

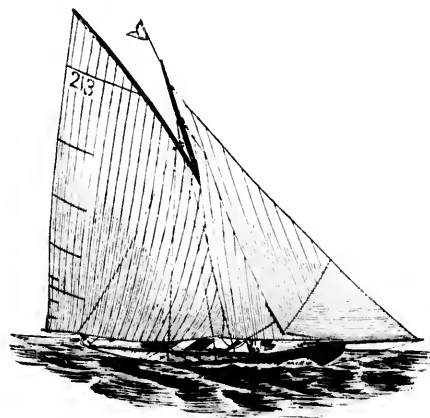

NOX.—FIGURE 511.

Fifth Class.

Nadia	29.06	11 10	3 50 30	4 48 13
Samoa	29.98	11 10	4 00 27	4 50 27
Velvette	27.34	11 10	4 55 51	4 52 16
Volante	29.65	11 10	4 07 05	5 56 41
Norma	28.50	11 10	4 09 41	4 57 31
Amelia	29.76	11 10	4 28 41	5 18 27

Course, same as third class. Prizes \$40, \$25, \$15.

Maud B.	24.74	11 20	1 56 36	2 36 30
Undine		11 20	2 50 07	
Katie Hall	22.53	11 20	2 49 23	3 56 59
Romola	21.84	11 20	2 53 40	3 30 27
Restless	24.80	11 20	3 22 02	4 02 02

Course 10 miles; five miles to windward and return. Prizes \$30, \$20, \$10.

June 25, 1891. Club Race.

Velvette	2 00	4 31 00	2 43 11
Amelia	2 00	4 52 00	3 04 44
Romola	2 00	4 51 30	2 54 30
Undino	2 00	time not taken	
Restless	2 00	4 57 00	3 00 51
Modjeska	2 00	time not taken	

Light wind, smooth water. Course, 12 miles, triangular.
July 20, 1891. Annual Regatta held under the auspices of the LAKE YACHT RACING ASSOCIATION.

Triangular course, 12 miles round. First class three times round; second class same; third class same; fourth class twice; fifth class twice; sixth class once. Suitable prizes. Smooth water. Fair breeze at start but dying toward finish.

August 6, 1891. Club Race.

Velvette	2 15	4 18 35	first
Amelia	2 15	5 00 12	
Majel	2 15	did not finish	
Romola	2 15	5 13 10	first
Undino	2 15	5 51 25	2d on time
Priscilla	2 15	time not taken	
Alta	2 15	6 02 00	
Restless	2 15	5 50 20	

Triangular course, 12 miles. Wind light; no sea.

August 20, 1891. Club Race.

Name.	Start.	Finish.	Corrected Time.
	H. M.	H. M. S.	H. M. S.
Amelia	2 15	4 11 15	first
Velnetto	2 15	4 23 00	
Restless	2 15	4 33 40	4 33 40
Undine	2 15	4 42 00	4 30 00
Priscilla	2 15	time not taken	

Triangular course, 12 miles. Good breeze; smooth water.

September 3, 1891. Club Race.

Romola	12 00	2 52 10	3 01 10
Restless	12 00	2 57 00	3 09 30
Undine	12 00	3 04 00	3 04 00
Priscilla	12 00	time not taken	

Triangular course, 12 miles. Light breeze; no sea.

September 7, 1891. Club Race.

Velnetto	12 00	2 10 20	2 14 45
Amelia	12 00	2 10 50	2 10 50
Romola	12 00	2 32 31	2 42 33
Undine	12 00	2 52 37	2 43 02
Priscilla	12 00	3 00 31	2 53 37

Course, triangular, 12 miles.

September 17, 1891.

Velnetto	12 00	2 35 15	2 31 10
Amelia	12 00	2 42 17	2 42 17

VELNETTE covered the entire course, but was protested by AMELIA and ruled out.

Romola	12 00	2 52 40	2 52 40
Undine	12 00	3 05 30	2 50 55

Triangular course, 12 miles. Fair breeze; little sea.

September 24, 1891. Club Race.

Amelia	1 00	3 23 41	2 23 41
Velnetto	1 00	3 20 35	2 24 55

Triangular course, 12 miles. Strong wind and big sea.

The rules were so amended (1891), governing the Madge Cup, giving the cup to the yacht making the best record out of all the season's events. At the end of the season the points were as follows, making it a tie: AMELIA 11, VELNETTE 11, ROMOLA 11.

May 28, 1892. Cruising Race to Sodus Bay (32 miles).

Madge	9 15	4 13 10	6 46 30
Onward	9 15	4 04 50	6 49 50
Modjeska	9 15	6 40 05	
Amelia	9 15	7 21 10	
Velnetto	9 15	time not taken	
Ripple	9 15	time not taken	
Armida	9 15	time not taken	
Majd	9 15	time not taken	

Wind light to calm; no sea.

July 2, 1892. Cruising Race to Oak Orchard (30 miles).

Nox	9 00	3 20 30	first
Amelia	9 00	3 34 00	fourth
Armida	9 00	3 26 30	second
Modjeska	9 00	3 25 30	third
Velnetto started $\frac{1}{4}$ hour late		4 23 30	fifth

Light southeast breeze at start, hauling around off the lake and freshening to about 12 miles an hour; not much sea.

July 23, 1892. Annual Regatta of the ROCHESTER YACHT CLUB, held under the auspices of the LAKE YACHT RACING ASSOCIATION.

Triangular course 12 miles around, two rounds.

First Class.

Cinderella	10 40	2 39 45	3 55 24
Vreda	10 40	2 51 01	3 59 09
Onward	10 40	3 35 13	4 48 00
Oriole	10 40	3 41 57	5 01 57

Second Class.

Aggie	10 50	3 45 57	4 49 01
White Wings	10 50	3 43 20	4 53 20
Verve		did not finish	

Course same as first class.

Third Class.

Start.	Finish.	Corrected Time.
H. M. S.	H. M. S.	H. M. S.
11 00 00	4 13 50	5 13 50

Parted holstay and withdrew

Course same as first class.

Fourth Class.

11 10 00	4 52 35	5 42 35
11 10 00	5 50 48	6 38 39

Course same as first class.

Fifth Class.

11 20 00	5 14 05	5 54 05
11 20 00	5 18 23	5 57 57

Course same as first class.

Sixth Class.

11 30 00	2 20 40	2 50 13
11 30 00	2 20 45	2 59 29
11 30 00	2 33 20	3 03 20

Course same as first class.

Seventh Class.

11 30 00	2 41 03	
11 30 00	2 57 57	

Triangular course, 12 miles, one round.

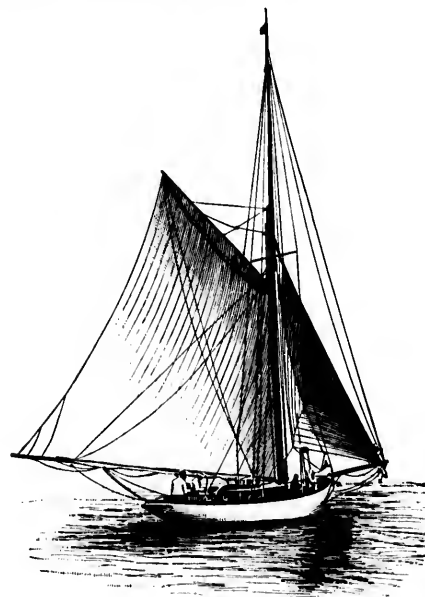

RIPPLE.—FIGURE 512.

Seventh Class.

Dot	11 30 00	3 12 15	3 39 15
Undine	11 30 00	3 11 40	3 41 40

Course same as sixth class.

Wind moderate at start, dropping and becoming variable at end of race. Smooth water, slight fog and some rain.

On first part of second round, CINDERELLA carried away her topmast but succeeded in finishing as above.

August 25, 1892. Club Race.

	Start.	Finish.
	H. M. S.	H. M. S.
Nox, sailed over course only starter	1 00 00	2 35 00
Undine, first	1 00 00	
Priscilla, second	1 00 00	
Dot, third	1 00 00	

The times in this race were lost.

Finish.	Corrected Time.
H. M. S.	H. M. S.
4 13 50	5 13 50
towed and withdrew	

4 52 35	5 42 35
5 50 48	6 38 39

5 14 05	5 54 05
5 18 24	5 57 57

2 20 40	2 50 13
2 20 45	2 59 29
2 33 20	3 03 20
2 40 58	
2 41 03	
2 57 57	

Course 4 miles west to a buoy and back, first class twice, second class once. Stiff wind and quite a sea.

September 19, 1892. Cruising Race to Presque Isle (30 miles).

Nox started 9:00:00 P. M. September 19th, finished 6:46:16 A. M. September 20th.

VELNETTE started 9:00:00 A. M. September 19th, finished 10:29:00 A. M. September 20th.

On account of bad compass, VELNETTE made land 16 miles west of Presque Isle and had to run down the shore.

Good stiff breeze. Heavy swell during latter part of race.

The MADGE CUP for the season of 1892 was awarded to NOX.

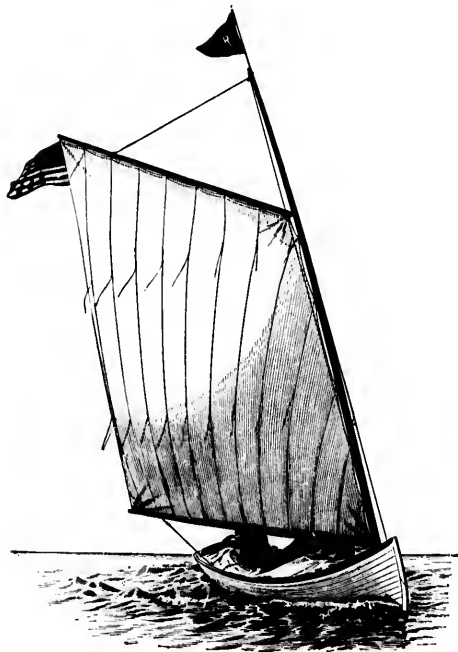

CHEROKEE.—FIGURE 513.

THE SEASON OF 1893.

The ROCHESTER YACHT CLUB record of races for the season of 1893 is as follows:

Cruising Race to Big Sodus Bay from Ontario Beach, 32 miles east.

	Start.	Finish.	Elapsed Time.
	H. M. S.	H. M. S.	H. M. S.
First Class.			
Cinderella, 1st prize	9 30 00	2 00 50	4 30 50
Onward	9 30 00	2 17 40	4 47 40
Second Class.			
Nox, 1st prize	9 00 00	2 23 15	5 25 15
Ripple, 2d prize	9 00 00	2 44 58	5 44 58
Velnetta, 3rd prize	15 mins. late	9 00 00	3 10 00
Modjesku	9 00 00	3 15 00	6 15 00

Wind at start easterly and light, going round to southeast and becoming fresh. No sea. All boats in second class were scratch,

except VELNETTE which was allowed 16 minutes by all in her class.

Fisher Cup Race. Off Ontario Beach, 30 miles. Triangular course.

	Start.	Finish.
	H. M. S.	H. M. S.
Cinderella	10 03 00	6 01 08
Onward	10 00 00	6 37 00

This was no race, as the time limit of 6 hours was exceeded. Wind light and variable. No sea.

Annual Regatta held under the auspices of the LAKE YACHT RACING ASSOCIATION, July 4, 1893. Off Ontario Beach.

	Start.	Finish.	Elapsed Time.	Corrected Time.
	H. M. S.	H. M. S.	H. M. S.	H. M. S.
First Class.				
Vreda, 1st prize	10 50 00	3 13 50	4 23 50	4 17 19
Onward	10 50 00	3 20 13	4 31 13	4 30 13
Second Class, 40 foot.				
Zelma	10 50 00	4 46 25	5 50 25	
Dinah	10 50 00		did not finish	
35 Foot Class.				
Cyprus, 1st prize	11 00 00	4 35 25	5 35 25	5 35 25
Ripple, 2d prize	11 00 00	4 48 35	5 48 35	5 47 23
Edith	11 00 00		did not finish	
30 Foot Class.				
Velette, 1st prize	11 10 00	4 01 50	4 51 50	4 51 50
Nadia, 2d prize	11 10 00	4 45 25	5 35 25	5 35 19
Latona	11 10 00		did not finish	
25 Foot Class.				
Nox, 1st prize	11 20 00	2 01 25	2 41 25	2 43 58
Maud B., 2d prize	11 20 00	2 07 15	2 47 15	2 47 15
Satola	11 20 00	2 20 58	3 00 58	3 00 47
Nydia	11 20 00	2 39 15	3 19 15	3 07 56
18 Foot Class.				
Dot, 1st prize	11 20 00	3 44 05		
Pastime	11 20 00	disabled		withdrew

Course triangular; 4 miles to a side, start being made to northwest. First leg of course due northwest. All buoys to starboard.

1st, 46, 40, 35 and 30-footers, two circuits over course, 24 miles. 25 and 18-footers, one circuit over course; 12 miles. Wind moderate, northwest. Very little sea.

PRIZES:

First class, VREDA, 1st prize \$40.

40 foot class, ZELMA, 1st prize \$30.

35 foot class, CYPRUS, 1st prize \$25; 2d prize RIPPLE, \$10.

30 foot class, VELETTE, 1st prize \$25; 2d prize, NADIA, \$10.

25 foot class, NOX, 1st prize \$20; 2d prize, MAUD B. \$10; 3rd prize, SALOLA \$5.

18 foot class, 1st prize, DOT \$10.

Fisher Cup Race, off Ontario Beach, August 26th. 30 miles triangular.

Onward
Zelma

This was no race, as the time limit of 6 hours was exceeded. Club Race, off Ontario Beach, August 26th.

First Class.		
Nox,	2 00 00	sail over
Second Class.		
Nydia	2 00 00	sail over
Third Class.		
Pastime	2 00 00	
Dot	2 00 00	did not finish

Fisher Cup Race. Off Ontario Beach, August 28th. 30 miles triangular.

Onward
Zelma

12 15 3 39 15
11 40 3 41 40
ing variable at end
carried away her top-

ish.
M. S.
5 00

This was no race, as there was not wind enough for either boat to finish in the 6 hour limit. During latter part of race squally and rain.

THE FISHER CUP.

The Fisher Cup was presented to the CHICAGO YACHT CLUB for competition by Mr. A. J. Fisher of Chicago, in 1882.

The cup has been raced for and won as follows:

CORA of Chicago, Ill., July 8, 1882.

CORA of Chicago, Ill., September 9, 1882.

CORA of Chicago, Ill., August 4, 1883.

ATLANTA of Belleville, Ont., Can., August 8, 1883.

NORAH of Belleville, Ont., Can., by default, September 17, 1884.

NORAH of Belleville, Ont., Can., in a race against OSWARD of Rochester, N. Y., July 30, 1892.

OSWARD of Rochester, N. Y., in a race against NORAH of Belleville,

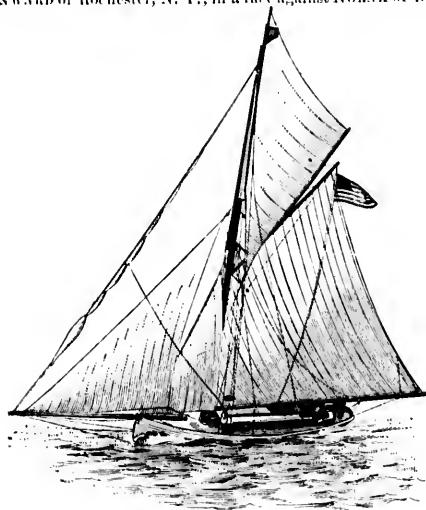

VELLETTE.—FIGURE 511.

Ont., Can., September 19, 1892, and it has been held by OSWARD since, the three attempts at a race in 1893 having exceeded the time limit.

On May 4, 1892, the BAY OF QUINTE YACHT CLUB adopted the following:

Whereas, the rules governing the competition for the Fisher Cup, for sloop yachts have proved in practice wholly inadequate, and

Whereas, Mr. A. J. Fisher, the generous donor of the said cup, has declared that "I have given up yachting entirely" and declines to further interest himself in the matter, and

Whereas, the CHICAGO YACHT CLUB, under whose auspices the cup was first offered for competition, is extinct, and no authority competent to render said rules practical and workable exists outside of the BAY OF QUINTE YACHT CLUB,

Therefore, be it resolved, by the BAY OF QUINTE YACHT CLUB, by and with the consent of the trustees of the said cup, that in order to encourage bona fide competition for the Fisher Cup aforesaid, and thus stimulate and promote yachting in our midst, the following shall be the terms and conditions upon and under which the said cup shall hereafter be competed for:

This cup is subject to challenge by sloop yachts, (belonging to any regularly organized yacht club), of not less than 36 feet corrected

length measured by the LAKE YACHT RACING ASSOCIATION'S measurement as existing in 1891, upon the following conditions:

1st. It is to be held by the winner thirty days after race without liability to challenge.

2nd. At any time after the expiration of that period, and up to the first of September in each year, the winner must accept any challenge, and be prepared to sail a race for the same within thirty days from the receipt of such challenge in writing, or forfeit the cup to the challenger, but should any yacht succeed in holding the cup in two consecutive races during one season, it will not again be liable to challenge until the commencement of the yachting season of the following year.

3rd. The challenge for this cup shall be in writing, and shall fix the day of the race not less than twenty-five days from the date of the receipt of the challenge by the holder of the cup, unless otherwise agreed between the parties.

4th. This cup will become the bona fide property of any yacht holding it successfully for four consecutive races, or for two consecutive yachting seasons without a race.

5th. The yachting season in reference to this cup is to be from the first Saturday in June until the last Saturday in September in each year.

6th. Should a yacht holding this cup be destroyed or rendered unfit for racing, or the owner thereof die, or should she be sold out of the club to which she belongs and not into another yacht club, the cup shall be returned to the club to be again sailed for; and if the cup should be held by a foreign yacht, and she should be sold out of the club to which she belongs and not into another yacht club, the cup shall not go with her, but shall be returned to the club to which she belonged when the cup was won, to be sailed for again; and in case any yacht is sold and her owner enrolls her in another club, the cup shall go with her to such other club, to be sailed for the same as if no transfer had been made.

7th. The course shall be thirty nautical miles in length, triangular in shape, ten miles round, three rounds, and be sailed over within six hours by the winning yacht or no race. In the event of failure to cover the course within the time limits, the attempt to be renewed day after day, except Sunday, until a race has been completed within the time aforesaid.

In case of either yacht failing to start, or withdrawing before a race has been completed, the cup shall be awarded to the other competitor. No restriction as to crews or steersmen.

The sailing rules, time allowance and regulations of the LAKE YACHT RACING ASSOCIATION shall govern in all other respects.

8th. The challenger shall address his challenge to the Secretary of the club to which the yacht holding the cup belongs.

9th. The challenger shall name one judge, the holder of the cup a second judge, and these judges may name a third; failing agreement to do so, the club shall name the third judge.

10th. The buoying of the course and all other matters of arrangement and detail shall be in charge of the club to which the holder of the cup may belong.

W. H. Biggar, Commodore B. Q. Y. C.; George N. Leavens, Secretary and Treasurer, B. Q. Y. C.; D. B. Robertson, Trustee Fisher Cup; R. S. Bell, Trustee Fisher Cup.

Belleville, May 3, 1892.

The cup was then held by NORAH, owned by Mr. John Bell, of Belleville, Ontario, Can., and belonging to the BAY OF QUINTE YACHT CLUB.

In the Summer of that year, OSWARD owned by Commodore J. R. White and others of the ROCHESTER YACHT CLUB, challenged NORAH; and July 30th was the day agreed upon for the race, which was to take place in the Bay of Quinte a few miles from Belleville.

The wind was unsteady and during most of the race light, but when near the completion of the first round OSWARD, then about

twenty minutes in the lead, carried out her topmast and NORAH won the race crossing the finishing line only a few minutes before the expiration of the time limit.

Mr. Bell and the others interested agreed to waive the time limit in regard to the challenge and ONWARD immediately challenged for another race, and September 19th was agreed upon.

The race was started in a stiff, puffy breeze which held throughout the day. NORAH carried one reef in her mainsail and working topsail, ONWARD coming to the line with full working canvas and working topsail.

There was no sea, as the part of the bay where the race was sailed is only about five miles long by four wide.

As required by the conditions, the course was triangular, 3 1-3 miles to a side to be covered three times.



AMELIA.—FIGURE 515.

ONWARD crossed the starting line seven seconds ahead of NORAH, immediately setting big jib topsail and balloon foresail, NORAH also setting big jib topsail.

On the stretch from Buoy No. 1 (the starting buoy), to No. 2 ONWARD drew steadily away from NORAH until about half-way to No. 2 when NORAH began to pick up and succeeded in passing ONWARD and rounding Buoy No. 2, about twenty seconds ahead, both boats now coming on the wind.

ONWARD gradually decreased the space between the two and rounded Buoy No. 3 ahead of NORAH and both started sheets for the home buoy, ONWARD keeping her lead, but in trying to jibe around the buoy she broke her steering gear and was compelled to head up into the wind past the buoy and come about, NORAH in the meantime coming up and making a pretty jibe, rounding the buoy some eight minutes ahead of ONWARD, continuing to gain slightly on the run to Buoy No. 2, ONWARD repairing her steering gear on this leg. In setting ONWARD's balloon foresail on this stretch, it was allowed to get into the water, and was so torn that it could not be used.

NORAH rounded Buoy No. 2 on this round ahead of ONWARD and passed Buoy No. 3 ahead, ONWARD decreasing her lead considerably even after carrying away her gaultopsail sheet and having to luff up into the wind in order to get the centreboard down. On the reach to Buoy No. 1 NORAH slightly increased her lead. She continued to gain on the run to Buoy No. 2, but when they hauled on the wind ONWARD again began to gain on her, rounding Buoy No. 3 some few

minutes behind NORAH and immediately setting a jib topsail under the boom as a water sail. ONWARD gained a little on this reach home, and although NORAH crossed the finishing line ahead ONWARD won the race and took the cup on time allowance, but had only forty-seven seconds to spare.

In May, 1893, CINDERELLA owned by Mr. R. K. Dreyer and belonging to the ROCHESTER YACHT CLUB, challenged ONWARD, and June 8th was the date named. The breeze was light and variable, no sea, and the boats failed to cover the course in the six hour time limit. The times are as follows:

	Start	Finish
Cinderella	11 30.8	11 31.8
Onward	10 00 00	6 01 08
	10 00 00	4 37 00

On July Fourth, 1893, Mr. Norman B. Dick of Toronto, Can., owning the Fifo cutter ZELMA belonging to the ROYAL CANADIAN YACHT CLUB challenged ONWARD, the race coming off August 26th.

This race like that of June 8th, between CINDERELLA and ONWARD, was started in a light breeze which only continued for a short time and then died out altogether, both boats being unable to finish in the specified time.

Another trial was set for Monday, August 28th, but at the start the wind was light and variable. Later in the day, however, it freshened, coming down in heavy squalls with rain, but on the second round, there only remaining a little over half an hour to make the remaining ten miles, both boats gave up the race and ZELMA did not renew the attempt.

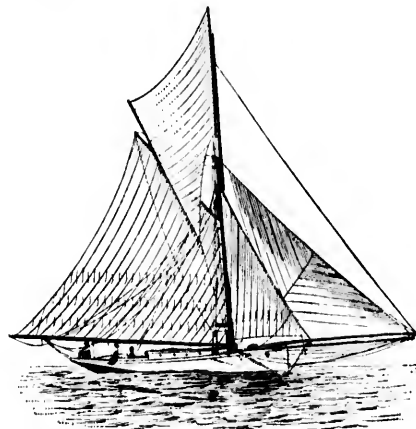

EDITH.—FIGURE 516.

The cup still remains in the possession of ONWARD and the ROCHESTER YACHT CLUB. The last three races were sailed off Ontario Beach, N. Y., under the direction of the Regatta Committee of the club.

The officers of the ROCHESTER YACHT CLUB for the year 1891, are as follows: Commodore, H. S. Mackie; Vice-Commodore, A. T. Hagan; Fleet Captain, J. W. Robbins; Secretary, Thomas B. Pritchard; Corresponding Secretary, Herbert Leary; Treasurer, W. H. Briggs; Measurer, Jas. Pillow; Fleet Surgeon, Porter Farley. Executive Committee: H. S. Mackie, A. T. Hagan, J. W. Robbins, Thomas B. Pritchard, Herbert Leary, W. H. Briggs, R. K. Dreyer, J. R. White, J. E. Burroughs, T. G. Young. Regatta Committee: J. E. Burroughs, B. G. Saunders, Thomas B. Pritchard, E. H. Chapin, I. W. Butts, F. G. Newell, W. J. Smith. Delegates to the LAKE YACHT RACING ASSOCIATION: J. E. Burroughs, Thomas B. Pritchard and A. E. Bickford. House Committee: A. T. Hagan. Membership Committee: C. S. Davis, A. E. Bickford and D. R. Clark.

BIOGRAPHICAL SKETCHES AND DESCRIPTION OF YACHTS ENROLLED IN THE CLUB.

EDWARD N. WALBRIDGE, Commodore of the ROCHESTER YACHT CLUB, is engaged in the real estate and grain business, at Rochester, N. Y. He was born in October, 1859, the son of Silas Dewey and Sarah M. Walbridge. Commodore Walbridge was, until quite recently, the owner of the yacht CHOCTAW and at one time owned PHEL and VELLETTE. He has been a yachtsman for fifteen years, and has been successively Captain, Vice-Commodore and Commodore. He is a charter member of the ROCHESTER YACHT CLUB and is also connected with the OSWEGO YACHT CLUB.

CHOCTAW.

CHOCTAW is a centerboard cutter built by George Lawley & Son in 1890 and owned for some time by E. N. Walbridge and a syndicate of Rochester gentlemen, during which time she hailed from Charlotte, N. Y., and sailed with the ROCHESTER YACHT CLUB. Is now owned by Thomas L. Arnold of New York City. She was designed by Edward Burgess and sails with the ATLANTIC YACHT CLUB. See Fig. 505.

DIMENSIONS.			
Length over all,	53 feet.	Length load waterline,	49 feet 8 inches.
Draft,	4 feet 2 inches.	Beam,	11 feet 5 inches.

SOUBRETTE.

A keel cabin cat designed by Edward Burgess and built by Norman Compton and launched in May 1891. The property of A. M. Bennett and Geo. W. Rives of Charlotte, N. Y., and sails with the ROCHESTER YACHT CLUB. See Fig. 506.

DIMENSIONS.			
Length over all,	27 feet 6 inches.	Length load waterline,	19 feet 6 inches.
Draft,	3 feet.	Beam,	8 feet.

S. GREGOR DORAN, New York City; born in Iroquois, Ontario, 1853. Of New England ancestry, the son of Solomon and Margaret Doran. Members of his family have been Alderman, Mayor and Justice of the Peace in Iroquois. Is the owner of the yacht (electric launch) VELOX and a member of the OSWEGO and ROCHESTER YACHT CLUBS, being one of the organizers of the latter. He has owned several other yachts besides VELOX—the steamers ETHEL, GENESEE, NAROD and ANGLER; the sloop ETHEL and the electric launch ELECTRON. Mr. Doran is a Master Pilot and has been a yachtsman for twelve years. He holds many positions of trust and honor, most of them being in Rochester, N. Y., corporations.

ARMIDA.

ARMIDA is a keel sloop owned by C. Van Voorhis and others of Rochester, N. Y. She was designed by J. J. Leary and was built by Joseph O'Doyle, who was her owner for some time. Was launched in 1885. Sails with the ROCHESTER YACHT CLUB. See Fig. 507.

DIMENSIONS.			
Length over all,	32 feet.	Length load waterline,	27 feet 6 inches.
Draft,	4 feet 8 inches.	Beam,	8 feet 2 inches.



RUFUS K. DRYER.

RUFUS K. DRYER, manufacturer and banker, Rochester, N. Y.; was born in Gorham, N. Y. Has owned the yacht OSWARD and now owns the cutter yacht CINDERELLA. Has been interested in yachting for several years and is a member of the ROCHESTER and OSWEGO YACHT CLUBS.

CINDERELLA.

A centerboard cutter designed by A. Cary Smith and built by Henry Pieprags for Wm. E. Iselin. Launched in April 1886. She has been for one year the property of Rufus K. Dryer, Rochester, N. Y. She hails from Char-

lotte, N. Y., has a cabin and sails with the ROCHESTER and OSWEGO YACHT CLUBS. See Fig. 508.

CODE SIGNAL LETTERS, K. G. D. V.

Official number, 126,351.

DIMENSIONS.			
Length over all,	61 feet 3 inches.	Length load waterline,	52 feet.
Depth,	7 feet.	Draft,	7 feet.
Beam,	16 feet 9 1/4 inches.		

Racing Record for 1891:—

NEW YORK YACHT CLUB—Squadron Run, August 4th; CINDERELLA won in her class. On the 6th of August she was defeated by CLARA. The same was the result in the Run of August 8th. However, on the 10th, CINDERELLA defeated CLARA, MISCHIEF and HILDEGARDE, racing for special cups. Again she won from CLARA on the 11th, taking the loser's place in the Squadron Run which took place on August 12th.

EASTERN YACHT CLUB—Sailed in four Squadron Races of the EASTERN YACHT CLUB on August 23d, 25th, 26th and 29th. Lost on the 23d and 26th, and took first place in the other two races, defeating SAYONARA and GOSsoon. She won the first prize, \$250.

YABLE.

YABLE is a centerboard lugger. She is owned by Edward B. Leary and hails from Charlotte, N. Y., sailing with the ROCHESTER YACHT CLUB. Was designed and built by N. H. Compton, at Charlotte, N. Y., and was launched in 1892. See Fig. 509.

L. Y. R. A. number, 211.

DIMENSIONS.			
Length over all,	11.42 feet.	Length load waterline,	13.17 feet.
Depth,	1.50 feet.	Draft,	67 feet.
Beam,	5 feet.	Racing length,	12 28 feet.



HENRY S. MACKIE.

HENRY S. MACKIE, Rochester, N. Y., was born in New York State, of Scotch descent; the son of Wm. S. and Jane C. Mackie. Has owned the yacht RAMBLER and is the owner of the cabin yawl MAJEL. Has been interested in yachting six years. Is a member of the ROCHESTER YACHT CLUB.

Mr. Mackie is a member of the Chamber of Commerce, President of the Loan Association, Past Commander of the Knights Templar and is connected with the Racer Cycle Co., and is President of the Mackie Piano Organ & Music Co. Was educated at the Rochester University.

MAJEL.

A cabin yawl, belonging to Capt. Henry S. Mackie, J. G. Cramer and J. F. La Clare of Rochester, N. Y. She was designed and built by W. B. Smith, Boston, and was launched in 1888, being constructed for W. J. Wilkinson of Boston. She hails from the port of Genesee (Charlotte, N. Y.) and sails with the ROCHESTER YACHT CLUB. See Fig. 510.

Official number, 92,290.

DIMENSIONS.			
Length over all,	39 feet 3 inches.	Length load waterline,	26 feet 7 inches.
Draft,	6 feet 3 inches.	Beam,	9 feet 6 inches.

NOX.

NOX is a centerboard lugger owned by Miller Bros. & Meerdink, and sails with the ROCHESTER YACHT CLUB. She was designed

CLUB.

ROCHESTER and OSWEGO

D. V.
1.

load waterline, 52 feet,
7 feet.

August 4th; CINDER-
August she was defeated
the Run of August 8th.
defeated CLARA, MISCHIEF
s. Again she won first
place in the Squadron

Iron Races of the East-
26th and 29th. Lost
in the other two races,
she won the first prize,

owned by Edward B.
g with the ROCHESTER
I. H. Compton, at Char-
Fig. 509.

11.

waterline, 13.17 feet.
67 feet.
12 08 feet.

MACKIE, Rochester, N.
in New York State, of
the son of Wm. S. and
Has owned the yacht
the owner of the cabin
has been interested in
. Is a member of the
YACHT CLUB.

member of the Cham-
President of the Loan
Commander of the
and is connected with
o., and is President of
educated at the Roches-

Mackie, J. G. Cramer
was designed and built
1888, being constructed
on the port of Genesee
ROCHESTER YACHT CLUB.

waterline, 26 feet 7 inches,
9 feet 6 inches.

Miller Bros. & Meerdink,
B. She was designed

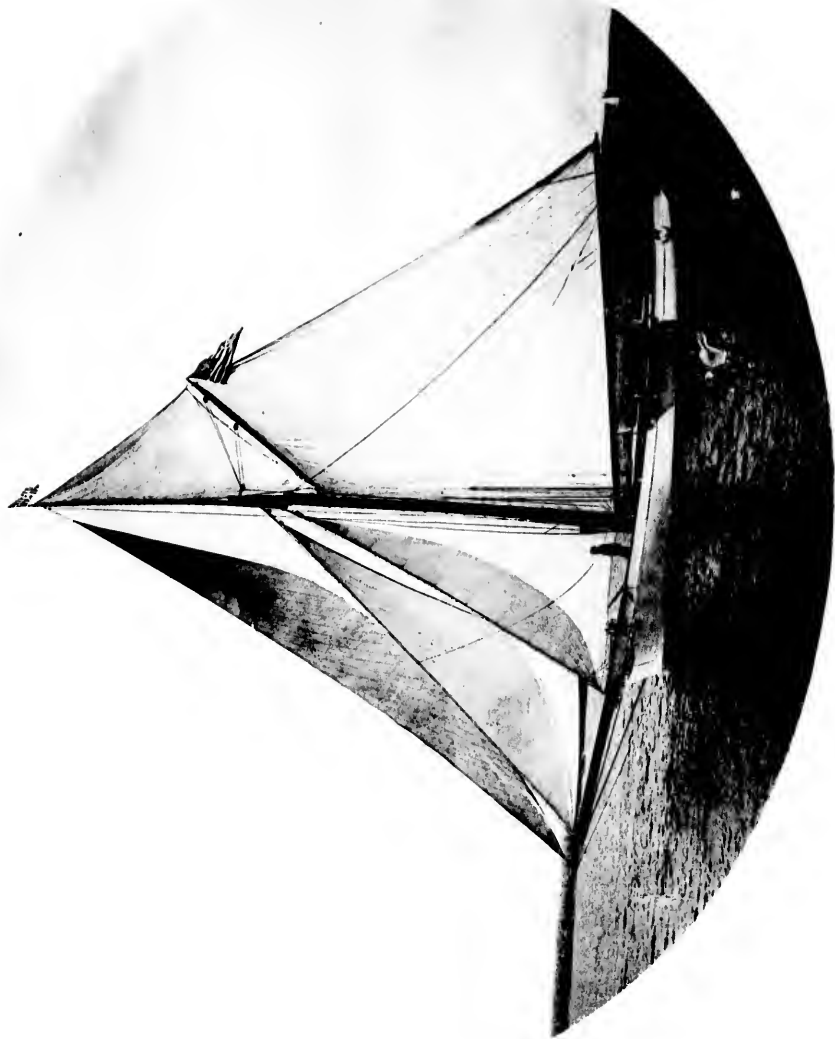

FENELLA.

PLATE LXXXIV

FENELLA.

PLATE LXXXIV

THE CASTLE OF FENELLA



The Castle of Fenella
is situated on the coast of
the island of Sicily.

The Castle of Fenella
is situated on the coast of
the island of Sicily.

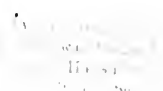

The Castle of Fenella
is situated on the coast of
the island of Sicily.

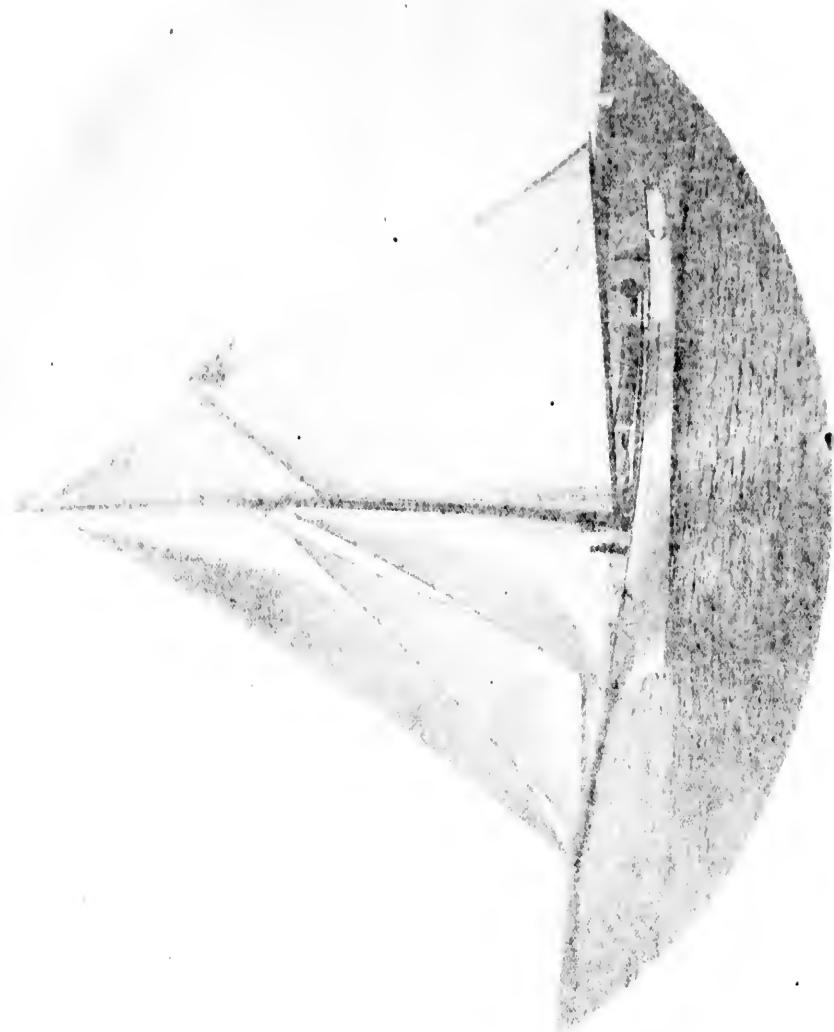

by W. M. Fife, Jr., and was built by Miller Bros. in 1892, being launched in May. Hails from Charlotte, N. Y. See Fig. 511.

DIMENSIONS.			
Length over all,	30 feet.	Length load waterline,	24 feet 6 inches.
Draft,	6 feet.	Beam,	7 feet 6 inches.

Racing Record for 1891:—

OSWEGO YACHT CLUB—Won in the Annual Regatta of July 18th, beating NORMA, SAGOLA and KELPIE.

ROCHESTER YACHT CLUB—Won in the Cruise to Oak Orchard, July 3d, defeating AMELIA, ARMDIA, MODJESKA and VELLETTE. Won in her class in the Club Race of August 25th. On September 19th, NOX beat VELLETTE in a Cruising Race.



GEORGE H. NEWELL.

GEORGE H. NEWELL of Rochester, N. Y., the late ex-Commodore of the ROCHESTER YACHT CLUB, was born in Roxbury, Mass., in the year 1828. He was well known in business circles, and as a yachtsman he was considered the father of the ROCHESTER YACHT CLUB. He was their first Commodore, and for fifteen years has been thoroughly identified with its success. The last boat he owned was the RIPPLE.

Heart failure was the immediate cause of his death which took place June 8, 1892, and the ROCHESTER YACHT CLUB may well be sympathized with in their loss of so ardent a yachtsman and so earnest a member.

RIPPLE.

RIPPLE is a cutter formerly belonging to the late ex-Commodore George H. Newell of Rochester, N. Y. She was designed and built by George H. Newell, and was launched in May, 1890. She hails from Charlotte, N. Y., and sails with the ROCHESTER YACHT CLUB. See Fig. 512.

DIMENSIONS.			
Length over all,	31 feet.	Length load waterline,	27.12 feet.
Draft,	6 feet.	Beam,	9.83 feet.

CHEROKEE.

CHEROKEE is a centerboard open cut-boat, owned by James Pillow of Rochester, N. Y. She was designed and built by Joseph O. Doyle and hails from Charlotte, N. Y., sailing with the ROCHESTER YACHT CLUB. Was launched in 1887. See Fig. 513.

DIMENSIONS.			
Length over all,	15 feet 6 inches.	Length load waterline,	14 feet 7 inches.
Draft,	1 foot.	Beam,	3 feet 10 inches.



THOMAS B. PRITCHARD.

two years and also the Regatta Committee for two years.

THOMAS B. PRITCHARD, Secretary of the ROCHESTER YACHT CLUB was born in Rochester, and is still a resident of that city. He has owned the yacht NAYOMIS and is now the owner of the cutter VELLETTE. Has been a yacht-man for eight years, during which time he has been closely connected with all the yachting affairs of his two clubs, the ROCHESTER and OSWEGO YACHT CLUBS, having served on the Membership Committee one year. Was one year Delegate to the LAKE YACHT RACING ASSOCIATION, was Secretary of the Executive Committee

VELLETTE.*

A cutter hailing from Charlotte, N. Y., and sailing with the ROCHESTER and OSWEGO YACHT CLUBS. Was designed and built by E. L. Williams of South Boston for E. N. Watbridge, *et al.*, being launched in June, 1887. Since April, 1892, she has been the property of Thomas B. Pritchard of Rochester. She has a cabin. See Fig. 514.

DIMENSIONS.			
Length over all,	27 feet.	Length load waterline,	23 feet 6 inches.
Depth,	5 feet 6 inches.	Draft,	5 feet 2 inches.
Beam,	8 feet.		

* W. C. Seward and L. B. Jones (Masters).

AMELIA.

AMELIA is a cutter yacht owned by Schirek Bros. of Rochester, N. Y. She was designed and built by Schirek Bros. and was launched in 1888. Hails from Charlotte, N. Y., and sails with the ROCHESTER YACHT CLUB. See Fig. 515.

DIMENSIONS.			
Length over all,	31.42 feet.	Length load waterline,	25.94 feet.
Draft,	6 feet.	Beam,	8.12 feet.

EDITH.

EDITH, a keel sloop, was designed by J. R. White and built by John Lake of Charlotte, N. Y. She was launched in April, 1888. Formerly owned by J. R. White and sailing in the ROCHESTER YACHT CLUB; but now the property of George W. Dickerman, hailing from Hartford, Conn. See Fig. 516.

DIMENSIONS.			
Length over all,	21 feet 8 inches.	Length load waterline,	27 feet 6 inches.
Draft,	6 feet.	Beam,	11 feet.



COMMODORE CHRISTIAN J. LICHTENBERG.

DETROIT YACHT CLUB.

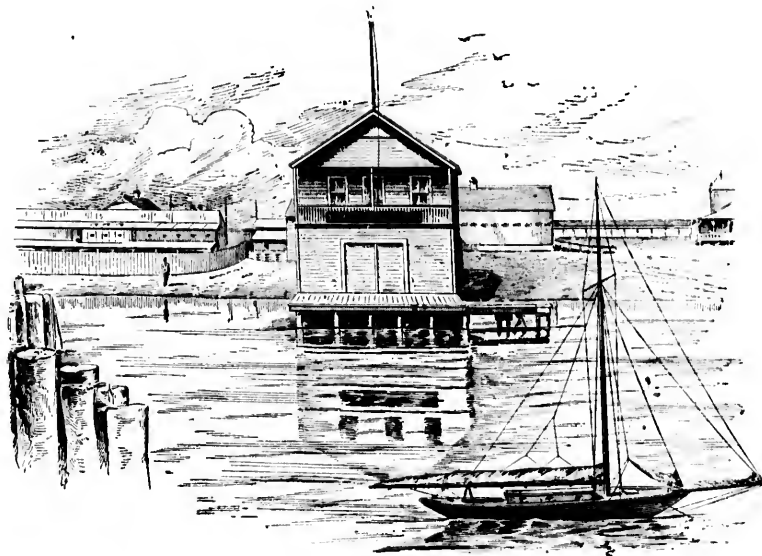

DETROIT YACHT CLUB HOUSE.

History of the Detroit Yacht Club.

THE DETROIT YACHT CLUB, familiarly known as the "Old Club," was organized in 1878 by former members of the International Yacht Club, which latter club terminated its existence three years before. Naturally, yachtsmen were desirous to form a new club, and also to put new life into the great sport that had fallen into decay, the result of which was the organization of the Detroit Yacht Club. Samuel Cowan was elected the first Commodore and the club sailed along smoothly until 1882, when unfortunately it passed temporarily out of existence.

In the meantime the Commodores were: Samuel Cowan in 1878, A. H. Major in 1879 and 1880, and O. W. Baker in 1881. Nothing was done in 1882 and 1883. In the following year the question of forming a new club was agitated, and a number of the members succeeded in forming what is now known as the Michigan Yacht Club. This action, however, put life into the old club, and the members rallied, electing J. Skiffington as Commodore; yet, for some reason, the club did not seem to prosper, and the next year no election was held. However, in 1886 it was re-organized, Commodore Skiffington was re-elected, and during the following year, 1887, it was incorporated, George Newberry being chosen as Commodore. From this time to 1891 the club came again to the front, holding a series of successful regattas each season. G. Larkins was elected Commodore in 1888, and since that time C. J. Lichtenberg has had the honor of holding the office.

In 1891, on account of a difference of opinion as to club policy, a number of members again seceded and organized the Citizens' Yachting Association; yet this year was one of the most successful ever experienced by the Detroit Yacht Club, for the members that were left went to work with a will to build up the club, meeting with decided success.

In 1891 a series of successful regattas was held, and in 1892 the regattas surpassed any ever held by the clubs of Detroit, in the number of yachts participating, the general success of the races and the time made.

In 1891 the club moved to its present anchorage, which is situated on the mainland opposite the Michigan Yacht Club House on Belle Isle, where it erected a small club house for the accommodation of its members. The lease on their present grounds will soon run out and the club has already taken steps to procure a new location, where they can remain permanently and erect a new club house suitable to fill the requirements of the organization.

The officers for 1892 were as follows:

Commodore,	C. J. Lichtenberg.	Secretary,	C. F. Fraser.
Vice-Commodore,	Col. J. H. Beattie.	Treasurer,	H. J. Reeves.
Rear-Commodore,	Dr. O. Scherer.	Measurer,	H. F. Hilton.
		Harbor Master,	E. F. Bates.

The officers for 1893, were:

Commodore,	C. J. Lichtenberg.	Secretary,	J. A. Minwegan.
Vice-Commodore,	O. Scherer, M. D.	Treasurer,	H. J. Reeves.
Rear-Commodore,	Harry C. Kendall.	Measurer,	G. C. Zimmerman.
		Fleet Surgeon,	Benjamin Jacob, M. D.

YACHTS ENROLLED IN THE DETROIT YACHT CLUB.

Class 1—35 feet and over on water line.

Name.	Owner.	Reg.	C. H.		Beam.	Depth of Hold.
			or Keel.	Water Line.		
			FT. 18.	FT. 18.		
Cruiser	E. H. Gillman	Sch.	C. H.	54 2	16 0	4 0
Cora	J. A. Russell et al.	Sch.	C. H.	51 0	16 1	6 1
Mattie M.	Paul Murray	Sip.	C. H.	39 0	13 0	5 0
Echel	H. W. Morley	Sip.	C. H.	41 0	15 0	5 4
Alert	W. A. Lorett	Sch.	C. H.	42 0	13 0	6 0

Class 2—30 to 35 feet water line.

		Reg.	C. H.		Beam.	Depth of Hold.
			or Keel.	Water Line.		
			FT. 18.	FT. 18.		
Alice Enright	J. J. Ackerman et al.	Sip.	C. H.	34 6	10 2	5 3 1/2
Princess	W. B. Moran	Sip.	C. H.	34 7	12 11	5 10 1/2
Josephine	(now Empress)	Sip.	C. H.	34 6	10 4	4 6
Lulu B.	M. Kramer et al.	Sip.	C. H.	34 8	11 2	4 7
Gertrude	W. Look et al.	Sip.	C. H.	31 4	10 4	4 0
Cygnus	C. J. Lichtenberg	Sip.	C. H.	35 0	14 0	5 4
Petrel	F. J. Dingerman	Sip.	C. H.	31 10	10 0	2 6
Pearl	J. Christian	Sch.	C. H.	33 0	11 0	3 8
Columbia	F. Dulack	Sch.	C. H.	30 3	10 1	3 0
	J. F. Hacker	Sch.	C. H.	30 3	10 1	3 0

Class 4—25 to 30 feet water line.		Rig.	C. B. or Keel.	Length Ft. 15.	Beam Ft. 15.	Depth of Hold Ft. 15.
Name.	Owner.					
Albion	Col. J. H. Beattie	Sq.	Keel.	25 0	12 0	1 6
Shamrock	H. C. Kendall	Sq.	C. B.	27 0	10 0	3 3
Corsair	J. Hovey	Sq.	C. B.	26 24	10 7	4 0
Irone Moore	F. Plinke	Sq.	C. B.	25 0	10 0	5 3
Muscatin	W. Schwelckhart	Sq.	C. B.	25 00	10 0	5 3
Surprise	C. Boston	Sq.	C. B.	25 00	10 0	5 3
Class 4—20 to 25 feet water line.						
Madeline	G. Zimmerman	Sq.	C. B.	22 2	9 2	1 8
Mudger	E. F. Bates	Sq.	C. B.	21 0	9 0	2 4
Blanche H.	A. F. Belleville	Sq.	C. B.	23 0	8 0	4 0
Echo	A. A. Ekhill	Sq.	C. B.	24 11	8 0	3 3
Ugo	F. H. Chelvers	Sq.	C. B.	22 0	10 0	3 0
Vixen	C. Schulz	Sq.	C. B.	21 0	8 8	2 8
Natal	H. A. Wright	Sq.	C. B.	23 10	10 0	3 0
Viola	W. Look	Sq.	C. B.	22 0	9 0	3 11
Henrietta	A. Peters	Sq.	C. B.	24 11	9 2	3 0
Sigma	A. Kunze	Sq.	C. B.	23 8	8 0	3 5
Class 5—18 to 20 feet water line.						
Cyclone	C. Schwelckhart	Sq.	C. B.	18 4	7 0	2 2
Baroka	W. Gregg	Sq.	C. B.	19 11	8 3	2 10
North Cape	A. Hansen	Sq.	C. B.	18 10	7 00	2 0
Let Her Go	R. C. Holbertson	Sq.	C. B.	19 00	7 10	3 0
Thistle	J. N. Krieger	Sq.	C. B.	19 11	6 10	2 0
Class 6—Sloops and single cuts 18 feet and under, water line.						
Corsair Jr.	B. Hilton	Sq.	C. B.	17 0	6 0	2 8
Norma	M. A. Gregg	S. C.	C. B.	16 4	5 8	2 2
Burma S.	H. Schmidt	S. C.	C. B.	17 10	7 0	2 34
Margie	J. K. Moore	Sq.	C. B.	16 10	6 10	1 10
Olive-Eva	E. Kimberg	Sq.	C. B.	16 0	5 0	2 1
George R.	H. Reichenbach	Sq.	C. B.	14 0	4 4	1 0
Nettie	A. Navarre	Sq.	Keel	10 10	6 3	2 1
Class 7—Double cuts and schooners under 22 feet water line.						
Augusta S.	C. Scherer M. D.	D. C.	C. B.	22 0	6 0	3 2
Louis	W. Cook	D. C.	C. B.	17 11	5 3	2 2
Clayton	E. B. Wendell	D. C.	C. B.	19 14	5 7	2 2
Puritan	H. Loring	D. C.	C. B.	17 11	5 0	2 2
Isac	H. E. Millard	D. C.	C. B.	19 8	5 11	4 4
Onward	J. H. Burton	D. C.	C. B.	20 9	6 8	4 6
Yava	J. F. Henkel	D. C.	C. B.	18 0	5 4	4 0
Olive	A. Woods	D. C.	C. B.	19 3	6 4	4 0
Josephine Jr.	W. Dupont	D. C.	C. B.	20 9	8 0	3 0
Noxley	E. D. Hopper	D. C.	C. B.	18 0	5 6	1 8

ACCORDING TO THE RULES AND REGULATIONS:

All yachts in the club measuring 16 feet and upwards on the waterline shall be enrolled in the squadron.

No yacht shall sail in a club regatta without her owner or a member of the club on board.

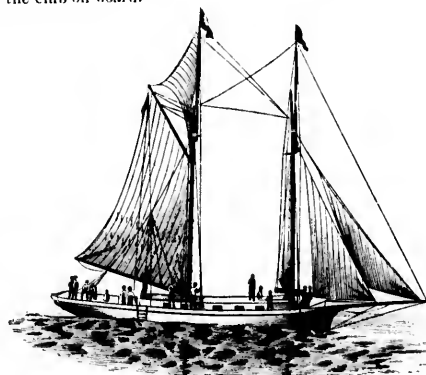

CRUSADER.—FIGURE 517.

Regattas shall be open to yachts of any regularly organized yacht club, provided the club to which they belong shall extend the same privilege to yachts of the Detroit Yacht Club, pennant flag regattas excepted.

No regatta or race shall be sailed under the auspices of this club before the 30th day of May, nor later than the 30th day of October of each year.

Class 1 shall consist of all yachts measuring 35 feet or upwards on the water line.

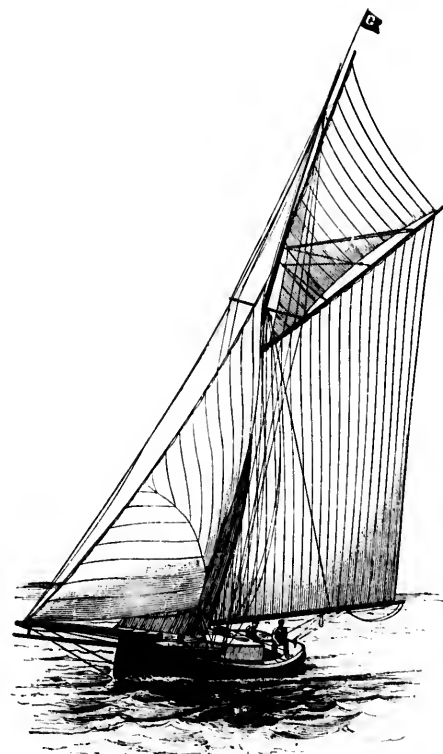

GERTRUDE.—FIGURE 518.

Class 2, all yachts 30 feet and under 35 feet on the waterline.

Class 3, all yachts 25 feet and under 30 feet on the waterline.

Class 4, all yachts 20 feet and under 25 feet on the waterline.

Class 5, all yachts 16 feet and under 20 feet on the waterline.

Yachts of a smaller class may enter into races against yachts of a larger class provided they accept the minimum measurement of length at the waterline of the larger class.

All double cuts under 22 feet on the waterline constitute a special class.

The gross measurement shall be the adding together the length on the waterline, greatest breadth of beam and the depth of hold from the under side of deck to the top side of planking at or near the mast as possible. In gross measurements a majority fraction of a foot shall count as one foot.

Two seconds for each foot difference of gross measurement will be allowed all yachts for each mile in the course.

RACING RECORDS OF THE DETROIT YACHT CLUB.

All the races in 1891 and 1892 have been started from the club house around the "Grosse Pointe" Lightship in lake St. Clair, a distance of thirteen miles in all. This gives a course which is half in the river and half in the lake, and has proved very satisfactory to all.



on the waterline.

on the waterline.

on the waterline.

on the waterline.

into races against
the minimum meas-
class.

waterline constituto

ding together the
am and the depth
e of planking at or
ements a majority

gross measurement
ese.

YACHT CLUB.

ted from the club
lake St. Clair, a
urse which is half
ery satisfactory to

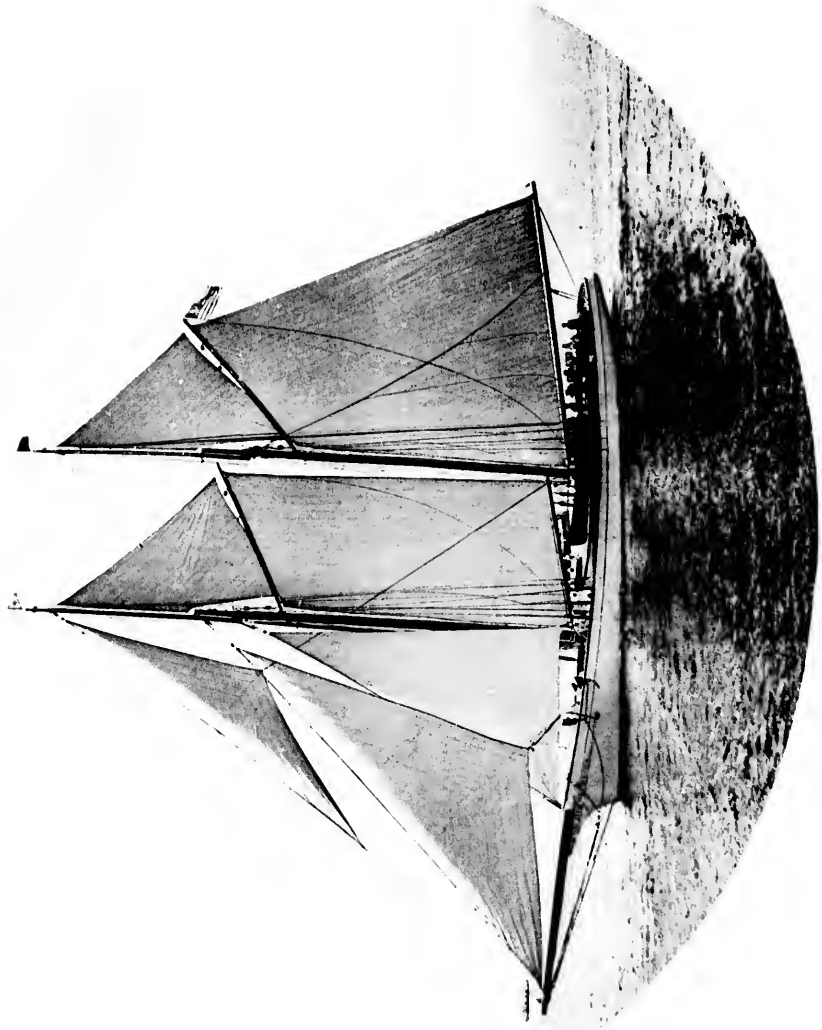

NIRVANA.

PLATE LXVI.

NIRVANA.

PLATE LXVI.



TABLE

	Elapsed	Time	Distance
From 1	00 00	00 00	00 00
1000	00 00	00 00	00 00
2000	00 00	00 00	00 00
3000	00 00	00 00	00 00
4000	00 00	00 00	00 00
5000	00 00	00 00	00 00
6000	00 00	00 00	00 00
7000	00 00	00 00	00 00
8000	00 00	00 00	00 00
9000	00 00	00 00	00 00
10000	00 00	00 00	00 00
11000	00 00	00 00	00 00
12000	00 00	00 00	00 00
13000	00 00	00 00	00 00
14000	00 00	00 00	00 00
15000	00 00	00 00	00 00
16000	00 00	00 00	00 00
17000	00 00	00 00	00 00
18000	00 00	00 00	00 00
19000	00 00	00 00	00 00
20000	00 00	00 00	00 00
21000	00 00	00 00	00 00
22000	00 00	00 00	00 00
23000	00 00	00 00	00 00
24000	00 00	00 00	00 00
25000	00 00	00 00	00 00
26000	00 00	00 00	00 00
27000	00 00	00 00	00 00
28000	00 00	00 00	00 00
29000	00 00	00 00	00 00
30000	00 00	00 00	00 00
31000	00 00	00 00	00 00
32000	00 00	00 00	00 00
33000	00 00	00 00	00 00
34000	00 00	00 00	00 00
35000	00 00	00 00	00 00
36000	00 00	00 00	00 00
37000	00 00	00 00	00 00
38000	00 00	00 00	00 00
39000	00 00	00 00	00 00
40000	00 00	00 00	00 00
41000	00 00	00 00	00 00
42000	00 00	00 00	00 00
43000	00 00	00 00	00 00
44000	00 00	00 00	00 00
45000	00 00	00 00	00 00
46000	00 00	00 00	00 00
47000	00 00	00 00	00 00
48000	00 00	00 00	00 00
49000	00 00	00 00	00 00
50000	00 00	00 00	00 00
51000	00 00	00 00	00 00
52000	00 00	00 00	00 00
53000	00 00	00 00	00 00
54000	00 00	00 00	00 00
55000	00 00	00 00	00 00
56000	00 00	00 00	00 00
57000	00 00	00 00	00 00
58000	00 00	00 00	00 00
59000	00 00	00 00	00 00
60000	00 00	00 00	00 00
61000	00 00	00 00	00 00
62000	00 00	00 00	00 00
63000	00 00	00 00	00 00
64000	00 00	00 00	00 00
65000	00 00	00 00	00 00
66000	00 00	00 00	00 00
67000	00 00	00 00	00 00
68000	00 00	00 00	00 00
69000	00 00	00 00	00 00
70000	00 00	00 00	00 00
71000	00 00	00 00	00 00
72000	00 00	00 00	00 00
73000	00 00	00 00	00 00
74000	00 00	00 00	00 00
75000	00 00	00 00	00 00
76000	00 00	00 00	00 00
77000	00 00	00 00	00 00
78000	00 00	00 00	00 00
79000	00 00	00 00	00 00
80000	00 00	00 00	00 00
81000	00 00	00 00	00 00
82000	00 00	00 00	00 00
83000	00 00	00 00	00 00
84000	00 00	00 00	00 00
85000	00 00	00 00	00 00
86000	00 00	00 00	00 00
87000	00 00	00 00	00 00
88000	00 00	00 00	00 00
89000	00 00	00 00	00 00
90000	00 00	00 00	00 00
91000	00 00	00 00	00 00
92000	00 00	00 00	00 00
93000	00 00	00 00	00 00
94000	00 00	00 00	00 00
95000	00 00	00 00	00 00
96000	00 00	00 00	00 00
97000	00 00	00 00	00 00
98000	00 00	00 00	00 00
99000	00 00	00 00	00 00
100000	00 00	00 00	00 00

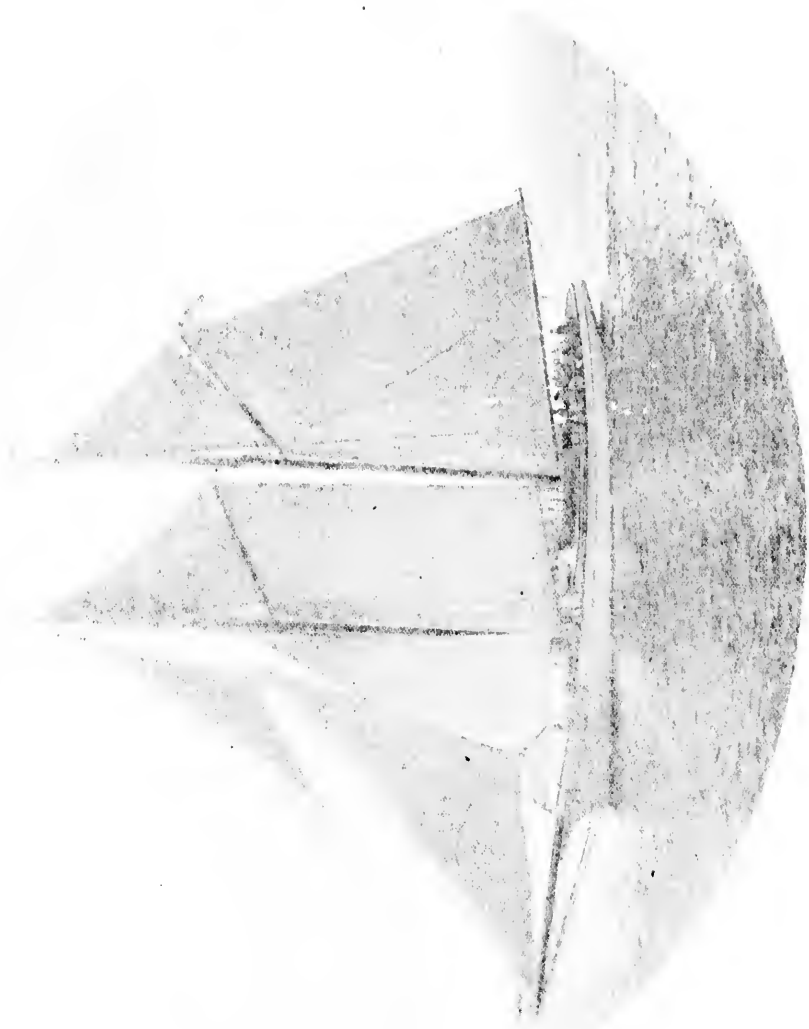

NIRVANA.

In 1892 the club held four pennant regattas. In the first, which was held June 20th, thirty yachts started, twenty-four of which finished. This was one of the grandest sights ever witnessed in Detroit River. The yachts started dead to leeward, and as they all went over the line with spinnakers set and kites flying they were a perfect picture. The time made in the race was very fast, that of ALION ENRIGHT in Class 2 being 1 hour and 55 minutes for the thirteen miles. Below is a summary of this race—fresh southerly breeze with rain-storm at end :

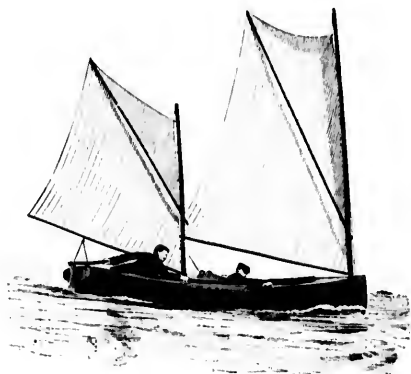

LOIS.—FIGURE 520.

Fifth Class:			
Cyebow	3 04 47	1 03 29	
Eureka	3 01 23	3 01 23	
Thistle	Withdraw.		
North Cape	Withdraw.		

Sixth Class:			
Olive-Eva	2 17 12	2 17 12	
Parma	2 18 06	2 18 06	
Corsair, Jr.	Withdraw.		
George R.	Withdraw.		

Special Class:			
Augusta S.	2 01 29	1 59 39	
Lois	2 18 45	2 08 31	
Josephine, Jr.	2 12 21	2 12 21	
Puritan	2 16 12	2 11 00	
Nettie M.	2 19 05	2 17 37	
Yava	2 57 40	2 55 28	
Martha	3 26 31	3 23 16	

CORSAIR JR. capsized and NORTH CAPE withdrew to go to her aid. The judges were W. K. Parcher, Capt. Joe Nicholson and Will Hammond. The time-keepers were Louis Hilsendrogen, J. A. Minwegan, C. F. Fraser, and Will Hayes.

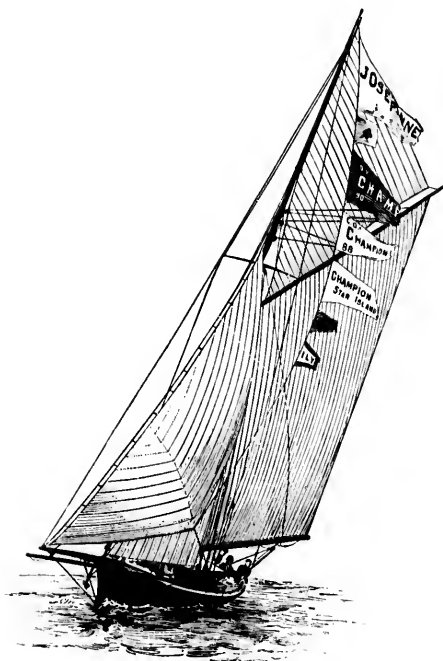

EMPRESS.—FIGURE 510.

First Class:		Elapsed.		Corrected.		
	H.	M.	S.	H.	M.	S.
Crusader	2	18	38	2	18	38
Cora	2	22	08	2	21	42
Second Class:						
Alice Enright	1	55	17	1	55	17
Lulu B.	2	01	55	2	01	55
Josephine	2	10	08	2	09	42
Columbia	2	19	39	2	16	37
Pearl	2	55	00	2	51	08
Third Class:						
Shamrock	2	10	13	2	10	13
Corsair	2	59	47	2	57	37
Fourth Class:						
Madeline	2	25	57	2	24	13
Naiad	2	34	30	2	34	30
Ugo	2	53	15	2	51	23
Viola	Withdraw.					
Blanche B.	Withdraw.					
Madge	Withdraw.					

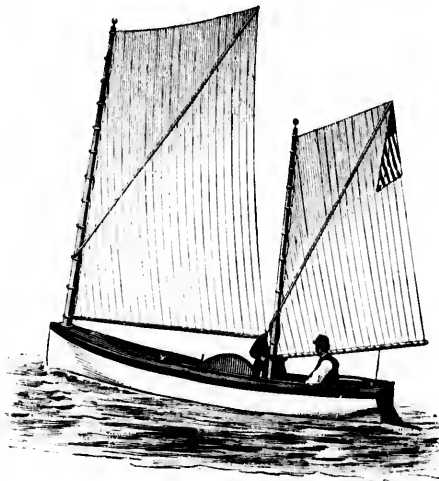

PURITAN.—FIGURE 521.

The winners in the various classes were:

Class 1, *CRUSADER* first, *CORA* second.

Class 2, *ALICE ENRIGHT* first, *LULU B.* second.

Class 3, *SHAMROCK* first, *COUSAIR* second.

Class 4, *MADLINE* first, *NALAD* second, *UGO* third.

Class 5, *CYCLONE* first, *EUREKA* second, *THISTLE* third, *NORTH CAPE* fourth.

Class 6, *OLIVE-EVA* first, *NORMA* second.

Class 7, *AUGUSTA S.* first, *LOIS* second.



AUGUSTA S.—FIGURE 522.

The Second Regatta was sailed on the 8th of August, and was more interesting than that of June 29th, in that the contests were more spirited and the finishes much closer.

The Second Class was represented by six of the fastest 35-footers in that section of the country, namely: *ALICE ENRIGHT*, *LULU B.*, *JOSEPHINE*, *PRINCESS*, *GERTRUDE* and *PEARL*, and this proved an exciting race. *ALICE ENRIGHT* came in first in this class, with *LULU B.* only 1 minute 15 seconds behind.

The Fourth Class also furnished a surprise, *UGO* beating *MADLINE*. There were again thirty yachts entered in this regatta, twenty-six starters, all of whom finished. In Class 7, *PERITAN* came out the victor, as did *CRUSADER* in the first, *SHAMROCK* in the third, *CYCLONE* in the fifth, and *OLIVE-EVA* in the sixth.

At this race the club entertained a party of visitors from Cincinnati on board the schooner *WIDGEON*.

The Third Regatta took place on the 6th of September, when twenty-six yachts started and twenty-one finished. In this regatta *PRINCESS* entered in Class 1 and easily beat the schooners *CRUSADER* and *CORA*. *ALICE ENRIGHT* won again in the Second Class, *SHAMROCK* in the third, *UGO* in the fourth, *CYCLONE* in the fifth, *OLIVE-EVA* in the sixth and *AUGUSTA S.* in the seventh. The

wind was variable in force and direction, blowing strong from the north, and later shifting to the west and falling lighter. The times were:

	Elapsed.			Corrected.		
	H.	M.	S.	H.	M.	S.
First Class:						
<i>Princess</i>	2	23	48	2	14	42
<i>Cora</i>	2	37	44	2	37	17
<i>Crusader</i>	2	37	52	2	37	52
Second Class:						
<i>Alice Enright</i>	2	06	41	2	06	41
<i>Josephine</i>	2	14	31	2	11	05
<i>Lulu B.</i>	2	21	01	2	21	01
<i>Gertrude</i>	2	43	30	2	41	40
<i>Pearl</i>	2	48	35	2	45	40
Third Class:						
<i>Shamrock</i>	2	20	20	2	20	26
<i>Surprise</i>	3	08	35	3	05	50
Fourth Class:						
<i>Ugo</i>	2	41	53	2	41	01
<i>Nalad</i>	2	56	50	2	50	50
<i>Madeline</i>	2	50	33	2	57	40
<i>Viola</i>	3	10	42	3	08	50
Fifth Class:						
<i>Cyclone</i>	2	44	00	2	42	51
<i>North Cape</i>	3	05	40	3	04	48
<i>Eureka</i>	3	14	23	3	14	23
Sixth Class:						
<i>Olive-Eva</i>	2	28	20	2	28	20
<i>Norma</i>	2	45	25	2	45	25
Double Cats:						
<i>Augusta S.</i>	2	22	54	2	22	54

PRINCESS is better known as *CITY OF THE STRAITS*. The judges were W. K. Parcher, W. J. Hammond and Walter Oades. Timekeepers, John R. Burton and L. N. Hilsendegen.



NORTH CAPE.—FIGURE 523.

The Fourth Regatta was held on the 21st of October, and nineteen yachts started, a very large number for this time of the season. The surprise of the day was the defeat of *ENRIGHT* by *JOSEPHINE* in the Second Class, and *MADLINE* beating *UGO* in the fourth, making a tie in that class.

ing strong from the
lighter. The times

orrected.
M. 8.
14 42
37 17
37 52

06 41
11 05
21 01
41 40
45 40

20 36
05 59

41 01
56 50
57 49
08 59

42 51
04 48
14 23

28 29
45 25

22 54
RAVTS. The judges
Valter Ondes. Time-

In class 7, PURITAN won again, making a tie with AUGUSTA S.

The pennant winners for the season were as follows:

Class 1, CRUSADER.

Class 2, ALICE ENRIGHT.

Class 3, SHAMROCK.

Class 4, UGO.

Class 5, CYCLONE.

Class 6, OLIVE-EVA.

Class 7, AUGUSTA S.

Besides this, for making the fastest time over the course in 1891 and 1892 ALICE ENRIGHT won the Hanley prize and the Mabley trophy; for making the fastest time in her class in 1892 she won the Koppitz Melchers trophy, and in 1891 and 1892 she won the Hopper Cup three times, thereby obtaining perpetual ownership.

This Fourth Regatta was sailed in a moderate and variable breeze. The summary is as follows:

	Finish. H. M. S.	Elapsed. H. M. S.
First Class:		
Princess	4 44 57	2 51 44
Crusader	5 30 05	3 27 45
Cora	5 50 42	4 00 10
Second Class:		
Josephine	4 40 05	2 47 17
Alice Enright	4 36 26	2 49 18
Lulu B.	4 59 12	3 00 54
Gertrude	5 09 38	3 14 28

	Finish. H. M. S.	Elapsed H. M. S.
Fourth Class:		
Madelme	5 02 49	3 16 19
Ugo	5 17 25	3 23 00
Madge		time not given

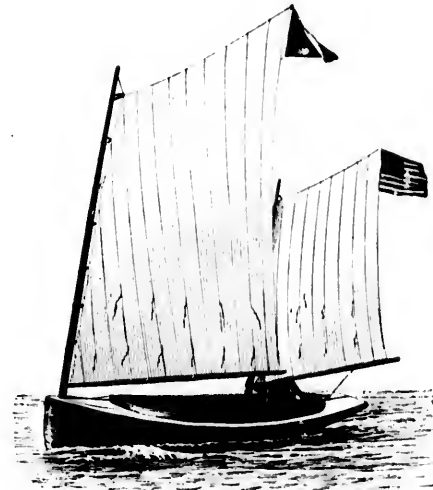

NOVELTY.—FIGURE 535.

Fifth Class:		
Eureka	5 31 20	3 41 00
Let Her Go		time not given

Double Cats:		
Puritan	4 31 50	2 43 58
Nettie N.	4 37 50	2 51 30
Lois	4 45 13	2 55 33
Augusta S.	4 50 50	2 57 01
Gladys	1 58 15	3 03 30
Josephine	4 51 42	3 05 35

The club has devoted its energies during the past two seasons to building itself up and can be congratulated on having been so far successful. It has an active membership of 103, and the officers hope by the end of the coming season to see this materially increased. It has lately raised the annual dues, and hopes by that means to obtain a better income. The club is entirely free of debt, with a good balance in the treasury. Its members are entirely in accord with one another, and all concerned are determined to add a list of successful races to their future records.

SEASON OF 1893.

The First Regatta of the season was held June 20, 1893. The starting gun was fired at 1:25 P. M. Only a gentle breeze was stirring and the yachts started with spinnakers and all canvas set.

The following yachts participated:

	Finish. H. M. S.	Elapsed. H. M. S.	Start. H. M. S.	Finish. H. M. S.	Elapsed H. M. S.
Third Class:					
Shamrock	4 51 44	8 03 17			
Second Class:					
Empress	1 34 45	5 41 00	1 34 45	5 41 00	4 06 15
Surprise	1 35 00	6 19 20	1 35 00	6 19 20	4 44 20
Gertrude			1 35 00		did not finish

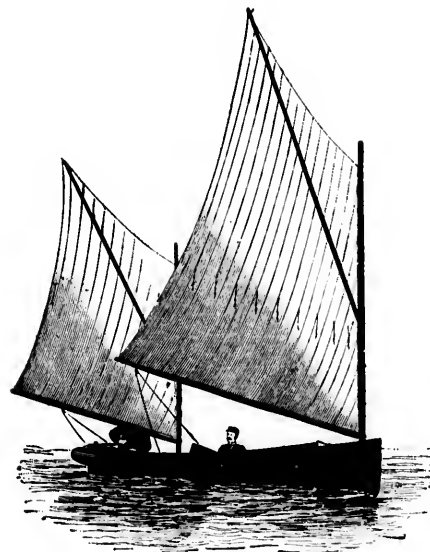

GLADYS.—FIGURE 534.

October, and nine-
time of the season.
r by JOSEPHINE in
the fourth, making

	Start.	Finish.	Elapsed
	H. M. S.	H. M. S.	Time.
	H. M. S.	H. M. S.	H. M. S.
Third Class.			
Shamrock	1 35 00	5 30 31	3 55 31
Corsair	1 35 00	5 39 43	4 04 43
Alborak	1 32 25	0 03 31	4 31 06
Fourth Class.			
Madeline	1 32 41	5 30 00	4 01 10
Fifth Class.			
Let Her Be	1 35 00	5 40 50	4 11 50
Nettie N.	1 31 10	0 14 12	4 40 02
Thistle	1 35 00		did not finish
Sixth Class.			
Corsair Jr.	1 27 21	5 05 00	3 34 39
Viola S.	1 27 32	5 13 02	3 45 30
Special Class.			
Lois	1 35 00	6 00 00	4 25 00
Augusta S.	1 35 00		did not finish

Both PEARL and MASCOTTE of the first class started but did not finish.

EMPRESS won in second class, SHAMROCK won in third class; MADELINE had a walk-over in fourth class. LET HER BE won in fifth class; CORSAIR JR. won in sixth class and LOIS won in special class.

The next regatta took place on August 23d. There was a good stiff 25 mile breeze even up the river and the yachts laid well over.

After getting out on the lake, ALBORAK'S bob-stay went and while LET HER BE was ploughing along her mainsail was made useless by the goose-neck breaking. GERTRUDE had a torn sail and CORSAIR went around with loused topmast and a double reefed sail. Over all the yachts the water dashed in torrents and pumps and buckets were kept at work. PEARL was handicapped at the start by stopping to pick up some boys who had upset their rowboat.

The regatta was full of excitement.

The following yachts participated:

First Class.			
Alert	1 44 31	4 16 00	2 31 20
Mattie M.	1 42 15	4 28 30	2 46 15
Pearl	1 50 00		did not finish
Second Class.			
Empress	1 42 25	4 16 02	2 34 37
Surprise	1 41 50	4 20 25	2 38 35
Gertrude	1 41 35	4 32 20	2 30 45
Lulu B.	1 41 55		did not finish.
Third Class.			
Shamrock	1 40 50	3 56 00	2 15 10
Corsair	1 44 28	4 36 00	2 51 32
Alborak	1 42 40		did not finish
Fourth Class.			
Madeline	1 47 15	4 42 30	2 55 15
Nixie	1 43 50		did not finish
Madge	1 41 40		did not finish
Fifth Class.			
Let Her Be	1 43 21	4 52 50	3 09 20
Nettie N.	1 40 53	5 05 40	3 24 47
Cyclone Jr.	1 40 30		did not finish
Thistle	1 50 00		did not finish
Sixth Class.			
Olive-Eva	1 46 30	4 24 25	2 37 55
Norma	1 50 00		did not finish
Corsair Jr.	1 42 48		did not finish

Special Class.

	Start.	Finish.	Elapsed
	H. M. S.	H. M. S.	Time.
	H. M. S.	H. M. S.	H. M. S.
Lois	1 41 03	3 54 00	2 12 57
Cyclone Jr.	1 40 30	3 53 30	2 13 00
Josephine Jr.	1 40 40	4 07 05	2 26 25
Viola S.			did not finish
ALERT	won in	First Class.	
EMPRESS	"	Second "	
SHAMROCK	"	Third "	
MADLINE	"	Fourth "	
LET HER BE	"	Fifth "	
OLIVE-EVA	"	Sixth "	
LOIS	"	Seventh "	

The last Regatta of the season was sailed October 3, 1893.

At the start there was a 12 mile wind; out in the lake it was unsteady and fluctuating and on the return the wind almost died away. Trophies were given for the best list of performances during the season. The Mabley trophy for the fastest time around the course was the one most of the yachtsmen were after.

The following yachts started:

First Class.			
Mattie M.	1 38 35	4 55 35	3 17 00
Alert	1 39 23	5 15 24	3 31 01
Second Class.			
Empress	1 32 40	4 09 18	2 36 38
Gertrude	1 35 51	4 40 42	3 04 51
Lulu B.	1 36 10	4 45 50	3 09 40
Surprise	1 33 45	4 44 10	3 10 25
Cygnus	1 41 10		did not finish
Columbla	1 42 00		did not finish
Third Class.			
Shamrock	1 31 20	4 08 08	2 36 48
Fourth Class.			
Madge	1 34 05	6 25 00	
Nixie	1 38 41	6 20 00	
Fifth Class.			
Nettie N.	1 32 35	4 56 10	3 23 35
Cyclone	1 33 37	0 00 00	4 20 23
Thistle	1 38 11		did not finish
Sixth Class.			
Olive-Eva	1 34 09		did not finish
DOUBLE CATS.			
Lois	1 35 34	4 44 04	3 08 00
Gladys	1 30 03	5 20 15	3 41 12
Viola S.	1 32 45	5 22 00	3 49 15
Cyclone Jr.	1 37 10		did not finish

The most exciting feature was aboard Lois which, through favorable wind and excellent seamanship, beat her class. Commodore Scherer fell overboard in his enthusiasm, but the crew picked him up.

MAUD M. won in First Class.
 EMPRESS " Second "
 SHAMROCK had a walk-over.
 NIXIE came in first in Fourth Class.
 NETTIE won in Fifth Class.
 LOIS won in Double Cat Class.

BIOGRAPHICAL SKETCHES AND DESCRIPTION OF YACHTS ENROLLED IN THE CLUB.

CHRISTIAN J. LICHTENBERG, Commodore of the Detroit Yacht Club; business, grain and general produce, Detroit, Mich., was born in Baden, Germany, the son of John G. and Catherine Lichtenberg. Has owned the sloops *MADELINE* and *CARRIE* and the schooners *OAK LEAF* and *MONA*. His present yacht is the sloop *GERTRUDE*. Has been interested in yachting since boyhood.

Commodore Lichtenberg was a leader in the Revolutionary Party of 1848. His family has been well known politically and socially for many years and has been honored with many prominent official positions.

GERTRUDE.

GERTRUDE is a centerboard sloop owned by Christian J. Lichtenberg, Commodore of the Detroit Yacht Club. She was designed and built by Barney Nehls, and launched July 4, 1889, for his own use. Commodore Lichtenberg has owned her for one year. She hails from Detroit, and sails with the Detroit Yacht Club. See Fig. 518.

CODE SIGNAL LETTER, G

DIMENSIONS.			
Length over all,	30 feet.	Depth,	5 feet.
Length load water line,	31 feet 6 inches.	Draft,	3 feet 9 inches.
Beam,	30 feet 10 inches.		



CHARLES F. FRAZER.

CHARLES FORDHAM FRAZER, Detroit, Michigan, was born in London, England. Has been a yachtsman for the past eight years, and has owned the yacht *MARJORIE*. A member of the Detroit Yacht Club, in which organization he has been Auditor for one year and Secretary for two years.

ROBERT LORIMER, Detroit, Michigan, was born in Detroit, and is the son of John S. Lorimer and Mary W. Lorimer. He is at present the owner of the yacht *PURITAN* and has been a yachtsman for the past ten years. Is a member of the Detroit Yacht Club.

PURITAN.

PURITAN is a centerboard double cut owned by Robert Lorimer of Detroit, Michigan. She was designed and built by the Detroit Boat Works, and was launched in the Spring of 1892. She hails from Detroit and sails with the Detroit Yacht Club. See Fig. 521.

DIMENSIONS.			
Length over all,	18 feet 8 inches.	Beam,	5 feet 6 inches.
Length load water line,	17 feet 11 inches.	Spars,	Mast 20 feet x 1 in.
Depth,	2 feet.	Foremast,	13 feet x 3 in.
Draft,	8 inches.		

Racing record for 1892: won a silver cup, the first prize.



DR. OTTO SCHERER.

DR. OTTO SCHERER, physician and surgeon, Detroit, Michigan, Vice-Commodore of the Detroit Yacht Club, was born in Detroit, November 21, 1865. He is the son of John Conrad Scherer and Augusta Scherer, née Pauli.

Dr. Scherer has owned the sloops *ALMA* and *SYLVIA*, while at present he is the owner of the yacht *AGUSTA S*. He is very much interested in ice-yachting as well as the more nautical sport, and has designed and built the ice yachts *BLIZZARD* and *ICE KING*.

AGUSTA S.

AGUSTA S, a centerboard double cut, belonging to Dr. Otto Scherer, Vice-Commodore of the Detroit Yacht Club, was built and designed by Carl Schweikart of Detroit, being launched April 15, 1892. Hails from Detroit and sails with the Detroit Yacht Club. See Fig. 522.

DIMENSIONS.

Length over all,	23 feet.	Beam,	9 inches.
Length load water line,	24 feet.	Beam,	9 feet 3 inches.
Depth,	2 feet 6 inches.	Foremast,	22 feet.
Mast,	18 feet.		

Racing record for 1892: *AGUSTA S*, won the championship in the special double cut class of the Detroit Yacht Club.



J. H. BEATTIE.

J. H. BEATTIE, of Windsor, Ontario, Canada, was born in England. Has been the Mayor of Windsor for three terms, and has also been the Lieutenant-Colonel of the Essex Fusiliers. He is the owner of the cutter yacht *ALBORAK*, and has been for one term Vice-Commodore of the Detroit Yacht Club.

ALBORAK.

A cutter designed and built by Thomas D. Dalton of Hamilton, Ontario, for her present owner, J. H. Beattie, of Windsor, Ontario. She was launched in

July, 1891, has a large, roomy, comfortable cabin, sails with the Detroit Yacht Club, and hails from Windsor, Ontario. She has five tons outside ballast.

DIMENSIONS.

Length over all,	37 feet 6 inches.	Draft,	6 feet.
Length load water line,	37 feet 6 inches.	Beam,	8 feet 3 inches.
Depth,	8 feet 6 inches.	From deck to truck,	15 feet.

JOHN R. BURTON, printer, Detroit, Michigan. Was born in England, the son of James and Eliza Burton, née Rich. Mr. Burton has been interested in yachting for some six years, and is the owner of the yacht *ONWARD*. A member of the Detroit Yacht Club, of which he was Secretary for one year.

ONWARD.

ONWARD is a centerboard double cut owned by John R. Burton of Detroit, Michigan. She was designed and built by Dean & Co., and has been in the possession of her present owner for five years. She hails from Detroit and sails with the Detroit Yacht Club.

DIMENSIONS.

Length over all,	20 feet 8 inches.	Depth,	2 feet 6 inches.
Length load water line,	20 feet.	Draft,	1 foot 6 inches.
Beam,	6 feet 8 inches.		



E. B. WENDELL.

EMORY BRADY WENDELL, yacht designer, Detroit, Michigan, born November 9, 1862. Has been closely identified with the yachting interests of that section of the country in which he lives. Was for several years Measurer of the Michigan Yacht Club, and was also on the Regatta Committee of the ISLAND AMERICAN YACHT CLUB. He has owned many yachts, among them *ELLA*, *NOXA CRUSADER*, the cat-boats *PENNY* and *CITY OF THE STRAITS JR.*, the double cuts *JANET*, *MUD HEN*, *LOIS* and *GLADYS*, and a part owner of the yacht *CITY OF THE STRAITS*. *GLADYS* and the cat-boat *JUDY* are his present

THE STRAITS. *GLADYS*

Elapsed
Time.
h. m. s.

00 2 12 57
30 2 13 00
05 2 20 25
did not finish

class.

r 3, 1893.

in the lake it was
wind almost died
performances during
time around the
ter.

5 35 3 17 00
5 24 3 31 01

0 18 2 36 38
0 42 3 04 51
5 50 3 09 40
4 10 3 10 25
did not finish
did not finish

08 08 2 36 48

25 00
30 00

6 10 3 25 35
00 00 4 20 23
did not finish

did not finish

4 04 3 09 00
0 15 3 41 12
3 00 3 49 15
did not finish

rich, through favor-
class. Commodore
crew picked him

class.

class.

yachts. Interested in yachting for sixteen years, and a member of the MICHIGAN YACHT CLUB (charter), DETROIT YACHT CLUB (charter), CITIZENS' YACHT CLUB (charter), CITY OF THE STRAITS YACHT RACING ASSOCIATION (charter), and the INLAND AMERICAN YACHT CLUB (charter). Also a member of the DETROIT BOAT CLUB and the ST. CLAIR FISHING AND SHOOTING CLUB.

GLADYS.

The double cut GLADYS is owned by Emory B. Wendell of Detroit, Michigan, he being her designer. She was launched in the Spring of 1892, and is her owner's pet. A model of her was built for exhibition at the World's Fair to form part of the exhibit of the Detroit Boat Works. She sails with the fleets of the following clubs: MICHIGAN, DETROIT, CITIZENS' and the CITY OF THE STRAITS YACHT RACING ASSOCIATION. She hails from Detroit. See Fig. 524.

DIMENSIONS.

Length overall,	29 feet 5 inches.	Beam,	5 feet 7 inches.
Length load waterline,	19 feet 11 inches.	Foremast, (1) in. diam., 21 ft. long.	
Depth,	2½ inches.	Mizzen,	3 in. diam., 11 ft. long.
Draft,	16 inches.		

Her owner sailed GLADYS alone, single handed, from Detroit across Lake St. Clair in a very heavy sea, in 3 hours 4 minutes—a distance of 27 miles.

CRUSADER.

CRUSADER is a centerboard sloop yacht, owned by E. H. Gillman. She is 54 feet 2 inches waterline, 16 feet beam, and 4 feet

9 inches depth of hold. Sails with the DETROIT YACHT CLUB. See Fig. 517.

LOIS.

LOIS is a centerboard double cut-bout owned by W. Cook. Sails with the DETROIT YACHT CLUB. Her principal dimensions are length load waterline, 17 feet 11 inches; beam, 5 feet 3 inches; depth of hold, 2 feet 4 inches. See Fig. 520.

EMPRESS.

EMPRESS (formerly JOSEPHINE) is a centerboard sloop yacht owned by M. Kramer and other members of the DETROIT YACHT CLUB, in whose fleet she is enrolled. She is 34 feet 6 inches load waterline, 10 feet 4 inches beam, and 4 feet 6 inches depth. See Fig. 519.

NOVELTY.

The yacht NOVELTY is a centerboard double cut owned by E. D. Hopper, and is enrolled in the DETROIT YACHT CLUB. She is 18 feet waterline, 5 feet 6 inches beam, and 1 foot 8 inches depth of hold. See Fig. 525.

NORTH CAPE.

NORTH CAPE is a centerboard sloop yacht belonging to A. Hansen of the DETROIT YACHT CLUB. Her dimensions are: 18 feet 10 inches waterline, 7 feet beam, and 2 feet 6 inches depth. See Fig. 523.

OT YACHT CLUB. See

est by W. Cook. Sails
dimensions are length
et 3 inches; depth of

aterboard sloop yacht
DETROIT YACHT CLUB.
inches load waterline.
h. See Fig. 519.

ie cat owned by E. D.
CLUB. She is 18 feet
neches depth of hold.

longing to A. Hansen
are: 18 feet 10 inches
h. See Fig. 523.



COMMODORE A. E. DOUGLASS,
ST. AUGUSTINE YACHT CLUB.

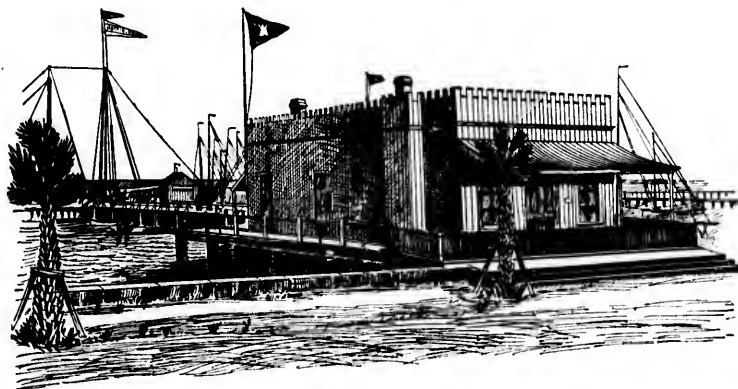

ST. AUGUSTINE YACHT CLUB HOUSE.

History of the St. Augustine Yacht Club.

ONE sunny January day in the year 1871, a few enthusiastic gentlemen who were making St. Augustine their winter home, gathered together in a little shanty on the old palmetto-post dock, which lies in front of the Spanish square. One seated on a soap box, another on a flour barrel, the early fathers of the club discussed the advisability of forming an association for the encouragement of sailing and out of door recreation.

From among these gentlemen, Lieut. R. F. Armstrong, one of the officers of the old Confederate cruiser ALABAMA, was elected Commodore. A small building on the same dock, nearer the shore, was at the time used as a store. The right to add to the east end of this building was secured, and for a year the Club House had a drug store on one end of it.

The whole building was finally obtained and somewhat remodeled, in which shape it has remained to this day.

On March 21, 1874, a meeting was held to perfect the organization. General Gordon Grainger was elected Commodore; Daniel Edgar, Vice-Commodore; R. F. Armstrong, Secretary and Treasurer; and Chas. C. Crary, Measurer.

At this meeting a committee was appointed to frame a Constitution.

On the 24th of March, 1874, the Constitution was adopted and it stated that "the objects of this club shall be the improvement of yacht building, and the encouragement of yacht sailing." The membership of the club increased steadily.

On February 25, 1875, a most important regatta took place, participated in by twelve sloops and nine cat-boats. This was followed by a cruise to Matanzas, which added much to the enthusiasm of the members. On the 15th day of February, 1877, a charter was granted

on which appear the names of R. C. Armstrong, Oliver Bronson, Charles C. Creary, Daniel Edgar, Newbold Edgar, John Low, S. S. Martan, A. E. Douglass and J. H. Janeway.

From time time there have been suggestions made to move into larger quarters, but the unanimous feeling has always been that as many members were obliged to remain North, it would be a great mistake to desert the delightful and cosy quarters over the water. Financially the club has always been on the best footing, being kept free from debt and holding a steady membership of the best known yachtsmen in the United States.

The officers for 1893 were as follows: Commodore, Andrew E. Douglass; Vice-Commodore, Hugh L. Willoughby; Secretary and Treasurer, W. S. Hall; Measurer, R. V. R. Stuyvesant; Fleet Surgeon, Andrew Anderson.

Trustees: Andrew E. Douglass, H. B. Ammidown, James M. Davis.

House and Executive Committee: W. G. Hall, H. P. Ammidown, W. W. Dewhurst.

Regatta Committee: Fairman Rogers, Daniel Edgar, Henry Belknap.

The club has a membership of seventy-six regular members, besides a large season membership.

The initiation fee is \$50; annual dues \$15; annual dues when absent for season \$5. Any person not a minor, introduced by a regular member of the club, seconded by another regular member shall, at the discretion of the House Committee, be entitled to all the privileges of the club except voting, etc.

Privileged members are required to pay \$5 for ten days, \$15 for thirty days, or \$30 for the season.

LIST OF YACHTS ENROLLED IN THE ST. AUGUSTINE YACHT CLUB.

NAME.	OWNER.	C. R. OR KEEL.	RIG.	LENGTH OVER ALL.	L. W. L.	BEAM.	DRAFT.
				ft. in.	ft. in.	ft. in.	ft. in.
Adelante	Henry M. Flagler	Stemmer	43 00	10 00	8 00	2 06
Ahela	Henry M. Flagler	"	183 00	100 00	24 00	10 08
Agnes	J. Norton Winslow	e b	Schooner	67 05	31 11	10 00	5 10
Aztec	D. A. Lorinz	k	Stemmer	78 00	60 00	14 02	4 06
Ballymena	Alexander Brown	"	148 00	132 00	18 00	7 06
Bertha	Henry Belknap	Naphtha	40 00	18 00	9 03	3 03
Cygnat	Daniel Edgar	e b	Sloop	38 00	31 00	11 01½	5 16
Dauntless	C. H. Colt	k	Schooner	123 10	116 07	26 07	12 00
Edith M.	John W. Masury	Stoop	37 00	12 05	3 03
Evaleen	John Gilsey	Cat	23 07	23 01	10 05	2 00
Favorita	C. W. Stachella	k	Naphtha	25 00	5 04	3 00
Fortuna	Henry S. Hovey	k	Schooner	100 04	96 05	22 00	12 00
Helen	Naphtha	25 00
Hesperus	John W. Masury	e b	Schooner	50 00	54 00	15 00	2 00
Jean	James Henwick	Steer-ace	109 00	85 00	17 00	7 00
Katydid	H. L. Willoughby	"	27 00	28 00	6 00	3 00
Magnolia	Fairman Rogers	"	99 00	96 00	17 06	4 06
Marion	Daniel Cox	Yawl	30 00	20 13	8 00	2 07
Maud H.	John M. Pendleton	e b	Cat	17 00	17 00	6 00	2 06
Oriole	Thos. B. Asten	ketch	Schooner	54 00	43 00	16 00	3 00
Orizaba	D. P. Rumsey	Stemmer	104 00	94 00	14 04	6 04
Reya	Pierre Lorillard	"	116 00	135 00	20 00	4 00
Susie	H. L. Willoughby	Cat	17 00	17 10	7 00	2 00
Wampamour	Hugh L. Willoughby	Stemmer	67 00	59 00	12 00	5 00
Wanda	James Stillman	"	147 00	129 00	18 00	10 00
Wandle	"	55 00	50 00	8 00	3 03

ACCORDING TO THE SAILING REGULATIONS.

In each season, if so voted by the club, there shall be one or more regattas and races given by the club.

The yachting season for all matches and races shall be limited to the period between the first of January and the first of May of every year.

In all matches of the club there shall be no restrictions as to character or quantity of sails.

There shall be in a race at least two contesting yachts of separate and distinct ownership.

Each yacht must bring back the same persons with which it started. No other means of propulsion than sails shall be allowed, and no oars or sweeps are to be allowed under any circumstances.

The rules for measurement of yachts of this club shall be as follows,

viz.: Add the extreme length over all and the length on the keel together and divide the sum so obtained by two.

For open yachts the allowance shall be one minute to the foot, for each foot of difference of the mean length, for a course of ten miles.

RACING SEASON OF 1893.

The First Race of the ST. AUGUSTINE YACHT CLUB for the year 1893 was sailed on March 16th. The winners were as follows:

SLOOPS.	Time.
	H. M. S.
Frolic, 1st prize \$25	1 50 12
Manila, 2d prize \$10	1 53 02
Idlewilde, 3d prize \$5	1 53 03
CATS.	
Arrow, 1st prize \$25	1 51 58
Ada, 2d prize \$10	1 57 02
Seminole, third prize \$5	1 58 09

BIOGRAPHICAL SKETCHES AND DESCRIPTION OF YACHTS ENROLLED IN THE CLUB.

ANDREW ELLICOTT DOUGLASS, New York City, Commodore of the ST. AUGUSTINE YACHT CLUB; was born at West Point, N. Y., November 18, 1819, of Scotch ancestry. His parents were David Bates and Ann Eliza Douglass. From 1843 he was an officer and ultimately President of the Hazard Powder Co., but retired from all business in 1876. Has owned two yachts, both named SEMINOLE, and is a charter member of the ST. AUGUSTINE YACHT CLUB.



W. S. HALL.

W. S. HALL, Secretary of the ST. AUGUSTINE YACHT CLUB, is a lawyer and capitalist of Chicago, Ill. His father was Rev. R. V. Hall, for many years a well known clergyman in Vermont. Mr. W. S. Hall was born in the Province of Quebec, of American ancestry. He has always taken a great interest in athletic sports in the University of Vermont, and is well known in American and Canadian cricket circles as one of the best amateur cricketers of twenty-five years ago.

Has been interested in yachting for about twenty years, making his winter home in St. Augustine, Fla. He is a member of the Union Club of Chicago.



HUGH L. WILLOUGHBY.

HUGH L. WILLOUGHBY, Vice-Commodore of the ST. AUGUSTINE YACHT CLUB, lives in Newport, R. I. He was born in Delaware County, New York State, August 7, 1856. The son of General Augustus and Estelle Willoughby. On his mother's side he is descended from the Lansat family, Barons of France. He is the Lieutenant commanding the Naval Reserve Torpedo Company of Newport. Has owned several yachts—sloops STELLA, CYGNET, COQUETTE and WINDWARD, the yawl WINDWARD and the steamers MIDGE, KATYDID and his present yacht WAMPANOAG. The Commodore is a life member of the NEW YORK YACHT CLUB.

DEAM.	DRAFT.
ft. in.	ft. in.
8 00	2 06
24 00	10 08
10 00	5 10
14 02	4 06
18 00	7 06
9 03	3 03
11 01 1/2	5 10
20 07	12 06
12 05	3 04
10 05	2 00
5 04	3 00
22 00	12 00
.....
15 00	2 00
17 00	7 00
6 00	3 00
17 06	4 06
8 00	2 07
6 00	2 06
19 00	3 06
6 04	6 04
20 00	4 00
7 00	2 00
2 00	5 00
8 00	10 00
8 00	3 00



CORINTHIAN YACHT CLUB.
OF PHILADELPHIA.



CLINTON COUNTY, N. Y.

History of the Corinthian Yacht Club.

STATIONS— } PHILADELPHIA, PA.
 } DESSINGTON, DELAWARE CO., PA.

ON the 12th of January, 1892, a number of Philadelphia yachtsmen and clubmen met in the Bullitt Building to consider the advisability of forming a yacht club. Mr. John W. Brock was appointed temporary Chairman and Mr. A. F. Bancroft Secretary. The object of the meeting was fully stated by the Chair, and after a thorough discussion it was unanimously decided to organize a club at once, under the name of THE CORINTHIAN YACHT CLUB of Philadelphia, with the following members as founders:

Robert K. Neff, Charles H. Brock, W. Barklie Henry, John W. Brock, Horace F. Smith, Marcel A. Vite, George M. Freeman, Breton Pratt, Robert C. H. Brock, Addison F. Bancroft, William F. Parry, Edward R. Coleman, Henry L. Mills, Joseph T. Rothrock, M. D.; Henry McAllister, John S. Lloyd, Louis P. Evans, William S. Ketchley, Jr., Thomas D. Whitaker, Enoch S. Farson, Ogden D. Wilkinson, Clement B. Newbold, Anthony J. Drexel, Jr.; Charles Heebner, J. Howard Gibson, George A. Fletcher, Spencer Ervin, Alexander Van Rensselaer, W. Wilkins Curr and Frank H. Rosengarten.

Charles Heebner and A. F. Bancroft were appointed a committee to draft a Charter and By-Laws. It was also decided to lease a tract of ground of ten acres, with a large house, wharf and stable at Essington, Pa. The meeting adjourned to meet again on January 27th, at which time the organization was completed and these officers elected:

Commodore, Edward R. Coleman; Vice-Commodore, Ogden D. Wilkinson; Secretary, Addison F. Bancroft; Treasurer, Marcel A. Vite.

At a special meeting held February 25th, the Committee on By-Laws reported that the charter had been granted. By-Laws for the government of the club were submitted and adopted. The By-Laws provide for a Commodore, Vice-Commodore, Rear-Commodore, Secretary, Treasurer, Measurer, Fleet Captain, Fleet Surgeon, twelve Trustees in whose hands the control and management of the club shall be vested, a Race Committee, Committee on Admissions and a House Committee.

The membership to comprise resident and non-resident, as well as honorary members; resident members, exclusive of yacht owners, limited to 200. Non-resident members are those not residing within 50 miles of the City Hall, Philadelphia. Entrance fee \$25 and annual dues \$25 for resident members, and one-half these amounts for non-resident members. Five general meetings of the club to be held each year, the second Wednesday of January, February, April, May and December. Yachts to be enrolled must be owned wholly by a member or members of the club.

At this meeting it was decided that the club should build three boats for the 18-foot class, for the use of members and for the encouragement of sailing and racing in the smaller classes. Charles H. Brock and Alex. Van Rensselaer were appointed a committee, under whose supervision the boats were designed and constructed.

At the second general meeting held April 13th, racing rules as

formulated by the Race Committee were submitted and adopted. These include the "Seawanhaka Rule" of measurement and time allowance.

Yachts are classified by their racing length and divided into two classes of schooners, six classes of sloops, cutters and yawls and three classes of open yachts.

At a special meeting held April 30th, Commodore Edward R. Coleman tendered his resignation as Commodore, his yacht not being in commission during the season. Other vacancies were filled by election and appointment and the following list of officers and committees for the remainder of the year 1892 were announced:

Commodore, Ogden D. Wilkinson; Vice-Commodore, Molton H. Forrest, M. D.; Rear-Commodore, W. Barklie Henry, Secretary Addison F. Bancroft; Treasurer, Marcel A. Vite; Measurer, William N. Howell; Fleet Captain, Robert K. Neff; Fleet Surgeon, Archibald G. Thomson, M. D.

Trustees: Ogden D. Wilkinson, Molton H. Forrest, M. D.; John W. Brock, Robert K. Neff, Russell E. Tucker, George M. Freeman, Thomas D. Whitaker, J. Howard Gibson, William A. Parry, W. Barklie Henry, Alexander Van Rensselaer, Clement B. Newbold.

Race Committee: Addison F. Bancroft, George M. Freeman, William R. Ellison.

Committee on Admissions: Charles H. Brock, W. Barklie Henry, Robert K. Neff, George M. Freeman, Enoch S. Farson.

House Committee: Marcel A. Vite, William A. Parry, W. Barklie Henry.

The Club House was formally opened on April 30th, being modeled and refurnished. There was a large attendance of members and guests, and from that date to the closing of the season it was kept open and was liberally patronized by the members.

The yachting season was formally opened on May 28th with appropriate ceremonies. The yachts were anchored in two lines off the Club House and on signal from the flag ship the club burgee was hoisted on the grounds and saluted by each yacht in succession, the answering salute being from the Club House. The day concluded with a reception on board the flag ship SPERANZA, tendered by Commodore Wilkinson to members and guests. On the morning of the 29th, on signal from the flag ship, the yachts "dressed ship" and presented a very pretty nautical display. In the afternoon the fleet started on a cruise in squadron, returning to anchorage at sundown.

On the morning of the 30th, the schooners SPERANZA, TEFER and BYDA, the sloops NAUSNA, VENETIA and MERMAID, the yawl ALICE, and the steamers SILVA and LORETA, started on a cruise in Chesapeake Bay. The fleet made a fine run to Annapolis where they remained for two days, the Captains and guests being present by special invitation at the closing ceremonies of the United States Naval Academy.

From Annapolis the run was made to Baltimore where they were the guests of the BALTIMORE YACHT CLUB. Several of the yachts entered and sailed in the Annual Races of that club, NAUSNA winning first prize in her class.

The first Annual Race of the club was sailed on June 16th, and a series of races was sailed by the 18-footers during the season.

The First Annual Club Cruise was held in August, in Long Island Sound, the rendezvous being at Larchmont, N. Y., by invitation of the LARCHMONT YACHT CLUB. Runs were made to Oyster Bay, Shelter Island, New London and Newport. The fleet disbanded at New London, several of the yachts joining the cruise of the NEW YORK YACHT CLUB. The flag ship *SPERANZA*, later in the month, continued to the eastward, stopping at Gloucester, Marblehead and Bar Harbor.

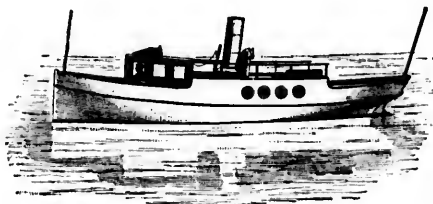

LINA.—FIGURE 526.

On November 1st the club leased rooms at 1,433 Chestnut street, Philadelphia, and during the Winter months entertainments of various kinds were given, consisting of lectures, talks on nautical subjects, exhibitions of photographs, monthly mess dinners, and lunches and dinners given by members.

The first annual meeting was held January 11, 1893. The reports of the officers and committees showed that the club was in a very prosperous condition, with a constantly increasing membership. The total membership was 114, the resident members numbering eighty-eight, with nineteen non-resident members, and seven honorary members. In the fleet there were seven schooners, nine sloops, eleven cutters, one yawl, five open yachts, ten steam yachts and three launches, a total of forty-six yachts.

The trustees were authorized to purchase property which had been leased by the club at Essington, Pa., and the officers elected for the year were as follows:—Commodore, Ogden D. Wilkinson, Vice-Commodore, Charles H. Brock; Rear-Commodore, William H. Parry; Secretary, A. F. Baneroft; Treasurer, Marcel A. Vite; Measurer, William N. Howell.

Trustees: Ogden D. Wilkinson, Molton H. Forrest, M. D., John W. Brock, Robert K. Neff, George M. Freeman, Edward H. Johnson, J. Howard Gibson, Russell E. Tucker, W. Barklie Henry, Alexander Van Rensselaer, Henry N. Almy, Louis P. Evans.

Race Committee: Addison F. Baneroft, George M. Freeman, William R. Ellison.

Committee on Admissions: Charles H. Brock, W. Barklie Henry, George M. Freeman, Henry E. Howell, Edward H. Tretter.

House Committee: Henry N. Almy, Edward H. Johnson, Henry S. Jeanes.

The first annual dinner of the club was given on the evening of January 12th at the Hotel Bellevue, a very large number of members being present.

The club property at Essington, Delaware Co., Pa., comprises ten acres of ground, a commodious house surrounded with spacious piazzas, a very substantial wharf and landing and a large stable. The house is admirably situated for a Club House, it being on a bluff directly on the shore, overlooking the entire harbor and commanding a magnificent view of the Islands and the New Jersey shore to the

southward, Chester and Wilmington Hills to the westward and a view of the Delaware river for nearly twenty miles.

The Club House, which is a large roomy building, contains dining-rooms, library, billiard room and a large general room on the first floor. On the second and third floors are the sleeping apartments. On the terrace, north of the Club House, are tennis courts and cricket and trap shooting grounds, while those who drive to the club will find ample accommodations for traps and teams in the stable, which has room for twelve horses in its stalls. A competent *chef* has charge of the club restaurant, quite a feature being made of lunches and dinners during the season.

Essington formerly known as the Lazaretto, is situated on Tinicum Island, ten miles from the City Hall, Philadelphia, and three miles from the city of Chester. The Delaware River, bordering on Essington, is divided by Maiden and Little Tinicum Islands, the main or

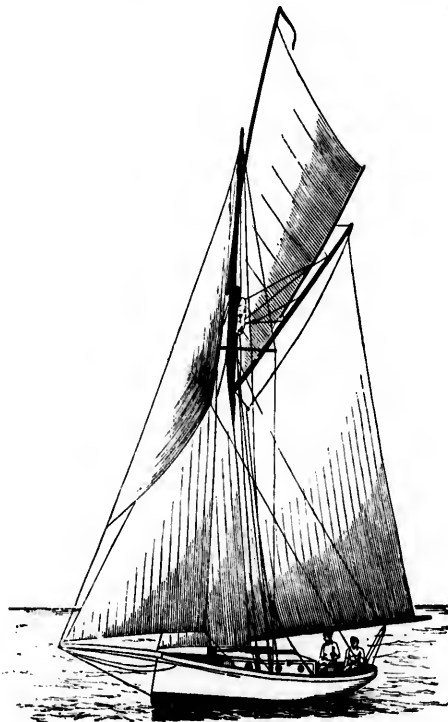

NARINA.—FIGURE 527.

ship channel being to the southward of these islands. From Maiden Island to Tinicum Island the U. S. Government has constructed a stone dyke, making the north or back channel for a distance of two miles in length and a half a mile in width, a commodious and safe harbor for vessels of any size.

The advantages of Essington as a harbor and an anchorage, its close proximity to Philadelphia and being accessible by train at convenient hours of the day and night, make it the most available place on the Delaware River for a yachting station.

LIST OF YACHTS ENROLLED IN THE CORINTHIAN YACHT CLUB, 1893.

SCHOONERS.

International Code Signal Letters.	YACHT.	OWNER.	PORT.	Tonnage.		Length over all.		Length L. W. L.	Extreme Beam.	Depth of Hull.	Draft.	C. B. or Keel.
				Gross.	Net.	ft. in.	ft. in.					
.....	Arethusa	F. de Funak	New York	17.32	16.45	49.07	44.05	15.00	5.00	6.00	e b	
KJNL	Flosse	Brevelon Pratt	Philadelphia	28.11	26.50	61.06	57.01	16.00	4.00	3.06	e b	
KQFW	Norma	Edward R. Coleman	"	89.47	85.00	105.00	95.02	21.08	10.08	12.00	k	
KJFH	Phantom	Henry S. Farnette	New Haven, Conn.	72.56	68.95	101.00	85.00	24.51	7.04	6.00	e b	
KLBP	Speranza	Ogden D. Wilkinson	Philadelphia	69.79	66.41	98.00	84.00	21.00	9.02	9.08	k	
KHJC	Telfer	William A. Parry	"	24.39	23.17	57.03	48.09	15.00	6.00	7.08	k	
.....	Vision	William G. Cook	New York	30.59	29.06	60.07	57.05	17.00	6.00	6.06	u b	

SLOOPS, CUTTERS AND YAWLS.

International Code Signal Letters.	YACHT.	OWNER.	PORT.	Tonnage.		Length over all.		Length L. W. L.	Extreme Beam.	Depth of Hull.	Draft.	C. B. or Keel.
				Gross.	Net.	ft. in.	ft. in.					
.....	Aene	Frank H. Rosenzarten	Jamestown, N. I.	7.02	6.67	30.00	26.00	12.00	4.03	e b	
.....	Alice	C. H. & R. C. H. Brock	Philadelphia	12.16	11.55	42.00	34.00	12.00	4.00	2.06	e b	
.....	Aurora	Herman A. Denekla	"	29.06	25.01	8.10	5.00	k	
.....	Curlew	Corinthian Yacht Club	"	29.04	17.08	6.04	4.06	4.04	k	
.....	Dawn*	J. Clement Uhler	"	23.00	19.06	9.00	3.00	2.06	u b	
.....	Ethel	James Bond	"	46.03 1/2	35.00	11.05	6.10	6.00	k	
.....	Ethelyn	William A. Parry	"	18.00	15.00	36.00	31.07	12.00	4.00	3.08	e b	
.....	Hebe	Edgar T. Scott	"	54.00	39.00	12.00	8.06	10.00	k	
.....	Iona	H. & A. G. Barrie	"	18.00	18.00	6.05	k	
.....	Iowa	Edward Samuel	"	17.00	16.15	48.00	33.00	14.00	7.00	4.00	e b	
.....	Irex	Henry S. Jencks	"	38.06	27.00	9.03	5.06	5.06	k	
.....	Killdee	W. Seymour Bank	"	34.00	28.00	12.00	5.00	4.06	e b	
.....	Lenni-Lenapl	Charles H. Brock	"	29.00	18.00	6.04	4.00	4.04	k	
.....	Marjorie	John S. Loyd	"	31.00	27.06	11.00	2.06	e b	
.....	Merrahl	Russell E. Tucker G. Herbert Millet	"	27.06	23.00	8.06	5.00	5.16	k	
.....	Nannie	Robert K. Neff	"	21.06	20.00	10.00	4.00	k	
.....	Narina	W. Barkle Henry	"	5.28	5.02	36.00	27.00	10.00	4.05	4.00	k	
KQSN	Narounya	Richard P. White	"	15.00	14.50	48.00	40.04	14.50	6.00	5.06	e b	
.....	Petrel	Corinthian Yacht Club	"	29.01	17.88	6.04	4.06	4.04	k	
.....	Pinta	Joseph Y. Jeanes	"	25.00	20.00	8.00	4.00	3.00	k	
.....	Rambler	Spencer Ervin	"	6.35	6.02	31.05	4.01	k	
.....	Rayen	William N. Howell	"	25.00	21.00	5.04	4.04	4.02	k	
.....	Roamer	Henry C. Boyer	"	22.06	18.00	6.02	5.04	4.04	k	
.....	Teal	Corinthian Yacht Club	"	29.01	17.08	6.04	4.06	4.04	k	
.....	Ventizia	Arthur Colburn	"	45.00	42.00	64.05	54.06	18.04	7.00	5.06	e b	
.....	Wasp	Edward R. Coleman	New York	26.01	24.73	72.00	45.05	13.00	11.00	10.08	k	

* Cat Yawl.

ward and a view
contains dining-
om on the first
ing apartments.
arts and cricket
o the club will
e stable, which
chef has charge
of lunches and

ted on Tincum
and three miles
ring on Easing-
ds, the main or

From Maiden
ructed a stone
of two miles
afe harbor for

anchorage, its
train at con-
available place

LIST OF YACHTS ENROLLED IN THE CORINTHIAN YACHT CLUB, 1893.

OPEN YACHTS.

YACHT.	OWNER.	PORT.	Length over all.		Extreme Beam.	Draft.	C. R. or Keel.	Rig.
			ft. in.	ft. in.				
Ahair	A. Lawrence Wetherill	Newport, R. I.	23 00	23 00	10 00	4 00	e b	Cat
Bridget	W. Wilkins Cur	Atlantic City, N. J.	19 00	e b	Cat
Blue Wing	Louis P. Evans	Philadelphia	16 00	12 00	3 00	3 00	fin k	Floop
Camilla	Hubert Brook	"	24 00	18 00	7 04	1 00	e b	Sloop
Coronet	H. Yale Dolan	"	26 00	26 00	10 11	1 11	e b	Cat
G. O. P.	E. S. Farson	"	16 00	16 00	e b	Sloop
Olyette	Charles Muenister	So. Sayville, N. J.	18 03	18 03	8 04	1 00	e b	Cat
Sand Fly	Robert H. Coleman	New York	16 00	16 00	7 0	1 00	e b	Cat
Scorpion	Victor J. Petry	Philadelphia	10 00	e b	Sloop
Skipper	James R. Hopkins	Newport, R. I.	18 05	18 02½	8 08	1 07	e b	Cat

STEAM YACHTS AND LAUNCHES.

International Code Signal Letters	YACHT.	OWNER.	PORT.	Tonnage.		Length over all.		Extreme Beam.	Depth of Hood.	Draft.
				Gross.	Net.	ft. in.	ft. in.			
.....	Aloha	Francis G. Stuart	Philadelphia	30 2	26 1	5 6
KJDS	Antia	William DuPont	New York	71.08	50.57	116 0	96 0	15 0	6 5	6 0
KLQX	Au Revoir	William Dupont	Wilmington, Del.	342.06	212.00	191 0	150 6	23 6	12 0	9 0
KFGM	Aycoed	A. J. Drexel	Philadelphia	129.65	66.23	138 1	100 0	18 0	10 5	9 0
KLQV	Beronda	Charles W. Bailey	"	17.01	9.47	53 5½	48 8	9 0	5 2	3 6
.....	Carolmita	H. Yale Dolan	"	50 0	45 0	9 0	3 6
.....	Lana	J. Howard Gibson	Moosehead Lake, Me.	33 0	29 0	7 6	3 6	2 6
KLRH	Loon	Robert M. Riddle	Philadelphia	18.29	9.14	62 0	57 0	9 1	5 2	3 9
.....	Loreta	Horace F. Smith	"	37 6	34 0	7 2	3 0	2 6
KDYB	Neutra	Samuel H. Austin, Jr.	"	141.30	78.97	130 0	115 0	20 0	9 0	7 3
KDSQ	Now Then	J. Edward Addecks	Boston	25.30	12.70	86 4	83 0	10 0	6 0	1 0
.....	Pickaninny	Robert M. Riddle	Philadelphia	7.82	3.91	40 0	35 6	7 5	1 5	1 0
KFDP	Sagamore	Edgar T. Scott	"	322.81	173.57	185 0	160 0	26 0	13 4	12 0
.....	Semmoie	Robert H. Coleman	Jacksonville, Fla.	44 0	40 0	7 5	2 5	3 0
SJLV	Siva	Milton H. Forrest, M. D.	Philadelphia	21.55	80 0	60 0	12 0	7 6	4 6
.....	Whiff	James R. Hopkins	"	7.00	4.00	41 3	37 0	8 0	4 0	3 2

ACCORDING TO THE RULES AND REGULATIONS.
CLASSIFICATION.

Yachts shall be divided into cabin and open classes. The cabin class shall be sub-divided according to their corrected lengths as follows:

SCHOONERS.

- Class 1.—All over 70 feet, corrected length.
- Class 2.—All over 70 feet and under, corrected length.

SLOOPS, CUTTERS AND YAWLS.

- Class 1.—All over 50 feet, corrected length.
- Class 2.—All over 40 feet and not over 50 feet, corrected length.
- Class 3.—All over 30 feet and not over 40 feet, corrected length.
- Class 4.—All over 25 feet and not over 30 feet, corrected length.
- Class 5.—All over 21 feet and not over 25 feet, corrected length.
- Class 6.—All of 21 feet and under corrected length.

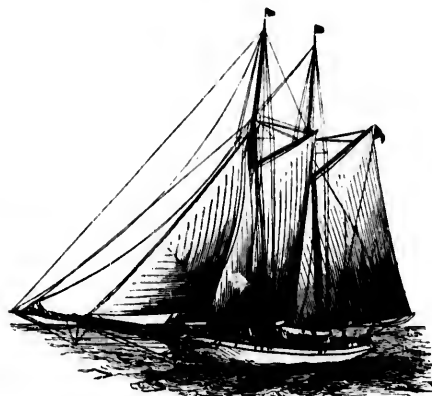

TELFER.—FIGURE 529.

Any yacht which shall have been launched prior to June 1, 1892, exceeding the higher limit in any class by not over the fraction of a foot, shall be included in that class.

Any yacht may enter a race in a higher class than that in which she belongs by assuming the minimum measurement of the class entered.

In mixed rig races, schooners shall be rated at 85 per cent. of their racing length, and yawls at 93 per cent. of their racing length.

OPEN YACHTS.

The open class shall be sub-divided as the Race Committee may direct for each race.

SYSTEM OF MEASUREMENT.

Cabin yachts shall be rated for time allowance according to the following measurement:

To the load waterline length add the square root of the sail area and divide the sum by two.

The open class shall be measured as the Race Committee may direct for each race.

The load waterline length shall be the distance in a straight line between the points furthest forward and furthest aft where the hull, exclusive of the rudder stock, is intersected by the surface of the water, when the yacht is afloat in racing trim, with all persons on board when the measurement is taken, amidships. The Measurer, at the time of taking his measurements, shall affix a distinctive mark at each point.

The sail area shall be ascertained by taking a perpendicular along the after side of the mainmast, from the under side of the gaff top-sail block or sheave on topmast to the upper side of boom when resting on the saddle, or on the lowest part of goose-neck the distance of which point from the main deck or house deck shall be recorded by the Measurer, together with other points used in measurement.

In all yachts, the forward point of measurement of the base-line shall be midway between the intersection of the bowsprit and jib topsail stay and the centre of the tack-tringle of the jib or flying jib, when set. In all cases where the length of the spinnaker boom exceeds the distance from the forward side of the forward mast to the forward point of measurement, such excess shall be added to the base line. The length to be measured for spinnaker boom shall be the extreme distance, when in use, of its outer end from the center of the foreside of the mast on which it is carried.

The after point of measurement shall be the end of the main boom in schooners, cutters and sloops, and of the mizzen boom in yawls. In all schooners, cutters and sloops the main topmast shall be measured from the hounds of the lower mast to the lower side of the top-sail halliard block or sheave, and 80 per cent of this length shall be taken from the extreme length of the main gaff measured from the inside of the jaws to the after end, the remainder being added to the base line as measured above.

The area from these figures is obtained by multiplying the corrected base by the perpendicular and dividing by two.

To the square root of the area, as ascertained, add the length, as ascertained, and divide the product by two; the result is the measurement for time allowance.

In boats which carry no headsail, the forward point of measurement for the base line shall be the after side of the mast, or of the foremast if there shall be more than one mast.

In vessels which carry no topmasts, the upper point of measurement for the perpendicular shall be the center of the eye in the upper peak halliard band. In such vessels, for the purpose of measuring the base line, the distance between the centre of the eye in the throat halliard band and that of the upper peak halliard band shall be used in the same way as is the length of the topmast where one is carried.

$$\frac{L. W. L. + \sqrt{\text{Sail area}}}{2} = \text{Racing Length.}$$

TIME ALLOWANCE.

Time shall be allowed for difference of measurement in cabin yachts according to the Time Allowance Table of the Club.

Time shall be allowed for difference of measurement in open yachts as the Race Committee may direct for each race.

CORINTHIAN RULES.

All yachts entered for a race for Corinthian prizes shall be steered by a member of this club, or by some other amateur.

No person who has ever sailed a yacht, or in a yacht, for hire, shall sail in any yacht under this rule.

This rule applies only to yachts of the 3d, 4th, 5th and 6th classes of sloops and cutters, and all classes of open yachts.

CREWS.

Yachts may carry as crews, in addition to the helmsman and club representative, one man for each five feet of length on deck or fraction thereof.

Rig
Cat
Cat
Sloop
Sloop
Cat
Sloop
Cat
Cat
Sloop
Cat
Draft
ft.
in.
5
0
5
2
...
6
2
0
0
3
12
5
4
6
3 2

Each yacht must bring back the same persons with which it started.

RULES AND MODELS.

The owner of every yacht winning a race shall, within ninety days after such race and before the prize shall be delivered, deposit with the Secretary a true model or a complete and accurate draught of her lines.

All drawings and models of yachts in possession of the club shall be kept for the use of members, and no copies or tracings shall be made unless by written permission of the owner of the yacht. The drawings and models shall be marked with the name of the yacht, the name of the club, date of survey and race.

SALES.

There shall be no restrictions as to sails.

DISTINGUISHING FLAGS.

Each yacht sailing in a race shall carry her owner's private signal at the main peak, which must not be hauled down unless she gives up

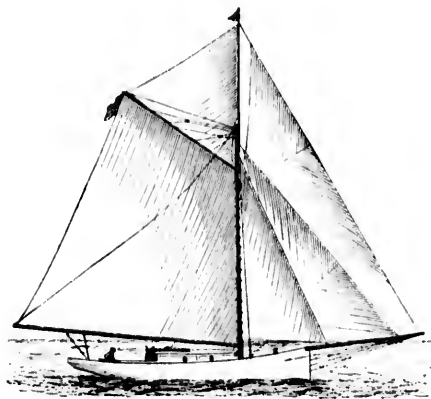

KILLDEE.—FIGURE 529.

the race. In case it is accidentally carried away, the flag must be re-hoisted in a conspicuous place as soon as possible.

OWNERSHIP.

Each yacht entered for a race, with its spars and sails, must be the *bona fide* property of the person or persons in whose name she is entered who must be a member or members of a recognized yacht club—and no member shall be interested in more than one yacht competing for the same prize.

TIME OF MAKING RACES.

There shall be no limit to the time in which races shall be sailed.

COURSES.

The course for the Annual Race of the club shall be one of the following courses, to be specified in the instructions.

FOR CABIN YACHTS.

Course No. 1.

From the starting line at Essington to and around Buoy 27, 1½ miles E. S. E. from New Castle, keeping it on the port hand, and return over the same course to point of starting, keeping to westward of Cherry Island Flats and Marcus Hook Bar, going and returning—30 miles.

Course No. 2.

From the same starting line to and around Buoy 28, off Edgnoor, keeping it on the port hand, and return over the same course to point of starting, keeping to westward of Marcus Hook Bar, going and returning—20 miles.

Course No. 3.

From the same starting line to and around a station boat off Marcus Hook, keeping it on the port hand, and return over the same course to point of starting—10 miles.

Course No. 4.

From the same starting line to and around the Red Spar Buoy No. 28, W. S. W. of Chester Island, passing it on the port hand, thence keeping to the southward and eastward of Chester Island to Black and Red Spar Buoy, West of Little Tinicum Island, passing on the starboard hand; thence to and across the finish line—6 miles.

Course No. 5.

From the starting line off the Club House to and around a stake boat anchored one mile east of the Club Pier, passing it on the port hand, thence to and around a stake boat off the Club Pier, keeping it on the starboard hand, thence over the same course and finishing between stake boat and Club Pier—4 miles.

Course No. 6.

From the starting line off the Club Pier to and around Black and Red Spar Buoy west of Little Tinicum Island, keeping it on the port hand, thence to and around Red Spar Buoy east of Chester Island, keeping it on the port hand, thence to and around Black and Red Spar Buoy west of Little Tinicum Island, keeping it on the starboard hand, thence to and around a stake boat off Quarantine Pier, keeping it on the port hand, thence to finish line off Club Pier—4 miles.

FOR OPEN YACHTS.

The course for open yachts shall be as the Race Committee may direct for each race.

STATION BOAT.

In the absence of the Race Committee's boat, a competent person appointed by the Race Committee, shall be at the finish line, to take the time and this time shall be considered final.

CLUB MEMBERS ON RACING YACHTS.

Each yacht shall have on board, during a race, a member of this club, or of the club from which she is entered.

Before the owner of a winning yacht shall receive the prize he, or, in his absence, the club member representing him on the yacht, must sign a certificate, stating that all the racing rules were complied with on such yacht during the race.

FITTINGS, BALLAST, ETC.

Yachts contending in a race shall keep their floors down and bulkheads standing.

No more than the usual anchors and chains shall be carried during a race, and these must not be used as shifting ballast or for altering the trim of the yacht.

No ballast shall be shipped or unshipped, and no water shall be started from or taken into the tanks, during the race or after nine o'clock, P. M. of the day previous to the race.

around Buoy 27, 13
the port hand, and
keeping to westward
going and returning

y 28, off Edgmoor
the same course to
Hook Bar, going

tion boat off Mar-
turn over the same

ed Spur Buoy No.
port hand, thence
Island to Black
passing on the
—4 miles.

around a stake
ing it on the por-
Pier, keeping it
and flushing be-

round Black and
ing it on the port
Chester Island,
Black and Red
on the starboard
ie Pier, keeping
r—4 miles.

Committee may

competent person
fish line, to take

member of this

prize he, or,
the yacht, must
were complied

wn and bulk-

carried during
r for altering

uter shall be
or after nine

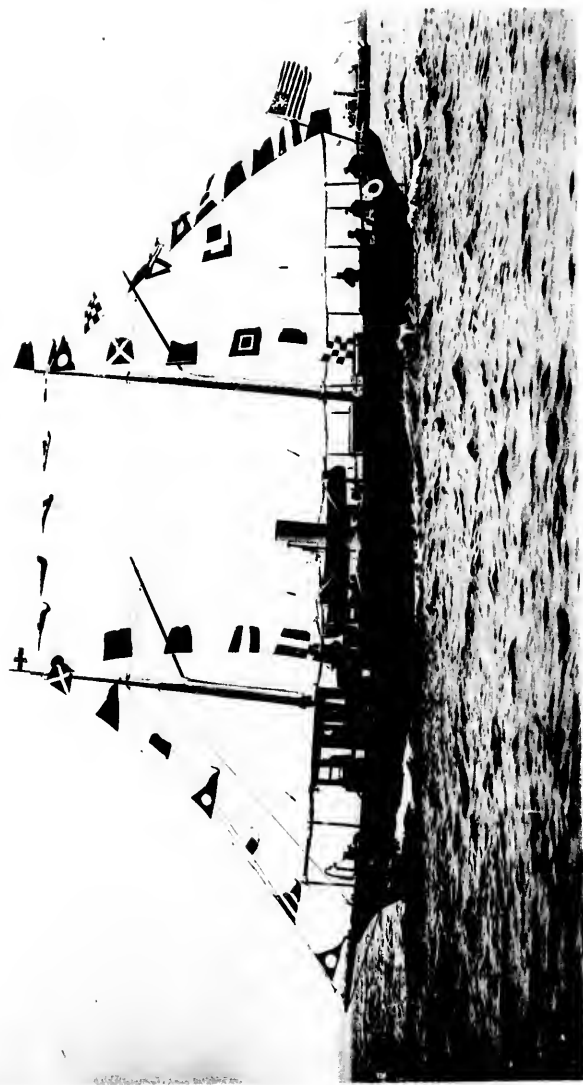

FROM A NEGATIVE BY BOLLES.

PLATE LXXVII.

LINTA.

THE YACHT RACE REGULATIONS

The first race shall be sailed by the ...
start on the ...
A vessel ... of loss and ...
considered ...

Article ...
A ...
start ...
out ...
of ...

Any ...
before ...

A yacht ...
may ...

No yacht ...
vessel or ...
purpose ...

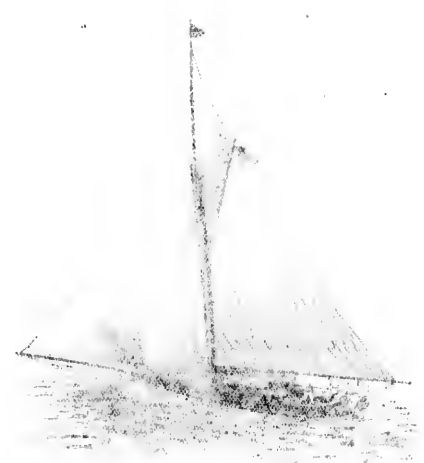

No ...
rule

All ...
The ...
marked ...
marked ...
may ...
the ...

A yacht ...
side of ...
keep ...

The ...
The ...
may ...
As ...

LINTA.

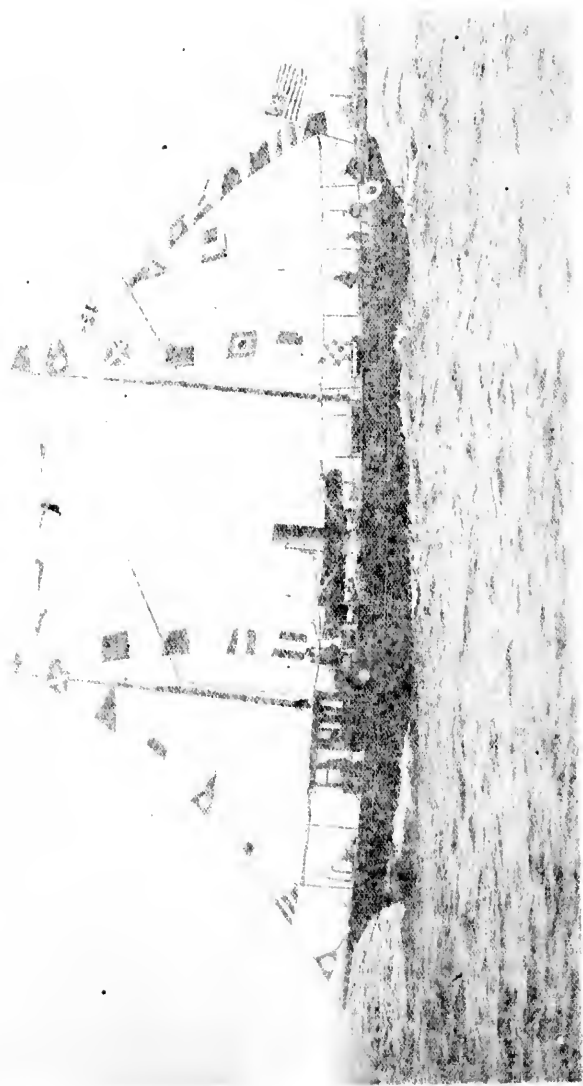

Trimming by dead weight shall be allowed up to the time of the starting signal but not during the race.
A race postponed or re-sailed shall, so far as regards this rule, be considered a new race.

RUNNING AGROUND, ETC.

A yacht running aground, or fouling a buoy, vessel or other obstruction, may use her own anchors, boats or warps, etc., to get off, but may not receive any assistance except from the crew of the vessel fouled.

Any anchor, boat or warp, so used must be taken on board again before continuing the race.

ANCHORING.

A yacht may anchor during a race, but must weigh her anchor again and not slip.

No yacht shall, during a race, make fast to any buoy, stage, pier, vessel or other object, or send an anchor out in a boat, except for the purposes described in the rules.

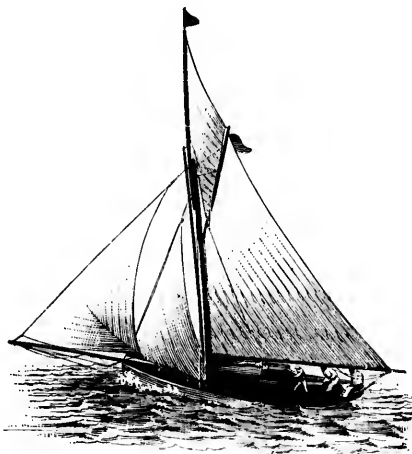

MERMAID - FIGURE 510.

PROPULSION

No means of propulsion, except sails, shall be employed during a race.

START AND FINISH.

All starts shall be flying

The time of the start and finish shall be taken when the point marked by the foremast in schooners, and the mainmast in single masted vessels and yawls, crosses the given line; but if this point in any yacht be across the line when the signal for the start is made she must return and re-cross the line.

A yacht so returning, or one working into position from the wrong side of the line, after the signal for the start has been made, must keep clear of and give way to all competing yachts.

TABLE OF TIME ALLOWANCE.

The allowances in this table are based upon the rule accepted by naval architects that, within economic limits, opportunities for speed vary in different vessels as the square roots of their respective lengths. As strong winds are required, however, to give to larger vessels the

full extent of their advantage in size, and as such a scale of allowance is not adapted to ordinary summer racing, 50 per cent. only of the allowance due to the rule is given in the table, and may be stated thus.

Time equals $5 \sqrt{\frac{3600 - 300}{L}} \sqrt{\frac{3600}{L}}$; 3600 representing the number of seconds in one hour, L the small yacht, and L the large one.

Practically the formula is $\sqrt{\frac{180}{L}} \sqrt{\frac{180}{L}}$ five-tenths of 3600 being 1800.

RECORD OF RACES.

The First Annual Race of the CORINTHIAN YACHT CLUB of Philadelphia was sailed June 26, 1892. The race was open to yachts of the ATLANTIC, BALTIMORE, CHESAPEAKE BAY, CORINTHIAN of New York, CORINTHIAN of Marblehead, EASTERN, LARCHMONT, MASSACHUSETTS, NEW YORK, NEW ROCHELLE, RIVERTON and SEAWANNAKA YACHT CLUBS. Twenty yachts entered and fourteen started, and of the latter only four completed the course, the others withdrawing. As the wind was very light, the committee signaled the first and second class schooners to sail the twenty mile instead of the thirty mile course.

At 11:11 o'clock the preparatory signal was given, and five minutes later the starting signal for first and second class schooners and sloops was given, and these being quite a distance from the starting line all were handicapped by five to ten minutes. At 11:26 the starting signal for the third class was given and at 11:31 for the sixth class. The 18 foot club boat CUREW was the only one of the starters to cross within the limit, all of the others were handicapped. CUREW finished at 5 hours, 41 minutes, 45 seconds; NARONYA in 6 hours, 51 minutes, 36 seconds; NARINA in 10 hours, 20 minutes, 41 seconds; the others withdrew. The corrected time cannot be given, as the yachts were not measured.

The tide at the start was on the ebb, the weather was cloudy and misty. The wind was very light, in fact, almost a calm prevailed what wind there was came from the south, which changed to southwest in the afternoon.

SCHOONERS.

	Start	Finished	Elapsed Time.
	H. M. S.	H. M. S.	H. M. S.
First Class.			
Speranza	11 21 00		withdrew
Second Class.			
Tedder	11 21 00		withdrew
Lydia	11 21 00		withdrew

SLOOPS.

First Class.			
Venizia	11 21 00		withdrew
Second Class.			
Naronya	11 21 00	6 51 36	7 30 36

SLOOPS, CUTTERS AND YAWLS.

Third Class.			
Rosalind	11 31 00		withdrew
Alice	11 31 00		withdrew
Narina	11 31 00	10 20 41	10 49 41
Mermaid	11 31 00		withdrew

SLOOPS.

Sixth Class.			
Roamer	11 30 00		withdrew
Teal	11 30 00	12 30 00	
Carlow	11 33 35	5 41 45	6 08 10

A series of races for 18-footers, load waterline, commenced August 6, 1892, the prize was a cup presented by ex-Commodore E. R. Cole-

man to the helmsman winning the greatest number of races. The course was 4 miles. The wind was south and light. The sea was smooth.

Name.	Start.	Finish.	Elapsed
	H. M. S.	H. M. S.	Time.
Teal	3 20 15	4 12 20	0 52 20
Curlew	3 21 15	4 10 30	0 50 30

CURLEW won by 10 seconds.



NAROUNYA.—FIGURE 531.

The Second Race took place September 24th. The wind was southwest and moderate at the start, very light at finish. Sea was smooth.

Teal	4 01 30	withdrew
Petrel	4 02 30	6 23 00 2 23 00
Curlew	4 03 00	6 21 30 2 21 30
Lenni-Lenapi	4 01 30	6 10 00 2 10 00
Blue-Wing	4 01 00	6 06 00 2 06 00

BLUE-WING was disqualified for fouling mark.

LENNI-LENAPI was pronounced the winner.

The Third Race took place October 1st. The wind was strong from the southwest and sea was lumpy.

Teal	4 05 00	4 53 30	0 48 30
Curlew	4 06 20	disabled	
Petrel	4 06 00	4 55 00	0 50 55
Lenni-Lenapi	4 05 30	4 51 30	0 46 30
G. O. P.	4 06 21	4 55 30	0 50 00
Blue-Wing		disabled	

LENNI-LENAPI won.

The Fourth Race was held October 8th. The wind was from the north and fresh. Sea was smooth.

Teal	4 01 00	5 01 25	1 00 25
Curlew	4 01 40	5 00 10	0 59 10
Petrel	4 04 12	5 06 05	1 05 05
Lenni-Lenapi	4 01 45	4 58 05	0 57 05
Blue-Wing	4 01 28	4 59 00	0 58 00
G. O. P.	4 01 30	4 54 40	0 53 40
Roumer	4 03 15	5 05 05	1 04 05

G. O. P. won.

Race Committee: A. F. Bancroft, Chairman; G. M. Freeman, W. R. Ellison.

THE SEASON OF 1893.

The Second Annual Regatta was held June 21st over an 8 mile course. The wind was from the southwest. The weather was clear.

CUTTERS.

Name.	Sailing	Elapsed	Corrected
	Length.	Time.	Time.
	Feet.	H. M. S.	H. M. S.
Second Class.			
Narounya	44.8	did not start	
Fourth Class.			
Narim	29.4	did not start	
Mermaid	26.8	did not start	

SLOOP.

Fifth Class.			
Pinta	24.2	2 30 34	
Sixth Class.			
Lenni-Lenapi	19.7	2 42 25	2 42 25
Teal	19.0	2 53 15	2 52 10
Curlew	19.0	2 44 14	2 43 15
Petrel	19.0	2 47 05	2 46 06
Iona	17.3	disabled	
G. O. P.	17.1	2 35 40	2 31 51

LENNI-LENAPI won.

A Special Handicap Race was sailed Saturday, June 24th, for yachts under 30 feet waterline length. The course was 8 miles. The wind from the south and the weather fair.

SLOOP.

Roumer	21.0	3 32 15	3 22 03
Lenni-Lenapi	18.7	3 15 00	3 01 40
Teal	18.0	3 37 00	3 22 36
Curlew	18.0	3 20 00	3 11 36
Petrel	18.0	3 31 00	3 16 36
Iona	16.4	3 10 40	3 02 34
G. O. P.	16.2	3 10 41	3 02 13

LENNI-LENAPI won.

A Handicap Race was sailed Saturday, August 26th, for yachts under 30 feet waterline length, and a Special Race for the Mosquito fleet of the RIVERTON YACHT CLUB. The course was 6 miles. Wind south southwest and weather clear.

CUTTERS.

Irex	not measured	1 51 20	
Mermaid	25.4	1 53 10	1 40 34

CAT-YAWLS.

Dawn	19.5	1 55 22	1 46 14
------	------	---------	---------

SLOOP.

Killdee	32.4	withdrew	
Pinta	23.4	1 54 32	1 48 57
Lenni-Lenapi	18.7	1 50 30	1 40 30
Iona	16.4	2 03 46	1 50 57
G. O. P.	16.2	2 01 11	1 48 05
Scorpion	not measured	2 18 15	
Blue Wing	not measured	did not finish	

DAWN won.

The Race of the Mosquito fleet, RIVERTON YACHT CLUB, was sailed over a 6 mile course. The following boats took part:

M. Freeman, W.

over an 8 mile
weather was clear.

Corrected
Time.
U.M.S.

not start

not start
not start

2 42 25
2 52 16
2 43 15
2 46 06
abled
2 31 51

24th, for yachts
les. The wind

3 22 03
3 01 40
3 22 36
3 11 36
3 16 36
3 02 34
3 02 13

24th, for yachts
the Mosquito
6 miles. Wind

1 40 34

1 46 14

1 48 57
1 40 39
1 50 57
1 48 05

ish

C. L. B. was
rt:



COMMODORE OGDEN D. WILKINSON,
CORINTHIAN YACHT CLUB (PHILADELPHIA).

LEO OF MUTTONS.

No.	Elap. Time.	
	U. S. M.	S.
No. 1.	not timed	
No. 2.	2 05 23	
No. 4.	not timed	
No. 5.	1 48 33	
No. 7.	not timed	
No. 10.	not timed	
No. 11.	not timed	
No. 12.	2 05 08	
No. 13.	2 02 10	
No. 15.	not timed	
No. 5 won.		

A Special Race for 18-footers took place Saturday, September 9, 1893. The prize was a silver cup presented by a member of the club. The course was 8 miles. The wind was west southwest and the weather fair.

	Sailing	Elapsed	Corrected
	Length.	Time.	Time.
		U. S. M.	U. S. M.
Lenni-Lenapi	19.7	2 11 06	2 11 06
Curlew	19.0	withdrew	
Ione	17.3	2 14 30	2 11 02
Scorpion	not measured	disabled	
Blue Wing	not measured	2 14 40	

BIOGRAPHICAL SKETCHES AND DESCRIPTION OF YACHTS ENROLLED IN THE CLUB.

OGDEN D. WILKINSON, Commodore of the CORINTHIAN YACHT CLUB (of Philadelphia), was born in Trenton, N. J., May 2, 1863. He is the son of Frederick R. and Harriet S. Wilkinson. Commodore Wilkinson is now living in Philadelphia, and is closely connected with the yachting interests of that section, as he has been for the past five years. He is the owner of the schooner SPERANZA and has also owned the schooner LYDIA. He was one of the founders of the club of which he is now the leading officer, which office he has held for two years. He has also been Vice-Commodore of the same organization. A member of the CORINTHIAN (of Philadelphia), NEW YORK and NEW HAVEN YACHT CLUBS.

SPERANZA.

SPERANZA is a keel schooner owned by Commodore Ogden D. Wilkinson of the CORINTHIAN YACHT CLUB (of Philadelphia). She was designed by J. E. Smith and built by J. P. Mumm, South Brooklyn, N. Y. She was launched in 1884, and has been owned by Commodore Wilkinson since November, 1891. She was lengthened in 1887 by David Carr, and overhauled in 1893 by Mills Camden. She hails from Philadelphia and sails with the CORINTHIAN (of Philadelphia), NEW YORK and NEW HAVEN YACHT CLUB. See plate LXX.

CODE SIGNAL LETTERS, K. L. B. P.

Official number, 116,016.

DIMENSIONS.

Length over all.	93 feet.	Length load waterline.	84 feet.
Depth.	9 feet 2 inches.	Draft.	9 feet 6 inches.
Beam.	21 feet 6 inches.		

Racing Record for 1892:—

CORINTHIAN (of Philadelphia) YACHT CLUB—SPERANZA won once (her only start) in the Annual Race sailed June 16th.



A. R. BANCROFT.

A. R. BANCROFT, Secretary of the CORINTHIAN YACHT CLUB (of Philadelphia). Mr. Bancroft is a charter member of the club of which he has the honor of being Secretary. He has always taken an active part in the affairs of the club, and fulfilled his duty as Secretary with efficiency. Mr. Bancroft has many friends in the club and out of it on account of his congenial nature.

FREDERICK DE FUNIAK, born 1840, in Rome, Italy. Member of the NEW YORK, ATLANTIC and CORINTHIAN



FREDERICK DE FUNIAK.

(of Philadelphia) YACHT CLUBS. Owner of the schooner yacht ARETHUSA for the past four years and recently purchased the schooner HER ROYAL HIGHNESS.

Was educated at the Military Academy, and served as engineering officer in the Army and Navy. Came to this country in 1862 as staff officer, served in the Confederate Army (western division) until the close of the War. Then on different Southern railways—was Gen'l Manager of the St. Louis, Nashville & Chattanooga Railway; also Gen'l Manager of the Louisville & Nashville Railroad and President of the Pensacola and Atlantic Railway; at present consulting engineer and railway expert. Member of the American Society of Civil Engineers and member of several scientific societies in Europe.

ARETHUSA.

The centerboard schooner yacht ARETHUSA belongs to Frederick de Funiak, having been owned by him since June, 1890. She was designed and built by Parker of Bucksport, Maine, and was launched in 1880. She was rebuilt in 1886 and again in 1892. Her original dimensions have never been changed. Has a large cabin and hails from New York City. ARETHUSA sails with the NEW YORK and CORINTHIAN (of Philadelphia) YACHT CLUBS. She has never raced, being a cruiser only. See plate LXXXI.

Official number, 105,921.

DIMENSIONS.

Length over all.	49 feet 7 inches.	Length load waterline.	44 feet 5 inches.
Depth.	5 feet 9 inches.	Draft, (with c. b. down 12 ft.).	6 feet.
Beam.	15 feet.		

Spars: Mainmasts, 32 and 34 feet; Topmasts, 16 and 18 feet.



J. HOWARD GIBSON.

J. HOWARD GIBSON, born in Philadelphia, Pa., where he now resides. The owner of the screw steamer LINA. Has been interested in yachting all his life. Is a member of the CORINTHIAN (of Philadelphia) YACHT CLUB.

LINA.

LINA is a screw steamer owned by J. Howard Gibson of Philadelphia, Pa. She was designed by Mr. Gibson and built by J. J. Becket of Camden, N. J. She was launched in 1889 and has always belonged to her present owner. She hails from Moosehead Lake, Maine. She

sails with the CORINTHIAN (of Philadelphia) YACHT CLUB. See Fig. 526.

DIMENSIONS.			
Length over all.	33 feet 6 inches.	Length load waterline.	29 feet.
Depth.	5 feet 6 inches.	Draft.	3 feet.
Beam.	7 feet.		

Engine: Vertical tandem compound, two cylinders, 4 and 7 x 6 inches. James H. Paine & Son, Boston, Mass.

Boiler: Vertical tubular, 3 ft. 1 in. in diameter, 4 feet high. Penobscot River Steam Boiler Works, Bangor, Maine, 1890.

Indicated horse power, about 18. Speed, between 10 and 11 miles per hour.

W. BARKLIE HENRY, railroad supplies, Philadelphia: was born in Philadelphia. Owns the yacht *NARINA*, and has been a yachtsman for many years, he says, "as long as I can remember." Mr. Henry was instrumental in the organization of the CORINTHIAN (of Philadelphia) YACHT CLUB, of which club he is still a member, as also of the RIVERTON YACHT CLUB.

NARINA.

The cutter *NARINA* is the property of W. Barklie Henry, Philadelphia, Pa. She was designed and built by Harry C. Ford, Bordentown, N. J., and launched in 1887. Was formerly known as *COURTESY* and was altered in 1892, being lengthened 8 feet on deck aft, giving her an overhanging stern. She has a cabin and hails from Philadelphia. See Fig. 527.

DIMENSIONS.			
Length over all.	35 feet.	Length load waterline.	27 feet.
Depth.	5 feet 6 inches.	Draft.	5 feet.
Beam.	8 feet 6 inches.		

Racing Record:—

1891—CORINTHIAN (of Philadelphia) YACHT CLUB—*NARINA* won the First Championship Race sailed June 6th. A winner in the Sixteenth Annual Regatta, with seven competitors.

RIVERTON YACHT CLUB—Was one of the winners in the Annual Fall Regatta.

1892—CORINTHIAN (of Philadelphia) YACHT CLUB—Won in the Annual Regatta of June 16th.

TELFER.

A keel schooner owned by William A. Parry of Philadelphia. Was designed and built by Pierce Bros., City Point, South Boston, Mass. Launched in 1866; rebuilt and lengthened in 1885 by Brown of Newark. *TELFER* was formerly known as *WIVERS*. Sails with the NEW YORK and CORINTHIAN (of Philadelphia) YACHT CLUBS. Hails from Philadelphia. See Fig. 528.

CODE SIGNAL LETTERS, K. H. J. C.
Official number, 80,087.

DIMENSIONS.			
Length over all.	57 feet 3 inches.	Length load waterline.	48 feet 9 inches.
Depth.	6 feet 9 inches.	Draft.	7 feet 8 inches.
Beam.	15 feet.		

W. N. SEYMOUR RUNK, wholesale grocer, Philadelphia, Pa. Born in Brooklyn, N. Y., March 13, 1867; descended from the Ten Broecks of Holland. The son of William Runk. Has owned the sloop *MARJORIE* and is at present the owner of the yacht *KILLDEE*. Has been interested in yachting for ten years, and is a member of the RIVERTON YACHT CLUB, and a charter member of the CORINTHIAN (of Philadelphia) YACHT CLUB.

KILLDEE.

A centerboard sloop, formerly *ELEANOR*. Launched in the Spring of 1887 for Geo. H. Neidlinger. Was designed and built by D. O.

Richmond, Mystic, Conn. In 1892 she was bought by W. N. Seymour Runk, her present owner. Her rig has been somewhat altered. She hails from Philadelphia and sails with the RIVERTON and CORINTHIAN (of Philadelphia) YACHT CLUBS. See Fig. 529.

DIMENSIONS.			
Length over all.	35 feet.	Length load waterline.	28 feet 6 inches.
Depth.	5 feet.	Draft.	4 feet 11 inches.
Beam.	11 feet 9 inches.		

Spars: Mast, 31 feet; Topmast 15 feet; Bowsprit, 15 feet; Boom, 30 feet; Gaff, 18 feet.

SAGAMORE.

A three masted topsail serow schooner owned by Edgar T. Scott of Philadelphia. Was designed by W. P. Puttee and was built by the New England Ship Building Company, Bath, Maine, being launched in 1888. She hails from Philadelphia, and sails with the CORINTHIAN (of Philadelphia) YACHT CLUB. See Plate LXXXIII.

CODE SIGNAL LETTERS, K. F. D. P.
Official number, 116,311.

DIMENSIONS.			
Length over all.	180 feet.	Length load waterline.	160 feet.
Depth.	11 feet 2 inches.	Draft.	12 feet.
Beam.	28 feet.		

Engine: Triple expansion, condensing vertical, 3 cylinders, 15, 24 and 37 x 30 inch.

Boiler: Two Scotch boilers built by the New England Ship Building Co.



R. E. TUCKER.

MERMAID.

A cutter yacht owned by R. E. Tucker, G. H. Millet and H. N. Almy of Philadelphia. She was designed and built by J. Borden Jr., Fall River, Mass., and was launched in 1886. She sails with the CORINTHIAN (of Philadelphia) YACHT CLUB. See Fig. 530.

DIMENSIONS.			
Length over all.	25 feet 6 inches.	Length load waterline.	22 feet.
Depth.	5 feet 6 inches.	Draft.	5 feet 6 inches.
Beam.	8 feet 9 inches.		

RICHARD P. WHITE, counsellor-at-law, Philadelphia, Pa., born at Londonderry, Ireland. His parents were Thomas White and Frances L. Mitchell. Mr. White owned *NEPENTHE*, and is now the owner of the sloop *NAROUNYA*. He has been a yachtsman for thirty years and belongs to the CORINTHIAN and PHILADELPHIA YACHT CLUBS. Mr. White has held, in a professional way, quite a number of positions of trust and responsibility. He has held the position of Attorney for the Committee of One Hundred, for the Committee of Municipality Reform, Pennsylvania Warehousing and Safe Deposit Co. and for the Guarantee Safety and Deposit Company.

NAROUNYA.

A centerboard cabin sloop built by J. J. Driscoll, Greenpoint, N. Y., and designed by A. Cary Smith. She was launched in 1882 for Fox Bros., Philadelphia. She has been the property of Richard P. White of Philadelphia for one year. She was formerly known as *KESTREL*. She has a cabin, hails from Philadelphia, and sails with the PHILADELPHIA and CORINTHIAN YACHT CLUBS. See Fig. 531.

CODE SIGNAL LETTERS, K. G. S. N.
Official number, 14,490.

DIMENSIONS.			
Length over all.	47 feet.	Length load waterline.	40 feet.
Depth.	5 feet 7 inches.	Draft.	6 feet.
Beam.	14 feet.		

ght by W. N. Sey-
somewhat altered.
ERTON and CURTIS
. 529.

28 feet 6 inches.
4 feet 11 inches.

it, 15 feet; Boom,

by Edgar T. Scott
and was built by
th, Maine, being
nd sails with the
Plate LXXIII.

100 feet.
12 feet

cylinders, 15, 24

land Ship Build-

by R. E. Tucker.
Almy of Phila-
ened and built by
r, Mass., and was
o sails with the
elphin) YACHT

inches.
27 feet.

lphin, Pa., was
were Thomas
NEPENTHE, and
een a yachtsman
PHILADELPHIA
nal way, quite a
le has held the
undred, for the
rchousing and
Deposit Com-

Greenpoint, N.
hed in 1882 for
of Richard P.
erly known as
and sails with
See Fig. 531

0 feet.
5 feet.



COMMODORE A. A. BROWN,
BALTIMORE YACHT CLUB.



BALTIMORE YACHT CLUB HOUSE

History of the Baltimore Yacht Club.

FOR some unknown reason Baltimore has never had a successful yacht club, although it was always admitted that its yachting facilities were unsurpassed. In January of 1890, Mr. George W. Coale, owner of the sloop yacht *LAGONDA*, called upon the resident yacht owners of Baltimore, consisting of Messrs. Alex. Brown, Edward L. Bartlett, S. C. Townsend, J. J. George, E. Bradley Jones and F. W. McAllister, and asked them to hold a meeting

of the finest pieces of property for a Yacht Club House in the United States was purchased at a cost of \$10,000.

In June, 1892, the First Regatta was held, being quite a success. Several boats which came over from the CORINTHIAN YACHT CLUB of Philadelphia greatly added to the interest of this occasion.

The membership of the club, which now numbers sixty, is rapidly increasing. At the annual meeting held March 28, 1893, the following gentlemen were elected to serve as Governors for the ensuing year:

Commodore, Alex. Brown; Vice-Commodore, Edward L. Bartlett;



IVANHOE.—FIGURE 532.

at the Merchants' Club. After the usual number of failures at getting all to agree upon a date for having such a meeting, February 6, 1890, was finally chosen, and it was agreed that it would greatly enhance the pleasure of yachting if a club was formed. A Committee was appointed to draft a Constitution and By-Laws, but it was not until the 6th of August, 1891, that the Committee made their report and the Constitution and By-Laws were accepted. The following were elected: Commodore, Alex. Brown; Vice-Commodore, E. L. Bartlett; Secretary and Treasurer, F. W. McAllister; Board of Governors, E. Bradley Jones, S. C. Townsend, Joseph J. George and George William Coale.

After this the membership increased very slowly principally owing to the fact that they had no Club House, and several committees were appointed to look after eligible sites. Finally, a suitable location was selected in Curtis Bay, and after eighteen months of hard work, one

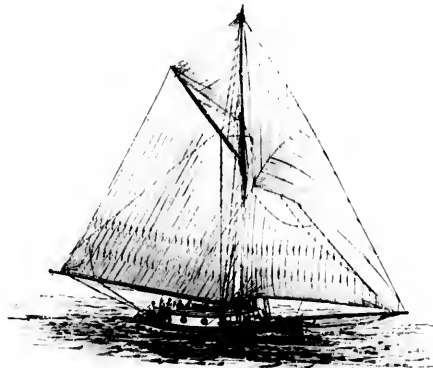

MASCOT.—FIGURE 533.

Secretary and Treasurer, F. W. McAllister; George F. Patterson, S. C. Townsend, James A. Smyser, David Murdoch.

House Committee: E. Bradley Jones; Chairman; James A. Smyser, S. C. Townsend, Walter Ancker.

Regatta Committee: George F. Patterson, Chairman; F. W. McAllister, Capt. John Thorpe.

ACCORDING TO THE RACING RULES.

For club races yachts shall be divided into classes as follows, but this classification shall not apply to races for any challenge cups held by or belonging to the club.

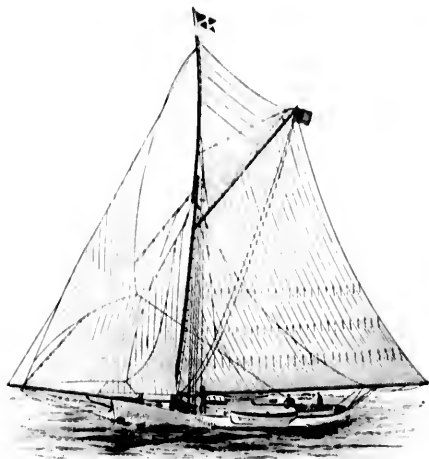

NEPENTHE.—FIGURE 534.

SCHOONERS.

- Class 1. All over 100 feet load waterline length.
 Class 2. All over 90 feet and not over 100 feet load waterline length.
 Class 3. All over 80 feet and not over 90 feet load waterline length.
 Class 4. All over 70 feet and not over 80 feet load waterline length.
 Class 5. All over 70 feet load waterline length and under.

SLOOPS, CUTTERS AND YAWLS.

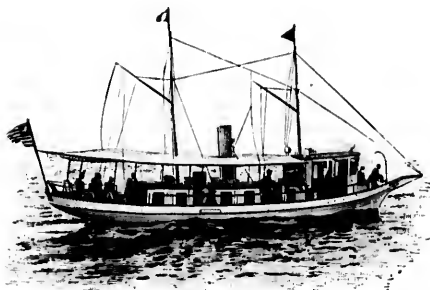

ELLA.—FIGURE 535.

- Class 1. All over 80 feet load waterline length.
 Class 2. All over 70 feet and not over 80 feet load waterline length.

Class 3. All over 61 feet and not over 70 feet load waterline length.

Class 4. All over 53 feet and not over 61 feet load waterline length.

Class 5. All over 46 feet and not over 53 feet load waterline length.

Class 6. All over 40 feet and not over 46 feet load waterline length.

Class 7. All over 40 feet load waterline length and under.

Any yacht which shall have been launched prior to the 20th day of June, 1888, exceeding the higher limit in any class by not over a fraction of a foot, shall be included in that class.

Yachts shall be rated for time allowance according to the rules of measurement of the club, and the time allowance must be calculated according to the table adopted by the club.

In races where different rigs sail together, schooners shall be rated for time allowance at 85 per cent. of their racing measurement, cutters at their actual racing measurement.

No member shall be interested in more than one yacht entered for a race in the same class.

Yachts in races may carry the following sails:

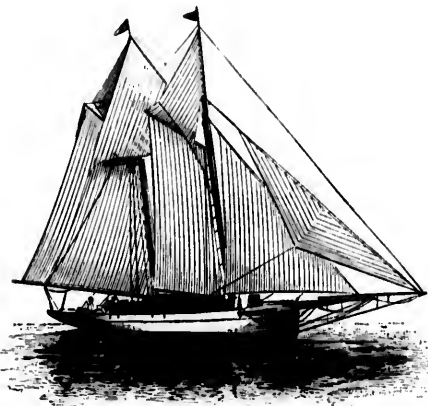

GAETINA.—FIGURE 536.

SCHOONERS.

Mainsail, foresail, forestaysail, jib, flying jib, jib-topsail, fore and main gaff topsail, main topmast staysail and spinnaker.

SLOOPS AND CUTTERS.

Mainsail, forestaysail, jib, flying jib, jib-topsail, gaff-topsail and spinnaker.

YAWLS.

Same as sloops and cutters, with mizzen and mizzen staysails.

Yachts may set light sails over working sails.

No means of propulsion other than sails shall be employed.

There shall be no limit to the time in which a race is to be sailed.

The First Championship Race of the BALTIMORE YACHT CLUB took place June 4, 1892. The start was made about 10 A. M., the course

THE YACHTS AND YACHTSMEN OF AMERICA

beginning from starting line to and around Seven Knoll Light, keeping it on the port hand, and return over same course to point of starting.



Ibis.—FIGURE 537.

keeping to the westward of Fort Carroll going and returning. The following summary shows the starters, and who won :

SCHOONERS.

Class 2.	
Leona, first	Capt. J. A. Smoyer
Ibis, second	Capt. S. C. Townsend
Taffer, third	Capt. W. A. Parry
Gaetna, did not finish	Capt. E. W. McAllister

SLOOP.

Class 2.	
Nepenthe, first	Capt. David Murdoch
Class 3.	
Lagonda, first	Capt. Geo. W. Gale
Alice, second	Capt. C. H. Brock
Class 4.	
Narna, first	Capt. Barklie Henry
Spectrum, did not finish	Capt. Roland

The Second Annual Regatta of the BALTIMORE YACHT CLUB was held on June 24th.

The following yachts participated :

	Start.	Finish
Albatross, schooner	4 38 8	4 58 8
Leona, schooner	2 10 45	4 58 18
Ibis, schooner	2 10 45	5 01 28
Lagonda, sloop	2 10 45	5 09 20
Flossie, schooner	2 10 45	5 10 55 1/2
Gaetna, schooner	2 10 45	5 12 27
	2 10 15	5 14 38

ALBATROSS won with LEONA second. NEPENTHE was ruled out by the judges for not rounding the buoy at the turn.

LIST OF YACHTS ENROLLED IN THE BALTIMORE YACHT CLUB.

SCHOONERS.

Racing No.	International Code Signal Letters.	NAME.	OWNER.	PORT.	Tonnage.		Length over all.		Length L. W. L.	Extreme Beam.	Depth of Hold.	Draft.	C. B. or Keel.
					Gross.	Net.	ft. in.	ft. in.					
3	Gaetina	F. W. McAllister	Baltimore	13.00	43 08	35 00	11 03	6 00	6 00	k	
4	Ihis	W. S. Townsend, S. C. Townsend	"	18.85	17.91	52 00	43 07	15 05	4 04	4 00	c b	
8	KDWR	Leona	James A. Smyser	"	20.82	19.78	50 10	46 01	15 04	4 08	4 05	c b	
....	Flossie	
....	Albatross	

SLOOPS, CUTTERS AND YAWLS.

Racing No.	International Code Signal Letters.	NAME.	OWNER.	PORT.	Tonnage.		Length over all.		Extreme Beam.	Depth of Hold.	Draft.	C. B. or Keel.
					Gross.	Net.	ft. in.	ft. in.				
....	Lagonda	Geo. W. Coale	Baltimore
5	KDHS	Serpente	J. J. George	"	18.00	17.90	48 00	15 00	5 04	5 04	c b	
....	Pirate
....	Mascotte	Isaac Francis	Baltimore

STEAMERS AND LAUNCHES.

Official No.	International Code Signal Letters.	NAME.	OWNER.	PORT.	Tonnage.		Length over all.		Length L. W. L.	Extreme Beam.	Depth of Hold.	Draft.	Dimensions of Engine.
					Gross.	Net.	ft. in.	ft. in.					
3,413	KLDS	Ballymena	Alexander Brown	Baltimore	145.05	72.53	148 00	124 00	18 00	11 05	7 00	Quad. Ex. 5 Cy. 1114. 16, 23, 22, 22 1/2 x 15	
120,405	KGJC	Cemfort	J. Bartlett	"	86.57	55.08	110 00	101 00	23 05	7 06	4 03	Screw Paddle.	
....	Ella	J. D. Mulford	"	81 00	49 06	11 06	3 08	3 06	Screw	
....	Ease	E. L. Bartlett	"	50 00	54 00	12 00	12 00	Paddle	
....	Ivanhoe	Edward Boose	"	57 00	52 00	10 06	4 09	3 06	Screw	

Depth of
 Hood.
 . In. ft. In.
 30 6 00 k
 74 4 00 e b
 8 4 05 e b

Draft.
 ft. in.

 5 04 e b

Dimensions of
 Engine.

Ex. 5 Cy. 1134.
 21 1/2, 22 1/2, 23 1/2 x 15
 Paddle.

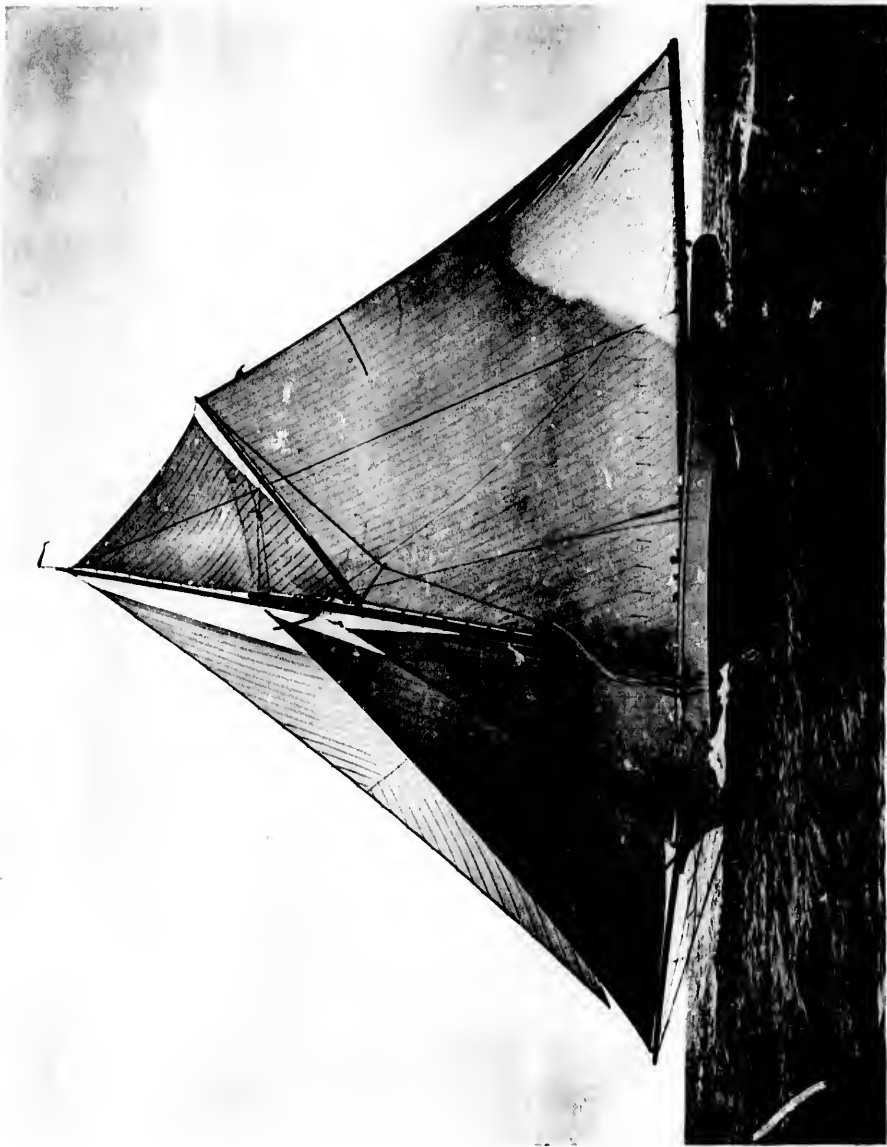

FROM A NEGATIVE BY CHILD

PLATE LXVIII

MINEOLA.

MINEOLA.

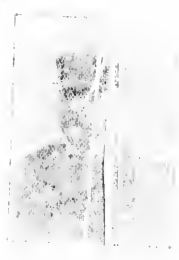

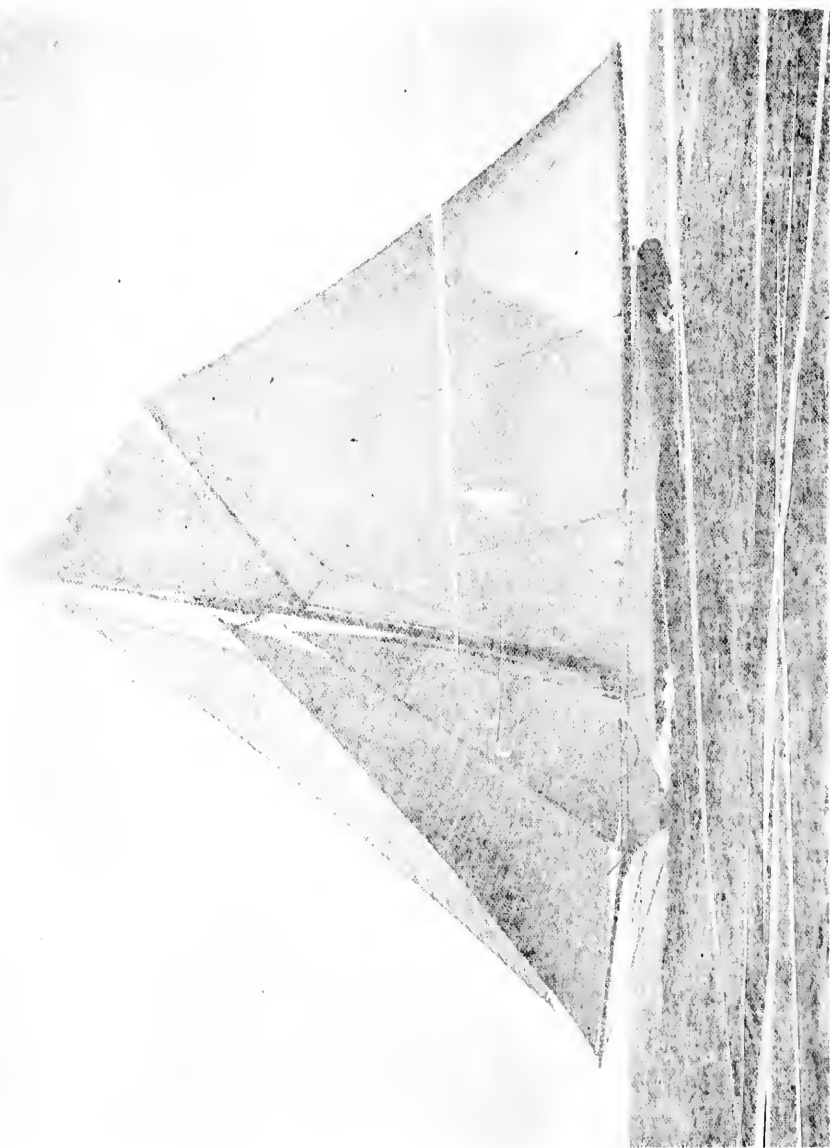

BIOGRAPHICAL SKETCHES AND DESCRIPTION OF YACHTS ENROLLED IN THE CLUB.

ALEXANDER BROWN, Commodore of the BALTIMORE YACHT CLUB, a native Baltimorean, born October 25, 1858. One of the incorporators of the BALTIMORE YACHT CLUB, organized 1891. Also a member of the NEW YORK and ST. AUGUSTINE YACHT CLUBS. Has been the owner of the steel schooner BALLYMENA until quite recently. Interested in yachting since 1886.

Commodore Brown is the head of the famous banking house of Alex. Brown & Sons, established 1811. He graduated from Princeton in '78, and then secured a position in this house. He was admitted into the firm in 1882 and became the head member of the house in 1890, on the death of his father. Still a young man, he carried on the business with the skill and unerring judgment of an experienced financier. The Commodore holds many positions of trust and responsibility, among them that of President of the Norfolk National Bank, the Annapolis, Washington & Baltimore Railroad Co., the Baltimore Trust & Guarantee Co., and of the Debardeleben Coal & Iron Co.; Treasurer of the Reform League; member of the Corn and Flour Exchange and of the Stock Exchange; Brigadier-General on the Governor's Staff, etc.

BALLYMENA.

A screw schooner built of steel until recently belonging to Commodore Alex. Brown of the BALTIMORE YACHT CLUB. BALLYMENA was built by the Herreshoff Mfg Co. of Bristol, R. I. for Mr. George S. Brown. She was designed by N. G. Herreshoff and was launched in 1888. She hails from Baltimore, sailing with the NEW YORK, ST. AUGUSTINE and BALTIMORE YACHT CLUBS. See plate LXXXIII. BALLYMENA has been sold to J. N. Brown, Providence, R. I.

DIMENSIONS.

Length over all,	18 feet.	Length load waterline,	122 feet.
Depth,	11 feet 5 inches.	Draft,	7 feet 6 inches.
Beam,	18 feet.		

CODE SIGNAL LETTERS, K, L, D, S.

Engine: Quadruple expansion, five cylinders, 11 $\frac{1}{2}$, 16, 22 $\frac{1}{2}$, 22 $\frac{1}{2}$ and 22 $\frac{1}{2}$ x 15 inch. Built by the Herreshoff Mfg Co.

Boiler: Steel pipe, 1892. Built by Almy Water Tube Boiler Co., Providence R. I.



EDWARD L. BARTLETT.

EDWARD L. BARTLETT, engineer and manufacturer, Baltimore, Md., and Vice-Commodore of the BALTIMORE YACHT CLUB, was born in Baltimore, of English ancestry, the son of David L. and Sarah A. Bartlett. He is the owner of the yacht COMFORT and has been deeply interested in nautical affairs since boyhood. A member of the New York and Union League Clubs of New York, the Maryland Club and the Merchants' Athenaeum of Baltimore. One of the founders of the BALTIMORE YACHT CLUB and a founder and the first President of the Builders' Exchange of Baltimore.

COMFORT.

An iron paddle steamer belonging to E. L. Bartlett, O. L. Bartlett and J. Hayward, of Baltimore, Md. Designed by Frederick Mayer and built for her present owners in 1887. She is a keel steamer hailing from Baltimore and sailing with the BALTIMORE YACHT CLUB.

CODE SIGNAL LETTERS, K, G, J, C.

Official number, 126,465.

DIMENSIONS.

Length over all,	102 feet.	Length load waterline,	98 feet.
Depth,	6.7 feet.	Draft,	4 feet.
Beam,	23 feet (extreme).		

Engine: Two cylinders, 10 and 12 inch stroke of piston, 12 inch.
Boiler: One Scotch Boiler, (Bartlett, Hayward & Co.); 80 horse power. Speed, ten miles per hour.



EDWARD D. BOOZ.

EDWARD D. BOOZ, ship and yacht builder, Baltimore, Md. He was born in Baltimore, October 23, 1860, the son of Charles W. and Harriet Booz. Has taken an active part in yachting during the past seven years and has owned five steam yachts: NAL, MANSION, ALBERT, ROSEBELL and his present vessel the screw steamer IVANHOE. He recently built a new yacht which has not as yet been named. He is a member of the BALTIMORE YACHT CLUB.

IVANHOE.

IVANHOE, a screw steamer belonging to Edward D. Booz of Baltimore, was designed by him and built by Clas. W. Booz & Sons, and launched in May, 1891. She has two cabins and a large pilot house. Hails from Baltimore and sails with the BALTIMORE YACHT CLUB. See Fig. 532.

DIMENSIONS.

Length over all,	57 feet.	Length load waterline,	49 feet.
Depth,	3 feet 9 inches.	Draft,	11 feet 6 inches.
Beam,	10 feet 6 inches.		

Engine: Vertical condensing, 8 x 7 inch. New York Safety Steam Power Co.

Boiler: Roberts safety water tube, 4 x 5 feet.

She has an average speed of 11 miles and has made 13.

SEPESTHE.

SEPESTHE is a centerboard sloop, formerly called BUSBY. Was designed by J. B. Herreshoff and built by the Herreshoff Mfg Co., being launched in 1869. She is owned by Josiah J. George, Davies Murdock and E. Bradley Jones. Was rebuilt and lengthened in 1876 and again in 1891. She hails from Baltimore and sails with the BALTIMORE YACHT CLUB. See Fig. 534.

CODE SIGNAL LETTERS, K, D, H, S.

Official number, 130,318.

DIMENSIONS.

Length over all,	45 feet.	Length load waterline,	42 feet.
Depth,	5 feet 4 inches.	Draft,	5 feet 4 inches.
Beam,	15 feet.		



J. D. MALLORY.

J. D. MALLORY, merchant, Baltimore, Md. Is the Treasurer of the BALTIMORE YACHT CLUB and the owner of the yacht ELLA. Has been a yachtsman all his life and has owned the yachts: FLYING SCUD, MASCOTTE, ELECTRA, HIGHLAND and LYDIA. He was one of the charter members of the BALTIMORE YACHT CLUB and declares that he has owned the fastest sharpie that ever floated.

Mr. Mallory was born in Fair Haven, Conn., and is the son of Willard Mallory.

HISTORY OF THE BALTIMORE YACHT CLUB.

ELLA.

A screw steamer belonging to J. D. Mallory of the BALTIMORE YACHT CLUB. She hails from Baltimore and sails with the BALTIMORE YACHT CLUB. See Fig. 535.

DIMENSIONS.

Length over all,	41 feet,	Length load waterline,	49 feet 6 inches
Depth,	3 feet 8 inches,	Draft,	3 feet 6 inches.
Beam,	11 feet 6 inches		



FRANCIS W. McALLISTER.

FRANCIS W. McALLISTER, of Baltimore, Md. Born in Philadelphia, Pa., November, 1853. He is descended from Captain James Cook, and is the son of William Y. and Annie J. McAllister. Mr. McAllister is an optician. He is the owner of the yacht GAETINA and was formerly the owner of the yachts FROLIC and DELIAE. He has been a yachtsman for twenty years and was one of the organizers of the BALTIMORE YACHT CLUB, of which organization he is Secretary and Treasurer.

GAETINA.

A keel schooner designed by W. O'S. Dhapfel, and built by John Jewell. She was launched in 1883. Her stern was lengthened in 1886 and in 1887 she came into possession of her present owner, Mr. Francis McAllister of Baltimore, Md. She has a cabin, hails from Baltimore, and sails with the BALTIMORE YACHT CLUB. See Fig. 536.

DIMENSIONS.

Length over all,	43 feet 8 inches.	Length load waterline,	35 feet.
Depth,	6 feet.	Draft,	6 feet.
Beam,	11 feet 3 inches.		

GAETINA covered the distance (60 miles) between Oxford and Baltimore in 7½ hours.



CLINTON TOWNSEND.

WILLIAM S. and CLINTON TOWNSEND, manufacturers of hats, Baltimore, Md., were born in 1859 and 1861, respectively, in that city. They have been interested in yachting from twelve to fifteen years and were among the founders of the BALTIMORE YACHT CLUB. They are the owners of the centerboard schooner Ibis. Members of the BALTIMORE YACHT CLUB, and on the Board of Governors.

IBIS.

A centerboard schooner hailing from Baltimore, Md. She was launched in 1886 for R. B. Roosevelt and has for the last two and half years been the property of Messrs. W. S. and Clinton Townsend, of Baltimore. Ibis has never been altered and sails with the BALTIMORE YACHT CLUB. Designed and built by William R. H. Dodge, Bayport, L. I. See Fig. 537.

CODE SIGNAL LETTERS, K. D. H. C.

Official number, 100,469.

DIMENSIONS.

Length over all,	32 feet	Length load waterline,	43 feet 7 inches.
Depth,	4 feet 4 inches.	Draft,	4 feet 6 inches.
Beam,	16 feet 3 inches.		

ino, 35 feet.
6 feet.

xford and Bal-

TON TOWN-
rers of h's.
n in 1859 and
city. They
yachting from
ere among the
YACHT CL'n.
e centerboard
of the BALTI-
the Board of

Md. She was
last two and
linton Town-
sails with the
William R. H.

feet 7 inches.
feet 6 inches.



COMMODORE ISRAEL F. FISCHER.

CANARSIE YACHT CLUB.

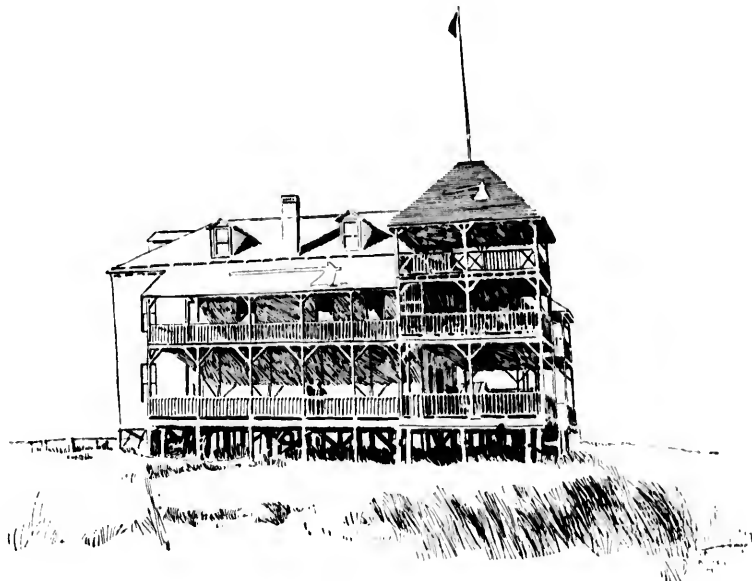

CANARSIE YACHT CLUB HOUSE.

History of the Canarsie Yacht Club.

IN the beginning of the year 1887, a few of the yachting enthusiasts of Jamaica Bay whose rendezvous was at Canarsie, held a consultation relative to the organization of a yacht club, the need of which they had long felt. Among these gentlemen were Edward F. Linton, Oliver E. Treadwell, John H. Ives, Dr. William A. DeLong, Daniel J. Brinsley and Ferdinand J. Kallenbach.

The result of this gathering was the formation of the CANARSIE YACHT CLUB. Oliver E. Treadwell was elected its first Commodore and the club began its career with fifteen members. At the end of the first year it had a membership of about twenty-five but had no settled plan as to a Club House.

In the next year, 1888, the Club had increased its membership to thirty-seven and Edward F. Linton was elected Commodore. In this year the club hired a house at the southwest corner of Canarsie Landing, erected for it by the Canarsie Railroad Company.

At the next annual election the Club had increased to forty-two members—1889—and Dr. William A. DeLong was chosen Commodore for the ensuing year. In 1890 the membership was fifty-four with Daniel J. Brinsley as Commodore.

The succeeding year—1891—saw the club entering on a new life. Israel F. Fischer was elected Commodore, and he has since been twice re-elected. In the Fall of 1891 the club purchased a plot of ground on Sands Bay Point, distant about a quarter of a mile easterly from Canarsie Landing. The plot is 75 feet front on the bay and 200 feet

deep. Shortly thereafter, by resolution of the club, and under the management of a Building Committee consisting of William H. Haulon, John H. Ives, Carl E. Henrichs, Frederick Sehnichtner and Daniel J. Brinsley, a large and commodious building was erected. In size this building is 50 feet front and 75 feet deep. In front of the house is a pier 100 feet in length, with bulkhead 50 feet wide, and here has been placed a very large floating stage. On the remaining 25 feet of frontage, a marine railway has been constructed for the hauling out of boats, and over the balance of the land not covered by the building, a strongly timbered platform has been erected for the storage of the smaller boats of the fleet.

The membership in March 1893, was 185, and propositions are very regularly offered, which from present indications, fairly promise a membership of 250 before the expiration of the present year. The initiation fee is \$15, the annual dues \$6 and the annual rent for a locker \$6. There is no charge for care-taking of boats, the employees of the club being required to give thorough attention to every boat belonging to members while at club's anchorage.

Two regattas have been held in each year in addition to the Annual Review which has been usually held on Decoration Day or the first Saturday in June.

In the Spring Regatta of 1892, which took place on the fourth Saturday in June, there were four classes for cat-boats, sloop owners failing to make up a race in their class. Twenty-two cabin and open cats took part in this race, which was over the club course, 10 miles

in length. In Class 1, ADELINE cabin cat won; in Class 2, SIREN, open cat won; Class 3, the open cat So So won, and in Class 4, the open cat GRACIE L. took the first place. SELFISH, open cat, won the Club Pennant for making the fastest actual time over the course, which was 1 hr., 42 min., 24 sec., for the 10 miles.

The Annual Regatta, 1892, of the club was sailed July 2d, over a 10 mile course on Jamaica Bay, in a strong southwest breeze. The times were:

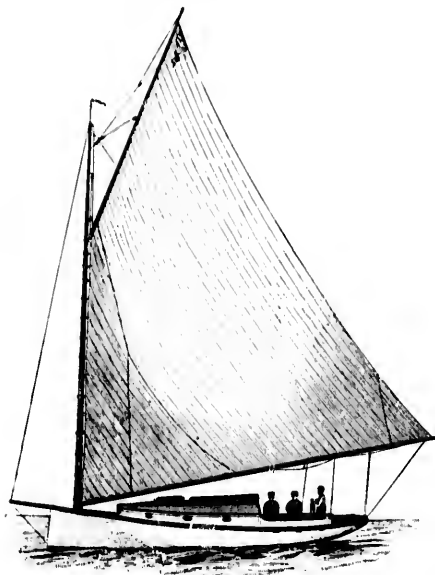

WELFARE.—FIGURE 539.

CABIN CAT-BOATS OVER 21 FEET.

Class A.	Elapsed	Corrected
	Time.	Time.
	H. M. S.	H. M. S.
Adeline	1 54 04	1 54 04
Loni	withdrew	
Gelert	withdrew	
Duchess	2 15 18	2 12 18

OPEN CAT-BOATS UNDER 21 FEET.

Class B.	Elapsed	Corrected
	Time.	Time.
	H. M. S.	H. M. S.
Steeple	withdrew	
Janet	1 55 18	1 55 18
Pilot	withdrew	
Selfish	1 52 24½	1 52 24½
Caddie	1 59 12	1 57 06½
Winnie	2 01 23	1 59 42½
Siren	1 54 46	1 52 03

OPEN CAT-BOATS UNDER 20 FEET.

Class C.	Elapsed	Corrected
	Time.	Time.
	H. M. S.	H. M. S.
So So	1 50 18	1 50 18
Spray	2 05 03	2 05 33½
Idol	withdrew	
Amaranth	2 00 46	1 59 08
Anita	2 01 28	1 59 35½
Lochluvar	2 05 20	2 02 19½
Flirt	2 03 02	2 02 05½

OPEN CAT-BOATS UNDER 18 FEET.

Class D.	Elapsed	Corrected
	Time.	Time.
	H. M. S.	H. M. S.
Wave	withdrew	
Teaser	withdrew	
Arno	2 08 12	2 06 50½
No Name	withdrew	
Gracie L.	2 06 37	2 06 37

The winners were ADELINE, SIREN, So So, and GRACIE L.; SELFISH winning the pennant for the best elapsed time.

The officers for the year 1893 were as follows:

Commodore, Israel F. Fischer; Vice-Commodore, Walter Smith; Secretary, John Taylor; Financial Secretary, Wm. J. Livingston, Jr.; Treasurer, Albert H. Aekerman; Measurer, Thomas O'Neil.

Board of Trustees: Daniel J. Brinsley; Chairman, William F. C. Nindeman, Eugene X. Karr, John McGiehan, Martin H. Duane.

House Committee: Dr. Wm. A. DeLong; Chairman, Frank V. McGiehan, Christian Kuehenbacher.

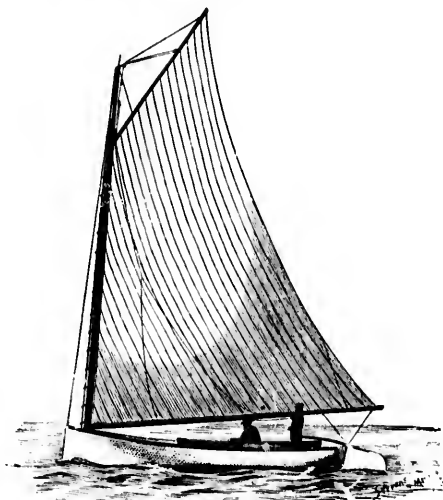

JANET.—FIGURE 539.

Membership Committee: Isaac Dredger, William H. Sampson, Chas. W. Simmons.

Regatta Committee: Walter Banta, Granville W. Harman, Phillip Bennett.

Delegates to the NEW YORK YACHT RACING ASSOCIATION:

Carl E. L. Henrichs, Frank L. Manchester, Adolph Wirsching, Fleet Captain, Edward N. Hussey.

LIST OF YACHTS ENROLLED IN THE CANARSIE YACHT CLUB.

SLOOPERS.					
NAME.	C. H. or Keel.	OWNER.	Length over all.	L. W. L.	Beam.
Rebecca M.	cb	E. W. Schermerhorn	11.00	0.00	11.00
Nomad	cb	Wm. A. Hale	23.00	00.00	16.00
			32.00	20.00	7.00

SLOOPS.					
NAME.	C. H. or Keel.	OWNER.	Length over all.	L. W. L.	Beam.
Orient	cb	Martin H. Duane	01.00	01.00	01.00
Sibud	cb	Emil Scheffern	18.00	38.00	15.00
Salle	cb	Jacob Frey	12.00	35.00	14.00
Isabel	cb	F. J. Kallendach	31.00	20.00	10.00
Alfred S.	cb	Geo. Schmutz	37.00	32.00	15.00
Pirate	cb	Harry D. Stillman	10.00	36.00	15.00
Muyonzenon	cb	Phillip Ketchum	35.00	30.00	14.00
			41.00

JIB AND MAINSAILS.					
NAME.	C. H. or Keel.	OWNER.	Length over all.	L. W. L.	Beam.
Duchess	cb	Albert H. Ackerman	11.00	11.00	11.00
Florence	cb	Henry Hanson	25.00	22.00	11.00
Steeple-Jack	cb	Chas. H. Kent	22.00	22.00	7.00
Secret	cb	Edward F. Linton	22.00	22.00	10.00
			24.00	24.00	9.00

CABIN CATS.					
NAME.	C. H. or Keel.	OWNER.	Length over all.	L. W. L.	Beam.
Wellare	cb	Israel F. Fischer	11.00	11.00	11.00
Lona	cb	John G. Darbert	20.00	25.00	12.00
Adeline	cb	Gilbert L. Johnstone	26.00	21.00	9.00
Dulkur	cb	Wm. F. C. Nindeman	27.00	27.00	10.00
Cicely	cb	Fredk. A. Heil	20.00	27.00	9.00
Pina	cb	Dr. T. H. Northridge	25.00	22.00	9.00
Iona	cb	S. G. D. Gourlay	27.00	21.00	10.00
			23.00	20.00	8.00

Corrected
Time
D. M. S.

1 50 18
2 05 15 1/2
rew
1 50 18
1 50 35 1/2
2 02 19 1/2
3 03 05 1/2

rew
rew
2 06 56 1/2
rew
2 06 37
ACIE L.; SEL-

Walter Smith;
Livingston,
O'Neil,
William F. C.
E. Duane,
n, Frank V.

Sampson,
an, Phillip

ON:
hing, Fleet

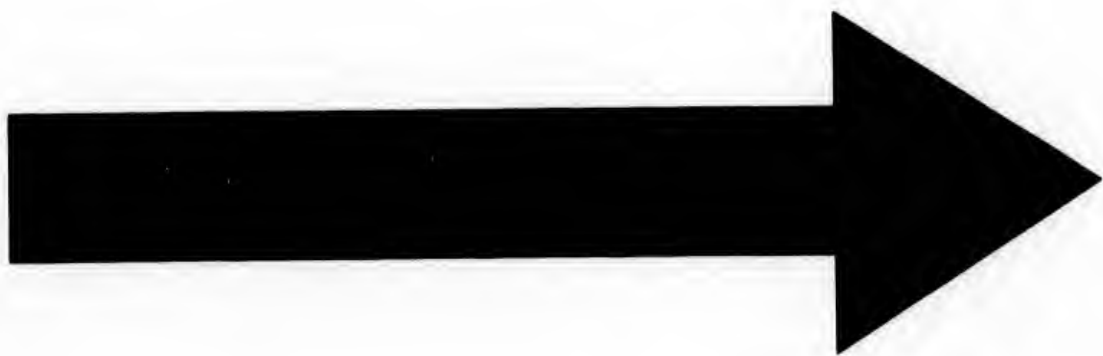

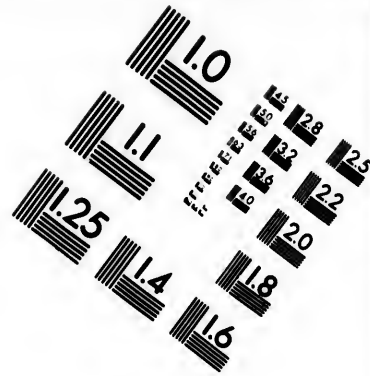
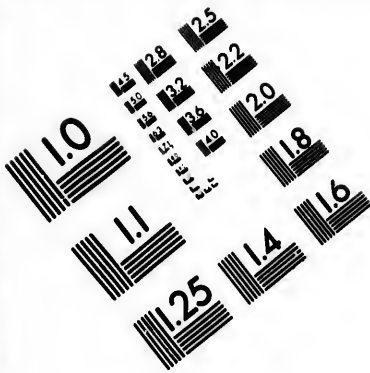

**IMAGE EVALUATION
TEST TARGET (MT-3)**

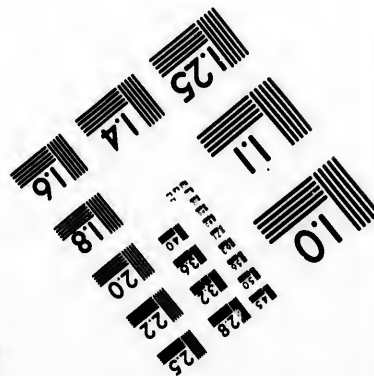
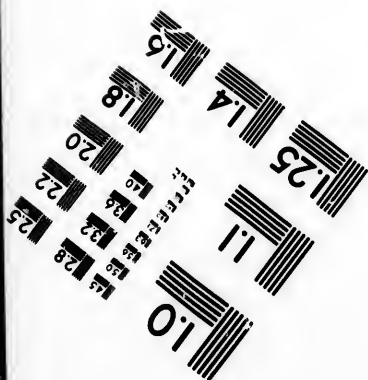
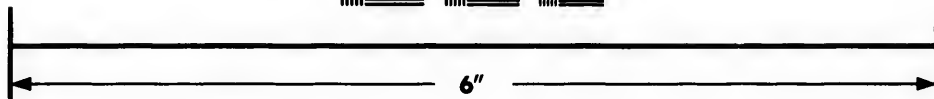
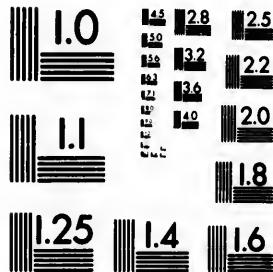

**Photographic
Sciences
Corporation**

23 WEST MAIN STREET
WEBSTER, N.Y. 14580
(716) 872-4503

0
16
18
20
22
25
28
32
36

10
12
15
20

LIST OF YACHTS ENROLLED IN THE CANARSIE YACHT CLUB.

OPEN CATS.

NAME	C. B. or Keel.	OWNER.	Length over all.		Beam.
			ft. in.	L. W. L. ft. in.	
So-So	e b	Daniel J. Hrustey	19 11 $\frac{1}{2}$	19 11 $\frac{1}{2}$	9 00
Winnie	e b	Joseph R. Clark	20 03 $\frac{1}{2}$	20 03 $\frac{1}{2}$	9 03
Jannet	e b	Dr. Wm. A. DeLong	22 03	22 03	9 10
Wave	e b	C. B. FitzMaurice	18 00	16 00	7 09
Teaser	e b	C. B. FitzMaurice	18 00	18 00	7 05
Nifti	e b	R. H. French	18 00	16 08	8 02
Unknown	e b	C. T. Hubbs	18 00	17 11 $\frac{1}{2}$	8 03
Sellish	e b	John H. Ives	21 11 $\frac{1}{2}$	21 11 $\frac{1}{2}$	10 01
Cuddle	e b	Eugen X. Karr	20 10	20 10	9 07
Amaranth	e b	Phillip Kelchum	18 03	18 03	8 03
Gracie L.	e b	F. L. Manchester	17 10	17 10	7 00 $\frac{1}{2}$
Siren	e b	F. V. McGeehan	20 03	20 03	9 04
Spray	e b	N. W. Curtis	18 00	18 00	8 10
Pilot I.	e b	Dr. T. W. Northridge	22 00	22 00	10 01
Bert	e b	Thos. O'Neil	16 00	16 00	7 00
Anita	e b	Dr. J. E. O'Donohue	17 11 $\frac{1}{2}$	17 11 $\frac{1}{2}$	8 03 $\frac{1}{2}$
Arno	e b	Walter Smith	10 04	16 04	6 00
Ideal	e b	Wm. H. Sampson	19 07	19 00	8 10
Alice	e b	Jere Smith	17 00	17 00	8 03
Lochlannar	e b	J. T. Sabia	18 03	18 03	8 02
Lorna Doone	e b	J. H. Truicy	20 00	20 00	9 03
H. H. Adams	e b	Frank Muler	21 10	21 10	10 02
Aurora	e b	A. Wisching	22 00	22 00	9 07
Gipsy Baron	e d	C. Warner	22 00	22 00	9 03
Flirt	e b	C. W. Simmons	18 00	18 00	8 01
Harry	e b	E. J. Gibbs	17 03	17 00	7 05
Bertha	e b	E. N. Hussey	18 00	18 00	8 03
Priscilla	e b	F. W. Stewart	19 08	19 03	8 11
Furman	e b	D. J. VanWicken	20 00	20 00	8 07
Crest	e b	Walter Smith	18 11 $\frac{1}{2}$	8 01

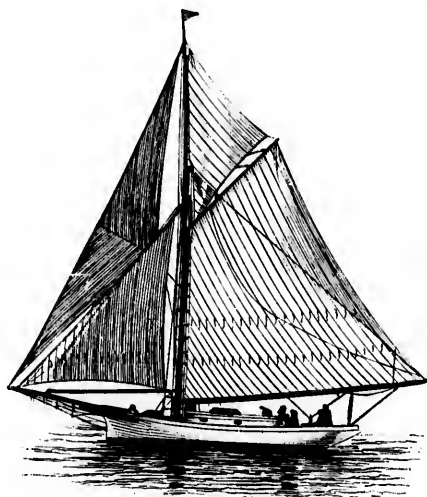

ISABEL—FIGURE 540

THE SEASON OF 1893.

The First Regatta of the season was held June 24, 1893, over an 11 mile course. The wind was from the north and the weather fair. The following yachts took part:

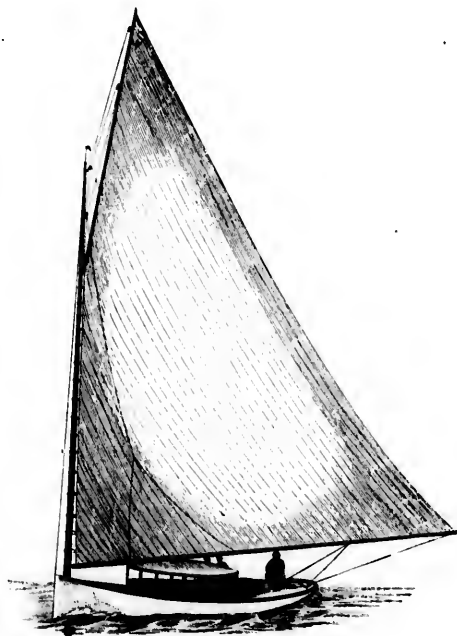

ATHALA.—FIGURE 511.

CABIN-CATS.

First Class.	Length. Ft. In.	Elapsed Time.	
		U. S.	U. S.
Welfare	27 06	2 40 05	2 10 33
Bulkur	28 00	2 36 20	2 07 18
Adeline	27 03	2 34 30	2 04 45
Lona	25 00	did not finish	
Louise	20 33	2 47 25	2 00 22
Athala	24 11	did not finish	



SIREN.—FIGURE 542.

JIB AND MAINSAUL.

Duchess	20 11	2 42 10	2 05 04
---------	-------	---------	---------

OPEN CATS.

Second Class.	Length.	Elapsed Time.	
Janet	22 01 $\frac{3}{4}$	2 48 30	2 13 01
Selfish	22 01 $\frac{5}{8}$	2 10 40	1 35 08
Caddie	21 00 $\frac{1}{4}$	2 39 55	2 02 56
Winnie	20 04	did not finish	
Siren	20 05	2 33 30	1 57 05
Harry Adams	21 01	2 41 08	2 07 16
Gypsy Baron	23 01	2 42 50	2 00 44

Beam.
ft. in.
9 00
9 03
9 10
7 09
7 05
8 02
8 13
10 04
9 07
8 03
7 00 $\frac{1}{4}$
9 04
8 10
10 01
7 00
8 03 $\frac{1}{4}$
6 00
8 10
6 03
8 02
9 03
10 02
9 07
9 03
8 01
7 05
8 03
8 11
8 07
....

HISTORY OF THE CANARSIE YACHT CLUB.

	Length, Ft. In.	Actual	Corrected
		Time, H. M. S.	Time, H. M. S.
Third Class.			
Wave	18 07	did not finish	
Spray	18 00	2 43 25	2 01 50
Ideal	19 03	2 33 35	1 53 52
Lochinvar	18 02½	2 38 55	1 55 37
Flirt	19 00	2 35 05	1 55 00
Fourth Class.			
Crest	16 10½	2 33 00	1 49 31
Tenser	16 02½	did not finish	
Niffi	17 03¼	did not finish	
Anita	17 11½	2 31 50	1 50 07
Martha	10 01½	did not finish	
Bert	15 00¾	did not finish	

ADELINE won in her class and DUCHESS was second.

SELFISH " " " SIREN " "
 IDEAL " " " FLIRT " "
 CREST " " " ANITA " "

The Second Regatta was held July 10th over a 10 mile course, the wind was from the west and the weather clear. The following yachts participated:

CABIN-CATS.			
	Length, Ft. In.	Elapsed	Corrected
		Time, H. M. S.	Time, H. M. S.
First Class.			
Adeline	27 03	1 50 15	1 20 30
OPEN CATS.			
Second Class.			
Caddie	21 00	1 50 32	1 13 33
Siren	20 05¼	1 54 40	1 17 01
Darry Adams	21 00	did not finish	
Third Class.			
Ideal	19 03	1 50 55	1 20 12
Flirt	19 00	1 52 00	1 19 04
Lochinvar	18 02	did not finish	
Meteor	19 02	did not finish	
Fourth Class.			
Crest	16 10	2 02 03	1 18 34
Anita	17 11	did not finish	

ADELINE had a walk-over.

CADDIE won in Class 2, with SIREN second.

FLIRT " " " 3, " IDEAL "

CREST " " " 4.

Corrected
Time,
H.M.S.

1 20 30

1 13 33

1 17 01

h

20 12

12 04

h

a

18 34

a



FROM A NEGATIVE BY CHILD

PLATE LXIX.

SATANELLA.
(Formerly Golden Fleece,)

1891

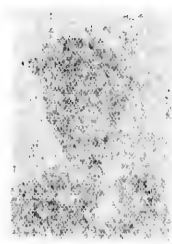

Wm. C. ...

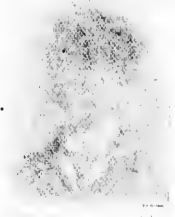

...

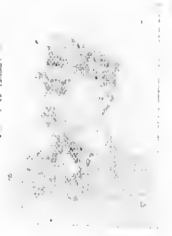

...



BIOGRAPHICAL SKETCHES AND DESCRIPTION OF YACHTS ENROLLED IN THE CLUB.

ISRAEL F. FISCHER, lawyer, Brooklyn, N. Y., Commodore of the CANARSIE YACHT CLUB, was born in New York City, August 17, 1858. He is the son of Isaac and Johanna Fischer. Has owned three yachts, GROWLER (jib and mainsail), SIREN (open cut) and his present yacht, the cabin cut WELFARE. Has been a yachtsman since 1887. His yacht WELFARE was designed by him. It was through the enterprise and indefatigable energy of the Commodore that the Canarsie Club House was constructed. Was a member of the Republican State Committee two years and was Chairman of Kings County Republican Executive Committee for two years also, though he resigned from this position before the opening of the last campaign. He was Chairman of the Campaign Committee of Kings County in 1889.

WELFARE.

A cabin cut-boat belongs to Commodore Israel F. Fischer of the CANARSIE YACHT CLUB who was her designer. She was built by Wallin & Gorman of South Brooklyn and was launched in 1893. She is a centerboard yacht hailing from Canarsie, L. I., and sailing with the CANARSIE YACHT CLUB. See Fig. 538.

DIMENSIONS.			
Length over all,	30 feet.	Length load waterline,	25 feet.
Depth,	4 feet 9 inches.	Draft,	2 feet.
Beam,	12 feet.		



WILLIAM A. DE LONG.

WILLIAM A. DE LONG, M. D., Brooklyn, N. Y., was born in New York City, the son of Joseph and Mary De Long. He is the owner of the yacht JANET, and has also in time past owned AMPHION, CARRIE, JEANETTE, LORLINE, SIREN, etc. Has been a yachtsman for fourteen years and was at one time Commodore of the CANARSIE YACHT CLUB, of which he is a charter member.

JANET.

A centerboard open cut-boat owned by William A. De Long of Brooklyn, N. Y. Was designed and built by Wallin & Gorman in 1891 for Dr. De Long. Hails from Canarsie and sails with the CANARSIE YACHT CLUB. See Fig. 539.

DIMENSIONS.			
Length over all,	22 feet 3 inches.	Length load waterline,	22 feet 3 inches.
Draft,	1 foot 10 inches.	Beam,	9 feet 6 inches.



EDWARD N. HUSSEY.

Spars: Mast, 35 feet; Boom, 27 feet; Gaff, 18 feet.

EDWARD N. HUSSEY, Fleet Captain of the CANARSIE YACHT CLUB. Mr. Hussey is thoroughly acquainted with the rules and regulations which govern yacht races, and on account of this knowledge and the enterprise he manifests in advancing the sport of yachting in the club, he was unanimously elected Fleet Captain. Capt. Hussey has numerous friends in and out of the club.

FERDINAND J. KALLENBACH, lithographer, Brooklyn, N. Y. Was born in Philadelphia, July 12, 1852, the son of Ferdinand and Susan Kallenbach. His present yacht is the sloop ISABELLE and he was formerly the owner of PILOT and ERIEL. A yachtsman for ten years and one of the charter members of the CANARSIE YACHT CLUB, of which organization he was Vice-Commodore for one year, and one year Chairman of the Regatta Committee.

ISABEL.

ISABEL, formerly CRICKET, is a centerboard sloop. Was designed and built by J. Lennox of South Brooklyn for George Mallory. Sold by him four years ago to her present owner, Ferdinand J. Kallenbach of Brooklyn. Launched in 1879. She is a cabin craft, hailing from New York City and sailing with the CANARSIE YACHT CLUB. See Fig. 540.

Official number, 100,333.

DIMENSIONS.			
Length over all,	32 feet.	Length load waterline,	31 feet 6 inches.
Depth,	4 feet 3 inches.	Draft,	3 feet 9 inches.
Beam,	14 feet.		



W. M. J. LIVINGSTON, JR., Financial Secretary of the CANARSIE YACHT CLUB. Mr. Livingston is a lover of the sport of yachting and enters into the sport with a true yachtsman's spirit. Owing to his thorough business methods he was selected as Financial Secretary, a trust which he has discharged with credit to himself.

SIREN.

The centerboard open cut SIREN belongs to Frank V. McCrechan of Brooklyn, N. Y. She was designed and built by Wallin & Gorman of South Brooklyn, and was launched in May, 1889. She sails with the CANARSIE YACHT CLUB. See Fig. 542.

DIMENSIONS.			
Length over all,	20 feet 6 inches.	Length load waterline,	20 feet 3 inches.
Draft,	1 foot 8 inches.	Beam,	9 feet 4 inches.



WALTER SMITH.

WALTER SMITH, Vice-Commodore of the CANARSIE YACHT CLUB, is a resident of Brooklyn, N. Y., where he was born in the year 1855. He is the son of Norman Smith and is in the insurance business.

Is at present the owner of the yacht ARNO and the yacht CREST which is building. He has taken an active interest in yachting for twenty years and takes great interest in athletics, especially aquatic. Is a member of the CANARSIE and WINDWARD YACHT CLUB and the SEAWANAKA BOAT CLUB. Was connected with the founding of the WINDWARD YACHT CLUB.

ARNO.

ARNO is a centerboard open cut-boat owned by Walter Smith of the CANARSIE YACHT CLUB. She hails from Canarsie, N. Y., and sails with the CANARSIE YACHT CLUB.

DIMENSIONS.	
Length over all,	16 feet 4 inches.
Length load waterline,	16 feet 1 inches.



JOHN TAYLOR.

JOHN TAYLOR, wholesale lamps and china, Secretary of the CANARSIE YACHT CLUB, Brooklyn, N. Y., was born on Brooklyn Heights, October 24, 1862. His ancestors were Scotch and his parents were James and Margaret Taylor. Has been a yachtsman for ten years and is a member of the CANARSIE YACHT CLUB.



PRESIDENT F. S. MALLOCH,
LAKE YACHT RACING ASSOCIATION.

History of the Lake Yacht Racing Association.

THE LAKE YACHT RACING ASSOCIATION fulfills the same functions among the yachtsmen of Lake Ontario that the YACHT RACING ASSOCIATION does for the fraternity in Great Britain.

Prior to its formation the yachtsmen of that great inland sea had no organization, no uniform system of rules, no final court of appeal for the settlement of disputes. Each individual club was a law unto itself. Regattas were few and far between, and badly attended. They have reformed things on the lake indifferently well since then, as the records of the past few years and the class of boats competing will show.

In 1884 the old TORONTO YACHT CLUB issued a circular, inviting delegates from the different clubs on the Lake—HAMILTON, BELLEVILLE, KINGSTON, OSWEGO, ROCHESTER, and the ROYAL CANADIAN YACHT CLUB, to meet them in Toronto for the purpose of forming an Association, having for its object the encouragement of yacht building and yacht racing, and the establishing and enforcing of uniform rules for the government of all races in which the yachts of two or more clubs should compete.

At this time, with the exception of Toronto, which had the year before adopted the Seawanhaka rule, the old length and beam rule of the THAMES YACHT CLUB with its premium on the plank on edge type was universally in force, and it was not without some misgivings that the representatives of the TORONTO CLUB approached the task of convincing those from other clubs of the utterly erroneous conception of size which the THAMES rule produced, and of the glaring injustice in time allowance which it encouraged.

The then Captain of the TORONTO YACHT CLUB, Mr. George E. Evans, who has filled since that date the position of Honorable Secretary of the Association, held the brief for his club, and the result of the meeting was that the Seawanhaka rule was adopted, a court of ultimate appeal for the decision of disputes in racing matters was formed, and a series of regattas was arranged which has, from year to year, given the greatest impetus to the royal sport upon the lake.

The Association has the satisfaction of being also an International organization, for besides the CANADIAN CLUBS enrolled in it, to wit: the BAY OF QUINTE, QUEEN CITY, ROYAL CANADIAN and ROYAL HAMILTON, it has also those two active and hospitable sister institutions, the OSWEGO and ROCHESTER YACHT CLUBS.

The Association holds its Annual Meeting on the second Saturday in November of each year, at which meeting amendments to the Sailing Rules are discussed, and the programme is arranged for the fixtures of the coming season.

Since 1884 the Seawanhaka rule has been adhered to, with the exception, however, that classification is by sailing length instead of by waterline length. That classification is as follows:

1st Class	over 46 feet	sailing length.
46 foot class	46 feet	sailing length and under.
40	"	" 40 " " " " " "
35	"	" 35 " " " " " "
30	"	" 30 " " " " " "
25	"	" 25 " " " " " "

The fleet of the Association now numbers no less than 222 boats,

among which may be mentioned, WHITE WINGS, DINAH, NANCY and the Watson cutter VERVE No. 2 of the ROYAL HAMILTON YACHT CLUB, OHOLE, VREDA and ALLEN, and also the two new Five boats, ZELMA and VEDETTE, of the ROYAL CANADIAN YACHT CLUB, NORAH and IOLANTHE of the BAY OF QUINTE YACHT CLUB. The old Burgess crack PAPPOOSE and the Five flyer YAMA of the OSWEGO YACHT CLUB. In addition to these there is also CHOCTAW, (Burgess) CINDERELLA and ONWARD, (Gary Smith) of the ROCHESTER YACHT CLUB.

The Presidents of the Association since 1884 have been the following well-known yachtsmen: John T. Mott of the OSWEGO YACHT CLUB; W. H. Biggar of the BAY OF QUINTE YACHT CLUB; J. R. Caruthers of the KINGSTON YACHT CLUB; the late George H. Newell of the ROCHESTER YACHT CLUB; J. F. Mosck of the ROYAL HAMILTON YACHT CLUB; A. R. Boswell of the ROYAL CANADIAN YACHT CLUB, and John T. Mott of the OSWEGO YACHT CLUB.

The officers for 1893 were as follows:

President, F. S. Malloch; ROYAL HAMILTON YACHT CLUB.
 Vice-President, A. R. Boswell; ROYAL CANADIAN YACHT CLUB.
 Hon'y Sec. and Treas. George E. Evans; ROYAL CANADIAN YACHT CLUB.
 Executive Committee: E. B. Mott, OSWEGO YACHT CLUB
 P. Schoffeld; QUEEN CITY YACHT CLUB.
 E. N. Walbridge; ROCHESTER YACHT CLUB.
 W. H. Biggar; BAY OF QUINTE YACHT CLUB.

ACCORDING TO THE RULES AND REGULATIONS.

The measurement of yachts shall be of length and sail area according to the following formula:

$$\frac{L \times W \times L + \sqrt{\text{Sail Area}}}{2} = \text{Racing Length.}$$

Length to be measured from the forward side of stem at the load waterline to the load waterline at stern wherever found, exclusive of any part of the rudder. This measurement to be taken when the yacht is afloat and in her ordinary trim, and without the crew on board.

The Measurer, at the time of taking his measurements, to affix a distinctive mark at each point.

The sail area to be ascertained by taking a perpendicular along the after side of the mainmast from the upper side of gafftopsail block or sheave on topmast to the upper side of boom when resting on the saddle, or when resting on the lowest part of goose-neck; should the gafftopsail, sheave or block be more than a quarter of an inch for every foot on the water line below the topmast rigging, then the measurement shall be taken from the under side of the topmast rigging, the length of which line is to be recorded by the Measurer, together with the other points used in measurement. But the measurement to be recorded as the height of the perpendicular shall in no case be taken as less than the distance from the upper side of main boom to the under side of the cross trees, or, if the yacht have no cross trees, to the under side of the main rigging (in the case of cat-

boats, perpendicular to be taken from the upper side of the throat hullard sheave), with four-fifths of the length of the gaff added thereto.

On schooners, cutters and sloops, a base line to be taken from the lee hole or point of contact of the jibstay on bowsprit or flying jibstay on jibboom to the end of the main boom, with one-quarter of the length of the main gaff measured from after side of mast to end added thereto. Any extension of either gaff or boom to be considered part of the gaff or boom. On yawls a base line is to be taken to the end of the mizzenboom without any addition. On cat-boats the base line to be the length of the boom, with one-quarter length of gaff added. On luggers the base line is to be taken as in cutters and sloops, with 38 per cent. of that portion of the yard which extends above the point where the main hullard is bent added. The perpendicular to be taken from the upper side of the main hullard sheave to the usual point on boom. Where the jib is set flying the measurement will be taken from the pin of the outhaul sheave.

The area from these figures is to be obtained by multiplying the base by the perpendicular and dividing by two. To the square root of the area, as ascertained, add the length, as ascertained and divide by two; the result is the measurement for time allowance.

There shall be no restrictions as to sails, or the manner of setting or working them.

CREWS.

One man shall be allowed for every five feet or fraction of five feet, of a yacht's corrected length, exclusive of owner and skipper. In the case of yachts over thirty feet corrected length, exclusive of the cook or any *bona fide* member of the press, neither of whom shall, however, in any way assist in the working of the yacht. No one, however, in the case of yachts of thirty feet corrected length and under shall be allowed to steer a yacht in any race unless he be a member of a club belonging to the association. Professionals to be allowed to steer boats in classes above thirty feet corrected length only.

TABLE OF TIME ALLOWANCE.

The allowances in this table are based upon the rule accepted by naval architects, that within economic limits opportunities for speed vary in different vessels as the square roots of their respective lengths. As strong winds are required, however, to give to larger vessels the full extent of their advantage in size, and as such a scale of allowance is not adapted to ordinary Summer racing, 50 per cent. only of the allowance due to the rule is given in the table and may be stated thus:

$$\text{Time equals } .5 \left\{ \frac{3600}{l^2} - \frac{3600}{L^2} \right\}; \text{ 3600 representing the number of seconds in an hour, } l \text{ the smaller yacht and } L \text{ the larger one.}$$

$$\text{Practically the formula is } \left\{ \frac{1800}{l} - \frac{1800}{L} \right\}; \text{ five-tenths of 3600 being 1800.}$$

LIST OF YACHT CLUBS BELONGING TO THE LAKE YACHT RACING ASSOCIATION.

BAY OF QUINTE, Belleville; OSWEGO, Oswego; QUEEN CITY, Toronto; ROCHESTER, Charlotte; ROYAL CANADIAN, Toronto; ROYAL HAMILTON, Hamilton.

THE SEASON OF 1893.

The programme of the LAKE YACHT RACING ASSOCIATION* round of 1893 was shorter and less interesting than usual. The start was made at Charlotte, N. Y., the port of Rochester and the station of the ROCHESTER YACHT CLUB, on July 4th; the fleet intends going next to Hamilton, where the regatta of the ROYAL HAMILTON YACHT CLUB is set for July 8th, and then continuing on to Toronto on July

*See *Forest and Stream* July 5, 1893.

10th, where the fleet will probably disband. The assembly at Charlotte, on July 3d, was quite small, YAMA and other noted boats being absent. CINDERELLA did not start, and the old New York sloop ONWARD with the Watson 20-rater VREDA made up the largest class, only ZELMA and DINAH being in the next. The course was a triangle of 4 mile sides, 24 miles for the larger yachts and 12 miles for 25 foot and 18 foot classes. The day was perfectly clear and sky bright, with the lake as smooth as a table, the wind being moderate from northwest. VREDA, sailed by Mr. Jarvis, was about 2 minutes astern at the end of the first round, but finally won easily. One of the buoys had been missing and a skiff anchored in its place, most of the yachts turning it in the absence of the usual buoy. When the 40-footers finished the first round they reported that they had not found the buoy, and DINAH gave up, but ZELMA, on learning the change completed the second round. The full times were:

	Elapsed Time.	Corrected Time.
	U. S. S.	U. S. S.
First Class; start 10:50.		
Vreda	3 13 50	4 21 50
Onward	3 20 13	4 30 13
40 Foot Class; start 10:50.		
Zelma	4 46 25	
Dinah	withdrew	
35 Foot Class; start 11:00.		
Cyprus	4 35 25	5 35 25
Ripple	4 18 35	5 48 35
Ethel	withdrew	5 47 25
30 Foot Class; start 11:10.		
Vedette	4 01 50	4 51 50
Nada	4 15 25	5 35 25
Latona	withdrew	5 55 10
25 Foot Class; start 11:10.		
Nox	2 04 25	2 41 25
Maud B.	2 07 15	2 47 25
Suloh	2 20 58	3 00 58
Syda	2 30 15	3 10 15
18 Foot Class; start 11:20.		
Dot	3 41 05	
Pastime	disabled and withdrew	

Lake Ontario, for all its fine weather, usually has one good blow in store for the fortnight of the LAKE YACHT RACING ASSOCIATION Races; in 1884 the fleet caught it at Oswego, next year the wind was waiting at the west end of the lake, and drove the yachts into all the ports on the north shore, the battered fleet being some three days in making the rendezvous at Oswego. In 1890 the annual blow turned up in the middle of the regatta at Kingston, sinking VOLANTE, giving VREDA's steel side some marks which she carries yet, and crippling others of the fleet. This year the winds favored Hamilton with a visit, bringing disaster to a number of the yachts.

The Second Regatta of the round was set for July 8th, under the management of the ROYAL HAMILTON YACHT CLUB, the courses being off the piers of Burlington Bay, the leeward mark being set four miles out in the lake, with a second mark at two miles. The first, 46 and 40 foot classes, sailed three times over this course, 24 miles; the 35 and 30 foot classes sailed two rounds, 16 miles; the 25 foot class sailed once around the 4 mile mark and once around the 2 mile, 12 miles in all, and the 21 foot class was to sail twice around the short course, 8 miles. The rules of the LAKE YACHT RACING ASSOCIATION class all yachts by sailing length, measured by Seawanbuka rule.

The wind was moderate, southwest at the start, but in a little while it went round to northwest, and blew all day in a succession of violent squalls that brought all the yachts down to one or two reefs at times, and compelled some to give up entirely. The starters were:

First class VREDA, ONWARD; 46 foot class, CONDON; 40 foot class,

LIST OF YACHTS ENROLLED IN THE LAKE YACHT RACING ASSOCIATION.

No.	YACHT.	OWNER.	PORT.	Topmast Stay	Topmast	Topmast	Topmast	Length over all.		L. W. L.	Racing Length.	Extreme Beam.	Draft.	Rig.	Allowance for one knot.
				to end of boom.	to end of boom.	to top of boom.	to top of boom.	ft.	ft.						
2	Aggle	Mariatt & Armstrong	Onkyville	72.50	52.78	30.41	22.10	40.00	30.91	41.14	12.00	6.10	Sloop	122.57	
3	Anleen	H. Myles	Toronto	94.75	67.41	34.33	31.41	...	55.00	56.90	Cutter	80.76	
4	Alert	J. B. Seaver	"	41.80	31.00	19.30	14.50	20.60	21.00	14.70	7.00	3.00	"	34.32	
5	Alert	G. H. Judd	Hamilton	54.35	41.35	25.83	19.45	...	29.70	32.38	Sloop	158.45	
6	Amelia	Shirck Bros.	Rochester	53.00	47.85	...	16.90	31.40	30.65	31.34	8.41	6.00	Cutter	163.88	
7	Armeda	Hamilton & Ordway	Charlotte	54.40	38.40	...	19.05	32.05	28.80	31.28	"	163.88	
8	Atalanta	W. J. Eyre	Brighton	106.66	82.35	...	35.35	70.00	63.42	66.21	19.08	5.83	Sloop	133.37	
43	Acacia	C. A. Thompson	Hamilton	41.00	26.75	17.00	14.00	...	20.41	22.72	"	219.76	
108	Adelme	J. Morris	"	29.00	...	13.50	12.67	...	18.17	18.91	"	256.06	
109	Anleen	A. Thomas	"	35.00	...	17.83	14.25	...	19.83	21.78	"	227.35	
123	Arlolme	J. Morris	"	30.58	...	15.83	14.00	...	18.75	20.50	"	243.02	
130	Alliance *	A. Taylor	Toronto	27.46	...	15.33	12.20	18.02	18.63	19.11	Lug & Jib	254.00	
103	Ariadne	Cape Vincent	58.82	54.00	Sloop	87.00	
180	Atela *	H. Helph	Toronto	Skiff	
190	Egeria *	F. C. Thompson	"	"	
191	Ariel	M. de S. Wedd	"	43.50	30.50	18.42	10.33	...	22.42	21.46	7.50	...	Cutter	205.79	
158	Alta	Follett & Schlutte	Charlotte	23.00	19.33	6.10	2.10	"	
9	Bessie	Chris Wolfe	New York	36.16	31.00	12.50	1.66	Sloop	
11	Brenda	A. A. Allan	Toronto	37.50	...	19.25	13.66	24.00	21.08	22.06	8.00	1.35	"	218.28	
12	Cuprice	N. H. Engau	"	81.33	...	17.53	12.61	21.00	18.00	20.45	6.70	1.00	"	210.63	
13	Christabel	G. Crean	"	34.00	...	19.00	11.58	...	19.31	21.00	Cutter	234.02	
14	Condor	C. A. B. Brown	"	73.66	51.50	...	22.66	...	39.00	42.70	"	117.59	
15	Coquette	W. Holmes	Hamilton	55.25	...	29.75	18.50	...	32.66	34.42	Sloop	148.91	
16	Cricknet	J. T. Mott	Oswego	53.20	46.20	27.70	20.35	...	32.50	34.36	Cutter	147.70	
18	Cygnel	T. McGaw	Toronto	82.50	57.50	...	0.66	...	43.42	47.63	Sloop	101.70	
19	Cyprus	J. Allan	"	55.00	41.31	...	19.16	...	29.10	32.80	Cutter	156.43	
173	Clytie	H. Weir	Hamilton	34.02	...	14.25	14.00	...	19.25	20.56	Sloop	230.14	
203	Canuck *	R. W. Hanna	Toronto	16.16	Lug & Jib	289.42	
159	Cherokee *	James Pillow	Charlotte	15.60	11.90	Cat	
210	Chestnut	C. P. H. Vary	"	18.60	13.60	4.00	3.00	Sloop	
181	Caruth	E. J. Sandford	Hamilton	35.17	26.50	15.17	13.42	20.88	"	226.05	
167	Dimh	F. E. Malloch	"	
20	Daisy	C. Postlewite	Toronto	31.10	...	13.10	...	31.10	18.30	19.01	5.00	1.50	275.05	
204	Dolphin	G. Schofield	"	36.33	...	17.87	13.41	...	18.58	21.19	Sloop	231.07	
112	Eclipse	W. Dixon	Hamilton	34.41	...	16.08	12.66	...	19.21	20.70	"	237.56	

* Sailing Skiff.

LIST OF YACHTS ENROLLED IN THE LAKE YACHT RACING ASSOCIATION.

Reg.	ft.	Allowance for one knot.	No.	YACHT.	OWNER.	PORT.	Topsail Stay to end of boom.	Topsail, Mainsail and Boom Sheets to top of boom.	Eyes of Huzzing to top of boom.	Gaff.	Length overall.	L. W. L.		Racing Length.	Extreme Beam.	Draft.	Reg.	Allowance for one knot.
												ft.	ft.					
loop	122.57		140	End	O. Martin	Toronto	32.25	10.50	13.58	18.62	20.35	5.30	4.00	Sloop	211.01	
utter	80.70		138	Eldie*	W. Ward	"	21.00	17.10	13.25
"	204.32		142	Excelsior*	J. Thompson	"	30.00	17.07	17.00	20.10	20.33	22.65	5.10	..67	Lug & Jib	220.70	
loop	158.45		23	Echo	Chas. Smith	Hamilton	51.00	38.41	21.83	18.67	20.33	20.60	Sloop	172.08	
utter	163.88		26	Ella	N. S. Stone	Oswego	20.85	45.16	23.20	40.00	31.80	38.90	13.00	2.50	"	130.73	
"	163.88		22	Erchless	G. Chisholm	Buffalo	24.25	15.58	13.75	18.10	20.20	7.00	5.00	Cutter	241.04	
oop	63.37		28	Escapo	C. Alexander	Toronto	50.33	30.10	16.33	20.75	20.60	"	172.42	
"	219.76		192	Edna	G. P. Heid	"	37.08	20.33	15.50	12.66	18.31	20.92	Sloop	235.06	
"	230.06		193	Erna	L. V. Perival	"	32.87	30.00	20.75	10.40	33.50	25.00	23.75	8.30	6.00	Cutter	172.42	
"	227.35		242	Ethel*	E. Apted	"	31.50	10.50	12.08	18.75	10.00	Lug & Jib	244.62	
g & Jib	254.00		242	Estelle	W. Q. Phillips	"	Vawl	
oop	87.00		168	Elicada	F. Cork	Hamilton	31.50	24.58	13.25	11.71	17.04	18.50	Sloop	250.00	
iff		30	Fascination	E. W. Austin	Oswego	52.70	42.40	20.00	31.00	30.30	33.58	11.50	3.66	"	152.00	
"		31	Finette	W. S. Thompson	Toronto	43.10	28.10	10.25	12.83	22.08	24.11	Cutter	208.80	
utter	205.79		33	Florence	Macfarlane & Goble	Oswego	27.00	20.00	11.70	2.00	"	
"		203	Florrie B.	J. McBrien	Toronto	41.75	31.75	18.83	15.91	20.70	24.75	Sloop	204.95	
"	218.28		194	Freida	S. H. Townsend	"	35.75	20.10	17.58	13.02	18.33	19.40	"	250.87	
"	240.63		195	Fleetwing	A. Sweetman	"	41.60	20.10	12.60	
utter	234.12		184	Fanny Jutten	W. E. Jutten	Hamilton	56.50	35.18	25.08	10.83	26.18	20.70	Sloop	172.42	
"	117.50		165	Gonza	J. J. Leary	Charlotte	22.80	18.00	7.50	4.00	"	
oop	148.04		1	Gwendoline	G. Robertson	Toronto	20.75	17.92	12.75	9.75	18.58	17.94	"	207.07	
utter	147.70		37	Hebe	J. B. Carruthers	Kingslon	Cutter	
oop	104.70		38	Hilda	B. Jennings	Toronto	30.58	19.50	15.25	20.80	22.00	Sloop	249.31	
utter	156.43		114	Heather Bell	Thompson Bros.	Hamilton	39.00	25.00	17.00	12.25	21.00	22.37	"	222.70	
oop	230.13		122	Isle of Wight	J. W. Jetton	"	49.50	34.50	22.90	10.58	24.50	28.25	"	180.79	
g & Jib	289.42		128	Ina	J. R. Woods	Toronto	38.08	19.51	11.21	19.02	22.40	"	221.00	
"		40	Imogene	H. Elliott	"	7.50	4.50	Cutter	
oop		41	Iolanthe	Bigger & Hostage	Belleville	63.41	66.25	20.10	34.00	37.23	Sloop	137.20	
"	230.06		42	Irene	F. Rolph	Toronto	32.75	17.00	10.50	20.80	17.75	19.00	5.00	3.00	"	248.79	
"		185	Ishkoodah	R. Stevenson	Montreal	"	
"	255.05		175	Java	J. J. Quinn	Toronto	37.33	17.04	13.43	18.20	20.04	Cutter	234.92	
oop	231.07		45	Kathleen	A. C. Anderson	"	32.16	13.80	11.25	18.75	19.10	Sloop	252.93	
"	237.10		46	Katie Gray	W. B. Phelps	Oswego	53.70	43.75	10.50	33.00	30.00	31.35	11.00	3.00	"	151.00	
"		47	Kelpie	F. Dallas	Toronto	45.83	35.10	10.25	10.50	28.00	21.50	25.54	7.83	5.00	Cutter	197.80	
"		148	Katie Hall	D. Hall	Hamilton	37.83	10.41	12.38	20.50	22.53	Sloop	221.47	

*Sailing Skiff.

LIST OF YACHTS ENROLLED IN THE LAKE YACHT RACING ASSOCIATION.

No.	YACHT.	OWNER.	PORT.	Topsail Stay	Topsail Halyard Sheave to top of Boom.	Eyes of Rigging to top of boom.	Gaff.	Length over all.		Racing Length.	Extreme Beam.	Draft.	Reg.	Allowance for one kind.
				to end of boom.				L.	L.					
				ft.	ft.	ft.	ft.	ft.	ft.	ft.	ft.	ft.		ft.
49	Lady Evelyn	Str R. Cameron	New York	86.00	80.00	105.00	92.00	94.50	18.50	12.50	Schooner	27.70
141	Little World *	T. World	Toronto	32.00	12.42	9.96	22.80	21.58	17.13	5.00	.07	"	277.44
15	Lotus	H. Weir	Hamilton	49.75	38.75	22.83	17.03	30.58	28.00	29.85	10.00	Sloop	171.00
189	Latona	J. V'rlin	"	51.75	22.50	17.83	27.41	29.70	"	171.01
182	Lucretia	E. J. Kernish	"
197	Lenore	J. H. Plummer	Toronto	Schooner
57	Majel	Mackie & Crauner	Charlotte	53.80	42.10	20.50	30.20	26.35	30.78	10.05	5.00	Cutter	166.48
63	Molly	T. World	Toronto	48.25	34.60	20.00	18.33	21.02	27.38	Cutter	181.75
64	Modjeska	O. S. Spaulding	Charlotte	54.80	34.00	15.90	35.00	20.90	30.70	8.50	3.00	Sloop	167.00
127	Maud B.	W. Burnside	Hamilton	42.00	29.33	18.58	15.91	22.60	24.74	"	203.98
205	Meteor	F. Williamson	Toronto	Cutter
176	Mermaid *	J. B. Bastien	Hamilton	18.02
177	Medora *	J. L. Stephens	"	17.00
178	May Flower *	Leonard Bros.	Dundas	15.00
206	May Flower	J. A. Jackson	Charlotte	32.00	28.00	10.80	2.00
66	Nadia	J. A. Fernside	Hamilton	59.83	38.17	22.17	10.00	25.79	29.42	Cutter	173.90
67	Nalud	G. Boyd	Toronto	44.33	31.83	18.75	14.91	28.75	21.84	20.67	6.91	5.00	"	189.83
68	Nimbus	C. B. N. Vary	Sodus Point	25.00	22.80	Schooner
110	Nudgey	H. J. Malcolmson	Hamilton	49.08	18.34	16.66	23.83	25.50	Sloop	197.98
145	Naney	F. Dalton	"	52.41	37.00	21.25	18.91	24.83	28.67	Cutter	178.30
129	Nello G.	W. Lee	Toronto	38.08	18.29	13.50	22.44	21.40	Sloop	205.79
179	Norline *	J. B. Young	Hamilton	11.58	8.00	9.83	18.50	14.50	Skiff
70	Onone	William Rose	Toronto	41.50	29.58	16.33	22.16	24.06	Cutter	208.80
71	Orlole	G. Gooderham	"	134.00	82.63	51.75	31.21	71.00	74.77	Schooner	68.01
160	Onward	J. R. White	Charlotte	58.00	48.00	Cutter
197	Old Girl *	P. Robertson	Toronto	Skiff
74	Pixie	Capt. Stupart	"	Yawl
76	Psycho	F. E. Kilvert	Hamilton	65.00	52.03	27.25	25.06	32.41	37.75	Cutter	135.10
77	Puritan *	H. L. Clarke	Toronto	Skiff
186	Phyllis	J. H. Buller	Hamilton	Sloop
187	Quickstep	J. Gardner	Toronto	42.16	18.16	16.00	22.48	21.68	Sloop	228.54
78	Hipple	G. H. Newell	Charlotte	55.80	20.67	34.00	27.12	9.10	6.00	Cutter
79	Rivet	E. Blake	Toronto	79.83	48.50	20.01	39.00	41.08	"	121.87
153	Rumola	Harding & Nugent	Charlotte	27.00	18.00	"
156	Rustler	E. H. Brown	Hamilton	32.25	12.75	14.00	17.75	19.20	Sloop	252.34
82	Seabird	W. Muir	Toronto	62.66	39.73	24.16	19.41	29.33	32.30	Yawl	168.60

* Sailing Skiff.

Rig.	Allowance for one Knot. ft.
Schooner	37.79
"	27.44
Sloop	171.00
"	171.91
....
Schooner
Cutter	166.48
Cutter	184.75
Sloop	167.00
"	203.98
Cutter
....
....
....
....
Cutter	473.99
"	189.83
Schooner
Sloop	197.06
Cutter	178.30
Sloop	205.79
Skiff
Cutter	208.80
Schooner	68.01
Cutter
Skiff
Yawl
Cutter	135.10
Skiff
Sloop
Sloop	228.54
Cutter
"	120.87
"
Sloop	232.34
Yawl	168.69

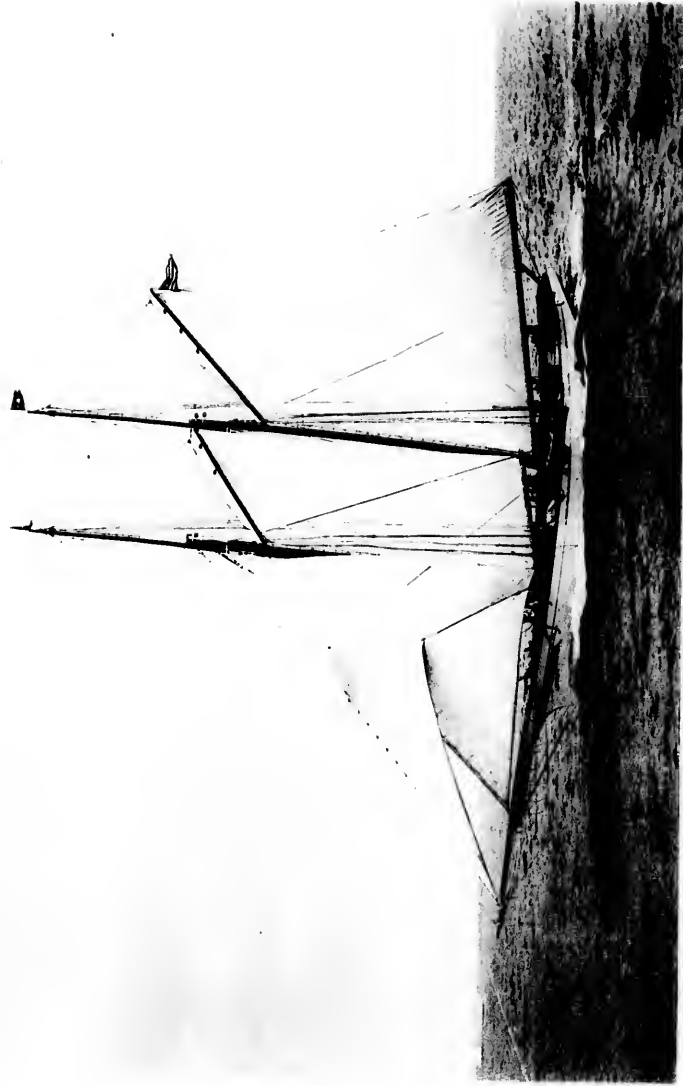

FROM A NEGATIVE BY STEBBINS.

PLATE LXX.

SPERANZA.



LIST OF YACHTS ENROLLED IN THE LAKE YACHT RACING ASSOCIATION.

No.	YACHT.	OWNER.	PORT.	Topsail Stay to point of boom.		Topsail Halliard Shave to top of boom.	Eye of Spigot to top of boom.	Gaff.	Length over all.		Racing Length.	Extreme Beam.		Draft.	Rig.	Allowance for one knot.
				ft.	in.				ft.	in.		ft.	in.			
83	Stella	G. S. Papps	Hamilton	30.33	17.41	13.00	20.50	32.43	Sloop	222.11	
117	Samon	E. Jarvis	Toronto	53.33	36.08	20.00	18.83	27.73	29.02	Cutter	171.32	
118	Schemer	G. H. Judd	Hamilton	41.58	20.50	16.33	18.25	19.07	21.19	Sloop	215.92	
131	Swan	W. Norris	Toronto	37.58	19.33	14.63	23.54	19.87	22.57	8.80	2.00	"	229.76	
149	Siesta *	Hidop	"	23.88	13.33	7.23	18.70	18.67	17.57	"	271.27	
174	Scraps	F. A. Wacham	Hamilton	37.42	14.91	13.00	19.33	21.00	"	214.02	
188	Spray	Maw & Draexke	"	36.50	27.75	16.08	13.12	18.75	20.97	Cutter	235.50	
199	Soubrette	Bennet & Hives	Charlotte	23.00	18.00	Cat	
87	Triton	W. McCabe	Hamilton	39.00	15.17	16.00	21.25	22.88	Sloop	218.47	
88	Unesny	W. B. Bonnell	Toronto	Skiff	
163	Undine	J. W. Hobbins	Charlotte	17.50	16.00	Sloop	
89	Vandetta	G. Henry	Hamilton	51.00	19.16	17.92	20.91	25.98	Cutter	195.20	
90	Velvette	E. N. Wallbridge	Charlotte	46.25	37.85	17.90	23.82	27.40	"	186.00	
91	Verve	N. B. Dick	Toronto	71.00	46.50	27.25	23.16	37.60	39.80	"	127.45	
92	Vervo	J. W. Hendrie	Hamilton	74.58	55.58	27.83	25.91	39.83	43.98	"	113.59	
149	Vreda	A. H. Boswell	Toronto	79.41	38.50	31.33	27.31	45.16	47.60	10.40	0.50	"	102.57	
53	Vision	Black & Burnett	Cobourg	64.50	45.88	27.66	26.33	34.31	30.08	35.00	11.75	3.75	Sloop	149.46	
147	Volante	G. Welster	Hamilton	46.42	31.75	21.92	19.12	27.31	29.10	7.75	6.50	Cutter	175.81	
21	Vera	H. Lawry	"	42.00	35.25	30.80	11.00	8.50	"	138.86	
95	Volante	E. B. Mott	Oswego	"	
198	Volante	C. Black	Toronto	Yawl	
109	Vixen *	J. Stewart, Jr.	Hamilton	41.41	32.20	14.00	20.16	23.52	Sloop	213.45	
97	White Wings	W. G. Townsend	"	15.08	Skiff	
98	Whistlewing	J. W. Rutherford	Toronto	72.25	60.66	22.31	42.83	45.74	Sloop	108.22	
100	Woos	J. Haverson	"	66.58	49.75	22.50	39.16	40.76	Cutter	123.93	
120	Water Witch *	Thos. Hobson	Hamilton	22.56	16.50	13.31	18.75	20.72	Sloop	237.76	
143	Woon	C. C. Gray	Toronto	32.66	17.00	16.75	19.33	21.50	"	20.33	
133	Widgeon	A. W. Dodd	"	46.75	39.83	19.83	18.16	23.25	27.52	Cutter	165.37	
121	Wave	W. H. Judd	"	31.02	16.46	11.63	19.83	19.83	20.49	6.25	Sloop	230.60	
154	Water Witch	A. Manchee	Hamilton	44.50	21.31	19.83	26.53	28.83	"	177.37	
164	Wenona	Clarke & Ross	Toronto	15.96	15.70	Log	
126	Xanthe	W. Johnson	Charlotte	24.03	18.00	Cat	
101	Yolande	C. Reed	Hamilton	34.41	27.25	16.16	14.00	18.80	20.80	Sloop	226.81	
155	Yuna	A. Ames	Toronto	32.91	26.63	Schooner	191.14	
102	Zeta	O. E. Paddock	Oswego	Cutter	
257	Gracie	Hackett's Harbor	Sloop	

*Sailing Skiff.



COMMODORE CHAS. W. BRAY, M. D.,

PORTLAND YACHT CLUB.

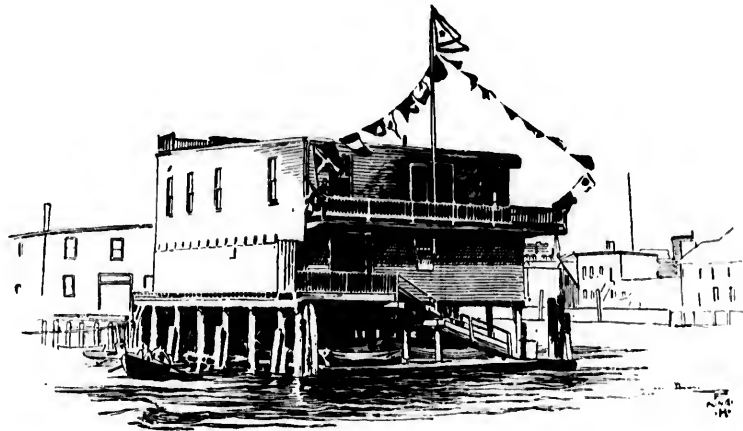

PORTLAND YACHT CLUB HOUSE.

History of the Portland Yacht Club.

STATION—MERCHANT'S WHARF, PORTLAND, ME.

THE old Vikings of the North the greatest of explorers, sailed out from their bays and inlets for pleasure as well as for plunder. The tendency is manifest again to-day in the sports of the English and American people, and in your modern yachtsman is the ancient Viking, still unsubdued, but civilized.

This hereditary love of the water began to assume yacht form in Casco Bay during the sixth decade of the nineteenth century, and in the latter part of May, 1868, resulted in a proposition for a general cruise of all the Portland yachts, out of which coastwise voyage of pleasure the PORTLAND YACHT CLUB grew.

A meeting was held at the office of Mr. W. W. Thomas, Jr., on the evening of June 1st, and it was agreed that the cruise should take place on Thursday the 11th. Captain A. M. Smith of yacht RAY was elected Commodore, and Captain B. J. Willard, of yacht NETTLE, Vice-Commodore, and the destinations were Boothbay Harbor and the City of Bath. The sun did not smile on the undertaking, the cruise being performed in the midst of calms, of fogs and storms. But it is these very conditions that make yachting the hardest of sports, and it proved the earnestness and purpose of these voyagers.

In April of the following year, another meeting was held at the office of W. W. Thomas, Jr. Captain A. M. Smith was chosen chairman, John A. Emery, Secretary, and it was unanimously agreed that they form themselves into a permanent organization to be called the PORTLAND YACHT CLUB, and the following were appointed officers for the ensuing year: James M. Churchill, Commodore; A. M. Smith, Vice-Commodore; John A. Emery, Secretary and Treasurer.

Constitution and By-Laws followed in due course, and by the 19th of May a club flag had been adopted, and the roll which had been prepared for signatures immediately received the names of twenty-one members. Thus the club began its existence with the full vigor of a majority, and the enrollment of the following ten yachts:

Schooner ETHEL, Sloop RAY, Schooner NETTLE, Sloop WHISPER,

Schooner LABEL, Sloops CLARENCE, SPY, ELLA, KATE, Schooner SPARKLE.

The first Annual Cruise occurred June 16, 1869. A club cruise along the shores of Maine was a novelty in those days, and attracted much attention. The fishermen were unable to comprehend the secret business of the fleet; the coasting packet Captains looked upon the yachting skippers as a class of lunatics and fools. They failed to see how anybody could brave the fogs and storms of Maine for fun. But the fleet made progress, and we read that it "proceeded up the Kennebec to Bath, where we were most hospitably entertained by His Honor, Mayor Patten," and again that "we landed at Jewell's Island and indulged in a great clam bake, spending most of the afternoon in this lovely sport."

Chowders and clam bakes were important features in those early days, and this resulted partly from the gallantry of the members to their lady friends, and largely from the necessity of making Casco Bay their place of pleasurable assembly. For the club was a boarder, or at most, a guest. It had no habitation of its own, and it held its business meetings at the office of one of its members. A proposition was made in July to lease Little Hog Island and erect a Club House which would cost in the vicinity of \$700; but the project was abandoned, and the club continued as a floating enterprise, making itself prominent in the way of celebrations, regattas and cruises, and gaining in the way of financial and social strength through the increasing of its membership.

June 6, 1870, the Spring Cruise was made to Boothbay, eleven yachts participating.

August 16th a regatta took place; no prizes were awarded first class yachts as they mistook the course. SPY and KATE took the second class, and WHISPER and MAYFLOWER the third class prizes. The club also took the city prize in the Fourth of July Regatta.

By the beginning of the next season (1871) its membership had reached one hundred and thirty-one. On the 3d of May of this year

the present club flag was adopted. September 8th the Annual Regatta took place and the first class prizes were taken by *ETHEL* and *NETTLE*; second class, *RAY* and *SPY*. There was no Annual Cruise.

In June, 1872, the club occupied rooms in the building at the end of Custom House Wharf. They were spacious and comfortable, and the windows and balcony commanded the whole harbor. In the regatta of this year *ALARM* took the first prize.

June 23, 1873, the Annual Cruise took place. In the Fourth of July Regatta, *RAY* and *ALARM* took the first prizes; *SPY* and *CLARENCE* the second class, and *DELLA* and *GANNET* the third.

The Club Regatta took place September 16th, and the prize was held by former winners. One new yacht and twenty new members were added to the club during this year, and Vice-Commodore Smith was made Commodore and Captain C. H. McQuillan of Bath, Vice-Commodore.

The Annual Cruise of 1874 took place July 6th, to Boothbay, and lasted a week, eight yachts participating. Rules and cups were provided for Challenge Cup Races during this season, and two regattas were sailed; one July 4th, in which *RAY* took the first class, *GUACIE* the second, *FROLIC* third; and another September 28th, in which *VIVA* won the first and *MATTIE* the second class prizes. Four new yachts were enrolled, seven members added, and the club was improved. J. P. Thomas was elected Vice-Commodore.

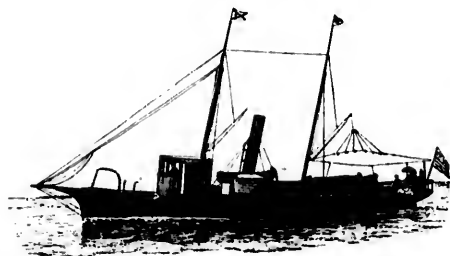

MAITLAND.—FIGURE 543.

In 1875 five regattas were sailed. *VIVA* took the first class prize, *GEORGIE* the second, *RIVAL* the third in the Challenge Cup Races. In a regatta on the 5th of July, *VIVA* won first prize and *SPARKLE* second. A review and picnic were held September 4th, and the season of a most successful year closed.

But the decline of the first enthusiasm was to be expected and in spite of the efforts of the previous year, the season of 1876 began with a membership of 100, as against 131 five years before. At the annual meeting, J. P. Thomas was elected Commodore, A. K. Paul Vice-Commodore; J. A. Emery Secretary; George H. Holden, Treasurer. There were again five races. In the Annual Challenge Cup Regatta, *VIVA* won the first, *CASCO* second, *MIST* third class prizes.

A race was sailed July 4th for prizes offered by the city. Mr. George H. Holden presented to the club a silver cup, to be offered as a prize, and held by the yacht in the second class which should win it twice. This was known as the Holden Cup. Three races were sailed and the cup was won by the sloop *GEORGIE*, Capt. Richardson. The Spring Cruise took place in May, to Wiscasset, and the Fall Cruise in September, to Freeport, ten yachts participating. Twenty-seven new members were admitted during the year and a library established at the club rooms.

Interest in yachting continued to increase. May 28 and 30, 1877, the Spring Cruise took place to Wiscasset, six yachts participating.

In the Annual Regatta, June 1st *VIVA* took the first, *MARY* the second and *MIST* the third class cups. *VIVA* having won in two previous Annual Races, and held the first class cup during the whole time, came now into complete possession. There were also five Challenge Races.

On August 15th, *GEORGIE* took the cup from *MARY* and August 24th, challenged in turn, retained possession; same day, *UNDINE* retained possession of her cup against *WHISPER* and *NETTLE*.

Sept. 4th, *MIST* accepted a challenge from *EDDA* and won the race, *VIVA* also beat *RAY* handsomely in a private match, June 23d, the prize being a supper for twenty.

The Annual Regatta of 1878 occurred May 28th; the second class cups were won by *UNDINE* and *TWILIGHT*; third class by *MIST*, no first class entries. July 23d, *TWILIGHT* won the second class Challenge Race. The Spring Cruise was made May 30th, to Boothbay, for three days, and a Fall Cruise of two days to Freeport. The membership increased to a total of 147; two new yachts were added, and an Act of Incorporation had been granted by the Legislature, April 3d.

The club at this time possessed well furnished rooms in their house at the end of Custom House Wharf; its membership was steadily increasing; there were 35 yachts (14 schooners, 19 sloops, 2 steamers) and their value was \$20,000.

The first class challenge cup was held by *VIVA*. Vice-Commodore Paul. *UNDINE* held temporarily the prize for second class schooners, and *TWILIGHT* that for sloops. The third class cup was owned by *MIST*, having been won in the Summer races. The officers were: John P. Thomas, Commodore; Alfred P. Paul, Vice-Commodore; John E. Bradford, Fleet Captain; George Donno Rand, Secretary; Fritz H. Jordan, Treasurer; A. K. P. Cobb, Measurer.

In 1879, the superiority of certain yachts having been established, interest in the challenge decreased; the only club race was the Annual Regatta of May 23d. Of the first class sloops, *VIVA* won, 6 hrs., 30 min., 12 sec.; of the second class schooners, *NELLIE* 3 hrs., 47 min., 3 sec.; sloop *TWILIGHT*, 2 hrs., 46 min., 53 sec.; no third class yachts started. But though challenges were not raised during the season, the interest of the association was awakened and intensified by the ending of the lease upon their club rooms, and the consequent suggestions of new quarters and a permanent Club House.

A Committee of three was appointed to take this matter into consideration and with full power to act for the best interest of the association. In July of this year, on the resignation of Commodore Thomas, Vice-Commodore Paul was elected to fill the vacancy, and was succeeded in his previous position, by Wm. Santer, Jr. In October, a vacancy again occurring in the chief office, Mr. Santer was chosen Commodore, and William W. Gould, Vice-Commodore.

In 1882 there were two Challenge Cup Races, and the Annual Regatta was held May 26th, under conditions of wind and weather peculiarly favorable. *CASCO* won the race, beating *TWILIGHT* by 10 seconds, standard time, and accomplished the course for which eight hours are allowed by club rules, in the remarkably quick time of 1 hr. 44 min., 46 sec.

In 1883 the club inaugurated a system of Open Regattas for money prizes, one being held August 2d, which created much enthusiasm, and was so successful as to recommend the continuance of the system. There were two Challenge Cup Races including the annual, and a regatta was held at Old Orchard, under charge of the association. Annual Regatta was won by the schooner *BONITA*, first class, and sloop *VIM*, second class. The club was visited during the season by 118 yachts from other ports. At the annual meeting, Mr. Geo. C. Owen was elected Vice-Commodore.

In the Annual Regatta of 1884, the first class cup was won by schooner *NELLIE G.* and the second class by sloop *WILLIE*. Before the year closed, however, the first class cup became again the property of the club, *NELLIE G.* being sold outside before winning her three races. The third class cup was also the property of the club,

and the second class was held on its first year by sloop **WILLIE**. **WILLIE** was again victorious in the Annual Challenge Cup Race of 1885, which occurred June 12th, going over the course in 2 hrs., 6 min., 13 sec. This was the only race which was sailed this year, and the interest in regattas seemed somewhat eclipsed by the general enthusiasm caused by the occupation of the new Club House.

This spacious building, with its beautifully furnished club rooms, its wide windows and balconies, was a new pride to the members of the association. It is the house which they occupy to-day. Its plans were made by John C. Stevens, and its construction carefully superintended by him. Though not of excessive cost, it is a model of convenience and elegance. For the accommodation of boats a raft is placed directly beneath. The lower floor is devoted to a large boat room and spacious lockers. The upper story contains kitchen, spar and work room, ladies' parlor, and at the front, the club room, whose windows and balconies look across the channel to the yacht anchorage.



DOROTHY Q.—FIGURE 344.

In February 1890, the house was in great danger from a fire which raged among the buildings of the neighboring wharves. Its boats were removed, its members gathered on the roof and used buckets of water; a fire boat lay alongside for several hours and the house narrowly escaped with scorched exterior and a damaged chart room.

The seasons which have followed have been marked by an increase in membership and a larger enrollment of yachts, but the competition spirit has not kept pace with the social development and the character of the yachting property indicates a disposition rather to enjoy the fascination of the harbor and the coast than the exciting contests of the regatta. In further corroboration of this it may be mentioned that several steamers will be added to the club in the coming Spring but no sailing vessels are as yet reported.

The regattas since 1886 are as follows:

Annual Regatta, June 9, 1886, won in the second class by sloop **WILLIE**, 2 hrs., 36 min., 56 sec., sailing time. Challenge Cup Regatta, July 30th, won by **WILLIE** again.

1887. Annual Regatta, June 16th, won by sloop **WILLIE** in the second class. 3 hrs., 40 min., 29 sec., sailing time.

Challenge Cup Regatta, July 14th, won by sloop **WARREN**, 2 hrs., 40 min., 56 sec., sailing time.

Challenge Cup Regatta, August 3rd, second class sloop **WILLIE**, 3 hrs., 18 min., 36 sec. Winning.

1888. Annual Regatta June 16th, second class sloop **GENEORA**, 3 hrs., 50 min., 42 sec. Winning.

1889. Annual Regatta, July 15th, second class sloop **WILLIE**, 3 hrs., 38 min., 15 sec. Winning.

1890. Annual Challenge Cup Regatta, July 16th, won by sloop **GENEORA**, in the second class, 3 hrs., 10 min., 1 sec.

Interest was also stimulated during this season by the presentation to the club of the Mallett Cups as prizes for a Special Regatta, open to yachts of the **MASSACHUSETTS** and **PORTLAND YACHT CLUBS**, the race to be held over the Portland course and subject to the rules of the latter association. The prize for the first class was won by **MONHEGAN** of the **PORTLAND YACHT CLUB** and of the second class by the sloop **SILARK** of the **MASSACHUSETTS**.

There was also a regatta on July 4th, for prizes given by the City of Portland, **MONHEGAN** winning in the first class, and the second and third class prizes going outside the club.

1891. Annual Race, June 11th, won by second class sloop **GENEORA**, 3 hrs., 27 min., 36 sec. Since this time **GENEORA** has been sold and the cups are now all in possession of the club.

1892. No regatta was held.

SEASON OF 1893.

The Annual Challenge Cup Race was sailed June 19, 1893, over an 18 mile course. The wind was from the southwest and moderate.

The following yachts competed:

	SLOOPS.		
	Length. Ft. in.	Elapsed Time. H. M. S.	Corrected Time. H. M. S.
Second Class.			
Chaos	37 03	4 51 20	4 11 42
Lella	25 01	6 00 05	5 08 22

Race was given to **LELLA** on account of disobedience to rules by **CHAOS**.

ACCORDING TO THE RULES AND REGULATIONS GOVERNING CHALLENGE CUPS.

The yachting season for all matches and races shall be limited to the period between the 15th of May and the 1st of October of each year. It shall be optional with the yacht holding the cup, to accept a challenge received between September 10th and the next annual regatta for Challenge Cups.

Once each season there shall be a Regatta for Challenge Cups, open only to yachts enrolled in the club, over the course named herewith and subject to the club regulations with time allowance. The date of this regatta shall be subject to a vote of a majority of yacht owners present at the annual meeting.

A cup will be awarded the yacht making the best standard time in each class, to be held subject to challenge.

A yacht winning the cup in three consecutive regattas, and holding it during the third season, shall be entitled to the ownership of the same, provided the cup has not been won during that time by any other yacht in a Challenge Race.

Any time after the Annual Regatta for Challenge Cups, or a challenge race, the winning yacht must accept any written challenge—the race to be sailed within twenty days—and within three days of receipt of challenge must name the hour and date of race. The race not to be sailed until three days from receipt of challenge. A cup-holder accepting a challenge must immediately notify, in writing, the Chairman of the Regatta Committee, stating the hour and date of the race.

Any yacht failing to accept a challenge as above, shall return the cup to the Secretary of the club. This cup shall be again sailed for by the several yachts of the class to which it pertains at the next Annual Regatta for Challenge Cups, or at any date agreed upon by the yacht owners in that class.

In each class each yacht shall be allowed to challenge the yacht winning the cup at the Annual Regatta but once during the season.

The winning yacht in a challenge race shall be subject to one challenge that season from each yacht in its class.

In order to win a Challenge Cup, two or more yachts of each class must start in the Annual Regatta, and in case only one yacht starts, the cup shall be held by her subject to challenge, and if no yacht starts, the cup shall be returned to the Secretary of the club, subject to the rule "failing to accept a challenge."

A cup holder failing to have a competitor at an Annual Regatta shall not thereby lose the credit of having won the cup at any previous Annual Regatta, provided it has not been won from her since that Annual Regatta.

Any yacht holding a Challenge Cup subject to challenge, leaving the club for any cause, must return the cup to the Secretary of the club, and the same shall be subject to the rule "failing to accept a challenge."

In case of change of owners of a yacht, the cup will follow the yacht as long as she be enrolled in the club.

The starting signal shall be given by the Regatta Committee or by some one designated by them.

Yachts will start from anchorage, or make a flying start as may be agreed upon by the participants. In case of non-agreement the Regatta Committee shall decide. No yacht will anchor to the eastward of the line.

The officers elected in March for 1892 were as follows

Commodore, Charles W. Bray; Vice-Commodore, Walter Woodman; Fleet Captain Wm. Willis Gould; Secretary Chas. F. Flagg; Treasurer, C. F. A. Weber; Measurer, Joseph H. Dyer; Fleet Surgeon, Chas. D. Smith, M. D.

Regatta Committee: The Commodore, ex-officio; Abiel M. Smith, R. Samuel Rand, Willis E. Carter, Wendel Kirsch.

The officers for 1893 were as follows:

Commodore, Chas. W. Bray; Vice-Commodore, Walter Woodman; Fleet Captain, Wm. Willis Gould; Secretary, Chas. F. Flagg; Treasurer, C. F. A. Weber; Measurer, Abiel M. Smith; Fleet Surgeon, Chas. D. Smith, M. D.

BIOGRAPHICAL SKETCHES AND DESCRIPTION OF YACHTS ENROLLED IN THE CLUB.

CHARLES W. BRAY, M.D., Commodore of the PORTLAND YACHT CLUB, merchant, Portland, Maine; was born in Naples, Maine, August 5, 1850, the son of Washington and Catherine J. Bray. His present yacht is the screw schooner **MAYLAND** (built for him), though he has also owned **ELECTRA**, **TEMPUS**, **VIVA** and the steamer **MAGGIE**. He has been a yachtsman for twenty years and has held his office of Commodore for six years, also having been Fleet Surgeon for three years. Dr. Bray stands high in his profession.

MAYLAND.

A screw schooner, designed by Joseph K. Dyer and built by C. B. Harrington of Bath, Maine. She was launched in April, 1890 being built for her present owner, Chas. W. Bray, M.D., of Portland, Maine. She hails from Portland and sails with the PORTLAND YACHT CLUB. See Fig. 543.

Official number, 92,190.

DIMENSIONS.

Length over all,	59 feet.	Length load waterline,	48 feet.
Depth,	6 feet.	Draft,	5 feet 6 inches.
Beam,	10 feet 6 inches.		

Spars: 30 feet, deck to truck.

Engine: Compound condensing vertical, two cylinders, 6½ and 11 x 8 inch. H. R. Stickney. Stroke of piston, 8 inch.

Boiler: Vertical tubular, 3 ft. 9 in. x 6 ft. 6 inch. Quinn & Co. Horse power, about 50. She has shown a speed of 10 miles.



CHARLES F. FLAGG.

CHARLES F. FLAGG, Secretary of the PORTLAND YACHT CLUB, business, marine insurance, Portland, Maine; was born in Kewanee, Illinois, in 1862. His father was Jacob B. Flagg and his mother Louisa F. Forbes. Mr. Flagg has been interested in all pertaining to yachting for some five years and has retained his present official position of Secretary for three years. He is connected with the Portland Lloyds and is well known in business circles.

DOROTHY Q.

A keel schooner owned by Walter Woodman, M.D., of the PORTLAND, EASTERN and MASSACHUSETTS YACHT CLUBS, and a resident of Cambridge, Mass. **DOROTHY Q.** was originally called **ANNIENNE**, then **THONA** and finally she was given her present name. She was designed and built by Lawley for Jacob Pfaff and was launched in 1879. Woodman has owned her since 1889. She has been owned also by R. H. Harding and Edmund Quiney. Was lengthened three feet by Lawley in 1880. A keel yacht and hails from Portland, Maine. See Fig. 544. Official number, 105,834.

DIMENSIONS.

Length over all,	48 feet 4 inches.	Length load waterline,	42 feet.
Draft,	7 feet 5 inches.	Beam,	14 feet 4 inches.

Regatta Committee or

as flying start as may be
non-agreement the Re-
anchor to the eastward

as follows

odore, Walter Wood-
etary Chas. F. Flagg;
H. Dyer; Fleet Sur-

elo; Abel M. Smith,
esch.

ore, Walter Woodman,
Chas. F. Flagg; Treas-
smith; Fleet Surgeon.

UB.

LAGG, Secretary of
YACHT CLUB, busi-
ness, Portland, Maine;
Chicago, Illinois, in 1862.
John B. Flagg and his
Forbes. Mr. Flagg
in all pertaining to
years and has re-
sidential position of Sec-
retary. He is connected
with the Lloyds and is well
known.

M.D., of the Port-
land, and a resident
of the city called ADRENNE,
at name. She was
launched in 1879.
She was owned also by R.
and measured three feet by
Portland, Maine. See

42 feet,
14 feet 4 inches.

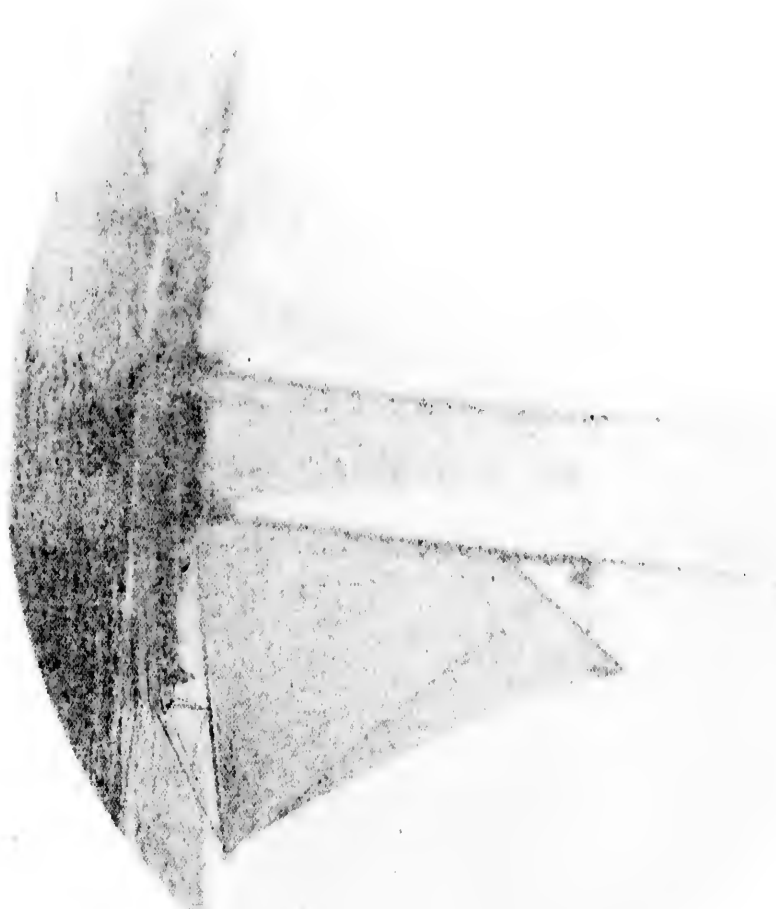

the Regatta Committee or

take a flying start as may be
of non-agreement the R.
will anchor to the eastward

ere as follows

Commodore, Walter Wood
Secretary, Chas. F. Frazier
Joseph H. Dyer; Fleet Surgeon

Staff Surgeon, Amos M. Smith
J. Kirsh.

Commodore, Walter Wood
Secretary, Chas. F. Frazier
J. Smith; Fleet Surgeon.

CLUB.

F. H. V. G., Secretary of
the Yacht Club, based
in Portland, Maine,
Lawrence, Illinois, in 1892.
Jacob B. Frazier and his
E. F. S. Mr. Frazier
and in all particulars to
be five years and in a
of official in the office of
years. He is connected
and in well

Dr. M. D. of the Port
of the Club, in 1892
1892. The ship was
and was launched in 1892
has been owned also by R.
of the Club, in 1892. See
in Portland, Maine. See

later in the year.

ARETHUSA.

PLATE LXXI.

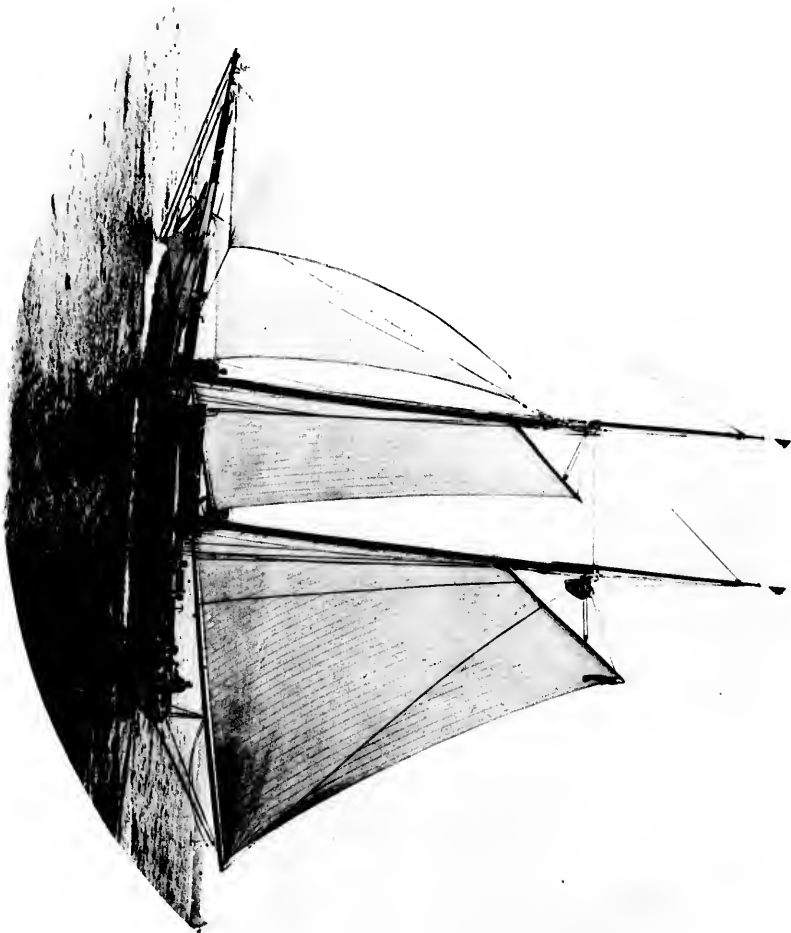

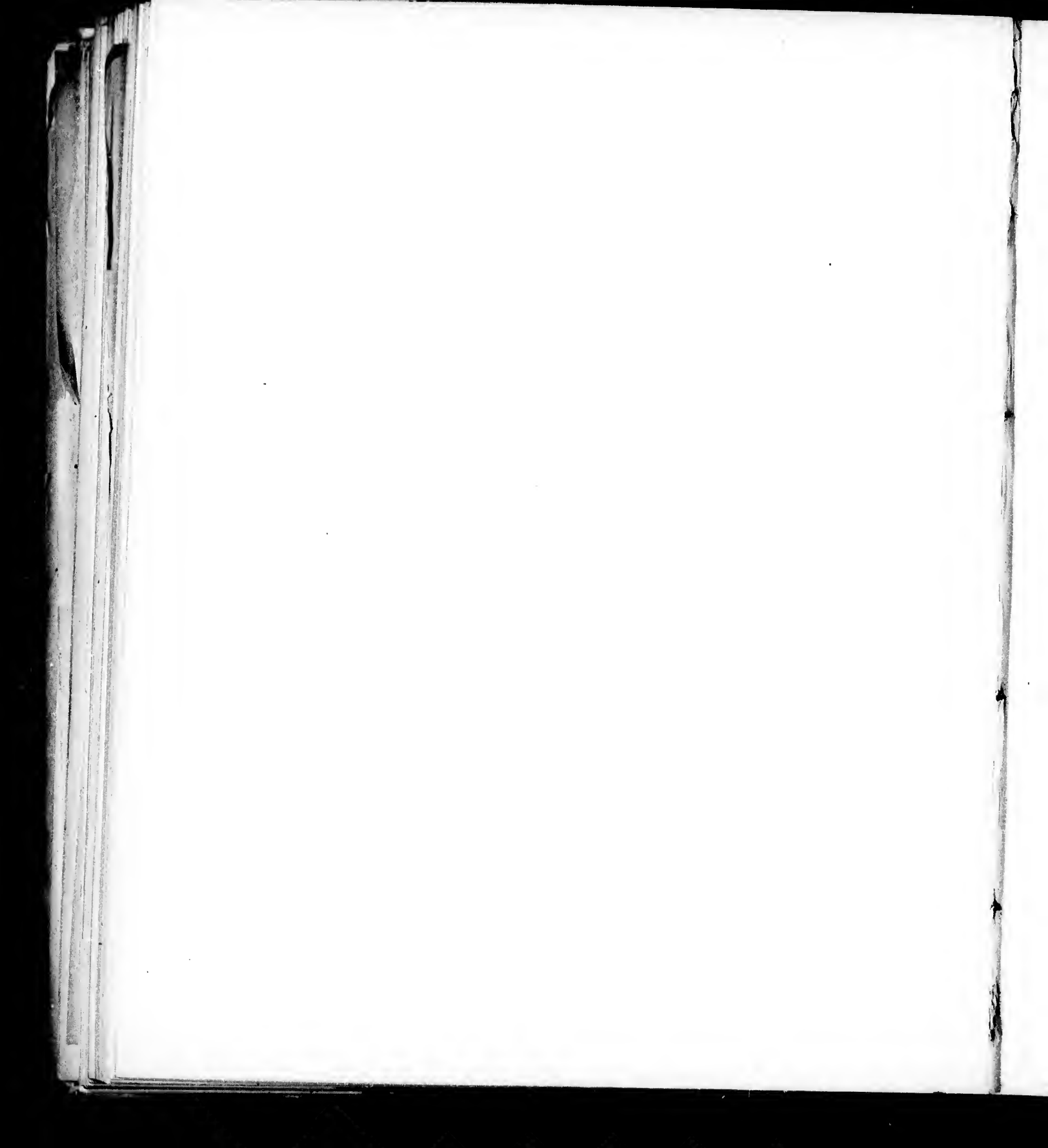



COMMODORE J. E. GUNKLE,

OHIO YACHT CLUB.

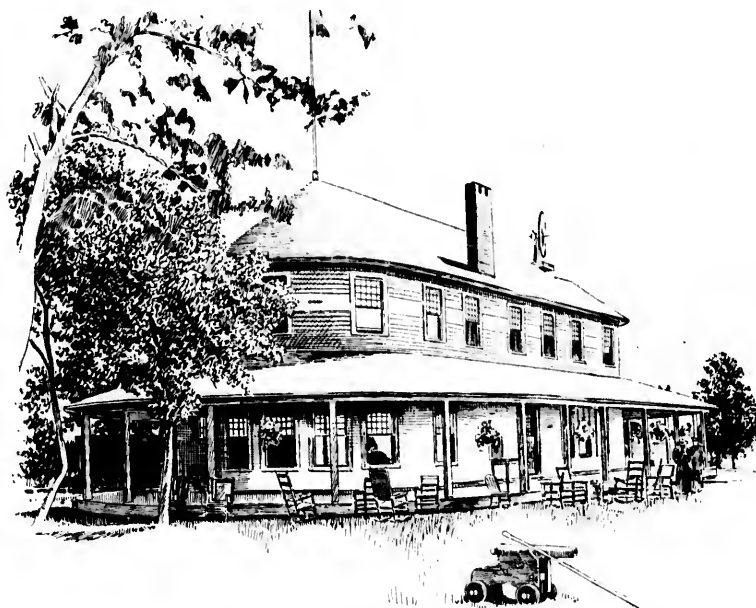

OHIO YACHT CLUB HOUSE.

History of the Ohio Yacht Club.

THE first meeting of the OHIO YACHT CLUB was held October 16, 1885, at the office of George W. Ketcham, who afterwards brought to Toledo the largest sailing yacht ever on Lake Erie. SPERANZA. There were only a few gentlemen present, D. R. Locke, G. H. Ketcham, George W. Bills, T. C. Purney, Henry Tracy and John C. Thompson. It was decided to make the capital stock \$25,000, shares \$10 each, and no member allowed to hold more than twenty shares.

The next meeting was held on the stage at Wheeler's Opera House. At this meeting there was a great crowd, D. R. Locke, better known to the literary world as Petroleum V. Nasby, presiding. The meeting was most enthusiastic and the curtain was rung down on a strong organization.

The first officers were as follows: Commodore, S. C. Reynolds; Vice-Commodore, Geo. W. Bills; Rear-Commodore, James Dority; Secretary, John E. Guncel (the present Commodore, the writer of stories and the holder of the *Forest and Stream* medal for the "champion fish line" of the United States); Treasurer, Geo. H. Ketcham; Measurer, E. P. Day; Fleet Surgeon, Dr. J. T. Woods.

The membership is now nearly four hundred and the club has a handsome home at Presque Island,—a French name meaning almost

an island—three miles or so from the city on Lake Erie, at the mouth of the Maumee River. The city Club House is in the Marine Building on the river at the foot of Jefferson street, where there are reception rooms, library, gymnasium, bowling alley, theatre, with large stage stocked with scenery where concerts and other performances are given monthly during the winter by and for the members and their lady acquaintances.

These city quarters were opened in the Spring of 1893 with a grand ball. The officers for 1893 were as follows: Commodore, J. E. Guncel; Vice-Commodore, James H. Southard; Rear-Commodore, Henry Tracy; Secretary, Geo. W. Stevens; Treasurer, Frank B. Hartman; Fleet Captain, Geo. L. Craig; Fleet Surgeon, Dr. J. T. Woods.

Regatta Committee: Capt. Charles Hubbard, Capt. C. W. Klausner, Capt. John G. Meilink.

ACCORDING TO THE RULES AND REGULATIONS.

The measurement adopted by this club shall be length on water line, extreme breadth of beam and depth of hold from under side of deck to topside of planking at the foremast.

Yachts shall be classified as follows:

Class A, over 45 feet.

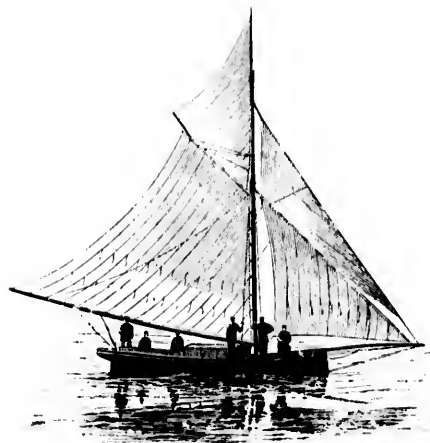

ADDIE.—FIGURE 545.

Class B, over 35 and under 45 feet.
 Class C, 30 feet or over and under 35 feet on the waterline.
 Class D, all boats measuring 25 feet or over and under 30 feet on the waterline.

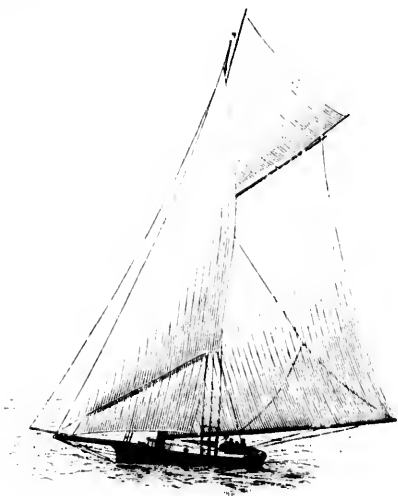

FANCHON.—FIGURE 546.

Class E, 20 feet or over and under 25 feet on the waterline.
 Class F, less than 20 feet on the waterline and over 15 feet.
 The time allowance shall be two seconds for each foot of difference in actual gross measurement for each mile in the course. But in computing the time allowance for schooners four-fifths, and for yawls seven-eighths of the waterline shall be taken in place of the full waterline.

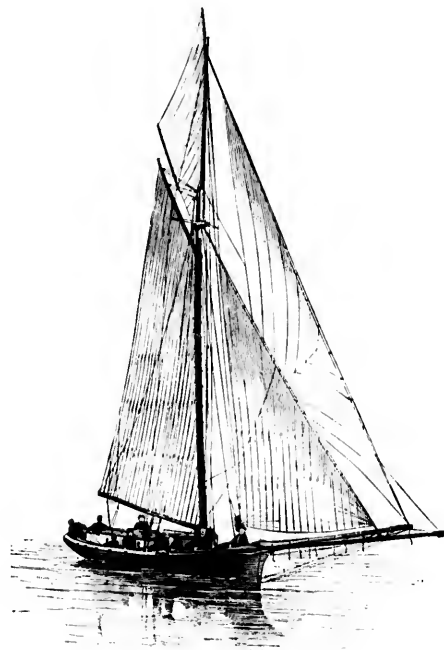

SIGMA.—FIGURE 547.

Yachts shall be allowed to carry one man for each 5 feet of gross measurement, length on waterline beam and depth added.

Any regatta or club race shall be declared off, unless one yacht in the class of 20 feet and upwards shall make the race at the rate of not less than 4 miles per hour, and of the class under 20 feet at the rate of not less than 3 miles an hour.

In 1893 there were only three yachts enrolled in the club, SIGMA, SCUD and IOLANDE, for which see list.

the waterline.
 1 over 15 feet.
 h foot of difference in
 course. But in com-
 -ffths, and for yawls
 in place of the full

LIST OF YACHTS ENROLLED IN THE OHIO YACHT CLUB, 1890.

YACHT.	OWNER.	PORT.	C. B. OR KEEL.	RIG.	LENGTH OVER ALL.		DRAM.	DRAFT	DEPTH AT MAST.
					L. W. L.	H.			
Sigma	S. C. Reynolds	Toledo	k	Stemmer	185.00	155.00	21.00	8.50	...
Speranza, Jr.	Wm. Gates	"	k	"	21.00	21.00	5.06	1.06	2.00
Zetta Belle	H. P. Toley	"	k	Naphtha	25.00	21.00	5.10	.21	...
Speranza	Geo. H. Ketchum	"	k	Schooner	35.00	81.00	21.06	3.66	9.02
Ida Voight	G. L. Butterfield	"	e b	"	19.00	39.00	14.02	2.00	3.00
Faneon	Bills & Curtis	"	e b	Sloop	31.00	32.10	14.00	2.06	2.10
Kate Graham	Dainbridge, Bills & Day	"	e b	"	31.06	31.03	10.10	3.10	3.0
Scud	V. H. Ketchum, Jr.	"	e b	"	10.00	30.01	12.00	1.07	4.00
Ice	Geo. G. Hadley, Jr.	"	e b	"	31.06	29.00	10.06	3.00	4.00
Shamrock	Ed. Mitchell	"	e b	"	30.00	29.06	12.00	3.10	1.06
Sunbeam	H. C. Quiggle	"	e b	"	37.00	28.06	10.00	3.06	4.00
Nelle C.	Edson & Gates	"	e b	Schooner	31.06	27.00	8.06	.20	3.00
Myrtle	M. T. Huntley	"	e b	"	30.00	26.06	8.00	.18	2.00
Charon	Khauser, Kirk & Southard	"	e b	Sloop	35.00	29.00	10.02	2.06	3.06
Pearl	Ed. Schuller	"	e b	"	...	26.07	11.05	...	3.00
Albatross	F. M. Howard	"	e b	"	35.08	27.00	9.08	.26	3.00
Iolanthe	V. W. Granger, Jr.	"	k	Cutter	28.00	23.06	7.03	1.02	...
Cygnat	Frank Purny	"	e b	Sloop	28.00	24.00	9.02	3.00	1.00
Circe	Robert Buchanan	"	e b	Cat	18.00	16.01	7.05	.06	2.00
Red Bird	H. E. Dowd	"	e b	Cat	16.06	15.09	5.10	.06	1.06

each 5 feet of gross
 depth added.
 t, unless one yacht in
 the race at the rate of
 under 20 feet at the

ed in the club, SIGMA,

BIOGRAPHICAL SKETCHES AND DESCRIPTION OF YACHTS ENROLLED IN THE CLUB.

J. E. GUNCKEL, Commodore of the OHIO YACHT CLUB. Commodore Gunckel is one of the most popular men of the club which he has the honor of presiding over as Commodore. He is and has been for years an enthusiastic yachtsman, entering into the sport of yachting with the true yachting spirit. His desire has always been to advance the best interests of the club, which, independent of yachting, partakes of social features during the season.



GEORGE W. BILLS.

GEORGE W. BILLS, ex-Commodore of the OHIO YACHT CLUB, is engaged in the advertising line. Was born in Monroeville, Ohio, April 7, 1830, and is a resident of Toledo. He is the owner of the famous yacht **FANCHOX**, as also the sloop **ANDIE**. Mr. Bills has been for years a follower of the sea, and with his yachting life added, he may lay claim to fifty years of nautical experience. Yet he writes "I am still as fond of the manly sport as the fish is of water, but never too old to learn."

In 1885 Mr. Bills organized the OHIO YACHT CLUB, of which he was two years Commodore, also being Vice-Commodore of the LAKE AND STRAITS YACHTING ASSOCIATION for two years. Is an honorary member of the MICHIGAN YACHT CLUB.

FANCHOX.

FANCHOX is a centerboard sloop owned by ex-Commodore George W. Bills, Toledo, Ohio. She was designed and built by Sutherland Bros., of Marblehead, Mass., for John Doler of Put-in-Bay. **FANCHOX** was launched in 1875. For the past eight years she has been owned by ex-Commodore Bills, hailing from Toledo and sailing with the OHIO YACHT CLUB. She has never been altered and is still exceptionally fast. See Fig. 546.

DIMENSIONS.

Length over all	36 feet 8 inches.	Length load waterline	31 feet 4 inches.
Depth	5 feet.	Draft	2 feet 6 inches.
Beam	12 feet 6 inches.		

Spars : Hoist, 33 feet ; Boom, 31 feet ; Gaff, 18 feet.

RACING RECORD.

The following list of races does not pretend to be a full account of the brilliant record of **FANCHOX** as it embraces only those races sailed under the auspices of the CLEVELAND YACHT CLUB.

July 4, 1880, first prize.

July 4, 1883, first prize, beating **SCUD** and **ALERT**.

July 4, 1884, first prize, beating **LULU** and **SCUD**.

July 16, 1885, first prize, beating **KATE GRAHAM** and **SCUD**.



GEORGE G. HADLEY, JR.

GEORGE G. HADLEY, JR., President of the Phoenix Coal Co., Toledo, Ohio; was born in La Fayette, Indiana, the son of George G. Hadley. His present yacht is **BEE**, though he has also owned the yacht **CLYDE**. Has been a yachtsman for five years and is a member of the OHIO YACHT CLUB.

BEE.

BEE is a centerboard sloop belonging to George G. Hadley, Jr., of Toledo, Ohio. Was formerly owned by parties in Buffalo but passed into the hands of Mr. Hadley in 1887. She was built in 1883, hails from Toledo, and sails with the OHIO YACHT CLUB.

DIMENSIONS.

Length over all	31 feet 6 inches.	Depth	6 feet.
Draft	3 feet.	Beam	10 feet 6 inches.

SIGMA.

The iron screw schooner **SIGMA**, owned by Col. S. C. Reynolds of Toledo, Ohio, was built in 1883 by John Craig. She hails from Toledo and sails with the NEW YORK and OHIO YACHT CLUBS. See plate XC.

Official number, 115,931.

Length over all	151 feet.	Length load waterline	130 feet.
Depth	9 feet 2 inches.	Draft	4 feet.
Beam	21 feet.		

Engine : Compound inverted, two cylinders, 16 and 24 x 28 inch. Boiler : 13 x 8 feet ; built by the Trenton Building Co., Trenton, Michigan.

SCUD.

SCUD is a centerboard sloop belonging to V. H. Ketcham, Jr. She hails from Toledo and sails with the fleet of the OHIO YACHT CLUB. See Fig. 547.

DIMENSIONS.

Length over all	40 feet.	Length load waterline	30.04 feet.
Depth (at mast)	4 feet.	Draft	4 feet.
Beam	12 feet.		



HENRY TRACY.

HENRY TRACY, manufacturers' agent, Toledo, Ohio, was born in Pittsfield, Mass., in the year 1835. He is the Rear-Commodore of the OHIO YACHT CLUB, which office he has held for three years, having also been Vice-Commodore for two years. He was one of the founders of the OHIO YACHT CLUB in 1885, and has been connected with yachting interests for thirty years. Has been the owner of the yachts **LIZZIE** and **BESSIE DOYLE**.

JB.

OLEY, Jr., President
x Coal Co., Toledo,
La Fayette, Indiana,
Hadley. His present
he has also owned
has been a yachtsman
is a member of the

E.
rd sloop belonging to
r., of Toledo, Ohio.
by parties in Buffalo
7. She was built in
O YACHT CLUB.

6 feet.
10 feet 6 inches.

l. S. C. Reynolds of
g. She hails from
OHIO YACHT CLUBS.

waterline, 130 feet.
8 feet.

16 and 24 x 28 inch.
ilding Co., Trenton.

V. H. Ketcham, Jr.
of the OHIO YACHT

waterline, 30.04 feet.
4.07 feet.

manufacturers'
Ohio, was born in
the year 1835. He
dore of the Ohio
office he has held
ing also been Vice-
years. He was one
the OHIO YACHT
has been connected
ists for thirty years.
of the yachts LIZZIE

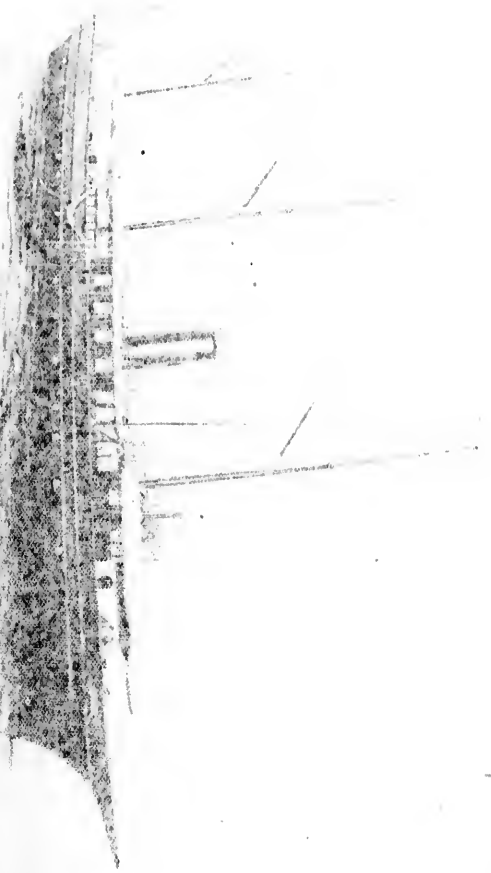

DESCRIPTION OF YACHTS ENROLLED IN THE CLUB

YACHT NAME: [Faint text]

TYPE: [Faint text]

REGISTERED AT: [Faint text]

OWNER: [Faint text]



YACHT NAME: [Faint text]

TYPE: [Faint text]

REGISTERED AT: [Faint text]

OWNER: [Faint text]



GEORGE G. HADLEY, Jr., President of the Phoenix Club, Toledo, Ohio, was born in Leavette, Indiana, the son of George G. Hadley. His present yacht is *Bibi*, though he has also owned the yacht *Crystal*. His first yacht was built in 1885 and is a member of the Ohio Yacht Club.

Bibi is an afternoon schooner belonging to George G. Hadley, Jr., of Toledo, Ohio. Was formerly owned by James R. English and passed in to the hands of Mr. Hadley in 1885. She was built in Toledo from Toledo and sails with the Ohio Yacht Club.

REGISTERED AT: Toledo, Ohio
 TYPE: Schooner
 LENGTH: 30 feet
 BEAM: 6 feet
 DEPTH: 4 feet

STOMA, an afternoon schooner owned by Col. S. J. Bayliss, Toledo, Ohio, was built in 1883 by John Cairn, St. Louis, Mo. It is registered with the New York and Ohio Yacht Clubs.

REGISTERED AT: Toledo, Ohio
 TYPE: Schooner
 LENGTH: 30 feet
 BEAM: 6 feet
 DEPTH: 4 feet

W. H. KETLUM, Jr., Toledo, Ohio, was born in [Faint text]. He is registered with the Ohio Yacht Club.

REGISTERED AT: Toledo, Ohio
 TYPE: Schooner
 LENGTH: 30 feet
 BEAM: 6 feet
 DEPTH: 4 feet

HENRY TRACY, Toledo, Ohio, was born in [Faint text]. He is registered with the Ohio Yacht Club.



HENRY TRACY, Toledo, Ohio, was born in [Faint text]. He is registered with the Ohio Yacht Club. He has been a member of the club for thirty years. He is the owner of the yachts *Lizzie* and *Dora*.

[Faint text describing other yachts and club members, including names like 'Lizzie', 'Dora', and 'Crystal'. The text is mostly illegible due to fading.]

Dr. J. V. Jr. President
 of the Ohio Yacht Club, Toledo,
 Ohio. He has been
 a member of the

... belonging to
 ... Ohio
 ... built in
 ...

... inches
 ...
 ... from
 ...

...
 ...
 ...

V. H. Koshman, Jr.
 of the Ohio Yacht

... feet
 ...

... was born in
 ... 1865. He
 ... the Ohio
 ... he has held
 ... Vice
 ... He was one
 ... of the Ohio Yacht
 ... for thirty years.
 ... the yachts Lizzie

SIGMA.

PLATE XC.

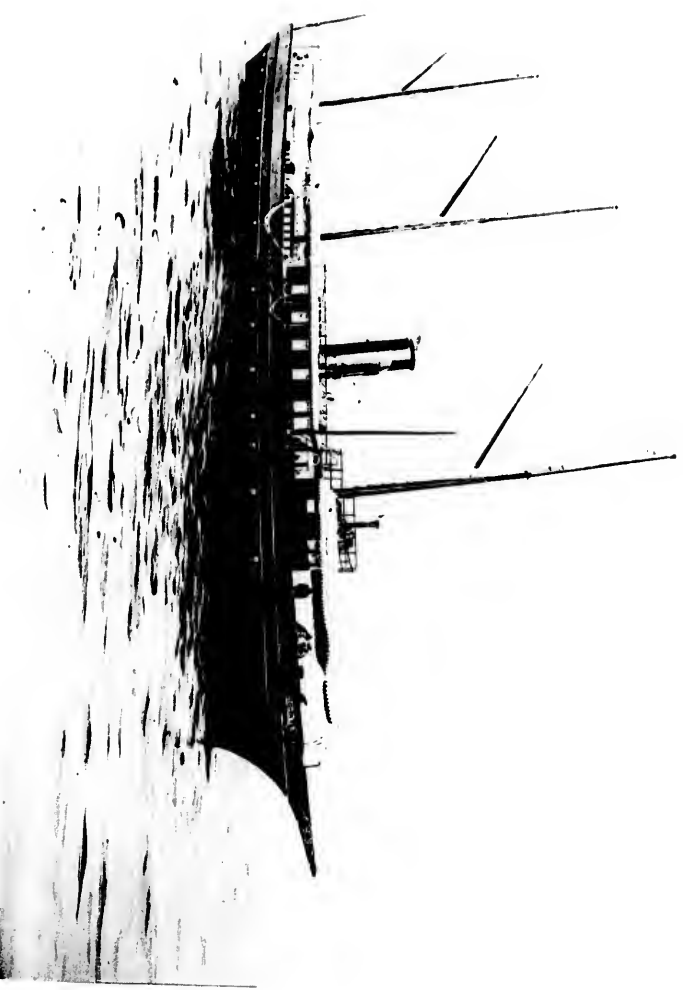





GIORIANNA.

PLATE LXXII.

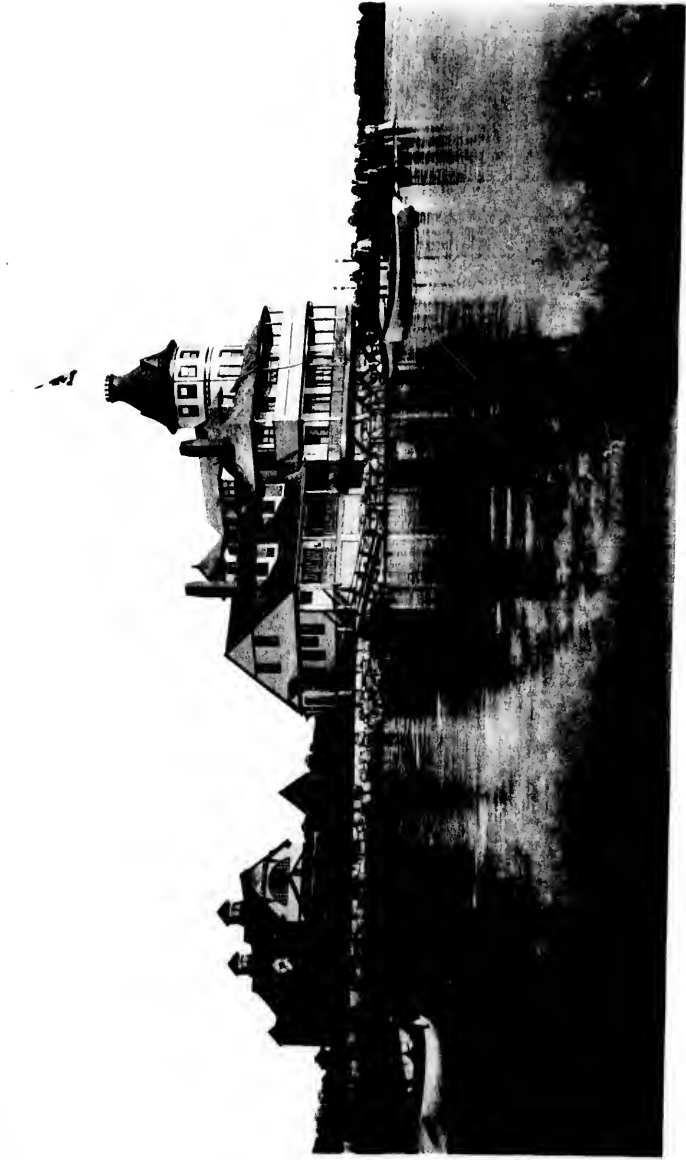

RIVERSIDE YACHT CLUB HOUSE.

RIVERSIDE YACHT CLUB HOUSE.

O

1911

1912

1913

1914

1915

1916

1917

1918

1919

1920

1921

1922

1923



VIEW OF ST. JOHN'S CHURCH

History of the Riverside Yacht Club.

ON the evening of May 25, 1888, Messrs. Geo. I. Tyson, Gilbert Potter, Wm. A. Hamilton, P. S. Schutt, Jos. E. Peck, John G. Porter, F. F. Friedman and P. C. Balli met at the residence of Mr. Geo. I. Tyson in Riverside, Conn., and the RIVERSIDE YACHT CLUB was organized. For four years previous the yacht club had been formed in Greenwich, Conn., and each year had proved a failure, so the above named residents of Riverside solved to start a club of their own. Messrs. Geo. G. Tyson, Alex. S. Williams and John F. Hamilton were also original members. The officers for the year 1888 were:

Commodore, Geo. I. Tyson; Vice-Commodore, P. S. Schutt; Rear-Commodore, W. A. Hamilton; Secretary, P. C. Balli; Treasurer, Jos. E. Peck; Measurer, John G. Porter.
Trustees: G. Potter, G. G. Tyson and J. F. Hamilton
Membership Committee: F. F. Friedman, W. A. Hamilton and P. S. Schutt.

The initiation fee was placed at \$10 and the annual dues \$10. Commodore Geo. I. Tyson offered to build a house for the club, building commenced during the Summer. Plans were drawn and the club had 22 members, and on February 6, 1889, was duly incorporated under the laws of the State of Connecticut. On Thursday, June 27, 1889, the new Club House was formally opened. A reception was given and over two hundred people attended.

The First Annual Regatta was sailed on Saturday, July 6, 1889, open only to club members. (See 1889 Record of Races.)

The club having decided to hold a Ladies' Day Regatta each year, the first was sailed Saturday, September 2, 1889. (See Record of Races.)

The First Pennant Regatta was sailed Saturday, September 21, 1889. (See Record of Races.)

The Second Annual Regatta was sailed Saturday, July 12, 1890.

The Second Annual Ladies' Day Regatta was sailed August 23, 1890. The wind blew a half gale from the northwest.

The Second Annual Pennant Regatta was sailed in almost a calm on Saturday, September 20, 1890.

The Third Annual Regatta was sailed Saturday, July 11, 1891, and for the first time was open to other clubs, the result being so satisfactory that it was resolved in the future to hold only Open Regattas.

Winners: Schooner, NIRVANA; sloops, ALCEDO, DOCTOR, VORANT, NAMELESS, MEROPE, DOT; cabin cut, NAHMA; open cut, TATTLE, ZELICA, Special Class, CHIPPAWAY.

The Fourth Annual Regatta was sailed Saturday, July 9, 1892. Winners: NIRVANA, PEERLESS, ELEANOR, ALCEDO, MEROPE, AURA, ALMIRA, NAHMA, TATTLE, WILMERAD, GERTRUDE and PHYLLIS.

The Fifth Annual Regatta was sailed Saturday, July 8, 1893. A good whole sail breeze from southwest.

Winners: ELEANOR, MOCCASIN, KATHLEEN, VORANT, PIXIE, AFDAX, ALMIRA, TARTHA, GERTRUDE.

In the Spring of 1891 Commodore Tyson built the horse sheds and spar lofts, and in 1892 the bowling alley 30x125 feet, with room for shuffle boards and billiard tables and a dormitory above for the servants, and in 1893 the new Club House was finished. It is through the liberality and energy of Commodore Tyson that the club

stands to-day in its high position and without a dollar of indebtedness.

In 1889 and 1890 the dues and initiation fees were increased and at present are—initiation fees \$25, dues \$15. The RIVERSIDE YACHT CLUB does not confine itself strictly to yachting. Every Saturday night during the season an entertainment is given in the Club House and in the latter part of July the Midsummer Ball is held. Ladies are always welcome.

Situated as the house is on the east bank of the Mianns River and near the sound, it is a rendezvous for the members living within 5 or 10 miles of the house. The new building contains sixteen sleeping rooms, meeting and model rooms, a private room for the ladies, kitchen, &c. Commencing with eleven members in '88, the club now numbers one hundred and seventy-five, and has enrolled 3 steam yachts, 4 schooners, 35 sloops, 9 cabin-cats, 11 open cats, and 10 daphnia launches.

The officers for 1891 are:

Commodore, Geo. I. Tyson, schooner NIRVANA; Vice-Commodore, Henry F. Crosby, sloop ERIOLON; Rear-Commodore, C. E. Jos. E. Peck; Measurer, E. Frank Lockwood.
Trustees: Aug. M. Brush, C. T. Pierce, Geo. G. Tyson, C. E. Dieffenhauer, C. E. Wilson, J. H. Redman, H. H. Tyson, E. H. Burtis.

Regatta Committee: C. T. Pierce, C. Olmstead, W. J. Sellock.
Membership Committee: S. D. Pierce, W. L. Marks, W. H. Redman.

ACCORDING TO THE RULES AND REGULATIONS.

CLASSIFICATION.

Yachts will be classified on type as follows: schooners, sloops and cutters, yawls, cabin cat-boats, open jib and main-sail boats, open cat-boats. Cabin yachts shall be classified according to their racing length and open yachts according to their actual load waterline length, as follows:

- 100 foot Class.—Measuring over 90 feet and not over 100 feet.
- 90 foot Class.—Measuring over 80 feet and not over 90 feet.
- 80 foot Class.—Measuring over 70 feet and not over 80 feet.
- 70 foot Class.—Measuring over 60 feet and not over 70 feet.
- 60 foot Class.—Measuring over 50 feet and not over 60 feet.
- 50 foot Class.—Measuring over 40 feet and not over 50 feet.
- 40 foot Class.—Measuring over 35 feet and not over 40 feet.
- 35 foot Class.—Measuring over 30 feet and not over 35 feet.
- 30 foot Class.—Measuring over 25 feet and not over 30 feet.
- 25 foot Class.—Measuring over 20 feet and not over 25 feet.
- 20 foot Class.—Measuring over 20 feet and under.

ALLOWANCE FOR RIG.

In mixed races, schooners shall be rated at eighty-five per cent. of their racing length, and yawls at ninety-three per cent. of racing length.

MEASUREMENT.

SEC. 1. Cabin yachts shall be measured and rated for time allowance and classification according to the following method:

To the square root of the sail area, add the load waterline length and divide the sum by two.

$$\frac{\sqrt{S. A.} + L. W. L.}{2} = R. L.$$

The result is the measurement, and shall be known as Racing Length.

(a) The measurement shall be obtained as follows: A base line shall be taken from a point midway between the jib topsail stay and the jib stay on the bow-sprit, or between the flying jib stay and jib topsail stay on the jibboom, in a straight line to the end of the main-boom.

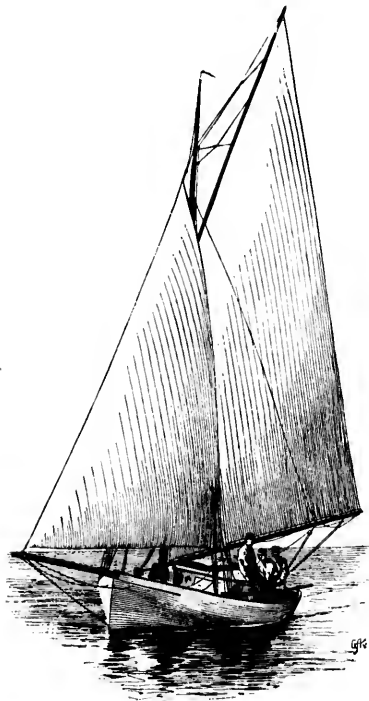

ALMA.—FIGURE 548.

To this measure shall be added that length of main gaff which will remain after 80 per cent. of the length of topmast has been subtracted from it. The gaff, for this purpose, shall be measured from the after side of the mast to the end, and the topmast from hounds to the lower side of sheave in topsail halliard block. In vessels which carry no topmast the distance between the center of the eye in the throat halliard band, and that of the upper peak halliard band shall be deducted from the length of the gaff and the difference added to the base line. The length of the base line as above defined shall be modified in any case where the spinnaker boom measures more than the distance from the fore side of foremast in a schooner, or mainmast in a single-masted vessel, to the forward point of base line as previously defined. Any excess in the length of the spinnaker boom beyond this point shall be added to the base line. The length to be measured for spinnaker boom shall be the extreme distance, when in

use, of its outer end from the center of the fore side of the mast on which it is carried.

For yawls the base line shall be taken from the same point forward as in vessels of other rig, to the after end of the mizzen boom.

In yachts which carry no head sail, the forward point of measurement for the base line shall be the after side of the mast, or of the foremast, if there shall be more than one mast.

(b) A perpendicular line to be taken along the afterside of the mainmast from the under side of the sheave for gaff topsail halliard to upper side of boom, when resting on the saddle, or on the lowest part of goose-neck, the distance of which point from main-deck or horse-deck shall be recorded by the Measurer, together with the other points used in measurements.

In yachts which carry no topmast, the upper point of measurement for the perpendicular shall be the center of the eye in the upper peak halliard band.

To obtain the estimated area from these figures, multiply the base by the perpendicular and divide the product by two.

Length on the load waterline is the distance in a straight line between the points furthest forward and furthest aft where the hull, exclusive of any portion of the rudder or rudder-stock, is intersected by the surface of the water, and is to be ascertained when the yacht is afloat and in ordinary trim, and with the crew, if aboard, stationed amidship. The Measurer, at the time of making his measurement, to fix a distinctive mark at each point.

The measurement of open yachts for the time allowance and classification shall be the length on the load waterline.

SAILS.

Yachts in races may carry the following sails:

Schooners:—Mainsail, foresail, forestaysail, jib, flying-jib, jibtop-sails, fore and main gaff topsail, main topmast staysail and spinnaker.

Sloops and Cutters:—Mainsail, forestaysail, jib, flying-jib, jibtop-sail, gaff topsail and spinnaker.

Open Sloops:—Jib and mainsail.

Cut-Boats:—Mainsail.

No topsail shall hoist above the truck, nor extend more than one foot beyond the peak of the sail above which it is set. Spinnakers shall be triangular in shape, and shall not hoist above the truck, nor extend beyond the end of the spinnaker boom.

FITTINGS, BALLAST AND TRIM.

After the preparatory signal, no ballast shall be taken on board or out of any yacht; nor shall any water be started from or taken into the tanks or other receptacles for the same on such yacht. All ceiling and bulkheads on cabin yachts must be kept on board and in their places. No ballast or article of weight shall be shifted on any cabin yacht. No booming out of ballast will be allowed. Shifting of ballast shall be allowed only on open yachts.

BOATS AND BUOYS.

All yachts of over 50 feet racing length in races shall carry on deck a serviceable round bottom boat, with oars and rowlocks or tholepins lashed in, 12 feet or over in length; on boats over 40 feet racing length and not over 50 feet racing length, one 10 feet or over in length. All yachts in races shall carry on deck, aft of main companion-way, two serviceable cork ring life buoys, each at least 27 inches in diameter from outside to outside, ready for immediate use.

CREWS.

All cabin yachts may carry in addition to the helmsman, one man for every 5 feet of length over all or fraction thereof.

All open yachts may carry in addition to the helmsman, one man for every 3 feet of length over all or fraction thereof.

Yachts of 25 feet racing length and under must be steered by a

member of this club or by some other amateur and be manned by amateurs.

All yachts must carry throughout the race the crew with which they started.

COURSES.

COURSE 1. From a line marked by two stake boats anchored southwest of Captain Knapp's Island (and well off shore), to the Black Buoy off eastern point of Little Captain's Island, keeping same on the starboard, thence to and around Black Buoy (or stake boat) off Matinecock Point, keeping same on the port hand, thence to and around Black Buoy (or stake boat) off Center Island, keeping same on the port hand, thence home, keeping Flat Neck Buoy on the starboard and the Black Buoy off eastern end of Little Captain's Island on the port. The starting line will mark the finish. Distance 17 miles.

COURSE 2. From the same starting line to Flat Neck Buoy, keeping same on the port hand to the Cow's Buoy off Shippan Point, keeping same on the starboard hand in rounding to a stake boat anchored 3½ nautical miles southwest west of this buoy and keeping stake boat on starboard hand in rounding to Flat Neck Buoy, keeping same on starboard hand, thence to starting line which will mark the finish. Distance 11 nautical miles.

COURSE 3. From a line marked by stake boat off the Club House, to and around stake boat off southwestern end of Captain Knapp's Island, keeping same on the port, thence to and around Flat Neck Red Buoy, keeping same on the starboard, thence to and around Red Buoy off western end of Captain's Island, keeping Black Buoy and islands on the starboard, thence home, going to westward and northward of Red Buoy off Comorant Reef. In returning, Captain Knapp's Island must be kept on the starboard. Sunk Rock to be left to the eastward both going and coming. The starting line will mark the finish. Distance 8 miles.

COURSE 4. From a line marked by a stake boat at or near Flat Neck Buoy 10 miles to leeward or windward and return.

COURSE 5. From a line marked by a stake boat at or near Flat Neck Buoy 5 miles to leeward or windward and return.

START AND FINISH.

All starts shall be flying. The time of the start and finish shall be taken when the point marked by the foremast in schooners and the main mast in single-masted vessels and yawls crosses the given line. But if this point in any yacht shall be across the line when the signal for the start in her class is made, she must return and re-cross the line, and in so returning or when working in a position from the wrong side of the line after the signal for the start has been made, must keep clear of and give way to all competing yachts.

The signals shall be as follows:

First: A red rectangular flag with a white square in the center, displayed from the forward flag-staff of the Regatta Committee's boat, as a signal for all yachts to approach the starting line. This will remain hoisted for five minutes.

Second: A large white ball substituted for the red flag, as a signal for all yachts to start. This will remain hoisted for ten minutes.

Third: The club flag substituted for the white ball, as a signal that the time for crossing the line has elapsed. This will be left flying. Attention shall be called to each of these signals by a gun. All yachts must cross the starting line during the time the white ball is hoisted, and any yacht that does not do so within that time shall be timed from the lowering of the white ball. In case any gun should miss fire, the hoisting of the signals shall be deemed sufficient notice. Should the Regatta Committee think it advisable, they may start any classes not more than half an hour before or after the balance of the fleet, in which case a notice to that effect will be posted in the Club House before nine o'clock on the morning of the race.

STAKE BOATS AND MARK BOATS.

All stake boats will display a red and blue ball and after dark will

show a white light suspended over a red light. A competent person shall be placed on the stake boat at the finishing line, whose duty it shall be, in the absence of the Regatta Committee, to take the time of the yachts. Should any stake boat, buoy or other mark, be absent or moved from its proper position during a race, the race may be re-sailed or not, at the option of the Regatta Committee.

TIME OF RACE.

There shall be no limit to the time in which a race is to be sailed unless otherwise stated by the Regatta Committee.

PROVISIONS.

No means of propulsion, except sails, shall be employed during a race.

PROTESTS.

All questions arising by protest or otherwise, in any regatta, and not covered by the racing rules, shall be decided by the Regatta Committee. Any violation of these racing rules and regulations in any

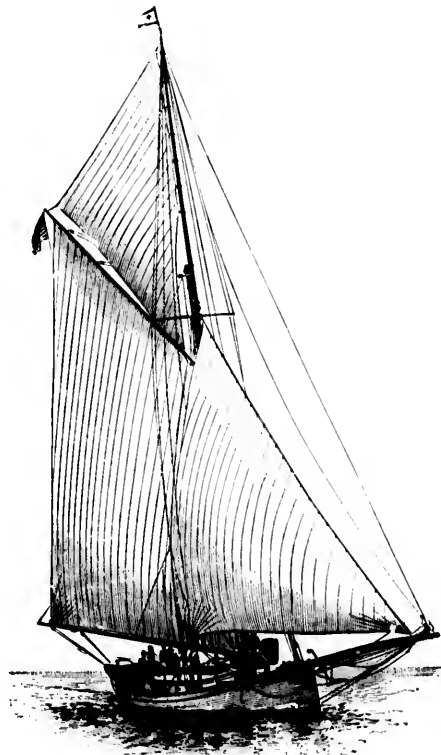

ALBEO. — FIGURE 519.

regatta shall be reported immediately after the regatta to the Regatta Committee, and all protests must be filed in writing with them before six o'clock of the day following the day of the regatta. If through protest the measurement of any yacht be called in question the Regatta Committee shall direct the Measurer to re-measure such yacht and the result as reported by him shall be final.

PRIZES.

At least two yachts in a class must start with full intention of completing the course or no prize will be awarded in that class.

DECLARATIONS.

Before the owner of a winning yachting can receive the prize, he, or in his absence, the member representing him on the yacht, shall sign a declaration that all the rules were complied with.

TIME ALLOWANCE.

The allowances in this table are based upon the rule accepted by naval architects that, within economic limits, opportunities for speed vary in different vessels as the square roots of their respective lengths. As strong winds are required, however, to give to larger vessels the full extent of their advantage in size, and as such a scale of allowance is not adapted to ordinary Summer racing, 50 per cent. only of the allowance due to the rule is given in the table; and may be stated thus:

Time equals $.5 \left(\frac{3600}{L} - \frac{3600}{l} \right)$; 3600 representing the number of seconds in an hour, L the small yacht, and l the large one.

Practically the formula is $\left(\frac{1800}{L} - \frac{1800}{l} \right)$; five-tenths of 3600 being 1800.



NAIDMA.—FIGURE 550.

RECORD OF RACES.

The First Annual Regatta was held July 6, 1889, over a 17 mile course. The wind was from the southeast and weather was clear. The following yachts entered:

SLOOPS.

Elapsed Time.	Corrected Time.
H. M. S.	H. M. S.

Class A.			
Wayward			
Aleedo	6 46 26		
Class B.			
Vorant	6 37 34		
Emma	6 55 25	6 47 22	

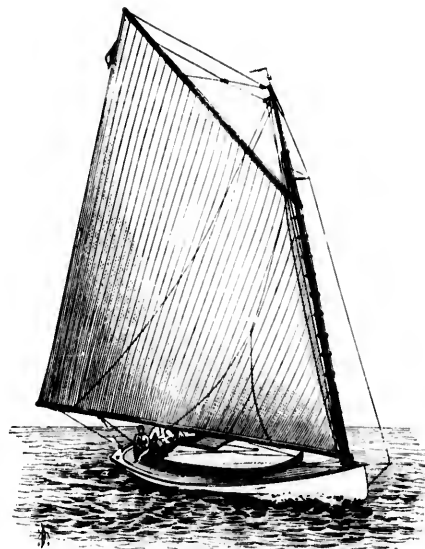

OCONEE.—FIGURE 551.

OPEN SLOOPS.

Siren	2 26 46
-------	---------

CABIN-CATS.

Dot	2 24 20
Zanth	2 36 30
	2 45 25

Class 3.

Rival	2 29 14
Lassie	2 51 07

Class 4.

Telephone	3 17 55
Pearl	3 00 20
	2 57 28

The Ladies' Day Regatta was held September 2, 1889, over a 12 mile course. The wind was from the southwest and the weather clear. The following yachts took part:

SLOOPS.

Class A.	
Eleanor	3 11 32
Class B.	
Wayward	
Aleedo	3 13 05
Class C.	
Vorant	3 30 49

Speed
Time,
M. S. Corrected
Time,
M. S.

20

34

25 6 47 22



6

9

10 2 35 25

3

7

5

10 2 57 23

1889, over a 12
and the weather

2

5

9

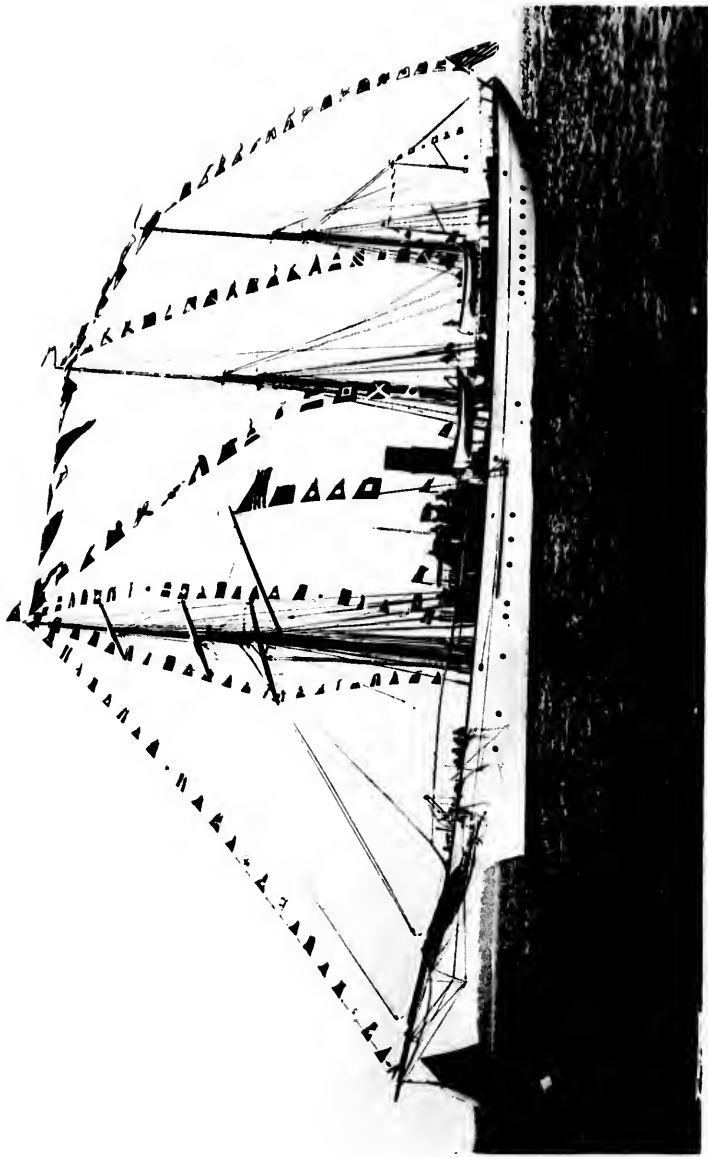

FROM A NEGATIVE BY BOLLES.

PLATE LXXIII

SAGAMORE.



SECRET

THE YACHTS AND YACHTSMEN OF AMERICA.

	CATS.	
	Elapsed Time, H. M. S.	Corrected Time, H. M. S.
Class D, Dot Zanth Siren	1 51 30 1 56 22 1 48 49	1 55 20 1 47 55
Class E, Rival Lassie Zelda	1 55 39 1 51 01 1 44 45	1 41 40
Class F, Telephone		2 05 47

A Pennant Regatta was sailed September 21, 1889, over a 17 mile course. The wind was from the northwest and very strong. The following yachts took part:

	STOOPS.
Class B, Wayward Alcedo Annie H.	3 20 15 3 00 58 3 31 35
Class C, Vorant	did not finish

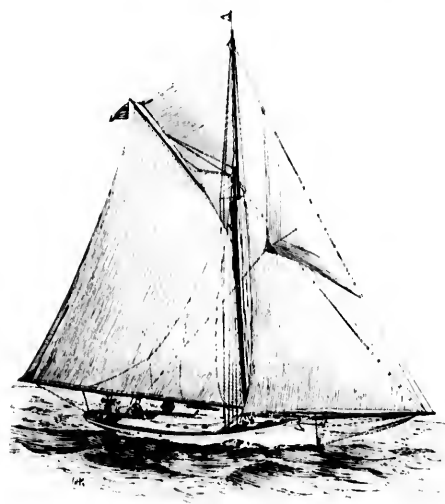

VORANT.—FIGURE 552.

	CUTTER
Class O, Moya	3 29 34
Class D, Dot Zanth Siren	1 44 20 did not finish did not finish
Class C, Lassie	1 59 07

	CATS.		
	Length, Ft. In.	Elapsed Time, H. M. S.	Corrected Time, H. M. S.
Class E, Telephone Pearl Anniece		1 59 25 2 13 55 2 16 12	

The Second Annual Regatta was held July 12, 1890, over a 17 mile course for classes 2, 3, 4 and 5, and 12 miles for class 8. The wind was from the southwest and weather fair. The following yachts took part:

	STOOPS.
Alcedo Wayward Vorant Zanth Pearl Siren	38 00 3 11 18 3 25 22 3 27 13 3 30 49 2 28 14 2 17 11

Ladies' Day Regatta took place August 23, 1890, over a 12 mile course, for classes 2, 3, 4 and 5, and over a 7 mile course for classes 8 and 9. The wind was from the northwest, heavy and squally and the weather was fair. The following yachts participated:

	STOOPS.
Class 2, Eleanor	47 00 2 07 00 2 07 00
Class 3, Alcedo	38 00 2 28 00 2 28 00
Class 4, Doctor	3 02 00 3 02 00
Class 5, Vorant Zanth	30 11 25 01 3 11 20 3 20 05 3 14 20 3 15 02

	CATS.		
Class 8, Dot Siren Pearl	25 06 24 07 24 03	1 02 38 1 07 37 1 01 28	1 02 38 1 07 00 1 00 45
Class 9, Rival Gertrude Lassie	19 11 24 10 19 11	1 16 40 1 05 58 did not finish	1 15 11 1 05 58

The Second Pennant Regatta took place September 29, 1890. The wind was variable, the weather was clear and sea calm. The following yachts participated:

	STOOPS.
Alcedo Doctor Vorant Wayward	3 07 49 3 22 50 3 30 36 3 04 50

	CATS.		
Pearl Dot Gertrude Nahna Lassie	1 49 07 1 15 40 1 51 36 1 51 27 1 55 31	1 47 59 1 15 40 1 49 07 1 51 04 1 54 11	

The Third Annual Regatta took place July 11, 1891. The course for yachts over 30 feet was 17 miles, and for under 30 feet 12 miles. The wind was light from the southwest and weather clear.

	SCHOONER.	
80 Foot Class, Nirvana	71 19 4 04 49 3 49 59	
	SLOOPS.	
45 Foot Class, Alcedo Eurybia Wayward	41 29 40 20 43 82	3 43 32 3 55 21 3 53 06 3 08 54 3 19 28 3 29 46

LIST OF YACHTS ENROLLED IN THE RIVERSIDE YACHT CLUB.

STEAM YACHTS.

YACHT.	OWNER.	Length over all.	L. W. L.	Beam.	Draft.
Katrina	Chas. L. Hubbard	11.00	11.00	11.00	11.00
Onida	E. U. Benedict	73.00	66.00	9.00	8.00
		130.00	121.00	20.00	8.00

SCHOONERS.

YACHT.	OWNER.	Length over all.	L. W. L.	Beam.	Draft.
Claymore	J. Kennedy Todd	11.00	11.00	11.00	11.00
Nirvana	Geo. I. Tyson	30.00	28.00	9.00	1.00
Water Witch	David Banks	82.00	73.00	20.00	8.00
		80.00	78.00	22.00	7.00

SLOOPS, CUTTERS, ETC.

YACHT.	OWNER.	Length over all.	L. W. L.	Beam.	Draft.
Alcedo	Wm. A. Hamilton	43.00	43.00	14.00	6.00
Eleanor	Alex. S. Williams	31.00	47.00	17.00	6.00
Eurybia	Chas. Fryer	47.00	38.10	14.00	6.00
Gannet	E. D. Huribut	29.00	30.00	8.00	4.00
Moya	Wm. E. Bond	30.00	27.00	9.00	5.00
Nirvana	John Moller	59.00	43.00	15.00	8.00
Swannanoa	J. D. Barrett	56.00	47.00	17.00	6.00
Vorint	Geo. G. Tyson	35.00	29.00	12.00	5.00
Wayward	Fred'k Delta	47.00	39.10	14.00	5.00
Whitly	Henry H. Tyson	57.00	50.00	17.00	4.00
Alma	C. E. Diefenthaler	28.00	24.00	10.00	4.00
Emma	E. L. Holly	20.00	20.00	7.00	1.00
Merope	W. S. Gilmore	25.00	24.00	10.00	3.00
Dilemma	Edmund Fish	38.00	26.00	7.00	3.00
Wabnetta	H. E. Doremus
Sanna	Alex. P. Ketchum	45.00	38.00	12.00	6.00
Gael (Sloop)	D. Prentice
Restless	F. I. Stott, B. F. Chester
Gwendoline	W. G. Burton	30.10	18.00	8.00	2.10
Mocasin	N. D. Lawton	53.00	39.00	18.00	6.00
Alice	T. Sawyer, Jr.
Gavilan	C. E. Diefenthaler
La Perichole	C. B. Huchanan
Crocodile	Wm. Osborne	48.00	39.11	14.00	5.00
Beatrix	Wm. Osborne	32.00	22.00	10.00	3.00
Kwo-no-she	Wm. M. Brownell
El Clane (Fin keel)	E. H. Durtin	25.00	18.00	5.00	9.00
La Puce	Wm. M. Brownell	25.00	18.00	5.00	9.00
Eidolon (Sloop)	Henry F. Crosby	56.00	36.00	12.00	7.00

Elapsed Time.
H. M. S.
3 47 22
3 51 45
4 51 51
4 58 00
3 50 40

4 10 11
3 54 15
3 50 21

3 01 51
3 27 41

3 57 25

4 04 48
4 00 00
3 50 15
3 23 09

over a 17 mile
The weather

Corrected
Time.
H. M. S.

2 40 28
2 49 08
not meas.

2 30 51
2 43 37
not meas.
3 03 40

2 51 51
2 50 11
2 50 18
not meas.

2 50 44

3 06 01
3 23 00
finish

2 35 22
2 46 14

2 40 40
2 35 30
2 43 21
not meas.
2 47 12

2 58 11
finish
finish

2 51 40

2 58 51

finish

LIST OF YACHTS ENROLLED IN THE RIVERSIDE YACHT CLUB.

CABIN CAT-RIGGED YACHTS.

YACHT.	OWNER.	Length over all.		L. W. L.	Beam.	Draft.
		ft. in.	ft. in.			
Alhara	John H. Hannan	26 02	25 06			
Anemone	M. F. Plant	31 00	24 06		12 00	2 04
Nahma	Wm. E. Lake, Jr.	21 06	21 00		10 00	2 00
Oneco	Chas. T. Pierce	30 00	24 06		10 00	2 04
Pearl	Gilbert Potter	27 06	24 00		10 00	2 00
Trochu	N. D. Lawton	26 00	21 00	
White Cap	J. H. Lord	27 08	23 10		10 00	2 10
Wenonah	T. T. Taber
Arvika	W. W. Gillman	23 00	18 06		9 00	1 06

OPEN CAT-RIGGED YACHTS.

YACHT.	OWNER.	Length over all.		L. W. L.	Beam.	Draft.
		ft. in.	ft. in.			
Gertrude	Wm. J. Selleck	23 03	20 08		9 07	1 11
Jubilee	E. D. Hurlbut, Jr.	17 06	17 06		8 00	1 06
Phyllis	Frank H. Jones	19 11	19 11	
Virgato	Edgar T. Mead, Jas. C. Lamb	18 06	18 06		8 06	1 03
Florence L.	22 00	18 00		7 06	1 03
Telephone	Geo. J. Bascorn	17 10	17 10		7 06	1 06
Sirene	H. E. Doremus, H. Outwater	24 07	24 07		10 08	1 06
Trump	Wm. C. Boscher
Chippie	H. R. Hatfield	17 09	17 09		7 06	1 06
Whimrad	J. H. Hannan	24 00	21 00	
Tattler	E. R. Hart, Jr.

NAPHTHA LAUNCHES.

YACHT.	OWNER.	Length over all.		L. W. L.	Beam.	Draft.
		ft. in.	ft. in.			
Alice	P. S. Schmitt	25 00	22 00		5 10	2 00
Floesie	E. Frank Lockwood	20 11	18 06 3/4		5 07	1 10
Nordkyn	J. Lawrence Marcellus	40 00	37 00		8 00	3 00
Adele	J. H. Eisner	25 00
Myra	H. E. Doremus	22 09	21 00	
Rita	Geo. Lowther
Anta	Geo. Lowther

Beam.	Draft.
ft. in.	ft. in.
12 00	2 04
12 00	3 00
10 00	2 00
10 00	2 04
10 00	2 02
....
10 00	2 10
....
9 00	1 06

Beam.	Draft.
ft. in.	ft. in.
9 07	1 11
8 00	1 06
....
8 08	1 03
7 06	1 03
7 06	1 08
10 08	1 08
....
7 08	1 08
....
....

Beam.	Draft.
ft. in.	ft. in.
5 10	2 00
5 07	1 10
8 00	3 00
....
....
....
....



COMMODORE GEO. I. TYSON.

RIVERSIDE YACHT CLUB.

BIOGRAPHICAL SKETCHES AND DESCRIPTION OF YACHTS ENROLLED IN THE CLUB.

GEORGE I. TYSON, Commodore of the RIVERSIDE YACHT CLUB, a native New Yorker of New England descent. The son of Isaac M. Tyson and Esther Ide; born August 30, 1835. Wholesale and retail news dealer and a Director of the American News Co. Member of the NEW YORK, ATLANTIC and RIVERSIDE YACHT CLUBS and a charter member of the latter club.

Commodore Tyson was Captain in the Seventy-first Reg't, N. G. S. N. Y., and served with that regiment in the Civil War, during the campaign of 1861, 1862 and 1863. He is the owner of the schooner NIVANA, his yacht for three years—was formerly owned by Gen'l Perkins. He has for five years been an active yachtsman and always the leading spirit of the club, which honors him with the distinction of Commodore.

NIVANA.

A keel schooner, altered from centerboard in 1888, now owned by George I. Tyson, Commodore of the RIVERSIDE YACHT CLUB. NIVANA was designed by George Steers and built by David Carl, and launched for W. Brown at City Island, N. Y., in 1884. She was afterwards the property of Gen'l Perkins for some time, and finally passed into the hands of Commodore Tyson some four years ago. Hails from New York. See plate LXVI.

POST OFFICE: GENERAL LETTERS, N. G. M. D.

Official number, 130,299.

DIMENSIONS.

Length over all,	82 feet 6 inches.	Length load waterline,	72 feet 6 inches.
Depth,	7 feet.	Draft,	8 feet 8 inches.
Beam,	20 feet 2 inches.		

VORANT.

A centerboard sloop belonging to George G. Tyson of New York City. She was built by Wallin & Gorman and was launched in 1880. Sails with the ATLANTIC, INDIAN HARBOR, CORINTHIAN, NAVY, RIVERSIDE and NEW ROCHELLE YACHT CLUBS. Hails from New York. See Fig. 552.

DIMENSIONS.

Length over all,	35 feet.	Length load waterline,	22 feet 6 inches.
Draft,	5 feet 8 inches.	Beam,	12 feet 4 inches.

Racing Record for 1891:—

INDIAN HARBOR YACHT CLUB—VORANT won in her class, defeating VOLVIA, VIKING and ESTELLA.



CHAS. E. DIEFENTHALER.

CHARLES E. DIEFENTHALER of New York City, was born in New York in 1863. He is a coffee merchant and a member of the RIVERSIDE YACHT CLUB. He is the owner of the yacht ALMA (formerly EMMA), and has been interested in yachting for three years.

ALMA.

A centerboard sloop, the property of Chas. E. Diefenthaler of New York City. She was formerly known as EMMA. She was designed and built by Charles Olmstead, being launched in 1888 for William Hamilton. Has been owned by Mr. Diefenthaler for three years. She sails with the RIVERSIDE YACHT CLUB. See Fig. 548.

DIMENSIONS.

Length over all,	28 feet.	Length load waterline,	21 feet 6 inches.
Depth,	4 feet.	Draft,	4 feet 3 inches.
Beam,	10 feet 4 inches.		

NAHMA.

NAHMA is a centerboard cabin cat-boat, formerly DIODON. Now owned by William A. Hamilton of Riverside, Conn. Designed and built by Richard Gommans, Buzzard's Bay, Mass., and for some time owned by Walter Luke. She hails from Riverside and sails with the RIVERSIDE YACHT CLUB. Was launched in 1888. See Fig. 550.

DIMENSIONS.

Length over all,	21 feet 3 inches.	Draft,	2 feet 4 inches.
Beam,	10 feet.		

ALCEDO.

ALCEDO is a centerboard sloop yacht, owned by William A. Hamilton of New York City. She was designed by C. Olmstead and built by Wallin & Gorman, South Brooklyn, N. Y., and launched in 1883. Hails from New York City and sails with the RIVERSIDE YACHT CLUB. See Fig. 549.

DIMENSIONS.

Length over all,	35 feet 6 inches.	Length load waterline,	30 feet 4 inches.
Draft,	4 feet 6 inches.	Beam,	14 feet.

Racing Record:—

1891—INDIAN HARBOR YACHT CLUB—ALCEDO won in the Third Annual Regatta of August 1st.

1892—RIVERSIDE YACHT CLUB—She was first in the Annual Regatta of July 9th, beating ELEANOR.



CHAS. TAYLOR PIERCE.

CHARLES TAYLOR PIERCE, manufacturer of paints and varnishes, Brooklyn, N. Y., was born in Boston in 1853. Has been a yachtsman for twenty-three years and has served in many offices of honor. Was Chairman of the Regatta Committee of the ATLANTIC YACHT CLUB for several years, and was also Rear-Commodore of the RIVERSIDE YACHT CLUB for some time.

He is at present the owner of the yacht OONEE, and has also owned the sloops WAVE, MARGUERITE, IMPERIA and the cat COOT. He was instrumental in the organization of the RIVERSIDE YACHT CLUB. Is a member of the RIVERSIDE, ATLANTIC, CORINTHIAN MOSQUITO FLEET and INDIAN HARBOR YACHT CLUBS.

OONEE.

A centerboard cat, the property of Chas. T. Pierce of Brooklyn, N. Y. She was designed by Glew and built by H. C. Wintringham, being launched April 18, 1892. She has a cabin, hails from Riverside and sails with the ATLANTIC, RIVERSIDE, INDIAN HARBOR and CORINTHIAN MOSQUITO FLEET YACHT CLUBS. See Fig. 551.

DIMENSIONS.

Length over all,	30 feet.	Length load waterline,	24 feet 6 inches.
Beam,	10 feet 6 inches.		

RACING RECORD FOR 1892.

Her maiden race took place June 4th, in the Larchmont Spring Regatta, but not being rightly trimmed, she was third. In the Marine and Field Regatta, held in New York Harbor June 11th, she came in first, beating three well known boats. She was poorly handled in the ATLANTIC YACHT CLUB Regatta of June 14th and was easily defeated. June 18th, Atlantic Special, she finished second, with four starters.

June 25th, at Greenwich, she was a close second. She finished third at Larchmont on July 4th. Again she was the third yacht in the Annual Regatta of the RIVERSIDE YACHT CLUB, July 9th.

She was altered slightly after this, and on July 24th, at the Regatta of the CHERRY DIAMOND YACHT CLUB in a class of five, she was the winner, beating Roi; at the first mark Roi was over fifteen minutes ahead. In this race she won the Tyson Cup.

The next race was that of the INDIAN HARBOR YACHT CLUB, off Greenwich, Conn., on August 2d, and started in a calm with six competitors in the class. It was finished in a gale about 8 o'clock, OONEE winning, with MYRTLE about five minutes astern. On August 7th, in the Hempstead Harbor Regatta, she beat the new boat WENONAH by a little over three minutes. Her last race was in the Fall Regatta of the LARCHMONT YACHT CLUB, with seven starters, but she seemed to have lost all her life, and gracefully came in fifth.

She won five first prizes during the season, very valuable and handsome mementoes. For a new boat, her performance during the season was considered very fair, and she raced against all the noted cabin cat-boats that sail in the vicinity of New York.



COMMODORE JOHN A. STETSON.

BOSTON YACHT CLUB.

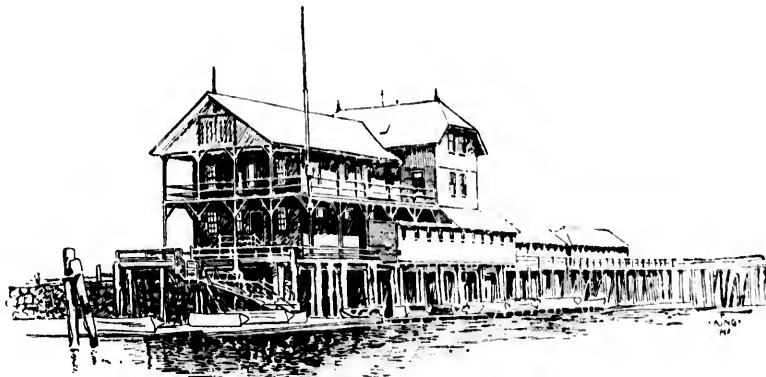

BOSTON YACHT CLUB HOUSE.

History of the Boston Yacht Club.

TO Augustus Russ, Benjamin Dean, Eben Denton, Charles E. Russ and Thomas Dean belongs the honor of founding the first yacht club in New England. Twenty-six years ago the coming season, they projected the BOSTON YACHT CLUB. At this time there were no clubs east of New York City. Nothing beyond cruising around during the Summer of 1866 was done, and the most active steps were taken in September. A circular was sent out in this month by the founders, calling a general meeting at the office of Mr. Augustus Russ, 14 Tremont street, on Wednesday, September 19th.

The following gentlemen were present at this meeting: Augustus Russ, Charles E. Russ, Dexter H. Follett, Eben Denton, Augustus Lathrop, Joshua H. Pitman, Thomas Dean, Benjamin Dean, Thomas Manning, Arthur Cheney, C. C. Sheafe, George A. Bates, H. B. Jackson, Daniel Briscoe and John Greer.

Following this, weekly meetings were held and by November 14th about 80 gentlemen had signified their willingness to become members. The meeting at which the organization was perfected, Constitution adopted and the first board of officers elected, was held in the Parker House, November 21st.

The gentlemen chosen for officers were: Commodore, Dexter H. Follett, schooner *NETTIE*; Vice-Commodore, Thomas Manning, schooner, *MINNIE*; Secretary, Thomas Dean; Treasurer, Augustus Russ; Measurer, Augustus S. Stone, of Bristol, R. I.

The first club signal was of the same shape as the present one, but with white field and a red cross extending from end to end, the bars of the cross meeting at the croch with a blue fowl anchor in triangle next the halliard. This flag was changed March 23, 1870, to the present flag, a blue field with red cross and white star in triangle. On December 5th a committee was appointed to procure a charter.

Club rooms were established at the corner of Tremont street and Pemberton Square. It was here the club held forth in the winter of

1866-67. The meeting of February 13, 1867, will be ever memorable in the club, for then notices were received that the Legislature of the State had refused the club a charter, on the grounds that such an organization might lead to immoral and ungentlemanly conduct, detrimental to the public welfare. The club regretted the charter being refused but still continued to flourish.

At a meeting held March 27, 1867, Capt. Greer broached the subject of a Club House at City Point. It was not thought feasible at the time and nothing was done. At this meeting it was voted that shifting ballast should not be allowed and that the sailing measurements should be whole length, plus one-third of aft overhang. The Regatta Committee, at this time, was appointed by the Commodore.

On June 25th, the club gave a Squadron Review in honor of President Andrew Jackson, who was then visiting the city at the celebration of laying the corner stone of the new Masonic Temple. Twelve yachts were in line and, notwithstanding the cold and heavy northeast wind, presented a fine appearance, and their evolutions in the President's road received the plaudits of a large number of spectators. The club, in remembrance of this day, has the President's letter, acknowledging the courtesies shown, handsomely framed and hung on the walls of the present Club House.

The first Club Review was held June 8, 1867, at Hull. The yachts participating were the schooners *NETTIE*, *JUNIATA*, *MERCURY*, *MINNIE*, *ELGE*, *MARIE*, *J. Q. ADAMS* and *SADIE*; sloops, *PARAQUITA*, *COLUMBIA*, *CLYDIE*, *TARTAR*, *MIST* and *VIOLET*. The steamer *ROSE STANDISH* gave a free passage to members and friends to meet the yachts. Gilmore's band furnished the music.

The First Club Regatta was sailed June 17, 1867. The start was made from a point between Rainsford and Gallop's Islands and the course of first and second classes was around Davis' ledge and return; the course for the third class around Gallop's, Long and Spectacle Islands. There were eight contestants over 38 feet, five 26 to 38 feet,

and three 18 to 26 feet. The prize takers were: SADIE and MINNIE first class, CLYDIE and VIOLET second class; FANNIE and PARAQUITA third class.

The second annual meeting of the club was held January 27, 1868, and the same board was re-elected. The Treasurer showed the total amount of receipts to be \$10,587.15. A new office of Rear-Commodore and an honorary membership list was proposed at this meeting. It was voted to apply for a charter again, and it was finally granted

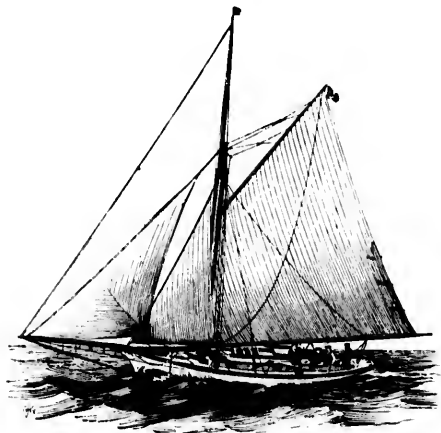

VASITI.—FIGURE 553.

by the Legislature on April 9th. Hon. Thos. Russell, the Collector of the Port, was made the first honorary member. February 26th. A complimentary dinner was given Commodore Follett, May 13, 1868, at the St. James Hotel.

At the first dinner ever given in Boston the tickets commanded a high premium, and the occasion was not only a memorable one in the club's history but also to all yachtsmen. While Commodore Follett held office, the many occasions of enjoyment attracted a large membership and many good times were had during 1867-68. A review and regatta were held June 26, 1868.

The First Club Cruise was sailed August 6, 1868. On Saturday and Sunday the fleet lay in Gloucester harbor. The next day a run was made to Newburyport. Tuesday and Wednesday Saco Pool was visited and Thursday the fleet reached Portland. They came in the following order: NETTIE, JUNIATA, PILGRIM, VIOLET and FANCHON. The schooner GLIMPSE, which had been East, joined the fleet here.

Shortly after this time troubles arose, but for which there would have been no EASTERN YACHT CLUB, it having been formed by some of the seceding members. The reason of the rupture was because the club lost sight of the objects of its founders. Interests of a social nature supplanted those of a yachting nature. During the year 1869, a few members held monthly meetings and the organization was barely alive.

The club rooms were given up January 1st. The officers this year were: Commodore, Thos. Manning; Vice-Commodore, Eben Denton; Secretary, Thos. Dean; Measurer, D. J. Lawlor; Treasurer, Augustus Russ. The first meeting of the corporation under the charter was held January 21, 1870, at the office of Augustus Russ, 15 Pemberton Square. Nathaniel Brewer, Jr., was elected clerk. On July 2d the club held its Annual Review, and on September 24th the Annual Regatta. The board of officers of 1869 were re-elected this year.

During the year 1871 there was a project suggested by the DONCHESTER YACHT CLUB to amalgamate the two clubs, but it met with little favor. Board of officers for this year: Commodore, Benjamin Dean; Vice-Commodore, W. H. L. Smith; Secretary, Thos. Dean; Treasurer, Augustus Russ; Measurer, D. J. Lawlor. Mr. Dean gave new life to the club, and at the October meeting many old members were re-instated. The first club supper was given on Friday, January 5, 1872, in the Parker House. It was a sumptuous banquet, as can be attested by the price of the tickets, which were \$12. Thirty members were present and the affair was a grand success. A diminutive silk flag and an illuminated bill of fare graced each plate, both the handwork of the artist members, W. F. Halsall and A. Claxton Cary. Among the gentlemen present were: Chas. L. Woodbury, James Lee, Jr., George D. Oxnard, L. S. Jordan, Jacob Pfaff, William Pratt, Augustus Lathrop, H. P. Shattnek, S. J. Capen, W. S. Whitney, G. A. Somerby, S. P. Wardwell, W. S. Bullock, F. D. Child, Gustavus Jackson, C. V. Whitten, S. D. Nickerson and N. B. Shurtleff. The invited guests were Mayor Gaston, Samuel Little, M. F. Dickinson, Hon. J. B. D. Cogswell of Yarmouth, and Hon. John B. Hathaway.

A life membership was established this year. Any one paying ten annual assessments of \$100 in advance would be free from all dues thereafter. A permanent fund was established by reserving one-half of the receipts. This was subsequently amended by reducing it to one-quarter of receipts and all life memberships. The office of Rear-Commodore was also created this year.

The board of officers for 1872 were: Commodore, Benjamin Dean; Vice-Commodore, W. H. N. Smith; Rear-Commodore, G. B. Durfee; Secretary, Thos. Dean; Treasurer, Augustus Russ; Measurer, D. J. Lawlor. Regattas were held this year on June 29th and August 31st. For 1873 the same board of officers was elected. On February 23d, the second annual supper was held in the office of the Treasurer, and an admission fee of \$20 was adopted in addition to

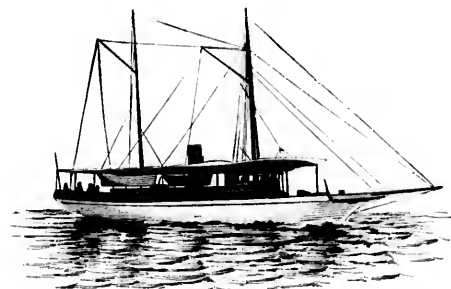

STELLAR.—FIGURE 551.

the yearly assessment of \$10. Land was bought at City Point, which the club acquired October 18th, by paying its permanent fund and giving a mortgage for the balance of \$5,000, payable in five years. A regatta was held on September 12th. In 1874 the officers of the previous year were re-elected. During the year the club finished its new Club House at City Point. It was designed by one of the members, A. C. Martin, and at the same time was considered of rare excellence. On July 18th a review and regatta was held, and a regatta was also sailed on September 12th. In 1875 the board of officers of the four preceding years were again re-elected. The dedication and first meeting in the new Club House was held April 2d of this year. A banquet was served, speeches made, and later an auction was held for choice of lockers, which netted a premium of \$305 above their rentals of \$328. With the increasing accommodations the membership

suggested by the Don- clubs, but it met with ar: Commodore, Ben- mith; Secretary, Thos. , D. J. Lawlor. Mr. October meeting many b supper was given on . It was a sumptuous the tickets, which were affair was a grand suc- illuminated bill of fare e artist members, W. F. gentlemen present were: D. Oxnard, L. S. Jor- throp, H. P. Shattuck, y, S. P. Wardwell, W. C. V. Whitten, S. D. ted guests were Mayor . J. B. D. Coggswell of

r. Any one paying ten be free from all dues d by reserving one-half ended by reducing it nberships. The office r.

odore, Benjamin Dean; mmodore, G. B. Dur- astus Russ; Measurer. on June 29th and Aug- cers was elected. On held in the office of the adopted in addition to

nt at City Point, which s permanent fund and y, payable in five years. 1874 the officers of the ear the club finished its ed by one of the mem- considered of rare ex- was held, and a regatta the board of officers of . The dedication and April 2d of this year. er an auction was held n of \$305 above their lations the membership

grew rapidly. During the month April the DORCHESTER YACHT CLUB held a regatta off City Point in honor of the new house. On September 2d the club held a regatta off the Club House.

On Sunday, about the middle of March, 1876, the club nearly lost its house by an ice gorge. At seven o'clock the ice formed in Dorchester Bay, and in going out with the tide it carried away the dolphin in front of the house. Upon the return tide the ice was swept back and struck the piles upon which the house rested, and carried away more than half of them. The house hung over the water, supported only by its shore end. Upon repairing the damages the house received a ten foot addition on its northerly side. The club's annual meeting was held on April 28th this year. Commodore Dean declined a re-election, having served five years. With his care the club started upon its second life with a small membership, laboring under an influence that threatened disbandment. It not only grew wonderfully in membership and yachts, but steadily gained in public favor and acquired considerable club property. The officers elected for this year were: Commodore, Arthur Cheney; Vice-Commodore Andrew Robeson; Secretary, Thos. Dean; Treasurer, Augustus Russ; Measurers, D. J. Lawlor and J. B. Smith; On June 24th the Annual Review was held, and on September 11th the Annual Regatta was sailed. At the annual meeting, January 31, 1877, the annual election of officers resulted in the choice of the board of 1876. This year was a great racing year with the club. The fixtures were: June 7th, Regatta; June 17th, Union Regatta with Dorchester; June 23d, Review; July 17th, Championship Races; August 2d, Championship Races; August 16th, Championship Races; September 12th, Championship Races.

For 1878 the officers elected were: Commodore, F. W. Peabody. Vice-Commodore, Nathaniel Wales, Jr.; Rear-Commodore, Andrew Robeson; Secretary, Thos. Dean; Treasurer, Augustus Russ; Measurers, D. J. Lawlor and J. B. Smith. The club held one regatta this year, a Union Regatta with Dorchester. For 1879 the board of officers of the previous year was re-elected. On June 21st, the club joined with the Dorchester and South Boston clubs in a grand regatta. On September 6th, a Club Regatta was held.

In 1880 the officers elected were: Commodore, Jacob Pfaff; Vice-Commodore, Clarence W. Jones; Rear-Commodore, C. A. Welch, Jr.; Secretary, Treasurer and Measurers the same as previous year. On June 17th, the club held an Open Regatta, and a Ladies' Day was held at Hull on September 5th.

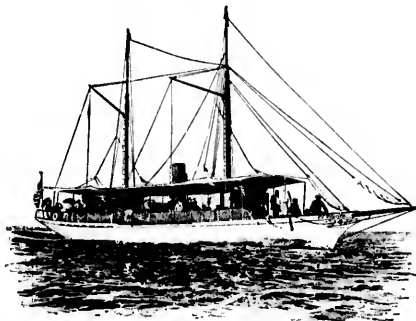

EL PLACITA.—FIGURE 533.

In 1883 the board of 1882 was re-elected, and a Ladies' Day was held on June 28th at Hull. On May 21st, this year, Washington E. Connor of New York, who was a member of the club, presented for competition an elegant silver cup, to be taken by any yacht of the club that would win it three times. In order to simplify the classification of yachts, Commodore Pfaff, with the consent of Mr. Connor, added another cup, and it was then arranged that all yachts over 33

feet should sail for the Connor Cup, and all under this measurement should race for the latter. The first race was sailed August 9, 1883, and the cups were not won until 1885, when AUGUSTA took the Connor Cup, and in 1866 the Pfaff Cup was still unsettled, although ten races had been sailed.

For 1884 the officers were: Commodore, Jacob Pfaff; Vice-Commodore, J. B. Meer; Rear-Commodore, W. E. Connor; Secretary,

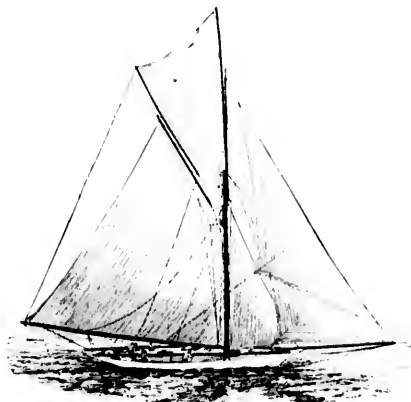

GORILLA.—FIGURE 536.

Measurers and Treasurer, the same as previous year. This year Ladies' Day was held on June 28th, and two Cup Races were sailed on August 9th and September 13th.

In 1885 the Board of Officers were: Commodore, Jacob Pfaff; Vice-Commodore, J. B. Meer; Rear-Commodore, W. E. Connor; all other officers same as previous year. Two Cup Races were sailed this year on June 13th and July 16th. For 1886 the board of 1885 was re-elected, and Cup Races were held on June 23d and July 23d.

The year 1887 the board of officers were: Commodore, Augustus Russ; Vice-Commodore, J. B. Meer; Rear-Commodore, J. P. Primney; Secretary, Thomas Dean; Treasurer, D. A. Dorr; Measurers, D. J. Lawlor and J. B. Smith. This year the deciding race for sloops for the Pfaff Cup was sailed on June 23d. The sloop EDNA, owned by A. L. Smith, was awarded the cup, having won three races. A race for the Pfaff Cup for schooners was started on the same day, but was not finished within the time limit. On July 7th, the second race for the Meer Cup for first class sloops was sailed. STANOW won the race and the cup was awarded to her owner, Dr. John Bryant, she having won the previous race sailed. In 1888 the Board of Officers for the previous year was re-elected. No racing was done this year.

For 1889 the officers were: Commodore, W. H. L. Smith; Vice-Commodore, W. P. Fowle; Rear-Commodore, N. G. Herreshoff; Secretary, Thomas Dean; Treasurer, Dudley A. Dorr; Measurers, D. J. Lawlor and J. B. Smith. The club was quiet this year, and no racing was indulged in.

The Board of Officers for the year 1890 consisted of the following gentlemen: Commodore, Augustus Russ; Vice-Commodore, J. A. Stetson; Rear-Commodore, N. G. Herreshoff; Secretary, Thomas Dean; Treasurer, D. A. Dorr; Measurers, D. J. Lawlor and J. B. Smith. The programme for the coming season will be arranged at a regular meeting to be held. The organization is in a most prosperous condition, owning property valued at \$50,000, and has 250 members on its list. The original founders of the club are alive and in good health, often spending a pleasant day on the water. The growth of the club has been very satisfactory.

and the founders look back with pride at the club's grand record.

The Boston Yacht Club claims to be the pioneer in New England to give Open Races—races open to members of any organized yacht club. These "Open" Races were sometimes called "Union Regattas."

Of the Open Regattas, the Boston Yacht Club gave some eminently successful and really grand ones. Racing was then more of a novelty, and there was no difficulty, with good prizes and good management, in getting up rousing races.

When racing became more or less general in that locality, the club did not feel so impressed with the necessity of regattas and devoted its funds to providing for the accommodation of its members and the

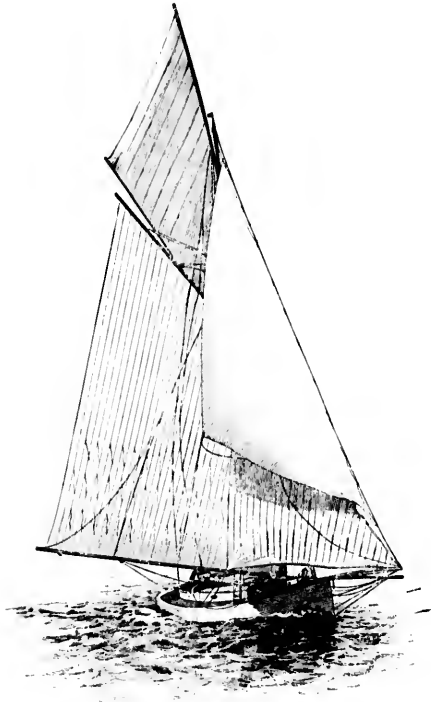

KITTY.—FIGURE 557

improvement of its yachting quarters which are admirably equipped to-day. An erroneous impression would be formed of the progress and condition of the club, were judgment to be passed on its yacht racing record alone.

The officers for 1892 were: Commodore, John A. Stetson; Vice-Commodore, J. W. Abbott; Rear-Commodore, Nathaniel G. Herreshoff; Secretary, Thomas Dean; Treasurer, Dudley A. Dorr; Measurers, George F. Lawley and Jefferson Borden. Regatta Committee: J. P. Phinney, G. Ripley Howe, Walter L. Dean, W. H. Wilkinson.

The following were the officers for the year 1893: Commodore, John A. Stetson; Vice-Commodore, J. W. Abbot; Rear-Commodore, Odin B. Roberts; Secretary, Thomas Dean; Treasurer, Dudley A. Dorr; Measurers, George F. Lawley, Jefferson Borden; Trustees, Benjamin Dean, Thomas Manning, Eben Denton. Regatta Committee, J. P. Phinney, G. Ripley Howe, Walter L. Dean, A. G. Fer-

nald, W. H. Wilkinson. Membership Committee: L. S. Jordan, E. H. Tarbell, J. Alfred Mitchell.

ACCORDING TO THE SAILING REGULATIONS.

The measurement adopted by this club is the length on the waterline added to one-third the difference between that and the length over all abaft the stem.

Yachts are divided into three classes, according to their measurement, and yachts of the first two classes are sub-divided according to their rig; the Regatta Committee, however, have the right to alter this classification at their discretion for special occasions.

The first class comprises all yachts measuring thirty-eight feet and upwards; the second, yachts measuring twenty-six feet and less than thirty-eight feet; and the third, yachts measuring eighteen feet and less than twenty-six feet.

Any yacht is allowed to enter races with yachts of a higher class than that to which she belongs by assuming the minimum measurement of the class she enters.

Time shall be allowed for difference of measurement according to the formula:

$$A = \left\{ \frac{1440}{L} - \frac{1440}{L'} \right\}$$

in which A represents the allowance, L the length of the yachts whose allowance is to be computed, and L' in the case of their table 110.6 or the standard length, the length of the boats being taken as one-third length on deck abaft the stem, plus twice the length on the waterline.

No changes in spars, ballast, or furniture in the first and second classes on the day of the race, nor trimming by dead weight in any class during a regatta is allowed.

Each yacht must carry throughout the race the same ballast and crew with which she started.

A yacht is allowed to carry one man for every five feet of her length or fractional part thereof.

There is no restriction as to sails.

Yachts of the first class must carry a boat not less than ten feet in length.

A member of the club must be on board each yacht contesting in a regatta.

The following courses for the regattas have been adopted by the club, with the proviso that the Regatta Committee may, if they see fit, appoint some other courses.

FIRST CLASS COURSE.

From a point off the Club House out on Broad Sound, leaving Ram Head Buoy on the starboard, Fawn Bar on the port, rounding the Whistling Buoy off the northeast ledge of the Graves, leaving it on the starboard; thence to the Bell Boat on the Hardings, leaving it on the starboard, up Lighthouse Channel, through the Narrows, leaving George's and Gallop's Islands, Nix's Mate Buoy, and Spectacle Island on the port, to the point of starting.

SECOND CLASS COURSE.

From a point off the Club House down the West Way, leaving Thompson's and Rainsford Island on the starboard, Long and George's Islands and Buoy No. 7 on the port, and back through the Narrows, leaving George's and Gallop's Islands, Nix's Mate Buoy, and Buoy No. 7 off Fort Independence on the port; thence to Cow Pasture, or Dorchester Buoy No. 6, leaving it on the port; thence back to the point of starting.

THIRD CLASS COURSE.

From the starting point, as above, to the Cow Pasture Buoy No. 6, leaving it on the port; thence to Buoy No. 7, off Fort Independence, leaving it on the starboard; thence to Sculpin Ledge Buoy, leaving it on the port; thence to Buoy No. 6 on the Lower Middle, leaving it on the port; thence to the point of starting.

by: L. S. Jordan, E.

REGULATIONS.

length on the water-
that and the length

ing to their measure-
-divided according to
ve the right to alter
occasions.

thirty-eight feet and
six feet and less than
ing eighteen feet and

hts of a higher class
e minimum measure-
ement according to

length of the yachts
he case of their table-
boats being taken as
s twice the length on

the first and second
y dead weight in any

the same ballast and

every five feet of her

t less than ten feet in

yacht contesting in a

been adopted by the
Committee may, if they see

l Sound, leaving Ram
e port, rounding the
Graves, leaving it on
ardings, leaving it on
the Narrows, leaving
and Spectacle Island

e West Way, leaving
starboard, Long and
nd back through the
Nix's Mate Buoy, and
; thence to Cow Pas-
he port; thence back

Pasture Buoy No. 6,
Fort Independence,
Ledge Buoy, leaving
er Middle, leaving it

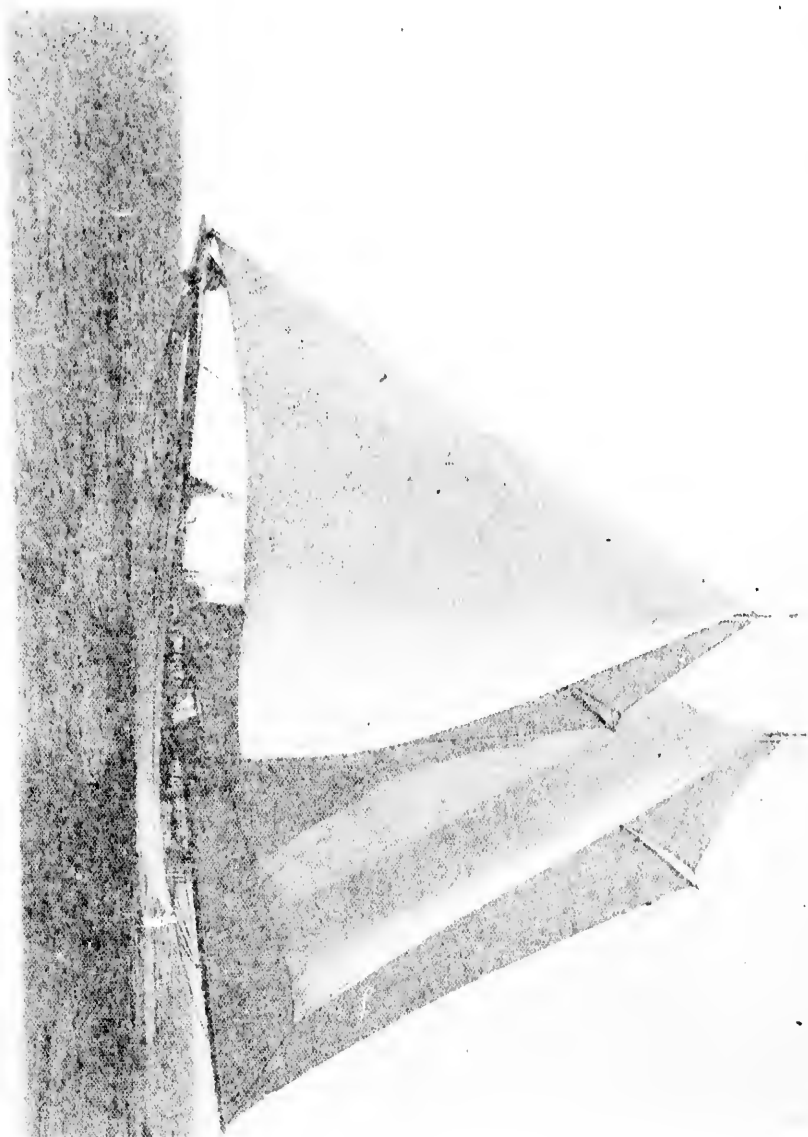

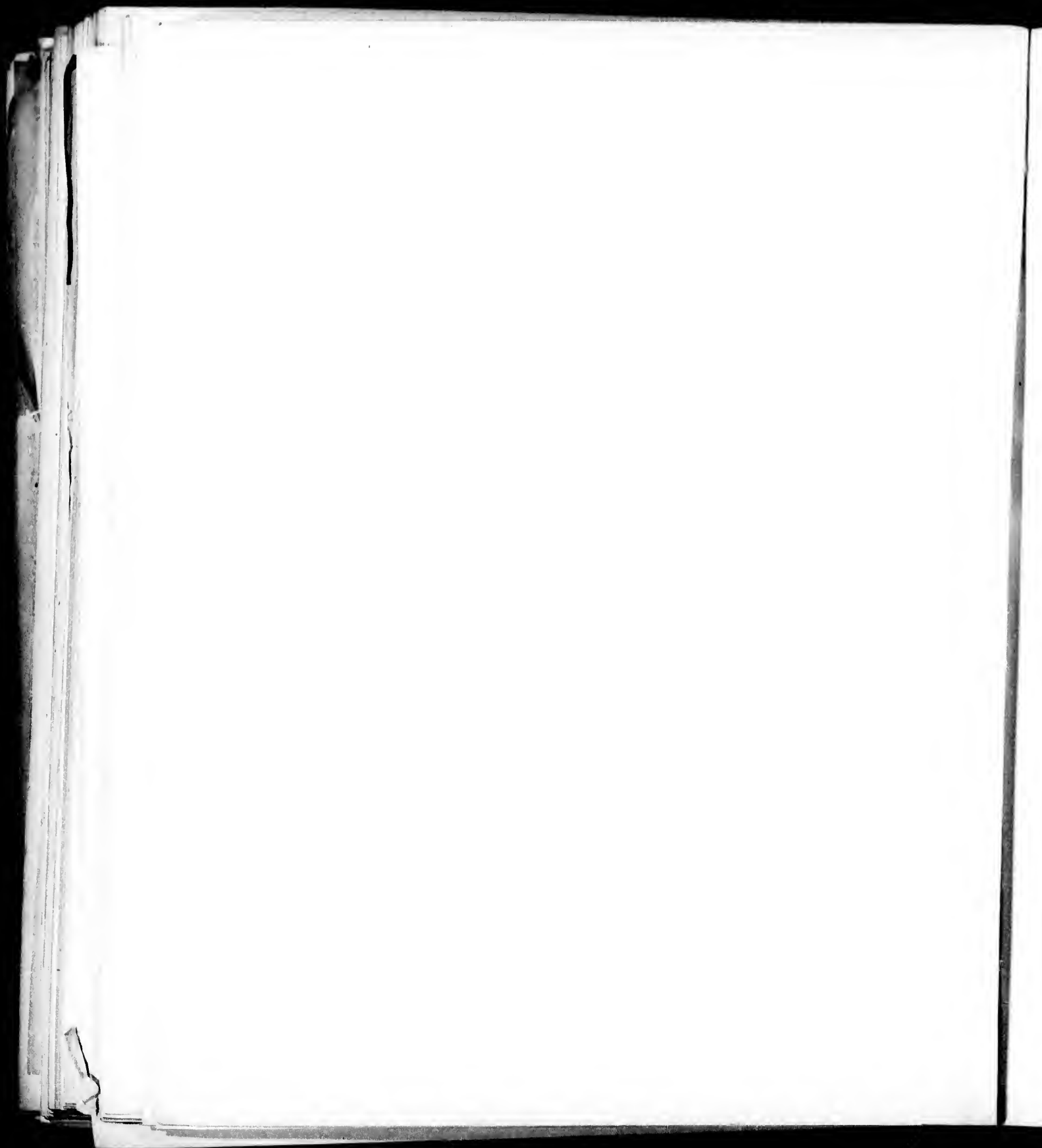

THE YACHTS AND YACHTSMEN OF AMERICA.

631

LIST OF YACHTS ENROLLED IN THE BOSTON YACHT CLUB 1893.

SLOOP, CUTTERS AND CAT RIGS.

NAME.	RIG.	OWNER	PORT.	Length L. W. L.	Breadth	Draft	S. R. or KEEL	Tonnage		
								Deck + Cab + Below	Old	New.
Alecco	Cat	Geo. H. Howe	Boston	11.00	11.00	11.00	...			
Aurora	Sloop	J. O. Shaw, Jr., et al.	Boston	18.00	15.10	7.00	...	11.00	11	11
Beth	Cat	S. W. Burgess	"	18.00	11.08	11.06	5.0	k		
Drynhild	Sloop	W. Dana Smith	"	18.00	17.00	0	1.0	e/b	10.71	15.88
Camilla	"	F. C. Welch	"	20.02	20.00	0	5.0	k		
Carmita	Cutter	Frank E. Peabody	"	20.00	20.00	0	5.0	k		
Chiquita	"	A. Hemenway	Marblehead	20.08	20.00	8.00	4.1	k		
Clio	Sloop	Frank F. Tripp	Boston	22.00	20.05	11.04	5.5	k		
Catherine	"	Walter L. Dean	"	20.00	20.00	10.00	5.0	e/b	5.00	
Clytie	"	W. H. Hollis, et al.	"	35.00	30.00	10.00	4.0	e/b	8.00	
Edith	Cutter	Adm Tindal	Eastport, Me.	35.00	33.17	12.00	4.0	e/b	10.00	18.00
Edith	"	F. F. Emery, Jr.	Boston	35.06	30.06	8.05	8.0	k		
Elaine	Sloop	Charles A. Lowe	Boston	40.00	42.00	10.00	7.0	k		
Gadfly	Job and mainsail	A. Hemenway	"	61.00	52.00	18.00	5.0	e/b		51.87
Georgia	Sloop	A. Rothe	"	25.00	21.00	10.00	4.0	e/b		32.30
Gorilla	Cutter	Olm B. Roberts	"	25.00	22.00	10.00	4.0	e/b		
Grimalkin	Cat	George H. Howe	"	54.00	49.11	14.02	7.2	e/b	14.00	20.80
Guardian	"	Alfred Q. Cole	"	25.00	22.00	10.00	4.0	e/b		18.80
Hilda	Cutter	C. P. Curtis	"	28.00	25.00	9.00	6.0	k		
Kuma	Cat Y.	J. Notman	"	35.00	31.05	11.00	6.0	k		
King Philip	Cutter	H. B. Torrey	Dallousse, N. H.	20.00		10.00	3.0	e/b		
Lackawanna	Sloop	E. F. Lucas	Boston	43.00	30.00	10.00	3.0	e/b	6.00	
Lapwing	Cutter	Bancroft C. Davis	Fall River	25.00	22.00	10.00	3.3	e/b		
Lena	Sloop	C. M. Cook	Boston	45.00	38.00	10.00	7.5	k		
Lorita	"	J. L. Butler	"	20.00	20.00	10.00	4.0	k		
Magnet	"	G. F. Burkhardt	Marblehead	30.00	25.00	9.00	4.0	e/b	6.00	
Myth	Cat	Walter Burgess	Boston	42.00	35.00	13.00	7.0	k		
Nahli	Sloop	W. E. Connor	"	21.00	21.00	9.10	2.0	e/b	20.00	15.00
Nebula	Cutter	C. W. Jones	New York	21.08	21.08	11.00	1.90	e/b	7.00	5.00
Neva	"	A. L. Smith, et al.	Boston	43.00	35.00	12.00	7.6	k		
H. D.	Job and mainsail	J. McIntyre, et al.	"	29.02	25.02	9.00	5.5	k		
Seven ("??")	Sloop-cutter	G. Wilson Atwood	"	30.00	20.00	7.00	5.0	k		
Shadow	Sloop	John Bryant	Cohasset	40.00	30.00	11.00	7.4	k		
Silver King	Cat, Job and mainsail	J. P. Phinney	Tarpon Springs, Fla.	30.08	33.05	11.04	5.4	e/b	12.00	12.45
Tetton	Sloop	D. H. McKay	Boston	18.00	17.00	8.00	8.0	e/b	18.81	12.80
Uarda	"	Jefferson Borden	Boston	35.00	32.00	14.00	6.0	k	5.00	
Urdine	Cat	W. C. Lewis	Fall River	30.00	21.00	7.00	5.0	k		
Urdine	Sloop	Benj. Dean	Boston	19.00	19.00	8.00	1.8	e/b	5.00	
Vandal	Cutter	J. A. and H. O. Stetson	"	51.00	50.00	16.00	5.0	e/b	15.00	15.00
Vashti	"	J. A. and H. O. Stetson	"	48.00	39.08	14.00	6.0	e/b		17.25
Vayu	"	G. H. Balch	"	38.00	28.08	11.00	6.0	k		10.00
Vague	Cat sloop	C. A. Welch, Jr.	Canaveral, Fla.	30.05	31.00	10.02	7.0	k		11.74
Wayward	Cutter	David Sears	Boston	28.00	24.00	10.08	1.0	e/b	1.00	
Winsome	Sloop	G. R. Tucker	"	55.00	60.00	11.08	11.0	k		
Zegerer	Cutter	Max Agniesz	Newport, R. I.	48.00	43.00	15.00	5.0	e/b		19.28
				52.02	42.00	12.00	8.0	...		

LIST OF YACHTS ENROLLED IN THE BOSTON YACHT CLUB, 1893.

SCHOONERS.

NAME.	OWNER.	PORT.	Length over all.		Breadth.	Draft.	C. B. or Keel.	Tonnage.	
			ft. in.	ft. in.				Old.	New.
Adrienne	J. K. Souther	Boston	71 00	60 00	18 00	9 00	k	85.25	40.25
America	Paul Butler	"	100 00	60 00	22 00	k	170.00	89.50
Gundred	B. Vaughan	"	53 00	45 00	14 03	8 00	k
Marguerite	Henry W. Lamb	"	96 11	70 00	21 00	11 00	c b	170.07	76.42
Princess	C. B. Tower	"	42 00	36 00	13 04	7 00	k	14.64
Troubadour	Wm. L. Lockhart	"	97 02	88 04	24 02	9 00	c b

STEAMERS.

NAME.	OWNER.	PORT.	Length over all.		Breadth.	Draft.	C. B. or Keel.	Draft with C. B. down.		Tonnage.	
			ft.	ft. in.				ft. in.	ft. in.	ft.	ft.
Annie S.	E. A. Pope	Boston	110 0	99 0	16 0	6 0	81.00
Carita	A. H. Davenport	"	69 0	61 4	12 5	4 6	k	32.21	10.12
El Pineta	J. W. Abbott	"	71 0	59 0	12 9	5 0
Fulmar	A. C. Fernald	"	41 0	35 4	7 6	3 0
Galatea	Melvin O. Adams	"	41 0	36 0	8 0	3 3
Gracie	A. P. Ordway	"	51 0	45 0	10 0	3 0
Iauza	John Evans	"	30 0	27 0	0 0	2 0
Iris	H. S. Whitney	"	45 0	10 0	4 0
Now Then	J. Edward Addicks	"	86 0	85 0	10 0	4 0	10.28
Sea Bird	Lewis J. Bird	"	97 0	75 0	15 0	6 0	k
Signal	W. L. Wellman	"	28 0	25 6	5 0	2 3
Vartina	R. H. White	"	93 0	76 0	16 0	7 0	93.00
Zuella	S. H. Hoper	"	32 0	31 0	4 0	1 0	3 00

CATAMARAN.

Florence (Cutter Rig)	J. H. Dodge	Boston	33 6	32 6	16 0	3 6	k
-----------------------	-------------	--------	------	------	------	-----	---	------	------	------



COMMODORE J. H. STERLING.

HORSE SHOE HARBOR YACHT CLUB.

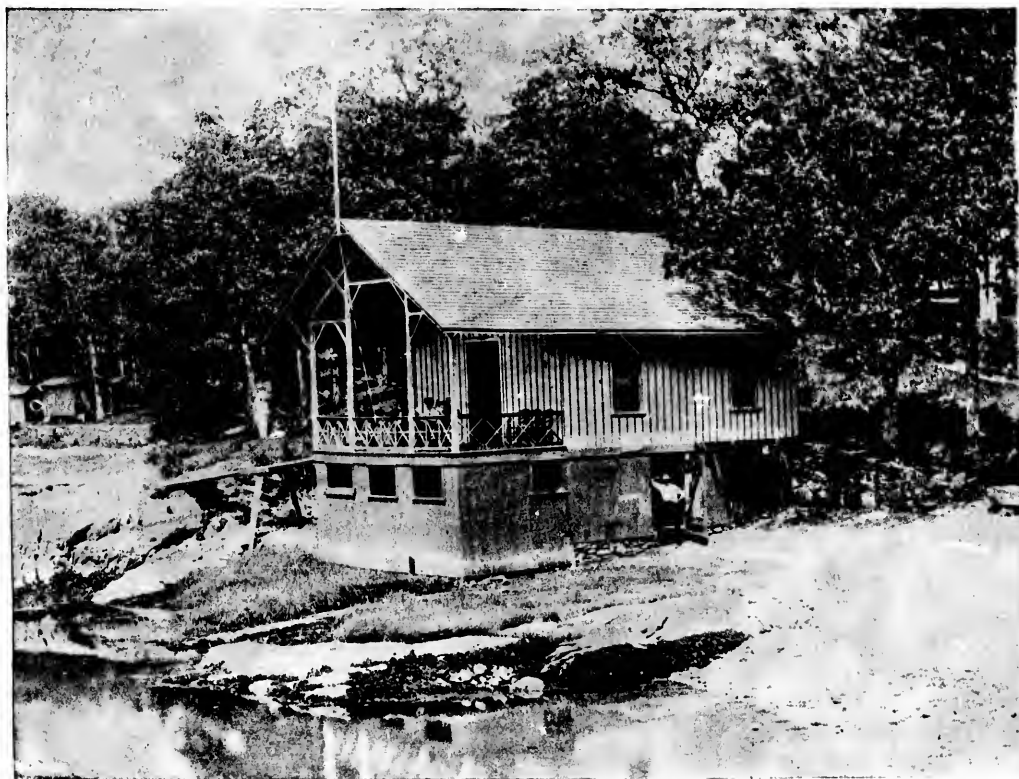

From a Photograph by Chas. W. Hull.

HORSE SHOE HARBOR CLUB HOUSE.

History of the Horse Shoe Harbor Club.

STATION—LARCHMONT, NEW YORK.

THE formation of the HORSE SHOE HARBOR CLUB was in the Spring of 1889 after the plans had been discussed for about one year by enthusiastic CORINTHIAN yachtsmen.

The need for some place of landing, and means of getting to and from boats was the chief reason for forming the club. Also a desire to revive the racing of small boats which had been such a great success some years before when the LARCHMONT YACHT CLUB was starting in the same place.

One evening in early June, some twenty men got together in the Club House, and it was decided to at least try the experiment. To cover the first outlay for building a proper float, approach, etc., several gentlemen, among them Messrs. Sterling and Foregis offered to be responsible to the extent of \$200 each, provided the funds did not come in sufficiently in the regular way. As a matter of fact, however there was a large increase of members within a very few weeks, and the club was well equipped before the season closed. During this year quite a number of informal races were sailed, no record being kept of them. Early in 1890 it was thought best to become regularly

incorporated and this was done by the Trustees then in office. From that time on, after the opening of the season of 1892, the club has continued to grow and prosper. Apart from the sailing element, the social element has been continually on the increase.

Such members who rarely enter a boat in the regattas held by the club, enjoy the privileges which the club affords of having a pleasant cool place to sit near the water, and the opportunity of meeting the various members in a pleasant social way.

The club was incorporated on the 28th of August, 1890, with the following objects:

1. The name or title by which said club or society shall be known in law shall be

THE HORSESHOE HARBOR CLUB.

2. The particular business and object of said club or society shall be to advance and support the art of yacht sailing and construction, and to provide a suitable Club House and anchorage for the use of its members.

3. The number of trustees of said club to manage the same shall be five, and the names of the trustees for the first year of the existence of said club are: Charles A. Singer, John R. Hull, George G. Murray, William Haigh, George W. Plum.

That the principal office of said society or club is to be at Larchmont, Westchester County, New York.

The following are the officers of the club for 1893-1894:

Commodore, Joseph H. Sterling; Vice-Commodore, Benjamin C. Lockett; Secretary, Chas. S. Gaubert; Treasurer, George S. Towle; Fleet Captain, Pierre Noël; Measurer, Frank E. Towle, Jr. Regatta Committee, Pierre Noël, Chairman; George G. Murray, John Neilson. House Committee, Vice-Commodore, Benjamin C. Lockett; Chairman, Geo. S. Towle; Chas. A. Andresen Harbor Master; Commodore, Joseph H. Sterling.



ELFIN.—FIGURE 538.

ACCORDING TO THE RULES AND REGULATIONS.

CLASSIFICATION.

All yachts shall be classed according to the actual load waterline length as follows:

- Class A.—Cabin sloops, 35 feet and over 25 feet.
- Class B.—Cabin sloops, 25 feet and under.
- Class C.—Cabin cats, 30 feet and over 25 feet.
- Class D.—Cabin cats, 25 feet and under.
- Class E.—Open boats, 23 feet and over 20 feet.
- Class F.—Open boats, 20 feet and over 17 feet.
- Class G.—Open boats, 17 feet and over 15 feet.
- Class H.—Open boats, 15 feet and under.

MEASUREMENT.

Yachts shall be measured and rated for time allowance according to the following method:

Length on load waterline plus one-third overhang, forward and aft.

The result is the measurement for time allowance, and shall be known as Racing Length.

All yachts are to be measured by the Club Measurer.

TIME ALLOWANCE.

Time allowance shall be calculated upon the Racing Length, as follows:

Twenty seconds to the foot on Course No. 1, 3 nautical miles; one minute to the foot on Course No. 2, 9 nautical miles; two minutes to the foot on Course No. 3, 17 nautical miles.

COURSES.

The courses for all races shall be as the Regatta Committee may direct for each race.

Course No. 1. From starting line off Horse Shoe Harbor, thence to Red Can Buoys off Hen and Chickens' Reef, thence to and around Red Spar Buoy off Hen and Chickens' Reef, thence to Black Spar Buoy off Constable Point, thence to finishing line. All buoys to be left on port hand, except Flagler's Red Can Buoy, which is to be left on the starboard hand.

Distance, 3 nautical miles.

Course No. 2. From starting line, off Horse Shoe Harbor, thence to and around the Westerly Red Spar Buoy on Execution Reef, thence to the easterly Red Spar Buoy on Execution Reef, thence to and around the Black Spar Buoy off Constable Point, thence to the finishing line. All buoys to be left on port hand, except Flagler's Red Can Buoy, which is to be left on the starboard hand.

Distance, 9 nautical miles.

Course No. 3. From starting line off Horse Shoe Harbor, thence to and around the westerly Red Spar Buoy on Execution Reef, thence to and around the Black Spar Buoy off Matinicoek Point, thence to finishing line. All buoys to be left on port hand.

Distance, 17 nautical miles.

SAILS.

The carrying of sails in regattas is restricted, as follows:

Cabin Sloops, Cutters and Yawls—Mainsail, working maintopsail, forestaysail, jib, flying jib, jib topsail and spinnaker; and on yawls, a mizzen and mizzen staysail.

No extra spars, booms out or whisker poles, excepting a spinnaker boom, shall be used.

Open Jib and Mainsail Yachts—Jib and mainsail.

Open Mainsail Yachts—Mainsail.

PRIVATE SIGNAL AND NUMBER.

Each yacht shall carry her private signal at the main peak and display her number, which will be furnished by the Committee, on both sides of the mainsail above the reef points. These numbers must be returned to the Regatta Committee after the race.

CREWS.

All yachts must be manned by amateurs exclusively, but any cabin yacht may carry and use her regular crew in any regatta.

All cabin yachts may carry, in addition to the Captain, one man for every five feet of length over all or fraction thereof. All open yachts may carry, in addition to the Captain, one man for every three feet of length over all or fraction thereof.

In all regattas each yacht must be steered by the owner or other amateur.

In any Special Race the Regatta Committee shall have power to remove any and all restrictions as to crew, helmsmen and sails.

TIME OF RACE LIMITED.

No race in any class shall be considered made unless finished by one of the yachts in that class before one-half an hour after the time

overhang, forward and
allowance, and shall be
measurer.

the Racing Length, as
3 nautical miles; one
miles; two minutes to

Regatta Committee may
Shoe Harbor, thence
thence to and around
f, thence to Black Spar
line. All buoys to be
buoy, which is to be left

Shoe Harbor, thence
Execution Reef, thence
n Reef, thence to and
point, thence to the fin-
d, except Flagler's Red
d hand.

Shoe Harbor, thence to
Execution Reef, thence
Cinco Point, thence to
and.

d, as follows:
il, working maintopsail,
pinnaker; and on yawls.

poles, excepting a spin-
sail.

THEY.
the main peak and dis-
the Committee, on both
These numbers must be
race.

clusively, but any cabin
any regatta.

he Captain, one man for
ereof. All open yachts
an for every three feet

l by the owner or other-

tee shall have power to
lmsmen and sails.

made unless finished by
f an hour after the time

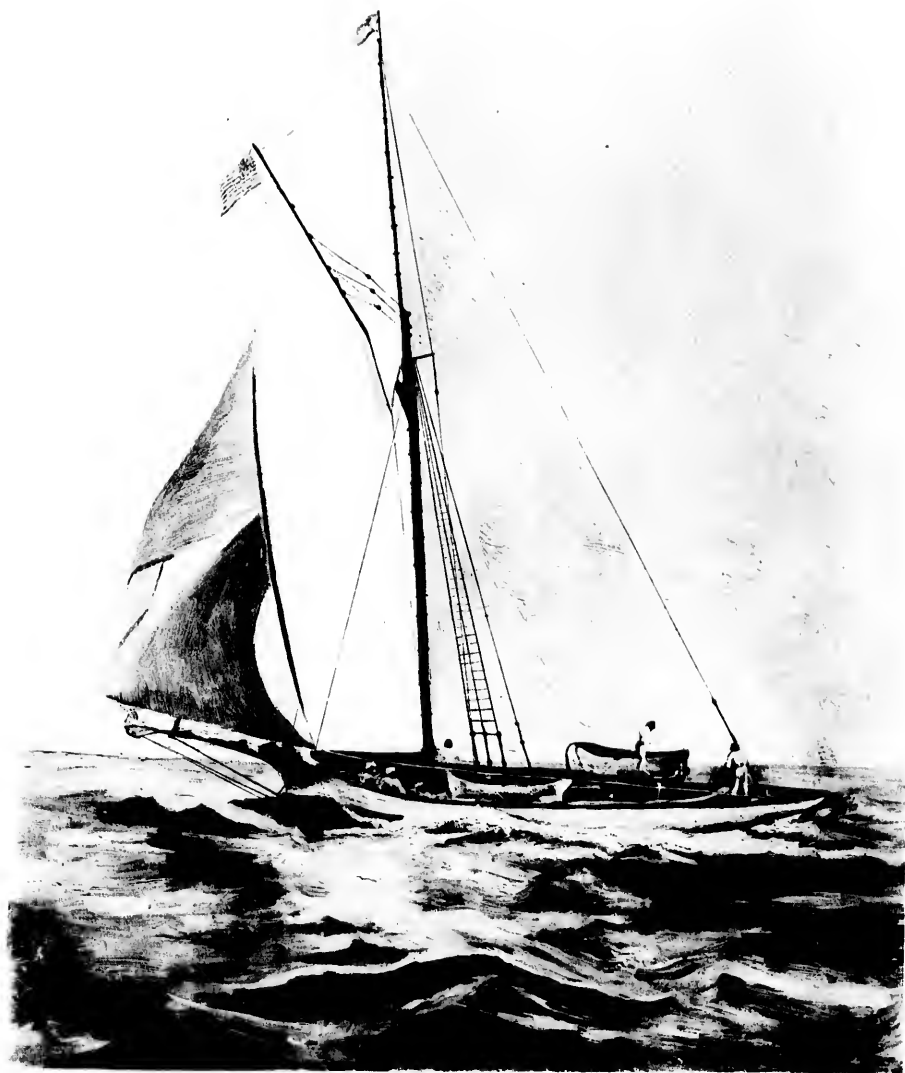

FROM AN OIL PAINTING.

PLATE LXXXVII.

DARE.

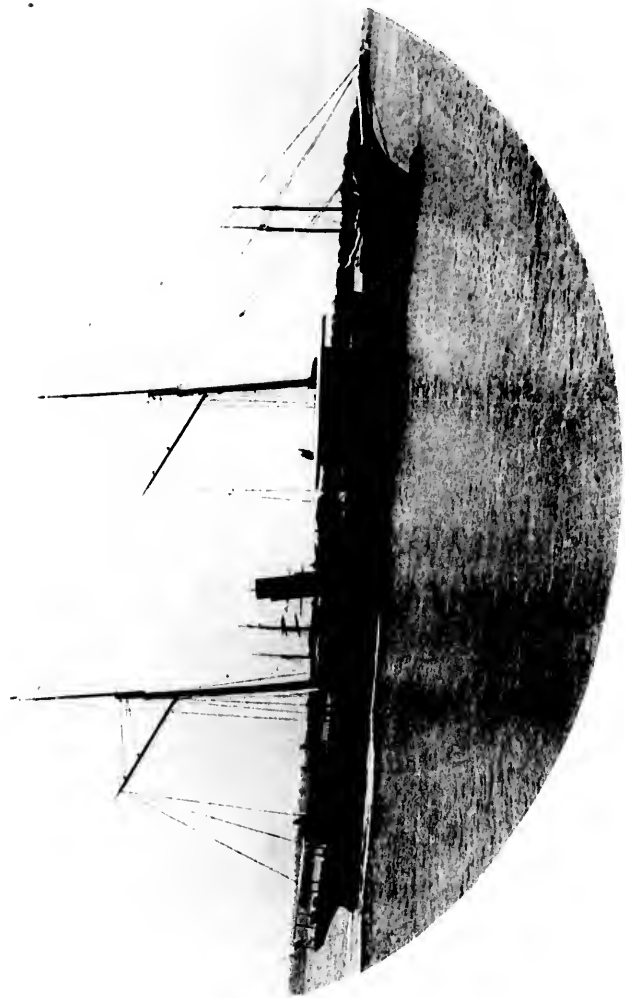

SUSQUEHANNA.

PLATE I. XXVIII

SUSQUEHANNA.

PLATE LXXVIII

Faint, illegible text at the top of the page, possibly a title or introductory paragraph.

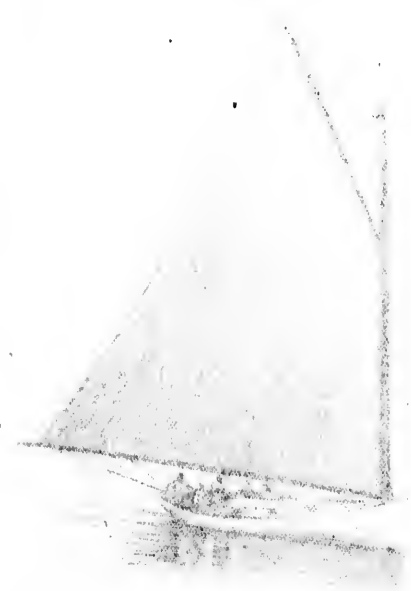

Faint text at the bottom left of the page, likely a caption or description of the drawings.

Faint text at the bottom right of the page, likely a caption or description of the drawings.

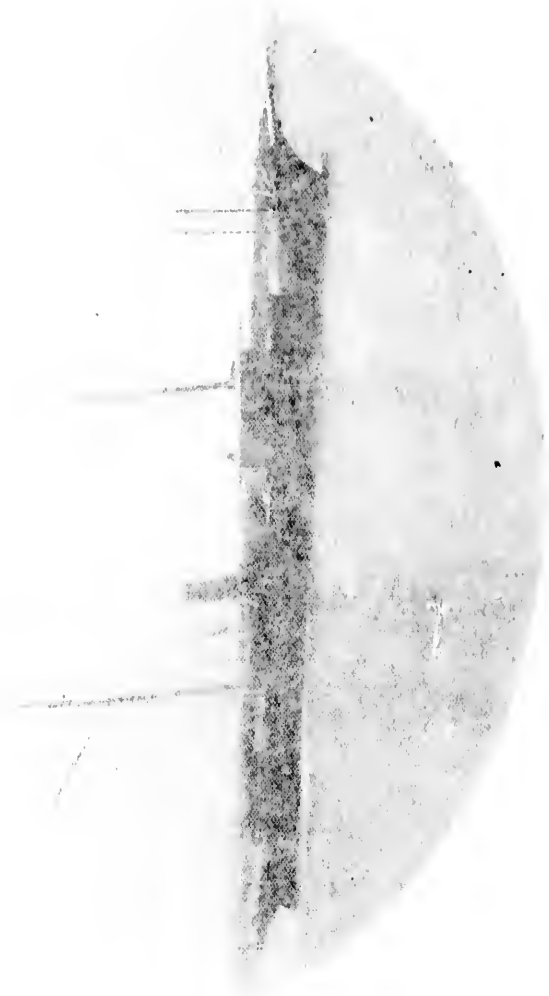

THE YACHTS AND YACHTSMEN OF AMERICA.

637

of sunset, as given in the table in the club book, except when it is specified in the notice of race that there shall be no limit to the time in which the race shall be sailed.

START AND FINISH.

All starts shall be flying.

The time at the start and finish shall be taken when the mast crosses the line.

If this point in any yacht be across the line when the signal for starting is given, she must return and recross the line.

A yacht so returning, or one working into position from the wrong side of the line after the signal for starting has been given, must keep clear of and give way to all competing yachts.

The starting and finishing line shall be an imaginary one, drawn between two stake boats, anchored off Horse Shoe Harbor, each carrying in the masthead a large Horse Shoe Harbor Club flag.

A competent person appointed by the committee shall be placed on a stake boat at the finishing line, who shall time the yachts in the absence of the Regatta Committee, and this time shall be considered final.

BALLAST.

After the preparatory signal no ballast shall be taken on board or out of any yacht. No ballast shall be shifted on any cabin yacht.

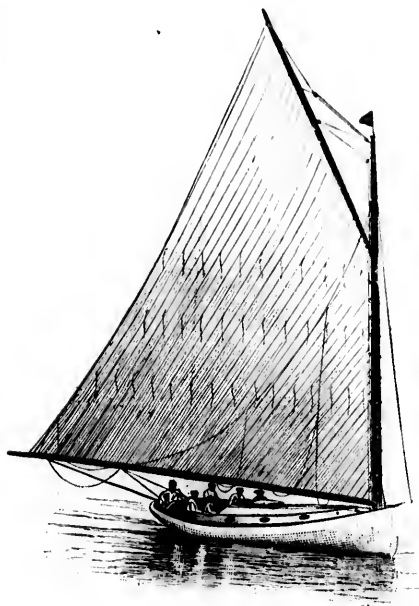

Rot.—FIGURE 559.

No booming out of ballast will be allowed, and each yacht must bring back the crew with which it started.

PRIZES.

Except in the Pennant Regatta, there shall be one prize awarded to the winning boat in each class sailing in a race or regatta—provided there are two or more boats starting in each class. No boat shall be entered for a regatta whose owner is in arrears to the club.

RACING RULES FOR NAUTICAL LAUNCHES.

CLASSIFICATION.

Launches will be classified as follows:

Class A.—Launches under 23 feet, load waterline.

Class B.—Launches 23 feet and under 30 feet, load waterline.

Class C.—Launches 30 feet, load waterline and above.

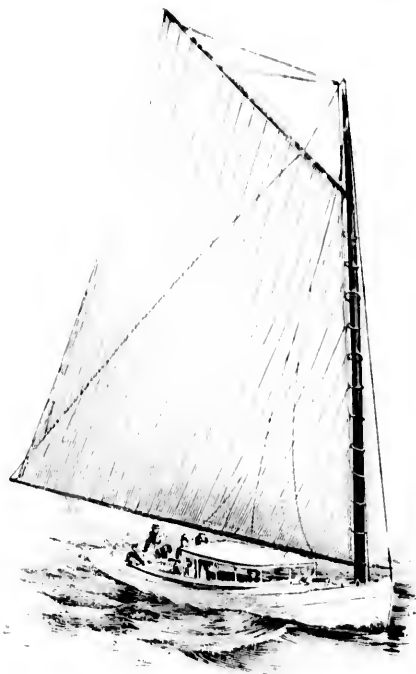

Blonde.—FIGURE 560.

PRIZES.

A first and second prize will be given as follows in each of the above classes.

In the event of three or more boats starting in any class, two prizes will be given.

In the event of only two boats starting in any class, one prize will be given.

There will be no race in any class unless two or more boats start.

TIME ALLOWANCE.

Time allowance will be calculated as follows:

On length—

Larger boats in their respective classes shall allow three seconds per foot of load waterline for each nautical mile of the course. Any portion of a foot will be considered a whole foot.

On Power—

Larger boats in their respective classes shall allow ten seconds for each nautical mile of the course for every additional two-horse power.

COURSE.

The distance will be nine nautical miles. The course, as per chart herewith, will be sailed three times over, leaving all buoys on the port hand, except Flagler's Red Can Buoy, which will be left on the starboard hand. The start and finish to be made over imaginary lines between stake boats anchored off the mouth of the Horse Shoe Harbor.

START.

Boats will be started in classes as follows:

Class A. A preparatory gun will be fired, and a red flag hoisted on the judges' boat as a signal for Class A to prepare to start. Three minutes later the starting gun will be fired and time for Class A will be taken.

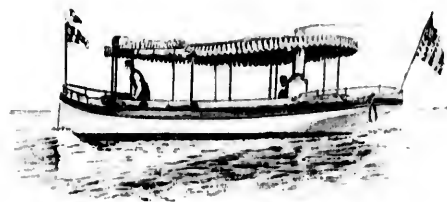

GROWLER. - FIGURE 561

Class B. Five minutes after the start of Class A a preparatory gun will be fired and a white flag hoisted on judges' boat as a signal for Class B to prepare to start, and three minutes later the starting gun will be fired, and time for Class B will be taken.

Class C. Five minutes after the start of Class B a preparatory gun will be fired and a blue flag hoisted on judges' boat as a signal for Class C to prepare to start, and three minutes later the starting gun will be fired and the time for Class C will be taken.

On the preparatory signals, boats in their respective classes will approach the starting line. Any boat crossing said line prior to the starting signal will be disqualified.

No time will be taken after starting gun has been fired.

RIGHT OF WAY.

An overlap in all cases shall establish the right of way, but the leading boat can in no instance force the overtaking boat off the course or onto a buoy.

CREW.

No restriction will be placed on the size of crew carried.

MEASUREMENT.

All launches must be measured by the Club Messenger, who will give to each launch a voucher stating the length and power of his launch, and voucher to be handed to the Clerk of the Course on the receipt of racing number. This will enable the Regatta Committee to figure quickly the time allowance after the race. Boats can be measured at any time on day of race, up to ten minutes before the start of Class A. To avoid delay owners of launches are requested to have their boats measured as early as possible.

NUMBERS.

Distinguishing numbers will be furnished by the Clerk of the Course; the same must be displayed on the bow-pole during the race in place of private or club signals, and must be returned to the Clerk of the Course immediately after the race.

PROTESTS.

The Regatta Committee will decide all protests relative to fouls that occur during the race, their decision being final. All other protests are to be made in writing to the Regatta Committee, no later than 6 P. M. on the day of the race.

ENTRIES.

The race is only open to launches propelled by naphtha power alone.

RECORD OF RACES SEASON OF 1893.

A Pennant Regatta was sailed August 26, 1893. The following yachts participated.

	Start.		Finish.		Elapsed.		Corrected.	
	H. M. S.	H. M. S.	H. M. S.	H. M. S.	H. M. S.	H. M. S.	H. M. S.	H. M. S.
Fairy	3 33 39	6 00 20	2 26 50	2 29 50				
Spindrift	3 32 01	6 17 21	2 45 17	2 44 17				
Loose	3 32 42	5 49 50	2 17 17	2 17 17				
Lark	3 35 02							
Whim	3 32 00	6 03 01	2 33 01	2 33 01				

FAIRY had a walk-over; LOOSE won, beating SPINDRIFT, and WHIM had a walk-over.

HANDICAP NAPHTHA RACE.

The Second Annual Handicap Naphtha Race was held September 2, 1893, the following were the entries:

Class A, under 23 feet load waterline. Start: Preparatory gun, 3:00 P. M. Starting gun, 3:04 P. M.

No.	Name of Boat	Owner.	Length		Nominal		No.	Finish			Elapsed		Corrected	
			over all	feet.	L. W. L.	H. Power		1st Lap.	2d Lap.	3d Lap.	True	Time.	Time.	Time.
	Midge	H. S. Baxter						H. M. S.	H. M. S.	H. M. S.	H. M. S.	H. M. S.	H. M. S.	H. M. S.
1	Ariel	Fred. E. Sondern	18	15.11	2	1	3 40 01	4 13 34	4 54 01	1 51 01	1 46 22			
2	Trochilus	M. W. Bronson	21	18.05	2	2	3 40 07	4 14 00	4 51 12	1 51 12	1 47 51			
3	Elsie	Jacob Smith	25	22.07	1	3	3 34 13	4 03 55	4 36 07	1 33 07	1 33 07			
4	Daisy	D. P. Duffie	25	22.05	4	4	3 35 12	4 04 52	4 38 29	1 35 29	1 35 29			
5	Aline	F. B. Salisbury	25	22.06	4	5	3 34 35	4 04 09	4 36 28	1 34 28	1 33 28			
7	Liris	A. K. Wright	25		1	7								
8	Olga	A. Ranchfuss	25	22.75	1	8	3 34 31	4 02 58	4 35 17	1 32 17	1 32 17			

Class B, 23 feet and under 30 feet load waterline. Start: Preparatory gun, 3:08 P. M. Starting gun, 3:11 P. M.

11	Sweetheart	Jos. H. Stirling	27	23.11	4	11							
12	Imp	Harry T. Shriver	27	21.00	0	12	3 49 10	4 05 51	4 37 27	1 24 27	1 23 00		
13	Kraken	H. A. Van Liew	35	27.04	0	13	3 39 39	4 05 04	4 31 11	1 24 11	1 23 11		
14	White Cap	C. V. Brokaw	30	26.11	0	14	3 41 40	4 08 47		no finish			
15	Erna	Nelson Greenfield	30		0	15							
16	The Wake	E. F. Caldwell	30	26.10	0	16	3 39 44	4 05 19	4 31 30	1 23 30	1 23 03		
17	Lotus	Geo. Bliss	30	27.00	0	17	3 40 15	4 06 00	4 35 36	1 24 36	1 24 09		
18	Elthilda	W. & C. W. Ballard	30		0	18							
19	Niobe	W. H. Caldwell	30	26.09	0	20	3 41 12	4 08 30	4 40 27	1 29 27	1 29 00		

Class C, 30 feet and over, load waterline. Start: Preparatory gun, 3:16 P. M. Starting gun, 3:19 P. M.

20	Vixen	Geo. Bullock	35		10	21							
21	Saghaya	H. C. Smith	35	31.05	10	22	3 40 44	4 11 59	4 42 05	1 23 05	1 18 53		
23	Cleopatra	Alex. Stein	40	37.37	12	23	3 42 15	4 03 22	4 26 12	1 07 12	1 07 12		
	Adroit	Clement Gould	40	37.00	12		3 42 10	4 03 25	4 26 14	1 07 14	1 06 47		

Judges: Pierre Noël, John Neilson and Geo. G. Murray. Time keeper: C. S. Gaubert. Clerk of the Course: Vice-Commodore B. C. Lockett. Scorers: J. R. Hull and G. W. Plum.

N. B. ADROIT, in Class C, was not racing for the prize. OLGA was first, ELSIE second and ALINE third in Class A. THE WAKE was first, IMP second and KRAKEN third in Class B. CLEOPATRA was first and SAGHAYA second in Class C.

HISTORY OF THE HORSE SHOE HARBOR CLUB.

A Regatta was held June 17, 1893, over Course No. 2; a distance of 9 miles, the weather was cloudy and the wind east by north.

		SLOOPS.				SLOOPS.					
		Length.	Elapsed Time.	Corrected Time.	No.	Sailing Length.	Start.	Finish.	Elapsed Time.	Corrected Time.	
		Feet.	n. m. s.	n. m. s.		Feet.	n. m. s.	n. m. s.	n. m. s.	n. m. s.	
Class A.		SLOOPS.				SLOOPS.					
Flash		32.00	did not start			Class B.					
		YAWLS.				Brenda					
Class AA.		30.00	1 21 02	1 21 02	Nora						
Audax		29.00	1 35 38	1 33 40	21.00						
Kittie		29.00	did not start			20.02					
Kwashed						21.06					
						CATS.					
						Class D.					
						Dream					
						22.00					
						disabled					
						Class E.					
						Fairy					
						21.09					
						Punch					
						18.06					
						Typhoon					
						22.07					
						did not start					
						Class F.					
						It					
						18.06					
						Spindrift					
						17.31					
						Giggle					
						19.02					
						Tone					
						18.06					
						Lark					
						16.00					
						2 02 36					
						2 01 30					
						did not start					
						1 42 23					
						1 43 23					
						1 42 02					
						1 41 02					
						1 51 45					
						1 50 45					
						BRENDA won in Class B. PUNCH won in Class E and TONE won in Class F.					
						The Annual Fall Regatta was held September 4, 1893, the following yachts took part:					
						Class AA.					
						Audax					
						2 31.20					
						2 36 33					
						3 42 35					
						1 06 02					
						1 06 03					
						Kwashed					
						4 32.17					
						2 37 49					
						3 46 12					
						1 04 23					
						1 00 21					
						Class A.					
						Mary C.					
						12 31.00					
						2 40 00					
						3 52 40					
						1 12 40					
						1 07 40					
						Flash					
						11 31.00					
						2 39 51					
						3 49 35					
						1 09 41					
						1 01 41					
						Eurybia					
						15 39.00					
						2 40 00					
						3 46 43					
						1 03 53					
						1 00 43					
						16 28.63					
						Class B.					
						Brenda					
						18 21.00					
						2 36 26					
						4 00 45					
						1 21 21					
						1 21 21					
						Class E.					
						Water Witch					
						30 21.00					
						2 40 00					
						did not finish					
						Caper					
						31 22.01					
						2 40 00					
						4 01 44					
						1 21 44					
						1 21 41					
						Whim					
						33 20.00					
						2 35 39					
						4 03 57					
						1 28 28					
						1 26 28					
						Class F.					
						Phyllis					
						35 19.11					
						2 40 00					
						3 52 35					
						1 12 35					
						1 12 35					
						Iris					
						36 18.08					
						2 37 00					
						4 02 55					
						1 25 55					
						1 24 55					
						Tone					
						37 18.06					
						2 37 21					
						4 01 05					
						1 23 41					
						1 22 41					
						Spindrift					
						38 17.11					
						2 36 36					
						4 11 35					
						1 31 49					
						1 32 11					
						It					
						39 18.06					
						2 37 50					
						4 11 25					
						1 31 35					
						1 33 35					
						Class H.					
						Kitten					
						43 15.00					
						2 37 31					
						3 33 25					
						0 56 51					
						0 56 51					
						Presto					
						44 41.11					
						Vitesse					
						45 11.11					
						Caprice					
						46 11.10					
						2 37 14					
						3 21 10					
						0 43 56					
						0 43 56					
						Sirene					
						48 .					
						2 41 45					
						3 55 36					
						1 33 51					
						1 33 51					

AUDAX won in Class AA; WHITE WINGS had a walk-over in Class B; ROI won in Class C; CAPER won in Class D; PUNCH won in Class E; TONE won in Class F and KEARSARGE had a walk-over.

A Regatta was held July 8, 1893, over Course No. 2. The weather was clear, the sea choppy and the wind from the south-west.

AUDAX won in Class A A; FLASH won in Class A; BRENDA had a walk-over in Class B; CAPER won in Class E; PHYLLIS won in Class F; CAPRICE won in Class H; STREN had a walk-over.

Finish.	Elapsed Time.	Corrected Time.
U.S.S.	U.S.S.	U.S.S.
	1 58 34	1 57 31
	2 02 05	2 02 05

disabled

	1 40 54	1 40 54
	1 40 58	1 38 58
did not start		

	2 02 36	2 01 30
did not start		

	1 42 23	1 42 21
	1 42 02	1 41 02
	1 54 45	1 50 45

Class E and IONE won in

September 4, 1893, the follow-

	3 42 35	1 06 02	1 00 03
	3 46 12	4 05 23	1 06 23

	3 52 40	1 12 40	1 07 40
	3 49 35	1 09 41	1 04 41
	3 46 43	1 06 43	1 06 43

	4 00 45	1 21 21	1 21 21
--	---------	---------	---------

did not finish			
	4 01 41	1 21 41	1 21 41
	4 03 57	1 28 28	1 26 28

	3 52 35	1 12 35	1 12 35
	4 02 55	1 25 55	1 21 55
	4 01 05	1 23 41	1 22 41
	4 11 35	1 31 49	1 32 49
	4 14 25	1 31 35	1 33 35

	3 33 25	0 56 54	0 56 51
--	---------	---------	---------

	3 21 10	0 43 56	0 43 56
	3 55 30	1 13 51	1 13 51

in Class A; BRENDA had
Class E; PHYLLIS won in
had a walk-over.

LIST OF YACHTS ENROLLED IN THE HORSE SHOE HARBOR CLUB.

STEAMERS.

NAME.	OWNER.	Length over all.	L. W. L.	Beam.	Draft.
		ft. in.	ft. in.	ft. in.	ft. in.
Emu	W. H. and G. P. Butler	81 00	77 06	15 00	6 04
Evelyn	John R. Hegeman, Jr.	85 00	81 00	13 00	4 10
Jessie	Charles H. Murray	80 00	66 00	14 00	5 00

SCHOONERS.

NAME.	C. B. OR KEEL.	OWNER.	Length over all.	L. W. L.	Beam.	Draft.
			ft. in.	ft. in.	ft. in.	ft. in.
Triton	c b	Infus King	80 00	62 00	18 06	6 06

CABIN SLOOPS, CUTTERS AND YAWLS.

NAME.	C. B. OR KEEL.	OWNER.	Length over all.	L. W. L.	Beam.	Draft.
			ft. in.	ft. in.	ft. in.	ft. in.
Andux (Yawl)	k	H. W. Eaton	42 00	30 00	10 04	6 06
Brenda	k	Francis M. Scott	25 02	21 04	8 02	4 03
Eurybia	c b	Charles Pryce	47 00	34 04	14 00	6 00
Flash	c b	Joseph H. Sterling	36 00	32 00	12 04	4 06
Kwasind (Yawl)	k	Oliver Adams	40 00	28 03	12 00	4 00
Nonpareille (Yawl)	k	Harold A. Sanderson	80 00	68 00	16 00	11 06
Pyxie	k	Oswald Sanderson	36 06	23 03	7 08	6 06
Trochilus	k	M. W. Bronson	50 00	41 06	15 00	6 06
Vision	c b	C. Sloyer Allen	30 06	26 06	11 06	3 04
White Wing	k	J. E. Spaulding	24 06	21 06	10 00	4 6

MAINSAIL (CABIN) BOATS.

NAME.	C. B. OR KEEL.	OWNER.	Length over all.	L. W. L.	Beam.	Draft.
			ft. in.	ft. in.	ft. in.	ft. in.
Blonde	c b	A. Montant	33 00	29 07	12 00	2 00
Cinch	k	John H. Hayward	26 02	23 06	12 01	3 10
Dream	c b	Isaac Snedker	25 07	22 00	8 00	3 00
Ellin	c b	Charles A. Anderson	29 00	26 08	12 00	3 00
Fredie	c b	C. C. Sibley
Jean	c b	J. R. Brechin	28 01	24 00	11 10	3 00
Nymph	c b	P. W. Flint	31 00	26 00	12 00	3 00
Pol	c b	B. V. Lynen and D. W. Thomas	33 10	26 04	12 00	2 06
Parula (Yawl)	c b	J. M. Hartshorne, Jr.	33 00	27 00	11 00	2 06
Waverly	c b	P. Thompson Turner	30 01	27 04	12 00	3 07
Whhn	c b	Geo. Gardiner Fry	22 07	20 04	10 00

LIST OF YACHTS ENROLLED IN THE HORSE SHOE HARBOR CLUB.

MANSAIL (OPEN) BOATS.

NAME.	C. B. OR KEEL.	OWNER.	Length over all.		Beam.	Draft.
			ft. in.	ft. in.		
Alice	cb	George G. Murray	17 00	17 00	7 10	1 03
Cuprice	cb	F. F. Proctor, Jr.	14 10	14 10	6 06	1 04
Cupid	cb	F. C. Lake	23 10	20 01	9 00	2 00
E. F. E. (Cimoe)	cb	E. F. Ely	15 03	14 08	2 03	03
Essex	cb	E. C. Tooker	15 00	15 00	4 00	1 00
Fairy	cb	Frank E. Towle	21 00	21 00	9 00	1 06
Fedora	cb	Edward H. Wales	23 00	23 00	9 00	2 00
Glugle	cb	Dincom Sterling	19 02	19 02	8 07	1 06
Helen	cb	H. Adro	22 10	22 10	9 00	1 06
Ime	cb	C. M. Bied	18 06	18 06	8 00	1 08
Iris	cb	John L. Roberts	22 00	18 06	8 04	1 03
It	cb	C. W. Solgwick	18 06	18 06	8 06	1 06
Kitten	cb	J. X. Arosemena	15 00	15 00	4 00	1 03
Lark	cb	Edward G. Fultz	15 10	15 10	8 00	1 01
Oban	cb	C. C. Little	20 01	20 01	9 00	1 10
Sahib	cb	William S. Alley	22 10	22 10	9 04	1 02
Skip	cb	William H. Moon	16 00	16 00	6 00	1 00
Spin-drift	cb	Benjamin C. Lockett	18 00	17 11	8 00 1/2	1 08
Sunshine	cb	N. J. Bishopick	19 06	16 00

LAUNCHES.

NAME.	OWNER.	Length over all.		Beam.	Draft.
		ft. in.	ft. in.		
Aline	F. S. Salisbury	25 00	22 00	6 02	2 00
Baltimore	Christian Ax	50 00	46 00 1/2	8 00	5 00
Canilla	John R. Hezeman, Jr.
Florence	A. Marshall	21 00	5 00	2 06
Growler	Pierre Noel	30 00	28 00	6 00	2 01
Kraken	H. A. Van Liew	35 00	28 00	6 00	2 03
Lark	Eugene Waugh
Nlobe	William H. Caldwell	30 00	28 00	6 03	2 03
Oso	Edward H. Wales	21 00
So So	F. W. Flint	23 00	21 00	5 00	2 00
Sweetheart	Joseph H. Sterling	27 00	23 00	5 00	2 00
The Wake	Edward F. Caldwell	31 00	28 00	6 00	2 00
Trochilus	M. W. Bronson	21 00	5 00	1 06

Beam.	Draft.
ft. in.	ft. in.
7 10	1 03
6 06	1 04
9 00	2 00
2 07	— 03
4 00	1 00
9 00	1 00
9 00	2 00
8 07	1 00
9 00	1 00
8 00	1 08
8 04	1 00
8 08	1 00
4 00	1 05
8 00	1 01
9 00	1 10
9 04	1 02
6 00	1 00
8 00 $\frac{1}{2}$	1 08
...	...

Beam.	Draft.
ft. in.	ft. in.
6 02	2 00
8 00	5 09
...	...
5 00	2 06
6 00	2 01
6 06	2 03
...	...
6 03	2 01
...	...
5 00	2 00
5 00	2 00
6 00	2 00
5 00	1 00

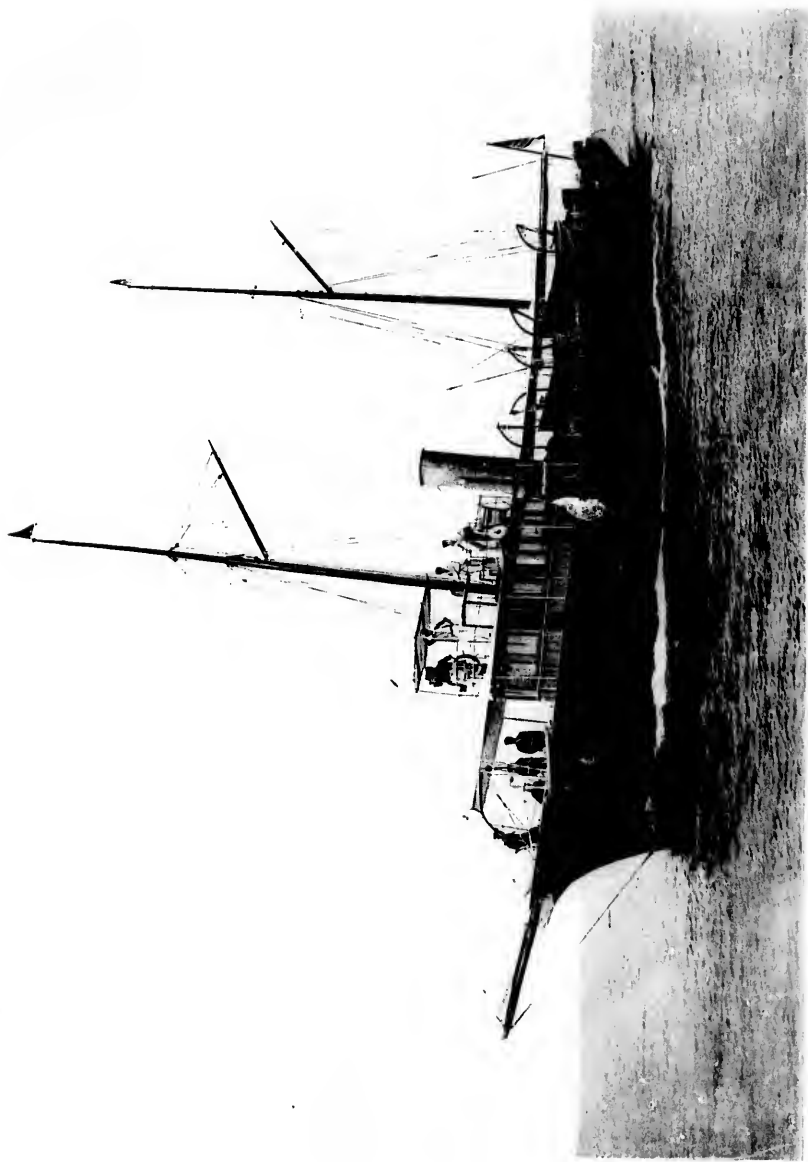

PLATE LXXIX.

AVENEL.

AVENEL.





BIOGRAPHICAL SKETCHES AND DESCRIPTION OF YACHTS ENROLLED IN THE CLUB.



JOSEPH H. STERLING.

JOSEPH H. STERLING, banker and broker, Commodore of the **HOUSE SHOE HARBOR CLUB**, is a native New Yorker, born in 1850 and is of Quaker parentage. Has been the owner of the sloop **REVERE**, the schooner **LEONA** and the sloop **DART**, his present yacht. Has held the offices of Vice-Commodore and Rear-Commodore, as well as the position which he now holds. He is a member of the **NEW YORK** and **LARCHMONT YACHT CLUBS** and **CORINTHIAN MOSQUITO FLEET**, and a charter member of the **HOUSE SHOE HARBOR CLUB**. Is also a member of the **Liederkrauz** and of the **Manhattan and Union League Clubs**.

Commodore Sterling is a very popular yachtsman and is enthusiastic in advancing the interests of yachting.

DART.

A centerboard sloop (formerly **MOLLIE**), designed and built by J. H. Soule, Bristol, R. I., and launched in 1876. Has been the property of Mr. Daryea and of Maturin Ballou, Esq., and at present belongs to Joseph H. Sterling, Commodore of the **HOUSE SHOE HARBOR CLUB**. Was re-built in 1890, being lengthened and given a new keel and stern. She hails from New York and sails with the **NEW YORK**, **LARCHMONT**, **CORINTHIAN MOSQUITO FLEET** and **HOUSE SHOE HARBOR CLUBS**. See plate LXXXVII.

CODE SIGNAL LETTERS, K. C. G. R.
Official number, 140,116.

DIMENSIONS.

Length over all,	70 feet.	Length load waterline,	57 feet 4 inches.
Depth,	5 feet 5 inches.	Draft,	7 feet.
Beam,	17 feet 2 inches.		

Has twice made the trip from Newport to Larchmont in 14 hours, and has the record of running—wind and tide favorable—32 miles in 2 hours, 20 minutes.

ROI.

ROI is a centerboard cabin cut-boat owned by R. V. Lynch and D. W. Thomas of New York. She was designed and built by D. and C. H. Crosby, Osterville, Mass., and was launched in May, 1892. She sails with the **INDIAN HARBOR YACHT CLUB** and **HOUSE SHOE HARBOR CLUB**, hailing from New York. See Fig. 559.

DIMENSIONS.

Length over all,	30 feet 10 inches.	Length load waterline,	26 feet 4 inches.
Draft,	2 feet 6 inches.	Beam,	12 feet 5 inches.

Racing Record for 1892 :

NEW ROCHELLE YACHT CLUB—**ROI** won in the Seventh Annual Regatta, sailed July 23d, beating **NELLIE**.

DORGLASTON YACHT CLUB—On July 4th, in the Annual Regatta, **ROI** was the winner in her class, defeating **ANCHER** and **GREYHOUND**.

INDIAN HARBOR YACHT CLUB—In the Fourth Annual Regatta of July 30th, **ROI** won, beating **ALMA**.



B. C. LOCKETT.

B. C. LOCKETT, Vice-Commodore of the **HOUSE SHOE HARBOR CLUB**. Mr. Lockett was elected to office for the very sensible reason that he takes pride in the success of the club and does all in his power to advance the best interests of the same. He is always ready for a yacht race and is in constant demand by the members, owing to his thorough knowledge relative to the management of a yacht and the rules and regulations governing a yacht race.

BLOODE.

A centerboard cut-boat owned by Alphonse Montant of New York City. Built by A. E. Smith, 1-6ip, N. Y., and launched in 1870. Hails from New York City and sails with the **SEAWANAKA CORINTHIAN**, **LARCHMONT** and **HOUSE SHOE HARBOR CLUBS**. See Fig. 560.

DIMENSIONS.

Length over all,	33 feet.	Length load waterline,	29 feet 7 inches.
Draft,	2 feet.	Beam,	12 feet.



PIERRE NOËL.

PIERRE NOËL, Fleet Captain and Chairman of the Regatta Committee of the **HOUSE SHOE HARBOR CLUB**. Mr. Noël is an enthusiastic yachtsman and members of the club will frankly admit that much of the success of the club is due to his indefatigable push and enterprise. He has been interested in yachting for the past fifteen years and is the owner of the naphtha launch **GROWLER**, which is generally used as the judge's boat at the various regattas held. Mr. Noël is also a member of the **LARCHMONT YACHT CLUB**, in which club he is equally popular on account of his even disposition and generous impulses.

GROWLER.

GROWLER is a naphtha launch, the property of Pierre Noël. See Fig. 561.

DIMENSIONS.

Length over all,	34 feet.	Length load waterline,	28 feet.
Draft,	2 feet 6 inches.	Beam,	6 feet.



CHARLES A. SINGER.

CHARLES A. SINGER, New York City, was born in New York City, December 20, 1860. Has been interested in yachting for ten years, and was instrumental in founding both the **LARCHMONT** and **HOUSE SHOE HARBOR CLUBS**. Was for two years President of the latter organization and one year Secretary of the **LARCHMONT YACHT CLUB**.

Mr. Singer has a large acquaintance and is a most popular yachtsman.



COMMODORE TRUMAN H. NEWBERRY.

ISLAND AMERICAN YACHT CLUB.

History of the Inland American Yacht Club.

STATION—DETROIT, MICH.

THE INLAND AMERICAN YACHT CLUB was organized and incorporated on June 16, 1890, at Detroit, Michigan, by Messrs. Frank H. Walker, W. C. McMillan, Alfred E. Brush, Truman H. Newberry, Cameron Currie and William F. Jarvis, for the promotion of steam yachting and the social interests of its members. While most of its incorporators were members of the NEW YORK YACHT CLUB, there were a great many other steam yacht owners who had no settled regulations for the uniform and rating marks of their own crews, and one of the principal objects sought by this organization was the fixing of common rules and regulations, and also the adoption of a routine for the guidance of the members at home and abroad.

The membership was limited to eighty-five, and was almost immediately filled. During the first year the club made four short cruises to which every member was invited and assigned to the different yachts participating as the guests of the officers. The officers for the year 1890 were re-elected in 1891 as follows: Commodore, Franklin H. Walker; Vice-Commodore, William C. McMillan; Rear-Commodore, Alfred E. Brush; Secretary, Cameron Currie; Treasurer, Truman H. Newberry; Measurer, William Fowler Jarvis; Fleet Surgeon, Frederick P. Anderson, M. D.

During the season of 1891 the cruises which were found so agreeable the season previous, were repeated with even greater success. At this time the club had a fleet of fourteen yachts, the smallest of which was eighty-seven feet over all.

In the year 1892, Commodore Walker, intending to go abroad, declined the honor of a re-election, and the officers elected were as follows: Commodore, Truman H. Newberry; Vice-Commodore, Alfred E. Brush; Rear-Commodore, Franklin H. Walker; Secretary, Cameron Currie; Treasurer, William C. McMillan.

The other officers and standing committees remained the same. These officers were re-elected for the year of 1893. The

whole theme of this organization is so entirely of a social nature that there is comparatively little to be said. BUILDING or fitting points are well deserving of mention.

The owner of each yacht enrolled in the club furnishes to the club a model of the same, which is the property of the club. These models are made on a scale of a quarter of an inch to the foot. The importance of such a rule can easily be seen, and the value of such a collection cannot well be over-estimated.

Then the Executive Committee of the club has a power which is rather unique in the history of yacht clubs, controlling almost the entire management of affairs, and doing away with the possible friction caused by club elections, etc.

There is another remarkable aspect of the INLAND AMERICAN YACHT CLUB, they have never found any way of disposing of their initiation fees, etc. The treasury remains intact, while all the expenses of the cruises are borne by individual yacht owners.

The Commodore's yacht is:

TRUANT.

A screw schooner owned by Truman H. Newberry of Detroit, Mich. was designed by the Herreshoff Manufacturing Co., and built by the same firm. Launched in August, 1892. She hails from New York City and sails with the INLAND AMERICAN YACHT CLUB. See Plate LXXXV.

CODE SIGNAL LETTERS, K. L. J. W.

Official number, 145,926.

DIMENSIONS.

Length over all,	132 feet.	Length load waterline,	128 feet.
Draft,	5 feet 8 inches.	Beam,	17 feet 6 inches.

Engine: Triple expansion, 3 cylinders, 10, 16 and 25 x 13½ inches.
Boiler: Built by Herreshoff, 7 feet square.

LIST OF YACHTS ENROLLED IN THE INLAND AMERICAN YACHT CLUB.

Code Signal Letters.	YACHT.	OWNER.	PORT.	Tonnage.		Length over all.		Extreme beam.		Depth of Hold.		Draft.	Dimensions of Engine.
				Gross.	Net.	Ft. In.	Ft. In.	Ft. In.	Ft. In.	Ft. In.	Ft. In.		
TM	Dawn	J. Stoughton Newberry	Detroit	6 74	3.37	48 0	47 0	7 6	3 8	2 0		Tr. Ex. 34y. 1-6 & 10	
TJ	Hinda	F. W. Fletcher	Alpena, Mich.	63 0	70 0	13 0 1/2	8 0	7 6		10 & 18x18	
TC	Idler	James McMillan	Detroit	125 0	95 0	15 0	7 6	5 0		9 1/2-14x21x11	
....	Lella	"	40.00	20.00	100 0	95 6	16 0	7 4		9-16x18	
TD	Lillie	A. E. Housh	"	31.21	21.56	97 0	79 0	15 6	1 8	4 8		8 1/2" pl. Com. 10 & 16x12	
TN	Lurline	J. H. Water	Windsor, Ont.	87 0	82 0	16 3	9 6	7 0		12-16x22	
TH	May Lily	Geo. Hill	Detroit	200.00	31.00	61 7	15 0	8 0		10-16x10	
TH	Pastime	F. H. Walker	"	110 0	98 0	19 0	6 7	6 2		Di. Com. 10 & 20x22	
TK	Sigma	S. C. Reynolds	Toledo, O.	158.58	100.20	155 0	140 0	21 1	9 0	7 0		10 & 32x30	
TF	Truant	T. H. Newberry	Detroit	32.14	25.61	87 6	74 0	16 0	5 0	4 5		8 1/2" pl. C. 1.2 Cy. 9 & 16-12	
TI	Vanda	C. D. Waterman	"	112 0	92 0	17 6	8 0	6 9		14 & 21x15	
TL	Vita	M. S. Smith	"	69.38	48.51	100 0	84 0	17 0	6 8	5 0		C 1.2 Cy. 10 & 18x11	

3.

Dimensions of
Engine.

Drift.

ft. in.	
2 0	Tr. Ex. 3 Cy. 14x14
7 6	10 & 18x18
5 0	9 1/2-11x21x11
....	9-10x18
4 8	Stpl Com. 10 & 16x12
7 0	12-10x22
....	10-16x10
6 2	Dbl. Com. 10 & 20x22
7 0	10 & 22x36
4 5	Stpl C. 1.2 Cy. 9 & 16-12
6 9	11 & 20x36
5 0	C 1.2 Cy. 10 & 18x11



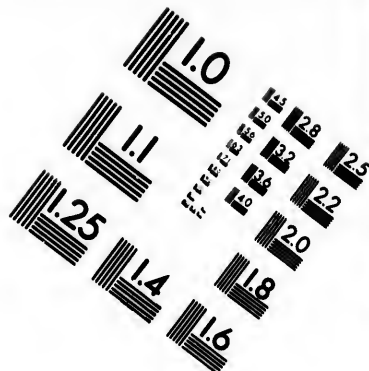
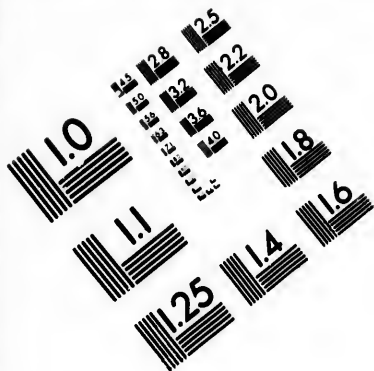

**IMAGE EVALUATION
TEST TARGET (MT-3)**

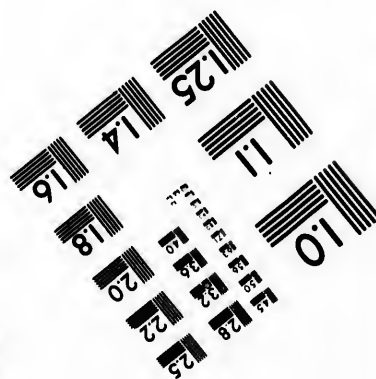
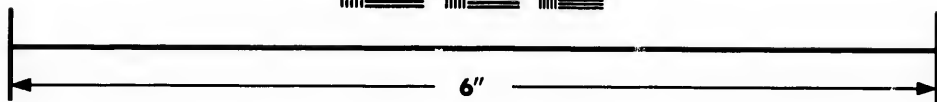
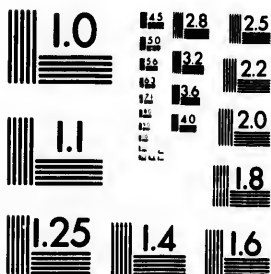

**Photographic
Sciences
Corporation**

23 WEST MAIN STREET
WEBSTER, N.Y. 14580
(716) 872-4503

2
18 20 22 25
19 23 28
24 26 27

10
11
12
13
14
15
16
17



MICHIGAN YACHT CLUB HOUSE.

History of the Michigan Yacht Club

In the broad and fertile plains with the lower slopes of the grand... most body... for the... The... for an... party... Club... city... who is... Chair... early... modern... Detroit for many... however, have... within

... Yacht... K. A. ... drawn...

... enjoyed a... not long before... 1882 not a... This led to a... and organizing... though... forth one of... 1904... a few...

It was... the Michigan... were present...

- | | |
|-----------------|-----|
| Henry... | ... |
| H. B. ... | ... |
| Alex. I. M. ... | ... |
| O. W. ... | ... |
| C. J. ... | ... |
| E. B. ... | ... |
| J. W. ... | ... |
| W. T. ... | ... |
| Jas. A. ... | ... |

- | | |
|-----|-----|
| ... | ... |
| ... | ... |
| ... | ... |
| ... | ... |
| ... | ... |
| ... | ... |

Henry... was... built... the... For... modern... 1882... subject... he left...

Thus the... the following year, when... of Directors, with Edgar D... man of the... which was... been... raised... club by... beautiful... was...

A grand... at... The... for... of the... J. C. Harris, ... D. S. ...

... for 1897... John A. ... Secretary, J. E. Harris, ... K. M. ... R. J. ...



WISCONSIN YACHT CLUB

History of the Michigan Yacht Club.

DETROIT as it is situated on the broad and beautiful straits which connect the upper with the lower lakes of the great chain that composes the finest body of fresh water in the world, possesses advantages for the amateur yachtsman of which few other American cities can boast. The straits deep and broad make an ideal sailing course for an afternoon pleasure party, while the many resorts on Lake Erie and Lake St. Clair give fine opportunity for the tired business man to leave the hot, dusty city and spend a week or two cruising. Then for the yachtsman who is hunting glory rather than pleasure, the broad bosom of Lake St. Clair presents a course for racing which embraces nearly all the requirements for the display of the fine points of the modern racing machine.

Thus yachting has been a prominent pastime in Detroit for many years back. Yachting organizations, however, have had their ups and downs, and as many as half a dozen clubs have flourished within the city borders.

The first club of prominence was the old INTERNATIONAL YACHT CLUB, organized in 1867, and numbering among its members residents of many States and the Dominion of Canada. Its life suddenly ended together with that of the first and only Commodore, K. C. Barker, who in 1875 was accidentally drowned while carrying ballast to his yacht in a small boat.

The DETROIT YACHT CLUB next enjoyed a position of prominence, but dissensions arose, and it was not long before interest in the organization began to die out, until in 1882 not a club race was sailed nor a meeting of any kind was held. This led to a division, a considerable number of the members resigning and organizing themselves as the MICHIGAN YACHT CLUB, which, though passing through the vicissitudes of early life, now stands forth one of the strongest yachting organizations of the West, having 200 members, a beautiful Club House located on a picturesque spot in lovely Belle Isle, and possessed of a fine fleet of yachts.

It was on the 14th day of April that the first meeting was held at the Michigan Exchange Hotel. The following named gentlemen were present and signed their names as founders:

Henry C. Hart	Detroit.	John H. Clegg	Detroit.
H. B. Scott	"	Ira A. Metcalf	"
Alex. I. McLeod	"	A. Marxhausen, Jr.	"
O. W. Baker	"	Arthur J. Phillips	"
C. J. L. McLeod	"	Geo. H. Scripps	"
E. B. Wendell	"	J. B. Baldy	"
J. W. Walsh	"	Chas. F. June	"
W. T. Baisch	"	Levi W. Partridge	"
Jas. A. Forrester	"	Alvert Ives, Jr.	"

Hugh Reichle	Detroit.	Geo. Boehlein	Detroit.
S. H. Ives	"	H. Kees	"
Frank Kramer	"	Jas. S. Hastings, Jr.	"
H. C. Penny, Jr.	"	J. F. C. Hollings	"
E. T. Nichols	"	E. J. Palmer	"
Wm. Blair	"	Chas. F. May	"
Chas. F. Moll	"	Andrew C. Kramer	"

Henry C. Hart, who had just completed his beautiful schooner LOUISE, was elected the first Commodore. Under his guidance the club built a pretty and comfortable house on the bank of the river just opposite the foot of Belle Isle, at an expense of \$2,500.

For five years the club continued smoothly and prospered, Commodore Hart being succeeded in 1887 by Commodore O. W. Barker.

In 1889 Fred. C. Whitney was elected commodore, and he agitated the subject of building a new Club House on Belle Isle. He started a subscription but when the work was only about half accomplished he left the city, going to the old country on a long business engagement.

Thus the club was left to drift without a hand at the tiller, until the following year, when at the annual meeting an entire new Board of Directors, with Edgar D. Miller, a young and enthusiastic yachtsman at the head as Commodore, was elected. The work of re-organization was then pushed with energy. Shares of stock which had been worth \$25 were raised to \$50 and the membership was rapidly increased. A site on the north shore of Belle Isle was granted the club by the city officials for a small yearly rental, and the present beautiful Club House was started. This was completed and opened June 22, 1891.

A grand naval display of the club's fleet passed in review before the house, and fully 1,500 guests partook of the club's hospitality. The newly acquired property had cost \$10,000 and fully \$2,500 more have since been spent in furnishings. The balconies facing the river command a view of the city front for several miles, while the waters of Lake St. Clair appear at a distance off toward the northeast.

The officers of the MICHIGAN YACHT CLUB for the year 1892 were as follows: Commodore, Joseph Nicholson; Vice-Commodore, Jno. A. Heames; Rear-Commodore, E. H. Gillman; Treasurer, S. Dow Ellwood; Secretary, J. E. Harris; Measurer, W. S. Grainger; Fleet Surgeon, D. S. Campbell.

The officers for 1893 were: Commodore, Merrill B. Mills; Vice-Commodore, John A. Heames; Rear-Commodore, R. F. Talman; Secretary, J. E. Harris; Treasurer, Frederick Marvin. Regatta Committee, R. F. Talman Edward Gruce, E. H. Gillman.

HISTORY OF THE MICHIGAN YACHT CLUB.

LIST OF YACHTS ENROLLED IN THE MICHIGAN YACHT CLUB.

STEAM YACHTS.

NAME.	OWNER.	Length.	Beam.	Depth.	Tonnage.	Old.	New.
		ft. in.	ft. in.	ft. in.			
Eder	James McMillan	95 3	15 0	0 3		57.27	41.18
Pastime	E. Chandler Walker	91 1	16 0	0 7		49.51	20.18
Tramit	Mrs. Helen Newberry	71 1	15 0	5 0		32.14	25 10
Billy	E. A. Brush	60 0	15 0	4 8		31.65	26.41
Vita	M. D. Smith	85 1	18 1	6 8		60.38	48.51
Leila	Hugh McMillan	56 7	15 2	6 4		48.20	21.10
Grace	M. B. Mills	63 7	18 0	8 7		41.71	24.97
Magna	W. K. Pareher	51 0	9 5	1 2		15.60	12.10
Louise	H. C. Hart	50 7	20 8	5 5		35.81	26.31
Larline	E. C. Walker

SAIL YACHTS.

NAME.	OWNER.	Reg.	C. R. or Keel.	Length over all.	Length L. W. L.	Beam.	Depth.	Draft.
				ft. in.	ft. in.			
Crusader	E. H. Gillman	Schooner	cb	61 0	55 00	16 0	4 06	3 02
Alert	W. W. Lovett	"	comp.	53 0	42 03	13 0	6 03	6 03
Princess	Wm. H. Moran	Sloop	"	46 0	35 03	12 7	5 09	6 10
Alice Enright	Enright Crew	"	"	41 6	31 06	10 2	6 00	1 00
Lulu B.	Wm. Look	"	cb	40 0	31 10	11 0	4 04	3 10
Empress	Wm. Look	"	"	40 0	34 06	10 4	4 06	4 06

CLASS III.

Jennie J.	Wm. Reid	Sloop	k	32 0	26 02	9 8	5 03	4 00
Muscot	W. Schweikart	"	cb	30 0	26 06	10 5	3 00	2 05
Eolus	A. E. Davis	"	"	33 0	28 00	9 0	3 00	2 00

CLASS IV.

Day Dream	E. D. Miller	Sloop	cb	31 0	24 09	9 0	6 04	2 06
Viking	Jno. P. Talbot	"	"	29 0	21 00	6 0	3 00	1 00
Aldina R.	A. C. Rousseau	"	"	31 0	21 03	9 4	2 08	1 05
Madeline	H. Dietz	"	"	26 0	21 03	9 1	2 07	1 06
Ugo	Thos. Chilvers	"	k	25 0	22 06	9 0	5 00	3 00

CLASS V AND SPECIAL CLASS.

Cyclone	W. Schweikart	Sloop	cb	20 0	18 01	7 6	2 03	1 00
The Bird	C. H. Brueker	D. Cat	"	19 0	18 03	4 0	2 00	1 00
Sheila	T. H. Davenport	Cat	"	21 0	18 00	7 2	2 04	1 05
Virginia H.	A. E. Brush	D. Cat	"	18 0	18 00	4 5	1 10	1 00
The Mude	T. H. Simpson	Cat	"	17 0	16 00	4 0	2 00	00
Annie	A. E. Davis	"	"	10 0	18 01	5 6	1 08	00
Grayling	A. E. Davis	Sloop	"	20 0	18 00	6 0	2 00	1 00
Aldina H., Jr.	A. C. Rousseau	Cat	"	12 0	12 00	5 0	1 03	00
Mouse	A. E. Davis	"	"	16 0	15 00	1 6	1 06	1 00
Sailor Boy	A. E. Davis	"	"	16 0	15 00	4 6	1 06	1 00
Lois	E. Brady Wendell	D. Cat	"	18 0	18 00	5 4	2 02	1 00
Judy	E. Brady Wendell	Cat	"	10 0	10 00	4 4	1 05	00
Nellie	A. Ives, Jr.	D. Cat	"	19 0	18 03	3 0	2 00	1 00
Alice H.	H. S. Robinson	"	"	19 06	19 03	5 6	2 01

New.
 ft.
 41.10
 20.18
 25 10
 20.41
 48.51
 21.10
 24.97
 12.10
 20.31

ft. in.	ft. in.
4 01	3 02
6 03	8 07
5 00	6 10
6 00	4 00
4 04	3 10
4 05	4 20

5 00	4 00
3 00	2 00
3 00	2 00

6 01	2 05
3 03	1 00
2 08	1 01
2 07	1 00
5 03	3 00

2 03	1 00
2 00	1 00
2 04	1 00
1 10	1 00
2 00	00
1 08	00
2 03	1 00
1 04	08
1 06	1 00
1 06	1 00
2 02	1 00
1 05	00
2 00	1 00
2 01

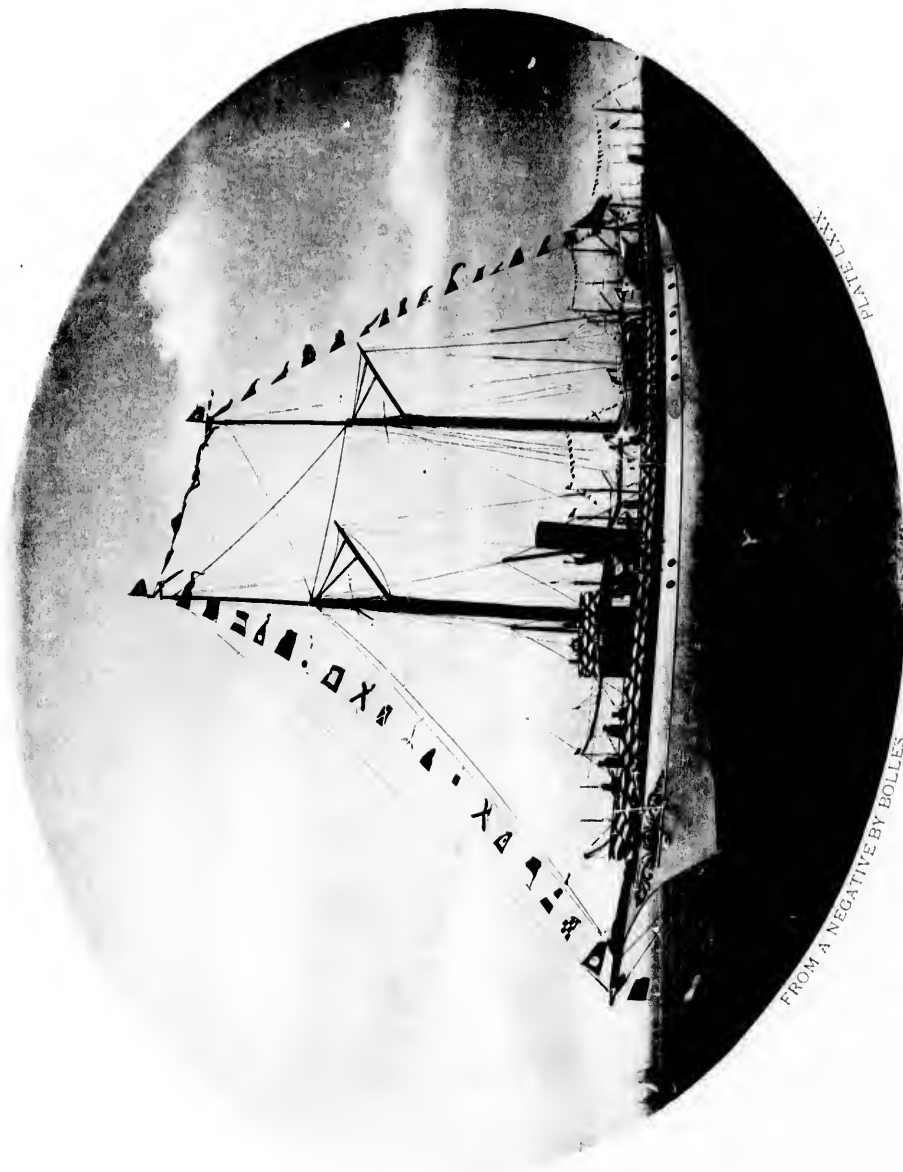
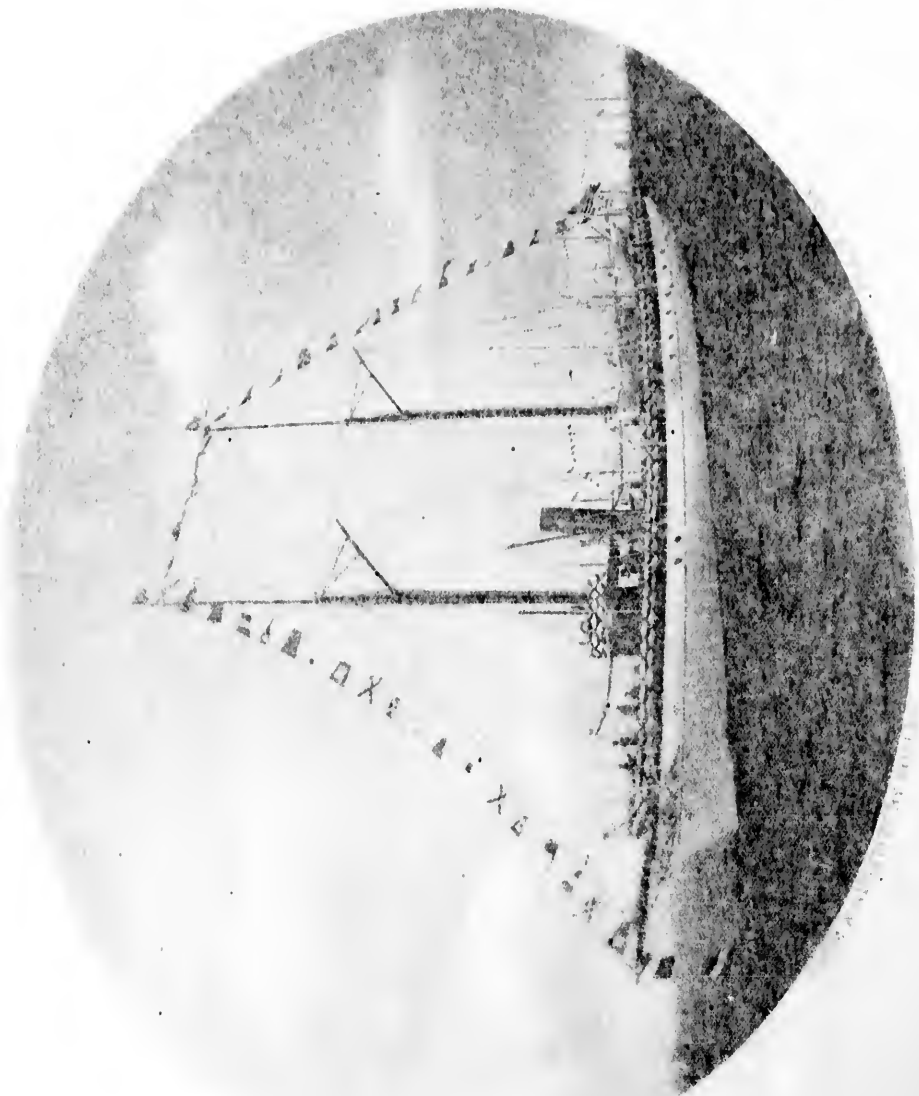

PLATE XXXI

FROM A NEGATIVE BY BOLLES.

GOLDEN ROD.



GOLDEN ROD

ACCORDING TO THE RULES AND REGULATIONS.

Yachts shall be rated for time allowance according to the following system:

To the square root of sail area add the load waterline length and divide the same by two.

$$\frac{\sqrt{S. A. + L.}}{2} = L.$$

The result is the measurement for time allowance.

The measurement shall be obtained as follows:

A base line to be taken from a point midway between the jib top-sail stay and the jibstay on bowsprit, or the flying jibstay on jibboom, in a straight line to the end of the main boom, with the excess of the

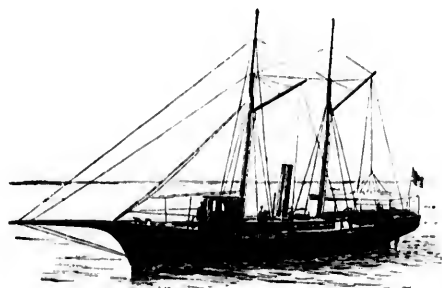

GRACE.—FIGURE 562.

length of gaff, measured from after side of mast, to end over 80 per cent. of the topmast measured from hounds to lower side of sheave on topsail halliard block.

The length of base line as above defined shall be modified in any case where the spinnaker boom measures more than the distance from the fore side of foremast in a schooner, or mainmast in a single masted vessel, to the forward point of base line as previously defined.

Any excess in the length of the spinnaker boom beyond this point shall be added to the base line. For yawls the base line to be taken from the same point to the end of the mizzen boom.

A perpendicular line to be taken along the after side of the mainmast from the underside of the sheave for gaff topsail halliard to the upper side of boom when resting on the saddle or on the lower part of goose-neck, the distance of which point from main deck or house deck to be recorded by the Measurer, together with the other points used in measurements.

To obtain the estimated area from these figures, multiply the base by the perpendicular and divide the product by two.

Length is the length on the load waterline, exclusive of any portion of the rudder or rudder stock, and is to be ascertained when the yacht is afloat in her ordinary trim, and with her crew, if aboard, stationed amidships.

The Measurer at the time of taking measurements, to fix a distinctive mark at each point. Any change in the measurements to be reported by the owners as customary to the Measurer. Allowance shall be calculated according to the table adopted by the club.

For club races yachts shall be divided into classes as follows, but this classification shall not apply to races for any challenge cups held by or belonging to the club.

Class 1. Shall comprise all boats measuring thirty-five feet or over on the waterline.

Class 2. All boats measuring thirty feet or over, and under thirty-five feet on the waterline.

Class 3. All boats measuring twenty-five feet or over, and under thirty feet on the waterline.

Class 4. All boats measuring twenty feet or over, and under twenty-five feet on the waterline.

Class 5. All boats measuring less than 20 feet on the waterline.

In races where different rigs sail together, schooners shall be rated for time allowance at eighty-five per cent., of their racing measurement, yawls at ninety-four per cent. and sloops and cutters at their actual racing measurement.

No member shall be interested in more than one yacht entered for a race except in the case of a member who has chartered his yacht to another member.

No yacht which has been chartered to a member shall be entered for a race unless she has been chartered in good faith, for a period not less than two months.

Yachts in races may carry the following sails:

SCHOONERS.

Mainsail, foresail, forestaysail, jib, flying jib, jib topsail, fore and main gaff topsail, main topmast staysail and spinnaker.

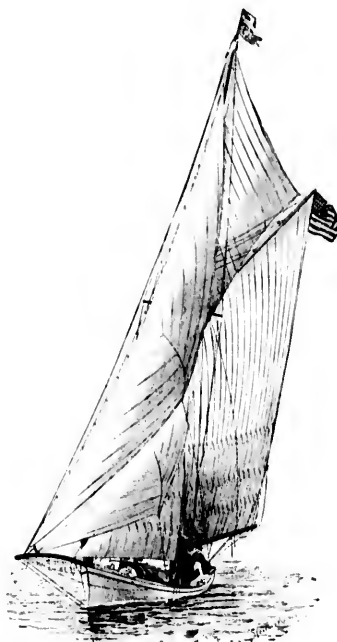

ALICE ESRIGHT.—FIGURE 563.

SLOOPS AND CUTTERS.

Mainsail, fore staysail, jib, flying jib, jib topsail, gaff topsail and spinnaker.

YAWLS.

Same as sloops and cutters, with mizzen and mizzen staysail.

Yachts may set light sails over working sails.

The allowances in the table adopted by the club are based upon the rule accepted by naval architects that, within economic limits, opportunities for speed vary in different vessels as the square roots of their respective lengths. As strong winds are required, however, to give to larger vessels the full extent of their advantage in size, and as such a scale of allowance is not adapted to ordinary Summer racing, 50 per cent. only of the allowance due to the rule is given in the table and may be stated thus:

Time equals $.5 \left\{ \frac{3000 - 300}{L} \right\}$; 3000 representing the number of seconds in an hour, L the small yacht, and l the large one.

Practically the formula is $\left\{ \frac{1800 - 1500}{L} \right\}$ five-tenths of 3000 being 1,800.

RACES.

Probably no event which took place on the Great Lakes ever created more interest and drew out more witnesses than the race under the auspices of the MICHIGAN YACHT CLUB between the famous Burgess Clipper *PARROOSE* and *CITY OF THE STRAITS*, a yacht designed and built in Detroit. It was the first time that an actual test of the comparative merits of eastern and western built yachts had been made, which fact drew to the race yachtsmen from many points, such as Buffalo, Cleveland, Toledo, Chicago, Port Huron and Saginaw.

The morning of October 7, 1891, the day set for the race, opened cloudy with a stiff wind prevailing. The start was made from a point in Lake St. Clair, just above the head of Detroit River and the course was logged off almost straight up the lake. It was a ten mile to windward and return race, but the wind shifted a few points after the start enabling the yachts to make the windward leg with one long and one short stretch. *PARROOSE* here showed a slight superiority, keeping a few points closer in the wind than her competitor. On the leeward stretch both yachts kept nearly even, finishing as follows:

	Start.	Finish.	Actual Time.	Equated Time.
	H. M. S.	H. M. S.	H. M. S.	H. M. S.
<i>Parroose</i>	11 39 28	3 02 18	3 29 50	3 29 12
<i>City of the Straits</i>	11 31 20	11 08 04	3 34 41	3 34 44

The breaking of a block on *CITY OF THE STRAITS* caused her to lose at least two minutes, so that the race proved both boats to be evenly matched.

A match for a \$500 stake was attempted between *ENRIGHT* and *JOSEPHINE*, October 21, 1891, over a 20 mile course. The weather was cloudy and the wind was light and baffling throughout. As neither yacht made the course within 4 hours 30 minutes, the race was ordered to be sailed on the following day although the elapsed time of *JOSEPHINE* was 4 hours, 30 minutes, 24 seconds. The next day October 22nd, the weather was cloudy; the wind was strong and steady and was a reefing breeze. *JOSEPHINE* won the race, beating *ENRIGHT* on time allowance of 1 minute, 30 seconds, just 20 seconds. Time of *JOSEPHINE*, 4 hours, 4 minutes, 20 seconds. Time of *ENRIGHT*, 4 hours, 4 minutes, 40 seconds. Judges: A. I. McLeod, Walter Oades, Crist, Lichtenburg.

On October 10, 1892, a contest between *CITY OF THE STRAITS*, re-christened *PRINCESS*, and *ALICE ENRIGHT* a crack compromise boat which had kept all the craft on Lake St. Clair and Lake Erie guessing for several years, was sailed under the MICHIGAN YACHT CLUB rules. The course was ten miles to leeward and return from a point in the lower part of Lake St. Clair and a whole sail breeze prevailed. *ENRIGHT* won; time being as follows:

	Start.	Finish.	Actual Time.	Equated Time.
	H. M. S.	H. M. S.	H. M. S.	H. M. S.
<i>Enright</i>	10 53 53	2 55 41	4 01 48	3 57 32
<i>Princess</i>	10 58 26	3 00 01	4 01 35	4 01 35

Equated
Time.
H. M. S.
3 29 12
3 34 44

ed her to lose
a to be evenly

ESUBUR and
The weather
oughout. As
utes, the race
gh the elapsed
ds. The next
was strong and
s race, beating
ust 20 seconds
nds. Time of
A. I. McLeod.

THE STRAITS,
ack compromise
and Lake Erie
CHIGAN YACHT
I return from a
sail breeze pre-

Equated
Time.
H. M. S.
3 57 32
4 01 35



COMMODORE M. B. MILLS,
MICHIGAN YACHT CLUB.

BIOGRAPHICAL SKETCHES AND DESCRIPTION OF YACHTS ENROLLED IN THE CLUB.

MERRILL B. MILLS, Commodore of the MICHIGAN YACHT CLUB, Detroit, Mich., was born October 12, 1854. Son of the late Hon. M. I. Mills, an early settler of Detroit. Mr. Mills is one of the most prominent business men of Detroit, and is connected with numerous companies in which he holds prominent offices. Among other positions, he is President of a well known cigar and tobacco company.

Has been a yachtsman for three years and is the owner of the handsome steam yacht GRACE. He is a member of the MICHIGAN YACHT CLUB.

GRACE.

The screw schooner GRACE is owned by Commodore Merrill B. Mills of the MICHIGAN YACHT CLUB. She was designed and built by Allan Kirby of Detroit for G. B. Hill of the same city, and was launched July 13, 1881. Commodore Mills has owned her for three years and he had her partly rebuilt in 1892. She has a flush deck and sails from Detroit. She is luxuriously fitted out and is one of the most complete pleasure craft on inland waters. See plate LXXXVI and Fig. 562.

DIMENSIONS.

Length over all,	71 feet.	Length load waterline,	48 feet.
Depth,	8 feet.	Draft,	6 feet.
Beam,	18 feet.		

Spars - Mainmast, 52 feet; Foremast, 50 feet.

Engine; Steeple compound, 10 x 16 inches.

Boiler; Marine tubular boiler, 17 x 4 feet. Built by Dessotelle, 40 horse power.



J. E. HARRIS.

J. E. HARRIS, Secretary of the MICHIGAN YACHT CLUB, Detroit, Michigan, was born in Indiana, November 4, 1860. He is the son of John K. and Jane Patton Harris, and is engaged in the wholesale oil trade.

Mr. Harris was a part owner of the famous yacht ALICE ENRIGHT until a year ago. He has been interested in yachting for six years.



JOHN A. HEAMES.

JOHN A. HEAMES, Vice-Commodore of the MICHIGAN YACHT CLUB, Detroit, Michigan, is the son of Henry and Harriet Heames. Was born in Detroit, May 22, 1839. Is a manufacturer of lime and dealer in building materials, and is also at present Register of Deeds, Wayne County, Mich. He is not a yacht owner, still for eight years he has been actively associated with the MICHIGAN and DETROIT YACHT CLUBS and the CITIZENS YACHTING ASSOCIATION.

His father held the position of President of the Common Council and served on several Commissions, and Commodore Hennes says with a seeming air of pride, that he was the only democrat elected on the county ticket last Fall.

He belongs to the DETROIT YACHT CLUB, the Detroit Athletic Club, the Lake St. Clair Fishing and Shooting Club, etc. Is also a member of the Masonic Fraternity, a Knight Templar, a member of the Scottish Rite and the Mystic Shrine. He is largely interested in gold and silver mines in New Mexico.



EDGAR D. MILLER.

EDGAR D. MILLER of Detroit, Michigan, was born in Covington, Kentucky. Held the position of Commodore of the MICHIGAN YACHT CLUB for two years and has been interested in yachting for seven years. Helped to re-organize the MICHIGAN YACHT CLUB in 1890, and is the owner of the sloop yacht DAY DREAM.

DAY DREAM.

DAY DREAM is a centerboard cabin sloop owned by Edgar D. Miller of Detroit, Michigan. She was designed and built in the Spring of 1887 by E. D. Cunningham for his own use. She hails from Detroit and sails with the MICHIGAN YACHT CLUB.

DIMENSIONS.

Length over all,	31 feet.	Length load waterline,	21 feet 6 inches.
Depth,	4 feet 6 inches.	Draft,	3 feet.
Beam,	9 feet.		

ALICE ENRIGHT.

ALICE ENRIGHT is a centerboard sloop designed and built by O. M. Hepburn of Toledo, Ohio, and launched in 1886 for a syndicate of gentlemen of the TOLEDO YACHT CLUB, among whom were Robert F. Talman and John J. Ackerman. She was built under a guarantee to outsail anything then owned in Toledo. She hails from Toledo. See Fig. 563.

DIMENSIONS.

Length over all,	41 feet 6 inches.	Length load waterline,	34 feet 6 inches.
Beam,	10 feet.	Draft,	5 feet.

RACING RECORD.

In her first race of 21 miles, though her topmast was carried away, she won easily, leading her nearest competitor SCUD, by 42 minutes; beating OBERON 1 hour and KATE GRAHAM 1 hour and 30 minutes.

In her second race sailed on Lake St. Clair, owing to adverse circumstances, she finished third. The same yachts competed.

In her third race, sailed at Put-in-Bay, she came in first, carrying off the Put-in-Bay Cup for the first time. She eventually won it three times, when it became her property. The same boats competed.

In her fourth race, sailed at Erie, she came in an easy winner of a purse of \$100. All the creek boats of Buffalo, Erie and Port Dover competed.

In her fifth race over the Toledo course, she won no place. After leading all competitors on two sides of the course, she got into shoal water and grounded on the third side, losing all chance of position.

Sixth race, Sweepstakes for \$750. Carried away rigging; no place.

May 30, 1887, TOLEDO YACHT CLUB Pennant Race; first prize.

July 4, 1887, at Buffalo; second prize.

July 25, 1887, at Put-in-Bay: Yacht Cannon and Put-in-Bay Cup; first prize. CITY OF THE STRAITS, KATE GRAHAM, OBERON, SCUD and SYLVIA competed.

July 28, 1887, Middle Sister Cup; first prize. Same yachts competed.

August 29, 1887; Toledo Yacht Annual. Machen Cup. Alter Cup. First prizes.

September 20, 1887; Sweepstakes champion flags and purse of \$750; first prize. SYLVIA and FAXON competed.

September 8, 1891; DETROIT YACHT CLUB Regatta; first prizes.

October 21, 1891; Stake Race, Lake St. Clair. Second on re-measurement.

May 30, 1892; Citizens' Regatta; first prizes.

June 20, 1892; DETROIT YACHT CLUB Regatta; first prizes and Koppitz & Melcher's Cup.

She also won three additional pennants in 1892, besides a first prize of \$750 in a Sweepstakes Race.



COMMODORE J. C. HOWELL,
DELVAN LAKE YACHT CLUB.

History of the Delavan Lake Yacht Club.

STATION—DELAVAN LAKE, WIS.

AFTER some informal talk, a meeting of yachtsmen was called July 23, 1892, at Mottowee Park Hotel, and J. C. Howell was chosen Temporary Chairman and C. V. Bachellé Temporary Secretary.

The following yacht owners and friends interested in yachting were present: J. C. Howell, G. M. Davis, H. H. Wallis, F. A. Braymer, Arthur Koch, George C. Swiler, Frederick B. Noyes, John Koelling, George O. Von Suesmilch, W. E. Davis, C. V. Bachellé, Arthur P. O'Brien, Augustus Newell, Martin O'Brien, Ernest S. Braymer and Arthur A. Braymer.

At a following meeting the club agreed to adopt the signal as suggested by the committee. This signal is an oblong flag of orange



JEANETTE.—FIGURE 564.

It was voted that the chair appoint a committee of three to draw up a Constitution and By-Laws; Messrs. Fred B. Noyes, E. S. Braymer and Arthur P. O'Brien were appointed.

At the next meeting a week later, held at the same place, the Constitution and By-Laws as prepared by the committee were adopted.

Messrs. E. S. Braymer, John Koelling and L. B. Jones were appointed as a committee to select colors and shape of club signal. Then followed the election of officers.

J. C. Howell was elected Commodore; L. B. Jones, Vice-Commodore; C. V. Bachellé, Secretary; John Koelling, Treasurer; Frederick B. Noyes, Measurer.



FLORENCE.—FIGURE 565.

and black, the colors divided by a line running from the upper left hand corner to the right hand lower corner, the orange at the top.

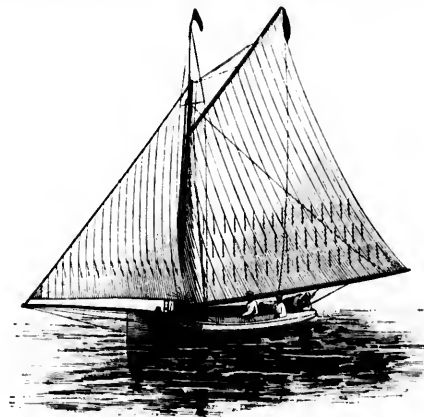

HENRIETTA.—FIGURE 566.

RECORD OF RACES.

August 8, 1892: Wind very squally, veering to all quarters. HEX-

HISTORY OF THE DELAVAN LAKE YACHT CLUB.

RIETTA was the on y yacht to finish, and as one of her crew expressed it, "her ballast kept her right side up, and her air tanks kept her from sinking, despite the fact that she was full of water." It was the worst blow Delavan Lake had experienced for a long time.

Following is a summary of the race:

	Length. Feet.	Allowance.	Elapsed	Actual
		m. s.	n. m. s.	n. m. s.
Henrietta	23.10	allows	2 17 02	2 17 02
Circe	22.01	1 43	capsized	
Ideal	17.96	7 50	disabled	
Jeanette	15.22	11 41	capsized	
Lurley	13.08	13 46	capsized	
Volunteer	14.67	12 29	must carried away	

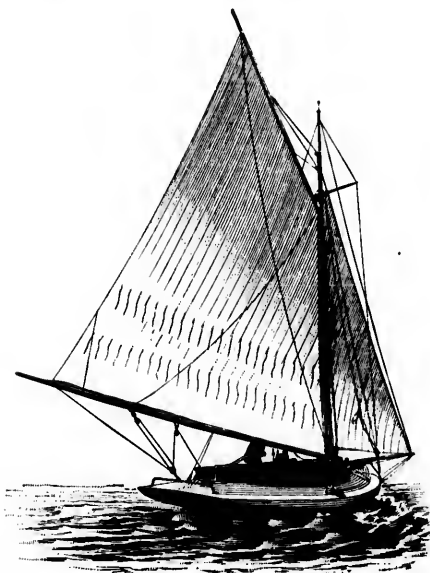

EULIANNA.—FIGURE 567.

August 19, 1892:

Henrietta	23.10	allows	1 30 55	1 30 55
Circe	22.01	1 43	1 38 25	1 36 42
Ideal	17.96	7 50	disabled	
Jeanette	15.22	11 41	1 58 02	1 46 21
Volunteer	14.67	12 29	2 02 09	1 49 40
Sinbad	18.75	6 30	disabled	

August 27th:

Henrietta	23.10	allows	1 21 45	1 21 45
Circe	22.01	1 43	1 20 23	1 18 40
Ideal	17.96	7 50	1 34 27	1 20 37
Jeanette	15.22	11 41	1 30 08	1 18 27
Lurley	13.08	13 46	1 31 44	1 17 58
Volunteer	14.67	12 29	1 32 52	1 20 23
Polly	11.03	17 50	1 39 24	1 21 34

August 29th:

Henrietta	23.10	allows	1 38 40	1 38 40
Circe	22.01	1 43	1 37 08	1 35 25
Lurley	13.08	13 46	1 43 55	1 30 09
Volunteer	14.67	12 29	1 50 31	1 37 44
Crescent	18.66	6 38	did not finish	



VOLUNTEER.—FIGURE 568.

On account of fouls by LURLEY and CIRCE, VOLUNTEER was declared winner. Therefore, CIRCE, LURLEY and VOLUNTEER each had one race to her credit, and to decide which should have the pennant a Special Regatta was sailed in the afternoon of the same day, August 29th:

Circe	1 40 50	1 40 50
Lurley	2 01 22	1 49 19
Volunteer	2 05 57	1 55 10½

The Pennant for 1892, accordingly, went to CIRCE. The wind was very light and almost died out in this race consequently the time was quite slow.

This ended the Season of 1892.

The club has been quite successful, considering the length of its existence, and its present membership numbers about fifty.

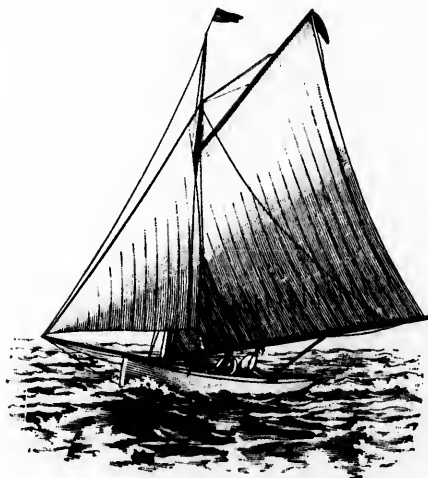

LURLEY.—FIGURE 569.



VOLUNTEER was
VOLUNTEER each
ould have the pen-
of the same day,

50 1 40 50
22 1 49 10
37 1 55 10½

E. The wind was
equently the time

the length of its
at fifty.



GRACE

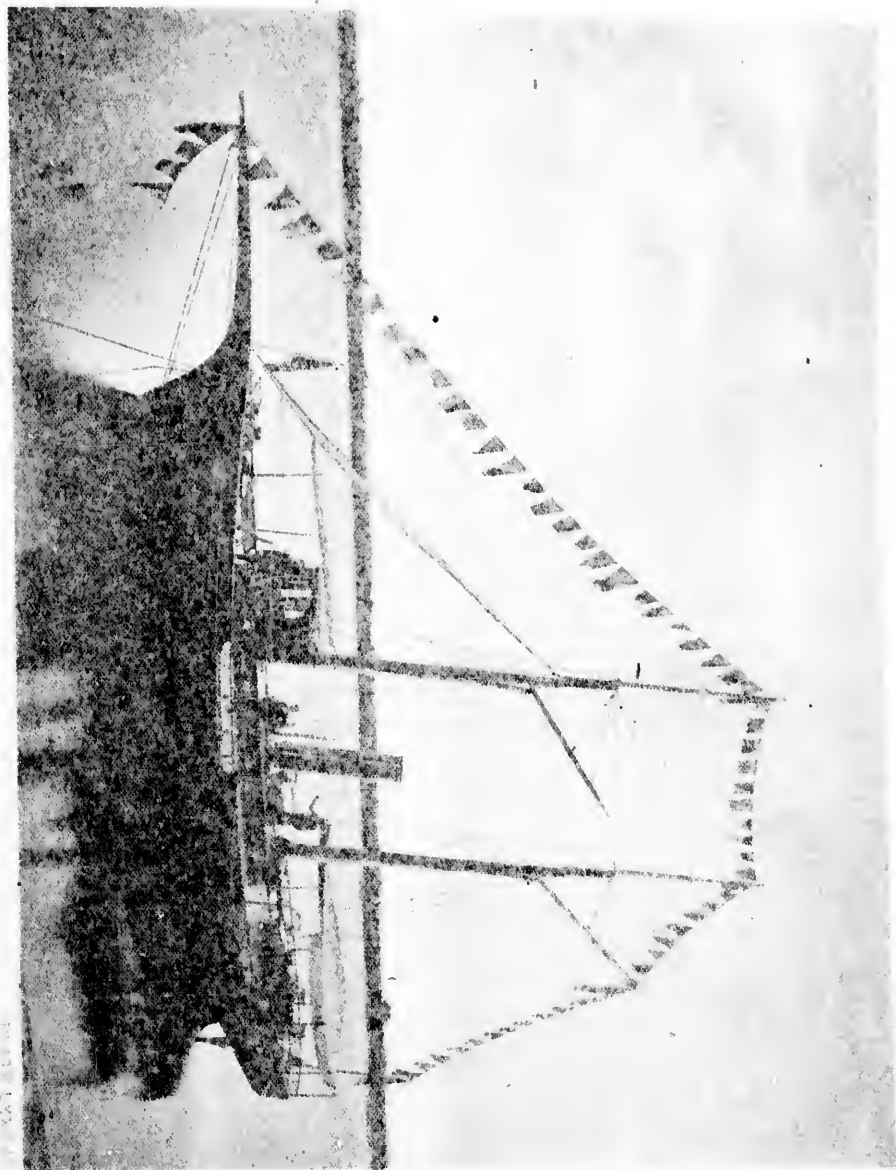

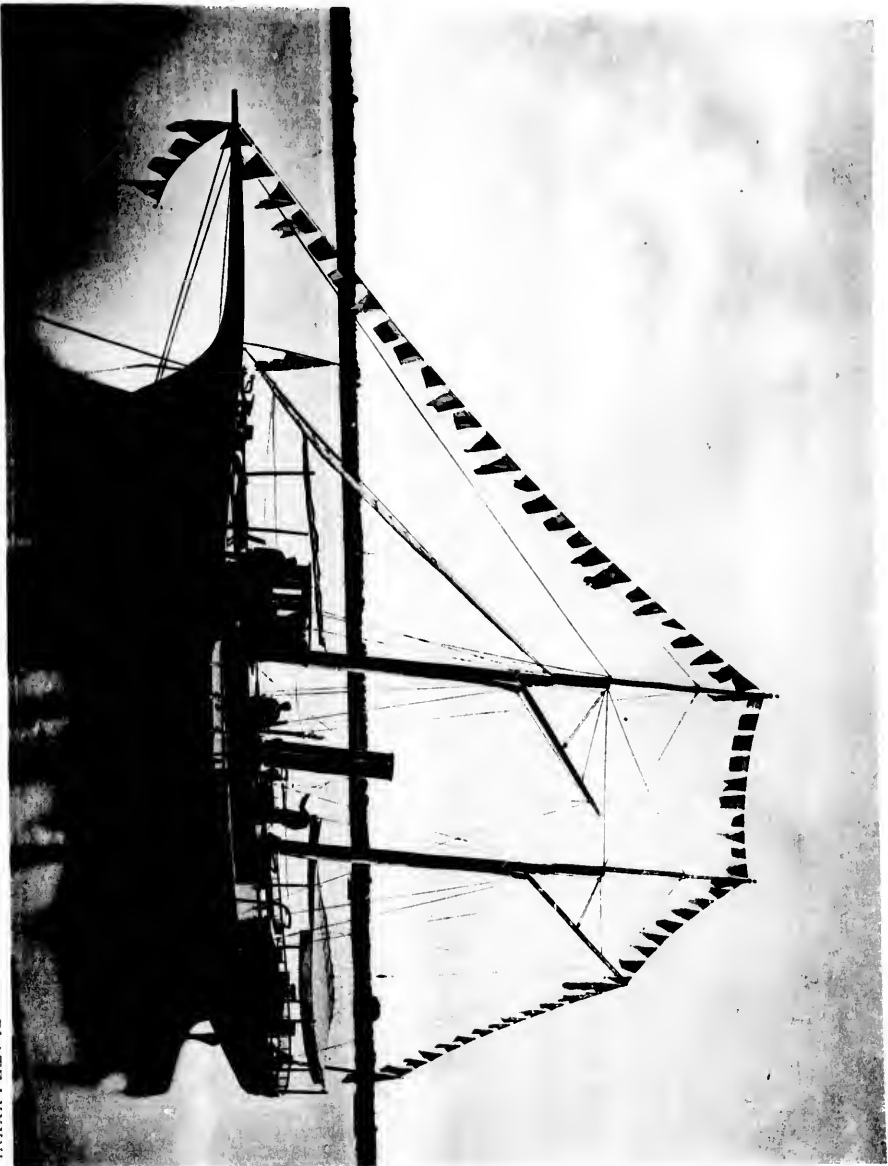

FROM A NEGATIVE BY ALYORD AND CO.

PLATE LXXXVI.

GRACE.

A VOLUNTEER WAS
A VOLUNTEER EACH
ONCE TWO THE PER
OF THE SURE DAY.

1850 1850
1851 1851
1852 1852
1853 1853
1854 1854
1855 1855
1856 1856
1857 1857
1858 1858
1859 1859
1860 1860
1861 1861
1862 1862
1863 1863
1864 1864
1865 1865
1866 1866
1867 1867
1868 1868
1869 1869
1870 1870
1871 1871
1872 1872
1873 1873
1874 1874
1875 1875
1876 1876
1877 1877
1878 1878
1879 1879
1880 1880
1881 1881
1882 1882
1883 1883
1884 1884
1885 1885
1886 1886
1887 1887
1888 1888
1889 1889
1890 1890
1891 1891
1892 1892
1893 1893
1894 1894
1895 1895
1896 1896
1897 1897
1898 1898
1899 1899
1900 1900



LIST OF YACHTS ENROLLED IN THE DELAVAN LAKE YACHT CLUB, 1893.

NAME.	C. H. OR KEEL.	OWNER.	Length overall.		Draft.
			ft. in.	ft. in.	
Hensletta	eb				
Cleo	eb	W. E. Davis	20 4	19 0	
Ideal	k	William & P. King	20 6	18 0	8 03
Villa Koch	eb	G. A. Siles	18 4	18 0	8 08
Ineog	eb	Arthur Koch	18 0	18 0	6 02
Jeanette	eb	F. C. Greene	18 0	15 5	6 00
Larley	eb	J. C. Howell	15 0	14 4	5 07
Volunteer	eb	John Koelling	20 0	16 4	5 02
Sinbad	eb	L. B. Jones	18 3	14 0	4 04
Crescent	eb	Berriman Bros.	17 6	11 8	4 06
Polly	eb	E. Williams, J. H. Cameron & Phoenix	18 0	15 5	7 03
Owl	eb	Dr. E. Noyes	18 8	18 4	7 02
Shadow	fixed e b	M. H. Lowell	16 4	15 9	3 11
Florence	eb	A. A. Brayner	14 4	13 8	4 05
		Dr. C. V. Buehler	13 9	11 8	3 10
			16 0	15 8	4 00

BIOGRAPHICAL SKETCHES AND DESCRIPTION OF YACHTS ENROLLED IN THE CLUB.

J. C. HOWELL, Commodore of the DELAVAN LAKE YACHT CLUB (1892-1913), grain commission, Board of Trade, LeGrange, Ill. Was born in 1831, in Batavia, N. Y. Has always been a yachtsman—as he modestly expresses it—"in a small way," and is the owner of the yacht *JEANETTE*.

Commodore Howell is one of the charter members of the DELAVAN LAKE YACHT CLUB.

JEANETTE.

JEANETTE is a centerboard sloop (open) owned by J. C. Howell, Commodore of the DELAVAN LAKE YACHT CLUB. Was designed and built by R. J. Douglass Company, Waukegan, Ill., for her present owner, and was launched in 1891. She hails from Delavan Lake and sails with the DELAVAN LAKE YACHT CLUB. See Fig. 564.

DIMENSIONS.

Length over all,	20 feet.	Length load waterline,	16 feet 10 inches.
Depth,	25 inches.	Draft,	14 inches.
Beam,	5 feet 2 inches.		

Spars: Mast, 19 ft. 2 in.; Boom, 16 ft. 7 in.; Gaff, 9 ft. 9 in.; Bowsprit, 7 feet (free).



CECIL V. BACHELÉ.

CECIL V. BACHELÉ, student, Chicago, Ill., was born in Chicago, December 14, 1874. He is the son of Dr. Gideon V. and Caroline V. Bachelé. Mr. Bachelé is studying at the University of Chicago. Has been interested in yachting for five years, and has been Secretary and Official Time-keeper of the DELAVAN LAKE YACHT CLUB since its organization in 1892. He sails the cut-bout *FLORENCE*.

FLORENCE.

FLORENCE is a centerboard cut owned by C. V. Bachelé, M.D., of Chicago, Ill. She was designed by her present owner and built by Thomas F. Bagley. She was launched in July, 1890, hails from Chicago and sails with the DELAVAN LAKE YACHT CLUB. See Fig. 565.

DIMENSIONS.

Length over all,	16 feet.	Length load waterline,	15 feet 8 inches.
Depth,	24 inches.	Draft,	8 inches.
Beam,	4 feet 6 inches.		

GEORGE M. DAVIS, manufacturer of steam specialties, Chicago, Ill., was born in Eaton, N. Y., the son of Richard M. and Rowena W. Davis. He is the owner of the centerboard sloop *HENRIETTA*, and is a member of the DELAVAN LAKE YACHT CLUB, being one of its founders. Has been a yachtsman for about one year.

HENRIETTA.

HENRIETTA is a centerboard sloop (open) designed by Curtis and built by Thomas Bagley for her present owner, George M. Davis. She was launched in May, 1892. She sails with the fleet of the DELAVAN LAKE YACHT CLUB. See Fig. 566.

DIMENSIONS.			
Length over all,	20 feet 4 inches.	Length load waterline,	16 feet 4 inches.
Beam,	8 feet 3 inches.	Draft,	20 inches.
Sail area,	538 square feet.		

Spars: Mast, 27 ft. 9 in.; Boom, 25 ft. 8 in.; Gaff, 15 ft. 9 in.; Bowsprit, 10 ft. 4 inch.



L. B. JONES.

L. B. JONES, Vice-Commodore of the DELAVAN LAKE YACHT CLUB, Chicago, Ill., was born in Walworth Co., Ill., in 1859. He is the son of Abijah and Susan Jones, and is a dealer in agricultural implements. He is the owner of the yachts *VOLUNTEER* and *EULIANNA*, both cut-boats, and has been a yachtsman for seven years. He is a charter member of the DELAVAN LAKE YACHT CLUB.

VOLUNTEER.

VOLUNTEER is an open centerboard cut-bout owned by Vice-Commodore L. B. Jones of the DELAVAN LAKE YACHT CLUB. She was designed by Crane of Chicago, was built by the R. J. Douglass Co., and was launched in June, 1891. She hails from Waukegan, Ill., and sails with the DELAVAN LAKE YACHT CLUB. See Fig. 568.

DIMENSIONS.

Length over all,	11 feet 8 inches.	Length load waterline,	14 feet 8 inches.
Depth,	17 inches.	Draft,	8 inches.
Beam,	4 feet 8 inches.		

EULIANNA.

EULIANNA is an open centerboard cut-bout, designed by F. W. Martin, built by the Racine Hardware Mfg Co., and launched in June, 1893 for her present owner, Vice-Commodore L. B. Jones of the DELAVAN LAKE YACHT CLUB. *EULIANNA* hails from Racine, Wisconsin, and sails with the DELAVAN LAKE YACHT CLUB. See Fig. 567.

DIMENSIONS.

Length over all,	20 feet.	Length load waterline,	18 feet 8 inches.
Depth,	2 feet 2 inches.	Draft,	1 foot 5 inches.
Beam,	9 feet.		

JOHN KOELLING, book merchant, Chicago, Ill., was born in Hamburg, Germany, of German parentage. He is the owner of the yacht *LURLEY* and is the Treasurer of the DELAVAN LAKE YACHT CLUB, of which he is a charter member. Has been interested in yachting for ten years.

LURLEY.

LURLEY is a centerboard yacht owned by John Koelling and sailing with the DELAVAN LAKE YACHT CLUB. Won in the race of this club sailed August 27, 1892, beating *HENRIETTA*, *CIRCE*, *IDEAL*, *JEANETTE*, *VOLUNTEER* and *POSY*. See Fig. 569.

DIMENSIONS.

Length over all,	18 feet 8 inches.	Length load waterline,	14 feet.
Beam,	4 feet 4 inches.		

18 feet 4 inches.
20 inches.

off. 15 ft. 0 in. ;

Commodore of the
YACHT CLUB,
Walworth Co.,
son of Abijah
a dealer in agri-
culture is the owner
and EULIANNIA,
has been a yachtsman
and charter member
YACHT CLUB.

CR.
The centerboard
-Commodore L.
was designed by
Co., and was
Ill., and sails
68.

14 feet 8 inches.
8 inches.

igned by F. W.
and launched in
L. B. Jones of
is from Racine.
YACHT CLUB. See

18 feet 8 inches.
1 foot 5 inches.

l., was born in
is the owner of
DELAVER LAKE
has been interested

elling and sail-
the race of this
CIRCE, IDEAL,

14 feet.



COMMODORE OLIVER SOLLITT.

FOX LAKE YACHT CLUB.

History of the Fox Lake Yacht Club.

STATION—JUDGE CO., WISCONSIN.

IN ALL the Western States there are numerous small lakes ranging in size from one to twenty miles in extent. Each of these so-called lakes has its adherents who visit their stamping grounds Summer after Summer for fresh air and recreation. You will always find at these resorts enthusiastic yachtsmen who enjoy sailing their small boats as much as the envied Captain who holds the stick on MAYFLOWER.

Fox Lake is a beautiful sheet of water about three miles long and one to two miles wide, and is one of the chain of lakes all connected by Fox River. The lake is situated about an hour and a half's ride from Chicago, which enables yachtsmen to spend Saturday and Sunday on their boats without interfering with their business.

Many prominent citizens of Chicago own cosy cottages on the shore of this lake and not a few boats of all descriptions plow its waters.

On the first day of July, 1891, at a meeting held for the purpose of arranging for the Annual Regatta on the Fourth of July, Mr. Oliver Sollitt, advocated the formation of a permanent organization for the two-fold purpose of encouraging the first out-of-door recreations and for carrying out measures of general improvement and benefit. The idea received its merited approval, and within two days the FOX LAKE YACHT CLUB was a permanent organization with forty-four members enrolled and fifteen boats in its fleet.

The first Regatta ever held on Fox Lake under the auspices of an organized yacht club, occurred on the Fourth of July, 1891. Eight yachts were entered and the race was a great success being the first of a series of five regattas during the Summer of 1891.

On the third Monday in April, 1892, the first annual meeting of the club was held (under the Constitution and By-Laws which had been adopted) in the parlors of the Grand Pacific Hotel. Seventy-five members had been enrolled during the first year of the club's existence. The Hon. George R. Davis was elected Commodore of the squadron, also the following officers: Commodore, Oliver Sollitt; Vice-Commodore, J. Albert Mason; Secretary, Byron Boyden; Treasurer, Dr. Karl Sandberg; Chaplain, Jenkins Lloyd Jones; Fleet Surgeon, Dr. R. N. Tooker; Measurer, James Gardner.

Regatta Committee: D. S. Daly, Leonhard Holmboe, B. C. Swift, J. C. McCord, M. P. Borden, Charles M. Boyden and Frank E. Hansell.

The club adopted the Seawanhaka rule of measurement and decided to allow twelve seconds per foot per mile; also to give six regattas during the season of 1892.

The Annual Meeting of the club for 1893-94, was held April 19, 1893, and with great enthusiasm. The following officers were elected Commodore, Oliver Sollitt; Vice-Commodore, J. Albert Mason; Secretary, Byron Boyden; Treasurer, J. A. Paterson; Chaplain, Jenkins Lloyd Jones; Fleet Surgeon, Dr. Karl Sandberg; Measurer, Leonhard Holmboe; Assistant Measurer, Robert Tooker.

Regatta and Executive Committee: Frank E. Hansell, George Martin, M. P. Borden, B. F. Swift, Summer Sollitt, F. J. Magin, John A. Putnam, J. H. Adams, J. B. Delbridge, D. S. Daly, Geo. Catlin, C. M. Boyden, James Gardner, Wm. Ramaker.

Six regular regattas were given by the club during the season of 1892-93, and four social entertainments, and at the end of the Summer the club was a most popular organization, at least four members having signified their intention to put a new boat on the lake.

ACCORDING TO THE RULES AND REGULATIONS.

There shall be six regular regattas in each year, to be held on the days designated at each annual meeting.

There shall also be four starting points for the above regattas as follows: West Shore, East Shore, South Shore, North Shore.

The choice of the regular regatta days shall be drawn by lots by the members interested in the different shores at the annual meeting.

In addition to the prizes provided for every regatta by the Regatta Committee, all first class yachts enrolled in the club shall compete for the privilege of holding the Commodore's Cup until the next regatta, when the cup shall be again sailed for. The owner, or owners, of every yacht winning the privilege of holding the cup, shall cause his, or their names to be engraved on it, together with the name of the yacht, date of regatta, and time in which the course was made. The yacht winning this privilege the greatest number of times the first season, shall hold the cup during the ensuing winter, but shall be bound to produce it the following season.

In the event that two or more yachts have won the aforesaid privilege an equal number of times, at the end of either the first or second season,* the tie shall be sailed off in the manner and at the time to be decided upon by the Regatta Committee.

Measurement shall be the Seawanhaka rule.

All yachts entered for a regatta or race shall be sailed by a member of this club, and manned by members in good standing. There shall be no restrictions as to persons carried by any yacht as live ballast merely.

Each owner of a yacht may select a uniform to be worn by the crew of each yacht at all meetings, regattas and excursions.

In all regattas and races the start shall be at 11 o'clock in the forenoon. The Vice-Commodore, or other officers of the day, may, if they deem it necessary, defer the start for a short time, but in no event shall the starting signal be delayed later than 11:30 A. M. The starting and finishing line shall be an imaginary one, drawn from the stern of the judge's boat to the flag in the buoy. The signals shall be as follows: One gun to get ready; one gun five minutes afterwards, to start. All yachts must cross the starting line within ten minutes from the last gun.

If any yacht or any part of her hull or spars be on or across the line before the signal of start is given, she must turn and re-cross the line. A yacht so returning, or working into position from the wrong side of the line after the signal to start has been given, must not pass between the judges' boat and the stake boat, and must keep clear of all competing yachts which are crossing the line properly. The time is to be taken from the moment when the boat's mast crosses the line. At the finish the boats shall cross the line without rounding the stake boat. This rule as to the manner of starting may be changed by the Regatta Committee or officer of the day for any stated regatta.

Fifth Regatta, July 29, 1893.

WINDWARD, 1st. All boats entered.

HORNET, 2d.

JOKEE, 3d. SATAN capsized.

* By end of season is meant after last regular regatta. The cup to be competed for in regular regattas only.

Ladies' Day. Regatta August 12, 1893.

Entries.
 JOKER, 1st. EUGENIA.
 HORNET, 2d. SATAN.
 WINDWARD, 3d. JOKER, HORNET and WINDWARD.

Extra—For cup presented by ladies:

Sixth Regatta, August 19, 1893.

SATAN, 1st. All boats entered.
 HORNET, 2d.
 JOKER, 3d.

First Regatta, June 17, 1893.

HORNET, 1st.
 SATAN, 2d.

Second Regatta, July 1, 1893.

Entries.
 JOKER, 1st. JOKER, HORNET.
 HORNET, 2d. WINDWARD, SATAN.
 WINDWARD, 3d. EUGENIA, PHOENIX,
 WILLY WUMPS.
 SANS SOUCI.
 GEO. R. LIDA.

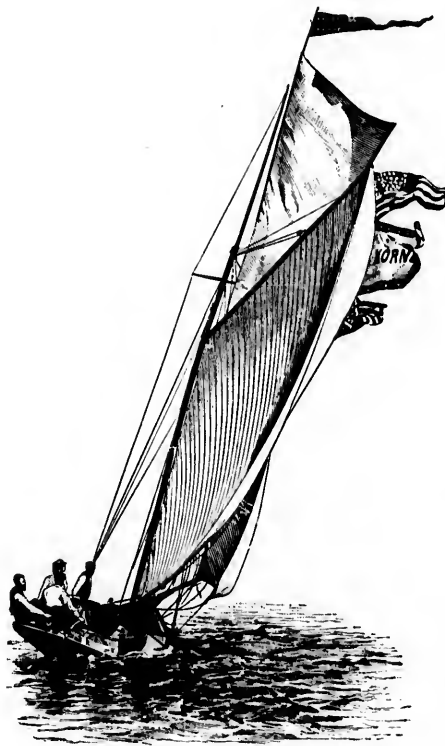

HORNET.—FIGURE 570.

The result of above races left SATAN and JOKER tie for the Commodore's Cup. This tie was sailed off under the rules, SATAN winning the race by one minute.

SATAN having won the majority of races during the season of 1892, is now the owner of the magnificent loving cup presented to the club by the Hon. Geo. R. Davis.

RECORD OF RACES, SEASON OF 1893.

The following is a record of the regattas of the FOX LAKE YACHT CLUB for the Summer of 1893:

Third Regatta, July 4, 1893.

JOKER, 1st.
 SATAN, 2d. Entries same as above.
 HORNET, 3d.

Fourth Regatta, July 15, 1893.

SATAN, 1st. Entries same as above; also,
 HORNET, 2d. FRANCIS M. PANZY.
 JOKER, 3d. EAST SIDE, BALD EAGLE,
 LINA BELLE, MISCHIEF.

THE YACHTS AND YACHTSMEN OF AMERICA.

659

LIST OF YACHTS ENROLLED IN THE FOX LAKE YACHT CLUB, 1893.

SLOOPS.

NAME.	OWNER.	L. W. L. ft.	Beam. ft.
Hornet	Oliver Sollitt	18	9
Sulan	Byron Boyden	18	9
Eugenia	M. P. Borden, F. E. Hansell, John A. Putnam	18	9
Orlole	B. F. Swift, G. L. Swift	22	9
Bald Eagle	J. H. Adams.	17	7
East Side	Dr. Karl Sundberg	17	7
Geo. R.	Oak Glen Association	17	7
Amateur	Oak Glen Association	17	7
Olive B.	Richard Morrison	18	7
(New boat)	B. F. Swift, G. L. Swift	25	9
(New boat)	Robert Tucker	18	8

CAT-BOATS.

NAME.	OWNER.	L. W. L. ft.	Beam. ft.
Sans Souci	Geo. Weidner	13	6
Willy Wimpys	Geo. Loumax, Alfred Loumax	13	6
Mischief	Geo. Catlin	13	6

CANOEES.

NAME.	OWNER.
Jaunita	H. B. Clow
Helo	Carlisle Mason
.....	J. H. Adams
Sunset	S. W. Boyden
Lida	James Gardner

BIOGRAPHICAL SKETCHES AND DESCRIPTION OF YACHTS ENROLLED IN THE CLUB.

OLIVER SOLLITT, contractor, Commodore of the FOX LAKE YACHT CLUB, Chicago, Ill. He is the son of Thomas Sollitt, and is the owner of the yacht *HOUSET*, which is 18 feet load waterline and 9 feet beam. Has been devoted to yachting all his life and is a charter member of the FOX LAKE YACHT CLUB.

As it is a conventional rule to select from the members of a club a man who is competent to fulfill the position of Commodore, as also a man as enthusiastic in the sport of yachting as possible, it was for this reason that the present Commodore was selected.



BYRON BOYDEN.

launched June, 1892.

BYRON BOYDEN, a lawyer, of Chicago, Ill. Is the owner of *SATAN*, a centerboard sloop, and has been interested in yachting all his life. Is a member of the FOX LAKE YACHT CLUB, having been one of its founders.

SATAN.

SATAN is a centerboard open sloop belonging to Byron Boyden of the FOX LAKE YACHT CLUB. She was designed and built by James S. Killen, a Hudson River yachtsman, for her present owner, and was

DIMENSIONS.

Length over all,	18 feet,	Length load waterline,	18 feet,
Draft,	1 foot 2 inches,	Beam,	9 feet

Spars. Boom, 25 feet; Gaff, 16 feet; Hoist, 21 feet.



J. A. MASON.

Superintendent of the Exposition.

Screw steamer, built and designed for her present owner, Mr. J. A. Mason of Chicago, and launched in the year 1889. She has no cabin, hails from Chicago and sails with the FOX LAKE YACHT CLUB.

DIMENSIONS.

Length over all,	30 feet.	Draft,	2 feet.
Beam,	6 feet 6 inches.		



JAMES W. PRINDVILLE.

J. A. MASON, Vice-President of the Excelsior Iron Works, Chicago, Ill., is of Scotch descent, the son of Hon. Carlisle and Jean Mason. He was born June 28, 1847. He is the Vice-Commodore of the FOX LAKE YACHT CLUB, and has been a yachtsman for six years. He assisted in the organization of this club, and he is the owner of the steam yacht *MITE*.

Was at one time a director in the Interstate Exposition of this city; also member of the Executive Committee and the

MITE.

Screw steamer, built and designed for her present owner, Mr. J. A. Mason of Chicago, and launched in the year 1889. She has no cabin, hails from Chicago and sails with the FOX LAKE YACHT CLUB.

DIMENSIONS.

Length over all,	30 feet.	Draft,	2 feet.
Beam,	6 feet 6 inches.		

Engine: Compound high pressure.

Boiler: Upright tubular, built by her owner. 12 horse power. Speed of 12 miles an hour, beating all yachts on Fox Lake.

JAMES WINSLOW PRINDVILLE, insurance and vessel agent, Chicago, Ill., was born March 31, 1851, in Chicago, the son of John and Margaret Prindville. He has been attached to yachting all his life and is a member of the FOX LAKE YACHT CLUB.

THE CLUB.

MASON, Vice-President of the
Elsior Iron Works, Chicago,
Scottish descent, the son of Hon.
and Jean Mason. He was born
1847. He is the Vice-Commo-
FOX LAKE YACHT CLUB, and
yachtsman for six years. He
the organization of this club,
the owner of the steam yacht

one time a director in the Inter-
sition of this city; also mem-
Executive Committee and the

her present owner, Mr. J.
the year 1889. She has no
in the FOX LAKE YACHT CLUB.

Draft, 2 feet.

Compound high pressure.

Upright tubular, built by her
2 horse power. Speed of 12
hour, beating all yachts on Fox

WINSLOW PRINDIVILLE,
insurance and vessel agent, Chicago,
born March 31, 1871, in Chicago,
John and Margaret Prindi-
has been attached to yachting
and is a member of the Fox
LAKE YACHT CLUB.



PLATE LXXXII.

MERLE.

REPORT

IN THE MATTER OF THE
ESTATE OF
JAMES H. HARRIS, DECEASED
ADMINISTRATOR
VS.
THE UNITED STATES OF AMERICA
DEBTOR

THE UNITED STATES OF AMERICA
vs.
JAMES H. HARRIS, DECEASED
ADMINISTRATOR
VS.
THE UNITED STATES OF AMERICA
DEBTOR

THE UNITED STATES OF AMERICA
vs.
JAMES H. HARRIS, DECEASED
ADMINISTRATOR
VS.
THE UNITED STATES OF AMERICA
DEBTOR

THE UNITED STATES OF AMERICA
vs.
JAMES H. HARRIS, DECEASED
ADMINISTRATOR
VS.
THE UNITED STATES OF AMERICA
DEBTOR

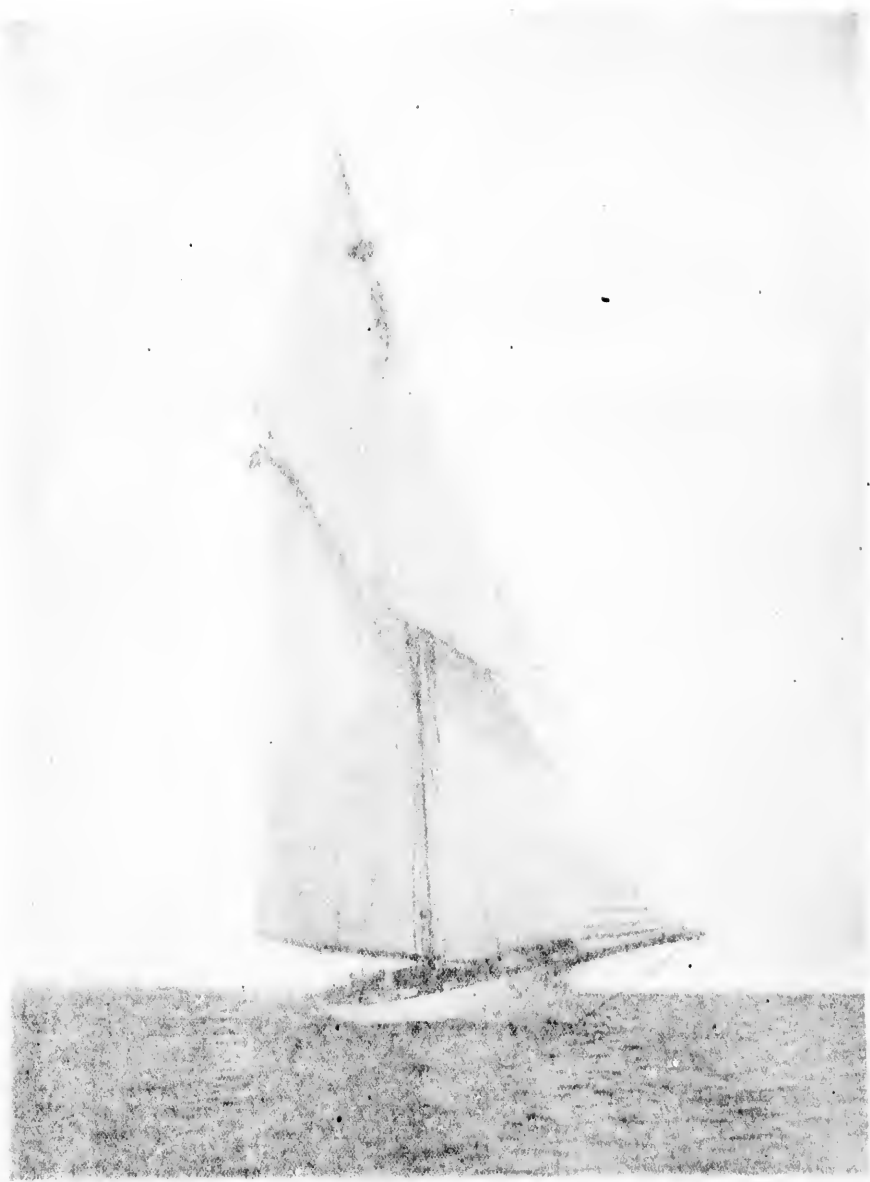

History of the Oconomowoc Yacht Club.

STATION—LA BELLE LAKE, OCONOMOWOC, WISCONSIN.

IN the Fall of 1878, the few who had early discovered the attractions of Oconomowoc and its vicinity and had located their Summer homes upon the banks of the beautiful lakes which surround it, together with some of the leading permanent residents, organized a yacht club for the purpose of encouraging and increasing their enjoyment of this delightful recreation.

The club was organized September 8th. The association was small at first and the boats of the fleet few and plain; but both have increased in number and the latter in style, until now the Oconomowoc YACHT CLUB has a membership of about 65, comprising most of the principal Summer and permanent residents of the vicinity and many that live elsewhere, including prominent gentlemen residing in Chicago, St. Louis and Milwaukee, and quite a respectable fleet, sail and steam, which for model finish are unexcelled on any inland waters.

La Belle Lake is peculiarly adapted to yachting. It is ample in size, while not large enough for annoying and dangerous seas; partly surrounded by the city it is easily accessible from all points and along every part of its beautiful shores, mainland and islands, are hospitable landings. From the tasty cottages that dot its shady banks, it is but a few steps for their owners to the decks of their trim little yachts.

A series of regattas are given by the club every season, and are more particularly enjoyable as, unlike most regattas, the yachts with their wealth of white canvass, and their graceful maneuvering as they twice sail the course over, are continually within easy view of the spectators. These regattas are systematically conducted, and the arrangements attending them and the prizes sailed for are on a liberal scale; The Regattas, the Reviews of the fleet and the occasions incident to the presentations of prizes are events of the season that add largely to the attractions of the place.

As the club increased in numbers and importance it also increased its scope. Being composed of the best elements of society in a state of perfect organization, it was felt that it could accomplish much for the good of the community, the enhancement of the natural attractions of the place and for the general prosperity. Committees were accordingly appointed to take measures for keeping the waters and shores free from defilement and for clearing them up, and other sanitary regulations and public improvements tending to the health and beauty of the place and surroundings; also for the enforcement of the laws for the preservation of the fish in the lakes from illegal and wanton destruction. These committees have, by their unremitting and direct efforts and by their influence in directing public opinion, already accomplished great and lasting good.

Another and most important object accomplished through the medium of the club was the conception, undertaking and successful carrying out to its present stage, of the scheme for connecting the lakes by locks and the improvement of connecting water-ways.

A committee to whom this was originally referred, after months of persistent labor, overcoming many obstacles and meeting with almost continual discouragement, much of which was owing to apathy or

ignorant opposition, but with the co-operation and encouragement of most of the prominent citizens, succeeded in getting the necessary rights of way, contracts made, etc., and then incorporated a company under the laws of the State of Wisconsin for the purpose of carrying out the project, and it was put into execution during the Spring and Summer of '85.

Several thousands of dollars were subscribed by those interested in seeing the work done. A lock was built between La Belle and Fowler Lakes which have a difference in level of eight feet. Bridges on public and private roads were raised, obstructions were removed, the channel straightened, and the river between Fowler and Oconomowoc Lakes otherwise rendered navigable, and a great public improvement thus carried out, which, it is believed, will prove the beginning of further navigable connection with others of the beautiful lakes of this region.

Thus this is a club with a list of members prominent in culture and station, numbering gentlemen who are actuated by neither hope of pecuniary profit or any selfish motive, acting systematically and in harmony for the two-fold purpose of encouraging the finest of out-of-door recreations, and for the carrying out of measures of general improvement and benefit, thus cultivating a healthful public sentiment.

The club has steadily grown in strength, and its prestige, influence and well directed usefulness, as well as its purpose as a pleasure association, make it one of the most creditable organizations in the country.

The first officers of the club were: Commodore, Walter L. Peck; Vice-Commodore, C. T. Sutton; Secretary, C. B. Draper; Treasurer, D. G. Munger; Measurer, H. Germain.

The following is a list of the officers for the year 1893: Commodore, Ferdinand W. Peck; Vice-Commodore, C. T. Sutton; Secretary and Treasurer, Oscar F. Jones; Measurer, Walter Dupee.

Executive and Regatta Committee: Ferdinand W. Peck, C. I. Peck, C. T. Sutton, Geo. W. Dupee, Edward Simmons.

ACCORDING TO THE RULES AND REGULATIONS.

No yacht or boat shall be enrolled in the squadron unless wholly owned by a member or members of the club. If any yacht or boat be let or hired to any person not a member of the club, she shall not be entitled, during the time of such letting or hiring, to the privileges of the club, or to wear its colors or signals.

When yachts are measured the allowance of time shall be one-half minute to the foot per eight miles.

In all cases where yachts of different classes compete for the same prize, the time allowance shall be made the same as though all yachts so competing were of the same class.

The sailing length of all yachts shall be the measurement on the waterline with full ballast. In case any yacht enter a regatta with more ballast than she carried at time of measurement, she shall be ruled out and forfeit all claim to prizes, unless she shall have reported

such extra amount of ballast to Regatta Committee before entering, in which case the committee shall make estimate of extra length (if any) that shall be charged in time allowance against her.

REGATTAS.

First Annual, September 1, 1878, Pennant, **MAGIC**.
 Second Annual, August 12, 1879, Pennant, **NAUTILES**.
 Medal, August 22, 1879, Gold and Silver Medals, 1. **BUDA**. 2. **MAGIC**.
 Triangular Course, July 21, 1880, **NAUTILES**.
 Third Annual, August 20, 1880, Pennants, Class 1, **SORTIE**. Class 2, **PEARL**.
 First Shufeldt Cup, September 14, 1880, Shufeldt Cup, **BUDA**.
 Second Shufeldt Cup, June 18, 1881, Shufeldt Cup, **ETHEL**.
 Third Shufeldt Cup, July 16, 1881, Shufeldt Cup, **ETHEL**.
 Fourth Annual, August 13, 1881, Pennants, Class 1, **UNDINE**. Class 2, **NIP**.
 Fourth Shufeldt Cup, August 15, 1881, Shufeldt Cup, **ETHEL**.
 Fifth Shufeldt Cup, September 19, 1881, Shufeldt Cup, **ETHEL**.
 Sixth Shufeldt Cup, July 4, 1882, Shufeldt Cup, **UNDINE**.
 Seventh Shufeldt Cup, Shufeldt Cup, Class 1, **ETHEL**. Final. Silver Medal, Class 2, **DAISY**.
 Fifth Annual, July 24, 1882, Pennants, Class 1, **UNDINE**. Class 2, **PEARL**.
 First Townsend House Cups, August 26, 1882, Townsend House Cups, Class 1, **ETHEL**. Class 2, **DAISY**.
 Second Townsend House Cups, June 30, 1883, Townsend House Cups, Class 1, **ETHEL**. Class 2, **DAISY**.
 First Cannon, July 14, 1883, Class 1—1. Brass Cannon, **ETHEL**. 2. St. L. Medal, **UNDINE**. Class 2, Chicago Medal, **DAISY**.

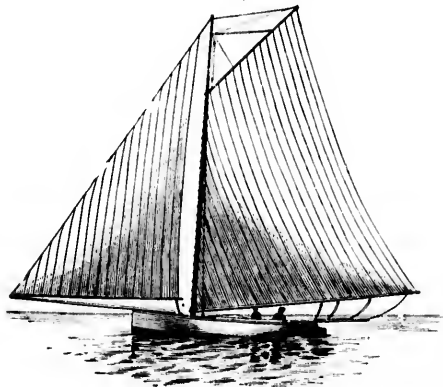

CORSAIR.—FIGURE 571.

Third Townsend House Cups, July 28, 1883, Townsend House Cups, Class 1, **ETHEL**. Class 2, **PEARL**.
 Sixth Annual and Fourth Townsend House Cups, August 18, 1883, Pennants and Townsend House Cups, Class 1, **ARLINE**. Class 2, **PEARL**.
 Second Cannon, September 1, 1883, Class 1—1. Brass Cannon, **ARLINE**. 2. St. L. Medal, **UNDINE**. Class 2.—Chicago Medal, **PEARL**.

Fifth Townsend House Cups, September 15, 1883, Townsend House Cups, Class 1, **UNDINE**. Class 2, **PEARL**.

Third Cannon, July 4, 1884, Class 1—1. Brass Cannon, **ARLINE**. 2. St. L. Medal, **ETHEL**. Class 2, Chicago Medal, **NAIAD**. Wind northerly; light.

Sixth Townsend House Cups, July 21, 1884, Class 1—1. Townsend Cup, **UNDINE**. 2. O. Y. C. Pennant, **ARLINE**. Class 2—1.

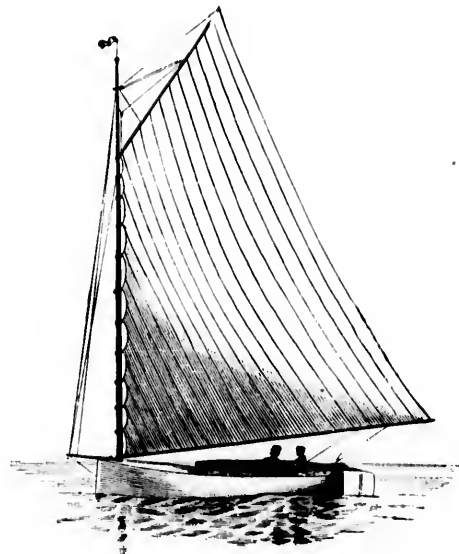

ARRON.—FIGURE 572.

Chicago Medal, **NAIAD**. 2. O. Y. C. Gold Medal, **TEASER**. Wind medium, southwest.

Seventh Annual and Fourth Cannon, August 8, 1884, Class 1—1. Cannon and Prize Pennant, **ARLINE**. 2. St. L. Medal, **ETHEL**. Class 2, 1. Chicago Gold Medal and Prize Pennant. Regatta for this class declared off on account of exceeding time limit. Wind light, variable.

Postponed Regatta for Second Class yachts, August 11, 1884. 1. Chicago Medal and Prize Pennant, **NAIAD**. 2. O. Y. C. Pennant, **PEARL**. Wind puffy, brisk southwest.

Fifth Cannon, August 30, 1884, Class 1—1. Cannon, **ARLINE**. 2. St. L. Medal, **ETHEL**. Class 2—1. Silver cat seal, **WHITE CAP**. 2. O. Y. C. Pennant, **NAIAD**. Wind northeast, squally.

First Triplet Medal, July 6, 1885, Class 1—1. Triplet Medal, **ARLINE**. 2. Club Anchor Medal, **UARD**. Class 2—1. Triplet Medal. 2. Oconomowoc Medal, **DAISY**. This Regatta was sailed in a severe gale, accompanied by squalls. Five of the nine yachts starting being either capsized or disabled before the finish.

Second Triplet Medal, July 25, 1885, Class 1—1. Triplet Medal, **NAIAD**. 2. Club Anchor Medal, **ETHEL**. Class 2—1. Triplet Medal, 2. Oconomowoc Medal. Race off as to this class on account of exceeding time limit.

Postponed Regatta for Second Class yachts, August 1, 1885, Oconomowoc Medal, **JETIE**.

Eighth Annual and First St. John's Cup, August 29, 1885, Class 1—1. St. John's Cup and Prize Pennant, **ARLINE**. 2. Anchor Medal,

r 15, 1883, Townsend
ABLINE.
Class Cannon, ABLINE.
Medal, NATAD. Wind

4. Class 1—1. Town-
ABLINE Class 2—1.

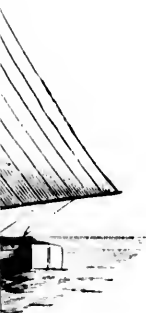

Medal. TEASER. Wind
August 8, 1884. Class 1—1.
St. L. Medal. ETHEL.
Pennant. Regatta for
ding time limit. Wind

s, August 11, 1884. 1.
2. O. Y. C. Pennant.

1—1. Cannon, ABLINE.
cat seal, WHITE CAP.
ust, squally.

1—1. Triplett Medal.
A. Class 2—1. Trip-
This Regatta was sailed
Five of the nine yachts
ro the finish.

ss 1—1. Triplett Medal.
Class 2—1. Triplett
to this class on account

August 1, 1885, Ocono-

August 29, 1885. Class
LINE. 2. Anchor Medal,



COMMODORE FERDINAND W. PECK,

OCONOMOWOC YACHT CLUB.

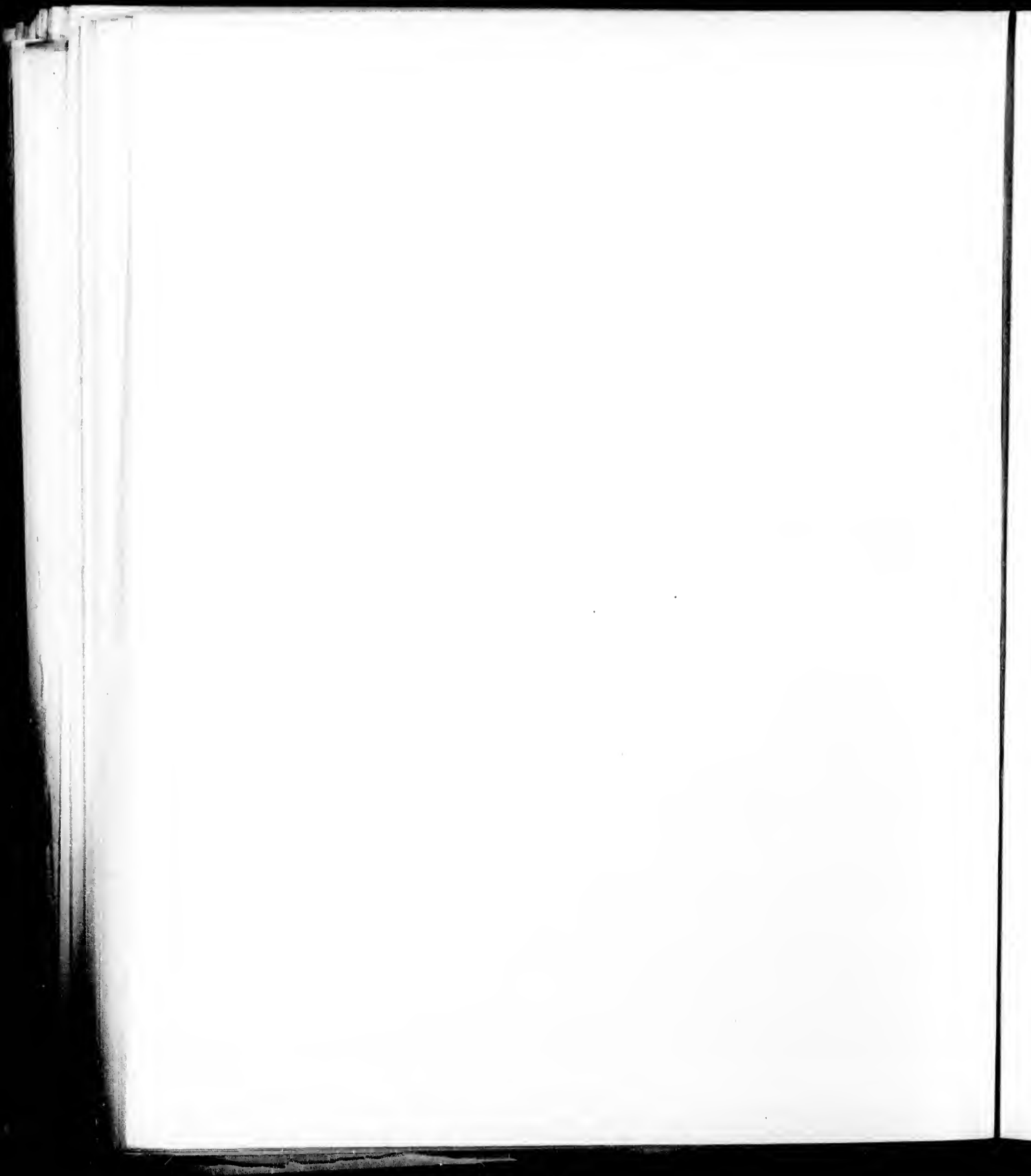

NALAD, Class 2.—1. St. John's Cup and Prize Pennant. 2. O. Y. C. Badge, VINES.

Third Triplet Medal, September 14, 1885. Class 1.—1. Triplet Medal, AULINE. (Hulley won). 2. Anchor Medal, USDINE. Class 2.—1. Triplet Medal, 2. Oconomowoc Medal, JUTIE.

This was the most closely contested regatta ever sailed by the fleet, there being a difference of but 52½ seconds time between the winner and USDINE, and 6½ seconds time between USDINE and her nearest competitor, TEMPEST. Very heavy northwest wind—all yachts reefed.

Miniature GENESTA. Prize for sloops; to be won three times by same yacht before ownership attaches. The following were the winners:

July 3, 1886, by AULINE; Com. Ferd. W. Peck.
July 24, 1886, by NALAD; Clarence I. Peck.
September 11, 1886, by VIVIAN; H. J. Cowley.
August 13, 1887, by TARPON; Com. Ferd. W. Peck.
July 9, 1888, by TARPON; Com. Ferd. W. Peck.
August 7, 1889, by TARPON; Com. Ferd. W. Peck.

The Collins Marine Glass. Prize for cuts; to be won three times before ownership attaches. The following were the winners:

August 3, 1887, by GLADYS; W. D. Simmons.
July 9, 1888, by ETHEL; Walter L. Peck.
July 6, 1889, by USDINE; Gale Thompson.
August 7, 1889, by GLADYS; W. D. Simmons.
July 5, 1890, by GLADYS; W. D. Simmons.

Munger Silver Yacht. Every part solid silver, exquisitely engraved, value \$1,000. Presented by Commodore Munger of Chicago. Open to all classes; to be won three times. The following were the winners:

July 5, 1889, by USDINE; Gale Thompson.
July 5, 1890, by TARPON; Com. Ferd. W. Peck.
July 3, 1891, by TARPON; Com. Ferd. W. Peck.
July 23, 1892, by NOVICE; Walter Dupee.

SEASON OF 1892.

Regatta sailed July 23d; wind southwest, fair. Judges, Capt. John A. S. Adler, Charles H. Whiting and D. McL. Miller.

The **MUNGER SILVER YACHT** was won by the cut **NOVICE**; corrected time, 1 hr., 6 min., 29½ sec.

The **RIVER SILVER CUP**, first prize for sloops, was won by **TARPON**; actual time, 1 hr., 5 min., 54 sec.

A **YACHT CLUB PENNANT**, second prize for sloops, was won by **MARVEL**; corrected time, 1 hr., 11 min., 22 sec.

A **GOLD CLUB BADGE**, first prize for cuts, was won by **NOVICE**; corrected time, 1 hr., 12 min., 37½ sec.

A **YACHT CLUB PENNANT**, second prize for cuts, won by **LADY MAY**; corrected time, 1 hr., 18 min., 56½ sec.

Annual Regatta, sailed August 20th; wind, south-southwest, light and unsteady. Judges, Gov. Geo. W. Peck, J. D. Long and Edwin Harlan.

Annual Prize Pennant, first prize for sloops, was won by **WINDWARD**; corrected time, 1 hr., 34 min., 14½ sec.

Second prize for sloops, **GOLD CLUB ANCHOR BADGE**, was won by **TARPON**; time, 1 hr., 39 min., 25½ sec.

First prize for cuts, Annual Prize Pennant, won by **GLADYS**; corrected time, 1 hr., 40 min., 24 sec.

Second prize for cuts, **GOLD CLUB ANCHOR BADGE**, was won by **NOVICE**; actual time, 1 hr., 54 min., 14 sec.

SEASON OF 1893.

A Regatta of the **OCONOMOWOC YACHT CLUB** took place July 22, 1893, over the club course. The wind was variable, there were eight starters. **NARCISSUS** was first and **MARVEL** second.

The next race was held July 31st, over club course. **USDINE** won in 1 hr., 8 min., 6 sec., beating **ARION** by 35 seconds. There were eight starters.

A Regatta was held August 12th, over club course. **ARION** won in 1 hr., 34 min., 47 sec., beating **GLADYS** by 5 min., 17 sec. There were seven starters. **CORSAIR** won in her class with three starters, in 1 hr., 24 min., (elapsed time) beating **TARPON** 5 min., 35 sec.

MYSORE won in her class with five starters, beating **WINDWARD**.

BIOGRAPHICAL SKETCHES AND DESCRIPTION OF YACHTS ENROLLED IN THE CLUB.

FERDINAND W. PECK, Commodore of the **OCONOMOWOC YACHT CLUB**, now living in Chicago, the place of his birth; is the son of Philip F. W. and Mary Kent Peck. Com. Peck has been a yachtsman for several years and is the owner of the yacht **TARPON**. He was one of the charter members of the **Oconomowoc Yacht Club** and has been intimately connected with yachting affairs throughout the West. Commodore Peck has also been, and still is a very prominent man in business as well as yachting. Has held or still holds the following positions of honor: Member of Chicago Board of Education, Presi-

dent of the Union League Club and Vice-President and Chairman of the Finance Committee of the World's Columbian Exposition.

TARPON.

Centerboard sloop, formerly **LILLIE R.**, the property of Ferdinand W. Peck, Commodore of the **Oconomowoc Yacht Club** and a citizen of Chicago, Ill. She was designed by P. McGeehan and was launched in 1880.

		DIMENSIONS.	
Length over all.	27 feet 6 inches.	Length at load waterline.	27 feet 6 inches.
Draft.	2 feet 6 inches.	Beam.	9 feet 6 inches.

LIST OF YACHTS ENROLLED IN THE OCONOMOWOC YACHT CLUB, 1893.

NAME.	OWNER.	RIG.	LENGTH.
Yalaha	Geo. Thompson	Sloop	27 06
Tarpon	Fred W. Peck	"	27 06
Corsair	R. G. Winslow	"	27 03
Artine	Fred W. Peck	"	22 07
Windward	Eugene H. Dupce	"	21 03
Magnome	Fred W. Peck Jr	"	21 00
Naiad	Clarence I. Peck	"	20 08
Matte W.	R. G. Winslow	"	20 06
Sortie	C. T. Sutton	"	20 00
Endine	William H. Thompson Jr	Cat	20 09
Ethel	Walter L. Peck	"	20 03
Lady May	Felix Morris	"	20 02
Novice	Walter Dupce	"	20 00
Gladys	W. D. Simmons	"	19 10
Aidon	R. G. Winslow	"	19 10
Macchee	G. W. Dupce	"	17 00
Princess	H. B. Simfeldt	Steamer	
Ador	Walter L. Peck	"	
Wyomee	Walter L. Peck	Electric	
Elston	John Dupce	Naphtha	
Whisper	Geo. A. Saxevers	"	
Zosura	A. Montgomery Ward	"	
Sweetheart	C. E. Kohl	"	

3.

LENGTH.

21 10
27 06
27 06
27 03
22 07
21 03
21 00
20 08
20 06
20 00
20 00
20 00
20 03
20 02
20 00
19 10
17 00



COMMODORE ERNEST P. WARNER.
LINCOLN PARK YACHT CLUB.

History of the Lincoln Park Yacht Club.

STATION CHICAGO.

THE LINCOLN PARK YACHT CLUB was organized in Chicago, during the Summer of 1891 and received its charter September 9, 1891. At the close of the season of 1892 there were twenty-nine active members and a squadron of fourteen yachts, ranging from fifty feet in length down to twenty feet. All the yachts of the club are sailed by their respective owners, thus showing the true Corinthian spirit.

During the season of 1892 several regattas were held by the club and prizes were awarded in the different classes, according to the rules of the club, regarding sailing, measurements, etc.

The annual meeting for the election of officers is held the first Tuesday in April of each year.

The officers elected for the year 1891 were as follows: Commodore, A. E. Bach; Vice-Commodore, vacant; Rear-Commodore, H. E. O. Heinemann; Secretary, C. O. Andrews; Treasurer, H. A. Pans,

enrolled in the Yacht Squadron, upon the owners filing with the Secretary a description thereof, containing its name, ownership, size and rig; such enrollment to be subject to a two-thirds vote of the club at any regular or special meeting. From the time of such enrollment, such boat shall be entitled to the privileges, and subject to the regulations of the club.

No boat which may be let or hired except to a member of at least one year's standing shall be entitled to enrollment in this club.

The owner of any boat which shall be sold, shall immediately thereafter notify the Secretary, who, if the purchaser be not a member of the club, shall cross its name from the Squadron, and make a report thereof to the club.



PHANTOM.—FIGURE 574.

1892.

Commodore, E. P. Warner; Vice-Commodore, H. E. O. Heinemann; Rear-Commodore, F. J. Chaiser; Secretary, C. O. Andrews; Treasurer, D. D. Dutton;

1893.

Commodore, E. P. Warner; Vice-Commodore, Geo. M. Pynchon; Rear-Commodore, T. Lovedale; Secretary, C. O. Andrews; Treasurer, D. D. Dutton.

ACCORDING TO THE RULES AND REGULATIONS.

BOAT SQUADRON.

Each boat owned, with its sails, spars and appointments, wholly and in good faith, by a member or members of the club, may be

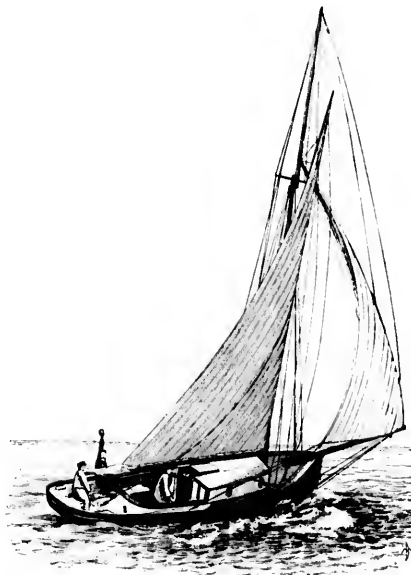

VIKING.—FIGURE 575.

In all regattas each yacht shall carry the club signal. The club signal shall be a swallow tail pennant, blue ground, with white ball in center.

REGATTAS AND RACES.

There shall be an Annual Regatta of the club in July of each year, and such other regattas as may be provided for by the club at a regular monthly meeting.

No boat shall enter for a regatta unless all dues and assessments owing by any member or members owning such boats shall have been paid.



AMERICAN GIRL.—FIGURE 576.

Boats must be entered for a regatta at a special meeting called for that purpose, at least three days before the time of starting. Such entry must be made in writing, and filed with the Secretary.

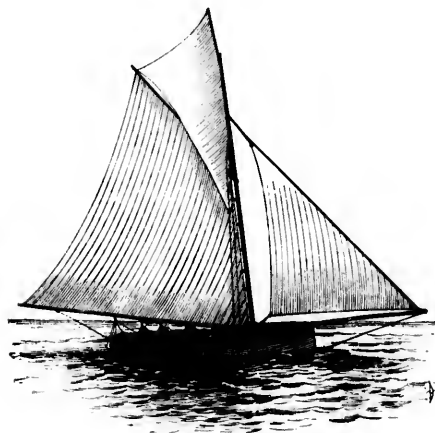

ALICE.—FIGURE 577.

CLASSIFICATION.

All yachts and boats shall be classed by measurement of length.
 First Class to consist of yachts 25 feet and over.
 Second Class to consist of yachts 18 feet and under 25.
 Third Class to consist of yachts 14 feet and under 18.

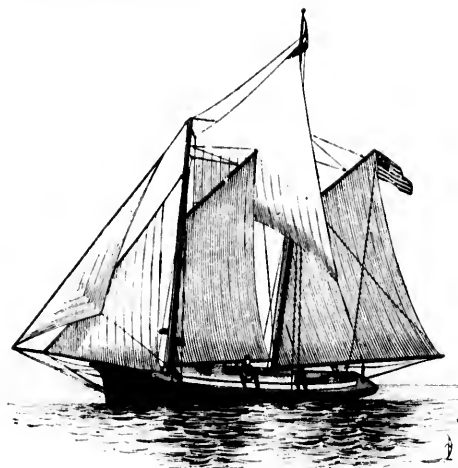

ELLIDA.—FIGURE 578.

Any yacht in a lower class may be entered and compete for a prize in a higher class by paying the entrance fee in such higher class; but such yacht can only compete for the prize declared in the class in which she is entered.

TIME ALLOWANCE.

The allowance of time for yachts of all classes shall be two seconds per mile for each foot of measurement.

CREWS.

All yachts may carry one man to each five feet and fractional part thereof equal to or exceeding two and one-half feet or more of the length on waterline, and no more in any race or regatta.

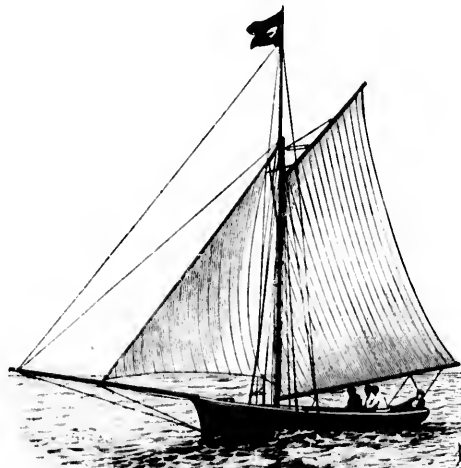

DRAGON.—FIGURE 579.



and compete for a prize
such higher class; but
declared in the class in

es shall be two seconds

et and fractional part
alf feet or more of the
r regatta.

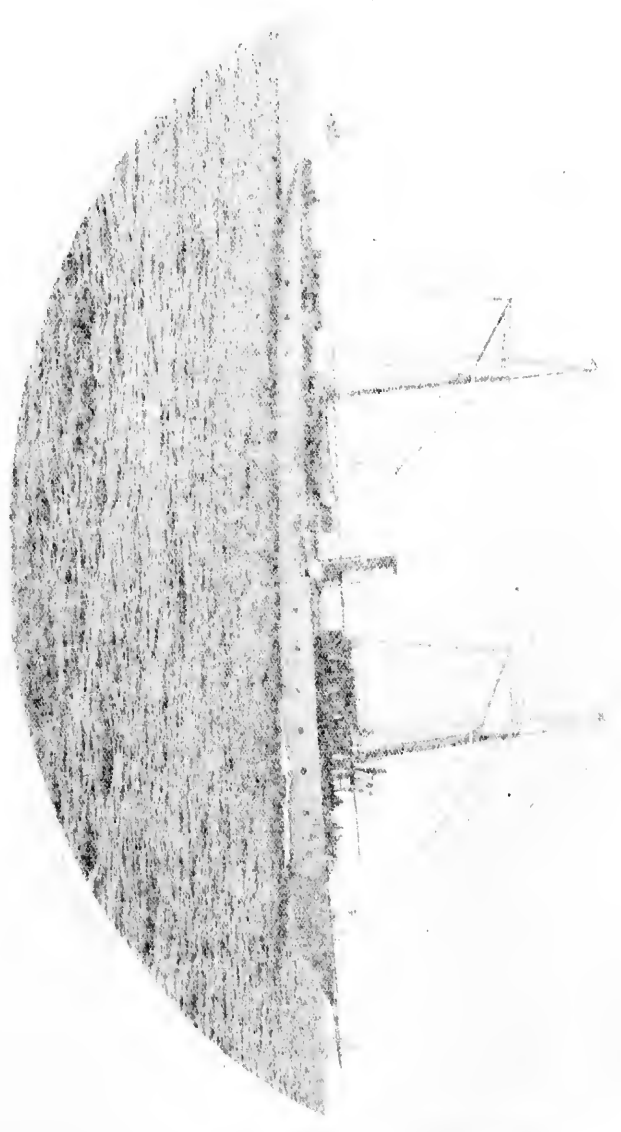

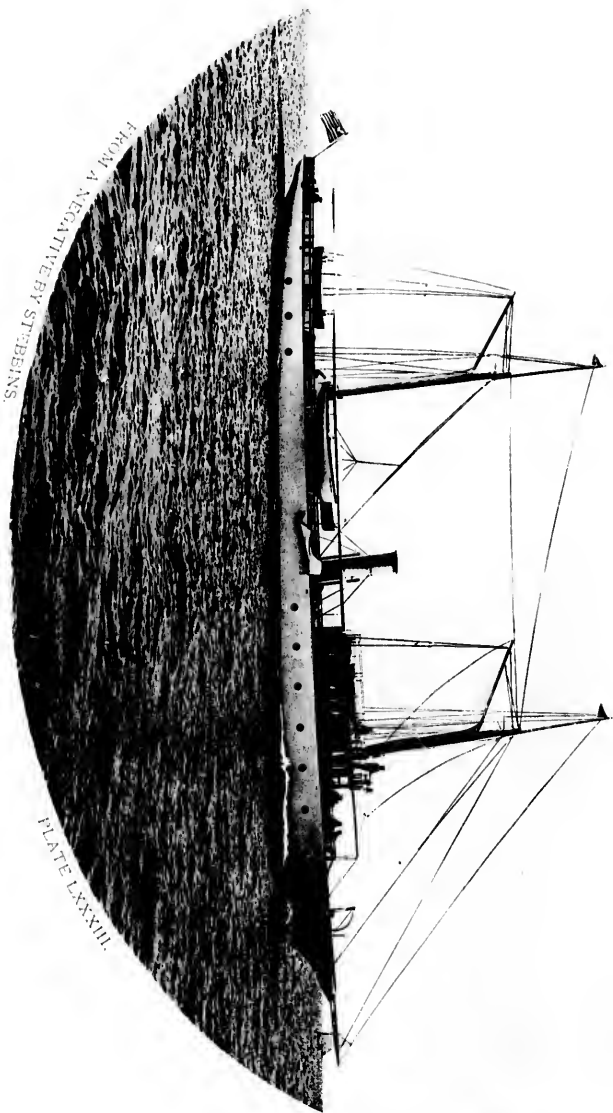

BALLYMENA.





LOIS.—FIGURE 580.

MEASUREMENTS.

The extreme length over all, including outriggers or extensions above or below the waterline, twice the extreme length of the water-



SKETCH.—FIGURE 581.

line, add these together and divide the total by three. Per example: over all 48 ft., waterline 16 ft., total 50 ft., divided by three, result 17 2/3 feet in length.

BALLAST, FOULING, PROTESTS, ETC.

After the start no throwing out, or taking in, or booming out of ballast shall be allowed. Each boat must bring back the same persons with which it started out. All ceilings, seats and fixtures must be kept on board and in their places during the regatta.

Any yacht shifting any dead ballast during a regatta or race of this club shall forfeit all claims to a prize.

Nothing but the hand lead and line shall be used in sounding.

A boat touching any other boat, buoy or flag used to mark out the course, shall forfeit all claim to the prize, except as further specified.

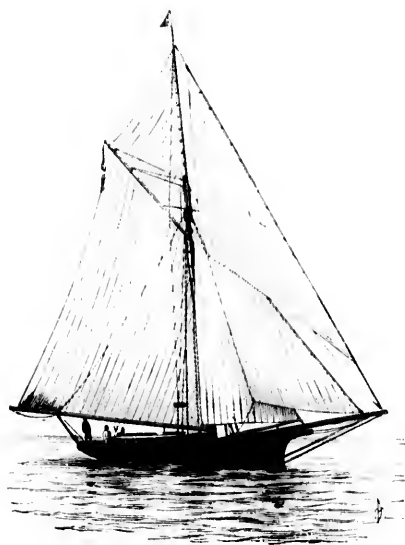

DUTCH.—FIGURE 582.

Anchoring will be allowed during a race, but no means allowed to propel a boat except sails.

A competent person may be placed by the Regatta Committee on board each stake boat, or any yacht, to make observations, and in the event of any information being required he may be examined by the judges for that purpose.

Any violation of these rules, or of the sailing regulations of the club, shall be reported to the judges immediately after the regatta, and if required by the judges, reduced to writing.

The judges, if in their discretion the charges shall not be frivolous, shall appoint an early day for hearing them, and upon such hearing may examine such witnesses as shall be produced before them. Only one person from each boat affected by the decision shall appear before them.

A prize shall be awarded to no boat which shall have broken any of the rules of the regatta, or the sailing regulations.

No boat shall be sailed in any club regatta or race, except a member of the club shall be on board.

LIST OF YACHTS ENROLLED IN THE LINCOLN PARK YACHT CLUB.

NAME.	C. B. OR KEEG.	RIG.	OWNER.	LENGTH OVER ALL.	
				ft. in.	ft. in.
Phantom	cb	Sloop	E. P. Warner	42 00	38 00
Scorpion	cb	"	T. G. Dickinson	46 07	41 02
Druid	cb	"	Geo. M. Pynchon, <i>et al.</i>	49 00	44 05
Viking	cb	"	A. E. Huck, F. J. Chuser	30 00	26 05
Dragon	cb	"	Lovedale Bros. and S. B. Ford	25 08	22 00
American Girl	cb	"	Berriman Bros. and E. D. Wood	25 01	22 00
Lois	cb	"	Geo. W. Poole	21 01	18 11
Alice	cb	"	G. O. Andrews, D. D. Dutton	20 06	17 11
Lucy	cb	"	H. A. Paus	22 05	20 08
Blade	cb	"	Frank Holmes, <i>et al.</i>	22 02	19 03
Peridot	cb	"	Chas. Mansell	20 11	19 07
Ida K.	cb	"	P. P. Wood	18 08	18 06
Eldra	cb	Schooner	Heinemann Bros.	33 00	29 00½
Sketch	k	"	John Prindiville	36 00	32 00

BIOGRAPHICAL SKETCHES AND DESCRIPTION OF YACHTS ENROLLED IN THE CLUB.

ERNEST P. WARNER, electrical engineer, Commodore of the LINCOLN PARK YACHT CLUB, Chicago, Ill.; was born in Brooklyn, N. Y. Has been an enthusiastic yachtsman for twenty years, and is a member of the LINCOLN PARK YACHT CLUB and the CHICAGO YACHTING and ROWING ASSOCIATION. Has held his present office for one year and was also Fleet Captain for one year. Is the owner of the cabin sloop PHANTOM.

PHANTOM.

PHANTOM is a centerboard (compromise) cabin sloop yacht belonging to Commodore Ernest P. Warner of the LINCOLN PARK YACHT CLUB. She was designed and built by William Curtis in 1886, and was sold to Commodore Warner in 1889. Was rebuilt in the winter of 1891-92. Hails from Chicago. See Fig. 574.

Official number, 150,381.

DIMENSIONS.			
Length over all,	42 feet.	Length load waterline,	36 feet 9 inches.
Depth,	4 feet 6 inches.	Draft,	2 feet 10 inches.
Beam,	11 feet 4 inches.		

ALEX. E. BACK, ex-Commodore of the LINCOLN PARK YACHT CLUB, a merchant of Chicago, Ill. Born September 25, 1851, of Swedish ancestry, son of J. Back. His father was a sea captain. Mr. Back has been interested in yachting for eighteen years and is at present part owner of the yacht VIKING. He is a member of the LINCOLN PARK YACHT CLUB.

VIKING.

Centerboard sloop, the property of Alex. E. Back of Chicago, Ill. She was designed and built by J. Olson for Severin S. Johnson, and was launched in August, 1890. She is also partly owned by F. J. Chaiser. She hails from Chicago and sails with the LINCOLN PARK YACHT CLUB. See Fig. 575.

DIMENSIONS.			
Length over all,	31 feet 6 inches.	Length load waterline,	28 feet.
Depth,	4 feet 0 inches.	Draft,	3 feet 8 inches.
Beam,	8 feet 0 inches.		



T. J. CHAISER.

T. J. CHAISER, Rear-Commodore of the LINCOLN PARK YACHT CLUB. Commodore Chaiser is an enthusiastic yachtsman, always ready to join with other members of the club in securing yachts to compete for the prizes offered by the club. He secured his position of Rear-Commodore on account of the active interest he has continually taken in advancing the best interests of the club. He is part owner of VIKING, a yacht which has furnished him and his associates much sport.

AMERICAN GIRL.

The compromise centerboard sloop yacht AMERICAN GIRL—formerly INITIAL—is owned by Messrs. Berriman, Wood, Stroude and Moorehead. She was designed and built by F. Martin of Racine and was launched in 1891. Originally constructed for Fred. Lattimer. She now hails from Chicago and sails with the LINCOLN PARK YACHT CLUB. See Fig. 576.

DIMENSIONS.			
Length over all,	25 feet.	Length load waterline,	31 feet.
Depth,	4 feet 6 inches.	Draft,	2 feet 6 inches.
Beam,	7 feet 8 inches.		

Spars : Mainmast, 24 feet ; Topmast, 10 feet.



C. O. ANDREWS.

C. O. ANDREWS, Secretary of the LINCOLN PARK YACHT CLUB, Chicago, Ill., was born in Chicago. He is one of the owners of the sloop ALICE, designed by himself. Is a charter member of the LINCOLN PARK YACHT CLUB, and has held his office of Secretary for three years.



D. D. DUTTON.

D. D. DUTTON, Treasurer of the LINCOLN PARK YACHT CLUB for two years, Chicago, Ill. He was born in Racine, Wisconsin, and is now a book-keeper in Chicago. Interested in yachting for fifteen years, and a part owner of the sloop yacht ALICE. He is a charter member of the LINCOLN PARK YACHT CLUB.

ALICE is an open centerboard sloop, belonging to C. O. Andrews and D. D. Dutton, of Chicago, Ill. She was designed by C. O. Andrews and built by Laberge and was launched in the Spring of 1890. Hails from Chicago and sails with the LINCOLN PARK YACHT CLUB. See Fig. 577.

DIMENSIONS.			
Length over all,	20 feet 6 inches.	Length load waterline,	17 feet 11 inches.
Depth,	34 inches.	Draft,	18 inches.
Beam,	7 feet 11 inches.		



HENRY E. O. HEINEMANN, Vice-Commodore of the LINCOLN PARK YACHT CLUB, is a newspaper writer of Chicago, Ill. Was born in Manchester, England, of German descent, the son of A. H. Heinemann. He was the German editor of the Department of Publicity and Promotion of the World's Columbian Exposition. Has been a yachtsman for ten years, and with his brother, Paul G. Heinemann, is the owner of the schooner yacht ELLIDA. A charter member of the LINCOLN PARK YACHT CLUB and the CHICAGO YACHTING and ROWING ASSOCIATION.

ELLIDA.

Centerboard schooner owned by Henry E. O. and Paul G. Heinemann. Built and launched in 1890 for her present owners. She hails from Chicago, has a cabin and sails with the LINCOLN PARK YACHT CLUB and the CHICAGO YACHTING and ROWING ASSOCIATION. See Fig. 578.

DIMENSIONS.			
Length over all,	32 feet.	Length load waterline,	27 feet 6 inches.
Depth,	5 feet.	Draft,	2 feet 7 inches.
Beam,	10 feet.		

Spars : Mainmast, 27 feet ; Foremast, 26 feet ; Main topmast, 15 feet.

DRAGON.

DRAGON is a centerboard sloop owned by Lovedale Bros. and S. B. Ford. See Fig. 579.

DIMENSIONS.			
Length over all,	25 feet 6 inches.	Length load waterline,	22 feet.

L. W. L.
11. 10.
38 00
41 02
41 06
26 05
22 00
22 00
18 11
17 11
20 08
19 04
19 07
18 08
29 00 1/2
32 00

GEORGE A. POOLE is a resident of Chicago, Ill. He is the owner of the sloop yacht *LOIS*, and is a member of the LINCOLN PARK YACHT CLUB.

LOIS.

LOIS is a centerboard open sloop yacht owned by George A. Poole, Chicago, Ill. Was built by Labirge for M. J. Metlaire, and was launched in 1889. She hails from Chicago and sails with the LINCOLN PARK YACHT CLUB. See Fig. 580.

DIMENSIONS.

Length over all,	21 feet 8 inches.	Length load waterline,	17 feet 8 inches.
Depth,	4 feet.	Draft,	2 feet.
Beam,	8 feet.		

Spars : Mast, 29 feet ; Gaff, 16 feet ; Boom, 21 feet ; Bowsprit, 12 feet.



CAPT. J. PRINDIVILLE.

could never be persuaded to take any reward.

CAPTAIN JOHN PRINDIVILLE, vessel agent, Chicago, Ill., was born in Ireland in 1825. His father was Maurice Prindiville. John Prindiville was educated at St. Mary's College and immediately took to the sea, starting in as cook and ending as captain. There is probably no man better known on the Lakes, either as a sailor or as one credited with deeds of daring and nobility. He has many times been the means of rescuing those whom death was staring in the face, and he

As a yachtsman, he has owned the vessels *ZOE*, *FRODO*, *GREYHOUND*, *COUNTESS OF DUFFERIN*, *WASP*, *MINNIE M.*, etc. He is now the owner of the cruising schooner *SKETCH*. Was the first Commodore of the CHICAGO YACHT CLUB, and is also a member of the LINCOLN PARK, CHICAGO YACHTING ASSOCIATION and CHICAGO YACHT CLUBS.

SKETCH.

SKETCH is a keel cruising schooner owned by Captain John Prindiville of Chicago, Ill. She sails with the LINCOLN PARK and CHICAGO YACHT CLUBS. Hails from Chicago. See Fig. 581.

Official number, 116,147.

DIMENSIONS.

Length over all,	45 feet 6 inches.	Length load waterline,	38 feet.
Draft,	4 feet 6 inches.	Beam,	10 feet.

DUPID.

DUPID is a centerboard cutter, her rig having been changed from sloop to cutter in 1891. She was formerly known as *MINNIE M.* and was designed by Cutlbert, her builders being Miller Bros. She was launched in 1887. Hails from Chicago and sails with the LINCOLN PARK YACHT CLUB. She belongs to George M. Pynchon. See Fig. 582.

DIMENSIONS.

Length over all,	51 feet.	Length load waterline,	47 feet 6 inches.
Draft,	4 feet 6 inches.	Beam,	15 feet.

E. FROLIC, GREY-
E M., etc. He is
n. Was the first
also a member of
TIONS and CHICAGO

aptain John Prin-
s PAUK and Chi-
ig, 581.

rtline, 36 feet,
10 feet.

een changed from
n as MINNIE M.
Miller Bros. She
is with the LIS-
M. Pynchon. See

47 feet 6 inches,
15 feet.



COMMODORE DANL. K. HALL, JR.,

HEMPSTEAD HARBOUR YACHT CLUB.

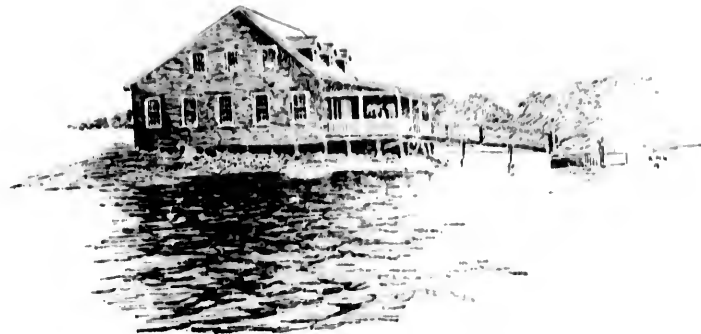

HEMPSTEAD HARBOUR YACHT CLUB HOUSE.

History of the Hempstead Harbour Yacht Club.

THE HEMPSTEAD HARBOUR YACHT CLUB was organized May 9, 1891, at Glen Cove, Long Island, for the purpose of encouraging sailing, rowing and other sports. A meeting for the election of officers was held May 15, 1891. Daniel K. Hall, Jr., was elected Commodore; Thomas Clapham, Vice-Commodore; A. H. Sleigh, Purser; J. B. Coles Tappan, Captain; Thos. T. Taber, Measurer.

On the Governing Board were: Thos. T. Taber, William L. Hicks and Paul H. Grimm.

At the second annual meeting, held on the first Saturday in March, 1892, the following officers were elected: Commodore, Daniel K. Hall, Jr.; Vice-Commodore, Thomas T. Taber; Purser, Robert F. Coeks; Captain, J. B. C. Tappan.

The other members of the Governing Board were: William L. Hicks, Samuel C. Pirie and Paul O. Grimm.

The Club House was designed by Arthur H. Sleigh and built by Daniel K. Hall, Jr., Thomas T. Taber, Arthur H. Sleigh and J. B. C. Tappan for the club. The club has now a membership of about fifty.

At the annual meeting of the club held March 4, 1893, the following officers were elected: Commodore, Daniel K. Hall, Jr.; Vice-Commodore, Thomas T. Taber; Purser, Robert F. Coeks; Captain, John Appleby.

Other members of the Governing Board: L. T. Duryea, S. C. Pirie and Paul H. Grimm. Thomas T. Taber was appointed Measurer.

RECORD OF RACES, 1891.

The First Annual Regatta was sailed on August 6th.

	Time.
Chippewa	0 31 8.
Indabazimbrt	4 15 05
Mary C.	3 40 18
Gertrude	3 11 30
	did not finish

CABIN SLOOP.

Class A.	
Gipsey	did not finish

CABIN CATS.

Class B.	
Melita	did not finish

OPEN CATS.

Homing	4 18 49
B. Q.	4 19 12
Phoebe R.	4 20 04

CABIN SLOOP.

Class C.	
Banner	3 00 40

OPEN CATS.

Sadie	did not finish
L. B. Prince	2 55 28
Skrælling	2 47 26

OPEN SLOOP.

Class E.	
Alice W.	3 00 14
Meadow Hen	2 51 59

OPEN CATS.

Vitesse	2 45 30
Presto	2 51 41
Coot	2 49 23

WINNERS.—HOMING, SKRÆLLING, MEADOW HEN, VITESSE.
Second Annual Regatta, August 6, 1892.

CABIN SLOOP.

35 Foot Class.	
Gertrude	2 16 45
Sentinel	did not finish
Beatrice	2 33 45

30 Foot Class.	
Chippewa	2 17 30
Duster	2 53 00

HISTORY OF THE HEMPSTEAD HARBOUR YACHT CLUB.

30 Foot Class.

Orinda

25 Foot Class.

Irene

Jennie Willis

25 Foot Class.

Oconee

Wenonah

20 Foot Class.

Sadie

Wang

Lohengrin

Concho

OPEN SLOOPS.

Time,
H. M. S.
2 28 00Sadie, winner
Republic

SLOOP LAUNCHES.

L. W. L.
Feet.
27.30
22.00

Winners were GERTRUDE, CHIPPEWA, ORINDA, JENNIE WILLIS,
SADIE, ADA F. and PRESTO.

A Pennant Regatta was held off the Club House September 8,
1892. The following yachts competed:

CABIN CATS.

2 29 15
2 31 30

OPEN CATS.

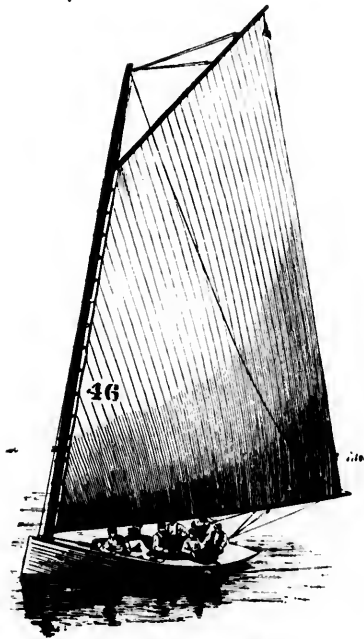
2 36 00
did not finish
2 39 00
3 02 15

GOLD DUST.—FIGURE 583.

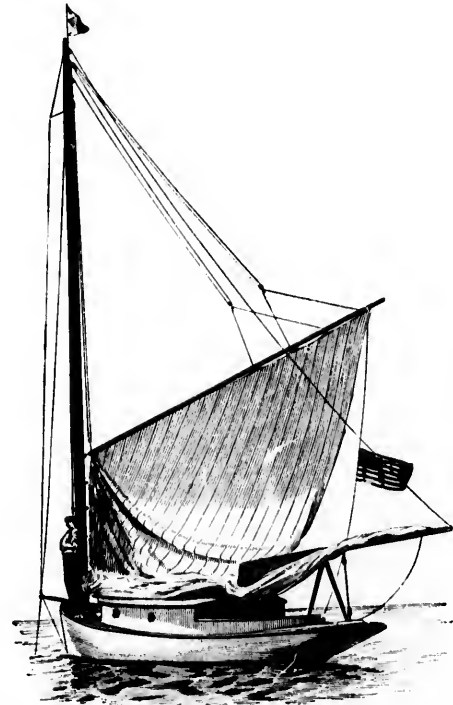

WENONAH.—FIGURE 584.

18 Foot Class.

Hume

Ada F.

Winkle

16 Foot Class.

Sea Gull

Presto

Coot

Sand Piper

Louise

2 11 30
2 06 00
2 59 452 42 45
2 01 45
2 15 00
did not finish
did not finish

Start.	Finish.
H. M. S.	H. M. S.
12 47 00	3 45 34
12 47 00	4 12 30
12 47 00	withdrew

WENONAH won by 26 min., 26 sec.

THE SEASON OF 1893.

The Annual Open Regatta of the HEMPSTEAD HARBOUR CLUB was sailed on July 15, 1893, in a strong southerly wind, and though many of the entries did not start, a good fleet turned out and the race was a success. The cabin boats sailed under the Seawanhaka rule and the open boats under a measurement of length plus $\frac{1}{4}$ overhang. Unlimited crews and shifting ballasts were allowed as usual in the open boats. The courses were:

THE YACHTS AND YACHTSMEN OF AMERICA.

673

FOR ALL BOATS OVER 18 FEET.

Starting across a line drawn between two stake boats anchored off the Club House, thence around Spar Buoy on easterly end of Execution Reef, leaving same on starboard hand; thence around Spar Buoy off Matinecock Point, leaving same on starboard hand, thence across finish line off Club House. 12 miles.

FOR ALL BOATS 18 FEET AND UNDER.

From starting line around Spar Buoy on easterly end of Execution Reef, leaving same on starboard hand; thence across finishing line off Club House. 7 miles.

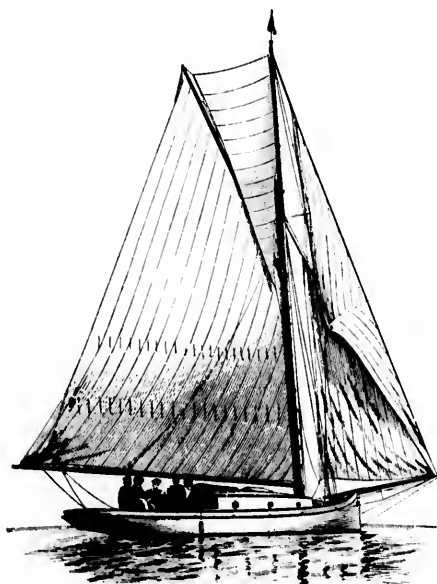

IONE.—FIGURE 585.

The strong wind brought a number of boats to grief; LOHENGREN capsized and COXOCHO withdrew to help her, GIGGLE parted her halibards and withdrew, and TOM COD lost her rudder but was steered to a finish by an oar. The Clapham boat CHIPPEWA made the best time, beating the fleet very easily. The official times were:

CABIN STOOPS.

	Start.	Finish.	Elapsed Time.
Class A, 30 feet and not over 35 feet.	0 38 55	0 36	0 33 55
Eldoran	1 10 00	3 49 54	2 39 54
Enthusie	1 10 00	1 10 00	1 00 00
Class B, 25 feet and not over 30			
Chippewa	1 10 00	3 29 42	2 19 42
Bone	1 10 00	3 23 00	2 13 00
Beatrice	1 10 00	withdrew	
Class C, 22 feet and not over 25			
Star W.	1 10 00	3 56 25	2 46 25
Wahneti	1 10 00	3 59 52	2 49 52

CABIN CATS.

Class D, 25 feet and not over 30.			
Kitty	1 10 00	3 12 12	2 02 12
Maura	1 10 00	3 28 45	2 28 45
Class E, 22 feet and not over 25.			
Coxoco	1 10 00	3 41 20	2 31 20
Nellie	1 10 00	3 39 00	2 29 00
Myrtle	1 10 00	withdrew	

OPEN STOOPS.

Class F, 25 feet and not over 30.			
Enthusie	1 20 00	1 10 00	3 00 00
Jennie Willis	1 20 00	3 37 21	2 27 21

OPEN CATS.

Class G, 22 feet.			
Elftua	1 20 00	3 37 42	2 47 42
Fairy	1 20 00	3 47 30	2 37 30
Class H, 20 feet.			
Giggle	1 20 00	withdrew	
Coclelo	1 20 00	withdrew	
Sadie	1 20 00	1 01 36	2 51 36
Baby	1 20 00	4 04 20	2 54 20
Lohengrin	1 20 00	capsized	
Class I, 18 feet.			
It	1 20 00	2 54 06	1 31 06
Ida May	1 20 00	2 59 05	1 39 05
Class J, 16 feet.			
Lark	1 20 00	2 54 00	1 34 00
Tom Cod	1 20 00	3 11 43	1 51 43
Presto	1 20 00	withdrew	
Meadow Hen	1 20 00	3 08 55	1 48 55

ELDERAN, CHIPPEWA, ALMIRA, KITTIE, NELLIE, JENNIE WILLIS, FAIRY, SADIE, IT and LARK won in their respective classes.

The Regatta Committee included Messrs. I. R. Coles, chairman, Ward Dickson, Samuel Hewlett.

t.	Finish.
s.	H. M. S.
00	3 45 34
00	4 12 20
00	withdrew

ARBOUR CLUB was and though many and the race was wanhaka rule and plus 1/4 overhang. ed as usual in the

LIST OF YACHTS ENROLLED IN THE HEMPSTEAD HARBOUR YACHT CLUB, 1893.

SLOOPS.

NAME.	OWNER.	PORT.	Extreme Length.	L. W. L.	Beam.	Depth of Hold.	Draft.
			ft. in.	ft. in.		ft. in.	
Malcap*	T. Wm. Sheridan	50 00	44 05	16 00	5 03	5 02
Gertrude*	Thos. T. Tabor	Glen Cove	28 00	33 00	13 00	6 00	4 00
Beatrice	Walter F. Herbert	Sea Cliff	32 00	29 00	11 00	2 10
Susie W.J.	Louis T. Duryea	Glen Cove	29 00	24 00	10 00	5 00	4 00
Mona	Daniel K. Hall, Jr.	"	21 00	18 10	7 00	4 06	4 00
Meadow Hen	Wm. L. Hicks	"	16 00	14 00	6 00	18	12

CATS.

Wenonah	Thos. T. Tabor	29 00	24 00	10 00	5 00	4 00
Dosoris	Geo. P. Vail	26 00	22 00	9 00	4 00	3 06
Gold Dust	Milton Hopkins	24 00	21 00	11 00	3 00	18
Skrælling	Wilmot T. Cox	22 00	18 00	7 00	3 00	18
Tamarack	Edw. B. Hall	16 00	15 00	5 00	12	5
Wang	J. K. L'Hommedieu	18 11	18 11
Coat	Arthur D. Prince	14 08	14 08	6 00	1 00	8
Presto	Harry Watson	15 00	15 00	7 00

KAYAKS LAUNCHES.

Sadie	Samuel C. Pirie	27 03
Republic	Lewis T. Duryea	22 00

STEAM LAUNCHES

Emma K.	Walter R. Willets	41 00	41 00	10 00	6 00	4 10
Roslyn	S. R. and S. L. Hewlett	42 00
	Paul H. Grimm					

* Built in 1875.

† Designed by T. T. Tabor, and built by A. W. Van Cott, in November, 1886.

‡ Designed by T. T. Tabor and built by Joshua Bebell.

23.

h of Hold,	Draft,
ft. in.	ft. in.
5 03	5 02
6 00	4 00
....	2 10
5 00	4 00
4 00	4 00
18	12

5 00	1 00
4 00	3 06
3 00	18
3 00	18
12	5
....
1 00	8
....

....
....

6 00	4 10
....

in Berrell.

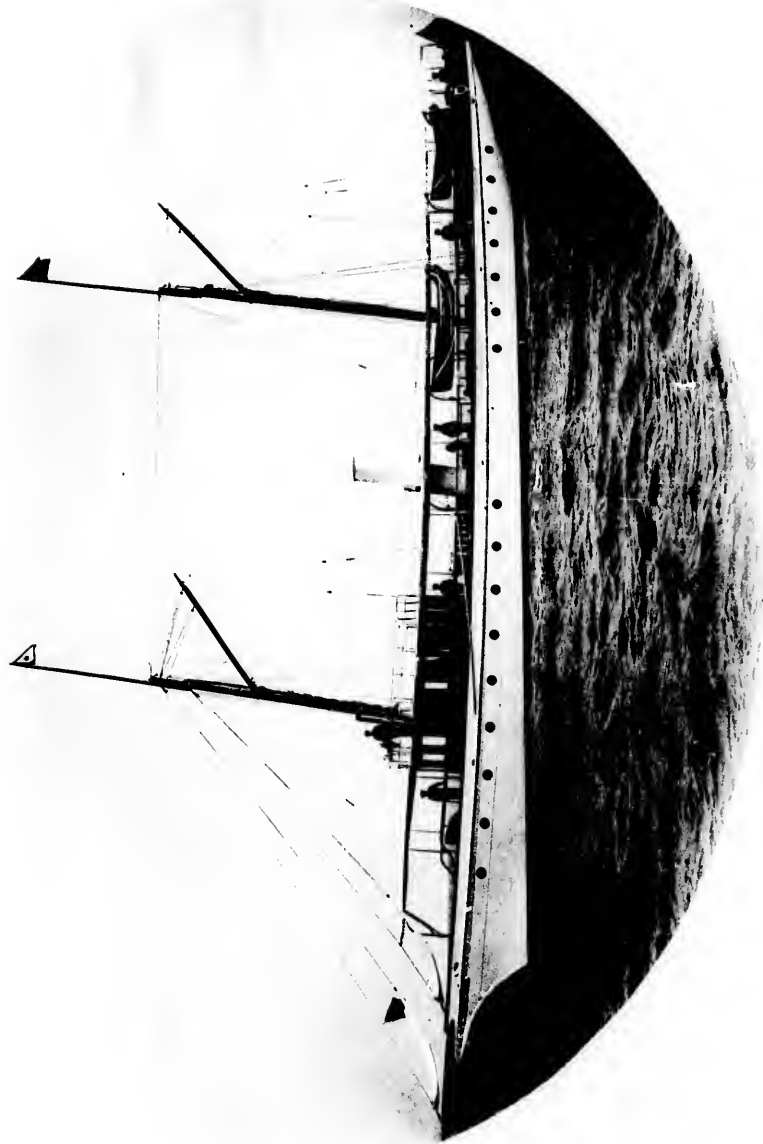

TRUANT.

PLATE LXXXV.

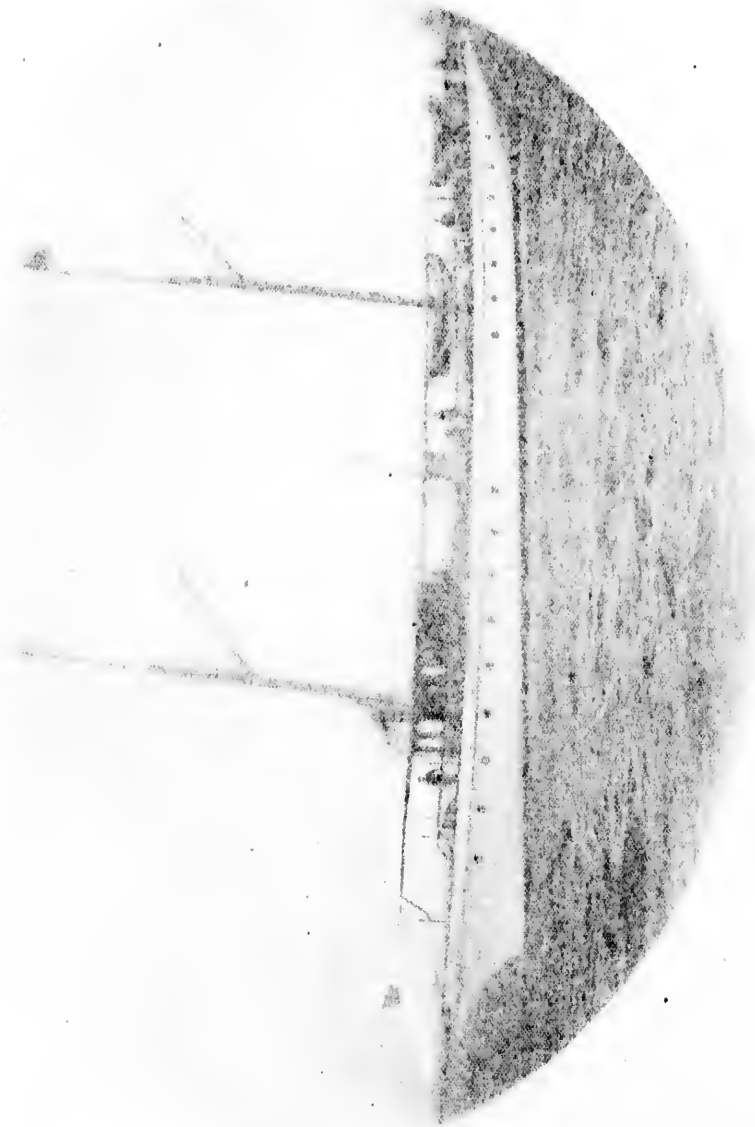

BIOGRAPHICAL SKETCHES AND DESCRIPTION OF YACHTS ENROLLED IN THE CLUB.

DANIEL K. HALL, JR., business upholstering, Commodore of the HEMPSTEAD HARBOUR YACHT CLUB, now living in Glen Cove; born in New York City, July 4, 1840, the son of Daniel K. and Ann A. Hall. The owner of the yacht *MONA* and has also owned *VIKING*. The former was designed by him. He has been interested in yachting since his boyhood, and was one of the founders of the HEMPSTEAD HARBOUR YACHT CLUB.

MONA.

Designed by Com. Daniel K. Hall, Jr., and built by John Devoe. She is the property of her designer, hailing from Glen Cove and sailing with the fleets of the CORINTHIAN MOSQUITO FLEET and HEMPSTEAD HARBOUR YACHT CLUB.

DIMENSIONS.

Length over all	21 feet 6 inches.	Length load waterline	18 feet.
Depth	5 feet.	Draft	4 feet.
Beam	6 feet 8 inches		

Spars: Mast, 23 feet; Gaff, 12 feet; Boom, 22 feet; Hoist, 11 feet; Staysail, 7 feet; Jib, 10 feet.

SUSIE W.

A centerboard cut owned by Vice-Commodore Louis T. Duryea. Sails with the HEMPSTEAD HARBOUR and LARCHMONT YACHT CLUBS.

DIMENSIONS.

Length over all.	30 feet.	Length load waterline.	21 feet.
Draft.	5 feet.	Beam.	10 feet 5 inches.

GOLD DUST.

GOLD DUST is a centerboard open cut-boat owned by Milton Hopkins and E. H. Ball. Was designed and built by Willis of Cow Bay, N. Y., hails from Sea Cliff and sails with the INDIAN and HEMPSTEAD HARBOUR YACHT CLUB. See Fig. 583.

DIMENSIONS.

Length over all.	21 feet.	Length load waterline.	21 feet.
Depth.	3 feet.	Draft.	18 inches.
Beam.	11 feet.		



THOMAS T. TABER.

THOMAS T. TABER, Vice-Commodore of the HEMPSTEAD HARBOUR YACHT CLUB. He is a yacht designer of New York City. Born in Brooklyn, N. Y., July 1, 1861. The son of Stephen and Rosetta M. Taber. His father was Congressman for two terms. At present the owner of *WENONAH* and *GERTRUDE*, and has also owned the yacht *KITTLE*. Interested in yachting for thirteen years; is a member of the HEMPSTEAD HARBOUR YACHT CLUB, of which he is a charter member, and the INDIAN HARBOUR and RIVERSIDE YACHT CLUBS and CORINTHIAN MOSQUITO FLEET. He has also held the office of Vice-Admiral of the late CORINTHIAN NAVY.

WENONAH.

A centerboard sloop owned by Thomas T. Taber of New York City. Designed by Mr. Taber and built by J. Bedell. Was launched in July, 1892. She is a cutter, hails from Glen Cove and sails with the INDIAN HARBOUR and RIVERSIDE YACHT CLUBS and CORINTHIAN MOSQUITO FLEET. See Fig. 584.

DIMENSIONS.

Length over all.	30 feet.	Length load waterline.	21 feet.
Depth.	5 feet.	Draft.	4 feet 8 inches.
Beam.	9 feet 6 inches.		

Spars: Mast, 40 feet; Boom, 32 feet; Gaff, 22 feet.

DO-SURTS.

The yacht *DO-SURTS* is a centerboard cabin cut-boat and is owned by George P. Vail, hailing from Glen Cove, N. Y. She sails with the HEMPSTEAD HARBOUR YACHT CLUB.

DIMENSIONS.

Length over all.	26 feet.	Length load waterline.	22 feet.
Draft.	3 feet 6 inches.	Beam.	9 feet.

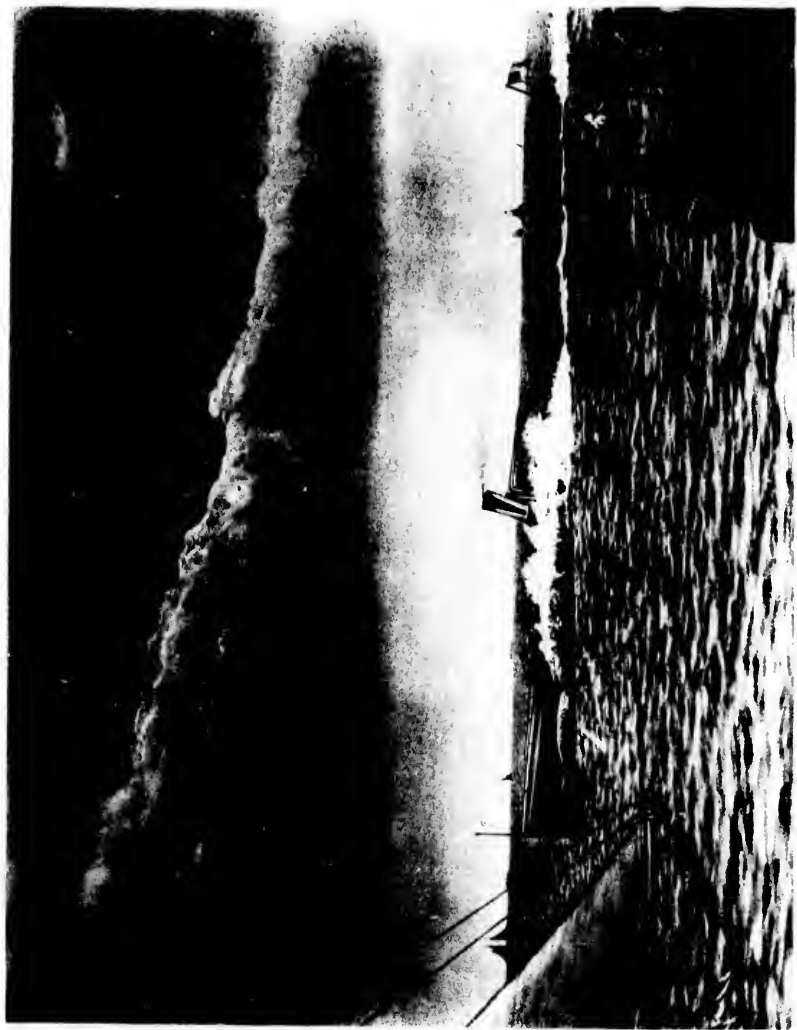

FROM A PHOTO. COPYRIGHT BY FREDERIKSEN

PLATE LXXXVIII

NORWOOD.

NORWOOD.



NORWOOD.
 A screw steamer built by the Herreshoff Manufacturing Co., Bristol, Rhode Island, for the U. S. Fish Commission. She was launched in 1880 and is now in the service of the U. S. Fish Commission. She is 124 feet long, 22 feet 6 inches wide, and has a draft of 9 feet 6 inches. She is powered by a triple expansion engine with 5 cylinders, 114 and 100 horse power. She is built of steel and has a hull form similar to that of a fish boat. She is fitted with a single mast and a single funnel. She is capable of making a speed of 12 knots. She is now in the service of the U. S. Fish Commission at Newport, Rhode Island.

DESCRIPTION.

A screw steamer built by the Herreshoff Manufacturing Co., Bristol, Rhode Island, for the U. S. Fish Commission. She was launched in 1880 and is now in the service of the U. S. Fish Commission. She is 124 feet long, 22 feet 6 inches wide, and has a draft of 9 feet 6 inches. She is powered by a triple expansion engine with 5 cylinders, 114 and 100 horse power. She is built of steel and has a hull form similar to that of a fish boat. She is fitted with a single mast and a single funnel. She is capable of making a speed of 12 knots. She is now in the service of the U. S. Fish Commission at Newport, Rhode Island.

Dimensions.
 Length over all 124 feet.
 Length and waterline 120 feet 6 inches.
 Breadth 22 feet 6 inches.
 Draft 9 feet 6 inches.

MAJOR.

A major property owned by Wareshoff and built by the Herreshoff Manufacturing Co., Bristol, Rhode Island. She was launched in 1881, built from San Francisco, and sails with the mails of the New York and Atlantic (R. or Y. or C. Co.). She was formerly owned by W. R. Hearst but was recently the property of the late Samuel L. Munn, as also the steam yacht Norwood. See page LXXXIX.

DIMENSIONS.

Dimensions.
 Length over all 124 feet.
 Length and waterline 120 feet 6 inches.
 Breadth 22 feet 6 inches.
 Draft 9 feet 6 inches.

Engines. Triple expansion, compound inverted, 5 cylinders (114 and 100) 22 1/2 x 15 inches. Indicated horse power 500.
 Boiler and engines built by the Herreshoff Manufacturing Company.

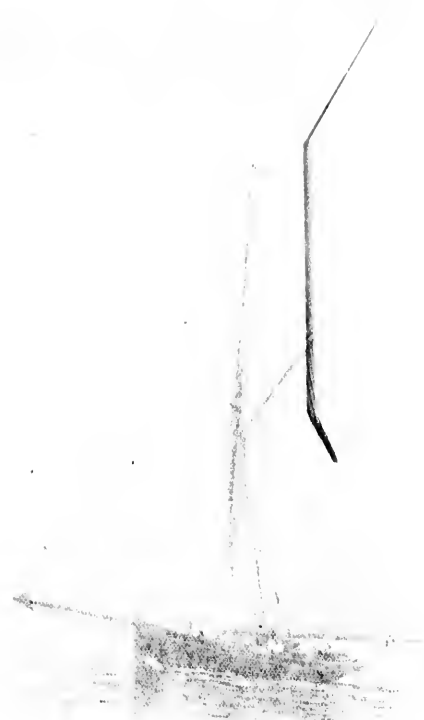

A major property owned by Wareshoff and built by the Herreshoff Manufacturing Co., Bristol, Rhode Island.

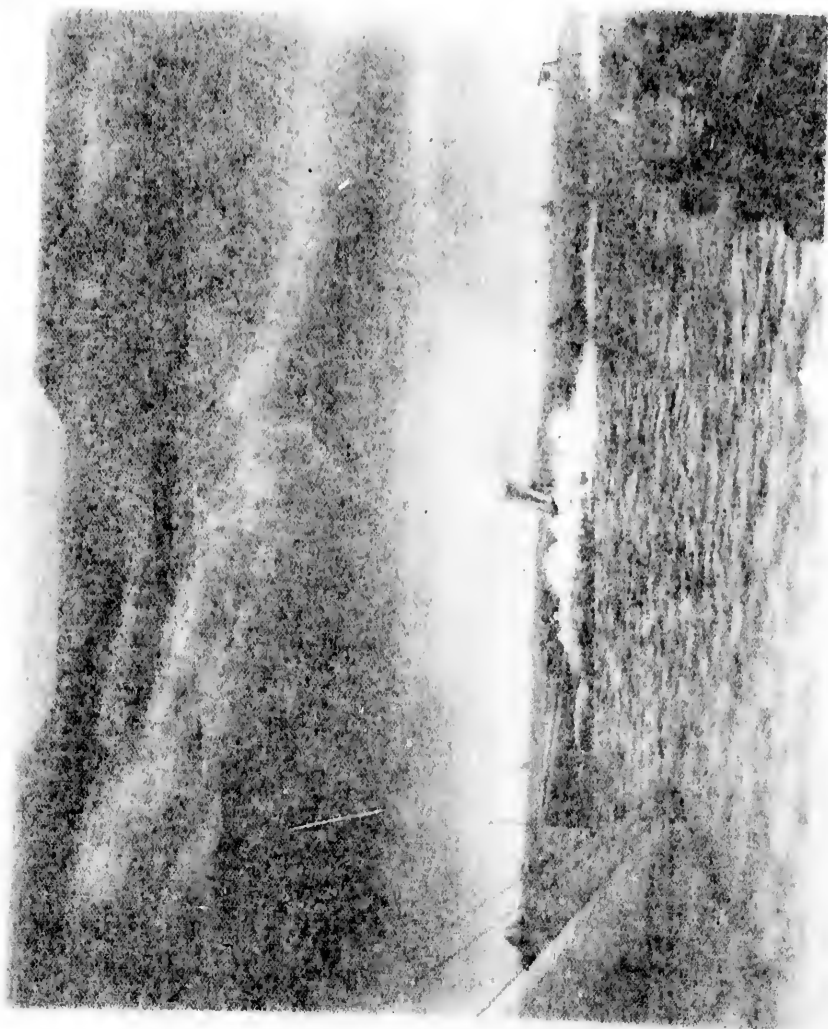

Description of Yachts not Enrolled in any Registered Yacht Club



NORMAN L. MUNRO.

NORMAN L. MUNRO, born in Pieton Co., N. S., in 1844, died February 24, 1891. Mr. Munro was the son of John and Mary Ann Munro, being of Scotch descent. Until he was twenty-five years old he was a farmer. He then came to New York to enter the employ of his brother George, who was already established as a publisher. Later, with a very meagre capital, he started a publishing business of his own, which was a success from the first. In the twenty-seven years in which he worked as a publisher he accumulated a fortune of more than \$1,000,000. The extent of his enterprise may be inferred from the fact that when he brought suit in 1886 for an infringement of a patent he made affidavit that he had spent \$350,000 the year previous for advertising alone.

During all his life Mr. Munro was an enthusiast on the subject of fast steam yachts. He has owned **NORMA**, **NOW THEN**, **SAY WHEN**, **HENRIETTA** and at the time of his death was the owner of **NORWOOD** and **VAMOOSE**.

NORWOOD.

A screw steamer—called by some a steam launch—built for her recent owner, Mr. Norman L. Munro of New York City, by C. D. Mosher, of Amesbury, Mass. She was launched in 1890. She has attained a remarkable speed, said to have at one time reached the rate of twenty-seven knots per hour. She beat **MOXMOOTH** (propeller) in a run from the Narrows to Sandy Hook. Her owner, Mr. Munro, claimed for her a speed of thirty miles per hour over a measured mile course. See plate LXXXVIII.

DIMENSIONS.

Length over all,	61 feet.	Length load waterline,	60 feet 6 inches.
Depth,	3 feet 8 inches.	Draft,	4 feet.
Beam,	7 feet 3 inches.		

Engine: Direct acting, triple expansion, 9, 14½ and 22½. Built by C. D. Mosher.

Boiler: Water tube (patent) built by C. D. Mosher, 100 horse power.

VAMOOSE.

A screw schooner designed by Herreshoff and built by the Herreshoff Manufacturing Co., Bristol, Rhode Island. She was launched in 1891, hails from San Francisco, and sails with the fleets of the **NEW YORK** and **AMERICAN (Rye)** YACHT CLUBS. She was formerly owned by W. R. Hearst but was recently the property of the late Norman L. Munro, as also the steam yacht **Norwood**. See plate LXXXIX.

DIMENSIONS.

Length over all,	112.6 feet.	Length load waterline,	109.4 feet.
Breadth,	12.4 feet.	Draft,	6.11 feet.

Engines: Triple expansion, compound inverted, 5 cylinders 11½, 16 and (3) 22½x15 inches. Indicated horse power 800.

Boiler and engines built by the Herreshoff Manufacturing Company.

YACHT "283."
A steam yacht owned by O. H. Boatman, Doughkeppon, N. Y.
See Fig. 587. Her dimensions are as follows:



"283," FIGURE 586.

DIMENSIONS.

Length over all,	90 feet.	Breadth,	17 feet.
Engine: Compound 10 and 20x12 inches.			
Boiler: Roberts 6 feet 6 inch, x 8 feet 6 inch.			

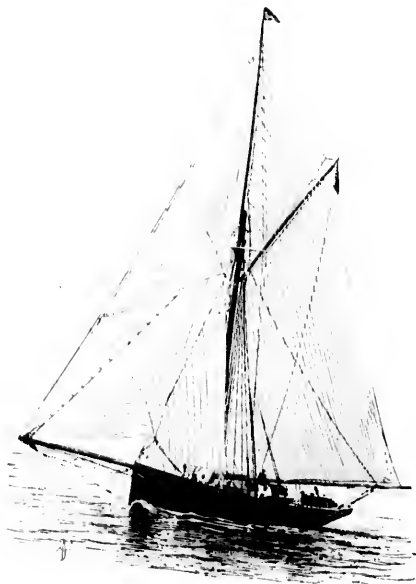

Isis.—FIGURE 587.

DIMENSIONS.

A keel cutter owned by Chas. G. Miller of New York. She was designed by A. C. Canfield, and built by C. & R. Poillon, Brooklyn.

N. Y. She was launched in 1881, but does not sail with any organized yacht club. See Fig. 587.

CODE SIGNAL LETTERS, K, C, W, B.
Official number, 100,364.

DIMENSIONS.

Length over all,	61 feet.	Length load waterline,	51 feet.
Depth,	8 feet 6 inches.	Draft,	9 feet.
Breadth,	13 feet.		

CLARA.

A keel cut yawl, owned by John M. Whitall and hailing from Bris-

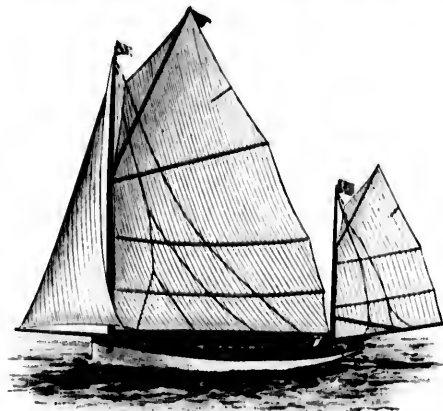

CLARA.—FIGURE 588.

tol, R. I. She was designed by N. G. Herreshoff and built by the Herreshoff Mfg. Co. in 1887. See Fig. 588.—53.

Official number, 126,750.

DIMENSIONS.

Length over all,	35 feet 1 inches.	Length load waterline,	29 feet 4 inches.
Depth,	5 feet 6 inches.	Draft,	5 feet 5 inches.
Beam,	9 feet 10 inches.		

WINDWARD.

A keel loop yawl designed and built by W. P. Stephens, Stapleton, Staten Island, N. Y., was lately owned by C. A. Whitehouse. Is



WINDWARD.—FIGURE 589.

now the property of R. H. Peebles of New York. Was launched in 1884, and hails from New York City. See Fig. 589.

DIMENSIONS.

Length over all,	22 feet.	Length load waterline,	18 feet.
Draft,	4 feet.	Beam,	6 feet.

LUB.

P. Stephens, Stapleton,
C. A. Whitehouse. Ia

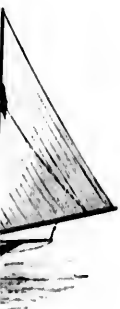

ork. Was launched in
589.

waterline. 18 feet
6 feet

FROM A PHOTOGRAPH BY JOHNSON



VAMOOSE.

PLATE LXXXIX.



INDEX.

ABBREVIATIONS.—I., Illustration; D., Description; DI., Dimensions; P., Plate of Photogravure; His., History; Biog., Biography; SL, Sloop; Sch., Schooner; K., Keel; C., Centerboard; Cat., Outboat; Catam., Catamaran.; D. Cat., Double Cat.; Lug., Lugger; Cut., Cutter; Sew. Sch., Sew. Schooner; Y., Yawl; S., Steam Yacht; Sew. St., Sew. Steamer; J. & M., Jib and Mainsail; C. Sch., Centerboard Schooner; K. Sch., Keel Schooner.

A

- Abbott, J. W., Biog. 633.
 Acacia, Sl., Di. 602.
 Ackerman, J. F., Biog. 390.
 Acme, Di. 577.
 Acorn, Cat., I. 406; D. 412.; Di. 409.
 Acorn, Cat., Di. 385.
 Active, Cut., I. 184; D. 210; Di. 277, 170.
 Adams, H. H., Cut., Di. 591.
 Adams, F. T., Biog. 300.
 Adams, G. C. and C. F., Biog. 253.
 Adlie, Sl., Di. 277; I. 614.
 Adlie, Cat., Di. 309.
 Adlie, Lug., Di. 517.
 Adela, Str., Di. 411.
 Adelalde, Di. 170.
 Adelante, Str., Di. 572.
 Adele, Di. 383.
 Adeline, Di. 602, 261.
 Adeline, Cat., Di. 593.
 Adelia, Sew. Sch., D. 251; Di. 171, 239, 325, 479.
 Admiral, Sew. Sch., D. 212; P. xvi; Di. 171.
 Adonis, Di. 313.
 Adrienne, K. Sch., I. 310.; D. 353.; Di. 325, 480, 632.
 Adrienne, C. Sch., D. 431; P. lxxxii; Di. 439.
 Adroit, Di. 510.
 Advertiser, Di. 452.
 Æolus, Sl., I. 407; D. 412; Di. 170.
 Æolus, Sl., Di. 648.
 Aggie, Cut., D. 201; Di. 223, 261, 602.
 Aggie, Sch., I. 538; D. 510.
 Agliala, Cut., D. 300; I. 309; Di. 389.
 Agnes, Sch., Di. 169, 276, 382, 572.
 Agnes, Sl., Di. 446.
 Alda, Sew. Sch., Di. 171.
 Alda, Str., Di. 431; D. 440; I. 430.
 Alda, Str., Di. 471.
 Aldean, Sl., Di. 602.
 Allean, Cut., D. 230; Di. 223, 261, 631, 602; P. xl.
 Almée, Di. 410.
 Albatross, Sch., Di. 300.
 Albatross, Di. 326.
 Albatross, Sl., Di. 615.
 Albertina, Cut., Di. 482.
 Alborak, Cut., I. 212; D. 256; Di. 218, 480, 170.
 Alborak, D. 669.
 Alcaa, Sch. I. 88; D. 212; P. xiv; Di. 169, 237, 276.
 Alcedo, Sl., I. 618; D. 625; Di. 623.
 Alcedo, Cat., Di. 494, 631.
 Alcylene, Cut., Di. 532; I. 527; D. 531.
 Alcylene, Sl., Di. 482.
 Aldina R., Sl., Di. 618.
 Aldina R., Jr., Cat., Di. 618.
 Alert, Sch., I. 183; D. 215; Di. 169, 471.
 Alert, Sch., Di. 563, 648.
 Alert, Cut., Di. 602.
 Alert, Sl., Di. 602, 261.
 Alfred S., Sl., Di. 593.
 Alga, Cut., I. 212; D. 256.
 Alice, Cat., Di. 591.
 Alice, Cat., Di. 280.
 Alice, J. & M., Di. 411.
 Alice, Sl., Di. 517.
 Alice, Sl., Di. 517.
 Alice, Sl., Di. 608; I. 606; D. 609.
 Alice, C., Di. 170, 577.
 Alice, K., Di. 277.
 Alice, Cat., Di. 480.
 Alice, Sch., Di. 237, 325, 480.
 Alice Enright, Cut., I. 619; Di. 618, 563; D. 651.
 Alico G., Di. 416.
 Alico H., D. Cat., Di. 618.
 Alicia, Str., Di. 171, 281, 509, 572.
 Alimo, Di. 282.
 Aliris, Di. 410.
 Allegra, Di. 171.
 Alley, Wm. S., Biog. 301.
 Alliance, Lug., Di. 692.
 All So, Di. 410.
 Alma, I. 618; Di. 623; D. 625.
 Almy, Str., Di. 171, 281, 386.
 Aloha, Str., Di. 578.
 Aloha, Sch., Di. 169.
 Alper, Y., Di. 410.
 Alpha, J. & M., I. 323; D. 318; Di. 452; P. lxxv.
 Alta, Cut., Di. 551; 602.
 Altama, Sch., I. 270; D. 276; I. 301.
 Altair, Cut., Di. 578.
 Amaranth, Cut., Di. 591.
 Amaranth, Di. 409.
 Amateur, Sl., I. 411.
 Amateur, Sl., Di. 659.
 Ambassadors, Sch., I. 37, 42; Di. 169, 277.
 Ambrose, E. H., Biog. 261.
 Amelia, Cut., I. 559, 579; Di. 551, 602.
 Amelia Victoria, Di. 471; I. 409; D. 475.
 America, Sch., I. 58; (as she was).
 America, Sch., I. 59, 478 (as she is); Di. 632; D. 498.
 America, Sheer Plan, 87, 95.
 American Girl, Sl., Di. 668; I. 600; D. 639.
 American, Y. C. (Newburyport), His. 513.
 American, Y. C., (Rye) His. 505.
 American, Y. C. Cap. I. 152.
 American, Y. C. Launch, Di. 510.
 America's Cup, I. 130.
 Amerique, (Launch), Di. 518.
 Ames, Allen, Biog. 410.
 Ames, Gov. (3 Masted Sch.), I. 22.
 Anaconda, Di. 383.
 Anchoria, Di. 282.
 Andrews, C. O., Biog. 669.
 Anemone, Di. 279.
 Aneta, Cat., Di. 591.
 An-to, Y., I. 492; D. 198; Di. 182.
 Anzler, Di. 410.
 Anita, Str., Di. 171, 386, 578.
 Annie, Cut., Di. 482.
 Annie, K. Sl., Di. 296.
 Annie, C., Di. 383.
 Annie, Cat., Di. 618.
 Annie S., Str., Di. 479, 632.
 Apache, Di. 279.
 Ap'oro-lito, (N. Launch), Di. 510.
 Aquilo, Di. 239.
 Arab, Sl., I. 371; D. 391; Di. 277.
 Arctusa, Sch., D. 583; Di. 169, 577; P. lxxi.
 Argo, Y., I. 49; D. 351, Di. 328.
 Argo, C., Di. 417.
 Ariadne, Di. 170.
 Ariadne, Sl., Di. 201, 602.
 Ariadne, Cat., Di. 602.
 Ariadne, Cat., Di. 153.
 Ariel, Sch., P. xiv; Di. 169, 237, 382.
 Ariel, Cut., Di. 223, 602.
 Ariel, Sl., Di. 416.
 Ariel, K., Di. 277.
 Ariel, C., Di. 277.
 Arion, Cat., Di. 601; I. 692.
 Arline, Sl., Di. 664.
 Araila, Cut., Di. 551, 602; I. 553; D. 560.
 Arno, Cat., D. 537; Di. 591.
 Arrow, Str., Di. 389.
 Arrow, Sl., Di. 396.
 Arrow, Cat., Di. 409.
 Atala, Di. 170.
 Atala, Cat., Di. 328.
 Atalanta, Str., Di. 509.
 Atalanta, Sch., Di. 510; D. 511; I. 507.
 Atalanta, Sheer Plan, 65.
 Atalanta, Sl., Di. 602.
 Atalanta, Sl., Di. 481.
 Atalanta, Cat., Di. 453.
 Athala, Cat., I. 595.
 Athena, Di. 383.
 Athlon, Di. 170, 383.
 Atlantic, Y. C. His. 396; Squadron Page 871.
 Atlantic, Str., Di. 380.
 Atlantic, Sch., I. 288; D. 305; Di. 169, 276.
 Astor Cups, I. 118, 119.
 Audax, Y., Di. 277, 611.
 Augusta S., D. Cat., I. 506; Di. 504; D. 509.
 Aura, Di. 279.
 Aurelia, Sl., Di. 452.
 Au Revoir, Di. 171, 386, 578.
 Auris, Cat., Di. 481.
 Aurora, Str., Di. 171.
 Aurora, Sl., Di. 238, 631.
 Aurora, Sl., Di. 452.
 Aurora, Di. 577.
 Aurora, Cat., Di. 591.
 Ava, Di. 171.
 Avalon, Sch., Di. 169.
 Avond, Sew. Sch., P. lxxix; Di. 602, 609, 578.
 Awa, Sl., Di. 446.
 Awa, Di. 383.
 Awixa, Di. 277.
 Azalea, Sch., I. 270; Di. 301, 169.
 Aztec, Sew. Sch., P. xxxii; Di. 171.

B

- Baboon, Cut., Di. 480, 326.
 Bachelie, C. V., Biog. 636.
 Beck, A. E., Biog. 609.
 Bainbridge, R. W., Biog. 609.

- Baker, H. A., Biog. 33.
 Bald Eagle, Sl., Di. 650.
 Ballymena, Sew. Sch., Di. 572, 171, 588;
 P. lxxxiii; D. 580.
 Baltimore, Di., 282.
 Baltimore, Y. C. Hls. 585.
 Banshee, C., Di. 277.
 Banshee, Cut., Di. 311.
 Bancroft A. R., Biog. 583.
 Bangs, Edw. A., Biog. 254.
 Banks, David, Biog. 300.
 Bantam, Di. 277.
 Barbara, Cut., Di. 480, 170; I. 181; D. 281;
 P. xxiv.
 Barburn, Di. 170.
 Barber, A. L., Biog. 212.
 Barge, Burmese, I. 44.
 Barge, Cleopatra's, I. 45.
 Barraconta, Di. 300, 171.
 Barrett, C. L. Portrait, 539.
 Barrett, M. M. Portrait, 539.
 Barron, J. E., Biog. 211.
 Bartlett, E. C. Portrait, 539.
 Bartlett, E. L., Biog. 539.
 Barton, B., Di. 430.
 Bayadere, Di. 238.
 Beatrice, Str., Di. 171.
 Beatrice, Di. 383, 238.
 Beatrice, Di. 326.
 Beatrice, Sl., Di. 674.
 Beatrice, Sl., Di. 623, 446; D. 448.
 Beatrice, Di. 277.
 Beattie, J. H., Biog. 509.
 Beaver, Di. 313.
 Beckwith, L. F., Biog. 212.
 Belle, B. R., Biog. 211.
 Belouin, Cut., Di. 383, 277, 170, 471; I. 187;
 D. 217.
 Bee, Sl., Di. 615; D. 616.
 Beecher, J. G., Biog. 448.
 Beeman, E. E., M. D., Biog. 420.
 Beetle, Cut., Di. 481.
 Belknap, R. L., Biog. 211.
 Bellehazen, Di. 281.
 Belmont, A., Biog. 474.
 Belmont, P., Biog. 474.
 Bennett, F. L., Biog. 533.
 Bermudian Rig, (Chispa.) I. 39.
 Benjamin, A. B., Biog. 448.
 Beronda, Str., Di. 578.
 Bert, Cat, Di. 594.
 Bertha, (N Launch), Di. 572.
 Bertha, Cat, Di. 594.
 Bess, Di. 410.
 Bess, Sl., Di. 517.
 Bessie, Cat, Di. 312.
 Bessie, Str., Di. 306.
 Bessie, Cut., Di. 417.
 Bessie, Sl., Di. 602.
 Beth, Cat., Di. 631.
 Betty, Di. 480, 238.
 Beva, Di. 170.
 Binnavar, Di. 312.
 Bijou, Di. 430.
 Bills, G. W., Biog. 616.
 Birchwood, Cat., Di. 548.
 Bird, L. J., Biog. 348.
 Birdsall, E. T., Biog. 412.
 Bireme & Trilreme, I. 15.
 Bird, Sl., Di. 452.
 Blackstock, T. G., Biog. 238.
 Blade, Sl., Di. 638.
 Blanch B., Sl., Di. 564.
 Blonde, Cat, Di. 641, 280; I. 637; D. 643.
 Blondy, Di. 306.
 Blue Wing, Di. 578.
 Blunt, E., Biog. 301.
 Bohemian, Launch, Di. 282.
 Bohemian, Sch., Di. 480, 225; I. 339; D. 352.
 Bohemian, Cat, Di. 409.
 Bonita, Cat, 453.
 Bonita, Y., 471.
 Bouito, Sl., Di. 480.
 Bonnie Doon, Di. 277.
 Bonnie Jean, Cut., Di. 548.
 Bonnie Kate, Di. 170.
 Boojum, Y., Di. 280.
 Booz, E. D., Biog. 589.
 Bo-Peep, Sew. Str., Di. 281, 171; I. 290.
 Boston Y. C. Hls. 627.
 Boswell, A. R., Biog. 228.
 Bounce, I. 94.
 Boyd, G., Biog. 220.
 Boyden, B., Biog. 600.
 B. Q., Di. 409.
 Bray, C. W., M. D., Biog. 610.
 Breeze, Sch., Di. 611.
 Brenda, Sl., Di. 602, 223.
 Brenda, Di. 641, 277.
 Brenda, Cut., Di. 482; I. 480; D. 497.
 Brenton's Reef Cup, I. 131.
 Brentwood, Sch., Di. 611.
 Bridget, Cat, Di. 578.
 Britannia, Cut., Sheer Plan, I. 98.
 Brokaw, W. G., Biog. 302.
 Brooklyn Y. C. Hls. 403.
 Brown, Alex., Biog. 589.
 Brown, C. A. B., Biog. 220.
 Brown, F. B., Biog. 348.
 Brunhilda, 278.
 Brunhilde, Sch., Di. 169.
 Brynhilde, Sl., Di. 631, 481, 326.
 Buck-eye, Chesapeake, I. 36.
 Buck-eye, Typical, I. 35; D. 40.
 Buffalo Gal, Di. 532.
 Buffalo Y. C. Hls. 523.
 Bug, Sliding Gunter, I. 31; Di. 312; D. 321.
 Bulkar, Cat, Di. 593.
 Burlington, Sch. Sharpie, I. 24.
 Burgess (Scott, Last Boat), I. 70.
 Burmese Barge, I. 44.
 Burrell, R. M., Biog. 448.
 Burrift, T., Biog. 419.
 Burton, J. R., Biog. 509.
 Buster, Di. 409.
 Buder, J. L., Biog. 496.
 Butternut, Sl., Di. 312; I. 315; D. 322.
 Cabin of Magic, P. III.
 Caddie, Cat, Di. 280.
 Caddie, Cat, Di. 594.
 Caiman, House Boat, Di. 171; I. 42.
 Callisto, Di. 410.
 Calluma, Sheer Plan, 98.
 Calumet, Di. 386, 171.
 Calypso, Cat, Di. 482, 385; I. 489; D. 497.
 Calypso, K. Sl., Di. 390; D. 402.
 Calypso, Cat, Di. 453.
 Cambria, Sheer Plan, 95.
 Camera, Launch, Di. 548.
 Camilla, Di. 611, 326, 238; I. 341; D. 353.
 Camilla, Str., Di. 586.
 Camilla, Sl., Di. 578.
 Campbell, F. J., Biog. 229.
 Campbell, H. M., Biog. 533.
 Canarsie Y. C. Hls. 501.
 Canoe, Australian, I. 9.
 Canoe, Birch Bark, I. 11.
 Canoe, Esquimo, I. 13.
 Canoe, Indian, I. 9.
 Canoe, Ont of Reed, I. 9.
 Canoe, Skin, I. 12.
 Canoe, Solomon Islands, I. 9.
 Canuck, Lug., Di. 602.
 Canton, Pleasure Boat, I. 42.
 Cape May Cup, 133.
 Caprice, Sl., Di. 503.
 Caprice, Sl., Di. 602, 223.
 Caprice, Di. 320.
 Caprice, Y., Di. 544.
 Caravels, I. 18, 19, 20.
 Carita, Str., Di. 632.
 Carl, J. & M., Di. 488.
 Carlotta, Di. 169.
 Carmita, Cut., Di. 611.
 Carmita, Di. 480, 238, 170.
 Caro, Cut, Di. 471, 385, 280.
 Caro, Cut, Di. 611.
 Carolina Y. C. (South) Hls. 409.
 Carolinita, Str., Di. 578.
 Carrie, Di. 277.
 Carrie, Str., Di. 396.
 Carrie, Cut, Di. 409.
 Carrie W., Di. 416; I. 443; D. 448.
 Carulli, Di. 602, 291.
 Cary, W. A., Biog. 349.
 Casella, Di. 325.
 Cat, May, I. 25.
 Cat, Double, Doris, I. 26.
 Cat, Nomenclature, 112.
 Cat Yawls, I. 28, 29; D. 22.
 Castanea, Di. 446.
 Catamaran, I. 34, 35; D. 38.
 Catamaran, Ceylon, I. 12.
 Catamaran, Fiji Islands, I. 11.
 Cat-Boat, D. 21.
 Catherine, Cat, Di. 453.
 Catspaw, J. & M., Di. 326; I. 490; D. 498.
 Catspaw, Sheer Plan, 98.
 Cavalier, Sch., Di. 382, 169; I. 372; D. 391.
 Celia R., Di. 452.
 Centerboard, Chap. on, 101.
 Centerboard Cutter, Puritan, I. 32.
 Cores, Str., Di. 449; I. 445; D. 450.
 Cores, Sl., Di. 544; I. 542.
 Chaiser, T. J., Biog. 609.
 Challenge, Cat, Di. 503; I. 500; D. 504.
 Chaperon, Cut., Di. 311; I. 310.
 Chappaquoit, Sl., Di. 481, 326; I. 333; D. 351.
 Charlotte, Di. 170.
 Charlotte, Sew. Sch., Di. 171; I. 187; D. 217.
 Churon, Sl., Di. 615.
 Cherokee, Cat, Di. 602, 531; I. 557.
 Cherub, Di. 282.
 Chesapeake, Buckeye, I. 36.
 Chestnut, Sl., Di. 602, 551, 431.
 Chetolah, Di. 239.
 Chief, Cat, Di. 409.
 Chief, Di. 410.
 Chin Chin, Di. 279.
 Chlpaunk, Di. 313.
 Chiquita, Cut, Di. 480, 238, 631, 170.
 Chisholm, A. L., Biog., 533.
 Chispa, Di. 383; I. 39, 536; D. 540.
 Chispa, K. Sl., I. 379; D. 392.
 Christabel, Di. 602, 223.
 Chita, Di. 430.
 Chloe, Di. 329.
 Choctaw, Cut, Di. 551, 383; I. 550; D. 500.
 Cinch, Di. 642, 279.
 Cinderella, Cut., Di. 551, 331; I. 554; D. 560.
 Ciree, Cut., Di. 471, 277.
 Ciree, Cat, Di. 322.
 Ciree, Di. 410.
 Ciree, Cat, Di. 615.
 Ciree, Di. 655.

Dryer, R. K., Biog. 560.
 Duchess, J. & M., Di. 503.
 Dudley, G. E., Biog. 440.
 Duggan, H. G., Biog. 321.
 Dug-out, Primitiv, I. 7.
 " War Canoe, I. 7.
 " Indian, I. 8.
 " New Zealanders, I. 8.
 " Burmese, I. 8.
 Duncan, W. B., Jr., Biog. 242.
 Dunne, F. L., Biog. 350.
 Duplex, Aux. Y., Di. 277.
 Duplex, Catam., I. 35.
 Durant, W. W., Portrait, 214.
 Durham, M. R., Biog. 440.

E

Eagle, Cut., Di. 311; D. 222.
 Ease, Str., Di. 588.
 Eastern Y. C. Hs. 233.
 East Side, Sl., Di. 650.
 Eaton, W. S., Biog. 254.
 Echo, Di. 261.
 Echo, Sl. Di., 482, 326; I. 320; D. 349.
 Echo, Sl., Di. 663.
 Echo, Sl., Di. 564.
 Eclipse, Str., Di. 171.
 Eclipse, Di. 170.
 Eclipse, Sl., Di. 602, 261.
 Edda, Cut., Di. 611.
 Edda D., Di. 409.
 Eddies, Di. 460.
 Edgewater, Di. 239; I. 351.
 Edith, Cut., Di. 480.
 Edith, Cat., Di. 481.
 Edith, Cut., Di. 631.
 Edith, Cut., Di. 631.
 Edith, Cut., Di. 611.
 Edith, Cut., I. 570, 559.
 Edith L., Di. 450.
 Edith M., Sl., Di. 572.
 Edna, Sl., Di. 608, 223.
 Edna, Di. 417.
 Edna, Sl., Di. 481, 517.
 Edwards, A. D., Biog. 366.
 Eidolon, Sl., Di. 623.
 Elaine, Cabin Cut., Di. 279; D. 393.
 Elaine, Cat., Di. 385; D. 391.
 Elaine, Sl., Di. 631.
 El Chico, Fin K., Di. 312; I. 30; P. xxxi.
 El Cisno, Fin K., D. 623.
 Eldiva, Di. 170.
 Eleanor, Di. 623, 70.
 Eleanor, Sl., Di. 452.
 Eleanor, Sl., Di. 503.
 Electra, Sew. Sch., Di. 380, 281, 171; D. 209; P. xii.
 Electric, Di. 452.
 Elf, Sl., Di. 517.
 Elf, Cut., Di. 481, 238; I. 241.
 Ella, Cut., Di. 641, 270; I. 636.
 Elfride, Di. 171.
 Ella, Sl., Di. 544.
 Eli W. Hoyt, Di. 517.
 Elizabeth, Cat., Di. 453.
 Ella, Sl., Di. 603.
 Ella, S. Launch, Di. 470, 588; I. 586; D. 500.
 Elleada, Sl., Di. 603.
 Ellida, Sl., Di. 312.
 Ellida, Str., Di. 360.
 Ellida, Sch., Di. 608.
 Ellis, R. N., Biog. 302.
 Elma, Sch., Di. 160; I. 177; D. 211.
 Eloise, Di. 409.
 El Placita, Sew. Sch., Di. 325, 230, 632; I. 620.

Elsa, Sl., Di. 481.
 Elsie, Sl., Di. 312; I. 410.
 Elsie, Skiff, Di. 603.
 Elsiemarie, Di. 169; P. x.
 Elvira, Di. 452.
 Embla, Sew. Sch., Di. 281, 171; D. 214; P. xxviii.
 Emerald, Sch., Di. 382, 276, 169; I. 373; D. 392.
 Emerald, Sch., I. 548.
 Emma, Di. 623.
 Emmi K., Launch, Di. 671.
 Emma S., Cut., Di. 501.
 Emmie, 411.
 Emperor Trojan, Trirème, Etching, Page 15.
 Empress, Str., Di. 171.
 Empress, Cut., Di. 618, 563; I. 565.
 Emma, Sew. Sch., Di. 611, 281, 389; I. 37; D. 390.
 Enid, Launch, Di.
 Enid, Cut., Di. 385.
 Enid, Sl., Di. 603.
 Enigma, Di. 169.
 Enterprise, Di. 383.
 Eole, Sl., Di. 417; I. 418; D. 421.
 Eone, Di. 282.
 Erchless, Cut., Di. 533, 223; I. 521; D. 533.
 Erma, Cut., Di. 603, 223, 261; I. 226; D. 231.
 Ermengarde, Di. 230.
 Escape, Cut., Di. 603.
 Esme, Cut., D. 360; I. 350; D. 360.
 Espirito, Cut., Di. 170; I. 175; D. 209; P. xiii.
 Estelle, Di. 582.
 Etecern, Di. 277.
 Ethel, Lag., Di. 603.
 Ethel, Sl., Di. 563.
 Ethel, Di. 577.
 Ethel, Cat., Di. 604.
 Ethelyn, Di. 577.
 Etienne, Di. 360.
 Eudora, Di. 446.
 Eugene, Di. 417.
 Eugenia, Sl., Di. 650.
 Eulanna, Sl., I. 564; D. 656.
 Eureka, J. & M., Di. 320; I. 337; D. 351.
 Eureka, Sl., D. 504.
 Europa, Di. 623, 383, 641, 277.
 Eva B., Di. 282.
 Evaleen, Cut., Di. 572.
 Evans, G. E., Biog. 229.
 Evelina, Di. 313.
 Evelyn, Str., Di. 509, 281, 171, 611.
 Evolution of the Yacht, 5-44.
 Evolution, Sheer Plan, 92.
 Excelsior, Di. 601.
 Exile, Sl., Di. 484.
 Exile, J. & M., Di. 326; I. 338; D. 352.
 Expert, Di. 270.
 Eyoor, Di. 325.

F

Fad, Di. 326.
 Fair Wind, Di. 410.
 Fakir, Naphtha, Di. 510, 282.
 Falka, Di. 481.
 Fanchon, Cat., Di. 453.
 Fanchon, Cut., Di. 615; I. 614.
 Fancy, Cut., Di. 381, 320, 338.
 Fanita, Di. 480, 238.
 Fannie, Di. 267.
 Fannie, D. 326.
 Fanny, I. 64; Di. 170.
 Fanny, Di. 383, 277.
 Fanny F., Di. 532.
 Fanny Jutson, Sl., Di. 603.
 Fauvette, Di. 171.

Fascination, Sl., Di. 603.
 Fawn, Sl., Di. 514.
 Fauna, Di. 277; I. 272.
 Faustine, Di. 230.
 Faustina, J. & M., Di. 411.
 Favorita, Naphtha, Di. 572.
 Fay, I. 401; D. 412.
 Fearless, Di. 382.
 Fedalma, Di. 380, 281, 171.
 Fedora, J. & M., I. 19, 270.
 Fedora, Cut., Di. 390; I. 399; D. 401.
 Fenella, Di. 382, 276, 169; D. 522; P. lxxxiv.
 Fidget, Str., Di. 230.
 Fidget, Di. 312.
 Fin Keel, El Chico, I. 30.
 Finette, Cut., Di. 603.
 Fire Fly, Cat., Di. 328.
 Fire Fly, Str., Di. 532.
 Fiscoe, Di. 431.
 Fischer Challenge Cup, I. 150.
 Fischer, I. F., Biog. 597.
 fisherman, Di. 390.
 Fixtures, Yachting, (1893), 51 to 55.
 Flagg, C. F., Biog. 610.
 Flagler, J. H., Biog. 511.
 Flush, Di. 641, 277.
 Flavette, Di. 312.
 Fleetwing, Di. 453.
 Fleetwing, Sch., Di. 169; I. 60.
 Fleetwing, 603.
 Fleur de Lys., Di. 276, 237, 471, 169.
 Flint, Claus R., Biog. 213.
 Flint, F. W., Biog. 303.
 Flirt, Cut., Di. 594.
 Flirt, Sl., Di. 503; I. 409; D. 501.
 Flora, Di. 446.
 Florence, J. & M., Di. 279.
 Florence, Launch, Di. 282.
 Florence, Cut., Di. 603.
 Florence, J. & M., Di. 593.
 Florence, Catam., Di. 632.
 Florence, Sl., Di. 653; I. 653; D. 650.
 Florrie B., Sl., Di. 603.
 Flossie, Sch., Di. 577.
 Fly, Di. 313.
 Foam, D., 254; I. 210; D. 237.
 Follansbee, E. N., Biog. 516.
 Folly, J. & M., Di. 270.
 Folly, Di. 326.
 Folly, Sch., Di. 430; I. 424; D. 431.
 Foot, Jeffrey, Biog. 229.
 Forbes, J. M., Biog. 253.
 Forget-me-not, Di. 171.
 Fortuna, Sch., Di. 572, 237, 169, 480, 382, 276; D. 255; P. xlix.
 Fowle, W. P., Biog. 480.
 Fox Lake Y. C. Hs. 657.
 Francis, Cut., Di. 483.
 Fraser, C. F., Biog. 569.
 Frenk, J. & M., Di. 483; D. 485.
 Freda, Sl., Di. 544.
 Fredonia, Di. 170.
 Freda, Sl., Di. 603.
 Freyja, Di. 383.
 Friend, H. W., Biog. 450.
 Frog, Sch., Di. 544.
 Frolic, Sch., Di. 611, 237.
 Frolic, Di. 238.
 Frolic, Sl., D. 321; Di. 311; I. 309.
 Frolic, Cat. Di. 484.
 Fulmar, Str., Di. 632.
 Furman, Cat., Di. 594.

G

Galabout, Sew. Sch., Di. 113, 171; I. 316; D. 322.

Gadabout, Str., Di. 470, 230.
 Gaddy, J. & M., Di. 631, 484.
 Gael, Di. 446.
 Galetina, Sch., Di. 588; I. 586; D. 500.
 Galatea, Cut., Di. 480, 471, 360, 238, 170; I. 32.
 Galatea, Sheer Plan. 95.
 Galatea, Str., Di. 632.
 Galavant, Di. 360.
 Gannet, Di. 471.
 Gannet, Di. 623.
 Gardner, G. W., Biog. 420.
 Gardner, G. H., Biog. 421.
 Gardner, J. O., Biog. 421.
 Gaviota, Di. 277, 170.
 Gaviota, Str., Di. 509, 230.
 Gazolla, Di. 885.
 Gebhard, F., Biog. 214.
 Gelert, Cat., Di. 593.
 Gem, Di. 383.
 Gem, Y., Di. 434.
 Genesta, Sheer Plan, 95. 90.
 Geo. De B. Keim, Cat., Di. 548.
 Georgie, Di. 631.
 George R., Sl., Di. 659.
 George R., Sl., Di. 564.
 Gerry, E. T., Portrait, 208; Biog. 269.
 Gerry Testimonial Cup, 113.
 Gertrude, Cut., Di. 674; I. 561; D. 569.
 Gertrude, Cat., Di. 409.
 Gertrude, Sl., Di. 563.
 Gevalin, Di. 382, 276, 169.
 Gibson, J. H., Biog. 583.
 Gigi, Y., Di. 483.
 Giggie, Di., 280.
 Gillig, H. M., Biog. 303.
 Gimcrack, I. 163.
 Gipsy, Di. 419.
 Gipsy, Sl., Di. 446.
 Gipsy Baron, Cut., Di. 591.
 Gitana, Str., Di. 434.
 Gitana, Sch., Di. 169; I. 311; D. 353.
 Gladys, Cat., Di. 664.
 Gladys, Cut., Di. 481, 326, 238.
 Gladys, D. Cat., Di. 511; I. 567.
 Glance, Di. 386.
 Gleam, Str., Di. 479, 325.
 Gleam, Sl., Di. 517.
 Glen Cova Rendezvous N. Y. Y. C. 165.
 Glidden, C. H., Biog. 504.
 Gloriana, Di. 471, 238, 170; I. 33; P. lxxxii.
 Gloriana, lines of, 90.
 Goelet Cups, 134, 135, 136, 144, 145.
 Gold Dust, Di. 674.
 Golden Hope, Di. 410.
 Golden Rod, Str., Di. 509; D. 512; P. lxxx.
 Gonza, Sl., Di. 603, 651.
 Gooderham, A. E., Biog. 239.
 Gooderham, Geo., Biog. 239.
 G. O. P., Sl., Di. 578.
 Gordon, W. A., Biog. 431.
 Gouge, H. A., Biog. 391.
 Gorilla, Cut., Di. 631, 480, 238; I. 629.
 Gossip, Di. 238.
 Gossip, Cat., Di. 446.
 Gossoon, Cut., Di. 480, 238; I. 488; D. 497.
 Gould, W. R., Biog. 401.
 Gov. Ames, 5 Masted Sch., I. 22.
 Grace, Cat., Di. 328.
 Grace, Sew. Sch., Di. 648; I. 649; D. 651;
 P. lxxxvi.
 Gracie (as she was), I. 63.
 Gracie, Str., Di. 632.
 Gracie, Sl., I. 536; D. 540.
 Gracie, Str., Di. 396.
 Gracie, Di. 383, 170; I. 180; D. 213.
 Gracie, Sl., Di. 611.
 Gracie B., Di. 409.

Gracie L., Cat., Di. 594.
 Grant, W. J., Biog. 265.
 Graves, G. M., Biog. 449.
 Gray, F. M., Biog. 231.
 Grayling, Cut., Di. 417.
 Grayling, Sch., Di. 382, 237, 169; D. 211;
 P. xxv.
 Grayling, Sl., Di. 618.
 Greene, C. M., Biog. 475.
 Gretchen, Di. 171.
 Greyhound, Di. 279.
 Griffin, Di. 311.
 Griffiths, F. C., Biog. 303.
 Grimalkin, Cat., Di. 409.
 Grimalkin, Cat., Di. 631, 482.
 Grimmel, F. C., Biog. 253.
 Gripp, Sl., Di. 481.
 Griselda, Di. 480.
 Growler, N. Launch, Di. 282; I. 638.
 Guardian, Di. 631.
 Guenn, Di. 471, 277.
 Guide, Di. 383.
 Gulnare, Cut., Di. 382, 170; I. 371; D. 391.
 Gundred, Sch., Di. 611, 632, 480, 237.
 Gunhilde, Di. 471, 385.
 Gutte, I., Portrait, 539; Biog. 510.
 Gwendolen, Sl., Di. 480.
 Gwendoline, Lug., Di. 603, 223.
 Gwendoline, Di. 623.
 Gyda, Di. 479, 325, 239.
 Gypsy, Cut., Di. 482.

H

Hagedorn, Cut., Di. 328.
 Hagedorn, Sprit, Di. 481.
 Haleyon, Sch., Di. 237, 169.
 Haleyon, Str., Di. 171.
 Haleyon, Str., Di. 171.
 Half Moon, Di. 281.
 Hall, W. S., Biog. 573.
 Hamilton, W. A. C., Biog. 321.
 Hanan, J. H., Biog. 214.
 Handsel, Cut., Di. 326, 238; I. 332; D. 350.
 Hanna, Di. 410.
 Hanniel, Di. 479, 230, 171.
 Harbinger, Di. 237, 169.
 Harlem, Naphtha, Di. 552.
 Harman, S. B., Biog. 230.
 Harpoon, Di. 320, 238, 170, 180; I. 231; D. 253;
 P. 1.
 Harriott, Di. 471, 277, 170.
 Harris, J. E., Biog. 651.
 Harry, Cat., Di. 591.
 Hattie, Di. 430.
 Hawk, Cut., Di. 481, 326, 238; I. 331, D. 359.
 Hazard, Sl., Di. 482, 517.
 Heames, J. A., Biog. 651.
 Heather Bell, Sl., Di. 603, 261.
 Hebe, Di. 300.
 Heedless, Di. 277.
 Helen, Sch., Di. 169.
 Helen, Di. 577, 277.
 Helen, Di. 326.
 Helen, Str., Di. 430; I. 424; D. 431.
 Helen, Naphtha, Di. 572.
 Helen, Cat., Di. 453.
 Helvetia, Di. 281, 171.
 Hempstead Harbour Y. C. His. 671.
 Henrietta, Sl., Di. 655; I. 653; D. 656.
 Henrietta, Sl., Di. 561.
 Henrietta, I. 59.
 Henry, W. B., Biog. 584.
 Hermes, Di. 453.
 Hermes, Str., Di. 479, 239.
 Hermes, Sch., Di. 382.
 Hermes, Catam., Di. 471.

Hero, Di. 385.
 Herrshoff, First Boat, 60.
 Her Royal Highness, Sch., Di. 510.
 Hesper, Di. 238, 170.
 Hesperus, Sch., Di. 572, 169.
 Hester, Di. 328.
 Hiawatha, Cut., Di. 481.
 Hibadee, Di. 326.
 Hilda, Sl., Di. 603, 233.
 Hilda, Cut., Di. 631, 480, 238.
 Hiblogarde, Sch., Di. 382, 276, 169, 510.
 Hiblogarde, Sl., Di. 383, 170; I. 177; D. 211.
 Hibred, Di. 300.
 Hill, T. R., M. D., Portrait, 539.
 Himpo, Di. 532.
 Hinda, Str., Di. 644.
 Hironelle, Str., Di. 509, 281.
 History of Yachting, 35.
 History of Yachting in United States, 57.
 Holden, Di. 326.
 Hope, Sch., Di. 430.
 Honing, Di. 409.
 Hornet, Sl., Di. 659; I. 658.
 Horse Shoe Harbor Club, His. 635.
 House-boat, Chimney, I. 42.
 " Studio, I. 42.
 " Shunglai, I. 41.
 " Western, I. 44.
 " D. 513.
 Hoovey, H'Y. S., Biog. 255.
 Howell, J. C., Biog. 656.
 Hower, F. B., Biog. 553.
 H. T. Howard, Di. 430.
 Hubbell, G. S., Biog. 531.
 Hughes, O. L., Biog. 412.
 Hull, Nomenclature of, 100.
 Hull Y. C. His. 323.
 Humming Bird, outline of, 93.
 Huntington, W. R., Biog. 421.
 Huron, Di. 471, 277, 238, 170; D. 218.
 Hussey, E. M., Biog. 597.
 Husted, Seymour L., Jr., Biog. 393.
 Hustle, Naphtha, Di. 593.
 Hustler, Di. 261.
 Hydriad, Di. 383, I.

I

Ianthe, Sch., Di. 480.
 Ianza, Str., Di. 632.
 Isis, Str., Di. 325, 239.
 Isis, Sch., Di. 588; I. 587; D. 500.
 Ida, Di. 396.
 Ida, Di. 410; D. 412.
 Ida, Y., Di. 417.
 Ida, Cat., Di. 453.
 Ida Belle, Sharpie, Di. 410.
 Ida K., Cut., Di. 417.
 Ida K., Sl., Di. 608.
 Ida Voight, Sch., Di. 615.
 Ideal, Cat., Di. 594.
 Ideal, Di. 655.
 Idle Hour, Di. 313.
 Idle May, Y., Di. 446.
 Idler, Str., Di. 171, 509, 646.
 Idler, J. & M., Di. 328; I. 328.
 Idler, Sl., Di. 452.
 Idler, Cat., Di. 471.
 Idler, Sl., Di. 611.
 Idlewild, Sch., Di. 166.
 Idlewild, Str., Di. 226.
 Idlewild, Launch, Di. 226.
 Idlewild, Cat., Di. 433.
 Ileran, Di. 388.
 Ildirin, Di. 170.
 Ileen, Di. 277, 170.
 Iloika, Di. 410, 388.

- I'll Away, Di. 261.
 Imogen, Cut, Di. 484.
 Imogene, Cut., Di. 603.
 Imp, Di. 479.
 Imp, Di. 171.
 Impatient, Str., Di. 500.
 Imperia, Di. 277.
 Impulse, Di. 290.
 Ina, Sl., Di. 603.
 Incog, Di. 655.
 Inez, Di. 277, 170.
 Inez, Sl., Di. 311.
 Inez, Y., Di. 312.
 Inez, D. Cat, Di. 564.
 Ingomar, Di. 313.
 Inland American Y. C. His. 645.
 Ino, Di. 452.
 I-sect, Di. 313.
 Intrepid, Str., Di. 380, 276, 239, 171.
 Intrepid, Sch., Di. 510, 471; I. 400; D. 470.
 Intrepid, Sch., I. 508; D. 512.
 Io, Cat, Di. 483.
 Iola, I. 406; Di. 888.
 Iolanthe, Sl., 603, 223.
 Iolanthe, Cut., Di. 615.
 Iona, Di. 577.
 Iona, Cat, Di. 593.
 Ione, Sl., Di. 446, 482, 326; I. 400.
 Ione, I. 678.
 Ionian, Cut., Di. 481.
 Iowa, Di. 577.
 Irene Moore, Sl., Di. 564.
 Irene, Sl., Di. 603.
 Iris, Str., Di. 313.
 Iris, Di. 383.
 Iris, Cat, Di. 385.
 Iris, Cut., Di. 532.
 Iris, Str., Di. 632.
 Iroquois, Sch., Di. 276, 237, 169; I. 274; D. 302.
 Iroquois, Launch, Di. 172.
 Iroquois, Di. 410.
 Irex, Di. 577.
 Isabel, Nap. Launch, Di. 446.
 Isabel, Sl., I. 505; Di. 503; D. 507.
 Ishkoodah, Di. 311.
 Isis, Cut., I. 677; D. 677, 277.
 Isle of Wight, Sl., Di. 603.
 Isolde, Di. 411.
 Isolene, Sew. Sch., Di. 500, 171; I. 500.
 Isolene, N. Launch, Di. 510.
 Ituna, D. 866, 281, 171.
 Ivanhoe, Str., Di. 589; I. 585; D. 580.
 Iztaccihuatl, Di. 311.
- J**
- Jackal, Di. 470.
 Jacqueminot, Di. 386.
 Jaffray, H. S., Biog. 215.
 Jane, Cut., Di. 483.
 Janet, Cat, Di. 504.
 Jathiel, Di. 479, 823.
 Jarvis, E. A., Biog. 230.
 Java, Cut., Di. 603, 201.
 Javelin, Str., Di. 471, 281, 171, 239.
 Jean, Str., Di. 572, 281, 171; I. 286; D. 305.
 Jean, Cat, Di. 641.
 Jeannette, Di. 655; I. 658; D. 666.
 Jennie J., Di. 648.
 Jennie B., Sl., Di. 503.
 Jenny, Di. 410.
 Jessica, Di. 471, 170.
 Jessie, Str., Di. 281, 641; I. 285.
 Jessie, Str., Di. 446; I. 537; D. 540.
 Jester, I. 331; D. 349.
 Jewel, Di. 326.
 Jewel, Di. 364.
- Jewel, Sch., Di. 160.
 Jib and Mainsail, I. 29; D. 23.
 Jib, Di. 282.
 Job Lot, Di. 326.
 Joker, Di. 328.
 Jones, C. H., Biog. 351.
 Jones, L. B., Biog. 656.
 Josephine, Launch, Di. 282.
 Josephine, Cat, Di. 460.
 Josephine, Cat, Di. 548.
 Josephine, Sl., Di. 484.
 Josephine Jr., D. Cat, Di. 564.
 Juanita, Cat, Di. 409.
 Juanita, Launch, Di. 446.
 Jubilee, I. 194; Di. 176; D. 220.
 Jubilee, Sheer Plan, 98.
 Judy, Di. 386, 171.
 Judy, Di. 430.
 Judy, Cat, Di. 648.
 Julie, Di. 510, 277.
 Junior, Di. 386.
 Junk, Chinese, 23.
 J. Y. McKane, Di. 411.
- K**
- Kala-Fish, I. 84, 80.
 Kallenbach, F. J., Biog. 597.
 Kalolah, Di. 171.
 Kanapha, Di. 386; I. 374; D. 392.
 Kane, S. N., Biog. 215.
 Kangaroo, Di. 277.
 Kangaroo, Di. 410.
 Kate Graham, Sl, Di. 615.
 Kathleen, Sl, Di. 582; I. 519; D. 522.
 Kathleen, Sl, Di. 603, 223.
 Kathleen, Sch., Di. 237; I. 235; D. 254.
 Kathleen, Cat, Di. 385.
 Kathleen, Sl., Di. 483.
 Katherine, Di. 326.
 Katie C., Di. 270.
 Katie Gray, Sl., Di. 603, 434; I. 438; D. 441.
 Katie Hall, Sl., Di. 603, 201.
 Katrina, Di. 278, 170.
 Katrina, Str., Di. 633, 171.
 Katrinka, Sl., Di. 503; I. 400; D. 501.
 Katydid, Str., Di. 572.
 Keewaydin, Cut., Di. 482.
 Kelpie, Cut., Di. 603, 223; I. 222; D. 220.
 Kelpie, Cut., Di. 481.
 Kelpie, Di. 453.
 Kersey, H. M., Biog. 215.
 Kestral, Ketch, I. 36; D. 41.
 Kestral, Di. 410.
 Kestral, Cat, Di. 453.
 Ketch, Kestral, I. 36; D. 41.
 Kier, Di. 517.
 Kilbride, I. 395; Di. 396.
 Kildee, Cut., Di. 577, 548; I. 580; D. 584.
 King Bird, Di. 453.
 King Fisher, Cat, Di. 510.
 King, J. B., Biog. 475.
 King Phillip, Cut., Di. 631, 480.
 Kismet, Sch., Di. 446.
 Kismet, Cat, Di. 453.
 Kite, Di. 452.
 Kitten, Cut., Di. 471.
 Kittoch, I. 397; Di. 396; D. 401.
 Kitty, Sch., Di. 480.
 Kitty, Sl., I. 630.
 Kitz, Di. 278.
 Knots and Miles, Table, 85.
 Koelling, J., Biog. 656.
 Koorali, Cat, Di. 484, 328.
 Kraken, Launch, Di. 282.
 Kraken, Sl., Di. 483.
 Kuma, Cat, Di. 631.
- Kuma, Cat Y., I. 28.
 Kwasind, Y., Di. 278, 641; I. 268; D. 301.
 Kwasind, Cut., Di. 483, 326.
- L**
- La Carolina, Launch, Di. 548.
 La France, Sl., I. 22.
 Lackawanna, Sl., Di. 631.
 Lady Emma, Di. 430.
 Lady Eva, Sl., Di. 531.
 Lady Evelyn, Sch., Di. 169.
 Lady Evelyn, Di. 604, 223.
 Lady May, Cat, Di. 604.
 Lady Sarah, I. 425.
 Lagoda, Di. 171.
 Lagonda, D. 392; Di. 386.
 Lakatoi, New Guinea, 13.
 Lake Yacht Racing Ass. His. 599.
 Lakeshul, Di. 409.
 Lakeshul, Di. 471.
 La Mouche, Di. 313.
 Lance, Cat Y., I. 529.
 Lance, Str., Di. 509.
 Lance, Str., Di. 313.
 Lanner, Di. 278.
 La Palma, I. 530; D. 540.
 La Perichole, Di. 280.
 La Puce, Di. 633.
 Lapping, Sl., Di. 544.
 Lapping, Cut., Di. 631.
 Larchmont Cup, I. 137.
 Larchmont Y. C. His. 267.
 Lark, Di. 453.
 Laska, Di. 382, 276, 237, 169; D. 210; P. xvi.
 Lassie, Cut., Di. 483; I. 210; D. 254.
 Latona, Sl., Di. 604, 261.
 Laura, Sl., Di. 223.
 Laura, Str., Di. 396.
 Laura E., Di. 411.
 Laurena, D. 351.
 Lawrence, F. R., Biog. 511.
 Lawton, N. D., Biog. 392.
 Laxen, Di. 278.
 Laxen, Di. 384.
 Lee Board, I. 102.
 Leeds, C. H., Biog. 522.
 Leeming, Thos., Biog. 392.
 Lelia, Str., Di. 648, 646.
 Lelia, Sch., Di. 611.
 Lena, Sch., Di. 237.
 Lena, Cut., Di. 631, 481; I. 370; D. 390.
 Lenni Lenapi, Di. 577.
 Lenore, Y., Di. 223.
 Lenore, Cut., Di. 360.
 Leona, Sl., Di. 481.
 Leona, Sch., Di. 588.
 Lesbris, Y., Di. 280.
 Lester, T. W., Biog. 265.
 Let Her Go, Sl., Di. 564.
 Levana, Cut., Di. 481.
 Levin, C. H., Biog. 322.
 Lichtenberg, C. J., Biog. 560.
 Lincoln Park Y. C. His. 665.
 Lillie, Di. 326.
 Lillie, Str., Di. 646.
 Lily, Str., Di. 396.
 Lily, Str., Di. 648.
 Lina, Str., Di. 509, 281; I. 576; D. 583.
 Lina, Str. Di. 578.
 Linda, Sch., Di. 544.
 Linotte, Di. 171.
 Linta, D. 478, 490; Di. 471; I. 478; P. 1xvii.
 Little Commodore, Di. 430.
 Little Marchioness, Di. 312.
 Little World, Sch., Di. 604.
 Livingston, W. J. Jr., Biog. 597.

Livonia, Sheer Plan, 65.
 Luando, Str., Di. 509, 281, 171.
 Lochinvar, Cat, Di. 694, 409.
 Lobs, J. & M., Di. 608; D. 679; I. 667.
 Lobs, Cat, Di. 648, 564; I. 20, 505.
 Lockett, B. C., Biog. 643.
 Lonn, Cat, Di. 593.
 Loon, Str., Di. 578.
 Loreta, Str., Di. 578.
 Lorimer, R., Biog. 569.
 Lorita, Sl., Di. 631, 481, 326.
 Lorna, Di. 410.
 Lorna, Str., Di. 281.
 Lorna Doone, Cat, Di. 504.
 Lorraine, Di. 280.
 Lotawana, Di. 170.
 Lots, Cat., Di. 483.
 Lotos, Launch, Di. 471, 172.
 Lotowana, I. 181; D. 213.
 Lottimer, W. A., Biog. 522.
 Lotus, Sch., Di. 270, 169.
 Lotus, Str., 171.
 Lotus, Sl., Di. 604, 261.
 Lou, Di. 446.
 Louie Belle, Di. 280.
 Louisa, Di. 384.
 Louise, Launch, Di. 313.
 Louise, Str., Di. 618.
 Lowery, G. C. W., Biog. 303.
 Loyd, D. I. 411, 382, 169; D. 412; P. lix.
 Luggar, D. 38; I. 34.
 Luggar, I. 21.
 Lucile, Str., Di. 239.
 Lucile, Str., Di. 171.
 Lucille, Cat, Di. 280.
 Lucy, Di. 261.
 Lucy, Sl., Di. 668.
 Lulu, Di. 311.
 Lulu B., Sl., Di. 648, 563.
 Lulu May, Naphtha Launch, Di. 532.
 Lurley, J. & M., Di. 655; I. 654; D. 656.
 Lurline, Str., Di. 281, 171.
 Lurline, Launch, Di. 282.
 Lurline, Launch, Di. 300.
 Lurline, Str., Di. 616.
 Lydia, Di. 382.

M

Mib, Di. 338.
 Mabel, I. 336; D. 300; Di. 311.
 Mabel, D. 351.
 Mabel D., Di. 328.
 Mac Donolue, J., Portrait, 539.
 Mackerel, Di. 396.
 Mackie, H. S., Biog. 560.
 Maccohee, Cat., Di. 604.
 Mad Cap, Di. 674, 384.
 Madcap, Sch., Di. 480.
 Madeleine, Sch., Di. 169, I. 37, 65.
 Madeleine, Sheer Plan, 65.
 Madeleine, Str., Di. 239.
 Madeline, Sl., Di. 604, 648.
 Madge, Sl., I. 308; Di. 311.
 Madge, Sl., Di. 482, 326.
 Madge, Cat, Di. 484, 328.
 Madge, Cat., Di. 551.
 Madge, Str., Di. 509.
 Madge, Sl., Di. 564.
 Maggie, Sl., Di. 564.
 Magic, Sch., Di. 510, 276, 169; P. lv.
 Magic, Sheer Plan, I. 95.
 Magna, Str., Di. 648.
 Magnet, Str., Di. 336.
 Magnet, Y., Di. 410.
 Magnet, Sl., Di. 631.
 Magnolia, Sch., Di. 480, 325.

Magnolia, Str., Di. 572, 171.
 Muggle, Di. 323.
 Maliland, Sew. Sch., Di. 611; I. 608; D. 610.
 Majel, Cat., Di. 604; 531.
 Majel, Cat, Di. 484; I. 533; D. 509.
 Majorie, D. 273.
 Malloch, F. S., Biog. 264, 601.
 Mallory, J. D., Biog. 589.
 Manatee, Str., Di. 509.
 Manito, Cat., Di. 503; I. 501; D. 501.
 Manning, J. S., Biog. 302.
 Manola, Di. 440.
 Mansfield, E. F., Biog. 419.
 Marchioness, Di. 452.
 Marena, Di. 482.
 Margaret, I. 535; Di. 532; D. 531.
 Marguerite, Str., Di. 386.
 " Launch, Di. 510, 282.
 " Launch, Di. 281, 172.
 " Sch., Di. 382, 337; I. 185; D. 216;
 P. xxxv.
 " Sch., Di. 632, 169.
 " Sl., Di. 312.
 " Sl., Di. 419; I. 415; D. 456.
 " Cat, Di. 385.
 " Cat., Di. 482.
 " Launch, I. 503.
 Maria, I. 58.
 " Sheer Plan, 87.
 Marian, Str., Di. 325, 239.
 Mariana, Naphtha, Di. 510.
 Marietta, Str., Di. 171, 356.
 Marietta, 417.
 Marina, Str., Di. 479.
 Marion, Str., Di. 171.
 Marion, Str., Di. 396; I. 398; D. 401.
 Marion, Sl., Di. 532.
 Marion, Y., Di. 572.
 Mariota, Di. 326.
 Mariposa, I. 330; D. 349.
 Mariquita, Di. 170.
 Marjorie, Di. 577.
 Marjorie, Sl., Di. 548.
 Marjorie, Di. 431, 278.
 Marjorie, Cat., Di. 481.
 Marjorie, Sl., Di. 481.
 Marvel, Cat, Di. 481.
 Mary, Di. 410.
 Mary A., Di. 410.
 Mary Lee, Di. 452.
 Mary Stuart, Str., Di. 552.
 Mary Taylor, Sheer Plan, I. 87.
 Mascot, Di. 434.
 Mascot, Sl., I. 585; Di. 618.
 Mason, J. A., Biog. 660.
 Maspeth, Naphtha, Di. 510.
 Matilda, Y., Di. 483.
 Matoxeh, Di. 326.
 Mattie, Cat, Di. 481.
 Mattie M., Sl., Di. 563.
 Mattie W., Launch, Di. 510.
 Mattie W., Sl., Di. 661.
 Maud, Cat, Di. 611.
 Maud, I. 395; Di. 396; D. 401.
 Maud, Sl., Di. 481.
 Maud B., Sl., Di. 604, 261.
 Maud B., Cat, Di. 572.
 Maude, Sl., Di. 517.
 Mavourneen, Sl., Di. 583.
 May, I. 25; Di. 170.
 May, Sew. Sch., Di. 281, 239, 171, 386; D. 299;
 P. vii.
 May, Sl., Di. 541.
 May Belle, Di. 532.
 Mayflower, Sl., Sheer Plan, 95.
 Mayflower, Sch., Di. 237, 169; D. 253; P. xli.
 Mayflower, Sl., Di. 601, 551.
 Mayflower, Skiff, Di. 601.
 May Lily, Str., Di. 616.
 Mayotta, Di. 278.
 McAllister, F. W., Biog. 590.
 McCarthy, W. N., Portrait, 539.
 McIntyre, T., Biog. 215.
 McGaw, T., Biog. 230.
 McGrady, J. H., Biog. 351.
 McMurray, R. K., Biog. 412.
 Meadow Hen, Di. 674.
 Measuring of Yachts, 122.
 Melora, Skiff, Di. 601, 261.
 Melissa, Di. 170.
 Memento, Di. 328.
 Mendota, Di. 385.
 Mentor, Di. 360.
 Mephisto, Di. 430.
 Mercury, Di. 446.
 Merle, Cat., Di. 532; I. 533; D. 533; P. lxxvii.
 Merlin, Sch., Di. 237, 169; P. xlv.
 Merlin, D. 251; Di. 278.
 Mermaid, Skiff, Di. 601.
 Mermaid, Cat., Di. 577; I. 581; D. 581.
 Mermaid, Sl., Di. 452.
 Meropé, Di. 623.
 Messenger, Launch, Di. 503.
 Meta, Cat, Di. 328.
 Meta, Sl., Di. 237.
 Meteor, Di. 169.
 Metusa, Di. 416.
 Michigan Y. C. Hts. 617.
 Microbe, Di. 312.
 Midget, Di. 328.
 Mignon, Di. 472, 279.
 Mignon, Di. 381.
 Mignon, Di. 261.
 Mignonne, Sl. Di. 661.
 Mildred, Cat., Di. 327, 238, 481; I. 404; D. 408.
 Miller, James, Biog. 401.
 Miller, J. C., Biog. 401.
 Miller, J. W., Biog. 401.
 Miller, E. D., Biog. 451.
 Milliceto, I. 170; D. 210.
 Millie, Sl. Di. 611.
 Mills, M. B., Biog. 651.
 Mindoo, Di. 396.
 Mincola, Cat., Di. 471, 384, 278, 170; D. 474;
 P. lxxviii.
 Minerva, Cat., Di. 472, 170.
 Minerva, Str., Di. 386.
 Minnelaha, Di. 171.
 Minnie A., Di. 311.
 Minnie B., Di. 328.
 Minnetonka Y. C. Hts. 451.
 Miramichi Y. C. Hts. 395.
 Miranda, Sch., Di. 472.
 Mischief, Sheer Plan, 95.
 Mischief, Di. 472, 327; I. 394; D. 398.
 Mischief, Cat, Di. 630.
 Mistral, Sl., Di. 510, 278.
 Mite, D. 660.
 Moccasin, Di. 384.
 Moccasin, Di. 623.
 Madesta, Di. 278.
 Modesty, Sl., Di. 452.
 Modoc, Cat., Di. 482.
 Mohawk, I. 65.
 Mohican, Di. 237, 169.
 Mojeska, Cat., Di. 604.
 Mollie, Cat, Di. 458.
 Molly, Cat., Di. 604.
 Molly Bawn, I. 314; D. 314.
 Mona, Sl., Di. 674; D. 674.
 Mona, Cat., Di. 412.
 Mona, Di. 278.
 Mona, Di. 361.
 Monck, J. F.,

308; D. 301.

599.

D. 210; P. xvi.
254.

D. 300.

D. 583.

78; P. lxxvii.

Monette, Di. 384.
 Monhegan, Di. 100, D. 215; P. xxx.
 Monroe, Augustin, Biog. 304.
 Montawk, Sch., Di. 160.
 Montawk, Cut., I. 426; D. 430; D. 31.
 Montezuma, Di. 328.
 Montecito, Y., Di. 381, 170; I. 39, 184; D. 216.
 Moodyne, Di. 327.
 Moodyne, Sl., Di. 482; I. 491; D. 498.
 Moore, Rev. W. L., Biog. 392.
 Morgan, Cups, 146, 147.
 Morgan, E. D., Biog. 300.
 Morgan, C. W., Biog. 393.
 Morrell, C. H., Biog. 539.
 Morris, A. W., Biog. 322.
 Mosca, Cut., Di. 483.
 Mosquito Boat, Wasp, I. 25; D. 21.
 Mosquito, Sheer Plan, 87.
 Mott, Augustus, Biog. 304.
 Mott B., I. 416; D. 421; D. 417.
 Mott, F. B., Biog. 440.
 Mott, J. T., Biog. 440.
 Mouse, Cat, Di. 648.
 Moustique, Cat, Di. 472.
 Moyn, Di. 623, 384; I. 373; D. 374, 392.
 Muggama Chuddee, Y., Di. 541.
 Munro, Norman L., Biog. 677.
 Murray, J. B., Biog. 476.
 Myles, Robt., Biog. 330.
 Myra, Launch, Di. 446.
 Myra, Str., Di. 386.
 Myra, Launch, Di. 313.
 Myra, Naphtha, Di. 510.
 Myrtle, Cat, Di. 328.
 Myrtle, Cat, Di. 385.
 Myrtle, Sch., Di. 615.
 Mystery, Cut., Di. 480, 327; I. 335; D. 351.
 Mystic, Sl., Di. 492.
 Myth, Cat, Di., 631.

N

Nadgy, Di. 261.
 Nadia, Cut., Di. 604, 361.
 Nadine, Cat, Di. 472.
 Nadjy, Sl., Di. 604, 279.
 Naera, Di. 160.
 Nahli, Cat, I. 605; D. 511.
 Nahli, Sl., Di. 510, 279.
 Nahma, J. & M., Di. 327.
 Nahma, Cat, I. 620; D. 625.
 Nahma, Sl., Di. 510.
 Naiad, Sl., Di. 410.
 Naiad, Sl., Di. 564.
 Naiad, Cut., Di. 604.
 Naiad, Sl., Di. 664.
 Naiad, Str., D. 264; P. II.
 Nama, Di. 318.
 Nameless, Di. 384, 278.
 Namouna, Di. 239, 171.
 Nan, Di. 409.
 Nancy, Cut., Di. 604, 261; I. 202; P. III.
 Nancy, Cut., Di. 483.
 Nannie, Di. 577.
 Nannie, Cat, Di. 548.
 Naomi, Sl., Di. 503; I. 501; D. 504.
 Narina, Sl., Di. 577, 548; I. 576; D. 584.
 Narounya, Cut., Di. 577; I. 582; D. 584.
 Narwhal, Str., Di. 446, 281, 509, 171; D. 216.
 Nautilus, Cat, Di. 453.
 Nautilus, Sch., Di. 548.
 Nautilus, Di. 384, 170.
 Nautilus, Str., Di. 171.
 Nautilus, Sl., Di. 360.
 Navahoe, Di. 278, 238, 170; Record 72; I. 178; D. 210.
 Navahoe, Sheer Plan, 97.

Navarch, Di. 325.
 Neutral, Str., Di. 380, 578, 171.
 Nebula, Cut., Di. 631, 480, 238.
 Nalles, R. C., Biog. 322.
 Nellie, D. Cat, Di. 648.
 Nellie C., Sch, Di. 615.
 Nelly G., Sch., Di. 480.
 Nelly G., Sl., Di. 604.
 Nemo 1st, Di. 313.
 Nepenthe, Cut., Di. 589, I. 580; D. 580.
 Nepenthe, Sl., Di. 430.
 Neroid, Di. 313.
 Nerona, Cat, Di. 481.
 Nerona, Cat, Di. 532.
 Nerius, Di. 430.
 Nothla, Y. Di. 384.
 Nettie, Sl., Di. 554.
 Nettie, Cat, Di. 280.
 Nettle, Cat, Di. 514, D. 547.
 Neva, Sl. Di. 446.
 Neva, Cut, Di. 641.
 New Haven Y. C. Hls. 443.
 Newell, G. H., Biog. 561.
 Next, Cat, Di. 280.
 Next, D. 516; Di. 517.
 Nozle, Di. 280.
 Nifti, Cat, Di. 591.
 Nimbus, Sch., Di. 604.
 Nimbus, Sl., Di. 480, 327.
 Nimpoy, Di. 170; I. 373; D. 383.
 Nina, Caravel, 17.
 Niobe, Launch, Di. 282.
 Niobe, Cat, Di. 324.
 Nirvana, Sch., Di. 633, 342, 169; I. 625; P. lxvi.
 Nirvana, Str., Di. 171.
 Nirvana, Di. 623, 278.
 Nixie, Str., Di. 396.
 Nixie, Sl., Di. 489; I. 485; D. 437.
 Noël, Pierre, Biog. 643.
 Nokomis, Launch, Di. 611.
 Nomad, Str., Di. 281, 171.
 Nomad, Di. 278.
 Nomad, I. 349; Di. 327; D. 352.
 Nomad, Sch., Di. 593.
 Nonpareil, Cat, Di. 481.
 Nonpareille, Di. 170, 611.
 Nonpareille, Di. 238.
 Nonpareille, Y., Di. 472, 303; I. 247; 305.
 Noyna, Scw. Sch., Di. 241, 171; I. 536; D. 511.
 Nora, Di. 278.
 Nordkyn, Di. 386.
 Norine, Skiff, Di. 604, 261.
 Norma, Cut., Di. 233.
 Norma, Str. Di. 323.
 Norma, Cat, Di. 564.
 Normandie, Di. 386.
 Norma, Sch., Di. 577, 159.
 Norma, Cut., Di. 480, 239.
 Norseman, Di. 247, 169; I. 142; D. 214.
 North Cape, J. & M., I. 533.
 North Cape, Sl., Di. 564; I. 566.
 North Star, Di. 327.
 Northrop, L. G., Biog. 534.
 Norwood, Scw. Str., D. 677; P. lxxxviii.
 Notus, Di. 384.
 Nourmahal, Scw. Bark, I. 185; Di. 171; D. 216.
 P. xiv.
 Novelty, D. Cat, Di. 504; I. 567.
 Novice, Di. 385.
 Novice, Cat., Di. 664.
 Now Then, Str., Di. 325, 239, 171, 632, 578; I. 323; D. 348.
 Nox, Lug., Di. 551; I. 555; D. 590.
 Nun, Sl., Di. 611.
 Nyanza, Di. 430.
 Nydia, Str., Di. 532, 386, 171.
 Nydia, Cat, Di. 387.

Nydia, Sl., Di. 482.
 Nymph, Sl., Di. 278, 170; I. 274; D. 303.
 Nymph, Cat, Di. 641, 270; I. 275.
 Nymphosa, Di. 360.
 N. Y. Y. C. Trophies, 140, 142.
 N. Y. Y. C. Hls. 163.
 N. N. Y. C. House, 164.
 N. Y. Y. C. Stations, 165, 166, 167, 168.
 N. Y. Y. C. Model Room, 174.

O

Oberon, Di. 171.
 Ocean Race, (1866), 61.
 Oconee, I. 620; D. 625; Di. 385.
 Oconomowoc Y. C. Hls. 661.
 Oddie, J. Van S., Biog. 216.
 Oeone, Sch., Di. 480, 325, 217, 169; I. 236; D. 254; P. xlviii.
 Oeone, Cut., Di. 604, 229.
 Ogdon, E. H., Biog. 547.
 Ohio Y. C. Hls. 613.
 Okicha, Di. 261.
 Olga, Cat, Di. 280.
 Olga, Cat, Di. 548.
 Olive, D. Cat, Di. 564.
 Olive, Launch, Di. 282.
 Olive B., Sl., Di. 659.
 Olive Eva, Sl., Di. 564.
 Oliver, W. L., Biog. 540.
 Olivette, Cat, Di. 578.
 Ollie, Di. 281.
 Olsen, Niels, Biog. 216.
 Omega, Di. 430.
 Onawa, I. 72.
 Onelda, Str., Di. 509, 633, 281, 172; D. 211; P. xliii.
 Onelda, Launch, Di. 510.
 Onward, Cut., Di. 551, 604, 431; D. 509.
 Onward, D. Cat, Di. 564.
 Opechee, Di. 328.
 Orea, Sch., Di. 544.
 Oriana, I. 400; Di. 396; D. 401.
 Orient, Sch., Di. 593.
 Orienta, J. & M., Di. 279.
 Orienta, Str., Di. 509, 386, 281, 172.
 Oriental, Di. 261.
 Oriole, Sl., Di. 659.
 Oriole, Sl., Di. 452.
 Oriole, Sch., Di. 604, 211; D. 223; P. xxxix.
 Oriole, Ketch, Di. 276, 169.
 Oriole, Launch, Di. 172.
 Oriole, Sch., Di. 573.
 Orion, Di. 384.
 Orithyia, Di. 380.
 Oriva, D. 212; Di. 278, 173; P. xxii.
 Orizaba, Str., Di. 572.
 Orrimoores, Di. 386.
 Osgood, Chas. H., Biog. 216.
 Oso, Di. 282.
 Osprey, Sl., Di. 312.
 Osprey, Sl., Di. 483.
 Osprey, Sch., Di. 510.
 Oswego Y. C. Hls. 433.
 Our Club, Di. 318.
 Oweene, Di. 238; I. 246; D. 277.
 Owl, Sl., Di. 481.
 Owl, Di. 835.

P

Paine, J. B., Biog. 256.
 Palmer, I. 189; Di. 383, 169; D. 218.
 Papoose, Di. 410, 223; D. 440; P. lxi.
 Parish, J. H., Biog. 449.
 Parm'ee, H. S., Biog. 448.
 Parole, Di. 385.

Pastime, Di. 640.
 Pastime, Str., Di. 648, 172.
 Pastime, Sch., Di. 925.
 Pauline, Di. 453.
 Paul & Stella, Di. 409.
 Penbody, H. C., Biog. 497.
 Pearl, Cat, Di. 312.
 Pearl, Sl., Di. 452.
 Pearl, Sl., Di. 615.
 Pearl, Sl., Di. 661.
 Peck, C. M., Biog. 450.
 Peck, F. W., Biog. 661.
 Peerless, Sl., Di. 452.
 Peerless, Sch., Di. 100; I. 170; D. 210.
 Peerless, Str., Di. 172.
 Peerless, Sch., Di. 472.
 Peet, Wm., Biog. 303.
 Peggy, Di. 885.
 Penguin, Di. 384.
 Peri, Cat, Di. 328.
 Peri, Sl., Di. 472, 278, 170, 510.
 Peridot, Sl., Di. 608.
 Periwinkle, I. 27; Di. 103.
 Perinuger, I. 27; D. 22.
 Perret, F. A., Biog. 413.
 Pert, Sl., Di. 517.
 Petrol, J. & M., Di. 279.
 Petrel, Cat, Di. 312.
 Petrel, Cat., Di. 317; I. 315; D. 320.
 Petrel, Sl., Di. 472.
 Petrel, Sl., Di. 482.
 Petrel, Sch., Di. 541.
 Petrel, Cat, Di. 548.
 Petrel, Sl., Di. 563.
 Petrel, Di. 577.
 Phantom, Sch., Di. 577, 446, 276, 190; D. 418;
 P. lxiii.
 Phantom, Sl., I. 437; D. 440.
 Phantom, Sl., I. 605; D. 609; Di. 608.
 Pharos, I. 289; Di. 281.
 Phelps, W. B., Jr., Biog. 411.
 Philomena, Di. 352.
 Phyllis, Sl., Di. 452.
 Pickaninny, Str., Di. 578.
 Pierce, C. T., Biog. 625.
 Pilgrim, Cat., Di. 480, 238; I. 103; D. 220.
 Pilgrim, Di. 327.
 Pilot, Cat, Di. 503.
 Pilot I., Cat, Di. 504.
 Pinta, Di. 577.
 Pinta, Columbus, 19.
 Pirate, Sl., Di. 593.
 Pirogue, Santa Cruz, 9.
 Pirogue, Java, 10.
 Pirogue from Archipelago, 10.
 Pixie, Di. 223.
 Playmate, Di. 385.
 Plover, Di. 446.
 Pluck & Luck, Di. 430.
 Plummer, W. H., Biog. 476.
 Pocahontas, I. 188, Di. 170, D. 218.
 Polly, Di. 655.
 Polly, Str., Di. 239.
 Polly, Str., Di. 479, 210.
 Polly, Sl., Di. 503; I. 500; D. 501.
 Pomingo, Sl., Di. 510.
 Poo-Bah, Di. 306.
 Pool, G. A., Biog. 670.
 Porcher, W. D., Biog. 501.
 Portia, Di. 278, 170.
 Portia, Di. 278.
 Portland Y. C. His. 607.
 Posey, I. 363; D. 350; Di. 327.
 Presto, Di. 674.
 Princess, Sl., Di. 648.
 " Di. 170.
 " Sch., Di. 632, 237.

Princess, Str., Di. 230.
 " Sl., Di. 182.
 " Cat, Di. 353.
 " Sl., Di. 560.
 Prindville, Capt. John, Biog. 670.
 Prindville, J. W., Biog. 669.
 Priscilla, Cat, Di. 280.
 Priscilla, Sch., Di. 480, 925.
 Priscilla, Cat, Di. 532.
 Priscilla, Cat, Di. 591.
 Proteus, Y., Di. 384, 279.
 Psyche, Cat., Di. 300.
 Psyche, Cat., Di. 601, 291; I. 299; D. 295.
 Psyche, Cat, Di. 481.
 Punch, Di. 280.
 Puritan, D. Cat, Di. 541; I. 565; D. 569.
 Puritan, C. Cat., Di. 238, 170; I. 32, 236; D. 236.
 Puritan, Sheer Plan, 95, 99.
 Puritanita, Di. 328.
 Puzzle, Str., Di. 509.
 Puzzler, Sl., Di. 517.
 Pyxle, Di. 611, 278; D. 305.
 Pyxle, Sheer Plan, 93.

Q

Queen Mab, Sl., Di. 278, 170.
 Queen Mab, Str., Di. 172.
 Queen Mab, Cat, Di. 382.
 Queen's Cup, I. 155.
 Quickstep, Sch., Di. 237, 109; I. 211.
 Quickstep, Sl., Di. 601.
 Qui Vive, I. 60.

R

Radna, Sew. Sch. D. 19; Di. 172; P. xxxvii.
 Raft, Indian, I. 6.
 Raft, Passit River, I. 6.
 Rahne, J. & M., I. 29.
 Rajah, Di. 278, 384; I. 411; D. 418.
 Rambler, Sl., Di. 511.
 Rambler, Di. 577.
 Ramona, Sch., Di. 472, 276, 109; I. 283, D. 303.
 Ramona, Sl., Di. 180.
 Ramona, Launch, Di. 611.
 Ramona, Sch., I. 537; D. 540.
 Random, Di. 479.
 Rattler, Di. 385.
 Raven, Di. 577.
 Ray, Di. 166.
 R. D., J. & M., Di. 631.
 R. D., Sheer Plan, 92.
 Roper, J. & M., Di. 483.
 Rebecca, Di. 109.
 Rebecca M., Sch. Di. 503.
 Reckless, Di. 170.
 Reckless, Launch, Di. 430.
 Record of Speed, 77, 85.
 Recruit, Di. 233.
 Reed, J. C., Biog., 231.
 Reed, G. W., Portrait, 539; Biog. 633.
 Red Bird, Cat, Di. 615.
 Regina, Di. 278.
 Reposo, Di. 281, 172.
 Republic, Sch., Di. 109; I. 183; D. 210.
 Republic, Launch, Di. 674, 282.
 Restless, Sl., Di. 611.
 Retriever, Cat, Di. 446.
 Restless, I. 419; D. 421.
 Reva, Str., Di. 572, 172.
 Reva, Sl., Di. 430.
 Roverie, Di. 172.
 Richmond, Di. 278.
 Rig of Yachts, 109, 123.
 Rigs, Nomenclature of, 112, 124.
 Riot, Di. 279.

Ripple, Sl., Di. 552, 431, 609; I. 556; D. 561.
 Ripple, Y., Di. 541.
 Rita, Sl., Di. 312.
 Rita, Launch, Di. 510.
 Rival, Str., Di. 172.
 Rival, Sl., Di. 410, 381.
 Riverton Y. C. His. 545.
 Rivet, Cat., Di. 601.
 Riverside Y. C. His. 617.
 Rramer, Di. 381.
 Rramer, Di. 577.
 Roberts, O. B., Biog. 633.
 Rocket, Sheer Plan, 93.
 Rochester Y. C. His. 519.
 Rodia, Di. 517.
 Roi, Cat, Di. 601; I. 637; D. 613.
 Rogers, E. B., Biog. 352.
 Romance, Sch., Di. 160.
 Romance, Sch., Di. 382.
 Romola, Str., Di. 509.
 Romola, Cat., Di. 601, 552.
 Romp, Di. 385.
 Rondina, Cat., Di. 327, 238, 180.
 Rosalind, Di. 278, 170.
 Rosamond, Di. 309.
 Rose Marie, Di. 381.
 Roslyn, Launch, Di. 671.
 Rover, Di. 281, 170; I. 374; D. 392.
 Rover, Cat., I. 440; Di. 417; D. 421.
 Rowena, Di. 312.
 Royal Canadian Y. C. His. 221.
 Royal Hamilton Y. C. His. 231.
 Rudder, first appearance of, 11.
 Runk, W. N. S., Biog. 591.
 Rattle, Sl., Di. 601.
 Ruth, Sch. Di. 360, 237, 161.
 Ruth, Str., Di. 300.
 Ruth, Str., Di. 411; D. 119; P. lx.
 Ruth, Sl., Di. 482.
 Ruth N., Di. 453.

S

Sachem, Di. 382, 276, 109; I. 176; D. 210; P. xv.
 Sable, Naphtha, Di. 671.
 Sagamore, Str., Di. 239, 172, 578; D. 604.
 P. lxxiii.
 Sagitta, I. 519; Di. 170; D. 523.
 Sahib, Di. 510, 280.
 Sailor Boy, Cat, Di. 648.
 Sails, D. 199.
 Sails, Measuring of, 122, 491.
 Saldia, Cat., Di. 238; I. 437; D. 607.
 Sallie, Sl., Di. 533.
 Salola, Di. 261.
 Samoa, Cat., Di. 603, 261; D. 264.
 Sannon Sail Boat, I. 12.
 Sandbagger, Cruiser, I. 80.
 Sanderson, H. A., Biog. 605.
 Sanderson, Oswald, Biog. 605.
 Sand Fly, Di. 578.
 San Francisco Y. C. His.
 San Francisco Y. C. His.
 Sanibel, Di. 386, 172.
 Sans Souci, Di. 659.
 Santa Maria, Cat., Di. 601.
 Saona, Di. 623, 264.
 Santa Maria, I. 12.
 Sapphire, Str., Di. 517.
 P. xviii.
 Sappho, Sch., I. 12.
 Sappho, Str., Di. 517.
 Sappho, Cat, Di. 517.
 Sappho, Sl., I. 12.
 Saracen, Cat, Di. 517.
 Sarcelle, Di. 517.
 Satan, Sl., Di. 517.

- Salmella, Di. 172; D. 475; P. lxi.
 Satellite, Di. 172.
 Sayonara, Di. 384, 278, 288, 472, 170; P. xiii.
 Sayward, G. H., Biog. 411.
 Say When, Di. 417.
 Schemer, Sl., Di. 605; I. 200; D. 301.
 Scherer, O., Biog. 509.
 Schooner, Nomenclature, 116; I. 37, 38; D. 41.
 Schuler, J. M., Biog. 441.
 Schuyler, R. M., Biog. 476.
 Scorpion, Sl., Di. 668.
 Scorpion, Sl., Di. 578.
 Scott, Launch, I. 70.
 Seoville, T. L., Biog. 512.
 Seud, Sl., Di. 615; I. 614; D. 616.
 Seabelle, D. 450.
 Sea Bird, Str., Di. 632, 325; D. 348.
 Seabird, Y., Di. 604.
 Sea Fox, Sch., Di. 480, 237, 160; I. 245; D. 257.
 Sea Fox, Sl., Di. 544.
 Secret, J. & M., Di. 508, 327; I. 311; D. 353.
 Secret, Str., Di. 886.
 Secretaries, Addresses of, 49.
 Sealey, C. B., Biog. 305.
 Sekara, Sch., Di. 480.
 Selfish, Cat, Di. 594.
 Seminoles, Di. 410.
 Seminoles, Str., Di. 578.
 Senator, I. 170; D. 212, 340; Di. 325.
 Seneca, Str., Di. 172.
 Seneca, Y., Di. 410; I. 409; D. 413.
 Senga, Launch, Di. 517.
 Senorita, Di. 278.
 Sentinel, Launch, Di. 282, 172.
 Seraph, Sl., Di. 605.
 Seresta, Di. 172.
 Serlense, Di. 812.
 Seven ("7"), Sl., Di. 631.
 Seymour, H. A., Biog. 450.
 Shackford, C. H., Biog. 510.
 Shadow, Sl., Di. 327, 238, 631; I. 320; D. 310.
 Shadow, Di. 655.
 Shamrock, Sch., Di. 382, 276, 160; I. 508; D. 512; P. lxxvii.
 Shamrock, Sl., Di. 564, 615.
 Sharpie, Modern, I. 23; D. 20.
 Sharpie, Sch., I. 24.
 Shaw, A. J., Biog. 408.
 Sheerwater, Str., Di. 281, 239, 172, 500.
 Sheer Plan, 87-90.
 Sheila, Cat, Di. 648.
 Shenecosset, Di. 172.
 Shenandoah, I. 21.
 Ship, Nomenclature, 120-122.
 Ship, Lugger Rig, I. 21.
 Ship, La France, I. 23.
 Shona, Cut., Di. 472, 238; I. 247; D. 257.
 Sibyl, Sl., Di. 472.
 Siedenbergl, G., Biog. 512.
 Siesta, Str., Di. 552.
 Siesta, Sl., Di. 605.
 Sigma, Str., Di. 434.
 Sigma, Str., Di. 640, 615, 172, 500; D. 616; P. xc.
 Sigma, Sl., Di. 564.
 Signal, Str., Di. 479, 632.
 Signal, Di. 411, 382.
 Sigrid, Di. 327.
 Silence, Sl., Di. 430.
 Silence, Y., Di. 279.
 Silva, Str., Di. 578, 172.
 Silver Bell, Cat, Di. 453.
 Silver King, J. & M., Di. 631, 327.
 Silver, Di. 411.
 Simons, E. H., Biog. 604.
 Sinbad, Di. 655.
 Sinbad, Sl., Di. 593.
 Sinbad, Str., Di. 509.
 Singer, C. A., Biog. 645.
 Siren, Sl., Di. 472.
 Siren, Cat, Di. 594; I. 303; D. 507.
 Siren, Sch., Di. 510.
 Sirocco, Launch, Di. 510.
 Sirocco, Sheer Plan, 61.
 Sirocco, J. & M., I. 477; D. 406.
 Siva, Sl., Di. 482.
 Sivanoy, Di. 292.
 Skin Canoes, I. 13.
 Skip, Di. 280.
 Skipper, Cat, Di. 578.
 Sketch, Sch., I. 607; Di. 608; D. 670.
 Skraellug, Di. 674.
 Skylark, Di. 172.
 Sliding Hunter, D. 24.
 Sloops and Cutters, 25, 26.
 Sloops and Cutters, 113, 114.
 Small, S. N., Biog. 352.
 Smith, Sir Donald A., Cup, I. 158.
 Smith, J. D., Biog. 218.
 Smith, W. N., Biog. 522.
 Smith, Walter, Biog. 597.
 Smoke, Cat, Di. 484, 329.
 Smuggler, I. 37; Di. 384; D. 303.
 Smuggler, Sheer Plan, 63.
 Smul, Sl., Di. 480.
 Snark, Di. 453.
 Social, Di. 276.
 Solitt, O., Biog. 690.
 Sophia, Di. 400.
 Sortie, Sl., Di. 604.
 So So, Launch, Di. 282.
 So So, Cat., Di. 534.
 Southern Y. C. His. 423.
 Soubrette, Sl., Di. 311.
 Soubrette, Cat, Di. 605, 572; I. 553; D. 560.
 Sonntag, D. 220.
 Southern Cross, Di. 382.
 Sparkie, Str., Di. 500, 172.
 Speed Record Sailing Yachts, 78-85.
 Speedwell, Str., Di. 472.
 Speranza, Sch., Di. 577, 446, 160, 615; D. 583; P. lxx.
 Speranza Jr., Str., Di. 615.
 Spindrift, Di. 172.
 Spray, Cut., Di. 311.
 Spray, Cut., Di. 605, 201.
 Spray, Cat, Di. 400, 385.
 Spray, Cat, Di. 548.
 Spray, Cat, Di. 501.
 Sprite, Cat, Di. 611.
 Spurt, J. & M., Di. 484, 517.
 Squirrel, Di. 300.
 Staples, Edw., Biog. 218.
 St. Augustine Y. C. His. 571.
 Stamford Y. C. His. 510.
 Starlight, Sl., Di. 611.
 Starling, Di. 172.
 Stateroom in Dauntless, P. iv.
 Steeple Jack, J. & M., Di. 503.
 Stella, Sew. Sch., I. 628.
 Stella, Sl., Di. 430.
 Stella, Sl., Di. 605, 261.
 Stella, 170.
 Stella, Str., Di. 281, 172.
 Stella, Str., Di. 386.
 Steam Yacht, Nomenclature, 118.
 Steam Yacht Aux., Nomenclature, 119.
 Sterling, J. H., Biog. 643.
 Stetson, J. A., Biog. 633.
 Stewart, J. L., Biog. 401.
 St. George, Di. 311.
 Stickney, B. W., Portrait 530.
 Stivers, R. M., Biog. 304.
 St. John, Di. 490.
 St. Kilda, Di. 360.
 St. Lawrence Y. C. His. 307.
 Stone, D. 215; Di. 172; P. xxxiii.
 Stranger, Str., Di. 386, 172.
 Stranger, Cut., Di. 480, 472, 360, 238.
 Stranger, Sl., Di. 443, I. 444; D. 440.
 Stranger, Cat, Di. 385.
 Stranger, Di. 328.
 Street, E. D., Biog. 401.
 Studio, I. 43; Di. 411.
 Sully, Thos., Biog. 431.
 Sultana, Di. 472, 172; I. 186; D. 216.
 Sunbeam, Sl., Di. 482.
 Sunbeam, Sl., Di. 615.
 Sunday, Di. 517.
 Superior, Di. 475.
 Surf, Di. 278.
 Surf, Di. 238.
 Surprise, Sl., Di. 564.
 Susan, Cut., Di. 485.
 Susie, Sl., Di. 482, 327.
 Susie, Sch., Di. 417.
 Susie, Cat, Di. 572.
 Susie B., Sl., Di. 446.
 Susie B., Sl., Di. 430.
 Susie W., D. 675; Di. 674, 278.
 Susquehanna, Str., Di. 509, 239, 172; D. 512; P. lxxviii.
 Sutton, H. F., Biog. 412.
 Swallow, Str., Di. 239.
 Swallow, Sl., Di. 452.
 Swallow, Di. 384.
 Swan, Sl., Di. 605.
 Swannona, Di. 384, 170, 623.
 Sweetheart, Launch, Di. 282.
 Sylph, D. 212; Di. 169; P. xx.
 Sylvia, Naphtha, Di. 548.
 Sylvia, Cut, I. 525; D. 633.
 Tabitha, Di. 385.
 Tabor, T. T., Biog. 675.
 Tadpole, Di. 327.
 Tadpole, Sheer Plan, 61.
 Talbannu, Di. 479, 325.
 Tamarack, Di. 674.
 Tantalus, Di. 386.
 Tarpou, Sl., Di. 664; D. 663.
 Tarantella, Catam., I. 31.
 Tautog, Di. 510, 280.
 Taylor, John, Biog. 537.
 Teal, Di. 278.
 Teal, J. & M., Di. 484.
 Teal, Di. 577.
 Teaser, Cat, Di. 504.
 Telfer, Sch., Di. 577, 169; I. 579; D. 584.
 Tempest, Di. 382.
 Thais, Sl., Di. 483.
 Thalia, Sl., Di. 446.
 Thalia, Launch, Di. 611.
 The Bird, Di. 385.
 The Bud, D. Cat, Di. 618.
 The Kid, Cat, Di. 385, 280.
 The Kid, Di. 453.
 Thelma, Cut., Di. 238; I. 487; D. 497.
 Thelma, Sch., Di. 446.
 The Margaret, Naphtha, Di. 552.
 The Mude, Cat, Di. 648.
 The Owl, Di. 327.
 Thera, Lagger, Di. 472, 280.
 Theresa, Sew. Sch., I. 507; Di. 500; D. 519.
 The Sabot, Di. 279.
 Thetis, Cut., Di. 360.
 Thetis, Sl., Di. 472, 278, 170.
 Thetis, Sl., Di. 544.
 Thetis, Launch, I. 438; D. 441.

- The Wake, Di. 282.
 Thistle, Di. 278, 170.
 Thistle, Str., Di. 300.
 Thistle, Sl., Di. 504.
 Thistle, Sheer Plan, 85, 90.
 Thistle-down, Di. 239, 201; D. 230.
 Thom, Di. 612.
 Three Brothers, Di. 328.
 Thrush, Di. 327; I. 329; D. 310.
 Thyra, Sew. Sch., Di. 281, 172, 380; I. 505; D. 511.
 Tiffany, Henry D., Biog. 210.
 Tigress, I. 381; D. 303; Di. 381.
 Tilio, Str., Di. 500, 281, 172.
 Tilio, Launch, Di. 548.
 Time Allowance, 85, 80.
 Tinga, Sch., Di. 282, 270, 160, 472; I. 284; D. 303.
 Titania, Sl., Di. 472, 238.
 Titania, Launch, Di. 510.
 Toboggan, Sl., Di. 472.
 Toinette, Di. 230.
 Tomahawk, I. 485; D. 497.
 Tomboy, Di. 278.
 Toment, Cut., Di. 484.
 Townsend, W. S., Biog. 500.
 Towuseed, Vinton, Biog. 500.
 Tracy, H., Biog. 610.
 Tramp, Di. 261.
 Tranquilo, Di. 172.
 Triad, I. 498; D. 498.
 Fridout, Di. 270.
 Trifle, Di. 517.
 Trineulo, Di. 382.
 Trio, Di. 446.
 Tritone, I. 14, 15.
 Triton, Sl., Di. 601.
 Triton, Sl., Di. 605.
 Triton, Sch., Di. 611.
 Trochilus, Di. 278, 170, 611.
 Trochilus, Launch, Di. 282.
 Trophies, Cups, etc., 120, 164.
 Trophy, Str., Di. 386, 172.
 Trophy, Str., Di. 472.
 Tropic, Y., Di. 410.
 Troubadour, Sch., Di. 632, 325.
 Troubadour, I. 335; D. 351.
 Truant, Sl., Di. 544.
 Truant, Str., Di. 172.
 Truant, Str., Di. 648, 619, 172; D. 645; P. lxxxv.
 Truant, Cut., Di. 400.
 Truant, Cat., Di. 517.
 Trudette, Sl., I. 486; Di. 482; D. 407.
 Trump, Di. 324.
 Turner, M., Portrait, 530.
 Turtle, Di. 230.
 Tycoon, Launch, Di. 282.
 Type of Yachts, 87.
 Typhoon, Cut., Di. 481, 328.
 Tyrant, Sl., Di. 517.
 Tyson, Geo. I., Biog. 635.
- U**
- Uarda, Sl., Di. 631.
 Uarda, Str., Di. 610.
 Uarda, Y., Di. 641.
 Uganda, Di. 446.
 Ugo, Sl., Di. 648, 561.
 Ulah, Di. 360.
 Ullilla, Cut., Di. 472, 238, 170.
 Una, Str., Di. 313.
 Una, Sch., I. 308; Di. 382; D. 300.
 Unda, Di. 311.
 Undertaker, Di., 327.
 Undine, Cut., I. 444; D. 449.
- Undine, Cut., Di. 312.
 Undine, Launch, Di. 313.
 Undine, Di. 327.
 Undine, Cat., Di. 409.
 Undine, Cut., Di. 518.
 Undine, Sl., Di. 605, 552.
 Undine, Cut., Di. 631.
 Undine, Sl., Di. 631.
 Undine, Cat., Di. 604.
 Unique, I. 418; Di. 417.
 Unknown, Cut., Di. 594.
 Unknown, Sl., Di. 503.
 Ursula, Di. 160.
 Ustane, Di. 327; I. 330; D. 332.
 Utowana, Aux. Sch., Di. 270, 230, 172, 472; D. 213, P. xxiii.
 Utowana, Sew. Sch., P. xviii.
 Uvira, Di. 300, 170.
- V**
- Vaga, Sl., Di. 483, 327.
 Valda, Di. 311.
 Valhalla, Di. 238.
 Valhalla, Sl., Di. 480, 327.
 Valiant, Di. 281, 170.
 Valkyr, Di. 170.
 Valkyrie, Races of, 74, 76.
 Valkyrie, Sheer Plan, 85, 98.
 Valkyrie, I. 101; D. 220.
 Vamoose, Di. 500, 172.
 Vamoose, D. 677; P. lxxxix.
 Vanadis, Di. 270.
 Vancluse, Di. 230.
 Vandal, Cut., Di. 483, 327.
 Vandal, Cut., Di. 631, 180.
 Vandetta, Cut., Di. 605.
 Vanessa, J. & M., Di. 483, 327; I. 329; D. 318.
 Vanitas, Sch., Di. 481.
 Varande, Di. 238.
 Varena, Di. 170.
 Varuna, Sch., Di. 276, 160.
 Varuna, Sl., Di. 452.
 Varuna, Str., Di. 632.
 Vashit, Cut., Di. 631, 481, 327; I. 628; D. 633.
 Vayu, Cut., Di. 631.
 Vedette, Str., Di. 386, 281, 172; D. 211; P. xvii.
 Vedette, Lugger, Di. 228, 201; I. 227; D. 231.
 Vega, Di. 172.
 Vega, Di. 237.
 Veluette, Cut., Di. 605, 552; I. 558; D. 561.
 Venetia, Di. 577.
 Ventura, Cut., Sl. 170, 278; D. 219; P. xxxiv.
 Ventura, Cut., Di. 480; I. 486; D. 497.
 Ventura, Cut., Di. 453.
 Ventura, Di. 383.
 Venus, D. 449; Di. 440.
 Vera, Cut., I. 202; D. 205.
 Vera, Cut., Di. 605.
 Verve, Cut., Di. 605.
 Verve, Di. 552, 223, 261, 605; I. 225; D. 230.
 Verve, Sl., Di. 452.
 Vessel from Grave of Sakkara, 13.
 Vessels, Columbus time, 20.
 Vesta, Str., Di. 172.
 Vesta, Str., Di. 386.
 Vesta, Sch., Di. 382.
 Vesta, Launch, Di. 517.
 Veto, Str., Di. 509.
 Vexer, Di. 517.
 Viator, Di. 276, 169; I. 271; D. 302.
 Victor, Str., Di. 281.
 Victor, Di. 446.
 Vida, Di. 410.
 Vidette, Di. 382; I. 375; D. 393.
 Vidette, Sl., Di. 446.
 Vidette, Lugger, I. 341.
- Vigilant, Crew of, 130.
 Vigilant, Sheer Plan, 95, 98.
 Vigilant, Races of, 74, 71, 73, 76.
 Vigilant, I. 74; Di. 170; D. 220; P. 1.
 Viking Ship, I. 16; World's Fair, 17.
 Viking, Cut., Di. 608; I. 603; D. 609.
 Viking, Sch., Di. 169.
 Viking, Str., Di. 172.
 Viking, Cut., Di. 311; I. 317; D. 322.
 Viking, Str., Di. 611.
 Viking, Sl., Di. 618.
 Villa Koch, Di. 655.
 Vindex, Di. 278.
 Viola, Sl., Di. 561.
 Viola, Sl., Di. 446, 170, 510.
 Viola, Str., Di. 509.
 Violet, Di. 280.
 Virginia B., D. Cut., Di. 648.
 Vision, Str., Di. 281, 172.
 Vision, Sl., Di. 603, 220.
 Vision, Di. 611, 278.
 Vision, Sch., Di. 577, 472.
 Vision, Sl., Di. 472.
 Vita, Str., Di. 648, 610, 172.
 Viva, Sl., Di. 611.
 Vivace, Sl. 325.
 Vive, Sl., Di. 503.
 Vivid, Di. 280.
 Vivid, Di. 311.
 Vivien, Di. 278.
 Vivienne, Di. 214; P. xxiv.
 Vixen, Sl., Di. 611.
 Vixen, Di. 381, 238, 170; D. 212.
 Vixen, Launch, Di. 282.
 Vixen, Di. 410.
 Vixen, Sl., Di. 481.
 Vixen, Skiff, Di. 605.
 Vixen, Sl., Di. 561.
 Vogue, Sl., Di. 631.
 Volante, Cut., Di. 605, 201; I. 260; D. 265.
 Volante, Sl., Di. 605, 223.
 Volante, Sl., Di. 452.
 Volante, V., Di. 434; D. 441.
 Volante, Sl., Di. 532.
 Volante, Sl., Di. 541.
 Volunteer, Di. 238, 170; I. 283; D. 288.
 Volunteer, Sch., Di. 382.
 Volunteer, J. & M., Di. 655; I. 654; D. 650.
 Volunteer, Sheer Plan, 95, 90.
 Volusia, Di. 278.
 Vorant, Di. 623, 384, 278; I. 621; D. 626.
 Vreda, Cut., Di. 605, 238, 361; I. 601; D. 600.
 Vreda, Sl., Di. 452.
- W**
- Walossa, Di. 388.
 Wacondah, Di. 410.
 Waconda, D., Di. 433.
 Wadens, Str., Di. 417, 170.
 Wahneta, J. & M., I. 455.
 Waif, Di. 170.
 Waif, J. & M., Di. 411.
 Walbridge, E. M., Biog. 500.
 Wampanoag, Str., Di. 411.
 Wanda, Str., Di. 411.
 Wanda, Sl., Di. 411.
 Wanda, Cat., Di. 411.
 Wanda, Cat., Di. 411.
 Wanda, Cat., Di. 411.
 Wanderer, Cut., Di. 411.
 Wanderer, Sch., Di. 411.
 Wanderer, Str., Di. 411.
 Wandew, Sch., Di. 411.
 Wandew, Sch., Di. 411.
 Wang, Cut., Di. 411.
 Wapita, Di. 411.
 Ward, D. 411.

- Warner, E. P., Biog. 609.
 Warren, Sl., Di. 611.
 Wasp, Cat, Di. 472, 170, 577; I. 381 P. xxvi.
 Wasp, Sl., Di. 312.
 Wasp, Sch., Di. 417; I. 415; D. 420.
 Wasp, Mosquito Boat, I. 25.
 Wasp, outlines of, 100.
 Wasp, Trophy, 139, 111.
 Water Lily, Cat, Di. 270.
 Water Lily, Di. 410.
 Water Lily, Sl., Di. 472.
 Water Wag, Di. 270.
 Water Witch, Sch., Di. 623, 109; I. 390;
 P. lvii.
 Water Witch, Sl., Di. 311.
 Water Witch, Sl., Di. 452.
 Water Witch, Str., Di. 386.
 Water Witch, Skiff, Di. 605i
 Water Witch, Lug., Di. 605.
 Watt, George, Biog. 402.
 Wave, Sl., Di. 483.
 Wave, Sl., Di. 605, 201.
 Wave, Cat, Di. 328.
 Wave, Cat, Di. 594.
 Wave, K. Sch., D. 510.
 Wave, Cat, Di. 453.
 Wave Crest, Sch., Di. 510, 270, 472; I. 180;
 D. 213.
 Wave Crest, Sl., Di. 480, 327.
 Wave Crest, Str., Di. 411.
 Waverly, Cat, Di. 611.
 Wa wa, Di. 223.
 Wayward, Di. 623.
 Wayward, Cat., Di. 631, 228, 170; I. 243; D. 250.
 Weetamoo, Di. 385.
 Weir, James, Jr., Biog. 303.
 Welcome Home, Di. 396.
 Weld Cup, 154.
 Welfare, Cat, Di. 593; I. 502; D. 507.
 Wendell, E. B., Biog. 569.
 Wenona, Cat, Di. 605, 552.
 Wenonah, Cat., Di. 472, 360, 170; I. 470; D. 476.
 Wenonah, Cat, Di. 674; I. 672; D. 675.
 West Wind, Di. 532; I. 523; D. 533.
 Weston, W., Biog. 476.
 Whiff, Str., Di. 578.
 Whiloway, Di. 170.
 Whiloway, Di. 410.
 Whim, Sch., Di. 276, 169.
 Whim, Sl., Di. 417.
 Whim, Cat, Di., 641.
 Whisper, Sch., Di. 481.
 Whisper, Sew, Sch., Di. 532; I. 521; D. 533.
 Whistler, Sl., Di. 480; I. 477; D. 490.
 Whistling, Cat., Di. 605, 223.
 Whitty, Di. 639.
 Whitesap, Di. 298.
 Whitecap, Launch, Di. 510, 282.
 White Cap, Y., Di. 298.
 White Cap, Cat, Di. 395.
 White Cap, Y., Di. 480.
 White Fawn, Di. 327.
 White, R. P., Biog. 584.
 White Squall, Di. 311.
 White Star, Str., Di. 446.
 White Wing, Di. 398.
 White Wing, Di. 641.
 White Wings, Cat., I. 200; D. 205.
 White Wings, Sl., Di. 452.
 White Wings, Sl. Di. 605.
 Whitlock, B. M., Biog. 210.
 Why Not, Sharpie, Di. 532.
 Wideswake, Di. 312.
 Widgson, Y., Di. 360.
 Widgson, Sl., Di. 605.
 Wildbird, Sl., Di. 503; I. 502; D. 504.
 Wild Duck, Aux. Str., Di. 239; I. 233; D. 253;
 P. xlii.
 Wild Pigeon, Di. 446.
 Wilkinson, O. D., Biog. 583.
 Willie, Sl., Di. 611.
 Willie Wimps, Di. 630.
 Willoughby, H. L., Biog. 573.
 Windemere, Di. 313.
 Windward, Y., I. 678; D. 678.
 Windward, Sl., Di. 601.
 Wind, Velocity, etc., 85.
 Winnie, Cat, Di. 594.
 Winona, Cat, Di. 328.
 Winona, Sl., Di. 592.
 Winona, Sl., Di. 481.
 Winona, Cat, Di. 453.
 Winona, Sl., Di. 593.
 Winsome, Sl., Di. 631, 238.
 Witch, D. 407.
 Wizard, Sl., Di. 510, 278, 238, 170; D. 218.
 Wizard, Sl., Di. 517.
 Wolfe, J. B., Biog. 210.
 Wona, Di. 223; I. 224; D. 229.
 Wooma, Cat., Di. 605.
 Woos, Sl., Di. 605.
 Worthington, G. H., Biog. 421.
 Words, C. A., Biog. 441.
 Wynn, Di. 360.

X

Xanthe, Di. 665.
 Xara, Di. 170.
 Xonia, Di. 446.

Y

Yacht Clubs, List of, 49.
 Yachting Fixtures, 51, 57.
 Yachts, Type of, 87.
 Yachts, Cost of, 125.
 Yachts, Measuring of, 122.
 Yachts, Cost of, 125.
 Yachts, Decoration of, 125.
 Yachting, Cost of, 125.
 Yalaha, Sl., Di. 604.
 Yama, I. 495; D. 449; Di. 431.
 Yampa, Sch., Di. 472, 109; I. 178; D. 212.
 Yampa, Cat., Di. 311.
 Yarle Standing Lug., Di. 552; I. 354; D. 560.
 Yava, D. Cat, Di. 564.
 Yawata, Cat, Di. 484.
 Yawl, I. 30; D. 43; Nomenclature, 177.
 Yolande, Sch., Di. 605.
 Youla, I. 338; D. 354; Di. 300.
 Ysoll, Di. 395.
 Ystan, Di. 281.
 Yum Yum, Di. 306.

Z

Zannah, Di. 517.
 Zampa, Di. 386.
 Zante, Di. 261.
 Zela, Di. 313.
 Zellen, Cat, Di. 510.
 Zelma, I. 222; D. 229; Di. 223; In Dock, 93.
 Zena, Cat., Di. 472.
 Zetta Belle, Najibtha, Di. 615.
 Zigeuner, Di. 631, 238; I. 235; D. 254.
 Zinga, Di. 280.
 Zingara, Di. 170.
 Zoe, Sl., S. Launch, Di. 312.
 Zoe, Sl., South, Di. 430.
 Zoraya, Cat, Di. 453.
 Zulela, Str., Di. 632.
 Zuleika, Di. 360.
 Zulu, Di. 327.

7.

8.

9.

101.

102; I. 178; D. 212.

103; I. 254; D. 500.

enclature, 177.

100.

223; In Dock, 99.

1013.

243; D. 254.

112.

