

No. 13.

1899-1900

# PAPERS

READ BEFORE THE

# ENGINEERING SOCIETY

OF THE

## SCHOOL OF PRACTICAL SCIENCE

TORONTO

---

PRICE, - - - - 50 CENTS.

---

TORONTO:  
THE CARSWELL CO., LIMITED,  
1900.

A  
620  
Scale

# The Northey Gas or Gasoline Engine.

JUNIOR MODEL.



This little motor is giving the greatest satisfaction throughout Canada for its handiness, safety and ease of operation. It is especially adapted for running Pumping Machinery or any isolated plant requiring small power. The running expenses are very light. Any one can manage it—thus dispensing with expensive skilled help. Runs for hours without attention. Gets up full speed in less than a minute—is always under control. Any desired speed can be obtained by regulating the fuel supply. Uses either Gas, Gasoline or Natural Gas for fuel. Send for Illustrated Booklet.

# Pumps

"FOR ALL DUTIES"

We manufacture over five hundred different varieties of Steam and Power Pumps for Stationary and Marine Purposes. Catalogue Specifications & Plans on request.

NORTHEY MFG. CO., Limited, TORONTO ONT.

ADVERTISEMENTS.

**C** NO HOT BOXES **E**  
**SPOONER'S**  
HONOR BRIGHT  
**COPPERINE**

NON-FIBROUS, ANTI-FRICTION, HIGH-  
CLASS BOX METAL

CANADIAN MADE AND STUMPS THE WORLD. MORE  
USED THAN ALL OTHERS COMBINED IN OUR AGRICUL-  
TURAL, MILLING, AND MINING MACHINERY, PUMPS, DYNA-  
MOS, AND FINE SMALL MACHINES. WAS ALSO SELECTED  
FROM ALL OTHER METALS AND USED BY THE LAURIE  
ENGINE CO., MONTREAL, FOR BEARINGS FOR THE LARGEST  
ENGINES ON THE AMERICAN CONTINENT.

**ALONZO W. SPOONER, MAKER**  
PORT HOPE, ONT.

HARDWARES ALL SELL IT.

..CATLING GUNS..

**SPOONER'S**  
**PHENYLE**  
**DEODORIZER.**

**GERMICIDE-DISINFECTANT FINE DUST POWDER**

RECEIVED TWO WORLD'S FAIR GOLD MEDALS

HOLDS PROF. ELLIS' CERTIFICATE--NO HOME SHOULD BE WITHOUT IT,  
PREVENTS CONTAGIOUS DISEASE OF ALL KINDS. KILLS ALL BAD SMELLS.  
KEEPS ANIMALS HEALTHY ON LESS FEED, HORSES, CATTLE, SHEEP, PIGS,  
POULTRY BIRDS, DOGS, ETC.

THE ONLY; PREVENTATIVE AND CURE FOR HOG CHOLERA

**ALONZO W. SPOONER, MAKER**  
PORT HOPE

FOR SALE AT HOOPER'S, KING STREET.

" BINGHAM'S, 100 YONGE ST.

WHOLESALE, LYMAN BROS. & CO., TORONTO.

TO BE USED IN ALL SCHOOLS AND PUBLIC BUILDINGS.

# Dodge Mfg. Co.

*OF TORONTO, LIMITED.*

SOLE MANUFACTURERS

**DODGE SPLIT FRICTION CLUTCH  
AND CUT OFF COUPLING . . . . .**

...ALSO...

**Dodge Patent Wood Split Pulleys**

**SHAFTING AND HANGERS**

OFFICE AND WAREROOMS:

**74 YORK STREET,  
TORONTO.**

Babcocks  
Boiler In  
Canadian  
Carswell  
Dodge M  
Dominion  
Evans &  
Fethersto  
Gould and  
Henry, T  
Harris Co  
Northey I  
Spooner, A  
Whitney I

Ashbridge  
Art Metro  
Berger &  
Canada Pa  
Grip Co. .  
Jennings V  
Pelson Iro  
Parkes Bro  
Robb Engi  
Rathbun C  
Royal Elect  
School of  
Vannevar  
Waterous E

# INDEX TO ADVERTISERS.

## FRONT.

	PAGE.
Babcocks & Wilcox .....	XII.
Boiler Inspection Co. ....	V.
Canadian General Electric Co. ....	VI.
Carswell Co. ....	VII.
Dodge Manufacturing Co. ....	II.
Dominion Bridge Co. ....	IX:
Evens & Howard .....	XI.
Fetherstonhaugh & Co. ....	XII.
Gould and Eberhardt .....	IV.
Henry, Thos. ....	X.
Harris Co. ....	X.
Northey Pump Co. ....	Inside Front Cover.
Spooner, Alonzo W. ....	I.
Whitney Electric Co. ....	VIII.

## BACK.

Ashbridge .....	XX.
Art Metropole .....	XXI.
Berger & Sons .....	XX.
Canada Paper Co. ....	XVIII.
Grip Co. ....	XVIII.
Jennings W. T. ....	XVI.
Polson Iron Works .....	XIV.
Parkes Bros. ....	XIV.
Robb Engineering Co. ....	XV.
Rathbun Co. ....	XIX.
Royal Electric Co. ....	Outside Back Cover.
School of Practical Science .....	XVII.
Vannevar .....	Inside Back Cover.
Waterous Engine Co. ....	XIII.

*Eberhardt's Patent  
Entirely Automatic  
New Type Gear Cutting Machines*

..Our..  
Index-Wheels  
are the nearest  
approach to  
Absolute  
Perfection  
ever attained;  
are composed  
of 2 or more  
Sectional  
Rings.  
We have  
Indisputable  
Evidence  
of their  
Superiority and  
Accuracy.

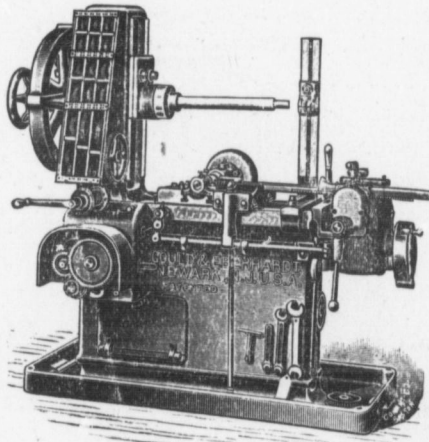

"VICTORIA."

2 to 10  
Perfect Teeth  
Finished at Once  
when using our  
RADIAL  
DUPLEX  
CUTTERS



This Pan catches  
the Oil and Chips.  
No Oil-Soaked  
Floors.

ORIGINAL, CONVENIENT,

EMBODIES ESSENTIAL ADVANCED FEATURES.

OUR HIGH CLASS MACHINES AND TOOLS IN USE ALL OVER THE WORLD

SHAPERS, DRILL PRESSES, TAPPING MACHINES,  
GEAR CUTTERS, RACK CUTTERS, CUTTER GRINDERS.

WRITE FOR OUR CATALOGUE.

**GOULD & EBERHARDT,**  
NEWARK, N. J. U. S. A.

JOHN L. B.  
PRES.



G. C. RO  
H. N. ROE

Heat

of fuel.  
at some t

Some  
have them

Are  
better use

Arran  
sure that

Did y  
through a

Inspection  
Man is wor  
than any an  
of Insurance

JOHN L. BLAIKIE Esq.  
PRES.

EW. RATHBUN Esq.  
VICE. PRES.

**THE BOILER INSPECTION & INSURANCE CO.**  
OF CANADA

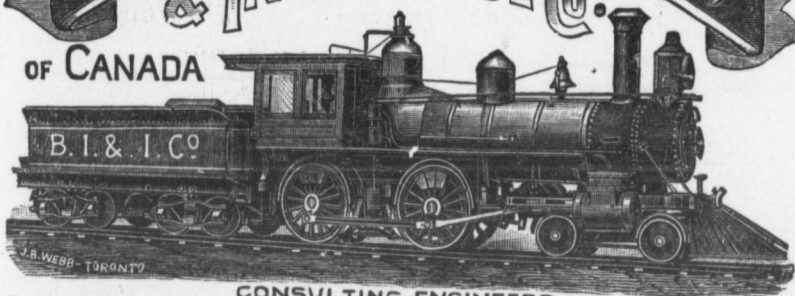

CONSULTING ENGINEERS

G. C. ROBB, Chief Engineer

H. N. ROBERTS, Sec.-Treas.

HEAD OFFICE TORONTO

**Heat and Power** cannot be obtained except by the expenditure of some form of fuel. All the fuels of earth are things upon which the sun shone at some time or other.

Some fuels have taken ages to reach the form in which we now have them, and it should be considered a crime to waste them.

**Are You Wasting any Fuel** that might be saved or put to better use?

Arrange to have your Boilers regularly inspected and make sure that the heat produced in the furnaces is being usefully employed.

Did you ever have the furnace ashes examined? Have some put through a sieve and see what will be found.

Inspection by a Skilled Man is worth more than any amount of Insurance.

**THE BOILER INSPECTION and INSURANCE CO.** gives both Inspection and Insurance.

# CANADIAN GENERAL ELECTRIC CO. (LIMITED)

Head Office: 14-16 King St. East, Toronto, Ont.

Branch Offices and Warerooms:

MONTREAL  
HALIFAX

ROSSLAND, B.C.

WINNIPEG  
VANCOUVER

Factories: PETERBOROUGH, Ont.

## ENCLOSED ARC LAMPS

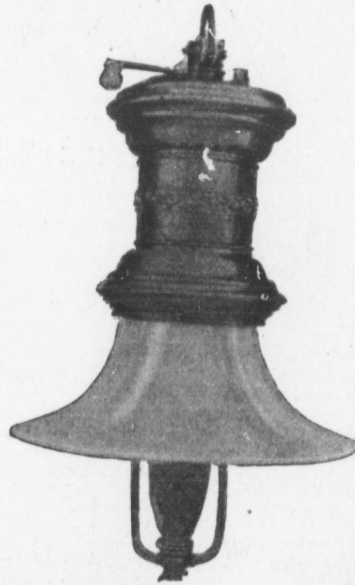

DOUBLE and  
SINGLE GLOBE  
TYPES

FOR DIRECT  
and ALTERNATING  
CURRENT CIRCUITS

WRITE US FOR PARTICULARS AND BULLETINS, ETC.

# Electrical Apparatus

RAILWAY, LIGHTING, MINING,  
POWER TRANSMISSION

Manufacturers of General Electrical Supplies



Now Ready in 350 pages demy 8vo. Cloth price. \$1.50.

Half bound Leather, \$2.00.

# THE CANADIAN LAWYER

A Handy Book of the Laws and of Legal  
Information for the use of

**BUSINESS MEN, FARMERS, MECHANICS**  
AND OTHERS IN CANADA

... CONTAINING ...

*Plain and Simple Instructions to all classes  
for Transacting Business According to  
Law, with Legal Forms for Drawing  
Necessary Papers. . . . .*

COMPILED BY

A BARRISTER-AT-LAW

NEW EDITION, Third, Revised and Enlarged, 1899.

ADDRESS ORDERS TO

**THE CARSWELL CO. Limited**

**30 ADELAIDE ST. EAST**

**..TORONTO**

## The Universal Verdict



mometer in accuracy, besides being direct reading, and portable. Faithfully yours,  
ORMAND HIGMAN, *Chief Electrician.*

Our New  
Ammeters and  
Voltsmeters for  
Direct and  
Alternating  
Current are  
especially  
adapted for  
Colleges and  
Schools.  
They will read  
correctly on  
circuits of any  
frequency.  
Convenient and  
Reliable, they  
are "a thing of  
beauty and a  
joy forever."



## Whitney Electrical Instrument Company

Penacook, N. H., and Sherbrooke, Que.

C. E. SHEDRICK,

Sherbrooke, Quebec, - - Licensee for Dominion of Canada.

INLAND REVENUE, CAN.,  
CHIEF ELECTRICIAN'S OFFICE,  
OTTAWA, Jan. 9, 1899.  
*Messrs. The Whitney Electrical  
Instrument Co.*

Sherbrooke, Que.

DEAR SIRS,—Replying to your  
letter of the 10th ult., I have  
very great pleasure in stating  
that the Watt and Ammeters  
manufactured and supplied by  
your Company have given good  
satisfaction. Particularly is this  
so in respect of the alternating  
current Ammeters. I consider  
them quite equal to the dyna-

Manufac

And All

Wor

P. O

**Dominion**



**Bridge  
Company**

Limited

Manufacturers of

**IRON AND STEEL  
RAILWAY AND HIGHWAY**

**Bridges**

And All Kinds of

**STRUCTURAL  
IRONWORK**



**Works at LACHINE, Que.**

P. O. Address :

Room 2, Windsor Hotel, MONTREAL, Que.

---

**THOMAS HENRY,**  
53 McGill Street. - - TORONTO ONT.

.... MANUFACTURER OF ....

**Blue Print**, from Parchment, Satin and Bond Papers. Best qualities.  
**Blue Print, Extra Rapid**, for dull weather.  
**Blue Print**, from **Linon Fabric**, very strong.  
**All Canadian Make**, fresh weekly.

.....ALSO DEALER IN.....

**Black Print**, Black Lines, White Ground, 30 in. and 36 in.  
**Imperial Tracing Cloth**, 36 in and 42 in.  
**Manilla Tracing Paper**, 40 in.  
**White German Sketch Tracing Paper**.  
**Helios Dr. Paper**, for **Direct** prints.  
**Cartridge and Eggshell** Drawing Papers.  
**Whatman's Double Elephant Duplex** Drawing Paper.  
Pencils, Erasers, Rubbers, Etc.

Circulars of Architects Books and Samples, and Prices of Papers sent  
on Application.

---

**THE E. HARRIS Co.**

OF TORONTO (LIMITED)

73 King St. East

DEALERS IN

**DRAWING AND**

**PAINTING MATERIALS**

Papers, Inks, Colors,

T Squares, Drawing Boards,

and Draughtsmens' Supplies

# FIRE CLAY CULVERT PIPE

IS MORE DURABLE AND CHEAPER THAN

.. **Iron Pipe** ..

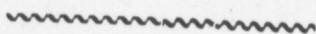

Write for Prices on 27 inch,  
30 inch and 36 inch . . . . .

MANUFACTURED BY

## Evens & Howard

FIRE BRICK CO.

ST. LOUIS, MO.

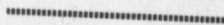

All Other Sizes Constantly in Stock

..... ALSO .....

**LOCOMOTIVE TILES AND FIREBRICK**

# Patents Procured

Counsel in Patent Causes and  
Patent Suits Prosecuted  
before the Courts.

IN ALL  
COUNTRIES

Validity and Infringement of Pa-  
tents Investigated. Assignments  
etc., drawn. Searches made.

## FETHERSTONHAUGH & CO.

Patent Barristers,  
Solicitors and Experts,  
Engineers and Draughtsmen

Foreign Members Chartered  
Institute of Patent Agents,  
London, England.



Members Patent Law  
Association,  
Washington, D.C., U.S.

OFFICES:

TORONTO, MONTREAL, OTTAWA,  
Canada.

WASHINGTON, D.C.  
United States.

HEAD OFFICE:

CANADIAN BANK OF COMMERCE BUILDING,  
19-25 King Street West,

TORONTO, Ont.

## STEAM BOILERS AND ACCESSORIES

FOR

Stationary and Marine Work,

*Heaters, Separators,  
Valves, Gauges,  
Damper Regulators,  
Quimby Electric Pumps,  
Automatic Stokers, and  
Smokeless Furnaces*

Complete Steam Power Plants  
Designed and Installed

Large Book, "STEAM," sent FREE  
upon application.

### BABCOCK & WILCOX, LIMITED,

LONDON and GLASGOW

HEAD OFFICE FOR CANADA:  
202 St. James St., Montreal.

TORONTO OFFICE:  
114 King Street West.

---  
---  
I  
t of Pa-  
gments  
made.

CO.

-----  
w  
S.

N, D.C.  
tes.

O, Ont.

IES

rk,

S,

talled

FREE

ED,

West-



TROPHIES WON IN ATHLETICS BY STUDENTS OF THE SCHOOL OF  
PRACTICAL SCIENCE, 1899-1900.

E

S



A  
620  
Scob

No. 13.

1899-1900

# PAPERS

READ BEFORE THE

# ENGINEERING

# SOCIETY

OF THE

# SCHOOL OF PRACTICAL SCIENCE

TORONTO

---

PRICE, - - - - 50 CENTS.



TORONTO :  
THE CARSWELL CO., LIMITED,  
1900.

---

---

Entered according to the Act of the Parliament of Canada, in the year one thousand nine hundred, by the Engineering Society of the School of Practical Science, in the Office of the Minister of Agriculture.

---

---

The  
neering S  
of 1899-1

As h  
neering.  
informatio  
students b  
sional life.  
—a subject  
the Societ  
of daily in  
important

The S  
from Mr. C  
McGill Un  
of Health,  
each a reco

The th  
contribution

The pre  
Toronto, A

## PREFACE

---

The present volume contains the papers read before the Engineering Society of the School of Practical Science during the session of 1899-1900.

As heretofore, the papers all deal with some branch of engineering. Besides being interesting reading, all contain valuable information and will, it is believed, be found useful not only by students but also by graduates and others engaged in active professional life. The several papers on the utilization of hydraulic power, —a subject hitherto somewhat neglected by those writing papers for the Society,—marks a growing interest in a branch of engineering of daily increasing importance, and one that promises to be a most important factor in the development of our country.

The Society is to be congratulated on having secured papers from Mr. Cecil B. Smith, late Assistant Professor of Engineering at McGill University, Dr. P. H. Bryce, Secretary of the Provincial Board of Health, and Mr. A. W. Campbell, Provincial Road Commissioner, each a recognized authority on the subject of which he writes.

The thanks of the Society are due to all who have, by their contributions, materially aided its usefulness.

The present edition consists of 1,500 copies.

Toronto, April 5th, 1900.

# CONTENTS

---

	PAGE.
President's Address .....	Thos. Shanks, '99 1
Aerial Cableways .....	W. E. Wagner, '99 10
The Problem of Speed Regulation in Plants Driven by Water Power .....	W. A. Hare, '99 37
Cold Storage .....	E. Richards, '99 76
Hydraulic and Electric Elevators .....	L. B. Chubbuck, '99 91
Circulation in Water Tube Boilers .....	W. Monds, '99 112
Some Notes on Bridge Drafting...R. K. Palmer, B.S. (U. of M.)	119
Notes on the Geology of Rossland Ore Deposits..E. Andrews, '97	128
Mine Timbering .....	E. V. Neelands, '00 137
A Trip to the Yukon .....	L. B. Stewart, D.L.S., D.T.S. 145
Canadian Steam Railways.....C. B. Smith, Ma. E. (McGill)	158
Roadmaking .. .. .	A. W. Campbell 167
Principles of Ventilation in their Application to Public Buildings .....	P. H. Bryce, M.A., M.D. 174
Notes on the Development of Water Power.....T. Barber, '99	189
Fire Making .....	W. H. Ellis, M.A., M.B. 201
Tensile Strength of Rivets and Bolts .....	D. C. Tennant, '99 206
The Strength of Glass .....	C. H. C. Wright, B.A.Sc. 221
Index to the First Thirteen Numbers.....	223

Pres  
THOS. SH

Trea  
W. G. CH

Fourth-Year  
W. E. W

Sec

## GENERAL COMMITTEE, 1899-1900.

---

PAGE.  
'99 1  
'99 10  
'99 37  
'99 76  
'99 91  
'99 112  
M.) 119  
'97 128  
'00 137  
C.S. 145  
ill) 158  
sell 167  
  
D. 174  
'99 189  
B. 201  
'99 206  
Sc. 221  
.. 228

**President.**  
THOS. SHANKS, '99.

**Vice-President:**  
J. A. JOHNSTON, '00.

**Rec. Secretary:**  
J. P. RIGSBY, '01.

**Cor. Secretary:**  
J. C. JOHNSTON, '00.

**Treasurer:**  
W. G. CHACE, '01.

**Librarian:**  
E. H. PHILLIPS, '00.

**Editor:**  
A. H. A. ROBINSON, B.A.Sc.

**Asst. Librarian:**  
D. E. EASON, '01.

**Graduates' Representative:**  
L. B. CHUBBUCK, '99.

**Fourth-Year Representative:**  
W. E. WAGNER, '99.

**Third-Year Representative:**  
H. A. DIXON, '00.

**Second-Year Representative:**  
M. V. SAUER, '01.

**First-Year Representative:**  
W. R. MACDONALD, '02.

# LIST OF MEMBERS.

## HONORARY MEMBERS.

J. Galbraith, M.A., M. Can. Soc. C.E.  
W. H. Ellis, M.A., M.B.

E. J. Chapman, Ph.D., LL.D.  
A. P. Coleman, M.A., Ph.D.

## LIFE MEMBERS.

Allen, J. R., O.L.S., '92.	Evans, R. B., '95.	Marani, C. J., '88.
Allen, T. R.	Ewart, J. A., B.A.Sc., '94.	Martin, T., B.A.Sc., '96.
Anderson, A. G., '92.	Fairchild, C. C., O.L.S., '92.	Martin, F. A., O.L.S., '87.
Angus, R. W., B.A.Sc., '94.	Fowler, C. P.	Macbeth, C. W., B.A.Sc., '96.
Armstrong, J., O.L.S., '95.	Fraser, A. T.	McAllister, J. E., C.E., B.A.Sc., '91.
Aspey, J. F., O.L.S., '88.	Francis, W. J., '93.	McAllister, A. L., B.A.Sc., '93.
Ashbridge, W. T., '88.	Gibbons, J., O.L.S., '88.	McCallum, A. F., B.A.Sc., '93.
Bain, J. W., B.A.Sc., '96.	Gibson, H. H., O.L.S.	McCullum, T. B.
Ball, E. F., A.M., Can. Soc. C.E., '88.	Goldie, A. R., '93.	McChuson, A. J.
Ballantyne, H. F., B.A.Sc., '99.	Goodwin, J. B., B.A.Sc., '92.	McDougall, J., B.A.Sc., '84.
Beauregard, A. T., B.A.Sc., '94.	Gray, A. T., B.A.Sc., '97.	McFarlen, T. J., '93.
Bergey, A. E., '94.	Haight, H. V., B.A.Sc., '96.	McGowan, J., B.A.Sc., '95.
Blackwood, A. E., '95.	Hanley, J. B.	McKinnon, H. S., B.A.Sc., '95.
Bow, J. A., '92.	Harkness, A. H., B.A.Sc., '95.	McKay, O., O.L.S., '85.
Boswell, E. J., B.A.Sc., O.L.S., '95.	Haultain, H. E. T., '89.	McKay, W. N., '95.
Bowman, F. M., O.L.S., C.E., '90.	Herald, W. J., B.A.Sc., '94.	McPherson, A. J., B.A.Sc., '93.
Brodie, W. M., B.A.Sc., '95.	Hicks, W. A. B., '97.	McPherson, C. W., O.L.S.
Bucke, M. A., M.E., '91.	Hull, H. S., B.A.Sc., '95.	McTaggart, A. L., B.A.Sc., '94.
Bucke, W. A., B.A.Sc., '94.	Hutcheson, Jas., O.L.S., '90.	Merrill, E. B., B.A.Sc., '90.
Burns, D., O.L.S., '83.	Irvine, J., '89.	Mines, W. H., B.A.Sc., '93.
Burwash, L. T., '96.	Irwin, J.	Minty, W. M., B.A.Sc., '94.
Canniff, C. M., '88.	James, D. D., O.L.S., B.A.Sc., '91.	Mitchell, C. H., B.A.Sc., C.E., '92.
Carey, A. B., '89.	Job, H. E., B.A.Sc., '94.	Mickle, G. R., B.A., '88.
Carpenter, H. S., O.L.S., B.A.Sc., '97.	Johnson, A. C., B.A.Sc., '94.	Mill, F. X., '89.
Chalmers, J. C., O.L.S., '94.	Johnson, S. M., B.A.Sc., '94.	Mollins, C. B., '96.
Charlesworth, L., O.L.S., '93.	Johnson, Geo.	Moore, J. E. A., C.E., '91.
Chewett, H. J., B.A.Sc., C.E., A.M. Can. Soc. C.E., '88.	Keele, J., B.A.Sc., '93.	Moore, H. H.
Clement, W. A., '89.	King, C. F., '97.	Newman, W. M., O.L.S., '91.
Deacon, T. R., O.L.S., '91.	Kirkland, W. A.	Paterson, C. H.
Dobie, J. S., B.A.Sc., O.L.S., '95.	Laing, A. T., B.A.Sc., '92.	Pinhey, C. H., O.L.S., D.L.S., '87.
Duff, J. A., B.A., '90.	Lane, A., O.L.S., '91.	Piper, A. G.
Duggan, G. H., M. Can. Soc. C.E., '83.	Laschinger, E. J., B.A.Sc., '92.	Proudfoot, H. W., '97.
Dunn, T. H., '93.	Lash, F. L., '93.	Raymer, A. R., '84.
Elliott, H. P., B.A.Sc., '96.	Lea, W. A., B.A.Sc., '92.	Richardson, G. H., '88.
	Lea, E. P.	Robinson, F. J., O.L.S., '95.
	Leask, J. D.	Rolph, H., '94.
	Lott, A. E., '87.	
	Main, W. T., '92.	

Rose, K., '88.  
Roseburgh, '89.  
Ross, R. A.,  
Russell, T. S.  
Scott, W. F.,  
Shields, J. D.,  
Shillinglaw,  
Shipe, R. R.,  
Shipley, A. E.,  
Sifton, E. I.,  
Silvester, G. E.

Alexander, F.  
Alison, T. H., C.E., '92.  
Allan, J. L.,  
Andrews, E.,  
Ardagh, E. G.,  
Bain, J. A., '90.  
Barker, H. F.,  
Barley, J. H.,  
Beatty, F. R.,  
Beatty, H. J.,  
Black, R. G.,  
Booth, T. R.,  
Boswell, M. C.,  
Bowman, H. J., D.L.S., '85.  
Bowman, A. M.,  
Bray, L. T., '90.  
Brown, L. L.,  
Brown, G. L.,  
Brown, D. B.,  
Boyd, D. G., '94.  
Boyd, W. H.,  
Burnside, T.,  
Burton, T.,  
Campbell, R. J.,  
Campbell, G. M.,  
Carter, W. E. H., '98.  
Chalmers, W. J.,  
Charlton, H. W., '97.  
Chubbuck, L. E.,  
Clark, J. T.,  
Clark, N., '01.  
Clark, J., '00.  
Clarke, F. F.,  
Clothier, G., '99.  
Collins, C. D.,  
Connor, A. W.,  
Cooper, C., '99.  
Coulthard, R. W.,  
Craig, J. A., '99.  
Darling, E. H.,  
Davison, J. E.,  
Dill, C. W., '91.

LIFE MEMBERS—Continued.

Rose, K., '88.  
 Roseburgh, T. R., M.A., '89.  
 Ross, R. A., E.E., '90.  
 Russell, T. S., O.L.S.  
 Scott, W. F., '97.  
 Shields, J.D., B.A.Sc., '94.  
 Shillinglaw, U. H.  
 Shipe, R. R., '96.  
 Shipley, A.E., B.A.Sc., '98.  
 Sifton, E. I.  
 Silvester, G.E., O.L.S., 91.  
 Sims, H. B., '95.  
 Smith, Angus, O.L.S., '94.  
 Speller, F.N., B.A.Sc., '93.  
 Squire, R. H., B.A.Sc., O.L.S., '93.  
 Stern, E. W., '84.  
 Stewart, L. B., D.L.S., D.T.S.  
 Stocking, F. T., '95.  
 Stovel, Roy H.  
 Symmes, H. D., '91.  
 Taylor, W. V., O.L.S., '93.  
 Thomson, T. K., C.E., '86.  
 Thomson, R. W., B.A.Sc., '92.  
 Tremaine, R. C. C., B.A.Sc., '95.  
 Troupe, G. E., '95.  
 Tye, A. T., '96.  
 Webster, E. B.  
 Wickson, F. R.  
 Wilkie, G.  
 Wright, C. H. C., B.A.Sc., '88.

ORDINARY MEMBERS.

Alexander, F. H.  
 Alison, T. H., B.A.Sc., C.E., '92.  
 Allan, J. L., '00.  
 Andrews, E., '97.  
 Ardagh, E. G. R., '00.  
 Bain, J. A., '00.  
 Barker, H. F., '94.  
 Barley, J. H., '00.  
 Beatty, F. R., '01.  
 Beatty, H. J., O.L.S., '91.  
 Black, R. G.  
 Booth, T. R.  
 Boswell, M. C. '00.  
 Bowman, H. J., O.L.S., D.L.S., '85.  
 Bowman, A. M., C.E., '86.  
 Bray, L. T., '0.  
 Brown, L. L., '95.  
 Brown, G. L., '93.  
 Brown, D. B., O.L.S., '88.  
 Boyd, D. G., '94.  
 Boyd, W. H., B.A.Sc., '98.  
 Burnside, T., '99.  
 Burton, T.  
 Campbell, R. J., '95.  
 Campbell, G. M., '96.  
 Carter, W. E. H., B.A.Sc., '98.  
 Chalmers, W. J., '89.  
 Charlton, H. W., B.A.Sc., '97.  
 Chubbuck, L. B., '99.  
 Clark, J. T.  
 Clark, N., '01.  
 Clark, J., '00.  
 Clarke, F. F., '00.  
 Clothier, G., '99.  
 Collins, C. D.  
 Connor, A. W., B.A., '95.  
 Cooper, C., '99.  
 Coulthard, R. W., '99.  
 Craig, J. A., '99.  
 Darling, E. H., '98.  
 Davison, J. E., '00.  
 Dill, C. W., '91.  
 Dickson, G., '00.  
 Dickenson, E. D., '00.  
 Dixon, H. A., '00.  
 Dunbar, M.  
 Elliot, J. C., '99.  
 English, A. B., '90.  
 Evans, J. W.  
 Fairbairn, J. M. R., '93.  
 Finch, H. J. W.  
 Fingland, W., '93.  
 Foreman, W. E., '99.  
 Forester, C., '93.  
 Forward, E. A., '97.  
 Fullerton, C. H., '00.  
 Garland, N. L., '90.  
 Gordon, C. B.  
 Grant, W. F., B.A.Sc., '98.  
 Gray, R. L.  
 Guernsey, F. W., '95.  
 Guest, W., '00.  
 Gurney, W. C., '96.  
 Hall, G. A.  
 Hanning, G. F., '89.  
 Hare, W. A., Stud. Can.Soc. C.E., '99.  
 Hemphill, W.  
 Henderson, S. E. M., '00.  
 Henry, J. A., '00.  
 Herman, E. B., O.L.S., D.L.S., '86.  
 Holcroft, H. S., '00.  
 Hudspeth, W. S.  
 Hunt, G. A., '01.  
 Innes, W. L., O.L.S., C.E., '90.  
 Irwin, C. A., '95.  
 Jones, J. E., '94.  
 Johnston, H. A., '00.  
 Johnston, J. C., '00.  
 Johnston, J. A., '00.  
 Kennedy, J. H., O.L.S., C.E., '82.  
 Kormann, J. S., B.A.Sc., '98.  
 Laidlaw, J. G., B.A.Sc., '93.  
 Laird, R., O.L.S., '86.  
 Laing, W. F., '96.  
 Langley, C. E., '92.  
 Latham, R., '99.  
 Lash, N. M., '94.  
 Lavrock, G. E., '98.  
 Little, F. J.  
 Lumbers, W. C., '00.  
 Marani, V. G., '93.  
 Meadows, W. W., O.L.S., '95.  
 McArthur, R. E., '00.  
 McAree, J., O.L.S., D.L.S., B.A.Sc., '82.  
 McCullough, A. L., O.L.S., '87.  
 McDowall, R., O.L.S., A. M. Can. Soc. C.E., '89.  
 McFarlan, G. W., O.L.S., '88.  
 McIntosh, D., '98.  
 MacKenzie, J. R., '00.  
 MacMurchy, J.A., '96.  
 McMillan, J. G., '00.  
 McMichael, C.  
 McNaughton, F. D., O.L.S., '98.  
 Middleton, H. T., '01.  
 Milne, C. G., B.A.Sc., '92.  
 Miller, L. H., '00.  
 Monds, W., '99.  
 Moore, F. E.  
 Moore, J. E., O.L.S., '88.  
 Morris, J. L., C.E., O.L.S., '81.  
 Murphy, E. J.  
 Neelands, E. V., '00.  
 Nicholson, C. J., '94.  
 Patterson, J., '99.  
 Perry, F. M.  
 Playfair, N. I., '92.  
 Pope, A. S. H., '99.  
 Phillips, E. H., '00.  
 Price, H. W., '01.  
 Roaf, J. R., '00.  
 Revell, G. E., '99.  
 Ritchie, N. T., O.L.S.  
 Rodger, J., O.L.S., '87.

ORDINARY MEMBERS—Continued.

Robertson, J. M., '93.	Spotton, A. K., '94.	Weekes, M. B., B.A.Sc., O.L.S., '97.
Robinson, A. H. A., B.A.Sc., '97.	Stacey, G. E.	Weir, H. M. '00.
Roper, W. P.	Stewart, J. A., M.A., '98.	Weldon, E. A., '97.
Ross, J. E., O.L.S., '88.	Stull, W. W., B.A.Sc., O.L.S., '97.	White, A. V., '92.
Roundthwaite, C. H. E., '00.	Tennant, D. C. '99.	Whitson, J. F., O.L.S.
Russell, R., '93.	Tennant, W. C., '00.	Withrow, F. D., '00.
Russell, W., '91.	Taylor, A., '00.	Willson, R. D.
Saunders, G. A., '99.	Thorold, F. W., '00.	Wickett, T., '89.
Saunders, H. W., '00.	Thorne, S. M. '00.	Wiggins, T. H., O.L.S., '90.
Shanks, T., '99.	Troupe, W. J.	Wilkinson, T. A., '98.
Shaw, J. H., O.L.S., '98.	Tyrrell, J. W., O.L.S., D.L.S., C.E., '83.	Williamson, D. A., B.A.Sc., '98.
Smallpiece, F. C., '98.	Van Every, W. W., '99.	Withrow, A. J., '90.
Smillie, R., B.A.Sc., '97.	Vercoe, H. L., '98.	Withrow, F. D., '00.
Smith, A. D. '92.	Wagner, W. E., '99.	Wright, R. T., '94.
Smith, A. H.	Watson, R. B., '93.	Wright, T. D.
Smith, R., '98.	Watt, G. H., '99.	Yeates, E. G., '99.

UNDERGRADUATE MEMBERS.

Alison, J. G. R., '02.	Forbes, D. L., '01.	Marrs, C. H., '02.
Barrett, R. H., '01.	Fotheringham, J. M., '01.	Mennie, R. S., '01.
Barker, H. G., '02.	Fuller, W. J., '01.	Mitchell, P. H., '02.
Beatty, W. G., '01.	Fuller, V. M., '02.	Millar, F. R., '02.
Beardmore, C. O., '02.	Fuller, T. H., '02.	Miller, A. H., '02.
Benson, T. B. F., '01.	Gagné, L., '01.	Miller, C. J., '02.
Bertram, G. T., '01.	George, R. E., '01.	Moore, F., '02.
Belton, C. H., '02.	Gibson, N. R., '01.	Morley, R. W., '02.
Blair, W. J., '02.	Gibson, E., '02.	Mullins, E. E., '02.
Bolger, E. B., '01.	Goodwin, A. C., '02.	Nash, T. S., '02.
Bowers, W. J., '01.	Gourley, W., '02.	Nevitt, J. H., '02.
Brandon, E. T., '01.	Greenwood, W. K., '02.	Osborne, J. P., '02.
Brereton, W. P., '01.	Hamer, A. T., '01.	Parsons, L. R., '01.
Broughton, J. T., '01.	Harvey, C., '01.	Parsons, W. R. W., '02.
Breslove, J., '02.	Hayes, L. J., '02.	Patten, B. B., '02.
Brown, J. M., '02.	Henry, J. S., '01.	Philp, D. H., '02.
Burwash, N. A., '02.	Henwood, C., '02.	Powell, G. G., '02.
Campbell, A. R., '02.	Hutchison, J. E., '02.	Ratz, W. F., '02.
Campbell, W., '02.	Isbester, A. J., '02.	Reid, T., '02.
Carter, E. W., '02.	Jackson, F. C., '01.	Rigsby, J. P., '01.
Carmichael, C. G., '01.	Johnston, D. M., '02.	Robertson, D. F., '02.
Chace, W. G., '01.	Keagey, J. W., '02.	Robertson, H. D., '02.
Christie, A. G., '01.	Laidlaw, A., '01.	Roy, J. E., '02.
Christie, W., '02.	Lang, A. G., '02.	Rust, H. P., '01.
Challis, J. B., '02.	Langmuir, F. L., '02.	Sauer, M. V., '01.
Cockburn, J. R., '01.	Laschinger, W. A., '02.	Seymour, H., '02.
Conlon, F. T., '02.	McBride, A. H., '02.	Shepherd, W. F., '01.
Connor, H. V., '02.	McCollum, G. C., '01.	Shingler, T. W., '02.
Corrigan, T. E., '02.	McDonald, W. R., '02.	Shuff, F. K., '02.
Costin, W. E., '02.	McDougall, A. C., '01.	Sill, A. J., '01.
Culbert, W., '02.	McKay, J. J., '02.	Sinclair, D., '02.
Cumming, R., '02.	McKay, J. T., '02.	Stevenson, W. H., '01.
Depew, H. H., '02.	McKellar, J., '02.	Stewart, M. A., '02.
Douglas, W. E., '02.	McKinnon, H. D., '02.	Stewart, J., '02.
Duff, W. A., '01.	McLennan, A. L., '01.	Steele, T. J., '02.
Dunn, H. C., '02.	McMaster, A. T., '01.	Stevens, W. A., '02.
Dunlop, R. J., '02.	McMillan, G., '01.	Taylor, T., '02.
Eason, D. E., '01.	McVean, H. G., '01.	Teasdale, C. M., '02.
Edwards, W. M., '02.	Mace, F. G., '01.	Thompson, W. J., '02.
Elmsley, B. R., '02.	Madden, J. F. S., '02.	Twiss, A. T., '01.
Elwell, W., '02.	Matheson, P., '02.	Wanless, A. A., '02.
Empey, J., '02.	Marquis, G. P., '02.	Whelihan, J. A., '02.

The

I than  
honor they  
for the cu  
tinued assi  
duties of t  
tarded in t  
characterist

As th  
society of t  
interest to

The p  
met with y  
proper aut

The g  
evidenced  
gratifying  
accommoda  
comfortable

The st  
in athletic  
have won  
field. In a



B., B.A.Sc.,  
'00.  
A., '97.  
'92.  
F., O.L.S.  
D., '00.  
D.  
'89.  
H., O.L.S., '90.  
A., '98.  
D. A.,  
J., '90.  
D., '00.  
'94.  
'99.  
'02.  
'01.  
H., '02.  
'02.  
'02.  
'02.  
'01.  
R. W., '02.  
'02.  
'02.  
'02.  
'01.  
F., '02.  
D., '02.  
'01.  
'01.  
'02.  
F., '01.  
V., '02.  
'02.  
H., '01.  
'02.  
'02.  
'02.  
J., '02.  
'01.  
'02.  
'02.

ENGINEERING SOCIETY  
OF  
The School of Practical Science  
TORONTO.

**PRESIDENT'S ADDRESS.**

I thank my fellow-members of the Engineering Society for the honor they have conferred upon me in electing me to the Presidency for the current session, and am encouraged to hope that their continued assistance and co-operation will enable me to discharge the duties of the office in such a way that our Society shall not be retarded in that influential development which has been so markedly characteristic of it since its organization.

As this Society is recognized as the representative student society of the School I wish to refer first to some matters of general interest to the student body, and, indeed, to our whole membership.

The proposal to form an Engineering Corps in the School has met with your unanimous approval, and it is to be hoped that the proper authorities will soon carry the idea into effect.

The growing importance of the work done in the School, as evidenced by a constantly increasing attendance of students, is a gratifying feature, and has given rise to a crying need for greater accommodation. Provision must soon be made to relieve the uncomfortable overcrowding in the drafting rooms.

The students of the School have always taken a prominent part in athletic sports, and the various teams made up from our members have won more than a local reputation for their prowess on the field. In athletics, as in all events where *esprit de corps* has been

a necessary factor to success, the characteristic unity of our students has been most commendable, and we are pardonably proud of the fact that "the School" has become synonymous with all that is desirable in college camaraderie.

I welcome to our Society the students of the first year, who are soon to become members, and I trust they will find our meetings both pleasant and profitable, and that they will do their utmost to promote the prosperity of our organization.

One of the most satisfactory features in connection with our work is that every student of the School of Practical Science is recognized as a member of this Society. In this connection the Council of the School have taken every opportunity to impress upon the students the fact that a hearty co-operation in the active work of this Society is an essential part of their regular work, and have not only allowed a portion of the school time to be used for the meetings, but have given us more substantial encouragement by taking the papers read by students into account in determining Honor standing. It is very gratifying to know that many of our members have availed themselves of the privilege thus accorded them, and a perusal of our last year's pamphlet will serve to show to what a great extent the success of the year's work was due to undergraduates of the School, and to the impetus given the Society by this generous action of the Council.

In speaking to you this afternoon I have selected for a subject, "Science, in Theory and in Practice." For the ideas here expressed I do not lay claim to any particular degree of originality, and therein may lie their chief merit. If they arouse thought and discussion, even if they provoke opposition or adverse criticism, they will have served a useful purpose.

We hear much of the distinction made between pure science and applied science; between the study of theorems, principles, and laws, and the applications of these to the needs of civilized life. Some magnify the former, and some exalt the latter. The defender of the one is ready to subscribe to the declaration of the American scientist that "the cook who invents a new and palatable dish for the table benefits the world to a certain degree; yet we do not dignify him by the name of a chemist;" while the advocate of the other agrees with the French magistrate who held that "the discovery of a

new dish  
there nev

Our  
in which  
relations  
exists.

To tho  
name alo  
ing. Suc  
denunciat  
Science,"  
degenerati  
to conjure  
rule-of-thu  
scientific r

There  
tive of dir  
is an ecce  
They valu  
covery of t  
the degree  
human ind  
directed w

Scienc  
of phenom  
knowledge  
co-related  
known, but  
of the unkn  
to both. T  
all be com  
phenomena  
noticed and  
and recorde  
and that th  
and research  
pered by th

new dish is more important than the discovery of a new star, because there never can be dishes enough, but there are stars enough already."

Our position as graduates and undergraduates of an institution in which practical science is taught, should lead us to consider our relations to the rival camps, and to enquire what cause for strife exists.

To those who are willing to obtain all their information from a name alone, the words "practical science," must be very misleading. Such philosophers will have reason to join Carlyle in his denunciations of that "mechanical manipulation falsely named Science," and will be justified in railing against the baneful and degenerating influences of modern education. They will be free to conjure up visions of a system in which empirical device and rule-of-thumb experience are substituted for accurate knowledge and scientific reasoning.

There are those, again, to whom the word "Science" is suggestive of dim, visionary, and unpractical ideas. To them the scientist is an eccentric and absent-minded dreamer—harmless, but useless. They value the invention of a burglar-proof lock more than the discovery of the law of gravitation. They prize any knowledge only in the degree in which it can be applied in the various branches of human industry, and argue that practical education should be directed with special reference to some gainful pursuit.

Science may be defined as systematized knowledge—knowledge of phenomena collected by careful observation and experiment, and knowledge of the laws by which these phenomena are controlled and co-related. Science is not confined to the narrow region of the known, but is constantly endeavoring to explore the greater field of the unknown, and to connect the two by basic principles common to both. The observer, the experimenter, and the philosopher must all be combined in the man of science in order that facts and phenomena which are met with at every turn, may be properly noticed and collected, that the knowledge obtained may be arranged and recorded, that underlying relations may be studied and defined, and that the laws thus ascertained may be used in further discovery and research. The scientific mind must be a judicial one, unhampered by the distorting influences of prejudice or of habit, always

willing to weigh any evidence which may be submitted to it, prepared to test that evidence by all available means, and free to accept conclusions which are thus established.

As has been indicated, science should promote discovery and research, and herein lies its practical application and its connection with art to which it can never be antagonistic. The comparison which has been made between pure science and its applications shows that the latter, when slavishly followed may degenerate into mere manipulation, just as abstract science, falsely understood, may be transformed into a sort of dreamy abstraction, productive only of the be-spectacled bookworm, or into a sort of narrow-gauge specialism which frequently gives rise to vain theorizings, or to the blind gropings of the inventing crank. Art and Science have mutual relations, and if in the past the former has been the parent and not the progeny of the latter, it has been owing to the fact that scientific methods were not used in advancing science. In late years a great change has been brought about, and it may reasonably be expected that in the future we shall see science leading and directing. The older methods whereby undefined results were attained by discouraging and laborious efforts, will give place to an intelligent seeking out of practical ends by logical and scientific processes. The engineer will not stumble along in guesswork and speculation, but will design intelligently.

This union of science and art may be noted as a distinguishing characteristic of the present age. Many of the philosophers of the olden times held art in supreme contempt, and valued science only as useful for mental gymnastics, and not for its knowledge of facts and phenomena, and for its practical applications. The inutility of scientific achievements was their chief claim to appreciation, and it is said that even Archimedes was much prouder of his discovery of the relation between the volumes of the cylinder and the sphere than of his enunciation of the principle of the lever that might have relieved Atlas of his burden. It is said that many of the ancient Greek philosophers entertained, in regard to physics and mechanics, the fallacious notion of the existence of a double system of laws; one theoretical, discoverable by contemplation and applicable to celestial bodies, the other mechanical, discoverable by experiment, and applicable to terrestrial bodies. It was many years later that the science of

motion,  
suppositi  
branches  
times, w  
physical  
tation w  
tical mar  
rudiment  
gressive  
and striv  
ditions w  
Gunpowd  
science o  
the scien  
modern  
developed  
evolution  
inaccurat  
clear the  
Vinci, an  
laid the  
every pha  
new meth  
the prece  
discoverie  
rational  
creations  
investigat  
The  
and syste  
had alrea  
fields hith  
of daily li  
It see  
has been l  
future of  
relation t  
departmen

motion, founded by Galileo, and perfected by Newton, overthrew this supposition and proved that celestial and terrestrial mechanics are branches of one science. As a result, development, in these olden times, was metaphysical rather than practical, and the study of physical science was avoided as being too utilitarian. Study and meditation were divorced from experiment and observation, and the practical man was left to plan and invent without the assistance of the rudiments of a true scientific education. Thus it was that art, progressive and enthusiastic, prompted by the demands of practical life and striving to supply these new and increasing demands as new conditions were established, was left to grope its way unaided by science. Gunpowder was known long before a Lavoisier lived to teach the science of chemistry; steam was used as a motive power years before the science of thermodynamics had been thought of; many of the modern marvels of invention and discovery were being gradually developed by men who were artisans rather than scientists. An evolution was in progress, however, and indefinite knowledge and inaccurate reasoning were slowly giving way to skilled observation, clear thought, and scientific invention. Such men as Galileo, da Vinci, and Newton, who were mechanics as well as philosophers, laid the foundations for the practical applications of science, and every phase of human industry soon felt the stimulus given by the new methods. Old theories handed down as an accumulation from the preceding centuries were closely examined in the light of new discoveries. Many were rejected to make room for their more rational successors and the survivals of the old science and the creations of the new were subjected to the severest tests of critical investigation.

The new science gave rise to new arts and led to a more complete and systematic development of those about which important facts had already been collected. Experimental work was commenced in fields hitherto untouched, and our knowledge of the common things of daily life and work was rapidly extended and systematized.

It seems evident that the recent advance of both science and art has been largely the result of a closer union of the two, and the great future of both undoubtedly depends upon the cultivation of each in relation to the other,—the science enabling us to promote every department of human industry and the art providing us with new

and interesting problems which can be solved only by the application of well-established scientific principles. The educational world has not been slow to recognize that a study of the natural and physical sciences is just as instrumental in strengthening the intellect and broadening the mental view of the learner as knowledge and discussion of the more popular speculative subjects of the past.

It is in the engineer, "the ingenious man," that this union of science and art should have its highest development. "When science—the accurate knowledge of what others have done—and experience—the knowledge of what we ourselves have done, are united in the one person, then we may safely say that we have seen the evolution of engineering from a craft to a profession. The only sound engineering progress is that which harmonizes with and therefore advances the great economic evolution which is moving so rapidly in the modern world. Engineering is in fact applied economics."

An engineer must possess an accurate knowledge of those principles, theories, and laws which have been the subject of long-continued discussion, experiment and study, but he must also be able to carry this knowledge into professional or business life, and to apply it in actual construction or design. However remarkable some of the products of engineering skill may be, they are not creations but developments; they are the results of the application of scientific data and a knowledge of natural laws, and no matter how great a genius the engineer may be, he cannot afford to discard those great principles which have been formulated in the system of pure science.

There is a large field in engineering for the man who can devote his time and ability to purely scientific and experimental work. There is much to be done in the lines of research and investigation that cannot be done by the practising engineer. Many old problems are still unsolved and new ones are constantly arising as a result of new conditions. The laboratory must frequently serve as the engineer's court of appeal and the work done there should direct and supplement that done in the office and in the field. The mathematician is as essential as the mechanic. The narrow practical man is prone to depreciate the value of his co-worker in the study or the laboratory, and the man of abstract science too often underrates the value of the mechanical or utilitarian side of the subject.

It sh  
ordinate  
that the  
order tha  
astronom  
probably  
of the pla  
in Englan  
position o  
eye of ma  
telescopic  
the discov  
ticians ha  
so much i  
in the nev  
gravitation

Scien  
help scien  
reward som  
as the dis  
the cause  
of a more  
us is to re  
scientific  
most impo  
us is to co  
we owe to  
apply the  
our quota,  
ledge by o  
confront u

This i  
rooted imp  
with the as  
them. We  
of inventio  
tion has be  
deduced b

It should be the aim of every engineer to reconcile and coordinate the two great phases of professional work and to remember that the theoretical and the practical are mutually dependent in order that each may have its fullest development. The history of astronomical study provides a striking illustration of this in what was probably the most remarkable discovery of the present century—that of the planet Neptune. Each of the great mathematicians—Adams, in England, and Le Verrier in France, determined by calculation the position of this planet in the sky before it had ever been seen by the eye of man, and it only remained for the astronomer to institute the telescopic search and to verify the results obtained in the study by the discovery of the planet in the exact spot which the mathematicians had indicated. The importance of the discovery consisted not so much in the fact that a new planet had been added to the list, as in the new proof which it revealed of the truth of Newton's law of gravitation upon which the calculations had been based.

Science promotes material prosperity and commercial interests help science. The man who works with the hope of pecuniary reward sometimes aids the advancement of knowledge quite as much as the disinterested and self-sacrificing toiler who devotes his life to the cause of research. The former is likely always to remain the type of a more numerous class, and one of the great problems before us is to render the work of these men more useful in the cause of scientific advancement. I think we ought to feel that one of the most important lessons that a technical school such as this can teach us is to constantly work with a sense of the great obligations which we owe to pure science, to make it our aim in professional work to apply the teachings of well-established truths, and to strive to add our quota, however humble it may be, to the sum of human knowledge by observing and recording the varied facts which are sure to confront us in the many problems of daily existence.

This is called the age of invention, and in many quarters a deep-rooted impression prevails that the inventor has done his work not with the assistance of the teachings of science, but rather in spite of them. We owe much of our modern material progress to the genius of invention, but we must also acknowledge that every great invention has been based upon well-known natural laws which have been deduced by scientific men from observed facts. The inventor

attempts to turn these scientific discoveries to practical account. He fails and a successor takes up his work, familiarizes himself with the methods of his predecessor and introduces improvements. The failures of unsuccessful investigators become the stepping-stones to ultimate success. In invention it is particularly true that "art is long," and it is remarkable what a great mass of facts must be collected, and what a great number of minds must be engaged before the finished triumph is reached. The completed design rarely comes suddenly, as by inspiration, but depends for its complete development upon science intelligently applied, and upon a knowledge of what other workers in the same field have done. Herbert Spencer says that the knowledge we inherit represents the accumulated experiences of a thousand generations. We are told that it required seventy years and hundreds of patents to get the now familiar sewing machine into workable shape, and that the persistent efforts of various inventors during a period of seventy-five years were necessary before the reaping machine could be turned to practical use. The history of these and of many other inventions teaches us the great importance of being fully equipped for any work by learning both the theory and the practice connected with it.

The practical man who rejects the use of any principles except those of trial and error, and who does not see that many of the practical problems of engineering are intimately connected with the most important scientific theories and laws, deprives himself and his profession of that healthy development which always accompanies true life. On the other hand the theorist whose resources are limited to speculative discussions of scientific theories and mathematical formulæ, and who regards their practical application as little short of sacrilege, retards that true progress which he professes to promote.

In conclusion let me quote the words of Professor Rankine, to whom the engineering profession is so much indebted:

"The cultivation of the harmony between Theory and Practice in Mechanics—of the application of Science to the Mechanical Arts—besides all the benefits which it confers on us, by promoting the comfort and prosperity of individuals, and augmenting the wealth and power of the nation—confers on us also the more important benefit of raising the character of the mechanical arts, and of those who practise them.

"Ev  
of scienc  
moting e  
those wh  
this rend  
bulk, hov

"Fo  
sity, a sn  
when an  
those wh  
dered wh

"Bu  
applied to  
of those s  
since, in  
metal shi  
the geni

"Th  
precious;  
and work  
results of



"Every structure or machine, whose design evinces the guidance of science, is to be regarded not merely as an instrument for promoting convenience and profit, but as a monument and testimony that those who planned and made it had studied the laws of nature; and this renders it an object of interest and value, how small soever its bulk, how common soever its material.

"For many years there has stood in a room in Glasgow University, a small, rude, and plain model, of appearance so uncouth, that when an artist lately introduced its likeness into a historical painting, those who saw the likeness, and knew nothing of the original, wondered what the artist meant by painting an object so unattractive.

"But the artist was right; for years ago a man took that model, applied to it his knowledge of natural laws, and made it into the first of those steam engines that now cover the land and the sea; and ever since, in Reason's eye, that small and uncouth mass of wood and metal shines with imperishable beauty, as the earliest embodiment of the genius of James Watt.

"Thus it is that the commonest objects are by science rendered precious; and in like manner the engineer or the mechanic, who plans and works with understanding of the natural laws that regulate the results of his operations, rises to the dignity of a Sage."

THOMAS SHANKS.

---

## AERIAL CABLEWAYS.

W. E. WAGNER, GRAD. S. P. S.

Wire rope cableways as a means of transportation have been used extensively by European engineers during the past twenty years, but it is only recently that they have been adopted to any considerable extent in this country.

The original method in America was to have a single cable, carrying only one load at a time, but this proved such a slow means of conveyance that it was very little used. Later the method was improved so that a continuous line of buckets might be used, increasing according to the number of extra buckets the original discharge. This is made possible by the means used to connect the buckets on carriers to the cable, so that they may pass easily over the pulleys and around the terminal sheaves.

A commoner method, used extensively in Europe, and which has been the principal agent for the adoption of cableways in America, is to use a stationary cable (or if the load exceeds five or six tons, two stationary cables) and a running endless rope. Carriages running on the stationary cable, are attached to the endless rope by friction grips, or other appliances, which work automatically, letting go of the hauling rope at desired points. The first method is cheaper where practicable and when a large capacity is not required, for it can only be run at a very slow speed and is much less economical for heavy duty.

Stationary cables as a rule are used for short lines with heavy loads, or for very long lines.

### SINGLE ROPE CABLEWAYS.

The buckets in these lines may either be fastened rigidly to the cable, or carried along by friction only. The latter method, which is by far the most convenient one, is very seldom, if ever, seen in America, but in Europe it is generally chosen where

the quan  
where th  
loads are  
ground d

The  
composit  
on the r  
pieces is  
These sh  
rope at th  
These ra  
approach  
incline, li  
where the

The  
miles an  
matically.  
means of

The  
end, fitte  
diameter,  
The powe  
horse pow

At th  
tightening  
rope is pla  
tightening  
with rock  
weight of  
as to alw  
conditions

Inter  
suitable p  
200 feet a  
intervening  
general lev  
the towers

the quantity to be carried does not exceed 500 tons per ten hours, where the inclines do not exceed one in three, where the individual loads are not greater than 600 lbs., and also where the section of ground does not necessitate spans of greater length than 600 feet.

The saddle in an iron frame is fitted with wood, or rubber, or composition friction blocks, by means of which the necessary friction on the rope is obtained. The frame which carries these friction pieces is fitted with two small wheels, carried on pins attached to it. These shunt wheels are employed for removing the carrier from the rope at the loading stations and at curves, where shunt rails are placed. These rails are held in such a position that when the carrier approaches, the small wheels engage on it, and running up a slight incline, lift the friction saddle from the rope, and enable it to pass to where the loading and unloading is required to be done.

The impetus derived from the speed of the rope (about four miles an hour) is sufficient to enable the carrier to clear itself automatically. The buckets which carry the material, are attached by means of hooks to curved hangers, pivoting on the V shaped saddles.

The other features of the ropeway consist of a driving gear at one end, fitted with a horizontally placed sheave, five to ten feet in diameter, depending on the size and construction of the cable used. The power may be supplied by steam, water, compressed air, or even horse power in the case of smaller lines.

At the opposite terminal, there is a similar wheel, provided with tightening gear, and around the two sheaves an endless band of wire rope is placed. The lower terminal generally runs on tracks, and the tightening gear in such cases, consists of a strong wooden box, filled with rocks or old iron, and hung in a wooden frame-work. The weight of this box, acts through a wire rope about suitable pulleys so as to always maintain the same tension in the line under any conditions.

Intermediately between these stations, the wire rope is carried on suitable pulleys, placed on frames of iron or timber, spaced about 200 feet apart, and of suitable height to allow the carriers to clear intervening obstacles, and also to regulate as much as possible the general level of the line. It is economical and good practice to place the towers as far apart as possible, for there is less wear on the

moving ropes, and they run quieter, and with fewer jerks than when closely spaced.

Where the country is level the supports cannot be placed very far apart, on account of the sag in the rope, unless the towers be made very high, so the span and the height of the towers becomes a question in each case of economy and convenience.

In general the towers are of no particular structure, made of four heavy timbers, braced together to suit their position, and carrying a cross piece for the pulleys. Where there is danger of snow slides, a single post is sometimes used, as it offers less resistance and is not so liable to be swept away.

Fixed carriers are specially suitable where the country is very hilly, and very steep inclines are liable to occur in the line. The friction carriers are limited to small grades, but the incline on which these lines will work seems to have no limit.

Where the ground is so uneven as to necessitate sudden changes in the vertical angle of the line, guard pulleys may be used, which depress the rope until the load passes, when its weight relieves the pressure on the guard wheels and enables it to pass under.

The carrier is fastened to the cable, either by using a steel clip, with suitable corrugations, to be inserted between the strands of the cable; or by tightening a steel band about the rope by means of a shank and key. Tests have been made on these clips under hanging loads, and they are found to sustain weights up to 1,500 lbs. without showing any weakness, or injuring the rope. This is amply strong enough, for the loads on these lines rarely exceed 500 or 600 lbs., while experience proves that loads ranging from 100 to 200 lbs. are the most economical.

For steep inclines or heavy duty, special terminal sheaves are employed at the driving end, and sometimes at both ends, to prevent the cable slipping. These "grip sheaves" are automatic in their operations having a set of teeth working in the circumference. The pressure of the cable on the bottom of the jaw causes the teeth to close upon it, securing a grip, that makes slipping impossible; and on the pressure of the rope being removed, the teeth spring open and release it.

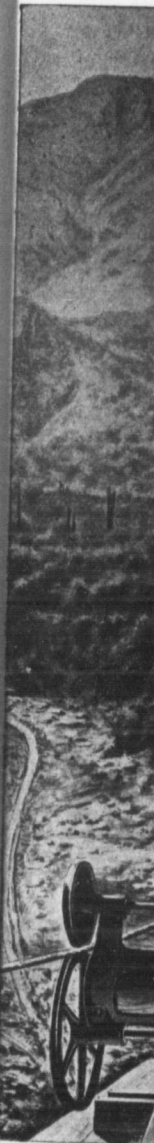

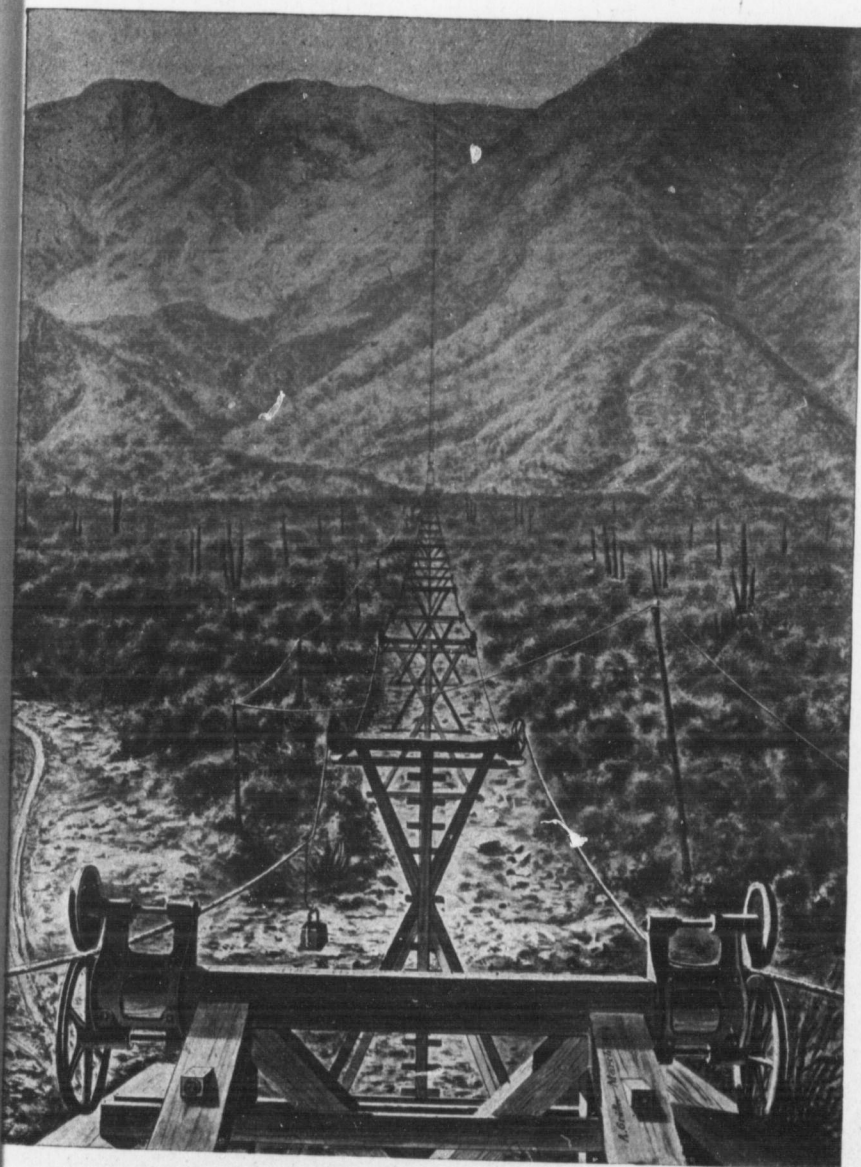

SINGLE ROPE CABLEWAY BUILT BY CALIFORNIA WIRE WORKS.

S.P.S.—2

When the point of discharge is lower than the loading point and the delivery is five tons or more per hour, the line will operate by the weight of the descending load under ordinary conditions, providing the grade exceeds eight degrees or one in seven. In such cases the speed of the line is controlled by a wood-lined band brake, operated by hand at the upper terminal, and occasionally for very heavy lines a brake is also needed at the lower end.

A remarkable instance of this is a ropeway in Japan, about 1,800 yards in length, for the greater part on an incline of one in one and a half. Such is the power generated by the descending loads, that it is necessary to absorb the greater portion of it, and thus render the line amenable to a hand-brake. The power could not be usefully employed, so a water-brake was introduced, in which a revolving fan drives the water against fixed vanes, which again repel it. In this way some 50 h.p. are absorbed, and the speed of the ropeway can be regulated exactly, by adjusting the re-action vanes. A small supply of cold water is provided to keep the temperature of the water employed in the brake, sufficiently low.

Sometimes the extra power thus afforded may be used to carry back and up such material as may be needed; and in some cases this extra power actually becomes a source of revenue. There are mines, where the descending ore even supplies enough power to operate a rock-crusher. In some cases where the grade is not quite sufficient for this, extra power may be supplied to the cable at the lower terminal, and transmitted through it to machinery above, without in any way interfering with the regular duty of the ropeway.

As has been mentioned the friction carriers may be shunted off the line and brought to rest at loading stations, but when fixed carriers are employed this is impossible, and all the loading and unloading must be done while the bucket is in motion, consequently the speed of the line generally ranges between two and four miles per hour. It is a simple matter to dump the buckets automatically by means of a fixed rod at the discharge terminal, which releases a catch and allows the bottom to open, and the contents drop out; then as soon as it is empty a counterweight at the back closes the bottom again and it is ready for loading.

The loading is generally done by hand, but where the material to be handled is of a uniform character such as coal or ore, some very

ingeni  
good e  
Co. of  
tubing  
the lev  
box, w  
ropewa  
bottom  
held be  
open f  
TH  
cable t  
along s  
At the  
under t  
clip on  
fixed d  
front of  
The sw  
feet of t  
hopper  
head, re  
Wit  
matter t  
station o  
cost of t  
As they  
the supp  
arranging  
carried a  
must be  
whence a  
the load  
regular t  
ropes to  
buckets  
stations i  
but make

ingenious methods of automatic loading have been devised. A very good example of a loader, is one built by the Hallidie Wire Ropeway Co. of California. It consists of a pendulum made from sheet iron tubing 12 ins. in diameter, swinging on trunnions about 20 feet above the level of the moving cable. At the lower end is attached a loading box, which contains when loaded, enough ore to fill one bucket of the ropeway. The loader hopper has two sides, a back, and a sloping bottom, the front being open. While the hopper is being loaded, it is held between a guide and a fixed door or bulkhead, which closes the open front.

The releasing of the hopper box is done by a clip on the moving cable to which the ore carrier is suspended, and which as it moves along strikes the end of a lever which raises the latch off its keeper. At the time the loading box is released the ore carrier is immediately under the nose of the loader box, ready to catch its contents. The clip on the moving cable then pushes the hopper out from behind the fixed door, at the same speed as the carrier, and thus opens up the front of the loader box and lets the contents pour into the carrier. The swing of the pendulum raises it sufficiently high, after a few feet of travel to clear the rope clip, and the pendulum with the empty hopper swings back by gravity, in between the guide and the bulkhead, ready to receive another load of ore from the ore bin.

With the friction clip as was seen, it is a comparatively simple matter to make a turn in the line, but with fixed carriers, an angle station of special construction is required, which greatly increases the cost of the line. This is due to the position of the clips and hangers. As they hang on the outside of the rope, it is necessary to have all the supporting sheaves and horizontal sheaves on the inside. In arranging a turn, one line, which should be the loaded one, can be carried around a horizontal sheave all right, but the inner rope must be carried across and over the loaded rope to a turning station, whence after passing around a horizontal sheave, it returns crossing the loaded rope and itself near the first sheave, and goes on to the next regular tower. This tower must be sufficiently high to allow the ropes to clear each other by seven or eight feet, and prevent the buckets fouling with the rope beneath. Sometimes two turning stations instead of one are used; this requires more structural work but makes a simpler turn.

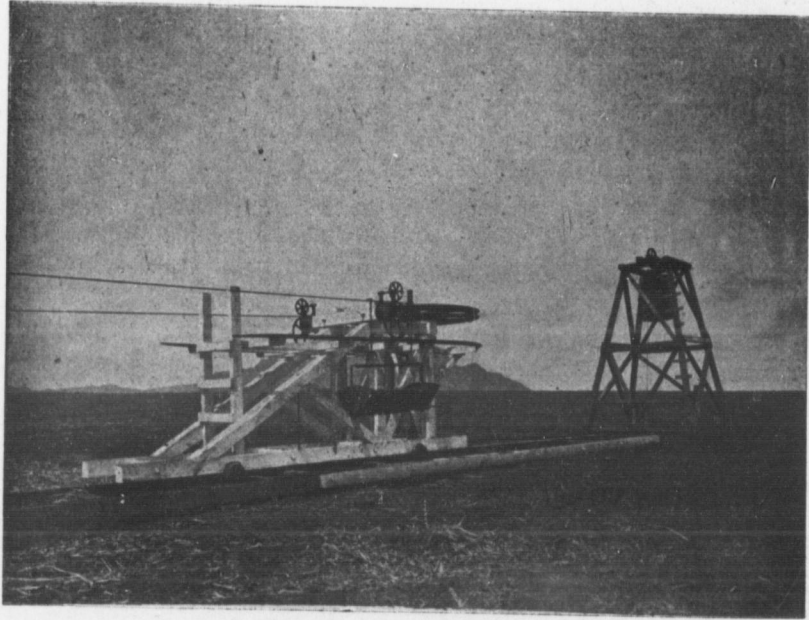

TERMINAL STATION.

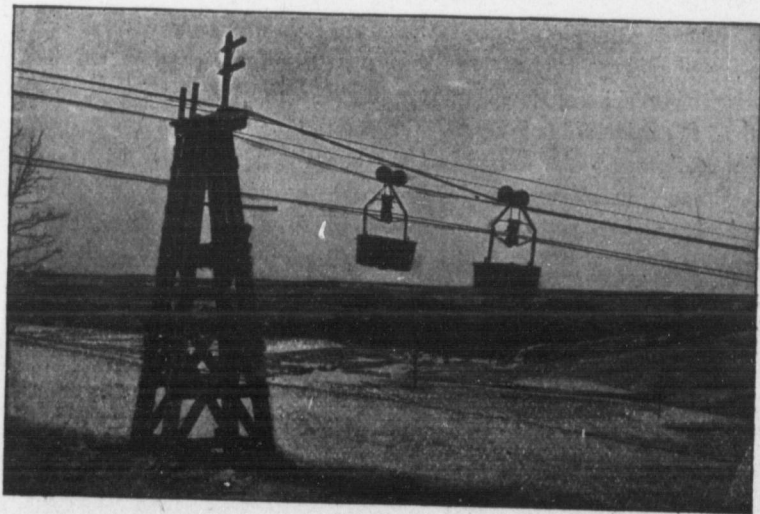

DOUBLE ROPE CABLEWAY, BUILT BY TRENTON IRON CO.

A  
them  
interva  
one ca  
use, as  
length  
miles.

In  
porting  
by han  
be plac  
work.  
swings  
the fiel

An  
is to ha  
needed,

Th  
stretche  
an endl  
carriers  
which t  
quantiti  
dividual  
one in t

Som  
ing load  
to the f  
are mov  
track.  
incline  
practical  
stretched  
of suppo

Of t  
in one c



Another point in favor of the friction grip is that lines using them may be of unlimited length, for stations may be placed at intervals along the line and the buckets switched automatically from one cable to the next. However this advantage is of little practical use, as cableways are seldom used of more than a mile or two in length, and single cables have been made to cover as much as five miles.

In the south these cableways are used extensively for transporting sugar cane from the fields. The loading is done altogether by hand, the cable being lowered on to a portable tower, which may be placed at any point in the line, so as to keep in touch with the work. Sometimes all the towers are movable and the whole line swings around in an arc, bringing the line to bear on every part of the field.

Another very convenient method to cover a large area of ground, is to have the line run around a rectangle, in this case only one line is needed, doing away with the necessity of extra stations at the corners.

#### DOUBLE ROPE CABLEWAYS.

The double rope system consists of two stationary track cables, stretched from one station to the other, over the tops of the towers, an endless traction rope running parallel to the stationary cables, and carriers hauled along the stationary cables by the traction rope, to which they are attached by grips. This system is used where the quantities to be transported exceed 400 tons per day, where the individual loads are more than 600 lbs; also where the inclines exceed one in three, and the spans exceed 600 feet.

Some of the advantages of this system are its capability of carrying loads of 2,000 lbs. or more, very little power being needed owing to the fact that only the carriers, connected by a light hauling rope are moved, and they run with the same ease as a car rolling on a track. On this account, these lines will run by gravity on a less incline than that required by a single-rope line. Long spans are practicable owing to the high tension at which the track ropes are stretched, which lessens the deflection in the rope between the points of support.

Of the two track ropes, one is used by the loaded carriers moving in one direction, and the other by the empty carriers returning.

On this account the return cable may be made of lighter rope, and so economy effected. In like manner when the spans are particularly long, heavy ropes are inserted in the line, so that the track ropes may be fittingly proportioned to the tension they must bear.

The track ropes are rigidly anchored at the upper end of the line, and the lower ends drawn taut by counter-weights. If the line exceeds a mile and a half in length, the track ropes are usually divided into two or more sections with a tension station for each section.

The hauling rope is operated by a suitable driving gear at one end, and controlled by a tightening gear at the other, and moves at a speed of from four to six miles an hour. For very long lines, or for shorter lines, which have a great difference of level between the terminals, stations are placed every 5,000 or 6,000 yards to supply power to the moving cable, but two sections of such a line can always be worked from their intermediate station by the same motor.

The attachment of the carrier to the hauling-rope is an essential point, as it must be made by means of an automatic clip, which will release itself, on touching a bar at the various stations, and at the same time will hold sufficiently tight to enable the hauling-rope to drag the carrier up any incline which may occur in the line. This is done by forming a knot in the hauling-rope, by putting a sleeve around it, or a suitable casting inside, at certain points, so as to make an enlargement which is caught by a suitable device on the carrier. This device sometimes consists of fork shaped pawls, which are thrown in and out of action by engaging with a guide rail at the stations. The speed of the carrier is sufficient to avoid any great impact of the knot with the grip. At the loading stations however, the loads being large, and the carriers starting from rest, a man is required to push off the carrier, when a knot is known to be approaching by the ring of a bell. A better arrangement, which does away with all undue wear in the rope, and is much less jerky, is that of a clip by which the hauling-rope is held simply by pressure.

The "Universal Friction Grip" is a good example of a pressure grip. The main feature is a short shaft on which are cut right and left hand threads of different pitches. This shaft has a bearing secured to the hanger, the nuts for the screw threads being also the jaws of the clamp, by which the rope is gripped. On one





RAISED A X TOWER ON SINGLE ROPE CABLEWAY.



WIRE ROPE TRAMWAY (BLEICHERT SYSTEM).

Length of line 9,000 feet; daily capacity 400 tons. Showing portion of a span 1,173 feet across the town of Wardner, Idaho.

end of the shaft is keyed a double lever, which in its upper end carries a pin, on which is a cylindrical counter-weight free to revolve.

The outer jaw of the clamp has a right-hand thread of very fine pitch, and the inner jaw has a left-hand thread of very coarse pitch.

Suppose the carrier to be in such a position that the hauling-rope passes freely between the open jaws. If the lever is now turned to the right the shaft will revolve and the clamp will close quickly until the jaws come in contact with the rope. At this moment the effect of the coarse-pitch thread on the inner jaw ceases, but the further turning of the shaft causes the outer jaw to continue its motion. Very little movement is now required to clamp the rope tightly; and this is done with all the power due to a fine-pitch screw.

The process of coupling is as follows:—When the carrier is moved from the switch rail of the station on to the carrying rope, the counter-weight on the end of the lever becomes at the same time engaged with a guide rail in an inclined position, and as it rolls up the incline, the lever is caused to turn. When leaving the guide rail the lever will stand about vertical, and in this position the jaws are in contact with the rope, and the coarse-pitch thread in the inner jaw will be out of action. At this moment the lower arm of the lever strikes against a pin, which compels the lever to turn further, thereby clamping the rope tightly by action of the fine-pitch screw in the outer jaw.

The release of the carrier from the rope is caused by a similar inclined guide rail, after leaving which the counter-weight by its gravity, continues to turn the lever, giving a wide opening to the jaws and fully releasing the rope.

As in the case of friction grips on single rope lines, angles may be turned readily by using guide rails, upon which the carriers shunt automatically as explained. Under the "Bleichert" system, controlled by the Trenton Iron Co., shunt rails are also used in passing sharp ridges. These "rail stations" as they are called, consist of a series of bents from 15 to 20 feet apart, supporting rails which overlie the track cables and save them from undue wear at these points.

Altho  
the inertia  
sary for t  
of the we

With  
and Basco  
tight, and  
to take a s  
is most lik  
much less  
is partly l

When  
day, and a  
carriers ar  
not requir  
loading sta  
charging to  
the end of  
one filled;

Where  
short, havi  
load over a  
in order to  
With favor  
supports.

While  
span from  
lower side  
ports, and  
less and th  
straight lin  
or forty mi  
than is nec  
material ma  
water is av  
ploying the

Long  
yards, are  
spans in A

Although in general the traction rope has only to overcome the inertia of the loads, it must be considerably stronger than is necessary for this, for on inclines it has to support a certain proportion of the weight of the load.

With the "Dusedau" system, under the control of the Broderick and Bascome Rope Co. of St. Louis, the hauling rope is stretched very tight, and supported by pulleys close to the fixed cable, to enable it to take a share of the weight even on level ground. This style of line is most likely better for sloping ropeways, but on the level it must be much less economical, for the great advantage of having a fixed cable is partly lost.

When the quantities to be transported do not exceed 100 tons per day, and are to be moved in loads of 2 to 6 tons at a time, only two carriers are used, one on each cable; and in this case shunt rails are not required at the terminal stations, for when the bucket at the loading station starts on its way, the empty bucket leaves the discharging terminal, passing each other at the center. On arriving at the end of the line, the loaded bucket is dumped, and the empty one filled; then the engine is reversed and the operation repeated.

Where very heavy loads are carried, the length of the line is short, having generally only one span, for it is difficult to pass a heavy load over a support, on account of the shape of the carriage, which in order to carry several tons must be made to straddle the cable. With favorable ground, spans up to 2,000 yards may be made without supports.

While many ropeways of this kind are employed simply to span from the upper portion of a mountain over a valley to the lower side of another, others are constructed with one or more supports, and skirt the side of a steep hill. In this case the loads are less and the speed never exceeds ten miles per hour, whereas with straight lines when run by gravity the speed sometimes reaches thirty or forty miles an hour. As the loaded carrier is usually much heavier than is necessary to draw up the empty one, a proportionate amount of material may be transported up as well as down; in some cases where water is available, it is even possible to run materials up alone, employing the descending carrier as a counter-balance filled with water.

Long spans like those mentioned above reaching up to 2,000 yards, are confined exclusively to European practice, the longest spans in America not exceeding a third of this length.

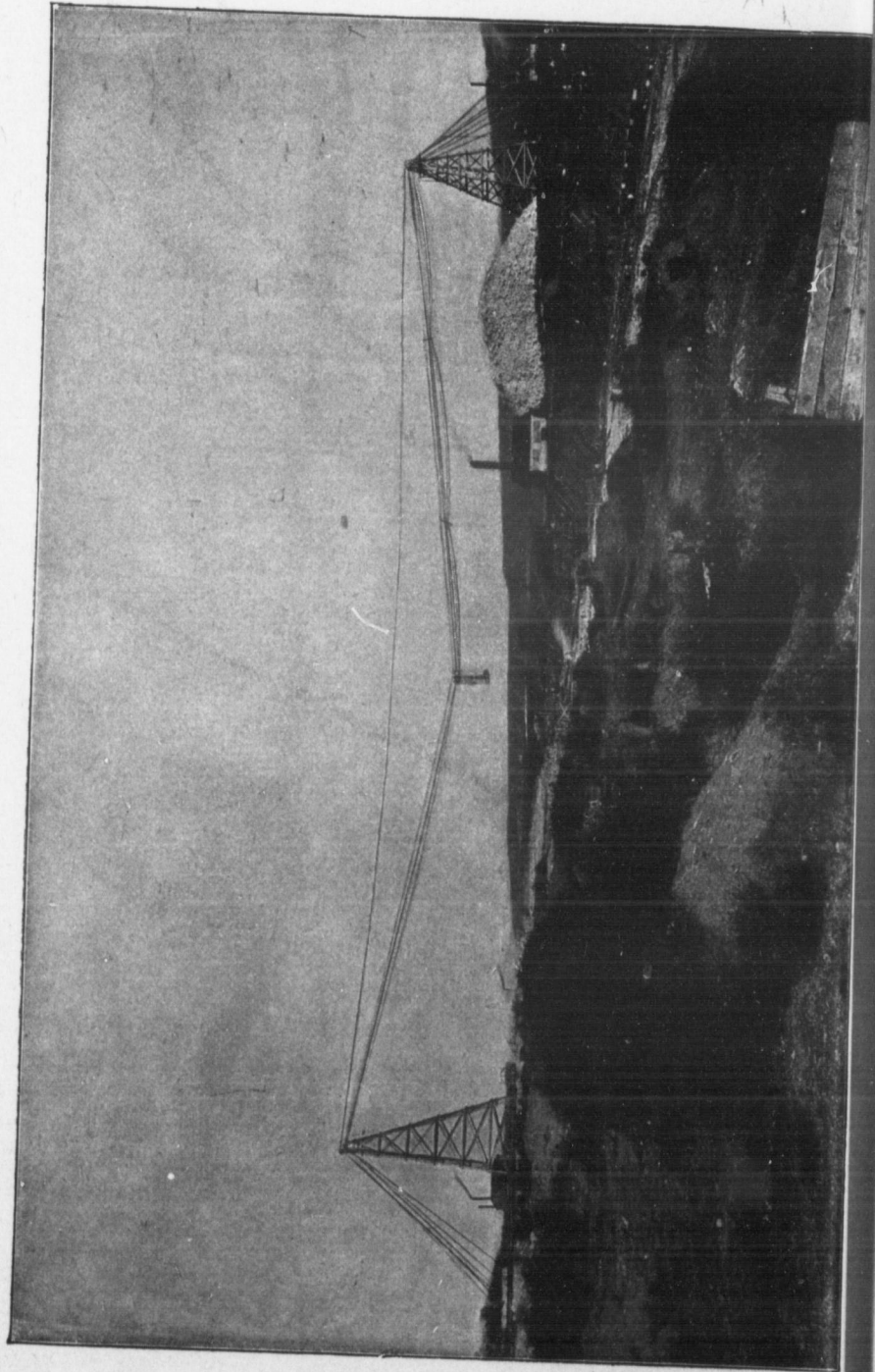

Sometim  
quantity to b  
carrier drawn

This for  
little used in  
purpose the  
single span, v

A modifi  
practice in A  
the cable hois

It is use  
short distance  
it is impractic  
span, interme  
double line of  
struction of t  
and hence wo  
construction o  
the track cabl  
to pass betwe

These lin  
hoist or lower  
hoisting rope.  
gravity, this i  
hoisting and c

In either  
blocks of hard  
other systems  
the ground at  
end for mainta  
supports of v  
especially whe  
simple A fram

Inclined c  
work, especiall

Sometimes for very steep inclines and long spans where the quantity to be transported is not great, a single cable is used, with a carrier drawn to and fro by an endless hauling rope.

This form of cableway like the one previously described is very little used in America except for logging, and when used for this purpose the construction is very crude, consisting generally of a single span, with trees for terminal posts.

#### CABLE HOIST-CONVEYORS.

A modification of the single line ropeway has recently come into practice in America for excavating and canal work, being known as the cable hoist-conveyor.

It is used for moving heavy loads of several tons weight over short distances. In cases where the line is of considerable length and it is impracticable to build towers of the requisite height for a single span, intermediate supports may be introduced, but in this case a double line of track cables must be employed on account of the construction of the ordinary carriage which straddles the single cable, and hence would not pass such supports. By using two cables a construction of carriage is obtained in which the wheels that run on the track cables are outside of the carriage frame, which is thus free to pass between the two saddles at the intermediate supports.

These lines as the name implies, not only convey the loads, but hoist or lower them at any point in the span by means of a separate hoisting rope. In inclined lines, where the carriage descends by gravity, this is the only moving rope required, but generally the hoisting and conveying is done by separate ropes.

In either case the track cable rests upon saddles or grooved blocks of hard wood, forming the peaks of the supports, as in the other systems using the stationary cable, and is anchored firmly to the ground at each end, a turn-buckle usually being provided at one end for maintaining the proper deflection. The towers are pyramidal supports of wood or iron as preferred, although in many cases, especially when the loads do not exceed one or two tons, these are simple A frames or masts guyed with wire ropes.

Inclined cable hoist-conveyors have been used largely for quarry work, especially in Pennsylvania, and Vermont.

If the loads are to be elevated from a quarry for instance, a stop or buffer-block is clamped to the track cable at the loading point, which arrests the carriage in its descent, and allows the bucket to drop to the place of loading. The hoisting rope is reeved through the carriage and fall block with a sufficient number of parts so that the hoisting resistance is less than the resistance to traction. Applying power to the hoisting drum, the load rises till the fall block encounters the carriage, when the latter proceeds to move up the line till the point of discharge is reached. Here it engages a latch, clamped to the track cable, which prevents the carriage running back while lowering the load. The power is thrown out as soon as the carriage engages this latch, and the lowering of the load is effected by means of a brake on the drum.

The limiting or least inclination on which such a line will work is about one in three. If the load is a descending one the operation is similar, but in this case lighter inclinations are practicable, the limit being a fall of about one in five for ordinary loads. The power required is considerably less, since it is only applied in raising the loads from the ground.

If it is required to load and unload at various points along an inclined hoist-conveyor the carriage may be attached to an independent rope, operated in conjunction with the hoisting rope, except when raising and lowering the load when it is held by a brake on the drum from which it is driven.

Owing to the steep inclination necessary for the successful operation of these lines, their application is very limited. In most cases the terminal points are on about the same level so that the movement of the carriage must be effected by means of an independent rope and drum.

Besides the hoisting rope these lines are sometimes provided with a dump-line, which is attached to the rear end of the skip. When it is desired to dump the latter, this line is drawn in at a higher rate of speed than the hoisting and hauling ropes, by being thrown on a drum of larger diameter. Thus the skip is tilted and the load dumped without stopping the carrier. In these lines, employing both a hoisting and a hauling rope a "fall-rope carrier" is employed to prevent them sagging, which they would do, being under very low tension.



For instance, a  
loading point,  
the bucket to  
beaved through  
of parts so that  
ction. Apply-  
the fall block  
ve up the line  
gages a latch,  
running back  
s soon as the  
is effected by

line will work  
the operation is  
acticable, the  
s. The power  
n raising the

oints along an  
to an inde-  
oisting rope,  
d by a brake

uccessful opera-  
most cases the  
movement of  
ent rope and

nes provided  
of the skip.  
awn in at a  
es, by being  
s tilted and  
e lines, em-  
e carrier" is  
l do, being

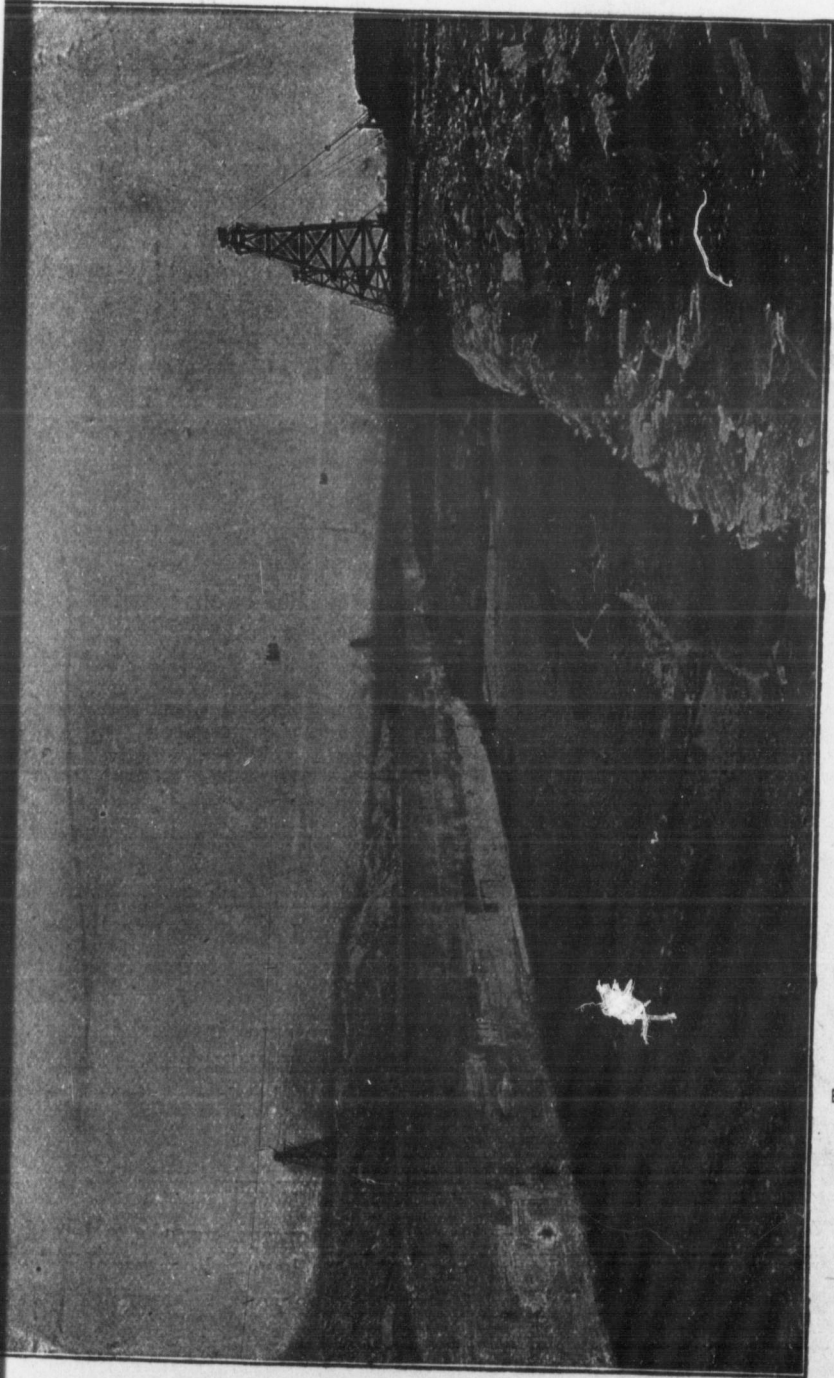

TRAVELLING CABLEWAY, SHOWING COMPLETED ROCK CUT, CHICAGO CANAL, SECTION 8.

The immense importance of these fall-rope carriers will be seen when it is considered that if the fall-rope were allowed to sag down for any distance it would be impossible to lower the fall block and the cableway would be inoperative, in addition to which would be the great wear on the rope from dragging on the ground.

These rope carriers must of course be movable in order to make way for the load. When the load is drawn in towards the terminal, the carriage gathers the rope carriers up in front of it, and when after dumping its contents the empty bucket returns towards the loading point the rope carriers are deposited one by one at the required places, either by being joined together and to the terminal station by a rope, or by being displaced from a horn on the front of the carriage by steel buttons fastened to a special button-rope. The spaces in the carriers are graduated in size as are also the buttons on the button-rope, so that each button will pass through every rope carrier except the one it displaces from the carriage.

In the "Laurent-Cherry" system controlled by the Trenton Iron Co., these rope carriers are dispensed with altogether.

In this system the arrangement of the hoisting-rope is as follows: Starting with the end which is fastened to the fall block, after making the necessary number of laps about the sheaves in the carriage and fall block, the rope is conducted to a sheave in the top of the head tower, thence down to the engine drum and around this as many times as may be necessary, thence around a take-up sheave, by means of which a uniform tension is maintained, and back to a point on the rope itself between the carriage and the tail tower, where it terminates, secured by a patent double swivel attachment. The rope thus makes what is practically an endless circuit, to which a short piece is attached, but which in reality is simply the extension of one end, some 200 or 300 feet long that terminates in the fall block, or long enough to allow for the greatest vertical lift, and yet not so long as to overbalance the unloaded fall block and prevent its descending.

#### TRAVELLING HOIST-CONVEYORS.

In some cases, as for instance the excavating of canals and trenches it is of the utmost importance to have a line that may be easily moved so as to keep in touch with the work. For small canals

and trenches easily disman

The sup upon skids o which must plenty of roo span is 200 f

In opera from separat fastened to t anchored to a distance from passes throug the bucket. between idler the spoil ba carriage and middle of one

The buck in, the bucket itself full. Th out-haul rope ever, is not so ropes must be while moving return also re especially if it under the line

In movin ing rope being "dead man" near the foot of the loading forward.

A far bett fies its erectio and run on tra as 1888 by Mr

and trenches the Hall Patent Hoist-conveyor is very suitable being easily dismantled and re-erected.

The supports for the stationary cable consist of a mast mounted upon skids on one bank, and a suitable tree or mast on the other, which must be placed far enough from the excavation to leave plenty of room for dumping the spoil. In general the length of the span is 200 feet.

In operating this line three moving ropes are necessary, driven from separate drums. One of these known as the loading rope is fastened to the bail of the bucket after passing through a block, anchored to a "dead man" in the bottom of the canal at a point some distance from the cable line. Another rope called the hoisting rope passes through a block in the carriage to a fastening on the bail of the bucket. The third rope, known as the out-haul rope passes between idler wheels in the hoist carriage to a block at the top of the spoil bank mast, through this to a block attached to the carriage and thence to a link on the bottom of the bucket in the middle of one side.

The bucket is knifed edged and when the loading rope is drawn in, the bucket is dragged horizontally along the bottom until it scrapes itself full. The hoisting rope then lifts the loaded bucket and the out-haul rope takes it to the discharging point. The operation, however, is not so simple as would appear by this description as all three ropes must be worked together, in order to keep the bucket upright while moving and to make it discharge at the proper time. The return also requires very skilled manipulation of the different ropes, especially if it is desired to drop the bucket to some point not directly under the line.

In moving the cableway, the ropes are disconnected, the loading rope being lapped through blocks, one of which is fastened to a "dead man" 50 or 60 feet along the bank, the other to the skids near the foot of the mast. Power is then applied to the winding-up of the loading rope, and the whole rig on the skids moves slowly forward.

A far better style of cableway, where the work to be done justifies its erection, is one in which both towers are well constructed, and run on tracks parallel to the canal. Such a line was used as early as 1888 by Mr. H. H. Carson of Boston in excavating some portions

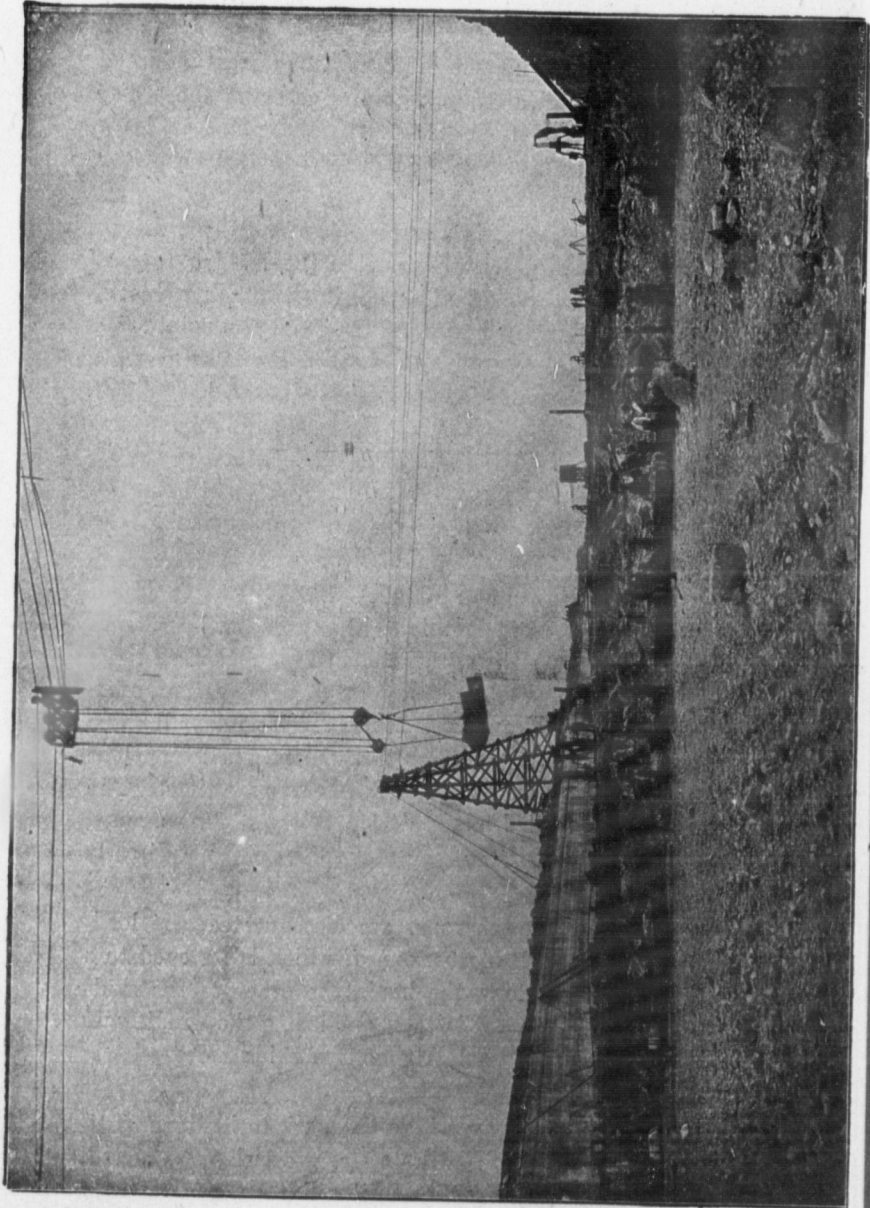

of the Bo  
dropped t  
making t

This  
generally  
the tail to  
engine, an  
material i  
which the  
ropes are  
anchorage  
with heavy  
a sheave, a

A hau  
a button li  
at the foot  
is attached

The c  
of car ax  
There are  
the car eig  
support the  
tracks, the

The en  
minute, an  
per minute  
higher spee  
and supplie  
engine. Th  
other divid  
the dump li  
pendently, a  
carried in ei

The ho  
the dump li  
the spoil ba  
diameter of

of the Boch Bay Park system. Since then the idea seems to have been dropped till the Lidgerwood Co. used the same system in 1890 in making the Chicago drainage canal.

This ropeway as used by the Lidgerwood M'fg. Co., has a span generally of about 700 feet, the head tower being 93 feet high, and the tail tower 73 feet high. The head tower is the one carrying the engine, and is made higher to add to the size of the spoil bank, as the material is dumped on that side of the canal. The main cable, on which the carriage travels is  $2\frac{1}{4}$  inches diameter steel, and the other ropes are of suitable size to handle a load of 8 tons. To form an anchorage for the cable the moving platform is weighted down with heavy stones, and two iron rods meet above the engine house in a sheave, around which the cable is passed and clamped.

A hauling-rope, hoisting rope, dump line, fall rope carriers, and a button line as already described are used in these lines, a weight box at the foot of the head tower allowing the button rope, to which it is attached, to play up and down a little.

The cars of both head and tail towers are supported by a series of car axles, the wheels of which run on standard gauge tracks. There are two axles under the foot of each post, and at the rear of the car eight axles are so arranged as to give a strong wheel base to support the machinery and ballast, three rails being used to form two tracks, the middle rail being common to each.

The engine is designed to lift 8 tons at a speed of 300 feet per minute, and to convey it along the cable at a speed of 1,000 feet per minute, but with increased steam pressure it works at much higher speeds. The boiler is of the locomotive fire-box type, 70 h.p., and supplies steam for both the cableway engine and the moving engine. There are two drums, one for the endless hauling-rope, the other divided into two parts, receives the main hoisting rope and the dump line. The drums may be worked either together or independently, and are of the same diameter, so that the load may be carried in either direction at a uniform distance from the fixed cable.

The hoisting rope carries the whole weight of the skip, and the dump line comes in slack, but at the same rate of speed. When the spoil bank is reached the dump line is thrown on an increased diameter of the drum, and being thus drawn in at a higher rate of

speed the load is discharged. The dumping takes place while the carriage is in motion, and the engine being immediately reversed, the bucket returns for the next load without the least delay. Special small engines are used for moving, the one on the head car being supplied with steam from the boiler, while on the tail car the engine is run by compressed air from the drill pipe which runs along the canal.

Pulley blocks are attached on both sides of the car to a stationary rope several hundred feet long running parallel to the line of the canal and attached to dead men at each end; and to double ropes attached to the car. A fourth rope is wound through the single blocks on one side, then several times around the drum of the moving engine, and through the blocks on the other side. With this arrangement the towers may be moved in either direction at a speed of 50 feet per minute.

The track is either laid for some distance ahead of the car, or more frequently 15 foot sections, permanently attached to the ties are used, and transferred from one side of the car to the other.

Since the use of travelling cableways by the Lidgerwood Co. has proved so economical and efficient, many other firms have designed similar lines.

The Roebling's Sons Co. make a cableway in which both towers are moved by the same engine that does the hoisting and hauling. The towers may be moved at a high speed up to 400 feet per minute, as there is no danger of one tower running ahead of the other and straining the cable, but this system has the disadvantage of an extra endless rope, spanning the canal, to move the tail tower. An additional shaft in front of the engine is connected to a vertical shaft with bevel gears, on the lower end of which is a winch; around this a steel rope makes two or three turns and is anchored at each end of the track between the rails. The tail tower is fitted in a similar way, the shafts in each tower being connected by a wire rope supported over wheels on top of the towers.

Single line ropeways under special construction have been applied to a great many different classes of transportation, among which we might mention the loading and unloading of vessels, the rescue of passengers from stranded ships, and in recent years the conveyance of passengers to inaccessible or difficult places.

The tower built for projecting boats back and forth by hoist-conveyors.

On the inclined hoist-chute.

Two ends to an iron rope. not in use at terminal or fastened by the proper one side.

In the gets through. Another view the ends be is then drawn is ready for imparting to the carriage itself prevent

Interest warships on an elevated

The de improved. Spanish war

It is p collier in to between the is recognized pair of she

The usual construction for loading vessels is to have the tail tower built out on a pier, and in a slanting position, or with a projecting beam, to allow the buckets to descend to the deck of the boat. The bucket is raised and lowered by the fall rope, and traversed back and forth on the cable by an endless traction rope as in ordinary hoist-conveyors.

On the California and Hawaiian coasts a very neat form of inclined hoist-conveyor is used extensively and is known as a cable chute.

Two or three hundred feet of 2-in. chain is connected at one end to an anchor, and at the other to a similar length of galvanized iron rope. This rope is attached by a light chain to a buoy, and when not in use lies on the bottom. The mast of the vessel forms the lower terminal of the line; and the chain and galvanized iron rope being fastened by a hook and eye coupling to the fixed cable, keeps it at the proper tension and prevents the vessel from being tipped to one side.

In the busy season the track cable is not taken in when a vessel gets through loading, but the ropes are coupled together and cast off. Another vessel coming picks up the ropes, uncouples them, passes the ends between the masts and couples them again; the track cable is then drawn up to a proper distance in the rigging, and the conveyor is ready for operation. Means are provided at the shore landing for imparting the proper tension to the track cable, and also for holding the carriage while raising or lowering, and a latch on the carriage itself prevents the load from falling in transit.

Interesting experiments are now being made by United States warships on the Miller conveyor for coaling ships at sea by the aid of an elevated cable.

The device was proposed in 1893 but has since been modified and improved. It was accepted by the authorities for use during the Spanish war, but was not ready in time.

It is proposed with this device for the warship to take the collier in tow, or the collier to tow the warship, leaving the distance between the ships about 300 feet; this method of securing ships at sea is recognized as being safe. The warship to receive the coal erects a pair of shear poles on its deck, which secured by guys, support a

sheave wheel, and a chute to receive the load. The collier is provided with a specially contrived engine, located aft of the foremast, having two winding drums. A steel cable  $\frac{3}{4}$  in. diameter leads from one drum to the top of the foremast, over a sheave, thence to the sheave on the warship, back to another sheave on the top of the foremast, thence to the other drum. This engine gives a reciprocating motion to the conveying rope paying out one part under tension.

A carriage of special form conveying bags of coal 700 to 1,000 lbs. is used, and is provided with wheels which roll on the lower part of the conveying cable, and grip on the upper part of the cable. This arrangement does away with a stationary cable, the returning rope taking its place by supporting part of the load.

During the transit of the load an elevator car descends to the deck of the collier and is loaded with bags of coal suspended from a bale, and elevated again to stops on the guides, so that a hook on the returning carriage engages with the bale supporting the coal bags, and the direction of the ropes being reversed the carriage makes a trip back again to the warship.

The speed of conveying is about 1,000 feet per minute, consequently the load will be taken from the collier and deposited in the warship in about twenty seconds. The total tension on the rope will never exceed say 8,000 lbs.; furthermore should the ships pull away from each other and the tow-line part, the only effect will be to unwind the rope from one of the drums, its end falling into the water, whereupon the other drum will wind it up and recover the carriage.

#### CABLEWAYS FOR PASSENGER SERVICE.

Cableways used exclusively for passenger traffic are as yet very rare, but many lines installed for the transporting of material are used incidentally for this purpose. A ropeway on the "Bleichert" system over the Chilkoot Pass in Alaska is a notable instance of a ropeway used in this capacity, for during the summer months many miners on their way to and from the Klondike make use of it to traverse this difficult piece of country.

Probably the only line of any considerable length in use at the present time, constructed solely for the carriage of passengers is situated in Hong Kong in connection with a large sugar works, in

which a nu  
freedom fr  
day's work  
is arranged  
the ropewa

Severa  
Tennessee,  
have been s  
The ropew  
Tennessee r  
on either si  
cables comb  
was 20 feet  
1,200 lbs.,  
Automatic l  
break or ru

The tri  
in three and

The lin  
the breaking  
resulted in  
broken cable  
point some f  
rescued by a

About t  
the Ohio riv  
distance of 3  
each, and ma

This lin  
line at Knox

There is  
"shoot," hav  
riages are all  
system is of a  
able goods.  
from 100 to 4



which a number of European workmen are employed, and to secure freedom from fever these men are transported at the end of their day's work to a sanatorium at a high level above the sea. The carrier is arranged for the accommodation of six men at a time, the speed of the ropeway being eight miles per hour.

Several years ago a passenger line was erected at Knoxville, Tennessee, and had this proved a success it is probable that it would have been soon followed by many similar lines all over the country. The ropeway consisted of two  $1\frac{3}{8}$  in. wire cables spanning the Tennessee river a distance of 1,060 feet, and anchored on the bluffs on either side which are 350 feet and 230 feet above the water. The cables combined had a breaking strength of 240,000 lbs. The car was 20 feet long by 6 feet wide and  $6\frac{1}{2}$  feet high weighing empty 1,200 lbs., and having a seating capacity of sixteen passengers. Automatic brakes were provided in case the propelling cable should break or run slack.

The trip down was made in about half a minute and the return in three and a half minutes. The fare being five cents.

The line was only operated for the part of one season, when the breaking of the moving cable caused a serious accident, which resulted in the killing of one of the passengers by one end of the broken cable striking him on the head. The car came to rest at a point some forty or fifty feet above the river and the passengers were rescued by a steamboat run under the car.

About the same time a similar ropeway was designed to cross the Ohio river at Wheeling, West Virginia, to Wheeling Island, a distance of 3,000 feet. It was to have two cars carrying fifty people each, and make the trip across at the rate of 1,000 feet per minute.

This line was never erected owing probably to the failure of the line at Knoxville which seriously involved the promoters financially.

#### CABLE SHOOTS.

There is still another system of ropeway in common use called a "shoot," having one fixed rope placed on an incline, on which carriages are allowed to run down uncontrolled, one at a time. This system is of a simple nature, and used for the transport of undamageable goods. The carriages have one or two wheels and carry loads from 100 to 400 lbs. At the lower end brushwood or other convenient

means are provided to absorb the force produced by the running load when it arrives at the lower terminal. This can be considerably lessened by regulating the sag of the rope, where the section of ground will admit, so as to reduce the speed of the runner with its load as it approaches the lower terminal.

Spans can be made without support up to 7,000 feet, and all that is required for fixing the rope is a good anchorage at the upper end and another with a tightening gear at the lower end.

Ropes for this purpose up to 3,500 feet span are made in the form of a strand, above this in order to obtain the necessary strength with a moderate size of wire, the ropes consist of several strands formed each of a number of wires.

The runners have wheels of small diameter and are made as light as possible, in order that after 50 or 100 loads have been delivered, the empty ones may be carried up to the upper end for a further delivery of material.

The applications of this system are too numerous to mention; probably many hundreds of miles are in operation, being used largely for the transport of firewood, coffee, and like materials, and is found where practicable to be efficient, economical, and speedy.

#### WIRE ROPES.

Before concluding this treatise it will be of advantage to say a few words about the construction and use of wire rope, for on it depends the whole working of the line.

In America the common practice is to construct the wire cables similarly to the hemp ropes, strands being first woven from the small wires and these, again woven together about a hemp or wire center, but in an opposite direction from the original wires.

Ordinary wire rope is composed of six strands each containing seven, twelve, or nineteen wires laid up about a hemp or wire center.

"Nineteen wire" rope with hemp center, having great pliability is best suited for running ropes on cable railways, while "seven wire" and "twelve wire" ropes being stiffer and less flexible are better adapted for guys and stationary ropes, and when employed for this purpose are galvanized. For transmission of power "seven wire" rope is generally preferred, as owing to the larger size of the component wires, a greater wearing surface is offered.

To ov  
strands ab  
wires, bei  
ropes. TH  
America, l  
the "Univ  
than ropes  
of wires l  
wires are l  
are expose  
creased.

To pr  
manufactu  
cable, the  
each other,

These  
stiffer than  
a smaller r  
equal stren

A cabl  
Wire Co. fo  
of which fo  
gular wire

Wire r  
feet, but w  
rope and th  
loaded on  
piece of sla  
next one in  
that it will

Wire r  
it is wound  
the rope is  
should be r  
in that ma  
kinking.

To overcome this undue wear the English custom is to lay the strands about the hemp center in the same direction as the individual wires, being just the opposite direction to the strands in ordinary ropes. This system of winding is also used to some extent in America, being known as the "Lang" or "Albert" and sometimes the "Universal" lay. Ropes wound in this way are more flexible than ropes of the same diameter and composed of the same number of wires laid in the ordinary way, and owing to the fact that the wires are laid more axially in the rope, longer surfaces of the wires are exposed to wear, and the endurance of the wire is thereby increased.

To present a maximum wearing surface, the Trenton Iron Co. manufacture a special kind of rope, which they call a "locked wire" cable, the outer wires being of such a shape that they interlock with each other, presenting a smooth surface.

These ropes have wire cores and on this account are somewhat stiffer than ordinary cables of the same size, but being much stronger a smaller rope of this design can be used for the same work, and for equal strength it is more flexible.

A cable having a similar smooth surface is made by the California Wire Co. for track cables. It consists of nineteen heavy wires, seven of which form a core, the other twelve alternately a round and a triangular wire are wrapped around this core.

Wire rope is usually shipped on reels holding several thousand feet, but where any part of the line is inaccessible to waggons, the rope and the rest of the machinery must be packed so that it can be loaded on mules. Each animal carries about 250 lbs., including a piece of slack rope about twenty feet long, connecting its load to the next one in the rear. This piece is usually held up by a native, so that it will not drag on the ground.

Wire rope must not be coiled or uncoiled like hemp rope. When it is wound upon a reel, the reel should revolve on a spindle while the rope is paid off; when laid up in a coil not on a reel, the coil should be rolled on the ground like a wheel, and the rope paid off in that manner, so that there will be no danger of untwisting or kinking.

To preserve the rope and prevent undue wear it should be covered thoroughly with raw linseed oil, or with a paint made of equal parts of linseed oil and spanish brown, or lamp black.

The drums and sheaves along the line should be as large as possible, for the larger the sheaves the less bending will occur in the cable and consequently the less wear. However every maker of wire rope supplies a table of the minimum diameters of sheaves to be used with every style of cable for a maximum safe working tension and the size of the sheaves depends largely on these values.

**THE PRO**

Among  
water falls  
of speed re  
a modern v  
most impor

The p  
great exten  
power in op  
plied with.

It was  
influence th  
tion; and a  
speed under

It is t  
by correct d  
close regulat  
there is a l  
the problem  
cases theory

With t  
operating pe  
extremely va

The loa  
as those of e  
easier to cor  
tric railway,

d be covered  
equal parts

as large as  
will occur in  
ry maker of  
f sheaves to  
working ten-  
values.

**THE PROBLEM OF SPEED REGULATION IN PLANTS DRIVEN  
BY WATER POWER.**

---

W. A. HARE, GRAD. S. P. S.

---

Among the many problems which the generation of power from water falls has brought to the attention of the engineer, the question of speed regulation, under the complex conditions which surround a modern water power plant, may be considered as being one of the most important.

The present demands for constant speed, brought about, to a great extent, by the widespread adoption of water falls as a motive power in operating electrical machinery, have only lately been complied with.

It was necessary, before success was assured, to determine what influence the design of different parts of the plant had on the regulation; and also to produce a governor which would retain a constant speed under the conditions of favorable design.

It is the intention of the writer in this paper to show how, by correct design, many of these influences which are detrimental to close regulation, can be considerably reduced. In nearly all this work, there is a large element of uncertainty, arising from the nature of the problem, in which experience is the only teacher; still in many cases theory will be of considerable assistance in preparing the design.

VARIABLE LOADS.

With the adoption of electrical transmission as a means of operating power machinery at a distance, have been introduced those extremely variable loads which make regulation so difficult.

The loads on electrical lighting circuits do not vary so suddenly as those of electric railway or power circuits, and therefore it is much easier to control the speed of the dynamos. In the case of an electric railway, if a number of cars are thrown off at once, the speed of the

dynamo would immediately increase, and as in most machines the voltage is proportional to the speed, it will be subject to those variations which, to say the least, are extremely undesirable. To control the speed of a turbine, when the load is varying from half to full load and vice versa, is a feat which will be found difficult with the best type of governor.

When many dynamos are driven from the same shaft, there is not the same danger of a sudden drop in the total load on the wheels, as the several fluctuations in the separate circuits tend to counteract each other. If there are only 2 or 3 machines, there is the remote possibility of a conjunction of a drop in all loads; but as this case is not at all likely to occur it would not be necessary to consider this case in the general problems of regulation.

Many operators of electric railway plants driven by water power, have considered this method of driving too risky and dangerous to be successful. This is simply because the design of the plant was such that it was almost impossible to secure the degree of regulation required with the existing load variations.

In all plants where a number of turbines are supplied from the same pipe or flume, and where the fluctuations of load on each individual turbine are distinct from those of any other in the set, the resulting changes of velocity in the supply pipe, which is approximately the algebraic sum of all the momentary changes in each of the turbines, will be very much less than if each wheel were supplied from its own pipe. In installations of this kind, water hammer is not so formidable, and in many plants is almost negligible. The same effect is reached, if we have all the loads of the separate turbines taken from one common shaft, to which each turbine is connected, by belts or gearing. By this means, a load variation, which would be considerable if it came all on one wheel, will not influence the speed to any extent when it occurs as a variation of the common load. If we were to take out the line of turbines, and replace them by one or two wheels of large power, the variations of the load would have the same influence as when all the wheels were coupled.

We then can reduce the effect of heavy load variations by employing large units, or by coupling the small ones. In either case the load variations, by being distributed over the whole plant, do not have so much effect on the speed, and also, the velocity of the water in the

flume is not  
to compen

There  
in which t  
engine. T  
close study  
engineer, b  
water whee

The e  
height of t  
not seem to

What  
ing an inst  
speed was  
which mus

The p  
is sometime  
sidering reg  
rate, and a  
that before  
new area o  
throughout  
equation, th  
The kinetic

Where  $K$  is  
per second.

$W$  is th  
 $v$  is th

If we c  
energy mus

We have.....

and.....

flume is not changed materially when the governor is put into action to compensate for them.

There are a large number of plants now in successful operation, in which the regulation is as close as could be effected by a steam engine. This degree of success has only been brought about by a close study of the problem, not only on the part of the designing engineer, but also on the part of the inventors and builders of the water wheel governors.

#### WATER HAMMER.

The exact influence that the length of the supply pipe, and the height of the fall, exerts on the problem of successful regulation, does not seem to be fully understood, even by many practicing engineers.

What was originally disregarded as of no consequence in designing an installation, on account of either low heads, or that constant speed was not absolutely necessary, now becomes a live problem, which must be solved before successful regulation can be secured.

The peculiar action of "water hammer," or "water ram," as it is sometimes called, is one that calls for our best attention when considering regulation. If we have a long pipe, discharging at a given rate, and attempt to throttle the water at the orifice, we will find that before we can check the flow to the value corresponding to the new area of the orifice, we must check the velocity of the water throughout the entire pipe; and as will be shown by the following equation, this represents a considerable change in the kinetic energy. The kinetic energy in the pipe line is represented by the formula:—

$$K = \frac{1}{2} \frac{W}{g} v^2 \dots\dots\dots (1)$$

Where  $K$  is the total kinetic energy present in the pipe line in ft. pds. per second.

$W$  is the total weight of water in the pipe line, in lbs.

$v$  is the velocity of the water in the pipe line, in ft. per second.

If we change the velocity in the pipe from  $v$  to  $v_1$ , the kinetic energy must change also.

We have.....  $K = \frac{1}{2} \frac{W}{g} v^2$

and.....  $K_1 = \frac{1}{2} \frac{W}{g} v_1^2$

Now let  $v_1$  be less than  $v$  then by subtracting we get,

$$K - K_1 = \frac{W}{2g} (v^2 - v_1^2) \dots \dots \dots (2)$$

The difference in the kinetic energy must be expended in some manner, before the velocity can be reduced to  $v_1$ . It will be found that if the valve is partly closed, the pressure at the lower end will rise suddenly, and if the valve is closed quickly, any great proportion of its travel, and no means are provided for the escape of the water, the pressure will rise high enough to perhaps burst the pipe.

From the standpoint of regulation, this effect of water hammer is very objectionable, so much so, as to prevent the use of governing systems which change the power supply by throttling the orifice, in cases where the effects of water hammer cannot be sufficiently reduced. When the regulation is effected by deflecting the jet, which acts on the wheel, the velocity in the supply pipe does not change with the variations in the load, and therefore no water hammer effect is created. This method can only be used with wheels of the Pelton type, and therefore does not come into the present discussion. With all types of reaction turbines, regulation is secured by varying the quantity of water passing through the wheel per second, and as there is no alternative open to us, we must consider the effect that water hammer has on the regulation; and see if there are not means by which it can be reduced, if not removed altogether.

Let us trace the course of events which take place when a turbine, operating at the end of a long flume, is regulated by means of a governor. We will suppose that the plant is running at a constant speed, when an increase in the load occurs. As soon as the speed begins to change, the governor is put into action, and attempts to connect the irregularity, by partly closing the gates. This action on the part of the governor will necessarily take some time, but even then, the velocity of the water in the supply pipe will be checked much too soon to prevent water hammer. The effect produced is a sudden rise in the pressure of the water near the wheel, which increases the velocity of the water passing through it. It is quite possible, then, that even if the gates be partially closed, the wheel may receive more power than it did before the gates were moved. This effect, though lasting only for a very short time, is sometimes in action

long enough to close the gates again, which still

We have seen that the pipe, near the pipe line, to be displaced. Similarly, in the kinetic energy and in the considerable amount brought back had opened power, in wider. The speed is the same fl

We can see that, except for stability if we

In the good regulation. It can easily be seen that the draft tube smaller diameter



long enough to allow the speed to be accelerated, and for the governor to close the gates still further. During this time, the kinetic energy represented by formula (2) has, to a great extent, been expended in giving velocity to the issuing water, and we now find the velocity of the water in the wheel not far above normal. In this double movement, the governor has closed the gates too far, and as soon as the velocity falls back to normal, the power supplied to the wheel will be found to be insufficient for the demand. The speed consequently falls, thus energizing the governor, which begins to open the gates again. The opposite effect is now produced in the supply pipe, which still further complicates matters.

We have found that a change in the velocity of the water in the pipe, necessitated a considerable change in the kinetic energy in the pipe line. When the gates were closed, a large amount of energy had to be disposed of, in some way, before the velocity could be reduced. Similarly, when a higher velocity is required, there must be an increase in the kinetic energy in the pipe, before the velocity can increase. All the energy in the pipe is obtained from the action of gravity on it, and in the case of long pipes, as will be shown later, there is a considerable duration of time required before the velocity can be brought back to normal. In the case under discussion, the governor had opened the gates, but as this was followed by an increase of power, in fact by an actual diminution, the gates are opened still wider. The gates are now opened too far, and it is not long before the speed is increased which again puts the governor into action, and the same fluctuations are repeated.

We can easily see that with such disturbing influences, regulation, except for very slight variations of load, would be an impossibility if we had no method of reducing or preventing this action.

#### DRAFT TUBES.

In the design of the draft tubes, these same influences against good regulation must be considered, together with some new ones. It can easily be seen, from what has been said, that theoretically, the draft tube should be as short as possible. We cannot, however, change the diameter, very much, unless we make it slightly conical, with the smaller diameter at the wheel. This design is preferable, not only

on account of regulation, but also, because it adds to the general efficiency of the installation.

The maximum length for any draft tube is theoretically about 34 feet, or the height of the water barometer; but for various reasons it is never made more than 25 feet, unless other considerations outweighed the ones under discussion.

If we have a draft tube 34 feet long, the pressure outside, at the top, will be approximately 14.7 lbs. per square inch greater than that inside, and for this reason we can hardly expect them to remain perfectly air tight. Any leakage of air at once destroys the vacuum, more or less, and when this occurs we have losses of head and efficiency which make our problem extremely difficult.

In all draft tubes, the water is held in position by the pressure of the atmosphere on the surface of the tail race. The pressure at the top of the column will always be less than atmospheric, depending principally on the length of the draft tube. When the plant is running normally, this pressure will remain fairly constant; but will vary with each change in the gate opening. If the quantity of water flowing per second is changed, by a movement of the gate, the kinetic energy of the column of water in the draft tube must necessarily change also, and can be expressed by formula (2). When the gate movements are gradual, the above change will not affect the regulation; but, on the other hand, if the gate is closed, suddenly, the velocity in the draft tube will not be changed as quickly as the gate movement would call for, and, as a result, the column will part at the top, and drop in the draft tube.

The change of kinetic energy represented by formula (2) must be expended in some way before the velocity can be reduced. Under normal conditions, the pressure on the top of the column, together with the pressure due to the height of the water, balances the atmospheric pressure; but when the column falls, these pressures are reduced. This creates an upward pressure at the bottom of the draft tube, which absorbs the kinetic energy, and reduces the velocity. When this has been done, the level of the water will be too low, and therefore the water will rise suddenly, and, if the disturbance has been very sudden, may strike the wheel with considerable violence. Apart from the liability to accident from this cause, it is evident that

the effect of  
tion, since  
supplied, w  
in all prob  
been starte  
of air in th  
supply of a  
degree of v  
stantly vary  
at the top.  
with every  
ing pulsati  
itself almo

If we  
(2), and c  
always be d  
purpose of

In man  
no small m  
pipes are of  
low heads, s  
load are vic  
electric rail  
winter is no

It is ne  
plete chang  
a moderate  
occur at sho  
able extent;  
value from

The sta  
pipe, as near  
of sufficient  
vary very m  
flume. The  
of the water

the effect of this swaying column must be very detrimental to regulation, since the head acting on the wheel, and consequently the power supplied, will vary with these fluctuations. If this occurs a few times, in all probability the draft tube will leak air, as the seams will have been started by the force of the returning water. With the introduction of air in the draft tube the trouble is more serious, as the continual supply of air through the leak, prevents the formation of the proper degree of vacuum. The result is, that there exists a partial and constantly varying vacuum, which causes the column to permanently break at the top. It is now suspended in the draft tube, swaying up and down with every slight change in the load. This produces a corresponding pulsation of the working head on the turbine, which would by itself almost effectually prevent any success in regulation.

If we make the draft tube short, we reduce the  $W$  in formula (2), and consequently reduce all these tendencies. This should always be done as far as possible, consistent with the demands and purpose of the installation.

#### STAND PIPES.

In many designs of water power installations, the regulation is in no small measure due to the stand pipe on the supply pipe. Stand pipes are of special value in plants; firstly, which have comparatively low heads, say under 40 feet; secondly, in which the fluctuations of the load are violent and of very short duration, as for instance in an electric railway power-house; and thirdly, in countries where the winter is not too severe.

It is not, in electric plants, of as much importance that a complete change from friction load to full load should be attended with a moderate fall in speed, as that large fluctuations of the load, which occur at short intervals, should not change the speed to any considerable extent; and it is in cases such as these that we get the most value from the use of stand pipes.

The stand pipe is located at the lower end of the flume or supply pipe, as near to the penstock as possible. It should be designed to be of sufficient diameter, so that the static pressure at the wheel will not vary very much for a given change in the velocity of the water in the flume. The top of the stand pipe should extend a little above the level of the water in the pond or forbay, and it is for this reason that it is

not applicable for high heads. Practice determines that stand pipes should be of the greatest diameter possible, and not to extend further above the level of the water in the forbay than to prevent water running over the top when the plant is shut down. The top should be turned over and an escape pipe put up to allow the overflow to run off.

In a plant equipped with a stand pipe, should a considerable proportion of the load go off; as for instance that caused by the throwing of a circuit breaker in an electric plant, the governor immediately closes the gates to the correct position for the new demand. The velocity of the water in the flume being thus checked, the water ram effect is expended in forcing water up the stand pipe and over the top. The static head on the wheel, and the corresponding pressure in the wheel case, can never be greater than that due to the column of water in the stand pipe, which as before mentioned, is only a short distance higher than the water in the forbay. The water ram effects are therefore disposed of effectually, because the velocity was not checked as quickly as if there were no stand pipe used, and therefore less water ram was created.

Should the load return to its original value again, the demand for water at the wheel will have its effect in lowering the pressure, and consequently the level of the water in the stand pipe will fall a corresponding amount. This drop in the level of the water means that the stand pipe has given up a certain amount of energy to the supply pipe, and thus tends to retain a more constant pressure over the wheel than otherwise.

It is therefore evident that the stand pipe, if it is to be capable of assisting materially in maintaining a fairly constant pressure over the wheel, cannot be much higher than the hydraulic grade line at that point, if the pressure is to be kept down to normal, and on the other hand, will have no range of action, if not made higher than this. The only course open to us, then, is to increase the area of the pipe at the top, so that a large quantity of water can pass up or down the pipe, without there being too much variation in the level of the water. We can, in this way, compensate, to some extent between the two demands to be made on it, which seems to determine the lines along which the design should be made.

If the  
will be pro  
a stand pi  
meet the c  
the installa  
that will b  
water.

In cou  
many degra  
problem, n  
the water  
plant is sh  
now free t  
weather, ev  
would gra  
which wou

Apart  
value in ma  
to offer mo

When  
other mean  
hammer. T  
of high hea  
press the ai  
and as a res

The air  
tion, as the  
would in a s  
water level.  
that they ar  
rise and over  
top of the st  
to the pressu  
so detriment

If the flume or supply pipe is long, the water hammer effects will be proportionately great. To diminish these effects by means of a stand pipe we will require one of sufficient area and height to meet the conditions, which will add considerably to the expense of the installation, not only for the pipe itself, but for the foundations that will be required to carry the weight of the pipe and contained water.

In countries like ours, where the temperature in winter falls to many degrees of frost, there is another element introduced in the problem, not encountered in countries farther south. If the surface of the water in the stand pipe should freeze over at night when the plant is shut down, the whole effect is destroyed, as the water is not now free to rise and fall with the pressure. In any case, in cold weather, even if the stand pipe was in operation, the ice on the sides would gradually accumulate until the pipe was completely closed, which would render it absolutely useless for regulating purposes.

Apart from these disadvantages, the stand pipe is of undoubted value in maintaining a constant head on the wheels, and so far seems to offer more advantages in favor of their adoption than otherwise.

#### AIR CHAMBERS.

When the head is too high to admit of the use of stand pipes, other means must be employed to reduce the effects of water hammer. The most natural step from the open stand pipe, in the case of high heads is to seal up the top, and allow the rising water to compress the air contained in the pipe. This idea has been enlarged on and as a result we have the present air chamber.

The air chamber, at best, is not of much use as an aid to regulation, as the pressure in it will rise and fall almost the same as it would in a stand pipe which was considerably higher than the static water level. When stand pipes are installed, it has been pointed out that they are made so that on an increase in pressure the water will rise and overflow. This prevents any degree of head higher than the top of the stand pipe. With air chambers, however, there is no limit to the pressure, so we still have those fluctuations of head which are so detrimental to regulation.

The chief use to which air chambers are put, is as a safeguard against water hammer, and when properly designed for this purpose they introduce a considerable factor of safety. It is evident that to absorb the energy of the moving column of water, the air chambers should be of ample size, to be of any service. They are sometimes installed on a pipe line and no further notice taken of them. This is a mistake, as water under pressure absorbs air, and an air chamber which at first would answer the purpose for which it was designed, would, in the course of time, be gradually filled with water, and become worse than useless. If a water glass, or a set of try cocks, be placed on the side, the level of the water can be readily ascertained. To replace the air which has been absorbed, an air pump should be used. If air-chambers are not pumped full of air, they will only be perhaps one-half full, when the full pressure is on, and the full effect one would expect from the size of the chamber is not obtained.

#### RELIEF VALVES.

Another device which is used to some extent to offset the influence of water hammer, is the relief valve.

In its simplest form, it is a spring balanced valve, placed on the supply pipe, which opens when the pressure in the pipe has reached a certain value, and by allowing the escape of the water, tends to prevent the pressure from rising much above this point. As soon as the pressure has fallen, the valve closes automatically. If designed on the right principles, and of ample size, these valves may be of considerable value in preventing great increases of pressure; but if not, they are very little good. One fault usually made, is that they are altogether too small for the work required of them, and consequently fail in their duty.

A combination of the air chamber and the relief valve is meeting with some success, and evidently contains some good features. The air chamber is placed between the valve and the supply pipe, and is supposed to ease the discharge from the relief valve when it experiences a sudden rise in pressure.

#### RELUCTANCE OR LAG.

We have shown in the preceding articles, some of the effects produced when the velocity in the supply pipe is checked by closing

the turbin  
tionable fr  
and by tal  
entirely eli  
difficulty e  
great. As  
when the g  
supply pipe  
low head, t  
where the  
tremely diff

In all  
quantity of  
could be do  
no difficulty  
It always h  
designed, th  
new movem  
quantity wh  
quently the

It shou  
possible the  
the gate is  
the way of  
of the chief  
when the ga

Suppose  
water per se  
this case th  
very close to  
other condit  
steady flow.

Under t  
forces acting  
giving to the  
to its fullest  
pressure at th  
when the ga

the turbine gates. These effects, though being extremely objectionable from the standpoint of regulation, can, with good design, and by taking proper precautions, be considerably reduced, if not entirely eliminated. If this were the only problem before us, the difficulty encountered in securing close regulation would not be so great. As it is we have another very important effect produced when the gates are opened again. If we have a plant in which the supply pipe is short and well designed, operating under a moderately low head, this does not become at all a serious matter, but in cases where the pipe is long, and poorly designed, we find that it is extremely difficult to secure good regulation.

In all turbine plants, regulation is effected by changing the quantity of water passing through the wheel per second, and if this could be done while the pressure was kept constant, we would have no difficulty in securing good results under a wide range of conditions. It always happens, however, that no matter how well the plant is designed, the pressure at the wheel will vary somewhat with each new movement of the gates, thus introducing another variable quantity which influences the power delivered to the wheel, and consequently the regulation.

It should be the aim of every designer to reduce as much as possible the variations of pressure which occur at the wheel when the gate is moved, as by doing so one of the greatest difficulties in the way of regulation will be removed. We will now consider some of the chief agencies which cause a change in pressure at the wheel, when the gate opening is varied to suit the load requirements.

Suppose we have a supply pipe delivering a certain quantity of water per second, with the gate opening one-half its maximum. In this case the velocity of the water as it issues from the orifice is very close to its theoretical value, and will not change from this if other conditions remain constant. This is called the velocity for steady flow.

Under these conditions, there is equilibrium in the pipe. The forces acting on the water in the pipe line, expend themselves in giving to the issuing water its velocity. If now the gate be opened to its fullest extent, the equilibrium is destroyed, because the back pressure at the orifice has been reduced. The first effect which occurs when the gate is opened, is a considerable decrease in the issuing

velocity at the orifice, for as the velocity of the water in the supply-pipe was not changed as quickly as the gate opening, the issuing velocity must become less in order that the same quantity per second be discharged. The velocity of the water in the supply pipe, will now increase until equilibrium has been once more established, which will be brought about by the velocity of the issuing water coming back to its former value. It is evident that the velocity at the orifice, after being reduced, will require some time before it can arrive at its normal value, corresponding to steady flow, and as a reduction of the velocity means a reduction of the power supplied to the wheel, we see that this *time* has considerable influence in the regulation. In order that we may determine the time required for the velocity to reach the steady conditions, we will consider the problem in its simplest form.

Let us suppose a pipe of a certain length  $l$ , and let the difference in level between the two ends be  $H$ . The maximum velocity at the lower end of the pipe when it is running full, and under conditions of steady flow, will be, if we neglect all frictional resistances, the theoretical value represented by the equation:

$$V = \sqrt{2gH}.$$

Let  $v$  be any proportion of this maximum value. Let us suppose that the pipe is full of water, and with the lower end closed. If now the gate at the lower end be instantly opened, the time that will elapse before the velocity of the issuing water reaches the value  $v$ , will be represented by the equation:

$$t = \frac{l}{\sqrt{2gH}} \log_e \frac{\sqrt{2gH} + v}{\sqrt{2gH} - v} \dots\dots\dots (3)$$

Where  $t$  is the time required for the water in the supply pipe to reach the velocity of steady flow, from rest;  $l$  is the length of the supply pipe in feet;  $H$  is the head of water acting on the wheel; and  $v$  is any velocity at the orifice between zero, and its maximum value  $V$ .

If we let  $v = V = \sqrt{2gH}$ ,  $t$  becomes infinity. This is the theoretical time required under these conditions, and is of course useless to us in this form. If, however, we let  $v = .95 V$ , we get a finite value for  $t$  which is not very far from what we would expect in an actual case.

In Fig. plotted from maximum v 100 feet.

In prac as being tru serve to show

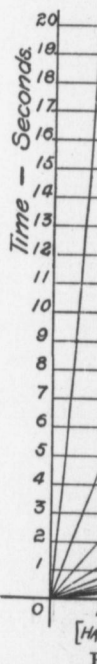

If we co the cross sect is slightly diff and  $A_2$  the ar

As  $v$  rep part of this ex



In Fig. 1 are shown a number of curves which have been plotted from the above equation, in which different values for the maximum velocity have been taken. In all cases  $l$  has been taken as 100 feet.

In practice we cannot take values calculated from this equation as being true as the suppositions are somewhat limited. Still they serve to show the general theory under which the water is moving.

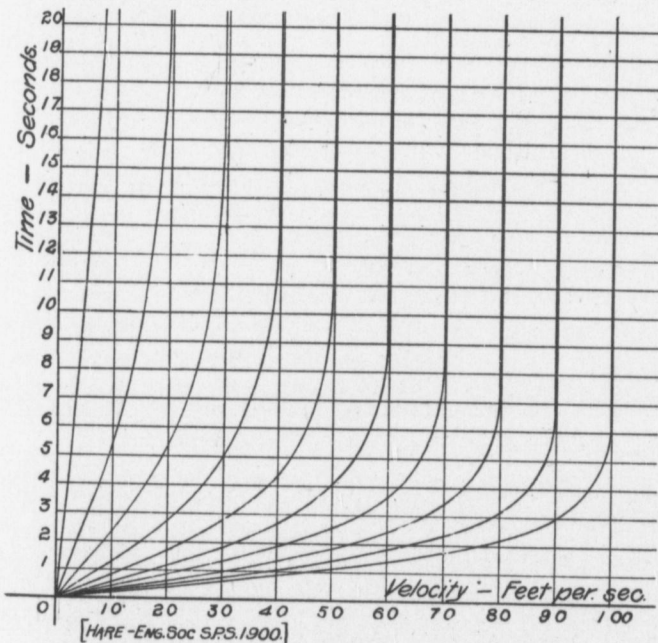

FIG. 1.—TIME—VELOCITY CURVES, FOR SUPPLY PIPES.

If we consider the effect of the gate opening, as compared with the cross sectional area of the supply pipe, we find that the equation is slightly different. If we let  $A_1$  represent the area of the supply pipe, and  $A_2$  the area of the gate opening, the equation becomes:—

$$t = \frac{l \left( \frac{A_2}{A_1} \right)}{\sqrt{2gH}} \log_e \frac{\sqrt{2gH} + v}{\sqrt{2gH} - v} \dots\dots\dots(4)$$

As  $v$  represents the velocity of the water at the orifice, the last part of this expression gives the same value as formerly; but as  $\left( \frac{A_2}{A_1} \right)$  is

always less than unity, the value given by the first part of this expression is directly proportional to the value  $\left(\frac{A_2}{A_1}\right)$ , and therefore the time  $t$  required is much less than when found by equation (3).

We see by this that the time can be reduced by making  $A_1$  large as compared with  $A_2$ ; that is, by making the area of the supply pipe large as compared with the maximum value of the gate opening.

Suppose we wish to find the time required for the velocity in a pipe 250 feet long, installed under a head of 99.5 feet, to reach the condition of steady flow, from rest. In Fig. 1 we find that the time for the water in a pipe 100 feet long to reach the velocity of 80 feet per second,—which is the theoretical maximum—is about 7.2 seconds. Now as the time is proportional to the length of the pipe, the time in our case will be  $7.2 \times 2.5 = 18$  seconds. In no practical case would these conditions apply, but if we now assume values for  $A_1$  and  $A_2$  and introduce them in equation (4), we will find the time considerably reduced. Let  $\frac{A_2}{A_1} = \frac{1}{9}$ , which is a value taken from actual practice, the time will then be  $\frac{1}{9} \times 18$  seconds = 2 seconds, which is a fair approximation to the actual case.

As friction has been omitted in this work, the time will be somewhat greater than that calculated.

Perhaps we are not so much interested in the time required for the water to reach its maximum velocity, as we are in the time elapsing before the full power of the wheel could be obtained from the water in the supply pipe, after the full load was thrown on.

Suppose we have a wheel running at its normal speed under friction load only,—which would be with about 6 per cent. gate opening—and the full load were instantly thrown on. The gates are rapidly opened by the action of the governor; but as we have already shown, the water in the pipe line requires some time to reach the condition of steady flow again, and therefore the power of the wheel will not be developed for some seconds after the movement of the gate.

Although we can tell with fair accuracy the velocity at the wheel at any time, we cannot find the pressures. If we suppose that the

pressure in  
being deliv

Where  
the velocity  
be very clos

Under  
the energy  
creases to it  
of the wheel  
entry witho

Unless  
energy of t  
other ways.  
without sho  
in giving a  
too fast the  
In either ca  
only give us  
the wheel.

There i  
ments of the  
efficiency of  
designed to  
to allow a m  
without muc  
the efficiency  
position of v  
at best.

The abo  
guides is atr  
proper speed  
conditions ar  
the power be  
times attempt

pressure in the wheel guides is atmospheric, we may express the energy being delivered to the wheel per second, by the equation—

$$P = W \frac{v^2}{2g} \dots\dots\dots (5)$$

Where  $W$  is the weight of water passed per second, and  $v$  is the velocity of the water in the guide passages; which in this case will be very close to the theoretical maximum.

Under these conditions it would be easy to plot a curve showing the energy being delivered per second for each value of  $v$  as it increases to its maximum; but even then, we would not have the power of the wheel, unless the wheel was running at the correct speed for entry without shock.

Unless a turbine is running at or near its normal speed, the energy of the water is not absorbed entirely, but expends itself in other ways. For instance; if the wheel is running too slow for entry without shock, the energy is partly expended on the wheel, and partly in giving a high velocity to the water at the off-flow; or if running too fast the energy of the water is not utilized to its fullest extent. In either case a knowledge of the power of the issuing stream would only give us a rough approximation to the energy being absorbed by the wheel.

There is another disturbing element, which, with large movements of the gate would make our work more difficult and that is the efficiency of the wheel at part gate. Most modern turbines are designed to give their maximum efficiency at seven-eighths gate so as to allow a margin of gate movement from about three-fourths to full, without much variation in the efficiency. Below three-fourths gate the efficiency drops rapidly, and any calculations made on the supposition of uniform efficiency would be very rough approximations at best.

The above equation will only be true, when the pressure in the guides is atmospheric, and also when the wheel is running at the proper speed for entry without shock. As in any practical case, these conditions are not likely to be met with, it is useless to try to express the power being supplied to the wheel by this equation as is sometimes attempted.

## STORED ENERGY.

In steam engine design, owing to the intermittent manner in which the power is supplied to the crank shaft, and to the variations of the load on the engine, flywheels are required to equalize the effects resulting from this variation of demand and supply. For the same reasons flywheels are necessary in water power plants where these conditions apply; but in the case of water powers, we meet with various other difficulties which make it necessary to provide this capacity for power storage.

1st. The principal reason for power storage in any case, is to provide a reserve of energy between the *demand* for a change in the power, and the *supply* from the source of energy. It is evident that if we could supply the new demand for power exactly as soon as it was required, the speed would not show any fluctuation, and there would not be any power storage needed. This is impossible, as by our system of governors, the speed has to change before the governor can act. As in the ideal case, there is no time lost between the demand and the supply, designers of governors should aim to lose as little time as possible in getting the governor to work. All time lost here will increase the amount of power storage required. This shows the influence of the sensitiveness of the governor on the power storage. We may however almost neglect this loss, as in all of the good governors now on the market the sensitiveness is most satisfactory.

2nd. The rigging of the gate, if not constructed in a substantial manner, will introduce a time loss between the movement of the governor and that of the gate. If the shafts are too light, we have torsional effects, and the gate movement does not correspond to the motion of the governor. With good design this loss may be neglected.

3rd. The gates to be moved in regulating a water power plant, being in many cases very heavy, cannot be opened and closed as easily and quickly as those of a steam engine for instance; and as the changes in the power supplied cannot be quicker than the operation of the gates, it is evident that the power storage, sufficient to retain the speed within certain limits, until the gates do operate, must be much greater than in ordinary cases of quick moving valves.

4th. I

wheel are c  
some time l  
on the desi  
load occurs  
not go beyo  
time to effe  
velocity of  
the variatio  
movement c  
of storing p  
increase of

For ins  
and having  
the dynamo  
normal at th  
from half t  
gates to pro  
in the suppl  
was, say 50  
flume has re  
would rapid  
energy were  
amount of e  
speed begins  
cient to tide  
speed at its  
wheel is pro  
slowing dow  
the change  
of the oppos  
the governor  
time, accord  
posed of. As  
of 50 h.p., t  
revolved at a  
an amount  
therefore by

4th. It has already been shown that when the gates of a water wheel are opened quickly, the ultimate velocity is not attained until some time has elapsed; the amount of time lost in this way depending on the design of the supply pipe, etc. When a sudden change in the load occurs, and it is required that the variation of the speed must not go beyond a certain limit in a certain time, and also as it requires time to effect a change in the position of the gates, and also in the velocity of the water in the supply pipe; it is evident, that to retain the variations of speed within the required limits, before the new movement of the gates can be completed, we must have some means of storing power, so that it may be given up to the system on an increase of load and absorbed by the system when a decrease occurs.

For instance let us consider the case of a wheel driving a dynamo, and having on the same shaft a flywheel of suitable design. Suppose the dynamo is only operating at half its output, and everything is normal at this load. The switch is thrown on, increasing the output from half to full load. The governor instantly begins to open the gates to provide more power, but gravity will not act on the water in the supply pipe as quickly as is desired. If the change in the load was, say 50 h.p., and 3 seconds must elapse before the water in the flume has reached its full velocity, then it is evident that the speed would rapidly fall considerably below normal, if no other source of energy were present. The flywheel, however, contains in itself a certain amount of energy, and as soon as the new load is thrown on, and the speed begins to fall, it gives out energy to the revolving parts sufficient to tide over the intervening time, thereby tending to retain the speed at its normal rate. The energy contained in a revolving flywheel is proportional to the square of its angular velocity; so that in slowing down it must give up the amount of energy represented by the change of speed. Should the change in the above example be of the opposite nature, i.e., should 50 h.p. be instantly thrown off, the governor will begin to close the gates, which will require some time, according to the rate at which the water hammer can be disposed of. As the system is now running under an accelerating torque of 50 h.p., the speed will rapidly increase. The flywheel cannot be revolved at a higher velocity, without there having been spent on it an amount of energy corresponding to the increase in speed; and therefore by absorbing a large amount of this energy, the speed is

kept within limits, until the movement of the governor has been completed, and the power supplied from the flowing water reduced to its new value, corresponding to the condition of uniform flow.

With good design in the wheel, gates, supply pipe, etc., the necessity for such power storage will be reduced considerably. In many cases where the designs have been prepared, apparently without any regard to the requirements of a plant for good regulation; fairly good results have been obtained by the adoption of flywheels, of a more or less ponderous nature, bringing with them difficulties in support, in bearings, and in balance, which are usually a source of trouble and expense. In many cases, it is an alternative between the installation of a flywheel, and the reconstruction of other parts of the plant. The cheaper method should be adopted if the results expected are equal.

It is frequently found that in cases where turbines are installed under medium heads in open flumes, that no flywheel is necessary. This is because the "reluctance" of the water is reduced to a minimum, allowing a sensitive governor to operate to advantage, and very little time is lost between demand and supply.

It must not be inferred, that because there is no flywheel, that therefore there is no power storage; as it must occur, to a more or less extent, in all moving machinery. In this case, the flywheel effect is produced by the wheels and connected machinery; especially if the plant is an electric one, where the turbine is directly connected to the large generators, as the armatures or inductors would serve the same purpose.

When variations in the load occur slowly, the governor can move the gates quickly enough to take care of the speed, without there being much power storage. It is with the violent fluctuations of load that the true value of the storage capacity is brought out.

In the case of an electric railway or lighting plant, violent changes in the load, are more apt to occur as decreases, than as increases. A short circuit on the leads may throw the circuit-breaker, when any proportion of the full load will be instantly thrown off. The power storage should be sufficient to retain the speed below a dangerous limit until the governor has had time to close the gates, which action, in no case, can be done quicker than the water hammer effects can be absorbed; and as with such changes of load the gate

movement  
time. Wh  
dants, and

Power  
in all cases  
variable loa  
of procurin  
in the plan  
if not done

When  
which it is  
further exp  
It should b  
load while  
which have

In pres  
of claiming  
data in any  
work is on  
It was thou  
of some val  
that effect t

The r  
capacity in

We hav  
of energy in  
ments of g

The pr  
capacity of  
Before we c  
as possible v  
out, that th  
supply of po  
machinery c  
with any ch  
brium is des

movement will be proportionately great, the closing will take some time. When the load is thrown on, it is usually done by the attendants, and the change is not likely to be as severe.

Power storage has considerable value in regulation, especially in all cases where one has to contend with water hammer, reluctance, variable loads, etc., but should never be advocated as the only method of procuring regulation. It has been shown that with good design in the plant the demand for power storage will be materially reduced, if not done away with altogether.

When a point is reached in the design of an installation, beyond which it is not thought expedient to reduce these bad effects by further expenditure, the question of power storage can be considered. It should be sufficient not only to take care of the variations of the load while waiting for the governor, but also for the flume effects which have not been prevented by the general design.

In presenting the following equations the writer has no intention of claiming any great degree of accuracy for this method, as the full data in any practical case cannot be obtained exactly, and at best our work is only an approximation to the actual conditions prevailing. It was thought, however, that a study of some of these points may be of some value in bringing out a few of the most important influences that effect the power storage.

#### FLYWHEELS.

The most convenient way of providing this power storage capacity in any revolving shaft is by the use of flywheels.

We have shown in the foregoing the necessity for such a storage of energy in any plant, where the conditions do not meet the requirements of good regulation.

The problem now before us, is to determine the power storage capacity of the plant that will be sufficient to meet the requirements. Before we can attack this problem we must determine as accurately as possible what these requirements are. It has been already pointed out, that the necessity for power storage arises from the fact that the supply of power to the wheel, and demand of power from the operated machinery do not remain at a fixed ratio to one another, and that with any change in the demand of power from the shaft, the equilibrium is destroyed, which requires some time before it can be restored.

One of the most important influences that affect the demand for power storage is this time loss which occurs between the demand and supply. To determine this accurately is impossible, as these losses may arise from different reasons. The time loss which occurs in the supply pipe has already been considered. We have also the time lost from want of sensitiveness in the governor, and from bad gate rigging, as well as the time required for the governor to effect the required movement of the gate. Though we cannot obtain this time accurately, we can obtain values which are fairly close approximations. In any case, if the power storage is sufficient to take care of the speed under violent fluctuations in the load, that would otherwise endanger the safety of the plant, we may be sure that for ordinary normal conditions of operation, the speed will show very little variation. If we then determine what power storage will be required for safety in one of these cases, we may neglect the small changes of load and time losses which occur constantly under normal conditions.

Before this phase of the subject is dealt with it would be as well to consider, somewhat, the theory of the flywheel itself.

The kinetic energy in any revolving mass is represented by the formula:

$$K = \frac{1}{2} I \omega^2 \dots \dots \dots (6)$$

Where  $K$  is the kinetic energy in foot pounds per second,

$I$  is the moment of inertia of the revolving mass about its axis.

$\omega$  is the angular velocity in radians per second.

Writing this formula in terms of the revolutions per minute, we have:

$$\begin{aligned} K &= \frac{1}{2} I \left( \frac{2\pi N}{60} \right)^2 \\ &= \frac{\pi^2}{1800} I N^2 \\ &= .005483 I N^2 \dots \dots \dots (7) \end{aligned}$$

Now as  $I$  is a constant for any flywheel, we may write the formula:

$$\begin{aligned} K &= (.005483 I) N^2 \\ &= M N^2 \dots \dots \dots (8) \end{aligned}$$

When multiplied kinetic energy foot pounds wheel before amount the at that speed To show kinetic energy have been by selecting them in each

Figure From draw the first. The of  $N$  in per the change that for an increase the were to be

2nd. The  $N$ , in per kinetic energy revolving at cent. in each



Where  $M$  is also a constant for the flywheel; and which, when multiplied by the square of the revolutions per minute, gives the total kinetic energy present in the wheel. This is the amount of energy in foot pounds, which, if acting for one second, must be expended on the wheel before it can be revolved at  $N$  revolutions per minute; or the amount that will be required to stop it in one second if it is revolving at that speed.

To show more clearly the influence of the value of  $I$  on the stored kinetic energy, and the revolutions per minute, a number of curves have been plotted from the following equations, which were obtained by selecting values for  $I$  ranging from 2,000 to 20,000, and introducing them in equation (7).

$$\begin{array}{l}
 K = .005483 \times IN^2 \quad \text{or} \quad K = M N^2 \\
 \left. \begin{array}{l}
 1. K = .005483 \times 2,000 N^2 \quad " \quad K = 10,966 N^2 \\
 2. K = .005483 \times 4,000 N^2 \quad " \quad K = 21,932 N^2 \\
 3. K = .005483 \times 6,000 N^2 \quad " \quad K = 32,898 N^2 \\
 4. K = .005483 \times 8,000 N^2 \quad " \quad K = 43,864 N^2 \\
 5. K = .005483 \times 10,000 N^2 \quad " \quad K = 54,830 N^2 \\
 6. K = .005483 \times 12,000 N^2 \quad " \quad K = 65,796 N^2 \\
 7. K = .005483 \times 14,000 N^2 \quad " \quad K = 76,762 N^2 \\
 8. K = .005483 \times 16,000 N^2 \quad " \quad K = 87,728 N^2 \\
 9. K = .005483 \times 18,000 N^2 \quad " \quad K = 98,694 N^2 \\
 10. K = .005483 \times 20,000 N^2 \quad " \quad K = 109,660 N^2
 \end{array} \right\} \dots(9).
 \end{array}$$

Figure 2 shows these curves plotted from the above equations.

From an examination of these curves and equations, we can draw the following conclusions:

1st. That for the same value of  $I$  or  $M$ , and for the same change of  $N$  in per cent., we have a greater range in the values of  $K$  when the change of  $N$  is positive, than when it is negative. That is to say; that for any given flywheel there will be more energy required to increase the speed 1 per cent., than would be necessary if the speed were to be reduced 1 per cent.

2nd. That for a given normal speed,  $N$ , and a given change in  $N$ , in per cent., there will be the same change per cent. in the kinetic energy, for all values of  $I$ . In other words; if we have a shaft revolving at a given normal speed, and change the speed say 2 per cent. in each experiment, we will find that the kinetic energy will

change the same in per cent., for all sizes of flywheels. The total change in energy, however, will be directly proportional to  $I$ , or  $M$ .

3rd. If we select any two values of  $N$  on the curve of any given  $I$ , and change both the speeds a given per cent., we will find that the greatest per cent. of change in the kinetic energy will occur for the higher value of  $N$ ; or with a given flywheel, the greatest change in per cent. of the kinetic energy will occur at the higher speeds, for the same per cent. of change in the revolutions per minute.

From the first we see, that the speed will change more quickly in the case of a decrease in the load, than for an increase of the same amount. In the second case, when the speed and its limit of varia-

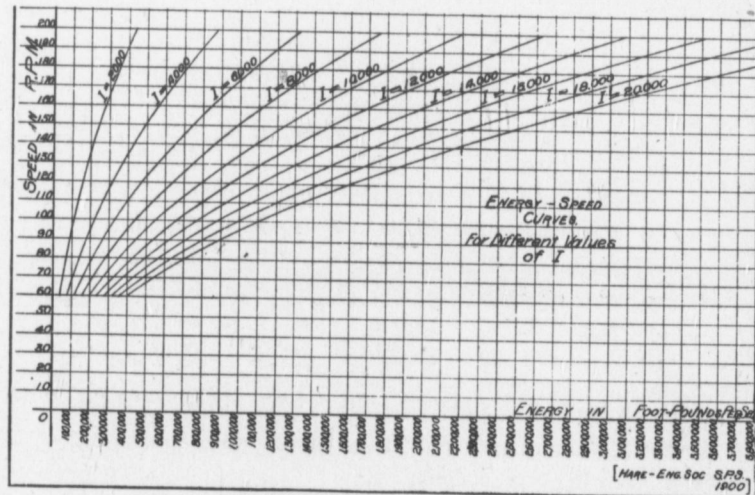

FIG. 2.—KINETIC ENERGY—SPEED CURVES, FOR FLYWHEELS.

tion are given, we have the available energy that we can take from, or add to, the shaft, directly proportional to the moment of inertia. From the third we see, that our flywheel should revolve as fast as possible, in order to obtain the best results.

Before we can design a flywheel that will meet the requirements of service, we must know; first, the maximum load change that is likely to occur; second, the time required for the water in the supply pipe to reach the condition of steady flow, after the gate opening has been changed; and third, the variation of speed that is allowable under this load change.

If our  
will most l  
has already  
waiting for  
we have pr  
some time  
change of l  
pipe to rea  
variation o  
wheel itself  
than 75 fee  
ing steel b  
In designin  
limit, whic  
and method

These  
in one equ  
Writing  
differentiat  
let  $dK = F d$   
the time  $dt$ ,

Intro

If the  
terms of the

If our plant is an electric one, the greatest variation of speed will most likely occur when the full load is thrown off instantly. As has already been pointed out, there is no time lost in this case in waiting for the supply pipe to conform to the new gate movement, if we have provided for water hammer effects; but there will always be some time lost in the movement of the governor and gate. If the change of load is an increase, we must wait for the water in the supply pipe to reach the normal conditions for the new gate opening. The variation of speed allowable will depend to some extent on the flywheel itself. In no case can we run a flywheel at a higher rim speed than 75 feet per second, if made of cast iron, but we may by shrinking steel bands on the rim, raise this limit to 160 feet per second. In designing our flywheel we must not let the wheel exceed this safe limit, which is fixed, once we decide on the nature of the material and method of construction.

These quantities are related to one another, and can be written in one equation.

Writing equation (6), we have:  $K = \frac{1}{2} I \omega^2$   
 differentiating,  $dK = I \omega d\omega$   
 let  $dK = F dt$ , and  $\omega = \frac{\pi N}{30}$  where  $F$  is the force in foot-pounds acting in the time  $dt$ , and  $N$  is the speed of the shaft in revolutions per minute.

Introducing these values and equating for  $I$  we have

$$I = \frac{F dt}{\frac{\pi N}{30} \frac{\pi}{30} dN} = \frac{900 F dt}{\pi^2 N dN} \dots \dots \dots (10)$$

If the load change is expressed in horse power, we can write  $F$  in terms of the horse power, as  $F = 550 H$ , and we get:

$$I = \frac{900 \times 550 H .dt}{(3.1416)^2 N dN}$$

$$I = 50153.7 \frac{H .dt}{N dN} \dots \dots \dots (11)$$

The total  
 I, or M.  
 of any given  
 and that the  
 occur for the  
 t change in  
 eds, for the  
 ore quickly  
 of the same  
 it of varia-



take from,  
 of inertia.  
 as fast as  
 requirements  
 ge that is  
 the supply  
 e opening  
 allowable

This equation may be used in this form to determine the moment of inertia required in the whole revolving mass. If we let

$H$  = the number of horse power thrown off or on the wheel,

$N$  = the normal speed of the turbine shaft in revolutions per minute.

$dN$  = the per cent. variation in the speed,

$dt$  = the time during which the energy of the revolving parts must retain the speed variation within the limit  $dN$ .

We can write equation (11) in terms of  $M$ , as

$$M = .005488 I \dots \dots \dots \text{from (8)}$$

Combining with equation (11) we get;

$$M = .005488 \times 50153.7 \frac{H}{N} \frac{dt}{dN}$$

$$M = 275.05 \frac{H}{N} \frac{dt}{dN} \dots \dots \dots (12)$$

which gives the constant  $\bar{M}$  for the revolving parts.

The value of  $I$  as found above gives us the moment of inertia of the whole shaft and revolving parts. If we can determine the value of  $I$ , of the turbine runner itself, as well as of all other heavy pulleys, etc., on the shaft, and subtract their sum from the value of  $I$ , calculated from equation (11), we will have the value of  $I$ , that is still required. This is the moment of inertia of our flywheel which we will call  $I^1$ .

The flywheel can be approximately designed from the equation

$$I^1 = \frac{wf (d_2^4 - d_1^4)}{g \frac{\pi}{32}} = \frac{wf (d_2^4 - d_1^4)}{327.58} \dots \dots \dots (13)$$

by putting in the value of  $I^1$ , previously found, or by using equation for  $M$ . We may write:

$$M^1 = \frac{wf (d_2^4 - d_1^4)}{59744.3} \dots \dots \dots (14)$$

In both these equations,

$w$  is the weight of one cubic foot of the material in the rim.

$d_2$  is the outside diameter in feet,

$d_1$  is the inside diameter in feet,

$f$  is the face of the wheel in feet.

This  
which is a

There  
which must  
tion, and th  
connecting

When  
necessity ha  
moved prom  
load, it is e  
so as not to  
ernor conne

There  
required to  
From result  
that even w  
head, the en  
Cases have b  
of a wheel w  
but of the sa  
than 50,000  
said to arise  
the design of

In gener  
water enterin  
its efficiency.  
duce a hydra  
efficiency, wh  
yet to be com  
fection, there  
which are giv  
conditions of

The que  
closed, is of c  
the governor,

This is of course neglecting the arms and hub of the wheel, which is a fairly close approximation for most cases.

## TURBINE GATES AND RIGGING.

There is another feature in the design of a water power plant, which must be considered as of no small importance to good regulation, and that is the design of the turbine gates, and the method of connecting them to the governor.

When we are governing turbines of large diameter, we must of necessity have large and ponderous gates; and as these gates must be moved promptly and accurately, to conform to the conditions of the load, it is essential that they be made to move as easily as possible, so as not to introduce too much strain on the gate rigging, and governor connections.

There seems to be great difference in the amount of energy required to move the gates of many of the wheels now on the market. From results of experiments made at Holyoke, Mass., it is found that even with wheels of the same size, and running under the same head, the energy required to move their gates varied considerably. Cases have been found in which the energy required to open the gates of a wheel was 2,000 foot pounds, while in a wheel of different design but of the same diameter, and running under the same head, no less than 50,000 foot pounds were required. These differences cannot be said to arise as much from the type of gate used, as to the fact that the design of that particular type was faulty.

In general, the duty of a turbine gate is to change the amount of water entering the wheel, while at the same time not to interfere with its efficiency. There is not a gate on the market that does not introduce a hydraulic loss, and consequently, a loss or diminution in efficiency, when it is partially closed. This is a problem which has yet to be completely solved, but although we have not reached perfection, there are wheels with gates of different types in operation, which are giving fairly good satisfaction, and efficiency, under all conditions of service.

The question of loss of efficiency when the gates are partly closed, is of considerable importance to the designing engineer. If the governor, when acting, moves to a position which would represent

the correct gate opening, were the efficiency constant throughout the travel of the gate, the power exerted by the wheel would not correspond to the gate opening, and therefore an error would be introduced in the regulation. The movement of the governor can, however, be made to compensate for this.

It is necessary then, before we can determine the proper gate opening for a given amount of power required from the wheel, to know the curve of efficiency of the wheel for various degrees of gate. Many wheels are built with their highest efficiency at part gate, usually seven-eighths, thus allowing a margin for variation with an almost constant efficiency. In cases like this, when regulating under small variations of load, the influence is not felt to the same extent; but when we have to consider the gate opening for large variations of load, the efficiency of the wheel at partial gate must also be taken into account.

The term gate opening, as used here and in general practice, does not mean the opening of the gates in square feet, but the proportional supply of water to the wheel, taking the maximum discharge, when running at normal speed, as unity. In this sense it will apply equally well to all types of gate, while if it meant area, the discharge would be different for each make of wheel or design of gate in use, and we would have no basis of comparison between different wheels.

#### BALANCING GATES.

One of the most important features to be considered when designing a rigging for a turbine gate, is perfect balance. With many types of wheels of faulty design on the market, this may become a difficult matter, but if the wheel itself is of good make, there should be no difficulty in securing fairly good results.

When one considers the weight and size of some of these large gates, and also the surprisingly short space of time in which they will have to be moved, he will see, that in order to minimize the strain on the governor mechanism and connections, it is absolutely necessary that the whole rigging must be in balance. This refers not only to mechanical balance, which would be the case were there no water in the penstock, but to water balance also, that is to say, the water itself must have no tendency to either open or close the gates, at any

point of the  
the govern  
fore, can b  
tage, if stre  
quickly.

In all c  
action of th  
of counter-v  
connection,  
therefore th  
to reduce a  
nections, to  
As the kine  
its velocity  
ferable to a  
be obtained

Gates w  
cannot be g  
design, and  
account this

Cylinde  
balance on a  
water balanc  
already desc  
does not p  
Some water  
by enclosing  
this case the  
culty arise or

Some cy  
fingers or au  
flow of water  
at partial gat  
fingers, not o  
they are the d  
moving the g

point of their travel. If the gate mechanism is in perfect balance, the governor can handle the gate with much greater ease; and, therefore, can be made lighter than otherwise. This is always an advantage, if strength and precision are not sacrificed, as it can act more quickly.

In all cases where gates are out of balance, not resulting from the action of the water itself, the simplest remedy is to balance by means of counter-weights suitably attached. It should not be forgotten in this connection, that as it is sometimes necessary to move the gates, and therefore the counter-weights, suddenly, that it is important in order to reduce as far as possible all sudden strains on the governor connections, to reduce to a minimum the inertia of the counter-weights. As the kinetic energy of the weight is proportional to the square of its velocity it can be seen that a large weight moving slowly, is preferable to a lighter one moving at a higher velocity. This can easily be obtained by any suitable system of connections.

Gates which are out of water balance to any considerable degree, cannot be governed accurately by any method. The fault lies in the design, and can only be corrected by a new design, which takes into account this only too often neglected phase of the subject.

#### CYLINDER GATES.

Cylinder gates, when used on vertical wheels, are always out of balance on account of their weight; and also to some extent out of water balance. The former defect can be easily offset by means already described, and where the gates are well designed, the latter does not present any considerable difficulty to good regulation. Some water wheel makers are getting entirely over this difficulty by enclosing all the running gear of the gate under the dome. As in this case the entire gate is submerged at all times, there can no difficulty arise on this score.

Some cylinder gates are out of water balance because of having fingers or auxiliary guides cast on them in order to facilitate the flow of water into the wheel, and raise the efficiency when running at partial gate. It is believed by some hydraulic engineers that these fingers, not only do not add to the efficiency to any extent; but that they are the direct cause of a good deal of the difficulty experienced in moving the gates, and therefore are not considered as being of any

value. It can easily be seen that the water in sweeping into the openings of the guides will press down on these projections with considerable force, which cannot but be detrimental to accurate government.

#### WICKET GATES.

This type of gate, when properly designed has much to commend it. The gates are hung around the casing of the wheel, and serve the double purpose of guides as well as gates. When hung properly they should have no tendency to either open or close by the action of the inflowing water. This is successfully accomplished by the best makers who use this type of gate. For regulation, it leaves nothing to be desired when of good design; as the gate being in water balance, can be moved with the greatest accuracy and quickness, without introducing needless strains on the governing mechanism.

There are certain makes of wheel on the market, which are fitted with this type of gate, that are anything but satisfactory. Lost motion is a frequent fault, and by this is meant that when the governor moves the gate to a certain point, the action of the water causes them to suddenly move first one way and then the other, because the connections to the spider arms are not positive, allowing play or motion lost. The result of this defect will be at once seen. At this critical point the gates move independent of the governor, which causes fluctuations in the speed. The governor, in attempting to correct this variation, only intensifies the disturbance, with a result that the speed of the plant cannot be kept constant, when the gate is at or near that critical point. Good construction insures absolute rigidity of the gate at all times. When under the influence of the governor, the motion must be perfectly restrained, by which the gate is brought to its proper position, and held there.

When wicket-gates are hung near one end, and operated by means of the spider arms from the other, they are very often out of water balance. In some cases, the strain on the mechanism is sufficient to cause excessive wear or other damage, besides introducing loads on the governor and connections, which are entirely unnecessary.

#### GOVERNORS.

A governor, in the case of any prime mover, is a mechanical device, which automatically increases or decreases the power supplied

to the motor  
in speed, re  
the most an  
increase of s

A prop  
wheels only  
thus retainin  
the gates onl  
without raisi  
is not all, f  
change in sp  
and not over

Let us c  
by a governo  
suppose that  
shown is a de  
opens the gat  
overshoots th  
drop, which  
This makes t  
opens the ga  
during this t  
in its velocity  
was required  
increase and  
this by partly  
velocity in th  
attempt to th  
hammer effec  
flow through  
actual increas  
error to still

It is now  
tive to feel sl  
able of checki  
a very undesir  
The periodic  
even if no fu



to the motor, to compensate for a corresponding decrease or increase in speed, resulting from changes in the load. It is evident that the most any governor can do, is to partly close the gates on an increase of speed, and to open them when the speed falls.

A properly constructed governor will open the gates of the water wheels only as fast as gravity, acting on the pipe line, can follow up, thus retaining a constant pressure in the penstock, and will also close the gates only as fast as the water hammer effects can be disposed of, without raising the pressure in the penstock to any extent. But this is not all, for a governor must, after being put into action by a change in speed, stop the movement of the gates at the correct place, and not overshoot the mark.

Let us consider the case of a wheel running normally, controlled by a governor that does not move to the correct position. Let us suppose that there is a slight increase in the load. The first result shown is a decrease in the speed. The governor being thus energized, opens the gates wider; but instead of stopping at the correct position, overshoots the mark. The pressure in the pipe will momentarily drop, which produces a decrease in the power supplied to the wheel. This makes the wheel run still slower, and as a result, the governor opens the gates wider. The gates are now open too wide, and as during this time the column of water in the pipe line has increased in its velocity, we have more power being supplied to the wheel than was required. As the speed, under these circumstances, will increase and rise above normal, the governor will attempt to check this by partly closing the gates. As we have already pointed out, the velocity in the pipe line had increased to its original value, and an attempt to throttle the discharge, is immediately followed by water hammer effects, and a rise in the pressure. This causes an increased flow through the wheel, which though only momentary, represents an actual increase in the power supplied to the wheel, causing the governor to still further shut off the water.

It is now easily seen that if we have a governor sufficiently sensitive to feel slight changes in speed, and prompt to act, but not capable of checking itself when the correct position is reached, we have a very undesirable condition of things, called "hunting" or "racing." The periodic fluctuations of speed will be of increasing amplitude, even if no further load changes occur, which will in itself destroy

regulation. In attempting to obviate this difficulty, some inventors have provided their governors with dash pots or dampening devices, which act very well when properly adjusted; but if they retard the action of the governor too much, are not desirable.

From the foregoing statements we see that it is necessary for a governor; 1st, to act quickly, i.e., to be very sensitive to slight changes in speed; 2nd, to act as promptly as possible in *beginning* its regulation stroke, and 3rd, to gradually come to rest at the exact position which conforms to the new condition of the load. The time required for the governor to settle down, will depend on the previous design of the plant, and on other considerations mentioned elsewhere.

This action is what is known as "dead beat," and is recognized, as being a very essential feature in a water wheel governor.

A governor should also be isochronous, or capable of running at different positions of the gate for the same speed. That is, the governor would stand in equilibrium, at any position, from friction load to full load, and always move the gate so as to bring the speed to normal. Nearly all the governors on the market, and certainly the best ones, embrace this principle to a greater or less extent; in fact it is useless to talk of a governor that is not designed to work along these lines.

One of the most important, and now recognized as one of the necessary requirements of a good governor, is the embodiment of the relay principle. This means that the governor works by instalments, cutting itself out of action automatically, as soon as it has operated.

This feature has been introduced to prevent "hunting," which it effectually does. In many relay governors, the motion of the driving mechanism is communicated to the gate rigging, through pawls, which are thrown in or out of action by the movement of the centrifugal balls. If a change of load occurs, the balls take up a new position, and in doing so, drop one of the pawls. The gate is now put into connection with the shaft of the water wheel, and is moved towards its correct position; but instead of being moved the entire distance corresponding to the load change in one stroke, the gate is only moved part way, and is disconnected. This is effected by arranging the mechanism of the governor, so that the movement that caused the gate to take a new position, also disconnects the governor from the gate. The governor on its return stroke will again engage

the gate thro  
These part  
slow enough  
tions, after  
flywheel is  
governor is  
ceding one,  
for the new

It can  
the gate mo  
fore huntin

Perhap  
governors, i  
designed to  
mover back

Let us  
of load occur  
ing them t  
change in t  
new gate p  
start huntin  
is prevented  
governor is  
to normal.  
of the two g

In Fig  
water power  
relay-return  
principles.

It cons  
hydraulic g  
gate mechan  
their pumps

In Fig.  
a clearer vie

the gate through the pawls, and another partial movement is effected. These partial movements follow each other very quickly, but still slow enough to allow the governor to adjust itself to the new conditions, after each movement. In this way, the power storage in the flywheel is more fully taken advantage of, as each motion of the governor is made under slightly different conditions from the preceding one, being nearer to the ultimate normal position of the gate for the new load.

It can easily be seen, that if the governor is properly adjusted, the gate movement will never exceed the correct position, and therefore hunting or racing is prevented.

Perhaps the latest principle to be embodied in water wheel governors, is what is known as the returning principle. Governors designed to act in this way, will always bring the speed of the prime mover back to normal, under all conditions of load.

Let us suppose a governor of this kind in operation, and as change of load occurs, the governor immediately operates on the gates, bringing them to their correct position. Now if left in this way, the change in the position of the centrifugal balls, resulting from the new gate position, would again actuate the governor, which would start hunting for the correct position. In returning governors, this is prevented by their mechanism, which acts in such a way, that the governor is prevented from working while the speed is coming back to normal. These features will be better shown in the descriptions of the two governors presented with this article.

#### "LOMBARD" GOVERNOR.

In Fig. 3 is shown a governor which is in use in many water power plants on this continent. It is classed as a hydraulic relay-returning governor, as it embraces in its action both of these principles.

It consists of a very sensitive speed indicator, a series of hydraulic governing cylinders, with their valves, by which the wheel gate mechanism is moved, and pressure and vacuum reservoirs, with their pumps for retaining the respective pressures in the tanks.

In Fig. 3 is shown a side view of the governor, while Fig. 4 shows a clearer view of the details of the upper mechanism.

In Fig. 3 will be seen the tanks situated under the bed of the governor. The smaller tank "1" contains a vacuum, while "2" is partly filled with very thin petroleum engine oil, and partly with air. The air in this tank is retained at a pressure of about 200 pounds per square inch by a pressure pump, which is also constructed to exhaust the vacuum tank "1." This pump is not shown in these cuts, but is situated on the other side of the cylinder "62," and driven from the

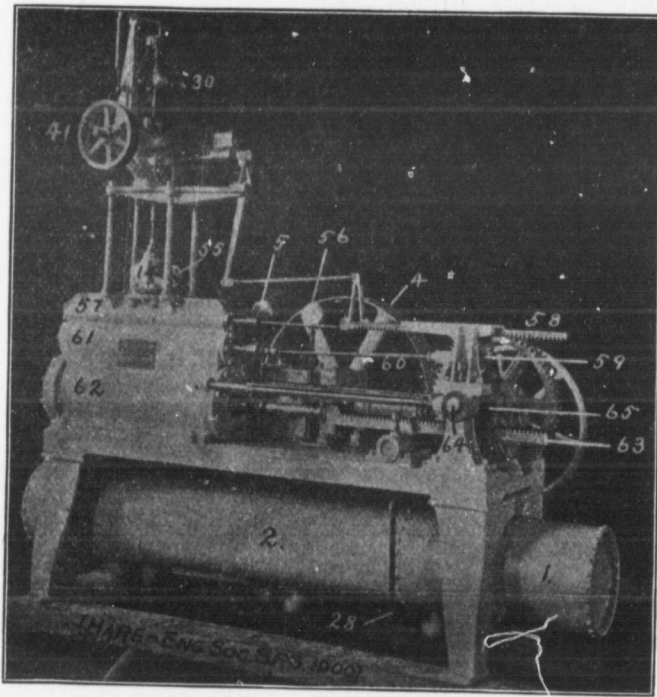

FIG. 3.—"Lombard" WATER WHEEL GOVERNOR (Side view).

shaft of wheel "4." The governor is belted, from the shaft to be governed to the wheel "4," which should revolve between 60 and 90 R. P. M.

In Fig. 3, "5" is a pressure gauge which indicates the pressure carried on tank "2," while "56" is a vacuum gauge which serves the same purpose for tank "1."

A safety valve is situated between the delivery of the pressure pump, and the pressure tank "2." It is adjustable, so that the pres-

sure carried in case. A pipe the throttle va ated by the ce

The verti either end of this cylinder i and runs on t centre, but to a large cylin directly above under tank pr the rack, "63,

We will n a portion of t speed will imm to fly out. Th carrying down the right hand "57" travels moves the float tion. This m thereto in cylin largest horizont It can easily b outward, bring central position closed, as the p wheel gates are lead.

These vari that the govern correct position nature all these

It is eviden late very accur piston valve, " of" speed of the

sure carried may be varied at will to suit the requirements of the case. A pipe leads from the bottom of the pressure tank "2" through the throttle valve "55" to the fluid filled valve "14," which is operated by the centrifugal balls "30."

The vertical piston valve, "14," lets oil under tank pressure into either end of the small horizontal cylinder, "57." The piston rod of this cylinder is connected to the rack "58," which moves in a sleeve, and runs on top of the floating gear, "59." This gear has no fixed centre, but to its axis is attached the piston rod "60," which actuates a large cylinder-valve in cylinder "61." This valve is situated directly above the main cylinder, "62," and serves to port oil into it under tank pressure. Cylinder "62" transmits its energy through the rack, "63," and shaft, "64," to the water wheel gates.

We will now consider the course of events which take place, when a portion of the load on the water wheel goes off instantly. The speed will immediately begin to increase, which causes the balls, "30," to fly out. This will result in the valve stem, "53," being depressed, carrying down also the fluid filled valve, "14," and letting oil into the right hand end of cylinder "57." As the piston of cylinder "57" travels inward, it carries with it the rack, "58," which also moves the floating gear, "59," and its rod, "60," in the same direction. This movement of rod "60" and the piston valve attached thereto in cylinder "61," will let oil into the right hand end of the largest horizontal cylinder, "62," causing rack, "63," to travel inward. It can easily be seen that pinion "65" will roll floating gear "59" outward, bringing the piston valve in middle cylinder "61" to its central position, when all motion will cease as soon as the ports are closed, as the piston is locked hydraulically in its position. The water wheel gates are now at their correct position for the new value of the lead.

These various motions actually occur so rapidly in succession, that the governor seems to be making one positive motion to the correct position. If the change in the load were of the opposite nature all these various motives would be reversed.

It is evident that if this were all, the governor would not regulate very accurately, as will be shown as follows:—Whenever the piston valve, "14," is moved out of its central position by variations of speed of the centrifugal balls, it would remain so until the balls

came back to their normal position. Also whenever the valve, "14," is not in its central position, the main piston and rack will be travelling in one direction or the other. If the load is suddenly thrown off the turbines, the centrifugal balls will fly out beyond their normal position, and valve "14," will cause the governor to begin to close the water wheel gates. The centrifugal balls do not get back to normal until after the water wheel gates have passed their correct position, and consequently, as valve "14" is open, the governor will move too far. The result of this action would be that the governor which moves very quickly would close the gate too far for the new value of the load, allowing the speed to fall below normal. The whole process would now be reversed and the speed would rise above normal, and the governor would begin to hunt. Because of this tendency, the makers have introduced an attachment which is intended to prevent all racing. It is known as the valve stem equalizer.

In Fig. 4 is shown the top of the governor, showing the valve stem equalizer, "43." This device is simply a dash pot which is capable of fine adjustment by means of the thumb screws "40," "40." The outer shell of the dash pot, "43," is connected to rod "42," while the piston joins on to the rack and pinion. The piston of the equalizer, "43," is provided with valves opening through it in either direction. These valves are held closed by stiff springs, so that the oil, with which the dash pot is filled, will only pass through when large load changes occur, and the governor makes correspondingly large movements from its normal position. By-passes are arranged from one side of the piston to the other, and controlled by the thumbscrews "40," "40." Thus by adjusting these screws we can cause the piston to move easily, or with difficulty, as desired. The dash pot is connected to a rack, whose motion is restricted by the spring "48." This rack engages a pinion on the valve stem, and is so connected as to act, in cases of sudden fluctuations of load, against the centrifugal action of the balls.

This combination of motions is effected in an ingenious manner. The pinion on rod "53," is engaged by the rack, which is connected to the dash pot "43." This pinion is rigidly keyed to rod "53," and is of considerable length, so as to remain in mesh with the rack, while the rod "53" moves up and down. The rod "53" is connected to the sleeve, on which the centrifugal balls are mounted,

by means of  
on rod "53"  
the balls do

If we no  
valve stem eq  
vent racing.

FIG. 4.—

"58" will b  
equalizer by t  
of the screws  
piston rod, sp  
now depressed  
raises the rod

by means of a screw thread, and it is so arranged that if the pinion on rod "53" is revolved, it will operate the valve "14," provided the balls do not change their position.

If we now consider again the above case, and suppose that the valve stem equalizer is properly adjusted, we will see that it can prevent racing. If the change in the load is large, the motion of the rod

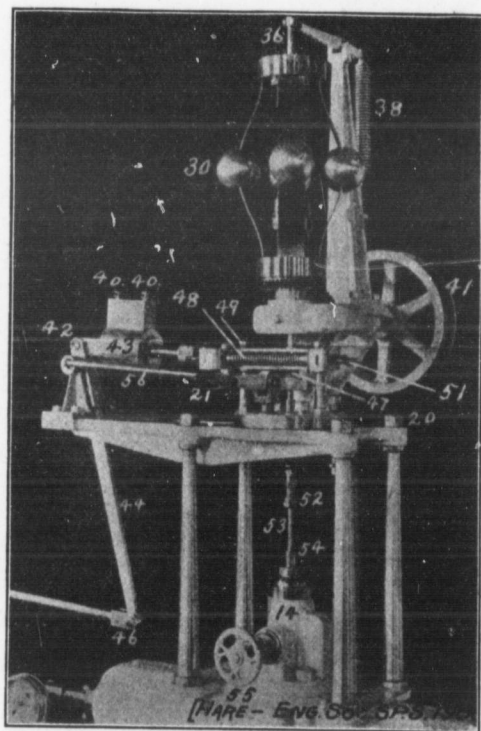

FIG. 4.—"LOMBARD" WATER WHEEL GOVERNOR (Top Mechanism).

"58" will be rapid, and as this is connected to the valve stem equalizer by the lever "44," it will receive a thrust, which, on account of the screws "40," "40," being set, will be partly transmitted to the piston rod, spring "48," and the rack and pinion. This spring is now depressed, and the rack, by its motion, revolves the pinion, and raises the rod "53," stopping the action of the rod "58," and allows

the movement of rod "63" to bring the cylinder valve, "61," to its central position, whence all action ceases; and the wheel gates are at their correct position. It will be seen that the thrust of rod "42" on the one side, and the spring, "48," on the other, will tend to move the piston in "43." If now we prevent the flow of oil by throttling, we can lengthen the time required for the spring, "48," to act, and consequently the point at which the valve, "14," will be closed.

The rotation of the pinion and valve stem serves to close the valve "14," by means of the screw before mentioned, without any additional motion on the part of the balls. Immediately after the closing of the valve "14," the balls will return to the position they held prior to the change in the gate. This would produce a new movement in valve stem "58" and valve "14," and so cause a new movement in the whole governor, were these points not provided for. When the rod "42" and equalizer "43" were moved at first, the spring "48" was depressed. Now this spring cannot return to its normal position without moving the piston in "43," and also revolving rod "58" by means of the rack and pinion. If the screws "40" "40" have been adjusted properly the action of the spring "48" in returning to its normal position, retarded by "43," will gradually revolve the pinion on rod "58," at the same time that the governor balls are moving back to their normal position. As both of these actions take place together, and are opposite to each other, the rod "58" is not moved sufficiently to cause any flow of oil in cylinder "57," and the whole mechanism comes back to its original position.

If, on the other hand, the change of speed be slight, the rod "58" will move more slowly, and, as a result, the centrifugal balls will have sufficient time to return to their normal position and close valve "14" before the gates have been moved too far.

#### "REPLOGLÉ" GOVERNOR.

In Fig. 5 is shown a relay returning governor, which is widely used and seems to give good results.

When set up for use, the mechanism is driven from the water wheel shaft by a belt on pulley "3," while the centrifugal balls "11" are operated from the same shaft by means of pulley "12," and belt. The water wheel gates are connected to shaft "1" by means of suitable connections. This shaft "1" is revolved by means of the power

SP  
transmitted  
quired to sta  
by hand by t  
is revolved fr  
"11" and t  
keyed to the  
through a pa  
centrifugal b  
much indepe

The inert  
the lever "10  
municated to  
transmits the  
5—by their m  
shaft "1," and



transmitted through pulley "3," as shown. When it is required to start or shut down the plant, the gates can be operated by hand by the hand wheel "15" and connecting gears. Shaft "5" is revolved from pulley "12," and carries on it the centrifugal balls "11" and the inertia weight "14." This inertia weight is not keyed to the shaft, but runs on a sleeve, which permits it to revolve through a part of a revolution, quite easily. It is connected to the centrifugal balls by means of two short chains "13," by which too much independent motion is prevented.

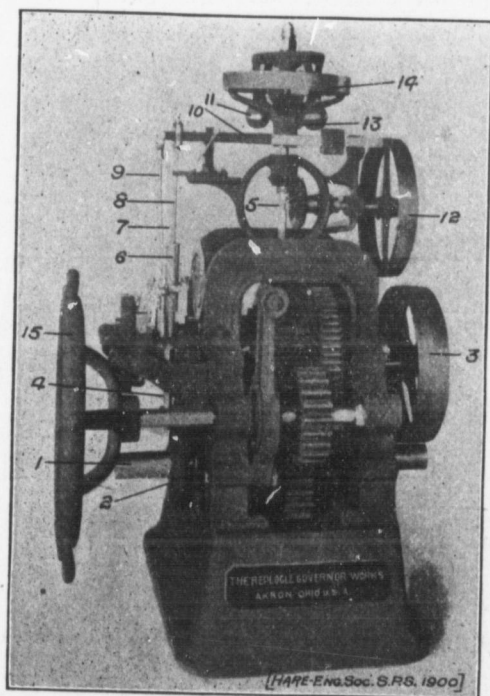

FIG. 5.—"REPLOGLÉ" WATER WHEEL GOVERNOR.

The inertia weight is connected by means of an annular slot, to the lever "10," so that the vertical motion of the weight is communicated to the lever "10," and which, by means of the rod "9," transmits the motion to the pawls. These pawls—not shown in figure 5—by their motion, connect the shaft bearing the pulley "3," with shaft "1," and so cause a movement of the gates.

The operation of this governor is somewhat as follows:—Let us suppose that everything is running normally. The inertia weight is now revolving at the same speed as the centrifugal balls; but, being freely suspended from them by means of the chains "13," it lags a little behind, and consequently the chains are not vertical, and the weight is slightly higher on the shaft "5" than it would be if the governor were not running. If now an increase in the load occurs, the speed of the wheel, and consequently the speed of "12" will decrease. As soon as shaft "5" begins to run slower, the inertia weight, because of the energy stored in it, will move forward, and in doing so it will take a lower position on the shaft "5."

As the lever "10" is connected to the weight it also will fall slightly, and cause the pawls to engage by means of rod "9." Pulley "3" is now connected to shaft "1," and the gates are moved to increase the power. When the proper movement has been effected, the rod "4," which engages cam "2" on shaft "1," is raised and in doing so raises oil cylinder "6" and rod "8," which in turn lifts lever "10" and rod "9" releasing the pawls, and preventing the governor from moving too far. This embodiment of the relay principle is one of the best features of this governor. By adjusting the screw "7" the relative movement of the rods "4" and "8" can be timed to a nicety, the adjusting depending on the general conditions under which the governor is operating

Should the load decrease, the reverse operation will take place. The inertia weight will now lag further behind, because of the increased speed, and will therefore rise on shaft "5," carrying with it lever "10" and rod "9," which connects the pawls as before. The cam will act to lower the lever "10" when the correct movement has been completed. Were it not for this attachment, the governor would continue to move the gates until the speed changed. In this case the movement would have been greater than required, and as the speed changed again the governor would again move too far. The result would be severe "racing," or "hunting," on the part of the governor.

The centrifugal balls do not directly act on the lever "10," but only through the inertia weight "14." The governor is much more sensitive this way, than when acting under the balls directly.

The return of which the the governor fugal balls and is holding both out of the speed do not come back weight will movement of the be noted that rods "4" and tively for sud oil passes thro slowly move slight change normal, witho changes are v when it will b the speed bac make another until the desc gradually brin

Tests ma varying condi can be control carefully desig

In conclu Lombard Wat the Replogle fully rendered

The returning principle is also found in this governor by means of which the speed is always brought back to normal. When the governor is set up, it is adjusted so that when the centrifugal balls are revolving at their proper speed, the inertia weight is holding lever "10" in its normal position; or the pawls are both out of contact with the gate-moving mechanism. Now, if the speed does not come back to normal, the centrifugal balls will not come back to their normal position, and consequently, the inertia weight will continue to act on lever "10," causing thereby a movement of the gates, until the speed does return to normal. It should be noted that with the dash pot or oil cylinder "6" between the rods "4" and "8" the motion of "4" is transmitted almost positively for sudden fluctuations of speed, but for slight variations the oil passes through the holes in the piston, and allows the governor to slowly move the gates, without being cut out of action. In very slight changes of load, the governor will bring the speed back to normal, without being cut out of action by the cam; but when the changes are violent, the governor will move to a certain position, when it will be cut out. If this movement was not sufficient to bring the speed back to normal, the governor will be cut in again and will make another movement and be again cut out. This will continue until the discrepancy in the speed is small, when the governor will gradually bring the speed back to normal.

Tests made on a modern number of plants, running under widely varying conditions of service, have shown that the speed of turbines can be controlled, within a small percentage, when the plant has been carefully designed.

In conclusion, the writer wishes to express his gratitude to the Lombard Water Wheel Governor Company of Boston, Mass., and to the Replogle Governor Works of Akron, Ohio, for assistance cheerfully rendered to him when engaged in preparing this paper.

"10," but  
much more  
ctly.

## COLD STORAGE.

E. RICHARDS, GRAD. S. P. S.

For many years, at least, Canada is destined to be an agricultural country rather than a manufacturing or trading one, and it would seem that one of the most important problems before her is the making of markets for dairy and fruit products. This would enable the tiller of the soil to pursue a more far-sighted and prudent policy than the exclusive production of cereals has proven to be. The present and future fertility of farm lands depend so largely upon the nature of the problem taken either directly or indirectly from them, that it seems a wise policy to encourage in every way the production of stock and dairy produce rather than the growing of grain, hay, etc., with their constant drain upon the fertility of the soil. Great Britain offers a splendid market for such goods but the great difficulty has been found in the lack of proper facilities for the storage and transportation of perishable products. Of late, however, the perfected systems of cold storage and transportation have made it possible that Canadian eggs, butter and fruit, may be placed upon the British market almost, if not quite as fresh, as any offered upon our own local markets.

The first link in this chain of storage and transportation is the cold storage warehouse, to which are brought the goods for chilling or freezing, and storing necessary to make up large cargoes.

It is the intention in this article to discuss briefly, a few of the problems arising in the designing of a cold storage plant.

Cases may be found, where, because of low cost of harvesting and storing ice, it may be advisable to use it as a cooling agent, but in nearly every case the many advantages possessed by a system of mechanical refrigeration will lead to its adoption. It would be found quite impossible to provide for thoroughly efficient cold storage on a

large scale with  
as pliable nor

The consi  
ing those of a p  
in case of any p  
of condensing  
cold water is a  
plant, as the p  
in the condensa  
demand the ch  
necessary to re  
ing the condensa  
only replacing,

Of the va  
the general fa  
relative merits

The great  
fluid in refrige  
extent, the diffi  
apparatus proo  
objection has  
fittings and pac

Ammonia  
of efficiency du  
or cock, rather  
work of expansi  
Ledoux for thes  
cent.

Sulphur di  
a much more c  
necessarily grea  
The latter fact  
quired to compr  
used in ordinary

The only o  
requires pressur  
to compress it s

large scale with ice as the refrigerant. As a system, it is not nearly as pliable nor as completely under control as mechanical systems are.

The considerations influencing one in the choice of a site, excepting those of a purely mercantile nature, will be much the same as those in case of any power plant, excepting the fact that a very large amount of condensing water, as cool as possible is needed. A good well of cold water is a veritable gold mine to the operator of a refrigerating plant, as the power required depends so largely on the temperature in the condenser. If it seems that more weighty considerations demand the choice of a site where water is not plentiful, it will be necessary to resort to the use of cooling towers or other means of cooling the condensing water so that it may be used over and over again, only replacing, from time to time, the portion evaporated.

Of the various mechanical systems the ammonia compression is the general favorite; but it will be well to make a canvass of its relative merits before accepting it as the best.

The greatest disadvantage possessed by ammonia as the working fluid in refrigeration, was for many years, and is yet to some slight extent, the difficulty experienced in providing a system of piping and apparatus proof against its strong penetrative properties. This objection has been almost entirely overcome by improvements in fittings and packing.

Ammonia and sulphur dioxide have, theoretically, the same loss of efficiency due to expanding the fluid through an expansion valve or cock, rather than in an expansion cylinder, in which the positive work of expansion might be recovered. Using the constants given by Ledoux for these two agents, this loss is found to be about seven per cent.

Sulphur dioxide, having a much higher specific volume, requires a much more cumbersome compressor, in which the friction losses are necessarily greater, but the working pressures proportionately lower. The latter fact is of no great importance, because the pressures required to compress ammonia are well within the range of pressures used in ordinary steam engineering.

The only other agent used to any extent is carbon dioxide. It requires pressures ranging as high as 1,100 pounds per square inch to compress it sufficiently for condensation at ordinary temperatures

of condenser water. This requires the use of very heavily built fittings and apparatus. Aside from this, the theoretical loss due to expanding the gas through an expansion cock is about thirty-three per cent.

It would, therefore, seem that there is good reason for ammonia being used so extensively. It remains to be shown that there are equally satisfactory reasons why the ammonia should be used in the compression, rather than in the absorption system.

All systems, working between the same limits of temperature, in a reversible cycle, or in a cycle in which all interchanges of energy are reversible, theoretically produce the same refrigerative effect, whether the interchanges are caused directly by chemical action as in the absorption, or indirectly through mechanical energy as in the compression system. At first thought, then, it would seem to be advisable to use the direct rather than the indirect application of the heat energy of the fuel to the working fluid, because in the best heat motor 10 units of heat liberated from the fuel barely produce 1 unit or 778 foot pounds of work. There are, however, two causes which so much modify theoretical results that the compression system actually proves more efficient.

The first of these causes is the evolution of heat from the absorption of the expanded gas in the weak liquor from the generator raising the temperature of the absorber to such an extent, that absorption almost ceases unless the absorber is cooled. This cooling causes a very serious falling off of efficiency from the theoretical. Secondly, the generator causes more or less steam to pass over with the gas to the condenser. This entrained water impairs the efficiency in that it carries off heat from the generator and having arrived at the refrigerating coils prevents part of the gas evaporating by holding it in solution.

Prof. Peabody, in his *Thermodynamics of the Steam Engine*, gives tests made on compression and absorption plants by Prof. Denton and compares results on the basis of pounds of ice per pound of coal. The compression plant proved to be nineteen per cent. more efficient. The comparison was, if anything, unfair to the compression plant. It was assumed that the absorption plant boiler would evaporate 10 pounds of water per pound of coal, and that the compression power plant would require 3 pounds of coal per horse-power

hour. Now, of steam per of coal.

There an solution of w amount of ca

The mos pressor or no tracted shut- might be part between two other one or loss averted. same thing. I as possible and with one alwa

Another and brine circ and brine circulat piping. Basic back pressure work, requiring be much mor culties experie storage with d ing rooms at t of coils contain nearly so. Th by connecting the cooling ro returns from a double actin to one part of other part. S equally divided peratures-rang rooms ranging

hour. Now, a good condensing engine requires only about 20 pounds of steam per horse-power hour, which is equivalent to only 2 pounds of coal.

There are some questions, quite important in themselves, the solution of which depends on the capacity of the plant and the amount of capital to be invested.

The most important one is whether to provide a reserve compressor or not. With a single machine, an accident causing a protracted shut-down means a very serious loss. Such a contingency might be partially provided for by dividing the total capacity needed between two or three machines. In case of accident to one, the other one or two might be run at maximum capacity and heavy loss averted. The use of a double compressor would amount to the same thing. If one were disabled, it might be disconnected as quickly as possible and the other worked to its full capacity. Three machines with one always in reserve would be the ideal arrangement.

Another question is that of choosing between direct expansion and brine circulation. In this, first cost plays a very large part. The brine circulation costs more by that of the cooler tank and brine piping. Besides this, it is less efficient. This is due to the lower back pressure in brine systems. But for general cold storage work, requiring a wide variation of temperatures, it proves to be much more flexible and capable of good regulation. The difficulties experienced in securing proper regulation in general cold storage with direct expansion are due to the necessity of maintaining rooms at temperatures differing as much as 25° Fahr. by means of coils containing the expanding ammonia all at one temperature, or nearly so. This may be partially overcome with a double compressor, by connecting the suction of one of the returns from one section of the cooling rooms at the lowest temperatures, and the other to the returns from the remaining rooms at higher temperatures. With a double acting machine the suction of one end could be connected to one part of the rooms, and the suction of the other end to the other part. Suppose a plant, in which the power would be about equally divided between some freezing rooms to be maintained at temperatures ranging from 10° to 20° Fahr., and butter, egg and fruit rooms ranging from 25° to 35° Fahr. In case this were divided into

two systems the greatest difference of temperature in one system would be  $10^{\circ}$ .

No investment in connection with cold storage pays better than that placed in good insulation. Wide differences of opinion are found regarding the construction of walls of refrigerated rooms. Some advocate open air spaces, while others advise filling them with mineral wool, cork dust, and even planing mill shavings.

The construction of insulation should conform to some general principles, which may be briefly stated as follows:—

(1) The flow of heat through any medium is nearly proportional to the difference in temperature between the spaces on each side of it. An insulation which would be quite sufficient for a room to be maintained at  $35^{\circ}$  or  $40^{\circ}$  might prove utterly inadequate for a room to be maintained at  $10^{\circ}$ .

(2) The best insulation cannot prove too good, and will certainly be the cheapest in the end.

(3) All materials should be as nearly non-absorbent as possible, and should be free from odors. In wood, spruce is the most suitable, as it is odorless and free from knots.

(4) Every precaution should be observed to prevent the penetration of air and moisture.

(5) Air is one of the best non-conductors of heat, if still, but a poor one if allowed to form convection currents, which it will do between surfaces, differing only very slightly in temperature, if unrestrained.

(6) The use of all porous substances, which settle and lose their porous qualities should be avoided. A permanently porous substance, non-conductive of itself, is of value as it thoroughly prevents all circulation in an air space.

Fig. 1 represents an insulation for the outside walls of rooms for temperatures as low as  $10^{\circ}$ . A metallic weather cover is shown on the outside. A double layer of good quality insulating paper is placed between the double layers of spruce lumber. The air space between the studding, which is two feet apart, is divided up by seven-eighths inch shelving, driven in tight between the studding at intervals of two feet. The lumber should be dressed on one side,

at least, to e  
should be to

Fig. 2 s  
temperature.  
wall before  
of partitions,  
two air space  
degrees. Th  
more than te  
so as to cover



To provid  
ing through,  
and caulked  
the best match  
sary in rooms  
any likelihood

The prop  
of any other li  
tion of the air  
vation. The  
experience in



at least, to ensure a uniform thickness. The inside layer of boards should be tongued and grooved.

Fig. 2 shows a construction inside a brick wall for the same temperature. Two coats of pitch or asphaltum are applied to the wall before proceeding to build the insulation. The construction of partitions, ceilings, and floors is also shown. The partition with two air spaces is for rooms differing as much as twenty-five or thirty degrees. The one with only one air space is for rooms not differing more than ten or fifteen degrees. The second layer of paper is laid so as to cover the joints in the first.

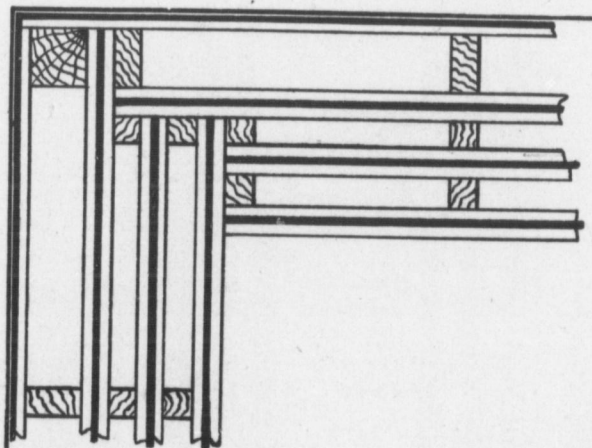

FIG. 1.

To provide for scrubbing out rooms without danger of water leaking through, destroying the insulation, the flooring should be heavy and caulked like the decks of ships. This would be preferable to the best matched flooring without caulking. This would be quite necessary in rooms for freezing fish, and in rooms where there would be any likelihood of drip from pipe coils.

The proper storage of eggs presents greater difficulties than that of any other line of produce. The temperature, humidity, and circulation of the air in the room are all important factors in their preservation. The opinion of the large majority of those having a wide experience in egg storage is in favor of a temperature between 30°

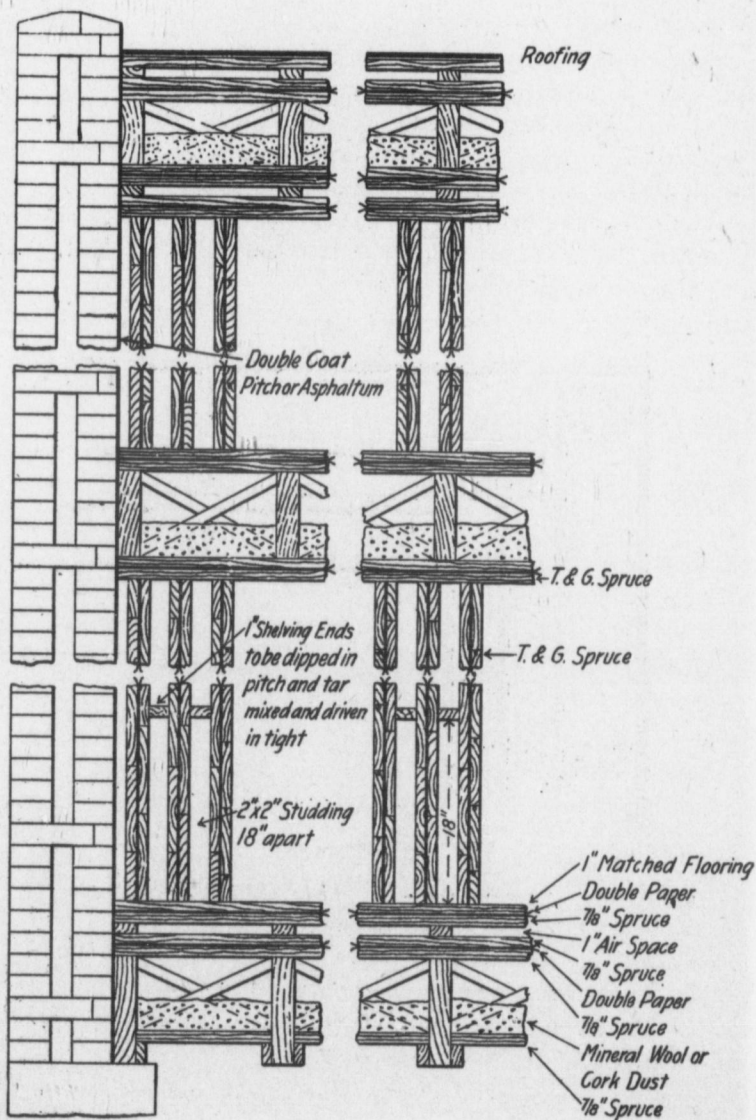

FIG. 2.

and 32°. A  
 have been att  
 out danger o  
 possible, even  
 and circulation  
 be considered  
 dew in a slug  
 in case the c

When or  
 gives the hur  
 one hand nor

Tempe	in Degre
28.	
29.	
30.	
31.	
32.	
33.	
34.	
35.	
36.	

Relative l  
 to that in sat  
 any temperatu  
 just takes plac  
 at the given  
 determined by  
 simply two th  
 of one is encl  
 water, prefera  
 through the ai  
 and a reading  
 the two therm  
 repeated until  
 The difference

and 32°. A fresh egg freezes at about 28°, and the best results have been attained in temperatures as near to this as possible without danger of freezing them. A margin of 2° would be the least possible, even with the greatest watchfulness. The proper humidity and circulation is a more difficult matter to determine. They must be considered together, because, a humidity which would cause mildew in a sluggish circulation might even cause undue evaporation in case the circulation were brisk.

When ordinary gravity circulation is used the following table gives the humidities which do not seem to cause mildew on the one hand nor excessive evaporation on the other.

Temperature in Degrees Fahr.	Relative Humidity.
28.....	.80
29.....	.78
30.....	.76
31.....	.74
32.....	.71
33.....	.69
34.....	.67
35.....	.64
36.....	.62

Relative humidity is the ratio of moisture in any atmosphere to that in saturated air at the given temperature. Saturation at any temperature is that condition of the air in which condensation just takes place, or the condition of the air which has its dew point at the given temperature. This relative humidity can best be determined by means of a sling psychrometer. This instrument is simply two thermometers mounted on a wooden frame. The bulb of one is enclosed in a little muslin bag. This bulb is dipped in water, preferably at the temperature of the room, and is whirled through the air a dozen times or so. It is again dipped and whirled, and a reading of the difference between the temperatures indicated by the two thermometers is then taken. The whirling and reading is repeated until the wetted thermometer shows a minimum reading. The difference between the readings of the two thermometers may

be translated into relative humidity by means of the following table, issued by the Weather Bureau at Washington:

t (Dry ther.)	Difference between dry and wet thermometers (t-t).												t (Dry ther.)
	Difference between dry and wet thermometers (t-t).												
	0°.5	1°.0	1°.5	2°.0	2°.5	3°.0	3°.5	4°.0	4°.5	5°.0	5°.5	6°.0	
28	94	88	82	77	71	65	60	54	49	43	38	33	
29	94	89	83	77	72	66	61	56	50	45	40	35	
30	94	89	84	78	73	67	62	57	52	47	41	36	
31	95	89	84	79	74	68	63	58	53	48	43	38	
32	95	90	84	79	74	69	64	59	54	50	45	40	
33	95	90	85	80	75	70	65	60	56	51	47	42	
34	95	91	86	81	75	72	67	62	57	53	48	44	
35	95	91	86	82	76	73	69	65	59	54	50	45	
36	96	91	86	82	77	73	70	66	61	56	51	47	

The terms circulation and ventilation are confused by many. Circulation is applied only to those currents in the air of a room due to natural or artificial causes. Ventilation implies a substitution of the air in the room by air from some outside source.

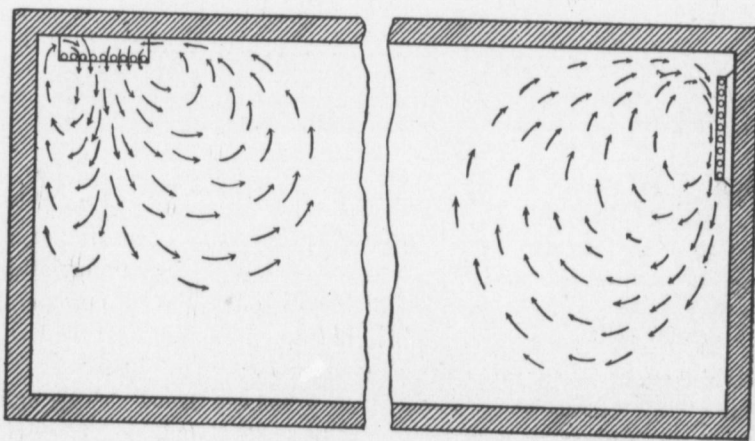

FIGS. 3 AND 4.

Figs. 3 and 4 represent fairly the circulation resulting from two methods of suspending the expansion or brine coils within the room. Figs. 5 and 6 show arrangements which give better distributed and more thorough circulation. Either of the latter will give about the best results that can be obtained with gravity circulation.

Natural  
as it does, s  
and, therefor  
a circulation

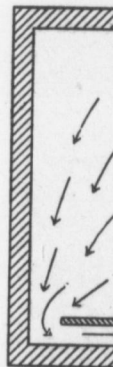

Well distr  
maintenance o  
ences as great  
circulation. 7

Natural circulation must, of necessity, be irregular, depending as it does, so much upon the amount of refrigeration required, and, therefore, it seems necessary to resort to other means to obtain a circulation both positive and well under control.

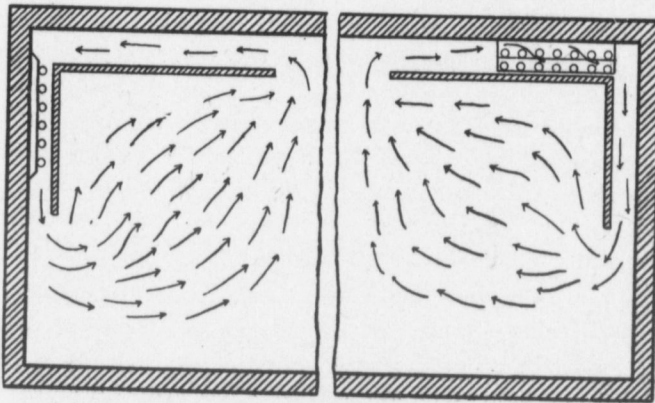

FIG. 5.

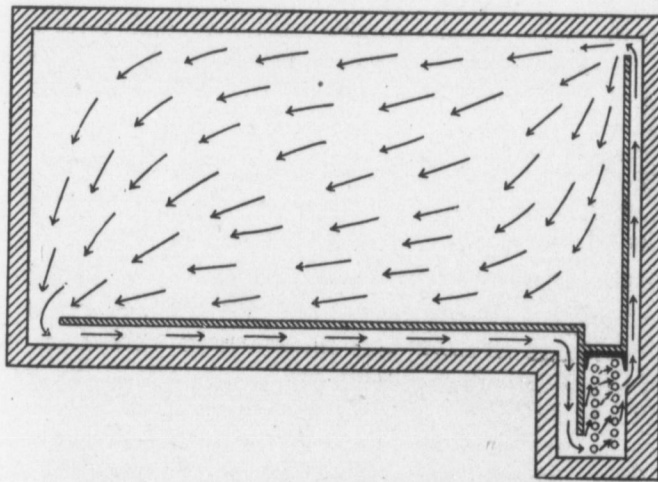

FIG. 6.

Well distributed and thorough circulation is necessary to the maintenance of a uniform temperature throughout the room. Differences as great as 5° have been found in rooms provided with poor circulation. Thorough circulation, also, serves a good purpose in

Following table,

0	(Dry ther.)
3	
5	
6	
8	
0	
2	
4	
5	
7	

ed by many.  
ir of a room  
s a substitu-  
ource.



ulting from  
s within the  
etter distri-  
ter will give  
irculation.

removing from the immediate vicinity of eggs or fruit the air containing the putrid elements due to the evaporation of the decomposing tissues. This purifies the air in two ways. First, the mere circulation of the air seems to have a purifying effect independent of the absorbent qualities of any surfaces over which the air may pass. Secondly, the moisture in the air congeals upon the cooling coils, and retains much of these impurities with it. It is apparent, however, that an excessive deposit of such impurities on the pipes would prove a contaminating rather than a purifying influence. This will suggest the advisability of placing the cooling coils in a separate chamber with a means of shutting off all communication with the storage room, so that the cooling coils could be melted off and cleansed without affecting the main room.

The fan will offer the only feasible means of providing for such a circulation as is needed for the efficient and thorough preservation of eggs. In a case like this where a high velocity is not required, a large, light, slow running fan offers many advantages over a higher speeded and necessarily heavier one. It will prove more economical of power, as experiments prove that doubling a fan's speed to double its capacity requires much more than twice as much power. With low speeds the centrifugal type will prove much more efficient, besides being more handily arranged in a duct or air passage.

Fig. 7 shows the arrangement of ducts in the British Linde system of forced air circulation, where the cold air enters the room from the side ducts, and the warm air returns by the center one.

Madison Cooper of Minneapolis, in his book, "Eggs in Cold Storage," suggests an arrangement like that shown in Fig. 8. The cold air is forced into the room through small perforations in the sides of the cold air ducts, placed one on each side of the room on the wall near the floor. The perforations are made twice as numerous on the bottom of the duct as on top. There are a few placed in the sides. The fan is placed between this duct, and the cooling chamber. The air passes out of the room again through perforations in the false ceiling, to the cooling chamber. The holes in the ceiling are made closer together in the centre of the room farthest from the ducts.

When the  
they say their  
when opened.  
certainly is in  
to ventilate it

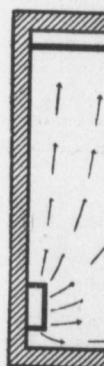

prefer no venti  
laden air in ou  
of washing and  
ample, and no  
the British Li

When the question of ventilation is broached to many egg men, they say their rooms are ventilated sufficiently through the doors, when opened. This may prove sufficient at certain seasons, but it certainly is indefinite and unreliable. Others say it would be well to ventilate if pure air were obtainable, but that they would much

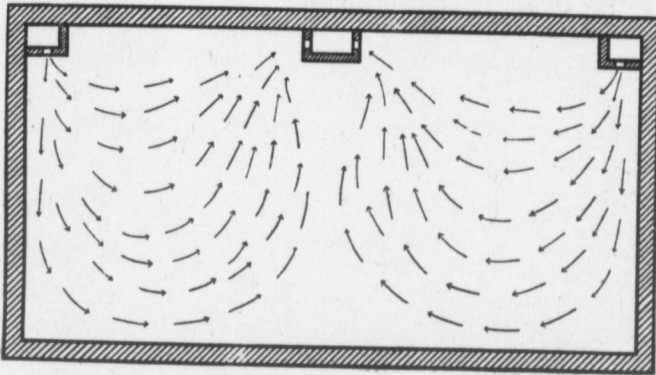

FIG. 7.

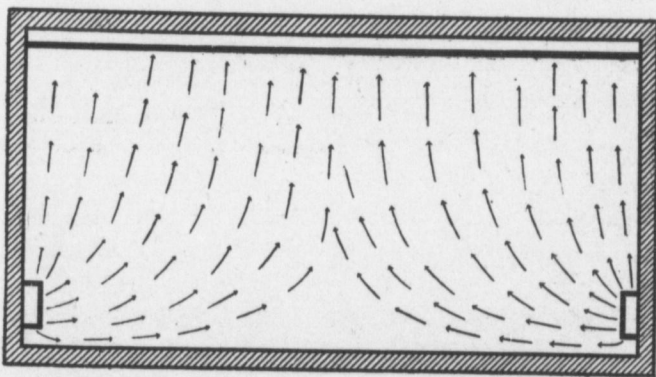

FIG. 8.

prefer no ventilation at all to the introduction of the dust and microbe laden air in our cities. It is quite possible that some of the methods of washing and purifying the air in process of circulation may prove ample, and no ventilation may be needed where they are used. In the British Linde system the circulating air is drawn through brine

dripping over the ammonia coils. This, doubtless, proves quite effectual while the brine is fresh; but it must soon become so contaminated with impurities that its cleansing power would entirely vanish unless means were provided for renewing it from time to time.

Mr. Cooper suggests apparatus like that shown in Fig. 9, for washing, cooling, and drying outside air for ventilating purposes. The air first passes through the washer which is simply a tank with a perforated diaphragm near the top, through which falls a spray of water. The air then passes to the cooler with its brine or ammonia coils, and from there to the drying and purifying tank, con-

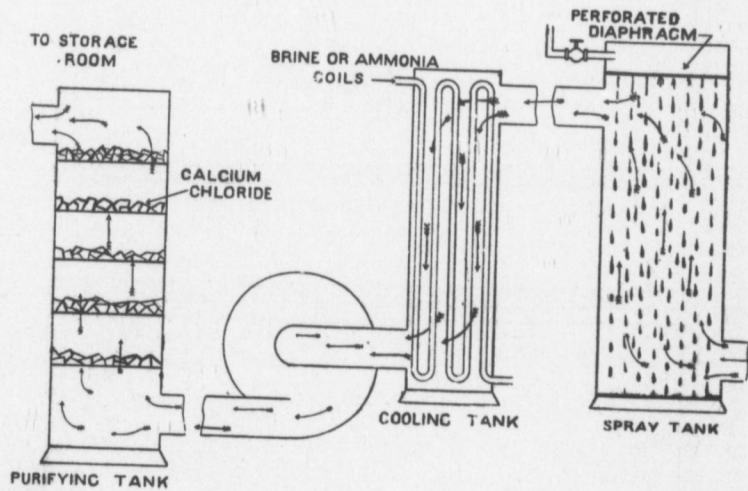

FIG. 9.

taining trays of calcium chloride. The air then passes into the room near the top. Openings of the same size are provided near the floor, through which the foul air may pass. He suggests putting the fan between the cooler and the dryer. In hot weather the ventilation should be done in the early morning, when the air is as cool as possible. At seasons when the outside air is about the temperature of the room, with proper care in choosing a time when its humidity is the same as that required in the room, ventilation could be secured by simply introducing sufficient air with a fan. When the outside air is at a lower temperature it would require

warming. In  
of the room  
certain amount

The quest  
safety in a ro  
Experience ha  
are observed.  
scrubbed, and  
white-wash. I  
it should be tr

The cold  
found in egg s  
gases, and all f  
reason forced o  
latter, if that o  
Fig. 5 or 6, w  
thorough venti  
cult to determ  
atmosphere on  
results, as they  
an evaporating

Opinion va  
The majority  
apples, and 35°

Butter ma  
ment produc  
need for thro  
perature there  
city generally  
lied by those  
ery butter nea  
this temperatur  
bad effect upon  
perature of 26°  
vents all fungu

Fish and g  
needed. Force  
fish. It has a



es quite effec-  
e so contami-  
ntirely vanish  
to time.

n Fig. 9, for  
ing purposes.  
a tank with  
falls a spray  
brine or am-  
ng tank, con-



es into the  
rovided near  
ests putting  
er the ven-  
e air is as  
about the  
time when  
om, ventila-  
air with a  
ould require

warming. In this case much ventilation might reduce the humidity of the room seriously, and it would be necessary to introduce a certain amount of moisture into the air.

The question is often asked whether eggs may be stored with safety in a room which has been used for apples or other fruits. Experience has proved that it may be done if proper precautions are observed. After the fruit is removed the floors should be scrubbed, and the walls and ceiling swept, and given a coat of white-wash. If the cooling coils are in a separate compartment, it should be treated in the same way.

The cold storage of fruit presents some of the same difficulties found in egg storage. Pears, particularly, give off large amounts of gases, and all fruits do the same to a greater or less extent. For this reason forced circulation would prove superior to natural. Still the latter, if that obtained from such an arrangement of room as shown in Fig. 5 or 6, would give good results if provision were made for thorough ventilation every day or so. The proper humidity is difficult to determine. Most storage men judge by the effect of the atmosphere on the fruit. The humidities given for eggs give good results, as they are about as low as could be used without producing an evaporating effect.

Opinion varies somewhat as to the best temperatures for fruit. The majority of cold storage men, however, favor 32° to 33° for apples, and 35° to 36° for pears, peaches, grapes, and dried fruits.

Butter may be stored successfully in a room with any arrangement producing fair circulation. There is not as imperative a need for thorough circulation, as with eggs and fruit. As to temperature there is great difference of opinion. The trade in this city generally demands a temperature as low as 22°, but it is believed by those who have studied the matter to be a mistake. Creamery butter nearly always is made with brine, which will freeze at this temperature. The freezing of the brine is believed to have a bad effect upon the grain of the butter. On the other hand a temperature of 26° to 28° does not freeze the brine, yet effectually prevents all fungus growth.

Fish and game are frozen up hard, and are kept frozen until needed. Forced air circulation is seldom resorted to except with fish. It has a wonderfully freshening and purifying effect on the

air of a fish freezing room. A combination of forced air circulation and freezing coils within the room, gives most excellent results.

All things else being equal, the larger the room the less refrigeration is required to maintain a given temperature. If the rooms are not provided with stagings, the height will be restricted to avoid having too high piles of goods. Twelve to fourteen feet would seem as great a height as would allow of the easy handling of cases or barrels. The width will depend upon the uniformity of temperature, and thoroughness of circulation required. In egg or fruit rooms with gravity circulation such as is obtained by constructions shown in Figs. 5 and 6, the width should not exceed 20 feet. This dimensions could be increased to 30 feet with a system of forced circulation. In case of butter rooms the size is restricted only by the necessity of maintaining a fairly uniform temperature.

HY

The original forms of hoists consisted of a controlled by the first reference vertically up Emperor Napoleon chaise volante the great Co elevator machine well known by the hoisting gearing from the motion of the instance in the expensive lift is still used in the car, and in shifters and m

What makes is the direct Fig. 1. The long vertical motion of this part of the same lift cylinder between

air circulation  
ent results.

less refriger-  
the rooms are  
cted to avoid  
t would seem  
g of cases or  
y of temper-  
egg or fruit  
constructions  
0 feet. This  
em of forced  
cted only by  
ture.

## HYDRAULIC AND ELECTRIC ELEVATORS.

---

L. B. CHUBBUCK, GRAD. S. P. S.

---

The origin of the modern elevator can be traced back to crude forms of hoisting machinery in use during the earliest ages. All these primitive forms up to the beginning of the eighteenth century consisted of a rope or ropes passing over one or more pulleys, and controlled by winding on a drum or some form of winch. Perhaps the first reference to an actual elevator, *i.e.*, a car capable of moving vertically up or down as desired, is given in a letter written by the Emperor Napoleon I, in which he describes "the flying chair" (*la chaise volante*) seen by him in Vienna. For many years after the great Corsican's time no appreciable advance was made in elevator machinery till about sixty years ago. About this time the well known belt driven hoisting machine was introduced, in which the hoisting rope from the car is wound upon a drum, rotated by gearing from some arrangement of tight and loose pulleys for reversing the motion of the car. For slow speed elevators, such as for instance in handling freight, or in many situations where a more expensive lift is not required, the old type of belt driven machine is still used very extensively. Improvements have continually been made in these machines, in the control of the winding drum from the car, and in various forms of safety devices, automatic stops, belt-shifters and methods of applying the brake.

What may be called the first really distinctive elevator machine is the direct acting lift, or "Plunger Elevator," as illustrated in Fig. 1. The car, or platform, is supported between guides on a long vertical steel tube or "plunger." Surrounding the lower portion of this plunger is a cylinder of slightly greater diameter, and of the same length, as the plunger. The space at the top of the cylinder between it and the plunger, is tightly packed, such that

on allowing water under pressure to enter the cylinder, the plunger and car are raised. Conversely, by allowing water to discharge from the cylinder the car is lowered. The control of the car is effected in this manner by means of a piston valve similar to that shown in Fig. 2. The plunger elevator is chiefly employed for freight purposes through short distances, and is used very extensively for sidewalk

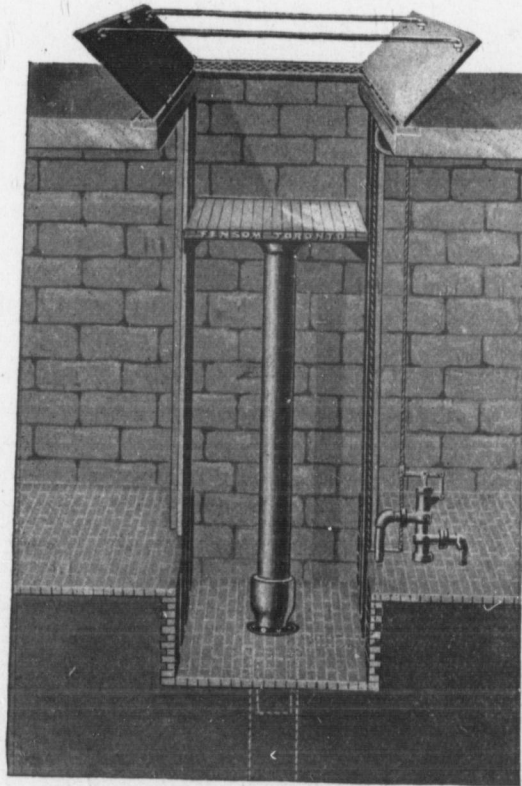
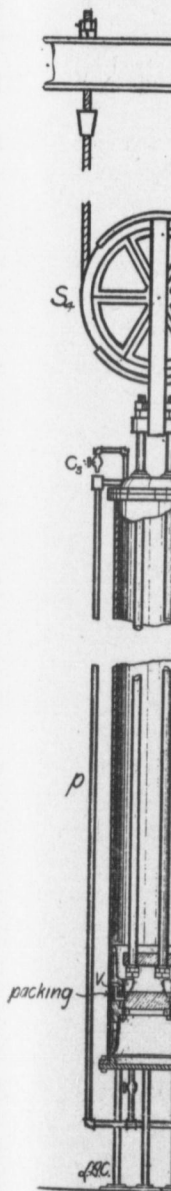

FIG. 1.—SIDEWALK LIFT HYDRAULIC ELEVATOR.

lifts. Though generally slow in motion, it is very simple, requires a minimum of floor space, and is capable of handling heavy loads.

The most familiar type of hydraulic elevator for passenger service is shown in Fig. 2. In this case a system of multiplying sheaves is used, by which the motion of a piston in a vertical, or horizontal cylinder, produces a high speed at the car. The main cylinder, as



the plunger  
 discharge from  
 car is effected  
 as shown in  
 light purposes  
 for sidewalk

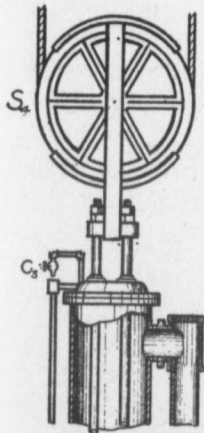
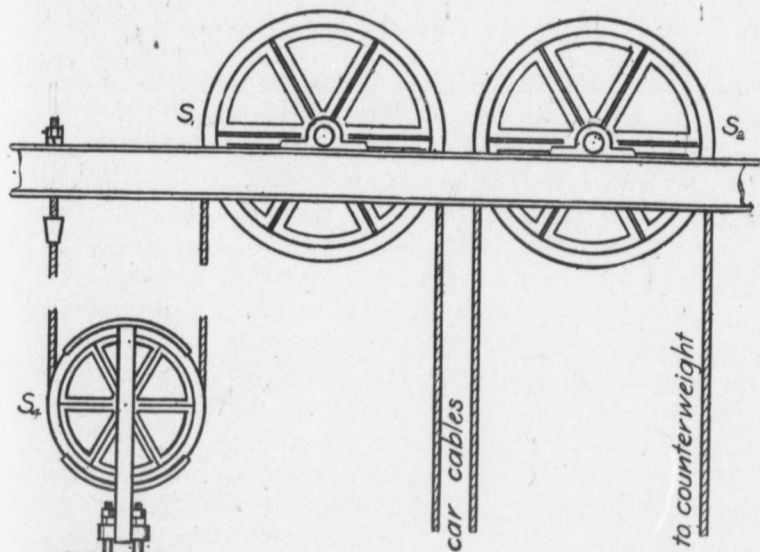

VERTICAL  
 HYDRAULIC ELEVATOR

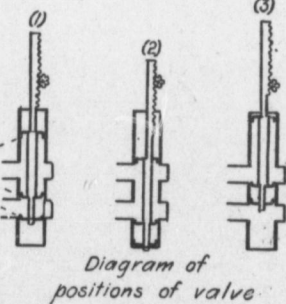
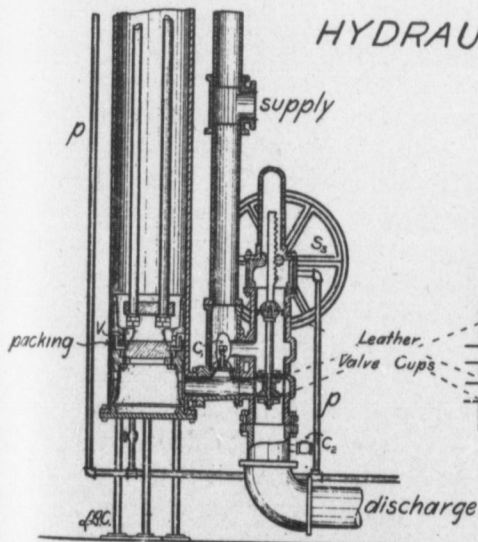

S.P.S.—7

FIG. 2.

requires  
 loads.  
 passenger ser-  
 vicing sheaves  
 horizontal  
 cylinder, as

shown in the figure, consists of a cast iron tube, whose dimensions depend upon the height of the lift, the pressure of water to be used, and the load and speed of the car. The operation of the elevator may be understood from an inspection of the valve at (1), (2), (3), which are diagrams respectively of the position of the main valve when the car is stationary, descending and going up. In (1) the full hydraulic pressure is acting on the upper surface of the piston, yet no motion is possible since the lower portion of the cylinder is filled with water, and no discharge can occur while the valve remains in this position. By raising the valve cups to the position given in (3), this water below the piston is released and the piston is forced downward, thus raising the car. When the car is required to descend, the valve is lowered to the position shown at (2). The pressure of the supply is now applied equally on both the upper and lower surfaces of the piston, and since the water is now free to circulate through the valve ports, the piston moves upward due to the excess in weight of the car and its load over that of the counterweights, travelling sheaves, and piston.

In case the car is stopped very quickly when going up, by suddenly dropping the valve to cut off the discharge, a very heavy strain would be put on the cylinder and valves, due to the momentum of this moving water. To prevent this undue strain, a check valve is placed at ( $C_1$ ), opening upward, so that, if from such a cause the pressure below the piston becomes abnormal, this valve is lifted, and some of the water is discharged into the circulating pipe against the pressure of the supply. Small check valves are also placed on the discharge pipe, and on the main piston. The former is for the admission of air, when stopping the car, behind the column of water passing through the discharge pipe. The check valve in the main piston is to allow any air that may have collected beneath the piston to pass upward through this valve to the top of the main cylinder, where it may be released from time to time by an air cock ( $C_3$ ). The pressure of air beneath the piston is very objectionable, since it causes a most disagreeable surging of the car when stopping. It will be noticed that there are two aprons or followers on the main piston. These serve the purpose of gradually closing the valve ports as the piston reaches the end of its travel, either at the top or bottom of the cylinder, and allows the piston to gradually cushion

itself on the device, for if either ascending or descending, the limit of its travel is reached.

It is customary to provide a live load by means of counterweights in hydraulic elevators.

*pilot valve*

ELEVATOR

of the car plus the weight of the counterweights, less the weight of the car itself. However, the weight of the whole system is considered when the car has been found to be in quarters of the

itself on the enclosed water. These aprons also serve as a safety device, for if from any cause the car should get beyond control in either ascending or descending, it would come to an easy stop at the limit of its travel.

It is customary to balance part of the weight of the car and live load by means of counter weights. This principle of counter weighting is very important and is employed with nearly all forms of elevators. As the weight of the counterweight approaches that

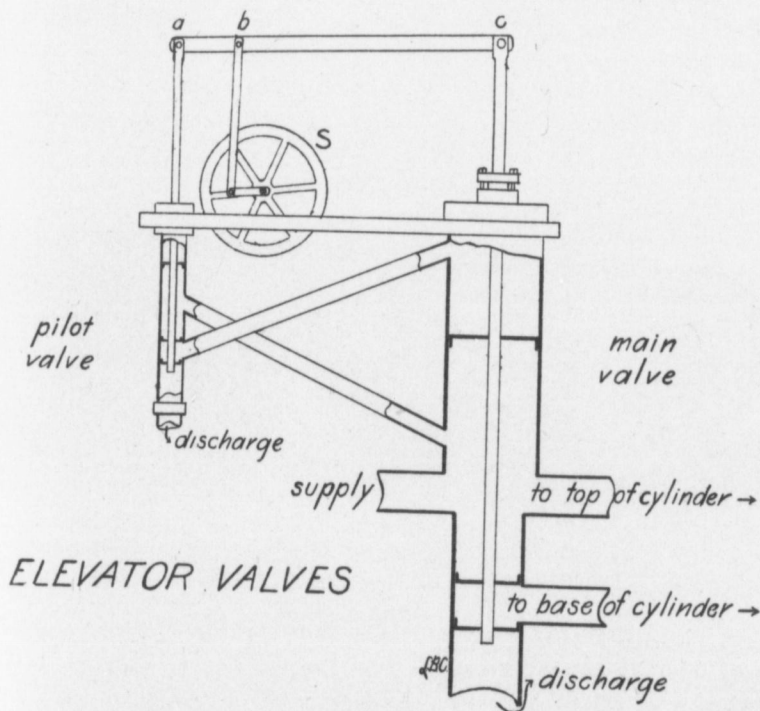

FIG. 3.

of the car plus the live load, the resultant load to be lifted becomes less, and less powerful hoisting machines are required. Conversely, however, the total friction is increased, and besides this the inertia of the whole system is nearly doubled, which is an important consideration where rapid starts and stops are desired. In practice it has been found best to counterbalance the car for one-half to three-quarters of the maximum load.

In order to obtain a more delicate control of the elevator than is given by the valve already described, a special valve is employed as illustrated in the diagram, Fig. 3. In this case the controlling sheave (*S*) operates a small "pilot valve," which in turn operates the main valve by hydraulic pressure. The upper valve cup of the main valve is made a little greater in diameter than the two lower valve cups. If then the water above the upper cup is free to discharge, the difference in pressure on the upper and lower valve cups will cause the valve piston to rise. If however the pressure of the supply is allowed to act on both surfaces of the upper valve cup, the unbalanced pressure on the lower cup will cause the valve piston to be lowered. In either event the motion of the main valve is limited by the horizontal lever connecting the main and pilot valve rods with the controlling sheave.

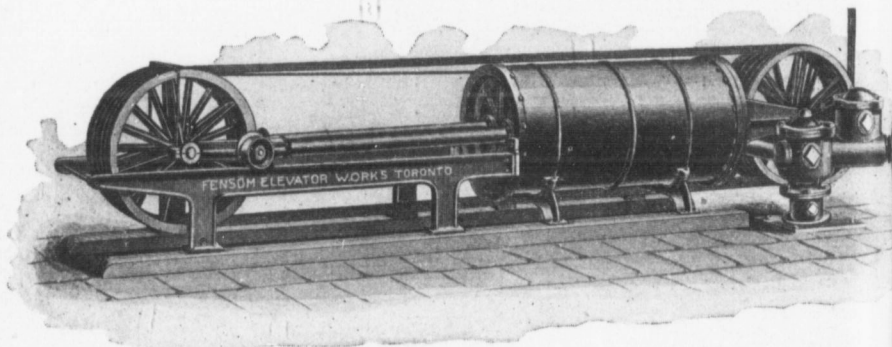

FIG. 4.—HORIZONTAL HYDRAULIC ELEVATOR.

There is another form of these multiple sheave hydraulic elevators, Fig. 4, which differs from the vertical type in that the main cylinder is placed horizontally. Owing to limited floor space the cylinders of these horizontal machines are made much shorter than the vertical cylinders, and in order to develop the necessary car speed are made of greater diameter, and have from six to twenty multiplying sheaves. In comparing the relative advantages of the horizontal and vertical types of these elevators, an important factor is the pressure of the supply water. Where the supply is obtained from the city mains or other low pressure source, the effective pressure at the top of a long vertical cylinder may be small, and the horizontal

cylinder made  
the most pop  
also the fact  
of stretch is

The pow  
may be obtain  
haps the most



cylinder machine has the advantage. The vertical type is however the most popular form due to the smaller floor space required, and also the fact that the length of cable and consequently the amount of stretch is less than with the horizontal elevators.

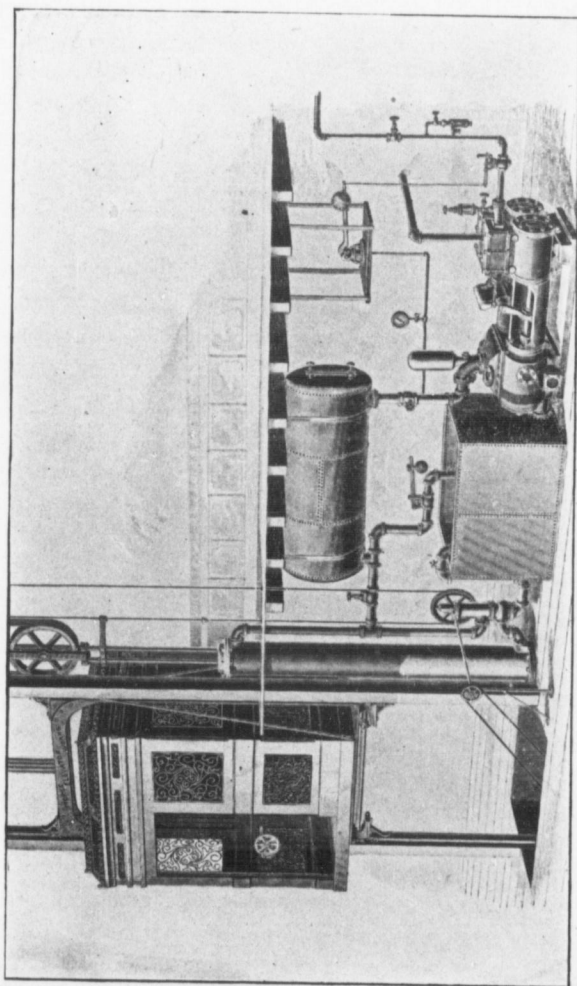

FIG. 5.—PUMPING PLANT.

The power necessary for the operation of hydraulic elevators may be obtained by a number of methods. The simplest and perhaps the most economical way in the case of very small plants is to

use the water pressure from the city mains. The pressure thus available in most cities and towns is about sixty to ninety pounds per sq. in. In the case of long travel, high speed elevators, especially where there are several elevators in constant use throughout the building, the quality of water used and discharged to the drain with this method makes it very costly. The standard practice in operating hydraulic elevators is by means of pumps in connection with either elevated or compression tanks. In these methods the same water is used over and over again, only sufficient water being added to the system as required to take the place of water lost by evaporation or small leakages. The general arrangement of such a plant is given in Fig. 5. The supply pipe to the elevator is brought from the lower portion of the pressure tank, which is strongly built of boiler plate and kept about two-thirds filled with water. The air enclosed in the upper portion of this tank is kept under a pressure of from 100 to 300 pounds per sq. in. Higher pressures than these are sometimes employed, but the strain on the valves is excessive and accidents are very liable to occur.

When the pressure in the tank falls, owing to the water supplied to the main cylinder on an upward trip of the car, an equal quantity of water is pumped into this tank from the discharge tank. This is done automatically by means of some form of regulating valve placed in the steam supply pipe to the pump. The valve is connected to the pressure tank by small piping, and when the pressure in the tank is up to the normal, this pressure acting on a diaphragm in the regulating valve keeps the steam supply pipe closed. When however the pressure drops, the throttle valve in the steam pipe is opened, and the pump continues to act till the pressure is again raised to the normal value.

There are several methods of operating pumps for hydraulic elevators aside from the use of steam. A common method consists in driving the pump by means of an electric motor, either direct connected or by belting. In some systems a starting rheostat is used controlled by a regulating valve connected with the pressure tank, such that the motor runs only when the pressure is low. In other cases the motor is allowed to run continuously, and when the pressure in the tank is up to the normal, an automatic valve opens a by pass around the pump. As the pump now simply causes a circulation of water around this by pass, the load on the motor is small.

The app  
the beginning  
These first e

driven elevator  
elevator being  
In these early  
the motor un

## ELECTRIC ELEVATORS.

The application of electricity to elevator service dates back to the beginning of the commercial development of the electric motor. These first electric elevators consisted of a motor belted to a belt

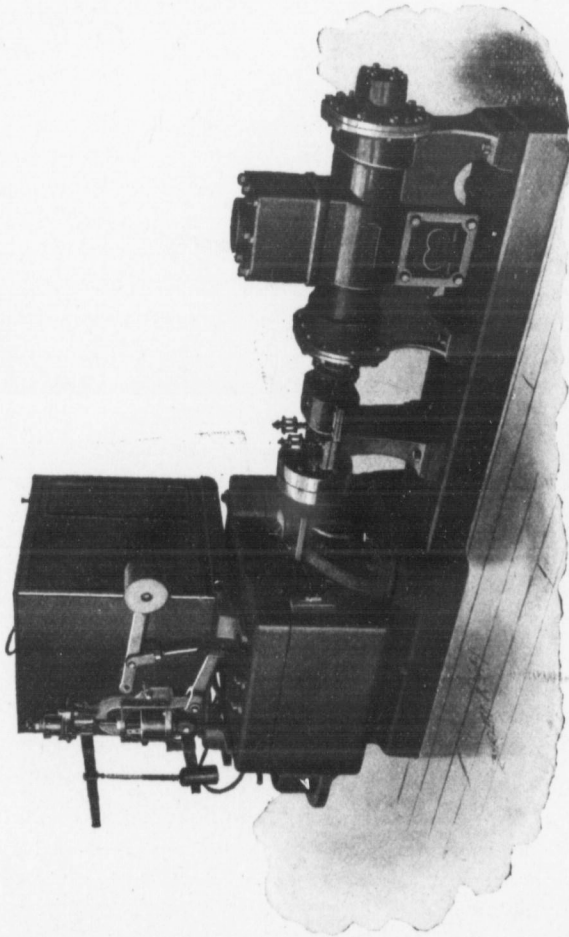

FIG. 5A.—“QUIMBY” SCREW PUMP DRIVEN BY ELECTRIC MOTOR.

driven elevator and allowed to run continuously, all control of the elevator being accomplished by means of the belt shifter and brake. In these early installations it was not considered feasible to start the motor under load, but when during the development of the

trolley, the successful operation of the direct connected motor became apparent, this principle was soon applied to elevator work. A diagram is given, Fig. 6, which shews the operation of a belt driven elevator. In all these belt driven machines the control of the elevator is effected by shipper ropes, and when operated by an electric motor a starting switch is usually connected to the shipper rope. There are a great many styles of these starting switches and rheostats, the one shewn in the figure however is a common type. On closing the shipper rope switch, either for an up or a down start, a magnetic clutch in the motor starter throws the arm of the rheostat in contact with a revolving worm, which causes the armature resistance in the rheostat to be gradually cut out. When this resistance is all out further rotation of the arm is prevented by the slipping of the clutch. Other forms of motor starters are operated by means of a solenoid, a gradual motion being obtained by the use of a dash pot.

In all belt shifting, belt driven elevators, economy is gained by the use of ordinary high speed, shunt wound motors, and as the motor is allowed to come wholly or partly up to speed before the load is applied, no great rush of current occurs at the moment of starting. The disadvantage, however, of these elevators is the jerky start caused by shifting the belt after the motor has attained a certain speed.

The type of electric elevator which is in most common use is shewn diagrammatically in Fig. 7, in which the motor is direct connected to the hoisting drum. It will be noticed that in nearly all these drum machines the power is transmitted to the drum by means of a worm and worm wheel. The use of this combination in place of simple spur gearing, is due to the noise of the latter, and also to the jerky motion given to the car by spur gearing unless very carefully set. There is also difficulty with the latter in making accurate stops, and greater danger of the motion of the machine being reversed by an overload on the car. Though the use of the screw and worm wheel would not seem at first to be as efficient as spur gearing, yet it must be remembered that in place of a single reduction of speed in the case of the former, two or three reductions by spur gearing would be necessary: and the total friction losses might be much greater than in the case of a single worm and worm wheel. By the use of a specially cut worm and wheel the efficiency of the combination may be raised to about 65 to 75 per cent. It is customary

in order to  
enclose both i

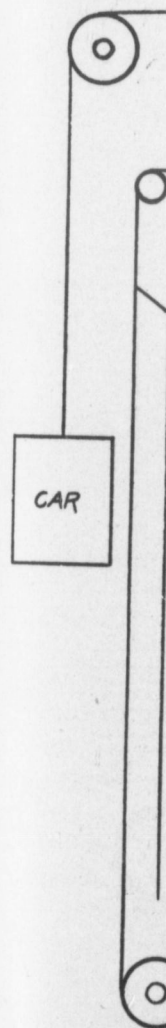

In some m  
wheels are used  
vent the heavy

in order to ensure the best operation of the worm and wheel to enclose both in an iron casing which is kept partially filled with oil.

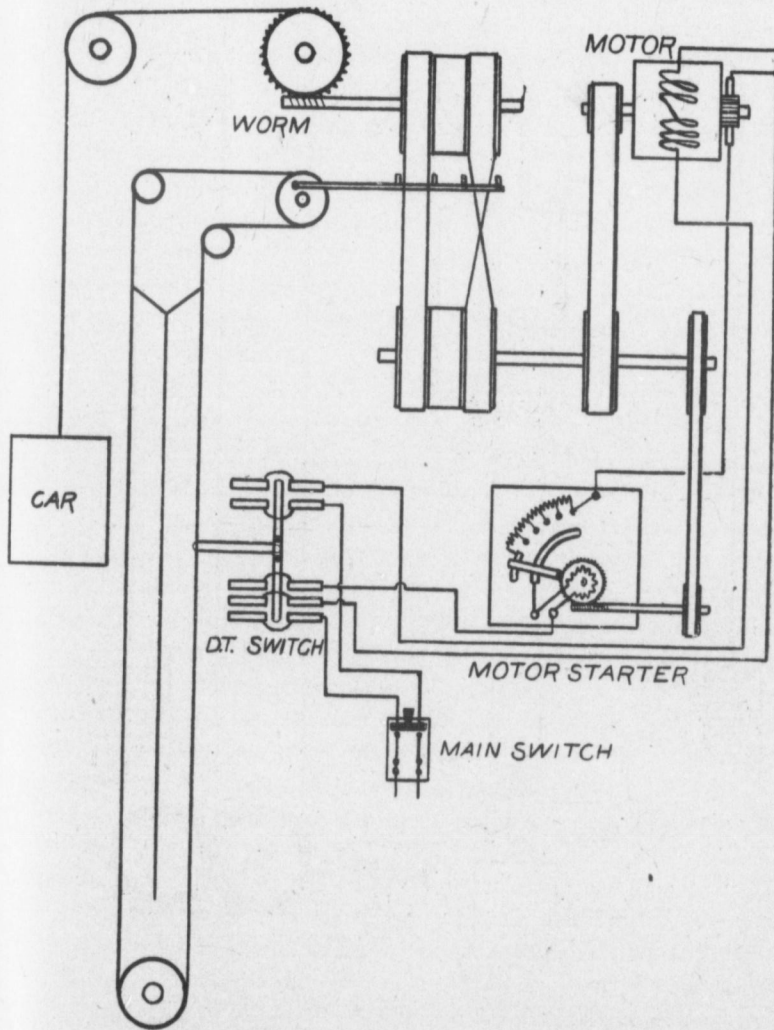

FIG. 6.—BELT DRIVEN ELECTRIC ELEVATOR.

In some machines, as shewn in the figure, two interlocking worm wheels are used in tandem. This method is adopted in order to prevent the heavy end thrust produced by a single screw and worm

wheel. This figure shews the usual method adopted in counterweighting drum elevators. Only part of the counterweight is connected to the car, or in case of a small load on the car the hoisting cable may

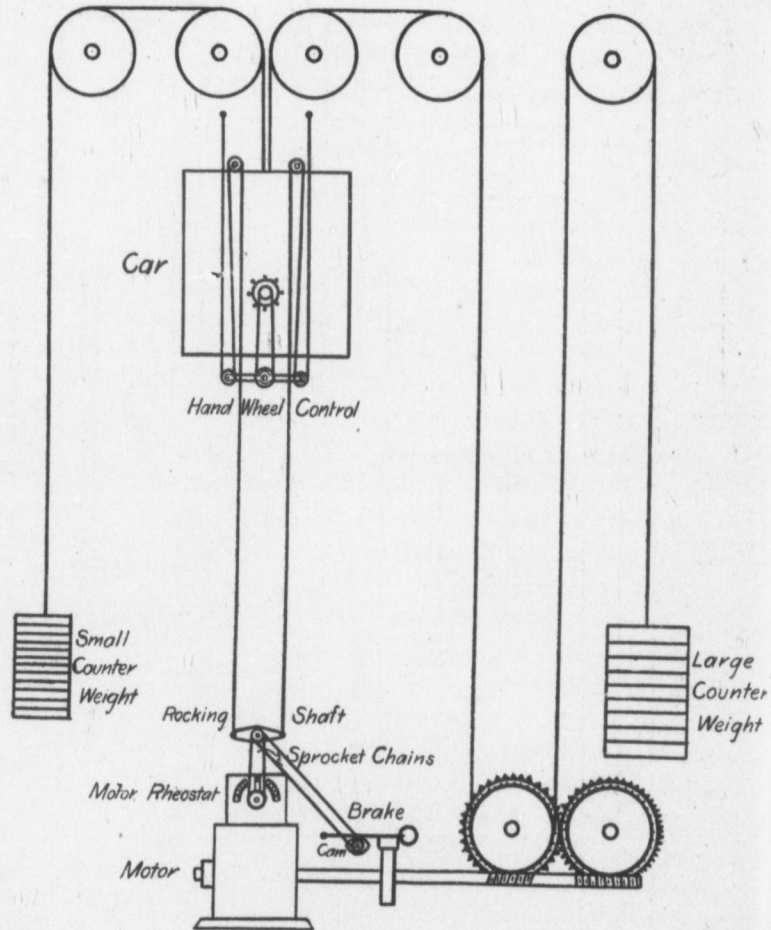

FIG. 7.—DIRECT CONNECTED ELECTRIC ELEVATOR.

become slack, which is an element of danger. On this account the greater portion of the counterweight is hung from the winding drum. In ordinary practice, the small car counterweight is made to counterbalance two-thirds of the weight of the car unloaded, while the large

or drum counterweight of

There are controlling the hand wheel in the hand wheel is beneath the top of the shaft two pulleys on the top of are fastened motor from the in the shape different man

For the buildings, a principle of this case, instead of pressure, the angular velocity, by means machines, these types. A diameter of one is required, such get half the r sheaves on the means of a t Where the height ing cable passing tion of the load shaft. In ord is employed, and at the other end

The efficiency more than any nut, a section tension, and is

counterweight-  
connected to  
ing cable may

or drum counterweight is of sufficient weight to balance the remaining weight of the car plus the average load.

There are several methods, both mechanical and electrical, of controlling the motor from the moving car. One of the commonest, the hand wheel mechanical control, is illustrated in the figure. The hand wheel in the car is connected by a sprocket chain to a lever beneath the floor of the car. Starting from fixed points near the top of the shaft, two flexible steel cables pass down the shaft, around two pulleys on the end of this lever, and up to and over two pulleys on the top of the car, after which they descend to the basement and are fastened at either end of a rocking shaft. In controlling the motor from this rocking shaft many ingenious forms of mechanism in the shape of levers, cams, toggle joints, etc., are employed by different manufacturers.

For the high speeds and long lifts met with in the taller office buildings, a special form of electric elevator has been developed, on the principle of its rival, the hydraulic multiple sheave elevator. In this case, instead of separating the multiplying sheaves by hydraulic pressure, the necessary thrust is obtained by converting the high angular velocity of the motor into a slow but powerful linear motion, by means of a screw and sliding nut. Like the hydraulic machines, these elevators are built in both the horizontal and vertical types. A diagram, Fig. 8, is given showing the general arrangement of one of these vertical elevators. Where a high ratio of speed is required, such as for instance fourteen to one, it is customary to get half the ratio, i.e., seven to one, by means of the multiplying sheaves on the machine itself, and to get the remaining ratio by means of a travelling counterweight, as indicated in the figure. Where the height of the elevator shaft is great, the weight of hoisting cable passing down the shaft to the car, will cause a great variation of the load and the speed of the car, as it travels up or down the shaft. In order to counteract this effect, a counterbalancing chain is employed, anchored at one end to a suitable point in the shaft, and at the other end to either the car or the travelling counterweight.

The efficient operation of these elevators depends, upon perhaps more than anything else, the construction of the screw and sliding nut, a section of which is given in Fig. 9. The screw is always in tension, and is so cut that the ball bearing surface is perpendicular

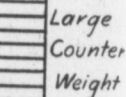

Large  
Counter  
Weight

account the  
ding drum.  
to counter-  
le the large

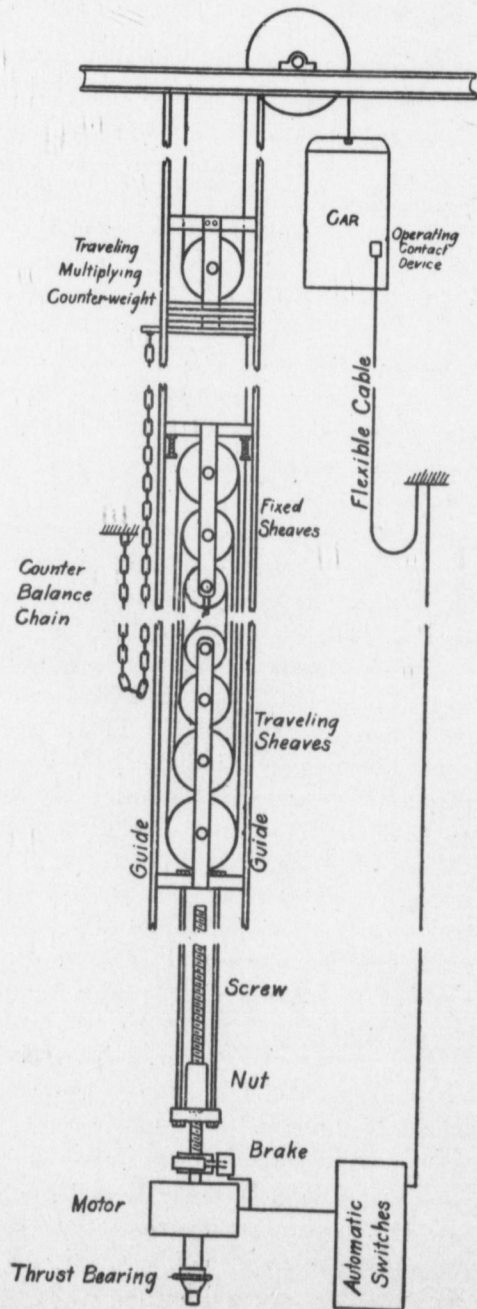
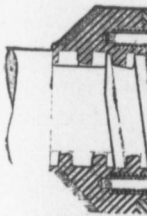

FIG. 8.—MULTIPLE SHEAVE ELECTRIC ELEVATOR.

to the axis of  
 such that as  
 the other end  
 which is made  
 as it is found  
 by the steel  
 surface. At t  
 or safety nut.  
 apart from th  
 the nut itself  
 a conical seat  
 the pressure l  
 ing. However  
 this pressure  
 bind on the s  
 motion is give



In all dr  
 both hoisting  
 nut machines  
 descending by

The type  
 elevators is of  
 loaded car up  
 it must posses  
 this work are v  
 six hundred r  
 shunt field is v  
 is compound, l  
 serves to stead



to the axis of the screw. A return channel is provided in the nut, such that as the balls roll out at one end they are carried around to the other end of the nut. This nut is hardened, but the screw, which is made of a forged bar of high carbon steel, is left unhardened as it is found that the rolling compression to which it is subjected by the steel balls, after a short time produces an exceedingly hard surface. At the end of the nut next to the crosshead is an additional or safety nut. This nut contains no balls, and has its threads held apart from those of the main screw by means of two small springs in the nut itself. The sliding nut is in contact with the crosshead by a conical seat, and normally the friction between these two, due to the pressure between them, is sufficient to keep the nut from turning. However if the hoisting cables should slacken from any cause, this pressure decreases and the springs on the safety nut cause it to bind on the shaft, and as the nut now revolves with the screw, no motion is given to the crosshead.

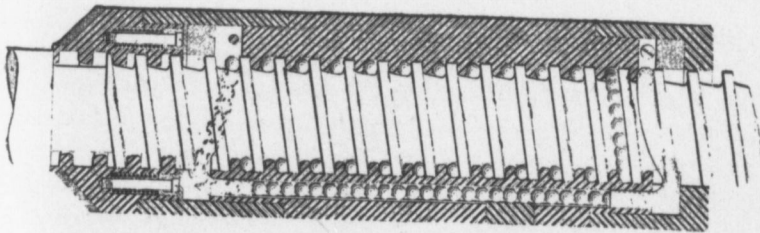

FIG. 9.—SECTION OF SCREW AND SLIDING NUT.

In all drum-winding electric elevators the motor operates in both hoisting and lowering. In the case of the screw and sliding nut machines however, current is used only in hoisting, the car descending by its own weight.

The type of motor to be employed in these direct connected elevators is of prime importance. Since the motor must bring the loaded car up to maximum speed as rapidly as smoothness will allow, it must possess a powerful starting torque. The motors used for this work are usually direct current, operating at low speeds of about six hundred revolutions per minute. In the simpler machines a shunt field is usually employed, but in many cases the field winding is compound, having a starting series coil, and a shunt winding which serves to steady the field. Where, as is generally the case, current

is used in the motor both in hoisting and lowering, reversing devices must be used. Where current is used only when the car is going up, the speed when descending must be checked by means of some form of brake. In this case the shunt field is left connected across the mains, and since the motor now operates as a dynamo, the speed may be controlled by short circuiting the armature through an adjustable resistance. The various switches, armature rheostat, and brake are in some machines all operated directly by levers or sprocket chains from the rocking shaft. In other cases the starting devices are operated partly mechanically, and partly electrically, while in many machines all control is effected electrically from an operating contact device in the car. In this case all the switches, etc., are operated from solenoids, and the armature rheostats either by solenoids or by means of a small pilot motor.

In private residences and some other cases where it is undesirable to employ an elevator boy, a special system of control is sometimes used. There are several of these automatic elevator systems, in all of which drum machines are used with solenoid control. In the "push button" system, a single push button is used at each landing. The pressure of any button starts the car, and on reaching that floor a car switch is tripped which stops the car. The car is controlled from the inside in the same manner as in ordinary systems. In another system a three-point switch is placed at each landing, and also in the car. Placing the switch, on a certain landing, at the "up" or "down" contact, starts the car in this direction, and on reaching the required floor the car is stopped by placing the switch at the "stop" contact. The control from the car itself is effected in the same manner. In both these systems while any switch is in use all the others are automatically disconnected, so that no interference from them is possible. It is also customary to include in the main circuit, a small switch placed at each elevator gate. These switches are all connected in series, so that if from any cause any gate should be left open, the elevator will not operate.

Besides these automatic systems, there is an important variable voltage method of control employed in many high class elevator installations. In this system, instead of controlling the motor by rheostats from constant potential mains, the current to the motor is varied by varying the voltage supplied. This has been done

in a few instances determined by

In the operation of a generator is being controlled by the generator field. The motor being started directly to the shaft of the dynamo. The field rheostat is connected to the mains. The speed is controlled by varying the generator field through the generator.

The great advantage is the fact that it gives control over the operation since it is practically no different from the other hand. The maximum load placed is about one-fifth of the efficiency. The outlay necessary is

The excellent (2) Reliability Cost.

*Safety.*—The safety in elevator operation is the widely varied which may result should be taken as a factor of safety. The provision must be made for stretching or breaking or at its limit of the motive power.

in a few instances by the use of storage batteries, the voltage being determined by the number of cells connected in series.

In the ordinary, or Leonard variable voltage system, a separate generator is used for each elevator motor, the speed of the motor being controlled by changing the resistance in circuit with the generator field. The elevator machine is of the ordinary drum type, the motor being shunt wound. The field winding is connected permanently to the supply mains while the armature brushes are connected directly to those of the dynamo. The terminals of the field winding of the dynamo (also shunt wound) are carried by a flexible cable to a field rheostat placed in the car, to which is also brought the supply mains. The direction of rotation, and speed of the motor is then controlled by the sense, and strength of current, respectively, sent through the generator field winding.

The great advantage derived by the use of this system is due to the fact that it allows an ideal start or stop, and gives a perfect control over the speed of the motor. The system is also economical in operation since owing to the small dynamo field current required, practically no power is wasted in starting or regulating rheostats. On the other hand, the dynamo must be of ample size to carry the maximum load placed on the motor, and as the average load is usually only about one-fifth of the maximum, the generator is running at low efficiency. The chief defect however in this system is the capital outlay necessitated by the use of a separate generator for each motor.

The excellence of any type of elevator is judged by its (1) Safety, (2) Reliability, (3) Economy in Operation, (4) Compactness, (5) First Cost.

*Safety.*—Without doubt safety is the question of prime importance in elevator design. From the very nature of elevator service, the widely varying loads, the rapid starts and stops, and the disaster which may result from the failure of the working parts, great care should be taken in the construction of such machinery, and a liberal factor of safety allowed. In order that absolute safety may be assured, provision must be made for preventing a fall in case of the cables stretching or breaking, for stopping the car in case of excessive speed or at its limits of travel, and for holding the car stationary in case the motive power is cut off.

Of the safety apparatus necessary for this work, part is placed on the machine and part on the car. In the case of hydraulic elevators, the limit stops consist of an apron on the piston or other means of closing the ports. In the case of electric elevators, a switch is opened at the limits of travel, which cuts off the power and allows the magnetic brake to act, or, on some machines, a sliding nut at the limits of travel causes the controlling sheave to be thrown to the stop position. The magnetic brakes used with electric elevators consist of a steel band, or bands, lined on the inside with wood or leather, and encircling the brake pulley. This band is normally held strongly against the pulley by means of a spring. In starting the car a current is sent round a magnet or solenoid which counteracts the effect of the spring, and releases the brake. This magnet or solenoid is placed in the main circuit to the motor, and the very operation of cutting off the current to stop the car, or any failure in the supply mains, at once applies the brake. Slack cable devices are sometimes placed on the car or at the machine. A common form of the latter consists of a lever which bears against the cables as they leave the main drum. In case the cable slackens, this lever is allowed to spring over, and by opening a switch, or otherwise, applies the brake. The safety speed stops may consist either of a centrifugal governor on the machine which operates the brake directly, or safety grips on the car operated by a centrifugal governor in the shaft. A standard form of the latter is shown in Fig. 10. Beneath the floor of the car is placed a small drum supported at each end on a short rod connected to a safety clutch through a toggle joint. The rotation of the drum on these two rods, by means of a right and left hand screw, draws the rod together and causes the safety grips to grip the guides. The free end of the rope wound on this drum is fastened to a continuous vertical rope, which passes freely around two pulleys, one at the top, and one at the bottom of the shaft. The upper pulley operates a centrifugal governor, and in case the speed of the car exceeds a certain limit, this governor lifts a lever, which causes the cams to grip the rope, holding it stationary. As the car continues to travel, the rope on the drum beneath the car is rapidly unwound, which operates the safety grips and stops the car.

A safety precaution, which has been adopted in several instances, is to tightly enclose the lower story of the elevator shaft, such that

View

part is placed  
 hydraulic ele-  
 tion or other  
 s, a switch is  
 r and allows  
 g nut at the  
 own to the  
 elevators con-  
 d or leather,  
 held strongly  
 e car a cur-  
 nteracts the  
 t or solenoid  
 operation of  
 the supply  
 e sometimes  
 of the latter  
 ey leave the  
 ed to spring  
 brake. The  
 governor on  
 grips on the  
 andard form  
 f the car is  
 d connected  
 of the drum  
 crew, draws  
 guides. The  
 continuous  
 at the top,  
 operates a  
 ceeds a cer-  
 ms to grip  
 travel, the  
 ch operates

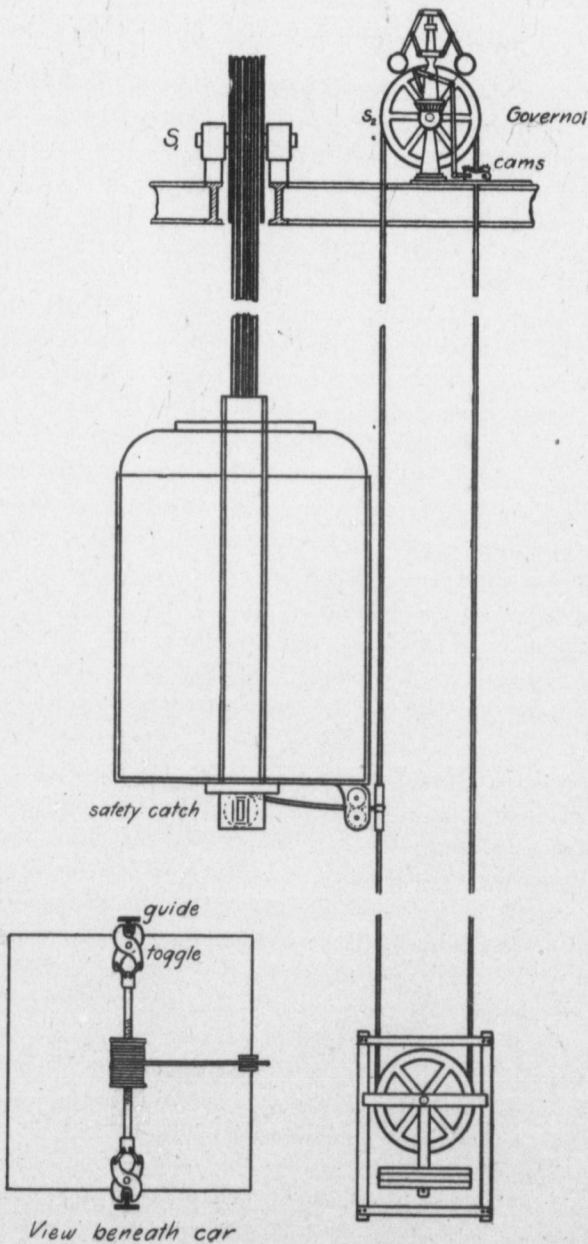

## SAFETY DEVICES

in case of the car falling, the air partially shut in below the car may act as an air cushion and bring the car to an easy stop. A few exciting trials have been made by allowing the car, containing baskets of eggs, etc., to drop freely the whole length of the shaft. Though in these tests no eggs were broken, still the ordinary mortal would prefer to depend for safety on this system only after all the ordinary devices had failed.

*Reliability.*—This comes next in importance to the question of safety. The necessity of shutting down an elevator frequently for repairs is not only expensive, but may seriously interfere with the accommodation of the building and will lower its value. Hydraulic, have perhaps the advantage over electric elevators in this respect, as the working parts are few and substantial. The only parts requiring renewals are chiefly the valve cups, and the packing of the piston, and this is only necessary at long intervals. Electric elevators are much more complicated, but on the other hand they are generally run independent of one another, so that an accident to any machine affects that elevator only. In the case of hydraulic elevators, all of which in one building are usually supplied from a single large pressure tank, any accident to the supply pumps, etc., will cause the shutting down of the whole plant.

*Economy in Operation.*—This is perhaps the most hotly contested question between the advocates of hydraulic and electric elevators. In the case of hydraulic elevators, the work expended in lifting the car, is as much when the car is empty, as when fully loaded, since in each case the water at the constant pressure of the pressure tank acts through the same volume of the cylinder. The power consumed by the motor in an electric elevator varies directly with the load. When starting the elevator however, and overcrowding the inertia of the moving parts, there is an abnormal rush of current, and in elevator service the starts and stops are so frequent that the average current used by the motor is much greater than that simply due to the load. On the other hand, certain high grade electric elevators will, when the car is descending, return current to the line, and the total current used by a bank of elevators in a building may be surprisingly small. One of the greatest advantages of hydraulic elevators is the storage of energy possible by means of the pressure tank. That is, the constant operation of one, or more small pumps, may be capable of supplying power to a large system of elevators operating intermittently.

Conversely, h  
very low comp  
ery. In some  
are used, whic  
ing a higher e

*Compactn*  
the electric el  
all the operati  
of the elevator

*First Cos*  
varies widely, s  
and other cons  
ever the differ

*Conclusion*  
depends entire  
plants in a loc  
figure from th  
ployed. In th  
choice of elev  
required, by th  
mains, the cost  
plant is used i  
elevator forms  
be changed ex  
the conditions i  
in order that th  
for the purpos

Conversely, however, the efficiency of the ordinary steam pumps is very low compared to the general high efficiency of electrical machinery. In some of the later hydraulic elevator plants fly-wheel pumps are used, which enable the steam to be used expansively, thus obtaining a higher efficiency.

*Compactness.*—In this respect and also in regard to cleanliness the electric elevator is pre-eminent. In many elevators of this type all the operating machinery can be placed in the space at the bottom of the elevator shaft.

*First Cost.*—The price of both hydraulic and electric elevators varies widely, according to the grade of machine required, the locality, and other considerations. For a first class plant in either case however the difference in cost for either system is small.

*Conclusion.*—The best form of elevator to install in any case depends entirely on the conditions governing that plant. For small plants in a locality where electricity may be obtained at a reasonable figure from the central station, this system is the one usually employed. In the case of medium and large-sized installations, the choice of elevators is determined by the class of elevator service required, by the cost of electric and hydraulic power from the street mains, the cost of coal, whether or not a lighting or steam heating plant is used in the building and other considerations. Since the elevator forms an integral part of the finished building and cannot be changed except at great expense, a careful preliminary study of the conditions involved should be made in each case. This is essential in order that the elevator after erection shall prove the most suitable for the purpose.

## CIRCULATION IN WATER TUBE BOILERS.

W. MONDS, GRAD. S. P. S.

With the increasing tendency towards the use of high-pressure steam, especially in the navy and marine, has come the introduction of the water-tube boiler with its numerous claims to safety and to economy in space and fuel. Doubtless these claims are greatly exaggerated, but still this type of steam generator seems to possess sufficient advantages to enable us to point to it as unmistakably the boiler of the future. "Efficient circulation" is the one point which is generally regarded as essential to the successful working of these tubulous boilers, and unless a manufacturer can show on paper at least, that his boiler has been designed to provide a definite course for the circulating water his output, in accordance with the law of supply and demand, is apt to be exceedingly small.

This paper has been prepared with the object of discussing a few of the main points in connection with circulation and to show the methods adopted in dealing with the subject.

### ADVANTAGES OF CIRCULATION.

It is a well-known fact that when water containing certain salts is heated to the temperatures which obtain in ordinary boiler practice the salts are precipitated. An example of this may be seen any day by examining the water coming from the ordinary hot-water boilers in our private houses, where, on account of the pressure, a high boiling point exists. The water will appear quite milky and this appearance increases with a rise in temperature. Now if this precipitation takes place in one of the tubes of a boiler, the salts if left unhindered will soon coat the inside of the tube and burn into a hard scale, which will in a short time decrease the efficiency of the heating surface as much

as twenty-five  
absolute dang  
becomes red-h  
and water to  
dents such as  
ally on board  
air-tight stoke  
comes very he  
cause the latt  
red-hot, once  
is generated so  
ciently to caus

It is, there  
much as possib  
precipitated p  
provide a settl  
ulation of the  
from the heat  
must of course  
very small whi  
scale and mud

Another v  
caused by the  
away from por  
bubbles which  
gives way.

One of the  
unequal expan  
strains on the  
of course due t  
tion, for water  
vection.

Nearly all  
type, that is th  
which acts as th  
water (Fig. 1.).



as twenty-five per cent. But this scale soon becomes a source of absolute danger, for the tube unable to transmit its heat to the water becomes red-hot and possibly bursts, allowing the scalding steam and water to rush out through the furnace and ash-pit doors. Accidents such as this are generally disastrous to the attendants especially on board ship, where the stokers are unable to escape from their air-tight stokeholds. Sometimes it happens that when the tube becomes very hot the different rates of expansion of iron and scale cause the latter to crack and peel off; this leaves the surface, now red-hot, once more in contact with the water, the result is that steam is generated so rapidly that the pressure in the boiler is raised sufficiently to cause rupture at some weak point, and disaster follows.

It is, then, very important to impede the formation of scale as much as possible, and evidently the best way to do this is to keep the precipitated particles in constant motion while within the tube and provide a settling chamber whither they may be carried by the circulation of the water, and where they may drop to the bottom away from the heat of the furnace. These mud-drums, as they are called, must of course be sufficiently large to make the velocity of the water very small while passing through them, in order to allow time for the scale and mud to drop.

Another very frequent accident through lack of circulation is caused by the formation of "pockets" of steam. The water is forced away from portions of the tube by the generation of large steam bubbles which cling to the sides, and the tube becoming white-hot gives way.

One of the greatest troubles with water-tube boilers has been the unequal expansion of the different parts, resulting in very serious strains on the joints, and consequent troublesome leaks. All this is of course due to unequal temperatures caused by a deficient circulation, for water is a poor conductor and only supplies heat by convection.

#### HOW CIRCULATION IS OBTAINED.

Nearly all the successful tubulous boilers are of the same general type, that is they consist of a bent tube in the shape of the letter U, which acts as the generator, surmounted by a reservoir for steam and water (Fig. 1.). If the fluid in one leg of the tube be of less density

than that in the other, the columns are not evenly balanced and consequently there will be a flow of the liquid from the denser to the lighter side in an attempt to restore equilibrium. Now in a boiler the difference in density is maintained continuously by the formation of steam bubbles in the lighter side, so that equilibrium is never attained and the phenomenon of circulation results.

There has been considerable discussion as to whether or not these bubbles really decrease the density of the fluid. Some writers have claimed that we might just as well anchor a string of corks in

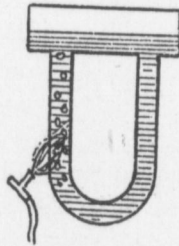

Fig. 1

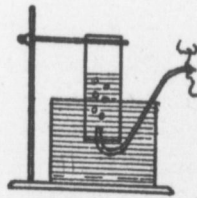

Fig. 2

the tube and then we would have circulation from cold water. But it is just this anchoring which causes the difference in the two cases, for the bubbles are free to move upward. The simple fact of being compelled to anchor the corks shows that a downward pull must be exerted on them, and this force transferred to the water is necessary to preserve equilibrium. It may be easily shown that the pull downwards on the corks must be equal to the weight of water displaced.

A very simple experiment may be made to show that a mingled column of gas and water is lighter than an equal column of solid water. Fig. (2) is self-explanatory; it shows an outer glass vessel filled to the brim with water, and an ordinary lamp chimney suspended in it. Now if air be blown up through the chimney a mingled column of air and water will rise in it much higher than the edge of the outer vessel, and yet no water will run over the side. This shows that the heads in both vessels though of different heights yet balance each other.

The gen  
of tubes actin  
and to have t  
from the heat  
well lagged an

A series  
Yarrow of the

of machine-gur  
necessity, and  
furnace

Fig. (3) re  
used by these g  
from which dep  
extremities by a  
burners capabl  
attached to a s  
up through the  
the water will

## DIRECTION OF CIRCULATION.

The general aim of manufacturers has been to have bundles of tubes acting as uptakes placed in the hottest parts of the furnace, and to have these tubes supplied by downtakes which are shielded from the heat as much as possible. In many cases the downtakes are well lagged and carried outside the furnace altogether.

A series of very interesting experiments was arranged by Mr. Yarrow of the celebrated ship-building firm, and Mr. Hiram Maxim

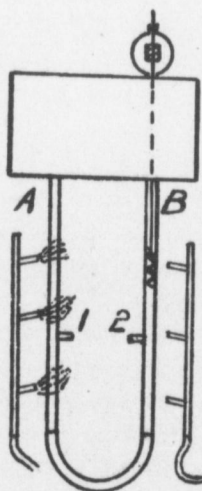

*Fig. 3*

of machine-gun fame, to show that special downcomers are not a necessity, and if they are used they should be placed within the furnace

Fig. (3) represents in diagrammatic form the improved apparatus used by these gentlemen. It consists of an upper drum or reservoir from which depend two glass tubes *A* and *B*, connected at their lower extremities by a copper bend. On each side are placed three Bunsen burners capable of separate regulation. A small screw propeller attached to a shaft is placed in the tube *B*, while the shaft extends up through the two bearings shown in the sketch. Any motion of the water will cause the propeller to turn, and the direction and

speed of the motion may be ascertained by observations on the indicator above the drum.

The burners on the side *A* were first lighted one by one, and soon a circulation of the water from *B* to *A* was set up, which became quite vigorous when the boiling-point was reached. After the water had been boiling steadily for some time the speed of the shaft was noted, and then the burners on the tube *B* were lighted. Instead of stopping the circulation already existing it was found that the motion of the water continued in the same direction as before, and with a greatly increased velocity.

Next, the flame was entirely shut off the tube *A* and applied to *B* only: the result was a considerable decrease in the velocity, as might be expected, but the current still continued quite vigorously in the original direction from *B* to *A*.

The conclusions drawn from the experiment by Mr. Yarrow were that the direction of circulation depends only on the direction in which it gets started, and not on the point of the application of the heat, and that the amount of circulation varies directly with the total heat added to the water.

A similar experiment was made by taking away the burners and connecting a compressed air tank to the cocks in the tubes at (1) and (2). Air was first let in at (1), and as it passed up the tube *A* it set up a circulation from *B* to *A*. Then air was allowed to enter the tube *B* at (2), but the bubbles, instead of rising, followed the course of the moving water from *B* to *A*, and greatly accelerated its velocity. When no air was allowed to enter at (1) the current, though decreased in velocity, showed no tendency to reverse, no matter how long air passed in through (2).

In the next experiment (Fig. 4), a similar apparatus was used, but with the addition of a third tube, which was intended to represent a downcomer in the Normand type of boiler. *A* and *B* were heated simultaneously and an upward circulation started in both, while a downward current took place in *C*. When the flow became steady *C* was heated, and immediately a great increase in velocity took place in all the tubes, while the direction of circulation remained as before. This result showed that if separate downcomers are used they should always be placed inside the furnace, where they may receive heat.

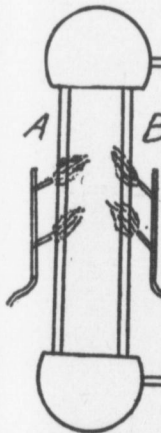

Fig. 4

As this a  
were provided  
altogether, and

If the ap  
horizontal tha  
with the bund  
used in such b  
prominent mal  
said to take th  
Yarrow's work  
that some of t  
of tubes, flows  
to supply the

But the  
boilers of the  
comers are no  
same time no  
Fig. (5) a nu  
chambers prec  
and the heat  
found that the  
and downward

But the following experiment showed conclusively that in boilers of the Yarrow, Normand and similar designs, separate downcomers are not a necessity, and may be dispensed with, and at the same time no injury to the efficiency of the boiler will result. In Fig. (5) a number of tubes are shown connecting upper and lower chambers precisely as in actual boilers. The side *D* was heated first, and the heat allowed to pass through to *E*, and in every case it was found that the circulation was upward in the first two or three tubes and downwards in the outer ones.

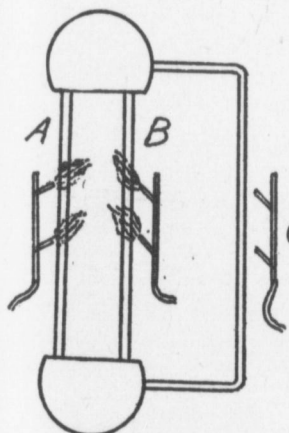

Fig. 4

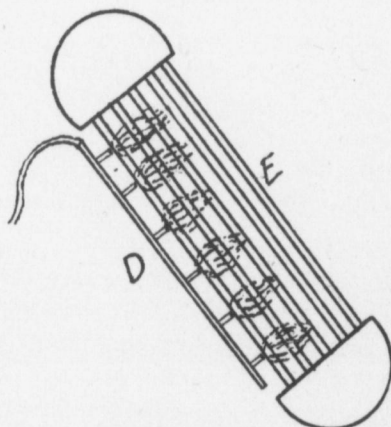

Fig. 5

As this action occurred no matter whether special downtakes were provided or not, Messrs. Yarrow have discarded downtakes altogether, and find that they lose nothing by so doing.

If the apparatus in Fig. (5) be inclined at a less angle to the horizontal than that shown, we will have an arrangement identical with the bundle of tubes connecting two headers or water-legs, as used in such boilers as the Babcock & Wilcox, the Heine and other prominent makes, while the overhead drums of these types may be said to take the place of external downcomers. Deductions from Mr. Yarrow's work, confirmed by experiments by other authorities, show that some of the water in the front headers enters the upper rows of tubes, flows toward the rear of the boiler and once more helps to supply the forward current in the lower rows of tubes.

## QUANTITY OF WATER CIRCULATED.

In boilers such as the Thorneycroft, which have "above-water" delivery, direct measurement of the circulation, has been made by the use of weirs, but with the ordinary type of "drowned" delivery such measurements are impossible, and recourse has been taken to mathematical calculations. Formulæ for the velocity in the tubes form the basis of all these calculations, and while the methods employed to obtain them are somewhat ingenious, results are so divergent that no practical use can be made of them.

There are  
should say tw  
and the contr  
ledge is often  
this enables h  
work, and to s  
part.

The cont  
finds the worl  
to carry it fo  
facture to the  
and on a pay  
from books, c  
ing on the su  
with these an  
that never see  
tion with thos

It may ha  
engineering sc  
there.

Neither a  
pert a man m  
understand wh  
liable to endan  
are enabled to  
colleges and th  
things, the en  
actual work in

**SOME NOTES ON BRIDGE DRAFTING.**

R. K. PALMER, B. S. UNIV. OF MICH.

There are in general two classes of engineers, or perhaps I should say two ends to engineering, the consulting engineer's end and the contracting engineer's end. The consulting engineer's knowledge is often general rather than particular, and rightly so because this enables him to take a bird's eye view as it were, of the entire work, and to see that each part bears a proper relation to every other part.

The contracting engineer has to face a different problem. He finds the work laid out in a general way and it becomes his duty to carry it forward and to look to all the processes in its manufacture to the smallest details. He must, in short, produce the work and on a paying basis. The former may get his knowledge largely from books, current publications, and from good specifications bearing on the subject, but the contracting engineer must be familiar with these and more, he must know all the little kinks and turns that never see the printed page, and can only be learned by association with those who have been long in that particular line.

It may have occurred to you that engineers are not made in our engineering schools, or perhaps I should say they are not completed there.

Neither are they made outside of our schools, for however expert a man might become with rules of thumb, still, he does not understand why he does things in a certain way and is therefore liable to endanger other peoples' lives. Our friends the medical men are enabled to get all that is desirable for practice in the medical colleges and the hospitals attached thereto, but, from the nature of things, the engineering student must bide his time to get at some actual work instead of imaginary cases.

I remember very distinctly that at the time I left the University I was crammed with theory to the exclusion of most that was practical, and, at that time, theory of itself was not of a great deal of use, for I got no chance to use it. I had a very vague idea of what occurred in a bridge works and my only excuse for taking your time is that I may tell those who are in a like position, something of how work is done there.

Most public works, and structural works in general, have a consulting engineer in charge of the work, who specifies more or less particularly just what the work shall be. In the case of a bridge he may just give the span, the loading, and such other items as the location demands, and the several bridge companies will submit specific designs and prices. Then, again, he may submit the complete design and ask for prices. Or yet again, he may submit detail drawings, although very rarely, as few men will make drawings that will satisfy a bridge company for actual manufacture.

In submitting prices the company must have a very close estimate of the necessary material to complete the structure, together with information of the probable difficulty of erection, and the location which involves the cost of transportation. Other considerations are the amount of work required in the shop and in the drawing office.

We will suppose we have received the contract for building some bridge. By this time, of course, we will have had the stress sheets and the general design completed. The next thing is to order the necessary material from the rolling mills, and to do this we must make very careful layouts, so that we can order our material just of sufficient size and no more—for excess involves waste, and hence, loss. These layouts are just pencil drawings on brown paper, showing the connections of the different members, and vary in scale from 1 in. to the foot to 3 in. to the foot.

Having made these layouts and calculated all rivets, pins and such things, we are ready to write what is called an original bill. This bill involves every piece of metal that enters into the contract including rivets and bolts, and tells where each piece goes. Then from this bill is written the orders to the various mills that furnish the raw or finished parts. For instance, it might be advisable to get plates in Scotland and angles and other shapes at the Pittsburg

mills, owing, material. For plates in Scotland orders in shop

We now shop drawing after—the in break the co people who t go down—per say just here The better p stresses per s range of stres cation. For but the roof gether with t come, due to long intervals sq. in., or ev would hardly

Now as t you gentlemen only say that keep drawing in bridge office another. Of simpler thing who checks h men ever tak checker, if yo come back to a purpose, an progress the finished your ing no longer makes him m



mills, owing, perhaps, to price, quality or time required to deliver the material. For the past few months it has been desirable to get plates in Scotland—the American mills being too crowded to execute orders in short enough time.

We now have all the necessary information to go ahead and make shop drawings, and this may be done at once, or a considerable time after—the information will keep. These shop drawings may save or break the company, and, likewise, save or break the necks of the people who travel across our bridge. Fortunately few bridges do go down—perhaps because the factor of safety is taken high. I may say just here that the term “factor of safety,” is falling into disuse. The better practice is to state definitely the allowable working stresses per square inch of section, having regard to the kind and range of stress together with the frequency and suddenness of application. For instance if you were making a roof truss with nothing but the roof to support you have the constant load of the roof, together with the weight of the truss itself, and whatever loads might come, due to snow or wind, each coming on gradually, and at rather long intervals. Here the unit stress could go to 20,000 pounds per sq. in., or even 25,000 pounds per sq. in. without danger, but you would hardly proportion a railroad bridge with such unit stresses.

Now as to the making of the drawings—a thing which some of you gentlemen may get interested in some time or other, I can only say that the sole way to learn to draw is to go and draw and keep drawing something—you will draw bridges later. Generally in bridge offices the drawings are made by one man and checked by another. Of course a man coming from college is started with the simpler things, and what he learns he gets largely from the man who checks his drawings. Let me say here that if any of you gentlemen ever take up bridge work my advice is to get under a good checker, if you can, and do not kick and worry when your drawings come back to you pretty generally marked up. It has been done with a purpose, and if you observe some of those little points you will progress the faster. And remember that after the checker has finished your drawing and signed his name thereto, it is your drawing no longer for he alone is responsible for errors. Responsibility makes him more careful than lack of responsibility does you.

But let us come back to those drawings. You will agree with me, I think, when I say that a structure of whatever kind and for whatever purpose, is best designed when it is perfectly balanced throughout. In other words every part should be proportionately equal to every other part. Your fence will not hold much when the bars are down, even if it is a good fence. This matter of perfect balancing is the acme of the draftsman's art, for it certainly produces the best structures at least possible cost for material.

To this end we must see that all joints and splices are correct and adapted to the case in hand. Due regard should be given to the methods used in manufacture to determine how much we might increase the sections and weights in certain places in order to duplicate similar parts, thus reducing cost. That is to say, if the added cost of making a part different from a similar part is greater than the cost of the extra weight necessary to make them alike, then in general we would make those parts interchangeable. The added cost arises through additional drawings and templates, and the fact that the workmen have to spend more time in finding out what is wanted.

In making the drawings it is best, in general, to show the structure assembled, because less is left to the imagination, and besides it requires less drawing. In starting our drawing the centre lines should first be laid down and then the sections drawn, making centre lines of the bridge coincide with the centre of gravity lines of the members as far as possible. Very frequently rivet lines of angles are used instead of gravity lines and of course our structure is somewhat weakened. If there be much difference between the two it is considerably weakened. Sometimes the centre of gravity line of a top chord member is placed a short distance above the centre line to overcome the sag of the member due to its own bending moment, but this is a refinement that is hardly warranted for the centre of gravity lines of the chords in various panels seldom coincide any way. The result of this raising of the centre of gravity may be made clearer by referring to Figs. 1 and 2, Fig. 1 being when the centre of gravity and centre lines coincide, and Fig. 2 when the gravity line is raised. Fig. 2 is exaggerated.

As an example of the relative position of centre of gravity lines, and rivet lines, let us make two angles  $6'' \times 4'' \times \frac{3}{8}''$  riveted in the usual way.

When plates coincide, and  
But when plates do not  
not consider the

Having laid out how it is  
wagons and he  
determine the  
the field conn  
need to use pe  
a shop joint.  
cannot be, as

Our top angles  
from panel to  
The previous  
to always mak  
stress. Compr  
the splice by  
are used to ke  
a full quota of  
to carry the s

Splices in  
and we would  
serve the effe  
Quoting "Coop  
of a riveted te  
either through  
line of rivet h  
cent. the net

Suppose w  
rivets, as show  
rivets that the  
them come opp  
ing opposite e  
mine the distan  
30% in excess  
tion let us use  
must be about

When placed like Fig. 3 it will be seen that the lines nearly coincide, and in this case we may use the rivet lines for centre lines. But when placed as in Fig. 4 the lines are separate, and we must not consider them coincident.

Having laid down the lines of our truss it behooves us to find out how it is to be shipped to its destination,—if to be carried on wagons and how far. The manner in which it is to be handled will determine the size of the pieces shipped—in other words it will locate the field connections. These must be known early because we will need to use perhaps 25 per cent. more rivets in a field joint than in a shop joint. The reason for this is that field rivets are not, and cannot be, as tightly driven as shop rivets under the air riveters.

Our top and bottom chords must be spliced if the section changes from panel to panel. If they are long they must be spliced anyway. The previous considerations will locate these splices, having a care to always make the splice on the side of the joint having the least stress. Compression members are usually brought to a tight fit at the splice by milling the ends, and in this case, only enough rivets are used to keep the members rigid, but if the joint be not planed, a full quota of rivets must be used with corresponding splice pieces to carry the stress.

Splices in tension members present a more complicated problem and we would do well to look more closely into it. Let us first observe the effect of putting rivet holes in a piece under tension. Quoting "Cooper's Specifications" for bridges we find, "The rupture of a riveted tension member is to be considered as equally probable, either through a transverse line of rivet holes or through a diagonal line of rivet holes where the net section does not exceed by 30 per cent. the net section along the transverse line."

Suppose we have a plate, say  $11\frac{1}{2}$  in. wide, with four lines of rivets, as shown in Fig. 6, and it is necessary that we so space the rivets that the total section be reduced by only two rivet holes. Let them come opposite each other on the line  $ab$ , our next rivets coming opposite each other on the line  $cd$ . It is necessary to determine the distance  $ac$  such that the net section on  $aeghfb$ , shall be 30% in excess of the section on  $aeffb$ . For convenience of illustration let us use 25% instead of 30%. On laying it out we find  $ac$  must be about 4 inches. It happens in this case that if the rivet

be left out that the 4 inches still stands, but if  $f$  instead of  $h$  be dropped then this distance,  $ac$ , becomes  $5\frac{3}{8}$  inches.

If  $f$  and  $h$  be dropped then to cut out one rivet the distance  $ac$  becomes  $5\frac{5}{8}$  inches. If  $f$  and  $g$  be dropped then to cut out one rivet the distance becomes  $7\frac{1}{8}$  inches, and on dropping  $e$  and  $f$  it becomes 4 inches. If  $g$  and  $h$  be dropped it becomes  $8\frac{5}{8}$  inches, which is impracticable, and the wider the plate and farther apart the rivet lines the greater the distance becomes, because if the relative lengths of the hypotenuse to the side as the angle changes.

Suppose we apply this to an angle gauged as shown in Fig. 5, using a 6" x 6" angle. This may be conceived of as a bent plate, which can be again made flat, and we would have the plate we have chosen above, and the same combinations would give the same results.

To splice an angle removing but one rivet. Let us take an angle 6" x 6" x  $\frac{1}{2}$ " = 5.75 sq. in. area. Deduct one hole for  $\frac{7}{8}$ " diameter rivet = 5.25 " " net. At 10,000 pounds per sq. in. this would stand 52,500 pounds.

Bearing of  $\frac{7}{8}$  dia. rivet on  $\frac{1}{2}$ " metal @ 15,000 lbs. per sq. in. = 6,500 lbs.  
Shear of  $\frac{7}{8}$  dia. rivet @ 7,500 " " = 4,500 "

Dividing 52,500 by 4,500, the smaller of these rivet values gives 12, the number of rivets required, they being in single shear as shown in Fig. 7. After the first rivet in this case two holes may be deducted as the stress is lessened by the amount that passes in one rivet, hence the rivets near the centre on each side are closer together. Note that the end rivets are on the inside gauge lines, which lessens the spacing here. This follows from our previous consideration of the plate, and the manner of deducting rivet holes.

In general, tension members are so designed that all rivet holes that are likely to be needed may be deducted, and still leave the net section intact. In favor of this we can use shorter splices, thus saving material and run less risk of a bad arrangement of rivets. On the other hand our section has been increased by the amount cut out, and if the distance between splices is great the added weight may be worth considering. In very many existing structures this principle of splicing has been disregarded, and the true unit strains are much greater than was intended. So far as the writer knows

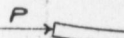

Fig.

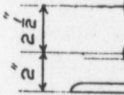

Fig.

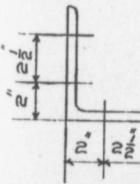
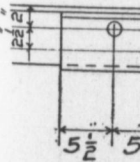
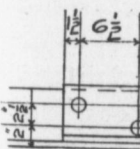

Fig.



instead of  $h$  be

the distance  
cut out one  
spacing  $e$  and  $f$   
es  $8\frac{3}{8}$  inches,  
farther apart  
if the relative  
ages.

own in Fig. 5,  
a bent plate,  
plate we have  
the same re-

us take an  
 $\frac{7}{8}$ " diameter  
would stand.

=6,500 lbs.  
=4,500 "

values gives  
ear as shown  
may be de-  
asses in one  
e closer to  
lines, which  
us consider-  
les.

rivet holes  
ll leave the  
plicies, thus  
t of rivets.  
the amount  
dded weight  
ctures this  
unit strains  
riter knows

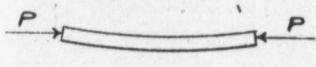

Fig. 1

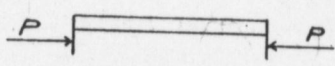

Fig. 2

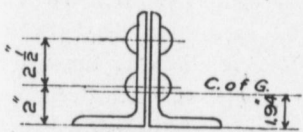

Fig. 3



Fig. 4

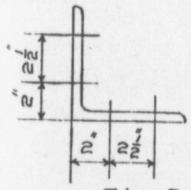

Fig. 5

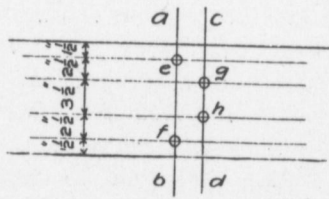

Fig. 6

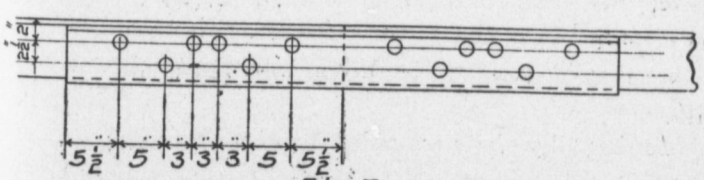
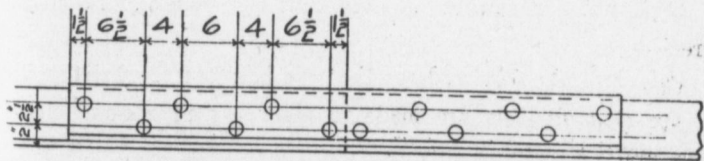

Fig. 7

no tests have been made to show how the plates and angles previously mentioned would break with the several arrangements of rivet holes. An investigation along this line would prove profitable to some one having a testing machine at hand and a thesis to write.

The making of practical working drawings for the bridge shop requires a knowledge of the part that each man plays from the beginning until the work is completed. After leaving the office the drawings first encounter the template maker, and the draughtsman must have a knowledge of the kind of template to be used and the manner of making it. He must see that his drawing has every dimension that will be needed to make the template for each individual piece, and nothing more, except the necessary information for the other portions of the shop. He must above all see that the plans are practicable. For instance, he must not require rivets to be driven in impossible places, as sometimes happens with the best of men. The method of erecting frequently decides the manner in which certain connections will be made, and the draughtsman must have his eye on the erector, so to speak, as well as the shop workmen.

The following will serve as hints to those who are just beginning to draw.

Give all general dimensions such as length over all, width, and clear head room, as well as the number of spans.

Look out for camber and see that the diagonal distances are correct.

Calculate pin sizes and see that eye bars are properly packed.

See that all slots are made to allow for expansion. Iron expands practically  $\frac{1}{8}$ " in 10' 0".

See that rivets are countersunk where necessary, check over all field holes and note that proper clearances have been allowed.

See that all rivets can be driven, bolts can be put in place and nuts turned.

See that filler plates are called for where necessary.

See that joints and ends to be planed are so marked.

Look out for rights and lefts.

See that laterals do not interfere with stringers or beams.

See that the  
beams.

See that str

See that eye  
and end posts, a

When two  
work and name

See that ge  
ing, size of rive  
tion necessary.

If bridge is  
beveled, and if  
either end are s  
of the bridge, an  
at different leve  
sideration.

Where ther  
it is customary  
sufficient clearan

In the worl  
of accuracy, an  
men never can a  
considerable exp

See that the rails will clear the rivets on the top of the floor-beams.

See that stringer bracing angles do not interfere with the ties.

See that eye bar heads clear the cover plates in the top chords and end posts, and calculate the bearing of the eye bars on the pins.

When two or more spans connect see that the ornamental iron work and name plates are at the extreme ends only.

See that general notes are complete *i.e.*, notes referring to painting, size of rivets and rivet holes, reaming and any general information necessary.

If bridge is on a grade see that the sole plates are properly beveled, and if the bridge is also on a skew note that the shoes at either end are some distance apart, measured along the centre line of the bridge, and hence the bridge seats on the same abutment are at different levels. This difference in level must be taken into consideration.

Where there are several thicknesses of plates packed together, it is customary to allow about  $\frac{1}{32}$  of an inch to each plate to insure sufficient clearance to erect the work easily.

In the work of laying out bridges eternal vigilance is the price of accuracy, and accuracy is a thing most to be desired. Some men never can attain great accuracy, and with most men it requires considerable experience, and long continued, intelligent effort.

---

## NOTES ON THE GEOLOGY OF ROSSLAND ORE DEPOSITS.

E. ANDREWES, GRAD. S. P. S.

It may be as well in beginning a discourse on the subject of the geology of the Rossland ore deposits, to make mention of the most reliable matter for reference on the subject, which will be freely quoted from in the course of this paper.

The published literature on the subject is indeed not very voluminous. We have first of all Mr. R. G. McConnell's report, contained in the "Summary Report of the Operations of the Geological Survey of Canada for 1896." The report of Mr. W. A. Carlyle as Provincial Mineralogist, for the same year, contains information concerning the mines, and gives the history of Rossland as a mining camp.

In the "Journal of the Canadian Mining Institute for 1899," we have a paper by R. W. Brock, entitled "West Kootenay Ore Bodies," which is especially interesting in that it connects the Rossland ore bodies with those of the other parts of West Kootenay.

In the recent law suit between the Centre Star and Iron Mask Companies, the opinions of Mr. Clarence King, and Mr. Lindgren of the U. S. Geol. Survey, who appeared as expert witnesses for the Centre Star, were elicited concerning the general geology of the district and the nature of the ore-bodies.

Several eminent geologists and mining engineers made special studies of the Rossland ore deposits, and their mode of occurrence, in connection with this important law suit, but only the two named gave evidence at any length, as the case was adjourned, even before all the witnesses on the Centre Star side had been heard. Their evidence was published verbatim in the columns of the Rossland Miner, and affords much interesting information. Mr. W. F. Ferrier of the War Eagle Co., and the late lithologist of the Canadian Geological

NOTES ON

Survey, read a p  
tute, while on th  
stood, dealt with  
ore deposit, but  
yet been publish

We learn fr  
immediate vicini  
tance round, bel  
are spread over

River, and run so  
boundary line, w  
covered by his re

These older  
mostly of porphy  
younger series co  
stitution.

"This erupt  
dark fissile slates,  
formation amid w  
bands, even wher  
along the strike.  
Trail Creek and o

These remna  
sedimentary rock

The age of  
Connell says of th  
ferous, and were  
period. Mr. Ki  
being of Cretaceo  
matter of no grea

Physiographi  
tination of the S  
rugged. It is dis  
of the Columbia a

The present  
forces, the numer  
themselves. In



Survey, read a paper in Rossland before the Canadian Mining Institute, while on their excursion there last summer, which, it is understood, dealt with the rocks of the district, and the occurrence of the ore deposit, but which, much to the present writer's regret, has not yet been published.

We learn from Mr. McConnell's report that the rocks in the immediate vicinity of the town of Rossland, and for some little distance round, belong to the older of a series of igneous rocks, which are spread over a wide area to the east and west of the Columbia River, and run some fifty or more miles north from the international boundary line, which of course is the southern limit of the region covered by his report.

These older rocks are the more basic of the series, and consist mostly of porphyrites, diabases, gabbros, tuffs, and agglomerates. The younger series consists of granite of various texture, colour and constitution.

"This eruptive series of rocks encloses bands and patches of dark fissile slates, which appear in most cases to be remnants of the formation amid which the igneous rocks were erupted, as none of the bands, even where 1,000 feet thick, can be traced for any distance along the strike. Slates holding small limestone bands occur on Trail Creek and other places."

These remnants are all that is still apparent of the original sedimentary rocks of the district.

The age of the igneous rocks is still uncertain, but Mr. McConnell says of the older granites that they are certainly post-carboniferous, and were probably erupted toward the close of the Triassic period. Mr. King, in his evidence, speaks of the Rossland rocks as being of Cretaceous age or thereabouts. Their age, however, is a matter of no great importance.

Physiographically the region forms part of the southern continuation of the Selkirk Range, and is everywhere mountainous and rugged. It is dissected by several deep river valleys, including those of the Columbia and Kootenay.

The present configuration of the country is due chiefly to erosive forces, the numerous mountain streams having cut deep channels for themselves. In some cases great thicknesses of rock have been

removed from the surface, and that this has taken place to a marked degree at Rossland is evidenced by the rounded form of the mountains there, and the holocrystalline and generally plutonic nature of the rocks which come to surface there. The deep gravel deposits round the bases of the hill afford further evidence of the same thing.

If we now turn to the accompanying geological map of the Trail Creek Mining District, we see that the town of Rossland is situated in an area of rock, roughly oval in outline. This consists of a mass of igneous crystalline rock, everywhere of a basic character, but which varies considerably in texture and composition in different parts of its mass. In general it is an augitic rock of the nature of a gabbro or augite porphyrite. In parts we find a comparatively coarse grained rock with porphyritic crystals of augite. In other places it is fine grained and loses its porphyritic character. It contains both orthoclase and plagioclase feldspar, and hence is not a true gabbro. The orthoclase is often present in considerable amounts, and the rock of this character has been classified by Mr. Ferrier as monzonite, which is the name given to designate a rock bearing augite and a large amount of orthoclase feldspar. Some slides, examined by the author, taken from typical specimens of the country rock about 50 feet south of the Centre Star vein, contained numerous small grains of augite and brown mica embedded in a mass of small feldspar crystals many of which were untwinned. The augite is to a large extent uralitized to hornblende, a band of uralitic hornblende surrounding a core of augite being the ordinary form. The rock also contained numerous small grains of pyrite, which is also apparent to the naked eye throughout the whole rock mass of the area spoken of.

At the west end of the area is a considerable body of rock which contains hornblende, as a primary constituent.

These rocks in general are very fresh in appearance, exceedingly hard and tough, and may be characterized as typical greenstones.

This central mass of crystalline rock has been pronounced, and probably correctly, to be the core of an ancient volcano, which once towered far above the present surface level, and poured forth the vast quantities of lava, ashes, and rock fragments, which now form the series of volcanic rocks, which roughly speaking form a ring round their plutonic core. The variations in the latter may represent different periods of outflow. It is however a feature common to

many such igne-  
minerals in diffe-  
another exampl-  
One class of rock  
sharp line of co-  
to cause them to

The rocks  
volcanic rocks.  
muds and ash r-

"In passin-  
port runs, "a se-  
zone of brecciat-  
seldom exceeding  
porphyrites and  
ciated in places  
with the porph-  
Mountain, and s-  
tains, and the ri-  
up the main ma-  
slates, tuffs, and  
Out Mountains,

These rocks  
see that they ar-  
many varieties, a-  
which were the  
The later granite

The central  
core, as describe-  
point, as within  
bodies, which h-  
of these, as we al-  
of Red Mountain  
War Eagle, Cent-  
typical ore bodie-  
They are develo-  
east and west, th-  
to a few degrees  
main vein of the

many such igneous masses to show variations in their constituent minerals in different localities, and the Rossland rocks do but furnish another example of what has been frequently observed elsewhere. One class of rock shades imperceptibly into the next, and there is no sharp line of contact. They are all sufficiently alike in composition to cause them to be referable to the same magma.

The rocks which surround this central core are essentially volcanic rocks. They consist of lavas, porphyrites, breccias, volcanic muds and ash rocks.

"In passing outward from the gabbro area," McConnell's report runs, "a section, taken at almost any point, shows a bordering zone of brecciated porphyrites and diabases of varying width, but seldom exceeding a mile, beyond which comes an alternating series of porphyrites and slates, and still further away agglomerates, associated in places with fossiliferous limestones. Slates and tuffs occur with the porphyrites on Red Mountain, on Kootenay Columbia Mountain, and south of the gabbro area on Lake and Bald Mountains, and the ridge running south from them. Agglomerates make up the main mass of the rocks of Sophia Mountain, and occur with slates, tuffs, and porphyrites on Granite, Spokane, Grouse, and Look Out Mountains, and on the ridge immediately east of Sheep Creek."

These rocks are represented by the gray area on the map, and we see that they are spread over a large tract of country, and include many varieties, and also enclose remnants of the sedimentary rocks, which were the rocks of the district prior to the volcanic outbursts. The later granites occur as intrusive masses in them.

The central area of crystalline igneous rock, forming the volcanic core, as described above, is very important from an economic standpoint, as within it and around its edges are contained the large ore bodies, which have made Rossland famous. The most important of these, as we all know, are those which outcrop on the southern spur of Red Mountain, and within which are the workings of the Le Roi, War Eagle, Centre Star and other mines. We will consider these the typical ore bodies of the camp, as they are by far the most important. They are developed along lines of fissuring running approximately east and west, their strike varying from a few degrees south of west to a few degrees north of west. The largest outcrop is that of the main vein of the Le Roi and Centre Star, which strikes a few degrees

south of west, the War Eagle vein strikes a little to the north of west. They all have a northerly dip.

It seems to be the concurrent opinion of the geologists who have examined these large ore bodies, that they lie in what are termed shear zones, that is, zones of fissuring, up which the mineral bearing solutions have risen, replacing the country rock with their minerals borne in solution. Hence we also hear them spoken of as replacement deposits in a zone of fissuring. We find that such a zone is divided into approximately parallel sheets by lines of fissuring, the enclosed rock being impregnated with sulphides, or completely replaced by them with the formation of solid bodies of sulphide ore. It is probable that only in rare cases was their an open fissure formed, and the movement of the foot on the hanging wall has probably not been great, though abundant slickensides testify to there having been a certain amount of relative movement between certain portions of the rock. Mr. King says that such shear zones are formed under great compressive forces, which keep the fissures constantly closed.

This theory of formation is nothing but the most plausible interpretation of the facts we observe in connection with the Rossland ore deposits. We do not find one continuous vein of ore descending to a great depth, but a series of ore bodies, varying in dip and size, sometimes running parallel to one another, one being in the foot or hanging wall of the other. The intermediate rock is more or less mineralized, and one large ore body is usually connected to the next by small stringers or films of sulphides, which represent the series of fissures up which the mineral bearing solutions have passed. It would seem that the work of the solutions depended upon the condition in which they found the country rock, where it was crushed and easily acted upon they totally replaced it and formed large ore bodies, where it was hard and compact they merely left thin seams of sulphide a fraction of an inch wide along the fissures they traversed, and barely permeated the rock.

Fig. 1 is an imaginary sketch, but will serve to give an idea of what such an occurrence is like in cross-section.

Fig. 2 is a sketch from memory of an occurrence on the 625 ft. level of the War Eagle. The ore streak on the right is about 18 inches wide and is contained between two well defined walls. The foot wall streak is a single fissure on either side of which the rock is

thickly impregnated of altered rock material portion containing

It will be noted in the rock of the In the 625 level dyke, of later origin

The rock enclosed which forms the surrounding country with it. As we places ground up mica have been detected these. Most of the



FIG. 1

considerable amount of pyrrhotite ore and is the marked similarity of the broken face of ore to a face of rock, as candle to detect the matter that they been found to contain

north of west.

gists who have  
at are termed  
ineral bearing  
their minerals  
as replacement  
is divided into  
enclosed rock  
aced by them  
probable that  
he movement  
great, though  
ertain amount  
k. Mr. King  
ressive forces,

ausible inter-  
Rossland ore  
scending to a  
d size, some-  
the foot or  
more or less  
l to the next  
nt the series  
e passed. It  
n the condi-  
crushed and  
e ore bodies,  
in seams of  
ey traversed,

e an idea of

the 625 ft.  
is about 18  
walls. The  
the rock is

thickly impregnated with sulphides. The intermediate space consists of altered rock more or less thickly flecked with sulphides, the central portion containing less than that close to the fissure.

It will be noticed that in neither figure are sulphides indicated in the rock of the hanging wall, and their absence is usually the case. In the 625 level however the hanging wall is, the writer believes, a dyke, of later origin than the vein.

The rock enclosed between and on either side of the fissures, which forms the principal gangue, is in all cases referable to the surrounding country rock, and is in many cases practically identical with it. As we might well expect in such a zone, it has been in places ground up, and other minerals such as quartz, calcite, and mica have been deposited in it, or its original constituents altered to these. Most of the rock connected with the veins contains a con-

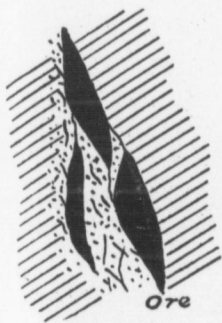

FIG. 1

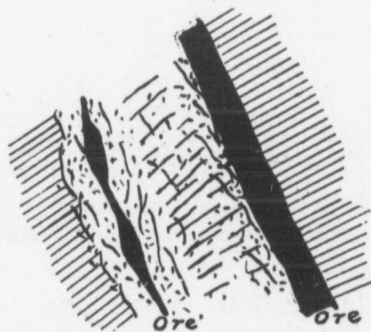

FIG. 2.

siderable amount of quartz, and we get little veins of quartz and calcite, usually mixed with sulphides. A striking feature in some places is the marked similarity in structure and general texture between the pyrrhotite ore and the rock. This is so pronounced that a freshly broken face of ore is often barely distinguishable at first glance from a face of rock, and it requires a close inspection by the light of a candle to detect the difference. The writer has known men to have taken a sample of a face after blasting, thinking that it was rock matter that they were getting, which on examination in daylight has been found to consist of almost pure pyrrhotite. In this case the

ore would appear to be what we might call a sulphide fossil of the rock it has replaced.

Mr. Lindgren said in his evidence: "The process by which the country rock is changed is called replacement. It is evidently caused by the introduction of solutions bearing different minerals, gold, copper, iron, and a great many other salts. This solution evidently acted on the country rock, introducing some minerals and forming others from the constituents which were already there; in fact more or less changing the whole aspect and composition of the rock. In favorable places the change to pyrrhotite and chalcopyrite went on more intensely. The minerals of the country rock were more or less completely replaced by these minerals. Their substance was dissolved out, and instead of the original substance the sulphides were deposited. A piece of petrified wood is an ideal example of replacement, not of the same character as the replacement in the rock, but it conveys the idea very nicely in that the substance of the wood is carried away, the *structure is largely retained*, but silica replaces the fibre of the wood. Impregnation is usually employed to signify the filling of minute pores in the rock. This impregnation took place in the case of the Centre Star vein; it probably always takes place, but it is subordinate to the main process of replacement, which I have already outlined." These remarks would apply equally as well to the other veins under discussion, as they do to the Centre Star vein, of which they were spoken.

One frequently finds dark spots, consisting of a chloritic mineral with crystalline outline, embedded in the pyrrhotite masses, which seem to represent the augite or hornblende of the original rock.

The sulphide minerals constituting the ore are pyrrhotite, by far the most abundant, chalcopyrite, and mispickel, while molybdenite, zinc blende, and even galena have been found in small quantities. Molybdenite is quite an important constituent of the ore of the Giant mine. The ore minerals have not as a rule assumed a crystalline form, the fracture of the ore is very uneven without any sign of cleavage. Crystals of mispickel are not uncommon, and some very perfect ones are found in the Deer Park mine. There is only a small amount of pyrite in the large Red Mountain deposits, it occurs partly as a secondary constituent. Some of the other veins of the district contain the above-mentioned minerals in different proportions.

The deposition  
out by the occurrence  
lining and often fissured zone. Several  
common. They  
which is enhanced  
from the mine, but  
generally considered  
thus conclude that  
as the rocks in which  
the molten condition  
which the ore bodies  
depths.

Subsequently  
ing up of the rock  
south has taken  
numerous dykes, and  
and have as a rule  
is a typical dyke  
colour and easily  
the dykes are generally  
them in mining,  
abrupt, the plane  
plane. In other parts  
bits of dyke rock  
entirely. The dykes  
sometimes no more  
little displaced by

Faulting has  
least one notable  
caused by the same  
dyke.

In conclusion  
have fully dealt with  
in this paper. Further  
tion of the general  
facts concerning

The deposition of the sulphide ores from hot solutions is borne out by the occurrences of zeolites along the vein fissures. They occur lining and often filling open spaces, which occur at intervals in the fissured zone. Several varieties are found, laumontite being the most common. They often assume a very beautiful crystalline form, which is enhanced by their limpid pearly lustre, when first taken from the mine, before they have lost their moisture. Zeolites are generally considered to have been deposited from heated waters. We thus conclude that the Rossland veins are of deep seated origin, and as the rocks in which they occur have been formed in place from the molten condition, being erupted from below, the condition under which the ore bodies occur should hold to practically unlimited depths.

Subsequently to the formation of the ore bodies a further breaking up of the rock mass on lines running approximately north and south has taken place. This is marked by the occurrence of numerous dykes, which cut through the veins in a great many places, and have as a rule an easterly dip of  $70^{\circ}$ — $80^{\circ}$ . The rock filling them is a typical dyke rock of the nature of a lamprophyre. It is dark in colour and easily distinguished from the country rock. The walls of the dykes are generally well defined smooth planes. In coming upon them in mining, the change from ore to dyke rock is often quite abrupt, the plane of division being a perfectly well marked smooth plane. In other places warning of the approach of a dyke is given by bits of dyke rock appearing in the ore, which gradually disappears entirely. The dykes do not often exceed 10 feet in thickness, and are sometimes no more than a foot thick. The veins appear to be very little displaced by them, if at all.

Faulting has taken place on planes parallel to the dyke, in at least one notable case, in the War Eage vein, which may have been caused by the same set of forces which opened up the fissures for the dyke.

In conclusion let it be said that the writer does not pretend to have fully dealt with the geological problems of the Rossland district in this paper. He has, however, endeavored to make plain the relation of the grander rock formation of the district, to set down certain facts concerning the ore bodies and rocks which he himself had the

opportunity of observing in eighteen months close acquaintance with one of the principal mines, and to bring to the notice of the meeting the conclusions which have been put upon these facts by those eminent geologists who have examined and given evidence concerning them. If his hearers have been interested in listening to the course of this paper he is gratified, and if they know more of rocks and ore deposits of Rossland than they did when he began, his efforts are more than repaid.

Like m  
present adv  
particular c  
greatest suc  
arrived at a  
themselves t  
the others re  
same mathem  
ations, owin  
of the stress  
sense and t  
out making  
of whatever

The fol

1. The  
line of the p
2. An a  
by wedging
3. A fir
4. All j
5. The  
to fall behin

The adv  
are so self evi

Mine tin  
cording as th  
drifts and ad



instance with  
the meeting  
ts by those  
nce concern-  
ning to the  
ore of rocks  
n, his efforts

### MINE TIMBERING.

---

E. V. NEELANDS, '00.

---

Like most kindred sciences, mine timbering has reached its present advanced state of development, as a result of exigencies in particular cases. The methods in vogue now, in mines where the greatest success in mining engineering has been attained, have been arrived at as a result of experience, the systems which have proved themselves the best under given conditions having been retained and the others rejected. Timbering underground cannot be reduced to the same mathematical science as similar work could be in surface operations, owing to the varied conditions and the complicated nature of the stresses to which it is subjected. In general, sound common-sense and the application of a few principles are sufficient without making any attempt to calculate the size of the different members of whatever construction may be contemplated.

The following general rules may be said to apply universally:

1. The greatest strength of the construction should be in the line of the probable thrust.
2. An absolute rigidity in the construction should be aimed at, by wedging or other means.
3. A firm, permanent foundation should always be secured.
4. All joints should be flat.
5. The timbering should never, even temporarily, be allowed to fall behind the mining operations.

The advantages of the principles embodied in the foregoing rules are so self evident that a further examination of them is unnecessary.

Mine timbering may be divided into three departments; according as the work is done in shafts, stopes or tunnels (including drifts and adits), each having its own peculiar features.

In the first, the construction is dependant upon the shape of the shaft, the nature of the ground and its inclination to the vertical. In America the rectangular shaft is almost universal, as it is economical and is easy to timber. In Europe where stone and brick are more largely used for lining, the circular form is common.

The shaft should be timbered as the sinking goes on, even if the walls are hard and self-sustaining. "Hitches" are cut in the rock in which "reachers" are placed which support the sets, every 20 or 30 feet apart, each successive pair being at right angles to the preceding ones. If the ground is bad the "reachers" are suspended on iron dogs, 1 inch in diameter, from the set above, and afterwards firmly wedged. In firm ground a lining of 3" plank is sufficient. Shoulders are cut and the planks, two wall pieces and two end pieces, placed in position without nailing, but held firmly in place by packing the waste rock between the wall and the lining. If the ground is bad a casing of larger timber up to 10" is used, their ends being shouldered and laid "skin to skin."

The new shaft of the Centre Star Mine in Rossland may be cited as an example of good modern shaft work on a small scale. The shaft has three compartments, and is in fairly firm ground. There are five different members used in the construction, not including the guides (Figs. 1, 2, 3, 4, 5, 6, 7, 8). Figs. 1 and 2 show the elevation and plan of the timbering, Fig. 3 shows the end of intermediate cross timbers, showing cut at *H*, Fig. 4 the inside face of side collar timber *A* showing cut at *F*. Fig. 5 the inside face of side timber. *C* showing cut at *F*. Fig. 6 gives end view of the post *D* (both ends the same). Fig. 7 the end of intermediate post at *D*, showing cut at *D*, (the ends being similar), and Fig. 8 shows the end of side timbers showing cut at *C* (both ends being the same). Pine is used throughout the construction, all timber being of course framed on the surface.

Should a cave-in occur in the shaft it is a frequent practice to put in crib work to fill the place of the removed rock. An instance of this may be mentioned. An extensive cave-in, caused by stoping alongside the shaft, occurred at the 200 foot level station in the Le Roi Mine, and the shaft is now strengthened by an elaborate system of crib work, for upwards of 100 feet.

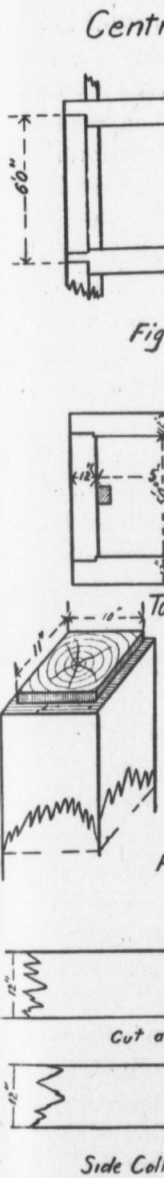

Centre Star Shaft Timbering

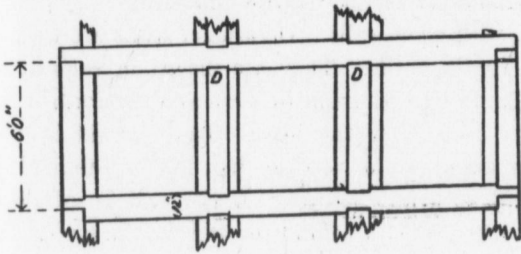

Fig 1 Elevation

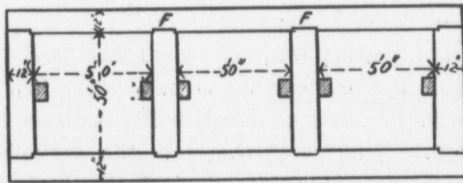

Fig 2

Top View Collars of Shaft



Fig 3. Cross Timbers

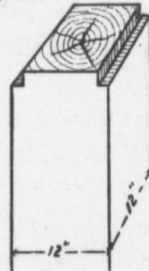
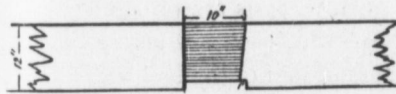

Fig 7

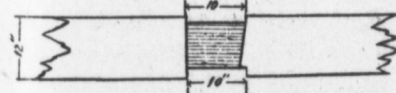

Fig 6

Post at D Both Ends the same



Cut at F Fig. 4



Side Collar Timbers Fig. 5.

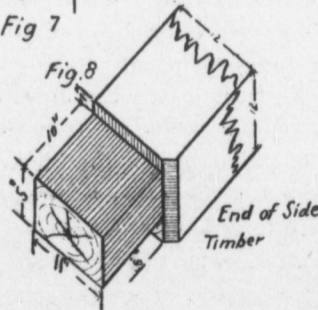

Fig. 8

End of Side Timber

Timbering in stopes varies according to the size of the chamber, the dip, and the nature of the ore and walls. The cost of the timber is also a not inconsiderable factor. Little timbering is required in narrow, steep veins, with good walls. Occasional stulls are used resting in hitches cut in the walls. They are placed in rows about 6 feet apart, lagging being laid on them to serve as a platform to work from and to receive rock from the blast. They should be placed at a slightly smaller angle to the vertical than the perpendiculars to the walls, and should be firmly wedged. If the wall is soft, timber should be placed to act as a plate behind the ends of the stulls. Many methods have been devised for strengthening the single stull, the most common forms being stulls extending from hitches cut in the walls, as props in the form of an inverted V, and for soft ground the props are perpendiculars set against the walls.

Ihlseng gives the following formula for calculating the diameter of a single round stull  $d^3 = 0.05 hw^2m$ , where  $h$  is the height of the wall along the vein, in the distance between the stulls,  $w$  the width of the vein, and  $d$  the diameter of the stull, the strength varying directly as the cube of the diameter. It is better to increase the number of props than the diameter.

For timbering large stopes, several elaborate systems have been devised

The square sett system is at present the favorite. It was first introduced in the Comstock Lode and when its advantages were fully appreciated it speedily became the most approved method. Fig 9.

The following is the method of putting up the setts employed in the Le Roi Mine in Rossland. The muck is scraped away till firm rock is reached, on this a 3" plank is laid, to serve as a mud sill, perpendicular to the walls, on this, posts are set up 4' 6" apart. The posts at the top fit into a cap which extends across them parallel to the mud sill from the hanging wall to the foot wall. Hitches should be cut and the whole firmly wedged. The mud sills are about 4' apart, the setts are supported from the sides by collar braces from cap to cap. The shoulder of the cap should fit into the end of the post in order to prevent any lateral motion on the part of the latter. Foot braces are nailed in between the posts, they consist of pieces of plank of about 3" x 4" size, of the proper length, driven in and nailed. These should be the only nails used in the construction.

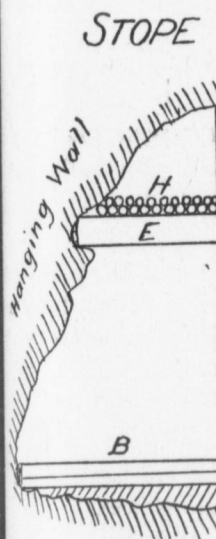
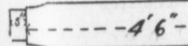
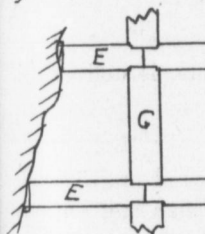

Fig. 6

CAP  
Fig. 7

# STOPE TIMBERING — LE ROI

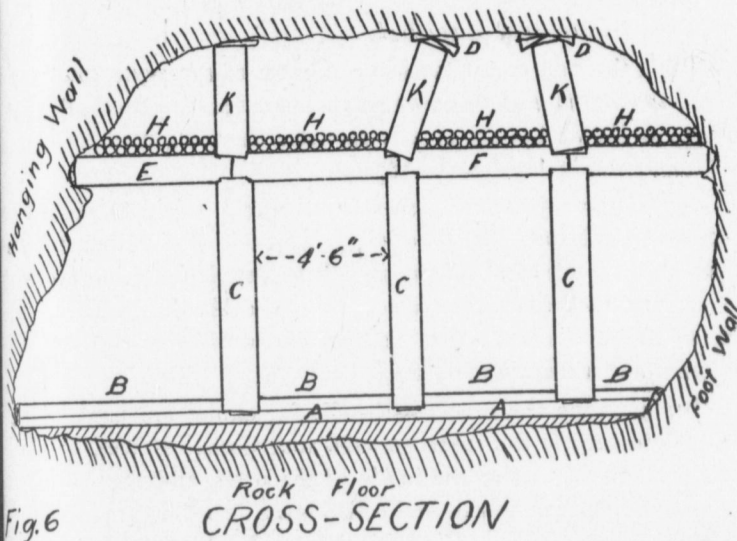
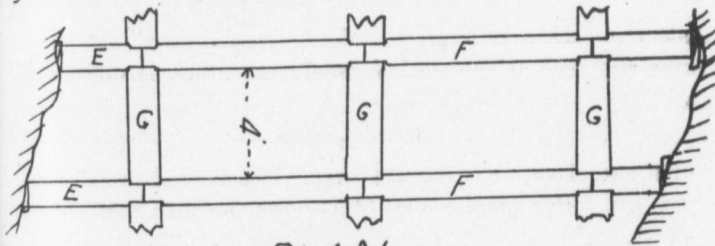

Fig. 6



PLAN

Lagging and Spraggs removed

- A,A - mud sill
- B,B - foot braces
- C,C - posts
- D,D - wedges
- E,E - butt cap
- F,F - cap
- H,H - lagging
- K,K - spraggs

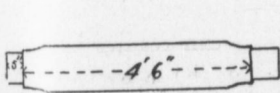

CAP  
Fig. 7

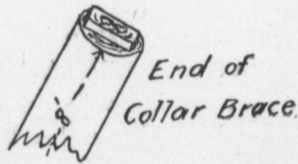

PLATE 1A.

On these caps another series of posts can be set up and the series continued till the roof is reached.

From the caps of the top sett a number of spraggs extend to the roof to support it, and to keep the whole system of setts rigid. These spraggs at the Le Roi are usually cut from the poles used for lagging and are driven in tight and wedged.

Across the caps of the upper setts lagging is laid to protect the men working below. In Rossland poles 4" to 8" in diameter, and about 16' long are used. They should be double laid wherever they are expected to receive the muck from the blasting. These poles can be shifted from floor to floor as the work goes on, and thus an important saving is effected.

For handling the muck, perpendicular chutes are used, of such a size as to occupy the space between four posts. Braces, 3" plank, are set in grooves cut in the inside of the posts, and then 3" planks are spiked from cap to cap and collar brace to collar brace, to form the sides of the chute. If the drop exceeds about two floors it is customary to shift over a sett in order to break the fall and minimize the wear and tear at the bottom where the muck is delivered into bins which are periodically relieved by cars.

Figs. (7a, 8a) illustrate the above method. Fig. (7a) shows the cap, plan and elevation being the same. Fig. (8a) shows the ends of the post and collar brace. Fig. (6a) shows the plan and end elevation of stope timbered by square setts.

If great strength is required crib-work is sometimes used. A good foundation should be obtained and two or three logs are laid parallel and upon them in notches cut near the ends, cross sills are laid and then more logs parallel to the first, the spaces are filled up with smaller timbers wedged tight by, or with waste. Crib-work is sometimes built up on the top of the upper row of square setts to reinforce the spraggs which are temporarily supporting the roof.

In swelling ground such as felsite or trachyte, it is customary to have some weak points in the frame which can readily be replaced and thus save the whole construction. It is of the utmost importance that any indication of a movement should be at once attended to, as with each member displaced, an additional strain is forced upon the others, and in a comparatively short time the chamber may be lost beyond recovery.

Method  
of the ground  
drifts in good  
natural support  
sufficient size for  
even in the  
is sometimes  
apart on each  
ends being  
to hold them  
incline slightly  
principle of the  
of posts is  
lagging is laid  
ground. If  
to rest in a  
should be taken  
way for the  
being due to

Iron and  
underground  
are put to  
form are large  
to an early  
for lining  
that the ground  
couple of weeks  
must be reached  
the rock to  
solid, a hitch  
the ground  
arch is built,

Iron and  
resistance to  
of the atmosphere  
heavy hot air  
by better ventilation  
stantly changing

Methods of timbering in tunnels depend mainly upon the nature of the ground in which operations are being carried on. In narrow drifts in good ground it is not considered necessary to reinforce the natural supporting walls by artificial means, but in tunnels of sufficient size for extensive operations some timbering should be used even in the firmest ground. To support a scaly roof a series of setts is sometimes used. A row of posts are set up on sills about four feet apart on each side of the tunnel and a cap laid on each pair, the ends being carefully framed. Ties extend across between the setts to hold them firmly in position. It is customary to let the posts incline slightly towards the centre of the tunnel to enlist the principle of the arch. If the tunnel is wide enough for two tracks a row of posts is put in to support the cap in the centre. Along the caps lagging is laid in double or single rows according to the nature of the ground. If one wall is good one end of the cap is sometimes allowed to rest in a hitch, while a post supports the other as above. Care should be taken in timbering tunnels to allow room for a passageway for the men. Upwards of 12 per cent. of fatalities in mines being due to crushing by cars in haulage-ways.

Iron and masonry are beginning to play an important part in underground work. In Europe, owing to the cost of timber, they are put to extensive service. Old iron rails and posts of a circular form are largely used, especially when the conditions are favorable to an early decay of ligneous matter. Masonry is frequently used for lining shafts, especially in the Old World, but it is necessary that the ground be strong enough to stand without support for a couple of weeks, as to obtain a sure foundation, a considerable depth must be reached. In some cases a V-shaped chamber is built into the rock to obtain the necessary stability. In tunnels, if one wall is solid, a hitch is cut to act as support and an arch built around to the ground on the opposite side; if both walls are bad, a complete arch is built, or sometimes an elliptical form is used.

Iron and masonry possess a great advantage over wood in their resistance to decay. The life of timber depends on the condition of the atmosphere and the care taken in dressing. The effect of the heavy hot air of a mine is a decomposition which can only be stayed by better ventilation or the use of antiseptic preparations. A constantly changing temperature, or a variation in the amount of mois-

ture, is very destructive. A cotton-fungus mould is a sure sign of a bad atmosphere. As this fungus spreads rapidly it should be attended to at once. In stopes in the Le Roi, not over four years old, timbers twelve inches in diameter have fallen apart through sheer rottenness due to this cause, the mould being in many cases a foot long.

The destruction of the timber, which is due to the damp air, the attacks of insects, and the fermenting of the albuminoids of the sap may be materially delayed by chemical treatment. Creosote is largely used for this purpose. It is forced into the timber by placing the latter in an iron chamber from which the air has been extracted, and then admitting the creosote under a pressure of about 100 pounds per square inch. In salt mines, steeping in brine has been found to give increased endurance to the timber. The sulphates and chlorides of zinc also prove excellent antiseptics.

Care should be taken in the selection of the timber, but the choice is often influenced by circumstances. Oak is the best for general purposes, but that which is most convenient is generally accepted. Spruce and pine are also good, but such woods as cottonwood should be rejected. Well seasoned timber is desirable under all conditions, as it combines the essential features of good material, strength, lightness, and durability.

---

Notwithst  
Yukon region  
Foremost amo  
renness and d  
rigorous clima  
The responsib  
the wrtten r  
adventures re  
The latter ma  
lections of th  
ships and pri  
years ago, the

The cour  
no means thi  
facturing into  
many years, t  
to draw their  
banks from y  
found, and is  
valuable addi  
farming on a  
spots, and I  
other objects  
livelihood, an  
miner in his  
of garden pr  
his garden in  
rapid owing  
of nature wh  
shine is gre



## A TRIP TO THE YUKON.

---

L. B. STEWART, D.L.S., D.T.S.

---

Notwithstanding all that has been said and written about the Yukon region, many false impressions of that country still prevail. Foremost among these is the impression that it is a scene of barrenness and desolation, devoid of vegetation and possessing such a rigorous climate that none but the hardiest should venture there. The responsibility for this opinion is perhaps to be divided between the written reports of early explorers and the accounts of their adventures related by disappointed gold-hunters on their return. The latter may perhaps be excused if they retained no pleasant recollections of the country when, after having undergone all the hardships and privations entailed in a journey to the gold-fields a few years ago, their labors were not crowned with success.

The country however is neither barren nor desolate. While by no means thickly wooded, it has sufficient timber both for manufacturing into lumber and for fuel to last the present population for many years, though the steamers plying on the river will be obliged to draw their supplies of fuel from points farther and farther from its banks from year to year. Coal, or a good quality of lignite, has been found, and is being worked in various localities, and will prove a valuable addition to the resources of the country. Gardening, and farming on a small scale, have been tried with success in sheltered spots, and I have no doubt that many who have gone there with other objects in view will be induced to adopt this as their means of livelihood, and may derive more profit therefrom than the average miner in his search for gold, as there is a ready market for all sorts of garden produce. I was told that one man cleared \$12,000 from his garden in one season. Once the summer begins, growth is very rapid owing to the great length of the days, as by a kind provision of nature when the sun is north of the equator the duration of sunshine is greater the farther north the place may be. The climate

also has nothing to be dreaded. I can speak in the highest terms of the summer climate; it is dry, cool, bright, and bracing, and can only be found fault with, I think, by those that object to being obliged to feel energetic. The incessant daylight, lasting for about three months, is a distinct advantage in a country where the principal occupations necessitate a life in the open air, and where travelling must nearly all be done on foot. The prospector, in setting out on a trip, is enabled to dispense with blankets, thus materially lightening his pack, by sleeping during the day when it is warm, and working and travelling during the night, or that part of the twenty-four hours when it should be night. As regards the winter, I am told by those who have lived also in Manitoba, that the winter in that province is much more trying than that on the Yukon, as there is more wind. The darkness of the winter months is certainly a drawback, but this is mitigated by the frequent northern lights and by the brightness and long continuance of the moonlight.

The climate of the strip of country between the coast range of mountains and the sea, belonging to our neighbours across the line, is entirely different from that of the interior, being warmer but damp and foggy.

On May 27th last I set out for Dawson in search of as much wealth as could be gained during the summer months. Arriving in Vancouver on June 3rd, I at once set to work to make inquiries regarding routes and rates and to purchase a small camping outfit. I finally bought a through ticket to Dawson from the Canadian Development Company for \$135. I found afterwards that nothing was gained by getting a through ticket, and by doing so one lost any advantage that was to be gained by cutting of rates on the Yukon. My steamer was to leave on the following Monday, and the time at my disposal was fully occupied in completing my outfit and in getting my "outward entry" papers made out by a broker, a very essential proceeding as appeared later.

About 9.30 p.m. our steamer, *The Cutch*, pulled out from Vancouver. The following morning found us nearing Seymour narrows, where the tide runs so strongly that small steamers cannot make headway against it, so we were obliged to heave-to for an hour or so to await the turn of the tide.

The trip to tourists for m not be given her among islands, s hard to believe t seems to be runn unexpected quar rugged in the e most susceptible Queen Charlotte sweep of the P generally reduce arrival at Skeen for higher water to see the proces from the water catch was being the afternoon, t in the operatio

On Saturda rain, and with t very common s encounter with to the best rout sage over the W we heard the co up at the end forwarded to B now would hav anything to B deliver it there who professed t impassable, an days. The age but that route truth, the cho broker whom t things through

The trip to Alaska by the inside channel has been well-known to tourists for many years, so that a detailed description of it need not be given here. The whole route lies through narrow channels among islands, sometimes so narrow and of such length that it is hard to believe that one is not on a river; at times the steamer seems to be running into a cul-de-sac, when an outlet appears in an unexpected quarter. Everywhere the land is mountainous and rugged in the extreme. The only parts of the route where those most susceptible to mal-de-mer need feel any uneasiness are in Queen Charlotte Sound and Dixon Entrance; at these points the full sweep of the Pacific must be encountered for a few miles, which generally reduces the crowded appearance of the decks. On our arrival at Skeena river the tide was out, so we were obliged to wait for higher water in order to land our freight, which gave us a chance to see the process of canning salmon, from the time the fish are taken from the water until they are packed in the cans. The morning's catch was being landed on our arrival, and before we left, early in the afternoon, they were all canned, so there is not much time lost in the operation.

On Saturday, June 10th, we reached Skaguay in a shower of rain, and with the surrounding mountains hidden by cloud banks, a very common state of affairs there. On landing we had the usual encounter with customs officers, and then proceeded to enquire as to the best route to the Yukon. My ticket provided me with a passage over the White Pass by rail as far as the railway extended, but we heard the comforting news that endless tons of freight were piled up at the end of the track, from which point it was being slowly forwarded to Bennett by pack horses, and that any freight shipped now would have to await its turn. The company offered to express anything to Bennett at the rate of seven cents per pound, and to deliver it there without much delay; but we were assured by others who professed to know all about the matter, that the trail was almost impassable, and that nothing could be delivered in less than ten days. The agents of the Chilkoot Pass route made similar promises, but that route also had its detractors, and while trying to find out the truth, the choice of a route was decided for me by the customs broker whom I employed, through a misunderstanding, bonding my things through by the Chilkoot route. To save time, and finding

that others had chosen that route, I decided to let matters remain as they were. A rule always to be observed in that part of the world is never to go ahead of your outfit, always keep it ahead of you, so that evening I saw my camp outfit leave for Dyea on a scow, and the following morning took my baggage across in the ferry and saw all loaded on a wagon and started up the pass. I then returned to Skaguay and collecting the rest of my belongings, I recrossed to Dyea accompanied by Mr. R., whom I had met on *The Cutch*. We decided to remain there a day to give our baggage a chance to reach Bennett ahead of us, and then follow after it, keeping a sharp lookout in case it should have been side-tracked anywhere. We landed from the ferry on the dock, which did not extend inland as far as high water, and the tide being in we were cut off from the shore. A man with a skiff offered to row us ashore for 50 cents, but we were getting tired of paying 50 cents or \$1 at every turn, so we decided to await the ebb of the tide, and in a short time the water was shallow enough to allow us to wade ashore.

The construction of the railway over the White Pass has built up Skaguay at the expense of Dyea, which at this time was almost deserted, the employees of the Chilkoot Aerial Tramway Company being about the only inhabitants. Freight was transported by wagons from this point about eight miles to the beginning of the canon at Canon City, so-called, thence by cable tramway to the summit of the pass, nine miles farther, from which point it is drawn on sleighs as far as the snow extended, thence by pack horses to Lake Lindeman, thence across Lindeman by scows, and finally by wagons to Bennett. All this was done at the rate of five cents per pound. At this time the Chilkoot route was preferable to the other as far as the transport of freight was concerned, but the completion of the railway has of course changed that. In the days of pack horses the Chilkoot Pass was the summer route, being the shortest from water to water, and the White Pass the winter route, being about 900 feet lower, and having at the summit a chain of small lakes which made a good winter trail.

The next day we set out about noon by stage and arrived at Canon City about three or four o'clock. After lunch we started for Sheep Camp, our party now increased to five, and arrived there after a couple of hours scramble over an extremely rugged but picturesque

trail. Sheep Camp was an important night, resolving to had time to melt more difficult. I way without having except ourselves, the omission very proposed setting trail became more or climbing over sides. Then snow slope the walking the "Scales." I of snow, very st The most direct in the snow to n and I have been mer that at ever would tax him a mer a more round easier grade, but not take the ot the physique of 150 pounds up enveloped in fo to be had from sky had been cl 3,000 feet in a a fit state to e ahead. It took the slope to C was a small "r meal.

R. and I t ing behind for the sleighing. until it could

trail. Sheep Camp is a small settlement just below timber line, and was an important point in the days of packers. Here we spent the night, resolving to proceed very early in the morning before the sun had time to melt the snow on the pass, as then walking was much more difficult. By three the next morning we were again on the way without having any breakfast, as no one in the hotel was stirring except ourselves, and we had not gone far before we began to feel the omission very keenly, and often was the question asked, "who proposed setting out before breakfast"; but nobody knew. The trail became more and more rugged as we advanced, winding among or climbing over large masses of rock fallen from the mountain sides. Then snow was reached, and after clambering up a steep slope the walking became easier until we came to the place called the "Scales." Here in front rose what looked like a huge bank of snow, very steep, and with its summit lost in a bank of cloud. The most direct path from here was so steep that steps had to be cut in the snow to make climbing possible, a rope serving as a hand-rail, and I have been told by those who crossed the pass the previous summer that at every few yards the climber would meet somebody who would tax him a quarter for keeping the steps in order. Last summer a more roundabout path was generally used, which gave a slightly easier grade, but if the one we took was the easier I am glad we did not take the other. I could not help a feeling of admiration for the physique of the man who could carry a pack weighing 100 or 150 pounds up that slope. On arriving at the summit we were enveloped in fog, which prevented us enjoying the magnificent view to be had from there, especially towards the south, but even if the sky had been clear it is not likely that men who had climbed nearly 3,000 feet in a walk of about five miles before breakfast would be in a fit state to enjoy scenery with breakfast only a quarter of a mile ahead. It took only a few minutes to slide down the other side of the slope to Crater Lake, in the middle of which, built on the ice, was a small "restaurant," where we were soon enjoying a well-earned meal.

R. and I then pushed on at once for Bennett, the others remaining behind for the present, and a few miles brought us to the end of the sleighing. Here large tents were pitched to shelter the freight until it could be carried farther by the pack animals. Soon we

overtook a train of forty or fifty pack horses and mules laden with every imaginable article from the ordinary bale to large packing cases, furniture, doors and window sashes, and even some barber's chairs; the ingenuity of the packers must have been well tested. A little later Lake Lindeman appeared in sight, and soon the little settlement on its shore lay almost at our feet at the foot of a steep hill. The trail curved away to the left to descend the hill by an easy grade, but seeing a hotel not far away and being again hungry, we were not content to keep the trail, but struck down the hill and across the flat at its foot to reach the hotel as soon as possible. We had not gone far when a peremptory whistle made us look round, when we saw a mounted policeman beckoning to us from in front of a neatly built log building. The Union Jack floated from a flag-staff in front of the building, and the word "customs" escaped from both of us simultaneously. The collector evidently thought that we were trying to evade H. M. customs, when our sole object was the innocent one of appeasing our mountain appetites as soon as possible. Having satisfied the policeman that we were not smugglers, and enjoying the comfortable reflection that we were again in Canada, we proceeded on our way. In the afternoon we saw all our effects loaded on a scow to be taken across the lake, and then crossed over ourselves and reached Bennett about 6 p.m.

Bennett is an important point just now, being the terminus of the railway and the head of navigation of the branch of the Yukon that serves as the highway into the Klondike district. The old pioneers used to pack their outfits over one of the passes and then build boats here of lumber sawn by hand in the woods to take them down the river to their destination. Quite a business is still carried on in scow-building; one can be purchased for \$700, built of lumber sawn on the spot, and where one has a large outfit they probably afford the cheapest means of getting down the river, as they can be sold in Dawson or the lumber used for house building.

After a delay of a couple of days waiting for a boat I got away from Bennett on the *Australian*, Mr. R. having taken another steamer for Atlin the day before. After a slight delay at Cariboo crossing from shallow water we arrived at Tagish, i.e., at the police post at the foot of the lake of that name. Here a certain amount of

uneasiness must have been the sequence of a notice sent into the country informing that he possesses a large number of icebergs. This action on the part of the police that I could not look for any morning early we navigation of the rapids for portaging going on foot. Hing to another to eight days. A freight had not a My enforced stay rounding country etc. Pilots on the ing scows through figure, but I was value with the passengers are rare how ties of the rapids canoe. The can though neither s

Curious stories into partnership but quarrelling solve partnership make a fair division and everything The scow would ing stove would only one of any one of these occasions divided when a

uneasiness must have been felt by some of the passengers in consequence of a notice posted everywhere stating that anyone going into the country for the first time must satisfy the police officers that he possesses at least six month's provisions and \$500 in cash. This action on the part of the government was necessitated by the large number of indigents they had been obliged to support during the winter. As I should have had some difficulty in satisfying the police that I could comply with the letter of the notice, I took care not to look for any of them and they did not look for me. The next morning early we reached Miles Canon, where a break occurs in the navigation of the river, a wooden tramway five miles in length connecting the landing above the canon with that below White Horse rapids for portaging baggage and freight, the passengers generally going on foot. Here I made the mistake of going ahead and trusting to another to look after my things, which cost me a delay of eight days. A steamer was waiting at White Horse, but as my freight had not arrived I was obliged to let it go out without me. My enforced stay there I spent as best I could, exploring the surrounding country, taking snap shots at scows running the rapids, etc. Pilots on this part of the river make quite a profit from steering scows through the canon and rapids; they charge a pretty high figure, but I was told insure the cargo against loss by depositing its value with the police, which they forfeit in case of accident. Accidents are rare however where pilots are engaged, as once the peculiarities of the rapids are understood they give no trouble even to a good canoe. The canon is not nearly as serious an affair as the rapid, though neither should be run by any but experienced boatmen.

Curious stories are told of how two men would sometimes go into partnership in purchasing a scow and outfit to descend the river, but quarrelling before their destination was reached they would dissolve partnership and make an equal division of their property. To make a fair division the aid of a policeman was generally called in, and everything that could not be readily divided was cut in two. The scow would be sawn in two and the ends boarded up, the cooking stove would share a similar fate, and in short where there was only one of anything it would be cut in two, each taking half. On one of these occasions it was thought that everything had been divided when a frying pan was produced, and having no means of

dividing it the disgusted policeman hurled it as far as he could into the river, and both parties were satisfied.

After leaving White Horse I hoped to reach Dawson without further delay, but again met with disappointment. Either through a difficulty in steering the boat, or incapacity in the wheel-house, or both, our steamer soon developed a strong desire to become acquainted with every rock and sandbar in the river, and where there were no rocks or sandbars the shore answered just as well, and in it great V's were cut by our bow that would serve as harbours for small canoes, and then the shore would retaliate by breaking our rudders whenever the stern of the boat came in contact with it. The steamer *Domville* had sunk in *Thirty-Mile* river a few weeks before, filling about half the channel; the other half was not wide enough for our steamer, which struck the paddle wheel of the *Domville* and then her stern swung round in the current and lodged against the bank, thus completely filling the channel. This caused a delay of about ten hours. Later on we floated broadside on a bar at the head of an island when there was a deep channel on each side of it; hesitation as to which channel to take until it was too late to take either probably caused this mishap. Another delay of nine or ten hours ensued.

Everything must have an end however and we reached Dawson at last on June 30th. As an instance of the readiness with which nicknames are added to a man's name in that country, I may relate that on my return journey in coming up the river I heard some men discussing a certain "Sandbar Robinson" (the name of course fictitious), but at first it did not occur to me that they were speaking of the captain of the steamer on which I travelled down the river.

On approaching Dawson by water one is not likely to be favourably impressed with its appearance, though one's expectations of a place that has grown up so quickly and under such unfavourable conditions should not be very great. The principal part of the city is built upon an extensive flat, which when viewed from the river is completely dwarfed by the mountain or dome, as it is called, which rises abruptly in the rear to a height of 1,500 feet or so above the river. In a place whose population regard themselves as birds of passage, the buildings are not likely to be of a very substantial character, and this is the rule in Dawson, though some of the large trading companies have shewn their faith in the permanency of the min-

ing industries of built of timber and sufficient to last t events will shew t

One thing thsantly, and especi price charged for a carter to take t and found that hi fact that hay cost cents. The price able; it no longer country, unless p carrying it by sec now be had from the price increase a price as \$2.50 one could prepar

The day afte of land surveyors

The bulk of of mining claims prove of interes January 18th, 1 dike region wer length, following point, and exten hill on either si base of the hill the side boundar feet from the c

A prospect the bank of the writes on each which it extend and dates and is usually limit inscriptions on



ing industries of the region by erecting extensive warehouses, well built of timber and corrugated iron, and storing them with provisions sufficient to last the community for years. I have no doubt that events will shew that their faith has not been misplaced.

One thing that is apt to strike the newcomer rather unpleasantly, and especially if his finances are at a low ebb, is the high price charged for everything. After collecting my things I engaged a carter to take them to a place where I intended to pitch my tent, and found that his charge was \$4 per hour; this was explained by the fact that hay cost 20 cents a pound, and it had been as high as 30 cents. The prices of staple articles, however, are now quite reasonable; it no longer pays a man to take his own supplies into the country, unless perhaps he is taking a considerable quantity, and carrying it by scow down the river from Bennett. Good meals may now be had from \$1 upwards in Dawson, though out on the creeks the price increases with the distance from the city, reaching as high a price as \$2.50 on Sulphur Creek for a very ordinary meal such as one could prepare for himself in camp.

The day after my arrival in Dawson I became a partner in a firm of land surveyors, and was at once as busy as one could desire.

The bulk of the work done by surveyors being the laying out of mining claims, a brief description of the method of survey may prove of interest. According to the regulations in force prior to January 18th, 1898, under which nearly all the claims in the Klondike region were staked, creek and gulch claims were 500 feet in length, following the general direction of the creek or gulch at that point, and extended back in width from the creek to the base of the hill on either side, except where the distance from the creek to the base of the hill exceeded 1,000 feet, in which case the posts marking the side boundaries of the claim were planted at the distance of 1,000 feet from the creek.

A prospector in staking a claim generally blazes two trees on the bank of the creek at the estimated distance 500 feet apart, and writes on each a statement of the length claimed, the direction in which it extends from that point, whether up-stream or down-stream, and dates and signs it. As the education of the average prospector is usually limited, and he is in many cases a foreigner, many of the inscriptions on posts afford amusing reading. One post met with by

a surveyor contained the simple and direct statement, "I clem this clam," and a Norwegian signature that would have been quite unintelligible if the surveyor had not been assisted by the records in Dawson. The decipherment of these inscriptions is an important part of the surveyor's duties, the survey being based upon the location posts, and he must often bring to bear upon the matter the mind of a Sherlock Holmes, as there are many causes that tend to make the identification of a post after two or three years have elapsed, a matter of extreme difficulty. Fires may sweep over a piece of country completely effacing any writing made on the trees, or an unscrupulous individual, in whom the country abounds, may re-blaze a tree, substituting his own name for that already there. In the latter case the post may often be identified by finding the original writing on the chips lying about, but these are now usually collected carefully and burnt. In one instance that came to my notice the tree that served as a location post had been cut down close to the ground and a portion of it removed to mark the boundary of an adjoining claim, but fortunately we were able to identify it unmistakably.

Having found the location posts, the surveyor then runs a base line in the general direction of the valley and along the course of the creek, or produces the base of an adjoining claim already surveyed, and then runs the cross lines through the location posts and perpendicular to the base line, producing them to the base of the hill on either side of the valley. If the length of the claim, laid out as above described, would exceed 500 feet, its length is made exactly 500 feet, commencing at the location post nearest discovery claim, the overplus constituting a fraction, which is retained by the government. The surveyor must use his judgment in determining the base of the hill. In a good many cases the staker blazes two trees, one on each side of the track, at each end of the claim; in that case the end boundaries must pass through points midway between the location posts.

Under the existing regulations creek claims are laid out 250 feet in length, the length being measured in the same way as under the old regulations, but the side boundaries are "lines along bed or rim rock three feet higher than the rim or edge of the creek, or the lowest general level of the gulch within the claim so drawn or

marked as to be the lowest general level of the creek, or the lowest general level of the gulch within the claim so drawn or the general direction of the creek, or the lowest general level of the gulch within the claim so drawn or the centre of the creek, or the lowest general level of the gulch within the claim so drawn or the side boundaries of the claim, or the lowest general level of the gulch within the claim so drawn or worked.

After finishing about eight to ten miles of the Eldorado creeks, surveying some of them, accompanied by a man who seemed like a bear on his knees, for the creek dike, we arrived at a shingle nailed to the ground where we were working on a road-house for which we had spent the afternoon. They appeared, after finishing supper at a mill on the ridge to the east, setting out for the trail but we resolved to follow the trail a trail that leads from that of the last five miles found ourselves advertised "lumber too attractive, we retired after until further and arrived at and taking up next few days.

marked as to be three feet above the rim or edge of the creek or the lowest general level of the gulch opposite to it at right angles to the general direction of the claim for its length, but such boundaries shall not in any case exceed 1,000 feet on each side of the centre of the creek or gulch." Unless bed rock is exposed, the positions of the side boundaries can only be determined as the claim is worked.

After finishing some work in Dawson I set out one morning about eight to join my partners near the "Forks" of Bonanza and Eldorado creeks, where they had been engaged for a few days in surveying some claims. I carried my instruments and was accompanied by a man who was anxious to have some work done. After what seemed like a continuous wading through mud half way to our knees, for the creek valleys are usually very swampy in the Klondike, we arrived about noon at a point a little below the Forks. Here a shingle nailed to a post beside the trail indicated that my partners were working on the adjoining hillside, so we turned aside into a road-house for lunch before looking for them, and found that they had spent the previous night there. While having lunch one of them appeared, and presently we set out together and spent the afternoon finishing some work in the neighbourhood. After having supper at a miner's cabin we separated, Mr. B. striking across the ridge to the eastward towards Hunker Creek, and Mr. F. and myself setting out for Sulphur Creek. The distance was about 20 miles, but we resolved to walk as far as possible before resting. We followed the trail up Bonanza Creek to near its source, and then took a trail that leads over the divide that separates the Klondike basin from that of Indian River. After walking till two in the morning, the last five miles involving a climb of a couple of thousand feet, we found ourselves beside a road-house at the summit of the divide that advertised "lunch at any hour of the day or night," and this proved too attractive, so we turned in there, and after enjoying a "lunch" we retired after giving instructions that we must not be disturbed until further orders. About noon the next day we again set out and arrived about the middle of the afternoon at our destination, and taking up our quarters at a convenient road-house we spent the next few days in laying out several claims. Having finished our

work about noon on a certain day, we set out after lunch for Dawson, reached the Forks at six for supper, and arrived at Dawson shortly before midnight, having walked about thirty-three miles.

The above will serve as a sample of a surveying trip on the Klondike creeks, and, needless to say, one takes with him on such a trip but little besides his instruments. After being away from Dawson for a week or more one becomes very hungry for news from the outside world; on one occasion I paid a newsboy 50 cents for a Toronto Evening News a month old, and at another time the same price for a copy of the Mail and Empire, also a month old.

A few words should be said with regard to the mines, and the prospects of mining in that region. In this respect the country has not, I think, been exaggerated. Though the number of extremely rich claims is limited, there are a great many that will pay well for working, and a great many others that will pay well when worked in larger areas and by cheaper methods than those now in use. The two principal methods employed in the Klondike are by summer sluicing and by sinking shafts and drifting. Mr. Treadgold in his report on the Klondike makes a careful estimate of the relative cost of the two methods, placing the former at \$5 and the latter \$10 per cubic yard, so that any gravel yielding less than these values can at present be worked only at a loss. An idea of the expense of working a claim may be gathered from the fact that from a certain claim on Dominion Creek \$110,000 were taken in one season at a cost of \$90,000 exclusive of royalty. This may, of course, be an extreme case. The chief source of expense is the frozen ground; frost is always encountered at the depth of a few inches, and extends to the greatest depth to which any shaft has been sunk.

After the present small claim owners have worked out or abandoned their claims, long stretches of several miles of the creek valleys will be leased by companies with capital, who by using hydraulic machinery will be able to extract the gold which remains after the cruder methods now in use have failed.

A few figures taken from Mr. Treadgold's report will shew the richness of some of the claims. He says: "On a fair claim on upper Bonanza a cut 120 ft. x 30 ft. yielded 980 oz. On Eldorado a cut 120 ft. x 30 ft. yielded 12,000 oz. On lower Bonanza a cut 30 ft. x 30 ft. yielded 95 oz. On another lower Bonanza claim a similar

30 ft. x 30 ft.  
12 ft. gave 63  
1,800 oz.," etc  
be computed.  
of gold from a  
the probable to  
creeks of the  
taries of India  
of 150 ft., and  
yard will yield  
will, I think,

The count  
an extremely i  
imbedded in  
Frequently the  
and I was inf  
bed rock 18 f  
the Forks. Th  
not, a study of  
valuable light

It seems p  
farmer's sons i  
for sort, in the

30 ft. x 30 ft. cut yielded 580 oz. On upper Hunker a cut 120 ft. x 12 ft. gave 69 oz. On lower Hunker a cut 100 ft. x 50 ft. gave 1,800 oz.," etc. At \$15 or \$16 an oz. the values of these cuts may be computed. He also states that he has taken  $40\frac{1}{2}$  oz.—over \$600—of gold from about 20 lbs. of gravel. An estimate is also given of the probable total amount of gold that will be taken from the proved creeks of the Klondike region, including also the northerly tributaries of Indian River, based upon a total length of 75 miles, a width of 150 ft., and a depth of 3 ft. This mass of gravel at  $\frac{1}{2}$  oz. per cubic yard will yield 3,300,000 oz.; and all who have been in the country will, I think, regard this estimate as a moderate one.

The country, besides being rich in precious metals, must also be an extremely interesting one to the geologist; the organic remains imbedded in the gravel deposits must be well worthy of study. Frequently the miners unearth tusks and bones of the mammoth, and I was informed by a miner that a human skull was found on bed rock 18 feet below the surface of the ground somewhere near the Forks. The skull may have been buried by a landslide, but if not, a study of the locality by a competent person might throw some valuable light on the question of the age of man on our continent.

It seems probable then that men in their search for gold, like the farmer's sons in the fable, may bring to light riches of an unlooked for sort, in the realm of knowledge.



that of the United States. A continent was to be developed and the means at hand limited so that many economies were devised, and are even yet practiced, all justifiable when the ends in view are considered.

It was soon found that engines could haul trains on much heavier grades than had been used in England. The use of swiveling trucks and equalizing levers enabled much sharper curves to be freely introduced. Timber also was, and is yet, freely used for even important structures. The result of this cheaper system of construction, and the very slight charter, legal, and right of way expenses, and also of the fact that most roads in America even to the present day are single track is, that the capitalization of Canadian railways is only one-quarter of that of English ones, and the bonds and preferred stock only about one-fifth. (See Table I.)

It is evident that making allowance for a few roads which have more than one track, that the class of road is very much the same in the U.S.A. as Canada.

The justification for this great discrepancy in first cost is that the English railways have an enormous *traffic revenue in sight*, and capitalists there can figure pretty closely what the revenue of a given route is going to be. This enormous revenue of \$20,000 per mile per year is partly a result of the traffic offered and partly from the high freight charge of 2 cents per ton mile.

It is apparent that this high charge is partly justified by the shortness of the haul, which makes the terminal charges bear a large proportion of the total; but the light loads, and small four-wheeled freight cars, high speeds and frequent trains, must share the onus of this high charge. (See Table II.)

The development of heavy engines, heavy loads, capacious freight cars in which the dead load forms only 30 to 40 per cent. of the total, and moderate speeds, along with the long haul, has brought about a very low freight charge in America, being (Table I.)  $\frac{3}{4}$  cent per ton mile in U. S. A., and not much higher in Canada. On the other hand, Canadian traffic revenue is very light, only \$3,000 to \$3,500 per mile per year, partly due to moderate charges, but chiefly to sparse population. Although, unfortunately, our freight and passenger charges cannot be precisely determined, as there is a crucial deficiency in the traffic returns made by the railways to the Government, namely:—The ton-miles, and passenger miles. Until





CANADIAN STEAM RAILWAYS.

TABLE I.—EXTENSIVE SERVICES, 1908.  
TRAFFIC, EQUIPMENT, ETC.

ITEM.	CANADA.		GREAT BRITAIN.		UNITED STATES.	
	Total.	Per Mile	Total.	Per Mile	Total.	Per Mile.
Gross earnings per inhabitant .....	\$9.00	.....	\$10.60	.....	\$15.60	.....
<i>Passenger Traffic.</i>						
Number of passengers .....	13,987,580	870	930,967,000	43,900	543,000,000	3,006
Passenger cars .....	1,394	10 <sup>6</sup> / <sub>100</sub>	42,230	2	33,112	1 <sup>8</sup> / <sub>100</sub>
Average haul (miles) .....	38*	.....	8	.....	23	.....
Average load .....	3*	.....	49	.....	39	.....
Passenger cars per 1,000,000 passengers .....	143	.....	45	.....	63	.....
Passenger train miles .....	15,332,276	.....	184,200,000	.....	327,294,000	.....
Passenger trains per day (each way) † .....	14	.....	12	.....	2 <sup>1</sup> / <sub>2</sub>	.....
<i>Freight Traffic.</i>						
Tons of freight .....	21,524,421	1,340	334,230,000	15,800	763,000,000	4,230.
Freight cars .....	52,118	.....	603,710	.....	1,196,119	.....
Average haul (miles) .....	110*	.....	35	.....	116.	.....
Average load (tons) .....	119*	.....	73	.....	180.	.....
Freight cars per 1,000,000 tons .....	2,421	.....	1,806	.....	1,717	.....
Freight train miles .....	19,939,699	.....	150,400,000	.....	491,410,000	.....
Freight trains per day (each way) † .....	13 <sup>1</sup> / <sub>10</sub>	.....	9 <sup>1</sup> / <sub>10</sub>	.....	37 <sup>6</sup> / <sub>10</sub>	.....
<i>Mixed Traffic.</i>						
Various kinds of cars † .....	5,999	.....	31,088	.....	41,330	.....
Mixed train mileage .....	5,359,915	.....	4,300,000	.....	15,457,000	.....
Mixed trains per day (each way) † .....	3 <sup>4</sup> / <sub>10</sub>	.....	10 <sup>6</sup> / <sub>100</sub>	.....	8 <sup>3</sup> / <sub>100</sub>	.....
Total trains per day (each way) † .....	37 <sup>6</sup> / <sub>100</sub>	.....	22	.....	63 <sup>6</sup> / <sub>100</sub>	.....
<i>Engines.</i>						
Total number .....	2,023	.....	18,658	.....	35,111	.....
Average yearly engine mileage † .....	20,100	.....	18,160	.....	23,760	.....
Employees .....	55,000	.....	465,112	22	785,000	.....
“ killed .....	50	.....	442	.....	1,811	.....
“ injured .....	488	.....	2,654	.....	25,693	.....
Passengers killed .....	9	.....	83	.....	170	.....
“ injured .....	60	.....	1,109	.....	2,373	.....
“ killed, 1 in .....	1,554,000	.....	11,202,059	.....	2,984,000	.....
“ injured, 1 in .....	233,126	.....	838,387	.....	213,000	.....

\* Based on assumed average passenger and freight rates. † 365 da. in a year. Train each way called "one train per day."  
; Including switching engines. † Express, Baggage, Postal, Sleepers, Dining Room, Transportation Co.'s Cars, etc.

Including switching engines. 4 1/2

this is done, as it is in the U. S. A. (but not in England), no strictly intelligent study of the subject can be made; yet, judging by the best evidence bearing on it, and the U. S. A. railway returns, it is probable that the average Canadian freight charge is not more than 1½c. per ton mile, which is quite moderate by comparison considering the light traffic obtainable.

There is much evidence that in America at least, traffic revenue increases much more rapidly than the population tributary per mile of railway. A. M. Wellington, an authority on this subject, adduced various data to show that it increased as the square of the population served. By which we can see how very, very, important a matter the location of a railway is, striking at the root of the enterprise for success or otherwise, given a certain position however, the revenue will vary with other causes, prominent being competition and the pursuits of the inhabitants of the various districts passed through. The average is \$10 to \$11 per head per year for Canada, but is much less in rural parts and in country towns inhabited by retired merchants and farmers, and much more in industrial centres as Galt, Peterboro', Hamilton, Woodstock, etc. Increase of traffic 5 per cent. per year in east; 10 to 15 per cent. in west, if well located. Good or bad judgment, however, in location is often the deciding feature, looking on the railway as a business concern established for the purpose of selling transportation; as it is a unique enterprise, having nearly all its capital locked up in an unsaleable form, and cannot retire from business.

It must be a very feeble recently built town that will move to a railroad, usually a town whose centre is one or two miles from its railway, unless otherwise served, languishes, and the total result is stagnation and loss to all concerned. Some railways in seeking after that silliest of boasts, "long tangents," leave thriving towns to one side; other towns will not come down handsome in bonusing and are given the go-by, while in some few cases, a town is on such a hill or in such a valley as to be out of reach of any railway having regard for its grades. But we may take it as an axiom that—giving due weight to directness of route and total length, the key note in location is to link together the greatest aggregate population by passing through the *very heart* of centres of population.

Another point which the two great Canadian railways illustrate is the cumulative value of branch traffic brought on to the main line.

Branches then bought or built idea of feeding placing the c 100 per cent, car loads at freight for n some of the i of traffic, e.g.

Traffic n expenses in 1 or from 70 pe was handled place of 65 t interesting po changed from is some mone the rolling st nment.

Also not mile has incre selling fresh being built. age, per engi ings per train

(Note th investments, a lization.)

Having traffic, the na This cost wil on the physic ability of the the road, an traffic being used are the i haul depends

For mod track is 5 to

Branches themselves often do not pay dividends, but are or may be bought or built to fight rivals, or shut them out, and always with the idea of feeding the main line, in which case it is estimated that, placing the cost of handling a unit of traffic on the main line at 100 per cent, *extra* train loads can be handled for 50 per cent., *extra* car loads at 10 to 25 per cent., and *extra* passengers or parcels of freight for not more than 5 per cent. The reason being that only some of the items of expense of operation vary with slight increases of traffic, e.g., (Table III.)

Traffic revenue increased from \$2,910 with \$2,040 working expenses in 1895, to \$3,540 with \$2,320 working expenses in 1898, or from 70 per cent. to 65½ per cent, which means that \$630 of traffic was handled by an expenditure of \$280, or about 45 per cent. in place of 65 to 70 per cent. for the whole traffic. There are many interesting points to be taken from Table III. The net income has changed from a *minus* to a *plus* in 3 years, by increased traffic—there is some money to pay dividends to stockholders with, and to increase the rolling stock and make the structures and roadbeds more permanent.

Also notice that 1895-96, being bad years, the bonded debt per mile has increased, in other words, floating debts were liquidated by selling fresh bonds in 1897 in the face of a cheaper class of roads being built. Also that the earnings per inhabitant and engine mileage, per engine, have largely increased, but that the cost and earnings per train mile does not vary much.

(Note the poor character of railway holdings, as a whole, as investments, as shown by percentage net earnings are of gross capitalization.)

Having touched on the subjects of railway investments and traffic, the natural sequence will be to deal with the cost of operation. This cost will depend on the relative volume of traffic offered, and on the physical characteristics of the rolling stock and roadbed, the ability of the operating staff, and on the ruling and other grades of the road, and the amount of curvature. If we assume a certain traffic being offered, then the ruling grades and weight of engines used are the important factors. The load which a given engine can haul depends on the grades, curves, and condition of track.

For moderate speeds the resistance offered on a level, straight track is 5 to 7 lbs. per ton in summer, and 7 to 9 lbs. per ton in

TABLE No. III.—CANADIAN RAILWAYS.

STATISTICS FOR 1895, 1897, 1898.

ITEM.	Total.	Per Mile.	Total.	Per Mile.	Total.	Per Mile.
Mileage.....	16,091		16,687		16,871	
Population.....	5,100,000		5,300,000		5,400,000	
Square miles.....	1,600,000	317	3 3-10	318	3 36-100	320
Population per square mile.....	3 2-10					
Capitalization.						
Bonds.....	\$331,000,000	\$20,600	\$349,000,000	\$20,900	\$355,000,000	\$21,000
Preferred stock.....	106,000,000	6,600	107,000,000	6,400	111,000,000	6,600
Common stock.....	256,000,000	15,900	263,000,000	15,600	267,000,000	15,800
Loans, etc.....	37,000,000	2,300	37,000,000	2,200	39,000,000	2,300
Bonuses, etc.....	167,000,000	10,400	173,000,000	10,400	178,000,000	10,500
Total.....	\$897,000,000	\$55,800	\$926,000,000	\$55,500	\$950,000,000	\$56,200
Earnings.						
Passenger.....	\$13,300,000	\$ 830	\$13,900,000	\$ 840	\$15,600,000	\$ 930
Freight.....	29,600,000	1,840	33,500,000	2,010	38,500,000	2,280
Other.....	3,900,000	240	4,900,000	290	5,600,000	330
Total.....	\$46,800,000	\$2,910	\$52,300,000	\$3,140	\$59,700,000	\$3,540
Working expenses.....	32,800,000	2,040	35,100,000	2,110	39,100,000	2,320
Net earnings.....	\$14,000,000	\$870	\$17,200,000	\$1,030	\$20,600,000	\$1,220
Fixed Charges.						
Bond interest.....	\$15,000,000	4 62-100%	\$16,000,000	4 60-100%	\$16,300,000	4 6-100%
Interest on loans and rentals.....	1,800,000	5%	1,850,000	5%	1,980,000	5%
Total.....	\$17,100,000		\$17,850,000		\$18,280,000	
App. net income.....	— 3,100,000		— 650,000		2,320,000	
Per cent. net earnings of gross earnings.....	70		67		65	
Per cent. net earnings of gross capitalization.....	1 56-100		1 85-100		2 16-100	
Pass. charge per mile, estimated at 2.5c. per mile on average.						
Freight charge per ton-mile, estimated at 1.25c. per ton-mile on average.						
Earnings per passenger train-mile.....		\$0.87		\$0.80		\$ 0.81
Freight.....		1.48		1.42		1.43
Average cost per train-mile.....		0.80		0.77		0.77
Gross earnings per capita.....		9.00		9.90		11.05
Average yearly engine mileage.....		20,100		26,100		28,400

winter, and in  
instant of start  
1 per cent. gra

Curve resis  
almost directly  
worst or ruling  
each given engi  
handle a given  
cent., 25 per ce  
sanded, ordinar  
once the natura  
mizing in freig  
wheels; but as  
without injury,  
has for many  
condition of tra

The invent  
saw that the op  
wheels, and th  
undue concentr  
omitting the fl  
tained in this v  
successive stage  
that there are v  
an end. The le  
weight allowable  
of rail and stre  
has to decide on  
and govern its t

An increas  
by increasing th  
mical, as it will  
penses. But wi  
number of engin  
serious matter a  
of a road, from  
routes, the most  
traffic obtainabl  
struction, regula



largely controlled by the number of train loads necessary for a given traffic, and therefore by the ruling gradient, e.g., let us suppose two routes of known traffic and cost of construction are to be compared, on which the ruling grades are  $\frac{3}{4}$  ft. per 100 and 1 ft. per 100. (compensated. Then the hauling resistances are as 8+15 lbs. to 8+29 lbs., or  $\frac{23}{38}$ . Presuming a traffic of five freight trains per day on the lesser gradient, the one with the greater one will need  $\frac{23}{38} \times 5 = 6$  trains; now 1 train per day additional each way for a year will cost about  $80c. \times 50 \text{ per cent.} \times 2 \times 365 = \$292$  per mile = 5 per cent. on \$5,840 per mile, a very respectable difference in capitalization, which could be spent on construction or roadbed alone beneath ballast and still leave the enterprises on an equal footing, not to speak of the increased advantage which would accrue in the future to the road having lighter grades as the traffic increased. We must not, however, lose sight of the fact that very few roads when first started have such a traffic as I have mentioned, perhaps one or two partly filled freight trains and one passenger train per day will handle all the traffic offered, and then differences of grade or curve are not important. These matters assume greater importance as the traffic increases.

This leads me, in conclusion, to say that herein lies the value of an educated civil engineer as regards railway matters. That in the preliminary study and location, the constitution of this enterprise is being formed and the most important stage in its history is being considered. The railway affords occupation, or is an instrument in the hands of every branch, almost, of our profession. The civil and mechanical engineers build it, maintain it, and operate it; mining engineers look on it, in its cruder forms, as a crucial instrument in the development of mines and properties; and to the chemist we must look for an appreciation of the qualities of lubricants, steel rails, and car wheels, etc. I am aware that special knowledge of some narrow department will be of greater value to young men just entering in pursuit of employment and promotion, but I urge on you that of most ultimate advantage will be a broad generous study of a railway as a business enterprise. To rise to the highest positions you must be more than engineers, you must be business men, and versed in railway economics, therefore consider this great subject from as many standpoints as you can before the cares of office and narrowness of concentrated effort make it more difficult and less likely.

The va  
tation has b  
Effort has n  
railways, at  
tion of the  
agricultural  
cently. No  
their improv  
they have be  
that the day  
upon a more

The pre  
ary. Ever s  
has been in  
ber of days  
days being i  
work is direc  
superintend  
The townsh  
appropriation  
scattered and  
The method  
plainly refle

But the  
thing better.  
appreciation  
tral governm  
ment. Cour  
every respec

## ROADMAKING.

A. W. CAMPBELL, C. E.

The vast importance of country roads as a factor of transportation has been far from understood by the people of this country. Effort has not been spared in completing the system of canals and railways, at a cost of millions of dollars, yet the deplorable condition of the common highways, so essential to the development of agricultural resources, has passed almost unnoticed, until very recently. No extraordinary effort has in any way been made towards their improvement, and in many cases, so far from being better, they have been going from bad to worse. It is sincerely to be hoped that the day of this lethargy has passed, and that we are entering upon a more enlightened era in this respect, as in many others.

The present aspect of the road question is distinctly evolutionary. Ever since the founding of this Province the statute labor law has been in force, requiring every farmer to work a certain number of days on the roads adjacent to his property; the number of days being in proportion to the assessed value of his land. This work is directed by a farmer appointed by the township council, to superintend the work on every mile and a half or two miles of road. The township councils have been in the habit of making money appropriations, but these have been spent on the statute labor basis, scattered and misapplied, without any semblance of expert direction. The methods applied to their construction and maintenance are plainly reflected in their condition.

But the period of neglect is, we believe, giving place to something better. Statute labor is passing into disrepute, and a better appreciation of the value of good roads is springing up. The central governments are taking a more active part in their improvement. County Councils are exhibiting a greater interest, and in every respect the outlook for a more intelligent management of

country roads is encouraging, and the time is no doubt approaching when the care of roads, with bridges, culverts, and all that pertains to them, will offer a field for engineering employment, as is the case with England, Germany, France and the more advanced European countries.

It may be said that it will be a good many years before expensive roads, such as are made in the countries named, can be afforded by the sparser population, and less wealth of Ontario. While this is true in the main, nevertheless there are some roads such as Yonge Street, leading north to Lake Simcoe from Toronto, which could now be profitably built in the best manner. And even if the great majority of roads will receive comparatively inexpensive treatment, there is all the more reason, perhaps, for the best of engineering skill, in order that the means available for roads may be applied in the most economical and skilful manner so as to secure the best results from the limited expenditure.

The construction of a good gravel or broken stone road is largely a matter of good drainage. Almost every detail can be discussed as a matter of drainage. We make open gutters at the side of the road to carry away surface water. We place tile underdrains wherever they are needed to carry away sub-soil water, and secure a firm foundation. We round or crown the travelled roadway so as to throw the water from its surface to the open gutters. The travelled track, we cover with broken stone or other metal largely to form a water-proof covering, that will prevent moisture passing through and softening the sub-soil beneath so that it will not support the weight of a load.

The importance of keeping the roadbed dry cannot be too thoroughly impressed. Clay in thick beds, when dry, will support from four to six tons per square foot of surface, according to the quality of the clay. If only moderately dry it will support only from two to four tons per square foot of surface. If the clay is wet and soft it will yield to almost any load. Gravel, if well compacted, forms a much stronger roadbed, is less yielding to the action of moisture, and for this reason even for a thin surface coating, strengthens the road somewhat. But the real strength of the road must lie in the sub-soil. Vegetable moulds and alluvial soils are weak, having a sustaining power of only one-half to one ton per square foot, and

for this reason  
a gravel, cl

A porous  
attraction,  
this is added  
it rises high  
poured into  
let in the s  
draining su  
proper depth

With porous  
absorb nearly  
it shrinks  
menaced by  
and so the  
network of  
drained.

The in  
sence of wa  
under a road  
particles of  
packed. We  
soil itself, t  
sub-soil wil  
neath traffic  
soil should  
sible by un  
in Canada d  
buted very  
by frost.

It is di  
the constru  
enunciated,  
of applying  
of work un  
a knowledge

We hav  
cessful road



for this reason it is well to remove such soils, securing if possible, a gravel, clay, or sand foundation.

A porous soil, like a sponge, retains in its texture, by capillary attraction, a certain amount of water. When water in excess of this is added it sinks to the first impenetrable strata, and from there it rises higher and higher until it finds a lateral outlet; just as water poured into a pail will rise higher and higher until it finds an outlet in the side of the pail, or until it flows over the top. Under-draining supplies the necessary outlet for this excess moisture at a proper depth from the surface; "it lowers the water line."

With plastic clays the process is slightly different. Clay will absorb nearly one-half its bulk and weight of water. In drying it shrinks and is torn in different directions. The fissures commenced by a tile drain become new drains to lead water to the tile; and so the process of contracting and cracking continues until a network of fissures is produced, and the stiffest clay is thereby drained.

The injury done to roads by frost is caused entirely by the presence of water. Water expands on freezing, and the more there is under a road, and above frost line, the greater is the injury. The particles of soil in immediate contact with the water are first compacted. When room for expansion ceases within the body of the soil itself, the surface is upheaved. When thawing takes place the sub-soil will be found honey-combed, ready to settle and sink beneath traffic. It is therefore of the utmost importance that the soil should be relieved of the water of saturation as quickly as possible by under-drainage. The impassable condition of most roads in Canada during the spring, often axle deep in mud, is to be attributed very largely to a wet sub-soil which has been honey-combed by frost.

It is difficult, indeed impossible to lay down rules in detail for the construction of a road. There are principles which may be enunciated, which can be applied in every case; but the method of applying them differs to a greater or less degree in each piece of work undertaken. There must be good judgment, based upon a knowledge of the materials with which you have to work.

We have said that good drainage is the first principle of successful roadmaking. This, nevertheless, must be accepted with dis-

cretion. Something depends upon the location of a road. If it is upon an elevated ridge, it may be that natural drainage is sufficient with very little further attention. While if it passes over low swampy ground, the best of artificial drainage will probably be necessary. A great deal depends on the kind of sub-soil. If it is a stiff clay, any drainage that can be afforded may not be thrown away. If it is a loose gravel the need for drainage will not be so great. If it is a light sand the less drainage, in all probability, the better.

In nearly all roads there are certain points springy and spongy, which should be tapped by blind drains leading from the centre of the road diagonally to the sides. These would empty into the first watercourse available; or into side under-drains, if they exist. The usual form of complete under-drainage consists of two tile drains, one on each side of the roadway, beneath the open gutters into which these diagonal drains will discharge.

But a complete under-drainage of this kind will cost about \$500 per mile, so that it is usually advisable to curtail it as far as possible. In the case of sand it might be a positive injury rather than otherwise. Sand to present its greatest strength as a foundation requires a certain amount of moisture. The surface of an asphalt roadway consists chiefly of a body of sand held together by the mineral pitch asphalt, which is a material following the laws of a liquid. In the same way a certain amount of water in sand helps to solidify it. In view of this there should be under-drainage only where the signs of springs or other underground waters appear, and the open drains should not be placed at too great a depth. Along a sand road, too, it is well to plant trees, to shade and assist in retaining moisture. the elm being one of the most suitable for this purpose, as there is a happy medium even in the matter of shade.

In regard to the metal, the gravel or broken stone used on the road, it is usually necessary to choose the best and make the best of the local supply. An acquaintance with geology and mineralogy can readily be used to advantage in this regard. We must first, however, consider the main qualities demanded as a paving material. The stones forming the road covering should be tough rather than hard; for if they are hard they are likely to be brittle, and readily broken by the impact of a horse's shoe, and the weight of the load

applied through  
ing, grinding a  
cessfully than  
tough to resist  
and compacting  
for the road.

Trap rock  
roads. This is  
Granite is hard  
Limestone poss  
in the original  
species of ceme  
water-proof cov  
omical use, and  
in particularly  
is an excellent  
from the harde  
Province. It m  
or earthy matte  
stand traffic in

With road  
proved machine  
prominent place  
tion to the com  
and the shovel,  
Recently, howev  
screen attachme

The road g  
half the townsh  
indicates, for g  
from the gutter  
way, to form a c  
is, of course, the  
now followed in  
account in repa  
the shoulders w  
through the was

applied through the wheel. A tough stone will resist the hammering, grinding and bending tests to which it is subjected more successfully than will a very hard stone. Not only should a stone be tough to resist wear, but it should possess the quality of binding and compacting so as to form a smooth, water-proof surface covering for the road.

Trap rock is placed at the head of materials for broken stone roads. This is tough, hard, and has excellent wearing qualities. Granite is hard, but lacking in toughness, and does not bind readily. Limestone possesses the best binding qualities. The dust formed in the original crushing and by subsequent attrition, becomes a species of cement, which set and re-sets, and results in a very water-proof covering. Some kinds, however, are too soft for economical use, and this inability to resist wear makes the stone, except in particularly tough varieties, unsuitable for heavy traffic. Gravel is an excellent material for light traffic, particularly that formed from the harder Laurentian rocks, found in the eastern part of the Province. It must, however, be free from an excess of clay, loam or earthy matter, otherwise it will not assume a bond that will withstand traffic in wet weather.

With roadmaking as in nearly all branches of construction, improved machinery and implements are beginning to take a very prominent place. Until very recently the old drag scraper in addition to the common plow, and the ordinary farm wagon, with pick and the shovel, were the only tools employed on Canadian roads. Recently, however, wheeled scrapers, road graders, rock crushers with screen attachment, steam and horse rollers have been introduced.

The road grader or grading machine, is now used by about one-half the townships of the Province. They are used, as the name indicates, for grading the earth roads; that is, drawing the earth from the gutter and bringing it to the centre of the travelled roadway, to form a crown, on which the gravel or stone is placed. This is, of course, the cheapest kind of road construction, but is the plan now followed in our country districts. The grader is turned to account in repairing roads, using it as a scraper; or in cutting off the shoulders which form by the flattening out of the roadway through the washing down, and forcing down of the crown. These

shoulders, consisting of sand, earth and turf, should never be restored to the crown, but should be thrown outward, and the crown of the road restored by the application of new material.

The road graders are commonly operated by horse power, from two to six, usually four, horses being required according to the nature of the work. Better than this, a traction engine will provide a more constant draft, and although somewhat slower than horses, makes up for this in the time horses will need for rest. In addition, the operation by traction engine is usually cheaper than with horses.

The rock crusher is coming into more general use, although not more than thirty Ontario municipalities use them as yet. Where there is a great quantity of field boulders available for road metal, a small crusher which, can be mounted on wheels and moved from place to place throughout a township is very useful. If the stone is taken from a quarry, it is better to use a larger stationary crusher.

There should be attached to the crusher a rotary screen. This will grade the stone into various sizes, such as stone, dust and chips,  $\frac{3}{4}$  inches diameter;  $1\frac{1}{2}$  inches diameter;  $2\frac{1}{2}$  inches diameter. When graded in this way the coarsest stone is placed in the bottom of the road, and the finest on top, the screenings of dust and chips being mixed through all the courses to fill the voids and assist in forming a bond. A crusher is very useful, too, in preparing certain forms of gravel. If there are many large stones they will be broken to a proper size, and if there is an excess of sand or earthy material, this will be removed by the screen. In operating a crusher, a traction engine is frequently employed, and if it is a movable crusher, the engine can be used for taking the crusher from place to place. If it is a stationary crusher, a stationary engine will be sufficient, although it may be advisable to have a traction engine for operating the grader, which can then be used for both crusher and grader. In towns where electric power is available for a stationary plant, an electric motor is the cheapest and most convenient power.

The steam roller is, wherever a municipality can afford it, one of the most useful implements that can be used on the road, particularly where broken stone is the metal employed. Unless a roller is used, the stone must be spread loosely on the road, and left for

traffic to compact and convenience stone become bility of the out, prevents assume, when however, pre weather, and

By the compact and ing can be la end here. W erted in the face, which c labor or the r placed on thi the old and n

In a brief ing, there is of construction books on the to indicate th years to come stood, there w more permane be required w

traffic to consolidate it. This is a slow process, causing much inconvenience to travel, and during which the earth sub-soil and stone become largely mixed, thereby destroying greatly the durability of the road. Earth mixed with stone, as previously pointed out, prevents the strong mechanical bond which clean metal will assume, when the stones are wedged one against another. The earth, however, prevents largely this mechanical bond, softens in wet weather, and the surface is then more readily broken up.

By the use of a roller, the earth sub-soil should first be made compact and solid. In this way a smooth, durable, waterproof coating can be laid over a firm sub-soil. The use of the roller does not end here. When re-surfacing old roads, picks or teeth may be inserted in the roller. These passed over the road loosen the old surface, which can then be readily worked up still more, either by hand labor or the use of a weighted harrow. The new stone can then be placed on this roughened surface, and the whole again rolled down, the old and new metal being thoroughly bonded together.

In a brief review of some of the principal features of roadmaking, there is constantly a tendency to follow the stereotyped details of construction which are more fully dealt with in the various text books on the subject. In the present article, it has been my wish to indicate the class of practice which will be met with for some years to come in Ontario. When this, however, is thoroughly understood, there will be little difficulty in adapting this knowledge to the more permanent Macadam and Telford systems which will gradually be required with increased population and traffic.

## VENTILATION AND HEATING OF PUBLIC BUILDINGS.

P. H. BRYCE, M.A., M.D.

Secretary, Provincial Board of Health.

*Mr. President and Gentlemen of the Engineering Society:*

In my addresses to you in the several past years, I have endeavoured to deal with some practical subject in public health work, which you as engineers and architects may be expected to have to deal with. We have drained the ground upon which we were going to build a house; we have carefully considered the source and means of preserving its drinking water in a wholesome condition, and have also set forth in some detail the several means which modern science has supplied for properly dealing with the excretal matters which, as sewage, require removal from such a human habitation.

To-day I propose to deal with another feature of the sanitation of this house, viz., that of the house-air and the means whereby it may serve the requirements of health to its inmates.

It is safe to say that while there has been progress in the work of constructing buildings and in the mechanical appliances for heating them, and even ventilating them, in many individual instances during the past fifteen years, yet there is probably no branch of public health work which has shown so little progress in its systematic development in Ontario as of those methods of heating and ventilation, which even in the most general way, have official sanction and are governed by either legislative or municipal regulations. If one were to seek for an explanation of this it would probably be found: *First*, in the very nature of the problem. It must be remembered that the moment life in buildings with closed sides began in climates requiring artificial heat, it became artificial. "The wind bloweth where it listeth" are the words of the Teacher, applicable to the free movements of the outer atmosphere only, and all attempts

to confine  
methods a  
with fresh  
*artem.* A  
life of any  
Ontario as  
mode of co  
it is stated

Section  
work is be  
the persons

"(3) I  
render har  
vapors, dus  
facturing p  
jurious to l

As the  
visions sha  
is to say to  
as a dwelli  
factory with  
employed a

It is f  
schoolrooms  
pupil, with  
temperature  
every hour.

And a th  
lating publ  
arranged so  
fresh air in

It will  
in a conditi  
parable to th  
ing from re  
adult man r  
into his livi

to confine air and heat it necessarily cause a departure from nature's methods and convert the problem of supplying the dwellers in houses with fresh air into a question subject to the limitations of a *secundam artem*. A *second* reason is that from the very nature of the complex life of any population living in populous centres, there are not in Ontario as yet any regulations fixing in any definite way the size, mode of construction or number of inmates of houses, except where it is stated under the Factory Act that—

Section 15.—(2) “A factory shall not be so overcrowded while work is being carried on therein as to be injurious to the health of the persons employed therein.

“(3) Every factory shall be ventilated in such a manner as to render harmless, so far as is reasonably practicable, all the gases, vapors, dust or other impurities generated in the course of the manufacturing process or handicraft carried on therein, that may be injurious to health.”

As the Act states, however, these necessary and reasonable provisions shall not apply where persons are employed at home, that is to say to a private house, or a room or place which, though used as a dwelling, might by reason of the work carried on there be a factory within the meaning of the Act, and in which the only persons employed are members of the same family dwelling there.

It is further provided in the school regulations that public schoolrooms shall have an air space of not less than 250 feet per pupil, with a superficial area of at least 12 square feet, a uniform temperature of 67° F., and provision for a change of air three times every hour.

And a *third* reason is the lack of well-defined methods of ventilating public buildings, readily applicable to different buildings, arranged so as to secure at a moderate expense an adequate supply of fresh air in such a manner as to be free from draughts.

It will thus be seen that the problem of maintaining house air in a condition of purity necessary to make it in some degree comparable to that of the outside air is in practice a difficult one, judging from results; but nevertheless, when it is remembered that an adult man requires 3,000 cubic feet of fresh air per hour, introduced into his living room in order that such air may be maintained at a

point where the carbonic acid produced by combustion in the lungs shall not exceed six parts in 10,000 of air, it is apparent that the evils due to lack of ventilation in private dwellings, public buildings and factories, are one of the most serious sanitary questions existing in our communities. The adoption of some artificial or mechanical means for the purpose of introducing fresh air into dwellings is commonly termed "ventilation," and depends upon some method whereby the air of a room may be removed and replaced by outside air, which, owing to its free movements, always maintains practically the same constitution. This is understood when it is remembered that air moving at the rate of five miles an hour, or that of the gentlest breeze, will renew the air over a space of a foot square 26,400 times. In warm weather ventilation is easily possible by doors and windows, but in cold weather air must be introduced into rooms through ducts, having been previously warmed by a furnace.

From the standpoint of the public, there is no doubt that apart from a lack of knowledge of the directly injurious effects upon health of residence in badly ventilated houses, and of the existence of practical means of remedying the evil, the prime difficulty is that the individual recognizes by the eye no difference between the indoor and out door air. He can recognize closeness on coming into a foul atmosphere from outer fresh air, but this closeness is looked upon as inevitable, and the deadened sense of smell soon fails to recognize the foul odors. Moreover, the methods of heating and constructing houses vary so greatly that badly distributed warmth in houses makes people more anxious to confine the heat produced than to introduce fresh air.

Amid the questions of economy to the householder, of the architects who are specially sought out because of their ability to give a fashionable outside to houses, of competition amongst the innumerable manufacturers of furnaces, boilers, grates and stoves, all of which are *of course* modelled upon the latest scientific principles, it may be well to recall some of the laws underlying what seems so simple, and yet proves to be one of the most difficult practical problems which sanitarians, architects, and engineers are called upon to deal with.

To maintain the human body in a state of health, it must not only be supplied with an amount of food requisite for supplying it with energy for work, but it must also consume an amount equal

to the task  
As bodies lo  
plain that n  
venting an r  
us that for  
air temperat  
health. Fur  
not be in to  
per second, a  
the floor as  
climates rang  
the amount  
depend (a)  
number of r  
the heating  
house, it is  
poor conduct  
not readily  
brick, unpai  
be so well b  
through the  
ductors may  
different sub  
ness would  
brick. It is  
close space i  
important p  
better as a n

As rega  
plain that as  
mates, the a  
to supply th  
while the h  
readily trans  
the dwelling  
ventilation,  
plied to a r  
important p



to the task of maintaining the body at a temperature of 98.4° F. As bodies lose their heat both by radiation and conduction, it is plain that non-conducting clothing plays an important part in preventing an undue loss of body heat; but common experience tells us that for persons employed at sedentary occupations in-doors, an air temperature of from 60° to 70° F., is necessary to comfort and health. Further experience tells us that the air of the room must not be in too rapid movement, probably not more than a half-foot per second, and must further be, as nearly as possible, as warm near the floor as at 6 feet above it. With the atmosphere in temperate climates ranging in winter between 30° F., and—20° F., it is plain that the amount of heat required to keep the air of a house warm, will depend (a) upon the construction of the dwelling, (b) upon the number of renewals of air per hour, and (c) upon the character of the heating apparatus employed. As regard the construction of a house, it is necessary that the walls be made of materials which are poor conductors of heat, that they may be so built that moisture will not readily get into the interstices of the materials, as with soft brick, unpainted boards, and damp foundations; and that they will be so well built of close materials that air currents will not blow through them. How essential that building materials be poor conductors may be learnt from the notably different conductivities of different substances for heat. Thus, a wall of wood of equal thickness would be three times better as a non-conductor, than one of brick. It is of equal importance to remember that air confined in a close space is ten times as good a non-conductor as wood, hence the important part played by double windows, glass being ten times better as a non-conductor than wood.

As regards the required changes in the air of the room, it is plain that as this will depend on its size and the number of its inmates, the amount of air to be heated will be simply that required to supply the ideal 3,000 cubic feet per hour to each adult inmate; while the heating apparatus to be chosen will be that which most readily transfers its heat with the smallest loss to the air supplied to the dwelling. While it may be said that, in theoretically discussing ventilation, we need not regard by what method the air to be supplied to a room is heated, yet in practice, the question is a most important part of any system. When carbon or its compounds,

whether as coal gas or wood is consumed, it produces heat by the union of carbon with oxygen, while hydrogen at the higher temperatures if present, unites with oxygen to form water vapor. In combustion every pound of carbon forms 3.7 lbs. of carbonic acid, and emits heat enough to raise the temperature of 87 lbs. of water from 62° to 212° F. and every pound of hydrogen produces 9 lbs. of water, and emits enough heat to raise 417 lbs. of water from 62° to 212° F. For the purpose of estimating the value of any fuel, it is most convenient to estimate the number of pounds of water which can be raised by any given weight of fuel, though 1° F. or from 32° to 33° F. which is termed a *heat or thermal unit*, and which is roughly applicable for every degree from 32° to 212° F. Experiment has shown that 1 lb. of carbon produces 13,000 units of heat and 1 lb. of hydrogen produces 62,500 units. What then is apparent is that economy in heating means that the largest possible number of units of this heat, instead of being allowed to escape by the chimney, or other way, be transmitted directly or indirectly to the air of the rooms occupied; the air being in such a condition of purity and freedom from movements, and having such evenness of distribution, that a sense of comfort may be given to all the inmates.

The modes by which heat is transmitted to the air of a room, viz., by conduction, convection and radiation, all play their part, each being given a greater or less importance accordance as grates, stoves, furnaces, hot water or steam pipes be the method of heating adopted.

The following results, obtained by Profs. Carnelly and Haldane, of Dundee, Scotland, have much interest in this connection; but they are necessarily to be accepted not so much as indicating the value of any particular system as the mode of application of any of the systems accidentally adopted in those particular schools at that time.

Of 323 schools reported upon 150 were personally visited by Carnelly. The great differences were found in the amount of fuel used per pupil. One large school, with hot air furnace, used but 34 lbs. of coal per head in a season, while another used 417 lbs. One with an open fire used but 23 lbs., while another used 239 lbs. In a school for 1,000 scholars the cost in England averaged for installing the system £200 for grates and £500 for low pressure steam. The installation of a mechanical fan ventilating plant with heating cost in a building properly designed for it £850, and put in an old building

not special  
showed that  
effective in  
air; was mo  
draughts to  
greater cost  
janitor coul

A more  
of heating a  
under the su  
setts, 1896,  
fire-escapes  
tories and w  
are of extre  
scientific su  
ferring to t  
ventilating  
exact knowl  
can be done  
shafts or by  
abandoned.  
with certain  
all condition  
expense for  
out question

"When  
in school an  
years of exp  
tilation ther  
have felt it  
reached whe  
and there se  
comfort of t  
fortune not

"Good  
tribution of  
and their re  
perfect remo

not specially designed cost £1,000. The results of experiments showed that mechanical ventilation as by fans was much the most effective in maintaining the requisite purity and temperature of the air; was more independent of winds and changing weather; reduced draughts to a minimum, but has a greater first cost and somewhat greater cost for maintenance; but in a town with several schools one janitor could supervise the apparatus in all.

A more recent and perhaps more representative series of methods of heating and ventilation are those found in the reports prepared under the supervision of the Chief of the District Police of Massachusetts, 1896, who has special charge of the work of boiler inspection, fire-escapes and the heating and ventilating of public buildings, factories and workshops of the State. The several reports of this Bureau are of extreme interest, illustrating year by year an advance in the scientific supervision of public buildings. The report for 1896, referring to the ventilation of schools, says, "The practicability of ventilating schools admits of no doubt. It is as much a matter of exact knowledge as any problem in engineering or mathematics. It can be done by the aid of power, and may be accomplished by heated shafts or by fans; all dependence on natural ventilation should be abandoned. The system of mechanical ventilation can be relied upon with certainty. By mechanical means a steady inflow of pure air under all conditions and atmospheric changes can be secured. The extra expense for the power to move air should be recognized and met without question."

"When so many are enquiring how best to secure good ventilation in school and other public buildings, the correct methods gained by years of experience should be made known. In this matter of ventilation there are comparatively few who have made it a specialty and have felt it necessary to perfect their knowledge. The time has been reached when the importance of ventilation is generally appreciated, and there seems to be a willingness to do something for the health and comfort of the pupils in our public schools, and it would be a misfortune not to achieve some real progress."

"Good ventilation consists in the proper arrangement and distribution of the ducts of the incoming and the outgoing of the air, and their relation and correspondence with each other, so that the perfect removal of the foul air and the thorough diffusion of the fresh

air will be secured. How to supply the occupants of schoolrooms or crowded apartments with the proper quantity and quality of air has not always received the attention its merits demand. Something, however, during the past few years has been done towards an intelligent solution of the problem. To know how much air is needed for a given number of pupils in a schoolroom and to supply it by exact mechanical measurement is now no secret."

"In former reports I have explained some of the methods advocated and in operation in school buildings in the State. One of the methods or systems concerns itself only with supplying air, leaving it to make its way out through ducts provided for that purpose. This is done by means of fans or blowers forcing the air into the room. It is the plenum method. Another system or method advocated is directed to the extraction of the foul air by natural laws, requiring no mechanical means, depending upon the difference between the external and internal temperature, in other words, the tendency of warm air to rise."

"In our experience of the past eight years we have found that the interior temperature of foul-air ducts is practically the same as that of the room. The changes in the temperature are so frequent and the velocity of the wind so various, that, *unless additional heat is supplied to the duct*, the power of the duct or shaft to draw air from the room will fail in many instances to cause upward motion enough to be measured by the anemometer."

"The ways of adapting the means to the end in furnishing to and removing air from crowded rooms are not questions of experiment. The size of ducts, shafts, etc., their location in the rooms and their distribution are not at the present time severe problems. The questions, 'Shall the air be taken in at the floor or at the ceilings?' or 'Will an upward or downward movement in the air work to the best advantage?' have been settled upon principles which are available for the practical solution of the problem of ventilation."

"For the effective working of any system of ventilation, it is imperatively required that proper provisions should be *made to promote air currents in the right direction*, and first in the *fresh-air inlet*,—the supply of fresh, pure air from pure external sources. The size of this fresh-air inlet is of great importance. In many instances when provided in our public buildings it has been found to be too small.

The warming point. Varieties warming the and the high-

The difficulties depend upon the convection is due and by expansion walls and wind contact with our rapidity in the cooled by the that with outer the porosity or ing materials important parts minimize the variation in different rooms to retain the air at of the air approaching the carbonic air in the from thirty to according to agitation.

This must the inlets shall foot per second sensation of draught velocity of two to three may be endured at this last point in a room containing inches square, with a velocity of .83 feet per second for an adult person. The site purity of the minimum air space thereby permitted

The warming of the incoming fresh air should be considered at this point. Varieties of heating appliances are in use for the purpose of warming the air, two of which I will mention,—the hot-air furnace and the high-pressure or low-pressure steam apparatus.”

The difficulties to be overcome by the adoption of any system depend upon the operation of the same principles. Heating by convection is due primarily to the movement of air upward, heated and by expansion made lighter, and falling again as it is cooled by walls and windows. By these currents of warmed air coming in contact with our bodies, we are prevented from cooling with undue rapidity in the same manner as by conduction the air of the room is cooled by the cold outer walls and windows. It will thus be apparent that with outer currents of air, as winds blowing against a building, the porosity or openness of the walls and the conductivity of the building materials and the doubling of the windows, must all play important parts in the ventilation and heating of dwellings. To minimize the variations of temperature caused by these several influences in different rooms and at different parts of the same room, to maintain the air at a temperature of 60° to 70° F., to secure a humidity of the air approaching 70 per cent. of saturation and to keep the carbonic air in the room at a point below six parts in 10,000, or to secure from thirty to fifty cubic feet of fresh air per minute for each inmate according to age, and to do this economically *is the problem of ventilation.*

This must be secured too in such a manner that the velocity at the inlets shall not exceed six feet per second, to be reduced to half a foot per second when coming in contact with inmates to prevent the sensation of draughts, although experiment has taught us that a velocity of two to three feet per second of air at an ordinary temperature may be endured without a sense of notable discomfort. How much this last point means will be understood, when it is remembered that a room containing 500 cubic feet of air having an inlet of twelve inches square, if supplying 3,000 cubic feet per hour, would have a velocity of .83 feet per second while supplying only enough air for one adult person. It is thus apparent that in order to maintain the requisite purity of house-air without an excessive air movement, a minimum air space fixed by some at 750 cubic feet per capita is necessary, thereby permitting some four changes of air per hour.

Apart from the question of heating and propelling the air into a room, it is equally clear that the size of fresh-air inlets and outlets is of primary importance in the question of the movement of the air. An illustration will make this evident. Assuming that properly warmed air can safely move at a rate of two feet per second without discomfort, and that the fresh-air inlet occupied a quarter of one wall of a square room thirty feet wide, it will have renewed the air in the room within two minutes, or thirty times in an hour. As this air is distributed over a space in the room in columns, four times the volume of that opposite the inlet, the general velocity in the room would be but one-quarter that at the opening, or six inches per second. If further the rate of renewal be lessened, it is apparent that the size of the inlet can still be notably reduced if the distribution of the air at the point of entry to the room is assisted by the shape of the inlet. Many of these elements which enter into the problem have been estimated, and even given their place in tables; but it is well that the various elements of the problem be recognized. This may be done by a single example.

A school house of four rooms, each to have a cubic-air space of 240 cubic feet (or 4x4x15) per pupil for a school of 200 pupils is to be heated and ventilated.

The construction of the building having been made upon the principles of building already indicated, we have to supply means of ventilation for supplying 2,000 cubic feet of fresh air per pupil per hour, or 100,000 cubic feet per hour must be poured into each room with cubic capacity of 12,000 feet. This means  $8\frac{1}{3}$  changes of air per hour, or a renewal of air every 7 1-5 minutes. An inlet of 2 ft. x 2 ft. would deliver the requisite volume of air if moving at the rate of 6.94 feet per second. With the ordinary smooth ducts, as when lined with tin, to prevent friction as far as possible, it is estimated that from 20 to 25 per cent. is lost by friction, so that in the present instance the duct delivering air in the amount stated at the rate indicated should be about 2 ft. x 2.5 ft. in area. It is apparent that the forward movement of this volume of air will depend not only upon a steady motive power, a *vis a tergo*, by which, as with a fan, a regular pressure is maintained in the duct, thereby creating a plenum in the room, but also upon there being a free exit duct to conduct the air from the room, which removal of air can indeed be accelerated by

an exhaust fan at the exit shaft of the room. Much experience in the Massachusetts Bureau of Building has proved that one-fifth the area of inlets has proved a reason to change the rules." It is a rule determined as being, with the various conditions, is important to points at which in order to promote English and American the ordinary size of the inner walls, at a let should be at the outlet. This ing air is usually to ascend, and the higher temperature side of the room caused by the down wall, and the outlet.

Summing up the Police Inspection

"Whatever the various appliances in schools or other buildings, a system that can furnish the amount of air, warm as to supply fresh air, clarity and perfect should be the system

the air into a  
and outlets is  
nt of the air.  
that properly  
econd without  
quarter of one  
wed the air in  
r. As this air  
our times the  
in the room  
es per second.  
t that the size  
ion of the air  
e of the inlet.  
ave been esti-  
well that the  
y be done by

e-air space of  
200 pupils is

de upon the  
upply means  
per pupil per  
to each room  
changes of

An inlet of  
moving at the  
both ducts, as  
le, it is esti-  
o that in the  
stated at the  
t is apparent  
end not only  
with a fan, a  
ng a plenum  
conduct the  
ccelerated by

an exhaust fan at the outlet of the duct or by a coil of steam pipes in the exit shaft by which the air is heated and thereby made to ascend. Much experience in ventilating shafts by the officers of the Massachusetts Bureau leads to the conclusion that "as a rule, a reduction of one-fifth the area of the foul air outlets for the size of the fresh air inlets has proved sufficient for inflowing fresh air. I have seen no reason to change this statement, and it will be found that ventilating engineers and architects who have been the most successful in obtaining good ventilation have varied but little, if any, from the above rules." It is apparent that with the size of the inlets being determined as being, say 80, the outlet would be represented by 100. Along with the various elements as regards the size of inlets and outlets, it is important to have determined by experiment the most successful points at which inlets and outlets should be placed in any room, in order to promote the even distribution of the air introduced. Both English and American authorities are now agreed that in rooms of the ordinary size, as those in schools, inlets should be arranged on the inner walls, at a point from 6 to 8 feet above the floor, while the outlet should be at the floor in the same wall, and in close proximity to the outlet. This arrangement is based upon the fact that the incoming air is usually warmer than that of the room and therefore tends to ascend, and with the forward movement the impulse along with the higher temperature will distribute the fresh air to the farther side of the room; it being further aided by the lessened pressure caused by the downward movement of the chilled air along the outer wall, and the outward movement of this air along the floor to the outlet.

Summing up these points Mr. R. R. Wade of Boston, Chief of the Police Inspection Commissioners, says:

"Whatever differences of opinion may exist as to the merits of the various appliances that have been applied for the ventilation of schools or other public buildings, it must be admitted that the system that can furnish and remove under perfect control a sufficient amount of air, with a velocity that can be regulated and so distributed as to supply fresh air and remove foul air from each room with regularity and perfect independence of weather, summer and winter alike, should be the system to be adopted, and in all appliances that is the

simplest which most positively and directly effects the purpose in view."

The problem of heating the air equally has in every system proved of much difficulty in practice when a definite amount of fresh air is to be delivered. In estimating the work to be done, it is apparent that an average external temperature must be taken as the basis of ordinary work, and that for extremes a system of extra coils must

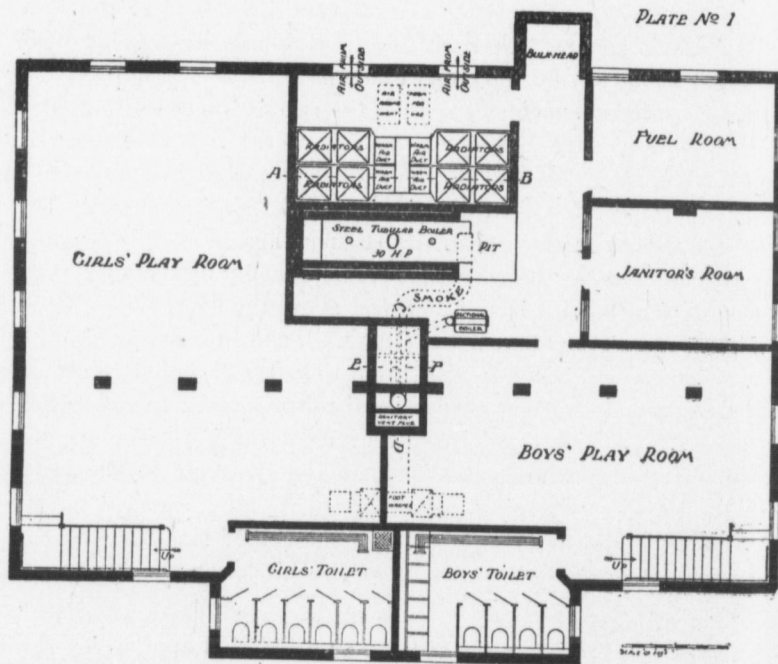

PLAN OF FOUR ROOM SCHOOL  
DESIGNED TO SHOW  
METHOD OF VENTILATION  
See Description

BASEMENT PLAN

be supplied either in the rooms or in the fresh air chambers in the basement. A four-horse power gas engine has been proved sufficient to give to a 4 ft. diameter fan enough revolutions to supply 1,000 persons (pupils) with 2,000 cubic feet per head per hour; hence with any system of steam heating, boilers of sufficient power can be economically used, even where electricity is obtainable for supplying power to the fan.

In the process of heating to a temperature chamber, to be weather steam

In practice is required to 32° and 212° F.



PLAN OF FOUR ROOM SCHOOL  
DESIGNED TO SHOW  
METHOD OF VENTILATION  
See Description

15° to 70° F., to 1,000. Now inches of barometer equal 81 lbs. A 60 lbs., it will 3,272 cubic feet the combustion if the combustion units, or more



he purpose in every system amount of fresh ne, it is apparen as the basis extra coils must

PLATE No 1



In the problem here we may assume that the outer air is to be heated to a temperature as low as 15° F. in the basement cold-air chamber, to be delivered in the room at 70° F., and that for colder weather steam coils be placed in the rooms for subsidiary heating.

In practice it may be said that the same number of heat units is required to raise water through any degree of temperature from 32° and 212° F., and proportionately air through any degree from

PLATE No 2

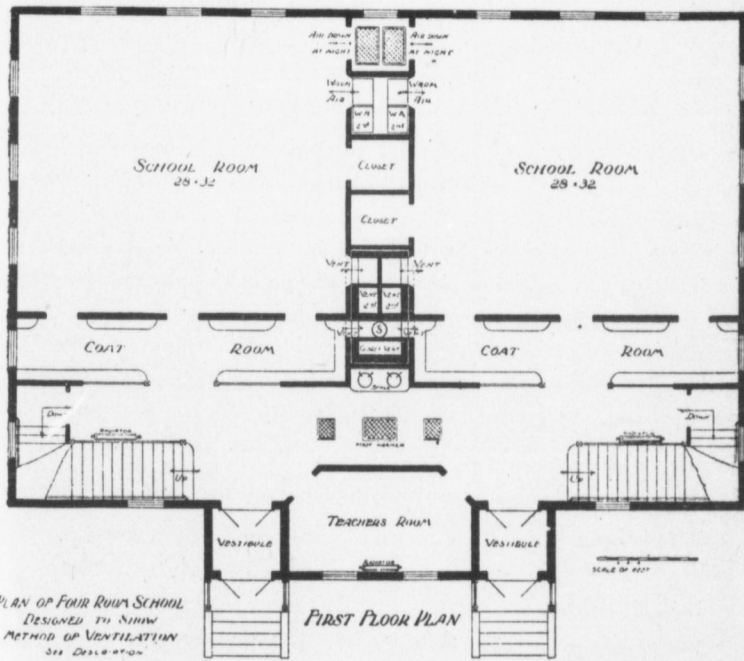

PLAN OF FOUR ROOM SCHOOL  
DESIGNED TO SHOW  
METHOD OF VENTILATION  
SEE DESCRIPTION

numbers in the ved sufficient supply 1,000; hence with can be econ- or supplying

15° to 70° F., the ratio between air and water being at 212° F., as 1 to 1,000. Now the weight of a cubic foot of dry air at 32° F. and 30 inches of barometric pressure is 566.9 grains, or 1,000 cubic feet equal 81 lbs. Assuming that a cubic foot of water at 212° F. weighs 60 lbs., it will hold 10,800 units of heat. Hence it would raise 3,272 cubic feet of air through 55° F. It has been estimated that the combustion of 1 lb. of coal will produce 14,000 heat units, and if the combustion in an ordinary furnace amounts in loss to 3,200 units, or more than one-fifth, we find that 1 lb. of coal will raise

1 cubic foot of water from 32° to 212° F., or will heat 3,272 cubic feet of air. Or, roughly, 4 lbs. of coal will be sufficient to heat the 12,000 feet of air required to change the air of a room, 32 ft. x 25 x 15, in 7½ minutes. It is apparent that the amount required will be the same, whether the method of heating be by hot water, steam or hot-air furnace, provided the combustion be equally good in all and the loss of heat the same, if the mechanism provided supplies the heat to the fresh air all at the same rate.

Taking warm weather with cold weather throughout the winter season in Ontario, this calculation would mean that, for a school-building of 4 rooms of the above size and holding 200 pupils, from 25 to 30 tons of coal would supply an adequate amount of heat.

The illustration of principles thus given in some detail enables us in some degree to estimate the various factors entering into the problem of ventilation. Many simple methods are adopted for lessening the evils of over-crowding and air foulness in small buildings, but the scientific problem having had its practical solution in a large measure determined, it now requires some specific measures for its systematic application to schools and public buildings. As an illustration of modern systems in practical operation the following may be given. It is from the Massachusetts report for 1896.

The plans are simply to show how the heating and ventilation of a four-roomed school building may be simply arranged:

The basement provides for the boiler-room with a 30 h.p. boiler, a cold-air room, the coal-room, the boys' and girls' playrooms, the w.c. and lavatories.

The ground floor has its hall-ways, and 1st and 2nd schoolrooms, its inlets and outlets for fresh air, and its cloakrooms.

The first floor has the principal's room, and the 3rd and 4th rooms, similarly heated and ventilated.

The third plan shows us in section the ducts and arrangements of cold-air room, and valves for regulating the temperature in the rooms, operated either by a chain or thermostat.

The areas of the ducts are given, while the heating provides for steam coils in three series so that 100, 120, 140, square feet of radiating surface for each room, may successively be turned on as the

external cold in  
ments provide  
these supply t  
The ventilation  
fan. One of  
will supply mo

It is appa  
are many detai  
supervision if

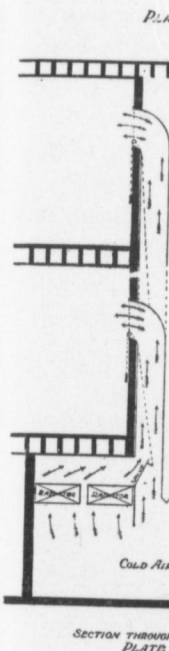

of friction and  
of cross-curren  
the exterior, th  
temperature, al  
and their effect  
of making com  
of legislative e  
means to secur

at 3,272 cubic  
nt to heat the  
n, 32 ft. x 25  
required will  
t water, steam  
y good in all  
d supplies the

out the winter  
for a school-  
pupils, from  
t of heat.

detail enables  
ring into the  
opted for les-  
small buildings,  
ion in a large  
asures for its  
As an allus-  
ollowing may  
1896.

nd ventilation  
ged:  
0 h.p. boiler,  
ayrooms, the

schoolrooms,

3rd and 4th

angements of  
in the rooms,

ing provides  
quare feet of  
ned on as the

external cold increases. In some the heating and ventilating arrangements provide for part of the steam coils to be in the school-room, and these supply the extra heat in severe weather by direct radiation. The ventilation may similarly, and with advantage, be supplied by a fan. One of 3 ft. diam. not exceeding 600 revolutions per minute will supply more than the calculated requirements of such a building.

It is apparent that with whatever system we may adopt there are many details in its practical operation which demand intelligent supervision if successful results are to be obtained. The questions

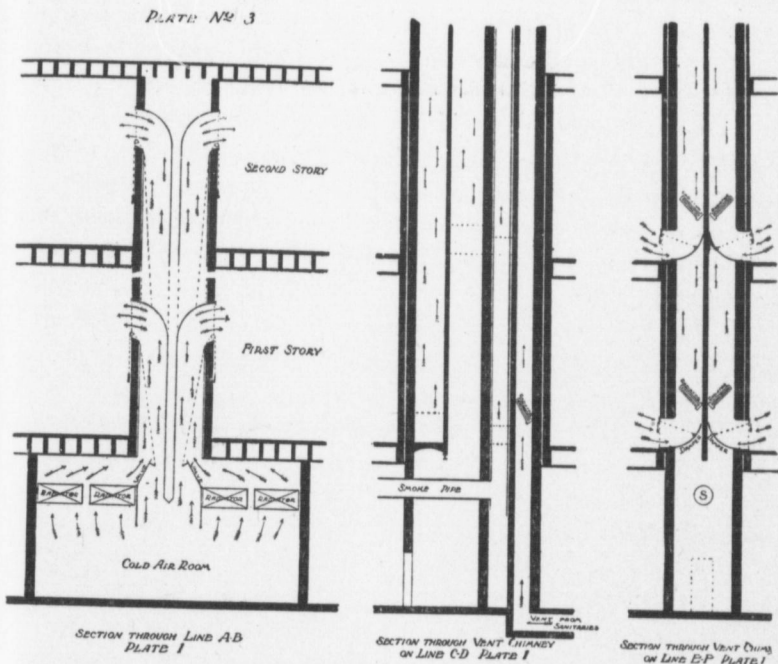

of friction and the size of fresh-air ventilating shafts, the velocity of cross-currents of air at the entrance of the shaft for fresh air from the exterior, the variations in barometric pressure and in external air temperature, all demand an intelligent comprehension of such causes and their effects, and of the means in the mechanism of ventilation of making compensation for such variations. From the standpoint of legislative enactments to provide for the application of scientific means to secure a standard of ventilation in any public building and

for supplying such system of expert officers for inspecting and regulating this work in public buildings in this Province, it would appear evident that at the present time there is no means similar to that for many years in operation in Massachusetts adequate for the work to be done. Local Boards of Health have, under the general provisions for inspection of the Public Health Act, probably enough powers to correct any serious unsanitary condition, but the exact scientific knowledge requiring to be applied to any particular case demands some special scheme to be formulated, so that new buildings in all urban municipalities and all school buildings in rural districts should have their plans approved before construction, and certainly proper provisions for ventilation, while definite powers to compel the adoption of adequate measures in old buildings should be put into systematic operation.

It will be, gentlemen, for you who are trained in the exact sciences which relate to this important matter, to so influence those in the position of municipal officers and trustees of schools to institute such improvements as will attain such desirable results as I have endeavoured to set forth.

## NOTES

As little power by the engine as the engine to this most i produce a hea

It is not subject, but to g of the profess of it; to follo to form a bas knowledge of

While th develop to th around us, we of energy, fun sun, to vent it same time we that at last w have begun to

So far as for by the sun the three grea tides. These causes we cou early date to e gant demands

All three invention, but

INGS.

ng and regu-  
would appear  
nilar to that  
for the work  
general prob-  
ably enough  
ut the exact  
rticular case  
ew buildings  
ral districts  
nd certainly  
s to compel  
ould be put

act sciences  
those in the  
stitute such  
I have en-

**NOTES ON THE DEVELOPMENT OF WATER POWER.**

---

T. BARBER, GRAD. S. P. S.

---

As little or no attention has been given to the subject of water power by those who have addressed your Society in past years, and as the engineering profession generally devotes so little of its time to this most important subject, a few remarks to your members might produce a healthy and desirable examination of the subject.

It is not my intention to go closely into the details of the subject, but to give such general ideas as may be useful to all classes of the profession; to impress on all the great economic importance of it; to follow out quickly the development as it has occurred and to form a basis of thought on which a more intimate and thorough knowledge of the principles governing it may be built.

While the natural and economical course would have been to develop to their full capacity the abundant supply of water powers around us, we have allowed this most fruitful and inexhaustive source of energy, furnished us directly and without process of ages by the sun, to vent its mighty forces on the rocks and stream beds. At the same time we have been denuding our forests and coal measures so that at last when our extravagances are apparent all around us, we have begun to look at the future with some apprehension.

So far as our heat, light and power go we need have little fear, for by the sun's mighty power and the law of gravitation, we have the three great sources of energy around us,—water falls, winds and tides. These will always be with us, for without them and their causes we could not live; their magnitude, were it possible at this early date to estimate it, would be found to satisfy the most extravagant demands of a universal civilization.

All three sources present unlimited scope for investigation and invention, but we are to confine our attention to the subject of water

falls which, without presumption, may be said to be the most important of the three. Wind and tide are intermittent, but water flows on forever.

As with our forest and mineral wealth, we may squander the energies of our water falls, and it is only by devoting ourselves to the economical features of the subject that we may hope to see them equal to all the demands made upon them.

Let us think right here what a field of usefulness electricity has opened up for them. Without it we might well entertain apprehensions for our future light and heat, and even for power itself. What a congestion it would be to have all the manufacturing concerns of the world gathered around the water powers within the limits of gearing.

All statements in this subject need qualifying, and hence the difficulty in clearly and honestly enunciating it. I have intimated that almost all the energies of our water falls have been allowed to waste themselves, but, of course, a large proportion of the convenient ones have been utilized; the remainder were waiting, as it were, for the advent of electricity.

Water as a motive power has long been used to serve man's purposes. Next to the muscular and animate forces of nature it was the first to bow to his ingenuity.

Its constraint to produce useful and economical results is based on a few simple propositions which reveal themselves on a little practical and theoretical investigation; it requires no complicated machinery, and is the cheapest and most direct and satisfactory source of energy at our command.

If this statement be true one would, on the surface of things, wonder why improvement has come so slowly. Water powers, however, have their disadvantages, and when we remember that the steam engine was introduced at a time when scientific and mechanical skill would most likely have been brought to bear on the subject, and that the steam engine overcame the most serious objections to the water wheel, we have the explanation at once.

Had electricity superseded the steam engine it is hardly possible to estimate what the conditions would have been to-day. Electricity also overcomes many of the difficulties and objections which a bare

water power  
tions to steam  
and economic  
forces than a  
city generated

Neglectin  
what has occ

Naturally  
present itself  
in the oversho  
the fall and c  
periphery, sim

Here, as  
not complicat  
discharge; the  
being in the d  
and other det

This prin  
percentage of  
excelled in th  
and inconveni  
to other and n  
cumbrous, an  
ing to give th  
the discharge  
with ice in the

Here in C  
wheels for ma  
are extant. I  
but it is to b  
wheel, princip

In the ne  
the principle i  
on the method  
ing the water  
buckets from t  
results would

water power presents, besides it overcomes many of the main objections to steam engines themselves. There is no more self-contained and economical device due to man's ingenuity in constraining natural forces than an electric car, propelled, heated and lighted by electricity generated at a water fall.

Neglecting what might have been, let us apply ourselves to what has occurred.

Naturally enough the first method of utilizing water power to present itself was that of pure gravitation. This was accomplished in the overshot water wheel, which received its water at the top of the fall and carried it down to the discharge level in buckets on its periphery, similar to those used in the elevation of grain.

Here, as in all forms of water wheels, the improvements, though not complicated, came slowly. The air vent to insure promptness of discharge; the proper curving of the buckets to insure of the pressure being in the direction of motion as far as possible throughout; these and other details of improvement were in time worked out.

This primitive wheel under suitable conditions gave a very high percentage of useful effect and, strange to say, at its best is barely excelled in this respect by the most modern turbine. Its faults and inconveniences were many however, and it has had to give way to other and more suitable forms. In the first place, its size made it cumbersome, and for all but low heads necessitated ponderous gearing to give the proper speed. It would not stand any back water in the discharge race and, worst of all, became fearfully encumbered with ice in the cold weather.

Here in Ontario we have not seen one of these overshot water wheels for many years, but in the lower provinces of Canada a few are extant. I know of one driving a planing mill in Nova Scotia, but it is to be replaced this summer by a modern turbine water wheel, principally on account of the ice difficulty.

In the next form of water wheel attempted, gravitation was still the principle involved. The breast wheel was an attempt to improve on the method of applying the water. It was thought that by receiving the water lower down and by confining it in a sluice around the buckets from the point of reception to the point of discharge, better results would be obtained. There were many good points about it

but its faults were numerous, its principal one being its increased size over the already gigantic overshot wheel, and this insured its early disuse.

The next principle to be attacked was that of impulse, or the direct application of an issue of water to the runner. The undershot water wheel was the result and may be styled the primitive impulse wheel.

This wheel had quite an extensive application in the early American saw mills and was known here as the Flutter wheel. Its efficiency however was low and it finally resolved itself into a current wheel, an occasional one of which may still be seen where dams do not exist.

With the old wooden constructions, impulse wheels were easily racked and with the little freedom which wood gave for proper lines and curves, their economical results were very poor; it is only under the most favorable circumstances and with modern forms and materials that they have been brought to a high state of efficiency. They will not answer all purposes, but have particular advantages under high heads and will be spoken of again in that capacity.

In our treatment of the subject we are now past the "Wooden Age," and with it passed the idea of pure gravitation. It is therefore time to state the basic proposition as it presented itself at this date: "How can the momentum of an issue of water best be arrested and communicated to the runner of a water wheel?" This is the problem to-day: it has not changed during the long and progressive century. In its solution the turbine principle is predominant, and for the majority of our situations we have the turbine water wheel as opposed to the old plain water wheel or simple runner.

Let us now proceed to see how the proposition has been attacked.

In the early part of the century the principles of reaction presented themselves for investigation, and a number of turbines on this principle were introduced. Reaction consists in relieving an issue of water under pressure, in the opposite direction to that in which motion is required to take place.

Dr. Barker's mill was the first and simplest attempt at utilizing the principle of direct relief; Whitlelaw's "Scotch Turbine" followed and was the only purely reaction turbine of the direct relief type to

contribute to  
of regulating  
stroying most  
was not long  
day, this orig  
bines and ma  
tables in a gr

By Newt  
bines as react  
nite principle

The prin  
factory and c  
with alone in  
However, nin  
bination of in  
part.

While pu  
satisfactory th  
principle was  
selves in the c  
original as we

In 1834  
impulse wheel  
jected by mea  
at right angle  
have their hee  
tum of the wa  
our principle

This whe  
rather cumbro  
small heads o  
day had not c  
ject that it ov

Let us pa  
simplify the B  
ing the proper



contribute to the economics of water powers. There were no means of regulating the supply of power from a given wheel without destroying most of that in excess of the requirements, and this defect was not long in proving fatal to this particular form of wheel. Today, this original form of reaction wheel has left the arena of turbines and may be seen watering our lawns and sprinkling the vegetables in a greengrocer's window.

By Newton's third law we would be obliged to think of all turbines as reaction wheels; but we have restricted the term to a definite principle, and hence its use here is not ambiguous.

The principle of pure reaction has never been thoroughly satisfactory and except for special purposes and reasons is seldom met with alone in the construction of modern turbines by men of ability. However, ninety-five per cent. of modern turbines work by a combination of impulse and reaction, in which reaction has the leading part.

While pure impulse water wheels in their initial forms were less satisfactory than the early reaction turbine, yet when the turbine principle was applied to them, they immediately established themselves in the economics of the subject, and are there to-day in their original as well as their modified turbine form.

In 1834 M. Fourneyron perfected his turbine. It is a pure impulse wheel; receives its water from the inside, whence it is projected by means of stationary guides onto the moving vanes or floats, at right angles to them at the point of issue. These moving vanes have their heel carried well around so as to remove the final momentum of the water as it leaves the outer rim, thus savoring a little of our principle of reaction.

This wheel gave a high percentage of useful effect, but was rather cumbrous and very expensive, so for general purposes of small heads or falls it cannot be said to have been a success. Its day had not come, and it is to later genius and economy in the subject that it owes its usefulness at the present day.

Let us pass on for the present. The attempts now were all to simplify the Fourneyron turbine, which was recognized as embodying the proper principles of utilizing the water.

It was attempted first by directing the water from the outside and discharging it centrally. This gave fairly satisfactory results, but lost whatever value there is in the outward tendency of the water in revolving and also increased the friction of the vanes. You may see this principle at work to-day in the upper half of the James Leffell turbine.

There was only one step needed to success, but it was nearly thirty years in coming in its true form. Instead of forcing the water to discharge into a contracted centre it was allowed to pass downward onto an inclined heel bucket which spread the discharge issue fully to the outside, and was curved and inclined in such a way as to arrest the highest possible percentage of the momentum of the water.

This is the principle of all the modern turbines of class number one, as we will style them, and they are the ones which comprise over ninety-five per cent of those in use. While details of this principle are still being considered and attempts made to bring them, if possible, to a higher state of perfection, there is no searching for other principles as pertaining to water turbines. I may say here that so far, most American inventors have neglected the real channel to success. In designing gearing they are very careful to find the proper curves which will work most harmoniously together. There are mathematical problems easy of solution which give the same information about water rolling on metal vanes.

Before leaving the subject of the design of runners it will be of interest to note why the early forms of water wheels and turbines were so largely an economical failure. With the single exception of the overshot water wheel, they endeavored to remove too suddenly the momentum of the water. Like starting a mass into motion, removing the motion takes time, and it was by adopting principles which gave this required time that true success came. The combination of impulse and reaction as outlined above accomplished the needed result and a high efficiency was obtained.

We shall see a little later, however, how pure impulse has been brought to recognize this principle and is to-day a grand success, and furnishes the most desirable forms for the most interesting and valuable of our water powers. It is also a problem at the present

time to develop independent and crowned the

The detest to us all. manufacturer diameter.

The work wheels the discharge such, the imp out far beyond their outside, is the amount fixes its size a volume that diameter of discharge issue other measures

While the as to size, the the water on issues. By spreading it under a given useful effect. of the discharge, ter, but is not other turbines

Also in a ant features a ing properties turbine: also its case, and serious disadvantage latest idea as form of the rotation and regulation should always

time to develop what may be styled pure reaction to the same independent and economical state, but without the success which has crowned the other form.

The details in connection with this last statement are of interest to us all. It alludes to the attempt on the part of inventors and manufacturers to develop great power and speed on a nominally small diameter.

The word "nominally," must not be overlooked. With these wheels the diameter is given as that of the upper, or, when used as such, the impulse half of the wheel. The discharges however spread out far beyond this upper structure and relieve the issue fully to their outside, thus constituting the real diameter of the runner. It is the amount of water which the turbine is able to discharge which fixes its size and the larger the diameter of discharge the greater the volume that may be passed through; therefore when determining the diameter of a turbine, measure its runner across the outside of its discharge issues; this is unquestionably the true diameter and any other measurement is a deception.

While there is no real justification in practising this deception as to size, there is an idea and one worth looking into in introducing the water on a small diameter and spreading it to wider discharge issues. By introducing the water in the slower moving centre and spreading it in the discharge, it is possible to get a higher speed under a given head of water and also a fairly high percentage of useful effect. The power, however, corresponds to that of a wheel of the discharge diameter, as it should, since this is the true diameter, but is not greater for the amount of water used than that of other turbines of good design of the same size.

Also in attaining the result mentioned, other and more important features are sacrificed. Notably among them are the self governing properties of a nicely balanced combined impulse and reaction turbine: also it gives a runner which cannot be lifted straight out of its case, and those who have handled turbines will know what a serious disadvantage this is. These and other faults stamp the latest idea as far from being a great success. Apart from the proper form of the runner, there is the most important feature of the direction and regulation of water. Where impulse is made use of, and it should always be a factor, direction is of vital importance.

Assuming the revolving vanes to have their proper proportions, curves and angles, the water should meet them at right angles at the point of issue. There is a multiple of forms of gate rigs or entrance guides, some of which are well principled, others not. To get some good points it is unfortunate that in most rigs other good points must be sacrificed. I may say that there are two general forms which present the best features: the pivoted gate and the lifting cylinder. With the general ideas given, you will be able to realize for yourselves the points of advantage of the different forms. Learn to study the graphical part of a turbine catalogue; it will not be so apt to deceive you as other parts.

We have mentioned catalogues, and it suggests a few pointers well to have; for the present, however, we must pass on to the subject of regulation as it is so closely allied to direction. Most forms of gateage now in use accomplish regulation with very little loss of efficiency. So long as the stream lines are not too badly disturbed or the solid column of water broken and sprayed, with a good runner, good results will be obtained. However, turbines need not, and should not, be run down to a very low percentage of their maximum capacity; the design should be such that the range required would not be more than from one-half to full gate or one-third to full gate at most.

Apart from the features of direction and regulation, the most important considerations are those of simplicity and durability. Simplicity is desirable for many prominent reasons, the chief among which are durability and ease of repair. Owing to the many destructive agencies at work on a turbine, there should be few moving parts and these moving parts should be protected from rapid wear by the use of metals in their construction which give the longest service or wear under the action of river water. What I think would represent a simple wheel would be one with few and protected wearing parts, and one that could be renewed from one end to the other without destroying the original set or disturbing the base. Also in this connection it will be well to mention that the runner must absolutely be of one single piece. All attempts at bolting its parts together have after a little usage failed, and even cast part have given trouble, so great is the racking effect on them. I will not go farther with you into the details of turbines, but let us now look at our ability

to meet the  
all heights  
three classes  
a high state

Taking  
this number  
or are made  
able a contr  
downward o  
wonder them  
and exists t  
glance at the

Our sec  
three hundr  
of water is  
the original  
the excessiv  
heads is born  
the runner n  
and connect  
unable to st  
great waste o

The hor  
Switzerland,  
began the h

Niagara  
as most of u  
for ourselves  
the engineeri

Where t  
limited and  
class of turbi

This clas  
without prej  
Pelton water  
water from o  
attempt to ch

to meet the requirements of to-day. While our water falls are of all heights we may say, their requirements are practically met by three classes of turbines. These we have at our hand and all are in a high state of perfection.

Taking as our first class the falls up to sixty feet in height: in this number we include a very large proportion of those which exist or are made; their aggregate power may not, however, bear so favorable a contrast. For these falls the latest or combined central and downward discharge turbines answer all requirements. It is no wonder then that this form of turbine has been so largely exploited and exists to-day in such great variety. We have just finished a glance at their details and so need not dwell here.

Our second class will include the falls between sixty and possibly three hundred feet in height, and we will stipulate that the volume of water is large; under these conditions nothing is known to excel the original Fourneyron turbine. The absence of reaction removes the excessive downward or axial pressure which in wheels for lower heads is borne on the footstep; also, the pressure of the water inside the runner may be used to suspend the immense weight of shafting and connections which metal, lignum or other bearings would be unable to stand except by their extravagant use and a consequent great waste of power and lubricants.

The honor of utilizing high falls of great volume belongs to Switzerland, and it was from there that the ideas came which have begun the harnessing of our mighty Niagara.

Niagara is our greatest living example of this class of falls, and as most of us have been fortunate enough to see the development for ourselves, and as full descriptions appear from time to time in the engineering periodicals, further details here would be superfluous.

Where the quantity of water in this second class of falls is limited and where the height exceeds the rough limit set, a third class of turbines is required.

This class may be considered more as motors than otherwise, and, without prejudice, may be said to be most ably represented by the Pelton water wheel. It is a pure impulse wheel and receives its water from one or more nozzles around its periphery. It does not attempt to check the issue suddenly; its curves are well proportioned

and principled, and its percentage of useful effect consequently quite high.

We have now discussed quite widely the various forms of turbines and their application to different situations. A few general remarks may be in point and, finally, some hints about installing them may form a useful conclusion.

To begin with, let me finish with the turbine catalogue. I have said to study the graphical part as most important and reliable: the only other point which we will consider will be the tables of power, speed and quantity of water. In very few instances are these reliable to the extent they should be. I do not want to create uncertainties, but unless a manufacturer is prepared to guarantee that under favorable conditions of installation and connection his turbine will work fully up to the tables, it is well to allow a good margin of power and quantity of water. In any case there is no harm in having an excess of power for emergencies such as backwater or overload. There seems to be some doubt as to the speed as given in tables. The speed given is of course that which will obtain at full load; when running light, the speed will probably be ten or fifteen per cent. higher.

Another point of interest is the fact that the theoretical and practical nomenclatures are exactly opposite. In practice a horizontal wheel is one having its axis horizontal and its plane of motion vertical, while in all literature on the subject of hydraulics, such a wheel is designated as vertical. So with the vertical wheel: in practice the position of the axis designates the wheel, while in theory, the plane of motion is the naming feature.

While this is well to know to save misunderstandings arising, a more important point is that of efficiency.

Were we to observe all known precautions in placing our best turbines and in removing obstructions and rough frictional surfaces, probably eighty-five per cent. of useful effect would be a common attainment. Under conditions as they exist, from seventy to eighty per cent. is the usual result and may be looked on as fairly satisfactory.

Tests of efficiency are usually conducted under the most favorable circumstances and conditions to the turbine in point and perhaps a high efficiency might be recorded for one, which in actual practice where a wide range of conditions are to be met, would be

entirely use  
though in t  
individually  
means of th  
course the i  
but one sho  
that they m  
speciality is

There  
of penstocks  
tion the adv

Both m  
intended. A  
localities; ap  
internally w  
moderation  
turbine, ren

If there  
another it is  
and recede f  
dency with i  
it to flow too  
city of water  
understand  
per second  
this loss var  
must be add  
design to all  
flow.

Rememb  
duces equally  
deeply from

In many  
water as it  
removed the  
thoroughly a  
more annoy  
strange that  
appear so mu

entirely useless. In this connection it will be well to remark that though in this subject testimonials are usually reliable so far as they individually go, still, to prove a good case for a certain turbine by means of them, they should cover a wide range of conditions. Of course the idea of special wheels for special cases is quite admissible, but one should be sure that their special features really do exist and that they meet well the special conditions of the case; often, the speciality is most prominent in the price.

There being two materials in general use in the construction of penstocks and connections, it will be well to call up for consideration the advantages and disadvantages of each.

Both materials when good, answer well the purpose for which intended. At present iron is the more expensive material in most localities; apart from this its distinguishing fault is that of bridging internally with ice during the cold weather and then on a slight moderation of temperature, precipitating the whole mass onto the turbine, rendering it liable to break or to choke.

If there is one detail of installation of more importance than another it is the matter of giving the water plenty of room to reach and recede from the turbine. On account of their expense, the tendency with iron head races or flumes is to cramp the supply and cause it to flow too fast to the wheel. Examine tables of the spouting velocity of water and the resistance to flow in long pipes and you will understand the loss. For a practical basis a velocity of eight feet per second constitutes a loss of one foot of head at the issue and this loss varies directly as the square root of the velocity; to this must be added the resistance loss in long pipes. It is taken as good design to allow a velocity of one and one-half feet per second at full flow.

Remember particularly that cramping of the discharge race produces equally serious losses; let the water spread and flow quietly and deeply from the turbine.

In many ways as important a point is to thoroughly strain the water as it is about to reach the turbine. If all solid matter be removed there will be no breakages. Neglect to strain the water thoroughly and the cramping of the discharge pit and channel cause more annoyance, expense and failure than any other points. It is strange that the necessity for getting the water to the turbine should appear so much more important than that of taking it away.

Finally, see that your structure is of proper strength throughout and that it presents no weak points where the strains are greatest. Leaks, nowadays, are not permissible; water under pressure is too valuable. In this connection I may say, trust rather to bolts than to framed timbers; the advantages are apparent.

There are many other points of interest which I would like to mention, and besides it would be a pleasure to me to go farther into details and discuss the points mentioned directly and more fully with you. However, at this late date in your society's year it is impossible for me to meet you, and we must defer further discussion for a more convenient time.

You will grant me that this particular paper would have been much more interesting and effective were it possible to present cuts exemplifying all the principles and important points mentioned. Let me say, however, that you will find most of the ones in point in books on hydraulics and original forms in old treatises on mechanics, so that by reference you will get what unfortunately cannot be given here.

The subject is a broad and interesting one. It lends itself closely to the economics of our present and future existence here. Strangely, perhaps, the difficulties and complexities of steam engineering command more widely the attention of our engineers and geniuses. Of course, the original trouble of distribution and the possibilities of ocean navigation were great stimulants, besides the wider field for invention.

Yet, think of it in this light:—Ten to fifteen per cent. of useful effect from fuel—neglecting oils and gases—expensive and complex machinery to constrain its energies; excessive handling of materials to supply it; many attendants to regulate it.

With water power:—Eighty per cent. of useful effect; simple machinery to constrain its energies; no handling of materials; small attendance.

Should we not therefore devote ourselves to the careful and complete development of this most economical and satisfactory source of energy; especially so since we have electricity with which we can distribute its power.

Meaford, April 5th, 1900.

Whether  
zation as to  
is no doubt  
one, and, co  
stantly smoo  
larger one.  
some tribes  
purpose of  
Vestal Virg  
once suggest

Of the  
glass, electr  
employed by  
the compress

An inte  
is described  
article on th  
pewter. A  
Mr. Worcest  
one of the v  
piston is a l  
sort. The o  
of the cylin  
compressing  
hair on fire.  
obtained is u  
cessfully req  
professes to  
of getting fir



## FIRE MAKING.

W. H. ELLIS, M.A., M.B.

Whether or not there is any people so low in the scale of civilization as to be unacquainted with the method of lighting a fire, there is no doubt that among many savage tribes the task is a difficult one, and, consequently, great pains are taken to keep a small fire constantly smouldering, which may be used at any moment to kindle a larger one. Women were often entrusted with this task, and among some tribes a society existed whose members were devoted to the purpose of keeping up a perpetual fire. The origin of the order of Vestal Virgins, and of the perpetual altar fires of the ancients at once suggests itself.

Of the various known methods of producing fire, the burning glass, electricity and chemical action are, for obvious reasons, not employed by savages. The means used are friction, percussion and the compression of air.

An interesting instance of fire making by the compression of air is described by Mr. Stertchly (*J. Anthrop. Inst.* xix. 4, 456) in an article on the fire syringe of North Borneo. This syringe is cast of pewter. A similar implement made of buffalo horn is described by Mr. Worcester ("*The Philippine Islands*," p. 298) as being used by one of the wild tribes of North Luzon. "In the front face of the piston is a hollow which is filled with dry plant hairs of a peculiar sort. The operator inserts the head of the piston in the open end of the cylinder and a sharp blow drives it suddenly home, violently compressing the air, and generating heat enough to set the plant hairs on fire. The piston is instantly withdrawn, and the spark thus obtained is utilized to start a blaze. To perform this operation successfully requires long practice. I have yet to see a white man who professes to be able to do it, and how the natives first came to think of getting fire in such a way is, to me, a mystery."

Much more obvious is fire from the sparks made by striking stones against hard oxidizable substances such as flint and steel, or quartz and iron pyrites. In such cases the heat of the impact ignites fragments of the metal or of the sulphide which fall burning through the air as a shower of sparks upon a prepared combustible.

The use of friction between two pieces of wood was widely disseminated among savage races. It was employed throughout both North and South America, in Polynesia, Australia, Asia and Africa.

Fire by friction with two pieces of wood is produced in three ways, by ploughing, sawing and boring. (Walter Hough, *American Anthropologist*, III. 359, 1890.)

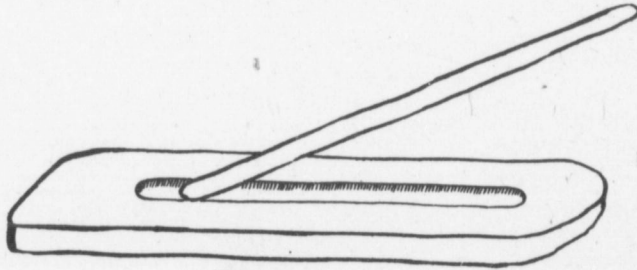

Fig. 1.

In the first method, which was used by Polynesians and some Australians, the pointed end of one stick is rubbed against another so as to produce a groove, at one end of which the borings produced by the operation are collected. Sufficient heat can be produced to set fire to these borings and from them a fire can be kindled. (Fig. 1.)

The second method (Fig. 2) is used by Malays and Burmese. Mr. Worcester (*loc. cit*) gives an interesting description of the use of this fire saw in the Philippines:

"I had always believed the operation of making fire by rubbing two sticks together to be a long and difficult process, requiring great strength and skill. In reality it is a very simple and easy matter, *if one has the right sort of sticks*. All that is necessary is one joint of thoroughly dried bamboo, say three-quarters of an inch in diameter. This is halved, and into the concave side of one of the pieces a V-shaped groove is cut, extending through to the outside, where it

opens by a convex side is fashioned of its edges hands, placed joint, and at slowly and scrape wood groove into ten to fifteen thirty more, in little cloud a sharp blow

its under sur pile of charre of living fire. he blows on the trick is simple ting fire on m

The third est of the th Algonquins of quimaux and other quarters with the hand Indians of the hand drill. cains, II., 242

opens by a long narrow slit. This half of the joint is now placed convex side up, on some smooth, hard surface. From the other half is fashioned a piece shaped somewhat like a paper-knife, and one of its edges is sharpened. This the fire-maker grips firmly in both hands, places it edge down on the convex surface of the other half-joint, and at right angles to the groove in it, and begins to rub slowly and steadily, bearing on hard. The sharp edges of the slit scrape wood dust from the upper piece, which, in turn, soon wears a groove into them, the dust falling down through the cleft. In from ten to fifteen seconds smoke begins to show faintly. In twenty or thirty more, as the rubbing grows rapidly faster and faster, it rises in little clouds. The operator suddenly stops, strikes the half-joint a sharp blow or two, to dislodge any sparks that may be clinging to

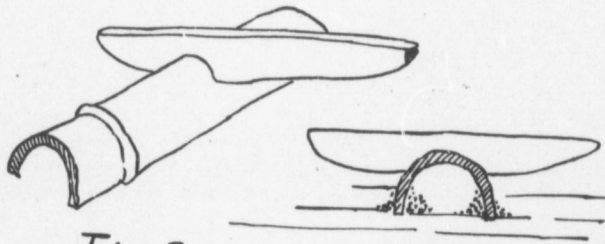

Fig. 2.

its under surface, and then snatches it up, exposing a little conical pile of charred wood-dust, at the apex of which glows a bright spark of living fire. Hastily pressing a handful of shavings down on this, he blows on them two or three times, and they burst into flame. The trick is simple enough when one once learns it. I succeeded in getting fire on my second attempt."

The third method (Fig. 3), that by boring, is much the commonest of the three. It is the method employed by the Iroquois and Algonquins of Canada, the Dacotahs of the Western plains, the Esquimaux and the Indians of South America, as well as many tribes in other quarters of the globe. The boring motion is produced either with the hands or by the help of some mechanical contrivance. The Indians of this continent were very expert in the use of this fire hand drill. According to Lafitan (*Moeurs des Sauvages Americains*, II., 242, quoted by Hough loc. cit), the Hurons and Iroquois

took a flat piece of cedar near the edge of which they bored a hole with a beaver tooth. From this cavity a little canal led to a match of frayed cedar bark. Inserting the pointed end of a round cedar stick in this hole they rotated it with their hands with such violence and rapidity that the borings which were pushed out by the canal took fire and ignited the cedar bark.

Captain Burke (*Am. Anthropologist*, III., 61) describes the Apaches as making fire in a precisely similar way by means of a fire stick which they carried attached to their lance staff by a string



Fig. 3.

passed through a hole. He has seen fire thus made in from eight to forty-seven seconds. The Apaches told him that under the most favorable circumstances they could make fire by running their hands down the vertical stick once. This took two seconds. The introduction of lucifer matches is rapidly making this method of fire making a lost art among the Indians.

The production of fire by the rotation of a stick with the hands alone is a matter requiring great skill and knack. Much more so than either the fire plough or the fire saw.

Sometimes the rotation of the fire stick was produced by mechanical means. Thus among the Esquimaux one man pressed down the stick by holding a stone in which a hollow had been made in which the upper end of the drill revolved, while a second man rotated it with a thong twisted round it and held in both hands. Other Esquimaux used a bow, the string of which was twisted round the drill. With one hand they held the "hearth" stick, with the other

the bow, wh  
mouth. Th  
twisted round

By mean  
to kindle a  
the cavity cl  
the heated bo  
With a bow  
and certainly  
very short tin

the bow, while the stone in which the drill revolved was held in the mouth. The Iroquois used a weighted drill rotated by a thong twisted round it like the string of a top.

By means of one of these mechanical fire drills it is quite easy to kindle a fire. The essential thing is the proper construction of the cavity close to the edge of the "hearth" with a canal to allow the heated borings to escape at one place and collect in a little heap. With a bow and drill of this kind, starting all cold, one can easily and certainly produce smoke in less than two seconds, and fire in a very short time.

## TENSILE STRENGTH OF RIVETS AND BOLTS.

D. C. TENNANT, GRAD. S. P. S.

Some and possibly most of those who will read this article hold to the popular opinion that rivets in tension are quite unsafe, and that such a use of rivets is to be studiously avoided if not condemned. However, although this opinion has heretofore to a great extent governed shop practice, yet it must be acknowledged that in many cases the use of rivets in tension, while not absolutely necessary, greatly facilitates the arrangement of the detail. Fig. 1 represents a detail used to hang a loft from the box-girder of the floor-system above it. Fig. 2 shews the section of a bridge floor built for a prominent American railroad. Both of these figures were taken directly from actual shop drawings, and may be considered typical examples. It may also be stated that some designers have for the last twenty years utilized the tensile strength of rivets by riveting the floor beams to the under side of the bottom chord in many of their bridges, and it is reported that no failure has ever taken place in such constructions. The strength of knee-braces and diagonal braces sometimes depends on the resistance of rivets to tension stresses as well as to shearing stresses, but few if any object to such constructions. Owing to the above considerations and the lack of experimental data on the subject, the writer decided to make tests on the tensile strength of rivets and bolts.

There was a series of tests made at the Watertown Arsenal in the year 1896 on the shearing strength of riveted and bolted joints, and it will be well to note the results here as they give a very fair idea of the relation between the strengths of rivets and bolts in shear. The tests were made on  $\frac{3}{4}$  inch and  $\frac{5}{8}$  inch steel and iron rivets and bolts. All plates used were of steel. For every riveted joint there was a similar bolted joint tested; thus the tests were in pairs and

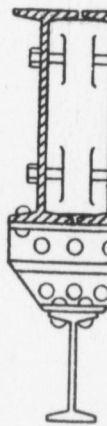

$\frac{7}{8}$ " RIVETS

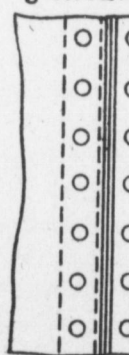

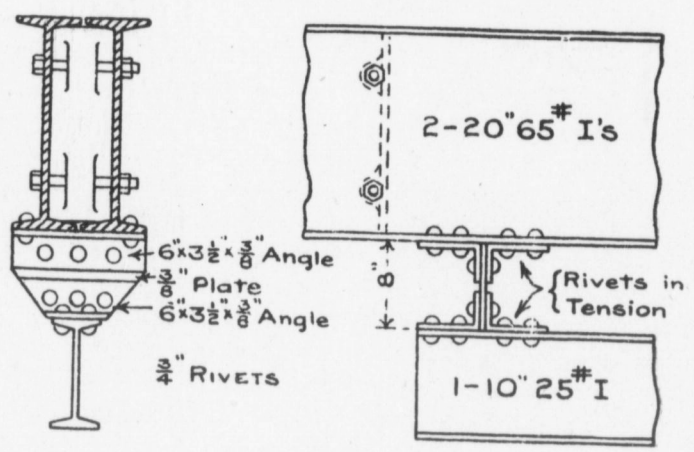

FIG. 1

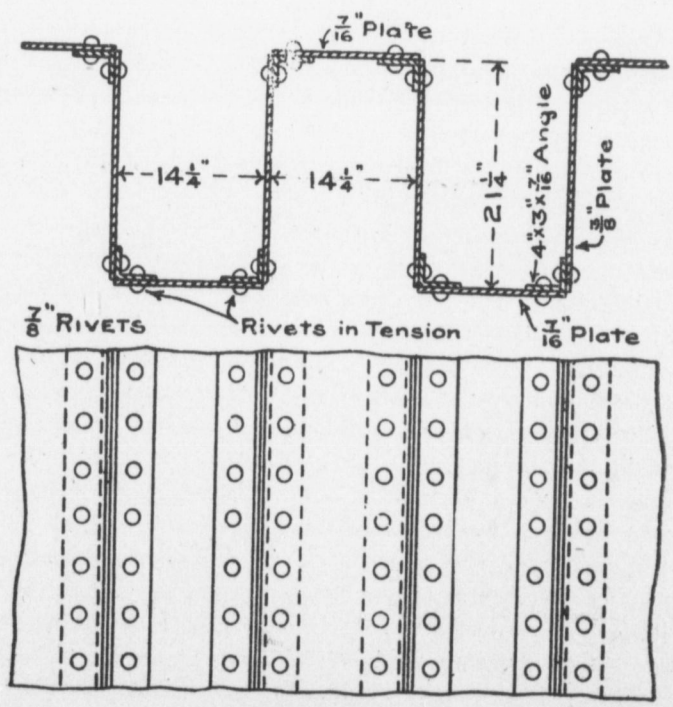

FIG. 2

only those pairs of tests are shewn in Table 1 that resulted in the shearing both of rivets and bolts. On an examination of this table it appears that both rivets and bolts are slightly stronger in single than in double shear; that the number of rivets in a joint has very little to do with the strength per rivet, and the same holds true for bolts; that if we consider the rivets to completely fill the holes, the difference in shearing strength between rivets of different diameters is completely accounted for by the difference in the area of the cross-section of the rivets after driven; that rivets are stronger in shear per unit area of sheared section than bolts of the same nominal diameter, but that the greater the diameter the closer the strength of the bolts approaches that of the rivets. Steel in every case is stronger than iron. The American Architect and Building News for March 26th, 1898, discussing the above series of tests sums up as follows:—"These results seem to indicate clearly that the average strength of a bolted joint is only about two-thirds that of a riveted joint of the same sort, and that, if the diameter of the bolts or rivets is rather small in comparison with the thickness of the plates, the strength of the bolted joint may not be much more than one-half that of the riveted joint. It is therefore unquestionably advisable, in designing bolted joints, to provide at least one-half more bolts than the number of rivets given by the ordinary rules for riveted joints."

All of the following tests in connection with the tensile strength of rivets and bolts were made in the laboratories of the School of Practical Science. The tests were conducted under the supervision of Mr. J. A. Duff, to whom the writer is indebted for many valuable suggestions. The apparatus shewn in Figs. 3 and 4 was designed for the purpose and proved to be rigid and entirely satisfactory. The apparatus shewn in Fig. 3 tested one rivet at a time, the grip of the rivet being 1 inch; that shewn in Fig. 4 tested two rivets at a time, the grip of each being about  $1\frac{1}{4}$  inches. With the latter apparatus, the load was equally divided between the two rivets and the maximum value was reached, and it had fallen considerably, before either of the rivets broke. On account of the lack of previous knowledge of the strength of both the rivets to be tested and of the apparatus used, it was thought best to make this series of tests on  $\frac{5}{8}$  inch rivets. The Swansea Forging Company very kindly supplied all the rivets and bolts used in the tests. Rivets were made from



ed in the  
 this table  
 in single  
 has very  
 true for  
 moles, the  
 diameters  
 the cross-  
 in shear  
 nominal  
 strength  
 in every  
 d Build-  
 ve series  
 indicate  
 ly about  
 nd that,  
 mparison  
 oint may  
 is there-  
 provide  
 n by the

strength  
 school of  
 pervision  
 ny valu-  
 was de-  
 satisfac-  
 ime, the  
 wo rivets  
 he latter  
 vets and  
 iderably,  
 previous  
 d of the  
 tests on  
 supplied  
 de from

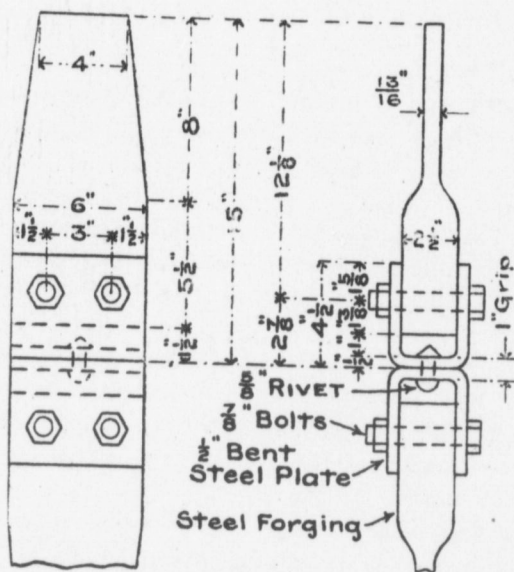

**FIG. 3**

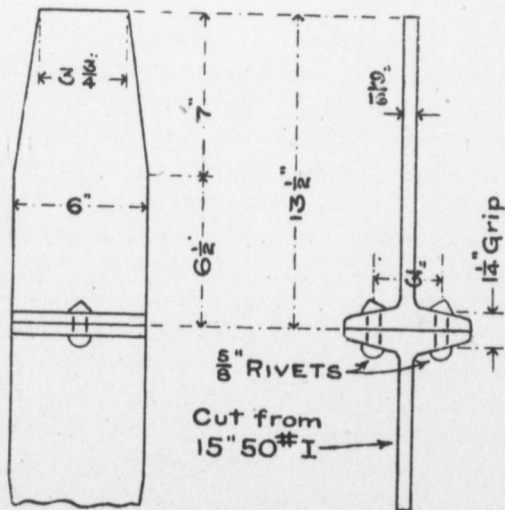

**FIG. 4**

three bars of rivet steel and bolts from two. In each bar used there was left about six feet at the end for tests on the material, and the rivets and bolts from different bars were kept separate from each other. Each of the five bars used stood the nicking and bending test and shewed a fine silky texture. The riveting was done at the Polson Iron Works, Toronto, with a pneumatic hammer riveter, no special care being taken to obtain favorable results. In order to make it possible for a considerable number of rivets to be driven at one time, six pairs of bent plates were prepared to fit the steel forgings shewn in Fig. 3, and three pairs of I beams as shewn in Fig. 4, were cut out. The heads of the rivets which were formed in manufacture were button heads, while those formed in the driving of the rivets were cone-shaped, and as all the rivets were to be driven hot the holes were drilled  $\frac{11}{16}$  inches in diameter.

Ordinary tension tests were made on the rivet steel, two test specimens being taken from the end of each of the five rods used, except No. 67, on which only one tension test was made. One specimen from each rod was used to determine Young's Modulus (E), extensometer readings being taken on the specimen for that purpose. The results shewn in Table 2 represent the average of the tension tests on each bar. The tests shewed Young's Modulus for the material to be about 28,000,000.

To perform the tensile tests on rivets the apparatus was gripped by the wedges of a Riehle screw power testing machine and the rivets were thus pulled apart. The speed of the machine was uniform and the duration of each test was from six to ten minutes. The results of tests made with the apparatus shewn in Fig. 3 are given in Table 3, and with that shewn in Fig. 4, in Table 4. The first number in the test mark is the number of the bar from which the rivets were taken. With one rivet the parts of the joint were just separated when a load of 10,000 pounds was reached, and with two rivets at about 28,000 pounds. The most important dimensions of the rivets and their general manner of failure are given in Fig. 5. All the rivets tested failed near the middle of the shank except five, in one the cone head was very eccentric and it failed by the shearing off of the rim of the head, four others snapped straight across directly under the head with a coarsely crystalline fracture. All those which failed by ordinary tension in the shank stretched considerably as shewn in

0947

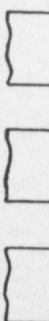

sed there  
and the  
om each  
bending  
e at the  
veter, no  
to make  
n at one  
forgings  
. 4, were  
manufacture  
he rivets  
the holes

two test  
ods used,  
specimen  
, exten-  
se. The  
ion tests  
aterial to

s gripped  
and the  
ine was  
to ten  
s shewn  
Fig. 4,  
er of the  
parts of  
unds was  
The most  
anner of  
near the  
was very  
he head,  
ead with  
by ordi-  
shewn in

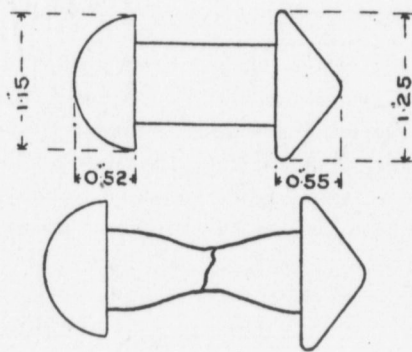

**FIG. 5**

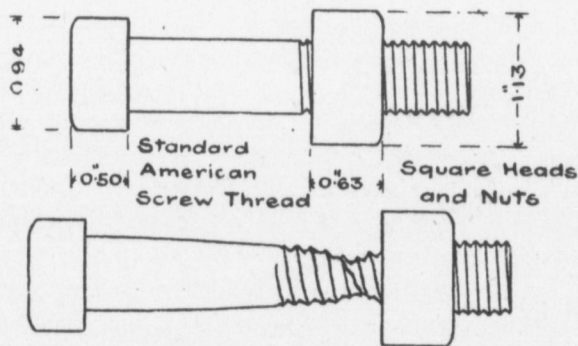

**FIG. 6**

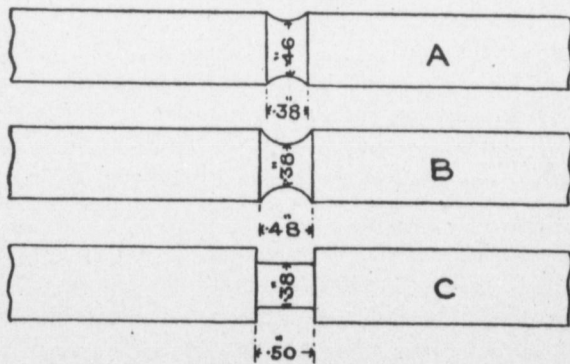

**FIG. 7**

Tables 3 and 4. It is very evident from the results of the tests that coarse crystallization introduces a great element of uncertainty in the strength of the rivet, and as this is probably caused by burning, great care should be taken in heating the rivets. It is also worthy of note that if care be taken in heating and driving, a tensile test is very much more likely to cause a failure in the shank of the rivet than in the head.

The results of the tests on the tensile strength of  $\frac{5}{8}$  inch bolts are given in Table 5. The dimensions of the bolt and a common appearance after failure are given in Fig. 6. Nearly all of the tests were made on two bolts at a time by means of the apparatus shown in Fig. 4, thin bevelled washers being placed under the head and nut. As a check two tests were made with the other apparatus. To ensure the end of the bolt clearing the steel forging a number of washers had to be inserted between the bent plates, and this gave in the two tests on single bolts a longer distance between the head and the nut of the bolt, and part of the threaded portion of the bolt was therefore included in this distance. This probably is the reason that the strength in the two single tests is comparatively low. In these two tests the parts of the joint were just separated at a load of about 5,000 pounds, and in all the other bolt tests at about 9,000 pounds.

The excess in strength per square inch in the rivets as compared with the plain bar having been observed, it was thought that the action of the rivet might be similar to that of a grooved specimen, and tests were therefore made to determine if such was the case. Three grooved specimens, one like each of the sketches in Fig. 7, were turned from each of the five bars. The average elongation of the grooved portion was, for "A" 56 per cent., for "B" 38 per cent., for "C" 62 per cent. The average contraction in area was, for "A" 68 per cent., for "B" 69 per cent., for "C" 74 per cent. The grooved specimens "A" were the only ones in which the un-grooved portion was stressed beyond the yield point.

The ultimate stresses per square inch obtained from all the tests made in connection with this paper are given in Table 6. The stresses in the grooved specimens are calculated from the smallest area of the grooved portion, those in the rivets are calculated on the area of the hole, and those in the bolts on the area of the un-threaded portion of the bolt. It will be seen that the increased

strength of the  
like grooved  
the bolts thou

In conclu  
tension test o  
test since the  
head very dire  
tests to be ma  
between the l  
has a consider

No. of RIVETS OR BOLTS IN JOINT.	D
2	
3	
4	
3	
2	
3	
4	
2	
3	
4	
6	
6	
8	
10	
12	
8	
8	
10	
10	
Averages	

strength of the rivets may be explained by considering them to act like grooved specimens "A" or "B." This would also explain why the bolts though threaded are as strong as the original bar.

In conclusion it may be said that outside of tensile strength the tension test of a rivet tells more about its quality than the shearing test since the tensile strength depends on both the shank and the head very directly. It is to be regretted that time has not permitted tests to be made on rivets of different diameters and of various lengths between the heads for the length between the heads very probably has a considerable influence upon the tensile strength.

TABLE I.

## SHEARING STRENGTH OF RIVETS AND BOLTS.

(Compiled from Tests made at the Watertown Arsenal.)

No. of RIVETS OR BOLTS IN JOINT.	DIAMETER. INS.	SHEARING STRENGTH		MATERIAL.	REMARKS.
		OF RIVET PDS.	OF BOLT PDS.		
2	3-4	24,250	18,840	Steel	Single shear
3	"	26,650	19,370	"	" "
4	"	25,020	19,220	"	" "
3	"	23,220	18,800	"	Double shear
2	"	23,260	16,600	Iron	Single shear
3	"	21,870	16,280	"	" "
4	"	22,850	18,130	"	" "
2	"	22,550	13,570	"	Double shear
3	"	21,520	13,080	"	" "
4	"	21,180	14,270	"	" "
6	5-8	16,000	8,630	"	Single shear
6	"	17,650	11,120	"	" "
8	"	17,350	10,890	"	" "
10	"	16,970	10,520	"	" "
12	"	14,160	9,420	"	" "
8	"	15,450	10,030	"	Double shear
8	"	16,360	9,010	"	" "
10	"	14,640	8,960	"	" "
10	"	15,400	9,490	"	" "
Averages	3-4	23,310	19,140	Steel	Single shear
	"	23,220	18,800	"	Double shear
	"	22,660	17,000	Iron	Single shear
	"	21,750	13,640	"	Double shear
	5-8	16,430	10,120	"	Single shear
	"	15,460	9,370	"	Double shear
	3-4	24,260	18,970	Steel	
	"	22,200	15,320	Iron	
	5-8	15,940	9,740	"	

## TENSILE STRENGTH OF RIVETS AND BOLTS.

TABLE II.  
TENSION TESTS ON THE MATERIAL.

BAR.	DIAMETER INS.	AREA SQ. INS.	YIELD POINT PDS.	ULTIMATE STRENGTH PDS.	STRETCHED LENGTH		CONTRACTED AREA AT FRACTURE SQ. INS.
					OF 8 INS.	OF INCH OF FRACTURE.	
63	0.622	0.304	9,700	14,050	10.56	1.73	0.066
64	0.625	0.307	9,950	14,200	10.58	1.73	0.067
65	0.620	0.302	9,700	14,050	10.78	1.74	0.070
66	0.621	0.303	9,450	14,200	10.77	1.73	0.070
67	0.620	0.302	10,500	14,400	10.71	1.71	0.078

TEST MARK.	ULTIMATE LOAD.
	Pds.
63-2	46,600
63-10	44,800
63-12	46,900
64-7	43,100
64-8	42,600
64-9	42,500
65-7	49,100
65-8	36,000
65-9	45,900

TABLE III.

## TENSION TESTS ON RIVETS.

TEST MARK.	ULTIMATE LOAD.	LENGTH BETWEEN HEADS BEFORE TEST.	STRETCH'D LENGTH BETWEEN HEADS.	AREA OF RIVET HOLE.	CONTRACTED AREA OF FRACTURE.	REMARKS.
63-1	24,410	1.00	1.52	0.371	0.107	
63-4	22,770	"	1.46	"	0.135	
63-5	20,720	"	1.53	"	0.116	
63-6	22,000	"	1.43	"	0.122	
63-7	21,200	"	1.55	"	0.132	
63-8	22,300	"	1.56	"	0.096	
63-9	21,400	"	1.43	"	0.107	
64-1	22,400	"	1.60	"	0.105	
64-2	22,000	"	1.54	"	0.105	
64-3	22,100	"	1.50	"	0.110	
64-4	22,300	"	1.55	"	0.105	
64-5	22,800	"	1.48	"	0.119	
64-6	22,400	"	1.69	"	0.102	
65-1	22,200	"	1.60	"	0.108	
65-2	22,500	"	1.48	"	0.119	
65-3	22,200	"	1.50	"	0.145	
65-4	21,850	"	1.45	"	0.139	
65-5	20,600	"	1.50	"	0.129	
65-6	21,600	"	1.49	"	0.119	

Joint slightly loose before test.

BAR.	NUMBER OF BOLTS IN JOINT.
66	1
66	2
66	2
66	2
66	2
66	2
67	2
67	2
67	2
67	2

In these tests  
portion of the bolt  
the pulling of the  
thread (all bolts 3

TABLE IV.  
TENSION TESTS ON RIVETS.

TEST MARK.	ULTIMATE LOAD.	ULTIMATE LOAD PER RIVET.	AVERAGE LENGTH BET. HEADS BEFORE TEST.	AVERAGE STRETCHED LENGTH BET. HEADS.	AREA OF RIVET HOLE.	AVERAGE CONTRACTED AREA OF FRACTURE.	REMARKS.
	Pds.	Pds.	Ins.	Ins.	Sq. In.	Sq. In.	
63-2	46,600	23,300	1.30	1.74	0.371		Cone Head sheared off, very eccentric.
63-10	44,800	22,400	"	1.79	"	0.128	
63-12	46,900	23,450	"	1.79	"	0.119	
64-7	43,100	21,550	"	1.86	"	0.110	
64-8	42,600	21,300	"	1.86	"	0.102	
64-9	42,500	21,250	"	1.83	"	0.105	Button Head tore off, fracture partly crystalline. Button Heads tore off simultaneously, fracture wholly crystalline. One Cone Head tore off, fracture wholly crystalline.
65-7	49,100	24,550	"	"	"	"	
65-8	36,000	18,000	"	"	"	"	
65-9	45,900	22,950	"	"	"	"	

TABLE V.  
TENSION TESTS ON BOLTS.

BAR.	NUMBER OF BOLTS IN JOINT.	LENGTH BET. HEAD AND NUT BEFORE TEST INS.	ULTIMATE LOAD PDS.	ULTIMATE LOAD PER BOLT PDS.	REMARKS.
66	1	2½	12,900	12,900	Stretched and torn in thread.
66	1	"	12,300	12,300	" "
66	2	1½	27,600	13,800	Stretched and stripped in thread.
66	2	"	27,600	13,800	" "
66	2	"	28,000	14,000	" "
66	2	"	26,800	13,400	" "
66	2	"	27,750	13,875	" "
67	2	"	29,200	14,600	Stretched and torn in thread.
67	2	"	28,800	14,400	" "
67	2	"	29,000	14,500	" "
67	2	"	28,250	14,125	Stretched and stripped in thread.
67	2	"	28,900	14,450	" "
67	2	"	28,300	14,150	" "

In these tests the contraction in area accompanying the elongation of the threaded portion of the bolt caused it to draw away from the nut and this was followed either by the pulling of the bolt through the nut or by the tearing of the bolt at the root of the thread (all bolts 3 inches long under the head, threaded 1½ inches).

TABLE VI.  
SUMMARY OF RESULTS.

NUMBER OF BAR.	ULTIMATE STRENGTH IN POUNDS PER SQUARE INCH.					
	PLAIN BAR.	Grooved Specimens. (on Net Cross Section).			Rivet. (on area of hole).	Bolt. (unthreaded part).
		A.	B.	C.		
63 .....	46,200	58,400	58,000	48,900	60,300	.....
64 .....	46,200	60,000	62,300	55,400	59,300	.....
65 .....	46,500	58,100	58,000	50,700	58,800	.....
66 .....	46,900	59,400	58,400	50,300	.....	45,400
67 .....	47,700	61,100	66,600	54,800	.....	47,600
Average.	46,700	59,400	60,700	52,000	59,500	46,500

The tests on the rivets from bar No. 63 were made first, and were communicated to a number of engineers, experienced in the designing of structural iron, with a request that they contribute a discussion on the use of rivets in tension. Some of these gentlemen very kindly acceded to the request and their opinions are given below.

It is greatly to be regretted that there was not time to communicate the results of the complete series of tests for discussion before publication, but unavoidable delays in the completion of the experiments and the necessity for publishing on a fixed date made this impossible. But although the discussions were written before the tests were completed, the writer believes that they represent the opinions prevailing amongst structural engineers.

MR. T. H. ALISON.

The experimental results recently compiled by Mr. D. C. Tennant in the laboratory of the School of Practical Science on the strength of  $\frac{3}{8}$ -inch rivets in tension, and on that of a similar bar in direct tension, give interesting differences, due to some well-known causes; and if it be possible to obtain by experiment the extent of the individual causes, an important advance would be made in the science of rivets.

Although value would be frequently be permit the en comparisons v gested that th pounds per so and the reduc

The marl to about 30% pletely filled partly account the rapid decre ment in upset be shown from bar exceeding adds to the ter results are clea tion has reduc of fracture is l

Dupuy, a permanent set the cooling pr greater set tha

Riveted w rivets perform ingly it is esse designed to gi elements and t sified into tho and mill build ing loads as br with rapidly d the greater; an favorable circu wise the divers rivets, and the quently heard.



Although the compilations are of a scientific nature, yet their value would be increased if in addition they were tabulated, as may frequently be observed in most engineering laboratories, so as to permit the engineer to readily grasp the results and to make mental comparisons with former experiments. It might, therefore, be suggested that the ultimate and elastic limit stresses might be given in pounds per square inch, the actual stretch in a length of 8 inches, and the reduction in area stated in percentage of the original bar.

The marked increase of 58% of a rivet above a bar will reduce to about 30% when it is considered that the  $\frac{1}{16}$  inch hole is completely filled with the metal of the rivet, and this in turn may be partly accounted for by the favorable process of tempering during the rapid decrease in temperature of the rivet. The mechanical treatment in upsetting the head will add its quota of strength, for it can be shown from the extensive experiments of noted scientists that a bar exceeding its elastic limit by stretching, hammering, or rolling, adds to the tension, but the tenacity and ductility are reduced. These results are clearly shown by the present experiments, for the elongation has reduced some 30%, and the reduction in area at the point of fracture is lessened some 10%.

Dupuy, a French scientist, contends that rivets, as bars, have permanent set and are subjected to tension above the elastic limit in the cooling process, also that the outside fibres appear to have a greater set than those nearer the centre.

Riveted work predominates in structural steel work, where the rivets perform the duty that the link does in the chain, and accordingly it is essential that this particular detail should be studied and designed to give the most efficient results in counteracting time, the elements and the class of loading. Structures may be generally classified into those carrying practically quiescent loads, such as office and mill buildings, and those sustaining movable or radically varying loads as bridges and coal pockets. The latter class of structures with rapidly decreasing, increasing or impact loading taxes the rivet the greater; and for this reason experiments made under the most favorable circumstances do not reasonably apply to practice, otherwise the diversity of opinion regarding friction of plates, tension in rivets, and the complete filling of holes with metal would be less frequently heard.

Rivets in tension are occasionally used to facilitate shop practice and field erection, but their duty is quite secondary. Wind loads are provided for in small buildings by triangular brackets that transmit their stresses to the main structure through rivets in tension, but the factors of safety are considerably increased. Up-to-date practice does not permit the designing of an important detail in this manner, and for this reason structures seldom suffer from this tearing off of rivet heads due to direct tension.

If sufficient metal is used to form the heads of rivets, the strength in the heads will greatly exceed that in the shank, but the rapidity of shop work, or the difficulty of access to the work in the field causes uncertainty as to the concentricness of the head. The frequent use of too long or too short a rivet has its objection in the set coming down on one side, causing an unequal distribution of the load, and when the rivet is strained a bending takes place across the junction of the head with the shank.

If rivets in tension were customary, the details would add much to the weight of the structure, since the angles or projections transferring stresses would be acted upon, and the bending would have the greatest effect in the root of the angle—the weakest portion—thus necessitating extra strength and weight.

Although rivets at the time of driving have considerable initial tension, yet it is contended that continual jarring by moving loads eventually loosens them. This would be sure to occur if the rivets were strained through the heads, and the uncertainty of the proportion of load carried by each rivet would be mere conjecture. In case the rivet heads are acted upon by the vertical and horizontal components of forces a combined stress in tension and bending would be the result, which would add to the tension of one set of outside fibres and would relieve the diametrically opposite to the same extent, which would reduce the factor of safety.

Cracks in the heads assist speedy corrosion which is very evident by the records of boiler explosions.

In the heating of rivets by the accustomed coke forges or by oil furnaces, the absorbing of sulphur causes a coarse grained, brittle and hard-working material, the effect of which is frequently seen in the ready snapping off of a head when occasion necessitates the knocking out of a rivet. The hard working quality retards the upsetting

in the field when connecting different sets in, which expended in fine

The experiment likely performed stress uniformly to drive the rivet although the method. In the field, the method mentioned, is questionable structure carrying it as to the result of such design. In occasional second bolts, the mate

I have been on rivets in tension same bar, but the cent. This, I know driving, some of the rivets with always that the use of rivets in not close down perfectly formed, such a rivet has highly strained.

The greater that the internal must be considered the greater is the and contracting crack off at the

Few authors highest I have

in the field where rivets in tension are most likely to be used in connecting different members. This gives an opportunity for blue heat to set in, which is detrimental to the strength if further work is expended in finishing the head of the rivet.

The experiments at the School of Practical Science were most likely performed under favorable circumstances, such as adding the stress uniformly and slowly, and using hydraulic or pneumatic power to drive the rivets, and yet in one experiment the head snapped off although the metal in the head should have given greater resistance. In the field, then, the use of rivets, owing to the objections mentioned, is questionable, and when we consider the completed structure carrying its varying and impact loads thus causing uncertainty as to the results of rivets in tension, no engineer should permit of such design. If it should be found necessary, however, to put in an occasional secondary joint in tension it would be much better to use bolts, the material of which has been fully investigated.

---

MR. F. M. BOWMAN.

I have been quite interested in the tests made by Mr. Tennant on rivets in tension. I note that all the rivets were made from the same bar, but that the results of the tests varied almost twenty per cent. This, I believe, can be accounted for from the fact that after driving, some of the rivets may not completely fill the holes. Driving the rivets with hydraulic power would fill the hole better, assuming always that the rivet is quite hot. The difficulty, however, with the use of rivets in tension, is the uncertainty. If the rivet head does not close down tight on either side, or if it is, in any way, imperfectly formed, it is of little value in tension. Also, whatever value such a rivet has, would not come into play until the other rivets were highly strained.

The greatest difficulty, however, to my mind, is due to the fact that the internal tension along the length of any well-driven rivet must be considerable; the hotter the rivet and the better it is driven, the greater is this initial strain. This is due of course to the cooling and contracting of the rivet after driving. I have known rivets to crack off at the head and can assign no other cause for the occurrence.

Few authorities allow any value for rivets in tension, and the highest I have seen is one-third their shear value. I would not care

to use more than this, and at such a value some other construction can generally be adopted which would be more economical and more satisfactory. Bolts can be used, but I do not like them, particularly in a structure subject to vibration.

---

MR. W. J. FRANCIS.

The writer is honored in receiving an abstract from Mr. Tennant's paper on Tension of Rivets, and in compliance with a desire expressed for the same makes the following remarks:

The results obtained are interesting and may prove of great value. It would appear very desirable to have an accurate record of the temperature of the rivet before driving, the number of blows administered in driving, the temperature of the rivet at the last blow and the temperature of the plates, which would be nearly the same as the atmosphere. The term "ordinary shop practice" is not definite, and from the writer's observations he would not be surprised to find vastly varying results from "ordinary practice" in different shops. In cold weather—to take an extreme case—rivets may be so driven that the heads fly off; while, on the other hand, a loose rivet may be formed in such a way as to make almost an ideal tension specimen—a rod upset at both ends. Between these extremes is it not possible to get all sorts of results, and have poor rivets shew up better than others which might be passed as good?

It seems scarcely fair to compare the tension tests of so many rivets with only one test from the bar, but does not the conclusion arrived at only indicate that the working of the metal improves its tensile value. This is clearly shewn in wire-drawing.

As to the use of rivets in tension in practice, the writer would say that he would not be inclined to place much reliance on the even distribution of the load over the different rivets, owing to the fact that it is practically impossible to tell the initial tension on any driven rivet. This being so, such a design could scarcely be called good practice. In the case of a bolted joint for tension, the range of initial tension can be brought within much smaller limits by setting up all of the nuts in the same way. But it seems best to avoid such joints altogether if possible.

The follow  
the School of  
Galbraith:

One of the  
assembly hall  
loaded and bro  
to the action  
bedded, and th

The sash  
pared box 8 i  
fastened well t  
scales divided  
graduated poin  
surface of the  
in the accompa

Portland c  
the glass care  
purpose the gra  
ed admirably.

The glass  
cement (88 lbs  
lbs.) was gradu  
78 lbs., this by  
88.5 lbs. was a  
while a second

The deflec  
420 lbs.

After the  
the pieces of gl  
ance the glass  
tainly thicker t

A sheet of  
not bedded no  
followed by she

## THE STRENGTH OF GLASS.

C. H. C. WRIGHT, B.A.Sc.

The following experiments were performed in the laboratories of the School of Practical Science under the direction of Principal Galbraith:

One of the lower sashes was taken out of a western window of the assembly hall of the school (top floor) and its single light of glass loaded and broken as indicated below. The glass had been exposed to the action of the weather for the past ten (10) years, was well bedded, and the putty was quite sound and hard.

The sash was placed with its weather side up on a carefully prepared box 8 inches high laid horizontally. Sides 12 inches high fastened well together were placed on top of the sash and then paper scales divided into half inches were pasted on each side. Light graduated pointers with their cardboard bases were placed on the surface of the glass. The whole made an arrangement as indicated in the accompanying sketch.

Portland cement was then sifted very gently over the surface of the glass care being taken to keep it of uniform depth, for which purpose the graduated pointers and scales already mentioned answered admirably.

The glass measured 36 inches by 36.75 inches and a bag of cement (88 lbs. net) was sifted over its surface, then a barrel (347 lbs.) was gradually added, this was followed by a box of cement of 78 lbs., this by a second of 54.5 lbs., and finally a layer of bricks of 88.5 lbs. was added to the superimposed load. The failure occurred while a second lot of bricks were being weighed.

The deflection was approximately  $\frac{7}{16}$  inches under a load of 420 lbs.

After the experiment the cement was passed through a sieve, the pieces of glass were collected and weighed, and from their appearance the glass was what is known to the trade as 26 oz. It was certainly thicker than double diamond and not so heavy as 32 oz.

A sheet of double diamond was next placed in the sash but was not bedded nor puttied, and the load applied as before. This was followed by sheets of 16 oz. and 32 oz. weight respectively.

*Old window*, with glass probably 26 oz.

Size of glass—36 inches by 36.75 inches.

Weight of glass—15 lbs.

Failed under a uniformly distributed load of— $656 + 15 = 671$  lbs.

Pressure in pounds per square foot— $74.55$ .

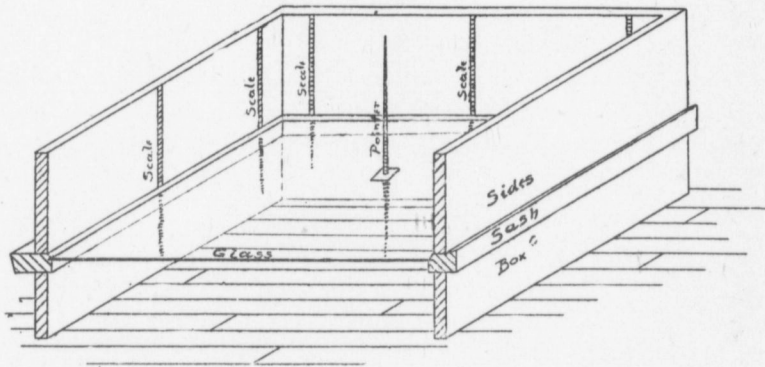

*Double diamond.*

Size of glass—36 inches by 36.75 inches.

Weight of glass—13.5 lbs.

Failed under a uniformly distributed load of  $262 + 13.5 = 275.5$  lbs.

N.B. This sheet of glass in its unstrained condition was badly warped.

*16 oz. glass.*

Size of glass—36 inches by 36.75 inches.

Weight of glass—10 lbs.

Failed under a uniformly distributed load of  $322 + 10 = 332$ .

Pressure in pounds per square foot—37.

*32 oz. glass.*

Size of glass—36 inches by 36.75 inches.

Weight of glass—17 lbs.

Failed under a uniformly distributed load of  $611.5 + 17 = 628.5$  lbs.

Pressure in pounds per square foot—69.8.

## INDEX

- Allison, J. L.  
 Andrewes, E. N.  
 Angus, R. W.,  
 The Sh  
 Bain, J. W., B  
 Notes on  
 The Acc  
 Ball, E. F., A.  
 Sewers  
 Water S  
 The Co  
 Mea  
 Hydraul  
 Sewage  
 Barber, T. Not  
 Blackwood, A.  
 Descript  
 Bowman, A. M.  
 Bowman, H. J.  
 Bryce, P. H., M  
 of I  
 The Chi  
 con  
 Disposal  
 Land Dr  
 Principl  
 Publi  
 Butler, M. J., C  
 Campbell, A. W.  
 Road Co  
 Pavemen  
 Roadmak  
 Campbell, G. M.  
 Carter, W. E. E  
 Chalmers, J. I  
 Rail  
 Rat Port

## INDEX TO THE FIRST THIRTEEN NUMBERS.

	VOL.	PAGE.
Allison, J. L. Transition Curves .....	ii.	52
Andrewes, E. Notes on the Geology of Rossland Ore Deposits.....	xiii.	128
Angus, R. W., B.A.Sc. The Gas Engine .....	x.	61
The Shaft Governor .....	xi.	76
Bain, J. W., B.A. Sc. Planimeters .....	ix.	19
Notes on Stamp Mill .....	x.	6
The Accuracy of the Assay of Pyritic Ores.....	xi.	67
Ball, E. F., A.M. Can. Soc. C.E. Asphalt Pavements.....	i.	40
Sewers .....	iii.	39
Water Supply .....	iv.	60
The Computation of Earthwork and Overhaul by Means of Diagrams .....	v.	48
Hydraulic Cements .....	v.	82
Sewage Filtration .....	vi.	44
Barber, T. Notes on the Development of Water Power....	xiii.	189
Blackwood, A. E. President's Address .....	viii.	1
Description of the Finlayson Marine Pipe Boiler....	viii.	189
Bowman, A. M. System of Survey in British Columbia.....	i.	19
Bowman, H. J., O.L.S. Municipal Engineering in Ontario...x.		177
Bryce, P. H., M.A., M.D. Underground Waters as Sources of Public Water Supplies in Ontario .....	iv.	15
The Chicago Canal and Some Sanitary Problems connected Therewith .....	ix.	55
Disposal of Sewerage .....	xi.	44
Land Drainage in its Sanitary Relations.....	xii.	119
Principles of Ventilation in their Application to Public Buildings.....	xiii.	174
Butler, M. J., C.E. Silica Portland Cement .....	xii.	100
Campbell, A. W., C.E. Roads and Streets in Ontario .....	x.	14
Road Construction .....	xi.	18
Pavements .....	xii.	106
Roadmaking ..	xiii.	167
Campbell, G. M. Vice-Work .....	viii.	33
Carter, W. E. H. President's Address .....	xii.	1
Chalmers, J. Double Track Tunnel Hamilton T. H. & B. Railway .....	ix.	61
Rat Portage Water Works .....	xii.	85

	VOL.	PAGE.
Chubbuck, L. B. Modern Systems of Interior Wiring . . . . .	xii.	58
Hydraulic and Electric Elevators . . . . .	xiii.	91
Chewett, J. H., C.E. The Removal and Destruction of Garbage . . . . .	vii.	11
Christie, Fred. W., C.E. Gold Mining in Nova Scotia . . . . .	xi.	129
Coleman, Prof. A. P., M.A., Ph.D. Mount Brown and the Sources of the Athabasca . . . . .	vii.	62
Connor, W. A., B.A. Solutions . . . . .	viii.	223
Corrigan, G. D. Modern Copper Smelting . . . . .	iv.	100
Davidson, J. L., Location and Construction of Crow's Nest Pass Railway . . . . .	xii.	135
Deacon, T. R. North Bay Water Works . . . . .	vi.	91
Dobie, J. S., Grad. S. P. S. The Action of Heat on Cement . . . . .	ix.	126
Duff, J. A., B.A. Presidential Address . . . . .	iii.	82
The Fundamental Principles of Dynamics . . . . .	v.	27
Diagrams . . . . .	v.	61
The Country Roads of Ontario . . . . .	viii.	49
Tests on Tensile Strength of Steel Boiler Plate . . . . .	x.	184
Neely's Formula for the Strength of Wooden Beams . . . . .	xii.	194
Elliott, H. P., B.A.Sc. Lightning Arresters . . . . .	ix.	13
A Discussion of the Considerations Affecting the Cost of Electric Power . . . . .	xi.	113
Ellis, W. H., M.A., M.B. Junker's Gas Calorimeter . . . . .	xii.	143
Fire Making . . . . .	xiii.	201
Galbraith, Prof. Technical Education . . . . .	v.	100
Goodwin, J. B., B.A.Sc. Tunnel at Niagara for Develop- ment of Power . . . . .	vi.	34
Niagara Falls Sewerage System . . . . .	x.	38
Gray, R. A. L. Power Switchboard and Dynamo Tending . . . . .	viii.	201
Greenwood, H. F., C.E. Concrete on Trent Valley Canal . . . . .	x.	80
Gurney, Cromwell. Illustrative Casualties in the Workshop . . . . .	ix.	8
Haight, H. V. Gear Cutting . . . . .	viii.	178
Standards in Machine Shop Practice . . . . .	ix.	38
Air Compressors . . . . .	x.	123
Hare, W. A. The Process of Manufacturing Mechanical Wood Pulp . . . . .	xii.	12
The Problem of Speed Regulation in Plants Driven by Water Power . . . . .	xiii.	37

Harkness, A. J.
Harvey, C. J.
and
Sta
Haultain, H. J.
Extract
Some E
Hemphill, W.
Po
Innes, W. L.,
A Brief
James, D. D. S
Johnson, S. M.
Brickwo
Kennedy, J. H.
Laing, A. T.,
her
Laing's
Laschinger, E.
the
Lea, W. A. P
President's
Leask, W. Cor
Lott, A. E. A
Notes fr
Ludgate, B. A.
MacDougall, A.
McAree, J., O.L
McCulloch, A.
McDowell, R.
McFarlen, T. J.
of S
McKinnon, H. J.
McLennan, J. C.
MacNabb, J. C.
McPherson, A.
Marani, C. J.
the.
The Sepa
Sanitary



INDEX TO THE FIRST THIRTEEN NUMBERS.

225

	VOL.	PAGE.
Harkness, A. H. Crushing Strength of White Pine .....	x.	180
Harvey, C. J. C.E. The Conjunction of the Nineteenth and Twentieth Centuries from an Engineering Standpoint .. .. .	xii.	156
Haultain, H. E. T. Presidential Address .....	iii.	11
Extract from Letter from .....	iii.	109
Some Experiences with a Canadian Turbine in Austria. vi.	83	
Hemphill, W. Construction of the Hamilton Cataract Power Company's Plant at DeCew Falls.....	xii.	76
Innes, W. L., G.E. Grading .....	viii.	5
A Brief History of Astronomy .....	ix.	26
James, D. D. Surveying in the City and Suburbs of Toronto. iii.	57	
Johnson, S. M. The Maintenance of English Roads .....	viii.	17
Brickwork Masonry .....	ix.	153
Kennedy, J. H., C.E. Reference Points and Bench Marks....	i.	27
Laing, A. T., B.A.Sc. The Waterworks System of Am- herstburg and Essex .....	v.	55
Laing's Planetarium .....	ix.	138
Iaschinger, E. J. Hirn's Analysis of Heat Distribution in the Cylinder of a Steam Engine .....	viii.	120
Lea, W. A. Photography .....	iv.	82
President's Address .....	vi.	1
Leask, W. Corrugations on Mill Rollers .....	iii.	63
Lott, A. E. A Re-Survey in Ontario .....	i.	24
Notes from an Engineer's Pocket Book .....	xii.	145
Ludgate, B. A. Problems from an Engineer's Pocket Book. .xii.	145	
MacDougall, A., C.E. Professional Prospects .....	vii.	7
McAree, J., O.L.S., D.T.S. The Crawford Gold Mine .....	vii.	26
McCulloch, A. L. Mortars and Cements .....	ii.	25
McDowell, R. Foundations .....	iv.	54
McFarlen, T. J. The Nickel Mining and Smelting Industry of Sudbury .....	vi.	48
McKinnon, H. L. The Cleaning and Annealing of Castings. viii.	132	
McLennan, J. C., B.A. Roentgen Radiation .....	ix.	142
MacNabb, J. C., O.L.S. Proposed St. Clair and Erie Canal. .vii.	62	
McPherson, A. J., B.A.Sc. Specifications for Sidewalks ....	x.	20
Marani, C. J. Historical Review of Sanitary Science and the "Germ Theory." .....	iii.	20
The Separate System and the Brockville Sewers.....	iv.	36
Sanitary Plumbing .....	v.	7

	VOL.	PAGE.
Marani, V. G. A Short, Practical, Essay on "The Sea and Its Waves" .....	v.	73
Merrill, E. B., B.A., B.A.Sc. Electric Traction as Applied to the Street Railway .....	vi.	57
Dynamo Design .....	viii.	205
Mickle, G. R. Freiberg Smelting Process .....	iv.	89
The Value of Undeveloped Mineral Claims .....	xii.	181
Minty, W. M., B.A.Sc. Notes on the Relation of the Mechanical Properties of Steel to the Chemical Composition .....	xi.	145
Mitchell, C. H., B.A.Sc. Earthworks on Roads and Railroads .....	v.	37
Triangulation Survey .....	vi.	23
Aerial Mechanical Flight .....	viii.	74
Monds, W. Circulation in Water Tube Boilers .....	xiii.	112
Morris, J. L., C.E. Masonry Foundations .....	iii.	52
Retracing Old Compass Lines .....	v.	70
Mundie, W. B., F.A.I.A. The High Building Problem.....	x.	28
Neelands, E. V. Some Adventures on the Abitibi .....	xii.	149
Mine Timbering .....	xiii.	137
Newman, W. The Drainage System in Essex and Kent.....	iv.	76
Palmer, R. K. Some Notes on Bridge Drafting .....	xiii.	119
Pedder, J. R., O.L.S. The Beeton Waterworks System.....	vii.	18
Raymer, A. R. Railway Surveys .....	ii.	34
Richardson, G. H. Rodding on Railway Work .....	ii.	9
Richards, E. The High Pressure Steam Boiler .....	xii.	9
Cold Storage .....	xiii.	76
Rosebrugh, T. R., B.A. Scale Calculus .....	iii.	48
Ross, D. A., B.A. Railroad Location in the Crow's Nest Pass Railway .....	xii.	29
Russell, S. Track Laying .....	iii.	73
Offsets from Tangent on a 1° Curve.....	iii.	111
Notes on Railway Location and Construction in the North-West .....	iv.	42
Russell, W. Township Survey .....	iii.	98
Scott, A. M., '96 Arts. The Pendulum .....	ix.	81
Shanks, T. President's Address .....	xiii.	1
Shield's J. D. President's Address .....	vii.	11

Shillinglaw, V.
Shipe, E. F.
Smith, C. B.,
Southworth, J.
Spiller, F. N.,
The U
The M
Stern, E. W.
Notes o
Cable I
Stewart, L. B.
vey
Distanc
An Exp
A Cano
A Sing
Longitu
A Trip
Stovel, H. R.
Stull, W. W.
Tennant, D. C.
Thomson, R. V.
Sewage
Thomson, T. F.
Bridge
Notes o
Foundat
Thorold, F. W.
Tye, A. T. TH
Tye, W. F. C.
Tyrrell, H. G.
Tyrrell, J. W.,
On Snow
Van Buskirk, V.
tion
Wagner, W. E.
Withrow, W. J.
Wright, C. H. C.
The Str

VOL.	PAGE.	VOL.	PAGE.
		Shillinglaw, W. H.	Hot Water Heating .....v. 20
v.	73	Shipe, E. F.	The Hardening and Tempering of Steel....viii. 169
vi.	57	Smith, C. B., Ma.E.	Canadian Steam Railways .....xiii. 158
iii.	205	Southworth, T.	Forestry. ....xii. 114
iv.	89	Spiller, F. N., B.A.Sc.	Asphalt and Asphalt Paving .....vii. 44
xii.	181		The Use of Asphalt in Engineering Construction...viii. 150
			The Modern Open-Hearth Process .....xi. 5
		Stern, E. W.	Notes on Field Work of Railroad Construction..i. 9
			Notes on Iron Bridge Building .....ii. 44
			Cable Railways .....iii. 36
		Stewart, L. B., D.T.S.	Description of a Timber Limit Sur-
			vey in the Rocky Mountains .....iii. 68
			Distance Measuring Micrometers .....iii. 92
			An Exploratory Trip Through the Rockies .....vi. 96
			A Canoe Trip on the Saskatchewan .....vii. 74
			A Single Form of Telemeter .....ix. 148
			Longitude by Lunar Distances .....xi. 53
			A Trip to the Yukon .....xiii. 145
		Stovel, H. R.	Hints to Prospectors .....xii. 177
		Stull, W. W.	History and Chemistry of the Cyanide Process.xi. 25
		Tennant, D. C.	Tensile Strength of Rivets and Bolts.....xiii. 206
		Thomson, R. W., B.A.Sc.	President's Address .....v. 1
			Sewage Disposal in Ontario .....viii. 194
		Thomson, T. K., C.E., A.M. Can. Soc. C.E.	Angle Blocks...ii. 50
			Bridge Specifications .....vi. 5
			Notes on Cement. ....vii. 36
			Foundations for a Twenty-one Story Building.....x. 96
		Thorold, F. W.	Electrolysis .....xii. 72
		Tye, A. T.	The Canadian Dawn Animal .....viii. 138
		Tye, W. F.	Cross Sectioning .....i. 31
		Tyrrell, H. G.	Explorations on the Battle River .....ii. 20
		Tyrrell, J. W., C.E.	Hydraulic Mining in British Columbia..x. 88
			On Snowshoes from the Barren Lands .....x. 104
		Van Buskirk, W. F., A.M., Can. Soc. C. E.	The Ventila-
			tion of Sewers .....viii. 128
		Wagner, W. E.	Aerial Cableways .....xiii. 10
		Withrow, W. J.	Petroleum .....ix. 38
		Wright, C. H. C., B.A.Sc.	Aspect and Prospect .....ix. 134
			The Strength of Glass .....xiii. 221

**The CELEBRATED MCEWAN HIGH SPEED AUTOMATIC PLAIN AND COMPOUND**

**OUR GUARANTEE**—The engine shall not run one revolution slower when fully loaded than when running empty, and a reduction of boiler pressure from the greatest to that necessary to do the work will not reduce the speed of the engine one revolution. Any engine failing to meet this guarantee becomes the property of the purchaser upon the payment of one dollar.

Specially Suited for Direct Connected Electrical Work.

Cut Illustrates an 8x13x12 Compound.

**WATERLOO, BRANTFORD, CANADA**

Most Simple Automatic Built.

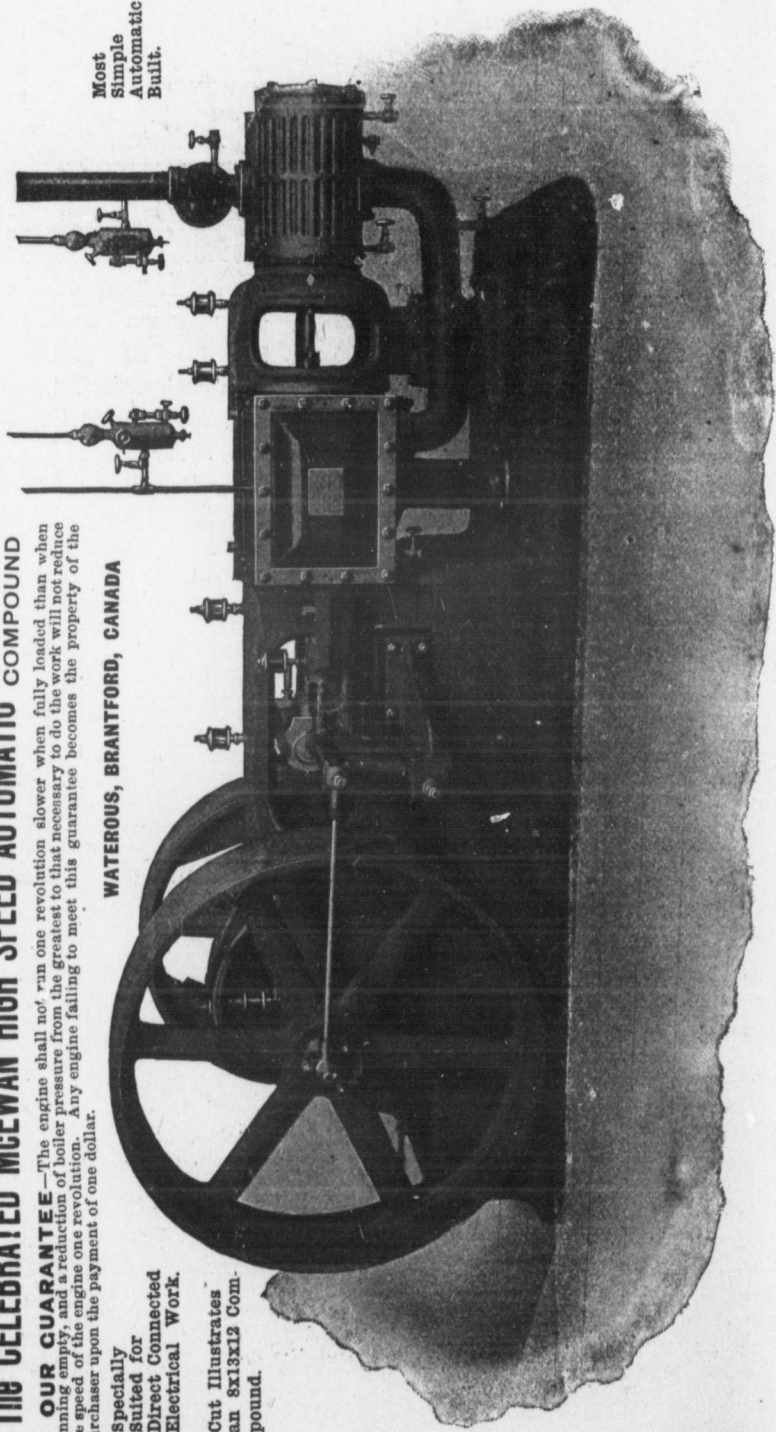

**THE P**

For Every Ser

**YARROW A**

Works and Office

**Par**

328

Telephone

---

# THE POLSON IRON WORKS,

TORONTO

---

**Engines and  
Boilers,  
Steel Vessels**

**For Every Service.**

---

BUILDERS IN CANADA OF THE  
**YARROW AND MOSHER**  
PATENT WATER-TUBE BOILERS  
Works and Office—  
**ESPLANADE EAST, TORONTO.**

---

# Park Brothers,

## Photographers

328 Yonge St., - Toronto.

---

Telephone 1269. Special Rates to Students

# THE "MUMFORD" BOILER

With Case or for Bricksetting.

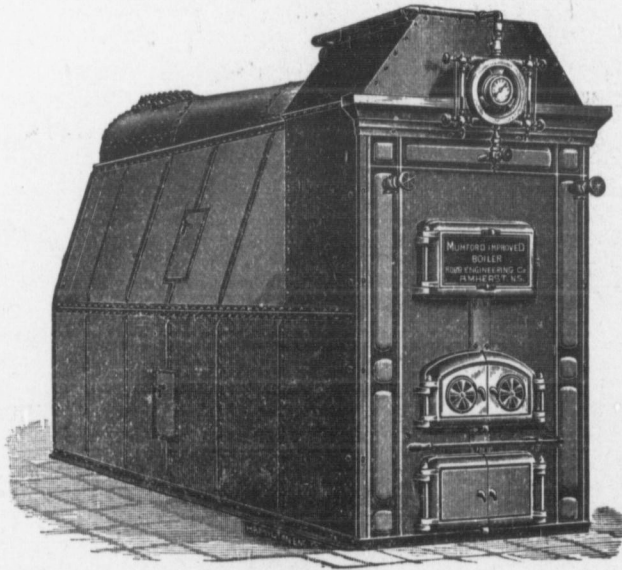

Tests made with same coal show this boiler is more economical than a well known water tube boiler.

It is internally fired, which prevents any heat being wasted, and has perfect water circulation.

Two settling chambers are provided for catching deposits of scale, and all parts of the boiler are accessible for cleaning.

~~~~~

**ROBB ENGINEERING CO., LIMITED.**  
*AMHERST, N.S.*



**W. T. JENNINGS,**

M. Inst. C. E.

**MOLSONS BANK BLDG., TORONTO**

Examination of Works, Surveys, Foundations, Bridges and Tunnels; Location and Construction of Steam, Electric, Incline or other Railways; Hydraulic, Mining, or other Engineering Works.

# School of Practical Science, TORONTO, CANADA.



*The Departments of Instruction are :—*

1. **Civil Engineering (Including Sanitary Engineering.)**
2. **Mining Engineering.**
3. **Mechanical and Electrical Engineering.**
4. **Architecture.**
5. **Analytical and Applied Chemistry.**



\*\*\*\*\*

**The regular course for the Diploma of the School, in each of the above departments, is three years in duration.**

A Post Graduate Course has been established, consisting largely of Laboratory Work, which leads to the degree of B. A. Sc. in Toronto University.

The following professional degrees are granted by the University to Graduates of the School :—C. E. (Civil Engineer); M. E. (Mining Engineer); M. E. (Mechanical Engineer); and E. E. (Electrical Engineer).

Occasional Students are received in all Departments.

The Session extends from October 1st to May 1st.

An Engineering Laboratory has been added to the equipment of the School for the purpose of training the Students in the experimental investigation of the Strength and Elasticity of Materials, the measurement of the Power and Efficiency of Machines, the applications of Steam and Water Power, and of Electricity. It is supplied with the necessary Testing Machines, Engines, Dynamos, Measuring Instruments and Standards.

A Mill Room has also been equipped with an Ore Crusher, Stamp Mill and Frue Vanner for the treatment of Gold Ores, and a Chlorination and Cyanide Plant, and a Roasting Furnace for the treatment of Base Ores.



**For further information apply to the Secretary,**

## **L. B. STEWART, D.T.S.**

# BUREAU



Is a  
for S  
beca  
repe  
pens

# CANADIAN





---

---

## BURMESE BOND PAPER

---

---



Is a most satisfactory Paper for use in Drafting ;  
for Specifications ; or for High Grade Stationery,  
because it has a good writing surface, will stand  
repeated erasures, is durable and is not too ex-  
pensive.

Ask your Stationer or Printer for it.



## CANADA PAPER CO. Limited,

TORONTO AND MONTREAL.

---



ce,

sanitary

neering.

try.  
\*\*\*\*\*  
above

laboratory  
y.  
Graduates  
r); M. E

ool for the  
on of the  
ower and  
er, and of  
Engines,

and Frue  
l Cyanide

T.S.

# THE RATHBUN COMPANY

- - - Deseronto, Ontario



MANUFACTURERS OF

"ENSIGN"  BRAND

## SILICA PORTLAND CEMENT

UNSURPASSED FOR USE IN

SIDEWALKS, PAVEMENTS, MASONRY.



...RECORD OF TESTS...

SCHOOL OF PRACTICAL SCIENCE,  
Toronto, Feby. 13th, 1899.

THE RATHBUN COMPANY, Deseronto.

Dear Sirs,—The following is the record of "ENSIGN"  
Brand Silica Portland Cement during the past year :

**FINENESS—**

|                           |   |   |      |
|---------------------------|---|---|------|
| Residue on sieve, No. 50, | - | - | .0%  |
| " " No. 100,              | - | - | .0%  |
| " " No. 200,              | - | - | 3.5% |

**SOUNDNESS—**

Pats kept in hot water for 48 hours were perfectly sound.

**TENSILE STRENGTH, average of five briquettes.**

|                             |      |                      |
|-----------------------------|------|----------------------|
| 7 days.                     | neat | 482 lbs. per sq. in. |
| 14 "                        | "    | 627 "                |
| 28 "                        | "    | 665 "                |
| 7 days, 3 sand to 1 cement, |      | 166 "                |
| 14 "                        | "    | 215 "                |
| 28 "                        | "    | 308 "                |

(Sgd.) C. H. C. WRIGHT.

WRITE FOR PRICES.

C. L.

Engine

NO

They aim to  
manipulation; A  
power; Steadine  
tremor, even in a

Their instr  
Geologists, and  
River, Harbor, C  
those made for  
is larger than th

Illustra

W.

609 TEM

Reports, Estir

M

Sewerag

Our A

co

Th

co

cat

he

tha

fir

---

# C. L. Berger & Sons

SUCCESSORS TO

**BUFF & BERGER**

IMPROVED

*Engineering and Surveying Instruments*

No. 9 Province Court, Boston, Mass.

They aim to secure in their Instruments:—*Accuracy of division; Simplicity in manipulation; Lightness combined with strength; Achromatic Telescope, with high power; Steadiness of Adjustments under varying temperatures; Stiffness to avoid any tremor, even in a strong wind, and thorough workmanship in every part.*

Their instruments are in general use by the U.S. Government Engineers, Geologists, and Surveyors, and the range of instruments, as made by them for River, Harbor, City, Bridge, Tunnel, Railroad and Mining Engineering, as well as those made for Triangulation or Topographical Work and Land Surveying, etc., is larger than that of any other firm in the country,

**Illustrated Manual and Catalogue sent on Application.**

---

## W. T. ASHBRIDGE, C.E.

Assoc. Mem. Can. Soc. C.E.,

609 TEMPLE BLDG. . . . . TORONTO

Reports, Estimates, Designs, Superintendence. Special attention given to

**Municipal Improvements**

*Sewerage Works—Water Supply—Pavements—Concrete Construction, etc.*

---

## Our Advertisers

On page iii. will be found a complete index of OUR ADVERTISERS. They are all good, reliable firms, and as considerable of the expense of publication is met by the advertising we heartily commend to OUR READERS that, as far as possible, they give these firms their support and patronage.

The Art  
Metropole **131 & 133** Yonge St.  
TORONTO

Opp. Temperance St.

### ARTISTS' COLORMEN

IMPORTERS AND DEALERS IN ARTISTS', ARCHITECTS', DRAUGHTSMEN'S AND  
SURVEYORS' SUPPLIES

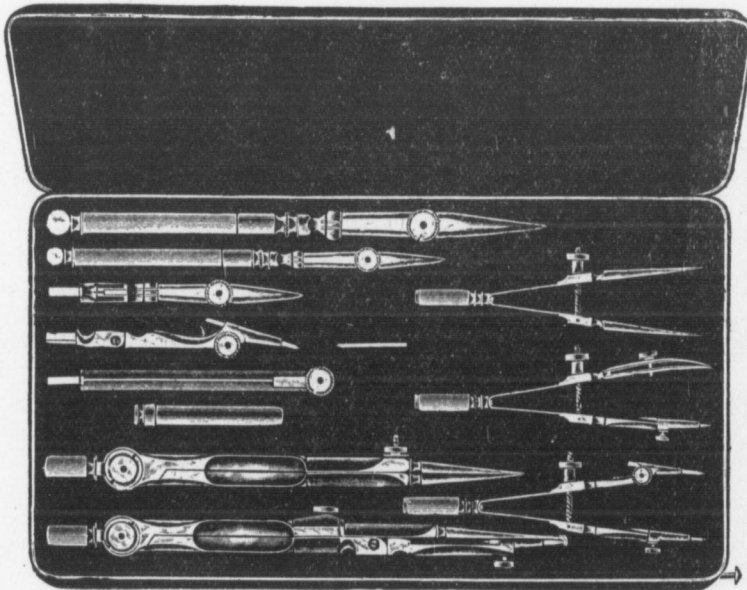

Drawing Papers  
T Squares  
Tracing Papers

Drawing Boards  
Detail Papers  
Profile Papers

Blue Print Papers  
Set Squares  
Rules and Curves

Oils and Water Colors  
Brushes for Oil  
Brushes for Water

Mathematical Instruments  
Mapping Pens  
Brushes for all purposes

Artists' Canvas  
Etching Pens  
Crow Quill Pens

Drawing Pencils  
Liquid Indian Inks  
Drawing Pens

Tracing Linen  
Erasive Rubber  
Crayons

Sponge Rubber  
Stick Indian Inks  
Etc., Etc., Etc.

Samples and Information on Application

**C. R. BESTWETHERICK**

'Phone 2124

Manager

There  
You h

A  
B  
B  
C  
C  
L  
F  
G  
H  
K  
K  
K  
K  
L  
M  
M  
M  
R  
S  
T

438 Y

# VANNEVAR & CO.

BOOKSELLERS AND  
STATIONERS . . . .

438 Yonge St., - - - TORONTO, Ont.



*There may be some Work in this List  
You have been looking for :*

|                                                          |         |
|----------------------------------------------------------|---------|
| Anderson's Prospectors' Pocket-book . . . . .            | \$ 1 50 |
| Bodmer's Hydraulic Motors . . . . .                      | 5 00    |
| Brown's Manual of Assaying . . . . .                     | 3 00    |
| Carhart & Patterson's Electrical Measurements . . . . .  | 2 25    |
| Carpenter's Experimental Engineering . . . . .           | 6 00    |
| Dana's Minerals and How to Study Them . . . . .          | 1 50    |
| "    Mineralogy and Petrography . . . . .                | 2 00    |
| Fresenius' Qualitative Chemical Analysis . . . . .       | 5 00    |
| "    Quantitative " " . . . . .                          | 6 00    |
| Gillmore's Limes, Cements and Mortars . . . . .          | 4 50    |
| "    Roads, Streets and Pavements . . . . .              | 2 00    |
| Ihlseng's Manual of Mining . . . . .                     | 4 00    |
| Johnson's Materials of Construction . . . . .            | 6 00    |
| "    Modern Framed Structures . . . . .                  | 10 00   |
| Kent's Mechanical Engineers' Pocket-book . . . . .       | 5 00    |
| Kidder's Architects' and Builders' Pocket-book . . . . . | 4 00    |
| Kuhnhardt's Ore Dressing . . . . .                       | 1 50    |
| Kemp's Ore Deposits in U. S. and Canada . . . . .        | 5 00    |
| Low & Bevis's Machine Drawing and Design . . . . .       | 2 50    |
| MacCord's Mechanical Drawing . . . . .                   | 4 00    |
| Merriman's Hydraulics . . . . .                          | 4 00    |
| Molesworth's Engineering Formulæ . . . . .               | 2 25    |
| Rafter & Baker's Sewage Disposal . . . . .               | 6 00    |
| Roberts-Austen's Metallurgy . . . . .                    | 3 00    |
| Searle's Field Engineering . . . . .                     | 3 00    |
| Trautwine's Engineers' Pocket-book . . . . .             | 5 00    |
| "    Railway Curves . . . . .                            | 2 50    |



BOOKS SENT POST-PAID ON RECEIPT OF PRICE  
MAIL ORDERS A SPECIALTY

## VANNEVAR & CO.

438 Yonge St.,

TORONTO.

# THE ROYAL ELECTRIC CO.'Y

MONTREAL, Que.

Western Office:  
TORONTO, Ont.

Sole Manufacturers in the Dominion  
of Canada of the

## "S. K. C." SYSTEM

ALTERNATING Current Generators, Induction  
and Synchronous Motors, Incandescent Light-  
ing, Arc Lighting and Power Transformers,  
High Grade Switchboards.

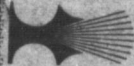

We also manufacture and sell Arc Dynamos, Arc  
Lamps, Railroad Generators, Railroad Motors,  
Direct Current Generators and Motors—Elec-  
trical Appliances—Incandescent Lamps.  
CORRESPONDENCE SOLICITED.

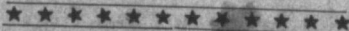
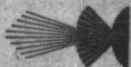

.. THE ..

## ROYAL ELECTRIC COMPANY

MONTREAL,

TORONTO.