

Technical and Bibliographic Notes / Notes techniques et bibliographiques

The Institute has attempted to obtain the best original copy available for filming. Features of this copy which may be bibliographically unique, which may alter any of the images in the reproduction, or which may significantly change the usual method of filming, are checked below.

L'Institut a microfilmé le meilleur exemplaire qu'il lui a été possible de se procurer. Les détails de cet exemplaire qui sont peut-être uniques du point de vue bibliographique, qui peuvent modifier une image reproduite, ou qui peuvent exiger une modification dans la méthode normale de filmage sont indiqués ci-dessous.

Coloured covers/
Couverture de couleur

Coloured pages/
Pages de couleur

Covers damaged/
Couverture endommagée

Pages damaged/
Pages endommagées

Covers restored and/or laminated/
Couverture restaurée et/ou pelliculée

Pages restored and/or laminated/
Pages restaurées et/ou pelliculées

Cover title missing/
Le titre de couverture manque

Pages discoloured, stained or foxed/
Pages décolorées, tachetées ou piquées

Coloured maps/
Cartes géographiques en couleur

Pages detached/
Pages détachées

Coloured ink (i.e. other than blue or black)/
Encre de couleur (i.e. autre que bleue ou noire)

Showthrough/
Transparence

Coloured plates and/or illustrations/
Planches et/ou illustrations en couleur

Quality of print varies/
Qualité inégale de l'impression

Bound with other material/
Relié avec d'autres documents

Continuous pagination/
Pagination continue

Tight binding may cause shadows or distortion along interior margin/
La reliure serrée peut causer de l'ombre ou de la distorsion le long de la marge intérieure

Includes index(es)/
Comprend un (des) index

Title on header taken from: /
Le titre de l'en-tête provient:

Blank leaves added during restoration may appear within the text. Whenever possible, these have been omitted from filming/
Il se peut que certaines pages blanches ajoutées lors d'une restauration apparaissent dans le texte, mais, lorsque cela était possible, ces pages n'ont pas été filmées.

Title page of issue/
Page de titre de la livraison

Caption of issue/
Titre de départ de la livraison

Masthead/
Générique (périodiques) de la livraison

Additional comments: / Various pagings.
Commentaires supplémentaires:

This item is filmed at the reduction ratio checked below/
Ce document est filmé au taux de réduction indiqué ci-dessous.

10X	14X	18X	22X	26X	30X
<input type="checkbox"/>	<input type="checkbox"/>	<input type="checkbox"/>	<input type="checkbox"/>	<input checked="" type="checkbox"/>	<input type="checkbox"/>
12X	16X	20X	24X	28X	32X

THE
CANADIAN PATENT OFFICE
RECORD

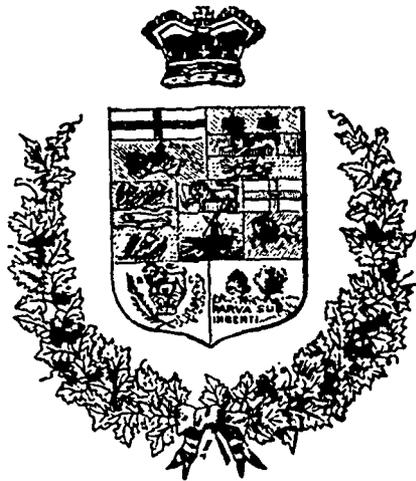

VOLUME III.



OTTAWA

PUBLISHED BY AUTHORITY

1875.



VOLUME III, 1875.—INDEX.

INDEX OF INVENTIONS.

Acids, carrier for, F. H. Kallfelsch.....	5185	Bench and automatic clothes wringer combined, J. A. Wilson.....	4951
Addressing machine, E. Langley.....	5399	Bill holder and paper fyle, W. H. Foy.....	4133
Advertising indices, J. O. Byrns.....	5349	Blacksmiths tuyere, V. R. Taylor.....	4816
Adze and axe, A. Beaudry.....	4908	Blinds screws, &c., apparatus for, H. M. Converse and G. S. Codd.....	4432
Air guns and pistols, A. A. Pope.....	4531	Blouses, &c., G. R. Eager.....	5139
Alcohol extract from wort, distilling, R. C. Brooks and A. J. Van Winkle.....	4292	Boat, portable, V. Colvin.....	6210
Animal fat, process of separating oleomargarine and stearine from, W. E. Andrew.....	5124	“ small, apparatus for detaching, G. D. Belcher, J. A. Stacy, G. K. Griffin and A. McEacharn.....	5310
“ poke, S. N. Gustin.....	4837	Boller anti-incrustation, battery for, J. F. Donoghue and G. Crompton.....	4854
“ “ J. B. McDonald.....	4940	“ feeder, F. McGulre.....	4163
“ and vegetable substances, process of preserving, G. Holgate.....	5068	“ flue, C. Dean.....	4950
Army equipments, G. H. Palmer.....	4791	“ cleaner, W. R. Anderson.....	5107
Auger, earth, R. B. Palmer.....	4719	“ heating water or raising steam, A. Spence.....	4682
“ machine, E. Dallaire.....	4992	“ heads, machine for turning flanges on, R. C. Nugent and R. McGregor.....	5383
Awls, crimping tacks, &c., machine for rolling, H. A. Williams.....	5227	“ injectors for, W. Randall.....	4807
Axle and axle box, A. Payette.....	5384	“ magazine for heating coal, W. T. Root and W. G. Wood.....	4561
Axle box, A. Payette.....	5370	“ non-conducting covering for, W. & C. M. O'Hara.....	4481
“ “ art of producing wrought metal carriage, W. J. Parmlee.....	5196	“ scale, composition for removing, A. Chavasse and A. Rambouillet.....	5382
“ oiler, D. McCullough.....	4632	“ tube expanders, O. Pagan, T. L. Ricart and M. A. Montejo.....	4895
Bag fastener, A. M. & M. M. Miller.....	4367	“ “ cleaning by steam, W. S. Van Esser.....	4241
“ holder, J. James.....	4938	Bolts, dies for heading and squaring, J. B. Clark.....	5177
“ and truck, J. Bellamy.....	4919	“ and rivets, machine for trimming the ends of, D. M. Kelly.....	5085
“ (paper) machine, B. Douce.....	4685	“ and studs, cutting and finishing the ends of, J. Nelson.....	4197
“ tie and fastener, J. Collins.....	4505	Book, salesman's check, W. Fingland and B. J. Draper.....	4833
Baking pan, hinged, E. E. O. Warner.....	5343	Book, R. D. Gouford.....	4355
Balling plasterers hair, W. R. King.....	4287	Boot calks, R. D. Breneman.....	5395
Ball casters, J. Johnson.....	4146	“ holder, A. N. Breneman.....	5395
Bark hemlock, extract, manufacture of, E. Bradley.....	5348	“ rubber, I. F. Williams.....	4402
Bark rasping machine, J. Moulton & S. R. Thompson.....	4704	“ “ last for, I. F. Williams.....	4408
Barrel or circular box, E. B. White.....	5172	“ seamless, last for making, J. K. Feick.....	4293
“ lifter, A. J. Small.....	4793	“ and shoe fastening, B. F. Sturtevant.....	4520
“ machine for cutting the headings of, (Extension) J. B. & E. W. Rathburn.....	4492	“ heel, machine for trimming, C. Laliberté.....	4834
“ machine for fitting, J. H. Ashdorn.....	4735	“ lasting machine, G. W. Copeland.....	5385
“ paper, J. L. Thompson and F. N. Davis.....	4248	“ latchet loop, (extension), J. F. Williams.....	4423
“ “ J. L. Thompson & F. N. Davis.....	4256	“ nails, Louis Goddu.....	4715
Bars tapered, machine for rolling, T. R. Venners and R. Rowley.....	5306	“ soles, machine for trimming and finishing, (extension,) L. Côté.....	4470
Battery, Gravity (electric) H. Neilson.....	4454	“ “ stiffener, G. Bréchet.....	4331
“ guns and repeating ordnance, J. P. Taylor.....	4184	“ “ “ I. Fréchette and Louis Côté.....	4767
Bed bottoms, P. C. Ingersoll.....	4742	“ tip, H. W. Merrill and J. W. Holtt.....	4858
“ “ J. V. Taylor.....	5015	“ wax thread sewing mechanism, G. W. Copeland.....	5246
“ fracture, I. M. Rhodes.....	4281	“ “ J. A. Stockwell.....	4220
“ spring, W. Jones.....	4202	“ “ E. B. Decker.....	4286
“ “ W. Crich.....	4818	“ “ G. W. Copeland.....	5238
“ “ E. B. Dodge.....	4867	“ “ forming seams of, L. E. DeVaru.....	5220
“ &c., cleansing, disinfecting and preserving feathers, &c., in, J. E. Townshend.....	4269	“ “ machine for bending and forming stiffeners for, L. Côté.....	4498
Bedstead, W. & G. West.....	4271	“ “ machine for screwing the soles of, C. D. Bigelow.....	4577
“ invalid (reissue), J. Goodwin.....	4272	“ “ machine for screwing the sole and heels of, C. D. Bigelow.....	4577
“ spring bottom, S. Moorell and C. Reinhard.....	4703	“ “ making counters for, H. Rogers & S. Moore.....	4361
Beehive, (extension), P. Nicolle.....	4587	“ “ working the shanks of, S. Bradford.....	4804
Bell door, J. P. Connell.....	4957	Bottles and stoppers, A. W. Newell.....	4925
“ hanging and operating, H. A. Dierkes.....	4235	Box, C. C. Holman.....	5237
Belt buckle, a fastener for machines, C. C. Rao.....	4493		
“ insoles, &c., galvanic, S. T. Norman.....	4254		

Bx machine, J. K., G. W. & J. A. Paigo.....	4583	Churn motive power for, J. F. Cole.....	4610
" and pans, metallic, H. Martin.....	4822	" power, J. Guest, Jr.....	5157
Brake, air, J. Steger.....	5080	" and washer combined, (extension), C. D. Van	
" for wheeled vehicles, W. P. Widdfield.....	5290	Allon.....	4008 5003
Bread slicer, M. Ahearn and M. Walsh.....	4372	Churning machine, R. Sutherland.....	5322
Brewing process, T. Hawks.....	4605	" stock, machine for grinding wood for, B. F. Barker	4368
Brieh turning, E. V. Winyard.....	5077	" white, treating jute, &c., for manufacture of, G. W.	
Brick machine, application of direct action engine to, James		Dubulsson.....	4667
Martin, Jr.....	4944	Clder mill, H. Sells.....	5255
Bridges and roofs, trusses for, E. Wassell.....	4379	" " J. Sims.....	5381
Bristle and fibre combing machines, C. Boeckh.....	5153	Cigar, M. Lesser.....	4760
Broom handle painting machine, E. A. Kitzmiller.....	4838	" bunching machine, C. Windrath.....	4935
Brush block boring machine, C. F. Ritcheb.....	4497	" mould, N. Dubrul.....	4406
" cloth and mop-holder, C. B. Clark.....	5226	" " J. Prentice.....	5017
Buckwheat, machine for cleaning, D. Pease.....	4946	" stamping machine, G. S. McConkey.....	5008
Buckle attachment, D. C. Young.....	4000	" manufacture of, J. B. Camyré and L. A. Dessaulles	4710
Buggy body, B. P. Aylsworth.....	4518	" " M. Lesser.....	4751
" seats, J. S. Wotherell.....	5138	Clamp, T. H. Marsh.....	5088
" top, J. H. Tackberry.....	5050	Clipping horses and sheep, machine for, J. Wilson and R.	
" " portable, P. J. Ayres.....	5254	Bowker.....	4764
Burglar proof safes, J. Taylor.....	4358	Cloth process and apparatus for cleaning, "Rosamond	
Burlap basket, S. Spencer.....	4912	"Woolen Company".....	5365
Butter package, C. B. Sheldon.....	4342	Clothes drier, reading desk and table combined, J. Bate...	4959
" process of making, from the oils of animal fat, W.		Clothes drying and quilting table, combined, (extension),	
E. Andrews.....	5291	J. M. Grover.....	4943
" worker, J. C. Rorick.....	4904	" ironing machine, G. W. Cottingham.....	5296
Buttons for clothes, G. Fournier.....	4169	" rack and ironing table, W. C. Arnold.....	4353
Cable chains, C. A. Chamberlin.....	5320	" washer, (extension) G. Huntington.....	4203
Calendar, perpetual, and pen holder, G. W. McCready.....	4570	" wringer, J. R. Smith.....	4218
Camera, reflecting stereoscope, W. Harris.....	4463	" " G. S. Walker.....	4535
Can, F. D. Brodhead.....	4201	" " automatic and bench combined, J. A.	
Canal boat, W. Ball.....	5129	Wilson.....	4951
Candlestick, pocket, M. Goldman.....	4302	Coal, artificial, J. W. Beaumont.....	4565
Canisters for tea, &c., R. DeLuc Van de Carr.....	4602	" ash sifter, T. Kane.....	5265
Cap, reversible, M. Fox.....	4976	" elevator, W. Gooding, C. Spalding and A. Winchester	4308
Capstan, M. Thibault.....	4186	" oil can, fumigating and fire lighting, E. Davis and C.	
Cards, playing, I. N. Richardson.....	5284	K. Jones.....	4450
Carpet cleaning machine, D. Whiteside.....	4958	Coat measures and drafting scales, R. G. McLellan.....	4780
" and beating machine, A. B. Sheraton.....	4756	Cock, compression stop and waste, F. Marsh.....	4546
" stretcher, W. H. Curtis and R. Morris.....	4162	Cod liver oil, treatment of, J. G. Hara.....	4489
" " P. B. Myers and S. Raugh.....	4261	Collins, apparatus for depositing, C. A. Sipe.....	4917
" " H. Carter.....	4988	Coke and illuminating gas, manufacture of, J. T. B.	
Carriage, G. White.....	4212	Rennett.....	4393
" O. B. Thompson and W. W. Grier.....	5075	Collars and cuffs, E. P. Furlong.....	4376
" childrens, R. Cobleigh.....	4227	" threaded, forming sheet metal, A. Taplin.....	4857
" " W. Haney.....	4330	Comb, A. Popperhusen.....	5372
" " H. C. Moody.....	5208	" duplex, B. F. Britton.....	4678
" hub, S. Mitchell.....	5109	Concrete blocks veneered with marble, H. Hogan, J. Bryce	
" spring, E. Wright and J. J. Krehbiel.....	4478	and J. G. Gibson.....	4782
" " A. W. Mitchell.....	4189	Conductors hand alarms and registers, T. B. Doolittle.....	4680
" and car step, G. A. Keene.....	4173	Cooking apparatus, gas, T. & J. C. Peacock.....	4300
" top, E. R. Stockwell.....	4853	" pots, W. H. Rabbit.....	5388
" and waggon, H. Sprague.....	5098	" steam, J. E. Thompson.....	4270
" wheel, P. Gendron.....	4702	" stove, R. Thomas.....	4176
Cartridge crasers, W. G. Rawbone.....	4651	" " combination of, with steam engine, T.	
Catamental sack, G. Meacon.....	5270	Penton.....	4419
Castings, metal, ramming and moulding machine for, J.		" utensil, J. H. and N. Weare.....	4198
B. McCure and R. M. Wanzer.....	4476	Copper ores, &c., process for smelting and refining, S. L.	
Cement fire proof roofing, J. B. Slichter.....	5298	Crocker.....	4430
" pipes, wells and drains, J. Regan.....	5176	Cordwood, floating mill and machine for splitting, P. May-	
Centrepieces, W. Warren.....	4737	rand, père.....	4487
Chains wivel, machine for, and process of making, W. C.		Corn planter, F. Van Doren.....	5097
Edger.....	4689	" sheller, W. E. Calhoun.....	4142
" barbers and dentists, W. B. Wright.....	4972	" " hand, J. E. Finley.....	4977
Chair and cradle, separable, E. Hambufer.....	4412	Corsets, H. A. Schandevyl.....	5048
" extension arm, A. H. Hornsby.....	4604	" M. K. Bortree.....	5363
" invalid, J. Roy.....	5115	Cotton cleaning machine, S. D. Keene.....	4136
" oscillating spring, W. T. Doremus.....	4329	Cot, perambulating, A. W. Richards.....	5125
Cheese box, S. Wallace.....	5316	Coupling, joint covering and tumbling rod, J. Harriman.....	5277
" hoop, D. M. McPherson.....	5031	Cradle and chair, separable, E. Hambufer.....	5413
Chimney cowls, W. M. Adams.....	5281	Crane, hydraulic, J. Hahn.....	5202
Churn, J. Campbell.....	4177	Crimpling machine, O. Noack.....	5133
" R. G. Blamey and J. Kulow.....	4480	" tucks, awls, &c., machine for rolling, H. A.	
" (extension), H. Bolton.....	4457	Williams.....	5227
" T. Prior.....	4448	Crown oil, &c., application of, J. W. Elliott.....	4223
" W. R. Wagner.....	4467	Cuffs and collars, E. P. Furlong.....	4376
" J. McKenzie.....	4627	Culinary apparatus, G. H. Bliss.....	5193
" B. R. Wagner and P. Edwards.....	4961	" boiler, I. C. Mayo.....	5232
" A. E. Mitchell.....	5000	" utensils, J. H. and N. Weare.....	1611
" T. Herron and J. Dunigan.....	5021	Cultivator, L. H. Hébert.....	4630
" A. Berry.....	5045	" or gang plough, J. Borer.....	4558
" A. Oot.....	5313	" and barrow, W. Stafford.....	4152
" dasher, S. Hall.....	4713	Curry comb, W. E. Lawrence.....	4369
" " J. E. Finley.....	4794	Curtain fixture, N. Campbell.....	4898
" " H. A. Stearns.....	5006	Cutter sleigh, C. A. Hennicke.....	5338
" " A. Holmes.....	5361	" head, G. J. Shlmer.....	5131
" egg beater and ice cream freezer combined, J. L.		Cylinder, lining for, E. Hill, jr.....	4699
Gregory.....	4850	Cylindrical objects, machine for holding, R. C. Gwathmey	5239

Gas machine, J. G. and W. Muller	4248	History and statistics apparatus, N. Loverin	4792
" " H. E. Casgrain	5076	Hoe, A. S. Acker	5030
" manufacture, W. J. Wauchope and J. Cowan	4664	" M. Johnson	4736
" process and apparatus for manufacture of, from petro- leum, &c., T. S. Dickerson	4796	" horse, J. M. Munro and A. P. Johnson	4806
" retort, F. H. Dale and F. H. Elchbaum	4881	" spring, R. Sylvester	4321
" apparatus for heating, J. P. Lockoy	4670	Hogs, machine for cleaning, &c., after being killed, N. Sil- verthorn	5106
" " process of cleaning, H. S. Wolf	5210	Holstways, W. Muir	4376
" wood, " making, G. Ramsdell	4304	Honey, artificial, F. G. White	4511
Gases of fuel, utilization of, J. C. Ramsdell	4843	Hoop cutting machine, H. Fowler	5327
Gate, R. H. Hudgln	4473	" " P. Cook	5336
" H. Hogle	4902	" machine, A. F. S. Skidmore	5170
" farm, W. Brown	4716	Horse, apparatus for breaking, J. Z. Walling	4826
" and doors apparatus for closing, T. Thornton	5315	" " to prevent from jumping, G. H. Thomp- son, A. A. Mathews and M. O. Mathews	5155
Gauge, quadrant bevel, W. E. Skinner	4933	" bridle, E. Fuller	4975
Gear wheels, bevel, mechanism for planting cogs of, G. M. Holmes	4310	" checks, J. Sugden and J. P. Goffrey	4512
Gelatine, extracting, from salted fish skins, J. S. Rogers	5259	" " M. Hubbell	4971
Glass furnaces, J. Nicholson, Jr.	4774	" collar, W. Hardy	4808
" " H. Ragot	4884	" " W. Irvin	4190
" process and apparatus for tempering, F. B. A. Royer de la Bastie	4267	" feed bags for, A. Nye, Jr.	5079
" relief letters coloured, J. A. Eginton	4842	" from jumping, &c., device for preventing, G. D. Chis- holm and S. Douglass	4191
Globes, method of mounting and operating, E. E. Fitz	4344	" hay knives and forks, W. C. Shorey	4911
Glue pot, W. S. Herland	4923	" overdraw checks for, J. A. Lakin	4491
Gold and silver ores, crushed, machine for amalgamating and for separating, by washing substances of differ- ent specific gravities, A. Heatherington	4304	" power, A. Tracy	4755
Governor for horse powers, J. D. Heebner and A. H. Selpt Grain, &c., apparatus for discharging, from vessels, C. W. Mills	5119	" " F. X. and A. Bellefalle	5298
" binder, C. Jewel	4934	" " J. G. and H. F. Taylor	4387
" cleaner, E. W. Johnson	4677	" rake, G. Barclay and J. Kennedy	4154
" or corn crusher and spice mill, J. Kaiser	5364	" " C. M. Clinton, L. Mood, E. C. and C. P. Gregg	4216
" drilling and seeding machines, J. C. Baker	4144	" " (extension), C. J. Corbin	4494
" " machine, feeding mechanism for, P. P. Mast &c., machine for facilitating the transfer of, W. Goodwin	4835	" " J. E. Wisner	4635
" " 4728	4211	" " A. S. Walbridge	4874
" and malt drier, F. H. C. May	4211	" " B. F. Lowell	5066
" scourer and separator, W. W. Ingraham and E. Beard storage boat, W. and I. Ingils	4628	" " D. P. Sharpe	5099
" 4289	4289	" " W. F. Neal	5274
Grate, J. B. Larkin	4404	" " R. Wilson	5355
" bars for furnaces, S. L. Legend	4409	" shoe, R. F. Cooke	1640
" water circulating and steam generating, W. H. Farris Grinding ring dress, metallic, E. S. Howland	4348	" " blank rolling machine, W. W. Lewis and J. Mit- chell	4388
5388	4348	" " machine, L. Myers and T. Armstrong	4440
Guitar head, W. H. White	5105	" " J. Russell	5143
Gum candy chewing, C. C. Moore	4374	Hose coupling, J. Amor	5135
Guns, J. L. Kerr	4521	Hub boring machine, E. Cassell, L. Whitlock and S. Scott " boxes and bands, H. A. Payne	4253
" breech loading, G. D. Booth	4276	" for vehicles, elastic, G. Leverloh	4723
5276	4276	5289	4723
Hame fastening, T. Foster	4845	Hydrant, W. H. McMillan	4930
" lock, S. Spicer	5022	" street, J. Flower	4909
" J. G. Eberhard	5039	Hydraulic elevator, T. Stebins	5189
4638	5039	Hydrogen generator and carburetter combined, B. Sloper Ice breaking boat, C. Schaal and C. Baner	4619
Hammer, C. Bilharz	4638	" cream freezer churn and egg beater combined, J. L. Gregory	4340
Harness, breast collars for, M. D. Murray and J. C. Hut- chinson	4742	" creeper, A., J. R., S. R. and C. L. Phillips	4856
" lug-thing, T. E. Webber	4772	" tool combination, A. V. M. Sprague	5362
4673	4772	4597	5362
Harrow, M. Wilson	4673	Insects, compound for destroying, C. W. Lewis	4597
" broad cast seeder and plaster sower, L. Dague	5009	" gathering machine, W. G. Swartz	5012
" and cultivator, W. Stafford	4152	Iron, furnace for making wrought, direct from the ore, W. A. Stevens and R. E. Cross	5311
" and land roller combined, H. J. Yeargin and W. Keith	5192	" glossing and fluting, J. Hewitt	4907
" and roller combined, J. Vessot, Sr., and Samuel Vessot	4224	" machine for charging heavy piles of, for heating pre- paratory to rolling, E. G. Scovill	4714
" wheel, E. R. Powell and F. C. Kennedy	4426	" moulding machine, J. Boyle	4245
4426	4426	" ores, furnace for reducing, J. Wilson	4165
Harvester, J. S. Royce	4461	" and other ores, process and apparatus for reducing, N. W. Wheeler	4166
" C. Russ	4981	" " melting of, E. H. Aydon and E. Field	4130
" H. A. Howe	5223	" art of piling, E. G. Scovill and A. Rhodes	5120
" attachment for cutting pease, B. and A. Tolton rakes, J. H. Myers	4727	" steel, &c., manufacture of, W. A. Lyttle	4607
4839	4727	" " apparatus and compounds for production of, S. R. Smith and J. Simpson	5218
" self-binding, J. F. Gordon	4193	" and steel, art of welding, purifying in melting and puddling furnaces and composition for that purpose, (extension), D. Litster	4860
" " D. McPherson	5114	4860	4860
4232	5114	Ironing board, S. M. Barré	4717
4232	5114	" G. C. Hill	4937
4617	5114	" table, U. B. Laberge	4179
4617	5114	" " J. B. Porter	4653
4405	5114	" and clothes rack, W. C. Arnold	4353
4438	5114	Jack, carriage, painters, A. G. Rykert	5211
4953	5114	" hydraulic, E. Biddle	5174
4906	5114	Jib and sail hank, C. W. Clements	4581
4237	5114	Kiln, G. C. Suris	4195
4182	5114	" for calcining lime, &c., W. S. Sampson	4621
4333	5114	" for calcination of plaster of Paris, &c., H. Wandby	4579
5171	5114	Knife cleaner, F. Doucette	4999
4428	5114	Knitting loom, N. W. Westcott and C. L. Spencer	5245
4298	5114		
4921	5114		
4569	5114		
5358	5114		
5360	5114		
5359	5114		
4759	5114		

Knitting machine, J. S. Shallor.....	4606	Matting roller, G. H. Longmore.....	4806
" " F. C. Topley.....	5279	Matrass, H. Whiteside, jr.....	5396
" " circular, E. Tiffany.....	4654	Measure liquid, S. C. Redgrave.....	4170
Lacers, G. P. Reeves.....	5317	" cloth, A. H. B. Blanchard.....	5201
Ladder, extension, R. Gilchrist.....	5158	" lip for sheet metal, A. Cummings.....	4872
" " fire, J. G. Taylor and J. H. Smith.....	4453	Meat chopping trap, L. Kimball, jr.....	4332
Ladder extension stop, R. S. Van Zandt.....	4873	" cooked, preserving and packing, W. J. Wilson.....	4563
" step, J. L. Isaac and R. Holliday.....	4818	" method of slaughtering, preparing and packing for	
" and wash bench combined, C. Hood.....	5152	exportation, K. Knott.....	4468
Lamp, F. Rhind.....	4291	" preserving process, J. Kluck.....	5093
" J. A. Pease.....	4536	Metal creasing machine, G. W. Howell.....	4762
" H. Taylor.....	4576	Meter, liquid, A. A. Post.....	4900
" L. J. Atwood.....	4789	Milk pan, G. McEwan and C. O. Gibson.....	1339
" burner, G. A. Baidler.....	4583	Middlings purifier, W. H. Gobbs.....	4614
" " I. J. Atwood.....	4768	" " R. L. Downton and J. A. Miller.....	5224
" " J. D. Gould.....	5377	" separator, A. Cobtree.....	4869
" chimney, S. T. Draper.....	5347	Milk, apparatus for cooling, J. Prince.....	4312
" cleaner, S. S. Ryckman.....	5205	" can, bottom of, J. H. Stone.....	4475
" protector, M. A. Johnson.....	4610	" " J. C. and A. Blyth.....	5389
" extinguisher, E. F. Chapin and E. C. Presby.....	4894	" cooler, W. Shea.....	4661
" " W. T. Wood.....	4899	" " N. E. Smith.....	4883
" " M. Waterbury.....	4918	" " O. J. Stickles, W. R. Remington and L. Bailey.....	5118
" reflector, C. M. Murch.....	4937	" " N. D. Martin and G. W. Seaver.....	5206
" wick, C. A. Shaw.....	4452	" " D. Gurnsey.....	5209
Land roller, H. Hollingshead.....	4171	" and meat safe shelf, J. Nickerson.....	5222
" " and harrow combined, H. J. Yeargin and W.		" pan, E. N. Porter.....	4263
Keith.....	5192	" " J. B. Brown.....	4437
Lantern, R. Nutting.....	4688	" " discharge pipe and stopple, G. McEwan.....	4562
" and dinner kettle combined, W. W. Price.....	4952	" " W. H. Johnson, C. A. Foote and G. E. Marvloe.....	5393
tubular, W. Walker.....	4617	Milking machine, W. Patterson.....	4668
Lasting tools, F. J. Davis.....	4901	Millstone dress, S. Keim.....	4687
Latch, locking, A. Worster.....	5273	" dressing machine, S. Griscom.....	4620
Lath machine, P. W. Hart.....	4754	" face tester for, J. Thompson.....	4445
Laundry polish, C. L. Holland and G. W. Caldwell.....	5003	" producing cold air round, G. Walling.....	5186
Lawn sprinkler, W. Lightfoot.....	5087	Mill trams, F. G. Wallace.....	5302
Lead pencils cutting attachment to, M. McCall and J.		Minerals, apparatus for calcining, &c., J. P. Lockey.....	4676
King.....	5040	Mining powder, R. Cahue.....	4905
Leather crimping machine, C. B. Lang.....	5162	Mirror, J. Grist, jr.....	4113
" machine for cutting and skiving, C. H. Orcutt.....	4978	Mitring machine, S. Williams and G. H. Bryant.....	5214
" water proofing and otherwise improving, M. Bird		Morticing machine, S. Rydbeck.....	4656
Leg splint, David Bissell.....	4194	" " S. Duck.....	4879
Lid prop, automatic, H. S. Pomeroy.....	5123	Motive power, J. N. Eddy.....	4629
Lifo preserver, L. Letourneux.....	4247	" " E. May.....	5137
" preserving bed, A. G. Haskell.....	5018	Motor, P. Peaudry and G. A. Choquette.....	4434
" saving appliances, A. Wood and T. T. Stevens.....	4572	" mechanical, J. W. H. Doubler.....	5132
Lifting jack, J. B. Fayette and L. Meeker.....	5102	Moulds and framings, to make wells, &c., J. Regan.....	5176
Light, apparatus for producing artificial, G. H. Greenough.....	4868	Mower and harvester, lawn, J. C. and C. J. Sturgeon.....	4221
Lighting streets and buildings, R. V. DeGuinon.....	5363	" reaper, W. N. Whiteley.....	4863
Lightning conductor, G. W. Otis.....	4277	" " (extension), W. N. Whiteley.....	5402 5403
" rod, S. O. Greening.....	4915	Mowing machine, A. G. Gray.....	4655
Lime kiln, J. B. Robert.....	4799	" " B. Atwood.....	4811
" " F. J. Chubb.....	5341	" and reaping machines, J. Forsyth.....	4673
Links, dies for welding, J. B. Bough.....	4670	" " R. D. Robbins.....	5251
Liquid meter, E. Marsland.....	5067	" " machines for grinding the	
" apparatus for evaporating, &c., J. P. Lockey.....	4676	knives of, E. W. Phelps,	
" " separating substances from, O.		J. Gregory and N. Bost-	
Holden.....	5371	wick.....	4541
Lock, W. Griffith.....	4855	" " table for, S. H. Hilbert.....	4631
" J. M. Gill.....	4961	Music, apparatus to facilitate the study of, E. Draper.....	4785
" H. Rogers.....	5029	Musical reed instruments, A. R. Koerber.....	5055
" combination, A. E. Peters.....	5001	Nail machine, J. Porth and H. Scheuerle.....	4552
" door, A. J. B. Berger.....	4800	" screws, &c., machine for separating, when taken out	
" hinge, C. B. Clark.....	5235	of tin bath, C. F. Lalonde.....	4268
" and key guard, I. Kenney.....	4930	" and spikes, feeding device of machine for forging, L.	
" nut bolt, Thomas Galbraith.....	4149	A. Dodge.....	5036
Locomotive, P. K. Dealy.....	5144	Neck tie holders, R. B. and M. Anderson.....	4225
" carriage for tram ways, &c., W. D. S. Moncrieff		Needle machine, W. Trabue.....	4446
&c., machine for lubricating the cylinders of,		Netting for fishing, &c., machine for making, B. Arnold,	
A. Davis.....	4970	W. E., W. J. T. and J. E. Hooper.....	4398
Lounges, S. S. Arnold.....	4675	Newspapers, machine for addressing, R. Dick.....	4986
Lubricating compound, G. B. Peters.....	4851	Non-conducting covering, C. L. Riker.....	5034
" oil, T. J. Gorden, D. H. Bumpus and W. H.		" material, J. C. Peacock.....	4506
Keeler.....	5035	Nut lock, F. L. Bates.....	4425
Lubricators, D. Jones.....	4174	" " C. Hutchinson.....	4831
" R. W. Drew and W. N. Lloyd.....	5092	" " C. L. Holland.....	5215
" J. W. Reed.....	5213	" " washer, S. T. Lamb and B. F. Avery.....	4331 4438
" for car axles, J. D. Stark.....	4638	" machine, W. C. Chartiers and M. McKain.....	4675
Lumber, apparatus for seasoning, C. R. Taylor.....	4285	" washer, lock, G. C. Thomas.....	4262
" dryer, J. J. Curran and C. Wilcox.....	5094	" method of locking and unlocking, C. Levey and W.	
Magnetic needles, adjustment of, G. Iles.....	5083	Myles.....	4349
Mail or other bags, J. Dewe.....	4435	Oil can, F. C. Wilson.....	4282
Malt and grain drier, F. H. C. May.....	4211	" " A. O. Kittridge, W. A. and W. J. Clark.....	5273
Mandrel for bending pipes, M. L. Orum and C. H. Miller.....	5074	" shield can for shipping, J. C. Moore and P. Hickey.....	5105
Mangle, clothes, G. R. Prowse.....	4676	" still, D. R. Winnett.....	4413
Manure spreading machine, J. S. Kemp.....	4659	" tank, S. Webster.....	5195
Marble and stone, artificial, J. Cowman and S. B. Barber.....	4626	" " S. Landon.....	5287
Marbleizing compound, S. W. Steel and J. Bayer.....	5285	" treating process, D. D. Cattanaeh.....	4297
Match box, (paper) machine, E. Fitch and L. H. Hamilton	5267	Omnibus, J. B. White.....	4284

Ore, apparatus and process for the reduction of, R.M. Eames	5342	Propeller, G. R. Moore.....	6082
" crusher, J. Hewitt.....	5073	" wheel, Z. C. Crean and D. Anderson.....	5398
" crushing and rock breaking machine, A. J. O. Day ...	4309	Pruning shears, J. L. O'Connor and H. Dockhan.....	5044
Organ, reed, G.W. Scribner.....	4539	Pulley block friction, G. Williams.....	4250
" stop action, A. M. Brush.....	5392	" differential J. A. Grove.....	4166
Oven, revolving reel baking, J. Hall.....	5147	Pump, C. C. Jones.....	4509
Overcoat and carriage robe combined, B. Levy.....	4134	" J.A. McMartin.....	4538
Ox bow fastener and guard, G. B. Tinker.....	4337	" (extension), E. Horsey.....	4686
Ozone machine, F. W. Bartlett.....	5337	" S. B. Strong.....	5293
Padlock combination, D. A. Root.....	4932	" bucket chain, A. L. Corey and E. W. Grant	4043 4725
Pails, &c., ball fastening for, P. Miles.....	4365	" " " W. C. Barker.....	4848
Paint brush, S. Brillinger.....	4660	" force, G. Seger, J. Hellbrunn, J. Koabel and J. Bauer.....	4625
" compound for mixing, A. A. Wilson.....	4841	" " E. Glendillon.....	4616
" elastic compound, J. B. Slichter.....	5207	" measuring for drawing oil from cans, J. G. Even- don and F. C. Wilson.....	4363
" fire proof, J. B. Slichter.....	5290	" oscillating water and air, G. Thurber.....	5320
" metallic, W. McKim.....	4601	Pump plungers and valves, J. Matthews.....	4993
Pantaloon stays, F. S. Yentzer.....	4447	" rotary, Lyman D. Green.....	5356
Paper, machine for grinding or reducing pulp for making, A. Gardner.....	4913	" " double acting reversible, R. Patrick and J. A. Macdonald.....	4936
" pulp, apparatus for manufacturing, J. W. Dixon.....	5374	" ship's, J. Brokenshire.....	5191
" " disintegrating fibrous substances for, A. H. Laffin.....	4939	" suction and force, C. Parham.....	4181
" stock, machine for grinding wood for, B. F. Barker white, treating jute, &c., for manufacture of, G. W. Dubulsson.....	4607	" " A. Riddell.....	5376
Passage tickets, L. Brush.....	4881	Pumping water out of a vessel which has sprung a leak, device for, W. D. Peters and G. H. Holt.....	4924
Pavement, wooden, C. H. Miller.....	4238	Punching machine for washers, &c., L. H. Young.....	4400
Pawl and ratchet mechanism, J. L. Bond and D. Shoff.....	4847	Purses, pocket books or wallets, J. Sale, jr.....	4824
Pent machine, F. Dodge.....	5028	Quilting frame, J. S. Bouter.....	4585
" A. E. Barthel and W. Smith.....	5271	" " A. Cornell.....	5275
Peg cutting handle, W. R. and C. E. Barton.....	4729	" and clothes drying table, combined extension, J. M. Grover.....	4943
" ribbon, machine for compressing, B. F. Sturtevant.....	4519	" and mat frame, C. F. Simmons and J. Franz.....	4598
Pegging jack, J. J. Stewart.....	5096	Rail joint and nut lock, R. Taylor and H. Silker.....	4846
Pen and ink holder combined, D. Mackinnon.....	4809	Railway, automatic, C. W. Hunt.....	4885
Petroleum, apparatus for storage and transportation of, G. Desgeorges.....	4148	" axle box, A. Higley.....	4996
Photograph burnishes, J. P. Bass.....	4718	" brake, W. P. Widdifield.....	5333
Photographic negatives and glasses, varnish for coating, J. W. Morgener.....	4303	" car, I. Brigan.....	4549
Piano-forte, W. McCammon.....	4838	" L. A. Root.....	5232
" T. Kater.....	5050	" axle, H. H. Rhodes.....	4307
" pedal attachment, L. C. Whiting.....	5145	" " bearing, J. Blakeley.....	5352
" and organ, H. Behnin and J. Diehl.....	4699	" " box, J. M. Brosius and S. K. Campbell.....	4415
Picture exhibitor, J. Buechner.....	5131	" " " G. Houlton and H. Osburn.....	4503
" frames, compounds for, C. D. Wilson.....	4773	" " lubricator, J. D. Imboden.....	5199
" " banger for, S. Dobbs and W. M. Brayton..	4401	" " coupler, E. M. Law.....	4386
Piers, &c., structure for, C. E. Hill.....	5325	" " A. Willson, P. E. Drake and E. M. Law.....	4339
Pen cushion and spooler combined, L. Mauro, D. McArthur, W. H. Chalker and G. Macgillivray.....	4888	" " D. P. Corey.....	4686
Pipes, water gas and sewer, machine for making, G. M. Fuller.....	5318	" " J. R. Smith.....	4506
Plane guide, W. S. Shippe.....	4347	" " H. F. McKerverey, A. McKay, C. S. Ramsay and P. McRae.....	5357
" iron adjustment, W. Johnston and W. W. Robertson.....	4431	" " automatic, M. Pettengill.....	4495
Planers, saw mill, &c., carriage movement of, W. Lamb.....	4359	" " coupling, E. C. Scarlett.....	4322
" of wood, &c., expansive gear for feed rolls of, R. N. Merlam.....	4474	" " R. D. Chatterton.....	5228
Planing machine, C. R. Patterson.....	4991	" " L. Dill.....	5250
" and grooving machine irons, concentric guide for, J. Morin.....	4711	" " G. H. Ames.....	5367
Plaster sower broad cast seeder and harrow, L. Dague.....	5009	" " self-acting, W. J. Monsell.....	4662
Plough, T. Richardson and M. McInnes.....	4501	" " freight, R. Eaton.....	4441
" S. J. Lundy.....	4590	" " grain doors for, D. F. Van Liew.....	4354
" S. Bellachey.....	5108	" " heater, W. M. Fuller and L. T. Lehmyer.....	4938
" J. Yocum.....	5346	" " truck, L. B. Stillson.....	4893
" cutter, T. Dewitt.....	4634	" " ventilator, E. E. Hargreaves.....	5252
" gang, B. Waggoner.....	4421	" " ventilating, E. C. Ibbotson.....	5373
" E. A. Beers.....	4882	" " trucks, G. W. Cook and E. H. Horsey.....	5233
" or cultivator, J. Bower.....	4558	" " washer, E. W. Evans.....	4141
" machine for cleaning, W. Moore.....	4983	" " wheel, L. J. Hewitt.....	4275
" swivel, A. Sanborn.....	5060	carriage draw bars and spring, R. D. Chatterton..	5241
Plumbers joint, C. G. Herbert.....	4827	" " station indicator, S. P. Littlefield.....	5047
" traps, manufacture of, F. N. Dubois.....	5387	construction of, A. Bowman.....	4600
Poison bottle, W. M. Caterson.....	4934	electric signalling apparatus for, F. L. Tople.....	5011
Poisonous insects, &c., compound to prevent the bites of, J. Ash.....	4743	joints, E. C. Ibbotson.....	4522
Pontoon boat, W. Ascough.....	4775	locomotive and car wheels, C. G. C. Simpson.....	5027
" and floating dock, J. L. Clark and J. Standfield..	4840	machine for removing snow from, S. G. Smith....	4188
" for raising sunken vessels, L. Payette.....	5116	" " " " G.H. Steadman.....	5136
Powder, blasting, H. Courtelle.....	5218	rail support, S. L. Porter and D. Peck.....	5256
Potato-digger, T. Head.....	4157	signal for level crossing, J. B. Jones.....	4733
" " D. Moodie.....	4462	" " light and head lamps for, (extension), A. Dick.....	4594
" " C. C. Parker.....	4622	single rail, H. L. Smith.....	4766
" " E. Bartlett.....	4623	snow plough, R. Sadler.....	5111
" " H. Bolton.....	5178	&c., station ticket for, W. T. Jell and L. F. Harvey..	4252
Printers inking roller, composition for, J. H. Osgood.....	4424	switch, E. Mercler, M. Lanctot and A. H. Elliott..	4229
Printing machine, E. Hely.....	5020	" " R. Pickel and J. Leet.....	4945
" and engraved metal surfaces, G. M. Bright and T. Barrow.....	4259	train brake, A. F. Gue and J. M. Kelloy.....	4360
		truck lifting machine, R. Aldred.....	5247
		trucks, W. H. Wright and B. J. Howd.....	5059
		wagon coupler, L. and A. Dion.....	4319

Spooling machine, J. W. West.....	1551	Stove pipe shelf, A. S. Chamberlin and A. S. Douglas.....	5014
Spring bed, L. A. Frigon.....	4412	“ “ stones, machine for making, H. Wandby.....	5173
“ vehicles, S. E. Foster.....	4510	“ shelf and bread toaster combined, H. N. Colby.....	4813
“ “ A. I. and L. A. Davis.....	4877	Straw cutter, D. S. Cornell and E. B. White.....	4417
“ “ A. S. Hopson and W. W. Iambie.....	5033	“ “ J. Elliott.....	4624
“ wagon seat, W. H. O'Dwyer.....	5069	“ “ D. Muxwell.....	2345
Square combination, W. Ascough.....	4288	Street car fare box, L. Maltus.....	1499
Stamp, composition, J. Scott, Jr.....	4823	“ “ device for, C. G. Jurlay.....	4612
Steam boiler, J. Currie.....	4646	“ lanterns, J. M. Bruce, M. M. Heath and G. E. Underwood.....	4414
“ “ J. H. Killey and W. Multhead.....	5242	“ pavement, J. McBean.....	5194
“ “ apparatus for preventing explosion of, C. W. Sulzbach.....	4739	Studs and bolts cutting and finishing the ends of, J. Nelson.....	4197
“ “ feed apparatus, regulator for, G. Henry.....	4974	Stump extractor, E. Farnsworth.....	5004
“ “ feeding apparatus of, N. Yagh.....	5257	“ “ B. W. Thurman.....	6236
“ “ heating and protecting, J. W. Dunn and G. B. Boyle.....	4200	“ machine, P. J. Ayres.....	4465
“ “ portable, J. Battersby.....	4593	“ and stone extractor, L. J. and A. C. House.....	4508
“ “ smoke consumer for, W. L. Powleson.....	5019	“ &c., machine for raising, B. H. Davis.....	4588
“ “ water regulator and alarm, H. S. Cole.....	4192	“ machine for pulling, F. P. MacKeigan.....	4207
condenser, E. O. Brinckerhoff.....	4172	Stumping machine, J. Fillon.....	4965
“ cylinder packing rings, method of expanding, J. J. Roberts, C. S. and I. R. Pharis and E. Laas.....	4795	Sugar and spirits from cereals, &c., A. Manbré.....	5108
“ drum, H. R. Ives.....	4161	Superheaters, D. Renshaw.....	4130
“ engine, T. A. Elsher.....	4381	Table clothes drier and reading desk combined, J. Bates.....	4959
“ “ G. B. Dixwell.....	4548	“ folding, S. T. Waggoner.....	5026
“ “ G. McNaughton.....	4684	“ “ F. C. Porter.....	4391
“ “ D. K. West.....	4690	“ for ironing, &c., A. H. Swalu.....	4639
“ “ combination of, with cooking stove, T. Penton.....	4419	“ leaf support, J. McElroy.....	4533
“ “ compound, F. Alden.....	5230	Tags, E. D. & O. B. Reynolds.....	4591
“ “ governor, stop motion for, T. Warren.....	4763	Tan vat, S. H. Hall.....	4652
“ “ high pressure, apparatus for, J. Delworth and J. C. Hodgins.....	4137	Tanning hides, A. Robblus.....	4817
“ “ oscillating, G. B. Thurber.....	5276	Taps, wooden, E. A. Hornbosel and E. Carroll.....	4545
“ “ rotary, F. Marsh.....	4153	Target, bell, A. Bedford.....	4970
“ “ surface condensers and feed water heaters for, J. E. Waterous.....	4771	Tea caddy, rotary, R. Malner.....	5071
“ gauge cocks, P. Scholdeld.....	4618	“ kettle, N. A. Manbré.....	4266
“ generators, D. Renshaw.....	4738	Telegraph, apparatus for transmitting sounds telegraphically, E. Gray.....	4949
“ man or walking machine, C. C. Roe.....	4175	“ art of transmitting sound telegraphically, E. Gray.....	4948
“ method of generating and utilizing, D. F. Mosman.....	4449	“ district signal and alarm, E. A. Calahan.....	5089
“ radiators, W. T. Root and W. G. Wood.....	4636	“ quadruplex, T. E. Edison.....	4608
“ trap, R. Patton.....	4258	“ signals, mode and apparatus for transmitting, J. W. Brown.....	5366
“ or water motor, R. H. Atwell.....	4324	T. legraphy, duplex, L. Schwendler.....	4537
Steel, manufacture of, J. P. Sharp.....	4871	Thermo-electric piles, C. Clamond.....	4616
“ iron, &c., manufacture of, W. A. Lytle.....	4607	Thill loop, F. S. Berry and G. F. Alexander.....	5007
“ “ S. R. Smith and J. Simpson.....	5218	Thistles, compound for destroying, J. Payne.....	4929
“ tempering oven, W. Stephenson.....	4411	Thrashing machine, grate separator of, J. Haggert and D. Brown.....	4352
Stench trap, J. C. Spencer and E. Archambault.....	5312	“ “ W. M. Leyde.....	4786
Step ladder, E. W. Grant.....	4705	“ “ G. S. Thompson.....	5221
“ “ J. Blauvelt.....	5072	“ gear, J. C. Bassett.....	5400
“ (extension), E. W. Grant.....	5390	“ grain, F. X. and A. Bellefeuille.....	5249
Stills, F. Beaumont, Jr.....	5369	“ for pease, A. Tolton.....	4559
Stirrups, J. Bull.....	5046	Time lock, P. B. Hennessy.....	4778
Stone and marble, artificial, J. Cowman and S. B. Barber.....	4626	Tire shrinking machine, J. D. Hobbs.....	5380
“ and stump extractor, L. J. and A. C. House.....	4508	“ tightener, F. Kent.....	4103
Stove, W. G. P. Cassels.....	4208	“ upsetting machine, T. Sullivan.....	4416
“ W. L. Phillips.....	4279	Tobacco, chewing, preparing plug, T. C. Williams.....	4341
“ J. W. Elliott.....	4707	“ cutter, J. L. Adams.....	4637
“ W. H. Landon.....	4663	“ machine for manufacturing, E. McMullen.....	4862
“ A. R. Morgan.....	4910	“ plug, T. C. Williams.....	4343
“ W. Burrows.....	5345	“ presses, T. I. Robertson.....	4731
“ base burning, E. Russey.....	4249	Tool, combined, A. Button.....	5394
“ box, false top for, T. O. A. Bayley.....	5053	Toy gun, W. H. Martin.....	5013
“ cooking, W. J. Copp.....	4734	Trace buckle, W. Challenger.....	4812
“ “ L. J. Herard.....	4752	“ fastener, R. Whiting and J. Kyser.....	4273
“ “ R. Thomas.....	5062	“ fastening, C. Robinson.....	4979
“ “ J. D. Smedley.....	5146	Trap, animal, J. Dildine.....	5141
“ “ device for preventing gravy from splattering over, J. Doyland.....	4582	Treenall wedge machine, J. Lennerton.....	4222
“ gas and fuel, J. C. Peacock.....	4296	Trellises, house and garden, W. H. Page and S. Mowry.....	4160
“ heaters, P. S. Laurent and E. Héribé.....	5150	Trowsers, overall, J. Greenebaum.....	5016
“ heating, W. H. W. Sheppard.....	4564	Truss pads, C. Cluthe.....	4183
“ “ L. M. E. Havaeand and V. Marty.....	4567	Tube expander, P. Fitzgibbon.....	5331
“ “ W. and J. W. Buck.....	4810	Tug pin for vehicle shaft, C. J. Riply.....	5188
“ “ M. C. C. Church.....	4989	Tumbling rod and coupling joint covering, J. Harriman.....	5277
“ “ A. Bettes.....	5264	Turbine, mould for casting, G. H. Jones.....	5118
“ hot air dumb, W. Peaker and E. O. Runlons.....	4658	“ water wheel, J. R. McCormack and J. L. Brown.....	4589
“ “ water reservoir for, J. B. Baldwin.....	4138	“ (extension), A. D. Cole.....	4966
“ and fire grates (extension) J. Smith.....	4514	“ “ G. H. Jones.....	5212
“ legs, R. Wheeler.....	5149	Type composer, R. Winder.....	5307
“ metallic shields and supports for, and machine for making, W. M. Conger.....	4187	Umbrellas, J. R. Hayes and J. Somerset.....	4571
“ pipe damper, R. Dalne.....	4747	“ and parasol case, R. S. Galbraith and W. Snow.....	5190
“ “ and spark arrester, H. Harris.....	4397	“ “ J. J. Higgins.....	4151
“ pipes, radiator and damper for, U. Baldwin.....	4385	“ runner, automatic, (extension), J. J. Higgins.....	4306
“ “ shelf, L. B. Doan.....	4144	Vacuum pans, J. Fairburn.....	5350
		Valves, stop, J. M. Melgar.....	4512
		“ cushion seated, steam, air and hydraulic, T. Shaw.....	4396
		“ gear, J. Tesseyman and P. Smith.....	4155
			4206

Aylsworth, Benjamin P., buggy body.....	4518	Beumer, Henry and E. Balkema, waggon axle.....	5269
Ayres, Parley J., stump machine.....	4405	Bigelow, Charles D., (assignee), machine for screwing the	
“ “ portable buggy top.....	5251	“ “ “ soles of boots and shoes....	4577
Babbitt, William H., cooking pots.....	5388	“ “ “ machine for screwing the	
Balley, Dexter S., elevator.....	5054	“ “ “ soles and heels of boots and	
“ James and Frederick A., fruit picker.....	5100	“ “ “ shoes.....	4578
“ Luman, O. J. Stickles and W. R. Remington, milk		Bilharz, Candidus, hammer.....	4633
“ cooler.....	5118	Biddle, Edward, hydraulic jack.....	5174
“ Samuel R., wood bending machine.....	4050	Bird, Matthew, waterproofing and otherwise improving	
Bain, Robert, and T. Saunders, burglar and fire proof safes		“ leather.....	4531
Baker, James H., H. E. and W. A. Susand, saw mill		Bissell, David, arm splint.....	4180
“ dogs.....	4781	“ “ leg “.....	4191
“ John C., grain drilling and seeding machines.....	4835	Bissett, Luther M., sower-shaker attachment for vehicles	
“ Joseph, flour scoop.....	4271	Blackman, Albert L., wheel.....	4969
“ Patrick, sash support and lock.....	4973	Blake, Thomas J., manufacturing shovels.....	1776
“ William C., chain pump bucket.....	4848	“ John G., W. S. Wooton and H. H. Fulton, secretary	
Baldwin, Cyrus W., hydraulic elevators.....	5351	Blakeley, Joseph, railway car axle bearing.....	5352
“ James B., hot water reservoir for stoves.....	4138	Blamey, Richard G., and J. Kulow, churn.....	1180
“ Oren, radiator and damper for stove-pipes.....	1385	Blanchard, Armand H. B., cloth measures.....	5201
Balkema, Edward, and H. Beumer, waggon axle.....	5269	Bland, Henry, sewing machine.....	1553
Ball, William, canal boat.....	5129	Blauvelt, Jacob, step ladder.....	5072
Ballantine, John, and D. Cameron, rotary-bed wood-plan-		Bliss, George H., culinary apparatus.....	5183
ing machine.....	5339	Blow, Jacob, fire kindler.....	4576
Barbarick, John H., slates.....	4540	Blyth, James C., and Alexander, milk can.....	5389
Barber, Samuel, and J. Cowman, artificial marble and		Boeckh, Charles, fibre and bristle combing machine.....	5153
stone.....	4626	Bogle, James S., and C. E. Patric, seeding machine.....	4850
Barclay, George and J. Kennedy, horse rake.....	4151	“ “ seeding machine.....	5217
Barker, Benjamin F., machine for grinding wood for paper		Bolvin, Guillaume, boot and shoe fastener.....	4331
stock.....	4368	Bolton, Henry, potato-digger.....	5178
Barnum, George T. D., and W. F. Dial, speed motion.....	4371	“ “ churn.....	4157
Baron, Jean, and A. Trumble, washing machine.....	4458	Bond, Joseph L., and Dennis Shoff, pawl and ratchet me-	
Barre, Stanislas M., ironing board.....	4717	“ chanism.....	4847
Barron, Francis, and G. M. Bright, printing and engraved		Booth, Gullford D., breech loading guns.....	4276
metal surfaces.....	4259	“ Thomas, pipe wrench.....	5341
Barthel, Albrecht E., and W. Smith, peat machine.....	5271	Borer, John, cultivator or gang plough.....	1558
Bartlett, Edward, potatoe digger.....	4623	Bortree, Moses K., corsets.....	5363
“ Frederick W., ozone machine.....	5337	Bostwick, Nathan, F. W. Phelps and J. Gregory, machine	
“ Sylvanus, saw set.....	4829	“ for grinding the knives of mowing and reaping ma-	
“ William D., heater furnace.....	5303	“ chines.....	1541
Barton, William R., and Clarence E., welt knives.....	4724	Bouter, James S., quilting frame.....	4585
“ “ “ peg cutter handle.....	4729	Bowes, William, wind wheels.....	4633
Bass, Joseph P., (assignee), photograph burnishers.....	4718	Bowker, Richard and John Wilson, machine for the clipp-	
Basset, John C., thrashing machine gear.....	5100	“ ing of horses and sheep.....	4761
Bastel, Louis, electro-magnetic engines.....	5280	Bowman, Amos, construction of railways.....	1600
Bates, Fluis L., nut lock.....	1125	“ George W., drier.....	4283
“ Jasper, combined clothes drier, reading desk and		Boyce, Eli G., and J. N. C. McIntosh, shaft support.....	5117
table.....	4959	Boyle, George B., and G. W. Dunn, heating and protecting	
Battersby, James, portable steam boiler.....	4593	“ steam boilers.....	4200
Bauer, Conrad, and C. Schaal, ice breaking boat.....	4310	“ James, iron moulding machine.....	4215
“ Jacob, G. Seger, J. Hellbrum and J. Konbel, force		Bradford, Lemuel, machine for making the shanks of boots	
“ pump.....	4525	“ and shoes.....	4801
Baugh, John B., dies for welding links.....	4670	Bradley, Earshaw, manufacture of extract of hemlock bark	
Baughman, Henry, saw gummer and sharpener.....	4741	Branch, Joseph W., method of inserting, &c., diamonds in	
Bayer, Joseph, and S. W. Steele, marbleizing compound.....	5285	“ meta lic holders for working in stone.....	5309
Bayley, Thomas O. A., false top for box stoves.....	5053	Bray, Mellen, rivet.....	4241
Baylis, Alfred G., gas burner.....	4784	Brayley, Charles C., rotary engine.....	4926
Bazin, Ernest, dredging boats.....	5375	Brayton, William M., and S. Dobb, hanger for picture	
Beard, Edward, and W. W. Ingraham, grain scourer and		“ frames.....	4101
“ separator.....	4628	Brenar, Abel J., Clark, and F. S. Smith, furnace grate bars	
Beatley, Joseph W., process and apparatus for the manu-		Breneman, Abraham N., boot holder.....	5395
facturing of illuminating gas.....	4980	Brewer, J. DuPuy, fishways.....	4720
Beaudry, Alexander, adze and axe.....	4908	Briant, Pierfort F., and F. Cuny, scrubbing brush.....	4555
“ Philippe, and G. A. Choquette, motor.....	4134	Bridgman, Irwin, railway cars.....	4549
Beaumont, Franklin, Jr., stills.....	5369	Bright, George M., and F. Barron, (assignees), printing	
“ Joseph W., artificial coal.....	4525	“ and engraved metal surfaces.....	4259
Becker, Lewis M., sewing machine.....	4120	Brillinger, Samuel, paint brushes.....	4669
Bedford, Augustus, bell target.....	1870	Brinkerhoff, Edwin O., steam condenser.....	4172
Beers, Edwin A., draught equalizer.....	4923	Britten, Benjamin F., duplex comb.....	4678
“ “ gang plough.....	4882	Brodhead, Francis D., can.....	1201
Behm, Charles, and J. Diehl, pianos and organs.....	4699	Brokenshire, John, ship's pump.....	5191
Beldler, George A., lamp burner.....	4563	Brooks, Edward J., metallic seals.....	1849
Belcher, George D., J. A. Staey, G. K. Griffin and A. Mc-		“ James S., method and device for backing electro	
Eachus, apparatus for detaching small boats.....	5310	“ type shells.....	4903
Bellachey, Samuel, plough.....	5108	“ James W., (assignee), heel trimming machine.....	5358
Bellamy, John, bag holder and truck.....	4919	“ “ heeling machine.....	5359
Bellefeuille, François X., and Achille, grain threshing mill		“ “ machine for attaching and trimming	
“ “ “ horse power.....	5249	“ “ heels.....	5360
Beltram, Samuel W., fire kindler.....	4765	“ Robert C., and A. J. Van Winkle, distilling alcohol	
Bennett, John T. O., manufacture of coke and illuminating		“ extract from wort.....	4222
“ gas.....	4393	Brosius, John M., and S. K. Campbell, car axle box.....	4115
Benson, Joseph, vapour burner.....	5104	Brown, David, and J. Haggert, grain separator of thrashing	
Bentley, Randall, roofs for buildings.....	4696	“ machines.....	4352
Berger, Ambrose J. B., door lock.....	4800	“ Edward J., and C. P. Crossman, salt box.....	4278
Berry, Austin, churn.....	5015	“ James B., milk pan.....	4137
“ Frank S., and G. F. Alexander, thill loop.....	5007	“ “ L., and J. B. McCormack, turbine water	
Bérubé, Etienne and Philippe St. Laurent, stove heaters.....	5150	“ “ wheel.....	4580
Best, John, (assignee), flat iron.....	4740	“ “ W., mode and apparatus for transmitting	
Bettes, Alexander, heating stove.....	5284	“ “ telegraphic signals.....	5366

Brown, William, farm gates	4716	Clark, William A., instrument for wrapping wire, &c., on broken vehicle shafts	4265
Bruce, John M., M. M. Heath and G. E. Underwood, street lanterns	4414	" William A. & Wm. J., and A. O. Kittredge, oil can	5278
Brunelle, Louis P., and S. Mohr, gravity battery	5244	Clay, John, and A. Sawtell, fire lighter	5101
Brush, Alexander M., organ stop action	5392	Cleveland, Caleb T., joint for furniture, &c.	4469
" George S., and F. Dingenais, rock drill	4592	Cliff, Edgar, rein holder	4528
" Louis, passage tickets	4861	Clinton, Charles M., L. Wool, E. C. and C. P. Gregg, horse rake	1216
Bryant, George S., and S. Williams, mixing machine	5214	Close, Walter R., friction catchwheels	4504
Bryce, John, H. Hogan and J. G. Gibson, concrete blocks veneered with marble	4782	Cluthe, Charles, truss pads	1183
Buck, William, and Judson W., heating stove	4810	Cobb John J., slides and wings for cutter sleighs	1695
Buchner, Julius, picture exhibitor	5131	Cobleigh, Russell, children's carriage	4227
Buerk, Jacob E., watchman's time detector	1839	Cochrane, William F., harvesting machine	1232
Bullington, Edwin E., J. W. Johnson, C. M. Manville, S. W. Alvard, L. B. Rodgers, E. R. Myer, I. Vosburg, C. F. Nichols and C. M. Dunlop, fanning mill	5182	Codd, George S., and H. M. Converse, apparatus for blinds, scenes, &c.	4432
Bull, John, straps	5046	Codyé, John C., water filter	4239
Bumpus, Delos H., T. J. Gordon and W. H. Keeler, lubricating oil	5035	Colby, Harriet N., combined stove shelf and bread toaster	4814
Burke, Patrick, gas carburettor	4260	Cole, Ashley D., turbine water wheel	4966
Barns, James T., root cutter	5110	" Henry S., water regulator and alarm for steam boilers	4192
Burrows, William, stove	5315	" Jeremiah F., motive power for churn	4619
Butler, Henry C., gang saw hanger	4164	Collins, George, saw bucks	1994
Button, Alphonso, combined tool	5394	" James, feed cutter	4950
Byrns, James O., advertising indices	5349	" Joshua, bag tie and fastener	4505
Cahuc, Raymond, mining powder	4995	Colvin, Verplank, portable boat	5210
Cahaban, Edward A., district signal and alarm telegraph	5059	Comey, William M., game	4257
Caldwell, George W., and C. L. Holland, laundry polish	5003	Commins, John, fire kindler	5169
Calhoun, Whitney E., corn sheller	4142	Conboy, Daniel, vehicle	4280
Cameron, Daniel, and J. Ballantine, rotary bed wood planing machine	5339	Conger, Walter M., metallic shields and supports for stoves, &c., and machines for making	4187
Campbell, George, and T. McKay, fire proof shutter	5126	Connell, John P., door bell	4957
" John, churns	4177	Connor, James H., washing machine	5340
" Nathan, curtain fixture	4898	Conrad, Jacob, and J. H. Fabringer, elevating building materials	4326
" Samuel K., and J. M. Brosius, car axle box	4415	Contrell, Charles C., and J. T. O'Brien, weaving heading for fringes, &c.	4362
Camyre, Jean B., and L. A. Dessaulles, manufacture of cigars	1710	Converse, Henry M., and G. S. Cold, apparatus for blinds, scenes, &c.	4432
Cant, Adam, wood planing machine	4530	Cook, George W., and E. H. Horsey, car truck	5203
Carpenter, John, wagon spring	4395	" Peter, hoop cutting machine	5336
Carroll, Edward, and E. A. Hornbostel, wooden taps	4545	Cooke, Robert F., horse shoes	4610
" James W., and J. Stauffer, sash fastener	4815	Copeland, George W., boots and shoes	5238
Carter, Henry, machine for stretching carpets	4988	" " boot and shoe wax thread sewing mechanism	5216
Casgrain, Henri E., gas machine	5076	" " boot and shoe lasting machine	5385
" and George Drolet, illuminating gas machine	4455	Copp, William J., cooking stoves	4731
Cassels, Walter G. P., stove	4208	Corbin, Charles J., horse rake	4191
Caswell, Ezra, clamping attachment for vices	4828	Corey, Aaron L., and E. W. Grant, chain pump bucket	4643
" L. Whitlock and S. Scott, hub boring machine	4253	" David P., car-coupler	1686
Caterson, William M., poison bottle	4934	" Aaron L., and E. W. Grant, chain pump bucket	4725
Catling, James J., weather strip	5305	Cornell, Augustus, quilting frame	5275
Catnack, Donald D., oil heating process	4297	" David S., washing machine	4746
Chalker, William H., L. Munro, D. McArthur and G. Macgwire, (administrators), spooler and pneushion combined	4888	" " and E. B. White, straw cutter	4417
Challenger, William, trace buckle	4812	Côté, Louis, heel stiffener shaping machine	4569
Chamberlin, Albert S., and A. S. Douglas, stove pipe shelf	5014	" " machine for trimming and finishing boot and shoe soles	4470
" Charles A., cable chains	5320	" " machine for bending and forming stiffeners for boots and shoes	4498
Chapin, Edward F., and E. O. Presby, lamp extinguisher	4891	" " and Isafe Fréchette, stiffeners for boots and shoes	4767
" Gardner B., D. L. Toppin, and D. C. and H. H. Meloon, wood planing machine	4527	Cottingham, Gideon W., sad iron	5295
Chartiers, William C., and M. McKain, nut machine	4675	" " clothes ironing machine	5296
Charland, Paul, movable roof	4614	Coursey, Thomas B., water wheels	4514
Chase, John C., washing machine	4963	Courtelle, Herenstein, plastering powder	5218
Chatterton, Richard D., railway carriage coupling	5228	Cowan, John, and W. J. Wauchope, (executor), gas manufacture	4664
" " railway carriage draw bars and springs	5241	Cowman, John, and S. B. Barber, artificial marble and stone	4626
Chavasse, Auguste, and A. Rambouillet, composition for removing boiler scale	5382	Cowper, Peter H., and F. Scholes, apparatus for manufacture of rubber belting	5010
Chisholm, George D., and S. Douglas, device to prevent horses from jumping, &c.	4191	Crabtree, Abraham, middlings separator	4869
Choquette, Gilbert A., and P. Beaudry, motor	4434	Creat, Francis C., and D. Anderson, propeller wheel	5498
Chrystie, Albert N., and Sir A. T. Galt, spark arrester	4204	Crieh, William, spring bed	4318
Chubb, Frederick J., lime kiln	5341	Crocker, Samuel L., process for smelting and refining copper ores, &c.	4539
Church, Marius C., heating stove	4989	Crompton, George, and J. F. Donoghue, anti-incrustation battery for boiler	4554
" Titus S., E. B. Flint and G. W. Gregory, method of cleansing furniture, &c.	4960	Crosby, Addison, machine for cleaning flues	5335
Clamond, Charles, thermo-electric piles	4616	Cross, Richard E., and W. A. Stevens, furnace for making wrought iron direct from the ore	5314
Clements, Charles W., jib and sail-bank	4581	Crossman, Charles P., and E. J. Brown, salt box	4378
Chapp, Emersons D., and P. Van Patten, fifth wheel for carriages	4880	Crowell, John H., weavers' harness	4912
Clark, Charles B., brush, cloth and mop holder	5226	Cummings, Allan, screw	4692
" " lock hinge	5235	" " lip for steel metal measures	4872
" Joseph, F. S. Smith and A. Brear, furnace grate bars	4962	Cunningham, Albert, saw mill dog	5184
" Josiah L., and J. Staudfield, floating docks and pontoons	4840	" " Peter B., running gear for vehicles	4674
" Nelson W., fish hatching apparatus	4927	Cuny, Francois, and P. T. Briant, scrubbing brush	4555

Herbert, Charles G., plumber's joint	1827	Jenks, Charles W., shirt front.....	4700
Herron, Thomas, and J. Dangan, churn	5021	Jeness, Orlando, vehicle spring.....	4522
Hewitt, John, ore crusher.....	5078	Jewell, Charles, grain binder.....	4677
" " glossing and sluting irons.....	4907	Johnson, Arthur P., and J. M. Munro, horse hoe	1896
" Leonard J., railway car wheel.....	4275	" Edwin W., grain cleaner.....	5364
Hibbard, Susan M., feather duster.....	4351	" Job, ball castors.....	4116
Hickey, Patrick, and J.C. Moore, shield can for shipping oil	5105	" John W., C. M. Manville, S. W. Alvord, E. E. Buffington, L. B. Rodgers, E. R. Myer, J. Vosburg, C. F. Nichols and C. M. Dunlop, fanning mill.....	5182
Higgins, Barnabas A., machine for bending wood for handles of shovels.....	4709	" Margaret A., lamp chimney protector.....	1610
Higgins, John J., automatic umbrella runner, 1151 4305	4306	" Moses, hoes.....	4736
Higley, Aaron, railway axle box.....	4996	" William H., barn door hanger.....	5090
Hill, Charles E., structures for piers, &c.....	5325	" " and W. W. Robertson, plane iron adjustment.....	4131
" Ebenezer, Jr., linings for cylinders	4693	" " C. A. Foote and G. E. Marvine, milk pan.....	5393
" Grace C., (assignee), ironing board	4937	Jones, Amanda T., (assignee), food preserving process.....	5037
Hobbes, Joseph D., tire shrinking machine	5380	" Charles K., and E. Davids, fumigating and fire lighting coal oil can.....	4150
Hodgins, John C., and J. Dilworth, apparatus for high pressure steam engines.....	4137	" Christopher C., pump.....	4509
Hodgson, John, smoke consumer.....	4479	" David, lubricators.....	4171
Hodgson, Thaddeus, circular saw guard.....	4543	" George H., mould for casting turbines.....	5118
Hogle, Henry, gate	1902	" " turbine water wheel.....	5212
Holden, Oliver, apparatus for separating substances from liquids.....	5371	" John B., railway signals for level crossings.....	4733
Holgate, George, process of preserving animal and vegetable substances.....	6068	" William, bed spring.....	4202
Holland, Charles L., lock nut	5216	Joselyn, " combined separator and fanning mill.....	4609
" " and G. W. Caldwell, laundry polish.....	5003	Kaiser, Jacob, grain or corn crusher and splice mill	4111
Hollingshead, Hugh, land roller	4171	Kalbelsch, Franklin H., carrier for acids.....	5185
Holman, Chester C., box.....	5237	Kallmeyer, Gustav, and E. Schmidt, sewing machine.....	5197
Holmes, Asher, churn dasher.....	5361	Kane, Thomas, coal ash shifter.....	5245
" George M., mechanism for planing the cogs of bevel gear wheels	4310	Kater, " plano-forte.....	5050
Holt, George H., and W. D. Peters, device for pumping water out of a vessel which has sprung a leak.....	4924	Kearney, Daniel, automatic fire alarm and extinguisher... ..	5378
Holwell, William A., sash regulator.....	4554	Keddy, James, securing knob roses to doors.....	5043
Hood, Cornelius, combined ladder and wash bench	5152	Keeler, William H., T. J. Gordon and D. H. Bumpus, lubricating oil.....	5035
Hooper, William E., William J., Theodore, and James E., and B. Arnold, machine for making netting for fishing, &c.....	4398	Keene, George A., carriage and car step.....	4178
Hopson, Albert S., and W. W. Lambie, vehicle springs.....	5033	" Samuel D., cotton cleaning machine	4136
Howd, Byron J., and W. H. Wright, railway trucks	5059	Keim, " mill stone dress.....	4687
Hornbostel, Ernest A., and E. Carroll, wooden taps.....	4543	Keith, William, and H. J. Yeargin, land roller and harrow combined.....	5192
Hornstby, Augustus H., extension arm chair.....	4604	Kelly, David M., machine for trimming the ends of bolts and rivets.....	5085
Horsley, Edwin, pump.....	4586	" George, feather renovating machine	5181
" Edward H., and G. W. Cook, car truck.....	5203	" James M., and O. F. Gue, railway train brake	4360
Houlton, Greenleaf, and H. Osburn, car axle box.....	4503	Kemp, Joseph S., manure spreading machine.....	4659
House, Luther J. and Albert C., stump and stone extractor	4508	Kendall, Orson B., water regulator and low water indicator.....	4777
Howard, Elijah L., hem stitching attachment to sewing machine	4196	Kennedy, Charles, wire fence	4701
Howe, Hemy A., harvester.....	5223	" Frederick C., and E. R. Powell, wheel harrow... ..	4126
" Jarvis, sand papering machine.....	5198	" James, and G. Barclay, horse rake.....	4159
Howell, George W., (co-inventor and assignee), metal creasing machine.....	4762	Kent, Frederick, the tightener.....	4403
Howland, Edmond S., metallic grinding ring dress.....	5386	Kerr, John L., guns.....	4521
Hubbell, Martin, horse collars.....	4971	Killey, Joseph H., and W. Muirhead, steam boiler.....	5242
Hudgin, Robert H., gate	4473	Kimball, Lewis, Jr., meat chopping tray.....	4332
Hunt, Charles W., automatic railway	4885	" Nelson, portable and stationary fence.....	5291
Huntington, Gideon, clothes washer	4203	King, Job, and M. McCall, cutting attachment to lead pencils.....	5010
Husband, Joseph D., fire kindler	4750	" Wendell R., balling plasterer's hair	4287
Hussey, John H., shoe	5113	Kinney, Israel, lock and key guard	4330
Hutchings, Charles, rein-holder.....	4797	Kittridge, Anson O., W. A. and W. J. Clark, oil can.....	5278
Hutchinson, Clark, nut lock	4831	Kitzmiller, Edward A., broom handle painting machine... ..	4838
" John C., and M. D. Murray, (assignees), breast collars for harness	4612	Klneck, James, meat preserving process.....	5093
" Moses, heating drum.....	4298	Knott, Kennard, method of slaughtering, preparing and packing meat for exportation.....	4168
" James, and J. Gerhardt, portable resawing gang saws.....	5091	Koebel, John, G. Seger, J. Hellbrunn and J. Bauer, force pump.....	4525
Ibbotson, Edward C., railway joint	4526	Koerber, Alexander R., musical reed instruments	5055
" " ventilating railway cars.....	5373	Krehblel, John J., and E. Wright, carriage spring	4478
Iles, George, adjustment of magnetic needles.....	5083	Kulow, John, and R. G. Blamey, churn.....	4480
Imboden, John D., car axle lubricator	5199	Kyser, James, and R. Whiting, trace fastener.....	4273
Imlay, Charles G., fare device for street cars.....	4612	Laas, Emil, J. J. Roberts, C. S. and I. R. Pharis, method of expanding steam cylinder packing rings.....	4795
Ingersoll, Platt C., bed bottoms.....	4742	Laberge, Us-lus B., ironing table.....	4179
Inghs, William and James, vessels used for floating elevators and screw propellers for same.....	4135	Lalain, Addison H., (assignee), machine for disintegrating fibrous substances.....	4930
" " " grain storage boat	1289	" " " disintegrating fibrous substances for paper pulp	4939
Ingraham, William W., and E. Beard, grain scourer and separator.....	4628	Laing, James, overhead sewing machines.....	4390
Irvine, William, horse collar.....	4190	Lakin, " A., overdraw checks for horses.....	4491
Irwin, Thomas, hot air furnaces.....	4410	Laliberté, Clovis, machine for trimming boot and shoe heels.....	4834
Isaacs, Jacob L., and R. Halliday, step ladder.....	4818	Lalonde, Charles F., machine for separating nails, &c., when taken out of tin bath.....	4268
Ives, H. R., (assignee), steam drum	1161	Lamb, Salem T., and B. F. Avery, nut lock and washer	4381
James, Joseph, bag holder	4998	" " " " washer	4138
Jasper, Gustavus A., method for promoting the combustion of fuel in furnaces	4325	" William A., waggon seat.....	4301
Jebb, William T., and L. F. Harvey, station tickets for railways, &c.....	4252	" Willard, carriage movement of saw mills, planers, &c.....	4359
Jeffery, Richard W., reaping machine.....	4646		

Mills, Clark W., apparatus for discharging grain, &c., from vessels.....	4984	Nutting, Stephen, wheel hub.....	1832
Mitchell, Albert E., churn.....	5000	Nye, Asa, Jr., feed bags for horses.....	5079
" Alexander, spark arrester.....	4694	O'Brien, John T., and C. C. Contrell, weaving headings for fringes, &c.....	4362
" Andrew W., carriage spring.....	4189	O'Connor, James L., and H. Dockham, pruning shears.....	5011
" John, and W. W. Lewis, horse shoe blank rolling machine.....	4388	O'Day, Andrew J., ore crushing and rock breaking machine.....	4309
" Samuel, carriage hub.....	5109	O'Dwyer, William H., waggon seat springs.....	5089
Mohr, Sigismund, and L. P. Brunelle, gravity battery.....	5244	O'Hara, Walter and Charles M., non-conducting coverings for boilers.....	1181
Moncrieff, William D. S., locomotive carriages for tramways, &c.....	5330	Olds, Aloxzo W., fence.....	1715
Montejo, Miguel A., O. Pagan and T. L. Ricart, boiler tube expanders.....	4895	Oot, Adam, churn.....	5313
Mood, Lynfred, C. M. Clinton, E. C. and C. P. Gregg, horse rake.....	4216	Orcutt, Charles H., machine for cutting and skiving leather.....	4978
Moodie, David, potato digger.....	4462	Orum, Morris L., and C. H. Mellor, mandrel for bending pipes.....	5074
Moody, Henry C., children's carriages.....	5208	Osburn, Henry and G. Houlton, car axle box.....	1503
Moore, Charles C., pencil holder for slate frames.....	4295	Osgood, Joseph H., composition for printer's inking roller.....	4124
" chewing gum candy.....	4374	" Ralph R., dredging machine.....	4922
" George R., propeller.....	5082	Osmer, Oren S., drawing machine.....	1145
" James C., and P. Hickey, shield can for shipping oil.....	5105	Otis, George W., lightning conductors.....	4277
" Stephen and H. Rodgers, making counters for boots and shoes.....	4361	Outerson, John and Andrew, filter.....	4722
" Wortley, machine for cleaning ploughs.....	4983	Packer, Daniel F., artificial fuel.....	1357
Morenel, David C., blowing engine.....	4335	Pagan, Orestes, T. L. Ricart and M. A. Montejo, boiler tube expanders.....	4895
Morgan, Alonzo R., stove.....	4910	Page, William H., and S. Mowry, (assignees), house and garden trellises.....	4160
" Gerry, machinery for making wedges.....	4517	Paige, John K., George W. and Jeremiah A., box machine.....	4583
Morgonmeter, John W., varnish for coating photographic negatives and glasses.....	4303	Paing Samuel, window blind.....	4233
Morin, Joseph, concentric guide for planing and grooving machine irons.....	4711	Palmer, George H., army equipments.....	1791
Morrell, John H., floodway for warehouses.....	4865	" Richard B., earth auger.....	1719
" Samuel, and C. Reinhardt, spring bottom bedstead.....	4764	Paradis, Rémi, shingle machine.....	4500
Morris, Royal, and W. H. Curtis, carpet stretcher.....	4162	Parham, Charles, suction and force pumps.....	1181
Mortimer, Daniel, art of rulling paper.....	4140	Parker, Carlos H., water wheel.....	4396
Moses, Frank, heating apparatus.....	4182	" C., potato digger.....	4622
Mosman, Daniel F., method of generating and utilizing steam.....	4149	Parmelee, Henry S., automatic fire extinguisher.....	4132
Moulton, John, and S. R. Thompson, bark rasping machine.....	4704	" Walcott J., art of producing wrought metal carriage axle boxes.....	5196
Mowbray, George M., explosive compounds.....	4769	Patric, Charles E., and J. S. Bogle, seeding machine.....	4850
" frictional electric battery.....	4875	Patrick, Robert, and J. A. Macdonald, double acting reversible rotary pump.....	4936
Mowry, Samuel, and W. H. Page, (assignees), house and garden trellises.....	4160	Patterson, Chester R., planing machine.....	4991
Murphy, Alexander A., and C. C. Hearle, fire extinguisher.....	4484	Patteson, William, milking machine.....	4668
Moyer, Cyrus E., felt shoe last.....	4314	Patton, Richard, steam trap.....	4258
Muir, William, hoistways.....	4375	Payette, Adolphe, axle boxes.....	5370
Muirhead, Walter and J. H. Killey, steam boiler.....	5242	" " and axle boxes.....	5381
Muller, John G., and William, gas machine.....	4244	" Louis, pontoon for raising sunken vessels.....	5116
Munn, Columbus, veneer cutter.....	5019	Payne, Henry A., hub boxes and bands.....	4723
Munro, John M., and A. P. Johnson, horse hoe.....	4896	" John, compound for destroying thistles.....	4929
" Lester, D. McArthur, W. H. Chalker and G. Macgwire, (administrators), spooler and pin cushion combined.....	4888	Peace, Frank P., and J. W. D. Williams, breech loading fire arms.....	4566
Murch, Chauncey M., lamp reflector.....	4987	Peacock, John C., gas and fuel stove.....	4296
Murdoch, Horatio W., and M. E. Snider, pocket door-fastening.....	4841	" non-conducting material.....	4506
Murry, Michael D., and J. C. Hutchinson, (assignees), breast collar for harness.....	4612	" Thomas, and John C., gas cooking apparatus.....	4300
Myer, Elijah R., C. M. Manville, J. W. Johnson, S. W. Alvord, E. E. Bullington, L. B. Rodgers, I. Vosburg, C. F. Nichols and C. M. Dunlap, fanning mill.....	5182	Peaker, William, and E. O. Rantons, hot air dumb stove.....	4658
Myers, Jacob H., harvester rakes.....	4839	Pease, Dan, machine for cleaning buckwheat.....	4946
" James H., shirt.....	5130	" Julius A., lamps.....	4536
" Leonard, and T. Armstrong, horse shoe machine.....	4440	Peck, Duane, and S. L. Porter, railway rail support.....	5256
" Platt B., and S. Rough, carpet stretcher.....	4261	Peel, William C., and J. V. Elster, dash boards for vehicles.....	5301
Myles, William, and C. Levey, method of locking and un-locking nuts.....	4349	Penton, Thomas, combination of steam engine with cooking stove.....	4419
Nell, William F., horse hay rake.....	5271	Peters, Alfred E., combination lock.....	5001
Nelson, Hugh, gravity battery.....	4451	" George B., lubricating compound.....	4851
Nelson, James, cutting and finishing the ends of bolts and studs.....	4197	" William D., and G. H. Holt, device for pumping water out a vessel which has sprung a leak.....	4921
Newell, Augustus W., bottles and stoppers.....	4925	Pettengill, Manasseh, automatic car-coupler.....	1495
Nichols, Collin F., E. R. Myer, C. M. Manville, J. W. Johnson, S. W. Alvord, E. E. Bullington, L. B. Rodgers, I. Vosburg and C. M. Dunlap, fanning mill.....	5182	Pharis, Charles S. and Isaac R., J. I. Roberts and E. Laas, method of expanding steam cylinder packing rings.....	4795
Nicholson, John, Jr., glass furnaces.....	4771	Phelps, Ebenezer W., J. Gregory and N. Bostwick, machine for grinding the knives of mowing and reaping machine.....	4511
Nickerson, John, milk and meat safe shelf.....	5222	Phillips, William L., stove.....	4279
Nicolle, Phillip, beehive.....	4587	" Albert J. R., Samuel R. and Charles L., ice creeper.....	5362
Noack, Oswald, crimping machine.....	5133	Pickel, Russell, and J. Leet, railway switch.....	4945
Nolan, John, water wheel.....	4749	Pomeroy, Henry S., automatic lid prop.....	5123
Norman, Samuel T., (assignee), galvanic belts, &c.....	4254	Pond, Daniel B., H. A. Stearns and L. Flagg, washing machine.....	4801
North, William C., ventilating faucet.....	4515	" Levi W., saw mill head block.....	5368
Nugent, Richard C., and R. McGrager, machine for turning flanges on boiler heads.....	5383	Pope, Albert A., air guns and pistols.....	4531
Nutting, Rufus, lantern.....	4688	" Frank L., electric signalling apparatus for railways.....	5011
" George E., and J. C. Githens, steam drill.....	5061	Poppenhusen, Adolph, comb.....	5372
		Porter, Edward N., (assignee), milk pan.....	4263
		" Frank C., folding table.....	4391
		" John B., ironing table.....	4653
		" Samuel L., and D. Peck, railway rail support.....	5256

Porth, John, and H. Schouerte, nail machine.....	4552	Root William T., and W. G. Wood, boiler magazine for heating coal.....	4561
Post, Alfred A., liquid meter.....	4900	“ “ “ “ steam radiator.....	4636
Powell, Edwin R., and F. C. Kennedy, wheel harrow.....	4496	Roricck, John C., butter worker.....	1904
Powers, Luther A., rake.....	1, 79	Rosamond Woolen Company" (assignee), process and apparatus for cleaning cloth.....	5365
Powleson, William L., smoke consumer for steam boilers.....	5019	Ross, John B., and O. V. Flora, saddle-tree.....	4131
Prentice, John, cigar moulds.....	5017	Rough, Solomon, and P. B. Myers, carpet stretcher.....	4261
Presby, Edwin O., and E. F. Chapin, lamp extinguisher.....	4891	Rourke, Francis, ventilating sewers and man-ces.....	1560
Price, Warren W., combination of lantern and dinner kettle.....	4952	“ “ ventilating of sewers.....	1897
Prince, John, apparatus for cooling milk.....	4312	Rowe, Horace E., feather renovator.....	1181
Prior, Thomas, churn.....	4118	“ Samuel, and G. R. Edwards, whiffletree.....	4188
Proctor, David R., spark arrester.....	5023	Rowley, Richard, and T. R. Venners, machine for rolling tapered bars.....	5306
Proudfoot, Frederick, drum heater.....	4336	Roy, Joseph, invalid chair.....	5115
Prowse, George R., clothes mangle.....	4876	Royce, John S., harvester.....	4461
Ragot, Henry, glass furnaces.....	4884	Royer do la Bastie, F. B. A., process and apparatus for tempering glass.....	1267
Rambouillet, Arsène, and A. Chavasse, composition for removing boiler scale.....	5382	Rugg, Percival N., wash bench.....	4757
Ramsay, Charles S., H. F. McKervoy, A. McKay and P. McRea, car-coupler.....	5357	Runions, Edward O., and W. Peaker, hot air dumb stove..	4658
Ramsdell, George, process for making wood gas.....	1304	Russ, Cyrus, harvester.....	1981
Ramsden, John C., securing the combustion of fuel and utilization of gases thereof.....	4843	Russell, Jacob, horse shoe machine.....	5143
Randall, William, injectors for boilers.....	1807	“ Leonard W., fence corners.....	1618
Rathbun, Hugo B., and Edward W., machine for cutting the headings of barrels.....	4492	Russey, Esck, base burning stove.....	4249
Raveaud, Louis M. E., and V. Marty, heating stoves.....	4567	Ryckman, Samuel S., (assignee), lamp chimney cleaner..	5205
Rawbone, William G., cartridge cresers.....	1651	Rydbeck, Sven, mortising machine.....	4656
Rawson, David W., clothes washer.....	5193	Ryder, Henry, furnace grate.....	4290
Redgrave, Samuel C., liquid measure.....	4170	Rykert, Alvaro G., carriage painters' jack.....	5211
Reed, Joseph W., lubricator.....	5213	St. John, Roswell H., sewing machine.....	5216
“ William H., gas carburetter.....	5231	St. Laurent, Philippe, and E. Berné, stove heaters.....	5150
“ “ air blower for carburetter.....	5243	Ste. Marie, Pierre C., screw windlass for steamers and sailing vessels.....	5095
Reeves, George P., lacer.....	5317	Sadler, Robert, railway snow plough.....	5111
Regan, John, framings and moulds to make wells, cement pipes, drains, &c.....	5176	Sale, Julian, jr., wallets, pocket books or purses.....	4821
Reinhard, Christopher, and S. Morrell, spring bottom bedstead.....	1703	Sampson, William S., kilns for calcining lime, &c.....	1621
Remington, William R., O. J. Stickles, and L. Bailey, milk cooler.....	5118	Sauborn, Augustus, swivel plough.....	5060
Renshaw, David, super-heaters.....	4130	Sanders, George N., and George N., jr., spikes, &c.....	5122
“ “ steam generators.....	4738	Satterlee, LeRoy, heating apparatus.....	4355
Reynolds, Edward D. and Oliver B., tags.....	1591	Saunders, Thomas, and R. Bain, burglar and fire proof safes.....	5081
“ George H., rock drilling machine.....	4857	Sawtell, Alfred, and J. Clay, fire lighter.....	5101
Rhind, Frank, lamp.....	4291	Scarlett, Edward C., railway car-coupling.....	4322
Rhodes, Armitage, and E. G. Scovill, art of piling iron.....	5120	Schadl, Christoph, and C. Bauer, ice breaking boat.....	4340
“ Henry H., railway car axle.....	4307	Schanderly, Harleta A., corset.....	5048
“ Isaac M., fracture bed.....	4281	Scheuerle, Henry, and J. Porth, nail machine.....	1552
Ricart, Thomas L., O. Pagan and M. A. Montejo, boiler tube expanders.....	4895	Schmidt, Edwin, and G. Kollmeyer, sewing machine.....	5197
Rice, John, rolling hoisting apparatus for saw mills.....	5175	Schnabel, William, wood elastic seat.....	1783
Richards, Arthur W., perambulating cot.....	5125	Schramm, John M. and Charles T., shingling roofs.....	4236
Richardson, David M., wheat polisher and separator.....	5326	Schofield, Peter, steam gauge cocks.....	4618
“ Isaac C., steam heating apparatus.....	5171	Scholes, Francis, and P. H. Cowper, apparatus for manufacture of rubber belting.....	5010
“ Ivory N., playing cards.....	5254	Schwender, Louis, duplex telegraphy.....	4337
“ Thomas, and M. McInnes, plough.....	4501	Scott, James, jr., composition stamp.....	4823
Riddell, Archibald, suction and force pump.....	5576	“ Samuel L. Whitlock and E. Caswell, hub boring machine.....	4253
Rigby, James, apparatus for the manufacture of gas from petroleum, &c.....	5038	Scovill, Edward G., (extension) machine for charging heavy piles for heating iron preparatory to rolling.....	1714
Ricker, Carroll L., non-conducting covering.....	5031	“ “ and A. Rhodes, art of piling iron.....	5120
Riply, Charles J., tug pin for vehicle shafts.....	5188	Scoville, Elijah U., and Washington L., door banger.....	1251
Risher, Thomas A., steam engine.....	1364	Scribner, George W., reed organs.....	1539
Ritchel, Charles F., brush block boring machine.....	4497	Seaman, Emeline, (administratrix) window blind.....	4891
Robbins, Asa, tanning hides.....	1817	“ William H., composition and process for testing the purity of dye in black silk thread.....	5005
“ Robert D., mowing and reaping machine.....	5251	Seaver, Gilman W., and N. D. Martin, (assignees,) milk cooler.....	5206
Robert, Jean B., lime kiln.....	4799	Seger, Garret, J. Heilbrunn, J. Koebel and J. Bauer, force pump.....	4525
Roberts, James J., C. S., and I. R. Pharis and E. Laas, method of expanding steam cylinder packing rings.....	4795	Seipt, Anthony H., and J. D. Hubner, governor for horse powers.....	5119
Robertson, Thomas I., tobacco presses.....	4731	Sellnas, Charles W., and A. A. Stimson, door spring.....	1392
“ William W., and W. Johnston, plane iron adjustment.....	4431	Sells, Hugh, elder mill.....	5255
Robinson, Charles E., apparatus for oil burning furnaces.....	4556	Seymour, William H., scaffold clamp.....	5328
“ Clark, trace fastening.....	1970	Shaffer, Julius S., knitting machine.....	4666
Rodgers, Alexander, circular saw carriage.....	4418	Sharp, Dennis P., horse rake.....	5099
“ gang saw mills.....	1429	“ James P., manufacture of steel.....	4871
“ Lyman B., C. M. Manville, J. W. Johnson, S. W. Alvord, E. E. Butlington, E. R. Myer, J. Vosburg, C. F. Nichols and C. M. Inlopp, fanning mill.....	5182	Shaw, Charles A., (assignee) lamp wick.....	4216
Roe, Cyrenus C., steam man.....	4175	“ George W., and C. E. Mattison, spinning machine..	5268
“ “ machine belt buckle or fastener.....	4493	“ Thomas, steam, air and hydraulic cushion seated valve.....	4396
“ David E., fly trap.....	4821	Shea, William, milk cooler.....	4661
Rogers, Henry, lock.....	5029	Sheldon, Cevadra B., butter package.....	4342
“ Homer and S. Moore, making counters for boots and shoes.....	4361	“ “ furniture castor.....	4334
“ John S., extracting gelatine from salted fish skins.....	5259	“ James H., (co-inventor and assignee), illuminating gas.....	5154
“ “ sewing machine castor.....	4477	Shoppard, William H. W., heating stoves.....	4561
Rood, “ combination pl. dlock.....	1932	Sheraton, Alfred B., machine for cleaning and beating carpets, &c.....	4750
Root, Dexter A., combination pl. dlock.....	1932		
“ Lawrence O., railway cars.....	5282		

Sherwood, Samuel, water wheel.....	4708	Stilson, Lyman B., car truck.....	4895
Shimer, George J., cutter head.....	5131	Stimson, Ashbel A., and C. W. Sellmas, door spring.....	4392
Shipe, Walter S., plane guide.....	1317	Stockwell, Emmons R., carriage top.....	1855
Shirreff, John, freezing and refrigerating machines.....	5258	" Henry B. and E. L. Mextill, self-lighting gas burners.....	1117
Shoff, Dennis, and J. L. Bond, pawl andatchet mechanism.....	4817	" John A., boots and shoes.....	1220
Shory, William C., horse hay knife I forks.....	4911	Stone, John H., bottoms of milk cans.....	1175
Silverthorn, Newman, machine for caulking, &c., hogs after being killed.....	5106	Strong, Samuel B., pump.....	529
Simmons, George P., and J. Franz, quilting and mat frame.....	4398	" Stephen, soap.....	5112
Simonds, George F., apparatus and process for tempering and straightening saws without hammering.....	5288	Struthers, John, snow ploughs.....	4770
Simpson, Charles G. C., railway locomotive and car wheels.....	5027	Stobbs, Jesse, road scraper.....	5032
" Joseph, and S. R. Smith, apparatus and compound for producing iron, steel, &c.....	5218	Sturgeon, John C., and Carson J., lawn mower and harvester.....	4221
Sims, John, elder mill.....	5381	Sturtevant, Benjamin F., machine for compressing peg ribbon.....	4519
Slpe, Conrad A., apparatus for depositing coffins.....	1917	" " fastening for boots and shoes.....	4520
Slprell, Bartus W., rock reamer.....	4211	Sugden, John, and J. P. Galloway, horse checks.....	4512
Sldmore, Abel F., hoop machine.....	5170	Sullivan, Thomas, tire upsetting machine.....	4416
Skinner, Carlos, drum heater.....	1113	Sulzbach, Carl W., apparatus for preventing steam boilers from exploding.....	4739
" William E., quadrant bevel gauge.....	4933	Surls, George C., kiln.....	4195
Slichter, Jacob B., elastic paint compound.....	5297	Susand, Henry E. and William A., and J. H. Baker, saw mill dogs.....	4781
" " fire proof paint.....	5299	Sutherland, Robert, churning machine.....	5322
" " fire proof roofing cement.....	5298	Syahn, Alva H., tables for ironing, &c.....	4639
Silker, Henry, and Richard Taylor, rail joint and nut lock.....	1810	Swartz, William G., insect gathering machine.....	5012
Sloper, Byron, hydrogen generator and carburetter combined.....	4619	Sylvester, Richard, spring hoe.....	4321
Smale, James, seamless shoe.....	5321	Tackaberry, James H., buggy top.....	5300
Small, Adoniram J., barrel lifter.....	4793	Tapley, Frederick C., knitting machine.....	5279
Smalley, Elmer A., rein holder.....	1158	Taplin, Albin, forming sheet metal threaded collars.....	4857
Smedley, John D., cooking stove.....	5116	Taylor, Carlo R., apparatus for seasoning lumber.....	1285
Smith, Frank S., J. Clark and A. Brear, furnace grate bars.....	4962	" DeWitt C., water meter.....	5308
" Hamilton L., single rail railway.....	4766	" Henry, humps.....	4576
" Henry, wind wheel.....	1205	" James, burglar proof safes.....	4358
" James B., car coupler.....	4806	" " G. and Henry F., horse powers.....	4387
" " H., and J. G. Taylor, extension fire ladder.....	4153	" " P., battery guns and repeating ordnance.....	4161
" John, stove and fire grates.....	4511	" John G., and J. H. Smith, extension fire ladder.....	1153
" Joseph R., clothes wringer.....	4218	" Jonathan V., bed bottom.....	5015
" Nelson E., (administrator) milk cooler.....	4883	" Richard and H. Silker, rail joint and nut lock.....	4846
" Preserved, and J. Tesseyman, valve gear.....	4155	" Ven Rensselaer, blacksmith's forge.....	4816
" Samuel R., and J. Simpson, apparatus and compounds for producing iron, steel, &c.....	5248	Telfer, James, lump holding attachment to sewing machine.....	4228
" Silas G., machine for removing snow from railways.....	4188	Perry, Charles A., setting diamonds in drills, &c.....	4219
" William, and A. E. Barthel, peat machine.....	5271	Tesseyman, John, and P. Smith, valve gear.....	4206
Snell, Sylvester, straw and barley fork.....	4603	Thibault, Magloire, capstan.....	4186
Snider, Martin E., and H. W. Murdoch, pocket door fastening.....	4814	Thomas, George C., lock nut washer.....	4262
Snyder, Charles R., work table.....	4698	" Robert, cooking stove.....	4176
Soffe, Henry, faucet.....	4317	Thompson, George H., A. A. and M. O. Mathews, apparatus to prevent horses from jumping.....	5155
Somerset, John, and I. R. Hayes, umbrellas.....	4571	" Gregory S., threshing machines.....	5221
Southwood, Richard D., and E. C. Tozer, freezing apparatus.....	4466	" John, face tester from millstones.....	4145
Spalding, Charles, W. Gooding and A. Winchester, coal elevator.....	4308	" " E., steam cooking.....	4270
Spence, Archibald, boilers for heating water or raising steam.....	4682	" Judson L., and F. N. Davis, paper barrels.....	4256
Spencer, Charles L., and N. W. Westcott, knitting loom.....	5245	" Orrin B., and W. W. Grier, carriage.....	5075
" John C., and E. Archambault, stench trap.....	5312	" Perley M., pipe wrench.....	5092
" Sylvanus, burial casket.....	4912	" Samuel R., and J. Moulton, bark rasping machine.....	4704
Splee, Robert, gas apparatus.....	4159	Thornton, Thomas, apparatus for closing doors and gates.....	5315
Spleer, Samuel, hame lock.....	5022	Thurber, George B., oscillating steam engine.....	5276
Splnehl, Dominique, saponification of mineral oils.....	4712	" " " water and air pump.....	5329
Sprague, Austin V. M., combination ice tool.....	4597	Thurman, Benjamin W., stump extractor.....	5236
" Harvey, carriage and waggon.....	5098	Tiffany, Eli, circular knitting machine.....	4654
Stacy, James A., G. D. Belcher, G. K. Griffin and A. McEachern, apparatus for detaching small boats.....	5310	Tilton, Joseph C., wash boiler.....	4391
Stafford, William, harrow and cultivator.....	1152	Tinker, George B., ox bow fastener and guard.....	4337
Standfield, John, and J. L. Clark, floating docks and pontoons.....	4840	Tison, Jean B., (assignee), window fastening machine.....	4133
Stark, John D., lubricators for car axles.....	4638	Tolton, Andrew, machine for threshing pease.....	4859
Stauffer, John, and J. W. Carroll, sash fastener.....	4815	" Benjamin and Andrew, harvester attachment for cutting pease.....	4727
Steadman, George H., machine for removing snow from railways.....	5136	Topley, Daniel J., fire extinguisher.....	4861
Stearns, Henry A., churn dasher.....	5006	Toppau, Daniel L., D. C. and H. H. Meloon, and G. B. Chapin, wood planing machine.....	4527
" " D. B. Pond and L. Plagg, washing machine.....	4801	Torrie, William S., soap.....	4559
Stebins, Timothy, hydraulic elevator.....	5189	Town, Franklin E., gang saw mill.....	4803
Steele, David, apparatus for extinguishing fires.....	5261	Townsend, Joseph E., cleansing, disinfecting and preserving feathers, &c., used in beds.....	1269
" Samuel W., and J. Bayer, marbleizing compound.....	5285	Tozer, Edmund C., and R. D. Southwood, freezing apparatus.....	4466
Steger, Joseph, air brake.....	5080	Trabue, William, needle machine.....	4146
Stephenson, William, steel tempering oven.....	4411	Tracy, Arthur, horse power.....	4735
Stevens, Thomas T., and A. Wood's, life saving appliances.....	4572	Trumble, Adolphus, and J. Baron, washing machine.....	4458
" William A., and R. E. Cross, furnace for making wrought iron direct from the ore.....	5311	Tucker, Edward, and J. S. Wallace, fire extinguisher.....	4892
Stewart, John J., pegging jack.....	5096	Tuerk, Frederick W., water wheels.....	4173
Stickles, Orrin J., W. R. Remington and L. Bailey, milk cooler.....	5118	Underwood, George E., J. M. Bruce and M. M. Heath, street lanterns.....	4114
		Van Allan, Cleoro D., churn and washer combined.....	4968
		" de Carr, R. De Luc, canister for tea, &c.....	4652
		" Doren, Francis, corn planter.....	5097
		" Liew, Dennis F., grain doors for freight cars.....	4354

" Patton, Frederick, and E. D. Clapp, fifth wheel for vehicles.....	4873	4880	Whitely, William N., mower and reaper.....	4863	5402	5403
" Winkle, Abraham J., and R. C. Brooks, distilling alcohol extract from wort.....	4292		Whiteside, Daniel, carpet cleaning machine.....			4958
" Zandt, Robert S., extension step ladder.....	4873		" Henry, Jr., mattress.....			5396
Vassie, William, and Frederick M. Willson, lamp holding attachment for sowing machine.....	4571		Whiting, Ryley and J. Kyser, trace fastener.....			4273
Venners, Thomas R., and R. Rowley, machine for rolling tapered bars.....	5306		" Lorrain C., piano pedal attachment.....			5146
Vessot, Joseph, Sr., and Samuel, harrow and roller combined.....	4224		Whitlock, Levi, E. Caswell and S. Scott, hub boring machine.....			4253
Volney, Carl W., explosive compounds.....	4524		Whitney, Edwin R., hay loader.....			4405
Von Esser, Wilhelm S., cleaning boiler tubes by steam.....	4211		Wickes, William W., refrigerator.....			4255
Vosburg, Isaac, L. R. Rodgers, C. M. Manville, J. W. Johnson, S. W. Alvard, E. E. Buffington, E. R. Myer, C. F. Nichols, and C. M. Dunlop, fanning mill.....	5182		Widdifield, Watson P., circular saw carriages.....			4890
Waggoner, Benjamin, kang plough.....	4421		" " " " wheeled vehicle brakes.....			5290
" " " " iron neck yoke.....	4422		" " " " railway brake.....			5333
" " " " Samuel T., folding table.....	5026		Wiegand, S. Lloyd, grate bars for furnaces.....			4409
Wagner, Benjamin R., (administrator) and P. Edwards, churn.....	4964		Wilcox, Carlos and J. J. Curran, lumber dryer.....			5094
" " " " William R., churn.....	4467		Williams, Albert D., dinner pail.....			4920
Walker, George S., clothes wringers.....	4535		" " " " George, friction pulley blocks.....			4250
" " " " " " W., portable range.....	4914		" " " " Henry A., machine for rolling crimping tacks, awls, &c.....			5227
" " " " Hugh L., sewing machine shuttle.....	4672		" " " " Isaac F., rubber boots.....			4402
" " " " William, tubular lantern.....	4517		" " " " " " " " " " last.....			4408
" " " " " " " " L., and B. G. Devoe, metallic fence.....	4681		" " " " James F., boot and shoe latchet loop.....			4423
Wallace, Ferrand G., mill trams.....	5302		" " " " W. D., and F. P. Peace, breech loading fire arms.....			4566
" " " " John S., and E. Tucker, fire extinguisher.....	4892		" " " " Phillip, machine for cleaning fruits.....			4350
" " " " Samuel, cheese box.....	5316		" " " " Samuel, and G. S. Bryant, mixing machine.....			5214
Walbridge, Alexander S., horse rake.....	4874		" " " " Thomas C., preparing plug chewing tobacco.....			4341
Walling, George, machine for producing a current of cold air round mill stones.....	5186		" " " " " " " " plug tobacco.....			4343
" " " " John Z., apparatus for breaking horses.....	4826		Willson, Alfred, P. E. Drake and E. M. Law, car-coupler.....			4389
Walsh, Maurice, and M. Ahearn, bread slicer.....	4372		" " " " Frederick M., and W. Vassie, lamp-holding attachment for sewing machine.....			4571
Wandby, Henry, kiln for the calcination of plaster of Paris, &c.....	4579		Wilson, Adam A., compound for mixing paint.....			4841
" " " " " " " " machine for making stove-pipe stones.....	5173		" " " " Charles D., compounds for picture frames.....			4773
Wanzer, Richard M., sewing machine.....	4581		" " " " F. Cortez, oil can.....			4282
" " " " " " " " and J. B. McCune, ramming and moulding machine for metal castings.....	4476		" " " " " " " " and J. G. Evenden, measuring pump for drawing oil from cans.....			4363
Ward, William, and W. J. Garton, wax thread heating machine.....	4127		" " " " James L., watch.....			4486
Warner, Emma E. O., hinged baking pan.....	5343		" " " " Joel, furnace for reducing iron ores.....			1165
Warren, Thomas, stop motion for steam engine governors.....	4763		" " " " John and R. Bowker, machine for clipping horses and sheep.....			4761
" " " " " " " " Wellington, centre pieces.....	4737		" " " " Joseph A., automatic clothes wringer and bench combined.....			4951
Wasell, Edward, trusses for bridges and roofs.....	4379		" " " " Mary G., vegetable boiler.....			4209
Waterbury, Milan, lamp extinguisher.....	4918		" " " " Melvin, harrow.....			4673
Waterous, Julius E., surface condensers and feed water heaters for steam engines.....	4771		" " " " Robert, horse rake.....			5355
Watkins, Albert H., vapour burner.....	5207		" " " " Thomas B., and M. P. Hayes, evaporating furnace.....			5058
Watson, Ellphalet, and E. E. Mann, apparatus for fog signals.....	5105		" " " " William J., preserving and packing cooked meats.....			4568
Wattles, Hiram J., vegetable washer.....	4217		Winchester, Arthur, W. Gooding and C. Spalding, coal elevator.....			4308
Wauchope, William J., (executor) and J. Cowan, gas manufacture.....	4664		" " " " Edward S., rock drill.....			4982
Weare, John H. and Nathan, cooking utensil.....	4198		Winder, Robert, type composer.....			5307
" " " " " " " " culinary ".....	4611		Wendrath, Carl, cigar bunching machine.....			4935
Webber, Thomas E., harness lug lining.....	4772		Wingard, Edward V., brick burning.....			5077
Webster, James F., leaf supporter for sewing machines.....	4320		Winnett, David R., oil still.....			4443
" " " " John F., screw machine.....	4617		Wisner, James E., fertilizer sower.....			4697
" " " " " " " " Stephen, oil tank.....	5195		" " " " " " " " horse hay rake.....		4935	4631
Welf, Alexander, splining wheel.....	5127		" " " " Wareham S., seed sowing machine.....			4291
Wells, Thomas, shovel.....	4671		Witmer, Tobias, slicing machine.....			4373
Wells, Henry M., window blind fastener.....	5052		Wolf, Horace S., cleansing gas retorts.....			5219
West, Daniel K., steam water or other engines.....	4690		Wood, Albert, and H. Wright, watchmen's patrol register.....			4323
" " " " John W., spooling machine.....	4551		" " " " Peter, shaft coupling for cutters.....			5262
" " " " William and George, bedstead.....	4271		" " " " William G., and W. T. Root, boiler magazine for heating coal.....			4561
Westcott, Nathaniel W., and C. L. Spencer, knitting loom.....	5245		" " " " " " " " boiler magazine for steam radiator.....			4636
Westman, William D., scroll saw.....	4825		" " " " " " " " T., lamp extinguisher.....			4899
Wetherell, James S., buggy seats.....	5138		Woods, Arthur, and T. T. Stephens, life sawing appliances.....			4572
Wheeler, Cyrenus, Jr., cutting apparatus for harvesting machines.....	4617		Woodward, Erastus, and E. D. Goodson, eyeletting machine.....			4377
" " " " Newman W., process and apparatus for reducing iron and other ores.....	4156		Wooton, W. S., J. G. Blake and H. H. Fulton, secretary.....			4230
" " " " Russell, stove legs.....	5149		Worster, Alexander, locking latch.....			5273
" " " " William F., fertilizer holder and distributor.....	4852		Wright, Enos, and J. G. Krebbel, carriage spring.....			4475
White, Eli B., barrel or circular box.....	5172		" " " " Philemon, back band for cart saddle.....			4886
" " " " " " " " and D. G. Cornell, straw cutter.....	4417		" " " " Sylvester J., and A. Wood, watchmen's patrol register.....			4323
" " " " Francis G., artificial bone.....	4511		" " " " William B., barber and dentist's chair.....			4972
" " " " George, carriage.....	4212		" " " " " " " " H., and B. J. Howd, railway trucks.....			5059
" " " " Hiram W., guitar head.....	5165		Yagn, Nicholas, feeding apparatus of steam boilers.....			5257
" " " " " " " " chin rest for violins.....	5167		Yeargin, Henry J., and W. Keith, land roller and harrow combined.....			5192
" " " " James B., omnibus.....	4284		Yentzer, Enoch S., pantalon stays.....			4447
" " " " Samuel S., dental engines.....	4199		Yeoman, William P., ear ring.....			1787
" " " " Stephen, suspended whistle-tree.....	4167		Yocum, John, plough.....			5346
			Young, Barker C., buckle attachment.....			4660
			" " " " Henry J., hay loader.....			4436
			" " " " Levi H., punching machines for washers, &c.....			4400

The Canadian Patent Office

RECORD

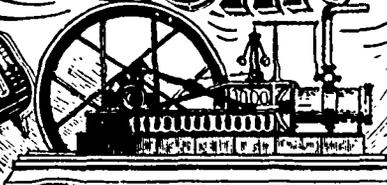
Vol. III.—No. 1.

JANUARY, 1878.

Price in Canada \$2.00 per An.
United States - \$2.50

CONTENTS.

INVENTIONS PATENTED,	131
INDEX OF INVENTIONS,	137
INDEX OF PATENTEES,	138
ILLUSTRATIONS,	139

INVENTIONS PATENTED.

No. 4130. DAVID RENSHAW, Boston, Mass., U. S., 3rd December, 1874, for 5 years: "Improvements on Superheaters." (Perfectionnements aux surchauffeurs.)

Claim.—1st. A superheater E, an induction pipe D, arranged partly above and partly below the grate C; 2nd. In combination with supply pipes G, of a superheater E, an induction pipe D, of greater diameter than said supply pipe; 3rd. In combination with an inner induction pipe D, a superheater E, receiving steam from the former; 4th. The induction pipe D, constructed as described with perforations in combination with the superheater E, within which it is arranged; 5th. The superheater globe E, provided with an inlet e, and outlet extension e', as described, the latter being of less capacity than the former.

No. 4131. ORFANDO V. FLORA, and JOHN B. ROSS, Madison, Ind., U. S., 3rd December, 1874, for 10 years: "Saddle Tree." (Fût de selle.)

Claim.—1st. The body and cantle A, which are made of one piece of wood, steamed bent and set in proper shape, and provided with a wooden bleat C; 2nd. In combination with the bent body and cantle A, the bent wood-crook B, secured thereto by letting partially into the same, as specified.

No. 4132. HENRY S. PARMELEE, New-Haven, Ct., U. S., 3rd December, 1874, for 5 years: "Automatic Fire Extinguisher." (Extincteur automatique d'incendie.)

Claim.—1st. In combination with the sprinkler E, valve F, spring I, and fusible supports, the cap H, extending down around the said supports; 2nd. In combination with the sprinkler E, valve F, spring I, and fusible supports, the adjustable screws N, and non-conducting material a; 3rd. The combination of the sprinkler E, valve F, spring I, fusible supports and the drip cup d; 4th. In combination with the supply pipe A, and distributing pipes, the valve B, between the supply and distributing pipes, the tube T, communicating from the supply pipe below the valve to the distributing pipe above and to the piston R, the said piston provided with a spring U; 5th. In combination with the distributor B, the cup C, attached thereto by a fusible material; 6th. In combination with the valve E, and its seat F, the projection L, on the valve through the water seat; 7th. In combination with an alarm and a valve through the movement of which the alarm is operated, a passage through or around the valve to permit the flow of sufficient water, or whatever it may be, above the valve as described.

No. 4133. WILLIAM H. FOYE, Portland, Me., U. S., 3rd December, 1874, for 5 years: "Bill Holder and Paper Fyle." (Groupe-notes et serre-papiers.)

Claim.—1st. The combination of the base b, and piece e, hinged strip f, spring j, having the edge i, flap a, flap c, and end piece g;

2nd. The combination of the base b, end piece e, strip f, spring j, having the edge i, flap a, flap c, catch l, and piece g, and side pieces d; 3rd. The combination of the back piece a', provided with the bands or wires e', upon which are held the folded index sheets b', each pair of said sheets having the series of successive folds d', as described.

No. 4134. BERNHARD LEVY, New York, U. S., 3rd December, 1874, for 10 years: "Combined Overcoat and Carriage Robc." (Par-dessus et robe de voiture combinés.)

Claim.—A robe having a top portion B, hood C, D, sleeves E, and pockets H, constructed and arranged as described, so that the sleeves are outside when the article is used as a coat, but may be turned into the pockets when it is used as a robe; the combination with hood C, having top D, of the robe having button N, as described, so that the piece C, D, may be used as a hood or collar.

No. 4135. WILLIAM INGLIS, Bolton, Eng., and JAMES INGLIS, Montreal, Que., 3rd December, 1874, for 15 years: "Improvements on the Construction of Vessels Used for Floating Elevators and on the Arrangement of the Screw Propellers Used in the same." (Perfectionnements dans la construction des vaisseaux employés pour tenir à flot les élévateurs, et dans l'ajustage des propulseurs à hélice pour cet objet.)

Claim.—1st. The arrangement of propeller B, situated as described, with inclined shaft D; 2nd. The arrangement of the engine and the cross shaft G, with the gearing and sliding crank or disc K, for connecting the engine to drive the screw propeller, as set forth.

No. 4136. SAMUEL D. KEENE, Providence, R. I., U. S., 3rd December, 1874, for 5 years: "Cotton Cleaning Machine." (Machine à nettoyer le coton.)

Claim.—1st. The combination of a scratcher or beater and drawing rolls with an adjustable mote board all arranged to operate together, as described; 2nd. The combination of the condensing rolls K, K', and the drawing rolls B', B'', with the grill M, all operating together as described.

No. 4137. JOSEPH DELWORTH, and JOHN C. HODGINS, Toronto, Ont., 5th December, 1874, (Extension of Patent No. 171), for 5 years: "Apparatus for High Pressure Steam Engines." (Appareil pour les machines à vapeur à haute pression.)

Claim.—1st. The perforated plate F, in the chamber A; 2nd. The mud cocks at G, G, at the chamber A, and at E, E, at the bottom of the apparatus; 3rd. The flanged joint H, of the top tube below; 4th. The V-shaped vulcanized rubber packing in the recess, in combination with the flanged joint H, for readily detaching the tubes from the apparatus; 5th. The recess for receiving the packing; 6th. The combination of the several parts constructed, arranged and operated substantially as described.

No. 4138. JAMES B. BALDWIN, Toronto, Ont., 9th December, 1874, for 5 years: "Hot Water Reservoir for Stoves." (Reservoir à eau chaude pour les calorifères.)

Claim.—A reservoir A, with a downwardly projecting tube C, in combination with a fire pot D, or its equivalent, as specified.

No. 4139. IRA P. MERWIN, Syracuse, N. Y., U. S., 10th December, 1874, for 5 years: "Improvements in Drain-pipe Moulding Machines" (Perfectionnements aux machines à mouler les tuyaux de drainage.)

Claim.—1st. In combination with the core standard having head H, and base E, the crotchet wedge bar F, arranged to slide in suitable supports or on the underside of the platform A, as described. 2nd. The combination with the flask of the core L, having the base lugs M, the core standard having lugs K, the same being thus adapted for connection and disconnection as specified.

No. 4140. DANIEL MORTIMER, Ottawa, Ont., 10th December, 1874, for 5 years: "Art of Ruling Paper." (Art de régler le papier.)

Claim.—A pattern sheet, Fig. 2, laid upon the sheet to be ruled when passing through the ruling machine, having openings C, to allow the pens of the ruling machine to strike upon the underlying sheet to be ruled, the pattern sheet receiving the continuation of the lines from "stop" to "strike" in the manner set forth.

No. 4141. ERASTUS W. EVANS, Boston, Mass., U. S., 10th December, 1874, for 5 years: "Car Washer." (Laveuse de wagons.)

Claim.—A car washer or sash brush, composed of the united parts, and of the combination of the parts A, and A', having bristles or other suitable material fastened in A, the said parts A, and A', being provided with a furrow C, with an india rubber band D, secured in the furrow in the manner described.

No. 4142. WHITNEY E. CALHOUN, St. Johns, N. B., 10th December, 1874, for 5 years: "Corn-sheller." (Egreoir à blé-d'inde.)

Claim.—1st. The combination of the revolving disc D, with the sheller bars S, S'; 2nd. The combination of the hollow cylinder C, with the revolving disc D, tongue t, and groove g; 3rd. The combination of the revolving sheller bars S, S', with the knives or spurs t, t'; 4th. The combination of the sheller bars S, S', with the pivots i, i', and springs u, u'; 5th. The revolving sheller arms S, S', set spirally to feed the ear as it is shelled; 6th. The concave and fluted guide L; 7th. The combination of the fluted guide L, and the dated and revolving cylinder U; 8th. The combination of the guide J, the spring M, and the adjusting screw S, and arm N; 9th. The combination of the spring u, with the posts e, and sheller bars S, so arranged that the spring can be removed as described; 10th. The combination of the main frame A, arms B, B', cylinders C, driving gears I, H, G, and F, revolving disc D, sheller arms S, S', springs u, u', feeder O, guide L, and spring m, all arranged and operating together as described.

No. 4143. CARLOS SKINNER, Waterloo, Que., 10th December, 1874, for 5 years: "Drum Heater." [Poêle sourd.]

Claim.—The drum A, constructed with inlet and outlet smoke apertures E, F, having internally a series of longitudinal air tubes B, and open ended cap C, forming a cold air distributing chamber for connection with a cold air duct D, as set forth.

No. 4144. JACOB KAISER, York, Ont., 10th December, 1874, for 5 years: "Grain or Corn Crusher and Spice Mill." (Mouture pour blé-d'inde et pour les épices.)

Claim.—1st. The frame A, shaft B, pulley B', handle B'', and bevel wheel B''', the upright spindle C, level pinion C', and tared disc C'', with under grinder C'', the concave cylinder D, with springs d', d'', and upper grinder D', hopper H, shoe S, and bracket L, as set forth; 2nd. The dress upon the face of the grinders D', and C'', in the mill, and also the various other kinds of dress, as shown in the drawings marked Figs. 8, 11 and 14, and illustrated by models marked Nos. 8, 11 and 14, which accompany the model of the machine.

No. 4145. OREN S. OSMER, Boston, Mass., U. S., 10th December, 1874, for 5 years: "Darning Machine." (Machine à repriser.)

Claim.—1st. The combination of a series of needles supported by a sliding carriage and operating to lay a series of yarns in parallel directions with a suitable clamp for changing the positions of these yarns and presenting them at right angles to the axes of the needles and into such a position that the next series of yarns laid shall interlace with them; 2nd. The combination with a series of needles mounted and operated as explained of a pair of upright guides or cases for supporting or clamping the work while being operated upon, and a plunger sliding within each guide under such an arrangement that when the first series of yarns is laid the faces of the plungers are detached and when the second course of yarns is laid the plungers meet and compel the second to interlace the first at right angles as stated; 3rd. The combination of the guide J, plunger C, cam block e, and sloping abutment; 4th. A sliding carriage and a series of needles in combination with devices for shifting the positions of the yarn; 5th. The combination with a machine for darning various objects or effecting analogous results organized as shown of a tension device essentially as stated; 6th. The combination with a machine for darning various objects or effecting analogous results organized as explained of a device for cutting the refuse ends of the yarn essentially as stated; 7th. A needle having one boundary of its eye reduced to a sharp edge for cutting the yarns; 8th. Placing the guide plate through which the needles pass at an angle to or obliquely with the path of movement of the needles in order to sever but one yarn at a time, or the series of yarns in succession; 9th. The combination with one of the guide cylinders or plungers of a device for locking the latter in position and preventing breaking of the needles; 10th. In combination with the stem of the plunger of the notched disc m, and bolt k, or their equivalents as stated; 11th. The arrangement of the teeth of the plungers as described, whereby the yarns are caused to travel or be laid in a path similar to the teeth saws; 12th. The combination with one of the plungers and guide cylinders preferably the upper of a means of adjusting the relative height of such plunger with respect to its mate; 13th. The employment of the tubular sleeve I, as a means of adjusting the height of the plunger as stated.

No. 4146. JOB JOHNSON, Brooklyn, N. Y., U. S., 10th December, 1874, for 5 years: "Improvements on Ball Castors." (Perfectionnements aux roulettes de meubles sphériques.)

Claim.—1st. The cylindrical socket a, open at both ends, and containing the ball b, in combination with the plate c, resting at its edges against a bearing within and around the ball-socket and the anti-friction bearing d, secured into a recess in the said bearing plate as set forth; 2nd. The separate bearing plate c, provided with a recess and a hardened anti-friction bearing, in combination with the cylindrical socket and ball of the castor as specified.

No. 4147. HENRY B. STOCKWELL and EDWARD L. MCGILL, Brooklyn, N. Y., U. S., 10th December, 1874, for 5 years: "Self-lighting Gas Burners." (Bees à gaz à allumage automatique.)

Claim.—1st. The combination of the magazine G, guide J, and r, swinging hammer D, spring d, cam E, cock B, and the burner of its tip C, as specified; 2nd. One or more feeding wheels k, in combination with the gas-cock B, and ribbon magazine G; 3rd. The shield or shields t, on the hammer D; 4th. The percussion or priming ribbon I, having its fulminate m, composed of the described ingredients or their equivalents, in or about the proportions named and for the purpose specified.

No. 4148. GABRIEL DESGEORGES, Montreal, Que., 10th December, 1874, for 5 years: "Apparatus for the Storage and Transportation of Petroleum." (Appareil pour l'emmagasinage et la transportation du pétrole.)

Claim.—An apparatus for the storage and transportation of petroleum, &c., composed of an outer chamber A, provided with discharge cock G, and inner chamber B, with opening C and plug D, discharge cock E and gauge F, as described.

No. 4149. THOMAS GALBRAITH, Port-Hope, Ont., 10th December, 1874, for 5 years: "Lock-Nut Bolt." (Boulon à noix de sûreté.)

Claim.—A slit or parting A in the point of a bolt B, so that the said point can be expanded as specified.

No. 4150. WILLIAM HAARMANN, Berlin, Prussia, 10th December, 1874, for 5 years: "Manufacture of Vanilline." (Fabrication de la Vanilline.)

Claim.—The production of artificial Vanilline by treating conifer or the cambial juice of conifer or coniferin, or a watery extract of conifer or any substance containing coniferin by either of the two processes as set forth.

No. 4151. JOHN J. HIGGINS, New York, U. S., 10th December, 1874, for 5 years: "Automatic Umbrella Runner." (Douille automatique de parapluie.)

Claim.—In combination with the stick C and springs c, c', of an umbrella, the runner composed of the inner tube A and outer tube B, all constructed and arranged to operate as set forth.

No. 4152. WILLIAM STAFFORD, Montreal, Que., 10th December, 1874, for 5 years: "Harrow and Cultivator." (Herse-cultivateur.)

Claim.—1st. The frame a, a'; 2nd. The mode in which the teeth d, d' are secured to the frame a, a'; 3rd. The mode of attaching each section to master-tree h, regulat'g or draught holes k, k', in frames a, a'; 4th. Regulat'g or draught holes in centre of master tree h.

No. 4153. FRANKLIN MARSH, Northampton, Mass., U. S., 11th December, 1874, for 5 years: "Rotary Steam Engine." (Machine à vapeur rotatoire.)

Claim.—1st. The combination of the slide valves D and D', the steam passages or ports h, h', h₂ and h₃, and the piston B, said combination and arrangement giving to the engine the feature of a double cut off, as described; 2nd. In combination with the piston B, the reverse valves a₁, a₂, a₃, and a₄, the slide valves D and D', and the passages h, h₂, h₃, and h₄, as set forth; 3rd. In combination with the piston B, the passages h, h₂, h₃, and h₄, the reverse valves a₁, a₂, a₃, and a₄, the slide valves D and D', and the exhaust passage n as set forth; 4th. In combination with the passages h, h₂, h₃, and h₄, the reverse valves a₁, a₂, a₃, and a₄, the lever l and the connecting rods e, whereby a reverse rotary movement is given to the piston B, by moving all said reverse valves at once through the medium of said lever and rods as described; 5th. The arrangement of the passages h, h₂, h₃, h₄ and the steam chambers c, extending and beyond said passages in combination with the valves D and D', whereby said valves are moved inward by the force of the steam entirely and operate at their rear ends, to cut off the steam from entering said passages when the valves are at their extreme outward position, as set forth.

No. 4154. GEORGE BARCLAY and JAMES KENNEDY, Oshawa, Ont., 11th December, 1874, for 5 years: "Improvements on Horse Rakes." (Perfectionnements aux râteliers à cheval.)

Claim.—1st. The combination of the spring shooting bar D, having pins e, d, slotted hollow axle C, and collar B, having radial grooves f with the wheel hub A, to operate as described; 2nd. The draw-bracket I, secured to the draw bar and sleeved on the axle, having a cam projection j, for automatically disengaging the pin e, from the radial grooves f, in the process of dumping; 3rd. Providing the rake with a foot bracket G, hinged centrally to its pivotal connection and having a lever e, as described; 4th. The tooth holders K, bolted separately to the axle and formed with a slotted vertical projection L, and having a slot h' in the base to hold the tooth in position as set forth.

No. 4155. JOHN TESSEYMAN and PRESERVED SMITH, Dayton, Ohio, U. S., 11th December, 1874, for 5 years: "Valve Gear." (Appareil de Soupape.)

Claim.—1st. The combination of valve moving lever C, c, actuated directly by the piston rod A, reciprocating plunger E, c, and spring G, connected and operating in the manner specified; 2nd. The combination of cam D, h, lever c', c, plunger E, c, and spring G; 3rd. In combination with plunger E, c, and fixed support F, the adjustable head f, adjustable nut I, and spring G, operating as specified.

No. 4156. NORMAN W. WHEELER, New York, U. S., 11th December, 1874, for 15 years: "Process and Apparatus for the Reducing of Iron

and other Ores." (Procédé et appareil de réduction des minerais de fer et autres.)

Claim.—1st. The process of reducing metals from the ores thereof described, that is to say by showering granulated ore downwards through a double atmosphere composed of a column of flame over a column of reducing gases. 2nd. In combination with means for reducing metals, by showering the ore down through a double atmosphere, consisting of a rising column of flame, over a rising column of reducing gases, the process described of transferring it from the foot of the shaft A, to the hearth of the oven B, connected therewith and there exposing it to the action of flame produced and controlled in the manner set forth. 3rd. The process described of making carbon steel, that is to say, by showering iron ore down through a double atmosphere consisting of a rising column of flame over a column of reducing gases, into a bath of carbonized iron, maintained in a state of fusion as described. 4th. The process of making chrome steel described, that is to say, by showering the ores of chromium and iron, in measured relative quantities, down through a reducing shaft containing a rising column of flame over a rising column of reducing gases, into a bath of molten metal. 5th. The feeding apparatus consisting of the cylinder m, hopper k, and suitable means for guiding the ore; 6th. The combination of the feeding apparatus with the reducing shaft A; 7th. The combination of both ore and flux feeding apparatus with the reducing shaft A; 8th. The combination of the gas conduit a, leading from a gas producer and a reducing shaft A, having the full combustion air holes g, g, and feeding holes t, t'. 9th. The combination in a reducing shaft A of the full combustion air holes g, g, ore feeding holes t, t', and flux feed holes c. 10th. The combination of a reducing shaft, as A, having full combustion air holes g, g with the furnace or oven B, gas conduit a, air conduit b, and door i, as described.

No. 4157. THOMAS HEAD, Copetown, Ont., 11th December, 1874, for 5 years: "Potato-Digger." (Extracteur à patates.)

Claim.—1st. The combination of moveable or shaking grated mould board B, to plough or digger; 2nd. The combination of rod C, crank D, shaft F, for communicating motion to grated mould board B, and the use of moving or other machine as prime mover to shaft F, as set forth.

No. 4158. ELMER A. SMALLEY, Hyde Park, Vt., U. S., (Assignee of N. F. Reed and T. O. Andrus, 11th December, 1874, for 5 years: "Rein-Holder." (Accroche guides.)

Claim.—1st. In combination with the cams D, D, and screw B, the adjustable elastic cord a. 2nd. The combination of the clamp, A, A', post C, rod b, cams D, D, all constructed as set forth.

No. 4159. GEORGE BARCLAY and JAMES KENNEDY, Oshawa, Ont., 11th December, 1874, for 5 years: "Improvements on Horse Rakes." (Perfectionnements aux râteliers à cheval.)

Claim.—1st. The combination of the cog wheel B, affixed to the hub, A, and a pawl bracket C, secured to the axle having a spring pawl D, to operate as described. 2nd. The projecting arm H, secured to the draw bar to release the pawl engagement, automatically as set forth.

No. 4160. WILLIAM H. PAGE and SAMUEL MAWRY, Greenville, Ct., U. S., (Assignees of G. C. Setchell), 11th December, 1874, for 5 years: "Improvements on House and Garden Trellises." (Perfectionnements aux treillis de maison et de jardin.)

Claim.—The trellis described, made by subdividing boards into rectangular strips and bars, and fastening the subdivisions together in various curved forms by the spring of the curved parts in the manner set forth.

No. 4161. HUBERT R. IVES, Montreal, Que., (Assignee of W. Burlingame), 11th December, 1874, for 5 years: "Steam Drum." (Réservoir à vapeur.)

Claim.—A steam drum or reservoir divided into two compartments as set forth; the lower compartment receiving steam from the generator by a series of ports and the partition between the chambers being perforated as explained, the whole being as stated.

No. 4162. WILLIAM H. CURTIS and ROYAL MORRIS, Buchanan, Mich., U. S., 11th December, 1874, for 5 years: "Carpet Stretcher." (Tendeur de tapis.)

Claim.—1st. The combination of the toothed bar A, lever B, balls b, b', and the bar C, provided with the ratchet c, and hook d; 2nd. The bar A, provided with tooth a, for holding the carpet, while being stretched as set forth.

No. 4163. FRANCIS McGUIRE, Toronto, Ont., 11th December, 1874, for 5 years: "Improvements in Boiler Feeders." (Perfectionnements aux alimentateurs des chaudières à vapeur.)

Claim.—1st. The upright case B, having water gauge I, and "ry-cocks J, attached with detachable bottom B, in combination with and connected to the boiler A, by the pipes U, and C, arranged as set forth; 2nd. The float G, with connecting rod a, lever E, hinged to the standard E, connecting links F, and lever F, pivoted on the standard E, and having the shorter arm F, enlarged to form a disc f, in combination with the supply plug D, arranged as described; 3rd. The plug H, in combination with the case B, arranged as described.

No. 4164. JAMES P. TAYLOR, Elizabethten, Ten., U. S., 11th December, 1874, for 5 years: "Battery Guns and Repeating Ordnance." (Canons de batterie et bouches à feu à répétition.)

Claim.—1st. The oscillating cylinder 8, and sliding cylinder 10; combined to operate as set forth; 2nd. The construction of the sliding cylinder 10, with spiral grooves having terminal notches or recesses adapted to lock the said cylinder in its forward position by the action of studs or projections on an outer cylinder engaging in such grooves and recesses as explained; 3rd. A lock cylinder carrying plungers which contain firing pins, and through the medium of a suitable charging block force the cartridges forward into their places within the barrels; 4th. The hooked retracting rods carried by the sliding cylinder and adapted to engage with the charging block as explained; 5th. The charging block consisting of a pair of plates held together by a clamp screw as set forth; 6th. The spring lips 32, to bear on the flanges of the cartridges; 7th. The guide pins or rods applied to the charging block for the purpose set forth; 8th. The firing mechanism consisting of guiding pins driven forward by springs and one or more revolving cams which retract and release said pins; 9th. The attaching nut 27, screw stem 23, and pin or spline 26, permitting the removal of the handle 25, or its ready attachment in operative position.

No. 4165. JOEL WILSON, Dover, N. J., U. S., 11th December, 1874, for 5 years: "Furnace for Reducing Iron Ores." (Fourneau pour réduire les minerais de fer.)

Claim.—1st. The arrangement and combination of the circular series of upright rotors B, and intervening flues C, the internal chamber E, within said series for the products of combustion, and the collecting chamber I, for receiving said products after they have traversed the intervening flues; 2nd. The arrangement and combination of the said internal chamber E, the circular series of upright rotors B, surrounding that chamber and the flue F, for delivering products of combustion from the balling furnace; 3rd. The arrangement and combination of the internal chamber E, the circular series of upright rotors, surrounding that chamber, the flues C, intervening between the said rotors and the internal annular flue-space b, surrounding said rotors; 4th. The arrangement and combination of the internal chamber E, the circular series of upright rotors surrounding said chamber, the flues C, intervening between said rotors, the annular flue space b, surrounding said rotor; 5th. The flue F, placed below the annular collecting chamber I, and communicating with the internal chamber E, which is surrounded by rotors and flues; 6th. The flue passages n, n', under the rotors B, leading from chamber E, into the annular space b, surrounding the rotors; 7th. The external conduits c, forming communications between the chamber E, and the upper ends of the descending flues C, as described.

No. 4166. JOHN A. GROVE, Bluffton, Ind., U. S., 11th December, 1874, for 5 years: "Differential Pulley." (Poulie différentielle.)

Claim.—The tooth X, arranged on the peripheries of the sheaves A, B, of differential pulley blocks and employed as set forth.

No. 4167. STEPHEN WHITE, Belleville, Ont., 11th December, 1874, for 5 years: "Suspended Whiffletree." (Palonnier suspendu.)

Claim.—The combination of the whiffletree C, sheaves D, trace chains E, guards F, staples G, and girths H, as set forth.

No. 4168. E. LAWSON FENERTY, Halifax, N. S., 11th December, 1874, (Extension of Patent No. 180), for 5 years: "Method of Making and Fastening Skates." (Manière de faire et assujétir les patins.)

Claim.—The method of securing the skate to the boot by drawing the skate lock on the sole of a boot at the same time clamping the heel of the skate firmly to the heel of the boot by means of a lever at the heel of the skate and without any connection between back and front other than the runner, in the parts and combination of parts by which results are obtained as described, the method of so making the heel plate by curving up a portion in front to form a jaw to hold the front part of the heel of the boot that the heel plate and front heel jaw shall be in one piece, the sliding heel plate running and sliding over the heel-plate with portions turned up at the back to form back heel jaws, and a portion turned down at the front for the lever head to work against in the method of adjusting the heel of the skate to different sized boots by moving the boot forming the fulcrum of lever in a slot; the runner, and the method of securing the toe and heel plates to the runner of the skate by cutting and turning down portions of said plates and fastening these portions, thus turned down to the runner, at the same time, forming slots in the toe plate.

No. 4169. GEORGE FOURNIER, Ste. Julie de Somerset, Que., 15th December, 1874, for 5 years: "Improvements on Clothes Buttons." (Perfectionnements aux boutons de hardes.)

Réclame.—Un bouton d'habit composé d'une platine B, portant une tige filetée C, avec une rondelle D, et la tête taraudée E, tel que décrit.

Claim.—A clothes button composed of a plate B, having a threaded stem C, with a washer D, and a screw head E, as described.

No. 4170. SAMUEL C. REDGRAVE, Lyons, N. Y., U. S., 15th December, 1874, for 5 years: "Liquid Measure." (Mesure liquide.)

Claim.—1st. The combination of the interior vessel A, and exterior holder B, the said vessel being made of glass and transparent over its whole surface and capable of an adjustment in the holder for pouring either at the front or side as described; 2nd. The combination with the transparent vessel A, and skeleton holder B, of the fastening consisting of the hinged clamp c, and sliding loop l, for securing the vessel in the holder at any adjustment as described.

No. 4171. HUGH HOLLINGSHEAD, Howick, Ont., 15th December, 1874, for 5 years: "Land Roller." (Rouleau d'agriculture.)

Claim.—1st. The combination of the double bars in front part of the frame of the roller, as set forth; 2nd. The combination of coupling the reach and iron brace to the front part of the frame of the roller, as set forth.

No. 4172. EDWIN O. BRINCKERHOFF, New-York, U. S., 15th December, 1874, for 15 years: "Steam Condenser." (Condensateur de vapeur.)

Claim.—The combination of the concentric cases A, B, having a water space between their tops, bottoms and sides, the pump C, provided with supply pipes D, and discharge pipes E, the U-pipes G, one or more, the coil I, the waste pipes H, h', and the condensed steam-pipes L, with each other and with the exhaust steam pipe K, of an engine; 2nd. The combination of the box or hollow table J, with the coil I, the inner case B, the U-pipe G, and the branch waste pipe h', of the condenser; 3rd. The outer case A, surrounding the mechanism of a steam condenser, in such a way as to form a water space upon the top, bottom and sides of said condenser as described.

No. 4173. FREDERICK W. TUERK, Jr., Berlin, Ont., 15th December, 1874, for 5 years: "Improvements in Water Wheels." (Perfectionnements aux roues hydrauliques.)

Claim.—1st. The curved buckets b, provided with a cylindrical rib, at their inner edge, in combination with the recessed rim of the wheel B; 2nd. The wedge shaped recesses b', formed in the rim of the wheel B, beneath the upper part of the brackets b, in connection with the curved slots f, in the partition plate F; 3rd. The partition plate F, provided with the openings c, and f', and the ring flange h, in combination with the parts A, D, of the case, and with the wheel B, b; 4th. The combination of the lignum vitae step H, the metallic cup I, screw K, with the spider J, and with the shaft C, that carries the wheel B, b; 5th. The combination of the sliding plates or gates L, the cross-arms M, the curved and toothed cross-head N, the rear wheel O, and the shaft and hand wheel P, Q, with the case A, D, for regulating the size of the discharge orifices of said case as described.

No. 4174 DAVID JONES, Millburn, Inverness, Scotland, 15th December, 1874, for 5 years: "Improvements in Lubricators." (Perfectionnements aux graisseurs.)

Claim.—The adoption and use of the construction of lubricator cup or reservoir, to the cylinder or valve, which operates by partial vacuum at each stroke of the piston and by the influences of gravity and capillary attraction with small area opened to the cylinder or valve, covered by a pad or a retarder regulating the quantity of lubricant to the cylinder or valve.

No. 4175. CYRENIUS C. ROE, Hamilton, Ont., 15th December, 1874, for 5 years: "Steam Man or Working Machine." (Mannequin à vapeur ou machine ambulante.)

Claim.—1st. The arrangement of a steam man as shown having the combination of levers F, driven by the crank shaft G, H, and piston K, of the cylinder C, or by two crank shafts and cog gearing as shown in Fig. 3, as specified also the arrangement of the steam pipe B, enclosed in the hollow shaft G, to the cylinder C, as shown or through the arm, all arranged as specified.

No. 4176. ROBERT THOMAS, Toronto, Ont., 15th December, 1874, for 5 years: "Cooking Stove." (Poêle de cuisine.)

Claim.—1st. The general arrangement in the construction of the stove as specified; 2nd. The combination with the circular grate Q, of the oven D, and dome C, of the water vessel or boiler A, of the top F, cover H, and rib R, of the draught doors P, P, raised into S, and chimney G, as set forth; 3rd. The device of extending the dome or cone C, up into the centre of the fire chamber, thus making the fire a circular one, and surrounding it, and applicable to heating as well as to cooking stoves.

No. 4177. JOHN CAMPBELL, Almonte, Ont., 15th December, 1874, for 5 years: "Improvements on Churns." (Perfectionnements aux barattes.)

Claim.—1st. The bars B, hinged at their upper ends to a fixture or beam, and connecting with the churn to prevent lateral motion when oscillating; 2nd. Providing the cream chamber A, with an internal cream breaker F, and cutter G, arranged and applied as set forth; 3rd. The actuating wheel H, and cord I, for operating the same, in combination with a cream chamber oscillating as described; 4th. Constructing the cream chamber with a raised rectangular cover C, provided with air apertures D, E, as set forth; 5th. Providing the cream chamber with an outlet J, for discharging the milk; 6th. Providing the cream chamber with feet K, as described.

No. 4178. GEORGE A. KEENE, Lynn, and FRANCIS A. SAWYER, Boston, Mass., U. S., 15th December, 1874, for 5 years: "Carriage and Car Step." (Marche-pied de voiture et de wagon.)

Claim.—1st. The subdivision of a rubber cushion or pad applied to the step of a vehicle into ridges to enhance its ready resiliency 2nd. The combination of a rubber cushion or pad divided into sections of different resiliency by different thicknesses of rubber. 3rd. The combination with such a pad of an internal plate or other equivalent strengthening material to resist the tearing action of the fastenings: 4th. The arrangement in the depression in the surface of such pad so that they may have free communication with depressed sections on the edge; 5th. Re-inforcing the front edge of such pad by beads or sections of beads of greater thickness and substance than the rest of the pad; 6th. The arrangement and combination of the plate shown in Figs. 7 and 9, with its rubber cover; 7th. The arrangement and combination of the stud I, and detachable shank J; 8th. The arrangement and combination of the plate shown in Fig. 8, with its rubber cover for the purpose of supporting the edge of the upwardly presenting rubber, each and all as described.

No. 4179. USSIUS B. LABERGE, Montreal, Que., 17th December, 1874, for 5 years: "Ironing Table." (Table à repasser.)

Claim.—1st. The combination of an ironing table A, having an elliptical end B, with the folding trestle F, constructed as described; 2nd. The combination of the dove-tailed groove C, and slot C, with an ironing table A, as set forth.

No. 4180. DAVID BISSELL, Detroit, Mich., U. S., 17th December, 1874, for 15 years: "Arm Splint." (Eclisse pour les bras.)

Claim.—The combination of extensible concavo-convex clamping plates A, or B, clamping bars C, and adjusting screws G; the combination of extensible clamping plates A, B, bars C, adjusting screws G, jointed rods E, and an adjustable fastening as I, J, K, the combination of pressure springs L, and adjusting screws M, with the clamping plates B, the springs, arranged to extend out of the plates along the wrist for supporting it, the combination of a clamp for the arm, also a clamp for the fore-arm and rods E, one of said clamps being contrived to adjust along the rods to extend the fractured parts, a splint composed essentially of zinc clamping plates, the combination of zinc facing plates, with the pressure spring as specified.

No. 4181. CHARLES PARIHAM, Valleyfield, Que., 17th December 1874, for 5 years: "Improvements on Suction and force pumps." (Perfectionnements aux pompes aspirantes et foulantes.)

Claim.—The stalk a, tube i, and cylinder c, constructed and arranged as described.

No. 4182. FRANK MOSES, Toronto, Ont., 17th December, 1874, for 5 years: "Heating Apparatus." (Appareil de chauffage.)

Claim.—The metallic coil F, G, and the tube A, A, to conduct the cold air into the said coil, as set forth.

No. 4183. CHARLES CLUTHE, Hamilton, Ont., 17th December, 1874, for 5 years: "Improvements on Truss-pads." (Perfectionnements aux bourlets des bandages herniaires.)

Claim.—The spiral spring of metal working on a centre covered or uncovered to be used as a truss-pad.

No. 4184. HORACE E. ROWE, Brockville, Ont., 17th December, 1874, for 5 years: "Feather Renovator." (Machine à rafraichir la plume.)

Claim.—1st. The chemical holder B, connected to the boiler A, and communicating with the steam pipe D, for conveying any chemical agent along with the steam to the feather chamber E; 2nd. The tubular perforated feather chamber E, and steam jacket G, arranged within the outer casing F, and having a conducting steam pipe or pipes D, connecting with the boiler A, and chemical holder B, as set forth.

No. 4185. ALFRED D. GRISWOLD, New York, U. S., 17th December, 1874, for 10 years: "Feather Duster." (Plumeau.)

Claim.—1st. A feather dusting brush constructed of a series of bunches of feathers A, or of single feathers, each of said bunches or single feathers being secured to one end of an elastic stem or prolongation B, secured to the head of the handle C; 2nd. In combination with the subject matter of the foregoing claim in a crown or shield D, constructed of feathers b, secured between two strips of canvas or other suitable material c, as described.

No. 4186. MAGLOIRE THIBAUT, Hull, Que., 17th December, 1874, for 5 years: "Capstan." (Cabestan.)

Reclame.—1o. La combinaison du levier K, du joug G, des coulisseaux H, H, avec le cabestan A, pour lever l'axe de vis sans fin L, et la décharge de la roue d'engrenage N; 2o. La combinaison d'un cabestan muni d'un joug G, et de ses appareils tel que décrit, avec un viaduc, un trouil, une chèvre, Figs. 4, 5, 6, une grue, Figs. 7, 8, 9, au moyen des roues d'angle U, V, tel que décrit.

Claim.—1st. The combination of the lever K, with the yoke G, of the grooves H, H, with the capstan A, for raising the axis of the endless screw L, and to disengage it from the gear wheel N. 2nd. The combination of capstan provided with a yoke G, and of its apparatus as described, with a windlass, a derrick, a crab wheel Figs. 4, 5, 6, a crane, Figs. 7, 8, 9, by means of pinion wheels U, V, as described.

No. 4187. WALTER M. CONGER, Newark, N. Y., U. S., 17th December, 1874, for 15 years: "Improvements in Metallic Shields and Supports for Stoves and Analogous Articles and in Machines for making the same by Spinning." (Perfectionnements aux garde-murs et sous-poêles et autres objets analogues et aux machines à fabriquer ces objets par le filage.)

Claim.—1st. The metallic stove support and heat shield represented in Fig. 1, having the flat portion A, and domed or elevated centre B, as set forth; 2nd. The device shown in Figs. 3 and 4, having a continuous sheet A, formed with a dome where the heat is received in combination with the shield or shields B, held between the dome and floor with a space above and below; 3rd. The device shown in Figs. 5 and 6, having one or more shields formed separate from the main body and supported above the same with spaces for ventilation between the parts; 4th. The construction of the latter, the dome B, screw b, and nut C, serving relatively to each other and to the body A, and shield or shields B; 5th. The device shown in Figs. 7 and 8, each having a heat shield in two thicknesses with a non-conductor between; them at a little distance from the body A, with space for ventilation between, as set forth; 6th. The chuck B, having an annular flat surface, the opposite holding means M, having a corresponding surface, and adapted to revolve therewith, in combination with each other, and with mechanism for raising the central portion while the flat portion is firmly clamped, and held in the plane condition; 7th. The adjustable frame E, with the sets of anti-friction rollers e, e', in combination with the loose ring M, chuck B, and mechanism for spinning a dome in the centre; 8th. The cam piece E, in com-

binaton with a spinning roller i, and its carrying means I, I, J, and feeding means P, adapted to serve in connection with the chuck B, and holding ring M; 9th. The heading roller r, and its connections in combination with the chuck B, holding means F, and mechanism for raising the centre; 10th. In combination with the chuck B, and adjustable frame E, and its connections adapted to hold a blank and the spinning roller i, and its connections adapted to treat the central portions of such blank, the feed screw P, connected with the carriage J, and receiving motion through the gearing wheel N, which is feathered upon the shaft K, to allow for the elevation and depression of the feed screw and its connected parts; 11th. The automatic liberation of the carriage J, and its connections from the feed screw P, by means of the step E, acting on the partial nut j, to detach it from the screw P, in connection with the cord l, for moving the carriage J, outward, all as specified.

No. 4188. SILAS G. SMITH, Hollis, Me., U. S., 18th December, 1874, for 5 years: "Machine for Removing Snow from Railroads." (Machine à enlever la neige des voies de fer.)

Claim.—The base a, prow b, disc c, carrying the fans j, shafts d, gears e, gears f, and shaft h, all combined to operate as described.

No. 4189. ANDREW W. MITCHELL, Detroit, Mich., U. S., and ANDREW McCORMICK, London, Ont., 18th December, 1874, for 10 years: "Carriage Spring." (Ressort de voiture.)

Claim.—The combination of the springs D, D, and E, E, when arranged as set forth.



INDEX OF INVENTIONS.

Ball castors, J. Johnson.....	4146
Battery guns and repeating ordnance, J. P. Taylor.....	4164
Bill holder and paper file, W. H. Foy.....	4133
Boiler feeders, F. McGuire.....	4163
Buttons for clothes, G. Fournier.....	4109
Capstan, M. Thibault.....	4186
Carpet stretcher, W. H. Curtis and R. Morris.....	4162
Carriage and car step, G. A. Keene.....	4178
Carriage spring, A. W. Mitchell.....	4189
Car washer, E. W. Evans.....	4141
Churns, J. Campbell.....	4177
Cooking stove, R. Thomas.....	4176
Corn sheller, W. E. Calhoun.....	4142
Cotton cleaning machine, S. D. Keene.....	4136
Cultivator and harrow, W. Stafford.....	4152
Darning machine, O. S. Osmer.....	4145
Drain pipe moulding machines, I. P. Merwin.....	4139
Drum heater, C. Skinner.....	4143
Elevators, floating vessel used for, and screwpropellers for same, W. and J. Inglis.....	4135
Feather duster, A. D. Griswold.....	4185
Feather renovator, H. E. Rowe.....	4184
Fire extinguisher, automatic, H. S. Parmelee.....	4132
Gas Burners, self-lighting, H. B. Stockwell and E. L. McGill.....	4147
Grain or corn crusher and spice mill, J. Kaiser.....	4144
Harrow and cultivator, W. Stafford.....	4152
Heating apparatus, F. Moses.....	4182
Horse rakes, G. Barclay and J. Kennedy.....	4154
" " " ".....	4159
Ironing table, U. B. Laberge.....	4179
Iron and other ores, process and apparatus for reducing, N. W. Wheeler.....	4156
Iron ores, furnace for reducing, J. Wilson.....	4165
Land roller, H. Hollingshead.....	4171
Lock-nut bolt, Thomas Galbraith.....	4149
Lubricators, D. Jones.....	4174
Measure, liquid, S. C. Redgrave.....	4170
Overcoat and carriage robe, combined, B. Levy.....	4134
Petroleum, apparatus for storage and transportation of, G. Desgeorges.....	4148
Potato digger, T. Head.....	4157
Pulley, differential, J. A. Grove.....	4166
Pumps, suction and force, C. Parham.....	4181
Railways, machine for removing snow from, S. G. Smith.....	4188
Rein holder, E. A. Smalley.....	4158
Rolling paper, art of, D. Mortimer.....	4140
Saddle tree, O. V. Flora and J. B. Ross.....	4131
Skates, making and fastening, E. L. Fenerty.....	4163
Steam condenser, E. O. Brinckerhoff.....	4172
Steam drum, H. R. Ives.....	4161
Steam engines, high pressure, apparatus for, J. Delworth and J. C. Hodgins.....	4137
Steam engine, rotary, F. Marsh.....	4153
Steam man, or walking machine, C. C. Roo.....	4175
Splint for arm, D. Bissell.....	4180
Stoves, hot water reservoir for, J. B. Baldwin.....	4133
Stoves, metallic shields and supports for, and machine for making, W. M. Conger.....	4137
Superheaters, D. Renshaw.....	4130
Trellises, house and garden, W. H. Page and S. Mowry.....	4160
Truss pads, C. Cluthe.....	4183
Umbrella runner, automatic, J. J. Higgins.....	4151
Valve gear, J. Tesseyman and P. Smith.....	4155
Vanilline, manufacture of, W. Haarmann.....	4150
Water wheels, F. W. Tuerk.....	4173
Whiffletree, suspended, Stephen White.....	4167

INDEX OF PATENTEES.

Baldwin, James B., hot water reservoir for stoves.....	4133
Barclay, George, and J. Kennedy, horse rakes.....	4154
" " " ".....	4159
Bissell, David, arm splint.....	4180
Brinckerhoff, Edwin O., steam condenser.....	4172
Calhoun, Whitney E., corn sheller.....	4142
Campbell, John, churns.....	4177
Cluthe, Charles, truss pads.....	4183
Conger, Walter M., metallic shields and supports for stoves, &c., and machines for making.....	4137
Curtis, William H., and R. Morris, carpet stretcher.....	4162
Desgeorges, Gabriel, apparatus for storage and transportation of petroleum.....	4148
Delworth, Joseph, and John C. Hodgins, apparatus for high pressure steam engines.....	4137
Evans, Erastus W., car washer.....	4141
Fenerty, E. Lawson, making and fastening skates.....	4163
Flora, Orlando V., and J. B. Ross, saddle tree.....	4137
Fournier, George, clothes buttons.....	4109
Foy, William H., Bill holder and paper file.....	4133
Galbraith, Thomas, lock-nut bolt.....	4149
Griswold, Alfred D., feather duster.....	4185
Grove, John A., differential pulley.....	4166
Haarmann, William, manufacture of vanilline.....	4150
Head, Thomas, potato digger.....	4157
Higgins, John J., automatic umbrella runner.....	4151
Hodgins, John C., and J. Delworth, apparatus for high pressure steam engines.....	4137
Hollingshead, Hugh, land roller.....	4171
Inglis, William, and James, vessels used for floating elevators and screw propellers for same.....	4135
Ives, H. R., (assignee), steam drum.....	4161
Johnson, Job, ball castors.....	4146
Jones, David, lubricators.....	4174
Kaiser, Jacob, grain or corn crusher and spice mill.....	4144
Keene, Geo. A., and F. A. Sawyer, carriage and car step.....	4178
Keene, Samuel D., cotton cleaning machine.....	4136
Kennedy, James, and G. Barclay, horse rake.....	4159
Laberge, Ussius B., ironing table.....	4179
Levy, Bernhard, combined overcoat and carriage robe.....	4134
McGuire, Francis, boiler feeders.....	4163
Marsh, Franklin, rotary steam engine.....	4153
McGill, Edward L., and H. B. Stockwell, self-lighting gas burners.....	4147
Merwin, Ira P., drain pipe moulding machines.....	4139
Mitchell, Andrew W., carriage spring.....	4189
Morris, Royal, and W. H. Curtis, carpet stretcher.....	4162
Mortimer, Daniel, art of rolling paper.....	4140
Moses, Frank, heating apparatus.....	4182
Mowry, Samuel, and W. H. Page, (assignees), house and garden trellises.....	4160
Osmer, Oren S., darning machine.....	4145
Page, William H., and S. Mowry, (assignees), house and garden trellises.....	4160
Parham, Charles, suction and force pumps.....	4181
Parmelee, Henry S., automatic fire extinguisher.....	4132
Redgrave, Samuel C., liquid measure.....	4170
Renshaw, David, superheaters.....	4130
Roe, Cyrenius C., steam man.....	4175
Ross, John B., and O. V. Flora, saddle tree.....	4131
Rowe, Horace E., feather renovator.....	4184
Skinner, Carlos, drum heater.....	4143
Smalley, Elmer A., rein holder.....	4158
Smith, Preserved, and J. Tesseyman, valve gear.....	4155
Smith, Silas G., machine for removing snow from railways.....	4188
Stafford, William, harrow and cultivator.....	4152
Stockwell, Henry B., and E. L. McGill, self-lighting gas burners.....	4147
Taylor, James P., battery guns and repeating ordnance.....	4164
Tesseyman, John, and P. Smith, valve gear.....	4155
Thibault, Magloire, capstan.....	4186
Thomas, Robert, cooking stove.....	4176
Tuerk, Frederick W., water wheels.....	4173
Wheeler, Norman W., process and apparatus for reducing iron and other ores.....	4156
White, Stephen, suspended whiffletree.....	4167
Wilson, Joel, furnace for reducing iron ores.....	4165

THE CANADIAN PATENT OFFICE RECORD.

ILLUSTRATIONS.

Vol. III.

JANUARY, 1875.

No. 1.

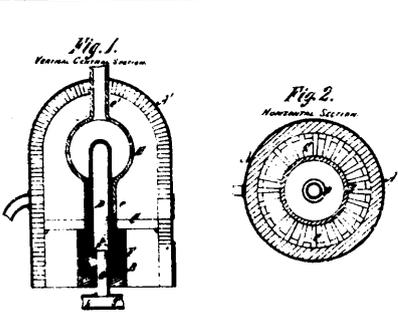

4130 Renshaw's Improvements on Superheaters

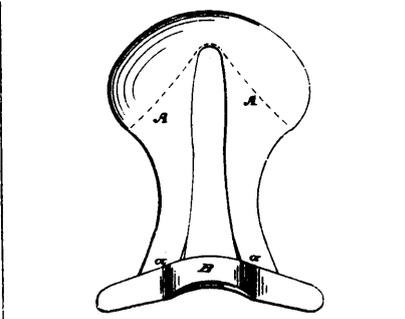

4131 Flora & Ross' Saddle Tree.

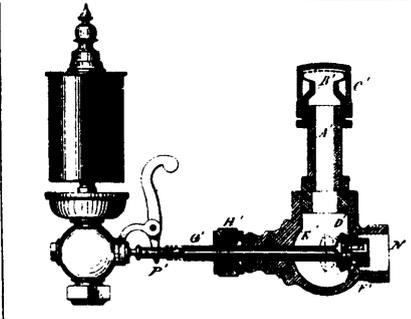

4132 Farmelee's Automatic Fire Extinguisher.

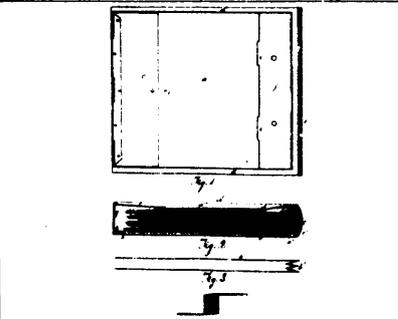

4133 Foye's Bill Holder and Paper File.

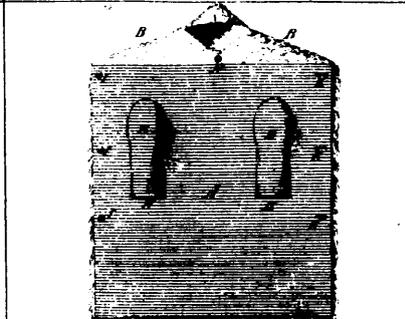

4134 Levy's Combined Overcoat and Carriage Robe

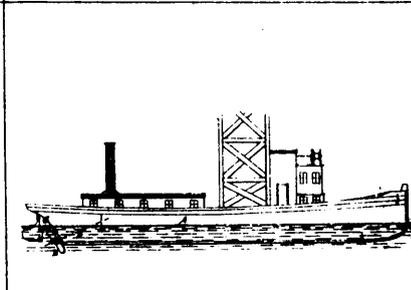

4135 Inglis & Inglis' Improvements on the Construction of Vessels used for Floating Elevators and on the Arrangements of the Screw Propellers Used in the same.

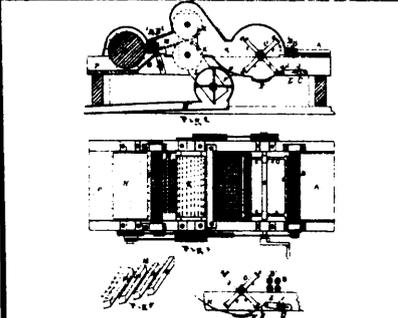

4136 Keene's Cotton Cleaning Machine.

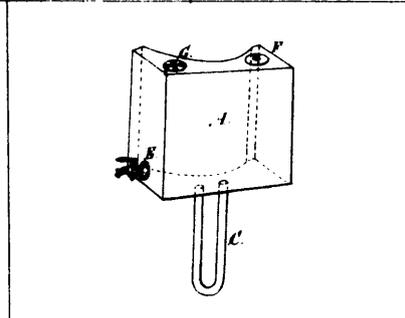

4138 Baldwin's Hot Water Reservoir for Stoves.

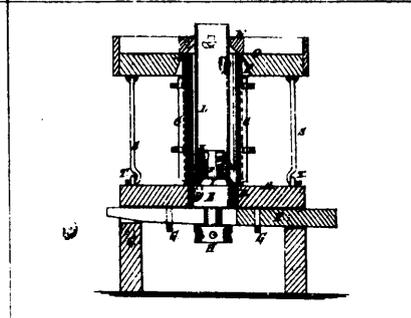

4139 Merwin's Improvements in Drain-pipe Moulding Machines.

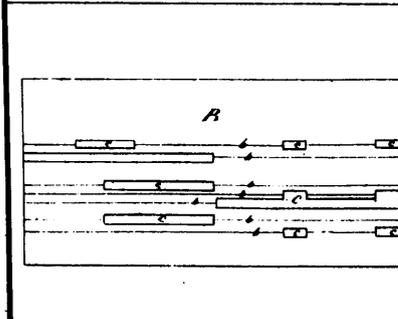

4140 Mortimer's Art of Ruling Paper.

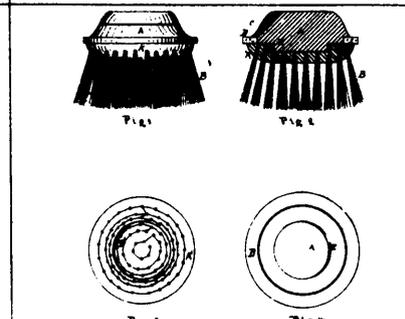

4141 Evan's Car Washer.

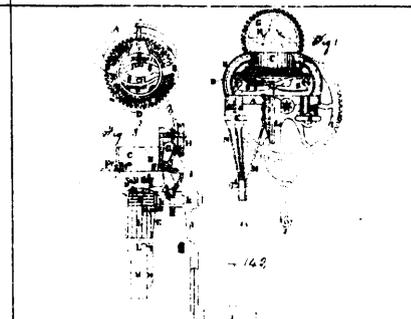

4142 Calhoun's Corn-sheller.

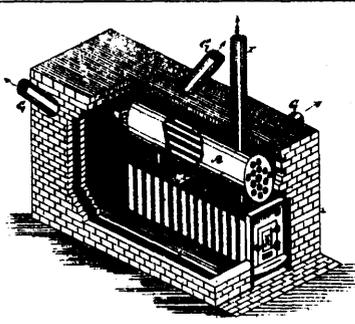

4143 Skinner's Drum Heater.

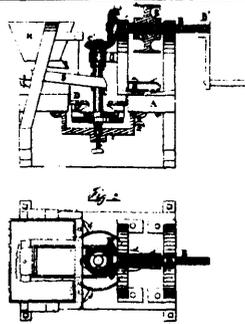

4144 Kaiser's Grain or Corn Crusher and Spice Mill.

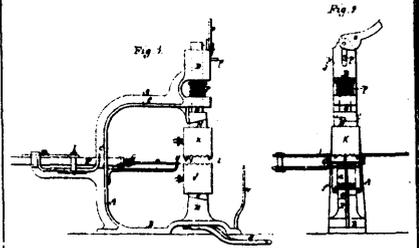

4145 Osmer's Darning Machine.

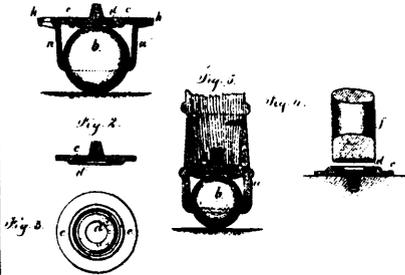

4146 Johnson's Improvements on Ball Castors.

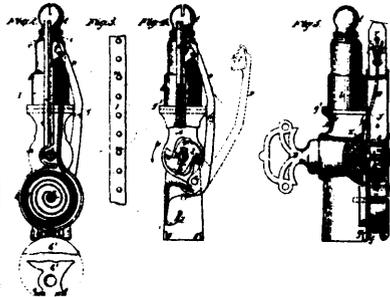

4147 Stockwell and Megill's Self-lighting Gas Burners.

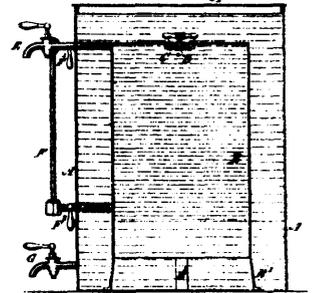

4148 Desgeorges' Apparatus for the Storage and Transportation of Petroleum.

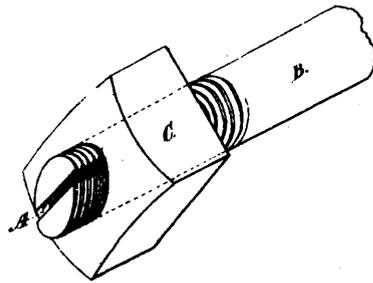

4149 Galbraith's Lock-nut Bolt.

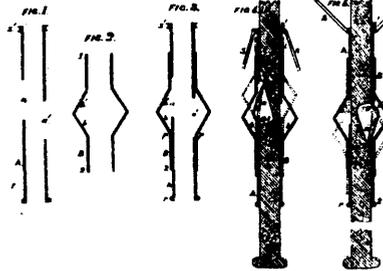

4151 Higgins' Automatic Umbrella Runner.

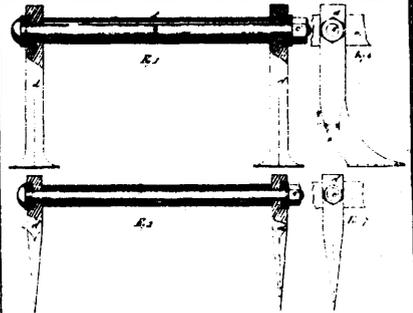

4152 Stafford's Harrow and Cultivator.

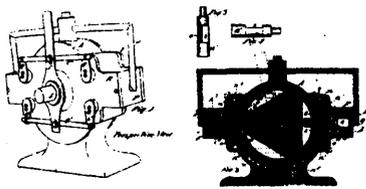

4153 Marsh's Rotary Steam Engine.

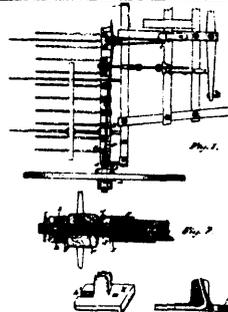

4154 Barclay and Kennedy's Improvements on Horse Rakes.

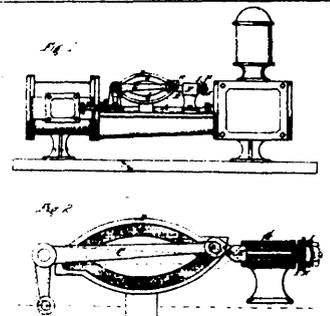

4155 Tesseyman & Smith's Valve Gear.

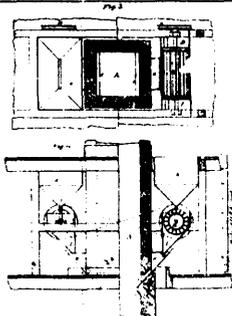

4156 Wheeler's Process and Apparatus for the Reducing of Iron and other Ores.

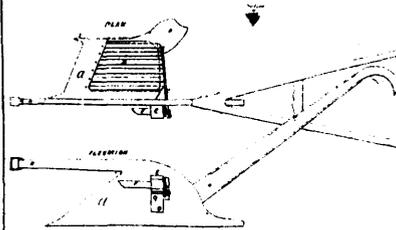

4157 Head's Potato-digger.

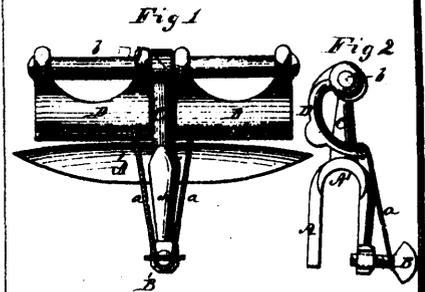

4158 Reed & Andrus' Rein-holder.

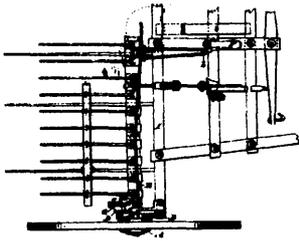

4159 Barclay & Kennedy's Improvements on Horse Rakes.

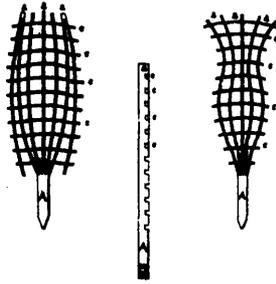

4160 Setchell's Improvements on House and Garden Trellises.

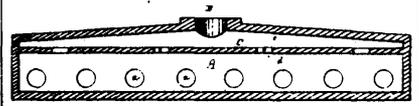
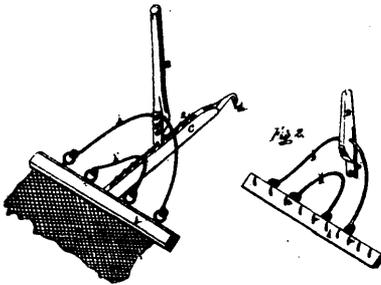

Fig. 2.

Fig. 3.



4161 Burlingame's Steam Drum.



4162 Curtis & Morris' Carpet Stretcher.

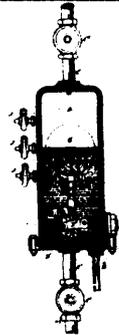

4163 McGuire's Improvements in Boiler Feeders.

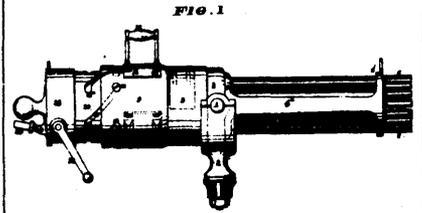
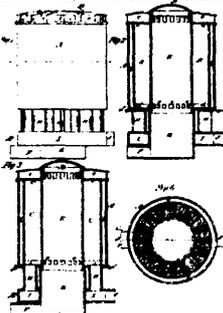
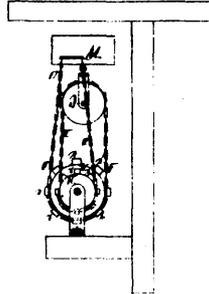

FIG. 1

4164 Taylor's Battery Guns and Repeating Ordnance.



4165 Wilson's Furnace for Reducing Iron Ores.



4166 Grove's Differential Pulley.

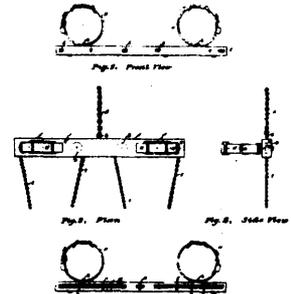
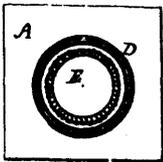

Fig. 1. Front View

Fig. 2. Plan

Fig. 3. Side View

4167 White's Suspended Whiffletree.



4169 Fournier's Improvements on Clothes Buttons.

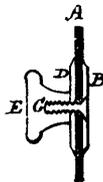

4170 Redgrave's Liquid Measure.

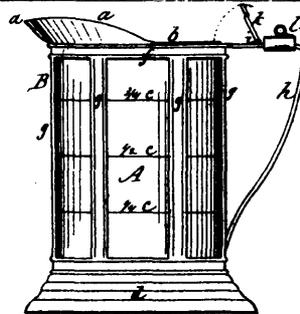

4171 Hollingshead's Land Roller.

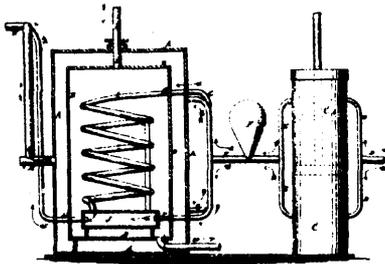
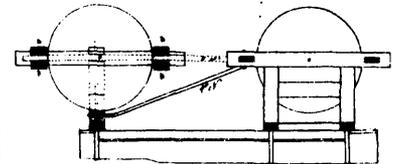

4172 Brinkerhoff's Steam Condenser.

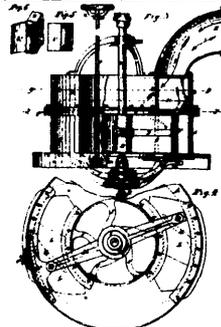

4173 Tuerk's Improvements in Water Wheels.

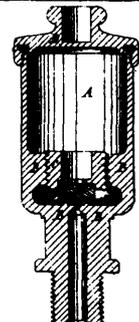

4174 Jones' improvements in Lubricators.

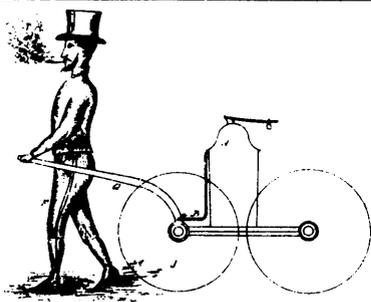

4175 Roe's Steam Man or Walking Machine.

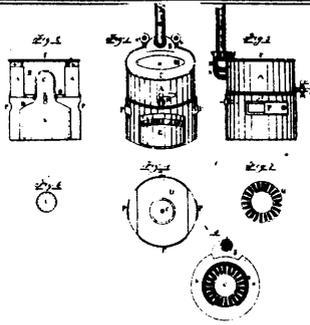

4176 Thomas' Cooking Stove.

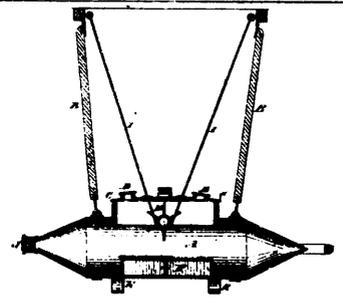

4177 Campbell's Improvements on Churns.

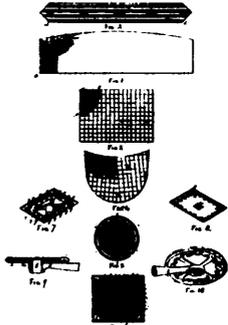

4178 Keene & Sawyer's Carriage and Car Step.

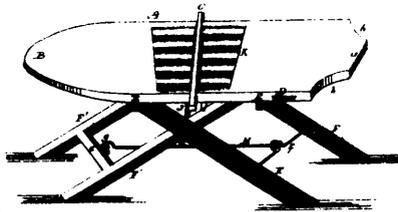

4179 Laberge's Ironing Table.

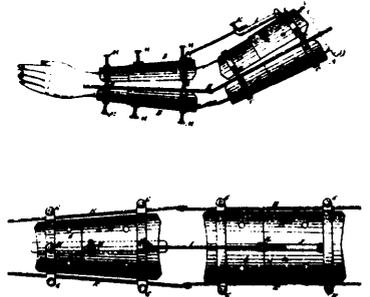

4180 Bissell's Arm Splint.

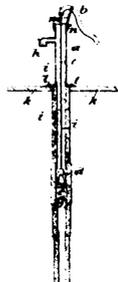

4181 Parham's Improvements on Suction and Force Pumps.

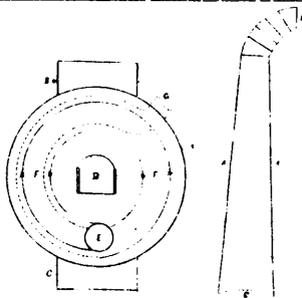

4182 Moses' Heating Apparatus.

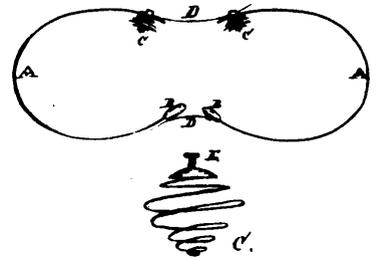

4183 Cluthe's Improvements on Truss-pads.

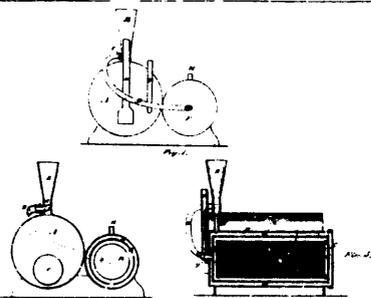

4184 Rowe's Feather Renovator.

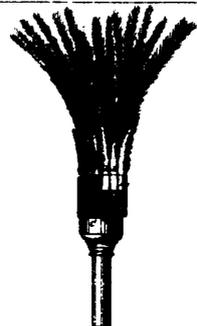

4185 Griswold's Feather Duster.

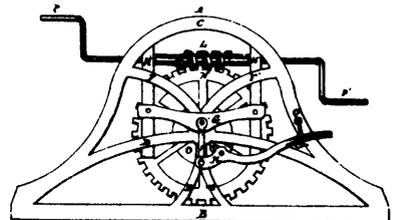

4186 Thibault's Capstan.

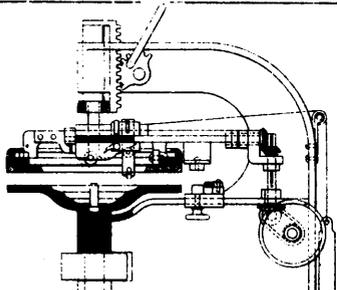

4187 Conger's Improvements in Metallic Shields and Supports for Stoves and Analogous Articles and in Machine for making the same.

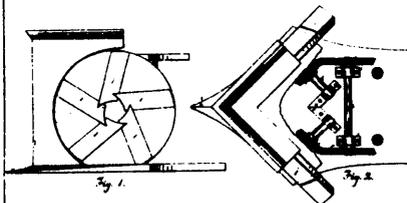

4188 Smith's Machine for Removing Snow from Railroads.

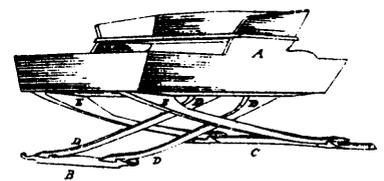

4189 Mitchell & McCormick's Carriage Spring.