

Technical and Bibliographic Notes / Notes techniques et bibliographiques

The Institute has attempted to obtain the best original copy available for filming. Features of this copy which may be bibliographically unique, which may alter any of the images in the reproduction, or which may significantly change the usual method of filming, are checked below.

L'Institut a microfilmé le meilleur exemplaire qu'il lui a été possible de se procurer. Les détails de cet exemplaire qui sont peut-être uniques du point de vue bibliographique, qui peuvent modifier une image reproduite, ou qui peuvent exiger une modification dans la méthode normale de filmage sont indiqués ci-dessous.

Coloured covers/  
Couverture de couleur

Coloured pages/  
Pages de couleur

Covers damaged/  
Couverture endommagée

Pages damaged/  
Pages endommagées

Covers restored and/or laminated/  
Couverture restaurée et/ou pelliculée

Pages restored and/or laminated/  
Pages restaurées et/ou pelliculées

Cover title missing/  
Le titre de couverture manque

Pages discoloured, stained or foxed/  
Pages décolorées, tachetées ou piquées

Coloured maps/  
Cartes géographiques en couleur

Pages detached/  
Pages détachées

Coloured ink (i.e. other than blue or black)/  
Encre de couleur (i.e. autre que bleue ou noire)

Showthrough/  
Transparence

Coloured plates and/or illustrations/  
Planches et/ou illustrations en couleur

Quality of print varies/  
Qualité inégale de l'impression

Bound with other material/  
Relié avec d'autres documents

Continuous pagination/  
Pagination continue

Tight binding may cause shadows or distortion along interior margin/  
La reliure serrée peut causer de l'ombre ou de la distorsion le long de la marge intérieure

Includes index(es)/  
Comprend un (des) index

Title on header taken from: /  
Le titre de l'en-tête provient:

Blank leaves added during restoration may appear within the text. Whenever possible, these have been omitted from filming/  
Il se peut que certaines pages blanches ajoutées lors d'une restauration apparaissent dans le texte, mais, lorsque cela était possible, ces pages n'ont pas été filmées.

Title page of issue/  
Page de titre de la livraison

Caption of issue/  
Titre de départ de la livraison

Masthead/  
Générique (périodiques) de la livraison

Additional comments: /  
Commentaires supplémentaires:

This item is filmed at the reduction ratio checked below /  
Ce document est filmé au taux de réduction indiqué ci-dessous.

10X	12X	14X	16X	18X	20X	22X	24X	26X	28X	30X	32X
<input type="checkbox"/>	<input type="checkbox"/>	<input type="checkbox"/>	<input type="checkbox"/>	<input type="checkbox"/>	<input type="checkbox"/>	<input type="checkbox"/>	<input type="checkbox"/>	<input checked="" type="checkbox"/>	<input type="checkbox"/>	<input type="checkbox"/>	<input type="checkbox"/>

# CANADIAN Journal of Fabrics

THE JOURNAL OF THE Textile Trades of Canada.

Vol. XI.

TORONTO, JULY, 1894

No. 7

**Walter T. Clover & Co.**  
ENGINEERS, MACHINISTS, ETC.  
SALFORD, Manchester, Eng.

Makers of **ELECTRICAL WIRE** and CABLE

ALSO MAKERS OF ALL KINDS OF  
**Rope, Twine and Cord Machinery**  
**SMALLWARE MACHINERY**

JAMES C. McARTHUR

CHARLES C. CORNEILLE

**McARTHUR, CORNEILLE & CO.**

Importers and Manufacturers of . . . OILS, CHEMICALS AND DYE STUFFS

SOLE AGENTS FOR

ST. DENIS DYE STUFF & CHEMICAL CO. (formerly A. PORRIER, Paris), Aniline Colors, Archil, Extract Cachou de Laval, etc.

BRITISH ALIZARINE CO., London, Paste and Dry Alizarine.

WATSON, WALKER & QUICKFALL, Leeds, Indig. Extracts.

310 to 316 St. Paul St. and  
147 to 151 Commissioners St. **MONTREAL**

Maintain large stocks, fully assorted, and will always be pleased to furnish quotations and samples.



**ANILINE**  
**COLORS**

Alizarine, Cyanine, Benzidine  
and Sulphon Colors

**DOMINION DYEWOOD & CHEMICAL CO.**  
TORONTO

REMARKABLY LIKE WOOL!

Send for Samples,  
and examine the  
appearance and texture of

**PERUVIAN**  
**COTTON**

A very grand  
Mixing Cotton

SMALL HANDY BALES.

**ALFRED BOYD,** 1 WELLINGTON STREET EAST, Toronto

—Dealer in—

FULLER'S EARTH, BORAX, CHEMICALS, etc.



WAREHOUSE & OFFICE 61 & 63 FRONT ST. W.  
**TORONTO.**

**ANILINE DYES** LOGWOOD, SUMAC, INDIGO Extracts

HEMOLIN BLACK, MORIN YELLOW

**WM. J. MATHESON & CO., Limited**  
423-425 St. Paul Street, **MONTREAL**

Main Office: 175 Front Street, New York.

Branches: Boston, Philadelphia, Providence.

Works: Long Island City, Port of New York.

**W. T. BENSON & CO.** 11 Common St. **MONTREAL**

DIRECT IMPORTERS OF

**FOREIGN WOOL**

AND ALL LINES OF

**CHEMICALS and DYESTUFFS**

Also Coconut and Palm Oil, and all other Soap Stocks

Sole Agents for

Messrs. JOHN DAWSON & CO., of GLASGOW

Manufacturers of  
. . . Extracts of Logwood, Fustic, Sumac, etc.

Complete Stocks of all the above always on hand.

**Bellhouse, Dillon & Co.**

30 ST. FRANCOIS-XAVIER STREET

Importers of **MONTREAL**

**Chemicals, Dyewoods, Acids**  
and **Aniline and Alizarine Colors**

Sole Agents for

**WM. PICKHARDT & KUTTROFF**

FULL STOCK OF THEIR CELEBRATED COLORS  
KEPT ON HAND

**BELDING, PAUL & CO., LTD.**  
SILK MANUFACTURERS

**Montreal**

Spool Silks, Crochet Silks, Art Wash Silks,  
Filoselles, Silk Serges, Ribbons.

ORGANZINES, TRAMS, SPUN SILK YARNS,  
AND ALL THREADS FOR  
MANUFACTURING PURPOSES  
MADE TO ORDER

**GEO. D. ROSS & CO.**

Woolen Commission Merchants  
and Manufacturers' Agents

CORRESPONDENCE SOLICITED  
ADVANCE MADE ON SHIPMENTS

MONTREAL: 648 CRAIG STREET  
TORONTO: 19 FRONT ST. WEST

**DYEWOOD EXTRACTS**

Manufactured by  
MUSLOW & Co., BURY, ENGLAND

**DOMINION DYEWOOD & CHEMICAL CO.**  
TORONTO

SOLE AGENTS FOR CANADA

A. E. CLARKE F. J. DEARS G. B. FLAVES

**A. E. CLARKE & CO.**



Manufacturers of **GLOVES & MITTS**  
TORONTO  
Branches at Montreal, Quebec, Halifax, Winnipeg and Victoria

WE PRINT

**WOOL LABELS** of every description

THE MONETARY TIMES PRINTING CO., LTD.  
TORONTO

**M. D. BARR & CO. Electrical Apparatus**

56 1/2 King Street East

CANADIAN AGENTS FOR:

- The Cincinnati Gearless Electric Motors, etc.
- The Standard Electric Co., of Chicago, Alternating and Arc Light Systems.
- The Ohio Brass Company's Street Railway Line Material.
- The Card Electric Company's Polyphase Iron-Cored Motors and Dynamos.
- The Stanley Transformer, the best on the market.

WE handle the best makes of the following goods:

- PAIR COVERS AND IRON WIRE, all sizes.
- INSULATED COPPER AND IRON WIRE, all sizes.
- INSULATED LAMPS for any system.
- INCANDESCENT AND CARBON.
- FAN MOTORS for direct or alternating currents.
- BECKHOFF CONTACT complete system.
- CONCRETE REINFORCING STEEL RAIL WAY TRACKS AND CAR EQUIPMENT.

SHAW, SOX & CO., HUDDERSFIELD

P.O. BOX 1254, MONTREAL

**WM. SHAW & CO.**

164 McGill Street

Montreal

**Textile Machinery**

SOLE AGENTS IN CANADA FOR

- Hutchinson, Hollingworth & Co., Ltd., Dobcross—Makers of the **KNOX LEE** and all other kinds of Looms, Patent Weaving and Beaming Machinery.
- Kenworthy, Royston & Co., Huddersfield—All kinds of Cloth Finishing Machinery.
- John Sykes & Sons, Huddersfield—Twisting Frames, Garnett Machines, Filters, Egg Factories, etc.
- Samuel Roberts & Sons, Cleckheaton—Card Clothing.
- Thornton Bros., Cleckheaton—Scrubbers and Carders, Condensers, etc.
- Thomas Broadbent & Sons, Huddersfield—Hydro Extractors.
- Wm. Whitley & Sons, Huddersfield—Spinning Bales, Winders, Dryers, and Concreting Machines, etc.

Orders for **SECOND HAND WOOLEN MACHINERY** personally attended to by **M. R. ROBERTS**  
and **M. S. SHAW, SR.** Machinery Sales attended to by **Commission.**

# CANADIAN Journal of Fabrics

THE JOURNAL OF THE  
*Textile Trades of Canada.*

Vol. XI.

TORONTO, JULY, 1894

No. 7.

## Canadian Journal of Fabrics

A Journal devoted to Textile manufactures and the Dry Goods and kindred trades.

Subscription: Canada and United States, \$1.00 per year; Great Britain, 5/- Advertising rates on application.

Offices. 62 Church Street, Toronto, and the Fraser Building, St. Sacrament Street, Montreal.

NOTE.—All remittances and business correspondence should be addressed to the Toronto office, and all correspondence connected with news or editorial should be addressed to E. B. BIGGAR, Publisher, Montreal.

Agency in Europe: Polsue Bros., 30 Poppin's Court, Fleet St., London, Eng.

Toronto Telephone, 1392 | Montreal Telephone, 2589

### THE CANADIAN TEXTILE DIRECTORY

A Handbook of all the Cotton, Woolen and other Textile manufactures of Canada, with lists of manufacturers agents and the wholesale and retail dry goods and kindred trades of the Dominion; to which is appended a vast amount of valuable statistics relating to these trades. Third edition 487 pages, price \$3.00. E. B. BIGGAR, Publisher, Montreal.

### SPOTS IN WOOLEN GOODS.

In working with fulling stocks on light weights there is a mere possibility that a tendency may exist for the formation of spots in the fabric which seem thinner or less felted than the rest of the goods. If any part of the box is worn, or in a condition to chafe the goods, such results are sure to come to pass, and if it happens that the cloth does not get properly and regularly turned so that its position is continuously changing, the uneven felting will be apt to appear in a more or less marked degree. There is no doubt that in fulling with the stocks the length of time during which the operation is continued is the only thing which keeps the process from being fraught with more risk in this particular than it is. But when the goods are pounded so long they usually manage to come under the influence of the felting mechanism for a sufficient length of time to at least insure regularity enough for all practical purposes. Practically, says the *Boston Journal of Commerce*, we may say that in the use of the fulling stocks the only way in which goods are liable to receive a worn or chafed appearance in spots, is where defects are present in the hammers or in the inside of the box, or when foreign substances happen to get in with the cloth. The latter sometimes occurs. A small article, like a nail or a screw or a nut, will cause untold havoc if it once gets into the piece in the stocks. Great care should therefore be taken when the goods are fed into the stocks, and all articles of the above nature should be kept out of the vicinity of the machine.

In the washers, one of the most common causes of bad spots in the goods is to be found in the condition of the rollers. A very slight unevenness or irregularity, a nail head or a splinter, may, upon certain kinds of goods, give rise to imperfections in the finished cloth. To insure a smooth roller, and to reduce the danger from this source as much as possible, we have found it a good plan to cover the rollers with cotton cord wrapped tightly and evenly into place. The same remarks apply in the case of the washer, too, as in that of the fulling mills and stocks, with regard to the condition of the inside of the machine. Any machine in which the cloth has to be pulled or dragged along over a wooden surface, or in which it has to come in contact with such a surface, is particularly open to care in this regard, and the finisher is not going beyond his province at all if he should insist on a careful examination of the inside of such machines once a week, for example, after cleaning up on Saturday mornings. Then if the operatives are required to sweep the floor often and well, and if no nails or screws are allowed in the walls or wainscoting, near the machinery in question, little danger need be feared of producing goods which are worn and rubbed away in spots throughout the piece.

In treating of this subject, we cannot overlook at this stage the treatment which goods sometimes get in the dyehouse. It is possible that sometimes worn and thin places are to be blamed more upon the dyer than they are upon the finisher, and where goods are dyed in the piece there is certainly great danger of this sort of thing while the cloth is in the dyer's hands. In the reeling of the goods, careless work on the part of the operator is almost certain to result in chafed spots on the cloth. In forcing down the cloth the way the stick or paddle is handled will be very apt to cause bad work. If the stick is made to slip along the face of the cloth when it comes in contact with it, or if the stick is placed in the cloth and then the goods are rubbed along the hard surface of the kettle in which they are contained, it is pretty sure to cause a streak or thinness in the goods that will be visible when all is done. The only way to avoid these things is to exercise care in manipulation. In reeling, also, or in the moving of the goods about in the vat or kettle, any irregularity on the surface should be carefully avoided. If rivets project or show sharp edges, or if the edges of the holes in perforated plating become sharp by much use, there

is great danger of wearing away the cloth that comes in contact with them.

In dyeing, too, it is possible for salts used in coloring, or in mordanting, to be employed in such quantities that they do not all dissolve, and when this is the case, if undissolved crystals are left in the bath to get into the meshes of the cloth, or to stick in the holes of the perforated linings, it is by no means a difficult matter to have the goods so worn and rubbed in places by their action that the effect will be noticeable in the finished cloth. Of course the only way to avoid this with certainty is to make it a point to see that perfect dissolution shall be accomplished, and the reliable dyer will certainly do this. Unless care is taken, too, in the matter of the water that is used in the dyeing, as well as in the finishing, small lumps of mineral deposits, or other hard ingredients, are more or less apt to get into the vat or tub, and if these stick in cracks or crevices they are a constant menace to the safety of the cloth.

To return to the finishing. When we come to the gigging there is not so much likelihood of producing thin spots in the goods, unless the cloth is already unevenly fulled. It is quite possible to gig in streaks which, on account of a streaked nap, will give the goods an appearance of being thin in streaks, but thinness in spots is not so apt to result. If, however, a fabric comes to the gig with worn spots in it, it is evident that the treatment at the gig can only add to the difficulty. The same also may be said with regard to the action of the shears, for in themselves, unless it is from the presence of flocks or knots upon the back of the goods, the shears can hardly be said to act very greatly toward making thin spots on the fabric. The shear, however, has the effect of greatly accentuating the wornness or thinness that has already existed. And in case a piece is fulled so as to be thicker in places, then the shear, by working upon these places, will have the effect of weakening them, and so of destroying the value of the piece altogether. Faulty brushes at the shears, or on the presses, will be pretty sure to conduce to the making of thin and worn spots in the nap. The only way to avoid these results is to attend particularly to the presence of knots, dust and flocks. And by keeping the machine and all its parts, as well as the cloth, free from these materials, and by giving attention to the condition of the brushes and rollers, and by seeing to it that all rests and rods over which the cloth must pass are as clear as possible of obnoxious substances that could get on to the surface of the cloth, we will be very apt to reduce to a minimum the real danger to which we have been referring.

#### GOOD ROVING.

Unevenness in any one strand of roving varies in character according to the causes from which it arises. Short thick bunches, or nubs, come from imperfectly carded stock. They may be large or small, but generally have equal diameters in all directions. Larger and at the same time longer enlargements of the strand

are almost always due to bunches taken into the wool card by the licker-in, either from imperfect feeding, badly set rolls, or because of an overloaded licker-in.

Of the setting of the feed rolls enough has already been said. There is only one right method of doing this, but the same changes in the feed that will conduce to the comparative evenness of the strands with each other may under certain conditions cause the licker-in to take the stock unevenly.

To make the drawing from the second breaker finer and softer, a writer in the *Manufacturers' Review* gives the following advice: slow the feed on the finisher, so as to get more doublings; give a more acute angle to the feed by slowing the tension bands on the long side of the table, or giving a flatter lay to the strands by lowering the presser bar. These are the most efficient methods for getting the feed in shape to avoid the bunches. Sometimes any one of them will suffice, while again all of them together will not bring about the desired result.

Then we must turn to the licker-in itself. It may be dulled by accident or long use, or become too full of waste stock or dirt, or may have, if the work is very heavy, too slow a speed for the amount of stock it is obliged to carry. The remedies for these conditions are obvious. If clothed with diamond wire, it should not be ground until necessity compels it, as the original cut point is by far the best, but a ground point is better than no point at all. It is very much the same in regard to cleaning. For such wire, the less done the better for the wire, its point and the work. But when long stock is so wound into the teeth that the fed stock must press itself to the points in order to have them take hold of it, or when the teeth are so filled with dirt that the gum rounds up their front edge clear to their point, it is time to clean out partially at least. When obliged to resort to higher speed, do not increase more than needed; too high a speed is wearing to both wire and stock.

Such unevenness as was last noticed occurs oftenest in the outer strands from automatic feeds, and when any of the above causes exist their effects are aggravated because of the doubling of the web at that point. Even when everything else is all right, very bad bunches may result from the doublings being too far in from the edge of the card, or because sufficient space has not been allowed for the waste end ring on the doffer. This not only gives an uneven strand, but a coarser one, while from the other causes mentioned, the extra stock in the bunches is taken from the other portions of strand, and is consequently followed by places in the strand lacking this stock, and consequently is much finer than the required size of the roving, as the bunches are coarser. Bunches resulting from these causes are seldom uniform in size, but come in series, gradually diminishing from large to small. Each series generally has its largest bunches at the beginning as the strand comes from the machine.

An unevenness very like the above is sometimes caused by untrue workers. In this case, however,

there will be a gradual alternate swelling and diminishing from fine to coarse and from coarse to fine, but quite uniform as to the amount of stock which either kind contains. Wool-carders who have always carefully kept their machines true may think that such effects could only be produced when the workers were very much out of true. They leap to the conclusion that it is caused by the high side of the worker taking up more stock than the opposite, which it will certainly do as long as both sides are equally sharp. But when a worker is only slightly sprung, if it is so closely set that the point is cut from the tooth while the lower side remains sharp, this last will be the one that will take up the most stock. This is oftener the cause of unevenness of this character than very badly sprung workers. In either case the greatest unevenness will be found among the centre strands. But all the workers may be perfectly true and yet this same unevenness be noticed with somewhat longer spaces. This is caused by an uneven cylinder surface, either from its being out of true or because portions of its clothing are without teeth. From the first cause the greatest unevenness, like that from the workers, will arise in the centre of the card, while in the other case it comes from where the most teeth are lacking.

It seems almost needless to say that untrue ring doffers will make coarse and fine places, as it is such an easy matter to keep them true. But doffers will get sprung, or, at least, their shafts will, and the journals become worn, and then some results similar to those from untrue workers are seen, only the coarse and fine places together will be equal in length to the circumference of the doffer. They will all be of nearly the same length with each other, if the points are equally sharp all the way round. But if the point is worn on the high side, there will be finer roving from both the highest and lowest sides, with the coarsest places coming from those portions of the ring immediately adjacent to its dullest part.

As it is very evident that all of this bad work can be avoided by keeping the machine true, well clothed and well ground, it may occur to the reader that this advice might have been given in very few words. If the information sought to be given here was only to reach those who are already informed, these papers would only be a waste of words. But there are learners to whom a hint as to where to look for the cause of their trouble is sometimes very valuable, and there are those who, though not carders, are just as much interested in the quality of work, and to whom a correct theoretical knowledge of wool carding would be of very great benefit. Not only these, but the carders who work for and with them are interested. For the carder himself, for all of his assistants, for those who must continue toward completion the process of manufacture which he has begun, and for those for whom he works to know just where to locate the cause of defective work, is useful and serviceable. This is why so much pains have been taken to specify so particularly the different appearances in various defects from different causes.

It is not to be supposed that any good carder permits his cards to get into a condition which will produce the defects referred to above in their extreme forms. But their existence in a slight degree will often account for shady, cockly, and light and heavy goods, and other imperfections; and even if this were not the case, if the carder is obliged to work anywhere near the limit of the capabilities of his stock, he can ill afford to let his machines get out of order to such an extent that any defect in the roving cannot be readily perceived and remedied.

#### THE BEST SOAP FOR WASHING AND FULLING.

The results of some recent experiments with regard to the adaptability of certain kinds of soap for washing and fulling, especially with reference to potash soaps, are given in the following article by a well-known German authority, who says that he became convinced that in by far the greater number of cases the hard, stiff feel and disagreeable smell of certain grades of cloth are not due to the oil residues from the spinning room, but entirely to those of the soap used. For instance, pieces of cloth lubricated with elaine and neutralized with soda were found to be absolutely clean and free from odor after drying. The bad smell became noticeable only after fulling with soap, and I wish to distinctly state here that it is due to the presence of soap, or rather, oil residues. The opinion is often expressed that, although cloth has a slight odor, it is nevertheless clean, and that it is simply owing to the soap. This is not true, however. Not long ago I experimented with a hard fulling soap, which the manufacturer warranted to be free from all insoluble ingredients, and prepared according to a special formula. But it produced results far less satisfactory than agents which made no pretension to being extra pure. It was unsuited even for the commonest uses, it produced very little lather, and left on the hands an oily coating that could be removed only after much trouble. For the practical man this operation is a fairly good test of the merits of a soap. If it lathers very little, or not at all, it is unsuited for washing and fulling, because by heavy suds only is the soap capable of keeping the dirt in the cloth in suspension and carrying it off when the soapy water is expelled. Besides this, it must not leave any residue in the cloth. Therefore, when a stiff, slippery mass is formed in the washing of fulling goods instead of strong, thick suds, the fuller may be certain that much dirt and soap will remain in the cloth, and that it will be stiff and have a bad smell after being dried.

The disagreeable smell is not always noticeable at once, but frequently not until after the finished cloth has been stored for a while. I have also observed that by drying at a low temperature, as, for instance, in the open air, the odor is not quite so pronounced as when a higher temperature, as in the hot chamber, is employed. Vat-blue pieces washed with the previously mentioned "doubly-purified soap" had an exceedingly nauseating smell after they were dried in the machine.

Besides the cleaning of the cloth with soap, the color is also of importance. It is most difficult of all to wash soap out of vat-blue cloth; first, because the wool is not boiled in dyeing, for which reason a large part of dirt and yolk, which are extracted by boiling, remain in the cloth; and, second, because the traces of lime from the vat produce a partial decomposition of the soap and form a lime soap, which dissolves only with difficulty. Vat-blue wool, especially if of a dark color, should therefore invariably be rinsed very carefully. It is generally believed that the lime residues from the vat are completely removed by the opener, but this view is incorrect.

In most instances, however, the incomplete removal of the soap, as previously mentioned, is altogether owing to the insoluble fats which it contains. To avoid this, I have of late used, more especially for piece-dyed cloth, only a readily soluble and strongly foaming potash soft soap, both for fulling and washing, and have obtained excellent results with it. The cloth receiving in all respects the ordinary treatment becomes cleaner much more quickly, and no bad odor is perceptible after drying. Formerly I was scarcely ever able to obtain either a white or a vat-blue piece devoid of smell when using fulling soap, and often I was compelled to wash it again with a stiff fuller's earth solution, and addition of aqua ammonia after teaseling and drying, whereby the cloth usually lost both in feel and in weight. Either the oil used for the soap, which the manufacturer said consisted of pure olive oil, tallow, and potash, saponifies readily and leaves no residues, or else the potash has a better effect than the soda of the hard fulling soaps. In short, the result was favorable in every respect, and hereafter I intend to use no other than potash soft soap for piece-dyed cloth.

The soft soaps have been practically banished for a number of years, and displaced almost entirely by the so-called hard fulling soaps. It is declared that they do not cleanse the woolen goods, that they make them hard and brittle, and retard the fulling process—or, at least, do not expedite it so much as the solid neutral fulling soaps. It is probable that formerly they were not prepared with the same care as now, and were frequently adulterated. I could observe none of these objections with the soap I used. The fulling process progresses equally as well as with a hard fulling soap. It is obvious, in view of the consistency of soft soap, that more of it must be used than of hard soap. If the cloth is treated as it should be, it will obtain the similar compact felt and remain just as soft as with hard soap. Since the neutral oil-curd soap must generally be sharpened with a little soda in the washing out, which is not necessary with soft soap, a still softer cloth is often the result when using the latter. This fact I am tempted to ascribe to the potash. I had frequent occasion to find in fulling, as well as in wool-washing, that it has not so drastic an action as soda, and that it imparts a soft feel to the wool fibre. The subsequent sharpening with soda, as recommended by many manufacturers of neutral soaps, is decidedly

hazardous. I have never obtained good results with it, since a simple mixing does not produce a thorough combination of soda and soap, and both agents will continue to act separately, thereby causing the cloth to become hard and board-like. Experts know well that soda has a far more violent action on *fulled cloth* than on *unfulled*. The oil percentage of the soap neutralizes the alkali, and thereby makes it of no effect. I would establish the following rule: Never sharpen either with pure or carbonate alkali when washing *fulled cloth*. It is far better to use a soap that foams well, and one that can be washed out easily. In case it will not fully accomplish this, dry the cloth and then wash it well with fuller's earth.

The only objection to soft soap is its large percentage of water, which essentially increases the cost of shipment, when ordered from a manufacturer living at a distance. But this disadvantage is entirely compensated by the advantage of obtaining better and cleaner goods. It is perhaps possible for soap manufacturers to produce a stiffer potash soap if they should try to. The principal condition, however, is that the soap must contain an oil which saponifies readily. It must foam well, be easily washed out, and leave no oily residues in the cloth.

ACCORDING to the most recent reports, Russia now produces in cotton manufactures more than is sufficient for that country's own requirements, the industry having developed very rapidly in recent years. There are about 900 factories, employing 250,000 workpeople. One firm alone has 20,000 employés. The total annual production amounts to about 350,000,000 roubles. In point of quality the goods are said to show great improvement. In the same country there are 150 linen goods factories, employing 44,000 hands. There are also over a thousand woolen mills, with 100,000 employés. In the silk industry production has not yet reached very great proportions, though there are 22,000 people engaged in it. The production amounts to 20,000,000 roubles worth.

ENGLISH woolen manufacturers are trying to gather sorry consolation for their losses from the fact that the French competitors are in an even worse state. Their production in the good old times was valued at about £40,000,000 sterling per year, but since the Meline tariff came into force this has shrunken seriously. In the district of Fourmisse the shrinkage has been so great that woolen mills are said to have lost about four-fifths of their former value, while land and house property in the neighborhood has depreciated about 50 per cent. In France, as in other European countries, the blame is laid upon the McKinley tariff, but in this case French manufacturers are, after all, only treated as they, with their protective barrier, have treated other nations. At all events, these woolen manufacturers are in a bad way and seem to feel so depressed that they have formed what they call a National Woolen Trade Association, and are appealing to the Minister of Commerce to see what can be done for them.

# S. Greenshields Son & Co. \_\_\_\_\_

General Dry Goods  
Merchants

MONTREAL

---

## SPECIAL VALUE IN CANADIAN PRINTS

We have just made a large clearing purchase of the two leading cloths from the Magog Mills, which we offer below Manufacturers' prices.

SEND FOR SAMPLES 



**Empire Carpet Works**

JAMES H. ETHERINGTON, - PROPRIETOR  
ST. CATHARINES, ONT.

MANUFACTURER OF

**ART SQUARES and STAIR CARPETS**

*3-Ply and Extra Super All-Wool Carpets  
and all grades of Union Carpets*

**STEVENSON, BLACKADER & CO.**

Manufacturers' Agents, MONTREAL

**The Montreal Cotton Co., Ltd.**

(Works at Valleyfield)

*Silesias, Ducks, Cambrics, Percates, Satteen  
Jeans, Turkey Reds, Pocketings, Beelited Twills,  
Linenettes, Shoe Goods, Window Hollands, Cor-  
set Cloths, Satines, Marseilles Cloths, Suitings,  
Shirting Satines.*

**The Globe Woolen Mills Co., Ltd.**

(Works at Montreal)

*Tweeds, Cassimeres, Meltons; Box, Costume  
and Mantle Cloths.*

**JAMES LOCKHART, SON & CO.**

Woolen Manufacturers'  
Agents

**59 BAY ST., TORONTO**

**GOLD MEDALIST DYERS.**

*All Kinds of Dry Goods in the Piece  
Re-dyed, Finished & Put Up.*

**MILLINERY GOODS**

Ribbons, Silks, Velvets, Plushes,  
Laces, Nets and Veiling technically  
treated, Re-dyed, Finished and Put  
up. Work guaranteed the best.

Ostrich Feathers Dyed, Cleaned and Curled,  
English or Parisian Mode.

**Superior Garment Dyeing & Cleaning**

IN ALL ITS BRANCHES.

**FRENCH CLEANING**

(Nettoye en Sec.)

A wonderful invention for Cleaning Fancy and Valuable Goods, Dress Suits  
and all other expensive articles. Guaranteed no Shrinkage  
or color running.

**BRITISH AMERICAN DYEING CO.,**

NEW WORKS, VERDUN.

Office 2435 Notre Dame St., Montreal.

Branch Offices:—90 King Street East, Toronto. 123 Bank Street, Ottawa  
47 John Street, Quebec.

JOSEPH ALLEN,  
Managing Partner.

Letter Address,  
Box 258 MONTREAL

**NEWLANDS & CO.** Manufacturers of

**Saskatchewan  
Buffalo Robes**



Buffalo Fur Cloth Coats  
Black Dogskin Cloth Coats  
Astrachans, Lambskins  
Stripe Jerseys, Elder Downs  
Glove and Shoe Linings

Factories at GALT, Ont., and BUFFALO, N.Y.

**The GALT KNITTING COMPANY Ltd.**

**GALT, - Ont.**

*Knitted Underclothing, and Top Shirts in  
Summer and Winter Weights.*

SELLING AGENTS:

The Maritime Provinces . . . . . Mr. WM. D. CAMERON  
Montreal, Quebec, Ottawa, . . . . . " JNO. F. HASKELL  
Ontario . . . . . " J. E. WARNOCK

WHOLESALE ONLY.

ESTABLISHED 1859

**THE C. TURNBULL CO.,**

OF GALT, Limited.

MANUFACTURERS OF

Full Fashioned Lamb's Wool Underclothing, Hosiery and  
Knitting Yarns. Perfect Fitting Ladies' Ribbed Vests,  
Sweaters, Jerseys, Knickers.

THE

**Canadian Colored Cotton Mills Co.**

SPRING, 1894

GINGHAMS

ZEPHYRS

FLANNELETTES

DRESS GOODS

SKIRTINGS OXFORDS COTTONADES

AWNINGS, TICKINGS, etc., etc.

**NOW READY**

See Samples in Wholesale Houses

**D. MORRICE, SONS & CO., AGENTS**

**MONTREAL and TORONTO**

THE  
**RIGBY**  
**Waterproof**  
CLOTHING



WE are now proofing Tweeds suitable for Men's Suits and Ladies' Ulsters and Jackets, which we are offering in the piece, samples of which are now being shown on the road by our travellers, on special trips with RIGBY GOODS.

Remember that we claim RIGBY proofed materials to be waterproof, which can be satisfactorily tested by any one before purchasing.

Ladies and Gentlemen will appreciate the comfort of having a nice Tweed Overcoat or Ulster, used in ordinary wear. Thoroughly Porous, and yet a sure Protection during a Rainstorm. Sample orders solicited.

**H. SHOREY & CO.,**  
MONTREAL.

**WM. MITCHELL**

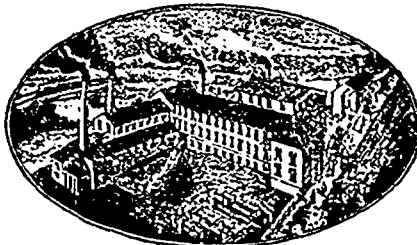

Manufacturer of  
Coco Matting and Mats  
Jute Matting and Carpets  
Wool Imperial Stair Carpets  
Wool Rugs  
Napier Matting (cable cord, extra heavy, heavy L.H.)  
Lettered Mats to order

Address all correspondence to the Works.

WILLIAM MITCHELL, - - - COBOURG, Ont.

**Thompson & Co.**  
SHERBROOKE, QUEBEC  
Manufacturers of  
BOBBINS and SPOOLS of every description  
For Woolen, Cotton and Rope Mills

*Extra facilities for supplying new mills and filling large orders*

Correspondence solicited. Orders promptly filled.

**Thos. Carlyle's**

Flexible, Mohair,  
Trousers, Livery,  
Official, Fancy Metal,  
Anchor, Ivory and Buffalo  
BUTTONS

Vest and Trousers,  
Gaiter and Anchor  
BUCKLES  
Mantle and Trousers  
HOOKS and EYES

**Aston,**  
Birmingham

ARE THE BEST IN THE MARKET

Agent for Dominion of Canada:

**A. McTAVISH WATT**  
9 LEVINE STREET MONTREAL

**Removal Notice**

**JAS. A. CANTLIE & CO.**

HAVE REMOVED TO

**ALBERT BUILDINGS**

290. ST. JAMES STREET

South Side Victoria Square . . MONTREAL

Toronto Branch: 20 Wellington St. West

**J. Ironside Thomson**

COMMISSION MERCHANT and MANUFACTURERS' AGENT

European Manufactures:

GEBRUDER BOCHMAN, Meerane and Mulsen, Saxony—  
Plain and Fancy Dress Goods and Overcoat Linings

FRANS MUTSAERTS & ZONEN, Tilburg, Holland—  
Serges, Vicunas, Beavers, Naps, Ulster Cloths, etc.

Canadian Manufactures:

GILLIES, SON & CO., Carleton Place—Fine Tweeds  
HARRIS & CO., Rockwood—Friezes, etc.

Correspondence Solicited. TORONTO and MONTREAL

**ROSAMOND WOOLEN CO., ALMONTE, Ont.**

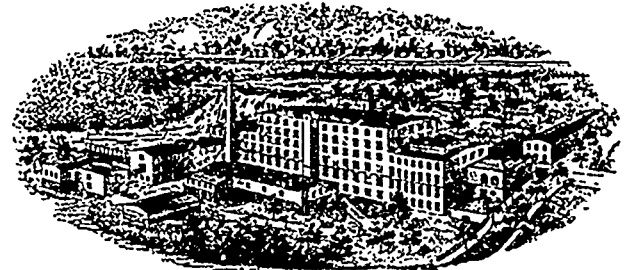

*Fine TWEEDS, CASSIMERES, and Fancy WORSTED SUITINGS AND TROUSERINGS*

Colors warranted as fast as the best British or Foreign goods.

**Hamilton Cotton Co., Hamilton**

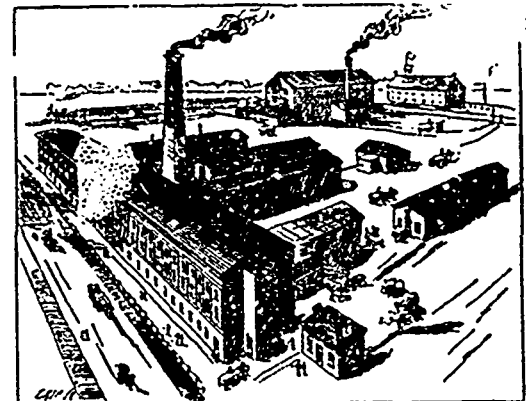

Manufacturers of

Cottonades,  
Denims,  
Hosiery  
Yarns,  
Beam Warps  
Carpet Warps,  
White and  
Colored  
Yarns,

Lampwick (standard and special sizes), Webbing, Bindings, etc. Best in the market.

SELLING AGENTS:

D. MORRICE, SONS & CO. MONTREAL and TORONTO  
Agents for Beam Warps: PAUL FRIND & CO., TORONTO  
Agents for Ribbing: A. McT. WATT, MONTREAL

## THE "ROBB-ARMSTRONG" ENGINE.

We illustrate on this page a new single valve automatic engine recently brought out by the Robb Engineering Co., of Amherst, Nova Scotia. In general appearance it does not differ greatly from several popular high-speed engines, and no radical departure has been made in principles of construction, the aim being to combine as many as possible of those points which have proven best in practice, with such improvements in details as have been suggested by observation and experience with other engines. In other words, it is not an attempt to develop a new species, but to advance

right of Fig. 2; the counter-weight is of equal moment with the reciprocating parts. The shaft bearings run in cast-iron shells, babbitted; they are not provided with means of adjustment for wear. The bearings are finished by grinding operations of great delicacy, and are round and parallel within a limit of variation smaller than the average machinist will usually detect, even with the aid of the micrometer. The shafts are made to gauge, and the shells are interchangeable, as are the other parts of the engine; hence, a duplicate set of shells may be kept for emergencies. The crank is covered by a cast-iron case, shutting it completely in except at the slot through which the connecting rod

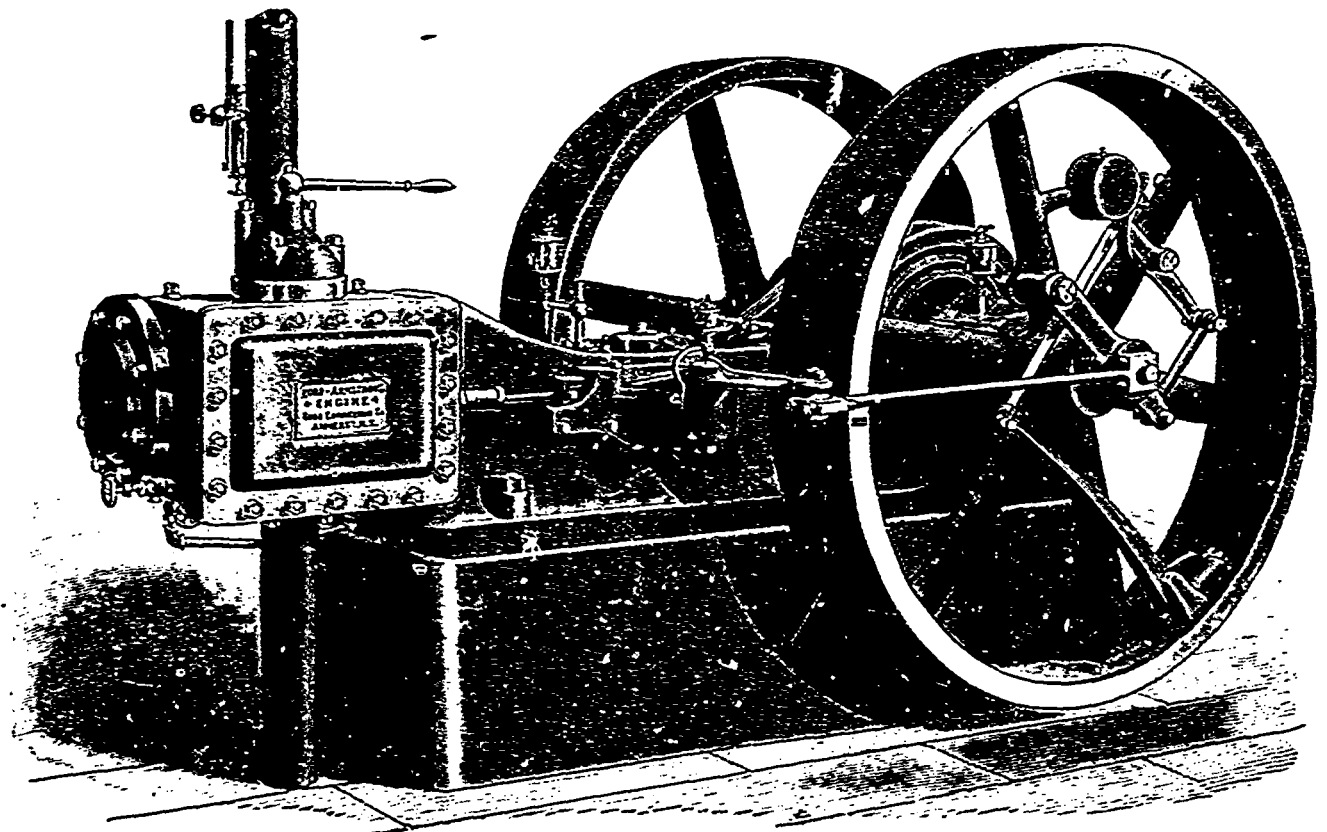

one step in the evolution of that already highly developed machine, the American high-speed engine. The following is a brief description of the main features:

The frame is of the "Porter" type with double-disk crank; it has considerable sectional area; carried well above the centre line, and is particularly thick at the top, thus bringing the metal in the direct line of strains between the cylinder and shaft bearings. The engine weighs a little over 100 pounds per horse-power, not an unusual weight, but the metal is distributed to give the greatest attainable stiffness, and without much regard to the "anvil principle," the foundation being expected to furnish all the weight required in that direction at less cost.

The crank is "built-up" of cast disks and forged steel pin and shafts, the peculiar arrangement of the crank permitting the fits of the shafts and pin in the disks to be very long, without separating the shaft bearings unduly, as is shown in the cross-section at the

works. The crank disks are without the usual finished flanges on the periphery, the crank case being designed to have a substantial and finished appearance, and free access is given to the crank-pin box when the hinged crank case is raised. The crank-pin is oiled through two half-inch holes, one extending from each side of the crank to the centre of the crank-pin, all oil wasting from the inner ends of the shaft bearings being instantly carried to the crank, while all oil wasting from the outer ends of shaft bearings is caught, and by a ring riding on the top of shafts and dipping into the oil below, is returned again and again to the bearings, until it finds its way to the crank-pin and escapes to the crank pit, to be drawn off and filtered. In practice the crank-pin does not need oiling other than as stated, but a sight-feed oil cup is provided in addition to those oiling the shaft bearings, which will, if desired, feed oil direct to the crank-pin through one of the half-inch holes before mentioned.

The fly-wheel governor is a modification of the "Straight Line," and, together with the valve, is used by arrangement with the Straight Line Engine Co.; the oiling devices mentioned will also be recognized as essentially "Straight Line."

The eccentric rod, so called, although there is no eccentric, has ball and socket bearings at each end, the balls being case-hardened and ground, and the sockets or boxes of phosphor bronze. The rocker arm, by which the eccentric rod drives the valve, is horizontal,

The crosshead is a single steel casting, of the "Slipper" type, the bottom of the slipper being babbitted. The piston rod is secured by being gripped in two places, about two inches apart, one place being threaded and the other a parallel fit. The crosshead is split and is gripped on to the rod by bolts; this proves very good, in that it can be taken apart and put together again without getting out of line more than permissible in the highest grades of engine work—a point in which the usual methods of securing piston

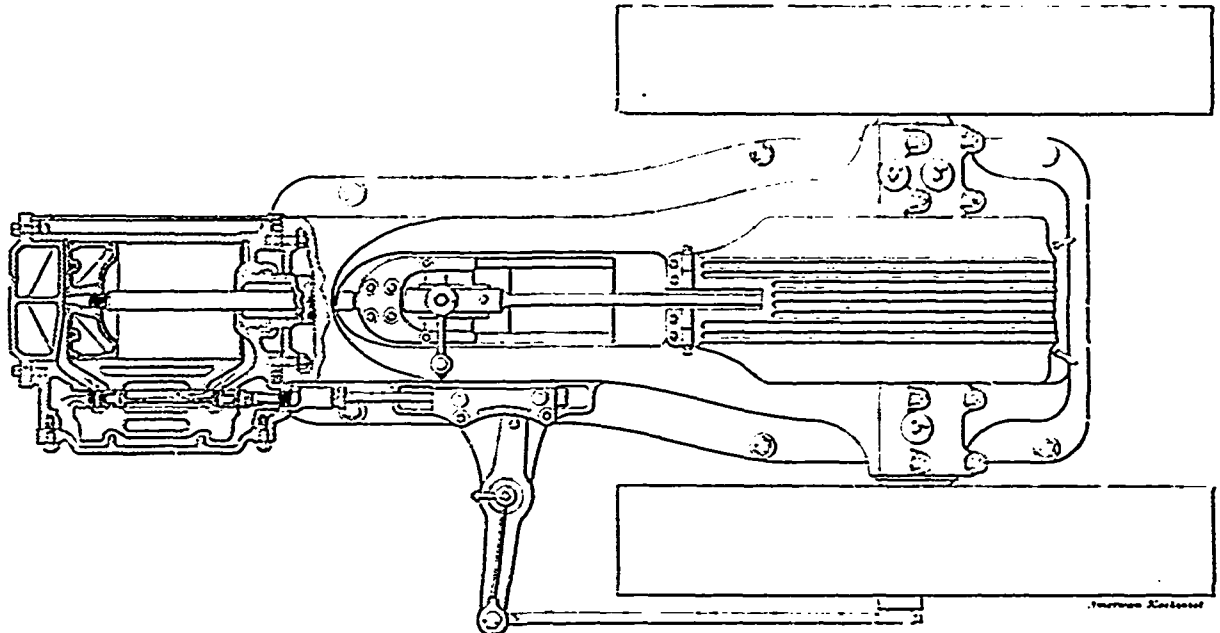

with a vertical axis; there is no twisting strain on either of its bearings, a straight line passing through all three of them. An index finger attached to this arm, as shown in plan view, Fig. 3, shows by the graduations over which it passes, the movement of the valve, and thus is of assistance in valve setting.

A small sight-feed oil cup, directly over the centre of the rocker arm, supplies oil through a tube to the outer end of the arm. The eccentric rod is hollow, being, in fact, a piece of hydraulic pipe, and through it

rods to crossheads (with the exception of the taper fit and key) are often faulty. The crosshead pin is of cast iron, as it is believed that, in connection with the large and long bearing, it is the best material for the place. The connecting rod is a steel forging, the crank end being of the "Marine" type, while the crosshead end is mortised for boxes, which are cast iron, lined with babbit. The adjustment is by a wedge and adjusting screws.

The babbit used in the engine is made from eight

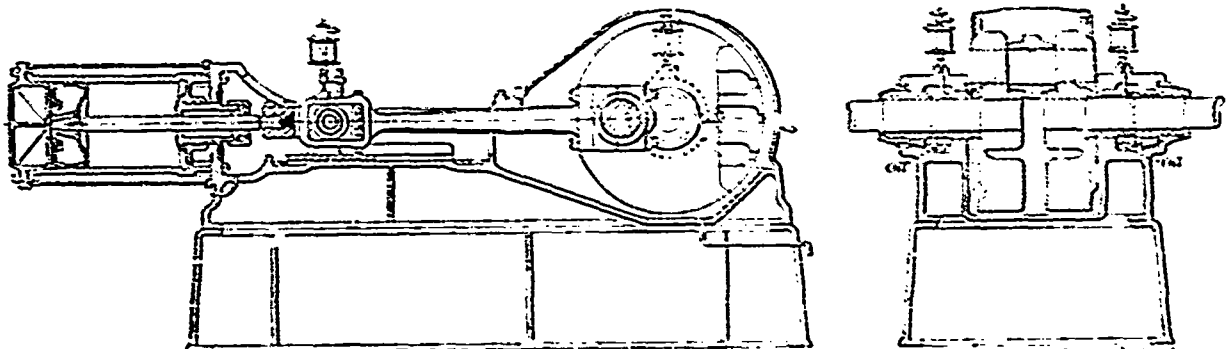

the oil passes to the eccentric pin, any oil finally escaping being caught and held in the flanged fly-wheel.

The centre bearing of the rocker arm works in a bath of oil so arranged that it is constantly flooded, and so that no oil can escape to the floor, any overflow draining to the crosshead guide, and finally to the crank pit.

parts Banca tin and one part each of antimony and copper. The piston is a single casting with sprung rings; it is made extremely light, both to save the cylinder from wear and to make it the "breaking-down" piece; though amply strong for all legitimate loads, it is expected to be weaker than other parts, the idea being that it is the best thing to break, when experi-

ments to determine the compressibility of water are being made with it. The exhaust passages are jacketed by air spaces from the cylinder, and from the live steam in the steam chest. The throttle is a modification of the "Coffin Valve" used by the Straight Line Engine Co.; but it is operated by a lever instead of a wheel, or ball handles.

The workmanship is intended to be equal to that of any other engine built. The firm also build cheaper automatics, but this engine was brought out to fill a demand for which they have previously been obliged to import the best and highest priced American engines. The engine was designed by E. J. Armstrong, who is now with the Ames Iron works, Oswego, N.Y.

FOR THE CANADIAN JOURNAL OF FABRICS:  
TEXTILE FIBRES.

BY P. L. SIMONDS, F.L.S., LONDON, ENG.

The vegetable fibres take rank in order as follows: Cotton, jute, flax, hemp and a few others of secondary importance. The mission of England seems to be to provide clothing for the rest of the world, and if we take the aggregate of the textile manufacturers of the United Kingdom, including yarn, apparel, haberdashery and millinery, our annual exports alone (exclusive of what is used at home) averages in value 110 millions sterling! Approximately the value of the textiles used in the world exceeds 640 million pounds sterling, and of the clothing 441 million pounds sterling. The consumption of fibre of all kinds, by different nations, exceeds in quantity 10,000 millions of pounds. That of the United Kingdom alone exceeds 3,000 millions, for we consume 28 per cent. of all the fibre in the world.

Over one million hands are employed in our textile factories, and a girl of twelve years old in a Lancashire mill can turn out 35 yards of printed calico daily, her work in one year sufficing to clothe annually twelve hundred persons in the East. Europe spends on all textile manufactures 406 million pounds, and other countries about 273 million sterling.

If we consider the vegetable fibres first, we find that our average imports in the last three years have been about 16½ million hundred weight of cotton, one million seven hundred thousand cwt. of flax, nearly two million cwt. of hemp, and six million cwt. of jute. Of these amounts we re-exported two million cwt. of cotton, one million and three-quarters cwt. of jute, and 809,000 cwt. of hemp, the rest being worked up at home. The value of the total imports were 38 million sterling for the cotton, and over nine million pounds for the other fibres.

There are about two million operatives in the world employed on cotton, producing ten million miles of cloth yearly, worth about one pound a mile. For China, Japan, and Central Africa we have no estimates of the consumption.

Of the cotton grown in the United States in the last seventy years, two-thirds was consumed by the various factories. The American crop of 1892 was 9,000,000 bales, or over 2,000,000 tons, and the cotton

crop of the world shows a steady increase, the decade ending 1892 being 500,000 tons more than the preceding decade. The history of cotton dates no further back than the tenth century, and its great development merely from the present century; while that of wool and its manufacture is nearly coeval with the history of man. The production of cotton is confined almost exclusively between the 36th parallels N. & S., while sheep, though varied in their kind, are adapted to the several conditions of soil and climate that exist between the latitudes of 68°. Great Britain uses up one-third of all the cotton produced, the United States being the next largest consumer. The cotton industry was only introduced into India about fifty years ago, and now there are one hundred and twenty-seven cotton mills at work there, employing 118,000 persons. If the Bombay Presidency monopolizes the cotton manufacture, that of Calcutta rivals it in the growth and manufacture of jute. The first mention of this fibre in the commercial returns was in 1828, when 364 hundred weight were shipped to Europe. The manufacture of sacks and of gunning cloth from it was then entirely in the hands of Indian peasants, but the export trade has now advanced to ten and a half million hundred weight, valued at eight million sterling. The bulk of this (six millions) comes to England, the manufacture centering chiefly in Dundee. Jute is the cheapest of all fibres, and can be produced in the East for one-eighth the cost of cotton. The bulk of the jute grown is converted into sacks for wool and grain, etc., but a portion is worked up in India and Scotland for fabrics. In England and America jute enters largely into a variety of woollen and silk goods, carpets, apparel, and other articles. The value of our exports of jute yarn and manufactures last year, 1893, was about £3,300,000. The introduction of unions is of undoubted antiquity. The first mention made of them in the Bible is (Gen. xli. and xlii.) when Pharaoh advanced Joseph, and caused him to be arrayed in textures of "fine linen." This occurred seventeen hundred years before the Christian era. And yet linen is comparatively little used for clothing at the present day. Twenty years ago the land devoted to flax in the world exceeded three million six hundred thousand acres, of which Russia had two million acres under flax, and the average yearly production is now five hundred thousand tons.

As an article of clothing, in hot Eastern countries especially, linen cloth is, of all others, the cleanest, coolest, and most agreeable. It was the ordinary dress of the ancient Egyptians. Both the living and the dead were clothed with linen. The wrappers of a mummy often measured upwards of three hundred yards, and varied from the finest muslin to the coarsest sailcloth. The Prophet Hosea twice mentions linen as one of the chief materials used for clothing in his time. Linen is, however, more expensive and scarcer than calico, and hence has been largely superseded by the cheaper cotton. A single pound of flaxen thread, intended for the finest specimens of French lace, is

valued at £120, and the length of the thread is about two hundred and twenty-six miles. One pound of this thread is more valuable than two pounds of gold.

Before Britain became so great a commercial nation, each town and village had its weaver, and every good housewife was expected to furnish her family with linen of her own spinning.

The Russian factories produce annually goods valued at over four millions sterling, which are made entirely from flax fibre. Much linen and thread is made annually by the peasantry at their homes, the value of which cannot be obtained.

Flax used to be extensively grown in Ireland, but the acreage under this crop has greatly decreased in the last few years, and we are chiefly dependent upon foreign supplies. We use up about two hundred million pounds, and the approximate value of the linens made in the United Kingdom is ten millions sterling. In France the quantity produced is greater. Hemp is more generally used for bagging and ropes than for clothing, since sackcloth is seldom indulged in.

What is termed in commerce "Manilla hemp" is in fact a plantain fibre, our imports of which have trebled in the last quarter of a century, and are valued at two and a half millions sterling. Although chiefly used here as rope, dress fabrics are made of it in the Philippines.

Another fibre which has been much vaunted, but has never come extensively into use, is the nettle fibre, species of *Urtica* or *Bosheria*. The French have adopted the Malay name of "Ramie," but in India it is termed "Rhea." There are probably two species, *Urtica nivea* of China, and *U. candicans* of Java. This first furnishes the strong and beautiful fibre woven into a fabric which has been inappropriately called "grass cloth." The bark is, in the East, softened by hot water or steam, and then separated into its tender fibres. The best is obtained from the young shoots; it is glossy, tough and lasting, combining, to some extent, the appearance of silk with the strength of flax. For more than eighty years experiments have been carried on with machines for decorticating the fibre, but unsuccessfully; hence the difficulty of removing the bark and preparing the fibre has kept it from coming extensively into use. It is, however, largely grown in Mexico, the United States, France, Queensland and other countries.

Passing now to a consideration of the animal fibres used for clothing, the first is the wool of the sheep. There are nearly 500 million sheep in the world, and these produce yearly about 2,000 million tons of wool. A heavier improved fleece is now obtained in our Australasian colonies, averaging about six pounds of greasy wool per sheep. It is curious to notice that the British possessions supply the bulk of the wool produced, and we are becoming less and less dependent upon Europe. Although colonial wool has declined in price about one-half per bale in the last 30 years, yet the quantity produced has enormously increased, having quadrupled in that period, and the average annual value

of the sales here has increased from £7,000,000 to £26,000,000 yearly. Our imports of wool are steadily increasing, for the greater part of the world's clip comes under the hammer at the London periodical wool sales. Last year our imports reached 737,600 million pounds of sheep and lamb's wool, but to this has to be added the imports of alpaca and goat's wool, woolen rags (to be worked up again), sheepskins and the production of wool at home, bringing up the total to 978,600 million pounds. We exported 430,000 million pounds. The value of the imports of these wools last year was 28,610 million pounds sterling. The 418 millions of population of Europe and North America consume 2,225 million pounds of raw wool, or in the proportion of nearly three pounds of clean wool per inhabitant.

Wool as an article of clothing is becoming more generally used than formerly, and even the teeming populations of China, Japan, and South America, are beginning more to appreciate wool as a clothing material.

Goat's wool, or mohair, and alpaca, are elements to be considered in the woolen manufacture. Formerly we used to get our fine goat's wool only from Turkey, but now our colonies produce it, and we receive in all 19½ million pounds. The export from the Cape only dates from about 1868, when it amounted to but 102,570 lbs.; now the shipments reach 10,000,000 lbs.

European competition has proved very disastrous to the fine fabrics which were once made up in Asia Minor from Angora yarn. This industry, which is said to have once employed 1,200 looms, turning out 20,000 pieces of stuff annually, besides gloves and stockings, and a material which was waterproof, and used as cloaks by the wealthier people, has about entirely disappeared, and we get our chief supply of mohair from the Cape and Australia.

The hair of the Angora goat was woven into cloth by the ancient Persians. These garments were dyed in brilliant colors with khenno or cochineal, and robes of such extreme beauty and splendor made from them that they were worn by the kings of Persia. The hangings of the Jewish Tabernacle consisted of a fabric made of goat's hair.

In the district of Orenburg, Russia, a great trade is carried on in shawls and neck wrappers. These are made of gossamer-like webs of goat's hair woven. They are marvellously light, a very large shawl weighing only a few ounces. Many of them are so delicately made that they can be passed through a finger-ring. Real cashmere shawls are made from the down or under fleece of the Thibet goat. In the time of the Great Mogul Emperors, 40,000 looms was the reputed number in Thibet; each loom averaged five shawls annually. The present number of cashmere looms is stated to be about 16,000, and the annual manufacture, 30,000 shawls.

The first shipment of alpaca wool from Islay and Arica was about fifty-seven hundredweight in 1834, but in 1849 one million pounds were sent to England, and now the United Kingdom receives four and three-

quarter million pounds. It is chiefly in Bolivia and the Sierras of southern Peru that the alpaca is found in numbers; but it is extending to Chili and Argentina, the latter republic owning 50,000. The wool is spun and woven locally into garments of a fine and delicate quality. They still make mantles, table covers, quilts, and various articles of ornamental dress there, which have a gloss upon them as if partly made of silk. Even the camel furnishes a hairy fibre which is woven into fine shawls, worth from £1,500 to £1,800, and the coarser kinds into caps, girdles, tent cloth and carpets. The number of camels in the world does not probably exceed 600,000 or 700,000, located principally in Asia and Africa. In Arabia the hair of the camel does not exceed 2 lbs. in weight, but the fleece of the Bactrian camel averages ten pounds. About 2½ million pounds of camel's hair are shipped yearly from China, through the port of Shanghai, chiefly to England.

The other animal fibres imported are horse hair, human hair\* and silk. The production of silk in the world may be roughly estimated at 60 million pounds, of which Europe produces 32 millions, the Eastern countries 24½ millions, and the United States 6½ million pounds. As the process of manufacture more than doubles the value of the raw material, the value of the manufactured article may be safely set down at 120 million sterling. The number of operatives employed on silk is unknown, but judging from the European and American civilized countries from which we have any reliable returns, it must exceed half a million persons.

But apart from the dry statistical figures given in this article, much information may be gained of the various uses of fibres for clothing and other purposes, by a study of the botanic exhibits at the Edinburgh and Kew Museum in England. In the latter there is an interesting collection of specimens of straw and grasses beautifully worked up; cotton in the various stages of preparation; flax from the seed stem to its manufacture into the costly fabrics for the dress, or the table; native cloths from New Zealand, China, Ceylon and the Sandwich Islands, and some of very delicate design are made of grasses, palm fibre, and the thin bark of the paper mulberry. Hats and cloaks made of the pith and fibres of palms, etc., and quite water-proof, from the Eastern Archipelago, Australia, etc.; the body cloth of the Dyaks of Borneo, made of the same substance, and aprons from the Navigators' Islands, formed of leaves cut and closely strung. A shawl made from that is known as Manila, but really a plantain fibre (*Musa textilis*), and beautifully worked, equal to the finest cambric.

Finally, when we consider the millions and millions of acres in the world which are employed for the growth of cotton, flax, hemp and other fibres, and those for grazing sheep, etc., of the millions of operatives in factories, and the looms and spindles employed in weaving

and spinning textiles for clothing, and the millions of pounds also spent throughout the world on wearing apparel and in textile manufactures, it forcibly impresses us with the great importance of the animal and vegetable fibres thus employed.

A METHOD has been invented in France for destroying the felting capacity of woolen yarns, to be used for hosiery. It consists in using the effects of aluminum salts combined with steam. The former have already been used, with soda added, but this was only partially successful. The woolen goods, the shrinking capacity of which was to be neutralized, were entered in a bath of sulphate of alumina, and when completely saturated with this fluid, the goods were then passed through a soda bath. The experiments utilizing steam for the shrinkage of woolen goods are not new, but the combination of the two methods is new, as is also the assertion that this method will effectually annihilate the felting capacity without impairing the fibre. Hitherto this capacity has only been produced by destroying the fibre at the same time, or nearly destroying it, with strong alkalis. This, of course, robs it of its most valuable properties. The felting is based upon the pliability of the wool fibres—a property so well known to every filler, and it is certainly a difficult matter to see how aluminum salts combined with steam can affect this property to the extent of destroying it. According to what ten inventors unhesitatingly say, however, this is the case. According to their novel treatment, the yarn is to be thoroughly saturated with a solution of some aluminum salt, after which it should be stretched tightly and then exposed to an energetic steaming. They claim that this method has also a similar effect upon cloth.

THE condition of the English cotton trade is well calculated to cause alarm among the manufacturers of that country. It is not so much that the demand for cotton goods has fallen off, so that the profits have become such a diminishing or indeed *minus* quantity. The following gives a striking illustration of this, and shows the profits and losses of the cotton mills in the Oldham district for the past ten years: 1884, 60 mills, profits £125,000; 1885, 87 mills, loss £2,730; 1886, 90 mills, loss £6,718; 1887, 88 mills, profits £85,810; 1888, 85 mills, profits £250,930; 1889, 86 mills, profits £220,587; 1890, 90 mills, profits £375,041; 1891, 93 mills, profits £10,764; 1892, 90 mills, loss £101,434, and 1893, 93 mills, loss £72,768. Statistics show that the consumption of cotton in Great Britain was last year 1,482,000,000 pounds, as compared with 1,656,000,000 in 1890. In the same period the exports of yarn fell from 258,000,000 to 206,000,000, and those of goods from 5,124,000,000 yards in 1890 to 4,653,000,000 yards in 1893. The fact that in the very countries whose imports of British goods show the most decline, the home manufacture of cotton goods has most increased, seems to point to the unlikelihood of British manufacturers catching up to the old figures in the near future. But they still fight on with bulldog pertinacity.

\* Human hair has been attempted for clothing, but the supply is insufficient, and it is chiefly used for false hair and wigs, as horse and goats' hair are sometimes used.

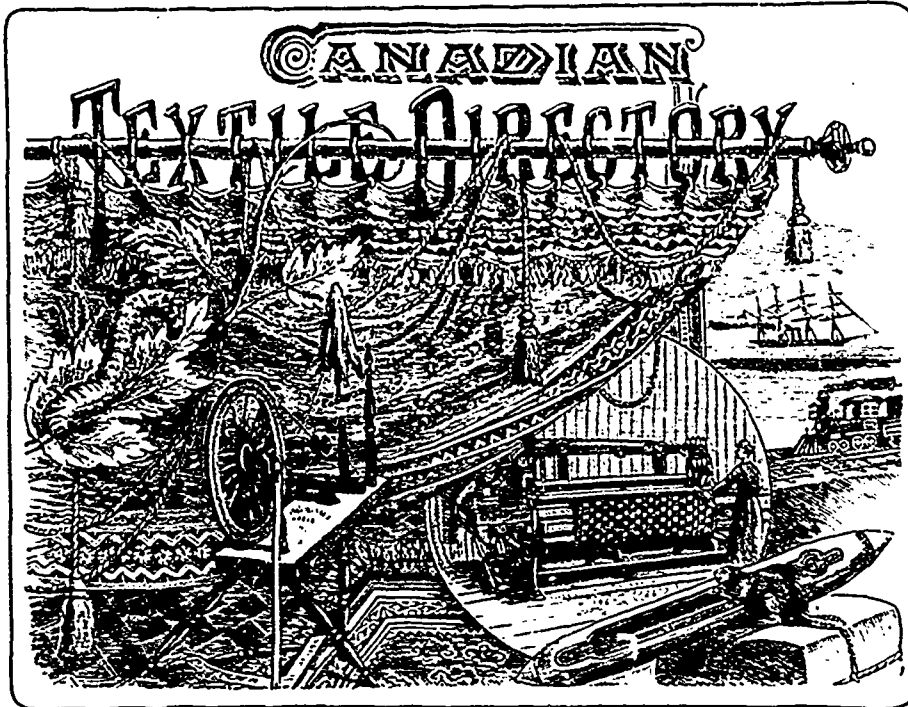

**T**HE "Canadian Textile Directory" is a reference book comprising all manufacturers and dealers in the textile trades of the Dominion. It embraces Cottons, Woolens, Print Goods, Carpets, Silk, Jute, Flax, Felt, Rubber, and Asbestos Goods, Clothing, Men's Furnishing (Haberlashery), Ladies' Wear, Buttons, Feathers, Job Dyeing Establishments, and Laundries, Furniture, Upholstery and Upholsterers Supplies, Sails, Tents, Awnings, Window Shades, and Wall Papers, Manufacturers and Dealers in Hats and Furs, Paper Mills Dealer in Raw Wool, Furs, and Cotton with principal Dealers in Dyestuffs, etc.

It gives lists of all Manufacturers, Agents, Commission Merchants, and Wholesale and Retail Dealers in the Dry Goods and kindred trades of Canada Also, Statistics, Tables of Imports and Exports, Customs Tariffs of Canada, Newfoundland and the United States, the Canadian Boards of Trade and Textile Associations, and other information. The Third Edition includes also the Trade of Newfoundland.

PRICE . . . . . \$3.00 PER COPY

**E. B. BIGGAR, Publisher**

Fraser Building, MONTREAL

or 62 Church Street, TORONTO

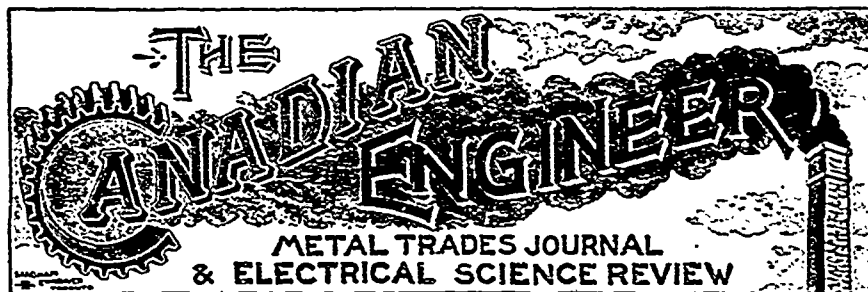

Published simultaneously in Toronto and Montreal.  
Subscription, \$1.00 a year.

**T**HIS Journal is devoted to the interests of Mechanical, Electrical and Mining Engineers; Stationary, Marine and Locomotive Engineers, Sanitary Engineers and workers in the metal trades, Machinists and Iron and Brass Founders, and generally to Mill-owners, Manufacturers, Contractors and the Hardware trade.

The *Canadian Engineer* has been received in the most flattering manner by the press and people whose interests it serves. Among the many press notices are the following:—

"There are some suggestive editorial notes, besides descriptive and technical articles and a wealth of short Canadian notes. It fills a distinct place in colonial journalism."—*Electrical Engineer, London, Eng.*

"The paper is brightly written, neatly printed, and replete with news of interest to our Canadian cousins."—*Electrical Power, New York.*

"Every article has a practical purpose, and it gives a great

deal of Canadian news of interest to the trades concerned."—*Water and Gas Review.*

"There is no reason why such a journal should not become a power in Canada."—*Charlottetown, P.E.I., Watchman.*

"It contains well-written technical and illustrated articles, and a surprisingly large amount of Canadian news."—*Metall and Eisen Zeitung.*

**TAKE IT.** Every subscriber to the CANADIAN JOURNAL OF FABRICS who has paid in advance will get the *Canadian Engineer* for 50 Cents for the first year, and every subscriber paying subscription to date will get the two papers for \$1.50. Close with this offer now. You will not have so good a chance later on.

ADDRESS:

**CANADIAN JOURNAL OF FABRICS**

Fraser Building, MONTREAL

or 62 Church Street, TORONTO



# WM. PARKS & SON, LIMITED

ST. JOHN, NEW BRUNSWICK

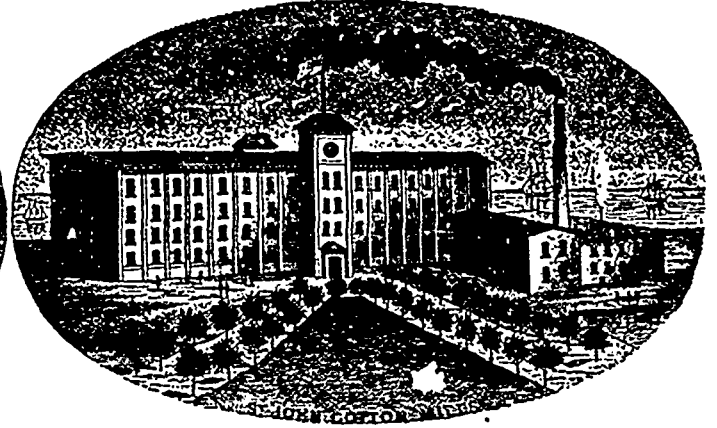
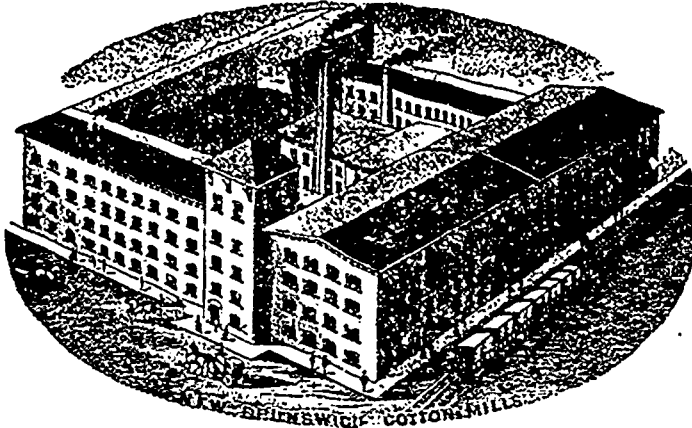

## Cotton Spinners, Bleachers, Dyers and Manufacturers

Yarns of a superior quality and Fast Colors for manufacturing purposes a speciality

NEW BRUNSWICK COTTON MILLS

ST. JOHN COTTON MILLS

DAVID KAY, Fraser Building, Montreal

AGENTS:

WM. HEWETT, 30 Colborne St., Toronto

JOHN HALLAM, Agent for Beam Warps, 83 Front Street East, TORONTO

# Pumps

& HYDRAULIC MACHINERY

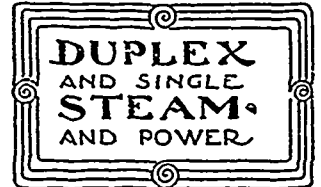

NORTHEY, LD  
TORONTO



**FUEL** is a Large Item in your Expense Account

Cut it down **One-Third**

by covering your steam pipes and boilers with **Sectional Mineral Wool Covering**, preventing condensation and loss of steam. Others have done it, why not you?

Full Line **ASBESTOS GOODS** on hand

Canadian Mineral Wool Co., Ltd., 109 Bay St. TORONTO

Geo. A. Cowan, Montreal Agent, 204 St. James Street  
Geo. R. Thomson, Manitoba Agent, Winnipeg

# BROADBENT'S HYDRO EXTRACTORS

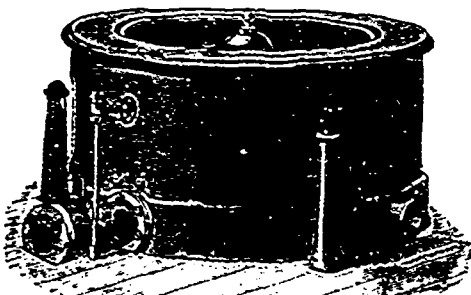

Direct Steam Driven. No Shafts or Belting required.  
Suspended on Links and requiring no Foundation.

Adapted for **Manufactories, Dyehouses, Laundries, Chemical Works, Sugar Refineries, etc., etc.**

— SEND FOR CATALOGUE —

**THOMAS BROADBENT and SONS**  
CENTRAL IRON WORKS  
CHAPELHILL, HUDDERSFIELD, ENGLAND

Telegrams: "BROADBENT, HUDDERSFIELD."

Agents for Canada: - - Wm. SHAW & CO., 164 McGill Street, Montreal.

THE following is the English Society of Arts prize process for cleaning silk, woolen and cotton fabrics: Take a pint of clean and clear soft water, and into it grate two good-sized potatoes. Strain through a coarse sieve into a gallon of water and let the liquid settle. Pour the starchy fluid from the sediment and it is ready for use. Rub the articles gently in the fluid, rinse thoroughly in clear water, dry, and press. It is stated that this process will not change the color of the material nor injure its texture.

CANADA is not the only country where government employment of convicts for manufacturing purposes comes in for censure. On behalf of Sir John Gorst, Colonel Sandys recently asked the Home Secretary whether his attention had been called to a strike at the Bootle Jute Company's works in Liverpool, and to the allegation of the employés that the competition of Her Majesty's prisons in sack-making rendered the employment of women at the wages heretofore paid no longer possible; and whether he would enquire into the prices at which sacks made in Her Majesty's prisons were sold, and so regulate the price, if necessary, as to prevent the wages of other workers being forced down by the undue competition of prison labor to a starvation point. The Home Secretary's reply to this was that the strike referred to was in no way connected with the fact that sack-making was carried on in Her Majesty's prisons, but that it was due to a threatened reduction of the hours of labor, and to some minor disputes between the female hands and their employers. With regard to prison competition, a certain party had, some days prior to the strike, made arrangements with the governor of Walton gaol to make about 1,000 sacks per week, which were, for a special purpose, required hand-sewn. It was also alleged that the prison work, what with extra carting, packing, etc., cost about 50 per cent. more than the bag-making at ordinary factories, which was all done by machinery, and that such prison labor did not in any way enter into competition with the latter.

#### THE NOTTINGHAM LACE TRADE.

The following sketch of the state of Nottingham and the lace trade gives a French view of the situation:—

To appreciate the importance of the trade of Nottingham, and the extent to which its prosperity depends upon fashion, it should be remarked that the Nottingham of to-day is in a position far different from that of the Nottingham of twenty or thirty years ago. Then she almost entirely monopolized the lace trade. For current requirements she had no rival either in England or outside of its borders. To-day she retains the monopoly of a large and very important branch of the lace trade; but in other departments Nottingham has to reckon with numerous rivals.

The lace trade may be divided into three sections—curtains, plain tulle, and fancy laces. We will not stay to deal with the two first named. There are machines producing curtains and tulle throughout the whole world, the consumption being steady and not dependent upon fashion. Nottingham and district furnish the major portion of these goods, but they do not possess a monopoly of the trade. Fancy laces may also be subdivided into three great sections—cotton lace, silk lace, and embroidered net. Silk and cotton laces are made on the Lever's machine; embroidered lace

is produced by a machine of a totally different character. The situation of Nottingham is at present this. She has no serious rival in the production of the best qualities of cotton lace, in the fine grades of silk lace she has great competitors in Calais and Caudey; while in ordinary cotton makes Derby, Ilkeston, and Long Eaton have to be faced. All of these, again, have to contend against the embroidered tulles of Plauen (Saxony) and of Switzerland, and it is goods of this class that are chiefly affected by fashion.

There is naturally a steady and constant movement in lace, altogether independent of fashion, from one year to another. Lace is forwarded to Spain and the Spanish speaking centres of South America, just as macintoshes are sold in the neighborhood of the English lakes (*sic*). The trade of Nottingham with these countries may be regarded as constant, the intrinsic beauty of lace sufficing to secure a *clientèle*, even if fashion does not stamp it with the mark of approval.

Lace has always been popular for female finery, and nothing graces their linen better. It is true that the demand has shrunk before the success of "all-wool" goods, which have found partisans amongst medical men, but fashion is in no way responsible for this fact. In spite of the current consumption, it must be admitted that Nottingham is not fully occupied and prosperous. It is, however, recognized that flat embroideries constitute the favorite trimmings for dresses and hats. The ordinary trade is not sufficient for Nottingham, which depends for its prosperity upon its specialty, which is fine lace. A local saying declares that lace is fashionable every ten years—that is, in every ten years there will be one in which lace returns to fashion, one in which it is in the full tide of prosperity, and one in which it wanes, while during the remaining seven it is no longer *a la mode*. This saying, based upon experience, is deserving of attention. The lace trade was, for instance, satisfactory from 1869 to 1872; satisfactory, and at its highest pitch, from 1879 to 1882. For history to repeat itself, it would be necessary to have a recommencement of the cycle in 1881, but there is a good explanation why the opposite was the case. In the spring of 1882 when Nottingham was not pre-occupied, appeared a machine which produced a description of lace absolutely novel. We refer to the embroidery machine. This machine was brought to Nottingham, and was shown to the principal manufacturers of the town. The patent was offered them, and in refusing that offer they committed an error which is now bitterly regretted. A buyer was promptly found elsewhere, who effected substantial improvements in the machine, established factories in Switzerland, which instantly developed into the most powerful rival Nottingham had ever known. The consequence was that the new embroidery tulle captivated the market and took the popular fancy. Moreover, when, towards the end of 1882, the ordinary course of fashion for lace had neared its close, and Nottingham found itself without orders to execute, the new embroidered tulle prolonged the extent of the fashionable demand, and the lace was worn without interruption for five or six years, from 1879 to 1885. History has, then, in the present case repeated itself, although the effect of the invention of the embroidery machine was to put back for three years, as far as Nottingham lace is concerned, the returns of the regulation period. There are now two specialties, those of Nottingham and those of Switzerland, producing different descriptions of lace on entirely different machines.

In view of these facts there are few business men in Nottingham who count upon a return of the great activity by which they benefited between 1879 and 1882. Those years are spoken of as a golden age never to be seen again. So ne candid business men confess that their profits reached an almost immoral level, that the gold so easily gained was that of Midas, and that it has brought Nemesis after it. When the lace operatives were earning £5 a week it is easy to understand that the employers were making colossal fortunes. The houses of the operatives increased so rapidly that in four or five years from thirty to forty miles of piping were laid in the new streets. Without attaching too much importance to the theory that a town depending upon the production

of an article of luxury must insensibly become a town of luxury, it is incontestable that the depression felt by Nottingham after 1882 owed much of its intensity to the prosperity which it had just enjoyed. Fashion changed, orders fell off, and many shadows darkened the threshold of the Bankruptcy Court. It may be said that capital, too, steadily comes forward when affairs are momentarily prosperous, and that only the firmest spirits of the commercial world know when to cry, "Hold! Enough!" It is, in fact, a risky thing to expend funds in the development of a business such as that of lace, which depends upon the caprice of fashion. A machine fitted with the latest improvements costs from £800 to £1,000. As it is estimated that in dull times 50 to 60 per cent. of the machines remain unemployed, it is evident that the losses in interest on capital alone can mount to a very high figure.

Nottingham has experienced during recent years how dangerous it is for a large town to depend upon an article of fashion. Even recently its existence depended entirely upon the production of lace and hosiery. But the distress of the operatives and the forced reduction of expenses amongst manufacturers brought about the introduction of new industries, such as the cycle and tobacco trade, in which the production increases regularly.

If one took the mass of salaries and the profits realized during a space of ten years, and divided them through the whole period, it would be found that the product sufficed for a liberal existence, and equalled that of an uninterrupted occupation. But, taking into account the peculiarities of human nature, one cannot expect the whole of manufacturers and operatives to take into account the rainy days—seven consecutive years—and prepare accordingly. A workman who earns £2 a week for ten years is better off than a man who thinks he is rich for a couple of years or so, and finds himself constantly in want for eight years.

#### THE ARTIFICIAL DYESTUFF INDUSTRY.

Probably no industry can claim to have had such a wonderful growth and rapid development as the manufacture of artificial dyestuffs. Its magnitude will not compare with many of our immense industries, yet the commodities whose values are conditioned upon the application of dyestuffs are very great. This industry is an example of the incalculable value of science as an adjunct to commercial progress, and of the method of applying scientific principles to every practical question. It is a principle which does away with guessing and haphazard experiment, everything being concluded and invented. There is no industry that has received the attention of scientists to such a remarkable degree as coloring, the whole life and thought of some of the most noted scientists having been devoted to the study of the class of compounds to which all artificial (synthetic) dyestuffs belong. The endless variety of colors and shades now produced are nearly all the results of pure science, and of profound and logical argument. It is thus that the coloring matters to-day are produced by thousands, all of which are absolutely and perfectly new, and their properties may be accurately predicted before even a sample has ever been prepared.

The industry of artificial dyestuffs had its beginnings in France, but soon left that country to settle in England, says the *Journal of Commerce* of New York. To Germany, however, is due its present imposing magnitude, and for more than a decade the world has looked to that country for the newest and most improved dyestuffs. Some of the large German works employ hundreds of chemists and assistants, who are constantly at work, and the buildings connected therewith are so numerous that they form little towns. The machinery is very costly and too varied to attempt its description here.

The question is sometimes raised if this rapid multiplication of colors is not excessive and unnecessary, and whether these complex processes may not be lessened in number and simplified. It perhaps seems but natural to assume that among such a vast number of colors it would be possible to select a few cheap and easily-made primary colors which, by mixing, would produce all other shades. But the laws of the combination of colors, in a physical sense, are

not applicable to dyestuffs when used for dyeing. In the process for dyeing there is a relation between the coloring matter and the fibre which is strictly chemical, an actual molecular combination between the dyestuff and the fibre; consequently different fibres act differently with the same dye, and it is necessary to have a variety of dyes, the greater the better, to produce the numberless colors of to-day. The number of textile fibres is constantly increasing, which creates a further demand for new colors.

The older dyestuffs have been remarkable for their affinity for silk and wool, rather than for cotton and cellulose fibres. In applying them to these latter, mordanting was necessary, which made the process of dyeing cotton both difficult and expensive. Less than nine years ago the first synthetical dyestuff was produced, which had a greater affinity for or was more soluble in cotton than in animal fibres. This dye was known as congo, and dyes without the use of a mordant. To-day there are several hundreds of such colors, dyeing every shade of the spectrum and giving the cotton dyer the same advantages as the silk and wool dyer.

There is much unfounded popular prejudice as to the question of fastness of artificial coloring matters. It was simply an unfortunate circumstance that the first synthetical dyestuffs that appeared upon the market happened to be of a fugitive nature. The vast number of colors now manufactured enables the dyer to select not only the most beautiful shades, but also those of great durability. Artificial dyestuffs are now made of such permanency as to excel indigo and the most noted of old natural dyestuffs. Experiment has proved their permanency without a doubt, and even the most delicate shades are now made of wonderful fastness.

#### THE DANGER OF MOIST WOOL.

The storing of moist or mordanted wool without taking sufficient precautions is decidedly risky. Even though moist washed wool will not ignite spontaneously, it will begin to rot in a short time. This condition begins generally from within, and the wool assumes a characteristic musty odor. When this stage has been reached the spinning capacity of the wool has become impaired, and it can be dyed only with great difficulty. If it has become musty, or mildewy in spots, the finished goods will show the well known and dreaded clouds and stripes caused by the decay of the fibre. These spots can never be removed by subsequent manipulations, because the structure of the cloth itself has deteriorated.

It is still more injurious to permit mordanted wool to lie for any length of time with the mordant clinging to it. Although freshly washed wool can be stored from twelve to twenty-four hours, especially in a damp, cool locality and when it is turned frequently, the storing of mordanted wool for a few hours even suffices to make the dyeing of a uniform color upon it impossible. Should circumstances compel such a postponement, it must, at least, be rinsed at once, after which it can be left to lie covered for a reasonable length of time. This remark applies especially to wool mordanted with chrome. In the mordanting bath, however, wool may be permitted to remain for some time without injury. Formerly dyers left the wool immersed for a long time in the mordanting bath, in order to prepare it for taking a lively ponceau with barwood on a mordant of alum and tartar. This is no longer necessary, as the artificial dyestuffs dye a sufficiently bright ponceau without keeping the staple immersed in the mordant.

If the wool has been taken out of the mordanting bath, and for some reason or other it becomes necessary to let it lie for some time, the dyer will do well to cleanse it as quickly as possible from the mordanting liquor. It should, therefore, be washed out at once, for which purpose the hydro-extractor may be used to advantage. Although wool mordanted with alum and tartar can be stored from twelve to twenty-four hours without fear of impairing the subsequent dyeing, care must be taken that the wool does not become dry in spots.

It is somewhat different with chrome mordant. This owes its effectiveness to the presence of free chromic acid, but the latter does not, as in alumina combinations, dissociate only in heat, but in the cold as well, and for this reason wool is often mordanted in

a cold chrome bath. If the wool thus mordanted is left to lie, the liquor will settle and the lower portion will become charged with an increased quantity of chromic acid. The dyer need not, therefore, be astonished if in spite of diligent turning over, the wool mordanted with chrome dyes unevenly. But even when the chrome-mordanted wool is exposed to light and chromic acid is no longer present at the exposed places, but is replaced by oxide of chrome, these spots will dye unevenly. It is necessary, therefore, to wash it as soon as possible after mordanting, and dye without much loss of time, in order to avoid the exposure of any part of it to the light.—*Faerber Zeitung.*

### MODERN CARPET DESIGN.

BY ALEX. MILLAR.\*

I fail to see why a copy of an ancient Persian carpet should be right if made in an Indian gaul and wrong if woven in an English factory; and in the East, bent as they are on making exact reproductions, they are unable to do so except in the matter of form, for the colors of modern Eastern carpets are often simply atrocious, and the dyers seem utterly unable even to appreciate the merit of the coloring of the splendid old examples which are set before them, much less to reproduce it. Horrible magenta pinks, crude yellows and emerald greens are accepted as a matter of course, if they come from the East, in preference to really fine pieces of color in British fabrics. So much is the superiority of English coloring recognized, that it is not uncommon for English versions of Eastern designs which have been faithfully colored after ancient examples, to be sent out to India and Persia as guides for coloring. Here I think I see the supercilious smile of the superior person, and hear him say, "Thus does commercialism ruin Eastern art." Now I hold no brief for the importers who do this thing. Their interests and ours as manufacturers are opposed. Nevertheless, I speak of what I know when I say that their action is a proof that the color sense which is so keenly alive at home has to be artificially fostered in the East. The reason English carpets have been sent out is because they are much nearer in color to the great classical examples than are most of the crude and garish productions which are turned out by the present generation of Eastern weavers when left to themselves. I am by no means certain that the sending out of these samples of good English color has any result. But the fact that they are sent shows that they are needed, and is an indication of the superiority of English color to that produced unaided by Orientals.

In spite of the fact that slavish copying of a limited number of traditional forms is the rule in the East, it is continually assumed that all Oriental work is unfettered, spontaneous, full of individuality, while British carpets are mechanical and uninteresting. I have heard carpets condemned in these respects as being machine made, every stitch of which had been wrought by hand. So much for the power of imagination in certain cities.

Those who might bring an elevating influence to bear upon the designing of English carpets should realize that, in passing them by and encouraging the use of Eastern fabrics, they are simply giving sway to the commercialism they so much and so justly detest, and are handing manufacturers over to its uncounteracted influence. And if they are designers they are spoiling their own market, for in proportion as they, by precept or example, encourage the use of Eastern carpets, they decrease the demand for designs of the highest class. Suppose that by any means the supply from the East were suddenly to fail, can there be a doubt that, in spite of all its difficulties, the best decorative artists would be driven to turn their attention to carpet designing, and would find in it a new and profitable market; and a designer might by arrangement with two manufacturers be able to use the same idea twice over; first, say for a curtain, and afterwards modified to make it suitable for a carpet, to the great benefit of the designer and also of the public who would find the problem of finding wall and floor coverings to harmonize greatly simplified.

The necessity under which manufacturers labor of producing

\* Read before the Society of Arts, London.

year by year a quite unnecessarily large number of designs, is one reason why their quality is not higher. It is becoming more and more unusual for a pattern to last more than a year or two. How is it possible, under such a system, for designs to be evolved equal to those of the East, which undoubtedly were the slow growth of considerable periods of time, which passed from weaver to weaver, receiving modifications by the way, and of which many versions, good and bad, must have been produced, the best being most highly prized, and therefore surviving to our time?

When British carpets are compared with those of the East, this continual demand for novelty should be borne in mind. If an entirely fresh set of patterns were demanded from and produced by Eastern weavers year by year, what sort of designs should we get? I do not advocate that British manufacturers should settle down to a mechanical reproduction of the same forms, or slight variations of them, but if they were not compelled to produce so many new things, the quality of those produced could not fail to be improved.

The necessity laid upon manufacturers of studying the requirements of foreign markets is not sufficiently kept in mind by their critics. And in this respect manufacturers find themselves between the devil and the deep sea. They are often blamed in consular reports for not studying the taste of foreign customers, and so losing their trade; but when they do study it, and produce designs exactly suited to it, art critics blame them for turning out such horrors.

The only remedy I can see for this state of things is the creation of so great a demand at home for the best class of designs that the manufacturers who desire to produce them will find a sufficiently large consumption to warrant their devoting themselves entirely to such work.

It should not be overlooked that even in those markets where taste is at its worst there has been a vast improvement in recent years. In the South American market, while the class of designs asked for remains much the same as formerly, there has been an enormous advance in the appreciation of good color. In Australia, the fern-tree gully and waterfall style of design is a thing of the past, and there is also a growing sense of the merit of fine color. In the United States there is a comparatively small cultivated public which can appreciate the very best work, but the general demand of late years has been for designs of extraordinary lightness and delicacy. Nothing more absolutely wrong in a floor covering could possibly be devised.

I cannot refrain from putting on record a protest against the shameless systematic piracy from which carpet manufacturers have suffered for many years at the hands of their American competitors. The world has been kept well informed of the grievances of authors and publishers, but we have had to suffer in silence. The British public has no idea of the extent to which this has been carried. Large factories in the United States have been kept going, and fortunes made, almost entirely by stolen designs. The American manufacturer has absolutely no sense of shame in this respect. Their emissaries come over here, and buy our goods for the express and avowed purpose of having them copied. The same persons, who are strictly honest so far as material objects are concerned, who would not on any account steal a roll of carpet, have no scruple in conveying to their own use a design which may have cost ten times as much. No doubt there is now a copyright law, which, in theory, offers some protection, but in practice it is, for various reasons, of little or no value, and the piracy of carpet designs goes on as merrily as ever.

I must admit that some English manufacturers have retaliated in kind, but they have very little opportunity of doing so, as few American designs are suitable for the home market. In some few instances honorable arrangements for the exchange of designs have been made.

The assets of the Toronto Fringe & Tassel Co. were sold, on the 17th inst., by Henry Barber & Co. to J. G. Strong, at 15 cts. on the \$1.

## Foreign Textile Centres

**MANCHESTER.**—Regarding the circumstances and general condition of our market there is little upon which to comment this week. A miscellaneous and irregularly distributed business has been in progress in some cases at fairly satisfactory rates, and in others the reverse. On the whole a very moderate amount of transactions has been recorded. The prospects of the new cotton crop continue good, the only materially adverse event that is reported as having befallen it yet being the cold snap in May, which has inflicted some damage in a few places and retarded the development of the plant over a rather wide area. In neither case, however, is the matter regarded as one of serious moment. In the meantime the figures of receipts at the ports have fallen a little below those of last year, but the cotton coming into sight in the same time, say the four weeks ending middle of June, is only 6,000 bales less than last year, the actual figures being 84,000 against 90,000. With favorable conditions to the end of August, the figures of the current crop may be enlarged by a fairly good amount from the receipts of new cotton. Little business is doing in this market, and the demand for goods is far from being brisk. Prices are steady, but buyers endeavor to obtain concessions for various fabrics, which may lead to many of their offers being declined. In few directions is profit being made by manufacturers, and where makers are employed a little time ahead, they uphold prices firmly, and expect some improvement before they accept new business. A moderate general inquiry for printers' and bleaching goods prevents much accumulation of stock anywhere, but many makers of these goods have not a full order-book. China shippers have done one or two very low lines in Mexicans. Burnley lumps are sluggish. A few orders for cloth at acceptable prices have come from Bombay and Kurrachee districts of India. Colored woven goods are bad to move. Sateens remain very dull. Dress goods are more flat. Home American yarns are dull of sale. In no direction is there more than a retail trade passing. Users are in no mood to buy for more than pressing wants. The few offers about are too low to be put through. No new feature in Bolton yarns can be mentioned.

**NOTTINGHAM.**—The lace trade shows no sign of revival, and business is dull and disappointing. Few orders are being received, and production will have to be further curtailed unless things take a turn for the better shortly. Continental and shipping orders are mostly small. A considerable proportion of the cotton fancy laces now selling is wanted in the fresh butter tint, and some are required in two tones. Guipure, Venise, and Valenciennes are still most in request. Common cotton laces are selling only to a small extent, and there is no improvement in the demand for trimmings, tattings, and edging. A few silk Guipure and Bourdon laces are being disposed of, but there is no abatement of the depression in the silk branches generally. Makers of plain nets report no improvement. Bobbin nets are moving slowly, and other plain cotton goods are not much wanted. Fine tulle, both silk and cotton, are slow of sale. The lace-curtain trade continues devoid of animation. The local yarn market is dull. Hosiery manufacturers are indifferently employed.

**BRADFORD.**—The wool market is inactive and very little business has been transacted during the week. Staplers keep their rates firm, despite spinners purchasing only what is required to cover orders on hand. Merinos are steady, and cross-breeds maintained in value. There is little inquiry for English descriptions, and purchasers are waiting for the new clip. Mohair is slow, and alpaca firm. There is no improvement in the yarn trade. Export merchants place very few orders, as they cannot induce spinners to accept offers made, and consequently business is altogether of a retail description. In the home trade some spinners are fairly well employed; but generally yarns are dull. The piece trade is dull; orders are scarce, and prices unsatisfactory.

**LEEDS.**—The state of the woollen market remains unchanged. Dulness characterizes the trade in a more marked degree than it

has done for some time past. Travellers find it very difficult to secure orders at remunerative prices. The threatened Scotch coal strike is interfering to a considerable extent with the trade in that direction. Serges continue to go largely into consumption, and vicunas, fancy tweeds and costume cloths are in fair demand. With some few exceptions very short time is being worked at the wholesale clothing factories. In Dewsbury and other parts of the heavy woollen district the stagnation is very pronounced, and according to some authorities matters are at present in a worse state than they have been for some time. Cheap clothes are in some demand, but high-class goods are almost neglected. There is a little passing in colored blankets, but other descriptions are not much asked for. There is not much doing in raw material, and prices are maintained.

**HUDDESFIELD.**—There is no improvement to be reported in this market, and complaints are general as to the stagnation in trade and the absence of buyers. Few repeat orders have come to hand, and there has not been much done in the way of purchasing for immediate use. Medium to better class worsted fancies, vicunas, and serges are in greater demand for next spring. There is a very fair inquiry for plain and curl serges and vicunas for coatings. Some firms are keeping well employed, but still there is a great deal of short time. With the Continent, as also with the United States and Canadian markets, there is rather more doing. The local wool market is moving slowly, prices are maintained.

**LEICESTER.**—The wool market has a more confident tone, and larger quantities of home-grown fleeces have changed hands. Speculative operations are being gradually resumed, but even in choice lots of strong lustre and demi-lustre fleeces, which are most in request, no advance can be established. Business in colonials is mainly confined to cross-breeds. The yarn market is only moderately active, but prices are well supported. The hosiery trade continues very flat, and there is a total absence of repeat orders for light fabrics. Cords, braids, beltings and other narrow elastic web productions sell readily, but broad webs are flat.

**DUNDEE.**—There seems to be a slight change for the better in the Dundee market. The linen trade, however, remains much about the same. The home trade is dull, and the American demand is also quiet. It is difficult to quit stocks and keep looms going without any definite outlook for future business. There is every appearance that there will be trouble soon among the mill and factory workers in Dundee. Trade has been very bad in the city for some months, and a week or two ago it became known that the masters contemplated reducing the wages, giving as a reason that were this done they would be more able to compete with Calcutta manufacturers. The employes held a mass meeting, and offered to submit the whole question to arbitration. The employers have refused to accept the proposal of the workers, and decided to reduce the wages in the meantime by five per cent., and if trade did not improve after the holidays, that a further reduction of five per cent. should be made. This has caused much dissatisfaction among the workers, and it is freely stated that unless arbitration is accepted, there will be a strike. As there are about 30,000 workers involved, a strike would be a serious matter for Dundee. Jute yarn is not dearer, indeed, notwithstanding all the recent curtailment of production, it is rather easier, by 1s. 3¼d. for 8 lb. common cop, and 1s. 5d. for 8 lb. sharp; good, 1s. 6d. to 1s. 6½d. In Hessians there has been rather more doing, but the price has not risen, and 1¼d. for 10½ oz. 40 in. is the current quotation for common goods. In flax there is nothing doing. Prices still favor buyers. France is not buying, and in consequence prices droop. Tows also are shrinking in value. Flax yarns and tow yarns are both quiet, with a tendency to lower prices. In linens there is still little doing, and makers are working on in hope that by the end of this month the settlement of the American tariff will enable them to get a better demand. Jute fancy goods are very quiet, and one hears of short time in this department being now general.

**GLASGOW.**—While the woollen manufacturing trade in Glasgow is not in a very satisfactory condition, no department has suffered so much from Continental competition as the shirting and wincey one.

Some houses, which a few years ago were doing a large business, now require an effort to keep their various establishments going. One firm has been so severely affected that it has had to dispense with about a dozen hands, a few of them having been in their employment for many years. In other textile industries the competition is now excessively keen, and owing to the higher wages in this country, the home manufacturers are distinctly handicapped. There are a number of disputes as to wages going on just now in various linen districts of Scotland. Strikes have occurred at Alyth and Blairgowrie. Business in the Ayrshire lace trade is still very depressed. The tariff difficulty has rather spoiled the American trade, while the cold, dull weather has seriously affected the home demand. Prices are very low, and hardly remunerative. Tweed manufacturers in the south of Scotland are complaining bitterly of the want of orders. It is no easy matter to keep the looms at work, as repeat orders are scarce. The prospects for next season are, however, considered encouraging, the first samples being well taken up. Spinners are now very quiet.

BELFAST.—The action of the banks will, of course, have supreme influence in promoting or in preventing the precipitation of a crisis upon the linen trade, in which it is now evident that numerous firms must together either stand or fall. The withdrawal of support, or any panic-stricken decision to at once impose undue limitation upon credit, may in the present critical juncture inflict upon the community consequences so serious that it will take many years of improved trade and a generous policy to foster and restore to a condition of prosperity. The depression which for the last year or two has so generally prevailed has not been without its effect upon the Irish linen trade. Especially in the case of those who cater for the American market has the pressure been severe. In many instances large stocks are held which at present cannot be realized, and capital has in this way been locked up which within the coming half-year will be again in circulation. Within the past week two other firms have failed, but in each case from reasons outside the influence of the Belfast disasters. Messrs Jonathan Pike and Son, Buckgrove, Dungannon, and Messrs. Stevenson and Boyd, of Moygashel, have, it is understood, sought the protection of the court, pending an arrangement with their creditors. Lately business has been much interfered with, both on home and shipping accounts, and the slight improvement in American inquiry has subsided on account of the prolonged uncertainty of the settlement of the tariffs, regarding which no reliable information seems to be obtainable. Some suggest the possibility of the Bill passing this month, while others hold the opinion it will be shelved till a later period.

LYONS.—The silk goods market is quiet, says the *Dry Goods Economist*. The spring season has closed without leaving much to remember it by in the shape of fall orders placed in advance, the still existing uncertainty as regards future fashion being too great to encourage buyers in placing large orders for goods, while, on the other hand, the course of the raw silk market and the declining level of prices also act unfavorably on the advance order business. Although, however, the general market is slow and shows much room for improvement, there has been some business done for fall, and the presence of buyers from the United States has been felt. In some lines the looms are better employed now than towards the close of the spring season, when the spring goods that were being delivered found no substitutes on the looms. Handkerchiefs have done fairly, but more on orders for special lines. Tie silks are rather quiet. Business in ribbons is gradually declining. Something is being done in moiré ribbons on reassortment. Plain satin and failles change hands in small lots. Check effects in ribbons also find buyers. In plain velvets the demand is small and fall orders are late in coming, so that as the opinion exists that velvets will do well later, many of the manufacturers have to work for stock in order to meet the demand that is expected to develop.

CREFELD.—Both England and the United States, who are the largest purchasers of Crefeld goods, seem to have been holding back. These orders may come yet but the time is fast approaching when they could no longer be placed, as deliveries could not be

made in time. In no branch of the Crefeld industry do conditions of full employment prevail. Tie and umbrella silks have reached their dull season and the looms are engaged in filling old orders, not much activity prevailing either in plain or fancy articles. In ribbons, manufacturing activity is only fair. In dress silks and trimmings hardly one third of the looms that should now be in full work are running. What the industry is most suffering from is the absence of business for export, the smallness of which in the first half of 1893 has been almost unprecedented. To the smallness of the business done for export in goods for the spring is to be added the smallness of the orders that have been placed for fall.

ZURICH.—The market is quiet, but not absolutely dead, and while for ready delivery business has decreased, something is being done for fall. Buyers from America and England have visited this market, while some business has also been done for Germany. Stocks of colored surahs and merveilleux are being reduced, and some lots of cheap grades of these have been disposed of, but at low figures. The demand for check effects in taffetas and surahs has declined, but some novelties in stripe effects have done well. Moiré finds some buyers, but the demand is limited to colored moiré Française, which is expected to have a good run in the fall. The fancy effects in moiré, on the other hand, are quietly disappearing. Moiré Pékins have been ordered for fall. A good demand is reported for Chiné effects in taffeta and small effects on taffeta grounds.

CALCUTTA.—In ordinary jute there appears to be no demand, nor is there anything offering. For mixing there is still a local inquiry for good native marks, but there is barely anything offering beyond what is known as "better than ordinary," and for which sellers ask a good deal better than ordinary rates. A sale is reported of upwards of 1000 bales of this class at Rs. 13 12, but other stuff is offering at Rs. 13 0 to 12 8. In bagging a further small lot of Davids was sold at Rs. 19 12, and buyers might go on to a small extent for butts of this mark, but we have evidently seen the last of them for this season. In jute fabrics the market has kept very steady during the last week reported. Export business has not shown much life, and whatever transactions are reported are mostly supposed to be covering old sales. The rise in exchange has stopped any inquiry for the present. Country trade, as well as Burmah and the Straits, are still showing no signs of coming out as operators, although a fair line of B twills is reported for August-December delivery on account of speculators. For the Colonies more sacks are reported to have been done. Hessians are steady, and a considerable business has been done in cloth, as well as in wheats and cotton packs. We close rather quieter all round.

#### THE DYEING OF JUTE.

Jute is, perhaps, the easiest of all the vegetable fibres to dye, says the *Manufacturers' Gazette*. The chemical composition of the fibre is such that many coloring matters, especially the so-called substantive and basic colors, have a direct affinity for it, and all that is necessary is that the jute be immersed in a plain, or at most a saline, solution of these dyes to thoroughly dye the fibre. The shades and tints are, however, not so brilliant in appearance as those which may be obtained from the same coloring matters on cotton, but good, full, solid-looking shades are readily obtained. Unlike cotton, jute may be also dyed with many of the azo colors by simply adding a little acid to the dye bath, or in some cases a little alum. In the latter case, the addition is made with the object of producing an alumina color lake with the dyestuff, and this becomes firmly fixed on the fibre. Some of the mordant dyes can also be applied.

It will possibly be more convenient to jute dyers if the subject be dealt with according to the colors, reds, yellows, blues, blacks, greens, etc., and not according to the properties of the dyestuffs which may be used. Care will be taken to point out the principles which underlie the applications of each class or kind of dyestuff, and the best methods of dyeing described in all cases. The treatment of the subject is rendered much easier to the author by the fact that he is able to illustrate these articles with a more extensive series of dyed patterns.

## THE TARIFF OF 1894.

ITEMS RELATING TO THE TEXTILE TRADES—FREE GOODS.  
(Concluded from last issue.)

- 508 Boracic acid, and borax, ground or unground, in bulk of not less than twenty-five pounds only.
- 514 Bristles.
- 518 Buckram for the manufacture of hat and bonnet shapes.
- 522 Caplins, unfinished Leghorn hats, and Manilla hoods.
- 526 Celluloid, xylonite or xyolite in sheets, and in lumps, blocks or balls in the rough.
- 533 Clays, including China clay, fire clay and pipe clay.
- 534 Clothing, donations of, for charitable purposes.
- 539 Cochineal.
- 542 Coir and coir yarns.
- 48 Cotton wool and cotton waste.
- 549 Cotton yarns, number forty and finer.
- 558 Duck for belting and hose when imported by manufacturers of rubber goods for use in their factories.
- 559 Dyeing or tanning articles, in a crude state, used in dyeing or tanning, not elsewhere specified; berries for dyeing or used for composing dyes, turmeric, nut galls; lac, crude, seed, button, stick and shell indigo, indigo paste and extract of, and indigo auxiliary or zinc dust; persis, or extract of archil and cudbear, terra japonica, gambier or cutch, extract of logwood, fustic, oak and of oak bark; camwood and sumac and extract thereof, tanners' bark, hemlock bark and oak bark.
- 563 Felt, adhesive, for sheathing vessels.
- 565 Fibre, Mexican, and tampico or istle and vegetable fibres, natural.
- 566 Fibrilla.
- 567 Fillets of cotton and rubber, not exceeding seven inches wide, when imported by and for the use of manufacturers of card clothing.
- 569 Flax fibre and flax tow.
- 578 Fur skins of all kinds not dressed in any manner.
- 588 Gutta percha, crude.
- 590 Hair, cleaned or uncleaned, but not curled, dyed or otherwise manufactured.
- 591 Hatters' furs, not on the skin, and hatters' plush of silk or cotton.
- 592 Hemp, undressed.
- 594 Hoofs, horn strips, horn and horn tips, in the rough, not polished or otherwise manufactured than cleaned.
- 605 Ivory and ivory nuts, unmanufactured, and veneers of ivory, sawn only.
- 606 Junk, old.
- 607 Jute and jute butts.
- 608 Jute cloth, as taken from the loom, not colored, cropped, mangled, pressed, calendered, nor finished in any way.
- 609 Jute, flax or hemp yarn, plain, dyed or colored, when imported by manufacturers of carpets, rugs and mats, and of jute webbing or jute cloth, and twines for use in their own factories.
- 610 Jute canvas, not pressed or calendered, when imported by manufacturers of floor oil-cloth for use in their own factories.
- 622 Madder and munjeet, or Indian madder, ground or prepared, and all extracts of.
- 641 Oxalic acid.
- 650 Plaits, chip, manilla, cotton, mohair, straw, Tuscan and grass.
- 655 Prunella.
- 660 Rags of cotton, linen, jute, hemp, and woolen, paper waste clippings, and waste of any kind except mineral waste.
- 661 Red liquor, a crude acetate of aluminum prepared from pyroligneous acid, for dyeing and calico printing.
- 664 Ribs of brass, iron or steel, runners, rings, caps, notches, ferules, mounts and sticks or canes in the rough, or not further manufactured than cut into lengths suitable for umbrella, parasol or sunshade sticks, when imported by manufacturers of umbrellas, parasols and sunshades for use in their factories in the manufacture of umbrellas, parasols and sunshades only.
- 666 Rubber, crude, caoutchouc or India rubber, unmanufactured; hard rubber, in sheets, but not further manufactured, and recovered rubber and rubber substitute.
- 680 Silk raw or as reeled from the cocoon, not being doubled, twisted or advanced in manufacture in any way, silk cocoons and silk waste.
- 682 Soda, sulphate of, crude, known as salt cake, barilla or soda ash, caustic soda; silicate of soda in crystals or in solution; bichromate of soda, nitrate of soda or cubic nitre, sal soda sulphide of sodium, nitrate of soda, arseniate, binarsenate, chloride, chlorate, bisulphite and stannate of soda.
- 687 Steel No. 20 gauge and thinner, but not thinner than No. 30 gauge, to be used in the manufacture of corset steels, clock springs and shoe shanks; and flat wire of steel of No. 16 gauge or thinner, to be used in the manufacture of corset wire and dressed stays, when imported by the manufacturers of such articles for use in their own factories.
- 701 Teasels.
- 702 Tin crystals, tin strip waste, and tin, in blocks, pigs, bars and sheets and tin plates, tin foil and tea lead.
- 708 Ultramarine blue, dry or in pulp.
- 712 Whalebone, unmanufactured.
- 717 Wool and the hair of the camel, alpaca, goat and of other like animals, not further prepared than washed, n.e.s.; and noils, being the short wool which falls from the combs in worsted factories.
- 718 Mohair yarns.
- 719 Wool or worsted yarns, when genapped, dyed or finished, and imported by manufacturers of braids, cords, tassels and fringes, to be used in the manufacture of such articles only in their own factories.
- 734 Bamboos, unmanufactured, and bamboo reeds, not further manufactured than cut into suitable lengths for walking sticks or canes, or for sticks for umbrellas, parasols or sunshades.
- 745 Copper rollers, for use in calico printing, when imported by calico printers for use in their factories in the printing of calicoes and for no other purpose (such rollers not being manufactured in Canada).
- 746 Elastic rubber thread.
- 750 Hatters' bands (not cords), bindings, tips and sides, hat sweats and linings, both tips and sides, when imported by hat and cap manufacturers only, for use in their factories for the manufacture of hats and caps.
- 753 Horse hair, not further manufactured than simply cleaned and dipped or dyed, imported for use in the manufacture of horse hair cloths.
- 754 Lastings, mohair cloth, or other manufactures of cloth, when imported by manufacturers of buttons for use in their own factories, and woven or made in patterns of such size, shape or form, or cut in such manner as to be fit for covering buttons, exclusively—these conditions to be ascertained by special examination by the proper officer of Customs, and so certified on the face of each entry.
- 766 Yarn spun from the hair of the alpaca or angora goat, when imported by manufacturers of braids for use exclusively in their factories in the manufacture of such braids only, under such regulations as may be adopted by the Controller of Customs.

Items of textiles not enumerated under any existing class are dutiable according to the material of which they are composed, whether cotton, wool, jute, silk, etc., while items which cannot be classified come under the head of "unenumerated articles," which are dutiable at 20 per cent.

Most textile machinery pays 27½ per cent. ad valorem. Machinery classed as "stationary" pays 27½ per cent., while "portable" machinery is dutiable at 30 per cent.

R. G. SLEK & Co., carpet merchants, Montreal, whose assignment was reported last month, have filed a consent of abandonment, and J. F. Torrance has been appointed provisional guardian.

## THOSE TRADE AND NAVIGATION RETURNS.

Editor CANADIAN JOURNAL OF FABRICS:

SIR,—Statistics are only of value inasmuch as they are correct, otherwise their value is considerably less than—*nil*.

I have already had the honor to call your attention to items in the Canadian Customs returns for the year ending June 30, 1893. You seem to have missed the point of my criticism. I desired to point out that these returns led me to think that the Custom House officials had, for reasons not apparent to me, been including in their total of United States trade goods shipped from England, Germany and elsewhere to Canada, *via* the ports of Portland, Boston and New York, thereby unduly swelling the total of our trade with the United States. Because goods pass *through* a port in the States *en route* to Canada, is no good reason why these goods should be placed to the credit of the United States' trade returns.

I will give one instance, though I could give many.

In the returns under the head of "Terra Japonica, Gambier and Cutch," the imports from Great Britain are put at 50,475 lbs., of \$2,734 value. Now this concern alone imported from Great Britain no less than 52,410 lbs. of cutch, and used further 21,188 lbs. of cutch, which I have every reason to believe also came from Great Britain. Of this amount 24,560 lbs. came through the port of Portland on through bill of lading, being shipped during the winter. If our shipments of cutch more than absorb the total quantity credited to Great Britain under the heading of "Terra Japonica, Gambier and Cutch," where then do the shipments of cutch to other people and the shipments of terra japonica and gambier come in?

Yours truly,

LOUIS SIMPSON,  
Gen. Manager Montreal Cotton Co.

## DEATH OF LT.-COL. MARTIN.

Many readers will learn with sincere regret of the death of Lt.-Col. John Martin, formerly commanding officer of the 6th Fusiliers, but better known in the commercial community as head of the old firm of John Martin & Co., wholesale furriers, St. Paul st., Montreal. The regiment he commanded was formerly known as the Hochelaga Light Infantry, and it was during his command that it saw service during the Fenian raid at St. Albans, where it acquitted itself so well. Col. Martin had great affection for his old regiment, from which he retired in 1883, and was much esteemed by his officers and men. Mr. Martin was born in Exeter, England, in 1826, and coming to Canada, started in the fur business in 1853, in Montreal. He built up a large trade, which was uniformly successful till the depression of last year, when he was compelled to call a meeting of his creditors. At that time Mr. Martin was suffering from a most severe attack of the grip, and his courage under a complication of difficulties evoked much sympathy. It was no doubt this severe siege of sickness and business troubles that hastened his death. Mr. Martin was a man of fine bearing. He was exceptionally well versed in the intricacies of the fur trade, and no man in Canada could talk more intelligently or entertainingly of fur trade matters. One could not ask of any fur-bearing animal of any quarter of the globe regarding which he could not give interesting information and tell something of its natural history and the conditions of the trade. Besides three daughters, Mr. Martin leaves behind him two sons who will be able successors to the business—Harry Martin, and Horace T. Martin, author of the interesting work on the Canadian beaver, which has often been alluded to in this journal.

In last month's issue we referred to the fact that Mayor Miner, who is President of the Granby, Que., Rubber Works, and who has done so much for that town, was to be fêted by his fellow townsmen. The event came off on the 22nd ult., when the town held a general holiday. The fête took the form of a demonstration in Victoria Park, where addresses were delivered by several prominent people. Athletic sports were then indulged in, and in the evening there was a grand banquet in the town hall, presided over by George Vit'ie.

## RECENT CANADIAN PATENTS.

Jos. E. Chenette, Napa, Cal., has patented a holder for sewing machine needles. It comprises a socket for receiving the end of the needle-bar, a nut and bolt for clamping the needle, a sliding-pin in the body of the socket, and a cam for projecting the pin into the needle opening.

John Reece, Boston, Mass., has patented a button-hole sewing machine containing the following: a clamp-frame and a stitch-frame, one relatively movable with relation to the other a manually controlled starting device, a work-clamp, and devices to automatically close the work-clamp after the machine has been started by the manually controlled starting device. There is mechanism for automatically cutting the material in the work-clamp preparatory to stitching, also for automatically spreading it. Devices are provided for the automatic stoppage of the machine on the completion of each button-hole. A cam device is provided in order to effect the relative changes of position of the stitch and clamp-frames, together with an actuating device for the same, and there are means also for automatically determining which two clutch pulleys shall move the actuating mechanism connected with the cam device. The needle is eye-pointed, and is located above the material, while below the latter there is a stitch-forming device, both being rotatable in unison about a common centre when stitching the eye of the button-hole by radiating stitches.

John Reece, Boston, Mass., has patented a sewing machine, in which, besides the ordinary stitching mechanism, there are comprised a mechanism for the production of over-edge stitches and devices to rotate the stitch-forming mechanism in one direction, rotation after rotation. There are devices to change the relative positions of the stitch-frame and clamp-frame for the purpose of insuring not only the production of over-edge stitches along the sides and outer end of the button-hole, but also to impart a slight movement to and from in the direction of the length of the button-hole, while the stitch-forming mechanism is being given a semi-rotation at the end of the button-hole.

Matthew H. Kohlrausch, Billerica, Mass., has patented a machine for scouring and rinsing cloth. It consists mainly of a series of tanks, placed side by side, submerging rollers placed in each tank, a carrier roll and a pair of continuous squeeze rolls, arranged longitudinally with regard to the series of tanks and common to them all, and guides arranged so as to deflect the cloth in its passage from the carrier-roll to the feed-roll laterally, and to guide it from each tank to the next. There are drip-catchers arranged above the sides of adjacent tanks to receive the liquid dripping from cloth passing between the squeeze-rolls from one tank to the next, and to return the liquid to the tank from which it was absorbed by the cloth. The squeeze-rolls taper uniformly in the same direction, and are provided with annular grooves arranged above the sides of the tanks, and with annular cushions arranged in these grooves and projecting from them.

## TRADE MARKS.

B. Priestley & Co., Bradford, Eng., have taken out a trade mark for textile fabrics.

Wm. McCabe, St. Louis, Miss., has taken out a trade mark for corsets, corset waists, dress and garment stiffeners.

The Crompton Corset Co., Toronto, have taken out a trade mark for dress shields.

The statement made last month that Wm. Calvert & Co. had made a settlement with their creditors at 50 cts. on the \$1 was premature. Such a settlement was offered by Mr. Calvert, in notes of his own spread over an extended time, but no agreement was come to. A further meeting will be held this month to take action.

H. P. LABELLE, furniture dealer, Montreal, has assigned on demand of Rolland Freres. Liabilities about \$100,000. The principal creditors are Hochelaga Bank, \$30,000; Banque du Peuple, \$12,000; Estate Evans, \$14,000; Mlle. Orkney, \$7,000; H. Picard, \$3,000; and J. A. Bulmer & Co., \$3,021.



**The Curtis Regulator Co.**  
 MANUFACTURERS OF  
**Engineering Specialties**  
 STEAMWATER PUMP, DAMPER REGULATORS,  
 TRAPS, VALVES, ETC.  
 Office and Manufacturing Beverly St. Boston

General Agencies:  
 NEW YORK, 109 Liberty St.  
 PHILADELPHIA, 2035 N. Front Street  
 MINNEAPOLIS, 210 S. Third Street

CHICAGO, 218 Lake Street

**WILLIAM CRABB & CO.**

Manufacturers of all kinds of

Hackle, Gill, Comb and Card Pins, Picker Teeth, Needle  
 Pointed Card Clothing in Wood and Leather for  
 Flax, Jute, Tow, etc.

Hackles, Gills and Wool Combs made and repaired; also Rope Makers' Pins, Picker Pins, Special  
 Springs, Loom and Shuttle Springs, English Cast-Steel Wire, Cotton Banding and General Mill Furnishings.

Bloomfield Avenue and Morris Canal, NEWARK, N. J.

**GROMPTON LOOM WORKS**  
 WORCESTER MASS  
 LOOMS FOR EVERY GRADE OF WEAVING  
 PERFECTION IN WEAVING  
 CLOSE-SHED LOOMS  
 OF WOOLENS OBTAINED BY THE GROMPTON  
 "1893" HIGH SPEED WOOLEN & WORSTED LOOM. WORLD'S FAIR MEDALS

Established 1848.

**A. EICKHOFF**

Manufacturer and Dealer in

Hatters', Furriers', Tailors',  
 Glovers' and Shirt Cutters'

**KNIVES AND SCISSORS.**

Knives for all kinds of business always on hand and  
 warranted. All kinds of Cutlery ground  
 and repaired.

No. 381 BROOME STREET,  
 Between Broadway and Bowery,  
 NEW YORK CITY

**MILL AND PLANT  
 FOR SALE**

The managing partner, and the only one of the  
 company with any experience in the business, died  
 last year, and in consequence we have decided to  
 sell the mill. We make both underwear and hosiery.  
 Plant nearly new and in good condition. Also, a  
 10 h.p. engine. This is the only mill of its class in  
 the Maritime provinces. We will supply all infor-  
 mation on application.

THE YARMOUTH HOSEY MFG. CO.,  
 YARMOUTH, N.S.

**PATENTS**

Promptly secured. Trade-Marks, Copyrights  
 and Labels registered. Twenty-five years ex-  
 perience. We re- whether patent can be  
 secured or not, fr. of charge. Our fee not due  
 until patent is allowed. 32 page Book Free.  
 H. B. WILLSON & CO., Attorneys at Law,  
 Opp. U. S. Pat. Office. WASHINGTON, D. C.

**ROTHSCHILD BROS. & CO.**

Manufacturers, Manufacturers' Agents  
 and Importers

**BUTTONS.**

Sole Agents for the  
 American Continent  
 CAMILLE & CERECH BISMONT  
 PARIS  
 Sole Agents for the  
 American Continent

Offices—425 & 427 Broadway, N.Y.  
 25 Rue de la Victorie, Paris, France.  
 11 & 13 Front St. East, Toronto.

**The R. Forbes Co.**

(Limited)

Manufacturers of

**WOOLEN AND WORSTED YARNS**

For Hosiery and other work

HESPELER, ONT.

**FILING DEVICES**

- The B.B. File
- The Morton File
- The Shannon File
- The Eclipse File
- The Yankee Letter File
- The Favorite File
- The Standard File
- The Sisson File

Document Boxes, Document Envelopes,  
 and every conceivable device for filing and  
 referring to papers and documents.

**MORTON, PHILLIPS & CO.**

Stationers, Blank Book Makers  
 and Printers

1755-1757 Notre Dame St., Montreal

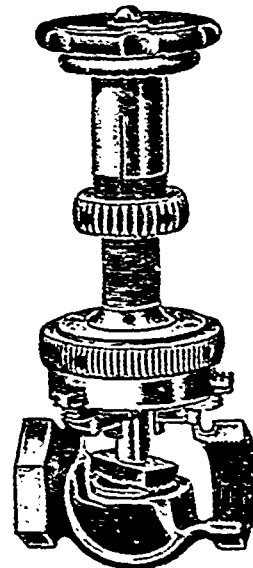

The "Morse"  
**VALVE  
 RESEATING  
 MACHINE**

Is used by the following Woolen and  
 Cotton Mills:

- Dom'n Cotton Mills
- Almonte Knitting Co.
- Globe Woollen Mills
- Granite Mills
- Penma Mfg. Co.
- R. Forbes & Co., Ltd.
- Brodie & Co.
- Treat Valley Mills
- Cobourg Woollen Mill
- Ferguson & Patterson, etc., etc.

**Darling Bros.**  
 RELIANCE WORKS  
 Montreal, Que.

Send for  
 New Catalogue

**WILLIS & CO.**

1,824 Notre Dame St. (near McGill)

**MONTREAL**

The Leading American and  
 Leading Canadian

**PIANOS...**

PARLOR ORGANS  
 CHURCH and CHAPEL ORGANS

## Among the Mills

There is a proposition to establish a woolen mill at Beeton, Ont.

The Oxford, N. S., Woolen Mfg. Co. are to build an iron picker and carding room.

Baird's woolen mill at Almonte has resumed and is now running three-quarter time.

Wm. Bright, Manager of Livingston Bros' flax mill, Brussels, Ont., was married a few days ago to Miss C. Wicks.

James Clark has refitted the carding machine in Barron's mills, Malden, Ont., and will carry on a custom carding business.

Work has been resumed at the Toronto Batting Co's. factory on the Esplanade. The company make wool batting and mattresses.

James Malone, boss spinner in the Almonte, Ont., knitting mill, was married a week or two ago to Miss M. Larkins, of Gloucester.

The Cornwall Manufacturing Company's mill has closed down for a couple of weeks in order to facilitate the making of some repairs.

John Morley, manager of Waterloo Ont., Woolen Mill, left a fortnight ago for England, where he has some woolen business to attend to.

James Sheene, whose woolen mill at Pennfield N. B., was burned down some little time ago, contemplates rebuilding on the old site.

The flax crop throughout Ontario will be an unusually good one, while the acreage in Manitoba in flax is much larger than last year.

The Brantford, Ont., cotton mills are hard at work again. About 170 to 180 hands are now employed, which is practically a full complement.

At the raising of Walshaw's new woolen mills, near Bolton, A. E. Harper, merchant, got his hand badly smashed, several bones being broken.

J. H. Hackland, of Hackland & Adams, at one time doing a large woolen knitting business in Paris, died the other day at his home, 7; Welles'ey street, Toronto.

Feodor Boas, of the Granite Knitting Mills, St Hyacinthe, Que., returned home a few days ago in good health, after a two months sojourn in New York.

Travellers for woolen firms are now on the road soliciting orders. Buyers are very conservative at present, and little business is moving. The outlook, however, appears to be brighter than it was.

Robert S. Fraser, 3 St. Helena street, Montreal, is offering a fine wool oil which mixes with water perfectly without the addition of any alkali. Mr. Fraser is also in a position to supply pure olive oil in the original hogshead direct from the refiners.

Dupont & Wilson have opened a new factory in Kingston, Ont., for the manufacture of damask mats, rugs, stair-cloths, oil-cloths, etc. They will make their oilcloths upon heavy cotton, coated up with pure lead colors, and all their goods are to be of high-class finish.

Brodie & Co., Hespeler, Ont., are taking advantage of the shut down and of the low water to deepen the tail race. This is cut in the solid rock and will require to be blasted. Some repairs will also be made to the shafting, etc. The mill is only expected to be closed down for about three weeks altogether.

The St. John Record says the situation of the Milltown (St. Croix) cotton mill is unchanged. No effort on the part of the company has been made to start the factory, and the recent employees are gradually obtaining employment elsewhere. The carpenters and machinists are at work, and the buildings and machinery are being generally overhauled and painted. A few hands are still employed making samples.

The binder twine factory at the Kingston penitentiary has been accepted from the contractors, and in future the machinery will be under the direction of Chief Engineer Devlin. It is now part of the penitentiary plant.

During the work of making improvements at the T. H. Taylor Company's woolen mill at Chatham, Ont., the creek bank on which their large brick chimney stood, slipped slightly. The chimney therefore was taken down and a 27 inch steel stack 76 feet high substituted.

A meeting of the creditors and shareholders of the Dominion Blanket and Fibre Co. will be held at the company's office, 7 St. Helen St., Montreal, on the 24th July, to discuss the present position of the affairs of the company, and devise means for increasing the capital stock and extending its operations.

W. C. Snow and Ira Snow, of Moncton, have been in Bouchette, N. B., placing the machinery in McLaughlin's new carding mill, which is expected to be in operation within three weeks under the management of Mr. Ira Snow. A. Sheraton's carding mill will commence operations soon.—*Moncton, N. B., Times.*

On the afternoon of the 5th inst., while working in his uncle's woolen mill at Campbellford, Fred Keir, a boy 13 years old, was caught in the belt of the carding machine and killed instantly. His body was horribly mutilated, his skull cap being torn off and brains scattered, one leg torn from the body and the other leg and one arm broken. An inquest was deemed unnecessary.

Whilst Archie Ellis was working at the machinery in Myers' woolen mill, St. Mary's, the other day, his head came in contact with a pair of revolving wheels. Mr. Ellis sustained a severe laceration of the scalp, which extended to the skull, necessitating five stitches being put in, and by the severing of an artery he also bled profusely for a time.

At a meeting of a committee of the Toronto city council, Ald. Hallam mentioned a company, with a capital of \$150,500, already employing 80 men in a woolen factory elsewhere, who would locate on the Don flats if given encouragement in the way of a site. They would then increase their staff to at least 120. It was decided to offer them two acres on the Don flats at a rental of \$600 a year.

Merrick & Hurlburt, of the Knitting Factory, Toronto Junction, have compromised with their creditors at 80 cents on the dollar. Their liabilities were \$5,700, the assets being nominally \$6,400. Mr. Merrick retires from the firm, and Mr. J. Hurlburt, who will hereafter carry on the business, is considering whether he will stay at the Junction or move the factory back to his old home at Mitchell.

Leigh & Loudon is the name of a new firm recently formed for the purpose of opening a mattress factory in Cornwall. Mr. Leigh is from London, Ont., and has had large experience in the business, and Mr. Loudon is a former resident of Cornwall, whose return will be hailed with pleasure by a large circle of friends. Arrangements are being made to secure premises in rear of the Glengarry Block, Pitt street, and it is proposed to commence operations at once.—*Cornwall Standard.*

A meeting of the creditors of Smith Bros., woolen manufacturers of Sarnia and Dresden, Ont., was held at the Queen's hotel, Toronto, on the 11th inst. Among the creditors represented were McMaster & Co., Toronto; John Hallam, Toronto; John Calder & Co., Hamilton; Robert Berryman, Hamilton; Gordon, McKay & Co., Toronto; W. R. Brock & Co., Toronto; Gault Bros & Co., Montreal, and Robinson, Little & Co., London. The gross liabilities are about \$38,000, and the nominal assets about \$60,000. Much sympathy was expressed with the firm, but the opinion expressed was that, to use a common phrase, it had bitten off more than it could chew, in the recent extension of its business. The firm offered a settlement of 65 cents in the dollar, in notes at four, six, nine and twelve months, but as no security was proposed, the creditors declined the offer. It was decided to appoint inspectors and sell the business, by which course it was thought that 70 cents in the dollar would be realized. Robert Berryman, of Hamilton, and John Muldrew, of McMaster & Co., Toronto, were named inspectors.

## TEXTILE MACHINERY (New and Second Hand)

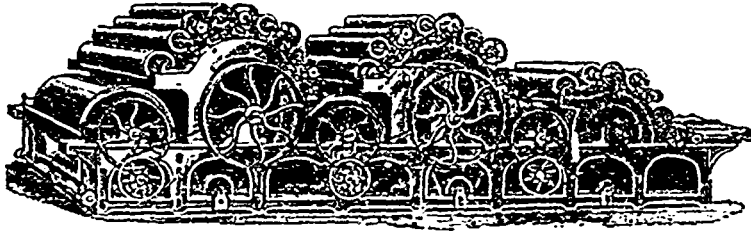

English Sales Attended.

3 ST. HELEN ST., MONTREAL

## CARD CLOTHING TETLOW'S

Stock in Canada

## Condenser Aprons

Buffed Surface  
Plain & Grooved

Oak-Tanned and White Belting  
Cotton Banding, Rim Spindle and Braided

Shuttles, Pickers, Heddles, Harness

Patent Frames, GENERAL FURNISHINGS

ROBT. S. FRASER

A G. Van Egmond's Sons' woolen mill at Seaforth is closed down at present.

We regret the statement appearing in last issue, from a correspondent, to the effect that the R. Forbes Co., of Hespeler, had closed down. We are glad to be able to say that there was no truth whatever in the report.

R. W. King & Co., manufacturers of knitting machinery, are getting into shape for work at their new factory, 503 Markham street, Toronto, and have now an order in hand for their well-known machinery.

The shoe-lace factory at Berlin, Ont., recently started under the proprietorship of the Rev. Mr. Tuerk, has been sold to the Worsted & Braid Co., at Toronto Junction. This company are now making a line of goods not hitherto manufactured in Canada—elastic laces and braids, both round and flat.

The Canada Hair Cloth Co., of St. Catharines, are running again after the repairs that have been made to the water wheel. This factory has 66 looms for the manufacture of hair cloth fabrics, and last year, owing to the attitude of the foreign combine in these goods, were called on to fill a large number of orders in the United States.

The Ontario Cotton Mill at Hamilton, owned by the Canadian Colored Cotton Co., closed down on the 13th. This mill employed about 400 hands. On closing down the hands were notified that the mill would not resume till the 10th September, and then at a reduced scale of wages. A number of the employes are endeavoring to seek employment elsewhere.

The Watson Manufacturing Co., manufacturers of knit goods, St. Catharines, report a good trade in the light weight shirts and drawers, which they make their specialty. They have added a new knitting machine during the past year. E. P. Watson is president, and R. M. Watson secretary of the company.

Warren Bros., knit goods manufacturers, of St. Catharines, who have for some years past made more or less of the Salvation Army jackets, have this year been given the contract for the whole supply, which will amount to about 200 dozen. The Army authorities have complimented this firm on making a better fitting jacket than is made by British manufacturers for the army in England, where these goods were formerly bought for the Canadian battalions. The yarn is still imported from England, however, being bought from Baldwin's, Halifax.

The Brantford cordage works considered their taxation exorbitant and applied to the city for exemption. The following report of a Council meeting, from a local paper, explains itself: A special meeting of the Finance Committee was held yesterday to consider the cordage works matter. Present, Mayor Watt, Alds. McGregor, Robson, P. A. Whitney and Turnbull. At a former meeting the following proposition was made to Manager Connor, of the cordage works, and by him submitted to headquarters, together with a letter containing his approval of the same: "That the city was prepared to exempt them from taxation for almost any reasonable period of time in the future and readjust the assessment for this year, provided they would start their factory on or before the 20th of the month." Since then a reply has been received from Montreal, as given in the *Courier* of Tuesday, to the effect that on account of unfair treatment in Brantford and dull times in general, they had decided to move their plant and

machinery to Port Hope. It was to consider this later communication that the special meeting was called. After some discussion it was decided that although the committee regretted the loss of the cordage works from the city, they had done all in their power to retain the same, and could do nothing further.

About three o'clock on the 3rd, fire broke out in the woolen mills owned by Richard Vause, at Glencoe, Ont., and in a very short time the large frame structure was ablaze. All efforts of the firemen to save the building proved fruitless, and it, with its contents, including a large supply of wool, tweeds, and machinery was destroyed. It will be a heavy loss to the town, as Mr. Vause carried on a very extensive business. The fire started in the top storey, and its cause is not known. A considerable quantity of wool, hosiery, carpets, etc., was saved; but the loss will be over \$4,000.

The *Edmonton Bulletin* says: "J. T. Turnbull, secretary of the Wool Growers' Association, has received several letters in reply to the advertisements and enquiries of the association. Wm. Zinger, who owns a woolen mill at Teeswater, Ont., may be induced to remove his mill to Edmonton, and another mill owner in Ontario also expresses his willingness to change his location for a consideration. As to trading woolen goods for wool, the Midnapore woolen mills offer 11½ cents a pound for unwashed wool, in trade, the wool to be of a quality containing 65 pounds of clean wool to every 100 pounds of unwashed. Blankets are traded at \$5 to \$8 a pair. Yarn at 70 cents for 4 banks of 20 yards in each bank either 2 or 3 ply."

One hundred weavers in the Moncton cotton mill struck on the 25th ult. The mill had been closed down for some time, starting up a few weeks previous to the strike at ten per cent. reduction in wages. It has been the practice of the manager to give a premium of twenty-five cents on each loom producing above a certain standard. Manager Wilson posted a notice that this premium would be discontinued, and the men struck after having unsuccessfully interviewed the manager. It is said the operatives there are paid ten per cent. higher wages than elsewhere. The men were only out three days when they returned to work on the manager's terms. The capacity of this mill is now being increased about 12 per cent., and a considerable quantity of new machinery has already arrived from England and is being set up. The new machinery, it is expected, will be installed by the end of August, when more hands will be taken on.

St. Catharines is getting to be quite a textile town. Besides the industries referred to in paragraphs elsewhere, there are now three carpet factories. The oldest of these, the Empire Carpet Works of James H. Etherington, now has 30 looms in operation, and employs about 48 hands. Notwithstanding the general depression, they have turned out a large quantity of goods during the past year, and many of their new patterns are remarkably handsome. They have recently made extensions to their dyeing department, and keep abreast of the times. Mr. Gates, whose recent removal from Woodstock here has been chronicled, has dissociated himself from S. Syer, and has taken in as a partner W. H. Gardner. The firm is now styled the St. Catharines Carpet Manufacturing Co., Gates & Gardner proprietors, and have 28 narrow looms and 2 broad looms. Of these, however, only 15 are set up and 7 in running order. They have fitted up a new dyehouse, and have an engine in readiness to supply power when needed. Mr. Gardner will act as

selling agent for the firm. It is noteworthy that Mr. Etherington and Mr. Gates were born in the same town in England, and went to the same school, and now they find themselves side by side in the same city in Canada as manufacturers. S. Syer, who was formerly traveler for the Empire carpet factory and then induced Mr. Gates to move to St Catharines in opposition to Mr Etherington is now attempting to get a third carpet factory in operation in opposition to both. He has got some second-hand looms from the old factory run by Thos. Hudson at Meaford, whose works were closed up, and whose plant was seized by the town in consequence of default in regard to the bonus. The prospects of the third carpet factory in St. Catharines are evidently not brilliant.

A CASE of blood poisoning from the dye in colored tights is reported from Toronto. Charles Marlow, one of the performers at the Wild Vest Show now at Hanlan's Point, was taken to St. Michael's hospital with a swelled leg. A week previous he bruised his left leg below the knee, but paid no attention to it. The dye from his colored tights, coupled with the unsanitary condition of the car in which the performers are living on the Esplanade, gave rise to blood poisoning, and he is now in a dangerous state

THE Ontario Glove Works, at Brockville, have put in considerable new machinery lately, including a steam cutter which cuts out six pairs of gloves at a time; and new laying-off machines heated by steam. Alterations have been made to the factory and stock-room, giving better facilities for manufacturing and arranging goods. Since the concern has been taken over by Mr. McLaren, this factory now makes its own McLa stock, and does a considerable amount of kid tanning. The firm have acquired the Canadian rights for a new style of suspender which they are now making in large quantities along with their gloves and mitts, and which appears to be taking well with the trade.

THE cloudiness and lifelessness of the colors of cloths which have undergone steam lustering upon a roller may be remedied as follows: Such goods require the most attentive treatment throughout all the stages of fulling and finishing. Since soda invariably turns white wool a little yellow, the latter is only to be washed; fulling is excluded, and it is to be treated only with urine and neutral soap. The wool lubricant must also be intelligently chosen, and a prolonged lying of the cloth in a wet condition is to be avoided under all circumstances. The steam-lustering is to be limited to the smallest degree, since steam also has a tendency to turn white wool yellow; in fact, it should be avoided altogether, if possible, and the cloth simply passed over the steam table. If not possible to do this, however, use only a low steam pressure and allow the steam to pass through the roller, until the cloth is thoroughly saturated with it. Then remove the cloth at once from the roller and let it cool. A white mix, however, will always become more or less yellow by steam lustering.

A NOVELTY has recently appeared in Chemnitz in the shape of hosiery, the idea being to repair hosiery so that it will appear as if new. To this end fast seams in the mesh are made across the toe, ankle, and heel. If, therefore, a hole appears in the toe, it is cut off and a new one attached, which is easily and quickly done by hand, the seam appearing practically the same as when new. In like manner the heel is repaired, or, in case of "general debility," the whole foot can be removed by cutting it off at the ankles. In order to make it possible for all to repair their own stockings, it is the design of the manufacturer to furnish with every dozen pairs of hosiery one dozen extra pairs of feet, three dozen pairs of toes, and three dozen pairs of heels. For the cheaper qualities of hosiery it is not likely this system would be demanded, says an English exchange, but in silk, silk-plaited, wool, and the higher priced cotton hosiery, it might be useful and economical. Whether it will meet with any degree of success remains to be seen, as many things of general utility are brought out which fail to catch the fancy of the people because of lack of push and enterprise in introducing them. However, the manufacturer of this hosiery has had sufficient confidence in it to take out letters patent in many countries to protect his system of manufacturing it.

THE contract for rebuilding the warehouses of Manchester, Robertson & Allison, St. John, N.B., which were badly damaged by fire recently, has been awarded to B. Mooney & Sons, who have begun work already. It will be completed in about two months.

In the case of J. E. Nelson Ratte, whom we mentioned last month as having been arrested for the alleged smuggling of furs into the United States, another development has taken place. George T. Buckingham, a special agent of the Treasury Department, stationed at Boston, who was the chief witness against Ratte and who was the principal cause of his arrest, has been dismissed from office. It is not known whether this is due to some political motive, or to the possibility that the American Government does not care to spend so much money in the attempt to capture alleged smugglers. Mr. Ratte does not know whether this dismissal will have any effect on his case; but he says he will have something to say at his trial which will startle several parties.

CHEMICALS AND DYESTUFFS.

Latest reports from the West say that many mills are closing down owing to scarcity of business. Notwithstanding these reports, the volume of trade is about up to average. The month of June showed a slight improvement over previous month. Quotations remain about the same as in our last report, and are as follows:

Bleaching powder.....	\$ 2 25	to \$ 2 50
Bicarb soda.....	2 25	" 2 35
Sal soda.....	0 70	" 0 75
Carbolic acid, 1 lb. bottles.....	0 25	" 0 30
Caustic soda, 60°.....	2 30	" 2 50
Caustic soda, 70°.....	2 60	" 2 75
Chlorate of potash.....	0 20	" 0 22
Alum.....	1 40	" 1 50
Coppers.....	0 70	" 0 75
Sulphur flour.....	1 75	" 2 00
Sulphur roll.....	2 00	" 2 10
Sulphate of copper.....	4 00	" 5 00
White sugar of lead.....	0 07½	" 0 08½
Bich. potash.....	0 10	" 0 12
Sumac, Sicily, per ton.....	70 00	" 75 00
Soda ash, 48° to 55°.....	1 25	" 1 50
Chip logwood.....	2 00	" 2 10
Castor oil.....	0 06½	" 0 07
Cocconut oil.....	0 06½	" 0 07

ENGLISHMAN, now residing in United States, thoroughly practical in the manufacture of Marseilles crochets, Mitcheline quilts and Turkey red table covers, is desirous of meeting capitalists who are willing to put capital against experience, or would superintend new place in a stock company, if compensation is satisfactory. No objection to any location, and is willing to learn inexperienced help and guarantee better results than any other manufactured fabrics. Address P.O. Box 267, Beverly, New Jersey, U.S.A.

WANTED—By a Maritime Province mill—a piece sewer and mender. None but a first-class hand need apply. Good wages will be paid. Address Box 1, JOURNAL OF FABRICS, Fraser Building, Montreal.

**A. KLIPSTEIN & COMPANY**

122 PEARL STREET, NEW YORK

**Chemicals and Dyestuffs**

ANILINE COLORS OF EVERY KIND

SPECIALTIES:

**Fast Colors for Wool** Such as DRY ALIZARINE, ALIZARINE BLUE, GREEN, YELLOW, etc.

Also CAUSTIC POTASH FOR WOOL SCOURING

WRIGHT & DALLYN, Agents - - HAMILTON, Ont.

A. TANGUAY, dry goods merchant, Quebec, has assigned on demand of H. Duverger, of Montreal Liabilities, \$35,500, with assets of about \$20,000. The principal Montreal creditors are A. Racine & Co., \$1,942; J. G. McKenzie & Co., \$1,840; F. F. & C. B. Kelly, \$1,490, and Gault Bros., \$1,476. P. Lafrance, of La Banque Nationale, has been appointed provisional guardian.

In the case of Adam Volkert, Montreal, who was charged with having in his possession some unprime furs, the expert's evidence showed that there were only four doubtful mink skins in the lot, and the case was dismissed. In Frederick Schnauffer's case, of the same nature, all the skins were proved to be prime, and Justice of Peace Sicotte ordered its dismissal, with costs against the inspector who had brought the charge.

In the case of Henry Hamilton versus Thomas Liggett, Montreal, who were formerly partners in the carpet and dry goods business, judgment went in favor of the plaintiff for \$1,509. Mr. Hamilton, now a large dry goods merchant, objected to the payment to Mr. Liggett, now the well known carpet dealer, of a 5 per cent. commission for sales effected in the dry goods department of their former business, which the latter claimed, at the same time crediting Mr. Hamilton with a 5 per cent. commission on sales effected in the carpet department. On this reckoning there would have been a considerable balance in favor of defendant, but the plaintiff claimed that no agreement as to commission had been made on either side, and the result of the action was that the judge upheld Mr. Hamilton's objection.

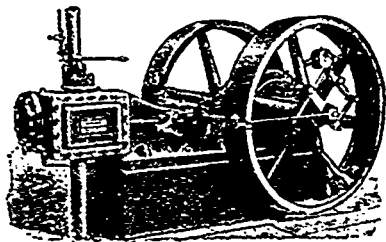

**The Robb-Armstrong Engine**

Simple and Compound

- Economical
- Large Bearings
- Perfect Regulation
- All parts interchangeable

**ROBB ENGINEERING CO., LTD.**  
AMHERST, N.S.

**H. W. KARCH,**

HESPELER, ONT.

MANUFACTURER  
OF

**Woolen Machinery,**

Falling Mills,

- Cloth Washers, Wool and Waste - Dusters, Drum Spool Winders, Reels, Spooling and Doubling - Machines, Ring - Twisters, Card Creels, Rag - Dusters, Dead Spindle Spooler (For Warp or Dresser Spools), Pat. Double-Acting Gigs, etc., etc.

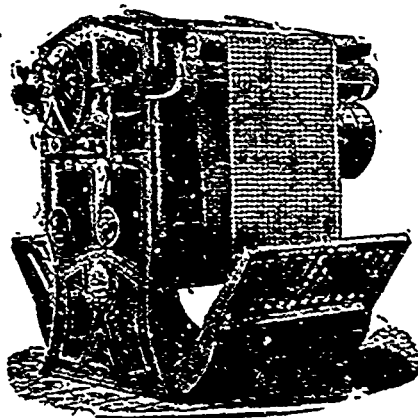

THOMAS KER

J. HARCOURT

**KER & HARCOURT,**

ESTABLISHED 1857

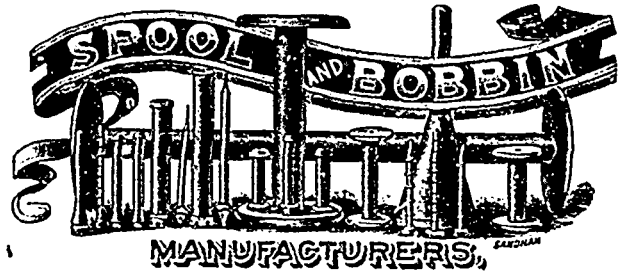

Orders by Mail will receive prompt attention.

Walkerton, Ont.

**WILLIAM WHITELEY & SONS,**

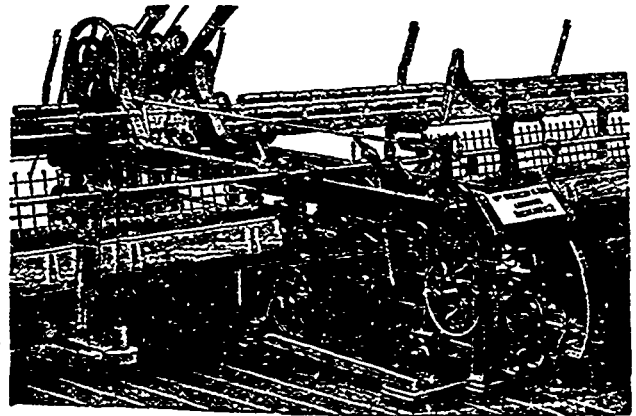

**LOCKWOOD, HUDDERSFIELD, ENGLAND.**

Winding Machinery, Improved Self-Acting Mule, Suspended Steam Driven Centrifugal Hydro-Extractor, Tentering and Drying Machines, Patent Wool and Cotton Dryer, Patent Wool Scouring Machine, Cross Raising Machine, Patent Crabbing and Winding-on Machine, Warp Sizing, Cool Air Drying and Beaming Machine, and other Woolen Machinery.

CATALOGUE ON APPLICATION

**WM. SHAW & CO., Agents,**

164 McGill Street, - Montreal.

**The Sun Life Assurance Co. of Canada**

Head Office: MONTREAL

This is a strong and prosperous Canadian Institution, with well-invested Assets

Assets . . . . . \$3,403,700.88

Income . . . . . \$1,134,867.61

Life Assurance in force . . . \$23,901,043.64



T. B. MACAULAY, Secretary.  
R. MACAULAY, President.

**JOHN HALLAM,**  
83 & 85 Front St. East, - - - Toronto  
and  
88 Princess Street, - - - Winnipeg,  
Wholesale Dealer in  
**DOMESTIC AND FOREIGN WOOLS,**  
Sumac, Japonica, &c.

**THE SMITH WOOLSTOCK CO.**  
Manufacturers and Dealers in all Lines of  
Wool Stock, Shoddies, &c., Graded Woolen  
Kugs, Carbonizing and Nourtraling.  
Best prices paid for Wool Pickings, Woolen  
and Cotton Rags, Metals, &c. Hard Waste, &c.,  
purchased or worked up and returned.  
219 Front St. E., Toronto | Foot of Ontario St.

**The Montreal Blanket Co.**  
Manufacturers of  
Shoddies, Wool Extracts  
and Upholstering Flocks  
Office and Works: COTE ST. PAUL  
P.O. Address: MONTREAL

**ROBT. S. FRASER**  
**Wools, Cottons, Noils, Yarns**  
Specialties:  
*English Pick Lambs and Downs*  
*Foreign Wools and Noils*  
*Egyptian and Peruvian Cottons*  
*Fancy Yarns*  
3 St. Helen St., MONTREAL

**ROBERT FLAWS,**  
**Dry Goods Commission Merchant**  
AND MANUFACTURERS' AGENT.  
Bay Street Chambers, - Toronto, Ont  
Cor. Wellington Street W.,

**DAVID KAY,**  
*Fraser Building, - Montreal.*  
REPRESENTING  
WM. PARKS & SON, Ltd., St. John, N.B.  
C. G. ELRICK & CO., Toronto.  
ASCHENBACH & CO., Manchester.  
E. PUTTMANN, Barmen, Germany.  
Correspondence Solicited.

**JAMES WATSON,**  
**General Agent & Broker,**  
20 JAMES STREET SOUTH,  
**HAMILTON, - - - Ont.**

**WM. D. CAMERON,**  
*Woolen & Cotton Manufacturers'*  
*Agent,*  
HALIFAX, N.S., & ST. JOHN, N.B.  
Address P.O. Box 401, - HALIFAX, N.S.

**A. T. PATERSON & CO.**  
*Importers of Foreign Wools*  
35 St. Francois Xavier St.  
MONTREAL, Canada

**CHAS. E. STANFIELD**  
**TRURO, N.S.**  
Manufacturer of  
**WOOLEN AND KNIT GOODS**  
Specialties:  
CARDIGAN JACKETS and LADIES'  
NON-SHINKABLE UNDERVESTS

**JOHN REDFORD**  
**Dry Goods Manufacturers' Agent**  
Sample and Stock Rooms:  
16 George St., HALIFAX, N.S.

**KINGSTON HOSIERY CO., LIMITED**  
KINGSTON, Ontario  
Manufacturers of  
The Celebrated ESTY HOSIERY  
The Celebrated BENSON SOCKS  
Overalls, Shirts and Drawers  
Selling Agents { JOHN S. SHEARER & Co., Montreal  
W. P. ROYER, Toronto

**YARMOUTH WOOLEN MILL CO., Ltd.**  
Manufacturers of  
Fine Woolen Tweeds, Homespun, etc  
**YARMOUTH, Nova Scotia**  
JAS. A. CANTLE & CO., Selling Agents  
MONTREAL and TORONTO

**.. JAMES LESLIE ..**  
MANUFACTURER OF  
**CARD CLOTHING**  
LOOM REEDS  
**Leather Belting**  
Cotton and Woolen Mill Supplies, &c.  
**428 ST. PAUL ST.** Cor. St. Francois  
Xavier Street  
**MONTREAL.**

**MISSISSIPPI IRON WORKS**

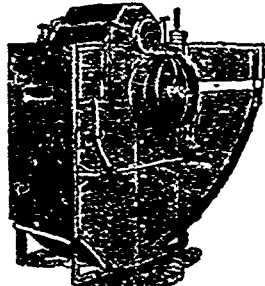

ESTABLISHED 1876

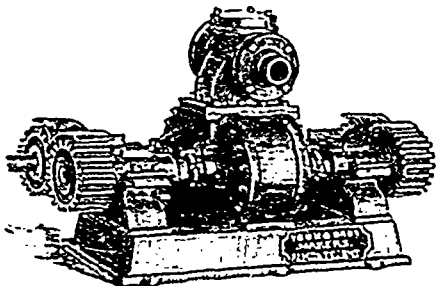

Manufacturers of English or American Fulling Mills and Washers, Wool Pickers Exhaust Fan Driers, Dusters, Rotary Force Pumps for Fire Duty, Boiler Feed Pumps, Shafting, Hangers, Castings, Pulleys, Gearing, Forgings.  
Full equipment of mills of every kind. YOUNG BROS., Almonte, Ont.

**HAWORTH & WATSON**  
MANUFACTURERS OF  
**COP TUBES**  
PAPER COP TUBES FOR MULE SPINNING.  
LARGE PAPER TUBES FOR USE ON BOBBINS.  
FULL LENGTH TAPERED TUBES.  
PAPER TUBES SILK MANUFACTURERS.  
PAPER CONES & TUBES FOR CONE WINDERS.  
LOWELL... MASS.

## LITERARY NOTES.

The history of the war of 1812 has yet to be written. Among the existing books on the British side of the subject, there is very little original work of value, if we except Auchinleck, and unfortunately Auchinleck's work is weakened by the same fault that mars every American historian of the war—a palpable bias in favor of his own side. A great deal of valuable material is being annually lost through the death of the veterans of 1812, but a vast amount is happily preserved in the archives at Ottawa and other sources, and scarcely any of this material has yet been put in order. It is to be hoped that some capable hand will begin this work at once, for the war of 1812 may be said to have been the real beginning of our national history. It was a Spartan era that developed heroism in every rank of life. It is hard to say whom we should idolize most, the noble Sir Isaac Brock, who fell with the shout of "Push on, brave York volunteers!"; the gallant De Salaberry, the French-Canadian hero of Chateauguay; the solemn chief Tecumseth, who never knew fear; or that sweet heroine, Laura Secord, the simple farmer's wife, who tramped those weary miles with bare and bleeding feet, facing the dangers of death every mile of her way, to warn Fitzgibbon of the approach of the Americans. And yet there were hundreds of heroes like those of whom we know nothing. Then there are many heroic officers like Col. Harvey, Col. Fitzgibbon, and Col. Proctor, of whom we know something in the histories extant, but of whom we crave to know more. We therefore heartily welcome the biography of that patriot and soldier, Col. Fitzgibbon, from the pen of his granddaughter, Mary Agnes Fitzgibbon, just issued under the title of "A Veteran of 1812," and in reading it we feel that we have the most complete and graphic picture of this brave man that will ever be given to the Canadian public. In perusing these pages it is gratifying to find that the picture is drawn by a pen which, though graphic and admiring, is neither servile nor merely flattering. It is also satisfying, in these days when biographers treat of almost everything else but the personality of their subject, to find Miss Fitzgibbon confining herself so strictly to the man and his doings. The consequence is that we have a most instructive account of the life and character of one of the finest soldiers in Canada's first war. The man who, with a detachment of 58 men, had the pluck to demand and achieve the surrender of a force of 544 of the enemy, as Fitzgibbon did at Beaver Dams, is a man whom even his foes would now delight to honor; and if a government which can throw money in hundreds of thousands into the pockets of boodling contractors ever can spare a thought for those worthies of 1812 who gave their lives to hold this country for Britain and make it what it is, we may some day expect a double monument to Laura Secord and Col. Fitzgibbon at Beaver Dams. Enough money was squandered on the Curran Bridge job, at Montreal, to have built a statue to these two in pure gold. But to return to the book, we would remark that it is an excellent specimen of typographical work, being issued by Wm. Briggs, of the Methodist Book and Publishing House, Toronto, and is embellished with a number of interesting engravings, most of them now for the first time published. Miss Fitzgibbon, as many of our readers may know, is the author of "A Trip to Manitoba," a chatty sketch of life in the Prairie Province, issued when the C. P. R. was first opened up, and which ran through more than one edition in England. Miss Fitzgibbon inherits the literary instinct on both sides of her house, being not only a near relative of Agnes Strickland, Mrs. Moodie and Mrs. Traill, so well known in English and Canadian literature, but descended from well known authors in the Fitzgibbon family. The reader will agree with us that she bears up well the traditions of the family, and we are not surprised to learn that the book is already having a large sale.

We heartily congratulate the *Monetary Times* on its improved appearance in its new dress of type and new "make-up." Before this improvement it was still the only commercial weekly which could be called attractive in typographical appearance, but its wide columns and clean type, and its artistically set advertisements, now challenge comparison with the best commercial papers of the

United States or England. But it is not for this reason merely that we admire the *Monetary Times*. "The apparel oft proclaims the man," it is true; but it is only because the clean exterior may sometimes symbolize the inner character that attention is called to it. What the mercantile community of Canada may feel proud of is that it has one commercial journal which in its twenty-seven years of life has never wielded the club of the blackmailer. It has always regarded its own integrity as of more value than an advertisement, and hence the powerful influence it now exerts in commercial circles. Under the broad-minded editorship of Mr. Hedley, there is no danger that these traditions will be departed from.

J. Van Sommer, jr., of Toronto, has sent us a book entitled "Britain and Her People," in which he seeks to trace the rise and development of the policy of "Political Union" throughout the British Empire. The book is divided into chapters, amongst the titles of which are "Building the Fleet," "Australia," "Canada: the Policy of the Seas," "Africa," etc., and is illustrated with two or three useful maps. The author finds that for many years there has been a natural change of thought as to the ultimate destination of the British Empire, and that this has gradually led to a conception of the great principles of "local self-control of local affairs" and "union of the Empire by popular representation in the British Parliament." He concludes from these facts and from a consideration of many other circumstances as well, that the time is now ripe for such a union, by which the Empire's vast and diverse resources will be developed to their fullest.

The *June Century* has a piquant, vivid little story entitled "The Magic Egg," which, while in the form of an extravaganza, strikes into the heart of a current fad. Two college students, Messrs. Allen and Sachtleben, who are contributing a record of their trip "Across Asia on a Bicycle," devote the *June* paper to a description of "The Ascent of Mt. Ararat." There is an interesting and authoritative account of "Edison's Invention of the Kinetograph" by Antonia and W. K. L. Dickson, Mr. Dickson having been associated with Mr. Edison in working out this invention. There is also an introduction by the inventor, and a portrait of him from a recent photograph, together with examples of the pictures shown by this new invention for reproducing to the eye the motions of a given scene as the phonograph reproduces the related sounds. An important undertaking is described by Mr. Theodore Stanton in an article on "Tissot's Illustrations of the Gospels," a series of pictures made by the French artist after many years' study of the types and scenes of the Holy Land. Amongst fiction is the conclusion of Mark Twain's "Pudd'nhead Wilson," containing some of the very best of his serious writing in the scene of the murder trial, in which the story reaches an exciting climax. There is also the concluding part of Mr. Thomas A. Janvier's sprightly "Loan of Half-orphans," and a new novelette is begun in "A Cumberland Vendetta," a tale of the Kentucky mountains, by John Fox, jr. To the first and third of these serials Mr. Loeb contributes illustrations.

The *Century* strikes into the summer season in the *July* number with the beginning of novelettes by Marion Crawford and Mrs. Burton Harrison. Mr. Crawford's story is entitled "Love in Idleness: A Fortnight at Bar Harbor," and is in the author's lightest and chattiest vein. The characters are New York people, and are strongly contrasted, and there is some lively and entertaining love-making at the very start. Some of the personages have appeared in "Katharine Lauderdale," but the story has an entirely separate interest. Mrs. Harrison's story, "A Bachelor Maid," with drawings by Wiles, opens in New York city, and deals with the aspirations of a young woman to whom the conventionalities of family life are somewhat irksome. Incidentally the story deals with some of the current questions in regard to the relations of women to society and public life. A third novelette, Mr. John Fox, jr.'s "Cumberland Vendetta," reaches its second part, and takes on a tragic character, as the illustrations by Mr. Loeb suggest. The short stories of the number are "Her Mother's Success," by Viola Roseboro', with pictures by Sterner, the characters being for the most part a traveling company of actors; "An Unexpected Legacy,"

by Alice Turner, and illustrated by W. L. Metcalf, relating the adventures of two old ladies who have come into a fortune and go to Boston to spend it, and "Susanna," a sketch of old times on the eastern shore of Maryland, by Nannie A. Cox, with pictures by Castaigne.

We have received from the Government Printing Office, Washington, a book of 700 pages, entitled "Wool and Manufactures of Wool," compiled by Worthington C. Ford, chief of the Bureau of Statistics. In the introduction are given many interesting facts relating to the condition of the sheep and wool-raising industry in various parts of the world. "The conditions of the wool supply," says the author, "have changed even more radically (in the period between 1860 and 1893) than the product. Europe has yielded to the southern hemisphere the growth of fine wools. . . . Careful husbandry is supplanting nomadic territory conditions. While the total American clip has increased three-fold in thirty years, the clip of Australia, under management most intelligent and scientific, has increased tenfold in the same period." The copious appendix is devoted chiefly to facts and statistics concerning the sheep, wool clip and woolen manufactures of the United States. There are tabulated returns also of the imports of woolen goods into Canada and other chief countries.

### COTTON IN JAPAN.

T. Ourakami, a correspondent of the *Economist Francais*, writing from Tokio, says that from the year 1857 or 1858, that is to say, a little before the opening of Japan to foreign trade, the natives knew that an ingenious system of cotton-spinning was in existence in Europe, and they were anxious to see it introduced into their own country. In 1875, after the return from a visit which Count Matsoukata, Minister of Finance, had paid to Europe, the Japanese Government purchased through him several small model machines for spinning cotton, and caused them to be distributed in those departments in which cotton is cultivated, in order that the inhabitants might become acquainted, not only with the machine itself, but with its uses. This was the commencement of the Japanese spinning industry, an industry which has since then experienced considerable development.

At the commencement of the industry the Japanese were only able to produce coarse yarns, those of No. 16, which were only suitable for replacing the ones hitherto produced in the primitive manner of the country, that is to say, by the distaff. From 1880 to 1884 cotton spinning became quite an important and flourishing industry in Japan. At the latter date there were 27 spinning companies throughout the country, producing about 617,000 Japanese pounds of yarn. The progress made was even more rapid during the period comprised between the years 1885 and 1889, as from the official statistics issued by the Japanese Government it appears that while in 1886 the amount of yarn produced amounted to 778,483 Japanese pounds, this quantity had increased in 1888 to 1,593,103 lbs., and in 1890 to 5,132,588 lbs. The number of spindles were respectively 65,420, 113,456, and 277,895. In 1890 there were 30 spinneries established in the country. The great development which had been effected in this industry in the years quoted above may be attributed entirely to the following causes:—At this period the demand for money was not so great, and capitalists experienced some difficulty in finding good investments. They looked favorably upon industrial enterprises, particularly upon the cotton spinning industry, which realized profits varying between 20 and 30 per cent. annually. Soon cotton spinneries sprung up one after the other to such an extent that the production of yarn in 1890, as compared with 1886, was quadrupled. The carding companies then passed through an acute crisis, for the production of yarns of the higher numbers having so greatly increased, it was difficult to find an outlet for the goods, and the surplus stock occasioned considerable embarrassment to the manufacturers. Among the manufacturers there were very few turning out fine yarns, those, for example, above No. 20, and the import of foreign yarns of this description continually increased. For example, the value of such imports in 1877 amounted to four million yen, while in 1888 they exceeded thirteen million (the par value of the yen is 4s. 2d.)

It will thus be understood that the progressive increase in the imports of foreign yarns on the one hand, and the check experienced in the production of Japanese yarns on the other, were due principally to an imperfect knowledge of this industrial art on the part of the Japanese. The manufacturers being desirous of acquainting themselves with the situation of the cotton industry abroad, sent out to Bombay two agents, who were commissioned to study the condition of the carding industry of India, and to bring back detailed information upon this subject. Soon afterwards a report was received from these agents to the effect that, judging from the condition of the Indian markets, it might be safely predicted that the cotton spinning industry of Japan had a brilliant future before it. In course of time it would, in their opinion, certainly have the monopoly of the Japanese markets, as it will soon be impossible for Bombay yarns to compete with the Japanese. The manufacturers being thus encouraged, commenced to study methods of turning out yarns of the finer descriptions, which are largely consumed in the country, and more perfected machinery was employed in order that a keen competition might be carried on with the foreign yarns. The result was very soon seen in an increased national production and a decreased importation. For example, in 1888 the quantity produced, in Japanese pounds, amounted to 957,000, and the imports in English pounds to 47 millions. In 1890 the quantity produced amounted to 32 million pounds, and the imports to 31 millions. In 1892 the figures were respectively 64 and 24 millions.

Thus, as it will be seen by the above, the imports of foreign yarns have fallen off year by year, and they decreased in value from 13 millions of yen in 1887 to seven millions in 1892. This is a result of the progress that has been effected in the national industry, and the great part of this success comes naturally from the skill of the workmen, who have learned much from their foreign competitors.

### UNITED STATES PATENTS.

The following list of patents granted by the United States Patent Office for inventions relative to textiles and textile machinery is reported for THE CANADIAN JOURNAL OF FABRICS by Glascock & Co., patent attorneys, Washington, D C., of whom printed copies can be obtained for 25 cents each.

#### PATENTS GRANTED JUNE 19, 1894.

- E. Murby, St. Louis, Mo, machine for making looped fabric.
- E. G. Johanson, Rockford, Ill., loom.
- G. W. Stafford, Providence, R.I., loom shuttle-box operating mechanism. Two patents.
- P. P. Craven, Manchester, England, ring spinning frame.

#### PATENTS GRANTED JUNE 26, 1894.

- H. A. Houseman, Philadelphia, Pa., knitting machine needle, actuating cam.
- C. B. Sander, Chemnitz, Germany, warp knitting machine.
- J. H. Lorimer, Philadelphia, Pa., textile machinery apron.
- F. N. Turney, Nottingham, England, apparatus for extracting oil from wood.
- D. H. Rice, Brookline, Mass., wool-washing machine. Two patents.
- F. G. Sargent, Graniteville, Mass., wool-washing machine.

#### EXPIRED JUNE 19, 1894.

- J. Sladdin, machine for making loom harness.
- Whittemore & Green, top roll for spinning machinery.
- S. George, spinning mule.

#### PATENTS GRANTED JULY 3RD, 1894.

- J. P. Odgers, Philadelphia, Pa, card frame or mount.
- H. S. and T. H. Greene, Lowell, Mass., cloth napping machine.
- E. Schweinefleisch, Milhausen, Germany, cloth napping machine.
- H. A. Houseman, Philadelphia, Pa., circular knitting machine.
- W. G. Connell, Philadelphia, Pa., loom.
- W. G. Connell, Philadelphia, Pa., woven fabrics.



## LONDON WOOL SALES AND CANADIAN MARKETS.

The fourth series of Colonial wool sales in London began on Tuesday, the 3rd instant. On that day, 5,400 bales were offered and there was a full attendance of buyers. An advance of 5 per cent. on the prices of merinos took place, as was also the case with cross-breeds, excepting the coarse parcels. There is not much advance on Capes and Natal. The larger lots of merinos were taken chiefly by Continental buyers. The bulk of the cross-breeds was purchased for the home trade, but some were bought by Germans. Prices obtained on the opening day were as follows:

	Bales.			
New South Wales	1,000	offered at	3 d.	to 7 $\frac{3}{4}$ d.
Queensland	500	offered at	7 d.	to 7 $\frac{1}{2}$ d.
Victoria	300	offered at	6 $\frac{3}{4}$ d.	to 11 $\frac{1}{2}$ d.
South Australia	300	offered at	4 $\frac{1}{2}$ d.	to 6 $\frac{1}{2}$ d.
West Australia	100	offered at	5 $\frac{1}{4}$ d.	to 6 $\frac{3}{4}$ d.
New Zealand	3,000	offered at	4 $\frac{1}{2}$ d.	to 10 d.
Cape of Good Hope and Natal	100	offered at	5 $\frac{1}{2}$ d.	to 6 $\frac{3}{4}$ d.

As the sales progress prices remain firm. The second series of wool sales at Antwerp took place from the 12th to 15th ult. The offerings were 7,095 bales River Plate, of which 3,453 were sold by auction at a fair rate. Of 1,467 bales of Australian, 422 were disposed of on the basis of current London values.

In the Toronto market there is considerable animation. During the past three weeks more wool has come into the market than in the like period for several years, and it must be said that the wool is in good condition. Among country merchants there is a speculative feeling based on the anticipation that prices in the States will go up when the tariff is settled—an anticipation which those in touch with the American market consider unfounded. In this market 16 and 17 cts. is paid for farmers' lots, and 17 cts. for parcels from country dealers.

In the Montreal market prices of wools remain firm at following quotations: Cape grease wool, 14 to 15 $\frac{1}{2}$  cts.; B.A., second, 26 to 30 cts.; Canadian, 17 to 19 cts.; North-West, 11 to 12 cts.

The *Winnipeg Commercial* of the 9th inst. reports: There is no material change in wool. Some fair lots have been bought at 8c., and 8 to 8 $\frac{1}{2}$ c. is the usual price for ordinary unwashed Manitoba fleece. The Toronto Hide Co. reports the purchase of the clip of the Canadian Agricultural Co., amounting to about 79,000 pounds, and 30,000 pounds at Medicine Hat of territorial ranche wool, at a price which would net producers 9 to 9 $\frac{1}{2}$ c.

## LOCAL WOOL MARKETS.

The following are the average prices quoted for Canadian wool at various markets throughout the country:—

Galt	16 to 18	cents
Clifford	10 to 15	"
Guelp, fine wool	17 to 18	"
" coarse wool	16 to 00	"
" unwashed	09 to 00	"
Orillia, unwashed	08 to 10	"
" washed	15 to 17	"
Fenelon Falls	14 to 16	"
Arthur	18 to 00	"
Sarnia	15 to 00	"
Renfrew	17 to 20	"
Pembroke	20 to 00	"
Peterboro, fleece	16 to 17	"
" Southdown	20 to 00	"
Listowel	16 to 20	"
Perth	18 to 00	"
Hamilton, coarse to medium	16 to 00	"
" Southdown	20 to 00	"
London	15 to 17	"
Seaforth	16 to 19	"

C. M. HARTLEY, a clothier in a large way of business at Halifax, has assigned.

J. D. COLQUHOUN & C. H. WATSON have opened a felt hat factory at Wales, Ont., under the name of the Wales Felt Hat Manufacturing Co. According to the *Cornwall Standard*, large orders have already been secured, and there is every prospect of a thriving business being established.

THE curators in charge of the business of the late Compagnie Generale des Bazars submitted at a meeting of the creditors recently, a statement showing the liabilities to be: direct, \$147,912.20; preferred, \$1,760; total \$149,672.51. The assets are: dry goods stock in the two stores, \$134,234.46; fixtures, \$7,228.58; book debts, good, \$17,490.47; doubtful, \$11,250.87; bad, \$11,270.56; cash on hand, \$3,001.65. Total amount of assets of all kinds, \$204,630.04. The offer of Louis H. Boisseau to buy the assets of the company has been accepted. Mr. Boisseau is to give 65 cents on the dollar, spread over a period of time, and \$30,000 being paid down.

THICK and hard stuffs are properly dyed with difficulty, and it is for this reason mainly that madder, which has a specially penetrative power, is still used in hat felt dyeing. The Höchst firm have just patented a process of dyeing wool with the sulpho-acids of alizarine dyes, which they claim will give a perfect penetration of the color in the thickest and heaviest milled felts. The wool is first dyed in an acid bath—Glauber's salt and sulphuric acid is best—and then treated with metallic lake-forming salts. This method is said to be an advance on any previous way of getting over the difficulty.—*Dyer and Calico Printer*.

THOMAS WARDLE of Leek, England, president of the English Silk Association, gives an interesting sketch of the silk industry in England, the beginnings of which he assigns to a far earlier date than the Revocation of the Edict of Nantes two centuries ago. He has in his possession some threads, to which he ascribes an English origin, attached to a parchment deed of 1194, and points out that the silk industry is mentioned in an Act of Parliament so far back as 1363, being thus nearly a century older than that of Lyons, which began in 1450. Mr. Wardle states that the annual production of the silk manufacturers of Lyons for the last nine years is more than 15,000,000, and English purchases of manufacture continental silk exceed yearly 12,000,000. As against these large figures British silk exports only reach 1,500,000. One aim of the association is to remove the prejudices of English ladies against home manufactures. It is, says Mr. Wardle, a mistake to think that English silks are dearer than French; and he quotes the authority of one of the largest distributors, who has found since he began to buy English silks that certain classes of them are better and cheaper and as tasteful as the French.

THE following is a description of the process of enameling woven cloth, to which we have referred before: A square of fine porcelain is covered with a light couch of chalk. A design in finely ground enamel is laid down on this after the fashion of ceramic work, taking care to leave a slight space between the colors so as to prevent them from running together in the subsequent baking. This operation is effected in an open muffle furnace, as in enameling on copper, and when completed the enamel detaches itself completely from the tile. It is washed free of chalk in acidulated water, and finally washed thoroughly in fresh water and dried. A satinete, or any colored tissue that may appropriately be decorated, is treated with many successive coats of caoutchouc in solution until it is completely impermeable. It is then allowed to dry. The caoutchouc is dissolved in benzine to a syrupy consistency with regard to the application of the enamel. A solution of caoutchouc in benzine is made, but much thicker than before, almost a paste being made. The enamel is glued on to the cloth with this preparation, taking care to leave a slight space between the different elements of the design. The outer circumference of the enamels are cut by hand or with a stamp after the fashion of braid, and finally sewn on to the cloth with gold thread or silk, or any other decorative material of the sort.

# GUARD AGAINST BOILER EXPLOSIONS

An efficient staff of Trained Inspectors

Prevention of Accident our chief aim

JOHN L. BLAIKIE ESQ. PRES.

E.W. RATHBUN ESQ. VICE-PRES.



OF CANADA

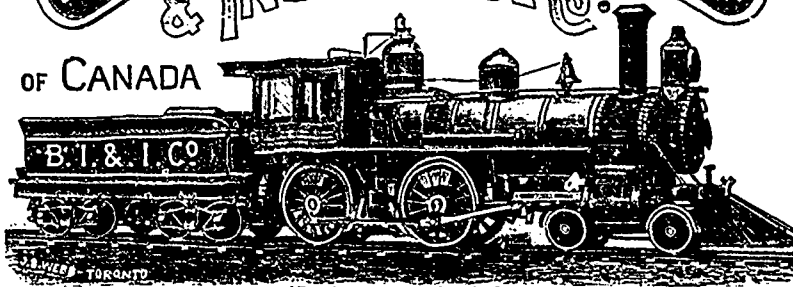

CONSULTING ENGINEERS

G.C. ROBB CHIEF ENGINEER  
A. FRASER SEC. TRES

HEAD OFFICE TORONTO

When were your boilers last inspected?

Are they in safe working order?

J. W. GRIER & MUDGE, Agents, O. E. GRANBERG, Resident Inspector, 92 St. Francois-Xavier Street, MONTREAL

MANUFACTURERS OF  
*Robin & Sadler, Oak Tanned Leather Belting, Montreal & Toronto.*

Cotton and Woolen Mills requiring Extra Heavy Belting should have the article we make expressly for their use.

## KAY ELECTRIC WORKS

MANUFACTURERS OF

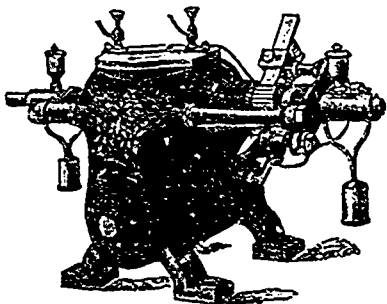

**Dynamos for Arc and Incandescent Lighting**

Electric Motors from 1-2 to 50 Horse Power

Plating Machines, Medical Batteries

and all kinds of Electric Appliances :: ::

263 James Street North, HAMILTON, ONT.

STATE VOLTAGE REQUIRED . . .

## Lachute Shuttle and Bobbin Works

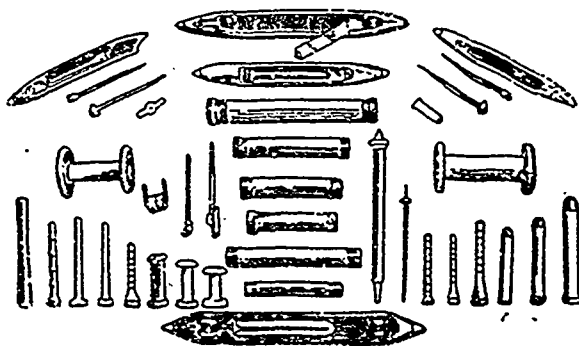

We are the largest Shuttle Manufacturers in Canada.

Slubbing, Roving and all kinds of Bobbins and Spools for Cotton and Woolen Mills

We have always on hand a large stock of Thoroughly Seasoned Lumber.

Orders solicited and all work guaranteed to give satisfaction.

**JOHN HOPE & CO.**

{ LACHUTE, P.Q.

## R. E. THOMAS PRINGLE

Constructing and Supervising Electrical and Mechanical Engineer

Contractor for complete Electric Light and Power Plants. Special attention given to estimates, plans, specifications and supervision of Electrical and Mechanical Work. Telephone No. 2631.

Room 57, Imperial Building  
107 St. James Street, MONTREAL

## Alliance Assurance Co.

Established 1824 :: Head Office, LONDON, Eng.  
SUBSCRIBED CAPITAL, \$25,000,000.

Rt. Hon. LORD ROTHSCHILD, - - Chairman  
Robt. Lewis, Esq., - - Chief Secretary

Branch Office in Canada:  
127 St. James Street, - - Montreal.

G. H. McHENRY, Manager.

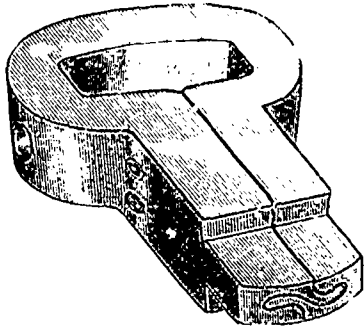

**JOHN W. BARLOW**  
 Manufacturer of  
**Loom Pickers,**  
 LAWRENCE, MASS.

This cut represents Barlow's Pat. Bow Picker with solid interlocking foot. Pat. Feb. 26, 1880

**C. G. SARGENT'S SONS**

Graniteville, Mass., U.S.A.

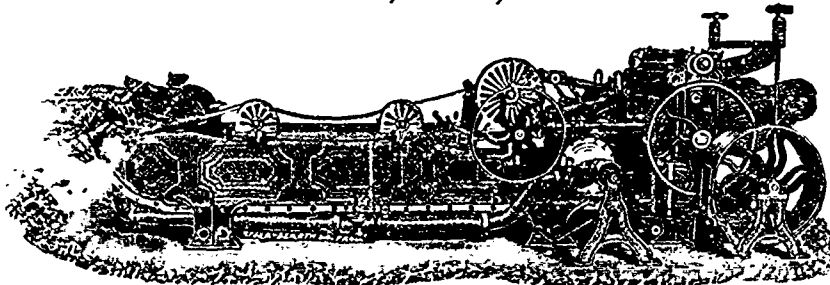

BUILDERS OF

**WOOL WASHERS, BURR PICKERS,**  
**WOOL DRYERS, etc.**

SEND FOR ILLUSTRATED CATALOGUE

**CHAS. F. TAYLOR,**

Successor to Burgess Cop Tube Co.

Manufacturer of

**PAPER**

**COP TUBES**

5 Custom House Street  
**PROVIDENCE, R. I.**  
**U. S. A.**

**G. B. FRASER,**

3 Wellington Street East  
**TORONTO**

REPRESENTING

Montreal Woolen Mill, Montreal, N.S., Tweeds,  
 Miller Bros. & Co., Montreal, Paper Collars and  
 Cuffs.  
 A. G. Van Edmond's Sons, Scaforth, Ont.; Tweeds  
 and Etoffes.  
 C. H. & A. Taylor, Galcar, near Huddersfield, Eng.,  
 Fancy Tweeds.  
 Hy, Langley & Co., Huddersfield, Worsted Coat  
 Ing. &c.  
 James Holdsworth, Upperhead Mills, Huddersfield  
 Woolen & Cotton Card Clothing.  
 Peter Besenbrush & Co., Elberfeld, Germany;  
 Buttons, Braids, &c.  
 S. B. Sherrill & Co., Cotton Brokers, Jackson,  
 Mississippi.

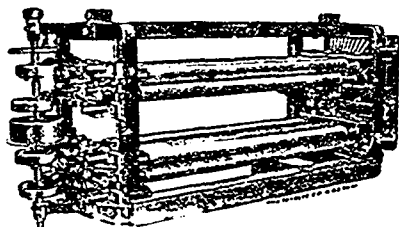

We manufacture Barker's Patent Noiseless  
 Fast-running Doffing Comb

**Barker's Patent Double Apron Rubbing  
 Motions for Condenser Cards**

*Are in successful operation on all grades of stock, being generally  
 adopted because they change carding and spinning  
 rooms for the better.*

**James Barker, Cotton and Woolen Machinery**  
 Second and Somerset Streets, **PHILADELPHIA, Pa.**

The **COBOURG WOOLEN CO., Ltd.**

COBOURG, ONT.

Manufacturers of

**Fine & Medium Tweeds**

Jas. A. Cantile & Co., Selling Agents,  
 Montreal and Toronto.

**BRODIE & CO.**  
**HESPELER, ONT.**

Manufacturers of

**FINE SERGES, FLANNELS**  
**MANTLE CLOTHS & DRESS GOODS**

MILLICHAMP, COYLE & CO., Selling Agents  
 MONTREAL and TORONTO

**E. W. MUDGE & CO.**

646 Craig St. - Montreal.

**TRIMMINGS**

—FOR—

**Knitting Mills and Woolen Mills.**

**TYING-UP RIBBONS.**

**Pink & White Cotton Tapes**

The Parkhurst Burr Picker is guaranteed  
 superior for cleaning Wool, Cotton or Hair.  
 Our new Picker Feeder is a decided success.  
 If your work is not satisfactory it will pay you  
 to write to the **ATLAS MANFG. CO.**

**NEWARK, N.J.**

Steel Ring Burring Machines a Specialty.

**F. W. WILSON**

*Bobbins*

*Shuttles*

and Textile Supplies

Commissions from Canadian and American Textile Manufacturers executed promptly.

Address:

**F. W. WILSON**

111 King Street

MANCHESTER, ENGL.

The best results in

# Card Grinding

are obtained by using



**DRONSFIELD'S PATENT GROOVED EMERY FILETING**

**DRONSFIELD BROS. (LIMITED)**

Established at Georgetown in 1877.

# ROBT. W. KING & CO.

Engineers and Mechanical Experts

Present Office: 505 Markham Street, TORONTO

HAVING accomplished the business for which we moved to Montreal, we have now returned to Ontario for the better convenience of our old customers.

All business arrangements made in moving to Montreal are cancelled and dissolved, and we wish it understood that we have now no connection with or interest in any woolen or knitting mill whatsoever, more than the friendly interest we have ever taken in the welfare of our friends and patrons, whom we have always striven to impartially serve, and of whom Ontario contains the larger number.

Yours respectfully,

**ROBT. W. KING & CO.**

THIS SPACE TO LET

**MOUNT BROS. SUPPLIES**



THE GREAT WORKS  
MONTREAL

We manufacture Electrical Goods of every description, which we can furnish at the lowest market price.

The Dyer, Calico Printer,  
Bleacher, Finisher and  
Textile Review

The recognized organ of the Textile Coloring, Bleaching and Finishing Trades in the United Kingdom.

Each number contains pattern sheets of the newest shades, and is full of special and exclusive information, worth many times over the amount of the annual subscription, Ten Shillings, post free.

PUBLISHERS:

**H. WOOD & CO., Limited**

150, HOLBORN, LONDON

**CARD . . . .  
CLOTHING**

**I**n English Oak  
n Flexifort  
n Cotton and Linen  
n Natural Rubber  
n Vulcanized Rubber

**S**end in your  
orders early.  
All Clothing  
ground. . . .

**The J. C. McLaren Belting Co.**

MONTREAL

.....

TORONTO

**SAMUEL LAWSON & SONS, LEEDS**

—MAKERS OF—

**Machinery for Preparing and Spinning  
Flax, Tow, Hemp and Jute**

**Special Machinery for the Manufacture of Binder and Ordinary Twines**

SOLE MAKERS OF

**Good's Patent Combined Hackling  
and Spreading Machine**

**Patent Automatic Spinning Frames  
Improved Laying Machines  
and other special machinery for the  
manufacture of Rope Yarns.**

Sole Makers of

**Bollmar's Patent Sack-Sewing Machines**

AND

**Brownell's Patent Twisting and Laying  
Machines for Twines**

Council Medal, London, 1851. Grand Medal,  
Paris, 1867. Prize Medal, Moscow, 1872. Diploma  
of Honor, Vienna, 1873. Highest Award, Phila-  
delphia, 1876. Gold Medal, Paris, 1873; Highest  
Award (Medal), Melbourne, 1880.

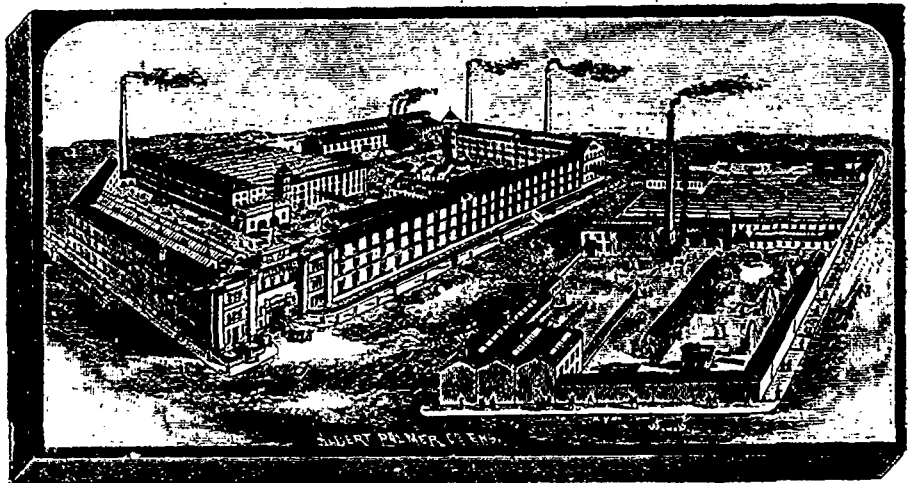

WRITE TO THE

**PATON MFG. CO.**

Sherbrooke, Que.

FOR

**Worsted Knitting and Fingering Yarns**

**NEW TORONTO WOOL STOCK CO.**

(ALFRED PARKER, Sole Proprietor)

A. S. PARKER, Manager

W. H. PARKER, Mechanical Supt.

**NEW TORONTO, ONT.**

MANUFACTURERS OF ALL KINDS OF  
**CARDED WOOL STOCKS AND GRADED SPECIALTIES**  
in Carbonized and Hand-Seamed Stock

The Proprietor asks for orders upon his long experience in the centre of  
the heavy Woolen Manufacturing trade of Yorkshire, England.

**Schofield Woolen Co.**

OSHAWA, ONT.

MANUFACTURERS OF

**Carpet and Hosiery Yarns**

**Ladies' and Gents' Underwear**

**MEN'S TOP SHIRTS A SPECIALTY.**

**L. S. WATSON MANUFACTURING CO.**  
LEICESTER, MASS.

**Manufacturers of WATSON'S PATENT MACHINE WIRE HEDDLES**

Guaranteed to be perfectly adapted to weaving all kinds of Woolen, Cotton and Worsted Fabrics, Fancy Cotton, etc., etc.  
Superior Harness Frames furnished promptly. Also Hand Cards of every description.