

## Technical and Bibliographic Notes / Notes techniques et bibliographiques

The Institute has attempted to obtain the best original copy available for scanning. Features of this copy which may be bibliographically unique, which may alter any of the images in the reproduction, or which may significantly change the usual method of scanning are checked below.

L'Institut a numérisé le meilleur exemplaire qu'il lui a été possible de se procurer. Les détails de cet exemplaire qui sont peut-être uniques du point de vue bibliographique, qui peuvent modifier une image reproduite, ou qui peuvent exiger une modification dans la méthode normale de numérisation sont indiqués ci-dessous.

- |                                     |   |                                     |   |
|-------------------------------------|---|-------------------------------------|---|
| <input type="checkbox"/>            | Coloured covers /<br>Couverture de couleur  | <input type="checkbox"/>            | Coloured pages / Pages de couleur   |
| <input type="checkbox"/>            | Covers damaged /<br>Couverture endommagée   | <input type="checkbox"/>            | Pages damaged / Pages endommagées   |
| <input type="checkbox"/>            | Covers restored and/or laminated /<br>Couverture restaurée et/ou pelliculée   | <input type="checkbox"/>            | Pages restored and/or laminated /<br>Pages restaurées et/ou pelliculées   |
| <input type="checkbox"/>            | Cover title missing /<br>Le titre de couverture manque  | <input checked="" type="checkbox"/> | Pages discoloured, stained or foxed/<br>Pages décolorées, tachetées ou piquées  |
| <input type="checkbox"/>            | Coloured maps /<br>Cartes géographiques en couleur  | <input type="checkbox"/>            | Pages detached / Pages détachées  |
| <input type="checkbox"/>            | Coloured ink (i.e. other than blue or black) /<br>Encre de couleur (i.e. autre que bleue ou noire)  | <input checked="" type="checkbox"/> | Showthrough / Transparence  |
| <input type="checkbox"/>            | Coloured plates and/or illustrations /<br>Planches et/ou illustrations en couleur   | <input checked="" type="checkbox"/> | Quality of print varies /<br>Qualité inégale de l'impression  |
| <input checked="" type="checkbox"/> | Bound with other material /<br>Relié avec d'autres documents  | <input type="checkbox"/>            | Includes supplementary materials /<br>Comprend du matériel supplémentaire   |
| <input type="checkbox"/>            | Only edition available /<br>Seule édition disponible  | <input type="checkbox"/>            | Blank leaves added during restorations may<br>appear within the text. Whenever possible, these<br>have been omitted from scanning / Il se peut que<br>certaines pages blanches ajoutées lors d'une<br>restauration apparaissent dans le texte, mais,<br>lorsque cela était possible, ces pages n'ont pas<br>été numérisées. |
| <input checked="" type="checkbox"/> | Tight binding may cause shadows or distortion<br>along interior margin / La reliure serrée peut<br>causer de l'ombre ou de la distorsion le long de la<br>marge intérieure. |                                     |   |
| <input checked="" type="checkbox"/> | Additional comments /<br>Commentaires supplémentaires:  |                                     | Continuous pagination.  |

# SCIENTIFIC CANADIAN

## MECHANICS' MAGAZINE

### AND

#### PATENT OFFICE RECORD

Vol. 10.

NOVEMBER, 1882.

No. 11.

### ARCHITECTURE IN THE STATES.



ALTHOUGH in painting and perhaps in sculpture also the United States are improving from year to year, it is astonishing how architecture drags behind. An enormous quantity of building goes on. Wards spring into being in a few years. Burnt cities rise again before the ruins have done smoking. But the edifices, although sometimes loaded with ornament and constructed with costly materials, are seldom the work of an architect in the true sense of the term as now used—namely,

as a master of building, as one says master of fine art. They are the work of masters of mechanical and technical arts as opposed to the fine arts. In New York it will be the merest chance if the next public building or costly residence does not fall into the hands of men who are not able even to sensibly "lift" modern European ideas in architecture. For one Jefferson Market Court House, with its pleasing, though not very original design in elevation and coloring, we have any number of buildings like the post-office, the Metropolitan Museum, the Cathedral in Fifth Avenue, the brown-stone Vanderbilt boxes. What frightens one in these buildings is the complacency with which owners and public regard them, and the silence of the press. They have the same vacuousness, the same absence of idea or sentiment for outline, composition, light and shade and color, which startle and disconcert the amateur in an exhibition of pictures at the Academy. Rich men and congregations are seldom able to secure for their large outlays the buildings which can be approved by a cultivated taste. A club might be expected to succeed better. But the recent experience of the Union League shows that a wealthy and ambitious organization, containing a very large proportion of cultivated men and

an unusually high average of brains, cannot save itself from grievous and elementary mistakes in architecture. It is evident that in the building committees appointed by the general or State Legislature, congregations and clubs, there is seldom or never a majority competent to select the best architect and get from him work that is worth the money expended.

As things are now managed, an architect of genius has to stultify himself nine times to get a chance in the tenth instance to build something that he really approves of—and who can do this long without degenerating? This fact reflects perfectly the state of the fine arts—nay, perhaps even of the government of the community that built it. Pretentious communities want pretentious buildings. If New York were not misgoverned would it have its present court-house? If Washington were not corrupt, would it have its present post-office? If New York society had any dignity or backbone, would millionaires be thrusting themselves forward by the mere weight of big houses, big picture galleries, and lavish decorations? The millionaires would not build palaces in six months, but would employ real architects to build quietly and beautifully, just as they themselves would gradually enter society on their personal merits, not on their money-bags. At Washington some pains would be taken that the great buildings erected by the public funds all over the land were the very best to be procured. The municipal government would slowly and carefully foster architecture by discouraging hasty work and reckless expenditure of the taxpayer's money. Clubs and congregations would make it their first business to judge of the qualifications of architects on artistic, not on personal or interested grounds. The main point is that the demand should be a demand of taste. Architects cannot be independent, cannot "educate the public," cannot wait until they are dead for recognition. They depend almost as directly on the public as the actor, and their audience is neither so numerous nor so ready to be pleased with what is set before it. Until the public shall reform, until the press shall begin to call owners and architects to account for vulgar, stupid, and ridiculous work, there is no hope for American

architecture. At present it represents the mere brute force of money more than anything else. It shows also restlessness, vagueness of purpose, smattering of foreign styles. No wonder many people prefer the barren monotony of blocks of bricks and mortar to the ineffectual efforts of our unhappy architects. And along with as thorough and searching criticism as the press can give, must go, on the sides of the architects and owners, the most elaborate drawings and models of projected buildings. For, alas! the building once in place is there practically for ever. Criticisms are forgotten and people accustom their eyes to the ugly mass. Then associations give it dignity, and the city is saddled with a dull and pointless building to which the citizens cling with a fervor of a St. Peter's or an Alhambra.

QUICK building is a process by no means unknown in this country or even in England especially in the suburbs of London, where towns of houses seem to grow like mushrooms, but we do not know of anything to compare with the details of the erection of the National Mining and Industrial Exhibition at Denver, as given in a Colorado paper. It appears that the contract for this building was signed April 5th last by Mr. E. F. Hallock, the contractor. The lumber had to be sawn from trees then standing in the forest, the brick made from the undisturbed clay of the earth, stone quarried, hauled from the mountains and worked, the ground excavated, railroads built to the grounds, and many other details too numerous to mention attended to. Since the breaking of the ground, about one hundred days, the grand structure has been erected and completed, and is now receiving machinery of all kinds, ores and minerals, and exhibits of every nature from all parts of the Continent. There have been 12,000 cubic yards of earth removed, 300 cords of foundation-stone laid, 4,000,000 bricks put in place, and 3,000,000 ft. of lumber fashioned into the building. Nearly four acres of tin roofing have been required, and an equal ground surface covered by the main floor of the building. The whole structure is of a most substantial character, the walls being made of heavy masonry, while the galleries are supported by solid columns, and the roofs by wrought iron trusses. The dimensions of the building are 500 ft. from north to south, and 310 ft. from east to west. It is in the form of a cross, with convenient and spacious vestibules and entrances at each of the four extremes. There are 2,000 linear feet of gallery, 29 ft. in width, affording an unsurpassed promenade, with a complete and extensive view inside and out. The 800 windows of the building afford abundantly the necessary light to the remotest corner. What building of similar dimensions has been put together in sixteen weeks?

THE death is announced of Prof. Emil Plantamour, director of Geneva Observatory. The deceased was born in that city in 1815, and took his degree at Königsberg. Soon afterwards (in 1840) he was appointed to the post of director of the observatory in his native city. He was elected an Associate of the Royal Astronomical Society in 1844, and since 1865 he has been a corresponding member of the Institut de France. Prof. Plantamour was widely known by his scientific writings, apart from the annual publications in connection with the observatory work.

## Educational.

### HOUSEHOLD SCIENCE.

Science in its many practical ramifications finds employment nowadays in almost every sphere of life. The present century has removed the covering of mystery which immediately surrounded it, and revealed a servant waiting our disposal, and capable of performing an immense quantity and variety of work. Its employment in the arts and processes utilized in the manufacturing world for the production of the necessary requirements and luxuries of our daily life, are so general that one is led to experience some surprise that the same reception has not been accorded to it, in spite of its many and obvious applications as a simplifier of labour, by the domestic circle.

The average modern household is a very complex arrangement, involving a great number and variety of operations, each of a separate nature, to keep it in order and supply the general wants of the habitants. It must be admitted that one-half, if not more, of these operations are of a trivial or tedious nature, undeserving of treatment by manual labour. For these purposes mechanical power is particularly adapted, for amongst the many beneficial results accruing therefrom, the following prominently present themselves: the numerous processes are effected with reliable certainty and expedition; time is left for the consideration of subjects and duties more worthy of attention; and, finally, bodily exertion is reduced to a minimum. We do not, of course, venture to say that manual labour can be entirely superseded by scientific contrivances, such a contingency is as impossible as it is unnecessary. Rather let the latter act in conjunction with the former as a useful assistant and companion.

The first point to which we would draw attention is, briefly, the connection which may be made between different parts of a house with respect to the speedy transmission of articles either too bulky, awkward, or insignificantly small to be capable of worthy conveyance by hand. The advantages arising from the application of mechanical power for accomplishing this object are very evident, more especially in this case of large or lofty houses. The continual "tramping" up and down stairs, too often for purposes no doubt absolutely necessary, but in reality undeserving of such expenditure of useful power, causes, besides natural bodily fatigue, loss of time, and waste of energy that might otherwise be profitably engaged. A small lift, of as light and simple a construction as the requirements of the house suggest, and fixed in accordance with the construction of the building, commends itself as a means of avoiding, to some extent, these inconveniences. A lift to fulfil ordinary domestic duties should involve in erection a great expenditure of neither money or time, and if the advantages to be derived from it in the future be carefully weighed side by side with these two items, the balance of the former will be found, we think to far outweigh that of the latter. And further, if the builder were to take the same details into consideration, and prepare the way when erecting his houses for the convenient reception of the necessary fittings, we venture to consider no more difficulties would be experienced, or extra time or labour bestowed on the matter than would be amply repaid afterwards by speedy disposal of the houses thus furnished. Presuming the duties of the lift to consist in transporting coals, food and similar articles from one floor to another, a balance arrangement worked by pulling a cord would be sufficiently powerful for raising such weight. Should something more extensive be necessary, a small winch might be attached, or hydraulic accumulator connected with the water main. Again, if a lift is impracticable, a common iron pulley with rope and basket, such as is used in the Government and large city offices for conveying letters, books, &c., from basement to upper floors, is better than nothing, and simple as the arrangement may appear, its uses are manifold.

Communication of a different nature by means of speaking tubes and electric bells, claims some attention *en passant*. The former are so easily fixed and the uses to which they may be applied so well known and appreciated in business life, that their introduction into private houses cannot be attended with anything but complete success. Electric bells are now rapidly coming into favour, and there is no doubt will shortly entirely supersede the clumsy and antique arrangement of wires and cranks now in general use. Any ordinary person who can handle a tool may fix, repair, or remove electric bells without difficulty; advantages, it is needless to add, the present system is entirely deficient in. Gas or water pipes are conductors

already prepared for conveying the electric fluid, thus having but one thin wire to be fixed up, a matter of no great difficulty. The Leclanché batteries now universally employed may be kept in a cellar or cupboard, or in fact, any out-of-the-way place, and require no attention for months.

Now as regards motive power for ordinary domestic requirements, a small gas engine is the simplest and most economical apparatus, suitable in every respect for supplying a continuous and steady flow of force. Engines of this description are now made in very portable and handy sizes, and constructed to consume but a small quantity of gas. They may therefore be fixed in a cellar or outhouse and connected by means of slight shafting, or fine endless band with, say, the kitchen, for it is in this department more especially power is required. The shaft or band would terminate in a small pulley or pulleys arranged in a position available from all parts of the room. It is evident that to this pulley other bands might be attached communicating at their other ends with washing, wringing, knife-grinding, sausage-making, mangling, coffee-grinding, apple and potato paring machine, a roasting jack, ice-making apparatus, and the numerous little labour-saving contrivances now being introduced from the United States. Finally, a band might be conveyed under the flooring to an adjoining apartment, for the purpose of driving a sewing machine, lathe, or punkah, or further extended and attached to a pump for irrigating a garden, washing windows, or extinguishing fires. When once the power is obtainable and conveniently situated for application, there will be no dearth of uses, and fresh ones will be continually cropping up.

It is impossible here, of course, to go fully into the question of the utilization of practical science in the house; it is too exhaustive a subject to treat in a short article. We have merely attempted to sketch some suggestions for its general application, and the benefits arising therefrom. It is a matter interesting to both builder and householder, and its economical utilization and further development, tending as they do to the simplification and speedy accomplishment of multitudinous operations attendant upon daily life, are worthy of every consideration.

#### PRESTON GILD FESTIVAL.

At Preston it has long been the custom to hold once every twenty years what is really called the "Guild Merchant," but popularly known as the Guild Festival. The time for this event has come round, and after most elaborate preparations the proceedings have been in progress this week.

A large part of the programme is occupied with matters relating to the textile industries of Preston and the district, but other trades have formed a part, and on Wednesday the procession of trades was held. In this grand procession which, we believe, was so elaborate as to occupy three hours in passing a given point, the following trades other than textile industries were represented:—Tinplate workers, fire brigade, stonemasons, saddlers and harness makers, boiler makers and iron ship builders, black and white smiths, butchers, soap manufacturers, iron founders, plumbers, and painters, carpenters and joiners, cabinet makers and upholsterers, bricklayers, coach makers, mungo manufacturers, lamplighters, engineering trades, brickmakers, paviors, omnibus proprietors, printers and lithographers, tailors, lacemakers, and underclothing manufacturers, plasterers, wire workers, and sewing machine makers.

The procession, as a whole, may be described as an industrial exhibition on wheels. Each of the trades represented was shown in operation on the trolleys which carried the delegates. Fishergates the main thoroughfare of the borough presented a view which was striking and curious to those who were privileged to view it with anything like comfort from any elevated position. The enthusiastic populace in holiday dress and holiday humour, the colours of innumerable flags and banners, the glittering regalia of the various orders and societies, with a confusion of sounds from drums, trumpets, and fifes, contributed to a scene of animation rarely equalled. About 150 tinplate-workers occupied the premier place in the procession. They were preceded by two mounted trumpeters and a workman clad in tin armour, lorries following containing a tape cylinder in course of construction, illustrations of gas-fitting and meter-making, workmen engaged in coffin tins and a wheel guard. Next came a fine exhibition of fire-engines, tenders, and reels, resembling on a large scale that which forms an attractive feature of the May-day procession with which Liverpoolian are familiar. The members of the

brigades, in their neat uniforms and glittering helmets, looked remarkably well. The Preston corps of firemen was augmented by the brigades of private firms. The stonemasons, coming next in order, numbered about 250, and wore wash-leather aprons trimmed with blue silk. They carried flower vases, finished and unfinished, and also showed building stone in process of dressing and the operation of stone-laying. Saddlers and harness-makers formed in the rear of the stonemasons, and were headed by a silk banner borne by youths dressed in spruce jockey costumes. A four-in-hand, with handsome silver-mounted harness, contained the masters, and in an old mail coach were seated journeymen saddlers. A lorry was fitted up in the form of a saddler's and harness-maker's workshop, and on it were four men busy at their craft. Boiler makers and iron ship-builders, to the number of 150, followed with a beautiful banner bearing the motto, "Excelsior; ever onward," and with three waggons, upon which were exhibited the combustion chamber of a marine boiler with men employed, rings of boiler casing and corrugated flues, a marine boiler, and models of steamships. The black and white smiths had men at work on four lorries—general smiths with a lorry containing steam engine and boiler, a steam hammer, a smith's fire, and a complete set of tools; shoeing smiths with a smith's fire, and the requisite implements showing a horse in process of being shod; whitesmiths engaged on some ornamental work; and agricultural smiths manufacturing farming implements. Among the smiths were three men clad in full suits of armour, and a boy in an ancient steel suit. With the iron-founders and range-makers were marble masons and polishers at work, and also range-founders and black and white smiths. The plumbers, painters, and glaziers were accompanied by the band of the Liverpool schoolship *Indefatigable*, and the boys, in their neat sailor costumes, attracted general attention, being frequently applauded along the route. The plumbing department of the procession contained a model of the interior fittings of a well-appointed house, a pump and fountain in operation. Men were at work on various kinds of painting, marbling, and writing, and others illustrated the paperhanging branch. The men, who numbered 350, wore aprons emblazoned with their trade coat of arms. A model of a church with men working, and a model of a joiner's shop with men employed, were carried by the carpenters and joiners. Cabinet makers and upholsterers, bricklayers, brickmakers, plasterers, and wireworkers also gave illustrations of the methods employed in their respective trades. The coachmakers, with a model of the Lord Mayor's coach borne by apprentices at the head of their procession, appeared with a four-in-hand coach, a Parisian phaeton, a landau with a canoe body, and a miniature brougham. Lamplighters, wearing a navy-blue uniform, each carrying a new lamp, were followed by a large representation of the engineering trades, headed by members of the Steam-engine Makers' Society, which was established at Liverpool in 1824. These were accompanied by lorries conveying a 9-pounder breech-loading field piece, sent by Sir Joseph Whitworth, Manchester; a model of Stephenson's first locomotive, a pair of brass horizontal engines, a pattern-maker's bench, wheel-moulding machine, and a pair of machine-made bevel and mortice wheels, with men at work; a smith's shop, boiler, and engine; a steam hammer, smith's fire and anvil, with smith at work; a turning shop, fitted with horizontal engine and boiler; a side lathe and shaping machine; a ring-spinning throstle, on Booth and Sawyer's principle, in process of being fitted up, etc. The Corporation paviors and flaggers exhibited a model street. The model, which weighed about three and a half tons, was carried on the largest lorry belonging to the London and North Western Railway Company, drawn by four of the finest horses from the Corporation stables.

THE Transit of Venus observing parties appointed by the United States are already on the way to their destinations. There will probably be four stations in the southern hemisphere. One is at the Cape of Good Hope, under Professor Newcomb; one at New Zealand, under Edwin Smith, of the Coast Survey; one at Santiago, Chili, under Professor Boss; and one in Santa Cruz, Patagonia, under Lieutenant Very, of the United States Navy. Some of the stations in the United States will be Cedar Keys, Florida; San Antonio, Texas; and Fort Thorn, New Mexico. The directors will be Professors Hall, Harkness, Eastman of the Naval Observatory, and Professor Davidson of the Coast Survey.

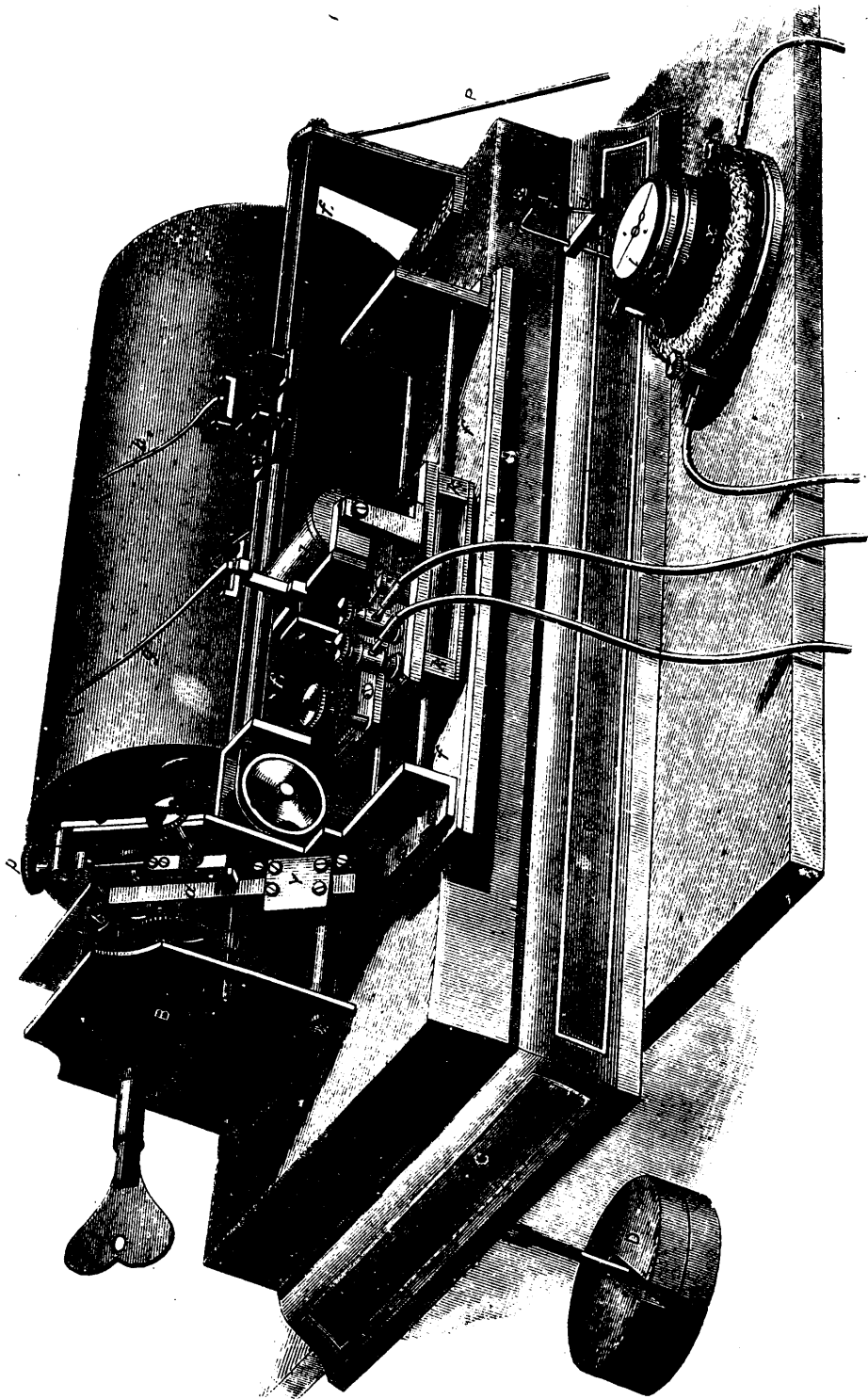

FIG. 1.—CHRONOGRAPH WITH THE HIPPE ESCAPEMENT.

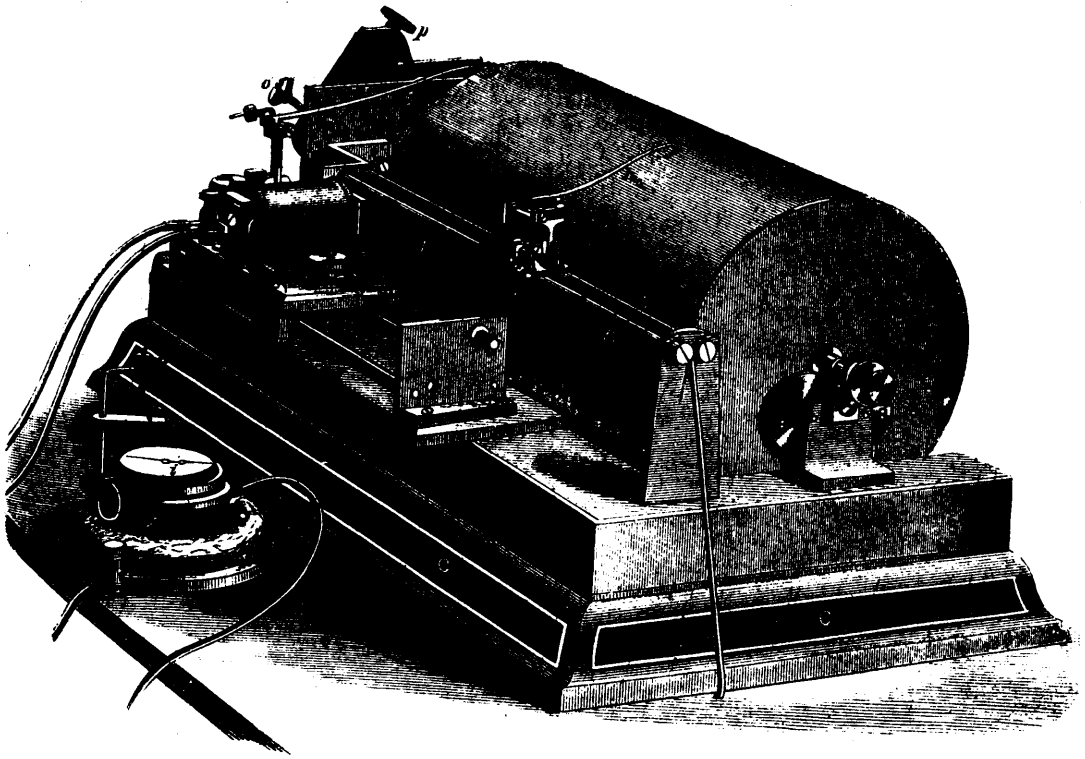
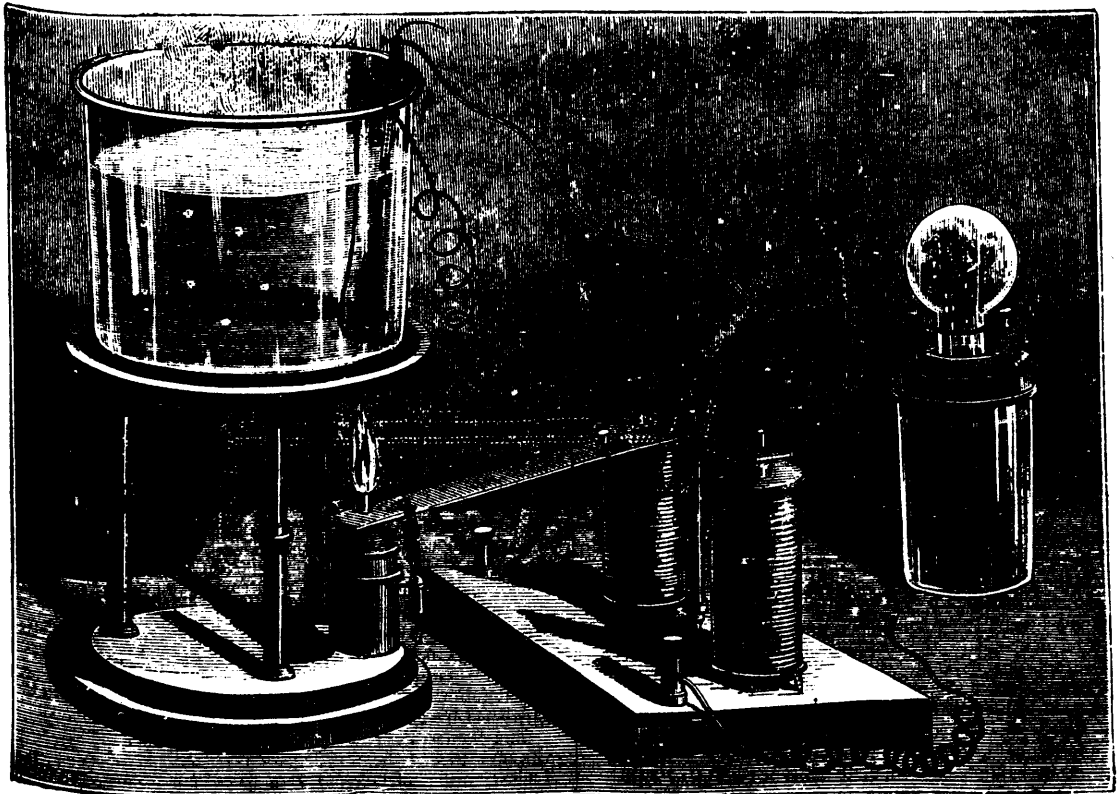

FIG. 2.—CHRONOGRAPH FOR ENGINEERING PURPOSES.



REGNARD'S TEMPERATURE REGILLATOR.

## Scientific.

### REGNARDS TEMPERATURE REGULATOR.

Those persons who are obliged by the nature of their labors to work in the country, at the seaside, or, in a word, far from towns where there are gas works, experience great difficulty in keeping stoves at a constant temperature. All regulations of any precision that are used in laboratories require the use of illuminating gas, which some mechanism or other lights or puts out at the desired moment.

At one of the recent sessions of the Société de Biologie, Mr. D'Arsonval presented a stove which was capable of operating without gas by utilizing the boiling points of volatile liquids. This leads me to describe a stove that I have made use of for some time past, and which operates very regularly, and with extreme sensitiveness.

Into a water bath there dips an electric thermometer, B, that is to say, a thermometer open at the top, into whose tube runs a very fine platinum wire, A, that may be raised or lowered, or fixed definitely before any degree whatever of the scale. The mercury in the thermometer bulb communicates, through a wire soldered into the glass, with a Leclanché or Daniell pile. Since the upper platinum wire is in connection with the other pole, as soon as the mercury, by dilatation, touches the latter the current will be closed. Interposed in this current there is an electro-magnet, D, whose armature, E, provided with a long lever, carries a benzine lamp, G. When no current is passing the lamp is placed under the stove; but, as soon as the current begins, the armature of the electro-magnet is attracted and the lamp is removed to a distance. The thermometer, becoming cool almost instantly, causes the mercurial column to leave the platinum wire. As soon as the current is broken the electro-magnet becomes inactive, and a spring, H, draws the lamp back beneath the stove, and so on. The accompanying cut sufficiently explains the mechanism.

It will be seen that the temperature of the stove cannot vary, since, as soon as it rises, the source of heat is removed; and as soon as it lowers the source of heat is replaced. This stove, like another that we have already made known, has the further advantage of being instantly regulated at any desired temperature; to effect which it is only necessary to fix the platinum wire opposite the degree that it is desired to have. After that it will be always at such degree that the current will be closed and the lamp removed from beneath the stove.—*Dr. P. Regnard, in La Nature.*

### CHRONOGRAPH FOR ENGINEERING PURPOSES, WITH THE HIPPE ESCAPEMENT.

The two engravings given herewith show the general construction and details of an improved chronograph for engineering and other purposes.

The instrument has been successfully applied to some of the different types of large pumping engines, such as direct-acting fly-wheel engines, geared pumping engines, and the "Davey engines;" it has also been used to determine the motion and relative motion of pump rods and pumps some 2,500 feet below the surface engine driving same, and at intermediate points. The results are exceedingly interesting and instructive, and as numerous indicator cards were taken from the engines and pumps simultaneously with the motion diagrams, nearly all conditions of motion and power, during the time under consideration, were definitely determined, and may hereafter form the subject of other papers.

Some very important results of the elasticity of long pump rods are clearly set forth; in one case, a rod at a point 1,800 feet below the surface showed a positive pause, while the engine driving it was nearly at its point of maximum motion, and pumps attached to the rods may, and do have, strokes in excess of or deficient to the stroke of engines driving same, and to an important extent. Hence it can be definitely stated that any consideration of motion, of pumps, or discharge capacity of same, driven by a long line of pump rods based upon the motion or stroke of a surface engine alone, will in no way be even approximate, unless the elasticity and effects of counterbalancing by balance bobs on that elasticity are also considered.

The effects of different degrees of compression upon the engines and motion of the pump rods in passing the centers have been considered, and the diagrams clearly show the importance

of considering it in connection with the strength of the rods and balance bobs.

The latest use of the instrument in conjunction with an engine test has been to determine, if possible, the rate of condensation of steam, per second, in the steam cylinders of a pumping engine, where the change of motion, due to each fractional part of the stroke, was determined. Also, a ten-hour experiment trial to show the economy of compression, as compared with a ten-hour trial of the same engine on the succeeding day where no compression was used (otherwise all conditions being similar), has been made, when changes of velocity of piston were determined by the chronograph.

This chronograph has been put to a variety of uses, among which are recording seconds as well as the velocity curve of engines, and timing horse races, etc. It has also been used in the Navy Ordnance Department for determining the speed of projectiles.

In the following paragraphs we give the references by letters to the engravings of the instrument:

C C, cast-iron baseplate covered with sheet brass, upon which the mechanism is secured.

B, metal frame containing gearing for driving drum, A, and escapement wheel, *b*; motion communicated by means of adjustable weights, D.

A A, light brass drum accurately balanced, revolving on friction rollers, 8 8, at both ends.

*ff*, parallel guide bars, upon which the tracing point, *h*, and its carriage travel back and forth, receiving motion, in one direction, from the engine or other moving parts, through the cord, P, passing between the bars, *f*, and attached to the tracing carriage; the return motion is derived from a coiled spring in the spring drum, C.

*e e*, small electro-magnets on tracing carriage, for raising the tracing point, *h*, off the paper and replacing it at any desired point to be especially observed.

*d*, electro-magnet on separate carriage, *k k*, adjustable on parallel bars, *f*, operating the steel tracing point, *g*, attached to the armature of *d*, for the purpose of recording seconds on the margin of the paper or at other parts of same as required.

*i*, chronoscope or watch supported on frame, X, the second hand of which swings the light platinum wire, J, breaking contact with the insulated wire, *k*, thereby breaking circuit with *d*, and recording seconds through the tracing point, *g*, on the paper.

*g* represents the adjusting screw for the wire, J.

*a*, steel spring of escapement. This spring is securely clamped in Y, its flexibility being controlled to a certain extent by means of the thumbscrews, *o* and *p*.—*W. R. Eckart.*

### THE NEW PRINCETON TELESCOPE.

The accompanying engraving shows the great telescope of the College of New Jersey, as it stands in Halsted Observatory at Princeton. It ranks fourth in the list of great refractors in use and is by far the largest belonging to any collegiate institution.

Halsted Observatory was built some fourteen years ago, at a cost of about \$56,000. In making the alterations necessary for the reception of the new telescope some \$5,000 more have been expended. The telescope and its accessories cost \$26,000. This sum was contributed by the friends of the college; the largest donors being Robert Bonner Esq. and R. L. Stuart, Esq., of this city, who gave respectively \$10,000 and \$6,000.

The telescope was made by Alvan Clark & Sons, of Cambridgeport, Mass., and all the appointments of the observatory are of the most modern character. The iron dome, under which the telescope is mounted, is 39 feet in diameter. The apparatus for turning the dome and opening the shutter is driven by a four horse power gas engine, which also actuates a small (Edison) dynamo machine for operating the electric lamps used in illuminating the building and furnishing electric currents for various spectroscopic purposes.

The following data respecting the telescope have been kindly furnished by Professor C. A. Young:

The diameter of the object glass is 23 inches. The radius of the curvature of the crown glass lens, outside surface, is 265.8 inches; inner surface, 81.9 inches. These surfaces are both convex. The flint glass lens (concave on both sides) has for the surface next the crown lens a radius of 73.4 inches. That of the surface next the eye is 292.2 inches. The distance between the lenses is 7.5 inches. The focal length is 30 feet

1 inch. The steel tube of the telescope has a length of 28 feet and a diameter of 83 inches in the middle. The length of the polar axis is 10 feet; diameter at bearings, 8 inches and 6 inches. The diameter of the coarse hour circle is 30 inches; of the fine hour circle, 28 inches. The length of the declination axle is 9 feet; its diameter at bearings,  $\frac{7}{8}$  and  $\frac{5}{8}$  inches. The diameter of the declination circle is 30 inches.

The driving weight of the clockwork weighs 320 pounds, and has a fall of 12 feet. The radius of the sector by which the clockwork drives the telescope is 40 inches. The centrifugal regulator or governor weighs 22 pounds, and revolves once in seven-tenths of a second. The weight is taken off the lower pivot by floating the regulator in mercury. The weight of the telescope and mounting is about seven tons. The height of the center of motion above the floor is 20 feet 9 inches. The declination circle is read from the eye end of the telescope by microscopes 9 feet long.

The telescope is provided with position and double-image micrometers of the best construction. The star spectroscope, by Hilger, of London, was constructed under the supervision of Mr. Christie, the Astronomer Royal, upon the same plan as that of the instrument for some time in use at Greenwich, but upon an enlarged scale. It is a direct-vision instrument, with three (so-called) half prisms. It is more than 6 feet long, and weighs, with its appendages, about 150 pounds. For the present it is expected this telescope will be devoted mainly, though not exclusively, to stellar spectroscopy.

For the purpose of comparison the following facts with regard to other large refracting telescopes will be found of interest. But two instruments excelling the Princeton telescope are now in use, namely, the 25-inch telescope made by Cooke, of England, and owned by Mr. Newhall, of Newcastle-on-Tyne; and the 26-inch equatorial, made by the Clarks, at the Naval Observatory, Washington. The third larger instrument, made by Grubb, of Dublin, and having an aperture of 27 inches, is now in process of mounting at Vienna.

The instrument nearest in size below the Princeton telescope, now in use, is the Strassburg refractor, with an aperture of 19 inches.

There are in process of construction five larger instruments, namely:

The Poulkova telescope 30 inches, and the McCormick telescope, 26½ inches; both by the Clarks. The Henry Brothers, in Paris, are making a 29 inch telescope for the Nice Observatory, and another, of the same size, for the National Observatory at Paris. One of the disks of glass (the crown) for the Lick telescope, to be 36 inches in diameter, has been received by the Clarks who are waiting for the flint disk before beginning the grinding. This gigantic instrument, when finished, is to be erected on Mount Hamilton, California.

#### CLAMOND'S INCANDESCENT GAS LAMP.

Every one is acquainted with the Drummond light, which is obtained through the combustion of a mixture of hydrogen and oxygen that raises a lime or magnesia crayon to a white heat.

Now, Mr. Clamond's new lamp is nothing else than the Drummond light rendered practical. The invention involves two characteristic improvements: (1) a substitution of atmospheric air, which is within reach of every one, for oxygen, which has to be manufactured; and (2) substitution of a wick of woven magnesia for the magnesia or zircon crayon.

For obtaining high temperatures, air may be substituted for oxygen on condition that it be itself raised to a high temperature; and it is by doing this that Mr. Clamond has been enabled to obtain an effect similar to that produced by oxygen in the Drummond light. But it is not so easy as might be supposed to raise to a high temperature, and within a very short circuit, a quantity of air six times greater than that of the illuminating gas. The velocity of such air, which is not much of a conductor of heat, must, in fact, be very great. Mr. Clamond has solved the problem by means of a very simple apparatus, which will be described further along, and which has the effect of putting all portions of the current of air in contact with the sides of a small tube of refractory earth heated externally.

The new burner has a double system of tubing, one for ordinary gas, and the other for air under a pressure of 35 to 40 millimeters of water. We learn that thus far only two types have been constructed—one burning 180 liters of gas, and giving 4.15 Carcels (equal to 43.3 liters per Carcel), and the

other consuming 500 liters of gas, and giving 18 Carcels (equal to 27.7 liters per Carcel).

Leaving aside for the present the production of air under pressure, let us study the operation of the burner, of which, in the accompanying figures, there is given a general view, a view of a burner divested of its jacket, a longitudinal section, and horizontal sections at different heights. A (Fig. 8) is a disk carrying two coupling tubes designed to receive the ends of the pipes that introduce the air and gas. B is a disk perforated with small holes, and forming a distributor, which serves for distributing the air and gas in suitable proportions through the burner properly so-called. For this reason it carries no less than five series of holes of variable number.

A certain quantity of gas mixes with a suitable proportion of air, and enters four pendent tubes, K, which are perforated with holes. The mixture burns, and the flame licks the superheater, G, which is thus raised to a very high temperature. Another portion of the gas mixes with a second quantity of air, and enters, through the tube, L, the lower part of the burner, where it inflames. Finally, a third quantity of air enters through the centre of the burner at F, traverses the superheater, G, and, by impinging against the sides, rises to a temperature of about 1,000°, and makes its exit through a series of apertures in the refractory piece, H. The combustion of the gas under the action of air at so high a temperature produces a jet of exceedingly hot gas, which, coming in contact with a basket of magnesian thread, N, at the bottom of the lamp, raises it to incandescence. This basket was a happy idea of Mr. Clamond's. It is conical in shape and made of a sort of laccwork of drawn magnesia. This latter, in powder, is made into a plastic paste with a solution of acetate of magnesia, and drawn out something like vermicelli. The thread, while still soft, is wound upon a conical mould that has a double backward and forward rotary motion. The cone, once formed, is taken from the mould and baked so as to give it the requisite solidity. In the lamp it is held by a small platinum wire basket that may be seen in Fig. 2. The magnesian basket thus prepared is capable of furnishing light for about forty hours, after which it must be replaced by another inasmuch as the diameter of the threads of which it is composed diminishes through the escape of the material in the form of an impalpable powder. The platinum wire support in which this magnesian wick is placed is mounted with a bayonet catch, so that the wick may be removed and replaced with the greatest facility. The present price of these wicks does not exceed twelve centimes, but it will be much lower in the future.

The light produced possesses all the equalities of incandescence, that is to say, perfect steadiness, and a very warm yellowish color, between the whiteness of daylight and the yellow light burning in ordinary gas burners. As the wick burns at the base of the lamp no shadows of the latter are cast. It will be observed that the quality of the gas plays no part in the light produced, since the latter results from the incandescence of the magnesia, and depends only upon the temperature.

We have reserved until now the weak point in Mr. Clamond's system—we refer to the production of air under pressure.

In a factory, shop, or anywhere that a motive power is at one's disposal, the production of such air presents no difficulty; and the economy effected in the gas burned and in the quality of light produced would offset the extra expense attending the purchase of the burners, the double piping, and the putting in of the small blower necessary for the production of air at the low pressure of 40 millimeters of water. The work required for such compression is, in fact, insignificant, for it does not represent 100 kilogrammeters per hour and per focus of 4 Carcel burners. A one horse steam power would serve for more than 2,000 foci. For installations of small extent, then, a small gas motor would be sufficient. In Mr. Clamond's shop, the numerous burners that light it are very readily run by a small Bisschop motor. For installations of less importance, and in which there is no motive power at disposal, Mr. Clamond has under study a system of blowers and weights which shall operate several hours without any attention having to be paid to them. It will be only necessary to wind up the weight every evening before lighting, by means of a winch. Seeing the small force necessary, such a project is very feasible; for several carbureted gas apparatuses employed in country mansions or in places distant from any gas works are already operating by such a process. The use of a small motive power is a drawback that it is not necessary to attach too great impor-



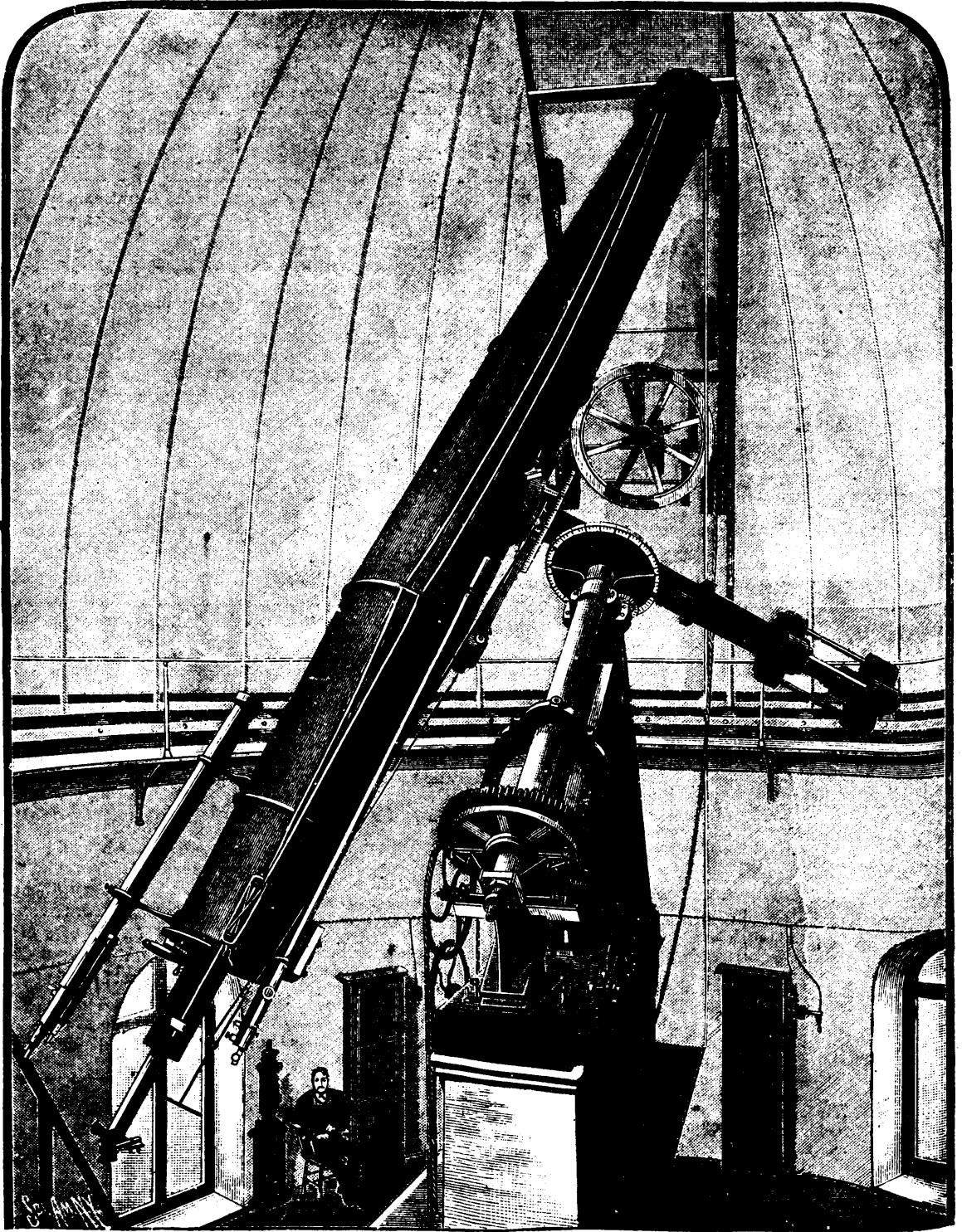

THE PRINCETON TELESCOPE.

tance to; it cannot be compared with that that the manufacture of oxygen would evolve.

Finally, we may add that, if some day the distribution of electricity to houses become *un fait accompli*, it will be easy to obtain from the electric current the slight power necessary

to actuate the blowing apparatus; and, in such a case, we shall see electricity come to the aid of gas and favor its economic use. Electricity and gas will then once again lend each other mutual support; and this is the best termination that could be desired to the contest now going on between them.

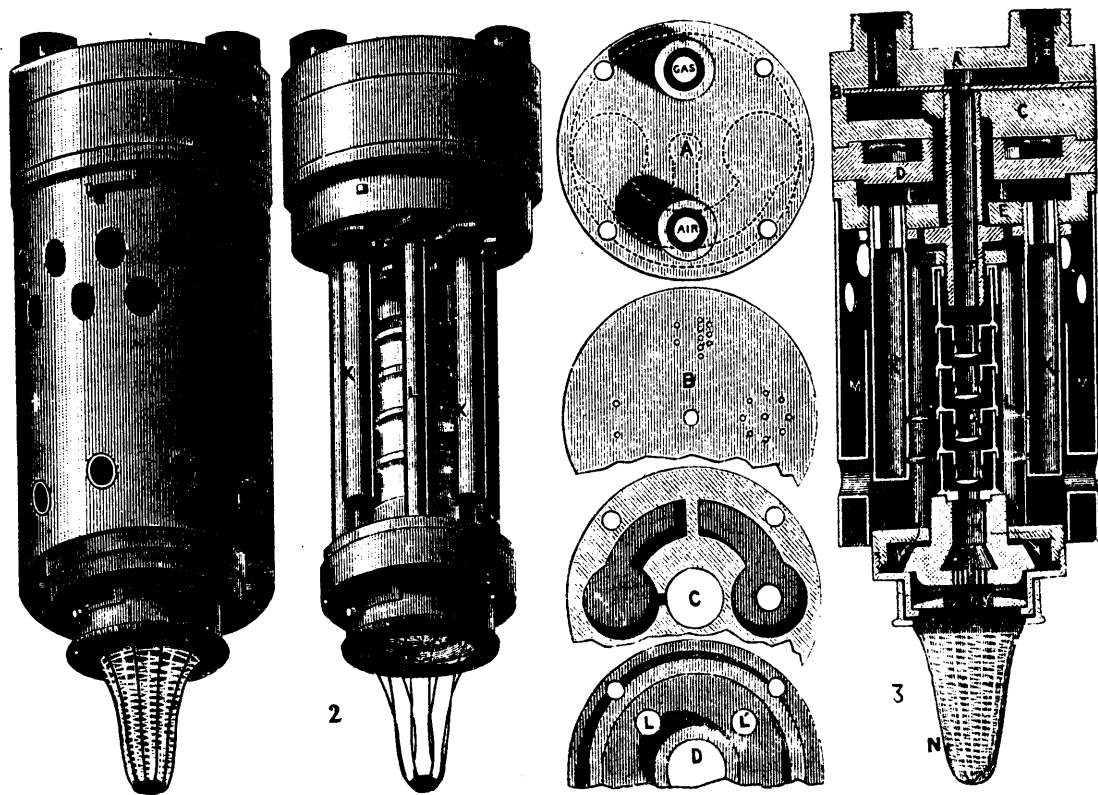

CLAMOND'S INCANDESCENT GAS LAMP.

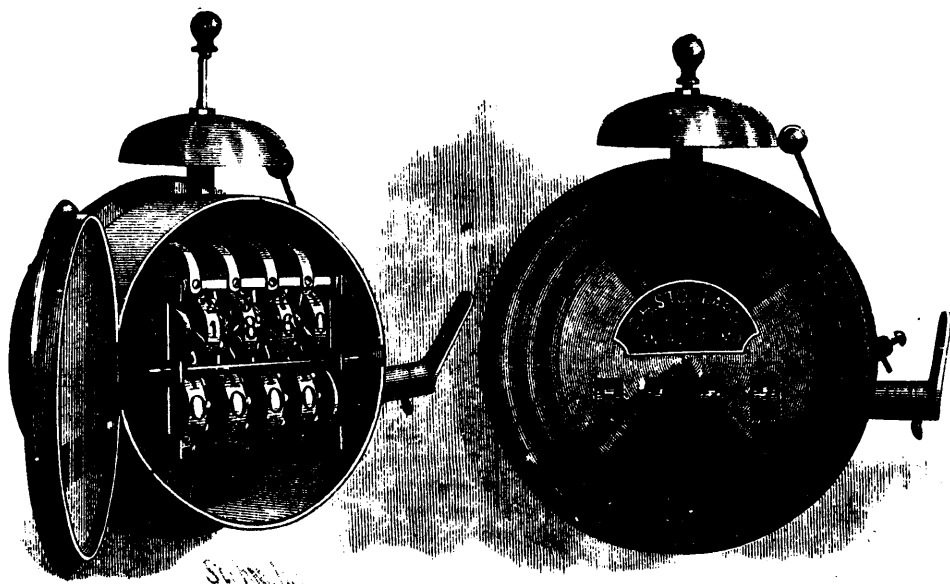

STODDARD'S ALARM REGISTER.

## DESCRIPTION OF FIGURES.

1. General view of the burner. 2. View of burner divested of its jacket. 3. Longitudinal section of burner. A, B, C, D, horizontal section of the burner at the points marked by corresponding letters in No. 3. 3. A, disk with air and gas inlets. B, distributor. C, D, E, distributing flues. F, entrance for air to the superheater. G, superheater. H, blowpipe of refractory clay. K, tubes serving as auxiliary burners for heating the air. L, pipe for leading the gas to the blow-pipe. I, refractory piece for giving a horizontal direction to the gas entering the blow-pipe. M, external jacket perforated with holes. N, platinum basket containing the magnesian wick.—*La Nature.*

## NEW ALARM REGISTER.

We give herewith an engraving of a novel self-setting alarm register, invented by Mr. C. H. Stoddard, of Kansas City, Mo. This instrument is capable of counting up to 1,000,000, and will give an alarm by ringing the bell at any prescribed number from 1 to 1,000,000. The instrument represented in the engraving has a capacity of 10,000 only.

Two sets of register wheels are geared together, an upper and a lower set. The lower wheels are displayed in the face of the register, while the upper set, which is concealed and only seen when the alarm is open, is for setting the alarm. This set is connected to a knob on top of the bell by a rod, by raising which the wheels are raised out of gear with the lower set, and are free to be turned in either direction to the number at which the alarm must be given. In the engraving the top set of wheels have been raised and turned to show 1860. By lowering the knob on top of bell the register is ready for work, and will not give the alarm until 1860 have been counted and registered on the lower set of wheels. When the number has been run the alarm will be given, and will then continue to sound until the press or other machine to which the register is attached is stopped, giving one tap of the bell to each number run over the prescribed number.

In places where a good many runs are made daily, the man in charge may forget to set the register before starting his machine. In this case the register will immediately warn him of the fact by giving the alarm. If the register is not properly set it will also sound the alarm.

But this is not all that this register will do. The automatic setting attachment is a most valuable feature. The figures seen on the lower set of wheels may all be instantaneously returned from any number, by simply raising the knob on top of bell. This at the same time raises the upper set of wheels out of gear.

This register may be used at any time without the alarm, and without adjustment, it being put in condition to operate in this way by simply raising the bell hammer until it is held by a catch made for that purpose. It can then be used as any other counter or register, with the advantage of the self-setting arrangement, and will never have to be opened.

This register can be attached directly to any kind of a machine, or to the wall or post. The crank or lever at the side is held to its shaft by a thumbscrew, and can be worked from above, below, or from the back by a cord or rod.

We are informed that this instrument is now used by some of the largest publishing houses in this country, and has proved itself entirely reliable.

Further information may be obtained by addressing Mr. C. H. Stoddard, Box 1139, Kansas City, Mo.

## LIGHTNING RODS.

During a recent thunder storm at Carrollton, Ill., the lightning struck the house of Mr. D. H. Gillespie, a resident of that city. The course of the electricity was as follows: Striking the lightning rod, on the top of the main part of the house, this conductor was followed until a point was reached about the middle of the peak; here, it is stated, was a bad connection which opposed the further passage of the electricity. If, therefore, here branched off down a tin gutter until arriving at the edge of the roof all conducting material ceased. The electricity then made its way across the wall, tearing off the weather boards *en route*, until another conductor was reached, this time a good one—a telephone wire connected with good earth; after reaching this wire the current passed harmlessly away into the earth.

We may here note that the house referred to was protected first, by a lightning-rod, and second, by a telephone line. It

appears also that the lightning rod, as usual, was not a well constructed one; while the telephone line (we are afraid *not* as usual), was well constructed, and, wonderful to relate, had a good and serviceable ground termination.

So long as irresponsible parties are suffered to carry on the lightning rod business, so long must trouble and disaster be expected to ensue.

In the present case, the damage is ascribed to the defective connection at the middle of the roof. Partly, no doubt, such was the case; other elements, we think, had their share in the matter.

In the absence of a detailed description, we may assume that the lightning conductor had an imperfect ground connection, was fastened to the house with insulators, and probably did not extend to a sufficient height above the roof to be an efficient protection.

Also from the fact that the electricity left the conductor at a point on the ridge, it would appear that the said conductor extended for some distance horizontally; a position which for lightning rods is to be deprecated.

A lightning conductor fulfills two functions it facilitates the discharge of the electricity to the earth, so as to carry it off harmlessly; and it tends to prevent disruptive discharge by silently neutralizing the conditions which determine such discharge in the neighborhood of the conductor.

To effect these objects, the rod should extend to a sufficient height, to be the most salient feature of the building, no matter from which direction the storm may come. The size of the rod, if copper, should not be less than three-eighths of an inch, or of iron, not less on any consideration than nine-tenths of an inch. (We are aware that such a size will be considered preposterous by lightning rod manufacturers, but such a size is the minimum of absolute safety.) The connection with the earth should be electrically perfect, should be branched in all possible directions, and if possible should be both soldered to gas or water mains, and to a plate sunk in moist earth. All joints should be soldered; and in no case should any portion of the rod run horizontally for more than four feet, unless ground connections are provided; where corners are to be turned they ought always to be turned with a gentle curve, and finally, lightning rods should never be insulated from the building. Is it conceivable that a stream of electricity can jump from a cloud to earth, and can then be kept on an iron rod by half an inch of glass? We may rest satisfied that if a rod is otherwise properly constructed, atmospheric electricity will never leave a good metallic conductor for a poor wooden one.

Having noted these points, telephone men can appropriate to themselves a few lessons from them: First, that it is not safe to rely upon a lightning conductor for a ground. Second, always to be particular in constructing such a good ground wire, that a telephone ground wire shall be a synonym for a good one, as a lightning rod ground is a bad one. Third, to have our ground wire large enough for the escape of heavy currents; this refers especially to the lightning arrester ground. Fourth, to run our ground wire to as many different points of communication with the earth as possible. Fifth, let your lightning arresters always be in good order, and your ground wires attached thereto, as straight as convenient. Finally, let us be particular in soldering joints, but if we never solder any other, let us never fall to solder the earth connection.

A telephone line is always a protection, but much more so, when properly installed, than when carelessly constructed.—*Review of Teleg. and Teleph.*

## THE CAUSE OF GRAVITATION.

Sir Isaac Newton discovered the law of gravitation, but not the cause.

He proposed a theory of the cause, but after about eight years of hesitation he abandoned it.

His theory was that there is a universal ethereal fluid, which is less dense in the interior of planets than at their surfaces, and less dense there than at a distance. Assuming this to be true, the tendency would be for bodies to move from the more to the less dense places.

Since Newton's time, no one has been able to suggest a plausible hypothesis by which to account for this most common, and at the same time most universal of all known phenomena.

But Newton gave up the idea that ether (etherism) is the medium through which the force of gravitation is communicated from one body to another without any material means or

medium. The difficulty was in explaining, or even conjecturing, in what manner the ether contributed to the results.

Science has made important advances since Newton's time. One of the most important of modern discoveries is that of the conservation of force. It is now well known that not an iota of matter nor of force can be brought into existence or excluded from existence. Force can only pass from one body and one place to another, and what one body gains, others must lose.

When a body is condensed it always loses a certain quantity of force. Light is force radiating from a body that is undergoing condensation. The same is true of heat. Gravitation is a concentrating force. It moves toward all bodies, and the quantity of the force is exactly in proportion to the quantity of matter in the body to which it moves. It is difficult to resist the conclusion that gravitation results from a process that occurs within the attracting body. This inference is unavoidable, since the force is in exact proportion to the number of atoms that the body contains. It cannot be a condensation of the body itself, for that would only produce radiant force.

A remarkable fact is, that the force of gravitation is unchanging and inexhaustible. It must, therefore, have an inexhaustible source. The very smallest bodies possess this attractive and unvarying power, and it is incredible that they can furnish the means of an exhaustless supply. Another fact is that the force of gravitation diminishes with distance from the attracting body. This proves that the force is in some way generated in the body, and not a distance from it.

The fact that the force of gravitation is exerted at vast distances proves that there must be an ethereal medium through which the force is communicated.

What we want is a theory that accounts for all these facts. Let us propose the following :

1. The ethereal atoms are continually coming in contact with the constituents of planetary matter, and becoming condensed.
2. When they condense they radiate a large portion of their expansive force in the form of light and heat.
3. This process of condensation and radiation necessarily produces a vacuum which the surrounding ocean of ethereal matter moves to fill. This movement thus produced is the cause of gravitation.

When any fluid fills a space, if from any cause, a vacuum is created in that space, there will be a movement from all directions to fill it. The phenomena of gravitation are just such as would result from a process in bodies, it must be the separate molecules, since the force is always in proportion to the mass, that is, to the number of constituent molecules. It is evident that the etherium must act in conjunction with the molecules, or atoms, in order to produce the vacuum. If we can satisfy ourselves that the ethereal matter becomes condensed when it comes in contact with the molecules of bodies, we have a sufficient explanation of the cause of gravitation, and also of planetary radiation.

The most serious objection to this theory is that, if true, it follows that all planetary matter is continually assimilating etherium, and consequently increasing in mass.

I strongly suspect that this process of assimilation is actually taking place in all bodies, though so slowly as to be imperceptible. It does not follow, however, that all the etherium which is condensed is assimilated. The greater part of it may be continually passing away from bodies in an invisible form, and mingling with the ethereal matter that surrounds the planets. If it is suggested that according to this theory all bodies must be radiating force (light, heat or electricity). The answer is that every interesting experiment seems to prove that this is actually the case.

It would also follow, if this theory were true, that all bodies should radiate a quantity of force (heat) in proportion to their mass. This is by no means improbable. Philosophers are far from being satisfied with any theory that has been proposed to account for the long-continued radiations of the sun. The idea that the sun is a mass of burning fuel has been abandoned. The theory now is that the sun's radiations are caused by the pressure or weight of its external upon its internal parts. It follows that the sun has been continually radiating less and less heat from the earliest geologic ages to the present time. But geology does not sanction this hypothesis. There is no evidence that the sun or the earth were ever any hotter than they are now. When the Nebular hypothesis was first proposed, it was assumed that the nebula was a vast mass of "fire-mist," or matter in a super-heated condition. By gradual cooling, the mass on its outer parts contracted. This earth was a similar fiery body—a small sun.

Eminent geologists indulge themselves before popular audiences, and in their books, with pyrotechnical descriptions of our globe, when it was in this radiant condition, gradually cooling down so as to allow the ocean to fall upon it, and animals to live upon its warm crest.

There are good reasons for supposing that the nebular hypothesis is in the main a correct theory, it by no means follows that the terrestrial nebula was a burning body, and that it contracted in consequence of its external parts becoming cool. It is much more probable that it contracts in consequence of the chemical changes which its various constituents underwent when substances of peculiar affinities come in collision.

The same processes that are going on now have gone on from the beginning. For example, a piece of stove coal is not hot, neither is the atmospheric air, but let them come together under certain conditions, and at once a chemical change occurs which causes the oxygen of the air to become condensed and its expansive force converted into radiant light and heat. The idea conveyed, even in scientific books, that heat-force from the sun is stored in coal is untrue. The force exists (in a latent state) in the oxygen, and keeps it expanded. When the oxygen comes in contact with the hot coal it instantly condenses and sets free its expansive force, which is converted into radiant heat and light. It is not unreasonable to suppose that an analogous process causes the condensation of ethereal matter, and the conversion of its expansive force into radiant force.

It is observed that this is merely an improved hypothesis. But it should be considered that on this subject no one has yet succeeded in inventing a plausible hypothesis.

We are merely exploring and prospecting in a region beyond the boundaries of science; like Stanley sailing on the river Congo toward the ocean, which no one before him had ever succeeded in reaching from the interior of Africa by that route.

J. S. G.

## Engineering, Civil & Mechanical.

### PORTABLE DRILLING MACHINES.

The engraving on this page represents a patent portable drilling machine, for which Parke & Lacy, in this city, are sole agents for the Pacific coast. The tool is especially useful in any machine shop. It can be placed as easily as a ratchet brace, and will drill at any angle, in any position, at any distance, and in any direction from the power. It is specially adapted to drilling all pieces which are inconvenient to move or which cannot be readily adjusted under stationary drilling machines.

The operation of the machine is as follows: The counter hanger is bolted to the ceiling or other convenient place, and receives from the "line shaft" by a flat belt on the fast and loose pulleys. The frame carrying the "idlers" rotates on a hollow stud, through which the round belt passes to the grooved driving pulley. The rotation of this frame permits the belt to be led to the drilling machine in any direction, radially, from the hanger, while the rise and fall of the weighted "idler" permits it to be led to any point within the scope of this rise and fall—say 10 to 15 ft. or more. By inserting sections of belt, by means of the hook couplings, any distance can be reached.

The base of the drilling machine is intended to be bolted or clamped to the piece to be drilled. The height of the post can be adjusted to suit the different lengths of drills and chucks used in the spindle. The radial slotted arm is fastened to the post by the stud and nut; the position of the drill being adjusted by the screw which travels the arm, and the worm and tangent wheel which rotates it on the post. When it is required to drill parallel with the base, the post is held by the clamp bearing on the side of the base. There is a shoulder turned on the bottom of the ball on the gear frame, and a half collar fitted to it and bolted on the arm; this keeps the spindle square with the base. When this half collar is removed, the spindle can be set to an angle in any direction.

When the drilling machine is not being used on the floor, it serves the purposes of a bench drill press.—*Mining and Sci. Press.*

OVER the Brüning Pass, which is familiar to Swiss tourists, and is situated 430m. above the Lake of Brienz, and 600m. above Lake Lucerne, a toothed-wheel railway (1m. gauge) is to be shortly made, at a cost of seven million francs.

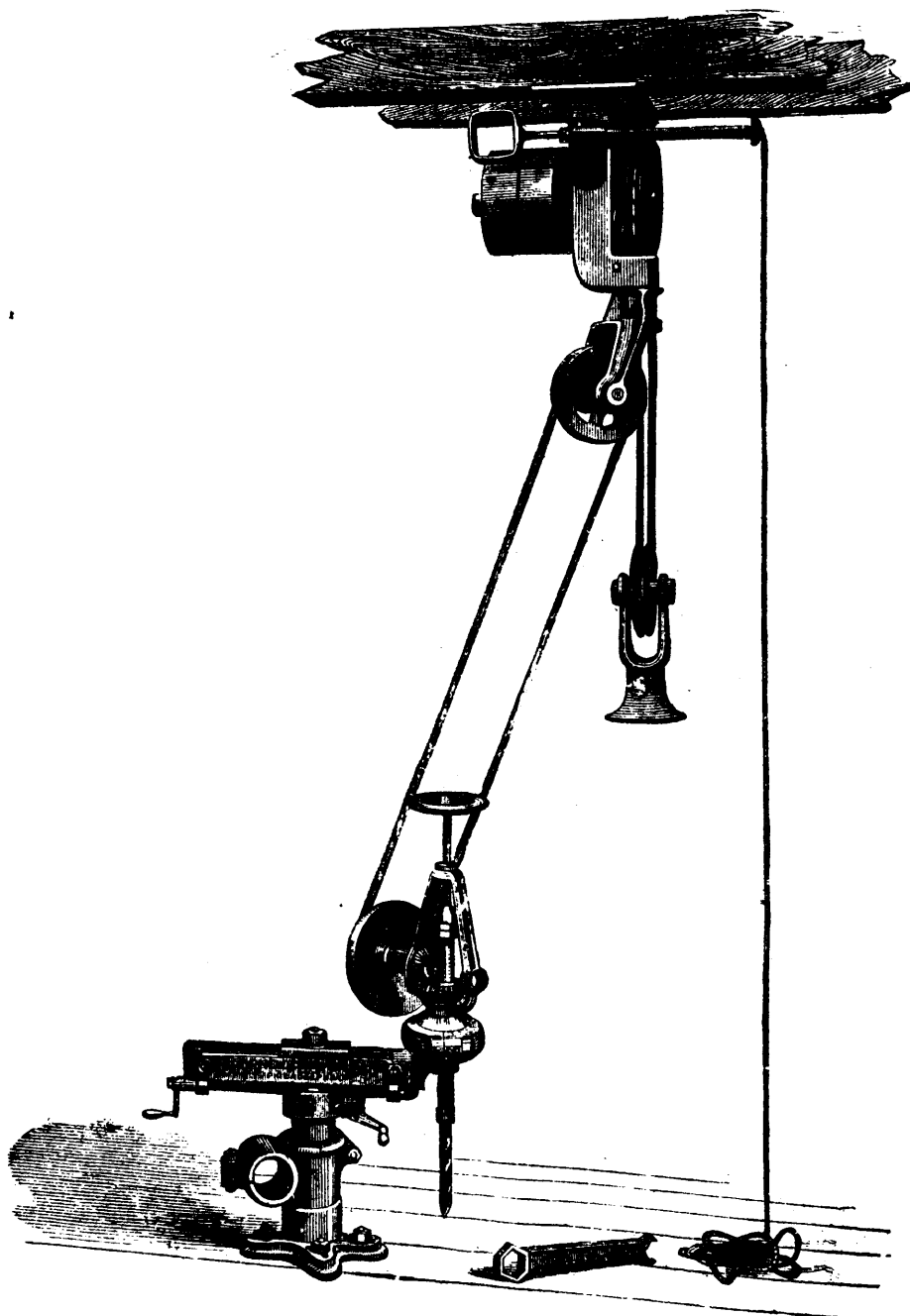

IMPROVED PORTABLE DRILLING MACHINE.

#### THE ITALIAN IRONCLAD DANDOLO.

The new twin-screw, double-turret vessel Dandolo, belonging to the Royal Italian Navy, completed, not long ago, the trials of the machinery previous to joining the squadron in the Mediterranean. Excepting the omission of the internal torpedo deck, she resembles the sister ship Duilio, in her general arrangement, but she has considerably surpassed her in speed. The Dandolo was built at the Royal Naval Arsenal at Spezia, under the supervision of Director Borghi, at whose suggestion the whole of the bow plating is worked flush, instead of the plates overlapping as usual. The length of the vessel is 337 ft. 8 in.; the breadth, 62 ft. 3½ in.; the mean draught at the trials with armament on board was 28 ft. 9 in.; giving a total displacement of 11,225 tons. The battery is heavily armored, and

is placed in the middle of the vessel; the two turrets rise above the weather deck, and are placed diagonally in the battery, so as to enable all four guns to be fired fore and aft. The armor of the turrets is impenetrable to all except the heaviest modern artillery. Each turret contains two 100-ton Armstrong guns made at Elswick, having a bore 17.72 inches, throwing a shot 2,018 lb. with a *maximum* of 511 lb. of powder, the ordinary charge being 355 lb. The turrets and guns are moved and worked by a complete system of hydraulic gear made at Elswick. The loading is also done by the same means, the rammer being below the weather deck and arranged to enter the gun when the muzzles are depressed for the purpose. Between the turrets is situated the mast, which really assumes the function of a lookout tower, as there are no sails.

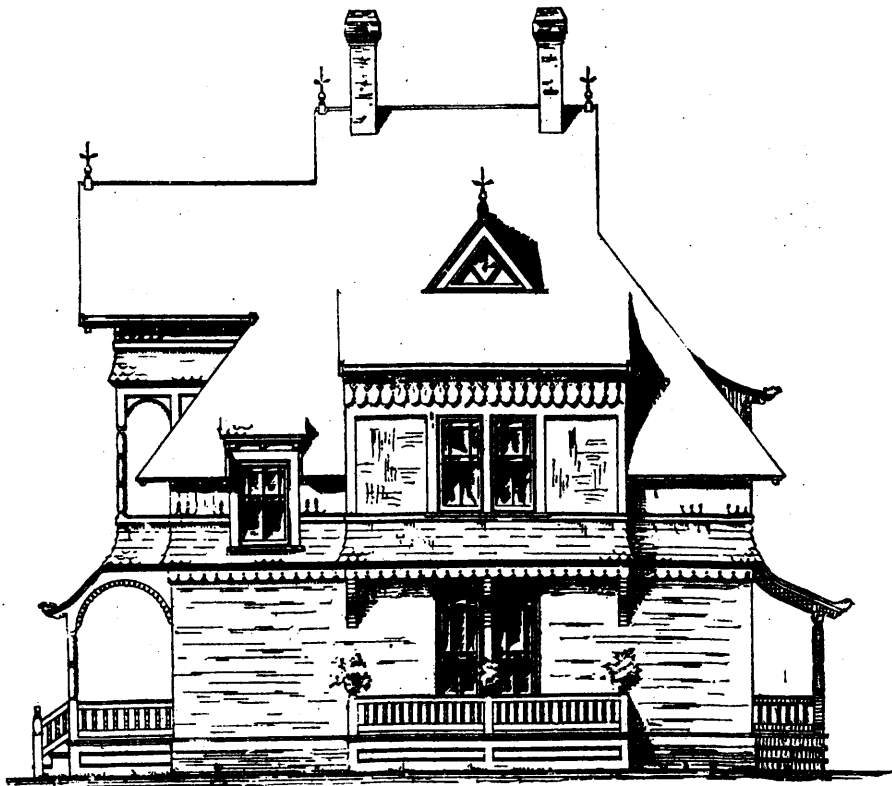

DESIGN FOR A COTTAGE, COSTING \$2,500—SIDE ELEVATION.

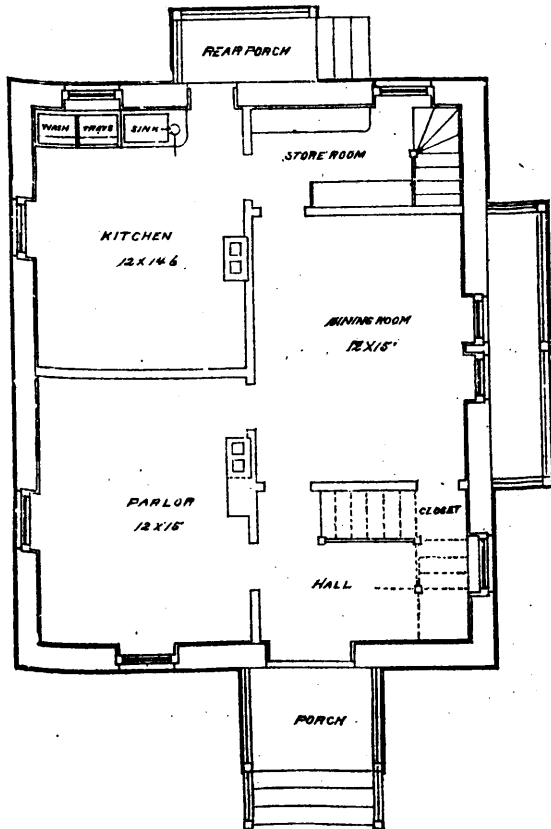

First-Floor Plan.

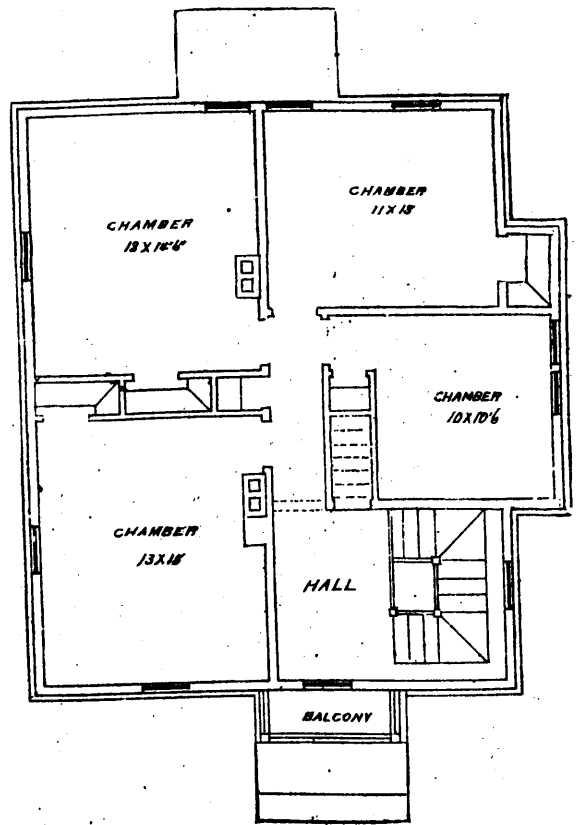

Second-Floor Plan.

The vessel is fitted with Forrester's steam steering gear, as well as very powerful hand steering gear, and has a beautiful self-acting arrangement, designed and fitted by the Italian constructors for checking and holding the tiller; in case of the chains breaking the tiller would lock itself amidships and remain at rest till the new chain was reeved.

The Dandolo carries four large steam launches, and eight other boats, all hung upon hinged davits, which are worked from the steam capstan, and which will hoist them right in board. The Dandolo is propelled by twin screws, worked by two independent pairs of engines, which were contracted to indicate a *maximum* power of 7,500 horses. These engines, together with the pumping and blowing engines, were constructed by Messrs. Maudsley, Sons & Field, of London. They are the first compound engines which were ordered for the Royal Italian Marine, though they have been awaiting the completion of the ship at Spezia since 1876, when they were brought out in the royal transport Europa. Each set of engines is placed in a separate water-tight compartment, one at each side of the vessel; instead of being side by side they are situated one in advance of the other, the alternate spaces being occupied by the magazines, which are placed immediately below the turrets. Each pair of engines has one high pressure cylinder, 64 in. in diameter, and one low pressure, 120 in. in diameter, with a stroke of 4 ft. Steam of 65 lb. pressure is supplied by eight large oval and double-ended boilers, having 32 furnaces in all. Four boilers are placed forward of the engines, and the other four aft, but each pair of boilers is contained in a separate water-tight compartment. The chimneys, which are ample in size and height, are built of one-inch plate from the main deck to the flying dock above the turrets, so as to enable them to withstand the great shock produced by the discharge of the guns.

A very perfect system of fans and ventilating pipes has been carried out, so that the whole of the cabins and even the engine room are kept perfectly sweet and fresh. There is also another arrangement for ventilation very closely resembling in principle the furnace system of ventilation in a mine.

On the 25th of May the Dandolo proceeded to sea for her first official trial, under the command of Commandante E. Acton, who was accompanied by the Admirals Martin-Franklin and Caini. The run to Genoa and back was accomplished without stopping in 6 hours and 28 minutes, with a mean indicated horse power of nearly 7,200, and a maximum of 7,415 horses, and the speed obtained was 15½ knots, with a consumption of 51½ tons of coal. The main object of the run was to ascertain the consumption of fuel on a prolonged full-power run. On the 29th of May the vessel was taken on the measured knot trial, when a speed of 15.55 knots was obtained with 8,050 horse-power. Our engraving is from *La Ilustracion Espanola*.

#### IMPROPER SETTING OF STEAM BOILERS.

There being no law in regard to the setting of boilers, every one is free to set a boiler as he sees fit. As might be expected, boilers are set with the side or end against the brick wall of a building, so that the side or end cannot be reached. If the brick wall happens to be the wall of a basement or sub-cellar, there will be an accumulation of dampness upon the shell of the boiler, which will start a corrosive action, and in a short time render it dangerous. Boilers are often set resting upon the cast-iron front at one end and a pedestal at the back end, leaving them without any support in the middle. As the iron deteriorates along the seams and becomes thinned by corrosion, it is in time very likely to break in two and demolish the premises. We maintain that all boilers should be so set that all parts of the shell may be accessible for inspection and repairs, and we have yet to hear a substantial reason why this could not be done. We also believe that all boilers over 10 ft. in length should have supports at the middle, instead of only at the ends, as is often the custom.

Boilers could be set more economically, both in the first cost of setting and the use of fuel, if this idea were constantly kept in view. Internally fired boilers should never be bricked over the outside; in fact, there can be no good reason why a single brick should come in contact with the shell at any part. It is well known that where bricks and mortar come in contact with iron, there is almost certain liability to corrosion. We have known of several cases where internally fired boilers have been wholly bricked in, except at the front ends; so that their external condition must be mainly determined from inside examination. We have also known such boilers to explode;

and when the shell has been carefully examined, it has been found corroded so nearly through the sheet that pieces could be easily cut out with a pocket knife.

When a casualty makes the public acquainted with such facts, they are loud in their denunciation of the owners; or, if there happens to be an inspection law in that locality, the inspector has to bear the brunt of their censure. The truth is, they do not consider that, before the explosion, the corroded parts either rested upon or were covered by the brick-work, so that no person could reach them for examination.

Externally fired boilers are often all bricked in, top and bottom; then, if required, the inspector is called in and requested to examine or test the boiler, and make out a certificate. He accordingly goes through the form, but we wish to ask, in all soberness: What does such an inspection amount to? Can an inspector give a conscientious certificate for the safe condition of a boiler carrying a stated pressure of steam, unless he has made a critical examination of every part? He has to trust to his judgment, and, unless he has more than the average of this essential quality in an engineer and boiler inspector, there is great risk incurred.

We saw an exploded boiler some months ago in which the iron appeared to be good. It was stamped as the best; specimens were taken from the ruptured sheets, which, in testing, stood a tensile strain of 48,000 and 50,000 lbs. to the square inch of section. But these tests did not show the fact, that, in the same sheet from which the specimens were taken, there was a baldly channeled seam, and the sheet was less than a thirty-second of an inch thick, being corroded where it had been in contact with brick work.

Test pieces taken from boilers are usually taken from the heart of the sheet, and are not fair examples of the iron in the boiler. Some engineers have placed the life of a boiler at 17 years, and others at 12. We are convinced that no general rules will cover the requirements safely, as some boilers are rendered unsafe in a very few years. A thorough system of frequent inspections will be a great deal more satisfactory.

What is wanted as one of the most essential safeguards against explosions, is a law requiring a boiler to be set so that all parts may be accessible for examination. The top of a boiler may be covered with felt or with a sheet iron jacket, having air spaces, as is done already to some extent, and with more economical results. When it is desired to inspect the boiler, the covering can be quickly lifted and replaced, involving no expense for repairs.

Until boilers are made accessible, and are properly and thoroughly examined, we may expect to hear of frequent boiler explosions.—*American Engineer*.

#### MINING SURVEYS IN MOUNTAINOUS REGIONS.

A rather curious case recently came before the Land Office, in relation to the Land Office regulations about surveys of mining claims when they are in high mountainous regions, inaccessible in winter. Mr. J. S. Wallace, of Hailey, Idaho, wrote to the Commissioner of the General Land Office representing, in effect, that there are mines located high up in the Sawtooth mountains, in new districts near the head-waters of Wood river, and that in case parties should make applications for patents of such mines during the period from about December to April, it would be impossible in a majority of instances, if not in all, for adverse claimants to procure surveys in accordance with present regulations within the period of publication, on account of the severity of the climate, deep snows, etc., in that locality.

In view of these facts, Mr. Wallace, who is acting as superintendent of mining property located in said mountains, suggests that the rights of all parties owning claims in the above mentioned districts would be most effectually preserved and protected, if the Surveyor general of the Territory was instructed to postpone the granting of any order for advertisement of applications for patents, until the country is open in the spring, when adverse claimants can procure their surveys.

When this letter was received, the Commissioner suggested that the Land Office might issue instructions waiving the present requirements as to surveys of adverse claims in cases in which the adverse claimants shall show under oath that such surveys cannot be executed and platted within the period of publication, on account of climate or other temporary difficulties, allowing adverse claimants to file such plats of surveys within a reasonable time after the obstacles to making surveys shall have been removed.

The matter then came before the Secretary of the Interior who did not agree with the suggestion of the Commissioner of the Land Office. He thought that adverse claimants should be held to reasonable diligence under the law in taking necessary steps to protect their interests. If there is danger or likelihood of applications for patents being presented during a season in which surveys cannot be made, the parties might anticipate such proceedings by securing surveys of their claims during the season in which no obstacles to making the same are present.

But, if application for patent in any case should be made at a time when it is impossible to secure a survey of the claim adverse thereto, then, as the law does not require impossibilities, the adverse claimant might show the nature, extent, and boundaries of his claim, as nearly as practicable from information within his reach, and present, under oath, his reasons for not following more clearly the regulations, and submit whether, under all the circumstances, he had not properly presented an adverse claim. This would give opportunity to waive the regulation requirement in a given case when the facts were presented justifying such action, and would be preferable to a general waiver of the rule in anticipation of a case calling for any such waiver.

To waive the requirements as to surveys of adverse claims in advance of the presentation of reasons therefor, would tend to encourage carelessness and indifference on the part of adverse claimants respecting such requirement, and would, the Secretary thinks, be equivalent to an invitation to adverse claimants to present excuses for laches, whereas they should exercise all reasonable diligence in their efforts to comply with the regulations.—*Mining and Sci. Press.*

## Architecture and House Decoration.

### SIMPLE WAYS AND MEANS FOR DECORATING THE HOME.

We have before spoken of the great need there is for the better understanding of the principles which govern the ornamentation of ordinary dwelling houses. Many people who have fairly good taste, are yet from want of training, unable to use it to advantage in house decorations.

In preparing these papers it has been the aim to embody, in the plainest language and manner, some simple ways and means of making the home life and surroundings interesting and beautiful. It is desired to show to those who are considering the expenditure of money—a little at a time, perhaps—in the adornment of their homes, how such may be done with economy, and how every spare moment may be devoted to the pleasant work.

The best, in decoration as in other things, as a rule, is the cheapest gloss, may be brought to bear upon our homes and lives with good and refining influence, without reproach, or fear of adverse criticism.

In these papers there is no pretense of perfection in the "science of the beautiful," but an endeavor to show how the simple principle of good taste and beauty may be brought into our home life, with good effect, and although the subject has been well discussed by other and abler minds, there is still some room left for suggestions, both as regards economy and methods of ornamentation. I will not attempt to cater to those favored few—speaking comparatively—whose more liberal means enable them to place their home adornment and decoration into the hands of experts for supervision: such need no advice, for they have plenty of other resources; but the field is still open, in my opinion, on this subject of simple ways from which every-day people may gather something of use as well as interest. And among the many books that have been written on this and kindred subjects, there is very little that can be found of use to the person of average means and educated, refined tastes, to assist them in gratifying laudable ambition in this direction, without leading them into extravagances and thus into discouragements. The object which I have in view is to be of use to those who, in trying to make the journey of life more enjoyable, by pleasant surroundings, by placing in these in the end, and I would advise all who contemplate furnishing or refitting, to do, where possible, but little at a time, but let that little be well done, and with the best of materials. Once well done and with good taste, it is

done for all time. Good taste is good taste the world over, and it is only the extreme in styles that changes, and we are not talking here of extremes, but of simple ways and means. Speaking of extremes, reminds me that æstheticism and its disciples have been of late so noticeably before the public, and seemingly, through the precepts and practices of false prophets, so thoroughly misunderstood, that a word or two here in connection with our subject would not be out of place. The love for the beautiful finds a place in every refined mind, and is a germ that desires cultivation, and is ever on the lookout for the means of gratifying that desire. Strip æstheticism of its habiliments, of charlatanism, its "vague platitudes," its lack-a-dasiacal airs and graces—of all in fact that is unmanly—return to its original and true principles, and we find it simply a true and healthy yearning for higher knowledge and culture; a seeking to surround the home and every day life with objects of true beauty, to fill the mind and higher thought, with soft, refining influences that may lift us out of the narrow sphere into which the prosaic duty of every day life induces us.

Such a home is like the warm and cheerful sunshine in the lives of child and friend alike, breaking through the clouds of commonplace life, and flooding it with new and joyous thoughts and experience, never to be forgotten as long as life itself lasts.

Thus æstheticism, robbed of its outward show and supercilious pages is something of interest that the reader may adapt to his own conditions and requirements. I do not know that I shall fully realize this object, but I can at least try.

We will first take up for consideration the average suburban house, as these vary but little, so far as number and general size of rooms are concerned, and in connection with this, will take an occasional peep into the farm-house kitchen or living room, and join the home circle, as they gather of an evening around the hearthstone in some "little cottage by the sea," or in the country. Standing now, as we are, on the threshold of our subject, I wish to say before entering, that in each style of room as we take it up for consideration, I shall try to give more than one example, in which the conditions and requirements differ materially, and will try to meet, as far as the limited space at my command will allow, the various established necessities that we shall find awaiting us at every turn, and remember, there are but a small minority of the many ways open to us. I do not argue that these are arbitrary or the best ways, but simply offer them as means I have found plain, useful and inexpensive. Having established this point in your minds, we will now cross the threshold of our subject and proceed to business.

I shall not attempt to show any definite series of connecting plans or rooms, nor shall I confine myself to the description of any one room, in more than one scheme of decoration, but will try and cover a broader field, by describing various halls, living rooms, chambers, etc., and as we go along give with each its separate plan, hoping in this way to give myself more scope, and make the subject of more interest to my readers. The outward style is of but little importance at the present time, but later on we shall see how good taste and judgment in decorating the outside surfaces will do much to make even an unsightly house an attractive object in a neighborhood, and a source of satisfaction to its inmates.

In the plan of proceeding we have adopted, I can touch on many little points I could not, should we confine ourselves to any one particular arrangement of rooms, and so be enabled to meet more fully the varied wants of my readers, by giving them hints that may be found useful, depending on the judgment in applying these to their varied requirements. Although there is some variety, in houses of this class, in the size, arrangement, etc., of rooms, each has its hall, the little-used parlor, the dining and sitting rooms, or library, kitchen and offices, and up-stairs the usual complement of chambers. First in consideration comes

#### THE HALL.

The first effect is received here, on entering, and our hall should give the key note, so to speak, of the whole, and should impress the visitor by its simple and quiet dignity. In many houses I know of, this has been entirely overlooked, and the hallways considered simply as highways to the various rooms and chambers, giving but a bare, unfriendly welcome to visitors, particularly if they be strangers, chilling and absorbing all that is cheerful in them, while passing through this commonplace ugliness to the living rooms beyond. Now all this



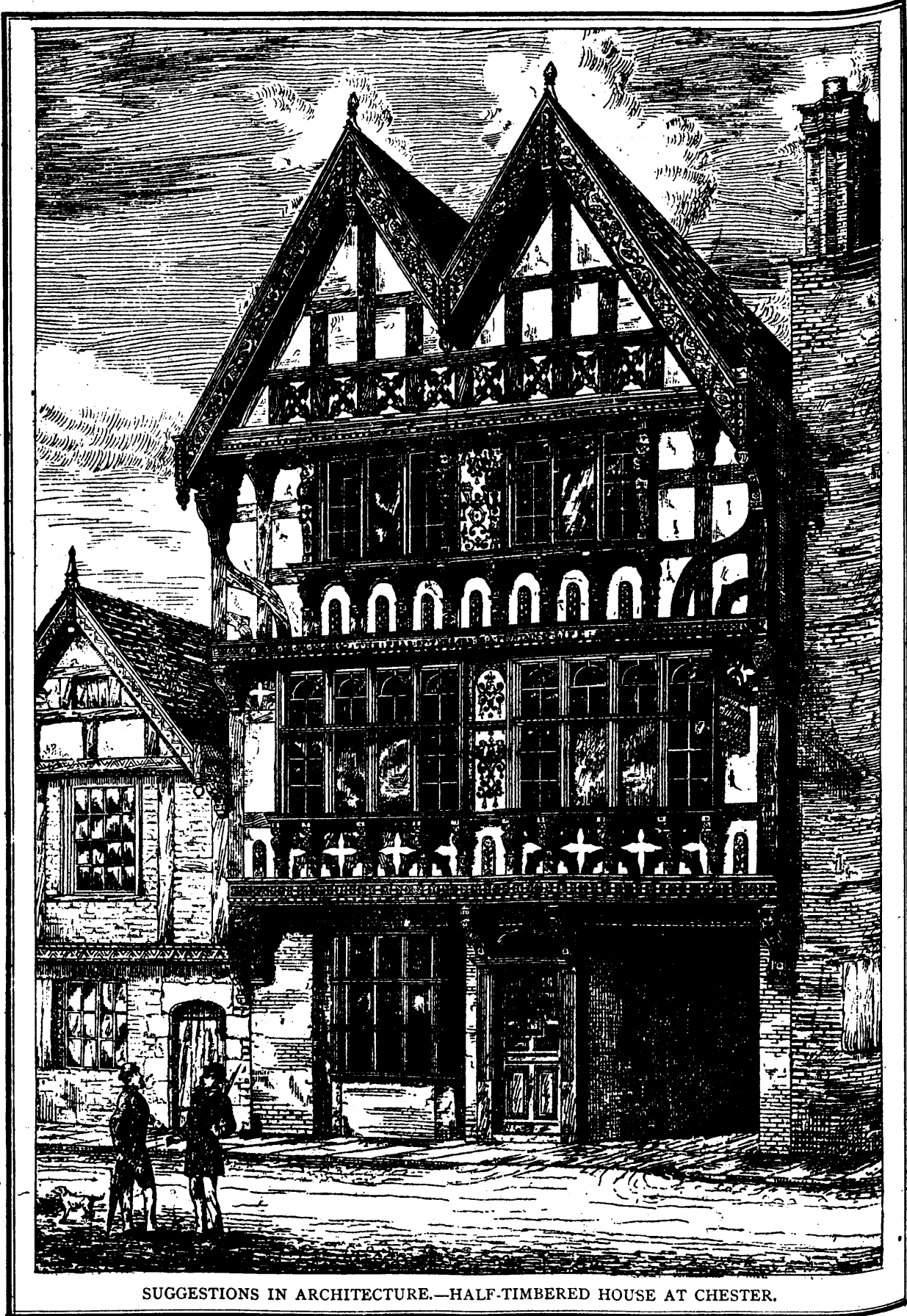

SUGGESTIONS IN ARCHITECTURE.—HALF-TIMBERED HOUSE AT CHESTER.

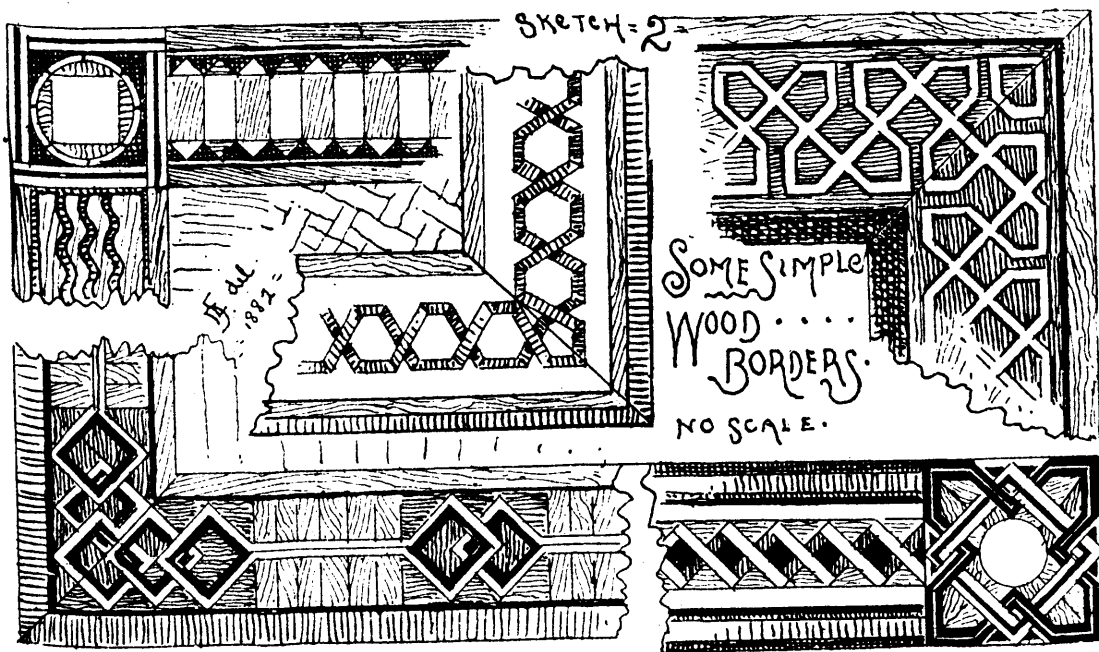

is unnecessary and wrong, for narrow, dark and unpromising as our halls may be, and very often are, there surely is something we can do to give them their proper dignity and place, as the entrance to a pretty and cheeffer home. I suggest hard wood floors laid in strips, or a quiet pattern with a deep border about the edges (Fig. 1). A few good examples of simple work are shown in the following sketch, No. 2. Such a floor is cleanly and healthful, requiring only the use of a damp cloth to keep it presentable, and a joy forever during the annual season of spring cleaning. The ideal polished floor requires more constant and intelligent labor in bringing to perfection and keeping there, than the average housekeeper is able, from

multiplicity of other duties, to give to it, and as we have no need to see our faces reflect from its glossy surface, we will put to one side the polished floor of palace and romance, and bring some more economical plan to bear upon it. Mr. Oakey, in his little book on "Building a Home," gives a receipt that may be of interest, although I cannot vouch for it from experience. I will give it here, he says: "Crude kerosene, a very cheap article, will be found to be the best application, administered once in ten days, with a cloth, the odor passes off rapidly, and the wood gradually assumes a real stone." A floor will last for years, with an occasional treatment of benzine and hot wax, applied with a large brush; it may also be filled, shellacked and rubbed down; but this last comes too near our "ideal" floor, and is too expensive to be of practical use here.

Experience leads me to believe the following method to be the best for our case in hand. The floor should be first well filled and oiled, and once in four months apply boiled linseed oil and wax, well rubbed on; this leaves a slight glossy surface, is easily kept in order and wears well, which are good points in its favor. To put down a hard wood floor, in an occupied house—since the invention of "Parquetry carpet floors," is not such an expensive luxury as one would be led to believe. These are made by machinery, of thin strips arranged in patterns on a canvas backing, making it about the thickness of ordinary carpeting. So, by first leveling off all uneven portions, this may be put down at prices ranging from \$1.50 to \$10 per yard. These floors wear well, are easily put down, and require no tearing up and relaying, which means dust, dirt and discomfort until the work is finished.

It is not always desirable or practicable to adopt hard wood floors, especially in hired houses, and in such a case, we have recourse to paint. Care should be taken when the color is medium or dark in tone that the first coat is very much the darker, gradually lighting up in succeeding coats, to the color required. This is so that scratches or nicks may not show light under, and furthermore, paint covers better with a light coat over a darker, as the light coat is apt to "grin" through in disagreeable, streaky way when the reverse is the rule. Three or four coats at most are sufficient, and in some instances two will answer. This depends on the amount of wear the floor will be subject to, and this point the judgment of the reader must decide. Care must also be taken that each coat dry thoroughly before the next is applied, also that too much oil is not used in mixing, as this will prevent its drying thoroughly or quickly. One or two coats of varnish, according to the exposure, will finish, allowing it to dry and harden well before using. Our floors may also be stained in imitation of cherry, walnut or other woods, and as many good receipts have

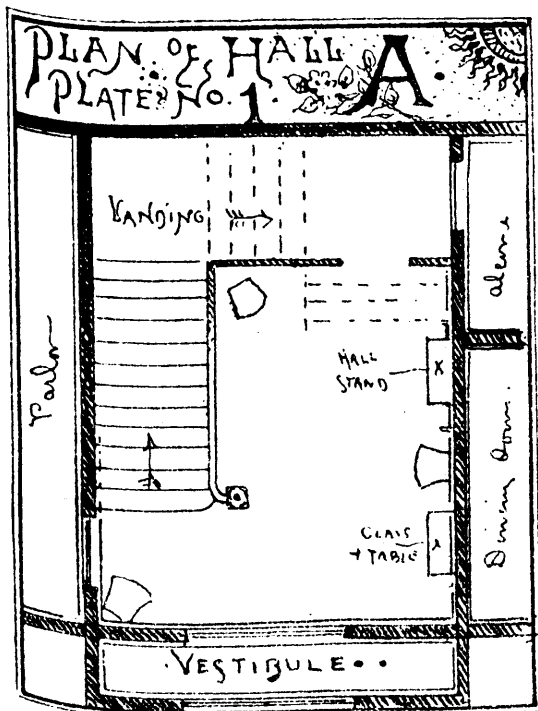

already appeared in our *Builder and Wood-Worker*, I shall not take up space by offering any here, for the present time at least, although later on I may do so. A border from four to six inches wide of a dark wood stain—walnut, for example, with a center of cherry stain, the whole finished with a thin coat of varnish makes a neat and pretty floor.

Here and there on the hall floor should be placed rugs, a large one for the main floor, and smaller ones where most desirable, never too many, as we should avoid a crowded appearance.

In the matter of rugs, I would suggest for looks, wear and economy, the well known Philadelphia rugs. These are, as the name implies, a home made article, and therefore free from the extra cost of duties, etc. The patterns are Persian in character, and of rich harmonious tones, with enough bright colouring introduced to give them a cherry look; the prices vary from two and one half dollars to twenty dollars each, and as the patterns are the same on both sides, the rug is not injured badly, by constant wear, for when too shabby may be turned. They can be obtained in almost any size and shape, and in tones to harmonize well with any good scheme of color decoration.

The stairway, whether finished in hard wood, painted or stained, should have a narrow strip of carpeting, of a plain dark tone, running the whole length, and finishing at the bottom with a small rug. A very pretty, although not a necessary addition, would be to hold the carpet in place by a small brass rod at the nosing of each step or tread, finishing the rods at the ends with a little brass ball or knob, screwed in place.

#### NEW OLD FASHIONED HOUSES.

We give herewith an example of the prevailing tendency in some branches of architectural designing, which is to go back to the good old times of the forefathers. Our engraving which is from the London *Building News*, represents a new dwelling house lately erected in Chester, England, a city that is well known for its various quaint structures.

The house is "half-timbered," and designed in accordance with the old houses in the city, the period being from 1600 to 1650. On the center breast-summit is inscribed "The Fear of the Lord is a Fountain of Life," following the Latin inscription, "Timor . Domini . Fons . Vite," on a shilling of Edward the Sixth found near the site. A short distance from this is the interesting house known as "Bishop Lloyd's," with its carved panels, Adam and Eve, Cain slaying Abel, Abraham's Sacrifice, the Immaculate Conception, the Sorrows of the Virgin, and other devices. The house has been built by Mr. N. Dutton, for his residence, and contains dining and sitting rooms, five bed-rooms, bath-room, w. c., closets, kitchen, scullery, pantry, cellars, yard, also the builder's yard and workshops in the rear.

#### FASHIONABLE FURNITURE.

The sturdy great grandfathers and simple minded great grandmothers of the present generation would open wide their eyes and mouths with astonishment could they but visit a fashionable furniture store of the present day. There they would see side by side with the familiar chests of drawers and tall clocks, which are now popular because of their antiquity, that ingenious modern contrivance called a "folding bed." Directing their attention to a massive combination book-case and writing-desk, elaborately carved and rich with French walnut veneering, the enterprising shopman would say to them: "Here is our new folding bed," and while the aged couple gazed with amazement upon the open desk with its pigeon-holes filled with stationery, and at the rows of handsomely bound volumes visible behind the glass doors of the book case, the shopman with a single movement of his hand would cause glass doors, books, stationery, and French veneering to disappear, giving place to an elegant bedstead with spring mattress, pillows, sheets and blankets. These folding beds are made in several different forms—some in imitation of circular top desks, some in the shape of parlor cabinets, and others to resemble wardrobes, book cases or sideboards. Cribs for small children are made so that when not occupied they can serve as ornamental supports for bronze figures, Satsuma vases, or other fashionable knick-knacks, and for rooms that have to answer the double purpose of boudoir and sleeping apartment there are other deceptive articles of furniture. Stationary washstands are inclosed in gilded ebony so as to pass

for bric à brac cabinets during the daytime, and innocent looking music stands can be transformed in less than no time into the most formidable of homeopathic medicine chests. Among the later novelties in the furniture line are the chairs and tête à têtes made of polished buffalo horns and rich plushes, the round tables of hammered and carved metal, and library and dining room sets carved and upholstered in Egyptian style. Some of the carved heads and figures on this style of furniture are not only curious, but they are artistic and very costly. The popular craze for antique household decorations has led to the making of bronze and hammered metal picture frames. The metal frames are molded or carved after selected designs and are manufactured to order to correspond with the general style of the room in which they are to hang. In wall papers the latest novelties are all in dark colors, in imitation of the interior English decorations one hundred or one hundred and fifty years ago.—*New York Times*.

#### PLAQUES.

It is no new or sudden freak of fashion to adorn the walls of our dwellings with ornamental pieces of pottery, metal or wood, decorated and beautified in numberless ways, to serve the purpose of pictures and tapestries, forming a pleasant change and relieving the eye when it has tired of painting and engraving. From the earliest ages, long before the art of painting was discovered, sculpture was in use, and the tablets found on the walls of the temples of antiquity are so many plaques, partly for adornment, partly to commemorate some noteworthy event.

The modern plaque differs somewhat in character from these, but is, in many instances, no less elaborate in its ornamentation nor expensive to produce. Pottery and metal are the materials mostly employed for this purpose, and sometimes a combination of the two, as in *cloisonne* ware, which presents perhaps the most beautiful appearance when hung to the wall in the form of a plaque, reflecting the light from its metallic portions, while the dark or brilliant portion of the enamel gives a rich beauty to the entire piece. The cost of this ware, however, prevents its general sale, as is the case with all the hammered metal work employed for ornamental purposes. In this case, then, as in many others where we seek to combine beauty and utility, we are driven back to the use of pottery, and well does it meet all requirements. Every grade is employed in the manufacture of plaques, ancient or modern, cheap or expensive, and as of late years the fashion of their use has rapidly increased, to-day the stores are filled with all sizes and shapes, and the demand seems without limit. Square, oval, and round in shape, measuring from three inches to as many feet in diameter, costing from half a dollar to thousands of dollars each, and decorated in every way that art, beauty, or stupidity can invent, it is no wonder that by a common impulse all house-furnishers decide that a few plaques are the only things needful to complete the beauty of their home, and rush eagerly to the nearest china store to obtain the coveted treasure.

As is often the case, the term "plaque" is a misnomer, or, rather, a designation used properly at first, but afterwards corrupted by inaccurate usage to apply to an article of quite different kind. Its literal meaning is a thin plate or slab of metal and the verb means to veneer or to plate, as silver-plating and the like, so that the term "plaque" can only be properly applied to articles in metal, stamped or hammered into shape. Common usage, however, sanctions its employment to describe all kinds of ornamental articles formed from either metal or pottery designed to be hung against the wall for the adornment of the room.

Janvier says in reference to this term: "In speaking of plaques, the French decorators refer only to perfectly flat or slightly curved surfaces of any shape, and without a bottom rim or base." This excludes all porcelain from the definition, as only faience or earthenware can be fired without the rim or foot to which he refers. This is the ground taken by most authorities, and although unfair in this one particular, is perhaps correct as a general definition.

It would be useless to attempt a description of the many varieties of ware and decorations offered in this city alone for this purpose. No one article is made in so many qualities and styles of decorations, and, like pictures, rarely do you meet with duplicates of decorations. A new fashion appears for the first time this season that is novel and very effective. We refer to the square or oblong plaques, just arriving from Paris. These are mostly decorated with woodland or river scenes, and from their shape are peculiarly adapted to fill the spaces over tops of

doors, while the decoration is seen to advantage at a little distance. Oval panels are also very handsome, and, in the majority of cases, a human figure at full length and erect fills the center, clothed in knightly costume, or arrayed in the robes and plumes of a duchess or lady of "ye olden times." We were shown, not long since, some round plaques most exquisitely painted by a Paris artist, who affixes his name to them, each one containing a most beautiful female face. Nothing could be handsomer than these, and as works of art they are entitled to the highest praise. All of these were upon faience plaques of ivory colored body, that formed an effective contrast with the softer tints of flesh and drapery. Barbotine plaques are also very handsome, but are difficult to keep clean and easily broken.

No prettier ornament can be devised for a room of any sort than a plaque properly chosen, of a decoration that is in keeping with the use of the room in which it is contained, and in harmony with its surroundings. From the nature of the article, plaques cannot be suspended from the walls or stood upon tables without some support. To meet this necessity a large variety of frames are made in plush or velvet, in which the plaque appears as a picture, its beauties being much increased by its surrounding. These frames are so arranged that they may be hung to the wall like a picture, or stood erect upon a center table. Little tin clasps are also sold to which a cord or wire may be attached to suspend the plaque.

### A BRUSH WITH THE PAINTER.

Is it not funny, by the way, that a rope should be a painter? It is enough to make a fellow ha-hawser. But let us be sober if you are, you think, cable.

The panther is sometimes called a painter, but this is a beastly use of the name.

The painter is not always an artist. Ah! 'tis too often the latter is but a painter.

The painter hides a good deal of cheap work. It fills me with painter say this.

The painter shows his gilt in a great deal that he does.

The painter is usually of an inoffensive nature, though he is almost always ready for a brush.

When he is painting a sign it is a sign he is painting.

The painter is a man of letter. He is a wonderful speller. He can show you specimens of orthography that can be found in no dictionary.

His strong point however, is punctuation. If you will study his signs, you will see the point where there is none, and vice versa.

The painter clothes our habitations with coats. Jacob was a painter. He gave to his son Joseph a coat of many colors.

When they went to their work Jacob made Joseph carry the Potiphar way.

When the painter comes to your houses, children, he mixes his paint as he uses it. The painter mixes in the best society.

The painter is not what you would call a flatterer. He is a plain going fellow, and attends only to his work. He never "lays it on thick," as the saying is; but he will sometimes come the putty over you.

The painter is generally a glazier, also. They are not all so.

His best-laid plans gang aft agley, sir.

That variety of painter known as artist loves to speak of his "creations." They are undoubtedly his, inasmuch as they are unlike any natural creations. His creations are mainly unnatural.

Though a man of color, the painter is a colorless subject, children, and, therefore, let us drop him.—*New Era*.

MANY chemists have doubted the existence of black phosphorus, holding that it is a mixture of ordinary phosphorus and metallic phosphide that gives the colour. M. Thenard, while admitting that this may often be the case, does not think it is always so. A short time ago, when moulding phosphorus in the ordinary way, and after obtaining a dozen rods all of the usual colour, he found that the thirteenth suddenly blackened at the moment of congelation, this effect extending throughout its mass. Other rods blackened partially. The black, or rather dark grey, phosphorus becomes white again when melted, and remains white if cooled suddenly; but if confusion be produced, it becomes black, as before, on contact with white or black phosphorus.

## Miscellaneous.

### NEW NOTIONS ABOUT THE MOON.

The French, English and Italian Governments sent, each, scientific expeditions to Egypt for the observation of the recent total eclipse of the sun. Among the most interesting results have been superior photographs of a comet seen near the sun, and of the corano, and also a revelation of the lines in the blue and violet end of its spectrum. Several new details have been observed, of which the meaning has still to be found out by study and comparison; the hydrogen and coronal lines were so bright that in the grating spectroscope, the rings of the second and third order could be seen. One of the most remarkable details is that the absorption lines in the group B (the red), was much intensified at the moon's edge. As these lines are also intensified by our atmosphere at sunrise and sunset, it appears to indicate that there is a trace of an atmosphere at the moon's edge, which if considered in connection with the recently announced theory of Helmholtz of Berlin, that water and air, if existing in the moon, must necessarily be accumulated at that side which is always turned from us, would seem to indicate that after all life may exist on the moon but not in the solid, dry side, consisting of heavy material, which alone we can see, but at the other side which we never see.

Mr. Dueberg bases, however, his theory upon a fallacious experiment made with a ball attached to a cord, and swinging in a circle around the hand, such a ball will, like the moon, turn always the same side to the centre of revolution, and if dipped in any liquid this will rapidly accumulate on the opposite or outer side. He forgets that in the case of the moon the centrifugal force and terrestrial attractions are balanced over all the material of which the moon is composed, while in the case of the swinging ball the centrifugal force tends to carry everything to the outside which is not prevented by the cord, therefore, any liquid free to move, will fly off in a tangent.

There is another interesting experiment which seems to prove the contrary, namely, that the lighter material of the moon must be nearer the centre of rotation, that is, at the side of the earth, and the heaviest material, at the other side. If a glass globe be filled with fluids of different specific gravities, but which will not dissolve or intermingle, and the globe be rapidly revolved, the fluids will arrange themselves in belts around the equator and the heaviest will be at the outside. So if we take a small quantity of mercury, a larger quantity of a solution of carbonate of potash in water, and a still larger quantity of naphtha, and place them in the globe, they will when brought in rapid rotation arrange themselves in layers, the heavy mercury will form a band at the equator at the greatest distance from the axis of rotation; inside of this will be the watery solution, overlapping the mercury belt in both sides, and inside of this the naphtha again overlapping the water, so that the lightest material will arrange itself nearest the centre of rotation. As in this experiment the different materials are under much more equal conditions than is the case in the experiment of Mr. Dueberg, it is not so entirely unlike the conditions of the moon, and would to suggest, therefore, that if there is lighter material on the moon than its solid parts, such as water and air, they would rather accumulate on the side of the earth, but thus far not a trace has ever been discovered, excepting only the faint indication during the recent eclipse referred to above.—*Industrial News*.

### TECHNICAL ART AT THE METROPOLITAN MUSEUM.

The class in carriage draughting and construction carried on in connection with the Metropolitan Museum of Art Schools will begin its third season October 9, under the auspices of the Carriage Builders' National Association. The class will be in charge of Mr. John D. Gribbon. The course of instruction covers linear designing, including scale and full size drawing, the geometry of carriage construction, carriage body-making, construction of carriage gearings, wheel making, and the principles involved in the suspension of carriages. The entire course of thirty-two weeks, every evening in the week, may be had for the nominal sum of eight dollars. The class will also be favored with free lectures by specialists on subjects connected with carriage mechanics.

# Cabinet Making.

## PICTURE FRAME MAKING.

Moldings ready rebated to receive the glass and backboard can be procured by the foot, the price varying according to quality and width of molding, the mere round beading so extensively used for water color drawings being exceedingly cheap. These need only to be cut to a miter or angle of forty five degrees, and glued up at the corners, with the addition of a small brad to give strength to the joint. The miters can be cut either with a fine tenon or mitering saw, a fret saw, or by means of a circular saw fixed in the lathe, but in any case a very fine tooth is requisite, or the face of the molding will be chipped off.

It is not easy to saw an accurate miter without a miter box. There are several good patented tools of this kind in the market, or one may be made as follows: Plane up a bit of dry

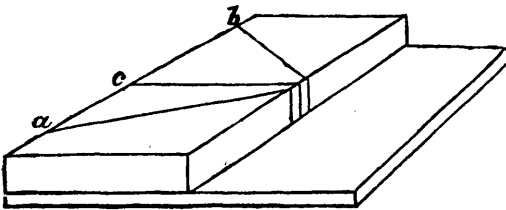

FIG. 1.

hard wood, about 18 in. long by 12 in. wide, and  $\frac{3}{4}$  in thick, trueing it on all sides. Plane up a second piece of stuff, but only 9 in. wide and 1 in. thick; glue and screw these together, so that a step is formed 3 in. wide. (See Fig. 1.) Now mark lines *a*, *b*, and saw them with a tenon saw quite through the upper board down to the lower one. These saw cuts are to be square to each other, and they must also be quite accurately perpendicular to the lower board. The result will be that if a piece of molding is laid on the step, and the tenon saw placed in either of the two saw cuts as a guide, the molding will be sawn off at the angle requisite to form a mitered joint. One piece is, of course, sawn by the left-hand saw cut and the other by the right-hand one. The molding, or other strip, must be held steadily against the back or "riser" of the step. A third saw cut at *c*, at right angles to the length of the boards, will form a guide by which to saw a strip squarely across instead of at a miter. Fig. 2 is a miter block and shooting

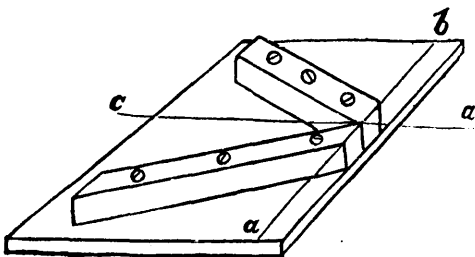

FIG. 2.

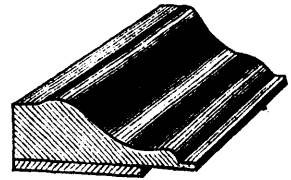

FIG. 5.

board, upon precisely the same principle, but made somewhat differently. Instead of a second upper board, two strips of any tolerably hard wood are screwed down to the base; these making with each other a right angle and a miter with the line *a*, *b*, which is that on which the saw is to work. To facilitate its accurate guidance, this board may also be made as a very shallow step, if preferred. The angle, however, formed by the meeting of the strips is always sawn off so as to give a sufficiently broad face to rest the saw blade against. To cut a piece off square it is placed against one strip, and the other is used to guide the saw. By making the guide strips of good thick stuff, say one and a half inch square, and then cutting a saw kerf through them in the line *c*, *a*, for a guide to the saw blade, this becomes, perhaps, somewhat more reliable. For small, light molding no subsequent planing of the mitered ends should be needed, as the somewhat rough surfaces left by the saw hold the glue better than perfectly smooth ones.

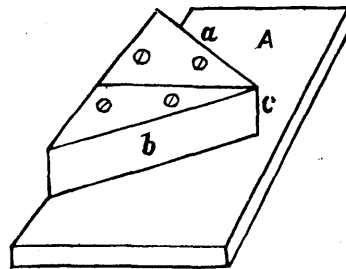

FIG. 3.

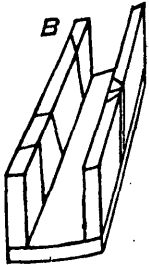

FIG. 4.

The ordinary miter saw is often too coarse a tool for frame making, and should be replaced by a finer one, generally made with a straight handle and brass back, but the saw kerf should be made by the same saw that is intended to be used in the work. The fine frame saws are rather difficult to keep accurately in the saw kerf, but cut beautifully if care is taken in this respect. There are mitering machines, some of which make good work. The circular saw and fret saw also both furnish ready means for rapidly mitering moldings, if fitted with the necessary adjustable blocks for securing the stuff at the proper angle.

Some fret saws are purposely fitted with a guide for sawing picture frame moldings, and answer well enough for the lighter material used for small frames, but they are of no use in the case of heavier moldings. For the latter it will be generally better to use a hand miter or tenon saw. The shooting board is made to enable a plane to be used on the sawn ends of the molding. It is made like the second mitering block (Fig. 2), but with a step, in which the plane lies on its side when in use. Of course, the body of such plane must have flat sides, like an ordinary jack-plane, so as to rest firmly upon the board, which takes its weight. The strip is then held securely

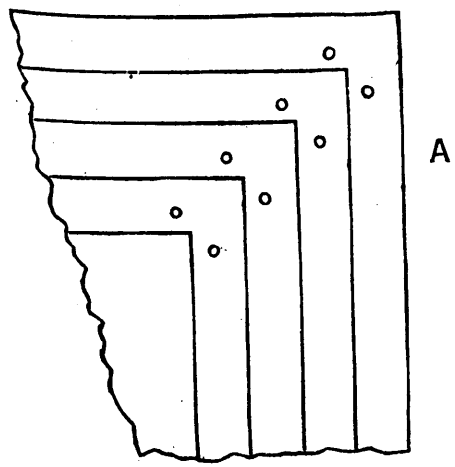
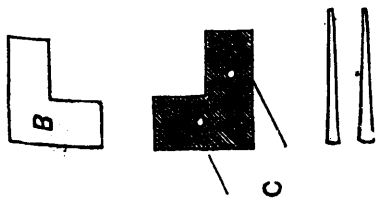

FIG. 6.

against one or other of the guide strips, so that its end projects over the step very slightly, bringing it in contact with the plane iron. The latter must be very finely set, so as to take but the thinnest possible shaving, or it will split a bit off the molding. Two other forms of miter boards, or rather a miter board and box, are made, of which one is illustrated in Fig. 3, the other at Fig. 4. In the first a solid block of hard wood is screwed down to a base board, the sides (*a*, *b*), being at right angles to each other, and a saw cut is made to guide the miter saw. The molding is laid against *a* or *b*. This is easy to make, and a good form. It is as well to cut off the extreme angle where the sides meet at *c*. Fig. 4 is a rectangular box in which to lay the strips to be mitered. Saw cuts are made as before, to cut right or left bevels, and another at right angles, which often proves useful for other work.



Some moldings are not thick enough to allow of cutting the ordinary rebate. An inspection of the section of such an ordinary bit of molding (Fig. 5) will explain this, as well as the only available remedy when such stuff is a matter of necessity. It will be noticed that the molding is worked quite thin just at the edge, where it will be necessary to rebate it to admit the glass and backboard. If, therefore, a rebate were attempted at this part, the strip would be cut through and the frame spoilt. In picture frame moldings the stuff is left thick to take the rebate. The only way to meet this difficulty is to glue on an extra thickness, and leave a quarter of an inch or so next the thin edge uncovered by it, which is practically the same thing in effect as cutting away the stuff. Of course this extra bit will have to be stained to match the rest, but it will seldom or never have to be gilt, as gilded moldings are not likely to be bought for frames, unless it be those specially manufactured for that purpose, which will therefore have been previously rebated. When it is necessary to glue on an extra thickness in the way suggested, this should be done before mitering, so as to cut both at once, which insures a better joint.

The next consideration is the gluing or nailing the pieces together. For the purpose of holding the strips in position, several patented devices have made their appearance, all much on the same principle, being screw clamps variously arranged. But if you will make your frames to standard sizes, you will find it easy to contrive clamps which will cost but little. Get a bit of seasoned stuff that is really dry and sound, an inch thick and large enough for the sized frames required. If larger than the width of such board, two or more must be glued up. Plane all perfectly level, and square up neatly. Screw on at the back a couple of strips to prevent the board from warping or twisting, and you have the main work done. Let Fig. 6, A, represent a part of this board. Now rule lines, squares or oblongs, representing a series of standard sizes of frames, and at each angle bore  $\frac{1}{4}$  in. clean holes, as shown. Next make

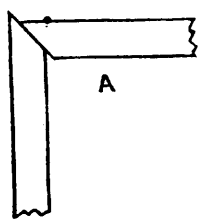

FIG. 7A.

four clamping or corner places, like B, of any tough wood—not pine, or it may split; and underneath, as marked at C, put in two iron pins (screws, with their heads afterwards sawn off), and let them stand out  $\frac{1}{4}$  in. or so. These pins are to be made to fit the two holes at any one of the marked corners. Then make eight thin wedges of hard wood, and you have a very useful clamping frame, the advantage being that the picture frame moldings lie flat upon it and out of twist. Glue up first both ends of one short strip and one of each long strip, and having two of the corner blocks in place, put the frame, made

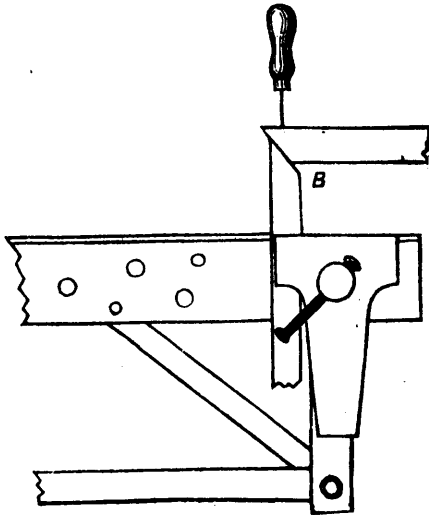

FIG. 7B.

thus far, against them. Glue and put in place the other short bit, and then place the other two blocks. After this take two or more of the wedges, and, giving them a slight tap, drive them between the strips and the blocks, and leave till dry. With a few extra packing strips nicely squared up, you can make one setting of the corner blocks serve for a smaller frame, if you have to make one now and then not quite of your standard size; but it is always of advantage to use standards, because artists' canvases, mill-boards, and sketching blocks are so made. For landscapes, the usual sizes are as follows (for portraits square canvases are used):

LANDSCAPE SIZES.	PORTRAIT SIZES.
9 in. by 5 in.	8 in. by 6 in.
11 in. by 7 in.	10 in. by 8 in.
14 in. by 10 in.	12 in. by 10 in.
16 in. by 12 in.	14 in. by 12 in.
18 in. by 12 in.	17½ in. by 14 in.
24 in. by 18 in.	21 in. by 17 in.
30 in. by 20 in.	24 in. by 20 in.

and so on up to any size required.

Water color paintings are nearly always mounted on white cardboard, which can, of course, be cut to any size suitable.

A great many of the plain beading frames for water colors are put together without the aid of glue, and these are not therefore held in such a clamping board as that shown. The workman having cut the miters correctly fixes one strip in his wooden bench vice, with one end upwards, and, holding the strip which is to be nailed to it in place, bores with a bradawl the necessary holes, and gently drives in one or more tolerably long brads. But in doing this the tendency is for the sloping surfaces of the miters to slide one upon the other, so that when the brad is driven home the result would be as in Fig. 7, A. Hence in placing the surfaces in contact he does not lay them exactly in their ultimate position, but as in Fig. 7, B, and the driving of the brad will then bring the corner truly together. After this brad has been driven home, a second can be put in the other way, *i. e.*, so as to stand at right angles to the first, the head now being in the other strip. After one corner has been done, joining two strips at right angles, the other two should be similarly joined, and then the third corner worked. The operation of putting a plain frame together is tolerably easy without any special contrivance for securing it. In fact, regular workmen rather despise appliances that are a confession of want of skill, and they will do work a great deal quicker and better by hand alone.

#### IMITATION OF INLAYING.

The grounds for inlaying should be got up to as level and smooth a surface as possible, so that the work when finished may have a fine surface, whether left simply varnished or French polished.

There are several methods of transferring designs to the surface to be ornamented, amongst which are tracing, pouncing, and stencilling. In tracing, the back of the design is rubbed over with either fine whiting, dry white-lead, pipeclay, French chalk, or any other substance of a like nature, if the ground work be dark enough to show the white tracing, care being taken to have only sufficient of the white upon the paper to be just perceptible, if too much is put on it will interfere with the sharpness of the outline in working. But if the ground be light in color, the paper should be rubbed with charcoal, black-lead, Indian red, or any colored chalk may be used. The design is then placed upon the surface to be inlaid, and the lines gone over with any convenient tracing point, an ordinary hard black lead, or ivory or bone tracer will be best. The effect of this is to leave a *fac simile* of the ornament upon the ground, in faint and white lines, or dark ones as the case may be. When the pounce is used, the design must be pricked through all the lines of the design with a fine needle, fixed into a small handle made of a thick pencil stick. The best way to make or fix the needle into the handle, is, to cut through the stick to half its thickness, then split it down to the cut part, which may then be removed. We now place the needle on the stick with its head or blunt end against the solid part of the stick, and replace the part of the stick previously removed, back again into its place, enclosing the half of the needle between the two, and tying them securely together with thin string or strong thread. When the design is properly pricked (a little extra time spent in carefully and closely

pricking will save much after trouble, when we come to the pencil work) it must be laid upon the work and dusted and rubbed with the pounce bag, when the design will be transferred through the perforations made by the needle on to the work; and will appear in white dots upon it. The pounce bag used, may be made of fine muslin, filled with powdered chalk, or charcoal. Ultramarine blue is a good color for some purposes. The bag should be tightly tied into a round ball, and in using should be first tapped over the design in places, then rubbed with the bag.

The ground work and design being now prepared for working we proceed to describe the manner of working, and will take as an example a design composed of four different woods, namely, maple, walnut, hawwood and tulipwood. As the same method is pursued in a design containing a dozen different woods, as in the one containing four, we shall thus get a clear description without risk of confusion.

Suppose that we are about to decorate the panels of a door with the woods and that we wish the work to appear as an inlaid design of maple, hawwood and tulipwood upon walnut. The panels must be first grained maple, that being the lightest wood, both as to depth of color and purity of tone, the graining color being secured in the ordinary way with weak beer or other glutinous medium. Now proceed either to varnish the whole of the maple, which would then form a ground for graining the other woods upon, or trace or pounce the design upon the maple, or pick in or pencil that part of the design which will remain maple in the finish, with a stopping varnish, such as Brunswick black, Canada Balsam, or any other quick drying varnish, which may afterwards be dissolved, and removed by turpentine, or alcohol, the great object being to use a varnish, insoluble in water, and yet capable of being removed without leaving any trace behind. Any turpentine varnish may be used if a little sweet oil is added to it so as to prevent it getting too hard, only a sufficient quantity being used to effect that purpose and to let it dry hard enough, so as to enable us to work over it without smearing and leaving a sharply cut and clear outline to the ornament. For most purposes Brunswick black is the best, as with care it will wash off with the turpentine without leaving any stain behind it. Canada balsam has its advantages in use especially for very delicate work, but on the whole we prefer the Brunswick black. The maple should not be grained very strong when used in this way, or else it interferes with the grain of the other light wood. We now grain the next lightest wood, namely, the hawwood, taking care to cover all those parts which have to remain of that wood, or the panel may be grained all over, which is the safest plan. The design must again be placed upon the panel, and those parts which have to remain hawwood, are traced or pounced on and covered with the stopping out varnish as before described. We now grain the tulipwood, traced in as before, and cover with the stopping. We have now the three woods grained and covered with the stopping varnish, these three forming the design.

We now grain the walnut to form the ground, into which the other woods will appear to be inlaid. In doing this we rub in and grain the panel all over its surface without regarding the previous graining and make the grain appear as if it were one solid piece of wood. As soon as this is dry, we take a large swan quill or flat tin tool of camel hair, and use turpentine or other spirit according to the nature of the stopping out varnish used, and saturate the whole of the panel with it. When it has had sufficient time to soak through the outer coats of distemper color and reach the stopping varnish, the spirit will soften it, and by gentle and careful rubbing with the brush the whole of the stopping varnish which covers the various woods, may then be removed by repeated washing with the turpentine until the whole design stands out clean, clear and sharp, all the spaces between the pattern being walnut. By working this we get all the graining at one level, just as if it were only one wood. We also secure flatness, which is absolutely necessary to the success of the work. Some grainers will grain one wood and then varnish it with ordinary hard-drying varnish, which cannot be removed as described above, and when this is dry they will grain and varnish another wood and so on to the end of the chapter, the result in the finish being that a rough and uneven surface is produced which utterly spoils the appearance of the work, and which no after-labor can remedy. White or semi-white lines, of box or cedar, are often inlaid in the real wood. In the imitation if a white line is wanted, the line must be put in with the pencil and stopping varnish, and we should use the Canada balsam for that purpose, if the ground is white. A white or black outline round the

various woods makes an excellent finish to the work. If we want a black outline, the panel must be brushed all over with drop black in distemper and the outline pounced or traced and put in with Brunswick black, care being taken that the black is only used of a sufficient thickness to form a solid black, which if carefully put on will only require a very thin coat. All the other woods may then be grained and stopped out as above described, the superfluous black being previously removed by washing with water, so that it will not interfere with the color of the after graining. If the lines are pencilled clean and sharp with the varnish, they will appear so when the stopping is removed, and of course will add very materially to the beauty of the work when finished.

Sometimes it will be required to inlay dark woods upon a light wood, the latter forming the ground work. In these cases it is best to grain the light wood first and give it a coat of varnish. When this is dry and hard we may then proceed with the other woods, just as if it were a plain ground as before described. It will be seen that we have here a method of ornamentation, which when used with skill and good taste is of great importance as a means of decoration. Twenty different woods may be used on the same design if required with a command of color quite as extensive as is ever necessary to produce harmonious combinations in any style. The most elaborate as well as the simplest designs may be thus worked out effectively.

We have hitherto been describing the process of imitating marquetry or inlaid woods as it is done on painted grounds. We have now to describe the process as it may be applied on the surface of real woods. In this case we do not require to grain the various woods, but simply to color, or stain the grain of the real wood, of the color of each separate wood we wish the inlay to represent, and as there are several methods, and various stains we shall endeavour to make the description easily understood. Of fancy stains or dyes we give a list:— Ground Brazil wood, well boiled with a little cochineal added after it has been boiled, will make a crimson stain, and if the wood is previously coated with saffron liquid, similarly prepared, it will give a scarlet tint. Logwood chips boiled, and pearlsh and indigo added afterwards, will make a purple stain. Oil of vitriol, in which powdered indigo is dissolved, will make a blue stain. Pulverized verdigris, sap green, and indigo, added to strong vinegar, will make a green stain. A small piece of aloes in varnish will make a bright yellow, French berries also make a good yellow. Archil is a good red stain. Iron rust dissolved in vinegar affords a silver gray for staining light woods; a coating of a light red stain over a yellow one will make orange. Logwood chips well boiled and the wood coated with it, will be turned black by iron rust dissolved in vinegar.

Xylatechnigraphy is thus described by its inventor: "In order that my said invention may be most fully understood and readily carried into effect I will proceed to describe more in detail the manner in which I prefer to operate. Any of the ordinary woods used by the cabinet-makers are suitable to be ornamented by my invention, as the grain of the wood remains visible in the finished work, more especially in the lighter wood thereof. Woods with little figure and consequently the least expensive, are the most suitable. The surface of the wood is powdered with chalk to facilitate the manipulation of the design, which is then traced or marked on the surface of the wood in any convenient manner, and then, so much of the design as is to remain of the natural color of the wood is painted or coated by the artist with white hard varnish or stain-resisting solution; gums dissolved in spirits are suitable, I use white hard varnish. It is applied with a brush in such a manner as to obtain a sound varnish coating on the parts of the design where it is required. If on the first application of the varnish a sound coating of the varnish is not obtained the operation must be repeated.

The varnish being set, the lightest stain which is to be employed is next laid on; and when this is dry such parts of the surface as are to remain without further color are in turn coated by the artist with the stopping varnish." Over this, when it is quite set, another darker stain is applied, and in this way the work proceeds, the artist employing any number of stains requisite to produce the effect he desires. These stains may or may not be laid over the entire surface, as may be most suitable or convenient to the work in hand; but the stains in all cases will overlap the one on the other for in laying on the stains, they are not to be worked to an outline of the design, but the outlines are to be obtained by the careful laying on of the solution or varnish, which prevents the stains at certain parts from sinking into the wood. When all the stains necessary to

the desired effect have been laid on in regular graduations, from the lightest to the darkest the work has to be cleaned off, that is to say, the upper films of the various coatings of resisting varnish, which will be discolored by the stains, must be removed with great care and by degrees, or the wood beneath will be soiled. This is a work of some delicacy; it requires the application of a varnish solvent of such a nature as to be under complete control. I employ as a solvent spirits of wine, and I temper its action by the addition of French polish. At the commencement of the cleaning operation, a mixture containing but a very small proportion of spirit is increased until the end of the process, and then spirits of wine is alone used. The work may (when it has been properly cleaned) be French polished, or varnished in the usual way. The solutions ordinarily used for staining wood are applicable to the process above set forth.

We now describe a method for staining white woods in various patterns in imitation of inlaid woods. It is simple, thoroughly effective, and much quicker than the process described above. Prepare the panel or table top as smoothly as possible; then give it one or two coats of the following mixture. Glue size of just sufficient strength to form a jelly, add to this a little egg albumen and a small quantity of alum. When thoroughly dissolved and mixed, coat the whole of the surface to be stained, with it. Two coats will be required, but this preparation must not be too strong. When this dry and thoroughly hard, the design must be traced or pounced upon it. Now use Brunswick black, or Canada balsam, and paint in the outline of the pattern and all other parts that are to remain of the natural color of the wood laying on the black with a good body. Let this remain until it gets thoroughly hard, which will be in about six or seven hours. Now take a sponge and clean water and wash off all the size preparation which is on the parts not covered by the Brunswick black (luke warm water may be used). The preparation must be all removed before any of the stains are applied. The Brunswick black prevents the water from interfering with the preparation which is underneath it, and also prevents the stains from running one into other, when they are being applied. The woods must now be allowed to dry, when it will be ready for the application of the colored stains. If the outline has been properly done, it will appear as a black outline. The various parts of the ornament and the line should be fully a sixteenth of an inch wide, but may be wider if required. Having decided what parts shall be one wood and what another, we proceed to put in the stains which may be either spirit stains or water stains, or part one and part the other, but whichever is used, the lightest stains must first be put in, and in doing this we need not confine it to the exact outline of that particular part, but it is as well to do so. The stain may be freely used and laid as level as will allow, but a little shadiness is not at all objectionable. Now proceed to the next darkest stain, and so on for as many stains as are required. When this is dry and hard, the Brunswick black may be washed clean off the wood with a brush and turpentine, using the turps freely until the whole of the Brunswick black is removed. When this is the case the various colored stains will appear enclosed with a white outline, which if properly done, will be sharp, and clean, and clear as an inlay of the real woods. What grain the white wood has, will be more or less seen through the stains, as they may be light or dark. The work may then be French polished, or varnished, but in all cases we would recommend the polish. When a black outline is required instead of a white one, the work must be prepared as before described, and then a coat of black in distemper must be put upon it, and the outline painted in with the Brunswick black as before. The black and preparation is then washed clean off, and the staining done as above directed. As a matter of course each stain may be covered with the Brunswick black before another is applied, but with ordinary care in the working, this need not be done.—*American Cabinet-maker.*

#### THE AMERICAN TRICYCLE SKATE.

(For Illustration, see last page.)

We give an illustration of the New American Tricycle Skate, said to be the fastest skate ever invented; twenty miles can be done with it. It is reported to act as well upon any ordinary surface, floor, carpet, &c., as any ice skate under the most favourable conditions, and to admit of any figure or evolutions possible in any other skate. The inventor is Mr. J. F. Walter, of 7, Queen's road, Bayswater, W.



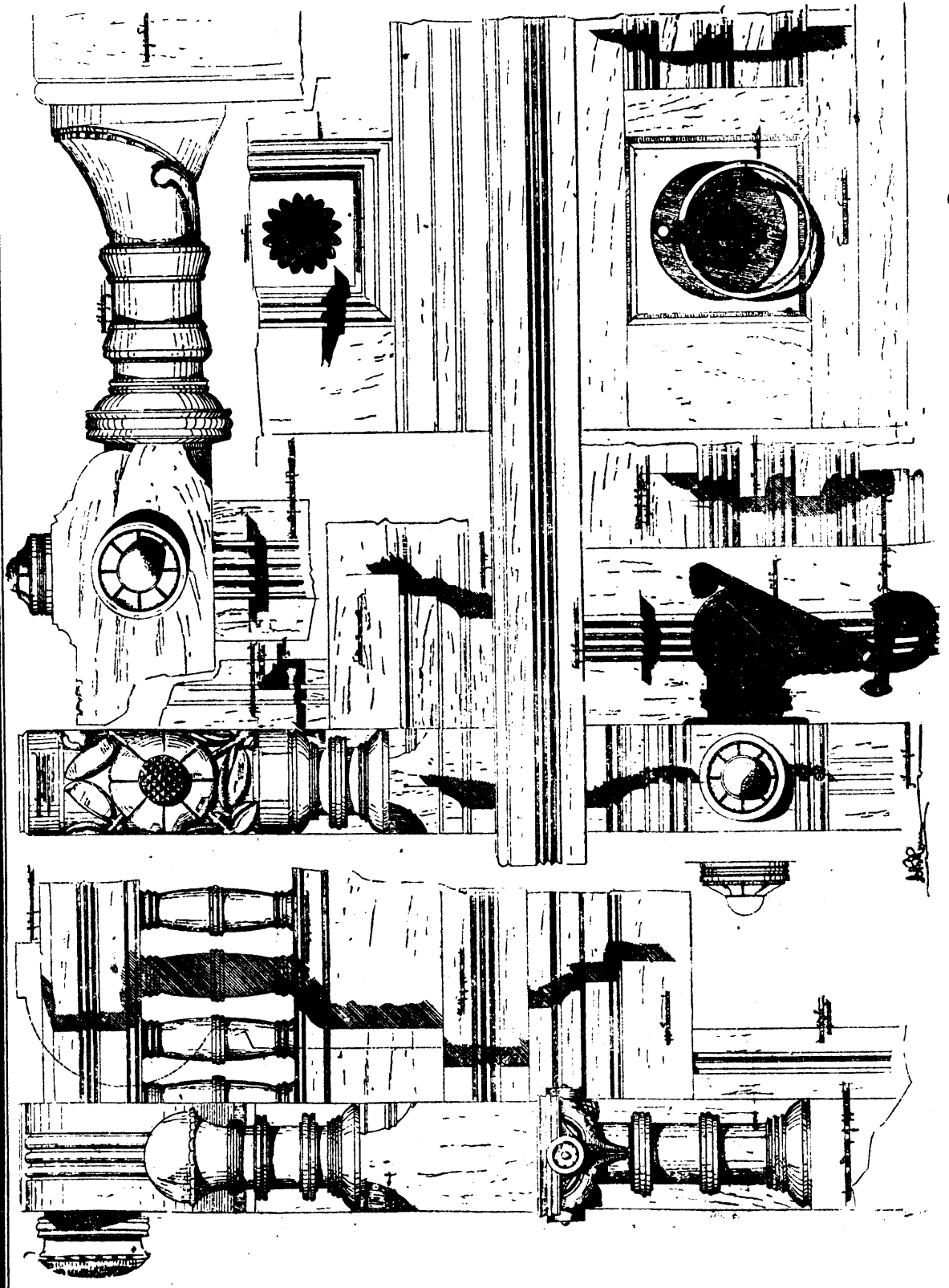

DETAILS OF SIDEBOARD GIVEN IN SEPTEMBER NUMBER.—FROM A DESIGN BY J. PH. RINN, ARCHITECT, BOSTON.

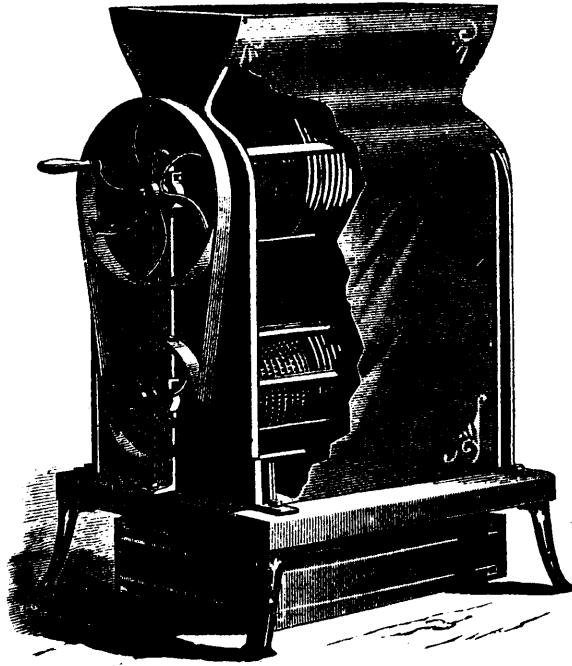

MUELLER'S CORN CRUSHER.

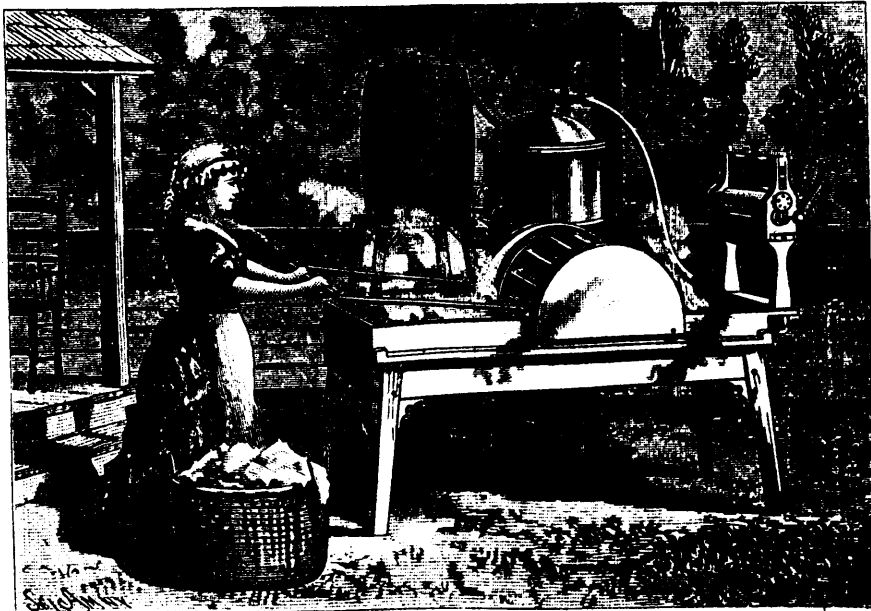

MERONEY'S WASHING MACHINE.

## IMPROVED WASHING MACHINE.

The engraving shows an improved washing machine recently patented by Mr. Thomas J. Meroney, of Salisbury, N. C. In this machine the clothes, while under the pressure of a corrugated roller, are subjected to the action of steam, so that while the clothes are being agitated or rubbed they are subjected to the action of steam.

This machine has a plain wooden tank lined with copper or galvanized iron, with perforated pipes in the bottom for the admission of steam, with corrugated copper or galvanized iron roller of sufficient weight. This roller gathers the air while passing back and forth over the clothes, and forces air and water through the fabric. At same time the steam is thrown up through the perforated pipes at the bottom of the tank. There are wooden strips between the pipes to protect them and make the bottom of the tank smooth. This machine is very simple both in construction and operation. It can be operated with very little exertion, and does its work quickly and thoroughly. It will wash the thickest fabric as well as the thinnest muslin or lace. In addition to its use as a clothes washer it may be used for washing wool, and the boiler answers a good purpose for steaming and boiling grain and vegetables for stock.

This machine differs from other washing machines in using steam as the principal agent for agitating the clothes and removing the dirt. Of course the steam always keeps the water at the boiling point, which is very desirable for rapid work.

Further information may be obtained by addressing the inventor as above.

## IMPROVED CORN CRUSHER.

An improved corn crusher invented by Mr. George C. Mueller, of Red Bluff, Cal., is shown in the engraving. It is designed for crushing ears of corn to reduce them to the proper state for fodder. The machine consists of two parallel cylinders journaled in a frame, and inclosed by a suitable casing, surmounted by a hopper, into which the ears of corn are fed. The upper cylinder carries a number of saws arranged a small distance apart, and revolves near a concave also made of saws, which are curved to form a tapering cavity in which the ears of corn are received. The saws of the concave enter the spaces between the saws of the cylinder, so as to insure a more thorough breaking up of the ears.

The corn entering the machine is first crushed into small fragments by the saws. It is then delivered by an inclined chute to the cylinder below, which is provided with a series of pins arranged in circumferential rows. This lower cylinder revolves near a concave, also armed with pins, and between these pins the corn is reduced to meal suitable for fodder. The meal is discharged into the box below.

The machine may be driven by hand power, horse power, or by connection with any convenient motor. It is compact, effective, and easily operated.

Further information may be obtained by addressing the inventor as above.

**SQUARING THE CIRCLE.**—There is one problem very often presented in laying out gear, especially where there is a rack to mesh with a spur wheel or a pinion, and that is "rectifying an arc." It is about as near to the impossible "squaring the circle" as approximation permits. It consists in stepping off upon a straight line tangent to a given circular arc the exact length of the arc, or, conversely, stepping off upon a circular arc the exact length of a given straight line. This problem may be solved on the drawing-board by geometrical construction, with an approximation closer than men can work with ordinary tools.

Suppose that A B in Fig. 1 is a circular arc, and that it is required to find upon the tangent A F its exact length. It is done as follows: Draw the chord A B and produce it to E, making A E equal to one-half A B. With center E and radius E B describe the arc B C, cutting A F in C. Then the straight line A C equals the arc A B, provided the latter does not exceed 60°.

To get the length on a circular arc, as A K, Fig. 2, which shall be equal to a given straight line—for example, A C, tangent to that arc—lay off A O equal to one-fourth of A C. With radius O C equal to three-fourths of A C, from O as center, draw an arc C K, cutting the circular arc in K. Then the arc A K will equal the straight line A C.—*Metal Worker.*

## Chemistry, Physics, Technology.

## THE PHOTOGRAPHING OF MOTION.

The admirable method devised by Mr. Muybridge, and which consists in employing instantaneous photography for analyzing the motions of man or animals, still left to the physiologist a difficult task; for it became necessary to compare with each other successive images, each of which represented a different attitude, and to class such images in series according to the position in time and space that corresponded to each of them.

Let us admit that nothing has been neglected in the experiment; that, on the one hand, the points of reference that photography is to reproduce have been arranged along the track to be passed over by the animal, so as to permit of ascertaining at each instant the position that he occupies in space; and that on another hand, the instant at which each image has been taken is determined, as happens with photographs taken at equal intervals. All such precautions having been taken, it is still necessary in order to obtain from the figures the meaning hidden therein, to superpose them one over the other (either in imagination or actually), so as to cover a paper band, corresponding to the road traversed, with a series of overlapping images, each of which expresses the position that the body and limbs occupied in space at each of the moments considered.

Such representations give rise to figures like those that the Weber brothers have introduced into use for explaining theoretically how man walks. In the works of these gentlemen we see only a series of silhouettes of men, shaded with cross-hatching of decreasing strength, and overlapping so as to represent the successive displacements of the legs, arms, trunk, and head at the different phases of one step. This mode of representation is the most striking one that has as yet been devised, and it has been adopted in the majority of classical treatises. Now, it has appeared to me (and experience has confirmed the provision) that we might demand figures of this kind from photography: that is to say, unite on the same plate a series of successive images representing the different positions that a living being moving at any gait whatever has occupied in space at a known series of instants.

Let us suppose, in fact, that a photographic apparatus be set up on the road which is being traversed by a walker, and that we take the first image in a very short space of time. If the plate were to preserve its sensitiveness, we might, in an instant, take another image that would show the walker in another attitude in another point of space. The latter image, compared with the former, would exactly indicate all the displacements that had occurred at the second instant. By multiplying the images in this way at very short intervals, we should obtain a succession of the phases of locomotion with perfect authenticity. Now, in order to keep the photographic plate as sensitive as necessary for successive impressions, it is necessary that absolute darkness shall exist in front of the apparatus, and that the man or animal that is passing shall be detached in white from a black background. But the blackest objects, when they are strongly lighted, still reflect many actinic rays; and so I have had recourse, in order to obtain an absolutely black field, to the method pointed out by Chevreul, my screen being a cavity with black sides. While a man wholly clothed in white, and brightly lighted by the sun, is walking, running, or jumping, the photographic apparatus, which is provided with a more or less rapidly revolving shutter, takes its image at more or less approximate intervals. This same method may be applied to the study of different types of locomotion; and a white horse, or a white bird, will give in the same way a series of their attitudes.

The window in the disk of my shutter may, at will, be enlarged or reduced, so as to regulate the duration of pose according to the intensity of the light, or according to the velocity with which the disk revolves. With the window reduced, and a slow rotation, we obtain images widely spaced apart. A rapid rotation gives more approximate images, but one whose time of pose might be insufficient if the windows were not enlarged. Finally, a swinging shutter placed before the other serves for regulating the beginning and end of the experiment.

The proofs from the negatives that I have obtained, and a sample of which is shown in the engraving, were made at the physiological station of the Parc des Princes, where I worked with the aid of Mr. G. Demy.—E. J. MAREY in *La Nature*.

## Inventions.

### THE NEW MALLET SYSTEM OF CONTROLLED COMBUSTION.

For months past the ground floor of the building No. 500 East Eighteenth street furnished a growing mystery to the habitual passers-by. There seemed to be no special industry carried on there. It was a plain open space, with a forty-horse double flue boiler, and nothing more. Steam was generated but it was allowed to run to waste up the tall chimney stack at the rear end of the building, but singularly enough, and that soon became the chief point of the mystery, there was no smoke evolved. For six months the boiler, which had been an ordinary affair, such as may be purchased in any boiler shop of the city, made steam, burned up ton after ton of coal, wood and even tobacco, but did not belch forth the usual volumes of smoke. The greatest care was taken to keep off prying eyes. A burly watchman, who was not to be bullied or cajoled, guarded the premises night and day, and but very few were permitted to pass into the building. Those who were allowed to enter were engineering experts who were invited to witness the practical workings of a furnace which promises to work a revolution in the furnishing of power by steam. The experts came there critical and doubting; they went away convinced that it was the greatest discovery since the invention of the steam engine. Among those thus invited to see the experimental boiler were J. M. Blanchard, United States Examiner of Patents; Frank Wilder, superintendent of the motive power of the Erie Railway; W. W. Evans, superintendent of the Grant Locomotive Works; W. H. Culver, of the Dickson Locomotive Works; Professor Thurston, of the Stevens Institute of Technology, and Mr. Rider, of the Delamater Iron Works, who came provided with chemical and mechanical testing machines, and gave this initial boiler a most exhaustive test.

#### THE INVENTOR OF THE SYSTEM.

The new method of burning fuel was the invention of E. J. Mallett, Jr. He is the son of General E. J. Mallett, for many years United States Consul General at Florence, Italy. He was partially educated there and displayed a great taste for chemical research. Coming to New York he placed himself under the tuition of Professor Joy, of Columbia College. This was before the establishment of the present School of Mines in connection with the college. Going West into Colorado young Mallett was sought for as an expert on the most difficult metallurgical questions. He saw the great waste in the treatment of silver ores and set about the building of reverberatory furnaces in which bituminous Colorado coal could be used. With wood ores had been roasted, but not successfully with coal. The idea of drawing the air through the fire instead of forcing it in suggested itself to Mr. Mallett and was found to be a good one. More perfect combustion was the result, and the works in Canyon City, perfected in 1878, have since yielded their inventor a handsome income. Mr. Mallett was the first president of the School of Mines of Denver City, Colorado and ranks in the highest place as a chemist and physician.

It will be remembered that an account of his original researches on the use of original researches on the use of filamental carbon (antedating Edison's experiments) for electric lighting were first fully described by the *Herald*. The whole question of fuel, waste and controlled combustion then came under Mr. Mallett's attention. He was not only an educated engineer in theory, but he had seen and directed practical enterprises on a large scale. He took as a motto the apothegm of Bacon, "If experiments are not directed by theory they are blind; if theory is not sustained by practice, it is deceiving and uncertain." He took the common lamp as a text and model. When the smoke is seen issuing from the flame of an ill adjusted common lamp, the flame itself is dull and murky and the heat and light diminished in quantity. It would be impossible to burn that smoke when once produced, and all the "smoke consumers" were at once rejected by the young inventor, who turned him again to his Argand lamp and, having adjusted it, saw it burn without producing any smoke with a flame white and clear and the quantity of heat and light increased. The lamp had not burned its own smoke, but it had burned without smoke. The step from the lamp to the furnace was a simple one.

#### APPLICATION OF SCIENTIFIC PRINCIPLES.

Experts had known for years that, scientifically, carburetted hydrogen and the other compounds of carbon require certain quantities of atmospheric air to effect their combustion, yet practically no means were adopted for ascertaining what quantities are supplied, or they are treated as though no such proportions are necessary. Scientifically it is known that inflammable gases are combustible only in proportion to the degree of mixtures and union which is effected between them and the oxygen of the air. Yet practically engineers have never troubled their heads whether such a mixture is effected or not. The perfect control over the air supplied to the lamp Mr. Mallett sought to extend to the furnace. The inflammable gases generated by the application of heat to coal may be burned in a laboratory experiment with great nicety. But there are many other surroundings in a furnace. First, the quantities are large; second, the bodies to be consumed are partly gaseous, partly solid; third, the gases evolved from the coal are part combustible and part incombustible; fourth, they are forced into connection with a large and often overwhelming quantity of the products of combustion, chiefly carbonic acid gas; fifth, the very air introduced it itself deteriorated in passing through the bars and incandescent fuel on them, and thus deprived of much of its oxygen; sixth, and above all, instead of being allowed a suitable time, the whole is hurried away by the current or draught in large masses. From a ton of bituminous coal about 10,000 cubic feet of coal gas are produced, requiring about 100,000 cubic feet of air, adding to this the 240,000 cubic feet required for the combustion of the coke, or solid part of the coal, and a gross volume of 340,000 cubic feet of air is shown as the minimum quantity for a ton of coal, independently of the excess above that chemically required. When a fresh charge of coal is thrown upon the hot fire a great quantity of gas is at once generated, and it is just at this time that the passage of air is most restricted, and hence the great waste, though the appearance or non-appearance of visible smoke is no test either for or against the admission of air, as to quantity, since smoke may come from too much air as from too little. The first fuel loss comes from air entering the furnace and absorbing a much larger amount of heat than it gives back before it passes out of the chimney. A fire box of a furnace, in a measure, simulates a gas retort, producing volatile hydrogen, which passes up a big gaspipe, the chimney, and is lost in space unless air enough to enable it to burn is brought in contact with it. This division of the air for combustion was an important feature, one part going to the combustion of the solid fuel and the other part for the combustion of the gases, and at different stages of the combustion variations in the air supply and for the combustion of the gases a supply of hot air. Mr. Mallett soon arrived at certain definite points in what he termed his "controlled combustion," which included the admission of known and controllable amounts of air to burning fuel; the division of the air necessary for combustion into two volumes, one to burn the solid, the other to burn the volatile constituents of the fuel; the power of varying the relation of these two volumes of air so that while the sum total of air entering a furnace may remain the same, variable quantities may be admitted beneath the fuel and into the gas-combustion chamber; the supply of hot air to fuel gases to prevent the lowering of their temperature before they are ignited; the supply of hot air to the gas combustion chamber in subdivided currents or jets to assure a rapid mixing of the air and fuel gases; the separation of the furnace into two compartments, the firebox and the combustion chamber, such separation being effected by a brick septum wall, having apertures through which the fuel gases may enter the combustion chamber in a controllable manner to permit of their immediate incorporation with hot air; the utilization of that part of the heat contained in burnt fuel gases not conveyed to the boiler and which in the usual practice is required to produce draught; the substitution of mechanical aspiration for chimney draught.

#### THE SYSTEM GRAPHICALLY SHOWN.

All of these points are accomplished in the Mallett modification of the usual furnace. Fig. No. 1 shows a section of a furnace. In the firebox is seen the mass of burning coal resting upon the grate bars, which in this case are merely lengths of pipe, running from the boiler face to the rear of the septum wall, which is built of firebrick. When the charge of coal is first thrown in upon the live coke the supply of air is allowed to go through these open pipes, while the air by the usual en-

(Continued on page 350)

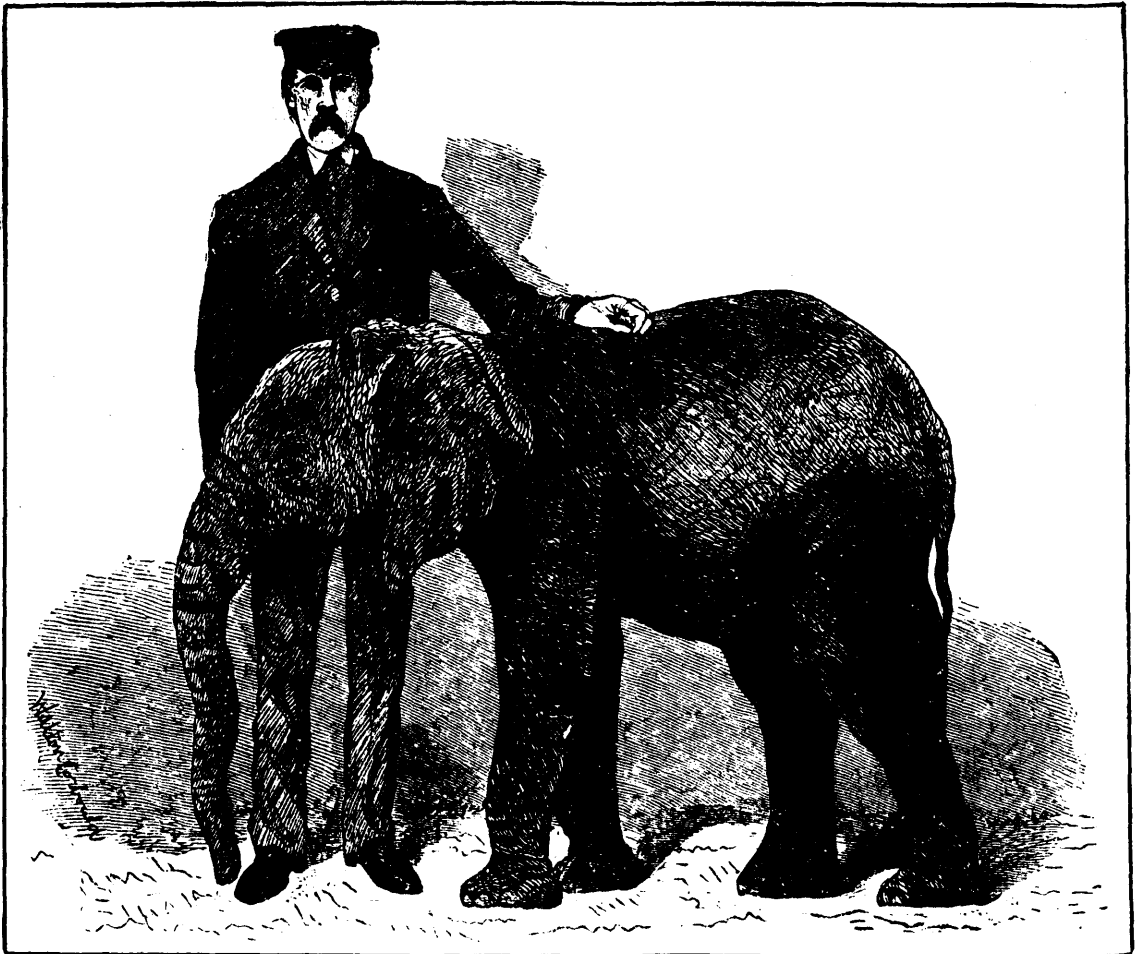

JINGO, THE YOUNG AFRICAN ELEPHANT, AT THE ZOOLOGICAL GARDENS, LONDON, ENG.

#### ZOOLOGICAL SOCIETY'S COLLECTION.

The stall in the Zoological Society's elephant-house rendered vacant by the departure of the much-lamented "Jumbo" has lately been filled by a miniature representative of the same species. "Jingo" as he has been named, in appropriate allusion to the circumstances now existing in the continent whence he came, is a young male African elephant, believed to be from three to four years of age, and measuring 4 ft. 2 in. in height. So far as can be ascertained, he is without defect internally and externally, not having even any holes or notches in his ears, without which a captive elephant is seldom to be found. Besides this, he is perfectly quiet and docile, and so soon as the wicker howdah which has been ordered for him is provided, will be ready to carry children about the Zoological Gardens, in the way of his larger brethren.

"Jingo" was purchased by the society of the well-known dealer in living animals, Mr. Carl Hagenbeck, of Hamburg, by whom he was imported about a year since from Upper Nubia. Every winter season for several years past large importations of living animals have taken place from this district, which is, in fact, the only accessible locality whence living African elephants can now be procured. In the South African colonies this huge animal may be said to be altogether extinct, with the exception of one herd still existing on the Knysna. But on the Atbara and Settite rivers, in Upper

Nubia, where Sir Samuel Baker performed his celebrated hunting exploits, the African elephant is still to be met with, though in yearly diminishing numbers. Captured here by the native Arab hunters, they are purchased by European agents, and walked to Suakim, whence steam transport readily conveys them to the ports of Europe. It will be understood that the younger animals only are selected for captivity, the older ones of both sexes being slaughtered for the sake of their ivory. "Jingo," whose portrait we now give, will, it is hoped, in process of time, attain something like the stature of "Jumbo," without developing any of his evil qualities.

Stories of venomous lizards are rife in all countries. In India the innocent house-geckos are commonly reported to be highly dangerous; and some of the Australian lizards bear an evil reputation, although their only fault lies in their extreme ugliness. But until recently it was held by naturalists that no known lizard had a really poisonous bite, although it would have been granted that some of the larger monitors and iguanas were quite capable of inflicting a serious wound with their jaws and teeth.

Of late years, however, it has been ascertained without doubt that a peculiar lizard found in the arid districts of Mexico and Arizona is really poisonous, and thus one exception has been established to the general proposition that "lizards are harmless creatures." \*

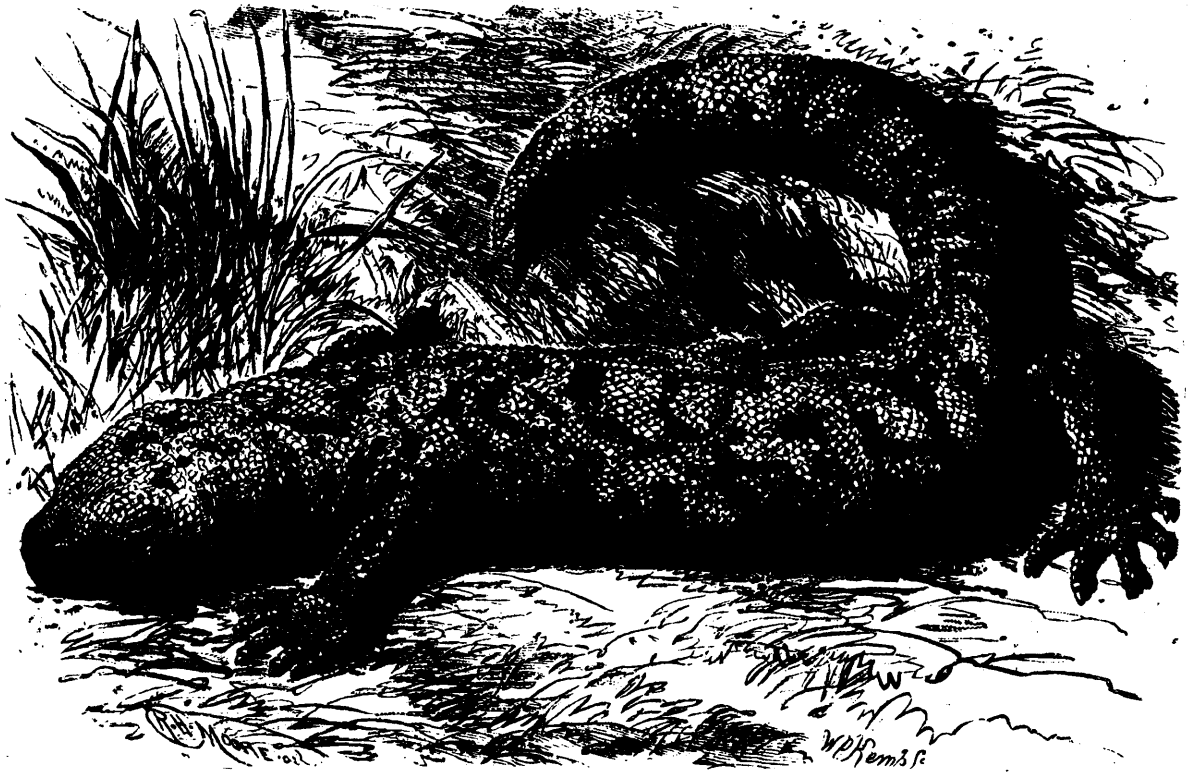

THE POISONOUS LIZARD (*HELODERMA HORRIDUM*) FROM MEXICO, AT THE ZOOLOGICAL GARDENS, LONDON, ENGLAND.

The lizard in question is the heloderm (*heloderma horridum* of naturalists) or "scorpione" of the Spanish natives of the countries which it inhabits. The heloderm, though its venom is proverbially not fatal to human life, is decidedly a dangerous animal. Mr. J. Stein, a German traveller in Mexico, having been bitten in the finger by one of these lizards suffered severe symptoms, similar to those ordinarily produced by a snake-bite, and the deadly effects of the fangs of the heloderm upon small mammals have been proved by actual experiments.

An example of the heloderm, shown in our figure, and which is believed to be the first that has reached Europe alive, has recently been presented to the Zoological Society of London, by Sir John Lubbock, and may be now seen in the reptile-house in Regent's Park. It is about fifteen inches long, and certainly not unattractive in appearance, being covered with red and black scales. The specimen in question is a native of Arizona, where it was forwarded to Sir John Lubbock by Mr. Treadwell, Manager of the Central Arizona Mining Co.

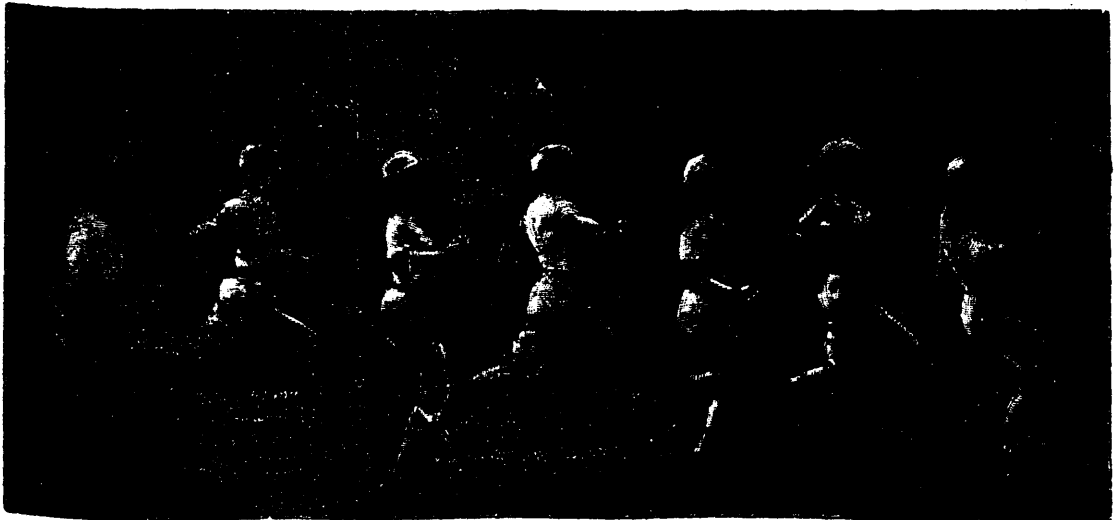

THE SUCCESSIVE PHASES IN THE MOTION OF A MAN RUNNING.

trance through the ash pit under the grate bars is cut off. The furnace becomes a retort, in which the coal is distilled and the carburetted hydrogen and other inflammable gases pass through the openings shown in the septum wall to meet a current of hot air and a fierce heat is the result. When the coal has become sufficiently heated then a moderate amount of air can enter the ashpit, working up through the coals, and the real process of burning goes on. To produce these results a mechanical draught is necessary, and this is brought about by a fan worked by a steam engine or by belt from a steadily working engine. If, however, the hot air and products of combustion were permitted to rush at this fan it would soon be burned out, and for a long time Mr. Mallett studied this part of his problem. He met it finally by injecting a spray of water into the flue through which the hot air was passing. The then moistened air readily gave up its heat to a coil of pipes through which the feed water of the boiler was passing and there was virtually produced a supplementary boiler in which both steam and water of an even temperature with that in the main boiler were produced.

Fig. No. 2 shows an ordinary stationary boiler. Below the furnace doors will be seen the row of grate bar pipes with the slide by which the supply of air passing into them may be regulated. It will be seen that the lever bar to the left works at one motion the slide over the grate bar openings as well as the slide in the ashpit door. There is no chance about it, but the amount of air for each boiler is carefully calculated and the levers set accordingly. The fireman has but to put on the coal and push the bar over to open the upper line of openings, permitting air to reach the combustion chamber, as shown in cut No. 1. When the fire has burned well up and rich gases are no longer given off the pushing of the lever over permits more air to pass in below and the complete combustion is secured. The fire is cleaned very easily by having a slot in the end of each grate pipe, and with a handle fitting them the fireman may give the bars a revolving motion, or, if need be a bar may be drawn out and a new one inserted without stopping the fires. In fact, once started a fire may be kept up indefinitely. The bars do not burn out, as there is at all times a strong current of air passing through them. To the right of the boilers, in Fig. No. 2 may be seen the cooling apparatus broken open to show the pipes within. The hot ultimate products of combustion, carbonic acid gas and nitrogen, come down from above and meet the small spray of water shower in the cut through the broken place in the flue. The pipe box, which is strongly made, has the hot air exhausted by the fan at the extreme right. The hot water pipe has a steam gauge upon it, as shown, and will have a safety valve as well, while between the pipe box and the boiler may be seen the connection by which the hot water and steam are respectively carried below and above the water line in the boiler. From the fan orifice comes out a torrent of carbonic acid gas mixed with nitrogen at a temperature of about 150 degrees. This may be allowed to go into the outer atmosphere at any point, and no chimney is required for it. The water spray keeps the gases at complete saturation, and this dew point is indicated by the dropping water from the small jet cock seen at the base of the superheater in cut No. 2.

The experimental furnace in East Eighteenth street having demonstrated that there was a real discovery, the Control Combustion Company was organized, and from February to August counsel were busy taking out patents the world over. The company is incorporated under the laws of the State of New Jersey with a capital of \$2,000,000. The trustees and owners of all the stock are.—Hugh J. Jewett, G. R. Blanchard, of the Erie road; R. Snyder Grant, of the Grant Locomotive Works; E. J. Mallett, jr., the patentee; Thomas C. Platt, of the United States Express Company; Walter S. Guruee, the banker, and H. E. Packer, of the Lehigh Valley Railroad. The company has an office in the Equitable Building and there the first application of the new style of boilers will be made. At present eight boilers are in use to supply the steam for heating the Equitable Building and running the elevator and dynamo machines, and the coal bill runs far up into the tens of thousands annually. Mr. Mallett is now changing two of the boilers and proposes to do with the other six boilers entirely for power. A few days more will witness the start of the new generators and then all who wish may see the smokeless chimneyless boilers in use.

#### THE SYSTEM ON THE RAILROADS.

A consolidated locomotive is being equipped for the Erie

Railway, with the appliances for the new system. Cut No. 3 will give some idea of the form of the boiler. The smokestack disappears entirely and in its place is a man hole merely. The fan may be seen in the cut with the small engine to work it. The gases produced by the complete combustion will escape about the periphery of the extended boiler casing. A powerful draft can be maintained even when the locomotive is at rest. The engines of the locomotives are relieved from the back pressure caused by exhausting steam through the nozzles and the heavy resonant noise is avoided. The exhaust steam passes along the side of the locomotive through the pipe seen in the cut, to the tender, which is divided into three compartments. The upper one is for the fresh water, the middle one contains copper tubes connected with the external air in front and with a suction fan in the rear. The exhaust steam circulates around the copper tubes and becomes in part condensed, the resulting hot water falling into the lower compartments. The uncondensed steam that comes in contact with a spray of water falling from the upper compartment and the condensed water also enters the lower compartment, from whence hot water is pumped into the boiler. The air used to condense the steam is employed for heating and ventilating cars, being delivered through a conduit, which with coupling ends, passes along beneath the cars. Three registers in the floor of the car admit the air. This system does away with coal stoves or heaters, and supplies the car with fresh air and warm air without danger of fire in case of a smash up. When the locomotive now under way is completed it is proposed to make with it a trans-continental trial trip. Having a number of passenger coaches heated and ventilated from the boiler, cold weather will be chosen, in order to indicate the value of the car heating system, and on the way the poorest fuel will be burned. The Illinois soft coal, the Colorado coal and any sort of fuel which any railroad company along the route may care to provide will be taken and used in this boiler without any display of smoke. With such a boiler in the Fourth avenue tunnel the accident September 22 would not have happened through the inability of the engineer of the second train to see the lights of the preceding train. The taking away of the smokestack will also enable the engineer to have a clear view of the road before him.

#### SAVING FUEL AT SEA.

On steam vessels there will be a similar change. The objectionable heavy smokestack is replaced by the small porthole aperture at a suitable height above the water line from which the gases resulting from combustion will escape into the atmosphere. As it is only required to get rid of these products, but in no sense by means of a chimney or flue to produce draught, any convenient aperture can be used. The objection to smokestacks on river steamboats where bridges exist is thus overcome, and the hinged and telescopic stack can also be dispensed with, the latter especially on war vessels. At present the arrangements for generating power or steam on the transatlantic liners are far from satisfactory; smokestacks fifty feet above the main deck level and fourteen feet in diameter, belching out high volumes of smoke, are nuisances. Below decks are ten or a dozen great boilers, burning up nearly two hundred tons of coal per day. With the more rapid production of steam by the complete combustion the work may be done with four boilers and at a saving of about fifty per cent of coal. No smokestack is used, but from a porthole the results of the boiler fires escape in an invisible stream of carbonic acid gas and some nitrogen.

#### THE SYSTEM ABROAD.

In a few days an experimental boiler, now erected in London, will be opened to public inspection. The English patents are controlled by a syndicate consisting of Winthrop Gray, Allen Thorndike Rice, James Frederick Kernochan and Richard Irving, Jr.; the French patents by General F. Herron and F. Degnon, Mr. Mallett and his associates have been proceeding slowly but surely. They have sought no notoriety, as there was no stock to sell, but among the engineering fraternity there has been a great of unsatisfied curiosity excited. But now, with the project beyond the pale of experiment, the company invites the public in to see the new idea in combustion, which is in no wise a mere smoke burner, but instead a non-smoke producer; for when smoke appears Mr. Mallett takes it as an indication that the combustion is not perfect and that the supply of air is either too great or too small. During an interview with a *Herald* reporter, Mr. Mallett, with a per-

fect command of the subject to which he has given so much attention, went over many of the points of his invention. The conversation in full ran as follows:—

REPORTER—Where were the experiments made?

Mr. MALLETT—A forty-horse steam boiler, equipped with the required appliances, has been in operation for several months in this city, and was subjected to all of the tests that scientific and practised experts could suggest. The results demonstrated a fuel saving of over forty-five per cent.

REPORTER—Can you explain to me how you effect such a saving?

Mr. MALLETT—I may, perhaps, be more concise by giving you extracts from a paper which I am preparing for the Royal Academy of Sciences of Turin, in view of that body offering 12,000 lire for the most important discovery made within the past two years. The system which I termed “controlled combustion” is based on certain experiential, fundamental principles which have as yet remained undeveloped in practice. Fuel loss arises, first, from imperfect combustion evinced by the production of carbonic oxide, often seen burning with a blue flame on a coal fire and on the top of chimneys; second by heat lost in producing chimney draught; third, by insufficient absorption of heat in the boiler itself.

#### EXPERIENTIAL PRINCIPLES.

REPORTER—Will you mention these principles?

Mr. MALLETT—They may be formulated as follows:—

*First*—Hydro-carbon fuel tends to burn with less carbonic oxide and smoke proportionately as its environing atmosphere diminishes in tension.

*Second*—Hydro-carbon fuel, tends to evolve carbonic oxide and also smoke if burned in a furnace until the temperature of the fuel reaches a certain elevation.

*Third*—The tension of the fuel gases within a furnace is never less than that produced by the burning of the fuel itself by natural draught, and is never sufficiently low, when compared with the rate of combustion, to prevent the origination of carbonic oxide or smoke.

*Fourth*—What was considered probable by Rankin, Peckett and others is demonstrated in controlled combustion—viz., that air for dilution in furnace combustion would be combustion rendered unnecessary provided chimney draught could be dispensed with; and provided also that without such draught a supply of sufficiently heated air in divided currents could enter the combustion chamber in regulable quantities.

*Fifth*—To maintain an atmosphere of the desired tension within a firebox an air exhauster must supplant the chimney, and the influx of air into the ashpit must be throttled.

*Sixth*—When combustion is urged by a blast fan causing the furnace air tension to be greater than normal barometric pressure, both physical and chemical actions result, differ from those created by a draught or flue fan incompatible with perfect combustion.

*Seventh*—Hydro-carbon fuel freshly charged into a furnace must not be supplied with air to initiate its burning until the temperature of the fuel is sufficiently elevated. The fuel must begin to distil before it begins to burn.

*Eighth*—To compel a rapid and intimate mixture of hot air with combustible fuel gases generated within a boiler fire-box these gases must not be allowed to ascend or envelop the boiler until after they enter the combustion chamber through channels in close proximity to those conducting freshly heated air into the combustion chamber.

*Ninth*—The heat from escaping furnace gases after leaving a steam boiler is, more completely radiated for additional heating and boiling of water if such gases be rendered athermous by being kept at their dew point.

*Tenth*—It is possible in practice to superheat all the feed water required by a steam generator from the waste heat of the escaping gases to a temperature equal to that of the water within the generator, and also to supply a portion of the feed in the form of steam.

*Eleventh*—The potential power of a steam generator may be increased to a greater limit than hitherto without diminishing the economic result.

*Twelfth*—To burn fuel rapidly without creating a too high localized temperature, it should not be supplied with sufficient air to burn it at once to carbonic acid only, but considerable carbonic oxide should be produced to be afterward burned in the combustion chamber.

REPORTER—Why does diminished air tension tend to prevent smoke?

Mr. MALLETT—If we take a tallow candle that burns with a smoky flame at sea level to a summit as high as Mount Blanc we shall find that the candle not only ceases to smoke before the summit is reached, but burns at such an elevation with a barely luminous flame, resembling that of alcohol. Conversely if an alcohol flame is burned in compressed air it becomes very luminous, and by further compression of the air the flame will actually smoke. To burn fuel we know that it must mix with air, and we know also that the more rapidly we mix the more rapidly we burn small particles. Now, air, when compressed, is approaching the solid form, and possesses in a less degree that molecular mobility of more diluted air. It thus occurs that such compressed air cannot enter and mix with flame and oxidize the carbon quickly enough to produce perfect combustion. On a mountain top, however, the less dense condition of the air permits so rapid an admixture with the candle flame that the candle not only ceases to smoke, but does not even diffuse light.

#### CHIMNEY DRAUGHT NOT NEEDED.

REPORTER—How can you dispense with a chimney?

Mr. MALLETT—An exhaust fan replaces the chimney and produces draught by drawing the gases of combustion from the furnace instead of forcing air into the ashpit as is customary. I can assist my explanation by making you a sketch of a boiler furnace as modified for controlled combustion. In fig. 1 you notice that the furnace under the boiler is divided into the fire-box proper and the combustion chamber by a division or septum wall, which replaces the ordinary bridge wall, having openings, as shown, through which the flames and fuel gases enter the combustion chamber. The air necessary for the combustion of the fuel gases enters the combustion chamber through the grate bars, which are tubular, having one end in communication with the external air and the other end opening into the combustion chamber just below the apertures in the septum wall. To respond to the demands of principle 1, just cited, provision is made to throttle the air that enters the ashpit, and thus compel the desired amount to pass through the hollow bars by the exhausting action of the fan. As the fan constantly tends to void the fire-box of air, and as the entrance of air from the ashpit can be restricted to any degree, a curious phenomenon results—viz., an air tension of the fire-box very much below that which could possibly result from chimney draught and independent of the rate of combustion.

REPORTER—Why could you not throttle the air that enters the ashpit, if chimney draught instead of mechanical draught was used?

Mr. MALLETT—It must be obvious to you that when draught is created by the burning of the fuel itself, if we attempt to diminish the amount of air entering the ashpit the draught will stop. In controlled combustion it is necessary to prevent any air gaining access to the fuel from the ashpit each time the furnace is charged with bituminous coal or wood, so that the fuel will rapidly distil before it begins to burn.

REPORTER—How can you possibly prevent fuel freshly charged into a furnace from beginning to burn until you want it to?

Mr. MALLETT—Just look at fig. 2, which shows a view of a boiler front. You see that the ashpit door has a sliding register which admits of any desired opening or can be entirely closed. You notice, also, that the open ends of the grate bars come through the boiler front, and are also provided with a sliding register. The lever handle actuates both sets of air registers. On charging fresh coal into the furnace the lever is caused to shut off all air entering the ashpit at the same time that it increases the area of the openings of the tubular bars. The heat of the furnace begins rapidly to raise the temperature of the fresh fuel, and the gases that at once begin to distil from the fuel are burned by the air passing through the tubular bars. At the proper time air is allowed to enter the ashpit and then the fuel really begins to burn. The supply of air, however, is always restricted, so as to maintain a low tension in the fire-box.

#### WHY FUEL IS NOW WASTED.

REPORTER—What do you mean, in principle 4, by air for dilution?

Mr. MALLETT—Fuel, when burning with such excessive velocity in a furnace, requires more air to come in contact





THE AMERICAN TRICYCLE SKATE.

with it and its gases than is chemically required for combustion. Ordinarily twice the amount of air is required. In controlled combustion the diminished density of the air produced as above described, together with its heated and subdivided condition as it enters the combustion chamber, permits of practically only twelve pounds of air per pound of fuel being used.

**REPORTER**—Why did you think of using a fan to exhaust furnace air and thus produce draught.

**MR. MALLETT**—When you consider that air is like a rope in this respect, that it can be better pulled than pushed, and that in inducing draught instead of blast by a pressure fan you are simulating the actual effect of a chimney without a loss, you must admit that the advantage of mechanical draught is great. While chimney draught causes a loss of fuel of from twenty-five or thirty-five per cent. draught by a flue fan can be produced at from three to four per cent of fuel expenditure.

**REPORTER**—Do not the heated gases destroy the fan in time?

**MR. MALLETT**—Not only would heated gases effect the fan, but their expanded volume would necessitate a fan of impracticable size. It was a difficult problem to devise a means of rapidly cooling furnace gases. Reflecting that dry air of even a very high temperature did not radiate heat to our own bodies in a Turkish bath as perceptibly as moistened air of a very much lower temperature in a Russian bath, it occurred to me that if these escaping gases could in a practical way be saturated with moisture and be thus kept at their dew point their radiating property would be so increased as to cause them to

be rapidly cooled when in contact with a cooler substance. The above sketch illustrates how this is done in practice. The square case to the right of the boiler is packed with iron pipe, forming a continuous passage for the circulation of water that enters the pipes at the bottom of the case, passing out from the uppermost series of pipes. The ordinary feed water of the boiler is, by means of a pump, forced into the lower series of pipes. The heated furnace gases enter the apparatus called an "athermous superheater" (athermous meaning opaque to radiant heat) at the top, pass in a downward direction through the stack pipes and then enter the exhaust fan. A spray of water, as shown, in quite an insignificant quantity, saturates the gases with moisture. This water comes from the uppermost pipes of the superheater, and, before escaping through the spray, has a boiling temperature. Although the gases entering the superheater may have a temperature of 1,000 degrees they will be cooled over 800 degrees during their transit. It is found that even with a very rapid rate of combustion and boiler evaporation all the feed water of the boiler will not only be heated to the same temperature as the water within the boiler, but that it will, in part, be converted into steam. In order to utilize this steam and not allow it to enter the boiler together with the feed water, a "separator" is attached to the superheater, which causes the superheated water to feed the boiler while the produced steam enters the steam space of the boiler; the products of combustion thus leave the furnace, not only in a perfectly invisible condition even when soft coal or wood is burned, but their temperature is reduced to the lowest possible limit.—*New York Herald.*