

Technical and Bibliographic Notes / Notes techniques et bibliographiques

The Institute has attempted to obtain the best original copy available for filming. Features of this copy which may be bibliographically unique, which may alter any of the images in the reproduction, or which may significantly change the usual method of filming, are checked below.

L'Institut a microfilmé le meilleur exemplaire qu'il lui a été possible de se procurer. Les détails de cet exemplaire qui sont peut-être uniques du point de vue bibliographique, qui peuvent modifier une image reproduite, ou qui peuvent exiger une modification dans la méthode normale de filmage sont indiqués ci-dessous.

Coloured covers/  
Couverture de couleur

Covers damaged/  
Couverture endommagée

Covers restored and/or laminated/  
Couverture restaurée et/ou pelliculée

Cover title missing/  
Le titre de couverture manque

Coloured maps/  
Cartes géographiques en couleur

Coloured ink (i.e. other than blue or black)/  
Encre de couleur (i.e. autre que bleue ou noire)

Coloured plates and/or illustrations/  
Planches et/ou illustrations en couleur

Bound with other material/  
Relié avec d'autres documents

Tight binding may cause shadows or distortion along interior margin/  
La reliure serrée peut causer de l'ombre ou de la distorsion le long de la marge intérieure

Blank leaves added during restoration may appear within the text. Whenever possible, these have been omitted from filming/  
Il se peut que certaines pages blanches ajoutées lors d'une restauration apparaissent dans le texte, mais, lorsque cela était possible, ces pages n'ont pas été filmées.

Additional comments:/  
Commentaires supplémentaires:

Coloured pages/  
Pages de couleur

Pages damaged/  
Pages endommagées

Pages restored and/or laminated/  
Pages restaurées et/ou pelliculées

Pages discoloured, stained or foxed/  
Pages décolorées, tachetées ou piquées

Pages detached/  
Pages détachées

Showthrough/  
Transparence

Quality of print varies/  
Qualité inégale de l'impression

Continuous pagination/  
Pagination continue

Includes index(es)/  
Comprend un (des) index

Title on header taken from:/  
Le titre de l'en-tête provient:

Title page of issue/  
Page de titre de la livraison

Caption of issue/  
Titre de départ de la livraison

Masthead/  
Générique (périodiques) de la livraison

This item is filmed at the reduction ratio checked below/  
Ce document est filmé au taux de réduction indiqué ci-dessous.

10X	14X	18X	22X	26X	30X
<input type="checkbox"/>	<input type="checkbox"/>	<input type="checkbox"/>	<input type="checkbox"/>	<input checked="" type="checkbox"/>	<input type="checkbox"/>
12X	16X	20X	24X	28X	32X

# The Canadian Patent Office

## RECORD

Vol. IV.—No. 8.

AUGUST, 1876.

Price in Canada \$2.00 per An.  
United States - \$2.50

### CONTENTS.

INVENTIONS PATENTED.....	115
INDEX OF INVENTIONS.....	CXXIII
INDEX OF PATENTEES.....	CXXIII
ILLUSTRATIONS.....	125

### INVENTIONS PATENTED.

#### No. 6214. Saw-gummer. (*Machine à affûter les scies.*)

Joseph M. Smith, Rochester, N. Y., U. S., 16th June, 1876, for 5 years.

*Claim.*—1st. The combination with the carriage E, and screw L, of the coiled spring B, resting at one end against a shoulder of the main frame, and connected at the other with the screw by means of a nut adjustable up or down on said screw, whereby the spring may be compressed a greater or less degree to vary the range of motion or the feeding pressure of the milling tool; 2nd. The combination with the screw L, and spring B, of the nut p, made adjustable upon the screw for the purpose of compressing the spring, and the hand wheel u, for releasing the said pressure; 3rd. The combination with the screw L, and spring B, of the clamp nut p, s, hand wheels t, u, and adjusting nuts w, w; 4th. The combination with the rod C, pivoted to the main frame and adjustable to different positions on the pivot of the rest D, provided with the slit a, to receive the saw and adjustable vertically upon the rod by means of the set screw d; 5th. The combination with the carriage E, and milling tool, G of the gauge K, projecting backward over the burr and resting against the point of the tooth to form a gauge to the cut of the burr; 6th. The insertable cutters i, i, constructed of diamond shape in cross section with opposite cutting edges whereby the cutters may be reversed; 7th. The combination with the milling tool G, constructed with grooves, and with insertable cutters i, i, fitting in the grooves of the shouldered flanges or rim M, M, clamping the cutters in place.

#### No. 6215. Improvements on Volta-electric Appliances.

(*Perfectionnements aux Appareils électro-voltaiques.*)

John E. Hetherington, Cincinnati, Ohio, U. S., (Assignee of Isaac L. Pulvermacher), 16th June, 1876, for 5 years.

*Claim.*—1st. The copper plate forming the negative element constructed with prongs A, A, slots a, a, and tongue B, adapted to be folded or rolled into tubular form; 2nd. The zinc plate E, forming the positive element constructed and perforated as represented wrapped with thread or other suitable fibrous material or tissue as an absorbent for the exciting fluid and adapted to be folded or rolled so as to be inserted into the copper element; 3rd. The combination of a zinc plate, provided with nicks c, c, to receive and hold thread, with a thread wound spirally thereon, and fastened by swaging or punching into the said nicks; 4th. The combination of the zinc plate with the copper plate to form an element for medico-electric purposes; 5th. The modified arrangement of copper strips or plates A, A, slitted longitudinally and the parts between the slits bent outward to form pockets to receive the zinc B, B, in combination with the said zincs to form a voltaic element or link.

#### No. 6216. Method of Manufacturing Gas for Heating and Illuminating Purposes.

(*Méthode de fabrication du gaz pour l'éclairage et le chauffage.*)

Henry Bray, London, Ont., 16th June, 1876, for 5 years.

*Claim.*—1st. The combination of tanks A, B, pipes C, E, funnel injector D, syphon F, and conducting pipe G; 2nd. The combination with the above, the retorts H, I, J, connecting pipes K, and L, and exit pipe M; 3rd. The method of generating pure gas by the combination of fluid excreta, with hydro-carbon.

#### No. 6217. Improvements in the Preparation of Hams.

(*Perfectionnements dans la préparation des jambons.*)

Alden B. Richardson, Dover, Del., U. S., 16th June, 1876, for 5 years.

*Claim.*—1st. The method of preparing hams by removing the bone, packing the boned ham into a tightly fitting hermetically sealed can, and cooking the same, whereby the bone cavity is closed and the ham rendered solid;

2nd. A whole, boneless, solid ham put up in a specially constructed hermetically sealed can.

#### No. 6218. Dust Preventer and Vapour Exhauster for Mill Stones.

(*Garde-poussière pour les meules de moulin.*)

Frederick A. Howland, Lambton Mills, Ont., 16th June 1876, for 5 years.

*Claim.*—In combination with the stone casing A, provided with an opening a, in the sheet metal box B, provided with an opening in the lower side corresponding to the hole cut in casing with tubular extension C, and fitted with the air valve G, and connected to the exhaust fan F, and general exhaust tube E, by the thin metal tube D.

#### No. 6219. Door-holder. (*Arrête-porte.*)

Hugh McDiarmid, Toronto, Ont., 16th June, 1876, for 5 years.

*Claim.*—The combination of a self acting holder in a box with a stop attached to the box.

#### No. 6220. Machine for Amalgamating Ores.

(*Machine à amalgamer les minerais.*)

Louis Carvell, Hampton, N. B., (Assignee of Thomas Walker, and Joseph W. Bancroft), 16th June, 1876, for 5 years.

*Claim.*—1st. An amalgamating retort combined with a furnace and having a movable valve V, for supporting a charge of ore while it is being subjected to the vapour of mercury, and for discharging the ore; 2nd. The cup-shaped valve V, within the retort in combination with a pipe z, through which mercury may be introduced into the receptacle of the valve V; 3rd. The combination in the retort of a tight fitting ore supporting Valve V, with valves O, and o, for supporting the ore without obstructing the outward passage of the vapour of mercury; 4th. The combination in the retort of the valves V, and X, and a condenser E.

#### No. 6221. Improvements on Skates.

(*Perfectionnements aux patins.*)

James A. Whelpley, Greenwich, and George E. Buteaux and Alfred B. Sheraton, Saint John, N. B., 21st June, 1876, for 5 years.

*Claim.*—1st. The combination of the lug tightener F, the dog D, and the right and left hand threaded nut C; 2nd. The device consisting of the piece c, and key d, for adjusting the skate transversely on the boot; 3rd. The heel dog formed with the brace e; 4th. The frame E, having raised bars at either end in combination with the sole plate B, and lugs b, b; 5th. The use of the right and left hand threaded nut when applied to a skate in the direction of its length and arranged for clamping or operating the side clamps and heel dog simultaneously; 6th. The application of the aforesaid invention to all description of skates whether for the ice or formed with rollers for floor or parlour use.

#### No. 6222. Improvements on Breech loading Cannons.

(*Perfectionnements aux canons chargeant par la culasse.*)

Joseph R. N. Owen, Hamilton, Nev., U. S., 21st June, 1876, for 5 years.

*Claim.*—1st. The cannon A, provided with the key chamber B, at the base of its bore or powder chamber, and having the key slot or passage C, leading from said chamber through the casable of the gun in combination with the breech block F, with its stem E, and lever handle g; 2nd. The cannon A, provided with the key chamber B, and key shot or passage C, when the rear faces a, a, of the key chamber are constructed on a spiral or incline in combination with the breech or head block F, with its corresponding spirally arranged or inclined rear faces f.

#### No. 6223. Improvements on Rein-holders.

(*Perfectionnements aux accroche-guides.*)

George A. Shaw, Toronto, Ont., 21st June, 1876, for 5 years.

*Claim.*—1st. The spring radial arm D, mounted on the stud pin c, or its equivalent in combination with the angularly placed flange E, arranged and operating in a fixed or portable rein holder or buckle.

#### No. 6224. Mordant for Dyeing Cotton and Woollen Goods.

(*Mordant pour teindre les étoffes de laine et de coton.*)

Frederick J. Bird, Stroud, Eng., 21st June, 1876, for 5 years.

*Claim.*—The composition of gall, nuts, tannin, alum, tin and soda.

**No. 6225. Improvements on Paper Dampers.**  
(*Perfectionnements aux humecteurs de papier.*)

Charles G. C. Simpson, Montreal, Que., 21st June, 1876, for 5 years.

*Claim.*—The pad a, of porous material for holding water by attraction having an impervious back b; 2nd. The pad a, of porous material for holding water by capillary attraction, having an impervious back b, with a front impervious margin c, or margins c.**No. 6226. Improvements on Washing Machines.**  
(*Perfectionnements aux machines à laver.*)

Jacob M. Rodkey, Peleeville, Ont., 21st June, 1876, for 5 years.

*Claim.*—The box A, within which is placed a false bottom formed by the fluted bars C, and platin pieces L, bound together by the end pieces D, and supported by the spring F, in combination with a fluted or corrugated roller G, pivoted within the box A, upon the crank axle II.**No. 6227. Improvements in Stump Extractors.**  
(*Perfectionnements aux arrache-souches.*)

Enoch Farnsworth, Punatawney, Penn., U. S., 21st June, 1876, for 5 years.

*Claim.*—1st. A clevis H, resting within a notched link F, and supporting a lever G, provided with holes Q, and sheaves I, in combination with the chain or rope J, and snatch blocks K; 2nd. The leg or standard A, provided with a ring shackle D, in combination with the bolt F, and legs or standards A<sub>1</sub>, A<sub>2</sub>; 3rd. The take up bar M, provided with the holes K, and clevis O, for supporting the stump chains P, in combination with the pin N, and lever G; 4th. The hold up link L, fitting within the notched link F, in combination with the take up bar M; 5th. The legs A, A<sub>1</sub>, A<sub>2</sub>, connected together in the form of tripod and provided with foot pieces B, in combination with the bar C, placed sufficiently far from the ground to allow each of the legs A, A<sub>1</sub>, to find a bearing upon the ground for itself; 6th. The take up bar M, provided with clevis O, in combination with the two stump chains P.**No. 6228. Improvements on Cultivators.**  
(*Perfectionnements aux cultivateurs.*)

Jonathan Wade, London, (Thp.) Ont., 21st June, 1876, for 5 years.

*Claim.*—1st. The bars C, C, divisions E, teeth F, shoes G, slotted bars H, set or thumb screws I; 2nd. The arrangement, in combination with frame A, of a series of movable bars C, C, attached to slots in frame by eyes and bolts D; 3rd. In combination with the movable bars C, C, the roller J, ratchet and lever L, M, and chains K.**No. 6229. Churn Power.** (*Moteur de baratte.*)

Truman Cole, Shannonville, Ont., 21st June, 1876, for 5 years.

*Claim.*—The combination and arrangement of steel spring A, clip-holding spring B, standard G, brace D, bed piece E, lever bar F, dash handle G, balance weight H, and screw I.**No. 6230. Attachment to Street Sprinklers.**  
(*Disposition aux arroseurs de rues.*)

George Trimble, Toronto, Ont., 21st June, 1876, for 5 years.

*Claim.*—The stop cock E, placed in the centre of the perforated pipe A, in combination with the flexible pipes B, B, attached to the cart C, and provided with valves D, D.**No. 6231. Improvements in Catapults.**  
(*Perfectionnements aux catapultes.*)

John A. Knight, Montreal, Que., 21st June, 1876, for 5 years.

*Claim.*—A catapult composed of the handle K, and rubber ejector X, the ring R, and hole II.**No. 6232. Process of Tanning Hides.**  
(*Procédé de tannage des peaux.*)

Charles Richter, Detroit, Mich., U. S., 21st June, 1876, for 5 years.

*Claim.*—1st. The solution composed of the ingredients before mentioned, viz. water, sulphuric acid, common salt, wheat bran or wheat middlings and sugar of lead; 2nd. The manufacture of leather from hides or skins by the application of the solutions composed of water, sulphuric acid, common salt, wheat, bran or wheat middlings and sugar of lead and water, sal soda, racoon oil and glycerine.**No. 6233. Improvement in Piston Packings.**  
(*Perfectionnements dans les garnitures de pistons.*)

John T. Wright and Martin Schueble, Dayton, Ohio, U. S., 21st June, 1876 for 15 years.

*Claim.*—1st. The socket ring F, fitting snugly into and against the head of the stuffing-box in combination with a packing-box G, having a convex edge d, conforming to the concavity of the said ring; 2nd. In combination with a piston rod B, a packing-box and a conical chamber formed therein, the cleft rings F, G, H, in the form of a conical frustum, recessed in the said chamber and adapted to be wedged therein by the steam pressure whereby they are made to automatically contract and clamp the said piston rod and form a steam tight joint therewith; 3rd. In combination with the rings F, G, H, recessed into a chamber packing-box a piston rod and a spring S, the collar I, applied between the said spring and the packing rings; 4th. The cleft packing rings F, G, H, in the form of a conical frustum; 5th. The combination of the packing rings F, G, H, having each a cleft i, with a conically recessed packing-box G, adapted to receive the said rings and to cause them to contract around the piston rod.**No. 6234. Improvements on Door Checks.**  
(*Perfectionnements aux arrêles-portes.*)

Simon R. Billings, Flint, Mich., U. S., 21st June, 1876, for 5 years.

*Claim.*—The body a, flanges b, latch c, having incline g, recess h, stop s, shoulder j, in combination with the spring f, and hole n.**No. 6235. Improvements on Soap for Washing Clothes, &c.**  
(*Perfectionnements au savon à laver le linge, &c.*)

Henry DeLewis, Halifax, N. S., 21st June, 1876, for 5 years.

*Claim.*—A compound of sal-soda, soap, borax, sulphate of soda and carbonate of ammonia.**No. 6236. Improvements on Straw-cutters.**  
(*Perfectionnements aux hache-paille.*)

Andrew Tolton and David Tolton, Guelph, Ont., 21st June, 1876, for 5 years.

*Claim.*—1st. The attachment to a straw cutter frame A, having a wheel B, carrying radial cutting knives of a fan box C, having a tube F, through which the cut straw is carried off by pneumatic force; 2nd. The attachment to the knife wheel B, of a straw cutter, of buckets or fans G, for the creation of a blast for forcing the cut straw through a pneumatic tube F, connecting with a fan box C; 3rd. The combination of a fan box C, having pneumatic tube F, and a knife wheel B, carrying fans or buckets G, for the creation of a pneumatic blast whereby the cut straw is carried through the tube to a place of deposit.**No. 6237. Improvements on Harrows.**  
(*Perfectionnements aux herces.*)

William T. McGhee and Jacob Waters, Wheeling, Mo., U. S., 21st June, 1876, for 5 years.

*Claim.*—1st. The XX-shaped harrow frames I pivoted together laterally at their front and rear ends and suspendedly attached to the wheeled frame 2nd. In combination with the X frames I, hinged together at their front and rear ends the shaft E, mounted on the wheeled frame C, having the winding discs F, F, and chains U, H, connecting with the harrows and operated by the lever handle J; 3rd. In the XX frames I hinged together at their front and rear ends the front ends, connected to the double tree K, and king bolt L, of the wheeled frame C; 4th. In combination with the XX frames double tree K, and king bolt L, the shaft E, having winding discs G, and chain M, connecting with the double tree K, of the wheeled frame; 5th. The XX harrow frames I, suspended at their front ends by the double tree K, and king bolt L, and chain M, and at their centres by chains H, H, in combination with the shaft E, having discs F, F, and G, for winding the chains by the hand lever J; 6th. The foot pawl O pivoted to the axle A, and disc G, having ratchets Q, in combination with the shaft E.**No. 6238. Improvements on Curtain Fixtures.**  
(*Perfectionnements aux ajustages de rideaux.*)

William E. Skinner, Milford, Mich., William O. Spaight, Tiffin, Ohio, and John Spaight, Cal., U. S., 21st June, 1876, for 5 years.

*Claim.*—1st. The combination with the bracket A, of the ratchet wheel D, and the gravitation pawl G, said pawl being suspended between the sides of said bracket below the bearing for the curtain roller; 2nd. A roller composed of sections telescoping for adjustment; 3rd. A curtain bar or rod composed of a tube and a rod sliding therein, said rod being provided with means for retaining the pieces in frictional contact; 4th. The combination with the corrugated roller C, of a flexible covering or jacket I; 5th. The combination with the bracket A, of the ratchet wheel D, pulley E, flange J, gravitation pawl G, and the guard H.**No. 6239. Improvements on Grain Binding Machines.**  
(*Perfectionnements aux machines à lier le grain.*)

Sarah L. Whitney, (Administratrix of the Estate of John H. Whitney deceased.) St. Louis, Mo., U. S., 21st June, 1876, for 5 years.

*Claim.*—1st. A twister for grain binders consisting of the rotating shaft C, having attached rigidly thereto the eccentric spindle a, provided with a laterally projecting finger or lip b; 2nd. The clamping device consisting of the stationary pin r, and the spring lever or jaw d, the latter being pivoted eccentrically to the pin r, whereby the wire is held tight when drawn in one direction and released when drawn in the opposite direction; 3rd. The finger b, pin r and conical bevelled roller u; 4th. The shaft C, provided with the rigidly attached spindle a, finger b, incline l, and cutting lip c, in combination with the stationary lip o, and the clamping device r, d.**No. 6240. Flour and Grocery Bag.**  
(*Sac à farine et épiceries.*)

Thomas Phillips, Akron, Ohio, U. S., 21st June, 1876, for 5 years.

*Claim.*—A paper bag having one surface of bleached pulp for the sake of merchantable appearance and the other surface of unbleached or slightly bleached pulp for the sake of cheapness and strength.**No. 6241. Improvements in Spring Beds.**  
(*Perfectionnements aux lits à ressorts.*)

John E. Townshend, Montreal, Que., 21st June, 1876, for 5 years.

*Claim.*—The mode and manner of securing together the mattress A, and spring bed B, leaving a sufficient space around the edges to admit of the clothes being securely held in place.**No. 6242. Improvements in Door Knobs.**  
(*Perfectionnements aux boutons des portes.*)

William H. Gonne, Chatham, Ont., 26th June, 1876, for 5 years.

*Claim.*—1st. The spindle E, and nut A, passing entirely through knobs B, B, to prevent them from being pulled off or from being separated from necks C, C, and as a means of adjusting them to suit any thickness of door 2nd. The ribs on neck and on rose to prevent them from turning the one in the knob and the other in the door.

**No. 6243. Improvements on Machines for Burnishing the Edges of Shoe Soles.**

(*Perfectionnements aux machines à polir la tranche des semelles des chaussures.*)

John W. Dodge, Malden, and Charles S. Fildell, Boston, Mass., U. S., 26th June, 1870, for 5 years.

*Claim.*—1st. The combination of the sleeve A, shaft B, and handle J; 2nd. The combination of sleeve A, rods K, and L, and frame M; 3rd. The combination of sleeve A, rods K, L, and I, and frame M. 4th. The combination of sleeve A, shaft B, tang F, and rod G.

**No. 6244. Process and Apparatus for Obtaining and Purifying Paraffine.**

(*Procédé et appareil de production et purification de la paraffine.*)

Francis X. Byerley, Cleveland, Ohio, U. S., 26th June, 1870, for 5 years.

*Claim.*—1st. The crystallizing tank F, provided with a perforated bottom in combination with straining cylinders E, provided with removable bottoms; 2nd. Crystallizing the substance in cylinders by heat or cold, and straining off the waste by means of a pump, then purifying such crystallized substance in a receiver having a filtering bottom with the proper solvents; 3rd. The shaft G, knife H, divided nut I, tongue L, jointed lever J, spring B, wormscrew M, and right angle lever N, weight and cord O, and pulley P.

**No. 6245. Improvements on Stoves for Heating Barrels.**

(*Perfectionnements aux poêles de tonnellerics.*)

Henry H. Hale and Edwin A. Shaw, Buffalo, N. Y., U. S., 26th June, 1870, for 5 years.

*Claim.*—1st. The fuel receptacle A and draft cylinder B, provided with annular shield or hood C. 2nd. The combination with the fuel receptacle A, provided with inclined ears E, of the detachable draft cylinder B, and hook C.

**No. 6246. Improvements on Bags.**

(*Perfectionnements aux sacs.*)

Henry Redden, New-York, U. S., 26th June, 1870, for 5 years.

*Claim.*—1st. The funnel-shaped collar B, having its ends screwed into the mouth of the bag A, a little distance within its edge to adapt it to be folded and rolled up within said mouth; 2nd. The combination of the straps C, with the mouth of the bag A, and with the funnel-shaped collar B.

**No. 6247. Improvements on Wrenches.**

(*Perfectionnements aux clés à écrous.*)

Edward H. Knight, Philadelphia, Pa., U. S., 26th June, 1870, for 5 years.

*Claim.*—1st. A wrench in which its jaw (or jaws), is controlled during engagement with the nut or other article and it is permitted to yield to allow the jaws to ride freely over the corners or angles of said article, and then to take hold automatically of an other face of the latter without removal of the wrench; 2nd. A wrench in which one of its jaws C is connected to a sliding bar A, which is controlled by a lever J, when the jaws engage with the nut or other article, and it is permitted to yield on the return movement of the wrench so that the jaws C, D, will ride freely over the corners or angles of said article; 3rd. The sliding bar A, carrying the jaw C, and the controlling lever J, operating thereon; 4th. The sliding bar A, with stop B, the wrench handle with stop a, and the inwardly depressing spring H; 5th. The jaw C, secured to the sliding bar A, and the jaw D, rendered adjustable relatively to the jaw C; 6th. The jaw C, and D, in combination with the sliding bar A, spring H, and the controlling lever J; 7th. The handle B, made of hollow parts or sections, and receiving one end of the sliding bar of a wrench; 8th. The strap F, with slotted plate d, in combination with the screw E, of the jaw of a wrench.

**No. 6248. Improvements on Machines for Welding Iron.**

(*Perfectionnements aux machines à souder le fer.*)

John B. Wills, Keeseville, N. Y., U. S., 26th June, 1870, for 5 years.

*Claim.*—1st. The combination of the dies r, u, t, v, arranged to operate on flat sided bars or rods. 2nd. The combination of the dies r, z, and compound die t, u, made in one piece, arranged to operate on flat sided bars or rods; 3rd. The combination of the dies r, r, and u, arranged to act upon round bars or rods.

**No. 6249. Improvements on Car-couplers.**

(*Perfectionnements aux attelages de wagons.*)

George Jones, Montreal, Que., 26th June, 1870 (Extension of Patent No. 429), for 5 years.

*Claim.*—1st. The novel combination of the hunter head a, recesses b, and c, link d, recess e, ball f, vertical passage g, pin h, and projections i; 2nd. The novel combination of the pin h, ball f, link d, and recesses c, and e; 3rd. The ball f.

**No. 6250. Apparatus for Making Cylindrical Vessels.** (*Appareil à faire les vaisseaux cylindriques.*)

John Kisor, Nevada, Ohio, U. S., 26th June, 1870, for 5 years.

*Claim.*—1st. In combination with the cylinder A, having clamps a, b, b, c, and band D, the plate d, cylinders or rollers E, E, and frames C, F, F. 2nd. In combination with the cylinder or block A, the rollers or cylinders E, E, having the annular flanges g, g, and grooves h, h, pivoted frames F, F, and frame C, or other support for the latter.

**No. 6251. Improvements on Burglar-alarms.**

(*Perfectionnements aux alarmes-voleurs.*)

Albert B. Schulenberg Windsor, Ont. (Assignee of John Woolner), 26th June, 1870, for 5 years.

*Claim.*—The strips a, and b, provided at their ends with emery and containing between them a charge of fulminate placed in the space between

the emery and retained in position by loops d, d', and band c, and also in eyelet holes e, e', for affixing the strips so prepared acting in combination or in any other manner.

**No. 6252. Method and Apparatus for Preserving Meat.**

(*Méthode et appareil de conservation de la viande.*)

Kennerd Knott, London, Eng., 26th June, 1870, for 5 years.

*Claim.*—1st. The circulating apparatus composed of the fan blowers B, the freezing box C, having a space b, above it the pipe coil or coils D, contained within it and the perforated air distributing pipes F in combination with a packing chamber A, whereby a circulation of the same body of cold air is maintained in the chamber without contact with the refrigerating agent; 2nd. The freezing box C provided with distributing air chest E, and a coil, or coils D, extending through the refrigerating agent connecting with the air chest; 3rd. The combination of the slotted bearers e, and screws g, for securing the same with the flanged columns f, having a series of perforations.

**No. 6253. Improvements on Apparatus for Pulverizing Ores, &c.**

(*Perfectionnements aux appareils à broyer les minerais, &c.*)

Robert M. Fryer, New York, U. S., 26th June, 1870, for 5 years.

*Claim.*—1st. The combination of a chamber A, arranged to rotate, revolve or oscillate on or about a horizontal axis, and a weight or arm L, so contained within said chamber that by the rotation revolution or oscillation of the said chamber the said weight or arm, and the material placed therein to be operated upon, may be caused by gravitation to have a reciprocating motion falling from one end of the said chamber to the opposite end; 2nd. The combination of a series of chambers A, and contained weights or arms L, with a central shaft S, around which said chambers are arranged for operation; 3rd. The combination of a series of crushing or pulverizing chambers A, and contained weights or arms L, with a centrally arranged amalgamating chamber I.

**No. 6254. Improvements in Tessellated Floors.** (*Perfectionnement des parquets tessellés.*)

Samuel P. Grocock, New York U. S. 26th June, 1870, for 5 years.

*Claim.*—The composite piece or section A, for quarrying flooring formed of wooden blocks b, arranged in a suitable design or pattern and the asphalt backing B, having a tongue and groove connection.

**No. 6255. Improvements on Packing Boxes.**

(*Perfectionnements aux boîtes.*)

Harrison N. Hart, Sandwich, N. H., U. S., 26th June, 1870, for 5 years.

*Claim.*—A packing box for lamp chimneys having a series of triangular compartments E, F, constructed and arranged in alternate order between the dividing walls C, B, and D.

**No. 6256. Machine for Lifting Weights.**

(*Machine à lever les fardeaux.*)

Lafayette A. Melburn, Napanee, Ont., 26th June, 1870, for 5 years.

*Claim.*—The combination of the frame A, fulcrum rod B, head C, friction loops D, and F, lug E, link G, and lever H.

**No. 6257. Improvements on Carriages.**

(*Perfectionnement aux voitures.*)

Simon P. Graham, London, Ont., 30th June, 1870 (Extension of Patent No. 1041), for 5 years.

*Claim.*—The manner of construction and making out of sheet iron the bracket body A, in connection with the wooden frame B, sill and body loop C, and seat D, in connection with the corner iron I, and corner iron and handle combined K, flange casing M and fillet under the top part of seat N, the iron bracket F and the manner of making reach G, in connection with the fifth wheel H and inverted V shaped iron L, and the construction of the spindle seat in connection with the hollow spindles with the iron rail M, bent frame for bottom of seat O.

**No. 6258. Improvements on Carriages.**

(*Perfectionnements aux voitures.*)

Simon P. Graham, London, Ont., 30th June, 1870 (Extension of Patent No. 1041), for 5 years.

**No. 6259. Apparatus for the Extraction of Gold from Auriferous gravel.**

(*Appareil pour l'extraction de l'or du gravier aurifère.*)

Philip Cadell, Victoria, B. C., 7th July, 1870 (Extension of Patent No. 3489), for 5 years.

**No. 6260. Improvements on Fire Hydrants.**

(*Perfectionnements aux bornes-fontaines.*)

Joseph P. Gallagher, St. Louis, Mo., U. S., and Jones M. Chapman, Sherbrooke, Que., 7th July, 1870, for 5 years.

*Claim.*—1st. The vertical shaft N, having cam Nt, at lower end, in combination with cam yoke O, and valve stem I, and handle N2, for operating slide valve H, working in chamber G. 2nd. The valve I, composed of leather discs i, and secured by screw collars i2, independently of the conical part i, in combination with a screwed shank l, working up into the hollow handle D, with sleeve nut m, at its flanged or lower end and held firmly in its place by cap E, to prevent the vertical movement of the hollow handle D, and sleeve nut m, for operating valve I; 3rd. One or more delivery pipes arranged with suitable valves to shut off the delivery pipes separately and allow one or more engines to connect and work or detach without interfering or stopping each other while working in combination with valve chamber A, and escape passage f, b, which drains all the water from the delivery pipes and prevents all danger of freezing.

**No. 6261. Swiss Bell Piano.***(Piano à clochettes suisses.)*

William H. Wood, Port Rowan, Ont., 10th July, 1876, for 5 years.

*Claim.*—1st. The swiss bells A, suitably arranged within a casing N, and provided with a sounding board M, in combination with the hammers B, pivoted to the frame C, and connected by the struts D, to the keys E; 2nd. The treadle I, connected by the rod H, to the bar F, which is provided with the arms G, in combination with the frame C, carrying the hammers B.

**No. 6262. Improvements on Skate Attachments.***(Perfectionnements aux attache-patins.)*

Charles Brewster (Assignee of Charles G. C. Simpson), Montreal, Que., 10th July, 1876, for 5 years.

*Claim.*—1st. The combination of clamp *g*, cable *k*, and friction block *l*; 2nd. The combination of the clamp *g*, cable *k*, friction block *l*, with bars *e*, and *r*, and screwed spindle *w*; 3rd. The combination of the cable *k*, block *l*, having screwed spindle *u*, bracket *b*<sub>1</sub>, and nut *a*<sub>1</sub>; 4th. The combination of the clamp or clamps *g*, bell crank or bell cranks *a*<sub>2</sub>, and *b*<sub>2</sub>, and bar *e*; 5th. The combination of the clamps *g*, bell cranks *a*<sub>2</sub>, *b*<sub>2</sub>, bar *e*, screwed spindle *w*, and clamps *f*<sub>2</sub>; 6th. The combination of the clamp or clamps *g*, links *a*<sub>3</sub>, *b*<sub>3</sub>, and *c*<sub>3</sub>; 7th. The combination of the clamps *g*, links *b*<sub>3</sub>, and *a*<sub>3</sub>, (the clamps being attached to the extensions of *a*<sub>3</sub>), and bar *e*.

**No. 6263. Improvements on Railway Wheels.***(Perfectionnements aux roues de railroads.)*

Anson Atwood, Brooklyn, N. Y., U. S., 10th July, 1876, for 5 years.

*Claim.*—1st. A steel or iron tire for railway-wheel having its inner surface, corrugated and presenting a wavy line in cross-section; 2nd. A body for a railway wheel, the outer surface of the rim of which is corrugated, presenting a wavy line in cross-section; 3rd. A body for a railway wheel, having on its rim a flange F, in combination with the pins or projections G, G; 4th. The combination of a tire having a corrugated inner surface with a rim of the central portion of the wheel having a corrugated outer surface forming a chamber between said surfaces; 5th. A fibrous packing for a railway wheel treated with glycerine or its equivalent; 6th. A packing of hemp or other fibrous material when used as an interlocking packing between the corrugated surfaces of the tire and the body of the wheel; 7th. A wrought iron ring shrunk upon and into a dovetail groove formed upon the central portion or body of the wheel; 8th. The combination of a tire having its inner surface corrugated, with a wheelbody having the outer surface of the rim corrugated, both presenting a wavy line in cross-section in combination with an interlocking fibrous packing material *l*, for the purpose of holding the tire upon the central portion or wheel body; 9th. A railway wheel having the tire with its inner surface corrugated and the central portion or wheel body whose rim has its outer surface corrugated, both presenting a wavy line in cross-section forming an annular chamber between the tire and the rim which chamber is fitted with a packing of hemp or other fibrous material interlocking and securing the tire to the central portion or body of the wheel in combination with the pins G, G, and sockets H, H; 10th. A railway wheel composed of the following parts: First, a steel or iron tire with its inner surface corrugated presenting a wavy line in cross-section; Second, a wheel body with its corrugated rim presenting a wavy line in cross-section; Third, a flange on the wheel body with pins or projections which prevent the turning or sliding of the tire upon the central portion or wheel body; Fourth, a fibrous packing which interlocks and secures the tire upon the body of the wheel; Fifth, a wrought iron ring to form a tight joint over the packing.

**No. 6264. Bark Rasping and Cutting Machine.***(Machine à râper et couper l'écorce.)*

Samuel R. Thomson, Portsmouth, N. H., U. S., 10th July, 1876, for 5 years.

*Claim.*—1st. In a bark cutting machine, a rotary cutter composed of collars having teeth projecting from their peripheries and located on a shaft or arbour with the teeth arranged in substantially straight rows or series composed of teeth which are separated by spaces of not less than twice their own width, and spiral rows or series composed of teeth on the successive collars whereby the cutter is adapted to reduce the bark into particles without liability of the teeth becoming clogged; 2nd. The slotted bed plate M, combined with the threaded adjustable standards M<sub>1</sub>, rising from the frame B, and provided with jaw nuts *n*; 3rd. The horizontally and vertically adjustable bed plate M, combined with the rotary cutter A, located in fixed bearings; 4th. The feed roll E, combined with the horizontally and vertically adjustable pivoted arms F, F; 5th. The pivoted arms F, F, having the slots J, J, combined with the threaded standards *z*, having the nuts *o*; 6th. The horizontally and vertically adjustable feed roll E, combined with the rotary cutter A, located in fixed bearings; 7th. The combination of the horizontally and vertically adjustable feed roll E, the horizontally and vertically adjustable bed plate M, and the rotary cutter A, located in fixed bearings; 8th. A feed roll having teeth arranged in parallel peripheral rows and straight longitudinal rows the latter being composed of teeth in alternate peripheral rows; 9th. The adjustable bed plate M, having the downwardly projecting apron *m*, combined with the cutter A, and chute or receptacle C; 10th. The clearer V, attached to the arms F, in combination with the feed roll E; 11th. The hopper T, having the hinged flaps or doors U, U, combined with the feed roll E, and rotary cutter A; 12th. The flap U, hinged to the bed plate M, and adapted either to form an extension of the bed plate or a covering for the side of the hopper.

**No. 6265. Candy Marble Machine.***(Machine à dragées de candi.)*

Bernhard Stern and Herman Stern, Chattanooga, Ten., U. S., 10th July, 1876, for 5 years.

*Claim.*—1st. The combination of the bed C, and pivoted bottom cutter A, whereby the balls may be readily dumped; 2nd. The combination of the bed C, the pivoted bottom cutter A, and the sliding cutter B, provided with guards E, F.

**No. 6266. Improvements on Preserving Fruit, &c.***(Perfectionnements dans la conservation des fruits, &c.)*

Susan Peebles and Elizabeth E. Mefford, Adrian, Mich., and Charles E. Clarke, Chicago, Ill., U. S., 10th July, 1876, for 5 years.

*Claim.*—1st. The mode of preserving fruits and vegetables that is subjecting them without removing the natural juices to the action of sulphurous acid and then drying the same; 2nd. A preparation consisting of dried fruits or vegetables from which the material juices have not been expressed impregnated with sulphurous acid.

**No. 6267. Improvements on Bevels, Try-squares, Level Rules and Compasses.***(Perfectionnements aux sauterelles-équerres et règles et compas.)*

William Ascough, Buffalo, N. Y., U. S., 10th July, 1876, for 5 years.

*Claim.*—1st. The combination with the stock A, of the clamp-socket D<sub>1</sub>, and the clamp E, said clamp being operated by the set screw F; 2nd. The combination with the stock A, of the receptacles H, H<sub>1</sub>, and the caps I, I<sub>1</sub>; 3rd. The combination with the stock A, of the tongue B, having the tapering knife edge B<sub>1</sub>, clamp socket D, clamp E, and set screw F.

**No. 6268. Improvements in the Process and Apparatus for the Removal of Night Soil.***(Perfectionnements dans les procédés et appareils à enlever les matières excrémentielles.)*

Richard S. Gillespie, New-York, U. S., 10th July, 1876, for 10 years.

*Claim.*—1st. The method of removing night soil and analogous matter by connecting such matter through an air tight conduit with a tight transportable vessel exhausting the air in the latter by a jet and thereby filling the transportable vessel to be taken away and emptied; 2nd. The method of withdrawing night soil and like matter from its receptacle into a transportable vessel and at the same time deodorizing its fetid vapours and gases, which consists in connecting the matter by an air tight conduit with an air-tight transportable vessel, and exhausting the air from the vessel outwardly through its extended outlet, or through that outlet and through either a shower of water or burning matter or through the three namely, an outlet, the water, and burning matter; 3rd. The method of loosening night soil and like matter preparatory to its removal, which consists in forcing a stream of air or water which may be previously disinfected if preferred, and forcing it into the matter to be loosened by a jet of an expansive aeriform fluid, such as steam carbonic gas, or compressed air or water; 4th. The combination of an air tight transportable vessel, an ejector operated by an aeriform fluid, a suction conduit and a valve controlling communication between tank and conduit; 5th. The combination of an air tight transportable vessel, an ejector operated by an aeriform fluid, a suction conduit, a valve controlling communication between such vessel and conduit, with the extended outlet of the vessel, and or with an outlet, and either a condenser or a deodorizer or with such outlet condenser and deodorizer; 6th. The condenser C, consisting of a water chamber, vapour and gas chamber, communicating valve, distributing nozzle *f*, and suitable inlets and outlets; 7th. The combination of pipe I, within or without the cesspool injector B, and pipe H<sub>1</sub>; 8th. The combination of suction pipe F, vessel A, ejector B, gas generator E, pipe *b*<sub>1</sub>, and suitable valves for controlling the ejection fluid and the sewage.

**No. 6269. Jar Clamp and Cover.***(Vis et couvercle de pot.)*

Francis L. Bodine, Philadelphia, Pa., U. S. (Assignee of Thomas Hipwell), 10th July, 1876, for 5 years.

*Claim.*—1st. A screw clamp or locking device constructed with short hooks, adapted for securing it to the lid, and also to the long hooks, adapted for securing the lid to the jar; 2nd. The combination of the lid B, and screw clamp C, constructed with one or more crooks or bends F.

**No. 6270. Swivel Head for Diamond Drills.***(Griffe de foret à diamant.)*

Milan C. Bullock, Chicago, Ill., U. S., 10th July, 1876, for 5 years.

*Claim.*—1st. The combination of a screw shaft C, and a hydraulic vessel *e*, provided with a gauge *z*, which indicates the pressure of the drill carried by said screw shaft upon the rock; 2nd. The combination of a screw shaft C, and a hydraulic vessel *e*, provided with a gauge *z*, which indicates the weight of the drill rod carried by said screw shaft; 3rd. The combination with the hydraulic cylinder *e*, of the roller G, and discs *a*, *a*, one of which is fitted to slide in said cylinder like a piston; 4th. The combination with the screw shaft C, feed nut F, counter-shaft M, and gears N, and O, of the gears K, L, hubs *m*, and movable plunger S, with its key *g*; 5th. The combination with the hubs *m*, *m*, *m*, and gears L, L, L, of the slotted counter shaft M, plunger S, keys *g*, and K, stripping handle R, hubs *u*, *u*, and ring T; 6th. The combination with the hub W, secured to the bearing D<sub>1</sub>, of the counter shaft M, and movable plunger S, with its key *g*.

**No. 6271. Horse-shoe Nail Machine.***(Machine à clou à cheval.)*

John B. Wills, Keeseville, N. Y., U. S., 10th July, 1876, for 5 years.

*Claim.*—1st. The combination of the dies *m*, *n*, *u*, *g*, and *z*, with header *c*<sub>1</sub>; 2nd. The combination of the dies *m*, and *n*, with the header *c*<sub>1</sub>; 3rd. The combination of the die *z*, with spring *d*<sub>1</sub>; 4th. The combination of the dies *u*, and *v*, for cutting and gauging; 5th. The combination of the die *v*, for the plate to abut against, with a guide *g*<sub>1</sub>; 6th. The combination of the dies *u*, and *v*, having surfaces 1, 2, 3, 4, 5, with the die *z*, having surfaces 1, 2, 3, 4, 5; 7th. The combination of the dies *u*, and *v*, having surfaces 1, 2, 3, 4, 5, die *z*, having corresponding surfaces 1, 2, 3, 4, 5, with die *g*, having surfaces 1, 2, and 3.

**No. 6272. Improvements on Sap Evaporators.***(Perfectionnements aux évaporatoires de sucreries.)*

John P. Baldwin, Barnston, Que., 10th July, 1876, for 5 years.

*Claim.*—1st. The pan B, having its bottom ribbed or corrugated to form independent chasms *e*, within and without the pan; 2nd. The pan B, having

its bottom formed of a series of independent ribs or corrugations *e*, dipping rearwardly; 3rd. The pan B, having one or more portions of its bottom corrugated to dip rearwardly in combination with a pan having a plain bottom placed forwardly of the same; 4th. The pan B, having a rear section corrugated and dipping rearwardly, and a forward portion plain on the bottom; 5th. The pan B, having a rearward section corrugated to dip rearwardly and the forward portion level either plain or corrugated in combination with a furnace A; 6th. The pan B, having a transverse partition dividing the same in front and rear sections; 7th. The spout C, connecting with the bottom of the ribs at the rear end of the pan and arranged transversely thereto, to draw off the boiler sap.

### No. 6273. Grain Cleaning Machine.

(*Machine à nettoyer les grains.*)

James Higginbottom and Edward Hutchinson, Liverpool, Eng., 10th July, 1876, for 5 years.

*Claim.*—1st. The combination of the stationary case E, having a discharge spout S, on the periphery intermediate between top and bottom with the vertically revolving disc D; 2nd. The combination in a grain scouring chamber, containing vertically revolving disc or discs and into which the grain has free admission so that it is kept constantly full with a slide or other regulator in the exit pipe; 3rd. The combination of the stationary case E, with the hood H, and the slide K; 4th. The combination of the diaphragms R, with the discs D, the washer plates F, and the casing E.

### No. 6274. Street Lamp. (*Lampe de rue.*)

Joseph S. Woods, New York, U. S., 10th July, 1876, for 5 years.

*Claim.*—1st. A lamp frame made of hollow oil holding tubes, supporting the glass, in connection with an oil reservoir at the lowermost part of the frame below the burner; 2nd. A glass supporting frame for street lamps, made of oil holding tubes, with horizontal ring-shaped top tubes, forming spaces for the transparent signs; 3rd. The combination of the oil holding glass supporting tubes and of the oil reservoir at the lower part, with an adjustable heating and illuminating burner to generate gas to sustain the oil in the tubes and feed it gradually to the burner; 4th. The combination of a lower stationary disc section of the burner having a central projecting seat and jet holes, with a regulating top section, screening thereon to heat up the gas generating tube and supply the gas to the illuminating burner.

### No. 6275. Improvements on Odometers.

(*Perfectionnements aux Odomètres.*)

Adam Chambers, Pueblo, Col., U. S., 10th July, 1876, for 5 years.

*Claim.*—1st. The two discs *i*, and *o*, with their respective stops turning upon the shaft of the wheel *h*, in combination with the sleeve *f*, lever *g*, stationary incline 25, second counting wheel *l*, and its incline 40; 2nd. The combination with the odometer of a clock movement and a stop operated by the odometer so as to compute the period of time in which the vehicle is in motion; 3rd. The fly stop *t*, slide 34, and ejector 35, operated by the spring lever *z*, that receives motion from the lever *e*, in combination with the clock movement and odometer register.

### No. 6276. Screw Threading Machine.

(*Machine à fileter les vis.*)

Frank P. Sheldon, Providence, R. I., U. S., 10th July, 1876, for 5 years.

*Claim.*—1st. The combination of the following instrumentalities for causing the nick in the head of a screw blank to be set in a given position before presentation to the holding jaws, viz.: a suitable feeding mechanism for selecting blank one by one *b*, holding jaws E, E, and a revolving blank turner C; 2nd. The combination of the spring fingers *b*, arranged to be capable of a sidewise movement with a revolving blank turner C, for enabling the screw blank to become engaged with the blank turner and afterward be disengaged therefrom; 3rd. The combination of the following instrumentalities for changing the backing off motion after the threaded screw is clear of the dies to the motion for threading the next blank, viz.: an adjustable collar M, partaking of the longitudinal movement of the die holder, a shifting clutch I, operated by suitable mechanism, and the revolving gear H, inducing by suitable gearing the requisite rotation for cutting the thread; 4th. The combination of a sliding bar K, having ear pieces K<sub>2</sub>, L, an adjustable collar M, partaking of the longitudinal motion of the die holder, a shifting clutch I, operated by the cam P, and alternately engaging pins *o*, *o*, at the times determined by the said sliding bar and collar and gears H, H, revolving in opposite directions, for the purpose of automatically changing the direction of the rotation of the die arbour; 5th. The combination of the sliding bar K, the levers N, N, and the spring latches *n*, *n*; 6th. The combination of the adjustable collar M, partaking of the longitudinal motion of the die holder, with the system of cams on the hollow shaft S, by means of a vibrating clutch gear connecting such shaft with the source of motion and the lever U, controlling a stop catch *u*, *t*, whereby the said cam shaft may be stopped while a blank is under the action of the cutting die and be started again after a blank has been discharged from the jaws or in case a blank has not been presented to the die; 7th. The combination in an automatic screw threading machine of the bifurcated discharger the gripping jaws and the feeding fingers, arranged and operating together, whereby the finished screw is ejected from the jaws, and the way cleared for the advance of the fingers with a blank; 8th. The combination of the feeding fingers *b*, *b*, with the stationary holding jaws E, E, when the latter are arranged to open in a plane which is intersected by the path of movement of the fingers whereby the blank can be presented so as to be gripped by the jaws without the requirement of any sidewise movement on the part of the fingers.

### No. 6277. Improvements on Drain Ploughs.

(*Perfectionnements aux charrues à rigoles.*)

Hermase Larose, Verchères, Que., 10th July, 1876, for 5 years.

*Résumé.*—La combinaison avec les autres parties d'une charrue ordinaire A, du couteau suruméraire F, de la glissoire C, des garants D, et de la rallonge E, assemblés et joints ensemble, au moyen de rivets ou de chevilles taraudés.

*Claim.*—The combination with the other parts of an ordinary plough A, of the additional coultter F, slide C, guards D, and the extension E, jointed and clamped together by means of rivets or screw bolts.

### No. 6278. Improvements on Window-fasteners. (*Perfectionnements aux arrête-croisées.*)

Luc D. Gélinas, La Baie, Que., 10 Juillet, 1876, for 5 years.

*Résumé.*—La combinaison de la tige A, avec ses dents ou accrocs F, et la crampe G, avec la croisée D, ou la jalousie F, etc.

*Claim.*—The combination of the rod A, with its teeth or serrations F, and the staple G, with the sash D, or the blind F, &c.

### No. 6279. Post Hole and Well Digger.

(*Sonde de puits et de pieux.*)

Isaac M. Perry, State Cut, Ind., U. S., 10th July, 1876, for 5 years.

*Claim.*—The combination with digger blades A, of the head B, one or more handle sections C, and cap D.

### No. 6280. Improvements on the Manufacture of Horse Shoe Nails and Cutters for the same.

(*Perfectionnements dans la fabrication du clou à cheval et aux cisailles pour cet objet.*)

George P. Clapp, John A. Pellow and Randolph Hersey, Montreal, Que., 10th July, 1876, for 5 years.

*Claim.*—1st. The cutters *a*, having grooves *c*, surfaces *d*, and head *b*, in combination with the cutter *e*, having a corresponding configuration; 2nd. The cutter *a*, having the grooves *c*, surfaces *d*, and head *b*, or other configuration formed on its side; 3rd. The plate *f*, corrugated on both sides and rolled to the proper width; 4th. A horse shoe nail having a bevelled head produced by shearing from the end of a plate corrugated on both sides turned over at each cut of the cutters.

### No. 6281. Improvements on Breach-loading Fire-arms.

(*Perfectionnements aux armes à feu chargeant par la culasse.*)

William P. Marston, Toronto, Ont., 10th July, 1876, for 5 years.

*Claim.*—1st. The circular grooves A, A, and slot or groove *a*, in breach block; 2nd. The circular projections or ribs B, on the under side of the barrel corresponding with and fitting into the grooves A, A; 3rd. The extractor C, with pin *e*; 4th. The screws *d*, *d*, fitting into the ribs B, B; 5th. The combination of the grooves A, A, and projections B, B, with the breach block and barrel.

### No. 6282. Waggon Brake. (*Frein de wagon.*)

Elisha H. Wheeler, Canton, Mo., U. S., 10th July, 1876, for 5 years.

*Claim.*—1st. The combination of levers B, and C, when constructed and arranged so that lever C, shall cross lever B, at 1, and being provided with a hole 4, for the attachment of a connecting rod; 2nd. The combination of levers B, and C, pawl bracket L, and segment A; 3rd. The combination of pawl bracket L, with its lug 7, lever C, and lever B.

### No. 6283. Pad for Interfering Horses.

(*Entravon pour les chevaux qui s'entailent.*)

Henry G. White, Palmyra, N. Y., U. S., 10th July, 1876, for 5 years.

*Claim.*—A strap A, wings *d*, *d*, and claw *b*.

### No. 6284. Ventilating Stove Board.

(*Plaque à ventiler les poêles.*)

Samuel Magill, Hamilton, Ont., 10th July, 1876, for 5 years.

*Claim.*—A plain or ornamental stove board A, constructed with bevel *b*, *e*, *g*, curve *d*, provided with ventilating holes *e*, and bell mouthed ventilator B, the same made either of cast iron with any ornamental pattern or stamped out of sheet metal in whole or in sections and put together.

### No. 6285. Improvements on Chairs.

(*Perfectionnements aux chaises.*)

Asher B. Stevens and Cheney Kilburn, Philadelphia, Pa., U. S., 10th July, 1876, for 5 years.

*Claim.*—1st. A flexible supporting structure consisting of two curved springs D, D<sub>1</sub>, the hangers B, B<sub>1</sub>, attached to the object to be supported and secured to the upper ends of the springs and bars E, to which the lower ends of the springs are attached; 2nd. The springs D, D<sub>1</sub>, made of one bent bar in combination with the hangers B, B<sub>1</sub>, and reinforcing plates K, through the medium of which the said springs are secured to the hangers; 3rd. The combination of the projections *m*, *m*, secured to the bars E, and having rubber pads *n*, with the springs D, D<sub>1</sub>; 4th. The combination of a chair having spring supports with a base H, having a ring I, and a central pin or bolt on which the chain can turn; 5th. The combination in a chair of the seat A, the springs H, H<sub>1</sub>, and standards M, constructed and adapted to the frames D, D<sub>1</sub>, or to the seat for the protection of the springs; 6th. The combination of the bars B, B<sub>1</sub>, the seat supporting springs H, H<sub>1</sub>, the standards M, and the rod N, by which the said standards are connected together; 7th. The combination in a spring tilting chair of a base A, and seat B, pivoted together with the curved springs D, D<sub>1</sub>, secured to the base and to the seat; 8th. The combination of the screw *h*, and seat A, pivoted to the screw with the springs D, D<sub>1</sub>, ring M, and the post *b*, of the base; 9th. The combination of the seat A, the screw *h*, and its projection *i*, for limiting the vibration of the seat; 10th. The combination of the base B, and its screw *h*, and the seat A, and its springs D, with the nut S, and its bar *n*; 11th. The combination of the seat A, and its connections with the bar *n*, bent forward at the ends.

### No. 6286. Improvements on Steam Pumps.

(*Perfectionnements aux pompes à vapeur.*)

Walter H. Laurie, Montreal, Que., 10th July, 1876, for 5 years.

*Claim.*—In combination with the steam chest of any direct acting steam engine the combination of the dog H, pivoted in the steam port and acting directly in the slide valve to give it initial motion, with the auxiliary slide valve N, operating by means of the passages *m*, and piston M, the piston valve O, to reverse the current of steam.

### No. 6287. Improvements on Hemmingway's School Seats.

(*Perfectionnements aux bancs d'écoles dits "Hemmingway."*)

Charles B. Record, Moncton, N. B., 10th July, 1876, for 5 years.

*Claim.*—1st. The set screw, 2nd. The combination of set screw feather and groove.

### No. 6288. Horse Power Link. (*Maille de manège.*)

Barnard L. Olds, St. Albans, Vt., U. S., 10th July, 1876, for 5 years.

*Claim.*—The horse-power link composed of the cast iron body and wrought iron back the latter terminating at each end in a curve forming a bearing for a journal within it.

### No. 6289. Machine for Washing Clothes.

(*Machine à laver le linge.*)

Catterick Paekham, Guelph, Ont., 10th July, 1876, for 5 years.

*Claim.*—1st. The form and position of the ribs *r*, and channels *F*, on the bottom of the tub *A*, the ribs *r*, and channels *F*, on disc *G*. 2nd. The guide bar *K*, with pins *n*, *n*, operating in the top rail *H*. 3rd. The centre bar *I*, with spring *O*, on disc *G*. 4th. The combination of the before claimed parts, viz. ribs *r*, channels *F*, *F*, guide bar *K*, with pins *n*, *n*, centre bar *I*, with spring *O*, with the tub *A*, disc *G*, bench *D*.

### No. 6290. Apparatus for Burning Saw-dust, &c. (*Appareil à brûler le bran de scie, &c.*)

Richard Hodson, London, Eng., 11th July, 1876, for 5 years.

*Claim.*—1st. The combination in a fuel feeding apparatus, of the hopper *B*, chamber *C*, propelling screw *D*, chute *C*, feed trunk *E*, fan or blower *F*, motive power engine *G*, and steam supply cocks *n*, arranged so as to enable the attendant to supply fuel mingled with a blast of air at any desired rate to a furnace; 2nd. The arrangement of gearing *f*, *h*, differential chain pulleys *I*, and *K*, and chain *i*, for transmitting motion from the shaft of the engine *G*, to the propelling screw *D*, so as to allow of the speed of the propelling screw being readily adjusted relatively to the speed of the fan or blower and of the action of the apparatus, being arrested automatically should the feed passages become choked; 3rd. The tapering mouth *E*, of the feed trunk *E*, constructed with hinged adjustable lips *e*, &c.

### No. 6291. Thill Coupling. (*Ajustage de limonière.*)

Osmore O. Roberts, Northampton, Mass., U. S., 11th July, 1876, for 10 years.

*Claim.*—The combination of the shaft iron *B*, and its T-pivot *C*, with the jack having the notch *H*, opening into one of its pivot holes and being located relatively to the working position of the shaft iron, to prevent the escape of the said iron, the combination of the set screw *G*, or its equivalent with the T-pivot *C*, of the shaft iron, and with the jack *D*.

### No. 6292. Freezing Apparatus.

(*Appareil de congélation.*)

Charles W. Gauthier, Sandwich, Ont., 11th July, 1876, for 5 years.

*Claim.*—1st. The partition *D*, having top and bottom air circulating apertures *I*, *J*, dividing the refrigerator into two or more compartments; 2nd. The arrangement of the ice chambers *L*, around the compartments *K*. *L*, shelves *E*, within the same and ducts *C*, to carry off waste water, in combination with partition *D*.

### No. 6293. Cooking Stove. (*Poêle de cuisine.*)

Edward Bartlett, Renfrew, Ont., 11th July, 1876, for 5 years.

*Claim.*—1st. The form and manner of placing the pieces *K*, *K*, to form a flue for the equal distribution of heat over the stove. 2nd. The position and shape of the plate *G*. 3rd. The use and shape of the insulo plate *G*, for covering the ovens *V*, *V*, and the combination of the plate *G*, with plate *G*, covering the space between *K*, *K*, immediately above the fire; 4th. The placing of the fire box *n* or through the centre of the stove between the ovens *V*, *V*; 5th. The construction of the fire bars or grate, viz. with solid pieces at each end to prevent the cold air entering otherwise than through the fire, the combination of the bars or grate with the adjustable grate or damper for the regulation of draft; 6th. The shape and combination of the fire and oven doors, with the grooves in the top and bottom of the stove; 7th. The construction and combination of the fixed pieces *J*, *J*, *J*, with the top *C* and the bottom *T*, and fire-box *X*, with doors *D*, *D*, and bars or grate *H*, and dust pan *F*, the combination and construction of the whole parts; 8th. The construction and application of the portable ovens.

### No. 6294. Improvements on Sewage Tanks.

(*Perfectionnements aux réservoirs d'égoûts.*)

Reuben A. McCauley, Baltimore, Ind., U. S., 11th July, 1876, for 5 years.

*Claim.*—1st. The deodorizer and safety valve *B*, combined and connected with, and operating by direct pressure from the ventilating tank or sewage receptacle *A*. 2nd. The combination of the ventilating sewage receptacle *A*, deodorizer and safety-valve *B*, and stand pipe *C*. 3rd. In combination with the tank *A*, having the discharge nozzle, the valve *C*, and plug *D*, connected by the links *b*.

### No. 6295. Barn Door Hanger.

(*Penture de porte d'étable.*)

Samuel H. Moore and Edward Y. Moore, Chicago, Ill., U. S., 11th July, 1876, for 5 years.

*Claim.*—1st. A barn door hanger in which the hub of the rotating wheel revolves within a series of loose chilled iron rollers; 2nd. The strap *A*, formed with the circular plate *B*, having the two circular concentric flanges *a*, *b*. 3rd. The wheel *c*, provided with projecting rim and hollow hub *F*. 4th. The combination of the circular plate *B*, with concentric flanges *a*, *b*, the wheel *c*, with hub *F*, and the loose chilled iron rollers *D*, *D*, placed between the hub *F*, and the flange *a*, and the whole closed by the cap *E*; 5th. The projecting lugs *m*, on the rim of the cap *E*, in combination with the notches *n*, in the flange *b*, on the plate *B*.

### No. 6296. Fare Register.

(*Registre de billets de passage.*)

William H. Hornum, New-York, U. S., 11th July, 1876, for 5 years.

*Claim.*—1st. A registering mechanism composed of a unit disc and a ten disc which are geared together with each other, the unit disk being provided with apertures *n*, arranged on a convolute curve in combination with a slide or prime mover, and with a general registering mechanism; 2nd. In combination with the slide or prime mover *L*, the slotted disc or ratchet wheel *g*, rod *o*, and cam groove *r*. 3rd. The combination of a latch *a*, with the slide or prime mover *L* and with the registering mechanism *C*; 4th. The combination of the single trip register *C*, composed of discs *G*, *H*, with the general register *D*, alarm *M*, and slide or prime mover *E*. 5th. The combination of diaphragms *ot*, of wire gauze with perforations *nt*, in the sides of the case to keep out the dust without interfering with the sound of the alarm.

### No. 6297. Boot Tree. (*Tige de botte.*)

Joseph K. Feick, Harrisburg, Ont., 11th July, 1876, for 5 years.

*Claim.*—1st. The combination with the parts *A*, *B*, of the boot tree, the screw shaft *E*, cam nuts *C*, *D*, and plate *F*. 2nd. The jackets *G*, and screws *H*, in combination with the parts *A* and *B*. 3rd. The last plate *K*, for supporting the part *B* and receiving the thrust of the part *A* when so stopped.

### No. 6298. Improvements in Eye Cups.

(*Perfectionnements aux baignoires oculaires.*)

Philetus J. Stevens, New-York, U. S., 11th July, 1876, for 5 years.

*Claim.*—The eye cup *A* with valves *g*, connecting tube *P*, and rubber ring *R*.

### No. 6299. Curd Knife. (*Couteau de fromagerie.*)

Alonso Sedgwick and Edwin B. Sedgwick, Poughkeepsie, N. Y., U. S., 11th July, 1876, for 5 years.

*Claim.*—1st. A curd cutter constructed of a series of parallel blades sharpened on both of their edges and with transverse blades sharpened in like manner, combined with one or more metallic head plates. 2nd. A series of double edged knives, constructed with lugs combined with slots formed in one or more metallic head plates; 3rd. A series of parallel double edged knives, one or more double edged transverse knives secured thereto. 4th. The knives secured to a non-porous head.

### No. 6300. Boot Tree. (*Tige de botte.*)

James H. Sampson, Paris, Ont., 11th July, 1876, for 5 years.

*Claim.*—The combination of the lever *F*, adjusting screw *G*, and nut *H* with the wedge piece, or slide of a boot tree having a series of backs with differential centres.

### No. 6301. West Thread Knitting Loom.

(*Métier à tricoter la trame.*)

Charles I. Spencer, Providence, R. I., and Samuel W. Pngtree, Lawrence, Mass., U. S., 11th July, 1876, for 5 years.

*Claim 1st.*—A machine for knitting cloth in which a weft or filling thread is inserted or woven into the stitches, the arrangement of the needles, in order that they stand at different angles to the axis of the jack or slide to which they are attached, and thus form a path between their upper ends for the passage of weft thread; 2nd. A machine for knitting cloth in which a weft thread is inserted or woven, the arrangement of a portion of the needles with an outward inclination from the axis of the jack or slide which carries them, whereby they are made susceptible to the action of the cloth at the time of taking the stitch and are thereby brought into a line concentric with the other needles at that time; 3rd. The combination of the automatically adjustable tail cap rollers, with the reciprocating needles and the needle cylinder wherein the required tension is put upon the goods while being woven. 4th. The combination of the automatically adjustable take up rollers with the shaft *N*, ratchet *R*, and regulating mechanism *h*, *ht*, and *h*. 5th. The combination of the gear wheel *H*, revolving frame *J*, fixed wheel *P*, and shaft *X*, with its automatically operating worm wheel *M*.

### No. 6302. Process and Apparatus for Amalgamating Metals and Machine for Washing Ores.

(*Procédé et appareil pour amalgamer les métaux et machine à laver les minerais.*)

Thomas A. D. Forster and George J. Firmin, Norristown, Pa., 11th July, 1876, for 5 years.

*Claim.*—1st. The process of amalgamating metals by projecting mercury and ground or pulverized ore together through the medium of a current of steam or air, forming a sand blast. 2nd. The method of amalgamating metals by a continuous operation consisting in feeding ground or pulverized ore into a receiver or cylinder where in the act of falling it is impinged by a current of steam or air which carries said ore in the form of a blast through said cylinder, mercury admitted with the steam, air or ore being at the same time carried along and producing amalgamation without cessation of feed. 3rd. The combination of cylinder *A*, hopper or feeding device *B*, steam or air pipe *D*, and mercury pipe *E*, the several parts being relatively arranged to produce a blast of mingled mercury and ore. 4th. The combination and arrangement of the cylinder *A*, hopper *B*, and steam or air pipe *D*, said pipes being advanced far enough into said cylinder to come within the circumferential opening of the hopper neck *b*. 5th. In combination with the steam or air pipe *D*, the mercury pipe *E*, the latter projecting beyond the delivery end of the former, and both being combined with an amalgamating vessel or cylinder. 6th. In combination with the cylinder *A*, hopper *B*, and steam and mercury pipes *D*, *E*, the duct *G*, affording an unobstructed passage for the ore and amalgamated metals from the said cylinder and serving to make the operation continuous. 7th. The ore washer consisting of a vessel *H*, having conical bottom *h*, hollow shaft *K*, rollers *L*, *L*, wings *M*, *M*, well *I*, and hull cocks *n*, *n*. 8th. The process of washing ore by upward filtration or by means of water brought into a tank through an exit port located above said bottom or point of admission; 9th. The tank *H*, having the conical bottom *h*, and well *I*; 10th. The combination of the hollow shaft *K*, conical rollers *L*, *L*, and tank *H*, having conical bottom *h*. 11th. The process of amalgamating metals by mixing ore and mercury or mercurial vapour in a close chamber and grinding the commingled mass under or between rollers.

12th. The combination with an amalgamating vessel M, in which ore and mercury or mercurial vapour are commingled, of a grinding roller or rollers for producing more perfect amalgamation; 13th. The combination of amalgamating vessel M, hopper O, retort R, and grinding roller or rollers T, with or without the agitators S.

**No. 6303. Composition for Plough Casting.**  
(Composition pour la fonte des charrues.)

David Clinton, Wellington, Ont., 11th July, 1876, for 5 years.

Claim.—A compound of cast-iron and steel.

**No. 6304. Liquid Measure. (Mesure liquide.)**

John W. Wilkinsoe, Meadville, Pa., U. S., 11th July 1876 for 5. cars.

Claim.—1st. The conical liquid measure F, in combination with the induction tube C, and ejection faucet or stop cock P; 2nd. The combination of the rod I and lever H, with the valve II, and measuring vessel E, all arranged to operate so that the valve II, will open to permit of the escape of air when the measure is being filled; 3rd. The combination of the rod I lever H and valve II, with the stop cock E arranged to operate so that when the latter is turned to discharge the contents of the measure the valve II will be opened to admit air into the measuring glass.

**No. 6305. Improvements on Landau Carriages.**  
(Perfectionnements aux landaux.)

Robert Dunn, St. Louis Mo., U. S., 17th July, 1876, for 5 years.

Claim.—1st. The side grooves A, arranged on the top of the body A, so that the said sashes may be moved around to the front of the top; 2nd. The angle brace D, and its connecting pins C, C', C'', by which the frame G is connected with the bows B; 3rd. The angle iron water guard F, secured to the top part of the carriage body A.

**No. 6306. Grain Binder. (Lieuse de grain.)**

John Parker, Portland, Ont., 17th July, 1876, for 5 years.

Claim.—1st. In combination with the frame A mounted on axle B, of a ground wheel C, the toothed gathering frame E, and sprocket wheels F; 2nd. The toothed head G, journalled on the frame A, in combination with a frame E; 3rd. The spring plyer jaws 4, attached to a tooth of the head G, and operating automatically for holding the binding wire; 4th. The radial arm hub 3, or notched disc, mounted on a hollow journal, and the shears 5, in combination with a spool 2, for twisting and cutting the wire.

**No. 6307. Improvements on Bolting Reels.**  
(Perfectionnement des blutairs tournants.)

Lewis V. Rathbun, East-Pembroke, N. Y., U. S., 17th July, 1876, for 5 years.

Claim.—1st. The combination with a bolting reel of the slotted segment F, pivoted at the bottom so as to move toward or from the reel, and the cam G made adjustable on the segment to vary the angle at which the snapping cords strike the cloth; 2nd. The combination with the rotating reel provided with the spring bolts; 3rd. The combination with the wedging sides S, S, and pointed end T, and pivoted to its support so as to rise under the back action of the spring bolts; 3rd. The case B, made in halves constructed with the slots or holes g, g, flanges c, e, barrel b, and side grooves h, h, to receive the spring bolt C; 4th. The combination with the slotted case B, having side grooves h, h, of the bolt C, constructed with the spino 5, and the spring D.

**No. 6308. Process of Enamelling Iron Ware.**  
(Procédé d'émaillage des objets en fer.)

Frederick G. Niedringhaus and William F. Niedringhaus, St. Louis Mo., U. S., 17th July, 1876, for 5 years.

Claim.—1st. The process of enamelling iron ware; 2nd. Iron ware enamelled.

**No. 6309. Dish Drainer. (Egouttoir a vaisselle.)**

Vashti Chandler, Pontiac, Mich., U. S., 17th July, 1876, for 5 years.

Claim.—The inclined shelves A, A, decreasing uniformly in width from bottom to top and having the longitudinal groove C, C', and drip tubes E, E, in combination with the inclined slat-D, and vertical slats D.

**No. 6310. Billiard Table. (Table de billard.)**

Hugh W. Colleder, New-York, U. S., 17th July, 1876, for 5 years.

Claim.—1st. In combination with a side and end broad rail or with two sides of a wooden frame table, an intermediate or interposed device or piece adapted to hold the ends of such broad rails or table sides in place laterally; 2nd. In combination with a wooden frame table a stand or plate suitably made to give a bearing to and afford means of securement to it of the leg when such stand or leg holding device is cast with or rigidly united to the plate or casting which is interposed and held fast between the sides of the table; 3rd. A corner plate or intermediate casting formed or provided with a bead or rib adapted to cover the joint between the wooden broad rails at the outer corner of their junction.

**No. 6311. Mechanism for Moulding the Soles of Boots and Shoes.**  
(Machine a former les semelles des chaussures.)

William H. Palmer, Dover, N. H., U. S., 17th July, 1876, for 5 years.

Claim.—1st. A mould block provided with an adjustable stamp or device G for forming in the toe portion of the sole a depression to receive the inner sole and upper; 2nd. A boot or shoe sole having a recess or depression at the toe formed by compression without removing any portion of the stock.

**No. 6312. Window blind. (Persienne.)**

Orden A. Doekham St Thomas, Ont., 17th July, 1876 for 5 years.

Claim.—1st. The hinged arm A, for the purpose of allowing the blind to be raised or opened out where it is required; 2nd. The pulley C; 3rd. The metal covering of the lower part of the opening B.

**No. 6313. Hand Stamp Printing Form.**  
(Timbre-composteur.)

Andrew Jackson and James C. Bryner, Montreal, Que., 17th July, 1876, for 5 years.

Claim.—1st. The sliding frames A, and D, making up together a form for the reception of type or blocks for printing said form being thus capable of

adjustment to any required length; 2nd. The slides or guides C, and F, which may be of any suitable form attached to the frames A, and D, respectively by the uprights B, B, and U, forming a handle for the apparatus; 3rd. The pinching screw k, or its equivalent fixed to one of the frames and working in a slot g in the other, to hold both firmly together when adjusted.

**No. 6314. Improvements in Reaping Machines.**  
(Perfectionnements aux moissonneuses.)

Leane Mills, Hamilton, Ont., 17th July, 1876, for 5 years.

Claim.—1st. In combination with a reaper the L shaped rake consisting of the handle H, with the loose head rake U, for sliding to the same; 2nd. The bar or case I, containing a groove G, and guards K, K', for the handle H, of the rake to operate in also the bar J, with its groove c for the rake head to slide in; 3rd. The arrangement and combination of the gearing for driving the rake consisting of the wheel T cog wheels O, O', shaft Q, crank R, connecting rod S, driven by the drive wheel 4th. The arrangement of the hand lever P, with the gearing and shaft for throwing the rake in and out of gear; 5th. The arrangement of the foot lever P', bracket m, spring o, pin n in shaft A, p, b, r, in smooth portion of cog pinion O', for operating the rake by foot; 6th. The arrangement of the guards C, E, and guard rail W for causing the cut grain to fall about ten or twelve inches from the rear end of table to allow room for the teeth of the rake to rise; 7th. The arrangement of the square grain table A, provided with slots B running parallel to each other for the teeth of the rake to operate through; 8th. The method employed for tripping the rake by means of the long tooth E, and trip L, for raising the teeth and the said tooth and bar N, for depressing the teeth; 9th. The arrangement of the bearings D, and W for the reel; 10th. The entire mode of constructing the rake and gearing for tripping and driving the same; 11th. In combination with a harvester the combination of the rod t, attached to cutter bar, plate j, handle k, rake U, operated by a crank for driving the rake.

**No. 6315. Improvements on Piano Pedals.**  
(Perfectionnements aux pedalis des pianos.)

William Muth, Montreal, Que., 17th July 1876, for 5 years.

Claim.—1st. The curved metal bar A in combination with the two end closed forks f, f, the central open fork F, and intermediate guide wires g, g, for allowing the bar A, to move freely and steadily up and down; 2nd. The supporting wires h, h, fixed into the bar A and resting on the sliding plugs j, j, j, for connecting the bar A, with the pedal levers; 3rd. The three duplex levers k, k, k, simultaneously acted on by the pedal stem l with spring m, acting in the contrary direction upon the whole system of levers.

**No. 6316. Dryer. (Stcherie.)**

James L. Adams and Joseph G. Blondin, Montreal, Que., 17th July, 1876, for 5 years.

Claim.—1st. The combination of a fan or blower F steam p pes S, and M, and 2nd. The external arrangement of openings D, and P, slide H, lever L, and scrap box J, 3rd. The combination mechanism composed of shaft E, horizontal transverse bar G, connected by bell crank E, slot dog or upright C provided with a clam or tooth, springs I, and lever L.

**No. 6317. Billiard Table. (Table de billard.)**

Hugh W. Colleder, New-York, U. S., 17th July, 1876, for 5 years.

Claim.—1st. In combination with the side broad rails and a cross beam metallic shoe pieces or holder plates and a bolt or nut or other device for fastening the parts together; 2nd. In combination with the cross beam of a table frame and the longitudinal beams or bars, metallic shoe pieces adapted to be secured on either side of the cross beam and to hold laterally and vertically support the ends of said longitudinal beams; 3rd. In combination with the end broad rails and longitudinal beams or bars metallic stands adapted to hold laterally and vertically support the ends of said longitudinal beams; 4th. Shoe pieces or castings adapted to be secured upon the opposite faces or sides of the cross beam and having tents or lugs which penetrate the beam and come together.

**No. 7318. Improvement on Steam Traps.**  
(Perfectionnement des trappes de vapeur.)

George W. Harrold, Rochester, N. Y., U. S., 17th July 1876, for 5 years.

Claim.—1st. The combination of the trap or casing A, the receiving pipe B, connected with the receiver the ejection pipe C connected with the boiler, (with or without the circulation pipe D) and the steam supply pipe D, to force by injection the water between the steam nozzle and the check valve or valves through the ejection pipe into the boiler; 2nd. The combination of the steam jet pipe D, and the syphon consisting of the pipes B C and E, connected and operating for forcing the water into the boiler by injection.

**No. 6319. Machine for Crimping the Heels of Mocassins.**  
(Machine a cramber les talons de mocassins.)

Charles Beaupré, Ottawa, Ont., 17th July, 1876, for 5 years.

Claim.—1st. The combination of the wooden block last B, iron crimping block F and frame C with the frame A lever frame D and half pinions e, to crimp the heels of mocassins or shoe packs; 2nd. In combination with a crimping machine A, the mocassin or shoe pack G, having no seams at the lower part of its heel, said mocassin or shoe pack being the product of the crimping machine A.

**No. 6320. Earth Auger. (Tariere a terre.)**

Isaac Ireland, Mount Forest, Ont., 17th July, 1876, for 5 years.

Claim.—The combination of the slide-bars 1, attached to the shell C, by clips d, the movable sides G, G of the shell C, the movable sheaves I, and J, with the shell C.

**No. 6321. Broom Corn Sizing Machine.**  
(Machine a coller la houque.)

Alphonso Walrath, Fort Plain, N. Y., U. S., 17th July 1876, for 5 years.

Claim.—1st. The spurrier and distributing belts D, D', D'', D''', of different lengths except the outer belts D, D', which are of the same length, and the guide strips e, e', e'', e''', in combination with the bin, divided into several compartments; 2nd. The spurred feeding-wheels H, H, in combination with the spring fingers g, g', supporting plate G, and cutter J.



**No. 6322. Railroad Car Adjuster.***(Appareil à remettre les voitures de railroutes sur la voie.)*

Charles Bigaquette, Montreal, Que., 17th July, 1876, for 5 years.

*Claim.*—1st. The combination of the screws and cylinders; 2nd. The two cases, one running within the other on revolving cylinders; 3rd. The application of the invention to moving houses, boilers, and other heavy machinery and bodies, into the exact position required.

**No. 6323. Improvements on Churns.***(Perfectionnements aux barattes.)*

Thomas Simmons, Hartford, Ct. U. S., 15th July, 1876, for 5 years.

*Claim.*—1st. The construction, combination, and arrangement of the stationary interior aerating tube H the nut I for locking it to the frame, the exterior driving tube J, and the revolving dasher K; 2nd. The combination of the frame A, B, and the geared wheels C, D, E, F, G, with the driving tube J, and its dog J' for operating the revolving dasher K.

**No. 6324. Machine for Mounting Photographs on Cards.***(Machine à monter les photographies sur des cartes.)*

Robert Sheane, Listowel, Ont., 17th July, 1876, for 5 years.

*Claim.*—1st. Box *x*, to hold cards on which to mount pictures, screw points L, E, passing through edge of box to hold cards, notches L', L, to take out picture when mounted, plate attached to the thumb screw I, in combination with the thumb screw and cross bar H, to hold cards in position against points L, E, while mounting box O, in which to place glass plate on which to lay picture to mount, 2nd. The combination of the different parts.

**No. 6325. Middlings Purifying Machine.***(Machine à épurer les gruaux.)*

Benjamin Barter, Toronto, Ont., 17th July, 1876, for 5 years.

*Claim.*—1st. The reciprocating bolting shaker B, suspended on a level or an incline, and divided into two or more planes or sections B<sub>1</sub>, of equal or unequal width rising one above the other to the feed hopper; 2nd. The breaker slats G, and H, inserted in the interval of height between the section of the shaker and the shaker and feed roller; 3rd. The combination of the section fan or fans C, one or more return chambers D, and the reciprocating bolting shaker B, divided into sections of different elevations and covered with graded or ungraded bolting cloth or solid or perforated wood.

**No. 6326. Seeder and Cultivator Tooth.***(Dent de semoir et de cultivateur.)*

John Y. Hammond, Oshawa, Ont., 17th July, 1876, for 5 years.

*Claim.*—The combination of the tooth A, having groove B, bar C, and screw D, with the chisel pointed shank E, fitting into said groove and held removably by the screw D.

**No. 6327. Improvements on Skates.***(Perfectionnements aux patins.)*

Charles Brewster, Montreal, Que., 17th July, 1876, for 5 years.

*Claim.*—1st. The combination of the clamp *f*, spindle *e*, with toggle joint consisting of parts *m*, and *n*, plate *d*, having inclined slots *h*, and clamps *k*; 2nd. The combination of the toggle joint *m*, *n*, sole plate *d*, having inclined slot *h*, and clamps *k*; 3rd. The combination of the clamps *k*, having ribs *a*, bar *b*, spindle *e*, and plate *d*, having inclined slots *h*; 4th. The combination of the clamps *k*, bar *b*, plate *d*, having inclined slots *h*, spindle *e*, and clamp *f*; 5th. The combination of the clamps *k*, plate *a*, spindle *e*, and plate *d*, having inclined slots *h*; 6th. The combination of the clamps *k*, plate *a*, spindle *e*, plate *d*, having inclined slots *h*, and clamp *f*.

**No. 6328. Boot Lace Fastener.***(Billet de soulier.)*

Thomas A. McDonald, Durham, and James W. McDonald, Campbelltown, N. B., 20th July, 1876, for 5 years.

*Claim.*—1st. The combination of the front plate *x*, having the slot *e*, calkins *f*, and tube *g*, with rear plate *b*, having double hole *h*; 2nd. The combination of the boot lace fastener A, with the boot B.

**No. 6329. Gear Trip for Harvester.***(Engrenage de moissonneuses.)*

Robert Thomson and Alfred R. Williams, Stratford, Ont. (Assignee of Orville Cooley), 20th July, 1876, for 5 years.

*Claim.*—1st. In combination with the cam gate of a harvester the latch *f*, slotted stud *J*, and wheels *e*, *e*, *e*, *e*, *e*, *e*, having an incline or lifting cam on its upper face; 2nd. In combination with the lifting wheel *e*, the driving wheel *b*, mounted loosely on the rack shaft and driven by a ratchet or clutch; 3rd. The forked lever *c*, in combination with the rake shaft *d*, and driving wheel *b*, of a harvester rake; 4th. The stud *J*, adjustable towards and from the rake shaft *d*, in combination with the driving gear wheel *b*, and the series of different sized driven wheels *e*, *e*, *e*, *e*, *e*, *e*; 5th. One or more studs *J*, adjustable towards and from the rake shaft *d*, in combination with the driving gear wheel *b*, and the series of different sized driven wheels *e*, *e*, *e*, *e*, *e*, *e*, placed at different positions around the shaft *d*, and operated by the latch *f*; 6th. In combination with the cam gate of a harvester held open by a spring and the cam plate to which it is applied and rake arms moving over it a gate latch and tripping mechanism; 7th. The combination of a spring gate, cam plate and rake arms a gate lever gate latch and adjustable tripping mechanism; 8th. The combination of a spring gate, cam plate, rake arms, gate latch and tripping mechanism for automatic operation, and the clutch and rod for operation at will of the driver; 9th. A cam gate adapted to be opened and closed automatically at regular intervals, and also adapted to be kept open or closed at the will of the driver so as to render the raking entirely under his control.

**No. 6330. Pitman Connection for Mowing and other Machines.***(Manchon d'embrayage de machines à faucher et autres.)*

Robert Thomson and Alfred R. Williams, Stratford, Ont. (Assignees of Orville Cooley), 20th July, 1876, for 5 years.

*Claim.*—The combination of the rigid plate A, or B, with the hinged plate A<sub>1</sub>, A<sub>2</sub>, or B<sub>1</sub>, B<sub>2</sub>, parts of which are permanently connected together and with the bolt *c*, and ball or swivel block.

**No. 6331. Tightener, Stripper and Guide for Belts and Endless Chains.***(Régulateur de courroie et de chaîne sans fin.)*

Robert Thomson and Alfred R. Williams, Stratford, Ont. (Assignees of Orville Cooley), 20th July, 1876, for 5 years.

*Claim.*—1st. The combination of two connected and pivoted pulleys with a belt or chain passing between them and pressed in opposite directions by them, and a spring for applying the pressure to said pulleys; 2nd. The combination of two connected and pivoted pulleys with belt or chain passing between them and pressed in opposition by them, and a spring for applying the pressure to said pulleys; 3rd. The combination of the support C, K, the forked arm *b*, *b*, and the pulleys *a*, *a*, with the torsional spring *d*; 4th. The notched ring L, combined with the support C, K, the spring *d*, and the pulley *a*, *a*, mounted on the arm *b*, *b*; 5th. The combination of a pulley *a*, arranged to strip the chain from the driving wheel, a second pulley *a*, arranged to raise the chain and guide it to the driven wheel with a chain passing between the pulleys and a spring or its equivalent for applying the pressure and taking up the slack of the chain.

**No. 6332. Improvement in Harvesting Machines.***(Perfectionnement des machines à moissonner.)*

Robert Thomson and Alfred R. Williams, Stratford, Ont. (Assignee of Orville Cooley), 20th July, 1876, for 5 years.

*Claim.*—1st. The combination of a frame work having a V-shaped surface to receive the box or bearing D; 2nd. The boxes D, made V-shaped on one side and held into position by the wedge bolt C; 3rd. The combination of one or more keys to hold the boxes D.

**No. 6333. Improvement in Reapers and Harvesters.***(Perfectionnement des faucheuses-moissonneuses.)*

Robert Thomson and Alfred R. Williams, Stratford, Ont. (Assignees of Orville Cooley), 20th July, 1876, for 5 years.

*Claim.*—1st. The slides or plates D, provided with the hubs G, secured to same forming the bearing for bolt or pin H, to attach the same to the head C; 2nd. The journal I, formed on said elbow and located directly central with the arm E, and hubs G; 3rd. The combination with the above and the collar F.

**No. 6334. Improvement in Reaping and Harvesting Machines.***(Perfectionnement des machines à faucher et à moissonner.)*

Robert Thomson and Alfred R. Williams, Stratford, Ont. (Assignees of Orville Cooley), 20th July, 1876, for 5 years.

*Claim.*—1st. The combination of the upper shoe D, with the platform and wooden beam A, together with the iron finger bar angle *c*, the iron finger bar B; 2nd. The combination of the above with the lower shoe E, as secured to the drag bar H, or the truck of a machine; 3rd. The upper shoe D, hinged to the lower shoe E, and both being hinged together to firmly secure the same when the machine is in operation; 4th. The combination of one or of the whole of the above parts together or separately.

**No. 6335. Improvements on Plough Points.***(Perfectionnements aux socs de charrues.)*

William H. Trissler, Cleveland, Ohio, U. S., 20th July, 1876, for 5 years.

*Claim.*—1st. A plough point adapted for attachment to a plough consisting of three pieces B, C, D, riveted together; 2nd. A plough provided with a point consisting of the three pieces B, C, D, riveted to each other and secured to the plough; 3rd. The slides G, provided with turned edges or flanges G, in combination with the point B; 4th. A plough provided with a point consisting of a single piece constructed with a point G, socket or recess I, having in the sides thereof openings *a*, and with or without interior ribs C; 5th. The auxiliary chambered point in combination with the plough and attached thereto by means of soft metal or composition.

**No. 6336. Rotary Churn. (Baratte tournante.)**

Hannibal Felt, Odin, Ill., U. S., 20th July, 1876, for 5 years.

*Claim.*—1st. The combination of the driving gear D, E, F, rotating frame I, J, K, dasher M, N, O, P, cream vessel G, and stand A, B, H; 2nd. The dasher constructed with a rotary frame M, N, having bearings in a removable frame O, P; 3rd. The combination of dasher with the cream vessel having lugs Q.

**No. 6337. Improvements on Horse-powers.***(Perfectionnements aux manèges.)*

George Gibson, Mount-Forest, Ont., 20th July, 1876, for 5 years.

*Claim.*—The combination of the arm H, spindle I, horse-power wheel B, bull pinion C, speed wheel D, pinion E, and fly wheel F, with connecting rod G, and frame A, to work circular saws, crushing machine, &c.

**No. 6338. Improvements on Hatchets.***(Perfectionnements aux hachettes.)*

John A. Thayer, Cambridge, Mass., U. S., 20th July, 1876, for 5 years.

*Claim.*—The combination tool consisting of a hatchet *a*, hammer *b*, nail puller *c*, adze, eraser, *d*, and handle *e*.

**No. 6339. Improvements on Grinding Mills.***(Perfectionnements aux moulins à farine.)*

William M. Woodbury, Rochester, Min., U. S., 20th July, 1876, for 5 years.

*Claim.*—1st. The combination of a mill stone with sustaining springs beneath and on the periphery thereof whereby the stone is permitted to yield both vertically and laterally; 2nd. In combination with the stone A, the spring C, and E; 3rd. In combination with the stone A, the rubber springs C, seated in the frame B, and sustained by the screws D; 4th. The rubber ring E, fitted between the stationary lower stone A, and the surrounding case on a line with the upper surface.

## List of Patents issued up to 24th Aug., 1876, but not yet Officially published in the Patent Office Record.

- No. 6466. G. Clements, New Milford, Susquehanna Co., Pa., U. S. A., "Improvements in Covers for Pots and Kettles," 24th August, 1876.
- No. 6457. S. White, Belleville, Ont., "Improvements on Whistletrees," 24th August, 1876.
- No. 6468. C. Ethier St. Eustache, Que. "Improved Sieve," 24th Aug., 1876. (Extension 1114.)
- No. 6469. The Welland Vale Manufacturing Company, Toronto, Ont., "Rodden's Improved Capped Ferrule or Socket," 24th Aug., 1876. (Extension of 616.)
- No. 6470. J. Smith, and C. Smith, Westville, Pictou Co., Nova Scotia, "Improved Process for Tanning and Drying Hides and Skins," 24th Aug., 1876.
- No. 6471. J. Chalifour Montreal Que. "Improved Lifting Machine," 24th August, 1876.
- No. 6472. J. Shickel, Bridgewater, Rockingham Co., Virginia, U. S. A., "Improvements on Plows," 24th Aug., 1876.
- No. 6473. L. O'Hara and H. Cooper Oswego, N. Y., U. S. A., "Lifting Jack," 24th Aug., 1876.
- No. 6474. S. P. at. St. Louis, Missouri, U. S. A., "Mariner's Compass," 24th Aug., 1876.
- No. 6475. T. S. C. Lowe, Norristown, Penn., U. S. A. "Process and Apparatus for producing and using Hydrocarbon and other Gases for Heating and illuminating purposes," 24th Aug., 1876.
- No. 6476. R. E. Letton Quincy Ill., U. S. A., "Improvements on Ryled Organs," 24th Aug., 1876.
- No. 6477. G. A. Shaw, Toronto, Ont., (Assignee of R. W. Semple, of Toronto, aforesaid,) "Improved Lock," 24th Aug., 1876.
- No. 6478. W. F. Foster, Chicago, Ill., U. S. A., "Glove Fastener," 24th Aug., 1876.
- No. 6479. N. E. Otto, Deutz, German Empire, "Improved Gas Motor Engine," 24th Aug., 1876.
- No. 6480. W. A. Smith, Clifton, Ont., "Improvements on Bank Checks, &c.," 24th Aug., 1876.
- No. 6481. E. C. Jones & W. Chaplin, Toronto, Ont., "Rodden's Balloon Tine," 24th Aug., 1876, (Dated 5th Feby., 1876, Extension 795.)



INDEX OF INVENTIONS.

Auger, earth, J. Ireland.....	6320
Bags, H. Redden.....	6216
Bag, flour, T. Phillips.....	6240
Bark, cutting, S. R. Thompson.....	6264
Barrels, heating, H. H. Hale and E. E. Shaw.....	6215
Beds, spring, J. E. Townshend.....	6241
Belts and endless chains, R. Thomson and A. R. Williams.....	6331
Billiard table, H. W. Collender.....	6310
Bolting reels, L. V. Rathbun.....	6307
Boot lace fastener, T. A. and J. W. McDonald.....	6325
“ tree, J. H. Sampson.....	6300
“ “ J. K. Felck.....	6297
Boots and shoes, W. H. Palmer.....	6311
Broom corn sizing, A. Walrath.....	6321
Burglar alarms, A. R. Schultenburg.....	6251
Candy machine, B and H. Stern.....	6265
Car couplers, G. Jones.....	6249
Carriages, R. Dunn.....	6305
“ S. P. Graham.....	6257
Carriage thill, O. O. Roberts.....	6291
Cannons, J. R. N. Owen.....	6292
Catapults, J. A. Knight.....	6231
Chairs, A. B. Stevens and C. Kilburn.....	6255
Churn, H. Felt.....	6336
“ S. Simmons.....	6323
“ Power, T. Cole.....	6229
Clothes, washing, C. Packham.....	6259
Compasses, W. Ascough.....	6267
Cooking stove, E. Bartlett.....	6293
Crimping, C. Beaupré.....	6319
Cultivators, J. Wade.....	6228
Cultivator tooth, J. Y. Hammond.....	6326
Curtain fixtures, W. E. Skinner, W. O. and J. Smith.....	6358
Dish drainer, V. Chaudler.....	6309
Door checks, S. R. Billings.....	6234
“ hanger, S. H. and E. Y. Moore.....	6295
“ holder, H. McDiarmid.....	6219
“ knobs, W. H. Goone.....	6242
Drills, M. C. Bullock.....	6270
Dryer, J. L. Adams and J. G. Blondin.....	6316
Dyeing, mordant for, F. J. Bird.....	6224
Earth Auger, J. Ireland.....	6320
Electric appliances, Voltaic, J. E. Hetherington.....	6272
Evaporators, sap, J. P. Baldwin.....	6297
Eye cups, J. P. Stevens.....	6296
Fare register, W. H. Hornum.....	6251
Fire arms, W. P. Marston.....	6251
Floors, S. P. Groocock.....	6251
Freezing apparatus, C. W. Gauthier.....	6292
Fruit, preserving, S. Peebles, E. Mefford and C. E. Clark.....	6266
Gas manufacturing, H. Bray.....	6216
Gold, extraction of, P. Cadell.....	6259
Grain binder, J. Parker.....	6306
“ binding, S. L. Whitney.....	6239
“ cleaning, J. Higginbottom and E. Hutchinson.....	6273
Hams, preparation of, A. B. Richardson.....	6217
Harrows, W. T. McGhee and J. Waters.....	6237
Harvesters, R. Thomson and A. R. Williams.....	6329
Harvesting, “.....	6332
Hatchets, J. A. Thayer.....	6338
Horse pad, H. G. White.....	6233
“ powers, G. Gibson.....	6337
“ power link, B. L. Olds.....	6258
Hydrants, J. P. Gallagher.....	6260
Iron enameling, F. G. and W. F. Niedringhams.....	6308
Iron welding, J. B. Wills.....	6248
Jar cover, F. L. Bodine.....	6269
Knife, curd, A. and E. R. Sedgwick.....	6299
Knitting Loom, C. I. Spencer and S. W. Pingree.....	6301
Lamp, street, J. S. Woods.....	6274
Measure, liquid, J. W. Wilkinson.....	6304
“ rotary, A. Chambers.....	6275
Meat preserving, K. Knott.....	6252
Metals, amalgamating, T. A. D. Forster and G. J. Firmin.....	6302
Middlings purifying, B. Barter.....	6325
Mills, corn, W. C. Woodbury.....	6329
Mill stones, F. A. Howland.....	6218
Moccasins, C. Beaupré.....	6319
Mowing machine, R. Thomson and A. R. Williams.....	6330
Nail, horse shoe, J. B. Wills.....	6271
“ “ G. B. Clapp, J. A. Pillow and R. Hersey.....	6250
Odometers, A. Chambers.....	6275
Ores, Amalgamating, L. Carvell.....	6220
“ Pulverizing, R. M. Fryer.....	6253
“ washing, T. A. D. Forster and G. J. Firmin.....	6302

Packing boxes, H. N. Hart.....	6255
Packing piston, J. T. Wright and M. Schuoble.....	6238
Pad, horse, H. J. White.....	6233
Paper dampers, C. G. C. Simpson.....	6225
Paraffine, F. N. Byerley.....	6214
Photograph, mounting, R. Sheano.....	6321
Plano, W. H. Wood.....	6261
“ pedals, W. Muth.....	6315
Plough casting, D. Clinton.....	6303
“ Points, W. H. Trissler.....	6335
“ trench, H. Larose.....	6277
Post digger, J. M. Perry.....	6279
Printing form, A. Jackson and J. C. Brymer.....	6313
Pressure, steam, W. H. Laurie.....	6286
Railroad car adjuster, C. Bigaouette.....	6322
Railway couplers, G. Jones.....	6249
“ wheels, A. Atwood.....	6263
Reaping machine, I. Mills.....	6314
Rein holders, G. A. Shaw.....	6223
Sap, evaporators, J. P. Baldwin.....	6272
Saw-dust, burning, R. Hodson.....	6290
Saw gummer, J. M. Smith.....	6214
Screw threading, F. P. Sheldon.....	6276
Seats, C. B. Record.....	6287
Seeder tooth, J. Y. Hammond.....	6326
Sewage tanks, R. A. McCaulay.....	6291
Shoe sole burnishing, J. W. Dodge and C. S. Thfeld.....	6243
Skate, C. Brewster.....	6262
Skates, J. A. Whelpley, G. E. Buteaux and A. B. Sheraton.....	6221
Soap, H. De Lewis.....	6235
Soll, night, R. S. Gillespie.....	6268
Sprinklers, street, G. Trimble.....	6230
Squares, W. Ascough.....	6267
Steam pump, W. H. Laurie.....	6286
“ traps, G. W. Harrold.....	6318
Stove board, S. Magill.....	6284
“ cooking, E. Bartlett.....	6293
“ for barrels, H. H. Hale and E. A. Shaw.....	6245
Straw, cutters, A. and D. Tolton.....	6236
Stump extractors, E. Farnsworth.....	6227
Tannin gides, G. Richter.....	6232
Thill coupling, O. O. Roberts.....	6291
Vessels, cylindrical, J. Kisor.....	6250
Waggon Brake, E. H. Wheeler.....	6232
Washing clothes, C. Packham.....	6289
“ machines, J. M. Rodkey.....	6228
Weights, lifting, L. A. Melburn.....	6256
Well digger, I. M. Perry.....	6279
Wheels, railway, A. Atwood.....	6263
Window blind, O. A. Dockham.....	6312
“ fasteners, L. D. Gellnas.....	6278
Wrenches, E. H. Knight.....	6247

INDEX OF PATENTEES.

Adams, J. L., and J. G. Blondin, dryer.....	6316
Ascough, William, squares.....	6267
Atwood, Anson, railway wheels.....	6263
Baldwin, John P., sap evaporators.....	6272
Bancroft, J. W., and T. Walker, amalgamating ores.....	6220
Barter, Benjamin, middlings purifiers.....	6325
Bartlett, Edward, stove.....	6293
Beaupré, Charles, moccasins.....	6319
Bigaouette, Charles, car-adjuster.....	6322
Billings, Simon R., door checks.....	6234
Bird, Frederick J., mordant for dyeing.....	6224
Blondin, J. G., and J. L. Adams, dryer.....	6316
Bodine, Francis L., jar cover.....	6269
Bray, Henry, gas.....	6216
Brewster, Charles, skates.....	6262
Brymer, J. C., and A. Jackson, printing form.....	6313
Bullock, Milan C., drills.....	6270
Buteaux, G. E., A. B. Sheraton and J. A. Whelpley, skates.....	6221
Byerley, Francis X., paraffine.....	6214
Cadell, Phillip, extraction of gold.....	6259
Carvell, Louis, amalgamating ores.....	6220
Chambers, Adam, odometers.....	6275
Chandler, Yashti, dish drainer.....	6302
Clapp, G. P., J. A. Pillow and R. Hersey, horse shoe nails.....	6250
Clarke, C. E., S. Peebles and E. E. Mefford, fruit preserving.....	6266
Clinton, David, plough casting.....	6303
Cole, Truman, churn power.....	6229
Collender, Hugh W., billiard table.....	6310

Cooley, Orville, belts and endless chains.....	6331	Perry, Isaac M., well digger.....	6279
“ “ harvesters.....	6329	Phillips, Thomas, grocery bag.....	6210
“ “ harvesting.....	6332	Phlow, J. A., R. Hershey, and G. P. Clapp, horseshoe nails.....	6280
“ “ mowing machines.....	6330	Pingree, S. W., and C. L. Spencer, knitting loom.....	6301
“ “ reapers.....	6333	Pulvermacher, Isaac L., electric appliances.....	6215
“ “ reaping.....	6334	Rathbun, Lewis V., bolting reels.....	6307
De Lows, Henry, soap.....	6235	Record, Charles B., seats.....	6287
Dockham, Ogden A., window blind.....	6312	Redden, Henry, bags.....	6246
Dodge, J. W., and C. S. Fifield, sole burnishing.....	6243	Richardson, Alden B., hams.....	6217
Dunn, Robert, carriages.....	6305	Richter, Charles, tanning.....	6232
Farnsworth, Enoch, stump extractors.....	6227	Roberts, Osmore O., thill coupling.....	6291
Felt, Hannibal, churn.....	6336	Rodkey, Jacob M., washing machines.....	6226
Felck, Joseph K., boot tree.....	6297	Sampson, James H., boot tree.....	6300
Fifield, C. S., and J. W. Dodge, sole burnishing.....	6243	Sedgwick, A., and E. B., curd knife.....	6299
Firmin, G. J., and T. A. D. Forster, amalgamating machines.....	6302	Schueble, M., and J. T. Wright, piston packing.....	6233
Forster, T. A. D., and G. J. Firmin, “.....	6302	Schulenburg, Albert R., burglar alarms.....	6251
Fryer, Robert M., pulverizing ores.....	6253	Shaw, George A., rein holders.....	6223
Gallagher, Joseph P., hydrants.....	6260	“ E. A., and H. H. Hale, barrels.....	6245
Gauthier, Charles W., freezing apparatus.....	6292	Sheane, Robert, mounting photographs.....	6231
Gellas, Luc D., window fasteners.....	6278	Sheldon, Frank P., screw threading.....	6276
Gibson, George, horse-powers.....	6337	Sheraton, A. B., J. A. Whelpley, and G. E. Buteaux, skates.....	6221
Gillespie, Richard S., night soil.....	6268	Simmons, Thomas, churns.....	6222
Gonne, William H., door knobs.....	6212	Simpson, Charles G. C., skate.....	6262
Graham, S. P., carriages.....	6258	“ “ paper dampers.....	6225
Grocock, Samuel P., floors.....	6254	Skinner, W. E., W. O., and J. Spait, curtain fixtures.....	6235
Hale, H. H., and E. A. Shaw, barrels.....	6254	Smith, Joseph M., saw gummer.....	6214
Hammond, John Y., seeder and cultivator.....	6326	Spaltb, J., W. O., and W. E. Skinner, curtain fixtures.....	6238
Harrold, George W., steam traps.....	6318	Spencer, C. L., and S. W. Pingree, knitting loom.....	6301
Hart, Harrison N., packing boxes.....	6255	Stern, B., and H., candy machine.....	6265
Hershey, R., G. P. Clapp, and J. A. Phlow, horse shoe nails.....	6280	Stevens, A. B., and C. Kilburn, chairs.....	6285
Hetherington, John E., electric appliances.....	6215	“ Philletus J., eye cups.....	6297
Higginbottom, J., and E. Hutchinson, grain cleaning.....	6273	Thayer, John A., hatchets.....	6338
Hipwell, Thomas, jar cover.....	6269	Thompson, Samuel R., bark cutting.....	6264
Hodson, Richard, burning saw dust.....	6290	Thomson, H., and A. R. Williams, belts and endless chains.....	6331
Hornum, William H., fare register.....	6296	“ “ “ harvesters.....	6329
Howland, Frederick A., mill stones.....	6218	“ “ “ harvesting.....	6332
Hutchinson, E., and J. Higginbottom, grain cleaning.....	6273	“ “ “ mowing machines.....	6330
Ireland, Isaac, earth auger.....	6320	“ “ “ reapers.....	6333
Jackson, A., and J. C. Bryner, printing form.....	6313	“ “ “ reaping.....	6334
Jones, George, car-couplers.....	6249	Tolton, A., and D., straw cutters.....	6236
Kilburn, C., and A. B. Stevens, chairs.....	6285	Townshend, John E., beds.....	6241
Kisor, John, cylindrical vessels.....	6250	Trinble, George, street sprinklers.....	6230
Knight, Edward H., wrenches.....	6247	Trissler, William H., plough points.....	6335
“ John A., catapults.....	6231	Wade, Jonathan, cultivators.....	6223
Knott, Kennard, meat preserving.....	6252	Walker, T., and J. W. Bancroft, amalgamating ores.....	6229
Larose, Hermase, trench ploughs.....	6277	Walrath, Alphonso, broom corn.....	6321
Laurie, Walter H., steam pumps.....	6286	Waters, J., and W. T. McGhee, harrows.....	6237
McCauley, Reuben A., sewage tanks.....	6294	Wheeler, Ellsha H., wagon brake.....	6282
McGhee, W. T., and J. Waters, harrows.....	6237	Whelpley, J. A., G. E. Buteaux, and A. R. Sheraton, skates.....	6221
McDiarmid, Hugh, door holder.....	6219	White, Henry G., horse pad.....	6253
McDonald, J. W., and T. A., boot lace fastener.....	6228	Whitney, Sarah L., grain binding.....	6239
Magill, Samuel, stove board.....	6284	Williams, A. R., and R. Thomson, belts and endless chains.....	6331
Marston, William P., fire arms.....	6281	“ “ “ harvesters.....	6329
Mefford, E. E., C. E. Clarke, and S. Peebles, fruit preserving.....	6266	“ “ “ harvesting.....	6332
Melburn, Lafayette A., lifting weights.....	6256	“ “ “ mowing machines.....	6330
Mills, Isaac, reaping machines.....	6314	“ “ “ reapers.....	6333
Moore, S. H., and E. Y., door hanger.....	6295	“ “ “ reaping.....	6334
Muth, William, Reaping machines.....	6315	Wilkinson, John W., liquid measure.....	6204
Niedringhaus, F. G., and W. F., enamelling.....	6308	Wills, John B., nails.....	6271
Olds, Barnard I., horse-power.....	6258	“ “ welding iron.....	6248
Owen, Joseph R. N., cannons.....	6222	Wood, William H., piano.....	6261
Packham, Catterick, washing clothes.....	6259	Woodbury, William C., corn mills.....	6339
Palmer, William H., boots and shoes.....	6311	Woods, Joseph S., street lamp.....	6274
Parker, John, grain blinder.....	6306	Woolner, John, burglar alarms.....	6251
Peebles, S., E. E. Mefford, and C. E. Clarke, fruit preserving.....	6266	Wright, J. T., and M. Schueble, piston packing.....	6233

# THE CANADIAN PATENT OFFICE RECORD.

## ILLUSTRATIONS.

Vol. IV.

AUGUST, 1876.

No. 8.

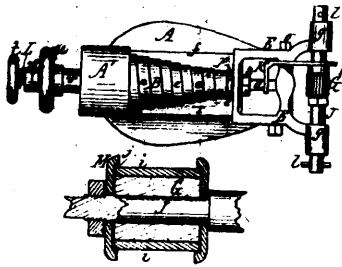

6214 Smith's Saw-gummer.

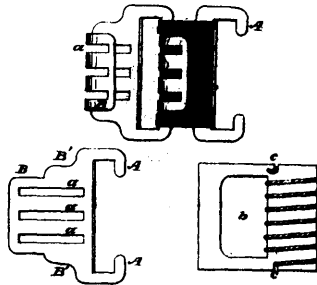

6215 Hetherington's Improvements on Volta-electric Appliances.

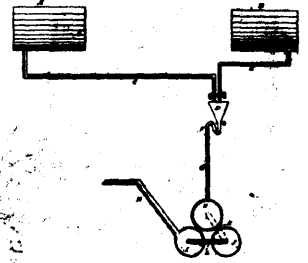

6216 Bray's Method of Manufacturing Gas for Heating and Illuminating Purposes.

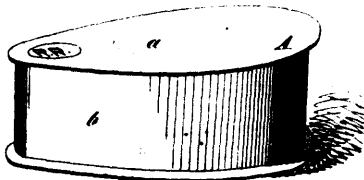

6217 Richardson's Improvements in the Preparation of Hams.

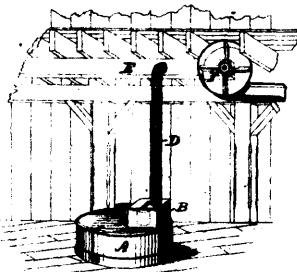

6218 Howland's Dust Preventor and Vapour Exhauster for Mill Stones.

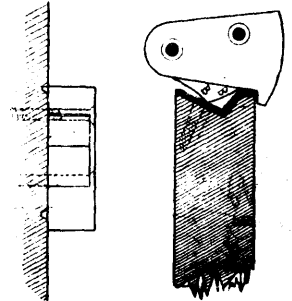

6219 McDiarmid's Door-holder.



6220 Carvell's Machine for Amalgamating Ores.

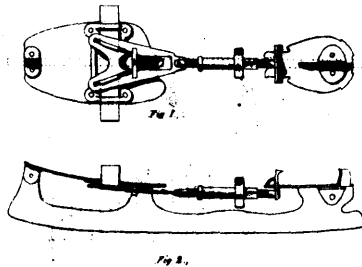

6221 Whelpley, Buteaux and Sheraton's Improvements on Skates.

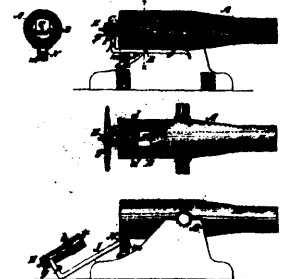

6222 Owen's Improvements on Breech-loading Cannons.

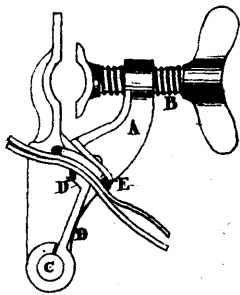

6223 Shaw's Improvements on Rein-holders.

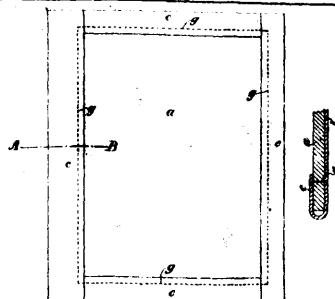

6224 Simpson's Improvements on Paper Dampers.

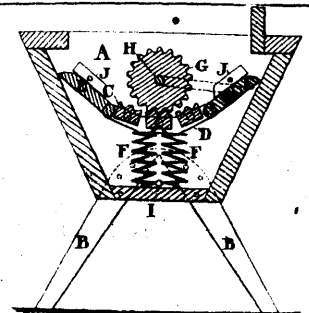

6225 Rodkey's Improvements on Washing Machines.

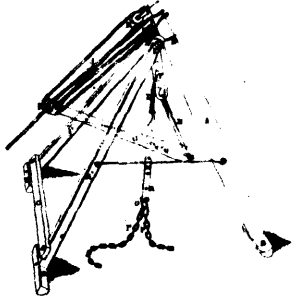

6227 Farasworth's Improvements in Stump Extractors.

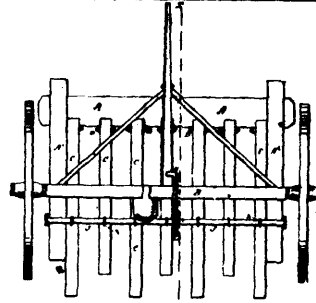

6228 Wade's Improvements on Cultivators.

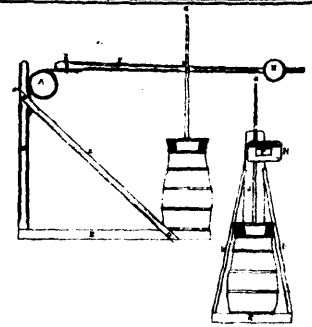

6229 Cole's Churn Power.

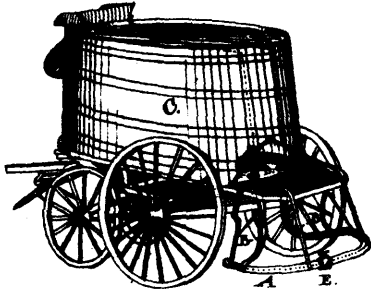

6230 Trimble's Attachment to Street Sprinklers.

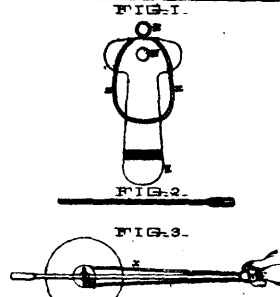

6231 Knight's Improvements in Catapults.

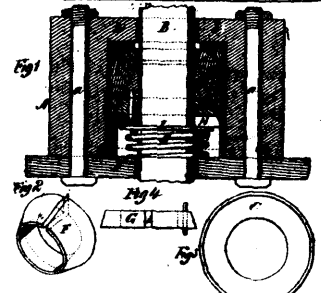

6233 Wright and Schueble's Improvements in Piston Packings.

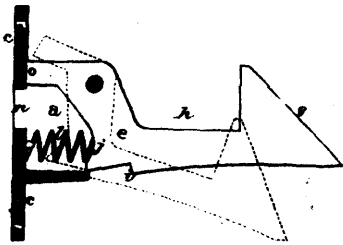

6234 Billings' Improvements on Door Checks.

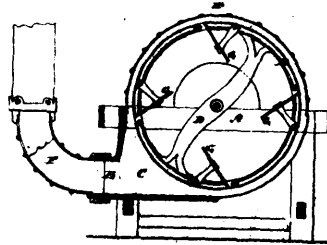

6236 Tolton's Improvements on Straw-Cutters.

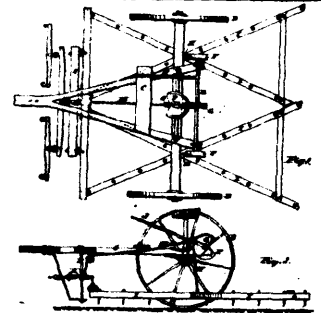

6237 McGhee and Waters' Improvements on Harrows.

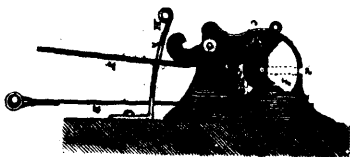

6238 Skinner and Spaitch's Improvements on Curtain Fixtures.

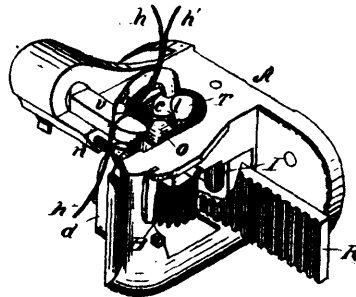

6239 Whitney's Improvements on Grain Binding Machines.

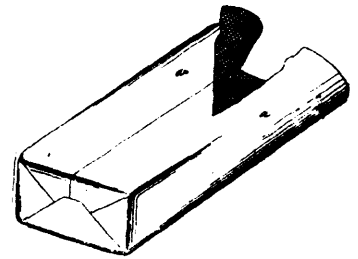

6240 Phillips' Flour and Grocery Bag.



6241 Townshend's Improvements in Spring Beds.

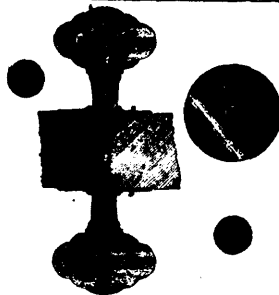

6242 Gonne's Improvements in Door Knobs.

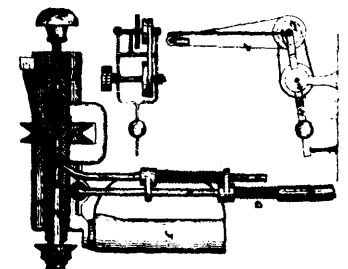

6243 Dodge and Fife's Improvements on Machines for Burnishing the Edges of Shoe Soles.

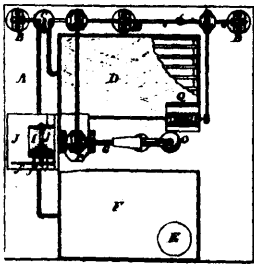

6244 Byerley's Process and Apparatus for Obtaining and Purifying Paraffine.

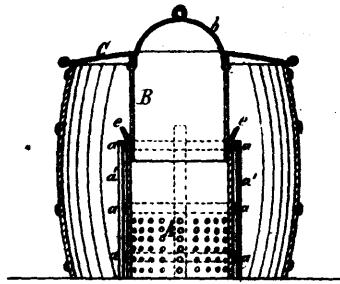

6245 Hale and Shaw's Improvements on Stoves for Heating Barrels.

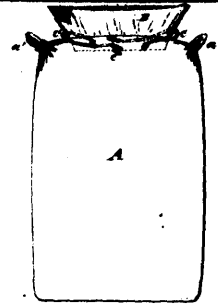

6246 Redden's Improvements on Bags.

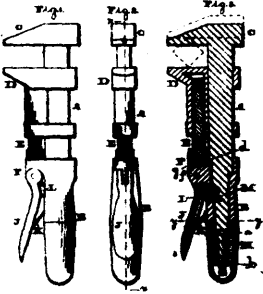

6247 Knight's Improvements on Wrenches.

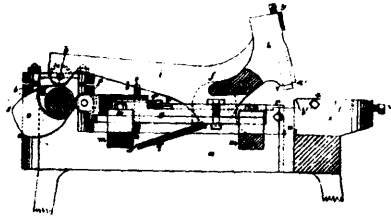

6248 Wills' Improvements on Machines for Welding Iron.

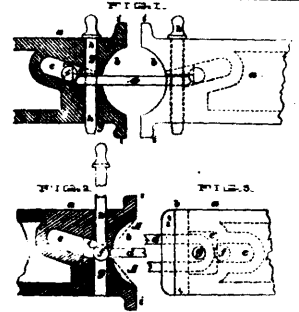

6249 Jones' Improvements on Car-couplers.

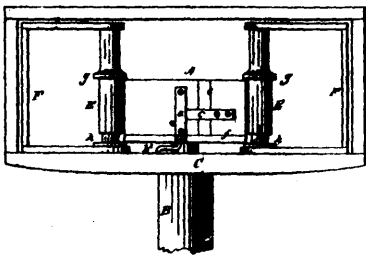

6250 Kisor's Apparatus for Making Cylindrical Vessels.

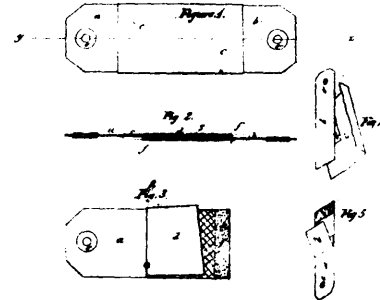

6251 Schulenberg's Improvements on Burglar-alarms

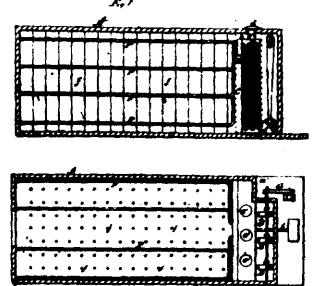

6252 Knott's Method and Apparatus for Preserving Meat.

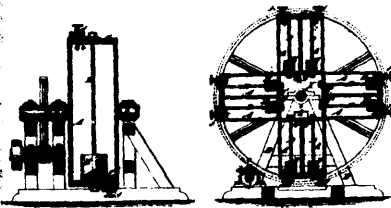

6253 Fryer's Improvements on Apparatus for Pulverizing Ores, &c.



6254 Grocock's Improvements in Tessellated Floors.

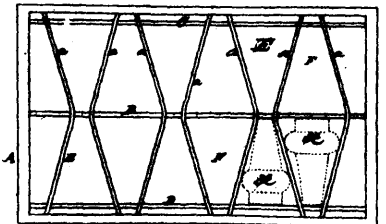

6255 Hart's Improvements on Packing Boxes.

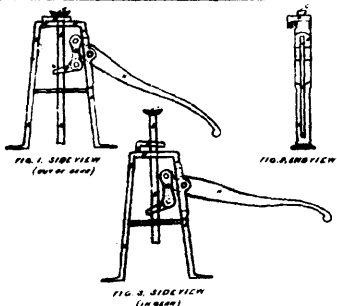

6256 Melburn's Machine for Lifting Weights.

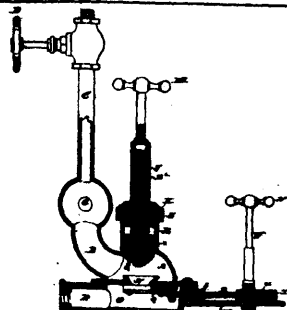

6260 Gallagher and Chapman's Improvements on Fire Hydrants.

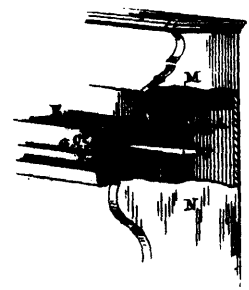

6261 Wood's Swiss Bell Piano.



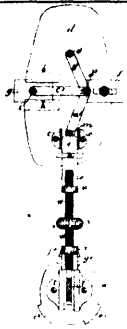

6262 Simpson's Improvements on Skate Attachments.

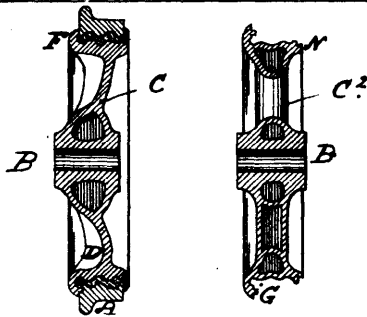

6263 Atwood's Improvements on Railway Wheels.

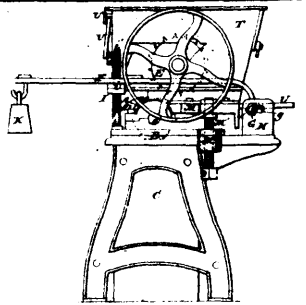

6264 Thomson's Bark Kasing and Cutting Machine.

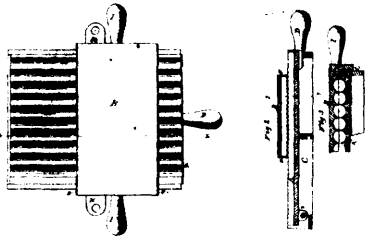

6265 Stera's Candy Marble Machine.

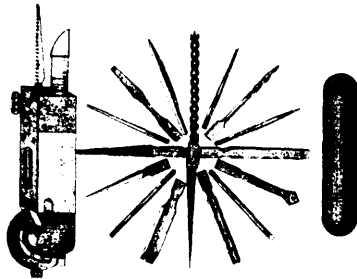

6267 Ascough's Improvements on Bevels, Try-Squares, Level Rules and Compasses.

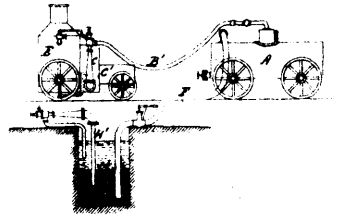

6268 Gillespie's Improvements in the Process and Apparatus for the Removal of Night Soil.

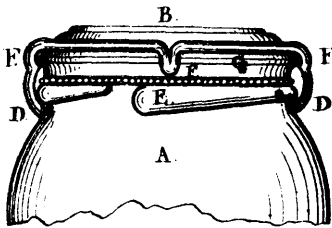

6269 Hipwell's Jar Clamp and Cover.

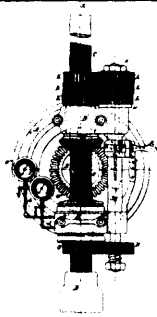

6270 Bu-lock's Swivel Head for Diamond Drills.

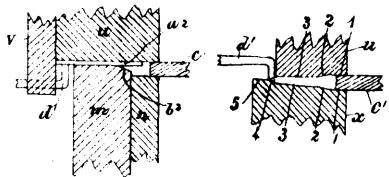

6271 Will's Horse-Shoe Nail Machine.

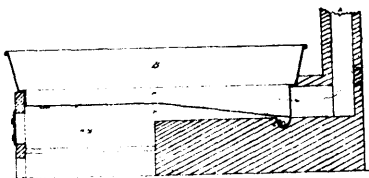

6272 Baldwin's Improvements on Sap Evaporators.

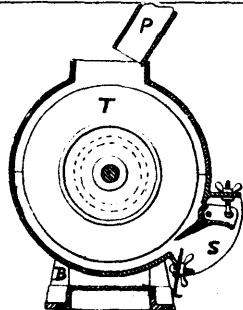

6273 Higginbottom and Hutchinson's Grain Cleaning Machine.

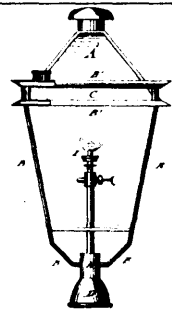

6274 Woods' Street Lamp.

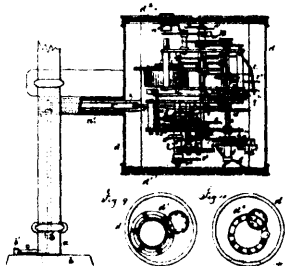

6275 Chambers' Improvements on Odometers.

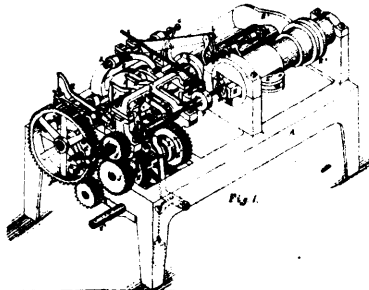

6276 Sheldon's Screw Threading Machine.

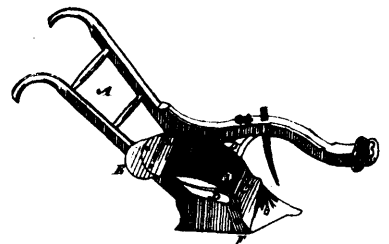

6277 Larose's Improvements on Drain Ploughs.

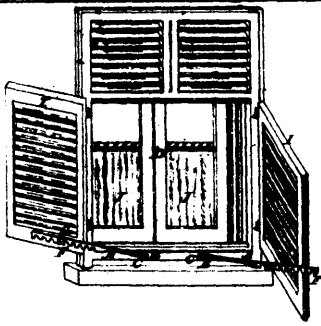

6278 Gelinus' Improvements on Window-fasteners.

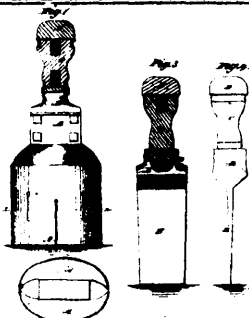

6279 Ferry's Post Hole and Well Digger.

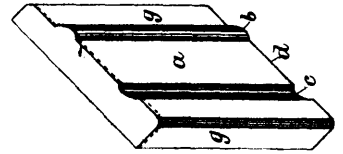

6280 Clapp, Pillow and Hersey's Improvements on the Manufacture of Horse-Shoe Nails and Cutters for the same.

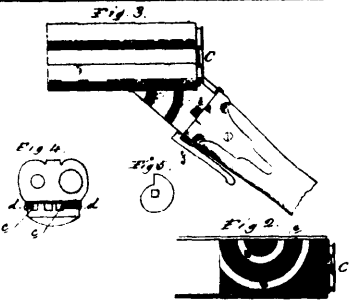

6281 Marston's Improvements on Breech-loading Fire-arms.

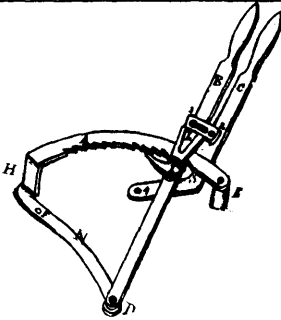

6282 Wheeler's Waggon Brake.

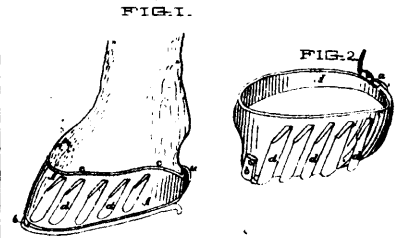

6283 White's Pad for Interfering Horses.

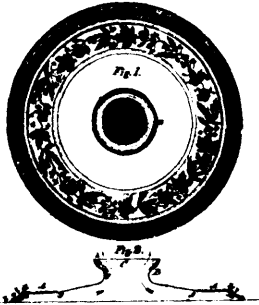

6284 Magill's Ventilating Stove Board.

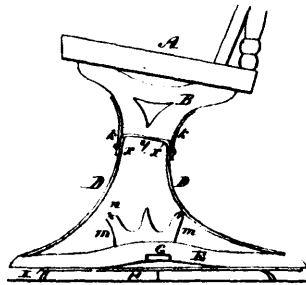

6285 Stevens and Kilburn's Improvements on Chairs.

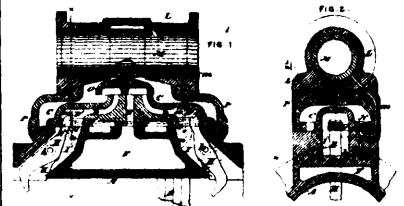

6286 Laurie's Improvements on Steam Pumps.

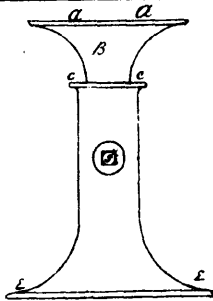

6287 Record's Improvements on Hemmingway's School Seats.

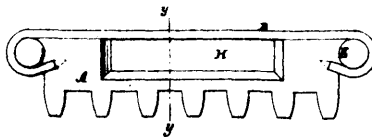

6288 Olds' Horse Power Link.

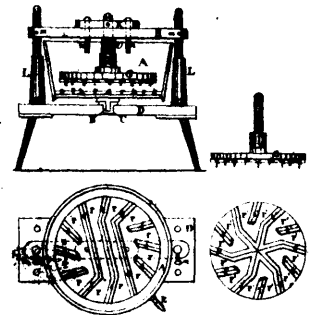

6289 Packham's Machine for Washing Clothes.

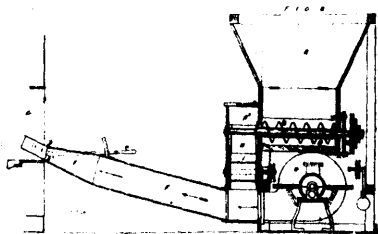

6290 Hodson's Apparatus for Burning Saw-dust

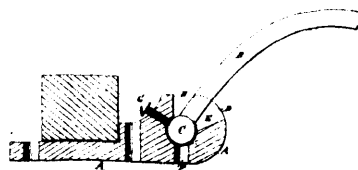

6291 Roberts' Thill Coupling.

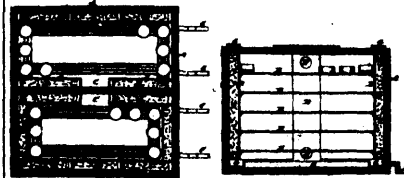

6292 Gauthier's Freezing Apparatus.

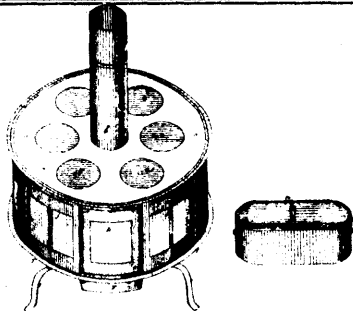

6293 Bartlett's Cooking Stove.

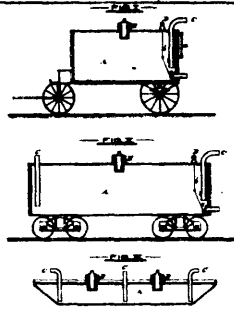

6294 McCauley's Improvements on Sewage Tanks.

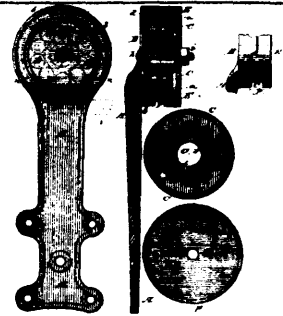

6295 Moore's Barn Door Hanger.

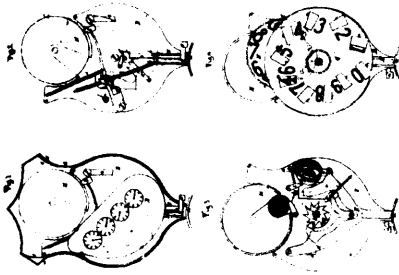

6296 Hornum's Fare Register.

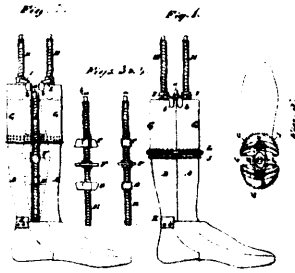

6297 Feick's Boot Tree.

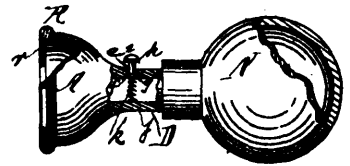

6298 Stephens' Improvements in Eye Cups.

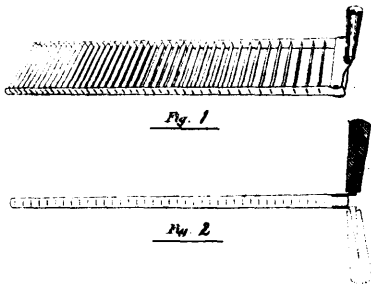

6299 Sedgwick's Card Knife.

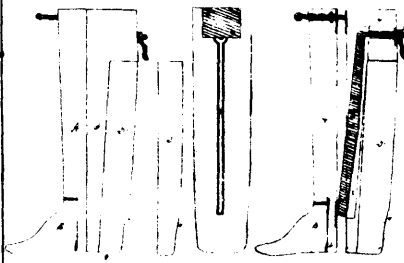

6300 Sampson's Boot Tree.

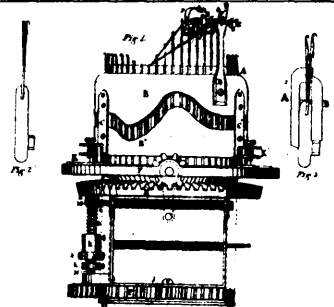

6301 Spencer and Pingree's Weft Thread Knitting Loom.

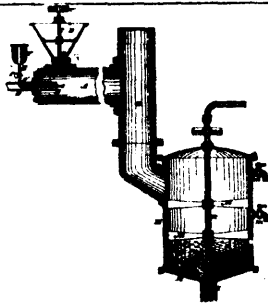

6302 Forster and Firmin's Process and Apparatus for Amalgamating Metals and Machine for Washing Ores.

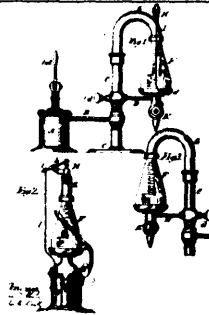

6304 Wilkinson's Liquid Measure.

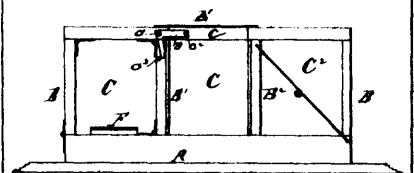

6305 Dunn's Improvements on Landau Carriages.

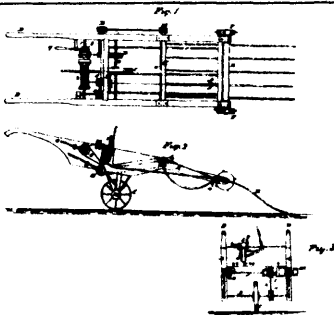

6306 Parker's Grain Binder.

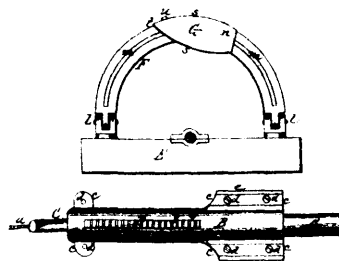

6307 Rathbun's Improvements on Bolting Reels.

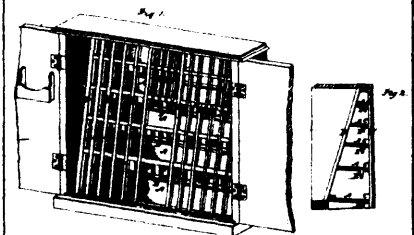

6309 Chandler's Dish Drainer.

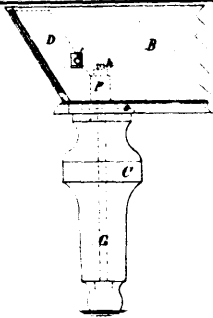

6310 Collender's Billiard Table.

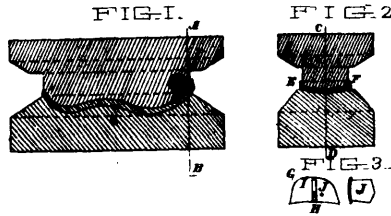

6311 Palmer's Mechanism for Moulding the Soles of Boots and Shoes.

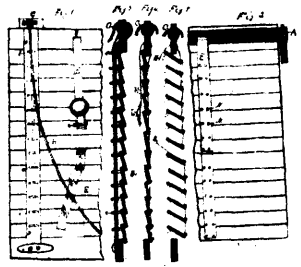

6312 Dockham's Window Blind.

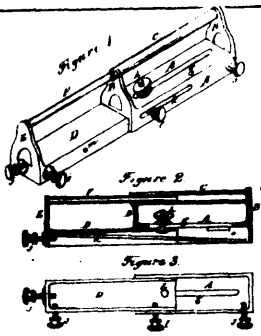

6313 Jackson and Brymer's Hand Stamp Printing Form.

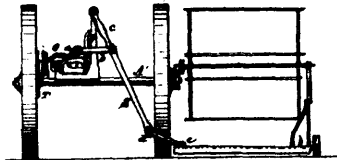

6314 Mills' Improvements in Reaping Machines.

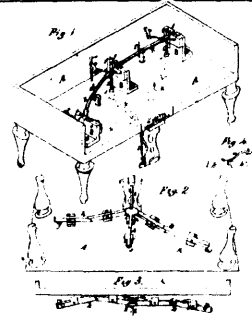

6315 Muth's Improvements on Piano Pedals.

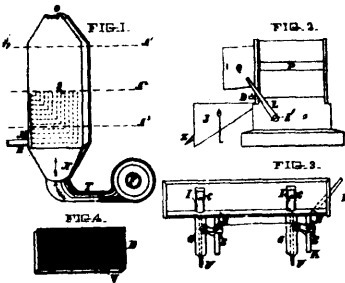

6316 Adams and Blondin's Dryer.

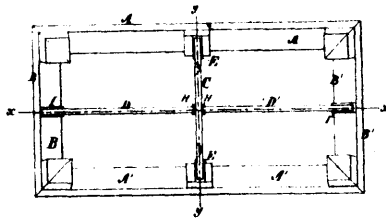

6317 Collender's Billiard Table.

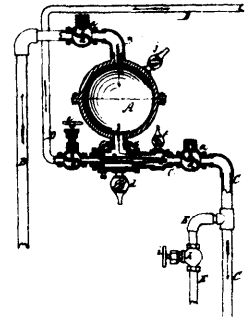

6318 Harrod's Improvement on Steam Traps.

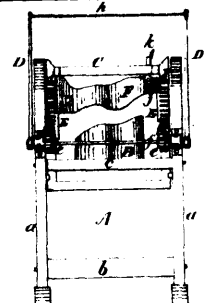

6319 Beaupre's Machine for Crimping the Heels of Mocassins.



6320 Ireland's Earth Auger.

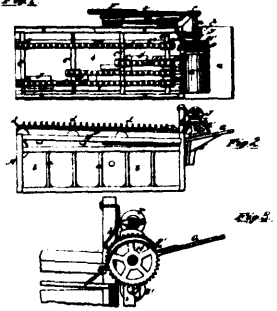

6321 Walrath's Broom Corn Sizing Machine.

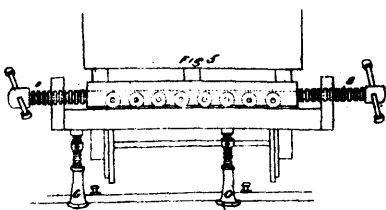

6322 Bigaouette's Railroad Car Adjuster.

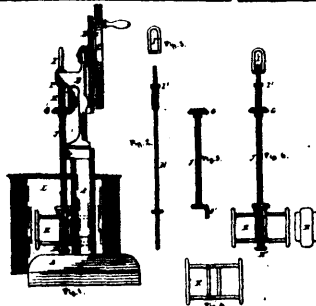

6323 Simmons' Improvements on Churns.

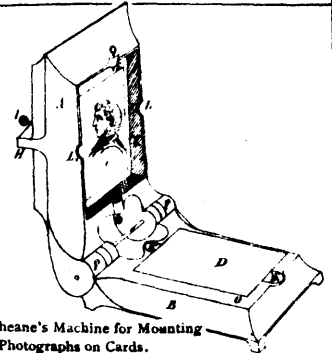

6324 Sheane's Machine for Mounting Photographs on Cards.

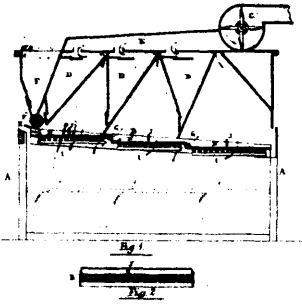

6325 Barter's Middlings Purifying Machine.

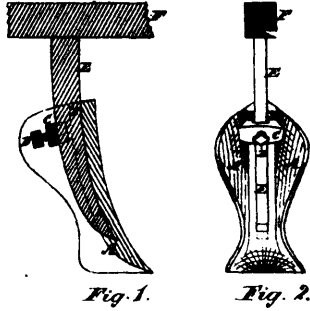

6326 Hammond's Seeder and Cultivator Tooth.

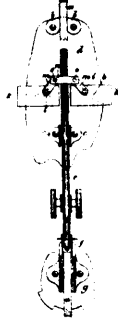

6327 Brewster's Improvements on Skates.

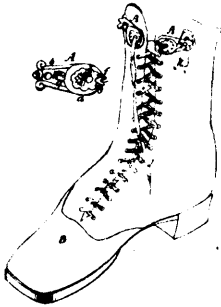

6328 McDonald's Boot Lace Fastener.

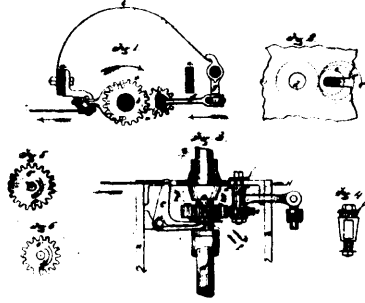

6329 Cooley's Gear Trip for Harvester.

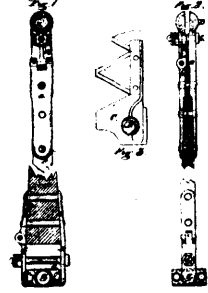

6330 Cooley's Pitman Connection for Mowing and other Machines.

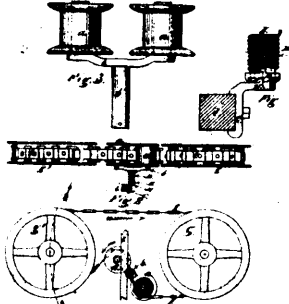

6331 Cooley's Tightener, Stripper and Guide for Belts and Endless Chains.

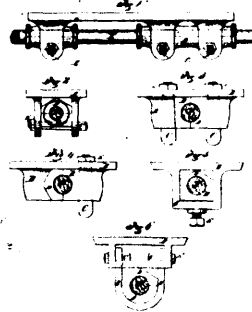

6332 Cooley's Improvement in Harvesting Machines.

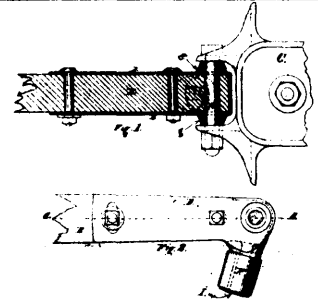

6333 Cooley's Improvement in Reapers and Harvesters.

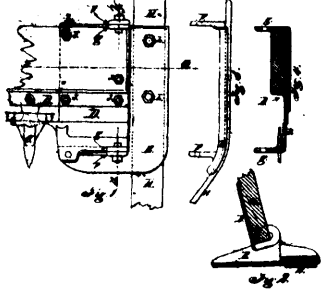

6334 Cooley's Improvement in Reaping and Harvesting Machines.

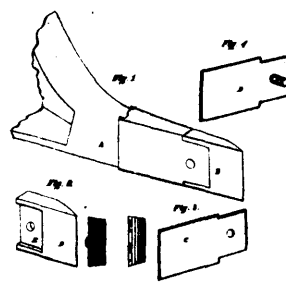

6335 Trissler's Improvements on Plough Points.

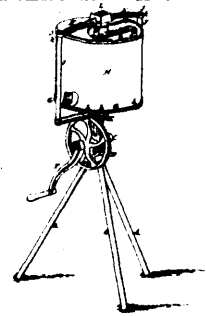

6336 Felt's Rotary Churn

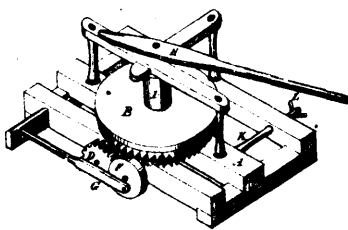

6337 Gibson's Improvements on Horse-powers.

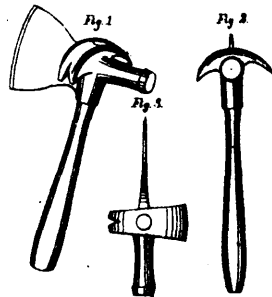

6338 Thayer's Improvements on Hatchets.

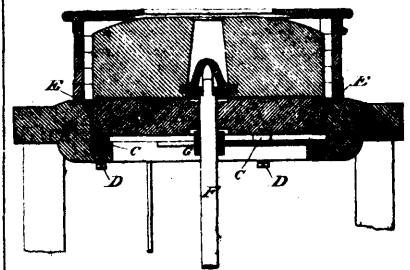

6339 Woodbury's Improvements on Grinding Mills.