

Technical and Bibliographic Notes / Notes techniques et bibliographiques

The Institute has attempted to obtain the best original copy available for filming. Features of this copy which may be bibliographically unique, which may alter any of the images in the reproduction, or which may significantly change the usual method of filming, are checked below.

L'Institut a microfilmé le meilleur exemplaire qu'il lui a été possible de se procurer. Les détails de cet exemplaire qui sont peut être uniques du point de vue bibliographique, qui peuvent modifier une image reproduite, ou qui peuvent exiger une modification dans la méthode normale de filmage sont indiqués ci-dessous.

- Coloured covers/
Couverture de couleur
- Covers damaged/
Couverture endommagée
- Covers restored and/or laminated/
Couverture restaurée et/ou pelliculée
- Cover title missing/
Le titre de couverture manque
- Coloured maps/
Cartes géographiques en couleur
- Coloured ink (i.e. other than blue or black)/
Encre de couleur (i.e. autre que bleue ou noire)
- Coloured plates and/or illustrations/
Planches et/ou illustrations en couleur
- Bound with other material/
Relié avec d'autres documents
- Tight binding may cause shadows or distortion along interior margin/
La reliure serrée peut causer de l'ombre ou de la distorsion le long de la marge intérieure
- Blank leaves added during restoration may appear within the text. Whenever possible, these have been omitted from filming/
Il se peut que certaines pages blanches ajoutées lors d'une restauration apparaissent dans le texte, mais, lorsque cela était possible, ces pages n'ont pas été filmées.
- Additional comments: /
Commentaires supplémentaires:

- Coloured pages/
Pages de couleur
 - Pages damaged/
Pages endommagées
 - Pages restored and/or laminated/
Pages restaurées et/ou pelliculées
 - Pages discoloured, stained or foxed/
Pages décolorées, tachetées ou piquées
 - Pages detached/
Pages détachées
 - Showthrough/
Transparence
 - Quality of print varies/
Qualité inégale de l'impression
 - Continuous pagination/
Pagination continue
 - Includes index(es)/
Comprend un (des) index
- Title on header taken from: /
Le titre de l'en-tête provient:
- Title page of issue/
Page de titre de la livraison
 - Caption of issue/
Titre de départ de la livraison
 - Masthead/
Générique (périodiques) de la livraison

This item is filmed at the reduction ratio checked below/
Ce document est filmé au taux de réduction indiqué ci-dessous.

10X	12X	14X	16X	18X	20X	22X	24X	26X	28X	30X	32X
									✓		

AN ADIAN MANUFACTURER

AND INDUSTRIAL WORLD

DEVOTED TO THE MANUFACTURING INTEREST OF THE DOMINION

The More Country Produces The Richer It Is

NATION THAT MANUFACTURES FOR ITSELF PROSPERS

J.L. JONES TORONTO.

VOL. 17. TORONTO, DECEMBER 20, 1889. No. 12.

"Old Dyewood Warehouse"
 Established over Fifty Years

Theo. H. Eaton & Son,
 Windsor, Ont. : Detroit, Mich.

DYEWOODS, DYEING DRUGS, CHEMICALS, ACIDS, Etc.

HIGH GRADE LOGWOOD.
 Domestic and Imported Extracts of Logwood, Fustic and Indigo.

FRENCH ARCHIL & CUDBEAR.

SOLE AGENTS FOR THE UNITED STATES AND CANADA FOR THE "CROWN ANILINE DYES."

ANILINE DYES

LARGEST AND ONLY DIRECT IMPORTERS,

Dominion Dyewood & Chemical Co.
 TORONTO,

SOLE AGENTS IN CANADA FOR
Farbenfabriken vorm Fried: Baya & Co.
 ELBERFELD, GERMANY.

IMPERIAL BANK
 OF CANADA.

Capital Paid-up, - - - - \$1,500,000
 Reserve Fund, - - - - 650,000

DIRECTORS:

H. S. HOWLAND, President.
 T. R. MERRITT, St. Catharines, Vice-President.
 William Ramsay, Hon. Alex. Morris,
 Robert Jaffray, Hugh Ryan,
 T. R. Wadsworth.
 D. R. WILKIE, Cashier. B. JENNINGS, Asst. Cashier.
 E. HAY, Inspector.

Head Office, - TORONTO.

BRANCHES IN ONTARIO.

Essex Centre. Niagara Falls. Welland.
 Fergus. Port Colborne. Woodstock.
 Galt. St. Catharines. Toronto.
 Ingersoll. St. Thomas. "Yonge St.
 Sault Ste. Marie. Cor. Queen.

BRANCHES IN NORTH-WEST.

Winnipeg. Brandon. Portage la Prairie. Calgary.
 Drafts on New York and Sterling Exchange bought and sold. Deposits received and interest allowed. Prompt attention paid to collections.

Agents, London, Eng., Lloyd's Bank Ltd., 72 Lombard St., E.C., with whom all deposits may be made for credit with Head Office or Branches.

ESTABLISHED 1856

THE J.C. Mc LAREN BELTING CO

SUCCESSORS TO THE LATE J.C. McLAREN

NEEDLE POINTED

CARD CLOTHING MONTREAL

THE GUTTA PERCHA & RUBBER MFG CO
 OF TORONTO.

BELTING. PACKING. CLOTHING HOSE.

WAREHOUSE & OFFICE, 43 YONGE ST. TORONTO.

The STILES & PARKER
 * PRESS CO. *

Middletown, - Conn.

MANUFACTURERS OF

Drop Hammers,
DIES
 -AND-
Special Machinery.

Carl W. Conner,
 Canadian Representative

63 FRONT ST. WEST, TORONTO.

John Bertram & Sons,
CANADA TOOL WORKS!

Dundas, Ont.

SEE ADVERTISEMENT, PAGE 429.

ANILINE DYES
 BENZIDINE COLOURS,

SOLE AGENTS FOR
 Actien Gesellschaft fur Anilin
 Fabrication Berlin.

MIDDLETON & MEREDITH,
 30 St. John Street, Montreal.

Also Dyewoods. Extracts, Chemicals.

**MACGREGOR,
GOURLAY & CO.
GALT, ONT.**

MANUFACTURERS OF ALL KINDS
OF

**Woodworking
Machinery**

— AND —

Dealer in Second-Hand Tools.

Office and Works at Galt.

Warerooms: 32 FRONT ST. WEST
TORONTO.

Macgregor, Gourlay & Co.

Largest Manufacturers of STEEL
and BRASS STAMPS in Canada.

**PRITCHARD
& ANDREWS
OTTAWA, ONTARIO.**

**Rubber Stamps,
Stencils, Seals, &c.
SEND FOR PRICES.**

THE

Field-Stirling Boilers

ARE UNEQUALLED FOR

**Safety, Economy of Fuel,
Dryness of Steam and
Durability.**

They are the cheapest Boilers in the market for the actual amount of water turned into DRY steam per hour, and this is the only reliable test of the power of any boiler. They are safe at any pressure. Our boiler tubes are tested at 1,000 lbs. per square inch. Our plates are tested at 60,000 lbs. per square inch. No cast iron is used in these boilers. No disastrous explosion is possible, because the flame never touches the shell at all. The circulation is perfect. All the water must pass through the large mud drum and deposit its sediment. For full particulars and prices apply to the manufacturers.

DOMINION SAFETY BOILER CO. Ltd.

31 Wellington St., Montreal.

**M^CARTHUR,
CORNEILLE & CO.**

(Successors to JOHN McARTHUR & SON)

310 to 316 St. Paul Street,
and
147 to 151 Commissioners Street,
MONTREAL,

offer at closest prices

PURE OLIVE OIL.

WINTER-PRESSED LARD OIL,
EXTRA FINE SPINDLE OIL,
and a full assortment of other
LUBRICATING OILS.

Also

CHEMICALS,

DYESTUFFS,

DYEWOODS,

EXTRACTS,

&c. &c. &c.

Are Sole Agents in Canada for

SOCIETE ANONYME

DES

MATIERES COLORANTES ET

PRODUITS CHIMIQUES,

DE ST. DENIS,

Successors to

**A. POIRRIER AND G. D'ALSACE,
PARIS,**

Manufacturers of

ANILINE DYES.

ARCHIL,

CUDBEAR.

&c. &c. &c.

Prize Medal, London Universal Exhibition,
1862.

Gold Medal, Paris Universal Exhibition,
1867.

Grand Diploma of Honor, Vienna Universal
Exhibition, 1873.

Medal and Diploma, with Highest Com-
mendations, Philadelphia Centennial Ex-
hibition, 1876.

Maintain large stock, replete with all the
new and improved colors. Will be pleased
to furnish quotations, with samples and
directions for use.

WILE KNOX. JOHN H. ELLIOT. EDGAR B. JARVIS.

KNOX, ELLIOT & JARVIS,

*Architects, Engineers and Mill
Constructors,*

Office: 13 Victoria Street, TORONTO.

**New York Dyewood, Extract
and Chemical Co.**

SOLID AND LIQUID EXTRACTS
OF

**LOGWOOD,
Fustic and Hypernic,**

OF SUPERIOR QUALITY.

OFFICE, 55 BEEKMAN ST. N. Y.

PILLOW & HERSEY M^FG CO.,

Manufacturers of every description of
Cut Nails, Tacks, Brads, Railway and
Pressed Spikes, Horse Shoes, Carriage, Tire
and other Belts, Coach Screws, Hot Pressed
and Forged Nuts, Felloe Plates, Lining and
Saddle Nails, Tufting Buttons, &c., &c.

The Hardware Trade, Shoe and Leather
Finding Dealers, and Boot and Shoe Manu-
facturers, will find the Largest and Best
Assortment and Greatest Variety of above
Goods always in stock, and can rely on orders
being rapidly executed, our facilities for
doing so being unequalled.

OFFICE, 105 Mill St., Montreal.

ELECTRIC LIGHTING

**Electric Gas Lighting, Elec-
trical Apparatus and
Supplies, Contrac-
tors for Electri-
cal Work.**

HENRY S. THORBERRY & CO.

39 King Street West, Room 2.

This Space for Sale.

W. C. HIBBARD, MONTREAL,

MANUFACTURER OF

Campbell
Water-proof
Wires.

Annunciator
and
Office Wire.

Silk and Cotton
Covered
Magnet Wire.

Aerial and Sub-
marine Cables.

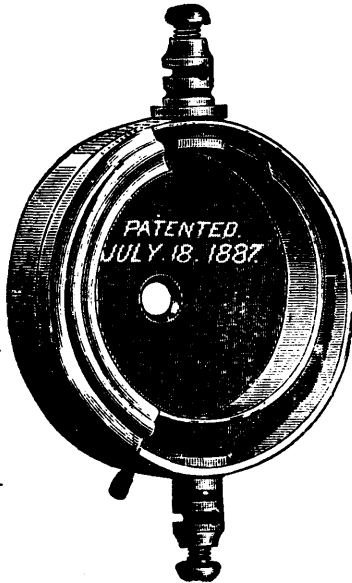

Superior
Water-proof
Tape.

Telephones.

Hotel & House
Annunciators.

Gas Lighting
Apparatus.

Burglar Alarms.

AUTOMATIC FIRE ALARM APPARATUS

And all Electrical Appliances and Supplies.

Butterfield & Co.

ROCK ISLAND, P.Q.

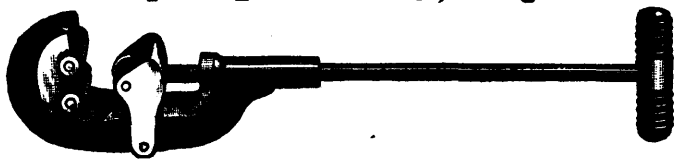

MANUFACTURERS OF

UPRIGHT DRILLS,

FOOT VISES AND
BOLT HEADERS.

STOCKS, DIES AND TAPS

FOR

Blacksmiths', Machinists', Carriage
Makers' and Gas-Fitters' Use.

Send for New Illustrated Catalogue
AND PRICE LIST.

DOMINION TIN AND STAMPING WORKS

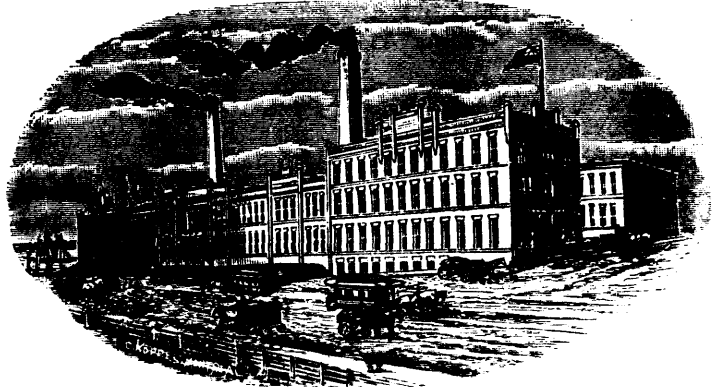

Plain, Stamped and Japanned Tinware,
Copper Goods,
Star Patent Stove Pipe Thimbles,
Stove Boards, Wire Goods,
Machine Oilers, Coal Hods,
Fire Shovels, House-furnishing Goods.

SPECIALTIES—Spice Tins, Mustard Tins, Baking Powder Tins, Blacking Boxes, Paint
Irons, Lye Cans, Grocers' Canisters, Square and Round Oil Cans,
Oil Tanks, Patent Butter Tubs (Tin Lined).

KEMP MANUFACTURING CO'Y

Cor. Gerrard & River Sts., Toronto.

Balcony Fire Escapes

BATTEN'S PATENT

ADVANTAGES :

The advantages of the BATTEN FIRE
ESCAPE over all others are :

That the balconies are made of the best wrought iron, of any ornamental design or pattern, and securely bolted through the walls. Can be made any length or width. The brackets and flooring are capable of bearing any number of persons standing on them. The ladders, with wide steps and of easy grade, can remain down permanently, or folded up, as desired, showing the ornamental balcony only in sight, which does not mar the architectural beauty of the building, and can be instantly released when desired. No ice or snow will remain on them, neither will the working parts rust; and they will work admirably in any weather.

A Stand Pipe is also connected for high buildings, with valves at each door and on the roof.

Our Escapes have been fully tested at fires and proved themselves invaluable for saving life and property. Iron guards on windows of Asylums and Reform Schools can be so adjusted as to be instantly released in the case of fire by the unfolding of ladder or sounding of a gong.

Straight Iron Ladders.

For situations not requiring a Balcony Fire Escape I can quote reasonable prices for strong and well finished STRAIGHT IRON LADDERS.

FREDERIC NICHOLLS,

Sole Manufacturer for Canada.

The Permanent Exhibition of Manufactures

63 to 69 Front St. West, TORONTO.

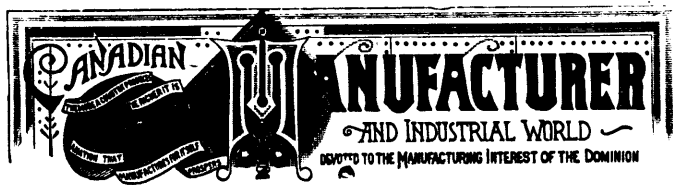

Published on the first and third Friday of each month, by the
CANADIAN MANUFACTURER PUBLISHING CO., (Limited).

63 FRONT STREET WEST, TORONTO.

FREDERIC NICHOLLS, *Managing Director.*
J. J. CASSIDEY, *Editor.*

SUBSCRIPTION, - - - - \$2.00 per year.

ADVERTISING RATES SENT ON APPLICATION.

MR. FREDERIC NICHOLLS is Secretary of
The Canadian Manufacturers' Association,
The Woolen Manufacturers' Association, and
The Tanners' Association.

His Office is at the Publication Office of the

CANADIAN MANUFACTURER,
63 Front Street West, Toronto.

DIFFERENTIAL DUTIES.

In a late issue of the London *Economist*, the question of the renewal or lapse of European commercial treaties is considered and discussed as a matter of immediate and pressing importance, from the fact that the treaties of 1881 and subsequent years are terminable in 1892. The *Economist* states that the leading principles of the Cobden Treaties, of 1860, are: the prevention of differential treatment of subjects, shipping, or goods of the contracting powers by means of the most favored nations' clause, and the fixture of tariffs by means of tables of duties, to remain in force for a term of years. It further states that commercial treaties between different European countries, signed during the nine years subsequent to Mr. Cobden's negotiations, were, both as regards their general stipulations and their tariffs, founded upon the above principles. The *Economist* proceeds to say with regard to the future:—"If tariff engagements are not renewed, or are only partially upheld, it must be remembered that it is of the highest importance to our trade to maintain intact the principle of the most favored nations' clause."

When the advocates of Commercial Union between Canada and the United States are brought to face the injustice which would be inflicted on the trade of Great Britain by means of the differential duties in favor of the United States, which are involved under their proposed policy, they endeavor to get over the difficulty by minimizing the extent of the injustice, and claiming that Great Britain should submit to it in view of the great benefit to be derived by Canada, and because of some alleged indirect political and commercial advantages which may accrue to England itself from the enhanced prosperity of Canada, and through the more amicable feeling growing out of the enlarged commercial relations between the

United States and Canada. The injustice is real and visible; the compensating advantages are imaginary and valueless.

It will be in the recollection of our readers that the Hon. Mr. Chamberlain stated in a speech which he delivered in Belfast, almost immediately after his appointment as British Commissioner on the Fisheries' Question, that if Canada insisted upon a treaty of Commercial Union with the United States, Great Britain would not attempt to prevent it by force, but Canada must understand that such a treaty was at variance with, and would terminate her political connection with, the Mother Country. It will also be remembered that not a single expression was made or step taken by any of the Merchants' Exchanges or Boards of Trade in any of the large seaboard cities in the United States, in favor of Commercial Union, until the feeling was created by Mr. Chamberlain's speech that this policy might be the cause of antagonism between Canada and Great Britain. The importance which, according to the *Economist*, is attached in England to the renewal of her commercial treaties on the basis of the principles above referred to, tends to show one of the political difficulties which Mr. Chamberlain had in view when making the speech alluded to.

In making commercial treaties with foreign powers, intended to secure for each of the contracting parties the prevention of differential treatment by means of the most favored nations clause, Great Britain must include her colonies, and in doing so would be acting in their interest as well as her own. Supposing Great Britain to have concluded such a treaty, say with France or Germany, how could she possibly consent either to make or sanction a treaty on behalf of Canada with the United States Government, under which American goods should be admitted into Canada on more favorable terms than those of France or Germany, both or either of which countries Great Britain had contracted to deal with under the most favored nations' clause?

THE IRON INDUSTRY.

In the December 6th issue of this journal we stated that the Toronto *Globe* had called in the assistance of Mr. T. D. Ledyard, an American capitalist with a large investment in Canadian iron mines, to show that under our present system it is impossible to successfully manufacture pig iron in Canada, and that it would be to the interest of Canada to have established some sort of political connection with the United States whereby Canadian iron ores would be admitted to that country free of duty. The *Globe* republishes the following extract from our article, the reference being to Mr. Ledyard:

Therefore through the medium of the *Globe* he poses as an educator of the Canadian public; attempting to prove that Canada would be happier and more prosperous under the domination of the Washington Government than she could possibly be as an independent Dominion and under the National Policy.

The *Globe* garbled our article, suppressing those portions of it which would have explained that paragraph which it reproduced. We had shown that one of the iron mines in which Mr. Ledyard is largely interested contains, according to his own statement, at least a million tons of ore within a hundred feet of the surface; that this ore is very rich in metallic iron, and specially adapted for the manufacture of Bessemer pig; that

it can be reduced in the blast furnace with about the average charge of fuel; that it can be mined for one dollar per ton, and that it can be laid down in Buffalo for \$3.25, Pittsburg for \$4.75, and Cleveland for \$3.90 per ton, duty paid, the American duty being seventy five cents per ton. This valuable mine is in Belmont township, Peterborough county, Ontario; and we stated on Mr. Ledyard's authority that the ore from it can be laid down in American lake cities, duty paid, at about the same cost of Lake Superior ores.

The *Globe* suppressed all these facts so important in the consideration of the question which it and Mr. Ledyard are so persistently forcing upon the attention of the people of Canada. As we have stated, the facts herein given, and also given in our previous article, are supplied by Mr. Ledyard himself, but they were not published in the *Globe*, for, for evident reasons, these anti Canadians have no desire to display them before the Canadian public. They have, however, received wide circulation in the United States. But the publication of these facts in the CANADIAN MANUFACTURER seems to affect the *Globe*, and presumably Mr. Ledyard also, similarly to the shaking of a red cloth before an infuriated bull; and our respected contemporary forgets its dignity and the amenities of respectable journalism by stigmatising what we said as "bare-faced falsehoods," and denying that Mr. Ledyard has ever said anything like what we have attributed to him. If Mr. Ledyard sustains the *Globe* in this denial, we would be pleased to have him go on record in it.

The *Globe* says that Mr. Ledyard has only simply declared that "the iron mines of Canada would be developed if the ore could be sold in the American market, and that the iron mines once being operated, the establishment of smelting furnaces would probably follow." We do not think that Mr. Ledyard will stultify himself by denying that he said that the ore from his Ontario mine could be laid down in Cleveland for \$3.90 per ton, duty paid. The stress of the arguments made by him in the *Globe*, and in the *Globe's* editorials on the subject, lies in the direction of the inability to ship Canadian iron ores to American markets in the face of the duty there of seventy-five cents per ton. The *Cleveland Iron Trade Review*, in its issue of December 5th, reviewing the iron ore market there, says that some of the 1890 product of the Aurora mine, one of the well-known Gogebic Bessemer hematites, had been contracted for at \$6 a ton; that the products of the Chapin mine were selling at \$5.50; of the Pence and Hennepin mines at \$6.25, and that the ore from the Republic mine would be held at \$7. These ores are very rich in metallic iron, but no more so than the product of Mr. Ledyard's Ontario mine; and if Mr. Ledyard can lay his ore down in Cleveland at \$3.90 duty paid, he ought to realize a profit of from \$2 to \$3 a ton on it. Why then is he so anxious for Commercial Union with the United States. Mr. Ledyard may be a very astute business man, and very desirous of realizing on his investment, but for some unexplained cause we find him holding his Canadian iron mine containing a million tons of ore in idleness, when the ore markets of the United States are booming, and the Lake Superior mines are being worked to produce much larger quantities of ore in 1890 than ever before. Why don't he dig out his million tons of ore and sell it in Cleveland at a certain profit of two or three million dollars,

instead of doing all he can to disrupt and destroy the autonomy of the Dominion of Canada? Or why is it that the gentleman does not engage in the manufacture in Canada of pig iron from his rich ores? He says that the cost of doing so is no greater here than in the United States. And in this he is sustained by Mr. Birkinbine, who, as was shown in our last issue, demonstrates that pig iron can be made at Ottawa for \$14 per ton. The Dominion Government pay a bounty of one dollar a ton on Canadian made iron, and iron in Toronto to-day is worth \$20 per ton or more. The consumption of iron in Canada is about three hundred thousand tons a year, and the production here only about 45,000 tons; why don't Mr. Ledyard start up a few furnaces and thus meet a part or all of this demand, instead of pouting because he can't get free access to the markets of the United States?

WHICH?

EFFORTS are made by some of the proprietors of Canadian iron mines, and by some annexationist journals, to create the impression that if there were closer political relations existing between Canada and the United States, the rich ores from these iron mines could be sold to advantage in the American market, and that unless these closer political relations are established these ores must remain embedded in the bowels of the earth. Of course this is but an effort to influence public opinion, for these iron mine proprietors and these newspapers all know that the American duty of seventy-five cents a ton levied upon imports of iron ore does not prevent the importation of vast quantities of the article into that country.

Previous to 1883 the American duty was twenty per cent. *ad valorem*, under which large quantities of ore were imported there; but in the year named the specific duty of seventy-five cents a ton was laid, under which the importations did not decrease; and now they average about a million tons a year. We have not the exact figures for the last fiscal year, but the importations of iron ore into the United States in 1887 amounted to 1,138,569 long tons, and in 1888 to 919,761 tons.

Mr. T. D. Ledyard says that the rich Bessemer ores of the mines near Peterborough, Ont., can be laid down in American lake ports, duty paid, at about the same cost as Lake Superior ores of equal quality and value; and that gentleman has stated that these Peterborough ores can be laid down in certain American cities at the following prices, duty paid:—Buffalo, \$3.25 per ton; Pittsburg, \$4.75, and Cleveland, \$3.90. According to a late report of the condition of the Cleveland market, as given by the *Iron Trade Review*, the average value of Lake Superior ores in that market was about \$6 per ton, the product of the Republic mine being quoted at \$7. It is claimed for the Peterborough ores that they are the equal of any produced in the Lake Superior region, and if this is a fact, and if it is a fact that the Peterborough ores can be laid down in Cleveland at less than \$4 a ton, duty paid, Mr. Ledyard could do a neat stroke of business by sending the million tons of ore he has in his Peterborough mine, which lies within a hundred feet of the surface, to Cleveland, where he could realize a profit of \$3 a ton.

What, then, is the use of these Canadian mine owners

and Canadian newspapers constantly shrieking for "Reciprocity," which means annexation to the United States, to enable them to send Canadian ores there, while they can send them there, paying the duty thereon, and realizing \$3 a ton on the transaction? The idea suggests itself that the refusal to thus enrich themselves in the manner pointed out indicates that to them the annexation of Canada to the United States would be of more value than three dollars a ton on all the iron ore they may own in Canada; that they are not the astute business men they are supposed to be, or that all this talk about the great richness and value of these Canadian mines exists only in their imagination.

A UTOPIAN DREAMER.

THE Canadian National Policy of Protection has many warm and true friends, and this influencing army is constantly being augmented, sometimes from unexpected quarters. Among the latest of these recruits is an anonymous correspondent of the *Toronto Globe*, who signs himself "Ironside." Mr. Ironside tells us that he has studied the subject of iron manufacture in Canada with particular reference to the establishment of extensive iron works in Toronto, and his conclusion is that there are various interests connected with the future of this city, which are calculated to make it an important centre for the manufacture of all kinds of iron and steel products. His inference that with Unrestricted Reciprocity with the United States Toronto would take the lead of even Chicago as a centre of iron industries, is but an inference which may be combated; not but what Toronto may, some day, excel Chicago in this respect, but that event would not be likely to follow Unrestricted Reciprocity. Setting aside Mr. Ironside's political conclusions, we reproduce his facts, which deserve some consideration. His argument is as follows:—

"The ore sent from Canada to the States, after paying 75 cents per ton duty, sells for from \$5 to \$7 per ton, according to the percentage of metallic iron. The same ore could be sold here, with just as good a profit, at \$4, yielding not less than 60 per cent. of metallic iron per ton. And coke or anthracite coal can be delivered here almost as cheaply as to the furnaces in Ohio, as soon as the Toronto, Hamilton & Buffalo Railway is built, with the branch from Smithville to Dunville. The coke or coal can be delivered from Pennsylvania or Ohio by vessel at Dunville, and then by rail (a distance of only 70 miles) to Toronto for less than a dollar per ton; in fact, after the completion of the Smithville & Dunville branch, it is likely that all the coal for Toronto and eastward will come in that way, as a vessel can deliver three or four loads at Dunville to one at Toronto, having to pass through the Welland Canal, as well as paying canal tolls.

"In view of this new and cheap way of obtaining coke and coal for the manufacture of iron in Toronto, I have taken the trouble to prepare some statistics in reference to the cost of the necessary furnaces and equipment for a first-class iron industry such as our limited market would likely absorb, and which, with an open market with the 60,000,000 of our cousins to the south of us, we could safely multiply a great many times, and Toronto would not be long in adding to her population a sufficient number to make half a million. From economic principles, aside from individual benefits, we ought to engage in an industry that would save our people from paying such large sums of money annually for iron products that can be produced here and sold as cheaply as the imported article. According to our Customs reports, over 12,000 car wheels and

axles are imported into the Dominion annually, and about 50,000 tons of pig iron, blooms, billets and bars to the value of over \$1,000,000, and large quantities of beam plate and other manufactured iron paid duties.

"Estimates of car wheel works, with a maximum capacity of 60 wheels per day, will cost approximately:—

Buildings.....	\$ 9,000
Cupolas, blowing apparatus, boiler, etc.....	7,000
Cranes.....	2,500
Chill plates, planks and patterns.....	20,000
	<hr/>
	\$38,500

"Car axle works, to produce 50 axles per day, will cost approximately:—

Buildings.....	\$ 5,000
Hammers.....	9,000
Furnaces and gas producers.....	5,000
Boilers.....	4,000
Tools and fixtures.....	3,000
	<hr/>
	\$26,000

"Machine shop:—

Building.....	\$ 4,000
Lathes and boring mills.....	16,000
Steam engine and boilers.....	5,000
Cranes and fixtures.....	4,000
Tools, etc.....	3,000
	<hr/>
	\$32,000

"A rolling mill sufficient for requirements of the above works will cost about \$120,000, and to properly operate such a work a working capital of say \$80,000 would be necessary. Thus the capital necessary to establish such a description of works as above will cost, for

Car wheels.....	\$ 38,500
Car axles.....	26,000
Machine shop.....	32,000
Rolling mill.....	120,000
Working capital.....	80,000
	<hr/>
	\$296,500

Which will give an annual product of 16,000 car wheels at \$2 profit.....	\$32,000
8,000 axles at \$2.50 profit.....	20,000
5,000 tons bar iron at \$8 profit.....	40,000
	<hr/>
	\$92,000

"These profits are on a low basis, but if reduced one-half there would still be a paying interest upon the investment."

According to Mr. Ironside, the importation of car wheels into Canada being 12,000 a year, the works he proposes for the manufacture of car wheels in Toronto, to cost \$38,500, would supply the demand in two hundred working days; and at a profit of \$2 on each of these wheels, that investment would pay over 60 per cent. profit on eight months work. Regarding the proposed car axle works, such works, costing \$26,000, and producing 8,000 axles a year at a profit of \$2.50 per axle, say \$20,000, would prove a profitable investment—about 80 per cent. per annum—even in the absence of Reciprocity. Mr. Ironside estimates that a rolling mill sufficient for the requirements of these works would cost \$120,000, and that it would produce 5,000 tons of bar iron, the profit upon which would be \$8 a ton—\$40,000 a year—say 30 per cent. upon the investment. We are also told that these profits are calculated on a low basis, and that if reduced one-half "there would still be a paying interest upon the investment."

We should say so. Mr. Ironside estimates the aggregate cost of establishing these works to be a little less than \$300,000, and the annual profit arising from operating them \$92,000, over 30 per cent. We expect that when this news reaches the United States, where hundreds of millions of dollars are invested in just such enterprises, and where a ten per cent.

profit is considered a good return on the investments, there will be a right lively scramble on the part of the iron manufacturers there to get to Toronto. If Mr. Ironsides will verify his estimates by reliable facts, the \$300,000 can be had in twenty-four hours notice without going outside of Toronto.

THE HOME MARKET.

A FREE TRADE contemporary, arguing in favor of throwing down the tariff wall between Canada and the United States, publishes the following table, showing to some extent the importations of American manufactures into this country last year :—

Furniture, over.....	\$ 75,000
House-furnishing hardware.....	82,000
Cottons, about.....	214,000
Sewing machines.....	39,000
Other machinery.....	322,000
Mechanics' tools.....	59,000
Builders', cabinetmakers' and saddlers' hardware.....	144,000
Hats, caps and bonnets.....	140,000
Agricultural implements.....	50,000
Bituminous coal, over.....	693,000
Sugar.....	459,000
Lamp oil.....	325,000
Boots and shoes and manufactures of leather.....	93,000
Lamp shades and chimneys } over.....	70,000
Crockery and chinaware }	
Books.....	62,000
Manufactures of steel.....	100,000
Manufactures of brass.....	78,000

The argument is that the people of Canada desire these things, and, being imports upon which tariff duties are levied, the consumers pay the duties.

The matter deserves special consideration at the hands of several classes of Canadians. The manufacturers who have their money invested in manufacturing industries producing such articles, and whose tall chimneys are kept smoking by through and because of the National Policy of Protection ; the thousands of Canadian workmen who earn their daily bread in the factories, foundries and workshops of these manufacturers ; the tens of thousands comprising the families and dependents of these workmen ; the farmers and all those interested in agricultural pursuits, who raise wheat, potatoes and cabbages to feed this army of consumers ; those other thousands who raise other food products—hogs, sheep, cattle, butter, poultry, etc., for these working people to eat, and all those who are engaged in the distribution of these necessities. It also demands the consideration of all who love their country better than they do any other country, and who value the welfare of Canada above that of any other nation.

Let these lovers of Canada consider the fact that to produce the furniture, tools, machinery, hardware, hats, caps and bonnets ; the boots and shoes ; the crockery, lamps, books, etc., alluded to, means that many thousands of working people, and many millions of dollars invested in manufacturing enterprises are necessary ; and that the difference between making these things in Canada and importing them from the United States, means the difference between the sale of the agricultural products of the country at remunerative prices in the near-by home market, and the sending of the least perishable of them to foreign countries, to be sold there at whatever they may bring. The articles enumerated in this list were not produced in Canada although they might have been, but the production of them gave employment to American workmen and American

capital ; and the food products to feed these workmen were produced on American farms by American farmers. Admitting, for argument, that our American friends can manufacture some of these articles a little cheaper than they can be manufactured in Canada, and that the duties levied upon imports is paid by the consumer, the contravention of the argument is that, to the consumer, who is the producer of the food products required by the workingmen of the country and their families, it is easier to pay the higher price for Canadian-made goods, after having sold his food products in the near-by home market, than to pay the lower price for foreign goods when there is so much less ready money in pocket received from the sale of the food products in foreign markets.

MR. T. D. LEDYARD.

In a recent issue of this journal, attention was called to the fact that while the iron ore beds of Canada are of exceptional richness and value, capable of being easily worked, and some of them within easy reach of transportation lines ; that while the cost of converting these ores into pig iron would be quite as low, or lower, in Canada than in the United States ; and that while there is a large and growing demand in the country for pig iron, the owner of at least one of these mines, while keenly alive to the value of his property, exhibited strange antipathy to engaging in the erection of blast furnaces in Canada for the conversion of his ores into iron, seeming rather to prefer holding them until such time as some political arrangement might be made whereby iron ores might be imported into the United States free of duty. This allusion was to Mr. T. D. Ledyard, the owner of valuable iron ore deposits near Peterborough, Ontario. We showed that, according to a statement made by Mr. John Birkinbine, an American expert, the rich ores from the Bristol mines, near Ottawa, could be made into iron at a cost of \$14 a ton ; and we also showed that the ores of Mr. Ledyard's Peterborough mine could be laid down in Cleveland, Ohio, for \$3 90 a ton, duty paid.

The statement of these facts, and others hereinafter alluded to, disturb the equanimity of Mr. Ledyard very much, and in a letter to the *Toronto Globe* concerning our article, he indulges in evasion and objectionable language. In this letter, referring to our article, Mr. Ledyard says that "a considerable portion of it is one tissue of mis-statements." Having made such a serious charge, the honorable treatment of a controversial adversary should have impelled Mr. Ledyard to show what these "mis-statements" were—to mention them specifically, and to show wherein they were false. But he does not do so, except to say that he is a native Canadian, and not an American, as we had supposed him to be. In our allusions to Mr. Ledyard, we stated that he preferred sending his ores to the United States, instead of manufacturing them into iron in Canada ; that he hopes to increase his profit on such shipments by some change in the laws of the two countries—Reciprocity he calls it ; that he attempted to prove that Canada would be more prosperous under Reciprocity ; that he loves himself ; that his claim is that his ores are quite as rich and valuable as any to be found in the United States ; and that he can lay them down in American lake cities, duty paid, at about the

same cost as Lake Superior ores. These items embrace about all that was said concerning Mr. Ledyard, and we request him to indicate wherein any of them misrepresent him in any way. We do not desire to do injustice to him, and if we have done so, we want to know it. That gentlemanliness that should govern in all intercourse between gentlemen, should have prevented Mr. Ledyard from using the language he did, and should impel him to apologize therefor when he cannot show its justice.

THE "RIGHTS" OF THE OTHER FELLOW.

At the usual meeting of the Toronto Trades and Labor Council, held a few days ago, the Municipal Committee, in their report, discussing the matter of the publication of the assessment rolls of the city, and approving of the idea, say:—

It would be a gross insult to organized labor of this city were a non-union newspaper to receive the work. It should be distinctly understood that tenders should be confined to the union daily newspapers.

There are many besides the Toronto Trades and Labor Council who desire to see the assessment rolls published, to the end that the public may learn who are the tax-payers, how much they pay, and to compare the assessments of different people on similar property. They think, too, that these rolls should be printed in the daily newspapers, and they desire to see it done; but it would be a gross injustice to the tax-payers, and to every decent, good citizen in the community were the authorities to restrict tenders for doing the work to only union newspapers. If this Legislative Committee are at all acquainted with the law of the land governing in such cases, they would know that to thus restrict the tenders for a public service in favor of any particular class would be unlawful, and could and probably would be prevented by the courts. Before the law all men stand free and equal; and it is nothing more nor less than impudence for organized labor to attempt to dictate to the authorities in such a matter.

The people are long-suffering and full of forbearance with these continued effort on the part of organized labor to starve into subjection to them all those who may prefer to show their manliness by keeping aloof from them. The theory advanced by these organizations is contrary to the natural rights of the masses. Society and the law admit the right of laboring men to organize—to work for whom they please, and to quit work when they see proper, and to fix the rate of wages at which they will render their services. But the "right" of these organizations to dictate further than this is not acknowledged by either society or law. In asking for tenders to perform certain services for the public the authorities have no right or power to discriminate in favor of organized labor, or against unorganized labor. Their duty is to see that the service to be performed is rendered at the lowest possible cost to the public, all things being considered.

This attempt at bulldozing is similar to that now being attempted in the Galt foundries, and it will meet with as little success. It is true that the local union there have the backing of the International Iron Moulders' Union, and that many of the strikers are supported by it; but another fact is lost sight of, which is, that in all probability, sooner or later, the moulders of the country who are supporting these strikers in

idleness will become weary of the task, and abandon it; while, seeing that the Galt foundrymen have all the labor they require, that they are getting out their work with promptness, that their work is of the best quality, and that it is not at all probable that any of the strikers could ever again obtain employment in these foundries, it is fighting against fate to continue the foolish and unnecessary struggle. Time was when some non-union workmen with sensitive organizations, flinched and felt uncomfortable at being called "scabs," but that day has passed. Men who respect themselves, and who desire the respect of other respectable men, are not to be driven against their views and interests by any organizations whatever.

Another forcible illustration of the failure of a labor organization to hold its grip and force its dictation is shown in the gas workers' strike in London. The public perceive in the strike a desperate attempt on the part of trades unions to establish a dictatorship over both capital and labor. The strike is not for shorter hours or more pay, but to force the gas companies to discharge non-union men. The unions see in this freedom from its control of both employers and employes, a check upon their authority, if not a virtual disruption of their organizations; and it is in a vain attempt to retain their grip that they have called out their men. As in the Galt case, these men have relinquished their employment without the slightest prospect of ever returning to it, and at mid-winter they are walking the streets in idleness, while their families are suffering for the necessaries of life.

EDITORIAL NOTES.

MERRY Christmas.

CANADA the Prosperous is the envy of her southern neighbor.

Is "Ironsides" the *nom de plume* of Mr. T. D. Ledyard?

THE discussion of the possibilities of the manufacture of iron in Canada can but result in good to Canada and additional glory to the National Policy.

MR. JEFFERSON DAVIS, ex-President of the defunct Confederate States of America, died in New Orleans, December 6. *De mortuis nil nisi bonum.*

HIGH grade Bessemer iron ores are worth \$7 a ton in Cleveland, Ohio; and, according to Mr. T. D. Ledyard, the high grade Bessemer iron ores of Canada can be laid down in Cleveland, duty paid, for less than \$4 a ton.

WE have knowledge of the fact that there are a number of manufacturing establishments in Canada whose regular supplies of pig iron are drawn from the United States. American iron is used in preference to British iron because it is cheaper.

ACCORDING to our Restrictionist friends, the fruits of Mr. Wiman's speeches will be Raspberries.—Toronto *Globe*.

There is not much doubt that the followers of 'Ras will be most effectually buried.—Toronto *World*.

'Ras buried as it were.

MR. GRAHAM FRASER, manager of the Nova Scotia Steel & Forge Company, New Glasgow, N. S., was in Ottawa a few days ago interviewing the Government relative to the erection of blast furnaces for the manufacture of pig iron in that Province, and the larger development of the iron industry there.

MR. T. D. LEDYARD assures us that he is a Canadian, to the manner born, and not an American, as he was said to be in a previous issue of this journal. The error was a natural one, judging from the way Mr. Ledyard is striving to have Canada become annexed to the United States.

HIGH grade Bessemer iron ores can be laid down in Toronto at about \$2 a ton; and fuel and limestone could be landed at furnace in Toronto as cheaply as in Cleveland. Over \$650,000 worth of pig iron was imported into Canada in 1888. Here is the opportunity for capital to be invested in an iron furnace in Toronto.

UNRESTRICTED Reciprocity with the United States means that all the rich iron ores of Canada that may be mined would go to supply employment to American blast furnaces: and whatever pig iron Canada required would have to come from American blast furnaces. Canada certainly does not desire Unrestricted Reciprocity.

FREE traders say that under Protection the duty is always added to the first cost of the goods. Is it so? The American duty on pig iron is \$6 per net ton. The Free Trade theory is that iron can be made cheaper in Britain than the United States. It is a concrete frozen fact that American iron, protected \$6 a ton, can be sold cheaper in Canada than British iron. Facts are stronger than theories.

MR. T. D. LEDYARD, the annexationist, who is largely interested in Canadian iron mines, has now become convinced that pig iron can be manufactured to advantage in Canada. The consumption of iron in Canada is very large, and there are hopes that Mr. Ledyard will engage in the production of iron here instead of waiting for annexation to open the way for the free admission of his ores to the United States.

THE Philadelphia Press notes that the price of steel rails was just the same in London and Pittsburgh last week, and wickedly adds that this is "one more instance in which the amount of the duty, \$17 a ton, is added to the price of the product." It is facts like this that knock the wind out of the Free Trade doctrinaires—and when the wind is knocked out of a Free Trader there isn't enough of him left, as a rule, to hold an argument with.

IN answer to enquiries, Mr. James M. Swank, General Manager of the American Iron and Steel Association, informs us that the consumption of iron ore in the United States during 1889 will be about 16,000,000 tons, of which about 860,000 tons will be imported, the imports for the first ten months of the year having amounted to 716,809 gross tons. The American duty on iron ore is seventy-five cents per ton.

THE Board of Works of the Toronto City Council have passed a resolution to the effect that all contractors doing work

for the city be required to pay their employes at least fifteen cents an hour for their services. This is right, and the action should be endorsed by the City Council. If the services of employes are of any value at all they are worth as much as fifteen cents per hour or more. If a contractor cannot afford to pay that much he should retire from business and become a day laborer, so that he could see how it is himself. No laboring man in Canada should be forced to work for less money than fifteen cents an hour.

"THE mills of the gods grind slowly," but they "get there just the same." We've been telling about the buncombe offer of the Illinois State Grange of \$10,000 for the patents for a perfect straw binder, and the other offer of a big reaper manufacturer, of a quarter of a million for the same clinch on the same tool. Now comes a poor workman from down in a back county in this State and tells us he has the machine almost completed, and that he will shortly invite us to witness it in successful operation. We've promised attendance at the trial, and hope to be able to give a most flattering description of the coming wonder in an early issue.—Reifsnider's *St. Louis Farm Machinery*.

THE South is still intolerant. It seems to look upon men who are in favor of moderate protection for the development of the marvelous resources of its own section as traitors to the Democratic party. The *Chronicle*, of all its Southern contemporaries who advocated a tariff for revenue and fair protection, is the only Southern daily that still stands by its convictions, and dares to maintain that a tariff for Revenue and Protection is not inconsistent with tariff reform. If the tariff in favor of cotton goods was taken off, every mill North and South would be closed in six months. Protection has developed the iron interests of the United States, so that we are now able to compete with England in the markets of the world, and sell steel rails that at one time cost \$150 per ton, at \$35 per ton. This is what Protection has done for the United States.—Augusta, Ga., *Chronicle* (Dem.)

THE *Monetary Times* calls attention to the fact that Alabama makers of pig iron are able to sell their product in New York at prices which compete with Pennsylvania—that they can do this because of the cheap negro labor of the South. It also says that Alabama iron can be put on cars at Birmingham, that State, at a price which will enable its being laid down in Toronto, duty paid, at about \$23 per ton. This, it says, is not a high grade iron, but still the margin of several dollars per ton between it and English iron of similar quality will lead merchants to look towards the more novel field. In the face of the fact that American furnacemen are protected by their tariff to the extent of \$7 a ton on imports of pig iron, American iron is freely sold in Canadian markets at prices that cannot be approximated by the iron manufacturers in Free Trade Britain. We have knowledge of the fact that quite a number of Canadian manufacturers receive their supplies of pig iron regularly from the United States. It is also a fact that pig iron can be manufactured in Canada from Canadian ores for considerably less money than similar iron can be imported for from either the United States or Britain

SPECIAL ADVERTISEMENTS.

Advertisements will be accepted for this location at the rate of two cents a word for the first insertion, and one cent for each subsequent insertion.

200-LIGHT GAS MACHINE for sale, only used two winters. Apply Wagner, Zeidler & Co., West Toronto Junction.

TISDALE'S BRANTFORD IRON STABLE FITTINGS.—We lose no job we can figure upon. Catalogue sent free. The B. G. Tisdale Co., Brantford, Canada.

IRON TURNING LATHE—12 inch over sheens, 20 inches in gap, 6-foot bed, in good order—for sale or exchange for small shaper. Standard Needle Co., Paris.

I WILL give a free deed of ten lots on the Scugog River to anyone who will start a manufacturing establishment employing a certain number of hands. A. D. MALLON, Lindsay, Ont.

BISCUIT FACTORY FOR SALE IN KINGSTON.—Including land, buildings and machinery, at \$5,000; going concern; good business; fully equipped. Apply to Macdonnell & Mudie, Kingston, Ont.

FLOUR MILL FOR SALE.—One of the best Water Powers on the Welland Canal. Could be converted for other manufacturing purposes. Address Richard Wood, St. Catherines Ont. P. O. Box, 977.

A DYER—Blue vats and fancy colors in wool and piece. Fast carriage green cloths, tricots, flannels, etc., etc. Am at present engaged in the States, but desirous of coming to Canada. Address, GUBELINUS, this paper.

FOR SALE—at Merrickville, Ont., within five minutes' walk of the C.P.R. station or the Rideau canal wharf, a first-class Water-Power with substantial buildings suitable for roller mill or other heavy machinery. Apply to MRS. M. P. MERRICK, Merrickville, Ont.

FOR SALE.—The Wilkinson Plough Co. (Lim.), of Aurora, Ont., are moving to West Toronto Junction about the 1st January next, and offer their works at Aurora for sale or exchange. They are large, complete works, and have a capacity of from forty to fifty ploughs a day. Apply either to Aurora, or to their temporary offices, 19 Wellington street east, Toronto.

FOUNDRY AND MACHINE SHOP FOR SALE IN DUNDAS—Formerly occupied by Thomas Wilson & Co., and lately by Cochrane Roller Mill Co., very suitable for manufacturing purposes; steam engine, boiler (new), also water power; a quantity of machinery and shafting in building. Apply to Thomas Wilson, Dundas; Kingsmill, Cattnach & Symons, Toronto; or Rruce, Burton & Bruce, Hamilton.

FOR SALE—A first-class (American made) automatic gauge lathe, but very little used, and in perfect condition, with counter shaft, hangers and pulleys complete; suitable for rapidly turning hoe, fork, or broom handles; also one iron top jig saw, nearly new. Apply to Samuel May & Co., 89 Adelaide street west, Toronto.

WHAT Edward Bellamy, author of "Looking Backward," says about what can be done with the servant girl? "To this I believe its answer must be, Nothing; second, What can be done without her? To this I think the response may safely be, Everything." Mr. Bellamy's paper on the Servant Girl Question will appear in *Good Housekeeping* of December 21, No. 121, and his views on the subject will command attention in every household. A portrait of Mr. Bellamy, engraved expressly for *Good Housekeeping*, will appear in the same number, accompanied by a personal sketch of his life and labors, the most complete and interesting that has yet been given to the public of the author of "Looking Backward."

Santa Claus, as we have before remarked, is one of our most agreeable visitors, a pleasant feature of these visits being that they occur every week. A weekly visitor for young people, in the form of such a delightful magazine, is something that will be particularly pleasing to those for whose enjoyment it is published; and the price of it, \$2.00 a year, places it within the reach of all. Any child can earn the money to pay for it, and it is really worth many times the cost. It affords an all-the-year-round visit from the old gentleman whose namesake it is, and whose presence is particularly expected in all well regulated families about this season of the year. Address the Santa Claus Company, 1113 Market Street, Philadelphia.

THE Christmas number of the Toronto *Saturday Night* is more essentially a Canadian holiday number than any previously issued, every feature having been chosen as typical of Canadian life. No issue of a Canadian paper ever before contained more expensive and artistic illustrations, all of which are original, and with two exceptions, done specially for this number by Canadian artists. There are other papers in Canada that now issue holiday numbers, and while the price of these is higher than *Saturday Night's* effort, none of them excel it in any respect. It is meeting with great and deserved success. The Sheppard Publishing Company, by whom *Saturday Night* is published, are also publishers of the *Canadian Fireside Weekly*.

THE Geo. F. Blake Manufacturing Company, Boston, Mass., builders of steam and power pumping machinery, during the past season have supplied the following cities and towns in Canada with steam pumps: Lachine, Que., two machines of 1,500,000 gallons per day capacity each; Toronto, two machines of 4,000,000 gallons each; Hull, Que., two machines of 1,250,000 gallons each, this being a total of four such pumps furnished for that city; Moncton, N.B., one machine of 1,750,000 gallons, and Beauharnois, Que., two machines of 1,000,000 gallons capacity each. The following cities and towns in Canada use the Blake pumping machines in their waterworks: Kingston, Morrisburg, Paisley and Iroquois, Ontario; St. Hyacinthe and Valleyfield, Que.; New Glasgow, N.S., and Charlottetown, P. E. I.

IN the *Dominion Illustrated* for December 7th, the series of Canadian Industries is continued—the works of the Montreal Rubber Company forming the theme of an article and a number of illustrations. This is a feature of our pictorial contemporary that ought to be extensively taken advantage of by our manufacturers. The view of the Brant Memorial, Victoria Park, Brantford, will be prized by all friends of the aboriginal tribes, and by all admirers of the brave and loyal chief who fought for Canada and the Empire. There are also some other views illustrative of Brantford's progress. The *Dominion Illustrated* is published by the Dominion Illustrated Publishing Company, Mr. G. E. Desbarats, managing-director. Subscription, \$4. Address: 73 St. James street, Montreal, and 36 King street east, Toronto.

THE *Youth's Companion*, published by Messrs. Perry, Mason & Co., Boston, Mass., is really one of the best papers issued from any press; and while, as its name indicates, it is specially intended for young people, it is of equal interest to those who are older. In fact, there is not a line of printed matter or an illustration in it that is not deserving of any attention that may be bestowed upon them; and as an educator it is invaluable. The Christmas number of the *Youth's Companion* is deserving of special mention, abounding as it does in seasonable and timely articles, and many pictures illustrative of the joyous season when the sentiment "Peace on Earth and Good Will to Men" is uppermost in the minds and hearts of all. The *Companion* is published weekly, subscription only \$1.75 a year; and subscriptions may commence at any time.

THE rapid and constantly increasing spread of applied electricity in its various branches is marvelous. The field is entirely new and intensely practical, and while thousands are working in it, only the first sods are being turned. The recital of what is being done in it reads like a fairy tale; yet the applications of electricity are in hundreds of directions all looking to the welfare, comfort

F. E. DIXON & CO.

MANUFACTURERS OF

TO MILL OWNERS
And Manufacturers.

USE ONLY

F. E. DIXON & CO.'S

STAR
LEATHER



RIVET
BELTING.

READ THIS:

Shepherd Street,
Toronto, Nov. 16, 1888.

Messrs. F. E. DIXON & CO.
Gentlemen,

The eighteen-inch Driving Belt we had from you in July, 1879, has given us thorough satisfaction. It has done all the work in our factory ever since, and looks as if it were good for the next ten years.

Yours truly,

WM. BURKE
For Langley & Burke.

BELTS for Saw Mills,
for Electric Light Works,
for Hard Places.

Lace Leather, Belt Oil, etc., etc.

F. E. DIXON & CO.

70 KING STREET EAST,
TORONTO.

L
E
A
T
H
E
R

B
E
L
T
I
N
G

GEO. F. HAWORTH & CO.,
— MANUFACTURERS OF —
Standard Canadian Belting.

**BELTS MADE ANY WIDTH, LENGTH OR STRENGTH REQUIRED.
BELTS REPAIRED.**

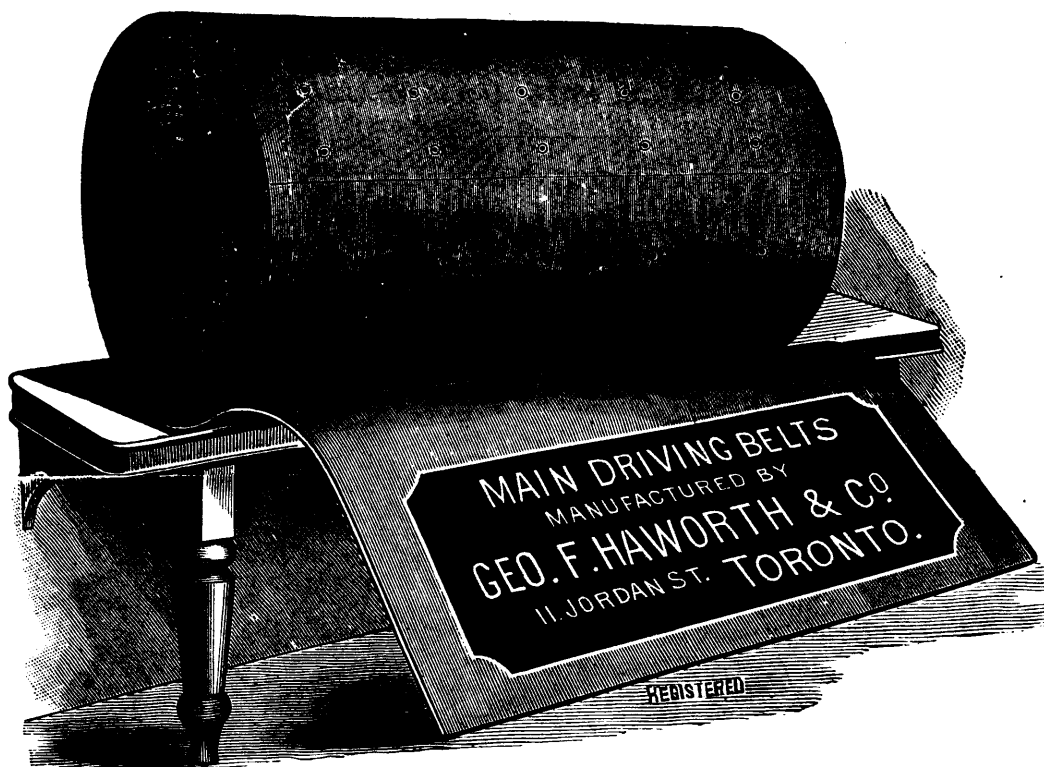

BELTS MADE WATERPROOF FOR SAWMILLS.

Over 200,000 feet sold during year 1888.

Belts Cut from the Solid Part of the Leather Only.

OFFICE AND FACTORY:
11 JORDAN STREET, TORONTO.

and convenience of mankind. With the advent of this new industry there springs into life *Electrical Industries*, published in Chicago by Electrical Industries Publishing Company, by means of which the producers of electrical appliances and the users and consumers of them are brought face to face. It contains directories of manufacturers and dealers; of all the electric light stations and electric railways in North America, and of all electrical associations; and its editorial, illustrated and special articles are all of the highest order. It is published monthly at \$3.00 a year.

THE Christmas number of *Good Housekeeping* is charmingly seasonable as usual, and the contents, if possible, more than ever attractive and useful. The first page is filled with an illustrated poem, "At Christmastide," by Mary Clark Huntington. For a great many people the leading attraction of the number will be found in the paper by Edward Bellamy on "Household Service Reform," and the portrait of Mr. Bellamy, with a sketch of his life and literary career. Mr. Bellamy asks, "What can be done with the servant girl?" and answers, "Nothing." Then he inquires, "What can be done without her?" and his response is, "Everything." Housekeepers may be surprised by these answers and by the notion Mr. Bellamy supports, that servant girls better be discarded altogether. He would substitute a system of co-operation in the various branches of house work; and if any one thinks that co-operation in these lines is not feasible, let him read Mr. Bellamy's argument. The interest in the subject and the writer is increased by a fine portrait of the famous novelist, accompanying an extended sketch of his work and life, which appears in another part of the same issue.

THE little men and women of this country—the rising generation who are sooner or later to appear upon the scene of active business life and control and shape the destinies of nations—must not be neglected or overlooked during their adolescence. With active minds, with busy brains, with eager hearts, they are ready to receive impressions; and it is the clear duty of those interested in them to not only defend them against evil influences, but to surround them with such influences as will tend to make them all that fond, loving hearts would have them. The D. Lothrop Company, of Boston, Mass., devote themselves in this direction by publishing books and magazines specially for the edification of the young, a part of their efforts materializing in the regular issues of *Wide Awake*, *Babyland*, *Our Little Men and Women*, and *The Pansy*. These delightful publications are adapted for the entertainment of all ages of juvenile readers, and of those also who are not yet able to read, but who can admire the beautiful pictures while the stories are being read to them; and the great excellence of all these publications consists in their being of a character that create good impressions. *Wide Awake*, \$2.40 a year; *Babyland*, 50 cents a year; *The Pansy*, \$1.00 a year; *Our Little Men and Women*, \$1.00 a year. D. Lothrop Company, Boston, Mass.

AN IMPORTANT ENTERPRISE.

A LARGE deputation of gentlemen were in Ottawa a few days ago to urge upon the Dominion Government to grant a liberal subsidy to the Central Ontario Railway. This road was originally built from Trenton to Coe Hill, in Hastings County, seventy-two miles, without Government aid. It is now proposed to extend it from Coe Hill on across the projected extension of the Irondale, Bancroft & Ottawa Railway to Sudbury, a distance of 210 miles. The deputation asked for a subsidy of \$6,000 a mile for the extension, and also a subsidy of \$3,200 per mile for the line already built by private enterprise, or a total assistance of \$1,288,000. A strong company contemplates an investment of no less than \$6,000,000 in connection with this road. S. J. Ritchie is President; James McLaren, of Buckingham, Vice-President; Senator Payne, of Cleveland, Ohio; Mr. Cornell, President of the First National Bank, Cleveland, and Thomas Edison, the electrician, are all heavy stockholders. The present terminus of the Central Ontario Railway is at well-known iron mines, and the company own a number of other valuable mines on the proposed extension. They have now about 40,000 tons of iron ore on the banks of Coe Hill. There are difficulties in the way of exportation to the States and in reducing the ore. To overcome the latter Mr. Edison has invented machinery which refines ore with little loss of metal. At Sudbury there are the largest nickel mines in the world. Here the company have two smelters at work, smelting 250 tons of copper ore per day, reducing it to what is known as "matt," of which there are 3,000 tons there at present. This requires to be refined and reduced to pure copper and nickel, of which there is a considerable percentage mixed with the copper, and forming the more valuable part. At present this matt is sent to Swansea, Wales, for refining. It is proposed by this company

to do this refining in Canada, Toronto being a favorite point spoken of. It is also proposed to establish a blast furnace at Trenton to smelt an alloy to be produced by mixing five per cent. of Sudbury nickel with Coe Hill iron. This alloy, a new discovery, is a wonderfully hard metal, and non-corrodible, being therefore specially adapted for plating men-of-war or merchantmen to keep them from "fouling." It is also a valuable metal for ordnance, small arms and bridges. This Trenton furnace will employ 400 men, and have a capacity of 250 tons a day, and a daily pay-roll equal to about \$2,500. The town of Trenton has obtained water-power, which will be put into operation next week, and is offered, with a site, free to factories. Trenton is also regarded as a favorable shipping point, particularly to the United States. In favor of the subsidy, Mayor Morrison presented a petition of 2,115 people of the town of Trenton. A petition signed by 1,370 people was also presented from Prince Edward, and one signed by 1,550 from the County of Hastings. The Ministers who received the deputation were Sir Hector Langevin and Mr. Bowell, the Premier being unwell and unable to attend. The merits of the scheme were presented by Dr. Pratt, Mr. Corby, Mr. Ostrom, Dr. Day and Mr. Gilmour. The Ministers promised to consider the matter. It is an open secret that the Government have decided to grant the subsidies asked for, and the deputation was meant to strengthen their hands.

BEEET SUGAR.

IN our last issue we discussed this question at some length, as it is likely to prove of great importance in Canada. Mr. Robert H. Lawder has furnished some further particulars of interest.

Mr. C. C. James, Professor of Chemistry, Ontario Agricultural College, Guelph, has concluded his analysis of the 26 samples of sugar beets which were collected and sent to him by Mr. Lawder, under instructions from Hon. Mr. Drury, who, as we formerly remarked, has been taking a warm interest in this subject. Professor James makes the average percentage of sugar in these beets 13.63, which almost exactly corresponds with the result obtained by Mr. Skaife's analysis, his average being, as stated in our last, 13.75 per cent. Professor James and Mr. Skaife made special and separate analyses of beet roots which were raised on the Provincial Farm at Guelph, as follows:

	PROF. JAMES.	MR. SKAIFE.
Percentage of sugar.....	17.10	16.4
Co-efficient of purity.....	83.	85.

This is a wonderfully favorable exhibit, and Mr. Story, the farm manager, is to be congratulated on the success of his experiment. Mr. Story cultivated his roots so that they were all grown below ground, and they were turned out of very fine shape and superior quality. In yield per acre, and percentage and purity of sugar, the Guelph crop is far above the average obtained in Europe. Professor James may well write, as he does: "I entirely agree with Mr. Skaife as to the high sugar quality of the sugar beets grown here."

It may be fairly claimed that the adaptation of the soil and climate of the Province of Ontario for the production of sugar beets of a quality profitable for the manufacture of sugar is fully established, and it may be expected that energetic steps will be taken at once for the vigorous prosecution of this new industry here.

The London *Economist* states the production of beet sugar in Europe in the crop year 1888-89 to have been 2,735,000 tons, against 3,330,000 in 1889-90, an increase in one year of 595,000 tons.

There is a misconception in some quarters as to the intrinsic value of beet sugar as compared with cane, for refining purposes, some entertaining the idea that a large proportion of cane sugar is required for mixture with beet sugar. The London *Economist* of November 30 quotes beet sugar 88° f. o. b. in Holland, at 12s @ 12s 1½d per cwt.; and good refining West India sugar at 11s 6d @ 12s. Then as to necessity for cane sugar to mix with beet, the statistics of the German sugar trade show that that country in 1886-87 imported sugar, reduced to raw, 4,678 tons, and consumed and exported 990,306 tons, the importation of cane sugar amounting to only one-half of one per cent. of the home production of beet sugar.

We clip the following extract from the *Watsonville, California, Pajaronian*, of October 31, as to the experience of farmers in that State regarding the profitableness of the sugar beet crops:—"There is not much complaint about sugar beets this year. The expense of cultivating the crop has been much less than last year, and farmers now have the hauling of the crop down to a thorough system. We have conversed with several farmers who have stated that their beet crop has netted them handsomely, and that they have never cultivated a more satisfactory crop."

Manufacturing.

This department of the "Canadian Manufacturer" is considered of special value to our readers because of the information contained therein. With a view to sustaining its interesting features, friends are invited to contribute any items of information coming to their knowledge regarding any Canadian manufacturing enterprises. Be concise and explicit. State facts clearly, giving correct name and address of person or firm alluded to, and nature of business.

MR. J. BOYD'S saw mill at Eastman's Springs, Ont., was destroyed by fire Nov. 17th, loss about \$3,000.

VALUABLE beds of red hematite iron ore, of great richness, have been discovered near Canmore, N.W.T.

THE woolen mills of Messrs. Sykes & Ainsley, Glen William, Ont., suffered damage by fire on December 5 to the extent of about \$5,000.

FIRE in the machine shops of the Nova Scotia Steel and Forge Company, New Glasgow, N.S., on Dec. 3, did damage to the extent of about \$1,000.

MR. J. W. WARD, of Galt, Ont., has become associated with Mr. Messer, of Berlin, Ont., and will establish a shirt factory in the former place.

FIRE in a drying kiln of the Hamilton and Toronto Sewer Pipe Company, at Hamilton, Ont., on December 7, did damage to the extent of about \$1,200.

THE Oxford Furniture Company, of Oxford, N.S., will remove their works to Moncton, N.B., if the citizens of the latter place will invest \$35,000 in the concern.

MR. S. S. BOYCE, of New York, wants to start a linen mill in Hamilton, Ont. He says that if agreeable arrangements can be made he will start a factory with from 50 to 100 looms.

MESSRS. GEO. E. TUCKETT & SONS, Hamilton, Ont., manufacturers of tobacco, will erect an additional factory in that city. The building will be five stories high and give employment to 500 hands.

THE Eagle Knitting Company, Hamilton, Ont., who began business there a couple of years ago, manufacturing gloves, stockings, underwear, etc., will build a new factory, thus greatly increasing their output.

MESSRS. ANDRE CUSHING & Co., who own an extensive sawmill at Union Point, near St. John, N.B., are introducing new and improved machinery into their works, thus largely increasing their output.

MESSRS. AUSTIN, BUSCH & KLINE will establish a factory in Walkerville, Ont., for the manufacture of all kinds of wood-working machinery if that town will give them a bonus of \$6,000 a year for ten years.

MR. WILLIAM SUTTON'S large flouring mill at Simcoe, Ont., was destroyed by fire, Nov. 28th. The mill was valued at \$10,000, and the grain and flour contained therein, and also destroyed, was valued at about \$8,000.

MR. J. T. FAIRGRIEVE, late of Messrs. Gemmel & Fairgrieve, Port Elmsley, Ont., has purchased the woolen mill at Smith's Falls, Ont., recently operated by Mr. D. Allport, and will make extensive additions thereto.

MR. W. R. THOMPSON, who is proprietor of a sawmill, stave, heading, shingle, lath and broom-handle factory at Teeswater, Ont., gives employment to about thirty hands. His broom-handle business is very large.

THE works of the new Belleville Rolling Mill Company, at Belleville, Ont., are being pushed to completion. The machinery for these works is being manufactured at Pittsburgh, Pa., and will be of the best description.

THE Parry Sound Transportation Company is a new concern recently formed at Owen Sound, Ont., and who have contracted with Mr. John Simpson, of that place, to build a steamer, the cost of which will be about \$50,000.

THE Hercules Manufacturing Company, Petrolia, Ont., have been licensed by the Cochrane Roller Mill Manufacturing Company, of Escanaba, Mich., as sole manufacturers in the Dominion of the Cochrane patent roller mill machinery.

MESSRS. JAMES HARRIS & Co., St. John, N.B., are building a large number of frost-proof freight cars for the Frost Proof Car Company, a new concern recently organized at that place. The cars are to be run on the New Brunswick Railway.

THE town of Peterborough, Ont., will bonus the Brooks Manufacturing Company to the extent of \$6,000. The company propose to manufacture carbons for electric lights and other electrical appliances, bells, clocks, vices, lamps, chandeliers and other hardware.

THE Welsbach Incandescent Gas Lamp Company, Halifax, N.S., are exceedingly busy manufacturing their specialty, giving employment to a large number of hands. There are thousands of these lamps in use in Halifax, and they are in general use throughout Canada.

It is proposed to establish rolling mills in Kingston, Ont., and to ask the city for a land and money bonus. The promoter of this scheme says that there is sufficient work within a radius of one hundred miles of Kingston to keep mills going and to employ at least 150 men.

MESSRS. GOLDIE & McCULLOCH, Galt, Ont., will build what is claimed will be the largest steel vault in Canada. It will be 13½ feet high, 18 feet wide and 20 feet deep, and weigh 140 tons. It will be for the Savings Bank Department of the Dominion Post Office at Ottawa.

THE E. B. Eddy Manufacturing Company, Hull, Que., have commenced the manufacture of sulphuric acid for use in their pulp factory in the manufacture of fibre ware. When these works are in full operation, which will be in a few days, the output of pulp will be about ten tons a day.

WORK on the Chignecto Marine Railway is progressing favorably. Most of the heavy cutting is done and twelve of the eighteen miles of the road bed are graded. The work on the piers has been stopped till spring, but everything is in readiness for pushing the work along rapidly as soon as spring opens.

MESSRS. E. P. BAIRD & Co., clock manufacturers, Montreal, have entered on a new field, and are about to open a factory at Plattsburgh, N.Y., where they have secured large premises for the purpose. Their specialties are advertising, composite and self-winding clocks, and they start with orders for over 5,000 on hand.

THE G. & J. Brown Manufacturing Company, Belleville, Ont., who have the contract for the Bay of Quinte bridge, have received three cars of steel plates and angles for the work, also a steam riveting machine, imported from Scotland. They are erecting a new building for the accommodation of this branch of their business.

A CHURCH was dedicated in London, Ont., Sunday last, the furniture of which was supplied by a factory at Walkerville, the branch of a Michigan concern driven over because of the N.P., without which they could do all their manufacturing in the States. As Grover Cleveland might say, "this is a condition—not a theory."—*World*.

THE Windsor, Ont., *Record*, speaking of the industrial activity of Walkerville, Ont., says that the buildings now being erected for the new malleable iron works at that place are 400 feet long by 60 feet wide, with a wing 240 feet long. Messrs. Kerr Bros., that town, have just occupied a commodious machine shop recently added to their works.

AN extensive works for the manufacture of wood pulp will be erected near or at St. Johns, Newfoundland, next season. There is unlimited water power there, inexhaustible supplies of suitable timber, abundance of cheap labor, and the works will be contiguous to a deep and safe harbor. English capital and English machinery are to be used.

MESSRS. JOHN FERGUSON and GEO. PATTINSON, of Preston, Ont., announce that the late firm of Robinson, Howell & Co., of that place, having been dissolved by the death of Mr. Daniel Howell, they, the remaining members of the firm, will continue the business as Ferguson & Pattinson, under the management of the same partner as formerly.

THE shirt factory matter has assumed a new phase. Mr. Messer, the practical man in the proposed Simonds Company, is willing to come to Galt if a local company is formed to take hold of the matter. Several prominent capitalists have the project under consid-

eration, and it is not improbable that it may come to something.—Galt, Ont., *Reformer*.

THE Hawthorn Woolen Mills, at Carleton Place, Ont., of which Mr. W. H. Wylie was a principal owner, have been sold to a company to be called the Hawthorn Woolen Company, who will carry on the concern. Mr. Wylie retires from the business, and Mr. J. M. Masson, late manager of the Blythe Woolen Company, of Peterboro', Ont., will assume charge.

AN order-in council has been passed placing on the free list until the end of next session crude sulphate of soda for manufacturing purposes only; and cotton yarns finer than No. 40, unbleached, bleached or dyed, now free of custom duty, for use in the manufacture of Italian cloths, cotton or worsted or silk fabrics, when imported for the manufacture of cotton loom harness.

THE big war canoe, "Unk-ta-hee," of the Toronto Canoe Club, that created an aquatic sensation at the A.C.A. meet, was so much admired by the American clubs that several are anxious to have duplicates. The Ontario Canoe Company are executing an order for one for the Trenton, N.Y., club. The canoe is 30 feet long and 5 feet beam.—Peterboro', Ont., *Review*.

THE saw mills in the lumber district along the Ottawa River have this year turned out the largest cut ever known, the total output being 795,000,000 feet, board measure. One firm cut 10,000,000 feet more than last year. As a result of the large mill product, the yards are better stocked than for many years past, notwithstanding that shipments were brisk during the summer.

PREPARATIONS are in progress for the erection of two saw mills on the south shore of Burrard Inlet, near the entrance of Port Moody harbor. Mr. Butchard, who owns valuable timber limits on the north side of the bay, has completed arrangements with a company of capitalists for the erection of a lumber manufacturing establishment on his place near there.—Victoria, B.C., *Colonist*.

MESSRS. WILLIAMS GREENE & ROME, who recently decided to establish a factory in Guelph, Ont., for the manufacture of shirts, collars, cuffs, etc., have started up the same, the expectation being that by the first of the coming year they will have about 75 hands at work. This concern, whose headquarters are in Toronto, are operating a factory at Berlin, Ont., in which over 400 hands are employed.

THE town of Aurora, Ont., is desirous of having some manufacturing concern there and occupy the works about being vacated by the Wilkinson Plow Company, who are erecting extensive works at West Toronto Junction, which they expect to occupy very soon. The Wilkinson buildings at Aurora are first class in every respect, and the town is a live one possessed of all modern improvements.

THE Canadian Locomotive and Engine Company, Kingston, Ont., manufacturers of locomotive, marine and stationary engines, and of boilers of all descriptions, inform us that they are sole licensees and manufacturers in Canada of the Armington & Sims high speed engines, the Atkinson patent "Cycle" gas engine, the "Hazletou" boiler, etc., regarding all of which the company will send descriptive catalogues on application.

A NUMBER of American and Canadian gentlemen were recently in Peterborough, Ont., investigating the advantages of that town with a view to establishing works for the manufacture of carbons for arc electric lights. The business at the first will give employment to from thirty to sixty hands, with a prospect of doubling that number in a short time. When established, this will be the only industry of the kind in Canada.

THE new agricultural implement works of Messrs. David Maxwell & Sons, at St. Mary's, Ont., are said to be among the largest and best equipped in the country. The buildings are most substantially built of stone, and a spur from the Grand Trunk Railway entering the grounds affords fine facilities for receiving supplies and shipping goods. Employment is given to about 100 hands, which number is soon to be largely increased.

MESSRS. ROSS & Co., London, Ont., are about starting up their oil refinery again for the manufacture of all kinds of refined and lubricating oils. A large number of workmen are now engaged overhauling the machinery, and where necessary replacing the old machinery with the most modern appliances for producing oils in the most perfect and economical manner. It is expected that the work of refining will be begun in a comparatively short time.

MESSRS. ARMINGTON & SIMS, Providence, R.I., have granted to the Canadian Locomotive and Engine Company, of Kingston, Ont.,

the exclusive right for the Dominion of Canada to manufacture their improved patent high speed engine. These engines are specially adapted for driving electric dynamos, and Messrs. Armington & Sims furnish the Locomotive and Engine Company with all the plans and drawings of the latest improvements made in this engine.

THE Albion Iron Works Company, Victoria, B.C., have been awarded the contract for repairing H.M.S. *Amphion*, the price to be paid being \$150,000. It will be remembered that the *Amphion* was very seriously damaged a few weeks ago while en route from Esquimalt to Victoria with Governor-General Lord Stanley and suite on board. The ship, by skilful management, was got safely back to Esquimalt and immediately placed in the dry dock there, where she now is.

WHAT is to be the largest ship owned in Canada is now being built at Kingsport, N.S., by Mr. Burgess, of Wolfville. Her gross tonnage is 2,304 tons, her length over all 275 feet, extreme breadth 45½ feet, depth 26 feet. The next largest ship to her in size is said to be the *County of Yarmouth*, which is 2,193 tons, 243 feet long, 44½ wide, and 24 deep. The *Karoo*, also owned by Mr. Burgess, is 2,100 tons, 248 feet in length, 44½ in width, 26.6 feet in depth.—St. John, N.B., *Sun*.

THE Rathbun Company, of Deseronto, Ont., one of the largest manufacturing concerns in Canada, have obtained possession of an extensive dock in the city of London, England, for the better accommodation of their British and Continental business, which they have called "Deseronto" Dock. Their foreign shipments include ash, birch and other native Canadian hard woods, for cabinet making purposes, sash, doors, blinds, etc., and many of the products of their chemical works.

THE Lloyd Manufacturing and Foundry Company, Kentville, N.S., are manufacturing three sizes of shingle machines, for which there is a large demand. They also manufacture cylinder stove machines; the latest improved Ratray saw mills, heading rounders, in three styles and sizes; stove planers and jointers, surface planers, buzz planers, all kinds of mill work, including shafting hangers, and mining machinery of all kinds, and castings of all kinds either for new work or repairs.

THE machinists employed by the Albion Iron Works Company are very busy at present. Besides the usual run of work they have now in hand a new walking beam, connecting rod and other machinery for the steamer *Amelia*; a tandem compound engine 75 horse power for the new government boat now on the ways at Spratt's wharf; and the machinery for the Electric Tramway Co. They have also put in position the new engines for the steamer *Hope*.—Victoria, B.C., *Colonist*.

MESSRS. T. B. PEARSON & Co., Victoria, B.C., manufacturers of shirts, underclothing, etc., became established in that business in that place in quite a small way in 1884. Two years ago they were forced by increasing business to move into more commodious quarters, and now these are being enlarged and power and much new machinery is being added. As far as possible the goods of the Westminster, B.C., Woolen Mills Co. are used, and the remainder imported from English and Canadian markets.

THE citizens of New Hamburg, Ont., propose to grant a bonus of \$25,000 to the London Tool Works, of London, Ont., of which Messrs. Yates & Gibson are proprietors, on condition of that concern removing to New Hamburg and employing not less than forty men. They are to erect buildings of the value of \$10,000, and are to pay the interest annually of the balance of \$15,000. They are to be exempt from taxation for any excess assessment over \$15,000. The vote is to be taken on the 28th Dec.

THE Dodge Wood Split Pulley Company, Toronto, a cut of whose factory at West Toronto Junction appears on page 427 of this issue, call attention to the fact that they are manufacturers of cone pulleys, friction pulleys, tight and loose pulleys, and all sorts of pulleys, which, they say, are from 40 to 70 per cent. lighter than corresponding sizes of iron pulleys, and which are the lightest, cheapest, strongest and best balanced pulleys in the world. They also mention their belt pulleys, which are described as strong enough for any power. These pulleys are made in all sizes from 6 inches to 16 feet diameter; and full stocks of them are constantly on hand.

DR. FERGUSON, M.P., and Mr. Geo. Pattinson, the surviving partners in this firm, met the executors of the estate of the late Daniel Howell here last week, and concluded the purchase of the third interest which Mr. Howell held in the Preston woolen mills. That fine establishment will, in future, therefore, be conducted by

Messrs. Ferguson and Pattinson, but the firm name of Robinson, Howell & Co., which is known from one end of the Dominion to the other, will be retained — *Galt Reformer*.

Messrs. Knox, Elliott & Jarvis, Toronto, were the architects who prepared all the plans and are superintending the construction of the extensive new works of the John Doty Engine Company, this city. This is a Toronto concern of which all Canada should be proud. They are young men who know their business in all its varying details; and many private residences, public and semi-public buildings and manufacturing and industrial establishments, planned by them, attest the fact here alluded to.

CONSIDERABLE excitement is reported from Gaspé, Que., on the south shore of the Gulf of St. Lawrence, in consequence of the extensive preparations now going on for the development of the oil deposits there. Col. James Foley, of Boston, representing a company of American capitalists, has arrived at Gaspé with machinery and a force of engineers, derrick builders, etc., and is hurrying forward preparations for sinking a couple of wells to a depth of 2,500 feet each. The company, it is reported, has acquired a large area of the land covering the Gaspé deposits.

THE French Chamber of Commerce of Montreal was to have met in that city on last Wednesday to present to Mr. H. A. Massey, of the Massey Manufacturing Company of Toronto, the grand prize, diploma and medal won by the exhibits of that company at the Paris Exhibition. Mr. J. X. Perrault is the bearer of this handsome tribute to the merit of Canadian manufacturers from the French Government. The grand prize is a beautiful work of art, a statue in bronze, by Fulger, and is, perhaps, the finest prize ever gained by any Canadian manufacturer.

THE London Bolt and Hinge Works, London, Ont., which was established only about a year ago, are doing an encouragingly large business, their recent orders during one week aggregating 1,200,000 bolts. This establishment gives employment to a large number of hands, and is one of the most important in Western Ontario. Although located in the same town, to the prosperity of which it adds so much, this is one of the industries that the London *Advertiser* desires to see frozen out of existence by the removal of the protection afforded it by the N.P.

MESSRS. J. D. LEARY, of New York, J. C. Robertson, of St. John, N.B., and associates, have been voted a subsidy of \$10,000 a year for twenty years by the city council of St. John towards the construction of a dry and wet dock, with wharf and warehouse accommodations in that city. If the scheme materializes, as it is likely to do, it means the expenditure of about a million of dollars in it, and afford accommodation for about eight or ten large ocean steamers. The projectors expect to obtain a subsidy from the New Brunswick Government of \$10,000 a year for twenty years, and a similar or larger one from the Dominion Government. As soon as the arrangements are completed work will be begun and completed within two years.

MR. GEORGE K. McLEOD's steam sawmill at Richibucto, N.B., recently erected, is about ready to be put into operation. This mill is claimed to be the finest of the kind in the Maritime Provinces. The main building is 128 feet long, 40 feet wide, the posts being 26 feet long; and there is a detached boiler house 40x27 feet. The smoke stack is 95 feet high, the flue being five feet diameter. There are three steel boilers, each 14 feet long and 5 feet diameter. There are two improved balanced slide valve engines. The furnaces are automatically fed with sawdust, carried from the mill by an endless chain. Its lumber cutting capacity is about 60,000 feet per day, and the shingle mill, which has not yet been placed, will have capacity to cut about 50,000 per day. Employment will be given to about forty hands.

MESSRS. PERLEY & PATTEE, the lumbermen who have large mills on the Chaudière, are introducing the Glover steam logger for hauling logs from the stump to the stream on which they are floated down to their mills. This is a giant machine 28 feet long, weighing 12 tons, that can be driven by steam on a snow road, and is estimated to draw as many as 30,000 or 40,000 feet of logs. The mechanism is simple. Nearly over the centre of the hind part of a double sled is placed a small engine, the boiler being located in the centre. The boiler is of steel, 5½ feet in diameter, 7½ feet high, and gauged to a pressure of 150 lbs., and either coal or wood can be used as fuel. There are four wheels on the driving axle, each four feet in diameter and weighing three tons, whilst a wheel in front acts as a helm. Its use will effect a great saving to the firm.

MESSRS. J. C. EVELEIGH & Co., Montreal, have acquired the right to manufacture leatheroid in Canada, and are now producing this article in marketable quantities. The article has been patented in

the United States, Canada and other countries, and is bound to become a popular article in the manufacture of trunks, travelling cases, etc. The substance presents a surface very much like leather, being quite as tough and durable, and is used for the outside covering of goods, while inside is a steel lining, springy and pliable, thus giving the trunk or case all the springy adaptability of a solid leather trunk. One advantage it has over the latter is its strength, for it is capable of being tossed about when filled with heavy contents in a manner that would ruin a solid leather article, and not suffer beyond ordinary wear and tear. Another great advantage is its wonderful lightness, being less than half the weight of sole leather in similar goods.

THE Bristol Iron Company having made a large sale of ore to the Crane Iron Company, of Catsqua, Pennsylvania, have commenced shipping. 1,500 tons have already gone forward, and the output is being daily increased as experienced miners arrive from other mining districts. The Bristol ore being a strictly Bessemer ore, high in iron and low in phosphorous, is being sought after by the large steel companies, especially by those making a specialty of low phosphorous steel, such as the Crane Company. The ore is loaded in cars at the mine, as the short line built by the owners of the mine to connect with the P. P. J. Ry. at Wyman's station is in operation. The C. P. R. takes it from Aylmer to Prescott; the Rome, Watertown & Ogdensburgh takes it to Sterling Junction, where the Lehigh Valley Ry. connects and takes it to the furnace. We shall watch the development of the business of this mine with much interest. — *Mining Review*.

THE St. Lawrence Starch Company, of Toronto, whose incorporation was recently announced in these pages, have acquired ten acres of ground on the lake shore east of Port Credit harbor, a few miles west of Toronto, and are erecting a large factory for the manufacture of starch, glucose, etc. The factory building will be three stories high, 197 feet long and 45 feet wide; and, being close to Lake Ontario, will have the advantage of abundance of clear, cold water at the nominal cost of pumping. The building is well under way, it being expected to have the works ready for operation early in the coming spring. The Toronto, Hamilton and Buffalo Railway, now being built, will pass through the grounds of the St. Lawrence Starch Company, affording it the best facilities for rail connection with Toronto. These grounds are sufficiently extensive to admit of additional manufacturing facilities when demanded by increasing business. The plans for this important industrial work were made by the well-known Toronto architects, Messrs. Knox, Elliott & Jarvis, under whose superintendence they are being built.

At the recent annual meeting of the St. John, N.B. Board of Trade, the report of the Secretary, giving a comprehensive review of the business enterprises of the city, shows that St. John is progressing at a most satisfactory rate. Alluding to the development of the manufacturing interests in that city, which are of a most encouraging nature, there port says: "Notwithstanding the fact that most of the following establishments have materially increased their facilities, they are, with scarcely an exception, running full capacity and with large orders on hand. Railway car works, rolling mills, brass and iron foundries, nut and bolt works, carriage spring and axle works, engine and boiler works, nail and tack works, horseshoe nail works, iron foundries, skate factory, edge tool factories, slate mantel works, saw and lead works, paint and varnish works, carriage manufactories, brick works, potteries, trunk factories, brush and broom factories, bedding factories, furniture factories, sash, door and blind factories, planing mills, pump factories, cooperies, ships' block works, tanneries, boot and shoe factories, larrigan factory, hatters and furriers, cotton factories, woolen mills, knitting factories, tailors and ready made clothing factories, shirt factories, straw hat factories, manufacturers of lumbermen's outfits, brewery, aerated and soda water manufacturers, flour and meal mills, bakeries, biscuit and confectionery works, tobacco and cigar factories, syrup and essence manufacturers, soap manufacturers, agricultural implement factories, vinegar factories, spring bed and mattress factories, spice and coffee mills, boot and shoe tree and last factories, match, box-packing case and washboard factory, boat builders, bridge and turn table manufacturers, excelsior factories, lumber mills, turners and wood working factories, lime quarries, granite polishing works, paper manufacturers, printers, publishers, book-binders, wood and copper-plate engravers, steam lithograph works, jewellers, sailmakers, roofing paper manufacturers, paper box and bag manufactories, fishing rod manufacturers, saddlers and harness makers. In fact, almost every line of manufactures and industries are represented in the city, and are generally in a prosperous state."

ONE of the greatest novelties in the recent Paris Exhibition was

to be seen at the stand of the American Screw Company, of Providence, R.I. The company exhibited two machines which produced wood screws, and other similar products, by a new process by which the metal is caused to flow in the direction required, and the thread and head of the screw are built up from the wire. Nothing is therefore cut away, and all the material is utilized. The process is the result of a series of costly experiments, extending over a long term of years. The process is interesting to the general public, on account of its novelty; and it is also interesting to the specialist, since it may be productive of numerous results at present unforeseen. Drop forgings have shown what can be done with hot metal by swaging, but the introduction of a homogeneous metal has rendered possible the manufacture of screws and other products by the cold rolling and swaging process, as developed and applied by this company. For many years screw threads have been rolled by experimental machinery, but such machinery was only capable of turning out screws having a shallow thread and a short length, and they were not of much use, as the material was too soft for most of the uses to which a screw has to be applied. The present machinery, however, works on the principle of forcing the metal displaced by the dies in a lateral direction, instead of allowing it to move longitudinally as before. In addition to the process for enlarging the diameter of the thread some four to six sizes larger than the body of the blank, and without which the enlarged diameter of the thread would have no practical value, there is the supplementary process for producing a corresponding enlargement of the head, having a swaged slot and a finished surface. Two machines are required for the production of a screw. The first machine takes the wire and holds it firmly in a clamp, whilst two strokes from a die form the head, and a third stroke produces the slot in the head. The wire is then carried forward, and a pair of shears cut off the required length, leaving a taper point. These forms are then thrown into a box attached to the second machine, where they are arranged automatically between guides, which keep them vertical and pass them on to the dies. These dies raise the thread and turn out the screws finished at the rate of sixty a minute, whereas the ordinary screw making machines now in use turn out not more than about seven in a minute.

The Aladdin Cooker consists of a wooden box, lined with copper, packed with sawdust between the copper and the wooden frame. The purpose of this thick wall is to hold the heat where it is wanted, wood being a very excellent non-conductor. The heat is conveyed from the lamp placed outside by a column of water circulating through two pipes and a double-walled copper cone; under this cone an ordinary kerosene lamp may be placed, so that the heat from the top of the chimney may be caught in the cone and through it may be imparted to the water inside the wooden box. The most useful form of this cooker has an inside measurement of 10 by 10 inches, by 20 inches deep. Meats or other food are placed in covered stone or earthenware pots. These pots, being placed in the bottom of the cooker, are surrounded by the water up to the lip of the pot. A platform, pierced with holes, is then placed across the middle, and upon this platform other vessels are placed, containing food which is to be cooked by steaming. If a lamp of considerable power, like a Rochester, Niagara or Day-light lamp, having a wick one and one-half inches in diameter, and burning three pints of oil in eight hours, be used, the water will speedily boil, furnishing steam to the upper story, but simmering the food which has been placed in the stone pots below. Meats and many kinds of grain ought not to be subjected directly to a boiling heat, but should be subjected only to that degree of heat by which they can be simmered. This is accomplished very perfectly in this apparatus; the meats may be simmered only in their own juice, or water may be put in the pots with the meat when the purpose is to prepare a large quantity of soup stock as well as to cook the meat. In this cooker, oatmeal, cornmeal, meat stews, and other kinds of food, may be placed at night; a lamp of moderate power being used, which will not boil the water, and will not therefore tend to evaporate it rapidly through the cracks in the cover. The cooker, with water heated only to 180° or 190° F., can be left to itself during the night, and a hot, nutritious breakfast will be ready the next morning. The cover is made of thick material, and a thick cloth is usually placed between the cover and the box to prevent rapid evaporation. There can be no danger of explosion from steam generated within, as the cover of the box is not fastened on. This cooker can only be used for simmering, stewing and steaming. For night work tin or sheet-iron chimneys fitted with a plate of mica for observing the wick, may be substituted for glass. The front of the cooker is protected with tin, and the low table on which it must be placed to bring the lamp under the heater, should be protected with tin on the front.—*Edward Atkinson, in Good Housekeeping.*

PORTLAND CEMENT.

THE most important discovery of the past decade, and one that will be hailed with satisfaction by engineers and builders all over Canada, is the finding of a large tract of land near Owen Sound containing the necessary ingredients for the manufacture of the best Portland cement. Hitherto it has been necessary to import this article from England, the cements made on this side of the Atlantic being of inferior quality. All this bids fair to be reversed now, and the probability is that before very long Owen Sound will be the centre of the cement trade of Canada. The find is situated in the bed of Shallow Lake, nine miles west of Owen Sound. This lake is remarkable from the fact that during the fall and winter it covers an area of one by nearly two miles to the depth of four feet, and entirely disappears in the dry season, leaving the ground with very little traces of its occupancy. The water departs by means of sink holes, and is said to issue from the ground again at different places and empty into Lake Huron.

The bed of this lake to the extent of 500 acres is covered with a rich deposit of carbonate of lime, underlying which is a deposit of clay, which by analysis has disclosed all the qualities necessary for making a very high grade of cement. Beneath this again is a strata of excellent white brick clay, so that the proprietors of this enterprise may be said to possess a veritable gold mine. An analysis of this carbonate of lime made by Prof. Chapman, of Toronto, gives 96.41 per cent of carbon, while the analysis of chalk, used in the manufacture of Portland cement at Medway, England, contains only 88.72 of carbon.

The discovery of this deposit was made by Mr. R. J. Doyle, one of Owen Sound's enterprising business men, while camping in the vicinity some years ago. He only expected a superior quality of whiting, but on ascertaining that the whiting contained such a large proportion of carbonate, he immediately set about securing from the Government a patent of the land.

The carbonate of lime lies on land the surface, and is from four to seven feet deep. It can be easily excavated with pick and shovel,

EVERY REPUTABLE DEALER KEEPS THEM.



Insist on having the Genuine, and see that they bear our name.

W. H. STOREY & SON, ACTON, ONT.

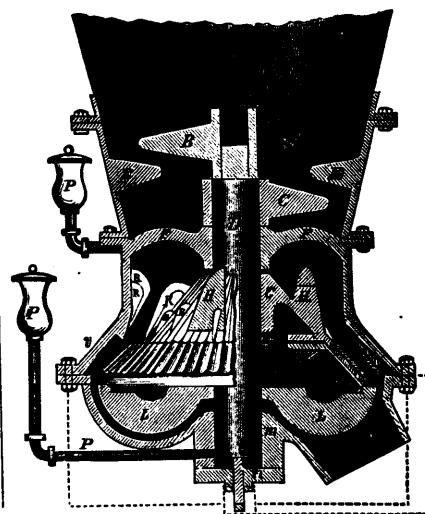

Important to Tanners.
SEGMENT BARK MILL.

For Grinding any hard substance SUCH AS

Cement, Plaster, Bones, Bats, Ores, Paint, etc. It is also used to grind Liquorice and Sarsaparilla roots. Also as a Corn Breaker.

The Segments will retain their cutting edges longer than those of any other Mill, and when dull can be quickly and cheaply renewed.

It has the following good qualities, viz.:—Fast grinding evenly prepared bark; is easily erected and small power required to drive it.

It works with ease in damp or frozen bark, and breakages are prevented by safety coupling.

PAXTON, TATE & CO.
PORT PERRY, ONT.

the only other locality where this can be done being Boulogne, in Germany. The carbonate of lime is also a valuable article of commerce, used for cleaning jewellery. It is perfectly free from sand, and gives a bright polish without leaving the slightest scratch. It seems almost providential that the calcareous clay used in making "Portland" cement should be found directly underneath the strata of carbonate, but such is the case, and the ease with which it is secured must considerably lessen the cost of manufacture.

Specimens of the cement which have been officially tested have stood a higher strain than any other cement, and City Engineer Sproatt, of Toronto, who visited and examined the deposit, has expressed himself as satisfied that Canada can now produce a cement that has hitherto been purchasable only in England or Germany.—*Toronto Globe.*

THE RATHBUN COMPANY.

In describing the town of Deseronto, Ont., a correspondent of the *Canada Lumberman* gives the following information concerning the Rathbun Company, whose headquarters and chief works are at that place:—

The Rathbun Company is strictly confined to the family of the Rathbuns. Mr. E. W. Rathbun is president and manager of the company, and is assisted by Messrs. F. S. and H. B. Rathbun. Some forty years ago Mr. Rathbun came to Deseronto, then a small hamlet, and commenced operations by erecting a sawmill with a capacity of about 30,000 feet a day.

The little mill of thirty-eight years ago and small office, has given place to a palatial building for office purposes, 45x85 feet, three stories high, and fitted with every modern convenience, and fire proof, with their own terra cotta fire proofing material, from cellar to roof, at an estimated cost of erection of some \$20,000. They now have two mills with a capacity of 200,000 and 50,000 feet a day respectively, a shingle mill of 200,000 shingles a day capacity; a flouring mill with 200 barrels a day output; a car works, where they can completely make and turn out four cars per day. This company has also boiler shops where they make locomotive, stationary and marine boilers; machine shops where they build locomotive, stationary and marine engines; and have a full equipment of steam hammers and all modern machinery necessary for

executing first-class work. Their door, sash and blind factory is a building of 400x75 feet, two stories high, and in it they manufacture doors, sashes and blinds which they ship to all parts of the world, besides supplying the home trade. Their chemical works are composed of a nest of eight charcoal kilns, with a capacity of fifty cords each per day. In their terra cotta works they make porous terra cotta fire-proof building materials, flat arches, segment arches, for protection of iron girders and iron columns, partitions, roof linings, furring, etc., and porous terra cotta hard bricks for sewers, drain tiles, etc. This is a daily increasing industry, and the manufactures of this branch are now being used by architects and builders in the large cities and towns throughout the Dominion. It was used in the buildings of the Bank of Commerce, New Canada Life Insurance Co., and Board of Trade offices in Toronto, and in many large buildings in Montreal.

Some conception of their lumber operations may be formed by the fact that their estimated handling from their own mills during the past year are from fifty-five to sixty millions of board lumber and some ten million feet of short lumber, lath, etc. In addition to above they operate rented mills at Ottawa, Calumet, Hawkesbury, Hungerford and Chandos, which swell their annual output to the respectable total of about 100 millions of board lumber for the past year.

In addition they own and run a fleet of some six steamers and ten sailing craft; the sailers are used for lumber carrying only, and a portion of the steam craft are used for passengers and freight, and make daily trips to many ports in Ontario and U.S., and in some instances trips twice and thrice daily.

This mammoth firm also own the Bay of Quinte railway (four miles), Napanee, Tamworth and Quebec railway (sixty miles), and the Thousand Islands railway (four miles). They are also bankers and general merchants.

Besides their great central establishments at Deseronto (where they have a perfect system of fire-saving and appliances for same, and which are hired by the Deseronto corporation in time of need), they have some nineteen branch houses in the Dominion of Canada and agencies in England, Scotland, United States, Australia, New Zealand and South Africa.

The staff employed necessary to efficiently conduct this gigantic concern, including agencies and the wood operations, is roughly estimated to consist of some 3,500 men, boys and girls.

WEBSTER'S

"Vacuum" Exhaust Steam Economizer

Is the Most Improved and Modern Appliance for the Economical Use of Exhaust Steam. Saves the Heat in Exhaust Steam which would otherwise go to Waste.

Utilizes the exhaust steam for heating buildings, etc., returning the condensation to boiler, and for making hot and purified water for boiler feeding and other purposes, and the combined advantages as enumerated in our pamphlet. Orders solicited on trial for acceptance.

We refer to the largest firms in the U. S. and Canada, who have adopted it and duplicated their orders after most exhaustive tests.

JAS. R. ANNETT, 372 Sackville St., Toronto, Ont.

CANADIAN LICENSEE for WARREN, WEBSTER & CO.

THE SASKATCHEWAN

BUFFALO ROBES,

(Which are an Excellent Substitute for the Real Article.)

Will be Exhibited by W. H. STOREY & SON, ACTON, at the Toronto Industrial Exhibition, along with a Full Line of our Specialties.

Everyone interested in the Buffalo should see the Fur Cloth that we are manufacturing for the coming winter, and which is used for

Buffalo Coats, Ladies' Jackets, Caps and Gauntlets, And patented and registered in Canada and the U.S.

Messrs. W. H. STOREY & SON have the exclusive sale for Canada.

NEWLANDS & CO., Manufacturers
GALT, ONTARIO.

GALT, 4th September, 1889.

TO

WOOLEN MANUFACTURERS

One of the best two-set Mills in Canada has been placed in our hands for sale at a sacrifice and on easy terms. Water-power and plenty of water all the year round. One mile from Railway Station. First class local trade and good connection outside. This property cost to build and develop \$20,000. Can be secured for \$8,000, one-quarter cash and balance as desired.

J. B. BOUSTEAD & CO.

12 Adelaide St. East, Toronto.

JUTE, LINEN or COTTON BAGS

For FLOUR, OATS, POTATOES, FEED, etc.

Every Quality, Weight and Size kept. The largest and best assortment in Canada. Daily out-turn, THIRTY THOUSAND BAGS.

BAG PRINTING in COLORS a specialty.

HESSIANS, BURLAPS AND HOP SACKING,

A splendid stock kept. Plain and Striped. Every quality, width and weight.

TWINES—We keep the best stock in Canada.

CANADA JUTE CO'Y (Ltd.),

STARK BROS., Agts.

MONTREAL.

62 FRONT ST. EAST, TORONTO.

FIRE PROTECTION.

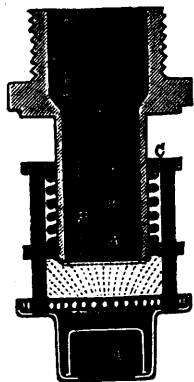

BUILDINGS EQUIPPED
WITH
**AUTOMATIC
SPRINKLERS**

BY
ROBERT MITCHELL & CO.

MONTREAL BRASS WORKS,
Write for estimates MONTREAL

The Barber & Ellis Comp'y,

NOS. 43, 45, 47, 49 BAY ST.

• ACCOUNT BOOKS •

MADE TO ORDER IN FIRST-CLASS STYLE.

PAPER BOXES MADE FOR ALL CLASSES OF GOODS

Correspondence Solicited.

TORONTO, - ONTARIO.

THE WELLINGTON MILL LONDON, ENGLAND,

GENUINE EMERY

OAKEY'S Flexible Twilled Emery Cloth.
OAKEY'S Flint Paper and Glass Paper.
OAKEY'S Emery Paper, Black Lead, etc.

Prize Medal and Highest Award, Philadelphia, 1876, for Superiority of Quality, Skillful
Manufacture, Sharpness, Durability, and Uniformity of Grain.

Manufacturers: JOHN OAKEY & SONS, Wellington Mills,
Westminster Bridge Road, London, Eng.

Enquiries should be addressed to

JOHN FORMAN, 467 St. Paul St., MONTREAL.

The Standard Drain Pipe Co.

ST. JOHN'S, P.Q.

INVERT BLOCKS

FOR BOTTOMS OF BRICK SEWERS.

These Blocks are made of Fire Clay, SALT GLAZED and VITRI-
FIED, and form the most perfect Invert known. Amongst
their special advantages, they are indestructible perfectly
smooth, affording the minimum of friction to flow.
Easily and cheaply laid on ANY BOTTOM.
Made in lengths of 18 inches, or to suit buyers.

The Standard Drain Pipe Company, St. John's, P.Q.

ROBT. CARROLL, Agent for Toronto.

NAPANEE CEMENT CO'Y

(LIMITED.)

NAPANEE MILLS, - ONTARIO.

MANUFACTURERS OF

HYDRAULIC CEMENT

Warranted equal, if not superior, to
any native cement,
and as good, for most uses, as Portland.

Full particulars of strength, tests, etc., furnished on application.
Endorsed by leading Cities, Engineers, Railways and others.

ROACH LIME. Particularly adapted for paper manufacturers,
gas purifying, etc.

To Prevent Boiler Explosions

And other accidents to Steam Boilers and to secure economy
in their working, insure with

THE BOILER INSPECTION AND INSURANCE CO. OF CANADA

Consulting Engineers and Solicitors of Patents

SIR ALEXANDER CAMPBELL, K.C.M.G.,
Lieut-Governor of Ontario, PRESIDENT.

JOHN L. BLAIKIE, ESQ., VICE-PRESIDENT.

GEO. C. ROBB, CHIEF ENGINEER. ALEX. FRASER, SECY-TREAS.

Head Office: 2 Toronto St., TORONTO.

Fenwick & Sclater,

43 and 44 Foundling St., Montreal.

MANUFACTURERS OF

Cast Steel Files and Rasps, Anchor Brand.
Cotton Waste, white and colored.

Asbestos Cement for covering Steam Pipes and Boilers

Asbestos Piston and Joint Packing. Asbestos and Rubber
Piston and Joint Packing. Plumbago Packing.

HOSE—Rubber, Canvas and Linen.

HOSE—Cotton, Rubber-Lined for Fire Brigades.

SELLING AGENTS FOR

Asbestos Packing Co., Boston; Boston and Lockport Block Co., Boston;
American Cotton Waste Co.; Montreal Tent and Awning Co.;
"Household" Fire Extinguisher Co.

S. LENNARD & SONS, DUNDAS, ONT.,

PATENTEES OF THE "ELYSIAN" SEAMLESS HOSIERY,

MANUFACTURERS OF PLAIN AND FANCY HOSIERY, CAPS, TUQUES,
SASHES, ETC., ETC., ETC.

TO THE WHOLESALE TRADE ONLY.

Represented in Eastern Ontario, Quebec, Nova Scotia and
New Brunswick, by

DUNCAN BELL, Montreal.

In British Columbia by

E. G. ANDERSON, Victoria, B.C.

In Western Ontario by

S. LENNARD, Senior Member of the Firm.

C. C. CLEVELAND.G. F. CLEVELAND.**J. L. GOODHUE & CO.**

MANUFACTURERS OF SUPERIOR QUALITY

LEATHER BELTING

DANVILLE, - QUE.

As Saw Mill work is the hardest that Belting has to do, we refer
by Permission to

Messrs. Gilmour & Co., Trenton, Ont.; The Rathbun Co., Deseronto, Ont.; Messrs. Boyd Caldwell & Son, Carleton Place, Ont.; The E. B. Eddy Manfg. Co., Hull, Que.; Messrs Beck & Co., Penetanguishene, Ont.; Messrs. Flatt & Bradley, Casselman, Ont.; Messrs. Hall, Neilson & Co., Three Rivers, Que.; Cookshire Mills Co., Sawyerville, Que.; The Bennett Saw Mill Co., New Westminster, B.C.; The Waterous Engine Works Co., Brantford, Ont.; The Wm. Hamilton Manfg. Co., Peterborough, Ont.

THE CANADIAN LOCOMOTIVE & ENGINE CO., Ltd.,
 KINGSTON, + ONTARIO.

MANUFACTURERS OF

Locomotive, Marine & Stationary Engines.
BOILERS OF ALL DESCRIPTIONS.

Sole Licensees and Manufacturers for Canada of Armington & Sims' High Speed Engines, The "Cycle" Gas Engine, Atkinson's Patent, The "Hazelton" Boiler.

DESCRIPTIVE CATALOGUES OF THE ABOVE ON APPLICATION.

NOTICE.

The Canadian Locomotive & Engine Co., Limited, of Kingston, Ontario, have the Exclusive License for building our Improved Patent High Speed Engine for the Dominion of Canada, and are furnished by us with Drawings of our Latest Improvements.

(Signed),

ARMINGTON & SIMS.

PROVIDENCE, R.I., Nov. 18th, 1889.

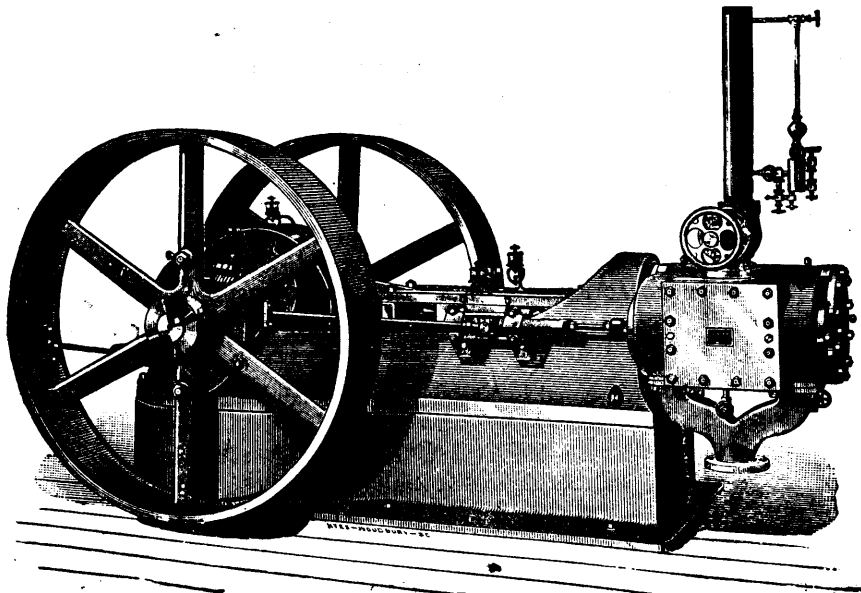

ARMINGTON AND SIMS' HIGH SPEED ENGINE FOR ELECTRIC LIGHT PLANT, &C.

GEO. W. SADLER, Proprietor.

ROBIN & SADLER
MANUFACTURERS OF
LEATHER -
- BELTING

129 BAY STREET,
TORONTO. *and* NOTRE DAME ST.,
MONTREAL.

Lace Leather, Loom Strapping, Cotton and Rubber Belting
and General Mill Supplies.

The Straight Line Engine

Single and Double Valve, and Compound. Thirty to Two Hundred and Fifty H.P.

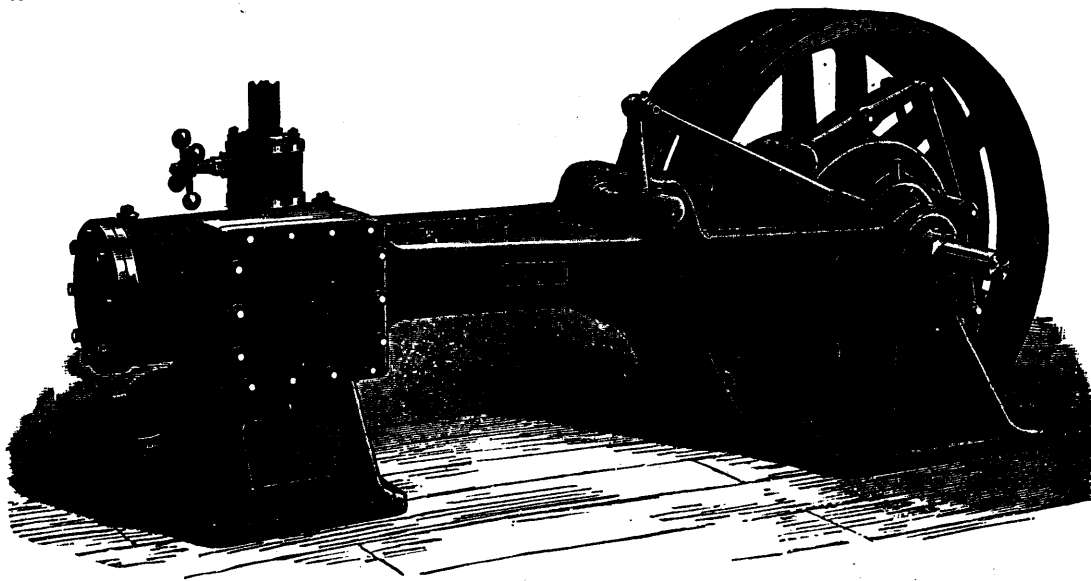

Williams & Potter, Gen'l Agents,
15 Cortlandt Street, **NEW YORK CITY, U.S.A.**

25 YEARS EXPERIENCE.

BELL • PIANOS.

HIGH CLASS ONLY.

Pure, Sweet Tone,

Elegant in Appearance, and

DURABLE THROUGHOUT.

In Constant Use in the Toronto Conservatory of Music and Toronto College of Music. The Professors in each of these Institutions Highly Recommend them.

SEND FOR CATALOGUE TO

W. BELL & COMPANY, - - GUELPH, ONTARIO.

Warerooms at Toronto, Hamilton, and St. Thomas, Ontario.

BAIN WAGON CO.

— MANUFACTURERS OF —

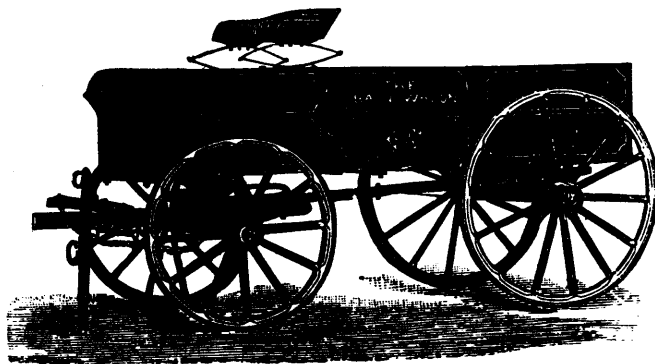

LIGHT RUNNING

FARM, SPRING & FREIGHT WAGONS

Also Heavy Sleighs and Steel Skein Log Trucks.

SEND FOR PRICES TO

BAIN WAGON CO. - Woodstock, Ont.

“DOMINION” PIANOS

Hold more Gold
Medals from the
World's Fairs than
all other Canadian
makes put together.

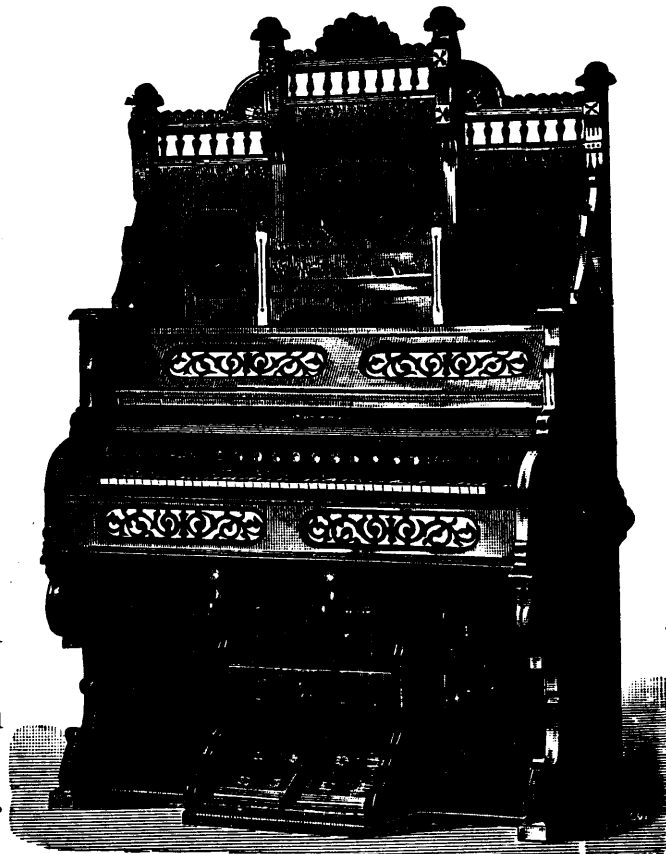

“DOMINION” ORGANS

Large stock now on
hand at very low
prices at the

TORONTO
Temple & Music
J. S. POWLEY & CO.
68 King Street.

The Chatham Manufacturing Co., Ltd., Chatham, Ont.,

MANUFACTURERS NOT ONLY OF

THE CHATHAM WAGON,

BUT OF

One and Two-Horse

LORRIES

With and Without Springs.

SHIP PLANK AND HARDWOOD LUMBER.

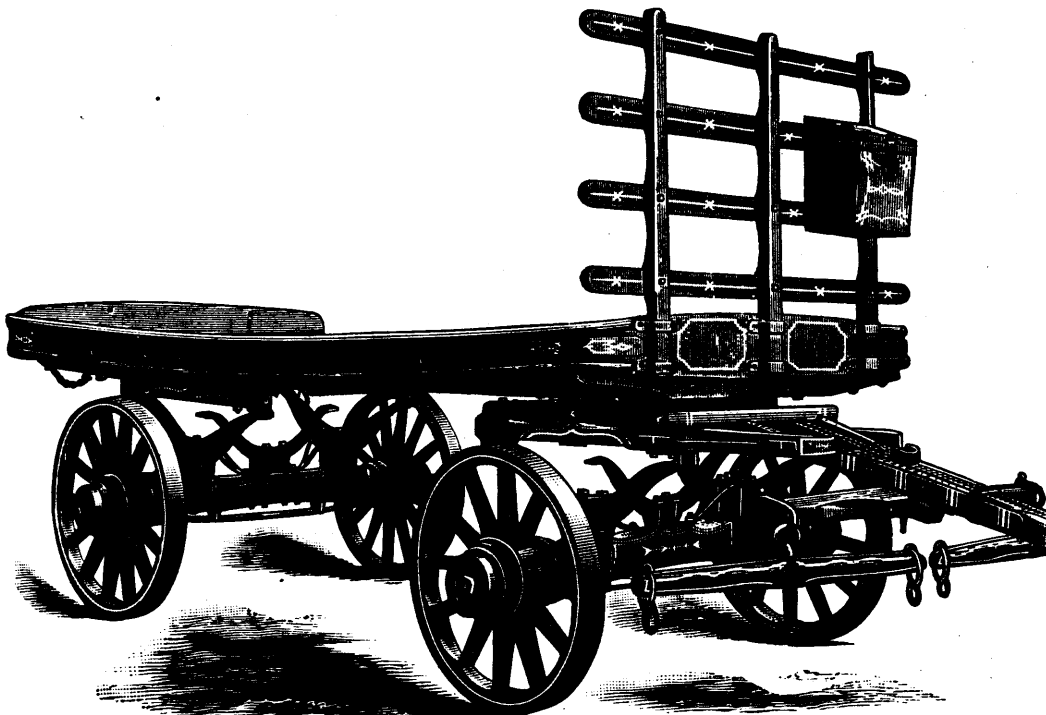

Of a two-horse, the above
is a faithful cut. Found to
be as durable, and the
greatest carrier and easiest
running Lorry made in Can-
ada. At greatly reduced
prices.

Correspondence solicited.

THE CHATHAM TWO-HORSE SPRING LORRY. 4 in. arms, 4 x 1/2 inch tire; capacity, 4 tons. The best and easiest running Lorry made in Canada.

A. E. CARPENTER, Pres. J. H. NEW, Vice-Pres. HENRY NEW, Sec.-Treas.



THE HAMILTON AND TORONTO

SEWER PIPE CO'Y,

(LIMITED,)

HAMILTON, CANADA.

SUCCESSORS TO

The Campbell Sewer Pipe Co. and
The Hamilton Sewer Pipe Co.

—MANUFACTURERS OF—

STEAM-PRESSED, SALT-GLAZED
VITRIFIED
SEWER PIPE,

FLUE PIPES, CHIMNEY TOPS and
SMOKE PREVENTIVES.

Established 1860



Canadian Rubber Co.

Cor. Front & Yonge Sts., Toronto.

MANUFACTURERS OF

RUBBER SHOES & FELT BOOTS,

Patent Pressed Double Strip Rubber Belting,

RUBBER
ENGINE,
HYDRANT,
SUCTION,
STEAM,
BREWERS'
and FIRE
HOSE.
HORSE
CLOTHING
STEAM
PACKING.



RUBBER
VALVES.
CAR
SPRINGS.
WRINGER
ROLLS.
CARRIAGE
CLOTHS
BLANKETS.
STOPPLES
etc., etc.

Mould Goods of Every Description.

LADIES' & GENTLEMEN'S TWEED and GOSSAMER CLOTHING

OUR RUBBER GARDEN HOSE IS THE
BEST IN THE MARKET.

J. H. WALKER, - Manager.

The Waterous Steam Fire Engine

Built in Four Sizes,

200 to 600 Gallons.

Cheapest, Lightest
and Most Simple

Fire Engine Built.

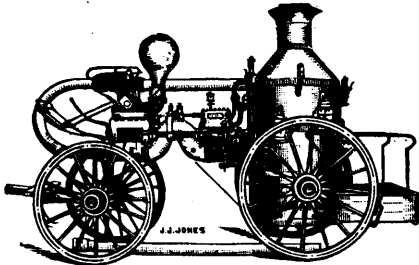

No. 4, City Size, side view.

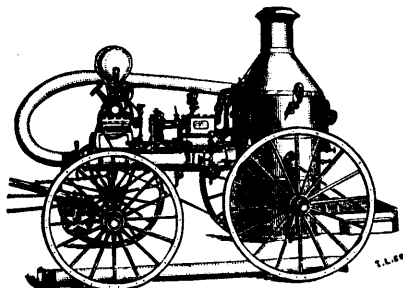

No. 2, Village Engine.

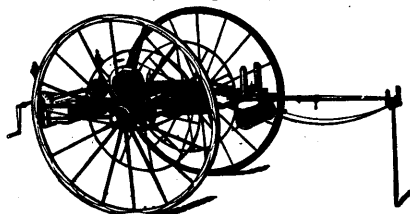

No. 1 Hose Reel.

No. 2 size,
Weight, - 3,000 lbs
Capacity, 250 to 300
gallons per minute.

-1 1-4 stream.
2.-7-8 stream.
3.- 5-8 stream.

Easily drawn by hand.
Other sizes in proportion.

Send for Catalogue.

HOSE REELS,
For hand or horse

COUPLINGS,
HOSE,
HOSE WAGONS,

Y's and Fire Department Sup-
plies generally.

THE WATEROUS ENGINE WORKS CO., Brantford, Canada.

GOLDIE & McCULLOCH

Galt, Ontario,

Have the following Machinery For Sale:

- 80 H.P. Wheelock Engine—New.
- 70 H.P. Corliss Engine—Good Condition.
- 35 H.P. Wheelock Engine—2 Years in use.
- 60 H.P. Whitelaw Buckeye Engine.
- 80 H.P. Inglis & Hunter Corliss and Boiler.
- 25 H.P. Inglis & Hunter Westinghouse Engine.
- 4-Side McKechnie & Bertram Moulding Machine
- 35 H.P. Boiler.
- 12 H.P. Upright Engine and 20 H.P. Boiler.
- 30 H.P. Boiler.
- 20 H.P. Slide Valve Engine.
- Macgregor, Gourlay & Co. Planer and Matcher
- 35 H.P. Killey & Co. Engine.
- 100 H.P. Killey & Co. Engine.
- 40 H.P. Slide Valve Engine.
- 10 H.P. Engine and 12 H.P. Boiler.
- 80 H.P. Dickey, Neil & Co. Engine.
- 30 H.P. Abell Slide Valve Engine.
- Iron Turning Lathe, 18 feet bed, 32 inch swing.

For Particulars Address

GOLDIE & McCULLOCH, GALT, ONT.

HAMILTON COTTON COMPANY,

MANUFACTURERS OF

THE STAR BRAND

COTTONADES, DENIMS, TICKINGS

- Star Brand—BEAM WARP.
 „ HOSIERY YARN
 „ BUNDLE YARN.
 „ CARPET WARP.
 „ BALLED KNITTING YARN.

First Prize, Silver Medals, for Beam Warps and Denims,
 Toronto, 1881.

General Agents,—

F. McELDERY & CO.,

204 MCGILL STREET, MONTREAL.
 22 & 24 COLBORNE ST. TORONTO.

Millers' and Manufacturers' INSURANCE COMPANY.

STOCK AND MUTUAL.

OBJECTS.

1. To prevent by all possible means the occurrence of avoidable fires.
2. To obviate heavy losses from the fires that are unavoidable by the nature of the work done in mills and factories.
3. To reduce the cost of insurance to the lowest point consistent with the safe conduct of the business.

METHODS.

All risks will be inspected by a competent officer of the company, who will make such suggestions as to improvements required for safety against fires, as may be for the mutual interests of all concerned.

Much dependence will be placed upon the obligation of members to keep up such a system of discipline, order, and cleanliness in the premises insured as will conduce to safety.

As no agents are employed and the company deals only with the principals of the establishments insured by it, conditions and exceptions which are so apt to mislead the insured and promote controversy and litigation in the settlement of losses will thus be avoided.

The most perfect method of insurance must, in the nature of things, be one in which the self-interest of the insured and the underwriters are identical, and this has been the object aimed at by the organizers of this company.

W. H. HOWLAND, Vice-President.
 JAMES GOLDIE, President.
 HUGH SCOTT, Managing Director.

Applicants for Insurance and other information desired, please address MILLERS' AND MANUFACTURERS' INSURANCE COMPANY No. 24 Church Street, Toronto.

ONTARIO BOLT CO'Y,

TORONTO.

MANUFACTURE

- THRESHING MACHINE TEETH.
 MACHINE BOLTS.
 BOLT ENDS AND BLANK BOLTS.
 BRIDGE RODS AND BRIDGE RIVETS.
 COACH SCREWS AND SKIEN BOLTS.
 THE SUPERB CARRIAGE BOLT.
 THE ECLIPSE SLEIGH SHOE BOLT.
 THE PRIZE CARRIAGE BOLT.
 THE ECLIPSE CARRIAGE BOLT.
 THE PRIZE TIRE BOLT.
 THE PRIZE PLOW BOLT.
 BEST WHIFFLETREE BOLT.

- BEST SHAFT & STEP BOLTS.
 BEST ECCENTRIC HEAD SPRING BOLTS.
 BEST ELEVATOR BOLTS.
 BEST NORWAY SHACKLE BOLTS.
 BEST RAILWAY TRACK BOLTS.
 BLACK IRON RIVETS.
 BOILER RIVETS.
 RAILWAY SPIKES.
 PRESSED SPIKES.
 HOT PRESSED NUTS.
 BRIDGE BOLTS & RAG BOLTS.

The Manufacturers' Insurance Co LIFE & ACCIDENT

HEAD OFFICE:

83 KING STREET WEST
 TORONTO, ONT.

The continued popularity of the Company is shown from the fact that \$305,000.00 of Life Insurance was received during January, and \$80,000.00 for the first week in February.

Issues Life Policies upon approved plans.

Issues Accident Policies containing all modern features.

AUTHORIZED CAPITAL:

Life Company, \$2,000,000.00
 Accident Company, 1,000,000.00

OFFICERS:

SIR JOHN A. MACDONALD, P.C., G.C.B. - - PRESIDENT.

VICE-PRESIDENTS:

GEORGE GOODERHAM, Esq., WILLIAM BELL, Esq.
 President Bank of Toronto. Organ Mnfr., Guelph.

J. L. KERR,

Secretary-Treasurer.

CANTLIE, EWAN & CO.

GENERAL MERCHANTS

AND

Manufacturers' Agents.

LEACHED SHIRTINGS,
GREY SHEETINGS, TICKINGS.
WHITE, GREY AND
COLORED BLANKETS,
FINE AND MEDIUM
TWEEDS, KNITTED GOODS,
PLAIN AND FANCY FLANNEL,
LOW TWEEDS, ETOFFES, ETC.

Wholesale Trade Only Supplied.

15 VICTORIA SQUARE, MONTREAL,
20 WELLINGTON ST. E., TORONTO.

Porous Terra Cotta

Fireproofing.

See it in use in new Bank of Commerce Building, Toronto; new Royal Insurance Company Building, Montreal; Imperial Fire Insurance Company Building, Montreal; St. Lawrence Sugar Refinery, Montreal.

The finest thing for suburban cottages. Excludes heat and cold, is cheap and durable.

Try our improved Cedar Oil for cleaning boilers. We guarantee it to satisfy or no pay.

ADDRESS

The Rathbun Company,
DESERONTO, ONT.

**ARMSTRONG'S
STEEL CUTTER GEARS**

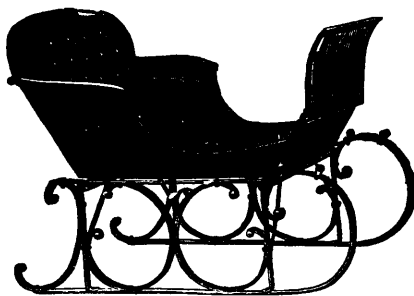

PORTLAND CUTTER.

A handsome business or pleasure sleigh, light, stylish, strong, durable, easy draft. Circular describing and giving particulars of the advantages claimed for these gears, which have now been proved by three hard winters' test, freely mailed on application. Get these particulars before purchasing. It will pay you handsomely.

J. B. ARMSTRONG MFG. CO. (Ltd.)
Guelph, Canada.

**TO MANUFACTURERS.
TO RENT.**

The Flats and Basement of that centrally situated property on Bay Street, below Front Street, being the BEST BUSINESS PREMISES and location in the City of Toronto, WITH POWER (guaranteed steady), Steam Heating, W. C., Wash-rooms, etc., on each floor. Heavy Weight Steam Hoist; good light on three sides; Lowest Insurance Rates; entrance from front or rear to each flat. Specially adapted for Factory, Warehouse and Office purposes.

The building has a depth of 100 feet, with a frontage of 54 feet on the west side of Bay Street and 34 feet on lane in rear; four stories high and basement. RENT CHEAP.

We have also in the same locality, Lot 70 feet front by 100 feet deep to a lane, on which we will erect factory buildings specially to suit a good tenant. For further particulars apply to

DICK, RIDOUT & CO.,

11 & 13 FRONT ST. EAST

**Industrial and Trade
DIRECTORY.**

Acids and Aniline Dyes.

THEO. H. EATON & SON, Windsor, Ont.; Detroit, U.S.A.—Importers of every Description Pure Aniline Dyes for Cotton and Woolen Manufacturers. Dye Samples furnished on application. Address all correspondence to Head Office, Detroit, Mich.

DOMINION DYEWOOD AND CHEMICAL CO., Toronto.—Importers and Manufacturers. Chemicals for Cotton, Woolen, Paper and Leather Manufacturers.

MCARTHUR, CORNEILLE & CO. (successors to John McArthur & Son), Montreal.—Supply of best quality at closest prices. Every description of coloring materials required by manufacturers of woollens, cottons, silks, paper, leather, &c. Are sole agents in Canada for the celebrated aniline dyes of A. Porrier, Paris.

MIDDLETON & MEREDITH, Montreal, Aniline Dyes, Benzidine Colors, Dyewoods, Extracts, Chemicals.

Agricultural Implements and Parts.

WELLAND VALE MANUFACTURING CO.—Lock No. 2, St. Catharines, Ont., Canada—Manufacturers of axes, scythes, forks, hoes, rakes and edge tools.

THE WHITMAN & BARNES MANUFACTURING CO., St. Catharines, Ont.—Manufacturers of mowing and reaping machine knives, sections, guard plates, cutting apparatus complete, spring keys and cutters, etc.

Bridge Builders.

DOMINION BRIDGE CO. (Limited),—Shops at Toronto, Ontario, and Lachine, Quebec. Builders of Steel and Iron Railway and High way Bridges.

Chemicals and Dye Stuffs.

MCARTHUR, CORNEILLE & CO. (successors to John McArthur & Son), Montreal.—Offer at closest figures chemicals required by soap-boilers, oil refiners, paper-makers, and manufacturers of woollens, cottons, leather, &c.

THEO. H. EATON & SON, Windsor, Ont.; Detroit, U.S.A.—Carry full line of Pure Dyeing Drugs, Dye Woods and Extracts adapted for the requirements of Woolen and Cotton Manufacturers.

DOMINION DYEWOOD AND CHEMICAL CO., Manufacturers.—Pure Dyewoods, Dyeing Drugs. Sole Agents. English, German, and French Aniline Dyes, for Woolen, Silk, Paper, and Leather manufacturers.

Edge Tools, Saws and Hardware.

WELLAND VALE MANUFACTURING CO.—Lock No. 2, St. Catharines, Ontario,

TORONTO LITHOGRAPHING CO.
Globe Building, Toronto
MAKE A SPECIALTY OF
Fine Color Work
CHROMO ADVERTISING
CARDS and NOVELTIES
also do a Superior Class of Wood Engraving

BINGHAM & WEBBER 

"Their Work Speaks Their Worth."
Their Telephone No. is 50
Their Office is in the Lakeside Court.

PREMIER CATALOGUE PRINTERS
OF CANADA

25 1/2 Adelaide Street East
Toronto

Canada. — Manufacturers of axes, scythes, forks, hoes, rakes and edge tools.

Gloves.

W. H. STOREY & SON, Acton, Ont.—Manufacturers of fine gloves and mitts in every variety and style.

Hoists and Elevators.

LEITCH & TURNBULL, Canada Elevator Works, cor. Queen and Peter Streets, Hamilton, Ont.—Patent Safety Hydraulic, Hand and Power Elevators. Telephone connection.

Hubs, Spokes, Handles, Etc.

F. W. HORE & SON, Hamilton, Ont.—Manufacturers of wheels, wheel material, shafts, poles, etc.

COWAN & CO., Galt.—Manufacturers of every description of wood working machinery.

Machine Tools.

JOHN BERTRAM & SONS, Dundas. — Machine tools and wood working machinery. Toronto wareroom, 58 Yonge St. Agents—The Polson Iron Works Co. Montreal wareroom, Craig St. Agents for Quebec—The Machinery Supply Association, Montreal.

Malleable Iron.

THE OSHAWA MALLEABLE IRON CO., Oshawa, Ont.—Manufacturers of malleable iron castings, to order, for all kinds of Agri-

cultural Implements and miscellaneous purposes.

SMITH'S FALLS MALLEABLE IRON WORKS, Smith's Falls, Ont. Manufacturers to order of refined malleable iron castings. Agricultural and other castings a specialty. Carriage castings in stock.

Knit Goods.

S. LENNARD & SONS, Dundas —Manufacturers of plain and fancy hosiery.

Oils.

McARTHUR, CORNEILLE & Co (successors to John McArthur & Son), Montreal.—Afford best value in pure olive and lard oils, also in all other leading lines of vegetable, animal, and mineral oils for factory use.

Paper Manufacturers.

WM. BARBER & BROS., Georgetown—Manufacturer of book and fine papers.

THE TORONTO PAPER MANUFACTURING CO., Cornwall, Ont.—Manufacturers

of engine sized superfine papers, white and tinted book papers, blue and cream laid and wove foolscaps, account book, envelope and lithographic papers, etc., etc.

Tanners' Supplies.

THEO. H. EATON & SON, Windsor, Ont.; Detroit, U.S.A.—Supply at lowest prices all Chemicals used by Tanners and Wool Pullers. Special Anilines for Sheep Skin Dyers, Wool Mat Manufacturers, etc., etc. Address correspondence to Head Office, Detroit, Mich.

Wire Works

THE B. GREENING WIRE CO., Ltd., Hamilton, Ont.—Perforators of zinc, iron and steel; manufacturers of wire cloth all grades, wire ropes, bank and office railings, etc.

TIMOTHY GREENING & SONS, Dundas Ont.—Wire manufacturers and metal perforators, wire cloth all grades, perforated sheet metals of every description, all kinds of special perforating and indenting to order.

SPECIAL MIXTURE USED

WRITE FOR PRICES

FOR SHOES & DIES

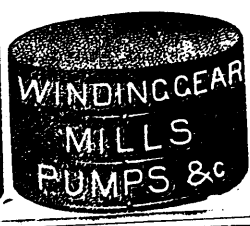
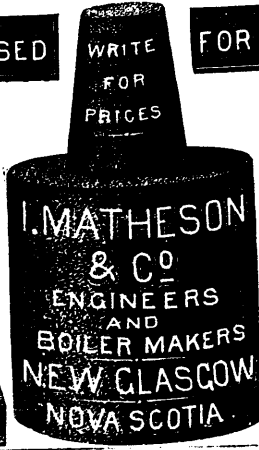
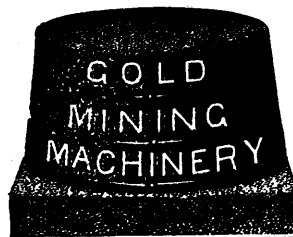

WEBSTER

THE BEST INVESTMENT for the Family, School, or Professional Library.

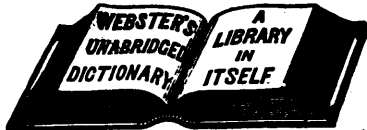

Besides many other valuable features, it comprises
A Dictionary of the Language containing 118,000 Words and 3000 Engravings,
A Dictionary of Biography giving facts about nearly 10,000 Noted Persons,
A Dictionary of Geography locating and briefly describing 25,000 Places,
A Dictionary of Fiction found only in Webster's Unabridged,
All in One Book.

3000 more Words and nearly 2000 more Illustrations than any other American Dictionary.

WEBSTER IS THE STANDARD

Authority in the Gov't Printing Office, and with the U. S. Supreme Court. It is recommended by the State Sup'ts of Schools of 36 States, and by leading College Pres'ts of the U. S. and Canada.

The London Times says: It is the best Dictionary of the English language.

The Toronto Globe says: Its place is in the very highest rank.

The Toronto Week says: It is the one final authority safely to be relied on.

The Montreal Herald says: Its use is becoming universal in Canada.

The Canada Educational Monthly says: No teacher can afford to be without it.

The New York Tribune says: It is recognized as the most useful existing "word-book" of the English language all over the world. Sold by all Booksellers. Pamphlet free.

G. & C. MERRIAM & CO., Publishers, Springfield, Mass., U. S. A.

The CANADIAN MANUFACTURER.

Subscription Price, \$2.00 a Year.

ROMPTON "1888" WOOL COMBS.
ROMPTON LOOM WORKS.
 WORCESTER, MASS. COTTON, WOOLEN, SILK. TAPE & CARPET LOOMS.

ALSO MANUFACTURERS OF GENERAL WIRE WORK. Window Guards, Stable Fixtures, RAILINGS: Sand Screens, Coal Screens, Etc.

THE B. GREENING WIRE CO. LTD.
HAMILTON, ONT.
WIRE CLOTH
ALL GRADES
WIRE ROPE,
PERFORATED SHEET METALS
GALVANIZED POULTRY NETTING
SOFA & CHAIR SPRINGS

MACHINE BRUSHES

All kinds, Made to Order.

Highest Quality of Work Guaranteed.

SEND FULL PARTICULARS OF DIMENSIONS AND QUALITY WHEN ORDERING.

Old Rollers or Blocks Re-filled with special care.

CHAS. BOECKH & SONS,

MANUFACTURERS,

Office and Warerooms: 80 York St.

Factory: 142 to 150 Adelaide St. W.

TORONTO, CANADA.

G. & J. BROWN M'F'G CO.

(LIMITED.)

BELLEVILLE, ONT.

Engineers, Boiler Makers,
Machinists, Foundry-
men and Bridge
Builders.

Railway and Contractors' Supplies a Specialty

FROGS, DIAMOND CROSSINGS,

SWITCHES, HAND CARS,

LORRIES, VELOCIPED CARS,

JIM CROWS, TRACK DRILLS,

SEMAPHORES, RAIL CARS,

DOUBLE AND SINGLE DRUM HOISTS, ETC., ETC.

Established 1828.

J. HARRIS & CO.

(Formerly Harris & Allan).

New Brunswick Foundry

RAILWAY CAR WORKS,
Paradise Row.

PORTLAND ROLLING MILLS,
Strait Shore.

PORTLAND, ST. JOHN, N.B.

Railway Cars of all descriptions. Chilled Car Wheels, "Washburn Peerless" Steel Car Wheels Car, Machine, Mill, Ship and all kinds of castings. Steam Engines, Mill and other Machinery. Nail Plate, Bar Iron, Street and Mine Rails, Ships' Iron Knees, Hammered Car Axles, Shafting and Shapes.

SCIENTIFIC AMERICAN

ESTABLISHED 1845.

Is the oldest and most popular scientific and mechanical paper published and has the largest circulation of any paper of its class in the world. Fully illustrated. Best class of Wood Engravings. Published weekly. Send for specimen copy. Price \$3 a year. Four months' trial, \$1. MUNN & CO., PUBLISHERS, 361 Broadway, N. Y.

ARCHITECTS & BUILDERS

Edition of Scientific American. A great success. Each issue contains colored lithographic plates of country and city residences or public buildings. Numerous engravings and full plans and specifications for the use of such as contemplate building. Price \$2.50 a year, 25 cts. a copy. MUNN & CO., PUBLISHERS.

PATENTS

may be secured by applying to MUNN & CO., who have had over 40 years' experience and have made over 100,000 applications for American and Foreign patents. Send for Handbook. Correspondence strictly confidential.

TRADE MARKS.

In case your mark is not registered in the Patent Office, apply to MUNN & CO., and procure immediate protection. Send for Handbook.

COPYRIGHTS for books, charts, maps, etc., quickly procured. Address

MUNN & CO., Patent Solicitors.

GENERAL OFFICE: 361 BROADWAY, N. Y.

IT PAYS ADVERTISERS TO KEEP POSTED.



pays for a book of more than 200 pages devoted to Newspaper Advertising, and containing information valuable alike to experienced and intending advertisers.



pays for a year's subscription to PRINTERS' INK, a journal no advertiser alive to his own interests can afford to be without.

Issued twice a month and containing articles bearing on every branch in advertising; in fact the trade journal of American advertisers. A sample copy will be sent for Five Cents. Address

GEO. P. ROWELL & CO'S
Newspaper Advertising Bureau,
10 Spruce St., New York.

Established 1872.

- THE ACCIDENT - Insurance Co'y of North America.

NEW FEATURE,

JOINT INSURANCE FOR PARTNERSHIPS

IMPORTANT TO MANUFACTURING FIRMS.

MEDLAND & JONES, Gen'l Agents,
Cor. Adelaide and Victoria Sts., TORONTO.

THE BELL TELEPHONE CO'Y OF CANADA

—Manufacturers and Dealers in—

Telegraph & Electrical Instruments,

Electro-Medical Apparatus, Fire Alarm Apparatus,
Magnets for Mills, Electrical Gas Lighting Apparatus,
Burglar Alarms, Hotel and House Annunciators,
Electric Call Bells, &c., &c.

FOR FURTHER PARTICULARS APPLY TO

No. 12 HOSPITAL ST., MONTREAL.



BEAUDRY UPRIGHT CUSHIONED POWER HAMMER

The most handy, compact, and above all, the most efficient tool ever invented for Manufacturers of all descriptions, Railroad Shops, Steel and Machine Forgers, File and Vice Makers, Knife and Cutlery Makers, Axle, Edge Tool and Agricultural Implement Manufacturers, Carriage Builders and, in fact, all others who need a first-class Hammer, and one of extraordinary capacity and adaptability. Correspondence solicited. Can be seen at Permanent Exhibition, Toronto.

MILLER BROS. & MITCHELL. Sole Makers for Canada, **MONTREAL.**

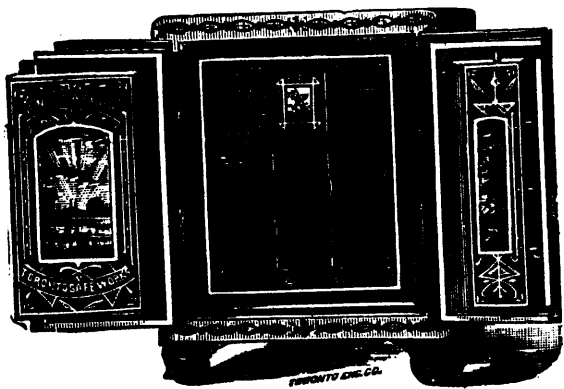

J. & J. TAYLOR'S Double Tongue and Groove FIRE-PROOF **SAFES**

(Patented
January 14th,
1888.)

Established 33 years.

All our new style Fire-proof Safes are fitted with **TWO COMPLETE TONGUES AND TWO GROOVES** on both the door and door frames, which effectually prevent the heat from passing between the door and frame into the interior of the safe.

They are also fitted with **CHILLED CHROME STEEL PLATES** under the Lock and Bolt Spindles to prevent drilling; and have **DRY AIR-CHAMBER** inside to prevent dampness to papers.

See Catalogues and Prices on application.

J. & J. TAYLOR, Toronto Safe Works

INTERCOLONIAL RAILWAY OF CANADA.

The direct route between the West and all points on the Lower St. Lawrence and Baie des Chaleur, Province of Quebec; also for New Brunswick, Nova Scotia, Prince Edward, and Cape Breton Islands, Newfoundland and St. Pierre.

Express trains leave Montreal and Halifax daily (Sunday excepted) and run through without change between these points in 30 hours.

The through express train cars of the Intercolonial Railway are brilliantly lighted by electricity and heated by steam from the locomotive, thus greatly increasing the comfort and safety of travelers.

New and elegant Buffet sleeping and day cars are run on all through express trains.

Canadian-European Mail and Passenger Route.

Passengers for Great Britain or the Continent, leaving Montreal on Friday morning, will join outward Mail Steamer at Halifax on Saturday.

The attention of shippers is directed to the superior facilities offered by this route for the transport of flour and general merchandise intended for the Eastern Provinces and Newfoundland; also for shipments of grain and produce intended for the European market.

TICKETS may be obtained, and all information about the Route; also **FREIGHT** and **PASSENGER RATES**, on application to

D. FOTTINGER,

Chief Superintendent.

RAILWAY OFFICE, MONTREAL, N. B., 2nd July, 1889.

N. WEATHERSTON,

Western Freight and Passenger Agent, 98 Rossin House Block,
York Street, TORONTO.

CARD CLOTHING

NEEDLE



POINTED

AND ALL OTHER VARIETIES OF

MACHINE CARD CLOTHING.

MANUFACTURED BY

JAMES LESLIE, Junction of Craig and St. Antoine Sts., Montreal.

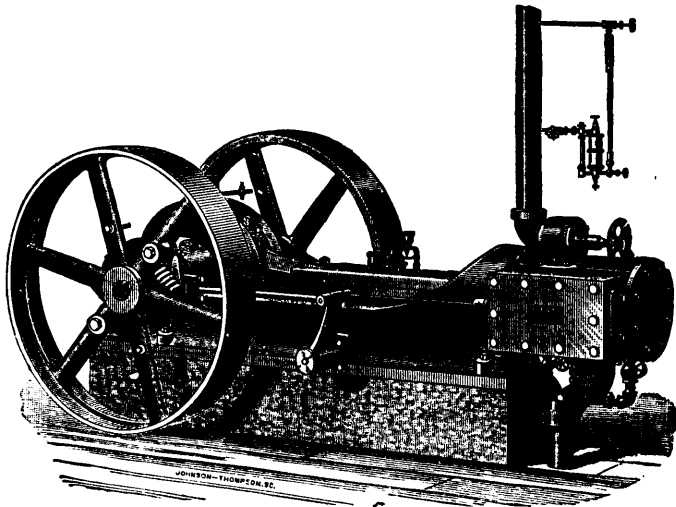

Armington & Sims Electric Light Engines.

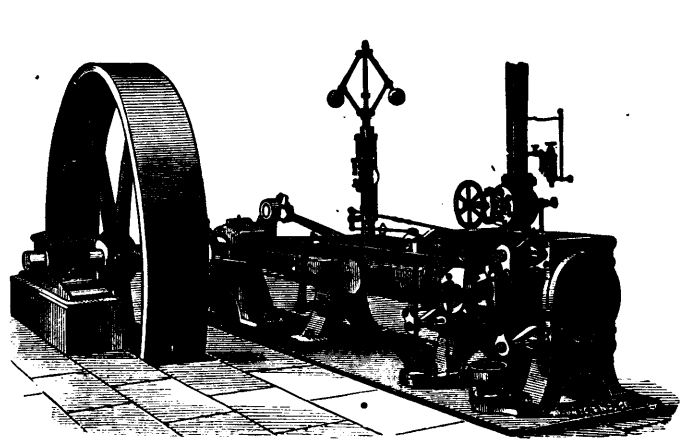

Reynolds-Corliss Engine.

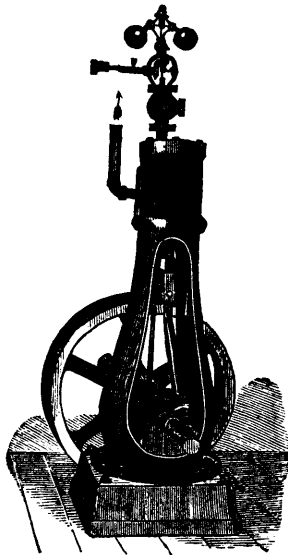

Vertical Engines.

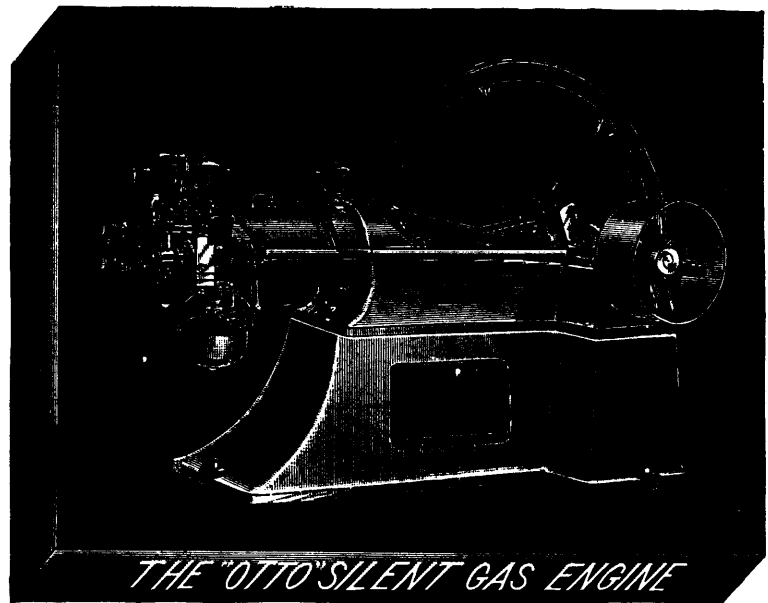

John Doty Engine Co.

TORONTO, ONT.

MANUFACTURERS OF

ENGINES AND BOILERS

OF EVERY DESCRIPTION.

SEND FOR CATALOGUES.

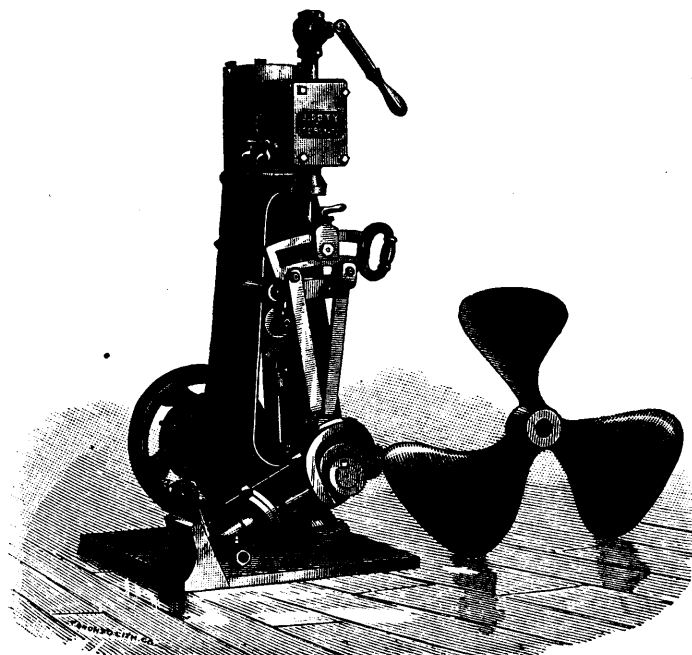

Yacht Engines.

THE
DODGE WOOD SPLIT PULLEY CO.
TORONTO.

CONE PULLEYS.

FRICTION
PULLEYS

TIGHT and
LOOSE
PULLEYS

40 to 70 per cent lighter
than Iron Pulleys.

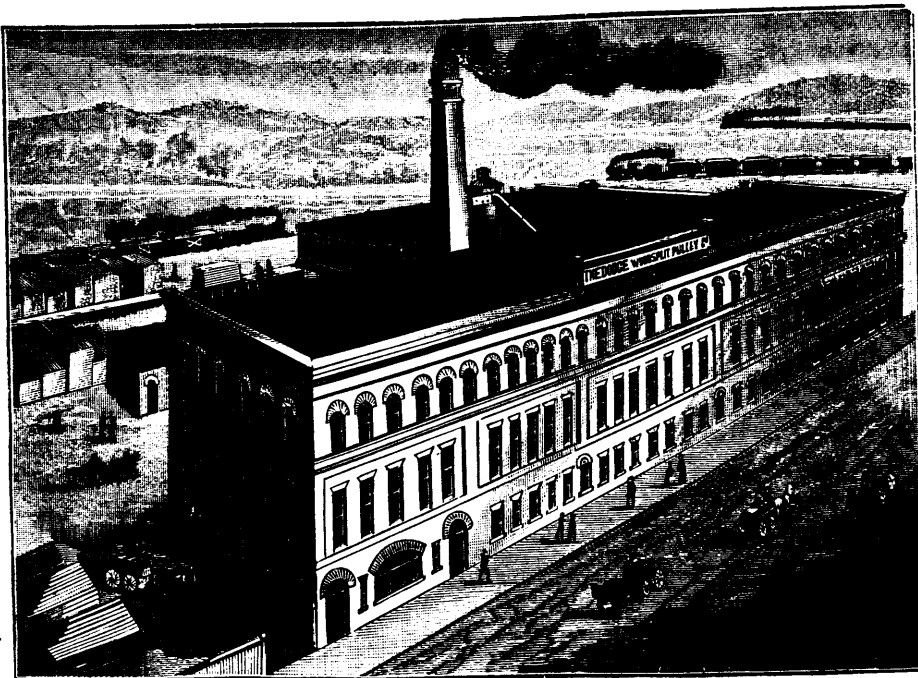

LIGHTEST

CHEAPEST

STRONGEST

and
BEST BALANCED

PULLEYS

IN THE WORLD.

—WORKS AT WEST TORONTO JUNCTION.—

WE FULLY GUARANTEE OUR

PATENT WOOD SPLIT BELT PULLEYS,

Strong enough for any Power.

We make our Pulley in all sizes from 6 inches to 16 feet diameter

FULL STOCK CONSTANTLY ON HAND.

ESTIMATES AND PLANS FURNISHED FOR

TRANSMISSION OF POWER,

1 to 1,000 Horse-Power, any Angle or Distance.

ALSO SHAFTING, HANGERS, COUNTER-SHAFTS AND BOXES OF ALL KINDS.

SEND FOR CATALOGUE AND PRICES.

The DODGE WOOD SPLIT PULLEY CO.

TELEPHONE 2080.

P.O. BOX 333

NEW AND IMPROVED
Pedestal Tenon Machine.

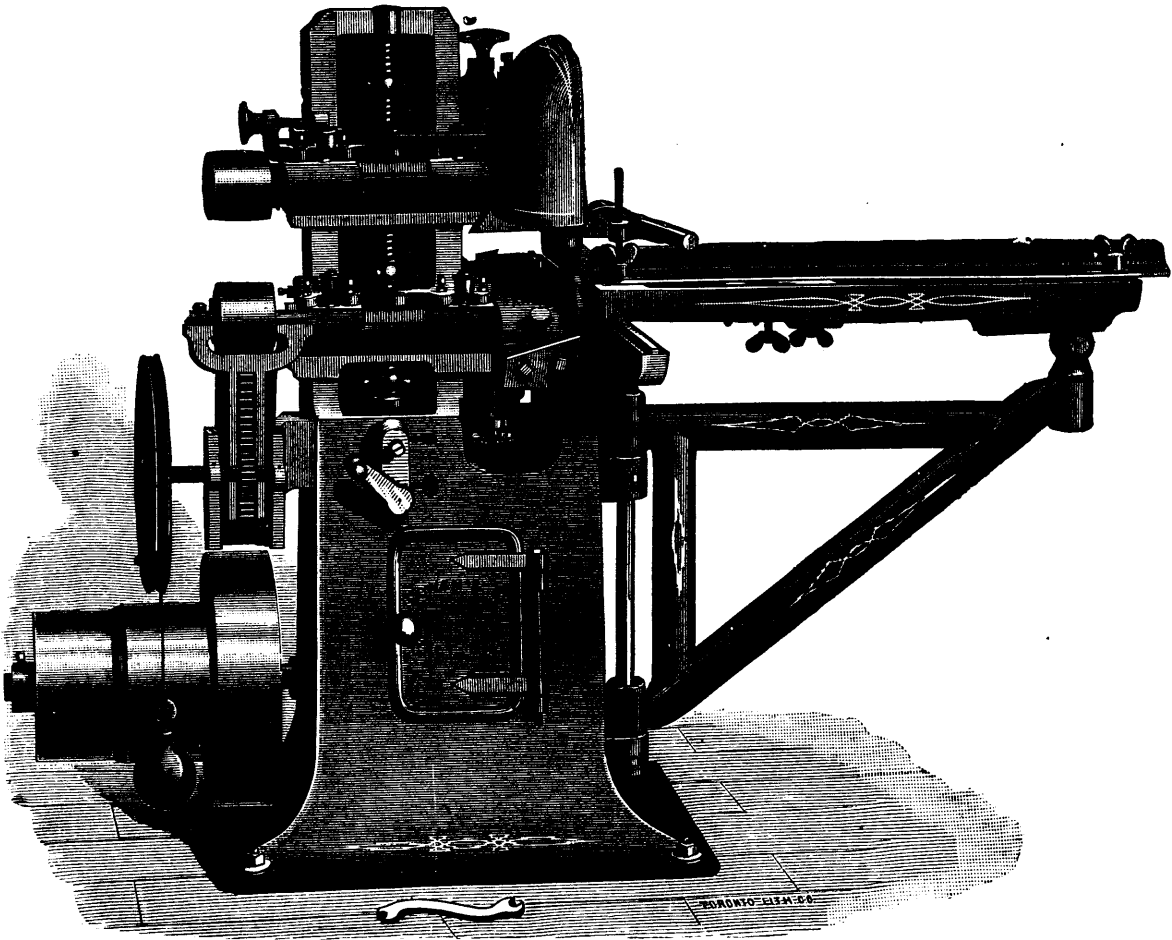

This is an entirely new style of Tenon Machine. The frame is cast in one piece, and the working parts stand solidly on a pedestal, avoiding all vibration.

The Cutter and Cope Heads are connected and are moved all together, or separately, as required. The Upper Head and Boxes also adjust horizontally to suit shoulder of tenon, the Cope Knives moving with the Heads to prevent re-adjustment.

A special feature in this machine is the Bed, or Carriage, which is at once light and strong. The outer end works on rollers and is moved very easily.

In cutting the tenon the Bed and Carriage move entirely past the Heads and Cutters, the operator having full control of the work. It has also the advantage of leaving the Heads and Cope Knives clear, and of ready access by the operator.

The Carriage is so arranged that it cannot tip over the Slides nor be thrown into the Cutters, and is also supplied with extension bar for long stuff, as in all Tenoning Machines.

This Machine is supplied with single or double Copes, as ordered, and for furniture work it is without Copes, and with an adjustable cut-off Saw.

COWAN & CO.

"Galt Foundry" Engine and Machine Works, GALT, ONTARIO, CANADA.

Canada Tool Works, **JOHN BERTRAM & SONS** DUNDAS, ONT.

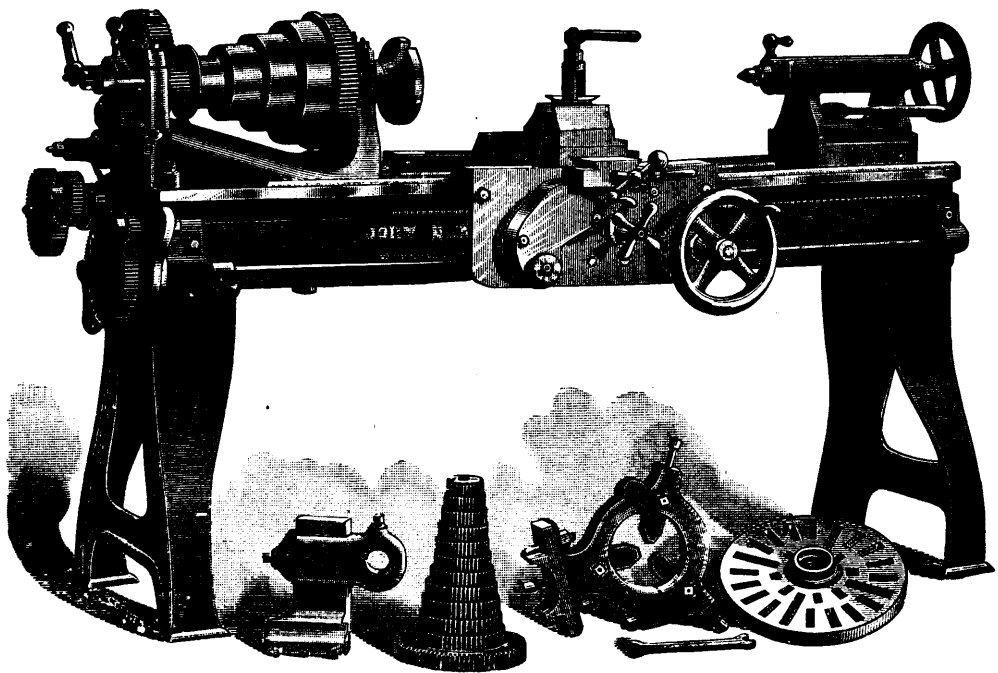

16-in. LATHE.

Manufacturers of
Machinists' Tools
and
Woodworking Machinery.

- LATHES,
- PLANERS,
- DRILLS,
- MILLING MACHINES,
- PUNCHES,
- SHEARS.
- BOLT CUTTERS
- SLOTTING MACHINES,
- MATCHERS
- MOULDERS,
- TENONERS
- BAND SAWS,
- MORTICERS,
- SAW BENCHES

Locomotive and Car Machinery, Special Machinery, Price List and Photographs on application.
Warerooms: Permanent Exhibition, Toronto; Polson Engine Co., 38 Yonge St.; Machinery Supply Ass'n, Montreal.

Geo. F. Blake Manufacturing Co.,

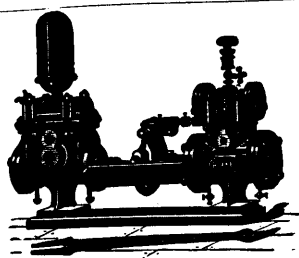

BOILER FEED PUMP.

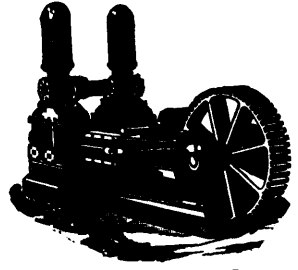

GEARED FEED PUMP.

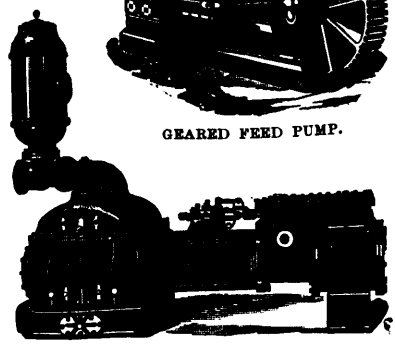

DUPLEX COMPOUND ENGINE

BUILDERS OF
SINGLE AND DUPLEX
Steam and Power
Pumping Machinery



BOSTON,
111 FEDERAL STREET *
* **NEW YORK,**
95 & 97 LIBERTY STREET.

SEND FOR ILLUSTRATED CATALOGUE.

These goods may be seen at the Permanent Exhibition 63 to 69 Front Street West, Toronto.

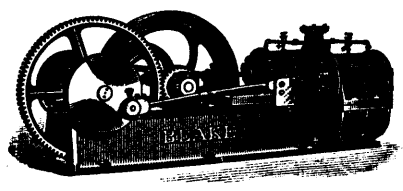

AIR COMPRESSOR.

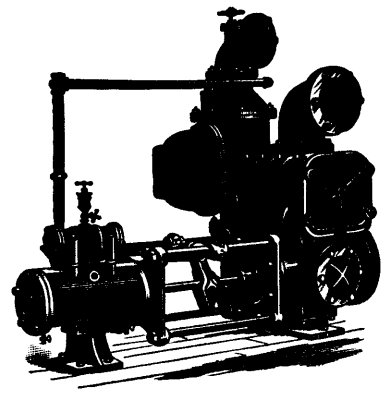

AIR PUMP AND CONDENSOR.

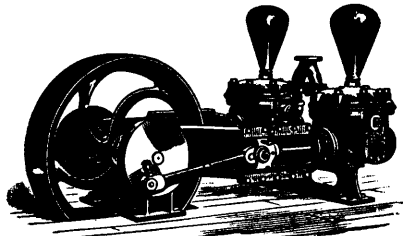

BELT PUMP

Nova Scotia Steel Co., Limited,

NEW GLASGOW, NOVA SCOTIA

(Only Steel Works in Canada),

MANUFACTURERS OF

Hammered *and* Rolled Steel

MADE BY THE

SIEMENS-MARTIN (OPEN HEARTH) PROCESS.

ROUND MACHINERY STEEL for Shafting, Spindles, etc. MILD STEEL for Rivets, Bolts.
Thresher Teeth and many purposes where Norway Iron is now used.

SPECIAL SECTION PLOW BEAMS, MILD STEEL CENTRE AND SOLID MOULD BOARDS,
COULTER STEEL HARROW DISCS,
AGRICULTURAL STEEL CUT TO PATTERN, SPRING, SLEIGH SHOE, TYRE, TOE CALK AND CROSS BAR STEEL
STEEL NAIL PLATE.

□□ Binder Bars, Z and other Special Sections.

STEEL MOWER BARS.

Particular attention given to the manufacture of Rake, Cultivator and Harrow Teeth, and other
Agricultural Spring Steel Forgings.



113 FEDERAL STREET, BOSTON.

93 Liberty St., New York.

Warren, Mass.

FOR SALE BY THE:

Polson Iron Works Company, 38 Yonge Street, Toronto, Ontario

WHERE MANY SIZES MAY BE SEEN IN STOCK.

SEND FOR ILLUSTRATED CATALOGUE.

Cobban Manufacturing Co'y Factory & Head Office: Toronto.
 Branch: 148 McGill Street, Montreal.

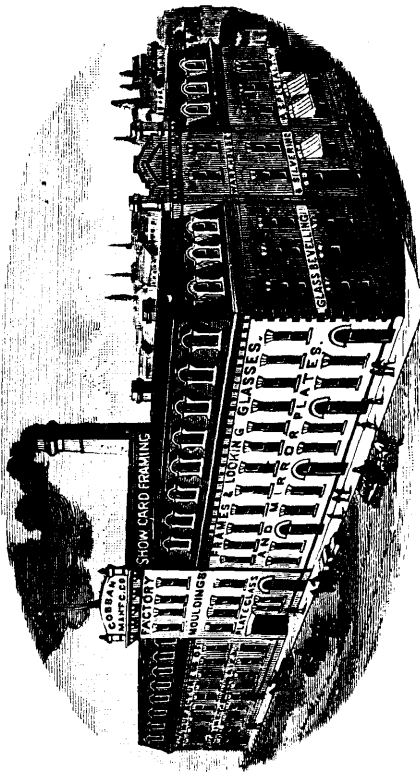

MANUFACTURERS OF
 Mantles, Over Mantles and Mirrors in Finest Hardwoods. Mouldings, Picture
 Frames and Looking Glasses. Mirror Plates: British, French, German,
 Shocks. Plate Glass Beveling and Silvering a Specialty
CLOSE PRICES. LIBERAL TERMS.

TORONTO.
MONTREAL.

HEINTZMAN & CO.

MANUFACTURERS OF

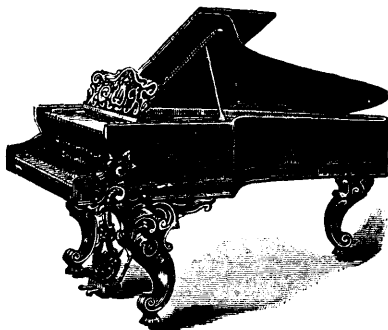

**GRAND,
 SQUARE,
 AND UPRIGHT
 PIANOFORTES.**

SEND FOR ILLUSTRATED CATALOGUE.

Warerooms, - 117 King St. West,
TORONTO.

GALT MACHINE KNIFE WORKS.

PLANING MACHINE
 KNIVES.

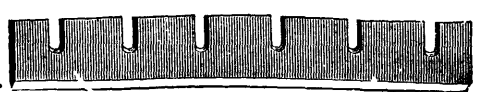

STAVE CUTTER KNIVES.

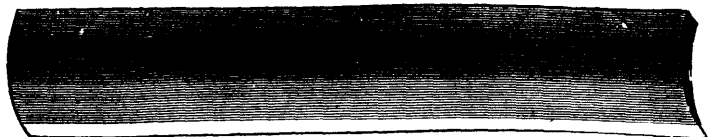

STAVE JOINTER KNIVES.

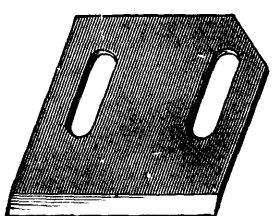
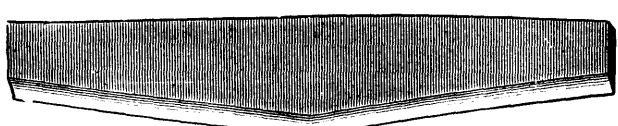

MOULDING, TENONING,
 MITREING,
 SHINGLE JOINTER,
 And other irregular shapes.

Cheese-box and Veneer, Paper Cutting, Leather Splitting and any special knife made
 to order. SEND FOR PRICE LIST. ALL WORK WARRANTED.

PETER HAY, - - - GALT, ONT.

IMPROVED METHODS

OF

Handling Anchors and Chains

With fewer men, in less time, and easier than by any other
 arrangement, by the use of the

Providence Windlasses.

Approved by Underwriters, Owners, Masters and Builders.

SOLE MAKERS FOR CANADA.

Windsor Foundry Company

WINDSOR, NOVA SCOTIA.

W. STAHLSCHMIDT & CO.

PRESTON, ONT.

MANUFACTURERS OF
School, Office, Church and Lodge
Furniture.

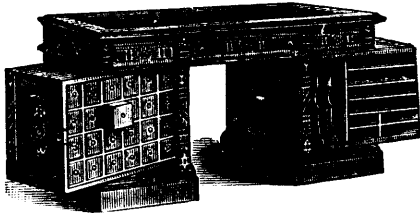

ROTARY DESK

No. 50.

Send for Circulars and Price List. Name this paper.

See our exhibit in the Annex at the Industrial Exhibition.

Young & Son,

MANUFACTURERS AND IMPORTERS
OF DYE STUFFS.

Black and Yellow Dyes,
Cutchine and Sakta a Specialty.

21 and 23 DE BRESOLES ST., - MONTREAL.

Mills, Port Neuf, Que.

J. Brooks Young Harrison B. Young.

New England Paper Co.

—MANUFACTURERS OF—

NEWS, WRAPPING AND MANILLA PAPERS.

ALL SIZES AND WEIGHTS

MADE TO ORDER.

21 and 23 De Bresoles St., Montreal.

J. Brooks Young, President.

Harrison B. Young, Treasurer.

This Space for Sale.



SMITH'S FALLS MALLEABLE IRON WORKS.

WM. H. FROST

MANUFACTURER TO ORDER OF

Malleable Iron Castings

FOR

Agricultural Implements
AND OTHER PURPOSES.

Also CARRIAGE HARDWARE.

SMITH'S FALLS,
Ontario, Canada.

THE OSHAWA Malleable Iron Co.

MANUFACTURERS OF

MALLEABLE IRON

CASTINGS TO ORDER

FOR ALL KINDS OF

Agricultural Implements

AND

MISCELLANEOUS PURPOSES.

Oshawa, Canada.

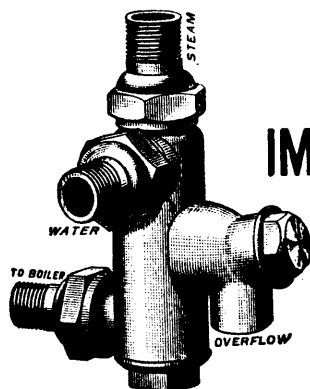

FEED YOUR BOILER WITH A PENBERTHY IMPROVED AUTOMATIC INJECTOR.

10,000 IN USE IN CANADA.

Cheaper than a Pump, takes up Less Room and
Feeds the Boiler with Water at
nearly Boiling Point.

SIMPLE, ECONOMICAL AND DURABLE.

And the Only Absolutely Automatic Injector in the Dominion.

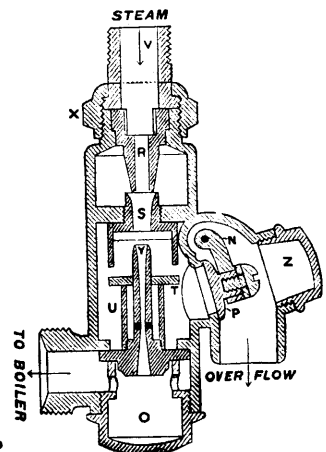

PROMINENT FEATURES ARE: They start at about 25 lbs. steam pressure and work to 150 lbs. Lift water up to 20 feet, and work from a head as well. They require little watching, as, being automatic, they restart if feed to boiler is broken by air or sudden jarring. The parts are interchangeable and can be removed without uncoupling machine. Send for pamphlet to **PENBERTHY INJECTOR CO., Detroit, Mich.** Factory at Windsor, Ont. Handled largely also by Watrous Engine Works Co., Limited, Brantford; J. H. Taylor, Montreal; S. J. Shaw, Quebec; Park Bros., Chatham; McDonald & Co., Limited, Halifax, N.S.; A. R. Williams, Toronto.