

## Technical and Bibliographic Notes / Notes techniques et bibliographiques

The Institute has attempted to obtain the best original copy available for scanning. Features of this copy which may be bibliographically unique, which may alter any of the images in the reproduction, or which may significantly change the usual method of scanning are checked below.

L'Institut a numérisé le meilleur exemplaire qu'il lui a été possible de se procurer. Les détails de cet exemplaire qui sont peut-être uniques du point de vue bibliographique, qui peuvent modifier une image reproduite, ou qui peuvent exiger une modification dans la méthode normale de numérisation sont indiqués ci-dessous.

- Coloured covers /  
Couverture de couleur
- Covers damaged /  
Couverture endommagée
- Covers restored and/or laminated /  
Couverture restaurée et/ou pelliculée
- Cover title missing /  
Le titre de couverture manque
- Coloured maps /  
Cartes géographiques en couleur
- Coloured ink (i.e. other than blue or black) /  
Encre de couleur (i.e. autre que bleue ou noire)
- Coloured plates and/or illustrations /  
Planches et/ou illustrations en couleur
- Bound with other material /  
Relié avec d'autres documents
- Only edition available /  
Seule édition disponible
- Tight binding may cause shadows or distortion  
along interior margin / La reliure serrée peut  
causer de l'ombre ou de la distorsion le long de la  
marge intérieure.
  
- Additional comments /  
Commentaires supplémentaires:

Continuous pagination.

- Coloured pages / Pages de couleur
- Pages damaged / Pages endommagées
- Pages restored and/or laminated /  
Pages restaurées et/ou pelliculées
- Pages discoloured, stained or foxed/  
Pages décolorées, tachetées ou piquées
- Pages detached / Pages détachées
- Showthrough / Transparence
- Quality of print varies /  
Qualité inégale de l'impression
- Includes supplementary materials /  
Comprend du matériel supplémentaire
- Blank leaves added during restorations may  
appear within the text. Whenever possible, these  
have been omitted from scanning / Il se peut que  
certaines pages blanches ajoutées lors d'une  
restauration apparaissent dans le texte, mais,  
lorsque cela était possible, ces pages n'ont pas  
été numérisées.

# The Canadian Patent Office

## RECORD

Vol. XV.—No. 3.

MAY, 1887.

Price in Canada \$2.50 per An.  
United States - \$2.80

### CONTENTS.

INVENTIONS PATENTED.....	223
ILLUSTRATIONS.....	251
INDEX OF INVENTIONS.....	1
INDEX OF PATENTEES.....	11

### INVENTIONS PATENTED.

NOTE—Patents are granted for 15 years. The term of years for which the fee has been paid, is given after the date of the patent.

#### No. 26,344. Shaft Support for Poles of Vehicles. (*Chambrière pour Timons de Voitures.*)

George F. Statter, Sioux, Iowa, U.S., 1st April, 1887; 5 years.  
*Claim.*—A support for the shafts, tongues, or poles of vehicles, consisting of a bar of suitable material rigid throughout its length, said bar bent inwardly at its ends, the lower end from its bent portion having a straight extremity, and the upper extremity having a hook thereon, substantially as and for the the purpose specified.

#### No. 26,345. Composition of Matter for Cleaning Wall Paper. (*Composition de Matières pour Nettoyer le Papier de Tenture.*)

William J. Dane and Charles F. Beck, Detroit, Mich., U.S., 1st April 1887; 5 years.  
*Claim.*—A composition of matter herein described for the purpose of cleaning wall paper, composed of granulated corn meal, common flour, sulphuric acid, alum and water, in the proportions specified.

#### No. 26,346. Thrashing Machine. (*Machine à Battre.*)

The Speight Manufacturing Company, (assignee of Nathaniel Burkholder,) Markham, Ont., 1st April, 1887; 5 years.  
*Claim.*—1st. The decks A and B, having their outer ends supported by swinging links and G, in combination with the crank-shaft C, provided with cranks a and b to support the inner ends of the decks, A, B, substantially as and for the purpose specified. 2nd. The decks A and B having their outer ends supported by swinging links D and G, a shoe F and return board J connected to the lower deck B, in combination with the crank shaft C, provided with cranks a and b supporting the inner ends of the decks A B, substantially as and for the purpose specified. 3rd. The decks A, B, suitably supported and caused to swing in opposite directions to each other, in combination with the swinging shoe F, connected to the deck B by the pivoted lever H and rod T, substantially as and for the purpose specified.

#### No. 26,347. Harrow. (*Herse.*)

Jane Hedley, Calgary, N. W. T., assignee of William J. Fetherston, Ottawa Ont., assignee of William W. Owens, Peterborough, Ont., 1st April, 1887; 5 years.  
*Claim.*—1st. The combination, with the bulls D, F and bull E, of the blocks G, having intersecting perforations G<sub>1</sub>, G<sub>2</sub>, G<sub>3</sub>, G<sub>4</sub>, and harrow teeth H, as set forth. 2nd. The combination, with the bulls E having notch E<sub>1</sub> and bull D, of the blocks J having intersecting perforations G<sub>1</sub>, G<sub>2</sub>, G<sub>4</sub> and harrow teeth H, as set forth. 3rd. The combination, with the bulls E, F, of the blocks K having intersecting perforations K<sub>1</sub>, K<sub>2</sub>, G<sub>4</sub>, and teeth H, as set forth.

#### No. 26,348. Horse Shoe. (*Fer à Cheval.*)

Thomas Penhorwood, Millwood, Ohio, U.S., 1st April, 1887; 5 years.  
*Claim.*—1st. The combination, with a horseshoe, of double-pointed

reversible calks and suitable fastening-bolts, substantially as shown. 2nd. A reversible double pointed calk for horseshoes, consisting of a perforated body, and the two points which extend at right angles to the body, and in opposite directions from each other, substantially as set forth.

#### No. 26,349. Railway Rail Chair.

(*Coussinet de Rail de Chemin de fer.*)

William Goldie, West Bay, Mich., U.S., 1st April, 1887; 5 years.  
*Claim.*—1st. A binder for railway spikes consisting of a metal plate placed between the rail and tie, and having its ends extending on each side of the rail, and provided with holes for the rail spikes, the said plate being of thin and narrow dimensions, whereby it is forced into the tie by the passing train, substantially as and for the purpose set forth. 2nd. A binder for railway spikes placed between the rail and tie, and consisting of a thin and narrow plate of metal having its ends extending beyond the rail, and provided with spike holes, and having the side edges of the extended portion turned upward and forming guide stops as b, as herein described and for the purpose set forth.

#### No. 26,350. Circulating Sectional Hot Water Boiler. (*Calorifère à eau.*)

William Johnstone, Ottawa, Ont., 1st April, 1887; 5 years.  
*Claim.*—1st. A circulating boiler consisting of laterally connected vertical headers B, each having a horizontal partition D, inlet and outlet connections E, F and A, group of circulating furnace tubes G, concentrically arranged baffling plates H, and fire box I below the furnace tubes, as set forth. 2nd. The combination of the vertical headers B, each having an independent group of circulating tubes G vertically arranged, and inlet and outlet E, F to connect with the house system of pipes for heating hot water, as set forth. 3rd. The fire box I, having tubes on three sides, connecting with two headers B on opposite sides of the door way, and a series of vertical headers B laterally connected, each having circulating furnace tubes G vertically arranged and provided with inlet and outlet connections E, F, as set forth.

#### No. 26,351. Car-Coupling. (*Attelage de Chars.*)

Charles R. Tunks, Adrian, and Thomas H. Simpson, Detroit, Mich., U.S., 1st April, 1887; 5 years.  
*Claim.*—1st. The draw-head having a partially-open bottom A, weighted coupling-bar working therein as described, and provided with a notch or recess in its rear end, in combination with the uncoupling-shaft, provided with a lifting-lever adapted to engage with the notch in the rear end of the coupling-bar as the uncoupling shaft is turned, all arranged and operating substantially as shown and described. 2nd. A draw-head provided with slots in its opposite sides, a coupling-bar substantially as described having side pins engaging with the slots in the draw-head, and provided with a notch or recess in its rear end, in combination with an uncoupling-shaft provided with a lifting-lever adapted to engage with the notch in the rear end of the coupling-bar as the uncoupling-shaft is turned, all arranged and operating substantially as shown and described. 3rd. The draw head A having a partially-open bottom A, weighted coupling-bars B working therein as described, and provided with a notch or recess d in its rear end, in combination with the uncoupling shaft D having the lifting-lever E, all arranged and operating substantially as shown and described.

#### No. 26,352. Rotary Engine for Steam Water or other Motive Power. (*Machine Rotative pour Moteur à Vapeur, à eau ou autre.*)

Robert H. Isbell and Walter S. Logan, New York, N.Y., U.S., 1st April, 1887; 5 years.  
*Claim.*—1st. A rotary engine or motor consisting of a series (two or more) of jointed arms within a closed cylinder or chamber pivoted together at one end at a point within the cylinder, and eccentrically as to the centre of the engine shaft and at the other end pivoted at

different points upon the sides of the cylinder, one end of each arm being pivoted to some stationary part, and the other end pivoted directly or indirectly to the shaft, in combination with appropriate devices to supply steam or other motive power successively to the different variable chambers thus formed by the jointed arms and the sides of the cylinder. 2nd. A rotary engine or motor consisting of a series (two or more) of jointed arms contained within a closed cylinder, and dividing such cylinder into variable chambers pivoted together at their inner ends upon a stationary pivot, which is affixed to the machine eccentrically as to the shaft, and at the outer ends pivoted at different points upon the sides of the cylinder being affixed to the shaft and turning with it, substantially as described, in combination with appropriate devices to supply steam or other motive power successively to the different variable chambers formed by the jointed arms and the sides of the cylinder. 3rd. A rotary engine or motor consisting of two jointed arms contained within a closed cylinder or chamber, and dividing such cylinder into variable chambers, pivoted together at their inner ends upon a pivot attached eccentrically to the shaft, and at their outer ends pivoted at stationary pivots placed at different points upon the sides of the cylinder, in combination with appropriate devices to supply steam or other motive power successively to the different variable chambers formed by the jointed arms. 4th. The three-armed machine shown in the drawings consisting of the combination of the inner cylinder E, the outer cylinder B and the cap C, the inner cylinder having 3 jointed arms pivoted at their outer ends at different points upon the sides of the cylinder, and at their inner ends pivoted together upon a stationary bar *r* affixed to the cap C, and having openings *e* into the chambers formed by the arms, the outer cylinder having cavities J and J1 and partitions *r* and *r*1 to supply and exhaust the steam or other motive power, substantially as described. 5th. In a rotary engine or motor consisting of one cylinder rotating within another by means of the pressure of steam or other power exerted within the inner cylinder the combination of the inner cylinder with its ports to admit the steam or other power, and the outer cylinder with a chamber or steam chest lying behind the disc of the inner cylinder, substantially as and for the purpose described. 6th. In a rotary steam engine having an inner revolving cylinder, and an outer cylinder with steam chest J1 as described, the partition *r*1 arranged between the partitions *r* and *r*1, substantially as and for the purpose described. 7th. A rotary engine or motor operated by jointed arms as described, so arranged that the pivotal point of the inner ends of the arms is one third of the way across the circle, which runs through the pivotal points of their outer ends upon its diameter, substantially as and for the purpose described. 8th. In a rotary engine or motor operated by jointed arms as described, a jointed arm which is just a little longer than the distance between its two ends when furthest extended, substantially as and for the purpose described. 9th. In a rotary engine or motor operated by jointed arms as described, a jointed arm consisting of two equal legs or parts, substantially as and for the purpose described. 10th. In a rotary engine or motor as described, the jointed arms provided at one or more of their pivotal points with corresponding ribs and grooves, substantially as and for the purpose described. 11th. In a rotary steam engine operated by jointed arms as described, the cylinder or chamber which contains the arms with the spaces in it which are not touched by the arms filled up, substantially as and for the purpose described.

### No. 26,353. Hanger for Sliding Doors or Windows. (*Coulisse de porte ou de croisée.*)

Reuben Clark and William F. Monro, Toronto, Ont., 1st April, 1887; 5 years.

*Claim.*—1st. A door-hanger composed of bars A, B pivoted together at a one end of one of the bars being pivoted to the door-frame, and the opposite end of the other bar being adjustably connected to the door-frame, in combination with the door D connected by a pivot to one of the bars, and to the other bar by a connection which will permit the vertical adjustment of the said bars, substantially as and for the purpose specified. 2nd. A door D supported by the bars A, B arranged as specified, in combination with the rod I, substantially as and for the purpose specified.

### No. 26,354. Combined Press and Double-Seaming Machine for Tinners in the Manufacture of Tinware. (*Presse et machine à ourlet double pour la ferblanterie.*)

Henry Pattison, John A. McRoberts and Henry Crawford, St. John, N.B., 1st April, 1887; 5 years.

*Claim.*—1st. In a machine of the character described, the combination of a vertically arranged shaft, a horizontally arranged disk mounted on said shaft, a horizontally arranged shaft, a vertically arranged die mounted on said horizontal and adapted to engage said disk, a crank or means for rotating the die, a treadle mechanism or means for causing the die to press on the disk, and a spring or means for keeping the pan or other vessel elevated from the disk while being double-seamed, substantially as described. 2nd. In a machine of the character described, the combination of the die *t* provided with the double-seaming edge or shoulder 14, the shafts D, E and disk K, said disk being recessed on its upper side for receiving a die or dies on the shafts D, and provided with the double-seaming edge 17, substantially as set forth. 3rd. In a machine of the character described, the die *t*, provided with the shoulder 14 and annular flange 15, in combination with the disk K, provided with the annular groove or rebate 16 and double-seaming edge 17, substantially as described. 4th. In a machine of the character described, the spring Q, in combination with the shaft H, disk K, shaft D and a die adapted to operate in conjunction with said disk, substantially as set forth. 5th. In a machine of the character described, the combination of the shaft D carrying a vertical die or dies, and the shaft H mounted in the standard E and carrying the disk K, said disk being provided with a double-seaming edge 17, and recessed on its upper side to re-

ceive a die or dies on the shaft D, and said standard adjustable to enable the disk to be moved laterally into position for use with the die or dies on the shaft D, and thereby convert the machine from a press into a double-seamer and *vice versa*, substantially as described.

### No. 26,355. Car-Coupling. (*Attelage de chars.*)

Robert H. Dowling, Charles H. Follett and Charles Follett, Newark, Ohio, U.S., 1st April, 1887; 5 years.

*Claim.*—1st. In a car-coupling, a draw-head having a hook or claw, a movable S-shaped jaw, and a pin or key for locking and releasing said claw, substantially as specified. 2nd. In a car-coupling, the combination, with the stem of the draw-head having the arc-shaped recess, the arc-shaped shoulder and the integral hook or claw having a portion of a key seat in its inner circle, of the S-shaped movable jaw having a key seat in the longer arc of its inner end, and the key for locking said movable jaw, substantially as specified. 3rd. The combination with the draw-head stem having the arc-shaped shoulder, the arc-shaped recess and the integral recessed guide hook of the S-shaped movable jaw having a key-seat in the longer arc of its inner end, substantially as specified. 4th. The combination, with the draw-head stem having the arc-shaped recess, the arc-shaped shoulders and the integral recessed guide hook, of the S-shaped movable jaw having the key-seat in the longer arc of the inner end, and the pin-hole in its outer end, and the key for locking said movable jaw, substantially as specified. 5th. The combination, with the draw-head provided with the split depending fulcrum of the curved lever, provided with a seat in its lower end and the coupling pin pivoted in said seat and extending up into the draw-head, substantially as specified. 6th. The combination, with the draw-head provided with the split depending fulcrum of the curved lever provided with a seat in its lower end, and the coupling pin having the upper larger and lower smaller portions or diameters pivoted in said seat and extending up into the draw-head, substantially as specified.

### No. 26,356. Sleigh. (*Traineau.*)

William M. Hoag, (assignee of Elijah A. Ovenshire), Lansing, Mich., U.S., 1st April, 1887; 5 years.

*Claim.*—1st. The combination, with a sleigh runner, of a knee and an axle having a rotatable engagement with said knee, substantially as described. 2nd. The combination, with a sleigh runner, of a knee having a rotatable axle engaged therewith, said axle connected with a bolster, substantially as described. 3rd. The combination, with a sleigh runner, of a knee, an axle having a rotatable engagement with said knee, and a bolster engaged with said axle by an intervening bolt, substantially as described. 4th. The combination, with a sleigh runner, of a knee, an axle having a rotatable engagement therewith, and a bolster engaged with said axle by a bolt movably engaged with said axle, substantially as described. 5th. A metallic sleigh knee constructed to engage a runner at its base, said knee recessed at the top between its inner and outer extremities, said extremities perforated to receive an axle, substantially as described. 6th. The combination, with a sleigh runner, of a knee, an axle having a rotatable engagement therewith, a bolster engaged with said axle with an intervening bolster plate, substantially as described. 7th. The combination, with a sleigh runner, of a knee recessed at the top, an axle rotatably engaged with said knee, a bolster plate engaged in said recess, a bolster located above said plate, and a connecting bolt engaging said axle plate and bolster, substantially as described. 8th. The combination, with a sleigh knee, of an axle rotatably engaged therewith, a sand plate and sand board engaged with said axle, substantially as and in the manner described. 9th. The combination, with a pair of sleigh knees, of an axle rotatably engaged therewith, sand board plates and sand board engaged with each end of said axle, and a bolster mounted on said sand board and connected with the axle by a ring bolt, substantially as and in the manner described. 10th. The combination with a sleigh runner, of a metallic knee and a brace J engaged with the ends of the runner, and with said knee in the manner described, and forming a rave or finger, substantially as described. 11th. The combination, with a pair of knees engaged with sleigh runners, of an axle rotatably engaged with said knee, the construction being such that the bolster may keep a horizontal position when said runners are tilted, substantially as described. 12th. The combination, with a sleigh knee recessed at the top of an axle rotatably engaged therewith, a plate located in said recess and engaged upon said axle, substantially as described. 13th. The combination, with a sleigh knee recessed at its top of an axle rotatably engaged therewith, and a bolster rotatably engaged upon said axle, substantially as described. 14th. The combination, with a sleigh knee, of an axle rotatably engaged therewith, a sand board and bolster rotatable engaged upon said axle, substantially as described.

### No. 26,357. Churn. (*Baratte.*)

Samuel McDonald and Dunoon D. McDougald, Alexandria, Ont., 1st April, 1887; 5 years.

*Claim.*—1st. In a churn having an upright cylindrical barrel, a revolving dasher journaled in the frame C having the arms *a* fixed in the spindle B, and connected with the three-sided sleeve *d*, oil cup *e* and pinion *f*, substantially as shown and described. 2nd. In an upright cylindrical churn, the above described fence having the bars *b* and stiles *e* placed in the barrel beside the frame C, so that the arms of the revolving dasher will swing between the bars of the fence, substantially as described and for the purpose set forth.

### No. 26,358. Paper File. (*Etui à papier.*)

Lovasso Field, Rochester, N. Y., (assignee of John C. Lang, Washington, D.C.), U.S., 1st April, 1887; 5 years.

*Claim.*—1st. In a paper-file, the box or receptacle having a guide or base *d*, in combination with a sliding and backwardly-tipping standard, having the follower-bard attached, and having rearward arms or projections and a lever acting between said projections and the base to maintain the standard in the required position. 2nd. In

a paper-file, a guide or base, in combination with a standard or follower-board having a sliding connection therewith, and free to tip backward at any point thereon, and a lever connected to the rear side of said standard, and acting upon the base, substantially as described to maintain the standard in an erect position. 3rd. In a file-holder, a receptacle having a base-board with a longitudinal guide therein, and a rigid upright at one end to sustain the papers, in combination with a follower-board, a standard rigidly secured to the board and adapted to both slide and tilt backward upon the guide, and a movable sustaining-lever pivoted to the rear side of the standard, and acting at its lower end upon the guide or base at a point in rear of the standard, whereby said lever is caused to sustain and lock the standard, and also to draw the standard backward and permit its inclination in the act of unlocking the same. 4th. The combination of a box or receptacle, provided with a guide *d*, the standard having a sliding connection with said guide, and adapted to incline backward as described, the arms *o* on the rear of the standard, the follower-board rigidly attached to said standard, and the lever pivoted between said arms, as described and shown. 5th. In a file-holder, a front-board, in combination with a base or guide, of a follower-board having a sliding and tilting connection therewith, and a brace connected by a hinged joint with the rear side of the follower-board, and arranged to bear at its lower end upon the brace or guide to sustain the follower in an upright position. 6th. In a paper-file, a box or receptacle, a follower-board having a sliding and hinged connection therewith, the plate *C* extending in rear of the follower-board, and a supporting lever hinged to said plate, the parts being constructed as described and shown, to limit the backward tipping motion of the follower-board.

### No. 26,359. File Case and Cabinet.

(*Carton de dossier et casier.*)

Lowasso Field, Rochester, N.Y., (assignee of John C. Lang, Washington, D.C.), U.S., 1st April, 1887; 5 years.

*Claim.*—1st. The sliding drawer or tray provided with stops or shoulders at its top and bottom, in combination with an enclosing case or cabinet, provided with corresponding stops or shoulders above and below the drawer to arrest and support the latter when withdrawn, substantially as described. 2nd. In combination with the sliding trays or drawers, provided with stops at the top and bottom, the receiving cabinet provided with the front rod lying between the trays, and serving as an under stop for one and an upper stop for the next, as described. 3rd. In combination with the cabinet having stops at its front at different heights, and the intermediate sliding trays having the under stop at a distance from the rear end, and the upper stops on the rear rounded corners, as shown. 4th. In combination with the tray or drawer, the internal leaf or follower jointed thereto, and the fastening wire of substantially U-form applied thereto, substantially as described.

### No. 26,360. Manufacture of Plated Ware.

(*Fabrication d'articles plaqués.*)

William A. Warner and Marcus B. Warner, Syracuse, N. Y., U. S., 1st April, 1887; 5 years.

*Claim.*—1st. In the manufacture of plated metal spoons, forks, and other like articles, fitted with protective precious metal or alloy fillings at their points of rest or contact, as specified, the method herein described, of providing said articles with said fillings, by first making holes or recesses for reception of said fillings in the flat blanks from which said articles are made, then, inserting and securing the fillings in said holes or recesses, afterwards, bending or striking up the articles into shape, and, subsequently, plating and finishing them, substantially as specified. 2nd. In the manufacture of plated metal spoons, forks, and other like articles, having incorporated precious metal or alloy fillings at their points of rest or contact, first, cutting the blanks formed which the articles are made, then, rolling and grading them, then, cutting them into shape, next, making the holes or recesses for the incorporated fillings, afterward, securing said fillings in the holes or recesses, and, subsequently, bending or striking up the filled blanks into the required shape of the article to be made, and plating and finishing them, essentially as described. 3rd. A flat cut and graded metal blank for spoons and other like articles, having one or more precious metal or alloy fillings at their points or points of wear and contact of the spoon or article made from said blank, substantially as and for the purposes herein set forth.

### No. 26,361. Process for the Manufacture of Thistle-down into Merchantable Material. (*Procédé de Fabrication du Coton (tête) de Chardon.*)

Emillie H. M. Caston, Toronto, Ont., 1st April, 1887; 5 years.

*Claim.*—1st. The within described process for preparing thistle flower or down into merchantable material, which process consists in tying or otherwise securing together the top of the flower or down, removing the stock and bristles, and subjecting the flower or down to heat for a short period, substantially as specified. 2nd. As a new article of manufacture, the product of the within described process, prepared substantially in the manner specified.

### No. 26,362. Carriage Seat. (*Siège de Voiture.*)

Charles Morgan, Bridgeport, N.S., 1st April, 1887; 5 years.

*Claim.*—1st. The combination, with the carriage-seat *A* and the back-board *A*, of back arms *C* attached to the back-board and hinged to the seat-back, side-arms *D* connected by a joint with the back-board, and provided with a sleeve *f*, the rod *d* supporting and guiding the sleeve *f*, and the spiral spring *h* placed on the rod *d* and maintained under compression, said joint being formed by inwardly extended screw-threaded ends of said arms, and plates *i* having screw-threaded eyes which receive said ends of arms, and said rod passing through lower end sleeves of the arms, and having screw-threaded connection with sockets connected to the seat, substan-

tially as herein shown and described. 2nd. The combination, with the vehicle seat and the back-board, of the side arms having screw-threaded end and eye-plate connections with the back-board, and provided at their lower ends with sleeves, screw-threaded sockets connected to the seat, and the screw-threaded rods passed through the sleeves at the lower ends of the side arms, and screwed into the said sockets together, with means to hold the said sleeves in position against the said sockets, substantially as and for the purpose set forth. 3rd. The combination, with the sleeve *f*, of the side arm *D*, the rod *d* and spiral spring *h*, of a yielding lining *g*, received in the sleeve *f* and covering the end thereof, substantially as herein shown and described.

### No. 26,363. Axle. (*Essieu.*)

Alexander F. Gibson, Galt, Ont., 1st April, 1887; 5 years.

*Claim.*—1st. An axle *A* turned to receive the axle-box *B*, said axle being split at *a* and having a hole in its end to receive the set-screw *C*, in combination with the nut *D* and set-screw *C*, arranged substantially as and for the purpose specified. 2nd. A tube *E* screwed into the axle box *B*, and provided with a cap *F*, in combination with a spherical valve *e*, arranged substantially as and for the purpose specified.

### No. 26,364. Cutter-Head used in Surface Planing and Moulding Machines. (*Porte-Couteau pour Machines à Raboter et à Moulures.*)

Samuel J. Shimer, Milton, Penn., U.S., 2nd April, 1887; 5 years.

*Claim.*—1st. The combination, with a cutter-head stock, a holding plate removably secured to the said stock and having a knife-seat formed thereon, and a knife provided with studs to move in diagonally-arranged grooves in its seat, of adjusting screws let in the ends of the holding-plate, whereby the knife may be moved forward or backward in its seat, substantially as described. 2nd. The combination with a cutter-head stock, and a holding-plate detachably secured thereto and formed with a knife-seat, and diagonally-arranged grooves across the knife-seat, of a knife formed with studs to set within the said grooves in the knife-seat, and adjusting screws let into the ends of the holding-plate, whereby the knife may be adjusted to any desired cut, substantially as described. 3rd. The combination, with a cutter-head stock formed with countersinks on its faces, a holding-plate secured to the stock and provided with set-screws to set within the countersinks of the head-stock, and having a knife-seat formed with diagonal grooves across its face, and a knife formed with studs to set within the grooves of the knife-seat, of adjusting screws let in the ends of the holding-plate to move the knife backward and forward, substantially as described. 4th. The cutter-head knife herein described, consisting of a plate of steel, formed or provided with studs *10*, projected from its face near opposite ends of the knife, and arranged to set in and traverse parallel guiding-grooves in the cutter-holder of a cutter-head, substantially as described. 5th. In combination, with a cutter-head and a knife thereof, formed with studs on its face, disposed in diagonal grooves in the holding plate, of adjusting screws let into the head from both ends parallel to the knife bed, and engaging with the ends of said knife, whereby the knife may be moved forward and backward and set at any desired cut, substantially as described.

### No. 26,365. Kiln for Making Charcoal.

(*Four à Charbon de Bois.*)

Edward W. Rathbun, Deseronto, Ont., 2nd April, 1887; 5 years.

*Claim.*—1st. In a kiln for the production of charcoal, the combination of the chamber *B*, with the chamber *C* and the flues *F*, *F*, *F*, substantially as and for the purpose hereinbefore set forth. 2nd. In a kiln for the production of charcoal, the combination of the flues *F*, *F*, *F*, with the chamber *C* and the pipe *D*, substantially as and for the purpose hereinbefore set forth. 3rd. In a kiln for the production of charcoal, the combination of the chamber *C* and the flues *F*, *F*, *F*, and the regulating valves *E*, *E*, *E*, substantially as and for the purpose hereinbefore set forth. 4th. I claim, in a kiln for the production of charcoal, the combination of the chamber *B*, having perforated walls, with the passage *G* and the pipes *J* and *H* for the admission of gas air or steam, or their combinations, to produce heat within the chamber *B* or the passage *G*, substantially as and for the purpose hereinbefore set forth. 5th. I claim, in a kiln for the production of charcoal, the combination of the chamber *B* and the flues *F*, *F*, *F*, and the valves *E*, *E*, *E*, substantially as and for the purpose hereinbefore set forth.

### No. 26,366. Baby Walker. (*Chariot d'Enfant.*)

Sarah E. Gleason, Tacoma, W. T., U.S., 2nd April, 1887; 5 years.

*Claim.*—The extensible frame *A*, *A*, *A*, *B*, having fixed panels *D* and movable panels *C* and *C* hinged to said fixed panels, combined with the hinged arms *E* and engaging means *I*, *i*, as set forth.

### No. 26,367. Hydraulic Valve and Valve Mechanism. (*Valve Hydraulique et Mécanisme de Valve.*)

John Fenson, Toronto, Ont., 2nd April, 1887; 5 years.

*Claim.*—1st. A valve chamber, having an adjustable partition connected to the valve, and arranged to cut off a portion of the valve-chamber from the inlet port, which is supplied with water under pressure, in combination with a valve-chamber connected by independent passage-ways to the main valve-chamber on either side of the adjustable partition, and provided with a valve by which communication between the two passage-ways may be opened and closed, thereby varying the pressure on the adjustable partition, so as to operate the valve it is connected to, substantially as and for the purpose specified. 2nd. The supply-chamber *D*, having a passage-

way leading into the cylinder H, protected by the valve B, which is connected to an adjustable partition a, designed to form a division in the chamber D, the passage-ways b, f and F, arranged as described, to connect the two divisions of the chamber D to the chamber of the valve A, as described, in combination with the valve C seated on the escape pipe I in the chamber E, and connected to the adjustable partition a, which divides the chamber E, as specified, and the passage-way F<sub>1</sub> connecting one division of the chamber E with the chamber of the valve A, the passage-ways F and F<sub>1</sub> being located in the chamber of the valve A, substantially as and for the purpose hereinbefore explained. 3rd. A passage-way located between the supply and discharge valve-chamber, and having two check-valves, the one near the discharge valve-chamber being set so that it remains closed when the water pressure from the supply is within the supply valve-chamber, but opens by the back pressure from the cylinder caused by the weight of the car, the moment that the water-pressure in the supply chamber is removed, thereby opening a passage-way between the lower portion of the discharge valve-chamber and the top portion of both the supply and discharge valve-chamber, so that the pressure of the water from the hydraulic cylinder shall instantly close the valves, substantially as and for the purpose specified. 4th. The valve-chambers D and E, provided with valves B and C, each connected to an adjustable partition a, dividing its respective chamber passage-ways F and F<sub>1</sub>, designed to connect the two chambers D and E on one side of their partitions, and the passage-way b arranged to connect the other side, in combination with the check-valves c and d located in the passage-way b, and so arranged in connection with their respective seats that an excess of pressure in the chamber E will open the valve c and close the valve d, and excess of pressure in the chamber D reverses this action, so that when communication is opened between the chamber E and passage-way f, communication between the passage-way f and chamber D is closed, substantially as and for the purpose specified. 5th. The double-seated valve-chamber M, provided with passage-ways leading to the valve-chambers D and E and cylinder H, in combination with the double-faced valve N fixed to the valve-spindle O, and designed to be acted upon by some moving part, so that the valve shall cut off communication between the cylinder H and supply-chamber D when the car reaches the top of the building, leaving the passage between the cylinder and the discharge-chambers open, so that the valve B remains under the control of the operator for the purpose of lowering the elevator, or to cut off communication between the discharge-chamber E and cylinder H when the car reaches the bottom of the building, in which position the passage-way between the cylinder and supply-chamber is left open, and the valve A remains under the control of the operator for the purpose of raising the elevator, substantially as and for the purpose specified. 6th. The double-seated valve-chamber M, provided with passage-ways leading to the valve-chambers D and E, and cylinder H, in combination with the double-faced valve N fixed to the valve-spindle O, and designed to be acted upon by some moving part, as specified, and mechanism to hold the valve N in the centre of the centre of the chamber M, when not otherwise acted upon, substantially as and for the purpose specified. 7th. The rock-shaft P connected to the spindle O, and provided with an arm Q, arranged to engage with the sleeve U placed on the guide-rod R, as specified, in combination with the sleeve V adjustably connected to the sleeve U, and arranged to be acted upon by the cross-head S, substantially as and for the purpose specified.

**No. 26,368. Art or Process of Preparing Smokeless Fuel.** (*Procédé de Préparation du Combustible sans Fumée.*)

Ferdinand Koopman, Hamburg, Germany, 2nd April, 1887; 5 years.

*Claim.*—1st. The art or process of mixing coal with limestone, pulverized or otherwise rendered into small pieces, and making briquets from such mixture, substantially as and for the purpose specified. 2nd. A compound, composed of pulverized coal, limestone and pyrolusite formed into briquets, substantially in the proportions and for the purposes set forth.

**No. 26,369. Steam Boiler.** (*Chaudière à vapeur.*)

Noel F. Sawyer, Haverhill, Mass., U.S., 2nd April, 1887; 5 years.

*Claim.*—1st. In a steam generator, the hollow water front a having the rearward projecting hollow water chambers a<sub>1</sub>, a<sub>2</sub>, adapted to form the sides of the fire-box, and having the inclined tops a<sub>11</sub>, a<sub>12</sub> for the purpose of causing a proper circulation of the water within said chambers a<sub>1</sub>, a<sub>2</sub>, as set forth. 2nd. In a steam generator, the hollow water front a having the vertical division walls a<sub>3</sub>, a<sub>4</sub>, as described, combined with the hollow water chambers a<sub>1</sub>, a<sub>2</sub>, and U-shaped circulating pipes g, g, connected to the rear of the water front a, as and for the purpose set forth. 3rd. In a steam generator, the hollow water front a and the U-shaped circulating pipes g, g, connected to the rear of said hollow water front, in combination with the fire-box arranged between the upper and lower legs of said U-shaped circulating pipes g, g, as set forth. 4th. In a steam generator, the hollow water front a and the U-shaped circulating pipes g, g, connected to it, as described, in combination with the plates f, n, and flue o in which the lower legs of the circulating pipes g, g, are contained, as and for the purpose set forth. 5th. In a steam generator, the hollow water front a and the U-shaped circulating pipes g, g, as described, in combination with the inclined cover m for conducting the products of the fire to the highest portion of said circulating pipes, and the return flue o for heating the lower portions of said pipes g, g, as set forth.

**No. 26,370. Cutter-bar Adjustment for Mowing Machines.** (*Souche de lames de faucheuses.*)

Newton Cossitt, Brockville, Ont., 2nd April, 1887; 5 years.

*Claim.*—1st. The combination of the arm A, brace B, pivoted connections b, b<sub>1</sub>, pintle a<sub>1</sub>, bracket D, D<sub>1</sub>, lever L, catch l, notched segment G, hinge joint H, lugs h<sub>1</sub>, and arm A, substantially as shown and described. 2nd. The combination of the arm A, pintle a, hinge

joint H, segment G, bucket D, lug D<sub>1</sub>, lever L, catch l, spring handle l<sub>1</sub>, and rod h<sub>1</sub>, substantially as shown and described.

**No. 26,371. Grain Separator and Cleaner.**

(*Tarare-cribleur.*)

John P. Bond, J. H. Brubaker and Thomas J. Calbert, Warsaw, Ind., U.S., 2nd April, 1887; 5 years.

*Claim.*—1st. The combination of the frame A, shoe and screens, the fan-chamber placed inside of the frame and provided with air openings, the fan, the exhaust passage R, door S, passage K provided with opening L, slide M, passage I and chamber N, whereby the grain is separated and cleaned either by suction or by suction and blast, substantially as described. 2nd. The combination of the frame A, the shoe and screens, the fan-chamber placed inside of the frame and provided with air openings, the fan passage R, door S, passage K provided with opening L, slide M and passage I with the chamber N, deflector or screen placed in the top of the chamber, the moderating board Q, and a means for moving it, substantially as described.

**No. 26,372. Mowing Machine.** (*Faucheuse.*)

William J. Clokey, Toronto, Ont., 4th April, 1887; 5 years.

*Claim.*—1st. A mowing machine in which spokeless main wheels are supported by suitable friction rollers, journaled around circular side-pieces of the frame of the machine, through which side-pieces the extension-bar supporting the cutter-bar, and the pitman to drive the knife passes, substantially as and for the purpose specified. 2nd. A spokeless main wheel C having a spur-wheel D attached to it to mesh with the spur-pinion G, in combination with the circular side-piece A of the frame fitted over the spur-pinion G, and provided with rollers E to revolve within the groove a, the whole being arranged substantially as and for the purpose specified. 3rd. An extension-bar M supported at one end at f to the frame, and at its other end to the cutter-bar O, in combination with the lever Q, arranged substantially as and for the purpose specified. 4th. An extension-bar M supported at one end at f to the frame of the machine, and having its end m bent at right angles to it and fitted into the sleeve N suitably connected to the cutter-bar O, in combination with the lever P sleeved on the bar M, and connected by gearing to the sleeve N, substantially as and for the purpose specified. 5th. An extension-bar M supported by the frame of the machine, and suitably connected to the cutter-bar O, in combination with a draught-rod U connected at one end to the extension-bar M, and at its other end to the whiffletree V, substantially as and for the purposes specified. 6th. A pitman K having an eye b formed on it with a conical hole formed in it to fit over the conical hub d fixed to the projection e, in combination with the bolt f and nut g, substantially as and for the purpose specified.

**No. 26,373. Watch Case Pendant.**

(*Queue de boîte de montre.*)

Casper Kistler, Sterling, Ill., U.S., 4th April, 1887; 5 years.

*Claim.*—1st. The combination of the pendant A, provided with the interior thread M and external annular shoulder H, the winding-stem B provided with the annular recess D, the screws C and the crown E provided with the annular recess G, and internal boss F having the exterior thread F<sub>1</sub>, the boss F being thus adapted to be screwed into the open end of the pendant A, and the outer end of the latter to enter coincidentally the recess G until the inner edges of the crown E shall abut against the shoulder H, substantially as shown and for the purpose described. 2nd. The combination of the pendant A, provided with the interior thread M and external annular shoulder H, the winding-stem B having a limiting longitudinal play in the pendant A, the crown E provided with the annular recess G and internal boss F having the exterior thread F<sub>1</sub>, the boss F being thus adapted to be screwed into the open outer end of the pendant A, and the outer end of the latter to coincidentally enter the recess G until the inner edges of the crown E shall abut against the shoulder H, substantially as shown and for the purpose herein specified.

**No. 26,374. Variety Moulding Machine.**

(*Machine à moulures variées.*)

Samuel J. Shimer, Milton, Penn., U.S., 4th April, 1887; 5 years.

*Claim.*—1st. The combination, with the lower tool, the main table and the upper tool arranged in the hinged arm E, of the intermediate detachable and adjustable table D formed with a tool aperture, and projected from and supported by an adjustable support on the main table between the tools above the main table, whereby the work may be accommodated to the action of the lower tool or to the tool in the hinged arm, as specified. 2nd. The combination, with the sliding housing of the lower tool spindle, of the vertical lifting rod provided with a lifting-arm, a vertical rod or turning-bar beneath the lifting rod, a cam-shaped block secured to the top of said turning-bar and serving as a rest or support for the lower end of the lifting-bar, and an operative device for rotating said cam-block and vertically reciprocating the lifting-bar, substantially as described. 3rd. The combination, with the hand-lever, of the shifting mechanism formed with a cam-shaped surface upon the lower end of the lifting-rod rests, and is supported and the sliding housing of the lower tool, of the lifting-rod disposed through guide-arms in the past of the machine, and having a projecting arm extending within the housing, substantially as described. 4th. The combination, with the table of a moulding machine, of the overhanging arm E comprised of a stationary base-piece, and a fore-arm hinged to said stationary base-piece by a lap-joint secured by a pivotal bolt, and having in one face a quarter-groove and in the other a pin projected within said groove, substantially as described.

**No. 26,375. Hat-Holder.** (*Porte-manteau.*)

William H. Atwood, Hudson, N.Y., U.S., 4th April, 1887; 5 years.

*Claim.*—1st. A hat-holder consisting of inwardly bent pointed at-

taching arms, having a spring-action to better retain their hold on the object to which they are secured, a hat-holding loop and a cross-bar at the junction of the attaching arms and hat-holding loop, and acting to steady the device in the vertical position, substantially as shown and described. 2nd. In a hat-holder, the combination, with the fastening arms having a projection on the cross-bar thereof, of a hat-holding arm, the lower portion of which engages the projection on the cross-bar of the fastening arms, substantially as shown and described. 3rd. In a hat-holder, the combination, with spring fastening arms having the outer bent ends thereof pointed and provided with a projection on the cross-bar thereof, of a hat-holding arm or loop attached to said cross-bar at its lower end, the said lower end of the hat-holding arm being adapted to engage the projection of the cross-bar of the fastening arms, substantially as shown and described. 4th. A hat-holder consisting of two spring arms adapted to be fastened to a moulding or like projection, and a hat-holding arm pivotally secured to the spring arms, the lower portion of the hat-holding arm being adapted to engage the lower portion of the member forming the spring arms, substantially as shown and described. 5th. In a hat-holder, the combination, with the attaching arms having pointed ends, of the hat-holding member formed with recesses or apertures near the outer end for receiving the pointed ends of the attaching arms when the device is not in use, substantially as shown and described.

### No. 26,376. Machine for Cutting Pipes.

(Machine à couper les tuyaux.)

Earnest C. Mount, Montreal, Que., 4th April, 1887; 5 years.

*Claim.*—1st. The combination of the clamp-jaws A, A', and the adjusting screw-lever handles B, B', with the spiral spring H, H', substantially as and for the purpose described. 2nd. The operating lever handles B, B', having collars or flanges, as and for the purpose described. 3rd. In a pipe-cutter, the combination of clamp-jaw A, cutter D with feeding screw E, for the purpose described. 4th. The pipe-cutting device having double clamp-jaws A, A', friction rollers C<sub>1</sub>, C<sub>2</sub>, C<sub>3</sub>, C<sub>4</sub>, lever adjusting handles B, B' and cutter D with regulating feed screw, substantially as described.

### No. 26,377. Toboggan and Boat Slide.

(Montagne russe et quai.)

Francis Forge, Shediac, N.B., and Henry A. Hillcoat, Amherst, N.S., 4th April, 1887; 5 years.

*Claim.*—A tilting table operating on an axle or hinges, substantially as and for the purpose hereinbefore set forth.

### No. 26,378. Ticket Case. (Casier à billets.)

Richard J. Matchett, Lindsay, Ont., 4th April, 1887; 5 years.

*Claim.*—1st. A case having sides A, provided with oblique grooves a fitted with a metallic lining a' and a stop a<sub>11</sub>, a series of slides consisting of strips S, s, s', having lips s<sub>11</sub>, s<sub>11</sub>', runners S<sub>1111</sub> having hooked ends s<sub>1111</sub>, and cross ribs S<sub>1</sub>, S<sub>11</sub>, S<sub>111</sub>, substantially as set forth. 2nd. The combination of the sides A, grooves a, stop a<sub>11</sub>, the runners S<sub>1111</sub> and hooks s<sub>1111</sub>, substantially as set forth. 3rd. The combination of the channels S, s, s', lips s<sub>11</sub>, s<sub>11</sub>', ribs S<sub>1</sub>, S<sub>11</sub>, S<sub>111</sub> and runnery S<sub>1111</sub>, substantially as set forth.

### No. 26,379. Machinery for Piping or Decorating Biscuits and Cakes and making fancy designs of "Icing" and ornamental biscuits. (Appareil pour monter ou décorer les biscuits ou gâteaux et faire des dessins de "glace" et de biscuits d'ornement.)

Emile Hérisse, Brighton, Eng., 4th April, 1887; 5 years.

*Claim.*—1st. The combination of parts forming the new machinery hereinbefore described and represented in the accompanying drawings at Fig. 1 to 10, consisting of the revolving frame E, pendant screws G, H, bridge I, chamber L with perforated bottom, spindle M, held piston P, hand wheels S and S<sub>1</sub>, nut T, spring U and cam V, the whole constructed and operating as before described. 2nd. The combination of parts forming the new machinery hereinbefore described, and represented in the accompanying drawings at Figs. 11, 12, 13, consisting of the revolving frame E, pendant screws G and H, bridge I with attached chamber L, spindle M<sub>1</sub>, held piston P, hand wheels S and S<sub>1</sub>, boss S<sub>2</sub> and falling table X, the whole constructed and operating as before described. 3rd. In machinery for the purposes described, expressing mixing from a chamber to hold same through a perforated bottom, by causing bottom to move towards a held piston in chamber. 4th. In machinery for the purposes described, the arrangement of parts for effecting the cut off as hereinbefore described, and represented in the accompanying drawings. 5th. In the arrangement for effecting the cut off by lowering table X, a spring or springs to prevent the table holding the tin from being jarred when lowered. 6th. In machinery for the purposes described, the combination of parts operating as described to enable a differential movement to be imparted to chamber and piston during working, consisting of the large threaded screw G, smaller threaded screw H or H<sub>1</sub>, bridge I with attached chamber L, spindle M or M<sub>1</sub> with piston P attached, and hand wheels S and S<sub>1</sub>. 7th. In machinery for the purposes described, a bottom to chamber for holding mixing formed with perforated design or designs, and having the exit of the perforations formed with an outside projection a, as described. 8th. In machinery for the purposes described, the revolving frame E, for the purpose stated.

### No. 26,380. Lubricator for Locomotives, etc. (Graisseur pour locomotives, etc.)

The Nathan Manufacturing Company, (assignee of Leopold Kazanzer), New York, U.S., 4th April, 1887; 5 years.

*Claim.*—1st. The combination of the oil reservoir, the condenser, the two sight feed tubes and their connections, the two oil exit pipes and auxiliary conduits leading from the condenser to the upper, sight feed connections for discharging steam into the oil exit directly over the upper ends of the visible food tubes, the parts being so arranged that the upper ends of the sight feed tubes are between the oil exit pipes and the discharge ends of the auxiliary steam conduits, substantially as and for the purposes hereinbefore set forth. 2nd. The combination of the oil reservoir, the condenser, the two visible feed tubes and their connections, the oil exit pipes and two separate and independent auxiliary steam conduits having no communication with each other and discharging steam from the condenser, each into its appropriate oil exit pipe, substantially as and for the purposes hereinbefore set forth. 3rd. The combination of the oil reservoir, the condenser, the two visible feed tubes and their connections, the two separate and independent auxiliary steam conduits connected each with its appropriate upper sight feed connection, the oil pipe O, and the single cross-channel O<sub>1</sub> through which oil is supplied to both of the lower sight feed connections, substantially as and for the purposes hereinbefore set forth. 4th. The upper sight feed connection, formed with a passage for connecting the auxiliary steam conduit and the oil exit pipe, in combination with the sight feed tube and the screw valve B<sub>1</sub>, movable towards and away from the sight feed tube, and constructed and arranged to open and close the upper end of said tube without closing said passage, as and for the purposes hereinbefore set forth. 5th. The combination of the oil reservoir, the sight feed tube and its lower connection, with the upper sight feed connection, provided with two independent oil outlet passages, the one for oil from the reservoir, the other for oil from a hand oiler, the condenser and auxiliary steam conduit leading therefrom to said upper sight feed connection, and the auxiliary hand oiler under the arrangement and for operation, substantially as hereinbefore set forth. 6th. The upper sight feed connection provided with passage n<sub>2</sub>, n<sub>1</sub>, by passage n, neck n<sub>3</sub>, oiler H and valve B<sub>2</sub>, in combination with the sight feed tube and its lower connection, the oil reservoir, the condenser and the auxiliary steam conduit, as and for the purposes hereinbefore set forth.

### No. 26,381. Composition for the Preservation of Fresh Fish. (Composition pour la conservation du poisson frais.)

Frederick Langton and William Rodden, Montreal, Que., 4th April, 1887; 5 years.

*Claim.*—The compound of glucose and dextrine in about the proportions herein set forth, and used as a paste or solution, as and for the purposes described.

### No. 26,382. Fire-Escape. (Saveteur d'incendie.)

George Larkin, William Michelsteller and D. H. Stevenson, Seymour, Wis., U.S., 4th April, 1887; 5 years.

*Claim.*—1st. The combination of the framework, the arms B of the lazy-tong frame having their lower ends bent and pivoted to blocks which slide in suitable grooves on the inner side of the supporting timbers Q, the shaft, the ropes and the pulleys connected to their lower ends with the ladder, the eyebolts G connected to their lower ends with the ropes H connected to the eyebolts and the ladder, substantially as shown. 2nd. The combination of the lazy-tong frame, a suitable framework upon which it is mounted, and a mechanism for extending it with the ladder, the eyebolts G, the ropes H, and the rope connected to the upper joint of the lazy-tong frame, whereby the ladder is steadied while being extended or contracted, substantially as described.

### No. 26,383. Grain Cradle. (Javelier.)

Peter B. Nally and Munroe R. Beames, Majors, S.C., U.S., 4th April, 1887; 5 years.

*Claim.*—1st. The combination of a snath having a fixed vertical bar at one end, the fingers connected to the vertical bar at one end, the adjusting sleeves fitted on the fingers independently of each other and adjustable longitudinally thereof, and provided with means for securely connecting them thereto at any point, the brace rods intermediate of the said sleeves and the snath, the retaining sleeves also fitted and secured on the fingers, and the rigid cross-bar connecting the retaining sleeves and movable therewith, substantially as described and for the purpose set forth. 2nd. The combination of a snath, the vertical fixed bar C thereon having the apertures or sockets c, c<sub>1</sub>, the fingers fitted at their inner ends in the openings or sockets, the adjusting sleeves fitted on the fingers and having the transverse openings f<sub>2</sub> and the fixed lugs f<sub>1</sub> on one side, the keys passing through the openings f<sub>2</sub> and the fixed lugs f<sub>1</sub> on one side, the keys passing through the openings f<sub>2</sub> of the said sleeves for securing the same to the fingers, the brace rods secured at one end to the lugs of the sleeves and at the opposite end to the snath, the retaining sleeves also fitted on the fingers and a rigid transverse bar I connecting the retaining sleeves, substantially as described. 3rd. The combination of a snath carrying a fixed vertical bar C at one end, the fingers connected to the bar, the adjusting sleeves fitted on and keyed to the fingers, the brace rods intermediate of the adjusting sleeves and the snath, the retaining sleeves also fitted on the fingers and having the parallel arms provided with the transverse aligned slots h<sub>2</sub>, the rigid bar I passing through the aligned slots of the retaining sleeves, and the keys for connecting the fingers, the sleeves and the bar detachably together, substantially as described for the purpose set forth.

### No. 26,384. Means of Controlling the Supply of Atomized Fuel for Steam Generators, etc. (Moyens de régler l'alimentation du combustible liquide pulvérisé, pour générateurs de vapeur, etc.)

John Gillies & Co., Carleton Place, Ont., (assignee of George W. Davison, Rochester, N.Y., U.S.), 4th April, 1887; 5 years.

*Claim.*—1st. In a device for regulating the flow of fluids through pipes, in combination with a steam generator and pipes for conducting said fluid, a valve body formed with a valve seat and provided with a valve proper for said seat, and a barrel or inclosure connected with the interior of said steam generator containing a movable piston or part, the same being connected with said valve, substantially as and for the purpose set forth. 2nd. In a device for regulating the flow of fluids through pipes, in combination with a steam generator and pipes for conducting said fluids, a valve-body formed with a valve seat and provided with a valve proper for said seat, and a barrel or inclosure connected with the interior of said steam generator containing a movable piston, the same being connected with said valve, the axes of said piston and valve being in the same straight line, substantially as shown and described. 3rd. In a device for regulating the flow of fluids through pipes, in combination with a steam generator and pipes for conducting said fluids, a valve body formed with a valve seat and provided with a valve for said seat reaching out of said body, a barrel or inclosure communicating with the interior of said generator containing a piston and a stopper for the outer open end of said barrel, a spiral spring within the barrel for said piston, the outer end of the latter being formed with a cavity in which the outer end of said valve enters, substantially as described. 4th. In a device for regulating the flow of fluids through pipes, in combination with a steam generator and pipes for said fluids, a valve body formed with a valve seat, and provided with a valve for said seat, a barrel communicating with the interior of said steam generator containing a movable piston formed with a cavity at its outer end, in which to receive the outer end of said valve, and a spring placed with said cavity to bear against said valve, substantially as and for the purpose set forth. 5th. In a device for regulating the flow of fluids through pipes, in combination with a steam generator and pipes for conducting said fluids, a valve body formed with a valve seat and provided with a valve proper for said seat, and a barrel or inclosure connected with the interior of said steam generator containing a movable piston formed with a cavity at its outer end in which the end of said valve rests, a spring placed within said cavity and an adjuster for said valve, substantially as and for the purpose set forth. 6th. In a device for regulating the flow of fluids through pipes, in combination with a steam generator and pipes for conducting said fluids, a barrel or inclosure connected with the steam space within said generator containing a movable piston, a lever for said piston to bear against a valve placed within said pipe, and a connecting rod for said valve and lever, substantially as shown and described.

**No. 26,385. Anti-Friction Roller for Waggon Reaches.** (*Rouleau anti-frottant d'avant-train de wagon.*)

John Q. Grant, George T. Dell and Frank P. Secor, Longmont, Col., U.S., 4th April, 1887; 5 years.

*Claim.*—1st. The combination of a waggon-reach, a pair of brackets notched so as to fit the said reach, and in which are journalled, so as to be free to rotate, a pair of rollers with the sway-bar, substantially as and for the purpose set forth. 2nd. The combination of the coupling-pole of a waggon, two brackets having notches adapted to fit the reach bolts securing said reach and brackets together, and a pair of double-conical or centrally-swelled rollers journalled in said brackets with the slide-bar of a waggon, substantially as and for the purpose set forth. 3rd. The combination of a waggon-reach or coupling-pole, a pair of brackets secured to said reach or pole, and one or more double-conical or centrally-swelled rollers supported in said brackets with a slide or sway bar of a waggon, substantially as described. 4th. As a new article of manufacture, a pair of brackets adapted to be fitted to the reach of a waggon, and one or more double-conical or centrally-swelled rollers adapted to be journalled therein, substantially as described and for the purpose set forth.

**No. 26,386. Woven Fabric.** (*Tissu.*)

David B. Kerr, Philadelphia, Penn., U.S., 4th April, 1887; 5 years.

*Claim.*—The combination of two or more wefts, each of a different color with figuring warp-threads, and a binder warp-thread between the two figuring warp-threads of each pair, as shown, described, and for the purpose specified.

**No. 26,387. Letter Blank and Envelope.**

(*Enveloppe-Papier à Lettre.*)

Arthur Cox, Toronto, Ont., 4th April, 1887; 5 years.

*Claim.*—1st. A sheet of paper folded in the form of a triangle, in combination with an envelope to contain the said sheet when folded, and having a slit made in it through which the apex of the triangle may protrude, substantially as and for the purpose specified. 2nd. A sheet of paper connected to and forming part of an envelope and folded in the form of a triangle, in combination with the said envelope having a slit made in it through which the apex of the triangle may protrude, substantially as and for the purpose specified. 3rd. A sheet of paper connected to and forming part of an envelope, but made narrower than the said envelope and folded in the form of a triangle, in combination with the said envelope having a slit made in it through which the apex of the triangle may protrude, substantially as and for the purpose specified.

**No. 26,388. Punch.** (*Emporte-Pièce.*)

Albert Burrowes, Toronto, Ont., 4th April, 1887; 5 years.

*Claim.*—A punch A, having a portion of its wall a surrounding its cutting edge removed, substantially as and for the purpose specified.

**No. 26,389. Machine for Making Lard Tablets.** (*Machine à Faire les Palettes de Sain-doux.*)

Henry H. Fearman, Hamilton, Ont., 4th April, 1887; 5 years.

*Claim.*—1st. A machine for making lard tablets, consisting of the combination of the sheet metal mould A, handle B, plunger C, rod a, substantially as and for the purpose specified. 2nd. The combination of the sheet metal mould A, handle B, plunger C, rod a, hole e, knob b and vent f, substantially as and for the purpose specified.

**No. 26,390. Sewing Machine.**

(*Machine à Coudre.*)

The Pentucket Variable Stitch Sewing Machine Company, Haverhill (assignee of Erastus Woodward, Somerville), Mass., U.S., 4th April, 1887; 5 years.

*Claim.*—1st. The combination of the stitch-forming mechanism, the feeder, the arm and rock shaft carrying the feeder, the adjustable mechanism for oscillating said rock shaft, a lever pivotally connected to the rock shaft, a movable fulcrum for said lever, a second lever by which said lever is supported, adjustable mechanism, substantially as described, whereby said fulcrum may be either oscillated or held stationary, and adjustable mechanism, substantially as described, for oscillating said lever, as set forth. 2nd. The combination of the stitch-forming mechanism, the feeder, the arm and rock-shaft carrying the feeder, the adjustable mechanism for oscillating the rock shaft, the lever E pivotally connected to the rock, the movable fulcrum G for said lever, the lever K<sub>1</sub> supporting said fulcrum, the adjustable fulcrum L<sub>1</sub> for said lever, and means, substantially as described, for oscillating said levers, as set forth. 3rd. The combination of the stitch-forming mechanism, the feeder, the arm and rock shaft carrying the feeder, the adjustable mechanism for oscillating said rock shaft, the lever E pivotally connected to the rock shaft, the fulcrum G and its operating mechanism, the slide I to which the lower end of said lever is connected, the lever J pivoted to said slide, the adjustable fulcrum for said lever, the cam whereby said lever is oscillated, as set forth. 4th. In a sewing machine, of the class described, having a universally movable automatic work feeder, the combination, with the needle shuttle automatic work feeder, and a tension device adapted to produce a constant tension on the thread, of automatic thread-holding and releasing devices, substantially as described, whereby the needle-thread is held while the shuttle is entering the needle loop, and released while the work is being moved by the work feeder, as set forth. 5th. The thread grasping and releasing device, composed of the fixed plate having an orifice for the needle thread, and the reciprocating plate which alternately covers and exposes said orifice, as set forth. 6th. The combination of the needle, the shuttle, the work feeder, an automatic thread grasping and releasing device, and a tension device, all arranged and operating substantially as and for the purpose specified. 7th. The combination, with the feeder carrying arm or slide, and the feeder loosely pivoted thereto, of a frictional connection between said arm or slide and the pivot of the feeder, whereby the latter is prevented from swinging with too much freedom, substantially as set forth. 8th. The combination, with the feeder carrying slide r<sub>1</sub>, and the feeder k<sub>1</sub> having the pin n<sub>1</sub> rigid therewith, of the split socket b and one or more set screws for compressing said socket against said pin, whereby the feeder is prevented from swinging on said slide with too much freedom, substantially as set forth.

**No. 26,391. Centrifugal Amalgamator for use in Connection with Crushed Ore, Sand, etc., containing Precious Metals.** (*Amalgamateur Centrifuge pour le Minerai Broyé, le sable, etc., contenant des métaux précieux.*)

William White, Mount Vernon, N. Y., U.S., 5th April, 1887; 5 years.

*Claim.*—1st. The combination, with a pan, and means for revolving the same, of a disk provided with riffs arranged to break joint, substantially as described. 2nd. The combination, with a pan, provided with a discharge orifice or tube, of a disk arranged above the pan riffs secured to the disk and projecting downward therefrom, said riffs being practically concentric with the axis of the pan, and arranged so that they break joint, as and for the purpose stated.

**No. 26,392. Device for Trimming Cartridge Shells.** (*Appareil pour Ébarber les Enveloppes des Cartouches.*)

Rollin White, Lowell, Mass., U.S., 5th April, 1887; 5 years.

*Claim.*—1st. The combination of a die, provided with an annular knife surrounding the die opening, a punch having a conical lower end, provided with splitting knives and a trimming punch, substantially as described. 2nd. The combination of a die, provided with an annular knife surrounding the die opening, a splitting-punch, provided with splitting knives, and a trimming-punch having an annular groove on its lower surface, as and for the purpose specified. 3rd. The combination of a trimming-die, provided with an annular knife surrounding the die-opening, and a punch adapted to press the open end of a shell upon said knife, substantially as set forth. 4th. The combination of a trimming-punch, having a groove in its lower surface, and a trimming-die having a knife surrounding the die-opening, a conical enlargement above the cylindrical portion, or downwardly-projecting teat, as and for the purpose specified. 6th. The combination of a die and a punch, having radial conical-shaped knives, and a cylindrical portion or teat projecting below said knives, as and for the purpose specified. 7th. The splitting-punch, having its lower end tapered or bevelled off, and provided with radial conical-shaped knives, as and for the purpose specified. 8th. The combination of a trimming-punch, having its lower surface extended laterally beyond the part which forms the anvil, and a trimming-die having a surface without the knife, upon which surface the extended surface of the punch may rest, as and for the purpose specified.

**No. 26,393. Die for Drawing Cartridges and other Blanks from metal. (*Etampe pour Laminer les Cartouches et autres ébauches en Métal.*)**

Rollin White, Lowell, Mass., U.S., 5th April, 1887; 5 years.

*Claim.*—1st. The combination of a die, composed of two or more superimposed plates, contained in one or more die-holders, one or more of said die-holders having a die-chamber larger than the plate of said die-chamber, and an elastic packing interposed between said die and the said die-chamber, substantially as shown and described. 2nd. The combination of a die, composed of two or more superimposed plates contained in one or more die-holders, one or more of said die-holders having a die-chamber larger than the plate of said die contained in said die chamber, and an elastic packing interposed between said die and the sides of said chamber, as and for the purpose specified. 3rd. The combination of a die, a die-holder having a die-chamber larger than said die, an elastic packing surrounding said die, a metallic ring surrounding said packing, and two or more screws thrusting against said ring, as and for the purpose specified. 4th. A die, composed of two or more superimposed plates, in two or more die-holders, all of said die-holders being provided with die-chambers somewhat larger than the plates contained in said die-holders, so that all the plates composing the die may have a slight lateral motion for the purpose of adjusting themselves to the work, substantially as shown and described.

**No. 26,394. Chill for Small Castings.**

(*Coquille pour Coulage de petites Pièces.*)

Candide W. Creteau, Longueuil, Que., 5th April, 1887; 5 years.

*Claim.*—1st. The chill or "print" A, pressed when in the mould against the rear face of the back plate, and having formed in it recesses to receive tapered bolts with projecting heads forming holes in such back plate all as herein set forth. 2nd. In combination with the chill or "print" A, with outwardly-turned perforations a, a, the tapered bolts B, B, with countersunk flat heads B', B', substantially as and for the purpose set forth.

**No. 26,395. Puzzle. (*Jeu de Patience.*)**

Henry Oelrich, Detroit, Mich., U.S., 5th April, 1887; 5 years.

*Claim.*—In a puzzle, the combination of the leaves A, B, the straps a, a, b, b', and the folding papers C, C', attached to opposite sides of the straps b, b', substantially as described.

**No. 26,396. Timber Roll.**

(*Rouleau à Bois de Charpente.*)

Robert M. Webb, San Francisco, Cal., U.S., 5th April, 1887; 5 years.

*Claim.*—1st. The anti-friction rolls C and bent adjustable standards D, in combination with the frame B and B' and roll A, for the purpose of holding the timber over the roll and relieving the friction, constructed and operated substantially as and for the purposes set forth. 2nd. The anti-friction rolls C and standards D, with set-screws E, in combination with the frame B and B' and the pivot or turn-table F and G, for the purpose of turning and guiding the timber while avoiding friction, constructed and operated substantially as and for the purposes set forth.

**No. 26,397. Machine for Grinding Mower Knives. (*Machine à remouler des couteaux des faucheuses*)**

The Mower Knife Grinder Company, New York, (Assignee of Rufus Dutton, Yonkers), N.Y., U.S., 5th April, 1887; 5 years.

*Claim.*—1st. In a machine for grinding mowing machine knives, the combination, substantially as hereinbefore described, of a knife clamp, a grinding wheel, means for reciprocating either of them for presenting to the grinding surface a knife edge progressively from the bottom of a V to the top of an edge, and a clamp-controlling spring which exerts its minimum force during the presentation by the clamp of the inner end of a knife edge of a grinding surface, and a greater force when presenting the outer end or tip of a knife edge to said surface, and is coupled to the reciprocating mechanism and graduated in its force thereby, substantially as described, whereby the pressure of a knife held by said clamp is increased progressively against the grinding surface while grinding from the bottom of a V to the tip of a knife edge. 2nd. In a machine for grinding mowing machine knives, the combination, substantially as hereinbefore described, of a knife clamp, a grinding wheel mounted upon a reciprocating arm or lever, a clamp-controlling spring coupled to said wheel arm and varied in its force while pressing a knife against the grinding surface, as a result of the various positions assumed by said wheel arm, during its reciprocating movement. 3rd. In a mower knife grinding machine, the combination, substantially as hereinbefore described, of a grinding wheel mounted at one end of a pivoted arm, a knife clamp frame pivoted to swing toward and from the grinding face of said wheel, arms at the foot of said frame, a pivoted lever bearing downward upon said arms, and a clamp-controlling spring coupled to the opposite end of said lever, and also to said wheel arm between its pivot and the wheel, whereby as the result of vertically moving said wheel the pressure of said spring applied at the rear of the clamp frame is progressively increased. 4th. In a mower knife grinding machine, the combination, substantially as hereinbefore described, of the grinding wheel and the knife clamp pivoted with relation to each other, substantially as described, for enabling the presentation of a knife held by said clamp to either of the edges of the grinding wheel, and adjustable stops for variably limiting the pivotal movements of said wheel and clamp, and thereby correspondingly varying their angular relations, for operating upon the section of a mower knife which has been irregularly ground. 5th. In a mower knife grinder, the knife clamp embodying the combination, substantially as described, of the horizontal bar provided with legs pivoted at their lower ends, and having an upper

surface affording a longitudinal seat for the rear edge of a knife bar, and having a centrally located bolt affording a shoulder for engaging with the outer edge of a knife bar, and two pairs of independent vertical clamping jaws located at opposite sides of said bolt, whereby the central portion of a mower knife may be securely confined by the use of either or both of said pairs of jaws, and also whereby either of the pairs of jaws and said bolt shoulder can be relied upon for securely holding either end of a knife while grinding the end sections thereof. 6th. The combination, substantially as hereinbefore described, of the grinding wheel, the knife clamp and its frame, the latter being pivoted at its lower end to a base plate, a horizontal bar on said frame serving as a seat for the rear edge of a mower knife bar, a rigid clamping jaw at each end of said bar, a pair of movable jaws each provided with a separate clamping bolt, forwardly projecting arms at the base of said clamp frame, and a spring for forcing said arms downward and thereby forcing the knife clamp toward the grinding face of the wheel. 7th. In a mower knife grinder, the combination, with a grinding wheel internally chambered for the reception of water, of a radial water duct having an external feeding aperture, and an internal exit located within the wheel, substantially as described, whereby water can be readily supplied to the chamber, and then securely retained therein without closing said duct regardless of variations in the position of said wheel and whether the same be in or out of use.

**No. 26,398. Musical Instrument.**

(*Instrument de musique.*)

Robert F. Flemming, jr., and Anthony Lux, jr., Melrose, Mass., U.S., 5th April, 1887; 5 years.

*Claim.*—1st. A stringed musical instrument, the body of which is provided with a parchment or vellum head, perforated at or near the point where the strings are operated with a cluster of circular openings to cause them to vibrate. 2nd. A stringed musical instrument, the body of which is provided with two removable heads, one of which is provided with a cluster of circular openings, and a series of strings within said body, corresponding in number and pitch with the strings upon the outside of said instrument. 3rd. A stringed musical instrument, the body of which is provided with a perforated vellum or parchment head, and a reverberant mounted upon a spring or yielding arm, and located beneath the perforated portion of said head, to regulate the amount of sound to be emitted therefrom. 4th. In a musical instrument, the combination of two removable vellum or parchment heads, one or more headed rods or posts interposed between said heads, and mounted in bearings with their heads in contact with the front or upper head, and a spring interposed between the head of said rod and its bearing, to maintain said rod in contact with said front or upper head. 5th. A stringed musical instrument, the body of which is provided with two vellum or parchment heads, a series of strings located within said body, and corresponding in number and pitch with the strings outside of said body, and a series of pins interposed between said inside strings and one of the heads, to transmit the vibrations of said head to said inside strings. 6th. In a stringed musical instrument, a mute or damper consisting of a support covered with a non-resonant material pivoted to the bridge of the instrument, and connected to a lever in such a manner that such support may be oscillated about its axis by said lever, and brought into contact with the strings to deaden and soften their tone. 7th. In a stringed musical instrument, a reverberant or sound-regulator consisting of a ring, having clamped thereon a disk of thin parchment or vellum, and mounted upon a spring arm beneath the openings for the emission of the sound. 8th. In a stringed musical instrument, provided with a series of strings within the interior of the body thereof, a twanging device consisting of a rod mounted in suitable bearings, in which it is adapted to be oscillated or reciprocated by means of a milled head located outside of said body, and having mounted thereon an arm provided with a cam portion by which any desired string may be snapped. 9th. In a stringed musical instrument, the combination of the strings and the tail-piece thereof, which a series of independent and detachable hooked wires interposed between said strings and said tail-piece. 10th. In a stringed musical instrument, a series of strings secured in a fixed position to one of the ends of the body thereof, passing through said end into the interior of the body where they are stretched over suitable bridges, and passing out at the opposite end to suitable tuning-pegs mounted in a suitable arm projecting from the lower end of the instrument. 11th. In a stringed musical instrument, the combination of the sides a, a, provided with the slots g<sub>1</sub>, g<sub>2</sub>, the vellum head A or Ar, the band f, the pull-downs g, g, the bolts g<sub>2</sub>, g<sub>2</sub> and the nuts g<sub>3</sub>, g<sub>3</sub>, all substantially as and for the purposes described. 12th. In a stringed musical instrument, the combination of the sides a, a, provided with the slots g<sub>1</sub>, g<sub>1</sub>, the vellum head A or Ar, the metal band f provided with the slots f<sub>1</sub>, f<sub>2</sub> and f<sub>3</sub>, and the stud or bolt f<sub>2</sub>, the bolts g<sub>2</sub>, g<sub>2</sub>, the nuts f<sub>3</sub>, g<sub>3</sub> and g<sub>3</sub>, and a series of pull-downs g, g, all substantially as and for the purposes described. 13th. In a stringed musical instrument, the combination of the sides a, a, the vellum head A and Ar, the metal band f provided with the slot f<sub>1</sub> at one end, and the bolt f<sub>2</sub> at the other, and the nut f<sub>3</sub>, all substantially as and for the purposes described. 14th. In a stringed musical instrument, the combination of the vellum head A<sub>1</sub>, the cross-brace c, the pins n<sub>4</sub>, n<sub>4</sub>, the vertically moving bridges n<sub>3</sub>, n<sub>3</sub>, the springs n<sub>5</sub>, n<sub>5</sub> and the strings n, n, all substantially as and for the purposes described. 15th. In a stringed musical instrument, the combination of the sides a, a, provided with the stiffening-pieces r<sub>2</sub> and r<sub>4</sub>, the neck B provided with the projection r, the extension r<sub>3</sub> secured to said projection and the screws l<sub>1</sub> and r<sub>3</sub>, all substantially as and for the purposes described. 16th. In a stringed musical instrument, the combination of the sides a, a, the vellum head A or Ar, and the series of longitudinal and cross-braces c, c, all substantially as and for the purposes described. 17th. In a stringed musical instrument, the combination of a series of strings n, n within the body thereof, the rod p provided with the stop rod q and the picker-arm p<sub>3</sub>, and mounted in suitable bearings so that it may be either oscillated or reciprocated therein, and the hook q<sub>1</sub> secured to a fixed support, all substantially as and for the purposes described. 18th. In a stringed musical instrument, a bridge composed of a wooden base portion and a metal strip, the upper edge of which is provided with suitable notches to receive the strings.



**No. 26,399. Valve for Water Closets, etc.***(Valve pour lieux à l'anglaise, etc.)*

William Scott, Malden, Mass., U.S., 5th April, 1887; 5 years.

*Claim.*—1st. The combination, with the this charge-pipe B of a tank, of a chambered valve D having an air-passage L leading from its chamber downward into said discharge-pipe, and a suitable water-passage H, substantially as described for the purpose specified. 2nd. The combination, with the discharge-pipe B of a tank, of a chambered valve D having a suitable air-passage leading therefrom, and a water-passage H making connection with a discharge pipe K, substantially as described for the purpose specified. 3rd. The combination, with the discharge-pipe B of a tank, of a chambered valve D having an air-passage L leading from its chamber downward into said discharge-pipe B, and a water-passage H making connection with a discharge pipe K, substantially as described for the purpose specified. 4th. The combination, with a tank for liquid, an outlet or discharge-pipe for the liquid, and a valve to said outlet-pipe, of a reciprocating lever for operating said valve, and having faces  $d_2$ ,  $a_2$ , and of an abutment for said lever connected to the valve and having faces  $f_2$ ,  $n$ , and said lever and said abutment adapted in one movement of said lever for said lever to work by its face  $d_2$  against the face  $f_2$  of said abutment, and thus to lift and open the valve and then to escape therefrom and leave the valve free to close, and in the other movement of said lever for said lever to work by its face  $a_2$  against the face  $n$  of said abutment, and thus to again lift and open the valve and then to escape therefrom and leave the valve free to close, substantially as described. 5th. The combination, with a tank for liquid, and an outlet or discharge pipe for the liquid, and a valve to said outlet-pipe, of a reciprocating lever for operating said valve and having faces  $d_2$ ,  $b_2$ ,  $a_2$ , and of an abutment for said lever connected to the valve and having faces  $f_2$ ,  $m$ ,  $n$ , and said lever and said abutment adapted in one movement of said lever for said lever to work by its face  $d_2$  against the face  $f_2$  of said abutment, and thus to lift and open the valve and then to escape therefrom, and also the face  $b_2$  of said lever from the face  $m$  of said abutment and leave the valve free to close, and in the other movement of said lever for said lever to work by its face  $a_2$  against the face  $n$  of said abutment, and thus to again lift and open the valve, and then to escape therefrom leaving the valve free to close and to bring the faces  $d_2$ ,  $b_2$  of the lever and the faces  $f_2$ ,  $m$ , of the abutment into position for operation, substantially as described. 6th. The combination, with a valve to a water-passage B, of an operating lever U and a valve lever R which is connected to said valve, and both levers constructed and arranged substantially as described, whereby from the movement of the operating lever in opposite directions, the valve lever is moved in the same direction, for the purpose specified. 7th. The combination, with a tank for liquid, an outlet and discharge pipe for the liquid, and a valve to said outlet-pipe, of a reciprocating lever for operating said valve and having faces  $d_2$ ,  $a_2$ , and of an abutment for said lever which is carried by a reciprocating lever connected to the valve, and has faces  $f_2$ ,  $n$ , and said lever and said abutment adapted in one movement of said lever for said lever to work by its face  $d_2$  against the face  $f_2$  of said abutment, and thus to lift and open the valve and then to escape therefrom and leave the valve free to close, and in the other movement of said lever for said lever to work by its face  $a_2$  against the face  $n$  of said abutment, and thus to again lift and open the valve and then to escape therefrom and leave the valve free to close, substantially as described. 8th. In combination, with a valve, of a water-passage B, a valve-lever R connected to said valve and provided with bearing-surfaces  $f_2$ ,  $m$  and  $n$ , and an operating lever U to operate lever R, and provided with bearing-surfaces  $d_2$ ,  $b_2$  and  $a_2$  which are arranged in relation to each other and to the said bearing-surfaces of valve lever, and said levers arranged in relation to each other, and the whole operating from the forward and backward movement of operating lever U, substantially as and for the purposes specified. 9th. In combination with a valve for opening and closing a passage B, the operating lever U having bearing-surfaces  $d_2$ ,  $b_2$ ,  $a_2$ , weighted arm V, elongated bearing  $q$ , fulcrum-pin  $r$  and abutment  $B_2$ , and the valve lever R having bearing-surfaces  $f_2$ ,  $m$ ,  $n$ , fulcrum  $h$  and abutment  $T_2$ , substantially as and for the purposes and operations described. 10th. The combination, with a tank for liquid, an outlet-pipe for the liquid, and a valve to said outlet-pipe, of two pivoted levers for operating said valve, one lever being provided with a nose  $C_2$  having three bearing faces  $d_2$ ,  $b_2$  and  $a_2$ , and the other with a nose  $A_2$  having bearing-surface  $f_2$ , and a nose T having bearing-surface  $m$  and separating notch or depression P, substantially as described for the purposes specified. 11th. The combination, with a tank for liquid, an outlet-pipe for the liquid, and a valve to said outlet-pipe, of two pivoted levers for operating said valve, one lever provided with a nose  $C_2$  having bearing-surfaces  $d_2$ ,  $b_2$  and  $a_2$ , a sliding pivotal point and a supplementary fulcrum  $e$ , and the other with a nose  $A_2$  having bearing surface  $f_2$  and a nose T having bearing-surface  $m$  and separating notch or depression P, substantially as described for the purpose specified. 12th. In a tank for liquid, a discharge or outlet-pipe for the liquid, a guided valve to said outlet-pipe adapted to be opened and closed, and a pipe which enters said outlet-pipe below the seat of its valve and is adapted to make communication between the liquid passage of said outlet-pipe and the external air, in combination with a valve or partition located in said outlet-pipe below the seat of its valve and adapted to reduce the area of the liquid passage of said outlet-pipe, substantially as described for the purpose specified. 13th. The combination, with a tank for liquid, an outlet-pipe for the liquid, a valve to said outlet-pipe having liquid and air passages, the air-passage extending into the outlet-pipe, and the valve adapted to be opened and closed, and an air-pipe separate from the air-passage of the valve and leading from the outside of the liquid in the tank to the outlet-pipe below the seat of the valve to said pipe, of a valve plate or partition located within the outlet-pipe near its valve-seat, and in relation to said air-passage of the valve, substantially as described for the purposes specified. 14th. The combination, with a tank for liquid, an outlet-pipe B for the liquid having a valve adapted to be opened and closed, and an air and overflow-pipe C connected to said outlet-pipe through a boss or side projection  $D_2$  thereof, in combination with a slide-plate  $E_2$  adapted to regulate the size of the opening of the outlet-pipe for the

passage of liquid from the tank, substantially as described for the purposes specified.

**No. 26,400. Hay and Grain Cock Weather Shield (Rick).** *(Couverture de meule de foin et de grain.)*

John A. Symmes and Luther R. Symmes Sherbrooke, Que., 5th April, 1887; 5 years.

*Claim.*—1st. As an improved article of manufacture, the herein-described concavo-convex flexible cover for hay and grain cocks, when the same is constructed of paper pulp in sheets, and moulded to shape between dies and provided with holes for guys, substantially as set forth. 2nd. The combination of the concavo-convex flexible cover A, having eyelets C around the peripheral edge, cords or guys D and pins E, as set forth.

**No. 26,401. Corn Sheller.** *(Egreoir à Blé d'Inde.)*

Aschel H. Patch, Clarksville, Tenn., U.S., 5th April, 1887; 5 years.

*Claim.*—1st. The combination, in a corn-sheller, of the toothed offset and bevel-edged wheel C, spring-pressed shell F, provided with spiral ribs, and with the guide  $o$  and the chute G arranged at an angle with the shell F, and having the finger  $p$ , substantially as herein shown and described. 2nd. In a corn sheller, the combination of the frame A formed of the yoke  $a$ , and cross-bar  $b$  carrying the sleeve  $c$ , the offset and bevel-edged toothed wheel C, the shell F having spiral ribs  $l$ , openings  $m$  and the guide  $o$  and the inclined chute G having the finger  $p$ , substantially as herein shown and described. 3rd. The combination, with the toothed wheel C and frame A, provided with perforated ears, of the shell F provided with pivot arms  $f$ ,  $\beta$ , the bolt  $k$  projecting from the frame and provided with the wing nut  $i$  and the spring  $k$  placed between the wing nut and the arm  $f$ , substantially as herein shown and described.

**No. 26,402. Carriage Train.** *(Train de Voiture)*

Charles Laforce, St. Jérôme, Que., 5th April, 1887; 5 years.

*Réclame.*—Un train métallique pour voitures à deux essieux composé de l'essieu postérieur A, fait de deux portions et recourbées en  $c$  de manière à donner la barre centrale D réunie à la pièce F en G au dessus de l'essieu antérieur, et ayant en outre les renforts  $h$ , H, reliant le sus dit essien A à la susdite barre centrale D, le tout tel que ci-dessus décrit A attaché au dessin ci-annexé.

**No. 26,403. Attachment for Sulky Ploughs.***(Disposition aux Charrues à Siège.)*

Joshua R. Randabaugh, Celina, Ohio, U.S., 5th April, 1887; 5 years.

*Claim.*—In combination with a sulky cultivator, having beams L and standards J, the cross-bar T secured to the tongue in front of the wheels, the hinged frames B outside the wheels having standards D, the diagonal extension bars B<sub>1</sub> provided with post C, the cross-bars E pivoted upon standard D and post C and hinged to the beams L, the cords F and cross-bar M, substantially as shown and described.

**No. 26,404. Portable Frog and Car Re-***placer for Railroads. (Rail de Raccordement Portatif pour Remettre sur la Voie les Chars de Chemins de Fer.)*

William O. Cooke, Providence, R.I., U.S., 5th April, 1887; 5 years.

*Claim.*—1st. The two-part portable frog or car-replacer, herein described, consisting of the castings A, B, constructed with the converging flanges 2, 8, adapted to be clamped together on opposite sides of the rail, as explained. 2nd. The casting A, consisting of the convex base or bridge-piece 1, the convex upwardly-projecting flange 2, terminating in an inclined tongue piece 3, and an inclined heel 4, in combination with the separate flange-bar 8 secured to the bridge-piece 1, substantially as herein shown and described. 3rd. The combination of the bridge-piece 1, longitudinal flange 2, heel-piece 4, vertical shoulder 5, separate flange-bar 8, heel-piece and vertical shoulder 10, substantially as and for the purposes set forth.

**No. 26,405. Sled.** *(Traineau.)*

Henry Meek, Oregon, Ill., U.S., 5th April, 1887; 5 years.

*Claim.*—1st. In sled or sleigh runners, a U-shaped beam curved in the form desired for the runner, combined with sleigh-knees rigidly attached to or formed integrally with said runners. 2nd. In a sled or sleigh, the combination, with a suitably-curved runner, having in it a series of apertures, of a shoe lying beneath the runner and provided with integrally-formed lugs projecting upward through said apertures, and keys for preventing the escape of said lug from said apertures. 3rd. A sled or sleigh, having runners U-shaped in cross-section, said runners being provided with apertures adapted to receive attaching lugs upon the sleigh-shoes, substantially as set forth. 4th. A sled runner consisting of a curved U-shaped beam, perforated at intervals, a cast shoe, provided with integrally-formed loops upon its upper surface at intervals corresponding to those between said perforations, and suitable keys for insertion in said loops, all combined substantially as set forth. 5th. The runner A, shoe D and knee 89, constructed substantially as shown and described, and combined with the beam band rave C, substantially as set forth. 6th. In combination, with a sled runner of U-shaped cross-section, a knee, consisting of a vertical and an oblique member rigidly united to each other near the runner, and to respective flanges of the runner upon the interior of said flanges, substantially as set forth. 7th. The combination of a U-shaped single piece runner, perforated at the bottom, and having an integrally-formed plate adapted to support the forward end of the rave, a shoe, having integrally-formed loops adapted to enter the perforations in the runner, and keys adapted to enter said loops and to prevent the removal of the shoes from the runner.

**No. 26,406. Apparatus for Checking, Recording and Indicating the Amounts of Cash Received, Taken or Paid, etc.** (*Appareil pour Contrôler ou Enregistrer et indiquer la Monnaie Reçue, Prise et Payée, etc.*)

Sidney Firth, Leeds, Eng., 6th April, 1887; 5 years.

*Claim*.—1st. The improved method of indicating the sums received, or other matters to be recorded, by the means and appliances severally operating substantially as hereinbefore described and shown in the drawings. 2nd. The combination for the purposes aforesaid, of the axle *d* operated by the handle *e*, such axle *d* being fitted with the cam blocks *v*, *w*, eccentric *6*, ratchet-wheel *35* and double arm lever *38*, controlled by the pawls *36* and *37*, spring *40* and pins *39* and *41*, substantially as hereinbefore described and shown on the drawings. 3rd. The combination for the purposes aforesaid, of the levers *a*, *b*, actuated by the axle *t*, crank *n*, pin *7* and cam *v*, and the lever *12* actuated by the axle *11*, crank *10*, pin *9* and cam *w*, substantially as hereinbefore described and shown on the drawings. 4th. The method of mounting the press with the wheels and printing appliances guided by rods *p* and guides *q*, and raised and lowered by the eccentric *6* and rod *19*, substantially as hereinbefore described and shown on the drawings. 5th. The method of operating the wheel and roller *26* by means of the rod and pawl *23*, spring *24*, lever *22* and pin *21*, substantially as hereinbefore described and shown on the drawings. 6th. The combination of parts together forming my improvements in apparatus for checking, recording and indicating the amounts of cash received, taken, or paid, such apparatus being also applicable to other analogous purposes, substantially as hereinbefore described and shown on the drawings.

**No. 26,407. Case for Physician's Prescription Papers, etc.** (*Boîte pour Prescriptions de Médecins, etc.*)

Ferdinand G. Uhlich, St. Louis, Mo., U.S., 6th April, 1887; 5 years.

*Claim*.—1st. The combination, with a box, of a marker and a support therefor, said marker being movable upon said support, substantially as set forth. 2nd. The combination of the box, the supporting-rod and the marker engaging said rod and movable in a circular direction, with the rod for its axis, and also in the direction of the length of said rod, as set forth. 3rd. The combination, with the box, the marker and a support upon which said marker slides, of a separate compartment or pocket for the reception of said marker, when not in use, as set forth.

**No. 26,408. Danger Signal for Railway Trains, etc.** (*Signal pour Trains de Chemins de Fer, etc.*)

Halcott P. Jones, Hillsboro, N.C., U.S., 6th April, 1887; 5 years.

*Claim*.—1st. In a car signal, the combination, with a suitable case, of a fixed and pivoted standard, a signal-flag secured to the standards, means for holding and releasing the pivoted standard, and a spring attached to the pivoted standard at one end, and to the case at its other end, substantially as set forth. 2nd. In a car signal, the combination, with a suitable case, of a fixed and a pivoted standard, the latter being provided with a neck, a signal-flag connecting said standards, a perforated spring-catch to engage the neck, means for releasing the catch from engagement with the neck, and a spring for moving the pivoted standard away from the fixed standard, substantially as set forth. 3rd. In a car-signal, the vertical stationary standard *H*, the pivoted standard, the signal-flag secured in slits of said standards, as described, the spring secured to the pivoted standard, the spring-catch *C*, the handle *D* and the rope secured thereto, substantially as set forth.

**No. 26,409. Rotary Ventilator.**

(*Ventilateur Rotatif.*)

John Williams, Quebec, Que., 6th April, 1887; 5 years.

*Claim*.—1st. In combination with the case *A*, provided with vane wheel *B* and eyes *L*, *M*, the gravitating cover *F* pivoted to the case, and provided with weight *H*, hook *T* and cord *J*, as set forth for the purpose described. 2nd. The case *A*, provided with springs *N* for holding the case removably in position, as set forth. 3rd. The combination, with the case *A*, having a vane wheel *E*, of the wire gauze screens *O*, *Q*, for filtering the air passing through the ventilator.

**No. 26,410. Sleigh.** (*Traineau.*)

George A. Strickland, Lakesfield, Ont., 6th April, 1887; 5 years.

*Claim*.—The runners *C* journalled on the axle *B*, in combination with the cross-bar *D* pivoted, as at *b*, to the body *A*, and to the runners *C*, substantially as and for the purpose specified.

**No. 26,411. Railway Flag Signal.**

(*Drapeau-Signal de Chemin de Fer.*)

James D'Arcey, South Quebec, Que., 6th April, 1887; 5 years.

*Claim*.—1st. A railway flag-signal, consisting of the staff *A*, having a suitable handle *B*, parallel shafts *D*, *D*<sub>1</sub>, *D*<sub>2</sub>, carrying flags *I* and ring *H* for locking the shafts, as set forth. 2nd. A railway flag-signal, consisting of the staff *A*, having a handle *B* and magazine *K*, in combination with shafts *D*, *D*<sub>1</sub>, *D*<sub>2</sub>, each carrying a flag *I* and a ring *H* for locking the shafts, as set forth.

**No. 26,412. Gaiter Boot and Shoe.**

(*Guêtre-chaussure.*)

Marcellus Walker, Cambridge, Mass., U.S., 6th April, 1887; 5 years.

*Claim*.—1st. A gaiter boot or shoe having an elastic goring *F*,

shaped as shown, to cover the small of the leg at its back from the counter upward, and also at each side but back of the ankle-bones, and thence to project at each side with an extension *H* under and to the front of the ankle-bones, and below and in line with the instep, in combination with the upper of an inelastic material such as leather, shaped and constructed to cover the remaining portions of the foot, and the whole secured together, substantially as described for the purpose specified. 2nd. A gaiter boot or shoe having an elastic goring *F*, shaped as shown, to cover the small of the leg at its back from the counter upward, and with an extension *H* at each side, but back of and crossing under the ankle-bones, and made wider on one side than on the other of the gaiter, in combination with an upper having a rear upward extension of inelastic material, such as leather, shaped and constructed to cover the remaining portions of the foot, and the whole attached together substantially as described for the purposes specified.

**No. 26,413. Horse Collar Fastening.**

(*Couplière de collier de cheval.*)

Miles T. Hayes, Burlington, Wis., U.S., 6th April, 1887; 5 years.

*Claim*.—1st. A fastening for separable horse collars, consisting of the two parts or fasteners *B* and *Br*, the body portions of which are curved to fit in the groove of the collar, one of the said fasteners being provided with a slot, and the other with a loop, hook, or staple of suitable length to project through the said slot to receive a key, substantially as described. 2nd. A fastening for separable horse collars, consisting of the two parts or fasteners *B* and *Br*, having curved body portions provided with arms or flanges to bear against the collar, one of the said fasteners having a slot *c*, and the other a loop hook or staple *d* adapted to enter and pass through the said slot, and one or both of the said fasteners having a loop *e* to receive the martingale strap, substantially as described. 3rd. The combination, with the separable horse collar *A*, of the fasteners *B* and *Br*, and the guard or protector *D*, the latter being arranged to project across the joint where the two parts of the collar come together, substantially as described.

**No. 26,414. Pump.** (*Pompe.*)

George S. Ayer, Saco, Me., U.S., 6th April, 1887; 5 years.

*Claim*.—1st. The combination of a pump stock, a casing *b* bolted thereto, and an air chamber having a rib on its lower surface, the air chamber being adjustable relatively to the pump stock and casing, substantially as described. 2nd. The combination, with the casing *b*, of the short shaft *f* having one end projecting from the casing, a handle secured to the other end of said shaft, and a lever pinned to the shaft inside the casing, the casing having a plugged aperture in line with the pin when the shaft *f* is turned to proper position, substantially as described. 3rd. The combination, with the pump stock, the casing *b* and air chamber *k*, of the hollow vent plug *m* extending into the space inside the casing, and having a side perforation which may form an open passage when the plug is screwed partly out, substantially as set forth. 4th. The combination, with a wooden pump stock, of a detachable metallic cylinder forming the working cylinder for the suction valve box, said cylinder having a conical seat for the drop box, substantially as shown and set forth. 5th. The combination, with a wooden pump stock, of a detachable metallic cylinder at the lower end of said stock, said cylinder having a conical throat for the drop box, and a reverse conical section below said drop box, said section being flanged for attachment of a wooden or metallic extension of the pump, all substantially as herein shown and described. 6th. The combination, with a wooden pump stock, of the detachable casing *b*, the adjustable chamber *k* and the detachable metallic cylinder having a working chamber for the sucker, and a conical throat for the reception of the drop box, substantially as described.

**No. 26,415. Cleaning Brush.**

(*Brosse de nettoyage.*)

Howard P. Nichols, Reading, Mass., U.S., 6th April, 1887; 5 years.

*Claim*.—1st. The combination of the connecting tubing *B*, the hollow handle having the sprinkling nozzle within the cap, the cap for the attachment of the brush and the swivelled sprinkling tube attached to the handle, substantially as specified. 2nd. The combination or the connecting tube *B*, the hollow handle *A* provided with the sprinkling orifices *c*, valve *D* and branch tube *F*, the cap *C*, the swivelled sprinkler tube *G* having the sprinkling plate *h*, and deflector flange *h* and the valve *H*, substantially as specified. 3rd. The combination of the connecting tube, the hollow handle *A* provided with the orifices *c* and valves *D* and *I*, the deflector plate *E* on the handle, and the swivelled sprinkler tube provided with the sprinkling plate *h* and the deflector flange *h*, substantially as specified. 4th. The combination of the connecting tube *B*, the hollow handle and detachable brush, and the curved sprinkler tube connected to the handle, substantially as specified.

**No. 26,416. Bob Sleigh.** (*Traineau accouplé.*)

Henry Jeffrey, Auburn Junction, Ill., Jacob Liver and Calvin A. Bierce, Winona, Minn., U.S., 7th April, 1887; 5 years.

*Claim*.—1st. The combination, with the knee *E* having the transverse rounded arms *K*, having a longitudinal recess *I* and tapering outward slightly from said recess, of cap *L* having a projection *R* on its under side fitting within the recess *I*, and concavities on opposite sides of the said projection to receive the upper rounded and tapered surfaces of the arms *K*, the said concavities being of greater width than the tapering arms, whereby a rocking and a lateral movement is afforded, substantially as and for the purpose set forth. 2nd. The combination, with the cap *L* provided on its under side with the projection *R* rounded recesses tapering outward from opposite sides of said projection, and recessed depending lugs *O* on opposite sides of the ends of the said recessed parts of the knee *E*, having a longitudinal recess *I* on its top, rounded arms *K* tapered outward from op-

posite sides of said recess, and resting in the recesses of cap L, the recesses being of greater width than the tapering arms, the clips N fitting in the recesses of lugs O and holding the cap and knee together, substantially as set forth. 3rd. The combination, with the knee E having the longitudinal recess, of the rave H resting in the bottom of recess I and bent downward at opposite sides thereof, the cap L provided with the projection R fitting in recess I and resting on the rave H, the cap being recessed to receive the arms K and rock and oscillate laterally thereon, substantially as set forth. 4th. The combination, with the runners A and the cross-beam M, of the knees E having longitudinal recesses I, and rounded outward tapered arms K on opposite sides of said recesses, the rave-bolts extending upward from the runners in front and rear of the knees E, the raves H resting between their ends on the bottom of the recesses I apertured to receive the upper ends of the rave-bolts, and bent therefrom downward and secured to the runners, the caps L having central projections R resting on the raves within the recesses I, rounded recesses receiving the arms K and grooved lugs O on opposite sides, the ends of said grooved portions and the clips N passed upward through the grooves in said lugs and secured to the beam M, substantially as set forth.

### No. 26,417. Lasting Jack for Holding Boots. (*Machine à enformer les chaussures.*)

Joseph Beaulieu and Lévi Beaulieu, Worcester, Mass., U. S., 7th April, 1887; 5 years.

*Claim.*—1st. The lasting-jack described consisting of the standard B, supported and braced as set forth, the swivel C with its joints at each end, and the arm D carrying a spring-pin and rest for supporting the work, all constructed and operating as and for the purpose set forth. 2nd. The combination of the standard B, supported and braced as set forth, the swivel C joined thereto by a movable joint held by a spring-bolt and notch, and connected to the arm D by a friction joint at right angles to the other, and the arm D carrying the holding mechanism for the work, all constructed and operating substantially as described and set forth.

### No. 26,418. Treatment of Milk.

(*Traitement du lait.*)

Abraham Forssell, Stockholm, (assignee of Alexander T. Pfeiff, Vik, Flen), Sweden, 7th April, 1887; 5 years.

*Claim.*—A mode of preparing a milk that will keep and is fit for every use, by cooling the milk yet warm from the cow, immediately after the milking, as fast as possible, down to between X 40 and 000, whilst it is stirred gently and without interruption, during about an hour, and without any particular admission of the air, substantially as and for the purpose set forth.

### No. 26,419. Adjustable Packing for Piston Rods. (*Garniture mobile pour tiges de pistons.*)

McGinnis Gildersleve, (assignee of William Pohlman), Middletown, N. Y., U. S., 7th April, 1887; 5 years.

*Claim.*—1st. The combination of the cylinder head A, casing C, spring G, solid ring E and sectional rings D, F, the ring D having the dowels *d*, all arranged substantially as set forth. 2nd. The combination of the cylinder head A, casing C, packing *c*, spring G, solid ring E and sectional rings D, F, the ring D having the dowels *d*, all arranged substantially as set forth. 3rd. In a piston-rod packing, the cylinder head A, casing C and packing *c*, combined with the spring G, solid ring E and sectional rings D, F, substantially as set forth.

### No. 26,420. Bead Fastener for Window Frames. (*Clou pour baguettes de châssis de fenêtre.*)

Charles R. Nelson, New York, N. Y., U. S., 9th April, 1887; 5 years.

*Claim.*—The combination, with a stop-bead having suitably shaped apertures, of washers placed over the apertures, which washers can completely cover said apertures, and of screws passed through the washers and the apertures into the casing, the diameter of the screws being equal to about one-third of the diameter of the apertures, to permit of moving the bead slightly in all directions without changing the positions of the screws, substantially as herein shown and described.

### No. 26,421. Braces. (*Bretelles.*)

Henri Beaudry, Montreal, Que., 9th April, 1887; 5 years.

*Claim.*—In combination, with a suspender strap provided with a button hole, a metal plate extending close up to the button hole on one side of the strap, and having its edge portion clamped upon the opposite side edges and end of the strap, all as herein set forth.

### No. 26,422. Machinery for Feeding Rollers and Purifiers in Roller Flouring Mills. (*Appareil d'alimentation des cylindres et blutoirs des moulins à blé à cylindres.*)

William Barnard, Galt, Ont., 9th April, 1887; 5 years.

*Claim.*—1st. The combination of the frame C, the thumb-screws and bolts *a*, *a* and the slot or opening *b*, and the springs *e*, *e* with the feed boxes B, B, substantially as and for the purpose hereinbefore set forth. 2nd. The combination of the frame C, and the feed boxes B, B, with the shaking rod D and the eccentric shaft E, substantially as and for the purpose hereinbefore set forth.

### No. 26,423. Drain Plough. (*Fouilleuse.*)

James Harper, Chamois, Mo., U. S., 9th April, 1887; 5 years.

*Claim.*—1st. In a drain plow, the combination of the frame K, the plate R hinged to its front end, and provided with an opening for the reception of the king bolt of a wagon gear, whereby the frame may be trailed from the front axle, the rotating cutter journaled in the frame, the plow in rear of the cutter, and the chute supported upon the front end of the frame and having its rear end bearing upon the upper side of the rotating cutter, for the purpose set forth, substantially as described. 2nd. The combination, with the running gear of a wagon, of the frame K pivotally connected to the front axle and trailing from the same, the rotating circular cutter journaled in rear of the cutter, the curved chute having its rear end bearing against the front upper side of the cutter, and the lever V fulcrumed to the rear axle of the wagon and connected to the rear end of the frame R, for the purpose set forth substantially as described. 3rd. In a drain plow, the combination of a frame K, a plate R, hinged to the front end of the frame and adapted to be connected with the front axle of a wagon gear, to thereby trail the frame from the front axle, a rotating cutter journaled in the frame, the plow carried by the frame in rear of the cutter, a chute resting at the rear end on the cutter, and a belt S connecting the chute to the plate R to thereby support the front end of the chute and prevent the displacement of the same, as and for the purpose set forth.

### No. 26,424. Oven Light for Bakers' Ovens.

(*Lumière pour Fours de Boulangerie.*)

Frank H. Van Houten, Matteawan, N. Y., U. S., 9th April, 1887; 5 years.

*Claim.*—1st. The combination, with the case and the revolving cut off of the burner mounted thereon having the gas supply pipe provided with main and auxiliary channels, and the regulating screw in the auxiliary channel, the slotted guide plate attached to the casing, the cock in the main channel of the supply pipe and the arm depending from the cock and engaging the slotted guide plate, substantially as specified. 2nd. The combination of the case and the revolving cut-off, provided with the pin and the spring having a recess engaging the pin the spring being secured to the case, substantially as specified. 3rd. The combination, with the case and the revolving cut-off having the lever F, of the burner, the supply-tube leading to the burner having the main and auxiliary channels, the slotted plate attached to the casing, the cock in the main channel and the arm depending from the said cock, substantially as specified.

### No. 26,425. Boot or Shoe. (*Chaussure.*)

Frank P. Woodbury, Salem, N. H., U. S., 9th April, 1887; 5 years.

*Claim.*—1st. A boot or shoe having a portion of the heel composed of a layer or layers of compressed wood pulp, and the remainder of leather or other suitable material, as set forth. 2nd. A boot or shoe having the lower layer *d* of the heel composed of leather or other suitable material, and the remainder of layers *c* of compressed wood pulp, as set forth. 3rd. A boot or shoe having a portion of the sole composed of a layer or layers *g* of compressed wood pulp, and the remainder of leather or other suitable material, as set forth.

### No. 26,426. Car-Coupling. (*Attelage de Chars.*)

Patrick F. Duross, Long Island, N. Y., U. S., 9th April, 1887; 5 years.

*Claim.*—In a coupling device, substantially as herein shown and described, the combination, with a draw head, of coupling hook C, gravity latch D and link-director E, and arranged and operating as set forth.

### No. 26,427. Hydraulic apparatus for Raising or Forcing Water and other Liquids, or Air and other Gases. (*Appareil Hydraulique pour Elever ou Refouler l'Eau et autres liquides, ou l'Air et autres Gaz.*)

Howard D. Pearsall, London, Eng., 9th April, 1887; 5 years.

*Claim.*—1st. In hydraulic rams, the combination of a receiver *c* into which some of the water from the flow-pipe flows during the closing of the main valve, and a passage *h* through which air enters the receiver *c* escapes from the receiver *c* during the closing of the main valve. 2nd. In hydraulic rams, the combination of a receiver *c* into which some of the water from the flow-pipe flows during the closing of the main valve, a passage *h* through which air enters the receiver *c* and also escapes from the receiver *c* during the closing of the main valve, a valve *i* closing the passage *h* and a float *b*. 3rd. In hydraulic rams, the combination of a receiver *c* into which some of the water from the flow-pipe flows during the closing of the main valve, a passage *h* through which air enters the receiver *c* and also escapes from the receiver *c* during the closing of the main valve, a valve *i* closing the passage *h*, and a float *b* and a screw *g* by which the distance of the float from the top of the receiver *c* is varied at will. 4th. In hydraulic rams, the combination of a receiver *c* into which some of the water from the flow-pipe flows during the closing of the main valve, a passage *h* through which air enters the receiver *c* and escapes from the receiver *c* during the closing of the main valve, and a main valve *m* through which water from the receiver *c* and also water coming direct from the flow-pipe *f* is discharged. 5th. In hydraulic rams, the combination of a single valve *m* acting as main and waste valve, and a valve rod *l* which is moved by external power instead of the valve being moved directly by the current of water in the flow-pipe. 6th. In hydraulic rams, the combination of a single valve *m* acting as main and waste valve, a valve rod *l* and a motor such as A actuated by the fluid under pressure in the air vessel *a*, or a water-wheel driven by the waste water. 7th. In hydraulic rams, the combination of a main valve *m* through which water from the receiver *c*, and also water coming direct from the flow-pipe *f*,

discharged, a motor A actuated by the fluid under pressure in the air vessel, or a water wheel driven by the waste water, and a cam  $\epsilon$  which presses on a rod connected with the valve  $\nu$  and assists in regulating the time of opening and closing of the valve  $\nu$ . 8th. The construction of valve  $m$  in figure 1 and enlarged views in figures 2, 3, and 4 having a tightening ring  $\gamma$  not attached to the valve but carried by the casing, and free to move through a small distance in a direction other than the direction of movement of the valve, whereby, when such valve is moved to a position near to its seat, the said ring  $\gamma$  is pressure existing in the apparatus. 9th. In hydraulic rams, the combination of a receiver  $c$  into which some of the water from the flow-pipe flows during the closing of the main valve  $m$ , a passage  $h$  through which air enters the receiver  $c$  and also escapes from the receiver  $c$  during the closing of the main valve, a valve  $v$  closing the passage  $h$  and a float  $b$ , a screw  $q$  by which the distance of the float  $b$  from the top of the receiver  $c$  is varied at will, a main valve  $m$  through which water from the receiver  $c$  and also water coming direct from the flow-pipe  $f$  is discharged, a valve  $r$  driven by a motor such as A actuated by the fluid under pressure in the air vessel  $\alpha$ , or by a water wheel driven by the waste water, and a cam  $\epsilon$  which presses on a rod connected with the valve  $\nu$  and assists in regulating the time of opening and closing of the valve  $\nu$ .

### No. 26,428. Purifier for Grain, Middlings, etc. (*Epurateur pour les Grains, Gruaux, etc.*)

James Higginbottom and Orsini Stuart, Liverpool, Eng., 12th April, 1887; 5 years.

*Claim.*—1st. In a grain or middlings purifier, the combination of a sieve D having cross bars supporting the cloth, with a travelling brush J and support K K, the latter having notches cut out of it to allow of the brush passing said cross bars. 2nd. The combination of a sieve D through which an upward current of air is drawn, with a dust collecting chamber C placed above said sieve through which the air passes to the exit trunk by means of entrances and exits, each unitedly much smaller in cross sectional area than the cross section of the chamber C, whereby the cross sectional area of the current in passing through C expands and goes slower and deposits a large part of its dust. 3rd. The chamber C placed in a dusty atmosphere, with limited access of that dusty atmosphere to it from above, and provided with a dust extracting device E and an exhaust A, both access and exhaust being of much smaller cross sectional area than the chamber itself, for the purposes described. 4th. The combination of the sieve D having an upward current of air passing through it, with chamber C above it narrow at bottom and broad at top, having a dust extracting device E and openings H to said current of air at each side at top, and an exhaust A at centre, whereby a dust extracting device is placed in the line of air current without impeding or un-equalizing the draught over the surface of the sieve to any appreciable extent. 5th. The combination of the chamber C placed in a dusty atmosphere, said chamber being broad at top and having sides sloping down to a conveyor E at bottom, in combination with entrances or the air H at top pointing downward, and an exhaust A drawing upward, whereby the particles of dust entering the chamber are projected downward into the worm, and the exhaust is taken from the more quiescent air at top. 6th. The combination of the chamber C, with a series of exhaust passages A, A, passing upward therefrom and delivering into an air trunk provided with a suction apparatus, whereby a uniform exhaust is taken from the chamber throughout its area, substantially as described. 7th. In a purifier, the combination, with an air trunk M and air passages A, of the slides or valves B placed between each passage and the trunk, whereby suction from each passage can be exactly regulated, adjusted and equalised, substantially as described. 8th. In a purifier, the combination of an air trunk M, with a travelling band N N at bottom, whereby the dust deposited in the air trunk is carried to one end and can be extracted easily, substantially as described. 9th. In combination, with a purifier, a collecting chamber or chambers C, S or others, having a worm E T at the bottom of such chamber delivering the dust collected to the outside with the delivery into said chamber pointing downward to said worm, whereby the dust or impurities are projected into the worm, and are by the worm continuously carried to the outside so that the attendant can by inspecting the condition of the deposits at all times ascertain the working of the machine. 10th. The combination of the sieve D, settling chambers C and worm E, with aspirator K A and worm T, for still further differentiating the dust extracted from the material in the screen. 11th. In combination with the screen D having an exhaust drawing the air from above it, the passages X and H and worm Q, whereby any light dust still left on the screen is aspirated away and the purified material carried off by conveyor Q.

### No. 26,429. Shifting Thill for Sleighs.

(*Limonière Mobile pour Traineaux.*)

James G. Richardson, Lake City, Minn., U.S., 12th April, 1887; 5 years.

*Claim.*—1st. The combination, with the cross bars C and the thill, of the sliding coupling composed of the slides F arranged at a distance apart, and the rod  $\nu$  connecting them interposed between the bar and the thill, substantially as and for the purpose described. 2nd. The combination of the thill, the rod B connected therewith, the rod D adapted to be connected with the cutter or sleigh, and the sliding coupling uniting the rods, one of said rods having a rotary and longitudinal movement, and the other rod having a longitudinal movement only relative to the sliding coupling, substantially as and for the purpose set forth. 3rd. The combination of the bar C, the rod D connected therewith, the thill, the rod B secured thereto, the sliding coupling and the catch for holding the coupling in an adjusted position, substantially as described and for the purpose specified. 4th. The combination of the bar C, the rod D, the thill, the rods and the catches E and G diagonally opposite each other and secured to the bar and thill respectively, substantially as and for the purpose described.

### No. 26,430. Car-Coupler. (*Attelage de Char*)

Engelbrecht K. Opheim, LaCrosse, Wis., U.S., 12th April, 1887; 5 years.

*Claim.*—1st. In a car coupler, the combination, with the draw-bar, of a block pivoted thereto and capable of horizontally movement thereupon, and a coupling hook pivoted in said block and movable vertically in relation thereto. 2nd. In a car-coupler, the combination of a draw bar, a horizontally movable block secured thereto, a vertically movable hook secured to said block, and springs connecting the movable block and the draw bar. 3rd. In a car coupler, the combination of a draw-bar, a horizontally movable block, a vertically movable hook secured to said block, a spring connecting the hook and the block and springs connecting the draw bar and block. 4th. In combination, with draw bar A having lugs  $d$  on each side, block B provided with arm D and lugs,  $c, e$ , a vertical pivot pin or bolt C a coupling bolt E provided with a lug  $f$ , a horizontal pivot F connecting the hook E and the arms D, a spring H between the lugs  $c, f$  and springs G between the lugs  $c, d$ , all arranged substantially as shown.

### No. 26,431. Dust Catcher. (*Arrête-poussière.*)

William Comerford and James Comerford, Rathdrum, Ireland, 12th April, 1887; 5 years.

*Claim.*—1st. A dust-catcher or apparatus for filtering air charged with stive dust or other light particles, the filtering portion of which is composed of grain, or seeds, or of coarsely ground or comminuted material, supported between or upon perforated reticulated or otherwise apertured surfaces, giving passage to the air without permitting the escape of the filtering material, as described and shown. 2nd. A dust-catcher or apparatus for filtering air charged with stive dust or other light particles from wheat cleaning flour, grinding, purifying or dressing machinery, the filtering portion of which apparatus is composed of a layer of grain, or small wheat, or crushed corn, or bran, supported between or upon perforated reticulated or otherwise apertured surfaces giving passage to the air without permitting the escape of the filtering material, as described. 3rd. A dust-catcher or apparatus for filtering air charged with stive dust or other light particles, wherein the filtering medium is composed of granular or of coarsely ground or comminuted material, supported by perforated, reticulated or otherwise apertured surfaces giving passage to the air without permitting the escape of the filtering material, in combination with means of mechanically withdrawing and renewing the filtering medium, substantially as described. 4th. A dust-catcher or apparatus for filtering air charged with stive dust or other light particles, constructed of a closed chest or chamber having its walls made double and perforated, reticulated, or otherwise apertured, and the intervening space filled with granular, or with coarsely ground or comminuted material, as herein specified, in combination with means whereby the said material is permitted to travel downwards by its own gravity, for the purpose of withdrawing and replacing the foul material, substantially as shown and described. 5th. A dust-catcher or apparatus for filtering air charged with stive dust or light particles, constructed of a closed chest or chamber having its longitudinal side walls made double, and perforated, reticulated, or otherwise apertured, and the intervening space filled with granular or with coarsely ground or comminuted material, and being closed at bottom by fluted rollers situated within the main chamber and receiving intermittent rotary motion, for the purpose of discharging portions of the material into the main chamber, and having an air passage communicating with the interior of the chest, and provided with a screw conveyor for supplying fresh material to the upper part of the filtering walls, and a second conveyor for removing the foul material from the lower part of the chest, the said rollers and conveyors being operated by mechanism, all as herein described and illustrated in the drawings.

### No. 26,432. Boiler Water Alarm.

(*Indicateur d'eau.*)

Francis R. Stevenson, Erie, Penn., U.S., 12th April, 1887; 5 years.

*Claim.*—1st. In a water-alarm for boilers, the combination, substantially as set forth, of a float, a flexible chain or cord connected with said float, which passes over sheaves and attaches to a weight, so that said weight will move counter to said float in a parallel vertical plane, a steam escape chamber, a valve regulating admission to said chamber, and a lever for moving said valve which is arranged with relation to said float, chain and weight, in a manner substantially as shown, whereby the said lever may be moved by the action of said parts to open said valve when the said float is unduly elevated or depressed. 2nd. In a water-alarm for steam boilers, the combination, substantially as shown, of a shell or case A connected with the boiler by a pipe extending from the top of said case to the steam-space of the boiler, and a pipe extending from the lower part of said case to a point below the low-water line of the boiler, a steam-escape chamber within said case and having its inlet controlled by a valve, and its outlet extending through the wall of said case, a lever for moving said valve, and a float for operating said lever when the said float is unduly elevated or depressed. 3rd. In a water-alarm for steam boilers, the combination, substantially as set forth, of the shell or case A connected with the boiler, as commonly, the steam-escape chamber E having its exit through the wall of the main case, and its entrance controlled by the puppet-valve F, the lever D for moving said valve, the float B, the cross-beam C having sheaves  $c, c$  thereon, the weight  $b$  and the chain B' connecting said weight and float and passing through slots  $d, d'$  in said lever D and over said sheaves  $c, c$  in said beam C.

### No. 26,433. Shop Front. (*Devanture de magasin.*)

John Gooch, Brompton Road, Eng., 12th April, 1887; 5 years.

*Claim.*—1st. Constructing shop fronts with a part or parts thereof movable, relatively to the other part or to one another, as hereinbefore described. 2nd. The method of guiding and supporting the part of the shop front, to be moved by means of a guided wheel or rolling

carriage or framing, substantially as hereinbefore described. 3rd. The method of imparting the desired movements to the wheeled or rolling carriage or framing, and to the part of the shop front supported thereby, by adapting to the said carriage a part of the shop front extensions depending through and below the flooring, and engaging with screwed connections situated below the level of the flooring and operated by connected gearing, substantially as hereinbefore described. 4th. In combination, the movable shop front 5 connected supporting and guided wheeled or rolling carriage or framing 12, the guiding rails 14, the top guides 24, the depending extensions 15, screwed rod 19, and actuating gearing 20, 23, 23, as set forth. 5th. The application of the upright 27, for the purpose of causing the movable part of the shop front to retain its closed position, and for acting as a door post to the private entrance and if required as a means of guiding revolving shutters.

### No. 26,434. Stove Pipe. (*Tuyau de poêle.*)

Frederick G. Mummery and John Baird, St. Thomas, Ont., 12th April, 1887; 5 years.

*Claim.*—A stove pipe having seam *a*, and screw threads *H* and *Hr*, substantially as and for the purpose hereinbefore set forth.

### No. 26,435. Combined Tobacco Box, Match Box and Cigarette Former. (*Boîte à tabac, porte-allumettes et moule à cigarettes combinés.*)

William J. Gardiner, Toronto, Ont., 12th April, 1887; 5 years.

*Claim.*—1st. A box *A* having compartments *C* and *D* formed in it, as described, and a sliding cover *B*, on one side of which the semi-cylindrical receptacle *E* having a semi-cylindrical cover *G* pivoted on it is formed, substantially as and for the purpose specified. 2nd. A compartment *D* having an opening *a* formed in it, and a hole *b* in one of its corners, in combination with a spike *e* connected to an adjustable slide *f*, arranged substantially as and for the purpose specified. 3rd. A semi-cylindrical receptacle *E* connected to the cover *B*, in combination with the semi-cylindrical cover *G* pivoted on the said receptacle, and arranged substantially as and for the purpose specified.

### No. 26,436. Keyless Watch. (*Montre à remontoir.*)

Joseph Robinson, Maryport, Eng., 12th April, 1887; 5 years.

*Claim.*—1st. The combination of the button *H*, attached to the shaft or stem winder *E* to revolve the pinion *C*, with the spring lever *D* that works on the lever pin or cam *B*, substantially herein described and according to the accompanying drawings. 2nd. The combination of the pinion *C* to revolve, the revolving plate or disc *A* to cause the striking of the gong *J*, or bell case or spring *F* to cause the tap or stroke, substantially herein described and according to the accompanying drawings. 3rd. The construction of the spring lever *D* fixed, the reverse way, as in Fig. 7, constructed to cause the taps or strokes when released by the levers *pin*, as shown in Fig. 2, 3, and 4 to mark off 5, 10, 15, 20, or other numbers of minutes, substantially as herein described according to the accompanying drawings. 4th. The combination of the whole of the apparatus worked by the movements of a keyless watch, and the pinion *C* to permit a watch to indicate the correct time in the dark, substantially herein described and according to the accompanying drawings.

### No. 26,437. Electric Battery.

(*Batterie électrique.*)

Charles G. Curtis, Francis B. Crocker and Schuyler S. Wheeler, New York, N. Y., U. S., 12th April, 1887; 5 years.

*Claim.*—1st. The combination, in a battery, of a negative element formed of two parallel walls having openings or passages there-through, a continuous conductive support for the said walls, and a positive element consisting of a solid plate interposed between, and insulated from, the walls of the negative element, and sustained by said support, substantially as and for the purpose set forth. 2nd. The combination, in an electric battery, of a negative element consisting of a holder of conducting material, supporting two parallel carbon walls or row of rods, the said holder having a central opening and a positive element consisting of a plate fitting said opening in the holder, and resting upon insulating supports attached to said holder at the ends of the opening, substantially as described. 3rd. The combination, with the electrode, or electrodes of a battery, of mechanism to raise and lower the electrodes out of and into the solution, and a counterbalancing spring, connected or combined with the raising and lowering movement so as to exert practically the same balancing or supporting effect at all points of the stroke, substantially as described. 4th. The combination, with the electrode or electrodes of battery, of mechanism to raise and lower the electrodes out of and into the solution, means for counterbalancing or partly counterbalancing the weight of the electrodes, and a friction-holding device arranged to take up or support any excess of the weight over the supporting power of the counterbalancing device over the weight and thereby holding the electrodes fixed at any point, substantially as described. 5th. The combination, with the electrode or electrodes of a battery, of mechanism to raise and lower the electrodes out of and into the solution, means for practically balancing or supporting the weight of the electrodes, and constructed to exert practically the same balancing or supporting effect at all points of the stroke, and a friction-holding device arranged to take up or support any excess of the weight over the supporting power of the spring or excess of the supporting power of the spring over the weight, substantially as described. 6th. The combination, with the battery-box or support *A*, of the arm *H* pivoted thereto, the rising and falling electrode or electrodes pivoted or mounted on and guided by the free end of the arm *H*, and means for holding the electrode vertical, or practically vertical, as it rises and falls. 7th. The combination, with the battery-box or support *A*, of the arm *H* pivoted thereto, the rising and falling electrode or electrodes pivoted or loosely mounted on the free end of the arm *H*, and the arm *K*, one end of which is also pivoted to the

box or support, and the free end of which is connected to the electrodes so as to guide or steady them as they rise and fall. 8th. The combination, with the battery-box or support *A*, of the arm *H* carrying the electrode or electrodes, the fixed holding arc or device *S*, and the moving holding device *R* bearing upon or engaging with the fixed device *S*, and connected with arm *so* as to move with it, substantially as described. 9th. The combination, with the battery-box or support *A*, of the arm *H* pivoted thereto and carrying the electrode or electrodes, the arm *K* also pivoted to the support *A* and connected with the arm or portion *J*, and the spring *M*, one end of which is connected with some part of the rising and falling movement so as to cause the lever arm of the pull of the spring to decrease as the tension of the spring increases, substantially as described. 10th. The combination, with the battery-box or support *A*, of the arm *H* pivoted thereto and carrying the electrode or electrodes, the arm *K* also pivoted to the support *A*, the arm or portion *J* connecting the electrode and arm *K*, the fixed holding arc *S* and the holding spring *R* attached to the end of the arm *K* and engaging with arc *S*, substantially as described. 11th. The combination, with the rigid arms or connecting portion *E* formed with the carbon-holder or support *D* at one end, and the zinc-holder or support *F* at the other, of the zinc-holder or support *F* rigidly attached to but insulated from the zinc-holder *F*, substantially as described. 12th. The combination of a series of zinc-holders *F* and a series of carbon-holders *D*, the zinc-holder of each couple being rigidly connected with the carbon-holder of the next couple by a conducting arm or portion, and the carbon and zinc holders of each couple being rigidly attached to, but insulated from each other, and means for raising and lowering the electrodes thus rigidly connected together, substantially as described. 13th. A battery jar or liquid holder, formed with a space or a portion cut away, which space is within the circumscribed figure or general outline of the vessel, and in which space the handle is located, substantially as set forth. 14th. A rectangular jar or liquid holder, formed with one of its corners rounded or cut away, and a handle at that corner which handle comes practically within the circumscribed rectangle, substantially as described. 15th. A rectangular jar or liquid holder, formed with a handle at one corner, and a lip or spout at the diagonally opposite corner both of which are practically within the circumscribed rectangle, substantially as described.

### No. 26,438. Combined Telegraphic and Telephonic Circuit. (*Circuit Télégraphique et Téléphonique.*)

Abner M. Rosebrugh, Toronto, Ont., 12th April, 1887; 5 years.

*Claim.*—1st. The combination, with a single electric circuit, of means, substantially as described, for sending Morse signals, and means, substantially as described, for transmitting signals by induced currents simultaneously in opposite directions, as set forth. 2nd. The combination, with a primary circuit containing a transmitter, of a secondary circuit going to line, and a bridge-circuit containing a receiver arranged to respond to signals from the distant station only, and electrostatic devices arranged in the branches of the bridge-circuit and the ground connections, as set forth. 3rd. The combination, with a telegraphic circuit, and means for sending Morse signals of secondary or induced current, transmitting and receiving devices connected to said circuit, with condensers or other inductors arranged between and connecting said circuits, and electro-magnets, as described, arranged in the telegraphic circuit for the purpose of controlling the secondary circuits, substantially as described. 4th. The combination, with a telegraphic circuit, and means for sending Morse, or similar signals, of secondary or induced current transmitter and receiver devices connected to said circuit, a condenser of great capacity in the ground or bridge circuit of the line, and a condenser of other inductor of small capacity in the line between the induced current instruments and the main line, or between said induced current instruments and the ground. 5th. The combination, with a telegraphic circuit, and means for sending Morse or similar signals, of secondary or induced circuit, transmitting and receiving devices connected to such circuit, a condenser or other inductor in a ground or bridging circuit between the Morse and induced current instruments, and an electro-magnet of comparatively high resistance also in the line circuit, substantially as described. 6th. The combination, with a telegraphic circuit and means for sending Morse or similar signals, said circuit containing a magnet of comparatively high resistance, of secondary or induced circuit, transmitting and receiving devices connected to such circuit, a condenser or other inductor of comparatively small capacity in said induced current circuit, and a condenser of greater capacity in the ground or bridging circuit of the Morse instruments, substantially as described. 7th. The combination, with a telegraphic circuit, and means for sending Morse or similar signals, of secondary or induced current, transmitter and receiver devices connected to said circuit, a condenser of great capacity in the ground or bridge circuit of the line, and a condenser or other inductor of small capacity in the line between the induced current instruments and the main line, or between said induced current instruments and the ground. 8th. The combination, with a telegraphic circuit, and means for sending Morse or similar signals, of secondary or induced circuit, transmitting and receiving devices connected to such circuit, a condenser or other inductor in a ground or bridging-circuit between the Morse and induced current instruments, and an electro-magnet of comparatively high resistance also in the line circuit, substantially as described. 9th. The combination, with a circuit, containing operating instruments, over which primary currents are sent, of a secondary current line circuit, over which induced currents are sent, and an induced current compensating circuit for rendering the induced current home receiver neutral to outgoing induced currents, substantially as described.

### No. 26,439. Fastening for Gloves, Overshoes, etc. (*Agrafe pour Gants, Pardessus, etc.*)

Christy M. A. Macdonald, (Wife of C. Campbell), Ottawa, Ont., 12th April, 1887; 5 years.

*Claim.*—1st. In a boot or glove fastening, composed of a button

and button-hole, a button, having a cylindrical shank threaded at the end and provided with a fixed corrugated shoulder, and a corrugated nut to fasten it to the fabric, as shown and described. 2nd. In a boot and glove fastening, composed of a button and button-hole, a recessed metallic button-hole lining, with eyelet flange on one side, and thin edges for compression over the fabric or a lining plate on the other, as shown and described. 3rd. The combination of the button A, with the eyelet E, constructed and applied as set forth.

**No. 26,440. Stocking. (Bas.)**

John H. Place, David R. Alexander and Thomas P. Matthews, Decatur, Ill., U.S., 12th April, 1887; 5 years.

*Claim.*—A stocking knitted throughout, the knee portion excepted, with a single thread in any well known manner, and having the knee portion knitted with two threads, each forming independent wales, arranged alternately with the wales of the other thread, the connecting threads of each set of wales being intermitted with the intervening wales in the uniform manner herein set forth, a single connecting thread being held by each and every wale loop, substantially as set forth.

**No. 26,441. Automatic Weight Register for Scales. (Régistre Automatique pour Balances.)**

James A. Jamieson and Elizabeth H. Radford, Montreal, Que., 12th April, 1887; 5 years.

*Claim.*—1st. An automatic weight register for scales, having lever or board S connected to lever T by means of piece *z*, vertical piece W connected at lower end to lever T at *g*, and at upper end to bell crank X at *p*, also connected to lever V, having counter weights *b* at *a*, the whole substantially as described and for the purposes set forth. 2nd. An automatic weight register for scales, having frame G hinged at H, and holding cylinders E and F, the latter being connected through bevel wheels K and L, and made to turn through the action of spring *e*, ratchet-wheel *f* and catch *g*, the whole substantially as described and for the purposes set forth. 3rd. An automatic weight register for scales, one part of which is made to swing backwards and forwards automatically, that is frame G, and mechanism contained through the action of levers S, T, V, vertical piece W, and bell crank X, whose end *e* butts against catch *d* and spring *e*, the whole substantially as described and for the purposes set forth. 4th. An automatic weight register for scales, in which the weight is registered by the position of small holes in cross-sectioned, paper wound around cylinders E and F, these holes being made by means of needle points N and O placed on weights D and C, those N placed on weights D are flush with the upper side, when points N and O and cylinders E and F, encircled with cross-sectioned paper come in contact, the whole substantially as described and for the purposes set forth. 5th. The combination of levers S, T, V, vertical piece W, bell-crank X and hopper Q, with frame G, cylinders E and F, bevel wheels K and L, ratchet wheel *f*, catches *d* and *g*, and weights D and C provided with the needle points N and O, also spring *e*, the whole substantially as described and for the purposes set forth.

**No. 26,442. Grain Cleaner. (Cylindre-Emotteur.)**

Wells E. Sergeant and Jacob H. Cook, Minneapolis, Minn., U.S., 12th April, 1887; 5 years.

*Claim.*—1st. The combination of the rotating disk, provided with the annular seat, the leather and brushes secured therein, the draft apertures and the valves, with the stationary disk provided with a dished bosom and the brushes, substantially as specified. 2nd. The combination, with the iron disk having the annular seats, with radial dove-tailed recesses, filled with soft metal, of the leather and brushes and tacks driven the leather and soft metal and clinched by the iron of the disk, substantially as specified. 3rd. The combination, with a perforated cylinder, provided with a vertical series of annular cleaning plates, of a series of alternating rotating disks graduated in distance from said annular plates, the intervals between the disks in succession upward, and their annular plates respectively being gradually increased, whereby the touch of the disks and plates upon the grain is kept up as the grain passes downward through the machine, substantially as specified. 4th. The combination, with a perforated cylinder, provided with a vertical series of annular cleaning plates, and a series of alternating rotary disks, perforated for the passage of air, and graduated in distance from said plates, as set forth, of the air passage surrounding said perforated cylinder and suction fan, substantially as specified. 5th. In combination, with a perforated cylinder, provided with a vertical series of annular cleaning plates, and having a top and a feeding chute connected thereto, of a series of alternating rotary disks perforated for the passage of air, and provided with the bridging guards Z and air passage surrounding the perforated cylinder and a suction fan, substantially as specified. 6th. The combination, in a grain-cleaning machine, of rotating cleaning disks and annular cleaning plates, the said disks being arranged in succession from above downward gradually nearer the respective annular cleaning plates, substantially as specified.

**No. 26,443. Malt Kiln. (Touraille.)**

Charles Brada and Fritz Goetz, Chicago, Ill., U. S., 12th April, 1887; 5 years.

*Claim.*—1st. In a malt kiln, a sectional floor divided transversely into a plurality of series of tilting sections, each series being separate from and independent of the adjacent series combined with separate operating means, substantially as described for each series, substantially as set forth. 2nd. A malt kiln floor, having a series of tilting sections, each provided at a point intermediate of its ends with a pendant arm, combined with a reciprocatory bar connecting together said pendant arms, and means, substantially as set forth, for reciprocating said bar. 3rd. The sectional floor of a malt kiln, divided transversely into a plurality of separate and independent series of tilting sections, combined with separate operating devices, one for each of said series, said operating devices being connected

with the tilting sections at points intermediate of the ends of the latter, substantially as and for the purpose described. 4th. The sectional floor of a malt kiln, divided transversely into a plurality of separate and independent series of tilting sections, each tilting section being provided with a pendant arm, combined with a set of reciprocatory bars for tilting the said sections, and levers for actuating said bars, each reciprocatory bar being connected with the pendant arms of the tilting sections of but one series of said sections, substantially as described. 5th. A sectional malt kiln floor, divided transversely into a plurality of separate and independent series of tilting sections, combined with supports, substantially as described, for upholding said sections, where the ends of the sections of one series are in opposition to the ends of the next adjacent series, and separate operating means, substantially as described, for each series, substantially as described.

**No. 26,444. Rolling Mill. (Laminoin.)**

Constant Roy and Albert Lambert, Paris, France, 12th April, 1887; 5 years.

*Claim.*—1st. The employment of ovens, in combination with a train of rollers, substantially as and for the purpose set forth. 2nd. The combination, with said ovens, of alternately horizontal and vertical rollers, substantially as and for the purpose set forth.

**No. 26,445. Bedding. (Literie.)**

Paul deLanoie, La Patrie, Que., 13th April, 1887; 5 years.

*Reclame.*—Un tube hygiénique pour la literie en générale qui consiste dans la combinaison de trois petits tubes C, A, et A', vissés l'un dans l'autre le tube A' ayant un renflement rond B, le tout tel que décrit et démontré et pour les fins indiquées.

**No. 26,446. Stove. (Poêle.)**

Charles Kibler, Jr., Neward, Ohio, U.S., 15th April, 1887; 5 years.

*Claim.*—1st. In a seven-plate box-stove, the combination of the fire-box proof plate G having the fue-openings H at its rear corners, the top plate of the stove having the pipe collar K made centrally near its rear edge, and the partial partitions I making the flues *i*, *i*, and *i* between the said roof and top plate, the former of which partitions communicate with the fue openings of the roof G, and the latter with the pipe collar, substantially as specified. 2nd. The herein described seven-plate box stove composed of the base plate A, the side plates C, C, the front plate D provided with the door F, the rear plate E, the top plate K provided with the pipe collar L, the roof plate G of the fire box provided with the fue openings H, H, and the partial partitions I, I forming the flues *i*, *i*, *i* between the top plate of the stove and the roof plate of the fire box, substantially as specified.

**No. 26,447. Washing Machine. (Laveuse.)**

Charles C. Maxwell, Watertown, Dak. Ter, U.S., 15th April, 1887; 5 years.

*Claim.*—1st. The rocking rubber consisting of the vertical walls, provided with the scalloped edges and with castings J having perforations H, and the corrugated cross bars connecting the said sides and secured by screws, as set forth, whereby the said corrugated bars may be turned to present new rubbing surfaces, substantially as specified. 2nd. The combination, with the tub of the rocking rubber consisting of the sides having scalloped opposite edges and a curvilinear lower edge, the castings secured to the said sides of the rubber and provided with inner scalloped flanges, and with perforations H and the corrugated bars secured to said sides, substantially as specified.

**No. 26,448. Grass Seed Sower.**

(Semoir à Graine de Foin.)

James Pedler, McGillivray, Ont., 15th April, 1887; 5 years.

*Claim.*—1st. In a machine for sowing grass seed and other grain, the box A formed with aperture A1, in combination with the lever G, or its substantial equivalent, and slide E, substantially as shown and described and for the purpose specified. 2nd. In a machine for sowing grass seed and other grain, the box A formed with an aperture A1, in combination with the lever G, hand hold H and slide E, substantially as shown and described and for the purpose set forth. 3rd. In a machine for sowing grass seed, or other grain, the fan N formed with flanges N1, substantially shown as and described and for the purpose specified. 4th. In a machine for sowing grass seed, or other grain, the fan N formed with flanges N1, in combination with shaft L, bearings M, M, bevelled gear wheels K, K1, shafts I, I1, bearing J, toothed wheels R, R1, and crank handle S, substantially as shown and described and for the purpose specified. 5th. The fan N formed with flanges N1, shaft L, bearings M, M, bevelled gear wheels K, K1, shafts I, I1, toothed wheels R, R1 and crank handle S, in combination with the slide E, lever G, hand hold H and box A formed with an aperture A1, substantially as shown and described and for the purpose specified.

**No. 26,449. Lubricator for Railway Locomotive Steam Engines. (Graisseur de Locomotive.)**

Warren H. Craig, Lawrence, Mass., U.S., 15th April, 1887; 5 years.

*Claim.*—1st. The oil reservoir provided with the central vertical tubular steam induct leading into the condenser, and with the lateral branch or induct opening out of the lower part of the vertical one, and through the side of the reservoir, all being essentially as set forth. 2nd. The combination of the tubular supporting shank having the steam passage extending through it, with the oil reservoir provided with the central vertical tubular steam induct leading up from such reservoir into the condenser, and with the lateral induct opening out of the lower part of the vertical one and extending to

the side of the reservoir and opening into the said supporting shank, all being essentially as set forth. 3rd. The oil reservoir provided with the pocket in its lower part and at one side of it as represented, and having thereto an oil induction tube extending up from such pocket nearly to the top of the said reservoir, and also having the two educts leading from it, the said pocket to the sight feed glass tubes arranged in the same side of such reservoir all being substantially as set forth. 4th. The two sight feed glass chambers or tubes, as arranged, on one side only of the oil reservoir, substantially and for the purpose as represented. 5th. A sight feed lubricator having its two sight feed glass chambers or tubes arranged at one side only of the oil reservoir, and also having its oil educts leading from it to the valve chests of the engine cylinders arranged to extend in opposite direction from the reservoir, as set forth. 6th. The combination, with the lubricator provided with the two sight feed glass chambers or tubes arranged at one side only of the oil reservoir of such lubricator, with a light or lantern arranged, substantially as set forth, to illuminate both of the said sight feed glass chambers or tubes at one and the same time. 7th. The combination, with the lubricator provided with the two sight feed chambers or tubes, with a light or lantern arranged to illuminate both of such chambers or tubes at one and the same time.

### No. 26,450. Clothes Mangle. (*Calandre*)

William Addison, Hamilton, Ont., 15th April, 1887; 5 years.

*Claim.*—1st. In a clothes mangle, the standards E, E and F, F hinged together at the bottom P, working in the pivot hinges m, m attached to the wall board K, in connection with the rollers A, A, gear wheels B, B, the spindles c, c, crank D and link L, as set forth. 2nd. In a clothes mangle, the screw bolts G, G and thumb screws J, J, in connection with the standards E and F for compressing and relaxing the rollers A, A, as described. 3rd. In a clothes mangle, the table Y hinged to the standard E, in connection with the arms I, staple V and spindles c in front standards, as shown, all operating substantially as and for the purposes of a clothes mangle as herein set forth and described.

### No. 26,451. Dry Goods Blocking Machine.

(*Machine pour Aramer les Draps.*)

Marie L. Laurier, Née Robitaille, (Assignee of Alphonse Laurier,) Montreal, Que., 15th April, 1887; 5 years.

*Claim.*—The above described folding machine, composed of the rolls B and C, the standards D having the clamps a and set screws b, bearings c and springs d, knobs E having the eccentric pins e fixed in their shanks and the bed roll C centred on said pins, substantially as shown and for the purpose set forth.

### No. 26,452. Draining Well. (*Puisard.*)

Jules Colas, Montreal, Que., 15th April, 1887; 5 years.

*Claim.*—1st. The combination, in draining-wells made of cast iron rings, of a funnel G as seat of a syphon, as above described. 2nd. The combination of a grate E fixed in cat's hole F, as above described. 3rd. The combination of pins I and clasps H made of cast-iron, with the ring B or other equivalents in bolting or clenching, substantially as and for the purpose hereinbefore set forth.

### No. 26,453. Horse Shoe. (*Fer à Cheval.*)

David J. Pryor, Boston, Mass., U.S., 15th April, 1887; 5 years.

*Claim.*—1st. A horse shoe consisting of the shoe proper A, provided with slots B, openings b, b and lug b, in combination with plate C having lugs c and D on its upper side, and on its lower side the toe-calk F, heel-calks G and series of small calks H and bolt E, as described and for the purposes set forth. 2nd. In a horse shoe, the upper shoe proper A, the plate I having recesses t, the washer K and the lower plate C having toe-calk F, heel-calks G, and series of small calks H, secured to each other in the position herein shown and described and for the purposes set forth. 3rd. The combination, with the horse shoe proper, the lower plate and the intermediate plate having a recess on its upper surface, of the washer interposed between the intermediate plate and the lower plate, and adapted to hold the intermediate plate between the shoe proper and the lower plate.

### No. 26,454. Locomotive. (*Locomotive.*)

Henry K. Adams, Nashville, Tenn., U. S., 15th April, 1887; 5 years.

*Claim.*—1st. In a locomotive, the combination with two driving-axes provided with wheels and crank-pins, of a master-shaft receiving motion from the engines and located above the plane of the driving-wheel axles, a crank-disk on said master-shaft, and rods connecting said crank disk with the crank pins on both the driving-wheels, substantially as and for the purpose set forth. 2nd. In a locomotive, the combination, with a master-shaft receiving motion from the engines, and located above the plane of the main axles, of one or more main axles provided with driving wheels, and in means for communicating motion from the master-shaft to the main axles, said axles being mounted in pedestals which are inclined to the plane of the main axles, as and for the purpose set forth. 3rd. In a locomotive, the combination, with a master shaft receiving motion from the engines and located above the plane of the main axles, of one or more main axles provided with driving wheels, and means for communicating motion from the master-shaft to the main axles, said axles being mounted in pedestals which are inclined to plane of the main axles so that their center is tangential to a circle struck from the centre of the master shaft and touching said center line, substantially as and for the purpose set forth. 4th. In a locomotive, the combination, with the engine-shaft A provided with the pinion B, of the master shaft D, spur-gear C, crank disk E, wrist-pin F, driving-wheels H, H, crank pins I, I, connecting rods K, K and pedestals O, O, which are inclined so that their center line l, l is at right angles to the line 22, substantially as and for the purpose set forth.

### No. 26,455. Vehicle Wheel. (*Roue de Voiture.*)

Ferdinand W. Starr, Springfield, Ohio, U.S., 15th April, 1887; 5 years.

*Claim.*—1st. In a wheel, the combination, with the rim thereof having holes for the spoke tenons, of metallic rings fitted into the rim outside of and around the said holes to prevent the rims from splitting. 2nd. In a wheel, the combination, with the rim thereof constructed of wood, of short thin metallic rings having one end sharpened and embedded into the rim around and outside of the holes for the spoke tenons. 3rd. In a wheel, the combination, with the rim thereof constructed of wood, of metallic rings sharpened from their inner side at one end leaving the interior bevelled at said end, and embedded into the rim outside of and around the holes for the spoke tenons, the bevel being such as to cause the rings to flare and clinch themselves in the wood. 4th. In a wheel, the combination, with the rim thereof constructed of wood, of the metallic rings having a flange at one end and embedded into the rim outside of and around the holes for the spokes sufficiently to leave the flange flush, or substantially flush with the rim. 5th. In a wheel, the combination, with the rim thereof constructed of wood, of thin metallic rings having a flange at one end, and having the other end sharpened from the inner side to form a bevel, the embedded into the rim outside of and around the holes for and spokes, the sharpened end clinching itself in the wood and the flange forming a shoulder for the spokes.

### No. 26,456. Hat. (*Chapeau.*)

Abraham Brahad, Montreal, Que., 16th April, 1887; 5 years.

*Claim.*—1st. A pull-over hat composed of a shape of soft felt coated on the crown to within a distance of its bottom, and along the edge of the brim with adhesive liquid and a pull over covering, all substantially as and for the purposes set forth. 2nd. A pull-over hat having the lower portion of the crown and the brim flexible.

### No. 26,457. Sulphite or Bisulphite of Sodium. (*Sulfite ou bi-sulfite de sodium.*)

William O. Crocker and William P. Crocker, Turner's Falls, Mass., U.S., 16th April, 1887; 5 years.

*Claim.*—1st. The herein-described method of producing sulphite of sodium liquor from sulphate of sodium for the reduction of wood to pulp, consisting in mixing sulphate of sodium with carbonaceous matter, roasting the mixture, leaching out the soluble part, evaporating to dryness, granulating the product, then heating it and agitating it in contact with air or oxygen until incandescence ceases and making into a soluble, substantially as set forth. 2nd. The herein-described method of producing sulphite and bisulphite of sodium liquor from sulphite of sodium for the reduction of wood to pulp, consisting in mixing sulphate of sodium with carbonaceous matter, roasting the mixture, leaching out the soluble part, evaporating to dryness, granulating the product, then heating it and agitating it in contact with air or oxygen until incandescence ceases, converting it into a solution and charging it with a portion of sulphurous acid, substantially as described. 3rd. The herein-described method of strengthening or re-enforcing the action of the sulphite of sodium in making wood pulp, consisting in providing it with an additional portion of sulphurous or other acid before the solution is introduced into the digester, substantially as set forth. 4th. In converting wood into pulp by means of sulphite or bisulphite of sodium, decomposing the sulphite or sulphate of sodium by the addition of calcium, substantially as set forth.

### No. 26,458. Process of Making Bisulphite of Sodium Liquor for reducing Vegetable Structures for obtaining Cellulose, etc. (*Procédé de préparation de la lessive de bi-sulfite de sodium pour réduire les structures végétales pour produire la cellulose, etc.*)

William O. Crocker and William P. Crocker, Turner's Fall's, Mass., U.S., 16th April, 1887; 5 years.

*Claim.*—1st. The herein-described method of producing bisulphite of sodium liquor, consisting in suspending by agitation neutral sulphite of calcium in neutral sulphate of sodium solution, and then charging the mixture with sulphurous acid until decomposition has taken place, as set forth. 2nd. The herein-described method of obtaining bisulphite of sodium liquor, consisting in roasting the acid sulphate of sodium to reduce it to neutral sulphate, and recover one proportion of sulphuric acid, suspending neutral sulphite of calcium in the neutral sulphate of sodium solution, and finally charging the mixture with sulphurous acid, as specified. 3rd. The herein-described method of obtaining bisulphite of sodium liquor from crude acid sulphate of sodium to reduce it to a neutral sulphate and recover one proportion of sulphuric acid, treating the neutral solution with sulphite of calcium suspended by agitation, and charging with sulphurous acid obtained by decomposing the sulphuric acid recovered, as specified. 4th. The herein-described process of obtaining bisulphite of sodium liquor, consisting in suspending by agitation neutral sulphite of calcium obtained by treating the used bisulphite of sodium liquor with oxide or carbonate of calcium in a neutral sulphate of solution, and then charging the mixture with sulphurous acid until decomposition has taken place, as specified.

### No. 26,459. Machine for Sewing Straw Braids in Making Hats. (*Machine à coudre les chapeaux de paille.*)

Thomas L. Kay and Summerfield Douglas, Hamilton, Ont., 16th April, 1887; 5 years.

*Claim.*—1st. The combination, in a feed mechanism, with the ec-

centric B and the feed surface A on the shaft C, in connection with the shaft J and rocker H to give the horizontal motion, the combination in a feed mechanism, with the crank E on the shaft D, with the connecting rods I and lever W in connection with the shaft G and arm F, and rocker H to give the perpendicular motion, as set forth. 2nd. The combination, in a needle bar motion, with the eccentric L on the shaft 6 connecting rod M, crank N on shaft D and lever O in connection with the link G, as described. 3rd. The combination, in a presser foot and adjustable guide with the bracket A<sup>2</sup>, hub G<sup>2</sup> and shaft S in connection with the front part B<sup>2</sup> of the foot plate, and the rear half C<sup>2</sup> of the same with the spring H<sup>2</sup>, and spring E on shaft S, as shown substantially as herein set forth.

**No. 26,460. Machine for Grinding Spherical Balls.** (*Appareil pour polir les corps sphériques.*)

Henry Richardson, Waltham, Mass., U.S., 16th April, 1877; 5 years.

*Claim.*—1st. The combination of the revolve M and frustum D, provided with means of revolving them, as described, with the ring E automatically adjustable as set forth, and with the tubular rotary grinder H arranged with such frustum D and ring E, and having means of revolving it the said grinder, as explained. 2nd. The combination of the revoluble tubular H, its pulley i and the vertically adjustable eccentric I having means of adjusting it, as described, with the conic frustum D, the automatically adjustable annulus E and the revolver M having mechanism for revolving it, as explained, the whole being to operate substantially in manner and for the purpose as represented. 3rd. The combination of the lever R and scale T, with the ball grinding machine, substantially as described, consisting of the revolver M, frustum D, automatically adjustable ring E and grinder H, the said grinder and revolver being provided with means of revolving them, as specified.

**No. 26,461. Stove.** (*Poêle.*)

Giles S. Ransom, Toronto, Ont., 1887; 5 years.

*Claim.*—1st. The fire pot B having the walls thick at centre or just below centre, as hereinbefore described. 2nd. The combination of the grate D, with the draw-centre E, substantially as and for the purpose set forth. 3rd. The combination with the grate D, the spindles a, ar, and the bolts P, substantially as and for the purpose set forth. 4th. The combination of the lever J, with the grate D, substantially as and for the purpose set forth. 5th. The combination of the openings N, the heating chambers G, G<sup>1</sup>, the flue H and the perforated slide L, substantially as and for the purpose set forth. 6th. The combination of the heating chamber G, G<sup>1</sup>, with the fire pot B, substantially as and for the purpose set forth. 7th. The combination of water box X, X, the fire pot B and heating chamber G, G<sup>1</sup>, substantially as and for the purpose set forth.

**No. 26,462. Gearing for Moving or Propelling Traction Engines, etc.** (*Appareil de mise en mouvement des machines de traction, etc.*)

George P. Brown, Malahide, Ont., 16th April, 1887; 5 years.

*Claim.*—The worm screw b on the shaft a, and the screw pinion c on the countershaft f, and the arrangement for throwing them into or out of gearing, and the gearing at the other end of the counter shaft f and line shaft k, and the two arrangements h, h, q, l and m, n, n for throwing these parts into and out of gearing, as shown, so as to put in motion or stop or reverse the line shaft k, all in combination, substantially as and for the purposes hereinbefore set forth, and only as applied to traction engines or articles propelled in a similar manner.

**No. 26,463. Radiator for Steam, etc.** (*Serpentin pour la vapeur, etc.*)

Clarence E. Safford, Lancaster, N.Y., 16th April, 1887; 5 years.

*Claim.*—1st. The combination, in a radiator, of a series of vertical sections A, each composed of a bottom chamber a, a top chamber b and vertical radiating tubes C made oblong in cross-section and connecting said top and bottom chambers and arranged with their flat or wide sides outward, and horizontal tubes d connecting the vertical tubes C between the bottom and top chambers, substantially as set forth. 2nd. In a radiator, the combination, with two radiating sections, of a hollow coupling C, provided on its outer side with a right and left screw-threads, and on its inner side or end with holding surfaces for the reception of a tool or wrench by which the nipple can be turned, substantially as set forth. 3rd. In a radiator, the combination, with two radiating sections, of a hollow coupling G provided on its outer surface, with right and left hand screw-threads g, g<sup>1</sup>, separated by an annular groove g<sup>2</sup> which is depressed below the screw-thread, and on its inner side with holding surfaces for the reception of a wrench, substantially as set forth.

**No. 26,464. Water Gauge for Steam Boilers.** (*Indicateur d'eau pour chaudières à vapeur.*)

Dougald H. Roberts, Wallaceburg, Ont., 16th April, 1887; 5 years.

*Claim.*—1st. A gauge-cock A, with a passageway E formed in it, in combination with a head having two or more seats formed on its face, and adjustably connected to the cock A, so that either of the seats may be utilized for the purpose of closing the passageway E, substantially as and for the purpose specified. 2nd. The head G having the recesses I formed on its face to receive the packing F, in combination with a lug J formed on the head G, and pivoted on the pin or spindle D carried by the jaws C formed on the cock A, substantially as and for the purpose specified. 3rd. The head G having the recesses I formed on its face, a passageway H to receive the pieces of packing F which fit into the recesses I, in combination with the lug J formed on the head G and pivoted on the pin or spindle D

carried by the jaws C formed on the cock A, substantially as and for the purpose specified. 4th. The head G having the recesses I formed on its face to receive the packing F, and the lug J to pivot on the pin or spindle D, in combination with the block L designed to fit on the pin or spindle D between the lug J and jaws C, substantially as and for the purpose specified.

**No. 26,465. Routing Machine.** (*Machine à ciseler.*)

George K. Birge, Buffalo, N.Y., U.S., 16th April, 1887; 5 years.

*Claim.*—1st. A routing machine for cutting patterns upon print-rollers, etc., consisting of a carriage, adapted to receive the print-roller to be operated upon, mechanism to be controlled by hand to give a motion to the carriage in the direction of the length of the print-roller, and a rotary motion to the roller in both directions, and a revolving drill or routing tool adjustable to and from the roller, substantially as shown and described. 2nd. A routing machine for cutting patterns upon print-rollers, consisting of a carriage adapted to receive the print-roller to be operated upon, and auxiliary roller adapted to receive the design of the pattern to be cut upon the print-roller mechanism, controlled by hand to give a motion in the direction of the length of the print-roller to the carriage, and a rotary motion to the rollers in both directions, a revolving drill or routing tool adjustable to and from the print-roller, and a pencil adjustable to and from the auxiliary rollers, substantially as and for the purpose stated. 3rd. In a routing machine for cutting patterns upon print-rollers, the combination, with the print-roller c mounted upon the axle b<sup>2</sup> having a rotary motion in either direction, controlled by the hand wheel d<sup>5</sup>, operating the intervening mechanism, as shown, and the carriage b in which the axle b<sup>2</sup> is mounted, such carriage having a motion in the direction of the length of the print-roller in either direction upon its bed, controlled by the hand-wheel e<sup>5</sup> operating the intervening mechanism, as shown, of the revolving drill or routing tool n adjustable to and from the roller c in a line perpendicular to its axis by means of the foot-lever h<sup>2</sup>, and intervening mechanism substantially as shown and described. 4th. In a routing machine for cutting patterns upon print-rollers, the combination, with the print-roller c, and auxiliary design-roller t mounted upon the axles b<sup>2</sup> and s, having a rotary motion in either direction controlled by the hand-wheel d<sup>5</sup>, operating the intervening mechanism, as shown, and the carriage b in which the axles b<sup>2</sup> and s are mounted, such carriage having a motion in the direction of the length of the print-roller in either direction upon its bed controlled by the hand-wheel e<sup>5</sup> operating the intervening mechanism as shown, of the revolving drill or routing tool n and pencil-point v adjustable to and from the rollers c and t respectively in a line perpendicular to their axis by means of the foot-lever h<sup>2</sup>, and intervening mechanism, substantially as shown and described.

**No. 26,466. Rudder.** (*Gouvernail.*)

Richard Fleming, Boston, Mass., U.S., 16th April, 1887; 5 years.

*Claim.*—1st. In a rudder of the character described, the body provided with the rudder proper B, in combination with a rope or ropes z for securing the inner end of said body to the stern of the vessel and tiller-ropes D, substantially as described. 2nd. In a rudder of the character described, the body A having the holes f, k, v, and rudder proper B secured to said body, in combination with the tiller-ropes D, pulleys g, h, wheel K, stays d, ropes z, and vessel C, substantially as and for the purpose specified. 3rd. In a rudder of the character described, the combination of the following instrumentalities, to wit: a body provided with a downwardly projecting rudder proper, a rope or ropes for securing the body to the vessel, tiller-ropes secured to the outer end of said body, pulleys for said ropes journalled in the bulwarks of the vessel, and a wheel for working said tiller-ropes, all constructed, combined and arranged to operate substantially as shown and described. 4th. In a rudder of the character described, the body A provided with a rudder proper, and with the stays or guards d, in combination with the rope z and tiller-ropes D, substantially as described. 5th. In a rudder of the character described, the combination of the body A provided with the rudder proper B, two tiller-ropes D, a rope or ropes for suspending or securing the inner or pivotal end of said body to the stern of the vessel, suitable sheaves for the tiller-ropes, and a wheel or means for operating the tiller-ropes, substantially as set forth. 6th. In a rudder of the character described, the intermediate sheaves h, in combination with the vessel C, wheel K, tiller-ropes D and body A provided with the rudder proper B and rope z, substantially as and for the purpose set forth.

**No. 26,467. Portable Scaffold.** (*Echaffaudage Portatif.*)

Alfred Lapointe, Montreal, Que., 16th April, 1887; 5 years.

*Claim.*—1st. A portable scaffold, consisting of a frame carried on the outside sill by suitable adjustable supports, carrying on its outer end a platform and secured to both outside and inside sills, substantially as herein set forth. 2nd. In a portable scaffold, the combination of the following elements: two side bars turned down at their inner ends, grips or hold-fast sliding on same, and raised or lowered by screwed bolts working in bars, bolts adjusted vertically in bars or attachments to same and carrying apparatus, bolts with turned and bent up ends, and means for adjusting same, and platform with guard round same, all as herein set forth and for the purposes set forth.

**No. 26,468. Drum.** (*Tambour.*)

Henry G. Lehnert, Philadelphia, Penn., U.S., 16th April, 1887; 5 years.

*Claim.*—1st. A drum, having its batter head provided with a snare, substantially as described. 2nd. A set of snares applied to the batter head of a drum, substantially as described. 3rd. A drum, having on the under side of its batter head a square, substantially as described. 4th. A drum, having both its batter and square head provided with



snare, substantially as described. 5th. A drum, having recesses or beds for a set of snares, which are applied to the batter head of the drum, substantially as described. 6th. A drum, having its batter head provided with a snare, and said head formed convex in relation to said snare, substantially as described. 7th. A drum, having its batter head provided with a snare, and its hoops formed with recesses on their inner sides relatively to said snare, substantially as described.

### No. 26,469. Bicycle. (*Bicycle.*)

Elenorio C. Hernandez, Boston, Mass., U. S., 16th April, 1887; 5 years.

*Claim.*—1st. In a bicycle, the combination of the following instrumentalities, to wit: a main driving-wheel, provided with an axle to which it is rigidly attached, a body mounted on said axle and provided with handles and a seat for the rider, a ratchet mechanism for preventing the wheel from turning backward, a crank rigidly attached to either end of said axle, a pedal mounted on the wrist-pin of each of said cranks, and provided with an upwardly-projecting standard for keeping the pedal in a horizontal position, or nearly so, a slide pivoted to the upper end of each of said standards and adapted to work vertically on said body, a spring connected with each of said standards and adapted to yield to permit the cranks to "pass the center," a backbone or arm, provided with a trundle-wheel at its lower end, and adapted to be elevated and secured in an elevated position to convert the bicycle into a unicycle, substantially as described. 2nd. In a bicycle, the combination of the following instrumentalities, to wit: the arm G provided with the wheel K and secured to the block  $\rho$ , and the arm L hinged to the upper end of the arm G, the block  $\rho$  being pivoted to the body B and provided with spring  $i$  for holding the arm G in an elevated position, and said body provided with the button  $p$ , adapted to engage the short arm L and keep the arm G depressed, substantially as set forth. 3rd. In a bicycle, the slide F fitted to work in the ways  $f$  on the body B, and provided with the rod T and spring  $v$ , in combination with the pedal M provided with the rigid standard R, having the bolt S, substantially as described. 4th. In a bicycle, the ratchet-wheels H, J, provided with the pawls E, in combination with the wheel A and body B, said ratchet-wheels being arranged in such a manner that the spaces between the teeth of one of said wheels will stand opposite the teeth in the other, substantially as and for the purpose set forth.

### No. 26,470. Wringer Wash Beuch.

(*Banc d'Essoreuse.*)

George J. Cline and Stephen E. Cowdery, Goshen, Ind., U. S., 16th April, 1887; 5 years.

*Claim.*—A vertical wringer-frame, pivoted to a horizontal supporting frame, and having the lower ends of its standards notched to receive a transverse bar of said horizontal frame, and adapted to be engaged by detents, substantially as set forth.

### No. 26,471. Manufacture of Brush Knots or Tufts of Bristles, etc. (*Fabrication des Touffes de Soies, etc., pour Brosses.*)

Richard C. Fellows, New York, N. Y., U. S., 19th April, 1887; 5 years.

*Claim.*—The improved brush knots described, the same being composed each of a number of bristles or fibers doubled at the middle and there encircled by a close-fitting ring of fine and pliable binding wire, the ends of which wire are tightly twisted together, so as permanently to confine and bind together the bristles in the ring, the diameter of said ring being less than the greatest diameter of the knot at the eye, so that the wired knots can be set in holes, which the bristles, when inserted, will sensibly fill, and the said knots being adapted for separate sale by insertion in holders, substantially as set forth.

### No. 26,472. Electric Watchmen Controlling Apparatus. (*Appareil Electrique pour Contrôler les Gardes de Nuit.*)

Obokar Skrivan and Francis Dvorak, Vinohrady, Austria, 19th April, 1887; 5 years.

*Claim.*—1st. An electric apparatus for controlling watchmen, consisting of one or several controlling stations and posts, so arranged that the user is compelled to move a hand during each period, which movements are announced automatically on the controlling clocks and electric bell in the controlling station, substantially as set forth. 2nd. The construction of the post commutator, in such a manner that by turning hand  $d$  the user turns disc  $f$ , with as many teeth as numbers on dial-plate and the ratchet disc  $\rho$ , substantially as set forth. 3rd. The construction of the electric controlling clock on plate H, with magnets M, the armature, as described, with escapement ratchet-wheel  $a$  and nut  $b$ , in combination with the contacts  $r, r, s, s$ , of the clock G and the bell F, substantially as and for the purpose set forth. 4th. The combination of the contact nut  $b$  of each controlling clock, with the contacts  $r, r$ , and  $s, s$ , of the normal clock G, in such a manner that no current is sent by the normal clock if the hand  $d$  is not moved at the prescribed time, substantially as set forth. 5th. The application of any usual transmitter, in connection with the above apparatus, and arranged so as to give a single stroke, instead of a continual ring, for the purpose set forth and described. 6th. In an electric apparatus for controlling watchmen, consisting of the controlling clock D and normal clock G, with their respective connections or parts, and so arranged as to produce the result set forth in the specification and illustrated in the drawings.

### No. 26,473. Railroad Signal.

(*Signal de Chemin de Fer.*)

Elias H. Mott, Oneida, N. Y., U. S., 19th April, 1887; 5 years.

*Claim.*—1st. In a railway signal, the combination of the yielding

bars adapted to be operated by a passing train, a rock-shaft extending beneath the track and having two arms  $e, e_1$ , the latter of which has a lug  $e_2$  extending inwardly to a point beneath the head of one of the rails of a track, a link  $d_2$  intermediate of the arm  $e$  and the yielding bars, a wire F connected to the lug  $e_2$  and extending beneath the head of the rail, the staples or eyes  $f$  for holding the wire, the signal devices and connections intermediate of the wire and the signal, substantially as described. 2nd. In a railroad signal, the combination of the following elements, namely: The yielding movable bars C arranged alongside of the track rail, and adapted to be operated by the car-wheel flanges, the curved spring D having the arm  $d_1$ , a rock shaft E, having the arms  $e, e_1$ , the pivoted bell-crank levers, the connecting wires, a bell, a pivoted spring actuated bell hammer and a slotted guide-arm, substantially as described. 3rd. In a railroad signal, the combination of the following elements, namely: the yielding movable bars C arranged alongside of the track rail, and adapted to be operated by the car-wheel flanges, a rock-shaft E having the arms  $e, e_1$  operated by the movable bars C, a bell and the wires connecting the rock-shaft with the bell, substantially as described.

### No. 26,474. Furnace for Precious Metals.

(*Fourneau pour les Métaux Précieux.*)

Charles L. Hartsfeld, Newport, Ky., U. S., 19th April, 1887; 5 years.

*Claim.*—1st. The portable water-jacketed blast furnace A, constructed as shown and described, of two sheet-iron casings  $a, a'$ , each sections separable horizontally conical in general form, and provided below with a removable bottom, substantially as set forth. 2nd. The portable water-jacketed blast furnace, constructed of two sheet-iron casings in sections, as described, of slightly conical form from the boshes upward, flaring thence downward to a cylindrical bottom section containing the slag and metal openings, in combination with a metal foundation ring suitably supported and provided with hinged bottom-plates, substantially as set forth. 3rd. The combination of the conical water-jacketed sheet-iron, blast furnace, consisting of a conical portion resting upon a cylindrical lower section, a metal foundation ring, within which the better plates are hinged, and a lining of refractory material resting upon the foundation ring, and carried upward to, or nearly to, the boshes, substantially as set forth. 4th. The combination of a water-jacketed blast-furnace, a connecting pipe C, a washer D and a perforated steam discharge ring arranged within the connecting pipe to force the products of combustion from the furnace to the washer, substantially as set forth. 5th. The combination of the furnace A, connecting-pipe C, steam discharge ring  $r$ , spray-wheel  $w$  and the washer D, substantially as set forth. 6th. In combination, with a blast furnace and a connecting C, the washer D, constructed as described, narrowed at the bottom, provided with partitions  $l$ , uptake E and overflow orifice, substantially as set forth. 7th. The washer D, consisting of an elongated tank, triangular in cross-section, provided with the inlet C, outlet E, partitions  $l$ , overflow orifice  $o$  and draw-off cocks  $m$ , substantially as set forth.

### No. 26,475. Reel-Supporting Arm for Harvesters. (*Bras Supportant le Râteau pour Moissonneuses.*)

John B. Gemmill, Red Bluff, Cal., U. S., 19th April, 1887; 5 years.

*Claim.*—1st. The combination, with an arm for supporting the outer or elevator end of a harvester reel, of a reel-bearing hanger secured the forward end of the arm, the forward end of the hanger being turned at right angles, or nearly so, to the bearing section, and adapted to form a support for a bearing adjusting bolt, a journal-box mounted on said hanger and an adjustable bolt, substantially as set forth. 2nd. The combination, with an arm for supporting the outer or elevator end of a harvester reel, of a reel-bearing hanger secured to the forward end of the arm, said hanger consisting essentially of a solid bar of metal, bent in zig-zag or step form, and adapted to be bolted to the said arm, and a journal-box mounted on said hanger, substantially as set forth. 3rd. In a harvester, the combination, with an arm located in tilting adjustment across and above the path of the elevator, of a hanger secured to the forward end of the arm, and having an upturned end, a journal-box adjustably secured to the lower section of the hanger, an adjusting bolt or rod attached to the said journal-box and extending through the upturned end of the hanger, and a nut for moving the bolt, substantially as set forth. 4th. The reel-supporting hanger, consisting essentially of a zig-zag piece of solid metal, having an upturned outer end, a diagonal brace extending from the upturned end of the lower section to the middle section, a second diagonal brace extending from the upturned end of the lower section to the middle section, a second diagonal brace extending from the middle section to the supporting-arm to which the hanger is secured, the sliding journal-box and the box-adjusting bolt passing through the upturned end of the hanger and a nut, the whole constructed and arranged substantially as set forth.

### No. 26,476. Speed and Pressure Air or Gas Gauge. (*Indicateur de la vitesse et de la pression de l'air ou du gaz.*)

John Gordon, jr., and J. B. Lowdon, Dundee, Scotland, 19th April, 1887; 5 years.

*Claim.*—1st. The combination of a spring-pressed variably-weighted collapsible bellows forming a pressure or vacuum receiver, with an indicating speed or pressure dial operated by a suitable multiplying lever, and band and pulley or rack and pinion gear, and a uniformly rotated registering drum receiving permanent records of the movements of the said collapsible bellows by a pencil or other marker conveniently mounted on a multiplying lever operated by the said bellows, substantially as and for the purposes described. 2nd. In such an improved speed or pressure gauge, the combination of a spring-pressed or weighted collapsible bellows forming a pressure or vacuum receiver, with an indicating speed or pressure dial operated by a suitable multiplying lever, and band and pulley or rack and pinion gear to indicate the pressure or speed of gaseous currents. 4th. In

such an improved speed or pressure gas gauge, the combination of a spring-pressed or weighted collapsible bellows forming a pressure or vacuum receiver, with a uniformly rotated registering drum receiving permanently the record of the movements of the said collapsible bellows by a pencil or other marker conveniently mounted on a multiplying lever operated by the said bellows to record automatically and permanently the duration, variation and magnitude of any changes of gaseous pressure. 4th. In such an improved speed or pressure gas gauge, the construction of the collapsible bellows consisting of rigid top and bottom plates of any suitable material connected by a flexible or collapsible cylindrical case, the top plate of the said bellows being spring-pressed or equivalently weighted so as to afford a constantly increasing resistance to the expansion or collapse of the bellows from a normal point of equilibrium, to indicate by suitably connected devices the variable pressures above or below atmosphere of the gas or air within the said bellows.

**No. 26,477. Attachment to Flesh or Bath Brushes.** (*Disposition aux brosses à friction ou de bain.*)

William J. Turkington, Aurora, Ont., 19th April, 1887; 5 years.

*Claim.*—1st. A fountain, flesh or bath brush provided with a reservoir being either enclosed in the brush or handle or attached thereto and constructed in such a manner that when in use the liquid will flow through and saturate the brush, substantially as and for the purposes hereinbefore set forth. 2nd. The combination of the flesh or bath brush A with the reservoir B, the tube D and the stop valve F, substantially as and for the purpose hereinbefore set forth. 3rd. The combination of the perforated nipple J with the reservoir B and stop valve F, substantially as and for the purpose hereinbefore set forth. 4th. The case of metal or other suitable material as shown in drawings P and Q with flanges R, R, strip S and slot T, in combination with the brush A, substantially as and for the purpose hereinbefore set forth.

**No. 26,478. Car-Coupler.** (*Attelage de Chars.*)

Charles E. Seabury, Stony Brook, N. Y., U. S., 19th April, 1887; 5 years.

*Claim.*—1st. The draw-head A, provided with a coupling hook acted upon by springs within the draw-head in combination with the draw-head B provided with a coupling pin, and with a spring to guide the hook into engagement therewith, substantially as described. 2nd. The draw-head A, provided with two oppositely arranged hooks D, D and two springs F, F, the points of the hooks being bevelled as shown at e, in combination with the draw-head B provided with the pin E and inwardly pointing springs G, G, substantially as described. 3rd. The connecting hooks placed upon the pin C, and held in horizontal position by the spring H, substantially as described. 4th. The connecting hooks united by the tube b, substantially as described. 5th. The connecting hooks D acted upon by the springs F and also by the spring H, substantially as and for the purposes set forth.

**No. 26,479. Cementing Tufts of Fibrous Material in Bored Stock for the Manufacture of Brushes, etc.** (*Collage au ciment des touffes de matières fibreuses dans les trous des blocs, pour la fabrication des brosses, etc.*)

Richard C. Fellows, New York, N. Y., U. S., 19th April, 1887; 5 years.

*Claim.*—The method of securing knots or bunches of bristles or fibre in a bored stock, by introducing powdered cement, liquifying it in the holes by the action of heat, inserting the knots or tufts and allowing the cement to set or harden, substantially as described.

**No. 26,480. Illuminating Gas Apparatus.**

(*Appareil à gaz d'éclairage.*)

Erazm J. Jerzmanowski, New York, N. Y., U. S., 19th April, 1887; 5 years.

*Claim.*—The gas generating apparatus, substantially as hereinbefore set forth, consisting of a circular casing having a flue extending from one side, and containing a central chamber having means for producing combustion therein, an annular generating-chamber surrounding the central chamber and provided with a lower outlet, and with means whereby steam and hydrocarbon may be injected therein, and suitable plates and partitions, substantially as described, whereby the products of combustion from the central chamber are caused to pass down one side under and up the other side of the generating-chamber and thence to the flue.

**No. 26,481. Electro-Phonetic Telegraph Sounder.** (*Avertisseur Télégraphique électro-phonétique.*)

Henry A. House and Henry A. House, jr., Bridgeport, Conn., U. S., 20th April, 1887; 5 years.

*Claim.*—1st. An electro-phonetic telegraph sounder, provided with a frame consisting of a ring having a bearing for the sounding head, and two projecting arms supporting the magnet and adjuncts, substantially as described. 2nd. The combination, with the frame consisting of a ring and projecting arms, of a cover consisting of a flexible sheet bent to form a back piece and sides enclosing the arms, substantially as described. 3rd. The combination of the ring arms and cover consisting of a sheet bent to form sides and back piece, and provided with lips adapted to engage with bearings upon the frame, substantially as described. 4th. The combination of the frame having a threaded ring seat y and arms and a sound reflector screwing into the frame ring and intermediate sound head, substantially as described. 7th. The combination, with the sounding head and centrally projecting bar, of the electro-magnet armature and limiters carried by the bar to directly limit the movements of the

armature, substantially as described. 6th. The combination of the sounding head bar extending therefrom, electro-magnet pivoted armature extended to form a horn, and limiters carried by the bar to define the movement of the armature, substantially as described. 7th. The combination of the sounding head bar extending therefrom, electro-magnet pivoted armature extended to form a horn, and limiters carried by the arm to define the movement of the armature, and spring normally holding the armature in an elevated position, substantially as described. 8th. The combination of the sounding head and electro-magnet and armature and a bar extending from the head with adjustable bearings directly limiting the movements of the armature, substantially as described. 9th. The combination of the frame having a ring and parallel arms, sounding head provided with a projecting bar carrying limiters, electro-magnet carried by one of the arms, and armature arranged to make contact with the limiters, substantially as described. 10th. The combination of the sounding head, magnet armature bar provided with two arms carried by the head, and limiters carried by the bars to make contact with the armature, substantially as described.

**No. 26,482. Type Writing and Matrix Making Machine.** (*Graphotype faisant les matrices.*)

George W. Baldrige, St. Louis, Mo., U. S., 20th April, 1887; 5 years.

*Claim.*—1st. In a type-writing and matrix-making machine, the combination of the pad D, the frame C<sup>1</sup> having bevels c<sub>3</sub>, and the type-bars C, C having the bevels c<sub>2</sub>, said bars in starting being lifted from the pad by means of the bevels c<sub>2</sub>, c<sub>3</sub>, as and for the purpose described. 2nd. In a type-writing and matrix-making machine, the combination of the magnet J, the plunger I, the elastic type-bar C, and the bearing E, substantially as described. 3rd. In a type-writing and matrix-making machine, the combination of the frame C<sup>1</sup>, the elastic type-bars C, C, the pad D, the magnet J, the plunger I and the bearing E, substantially as described. 4th. In a type-writing and matrix-making machine, the combination of the frame C<sup>1</sup>, the keys A, A, the connection a<sub>1</sub>, a<sub>2</sub>, the type-bars C, C, the pad D, the magnet J, the plunger I, and the bearing E, substantially as described. 5th. In a type-writing and matrix-making machine, the combination of the keys A, A, the upper-case lever N, and the contact bar K, substantially as described. 6th. In a type-writing and matrix-making machine, the combination of the lever B, the rod b<sub>5</sub>, the lever b<sub>1</sub>, the link b<sub>2</sub>, the lever P, the link p<sub>2</sub>, the dog Q, and the rack R, substantially as described. 7th. In a type-writing and matrix-making machine, the combination of the keys A, A, the connections a<sub>1</sub>, a<sub>2</sub>, movable contact bar K, type-bars C, C, lever N, the rod n<sub>2</sub>, the frame C<sup>1</sup>, and the stop c<sub>8</sub>, for the purpose described. 8th. In a type-writing and matrix-making machine, the combination of the carriage R<sub>1</sub>, the feed-rolls H, F, the pinions connecting the feed-rolls, the shaft R<sub>2</sub>, the lever t, the pawl t<sub>1</sub>, and the ratchet t<sub>2</sub>, as and for the purpose described. 9th. In a type-writing and matrix-making machine, the combination of the keys A<sub>1</sub>, A<sub>2</sub>, A<sub>3</sub>, and the yoke S, substantially as and for the purpose set forth. 10th. In a type-writing and matrix-making machine, the combination of the severally movable elastic type-bars C, C, the plunger I, and the bearing-surface E, substantially as described. 11th. The combination of the key A, the elastic connections a<sub>1</sub>, a<sub>2</sub>, the frame C<sup>1</sup> and the type-bar C to allow the plunger to rise sufficiently to clear the type-bar before said connection acts to draw the type-bar back. 12th. In a type-writing and matrix-making machine, the combination of the connection a<sub>2</sub>, the type bar C and the flanges c<sub>3</sub>, and c<sub>4</sub>, O, said connection a<sub>2</sub> being jointed to said type-bar between said flanges for the purpose of moving the type-bar properly. 13th. In a type-writing and matrix-making machine, the combination of the shaft R<sub>2</sub> the arms W, W, the bar W<sub>1</sub>, the frame C<sup>1</sup>, and the rollers W<sub>2</sub>, W<sub>3</sub>, substantially as described. 14th. In a type-writing and matrix-making machine, the combination of the shaft R<sub>2</sub>, the arm f<sub>2</sub>, f<sub>3</sub>, W, W, and the hooks f<sub>3</sub>, f<sub>3</sub>, as and for the purpose described.

**No. 26,483. Dust Collector.**

(*Aspirateur de poussière.*)

William E. Allington, East Saginaw, and William H. Curtis, Jackson, Mich., U. S., 20th April, 1887; 5 years.

*Claim.*—1st. In a dust collector, the combination, with a suitable duct or separating chamber provided with an air outlet at its top, of a chamber surrounding said air outlet and having itself an outlet for the air freed from dust, substantially as described. 2nd. In a dust collector and separator, the combination of a spirally arranged duct, of pipe having sides or walls of varying inclines, a communicating hopper secured to the underside of said duct, and at one side of the centre line thereof, and a chamber above said duct, substantially as described. 3rd. In a dust collector and separator, the combination of a spirally arranged pipe or duct having sides or walls of varying inclines, a bottom provided with openings, and suitable deflectors arranged over said openings, and a hopper situated under said pipe or duct, substantially as described. 4th. In a dust collector and separator, the combination of a spirally arranged duct having walls of varying inclines and an enlarged central portion, a hopper under the same, and a short central pipe connecting the hopper in the said central portion of the duct, substantially as described. 5th. In a dust collector and separator, the combination of a spirally arranged duct having walls of varying inclines, a bottom provided with openings and upwardly curved deflectors arranged over portions of said openings, a hopper situated at one side of the central end portion of said duct, a chamber secured on said duct having an inwardly projecting flange secured thereto between the duct and said chamber on its inner lower periphery, and a pipe having an opening and closing cover or plate movably secured to said chamber, substantially as described. 6th. In a dust collector and separator, the combination of a spirally arranged pipe or duct forming the main portion of the machine and having sides or walls of varying inclines arranged to form a circular or nearly circular chamber in the central portion of the said duct, the bottom having openings a<sub>7</sub>, a<sub>11</sub>, suitable upwardly inclined curved deflectors arranged over said openings, a hopper secured to the under side of said duct, and having an opening and closing door at its lower portion, a cylindrical chamber secured to the top

portion of said duct, a dust-exit pipe secured to its upper side, a pure air escape pipe secured to the top portion of said chamber, and an opening and closing cover or plate, substantially as described. 7th. In a dust collector and separator, the combination of a spirally arranged duct or pipe having a bottom  $a_2$  formed with elongated openings  $a_7$ ,  $a_{11}$ , and sides or walls of varying incline which form the duct wider at the bottom than at the top, and being nearly circular in the central portion of the machine, a hopper secured to the under side of said duct and communicating through said elongated openings  $a_7$  and  $a_{11}$  with the said duct, and pipe  $A_2$  opening into the hopper from the central nearly circular portion  $A_1$  of the machine, a metallic rectangular box having one open end secured on the under side of the bottom  $a_2$ , a cylindrical chamber above the duct having a flange provided with an opening, and an upward and downward flaring guard, a dust-exit pipe secured to the cylindrical chamber at its uppermost side, the pure air escape pipe on the top portion thereof and an opening and closing cover or plate, substantially as described.

**No. 26,484. Apparatus for Sealing Boxes and Packages for Transportation or Storage.** (*Appareil pour Sceller les Boîtes et Paquets pour l'Exportation ou l'Emmagasinage.*)

Andrew J. Phelps, Syracuse, N. Y., U.S., 20th April, 1887; 5 years.

*Claim.*—1st. An apparatus for sealing boxes or packages, comprising grippers adapted to seize respectively a portion of the box and the binder, a tightener connecting said grippers, and a sealing-punch adapted to impress the seal applied to the binder all in one tool, substantially as shown. 2nd. An apparatus for sealing boxes or packages comprising grippers adapted to seize respectively, a portion of the box and the binder, a tightener connecting said grippers and a sealing punch supported yieldingly and normally in a raised position and adapted to impress the seal applied to said binder, substantially as set forth. 3rd. In combination, with the grippers and a tightener connecting said grippers, a guide pivoted on one of the grippers, and a punch sliding in said guide, as and for the purpose set forth. 4th. In combination with the grippers and a tightener connecting the same a guide-support connected to one of said grippers adjustably in its position thereon, a guide connected to said support and a punch sliding in said guides, substantially as described and shown. 5th. In combination with the gripper  $A$ , the gripper  $A_1$  consisting of the jaw, a provided with the arms  $b$ ,  $b_1$ , the plate  $P$  adjustably connected to one of said arms the guide  $C$  pivoted on said plate the punch  $D$  sliding in said guide, and a tightener connecting the grippers, substantially as described and shown. 6th. The combination of the gripper  $A$  provided with a screw threaded channel, the gripper  $A_1$  formed with arms  $b$ ,  $b_1$ , and provided with a smooth-bored channel in range with the channel of the gripper  $A$ , the screw  $c$  passing through the smooth channel and working in the screw threaded channel, and having a handle abutting against the gripper  $A_1$ , the punch  $D$  adjustably arranged on the latter gripper, and a tightener connecting said grippers, substantially as described and shown.

**No. 26,485. Book Adjuster.** (*Appui-Livre.*)

Irvine J. Adair, Dallas, Texas, U.S., 20th April, 1887; 5 years.

*Claim.*—1st. The combination, with the holder having the horizontal longitudinal recess and the vertical screw-threaded aperture, of the base piece and the adjusting screw swiveled at its lower end in the said base-piece, as and for the purpose herein set forth. 2nd. The combination, with the holder having the horizontal longitudinal recess and the vertical screw-threaded aperture, of the base-piece, the adjusting-screw swiveled at its lower end in the said base-piece, and the spring catch arranged as described, as and for the purposes herein set forth.

**No. 26,486. Composition of Matter to be used in Soldering.** (*Composition de Matières pour Souder.*)

Arthur P. Smith, Pipe Stone, Minn., U.S., 20th April, 1887; 5 years.

*Claim.*—1st. The herein described composition for soldering which consists of melted tallow purified with quicklime, stearic acid and rosin, substantially in the proportions specified.

**No. 26,487. Bottle Cap or Cork Retainer.**

(*Ligature de Bouchon de Boutelle.*)

Frederick E. Heinig and Samuel Leidich, Louisville, Ky., U.S., 20th April, 1887; 5 years.

*Claim.*—A bottle cap or cork retainer composed of a strap which has its ends formed so as to be adapted to be fastened around the of a bottle, and which has two short straps extending from its upper edge but forming a part of the strap, and which are adapted to have their upper ends fastened together over the top of the cork, substantially as shown and described.

**No. 26,488. Sheet Metal Vessel.**

(*Ustensile de Métal en Feuille.*)

Francis A. Walsh, Milwaukee, Wis., U.S., 20th April, 1887; 5 years.

*Claim.*—1st. In a sheet metal vessel, a seam consisting of flanges on the top of the vessel spanning the rim of the body, the three thicknesses of metal being folded inward leaving the outer edge of the cover projecting over and clasping the curve of the adjacent rim of the body, whereby the necessity of soldering is avoided, substantially as described. 2nd. In a sheet metal vessel a seam consisting of flanges on the top of the vessel spanning the rim of the body, the three thicknesses of metal being folded inward leaving the outer edge of the cover projecting over and clasping the curve of the adjacent rim of the body, in combination with a support for the seam substantially as described. 3rd. In sheet metal vessels, wherein a portion of

the top is allowed to remain fast to the vessel after opening, the top formed with ears for receiving a bail or handle as set forth. 4th. The combination, with the slip cover of ears forming part of the permanent cover and adapted for securing the slip cover, in place as set forth.

**No. 26,489. Lathe for Turning Lasts, etc.**

(*Tour à Tourner les Formes, etc.*)

Samuel J. De Lue, Natick, Mass., U.S., 20th April, 1887; 5 years.

*Claim.*—1st. The combination with a last turning lathe frame, and the pattern and cutter wheels thereof provided with the usual mechanism for operating them relatively to the pattern, and to a blank to be turned of mechanisms substantially as described applied to the ways of such frame as set forth, and being to support and revolve a pattern last and a partially turned last in order to enable the latter to be automatically turned at its heel and toe by the cutter wheel, each of such mechanisms consisting of the bed plate  $M$ , the open standards  $H$ ,  $I$ , and the revoluble annuli  $p$  and their clamps, as described, such annuli and clamps being provided with mechanism for operating them, essentially as set forth. 2nd. The mechanism, substantially as described, for supporting and revolving either a pattern last or a partially turned last, as explained, such mechanism consisting of the bed plate  $M$ , the open standard  $H$ ,  $I$ , and the revoluble annuli  $p$  and their clamps, as described, such annuli and clamps being provided with mechanism for operating them, as set forth. 3rd. The combination of the posts  $L$  and  $M$  (projecting from the shaft  $r$ ) and the arched arm  $N$  hinged to one of the said posts and provided with the screw  $b_1$ , as set forth, with the bed plate  $M$ , the open standards  $H$ ,  $I$  and the revoluble annuli  $p$  and their clamps, as described, such annuli and clamps being provided with mechanism for operating them, as set forth, and the post  $M$  having the screw  $a$  and nut  $z$  for holding to it the said arm  $N$ , as specified.

**No. 26,490. Method of Laying Concrete under Water.** (*Mode de poser le Béton sous l'eau.*)

John C. Goodridge, Jr., New York, N. Y., U.S., 20th April, 1887; 5 years.

*Claim.*—The herein described method of laying beton or concrete under water, consisting of first inclosing the beton or concrete in paper bags or other soluble envelopes, and then lodging the bags or envelopes so filled in the desired position under water, in such a manner that the bag or envelope shall not be ruptured until after or at the time it and its contents are in place.

**No. 26,491. Paint Can.** (*Boîte à Peinture.*)

Edwin Norton and Oliver W. Norton, Chicago, Ill., U.S., 20th April, 1887; 5 years.

*Claim.*—1st. The combination, with the can-body having an interior shoulder consisting of an interior annular fold  $a$  in the stock of the can-body, the parts of said fold being pressed together and provided with a flange  $a_1$  above said annular shoulder, of a head  $B$  having an upwardly projecting flange  $b$  turned down and folded with the flange on said can body into a seam, substantially as specified. 2nd. The combination, with the can body  $A$  having an interior annular fold  $a$  in its stock, the parts of said fold being closed together, and the joint or crevice between the parts of said fold being soldered together and provided with an upwardly projecting flange  $a_1$  of a head  $B$  having an upwardly projecting flange  $b$  turned down and secured with the flange on said can-body, substantially as specified.

**No. 26,492. Asbestus Packing.**

(*Garniture d'Amianthe.*)

Rufus N. Pratt, Hartford, Conn., U.S., 20th April, 1887; 5 years.

*Claim.*—1st. The within described process of forming asbestus or the like fibers into a mass for use as a packing, which consists in mixing them in a solution of india-rubber or the like adhesive gum, and then distributing the fibers while wet in molds, the removing the molded mass and alternately drying and pressing the mass, the final pressure being applied after the final thorough drying of the mass, all substantially as described. 2nd. The within described process of forming a composition of asbestus and india-rubber or the like gum into a mass of uniform density while in a fibrous state, which consists in mixing the fibers with india-rubber in solution with naphtha or the like fluid, and then subjecting the mass to the alternate drying and pressing process, all substantially as described. 3rd. The within described process of forming asbestus packing which consists in distributing the fibers in a wet state in a mold of the desired shape, next removing it from the mold for drying, and then subjecting it to pressure, and repeating these drying and pressing operations in alternation until the mass is compressed to the desired density, all substantially as described. 4th. The within described process of forming packing-rings of asbestus fiber, which consists in distributing the fibers in a wet state about the removable core in the forming-chamber then compressing the mass with a tubular plunger, then removing the ring and partly drying it, then subjecting it to further pressure within the forming-chamber, and continuing these drying and pressing operations in alternation until the mass is compressed to the desired thickness, all substantially as described.

**No. 26,493. Process or Method for Preserving all kinds of Vegetable Products.** (*Procédé ou mode de Conservation detoutes sortes de Produits Végétaux.*)

Charles H. Sharman, Forest Hill, Eng., 20th April, 1887; 5 years.

*Claim.*—The art of preserving vegetables or vegetable products, by means of the application to them of a coating composed of wax gelatine or resin and sulphur, substantially as specified.

**No. 26,494. Purse.** (*Bourse.*)

Frederick H. Licker, Toronto, Ont., 20th April, 1887; 5 years.

*Claim.*—1st. In a purse, where the gussets are pasted over the ends of the pocket material, notches *a, b, c, d*, formed at the upper corners of the material forming the frame work of pockets, the double expansion folds *G* and the flap or fold *L*, in combination with the gusset-piece *T*, substantially as and for the purpose specified. 2nd. In a purse, where the gussets are pasted over the ends of the pocket material, notches *a, b, c, d*, formed at the upper corners of the material forming the frame-work of pockets, the double expansion folds *G* and *H* and the flaps or folds *L, L'*, in combination with the gusset-piece *T*, substantially as specified. 3rd. In a purse where the gussets are pasted over the ends of the pocket material, notches *a, b, c, d*, the double expansion folds *G* and *H*, and the flaps or folds *L, L'* formed at the ends of the pockets adjoining the pocket which carries the inner metal frame in combination with the gusset-piece *I* and the inner metal frame *F*, substantially as and for the purpose specified. 4th. In a purse, where the gussets are pasted over the ends of the pocket material, the notches *a, b, c, d*, formed on the folds which carry the inner metal frame, the double expansion folds *G* and *H*, in combination with the gusset-piece *I* and the material forming the ends of the pockets adjoining the pocket which carries the metal frame *F*, substantially as specified. 5th. In a purse, where the gussets are pasted over the ends of the pocket material, the gusset-piece forming the ends of the pockets, so adapted to the frame of the purse as to form at the ends of the pocket which carries the inner metal frame, a single inward fold which starts from the outermost edges of the pockets adjoining the pocket carrying the said inner metal frame, substantially as specified. 6th. In a purse where the gussets are pasted over the ends of the pocket material, the folds which are notched at the upper corners, and which carry the inner metal frame forming at the ends thereof flaps of a double thickness of material, which fold outwardly from the pocket which carries the metal frame in a triangular form, when the pockets of which said triangular-shaped flaps form part are expanded, substantially as specified.

**No. 26,495. Weighing Machine.**

(*Pont à Bascule.*)

William B. Avery, Birmingham, Eng., 21st April, 1887; 5 years.

*Claim.*—1st. A steelyard weighing machine, in which the weight of the goods is provided on a ticket or a band or on both, constructed arranged and operating substantially as herein shown and described. 2nd. In a steelyard weighing machine, the combination, with the weights and type bars, of means for carrying a band of paper and means for pressing the paper band onto the type, substantially as described. 3rd. In a steelyard weighing machine, the means substantially as herein shown and described for carrying the band of paper.

**No. 26,496. Plough Harness.**

(*Harnais de Charrue.*)

James F. Randall, South Haven, Mich., U. S., 21st April, 1887; 5 years.

*Claim.*—1st. The combination of the arched double-tree *A*, single-tree *B* provided with the flexible belly-band *C*, arranged above the same, substantially as and for the purposes described. 2nd. The combination, with the single trees *B*, provided with flexible belly-bands *C*, of the arched double tree *A* formed of a single piece of metal, and having its ends connected with said single trees by a clevis and a rolling joint, substantially as and for the purposes set forth. 3rd. In a plough harness, the combination of the double-tree *A*, single trees *B* connected thereto by a rolling joint belly-bands *C*, and clevis *F* arranged between said single tree and belly-band, all constructed, arranged and operating substantially in the manner and for the purpose set forth.

**No. 26,497. Automatic Lubricator.**

(*Graisseur Automatique.*)

Thomas Nopper, London, Ont., 21st April, 1887; 5 years.

*Claim.*—1st. A valve *C* operated automatically by a pitman, eccentric, or other suitable connection, as and for the purpose specified. 2nd. An aperture *C'* formed in a valve *C*, as and for the purpose specified. 3rd. An aperture *G* in the set nut *G*, as and for the purpose specified. 4th. An aperture *G'* in the set nut *G*, or other substantial equivalent, in combination with an aperture *C'* in the valve *C*, as and for the purpose specified. 5th. A valve *C* formed with an aperture *C'*, operated automatically by a pitman, eccentric, or other suitable connection, and guide or guides *E*, in combination with a set nut *G*, reservoir *A* and port *D*, substantially as and for the purposes set forth.

**No. 26,498. Nut Lock for Railway Rail Joints.** (*Arrête-Ecrou pour Joints de Rails de Chemin de Fer.*)

William H. Smith, DeSoto, Iowa, U. S., 21st April, 1887; 5 years.

*Claim.*—1st. The combination of the clasp support *C*, having vertical extensions at its ends, a dowel pin in one of said vertical ends, and a screw in the other, with two hook-shaped clasps, two nuts, two bolts, two fish-plates and the abutting ends of the rails, substantially as shown and described for the purposes stated. 2nd. The improved nut lock for railway joints, consisting of the clasp support *C* having vertical extensions at its ends, and pins or screws in said ends, and detachable clasps *f, f*, substantially as shown and described.

**No. 26,499. Oiler.** (*Graisseur.*)

Thomas B. Wilkinson and James L. Cutler, Arcadia, Ks., U. S., 21st April, 1887; 5 years.

*Claim.*—1st. The improved oiler, consisting of the body having the

spout, the upwardly-opening spring actuated valve, arranged, as described, within the said spout, the cylinder secured within the said body having the inwardly-opening valve at its lower end, and communicating near its upper end with the said spout, the piston, the piston-rod and the spring-actuated, centrally-pivoted lever, arranged as described, all constructed and arranged to operate in the manner and for the purpose herein set forth. 2nd. The combination, with an oil can having the usual spout, of a pump-barrel or cylinder secured within the said can, having the inwardly-opening valve at its lower end, and communicating near its upper end with the said spout, a piston working in the said cylinder, and means, substantially as described, for operating the said piston from the exterior of the can, as and for the purpose herein set forth. 3rd. The improved oiler, consisting of the body having the spout, the cylinder arranged within the said body having the inwardly-opening valve at its lower end, and communicating near its upper end with the said spout, the piston, the piston-rod and the spring-actuated centrally-pivoted lever, arranged as described, all constructed and arranged to operate in the manner and for the purpose herein set forth.

**No. 26,500. Implement for Separating and Holding Plates, etc., while being Cleaned.** (*Ustensile pour Séparer et Supporter les Assiettes, etc., en les Lavant.*)

Alfred M. Waite, London, Eng., 21st April, 1887; 5 years.

*Claim.*—The domestic implement hereinbefore described, specially adapted to the purpose aforesaid, the same consisting essentially of a pair of opposite jaws 3, 4, the opposite faces 5, 6 of which are respectively conformed to or are caused to approximately conform to the opposite sides of the rim, or like part of the article to be held, and the under one of which jaws is extended with a downward inclination 9 and chisel-edged extremity 10, the said jaws being hinged at a convenient part 11 and adapted with convenient handles 12, substantially in the manner hereinbefore described.

**No. 26,501. Construction of Driving Belts and Wheels Therefor.** (*Fabrication des Courroies sans fin et des Roues pour ces Courroies.*)

Arthur G. Meeze and Reginald N. Laurie (assignee of John Henderson and Alexander J. Adie, executors of the will of Patrick Adie), London, Eng., 21st April, 1887; 5 years.

*Claim.*—1st. The combination, with a metallic driving belt formed with an uninterrupted succession of transverse corrugations, to present in longitudinal section an unbroken series of reversed curves, substantially semicircular in form, of a metallic or non-metallic wheel or pulley, having a counterpart transversely grooved or corrugated periphery adapted to engage said belt, substantially in the manner and for the purpose herein set forth. 2nd. A driving belt, constructed of a thin metallic strip, having an uninterrupted succession of uniform transverse semicircular bends or corrugations presenting in longitudinal sections an unbroken series of reversed curves, in combination with a plain, straight metallic strip superimposed and secured longitudinally therein, to serve as a continuous cord for the several arcs of said curves, substantially in the manner and for the purpose herein set forth. 3rd. A driving pulley, constructed with a plain periphery, in combination with a strip or band of corrugated metallic or non-metallic material, secured upon and about said periphery to form an unbroken series of transverse corrugations thereon, substantially in the manner and for the purpose herein set forth. 4th. As a facing for pulleys, an endless band of india-rubber transversely corrugated on its outer face with grooves deepening from the centre of the band towards either edge thereof, substantially in the manner and for the purpose herein set forth. 5th. As a facing for pulleys, an endless transversely corrugated band of wood lincrusta-nalton papier mache, or other hard material, which can be easily formed to the desired shape, substantially in the manner and for the purpose herein set forth.

**No. 26,502. Horse Collar.** (*Collier de Cheval.*)

Adolphe Delande, Lafayette, Sidonnis Goette, and Diedrick Ohlmeyer, Donaldsonville, La., U. S., 21st April, 1887; 5 years.

*Claim.*—A horse-collar *A*, consisting of the strips *B*, hinged at one end and held adjustably at the other end, and covered with the leather and filling *C*, and provided with the loops *L, M, G* and *H* and pins *N*, all located as described.

**No. 26,503. Straw Rack of Separator of Threshing Machine.** (*Claie de Séparateur pour Machines à Battre.*)

Jonathan Brown, Malahide, Ont., 22nd April, 1887; 5 years.

*Claim.*—An improved grain separator, having a crank-shaft *o, q*, screen *s* or *u*, notched strips *m, m*, and risers or breakers *f, f*, all formed, arranged and combined in a frame, substantially as described and shown and for the purposes hereinbefore set forth.

**No. 26,504. Treating Wines and Liquors by Electricity and Apparatus therefor.** (*Traitement des Vins et Liqueurs par l'Electricité et Appareil pour cet Objet.*)

Edwin J. Fraser, San Francisco, Cal., U. S., 22nd April, 1887; 5 years.

*Claim.*—1st. The herein described improvement in treating wines and liquors, which consists in placing the liquid within the field or influence of an electro-magnet helix, substantially as set forth. 2nd. The herein described method or process of producing an electric or magnetic state or action in a body of liquid, for the purposes set forth, which consists in introducing the liquid within the field or

influence of an electro-magnetic helix. 3rd. The method of producing and maintaining an electric or magnetic state or action in a body of liquid by induction, substantially as herein described. 4th. An apparatus for treating or working upon wines and liquors by induction, consisting of a suitable vessel or receptacle for the liquid, and an electro-magnetic helix within the field of which the liquid is held by the receptacle, substantially as herein described.

### No. 26,505. Pie and Dish Lifter.

(*Poignée pour Tourtes et Plats.*)

William C. Conyers and John McLeod, Mahone Bay, N. S., 22nd April, 1887; 5 years.

*Claim.*—The combination of the handle A, spring B, ends of right lifter C, lifters D and E and stop F, substantially as and for the purpose hereinbefore set forth.

### No. 26,506. Halter and Harness.

(*Licou et harnais.*)

Marshall R. Dawlin, North Adams, Mass., U.S., 22nd April, 1887; 5 years.

*Claim.*—A halter constructed with a fitting, such as A, B, arranged at the meeting points of the straps, having the radial bucking-arms A, with cross-bars I and spurs K with which the straps engage, and having a blank centre from which said arms diverge and which covers and conceals the meeting ends of the straps, substantially as shown and described.

### No. 26,507. Wire Netting Machine.

(*Machine à natter le fil de fer.*)

Edwin Gilbert, Georgetown, Conn., U.S., 23rd April, 1887; 5 years.

*Claim.*—1st. The combination, with the upper and lower spindles arranged in pairs, and constructed with sectional journals and pinions, as described, one spindle of each pair having a direct passage through it from end to end of cop-cases between the pairs of spindle, for containing cops from which the wire is conducted through the said direct passages in the spindles, substantially as herein described. 2nd. The combination, with the upper and lower spindles arranged in pairs, and constructed with sectional journals and pinions, as described, one spindle of each pair having a socket containing a spring and the other having a socket of cop-cases having at the ends pivots or projections, before one of which the spring will yield to enable the other pivot or projection to be entered into the socket in the opposite spindle, substantially as herein described.

### No. 26,508. Oatmeal Chopping Mill.

(*Moulin à gruau d'avoine.*)

John E. Wilson, Galt, and Robert Thomson, Woodstock, Ont., 23rd April, 1887; 5 years.

*Claim.*—1st. A guide-plate C having grooves a cut in its surface, and extending from a point at or near the discharge side of the feed-box A, to a point at or near the chopping rolls B, substantially as and for the purpose specified. 2nd. A guide-plate C having grooves a cut in its surface, and extending from a point at or near the discharge side of the feed-box A to a point at or near the chopping rolls B, in combination with the roller D, substantially as and for the purpose specified. 3rd. A guide-plate C having grooves a cut in its surface, and extending from a point at or near the discharge side of the feed-box A to a point at or near the chopping rolls B, in combination with the skirt E, substantially as and for the purpose specified. 4th. A guide-plate C having grooves a cut in its surface, and extending from a point at or near the discharge side of the feed-box A to a point at or near the chopping rolls B, in combination with the roller D and skirt E, substantially as and for the purpose specified.

### No. 26,509. Lathing. (*Lattis.*)

Lawren S. Scott, Bristol, Vt., U.S., 23rd April, 1887; 5 years.

*Claim.*—1st. The described lathing fabric, composed of lath-strips united or woven together by twine, cords, or wire, having a selvage formed of projecting lath ends alternating intervals, substantially as shown and described for the purposes set forth. 2nd. The described lathing fabric composed of lath strips united or woven together by twine, cords, or wire, having a selvage formed of projecting lath ends alternating with intervals, substantially as shown and described, for the edges of the lath are bevelled in the manner described and for the purposes set forth. 3rd. The described lathing fabric composed of lath-strips united or woven together by means of twine, cord, or wire having selvages formed of alternating projecting lath ends, and corresponding intervals, substantially as specified, the several strips whereof are punctured or perforated for the reception of the nails, substantially as described and set forth. 4th. The described lathing fabric composed of lathing strips united or woven together by warp threads, or wires, as shown, having selvages of alternating projecting lath ends and corresponding intervals, said strips being bevelled and perforated substantially in the manner described and for the purposes set forth. 5th. The lathing-sheet consisting of the independent and separated ordinary wooden laths, and the interlacing or crossing wires traversing the series of laths immediately adjacent to each other on both sides, binding them together without springing them transversely, substantially as herein described.

### No. 26,510. Cement for Glueing or Cementing Wood, etc. (*Colle-forte pour le bois, etc.*)

Edwin Densmore, Grand Rapids, Mich., U. S., 23rd April, 1887; 5 years.

*Claim.*—1st. The improved cement consisting of glue, whiting, linseed oil, and the carbonate or oxide of lead or zinc, substantially in

the proportions specified. 2nd. The improved cement consisting of glue, whiting, linseed oil, and the carbonate or oxide of lead or zinc, and litharge, substantially in the proportions specified.

### No. 26,511. Waggon Jack. (*Chèvre de carrossier.*)

Charles Springer, Tidioute, Penn., U.S., 23rd April, 1887; 5 years.

*Claim.*—1st. As a new article of manufacture, a lever for waggon jacks having a curved portion which forms a rest for the axle of the vehicle, and having its long arm provided with a lip, substantially as and for the purpose specified. 2nd. The combination, in a waggon jack, of the hollow internally-threaded support erected upon a suitable base, a standard having a depending screw-thread shank working in the hollow support, a curved rack-bar secured to the standard, and a lever pivoted to said curved rack-bar, substantially as described and shown.

### No. 26,512. Danger Guard for Railway Frogs. (*Garde pour rails de croisement.*)

William Driscoll, Brockville, Ont., 23rd April, 1887; 5 years.

*Claim.*—1st. A guard bar for railway frogs, etc., substantially of the form described, one end adapted to bear on the lower flange and against the sides of two converging rails, and the other end terminating in a spike to be driven into a tie and bent near the ends, whereby the bar between the bends will be nearly on a level with the top of the rails, as set forth for the purpose described. 2nd. In combination with two convergent rails, of a bar inserted longitudinally in the space between the rails, and adapted to be secured to a tie or ties or sleeper, substantially as described for the purpose set forth. 3rd. The combination, with two convergent or converging rails, of a bar or rod forked at one end to bear upon the lower flange and against the side of the rails, and the other end adapted to be secured to a railway tie and bent upwardly near the ends to nearly the height of the rails to longitudinally obstruct the space between the rails, for the purpose set forth.

### No. 26,513. Tub or Box Fastening.

(*Fermeture de cuvette ou de boîte.*)

James H. Burt, West Randolph, Vt., U.S., 23rd April, 1887; 5 years.

*Claim.*—1st. A metallic fastener, the body of which is bent inwardly near its centre at an obtuse angle, and provided with pointed extremities bent inwardly at an acute angle to their respective arms A and B, substantially as described and for the purpose set forth. 2nd. A tub or box fastener having its body bent at d, at such an angle as will allow the upper end E to slide over the top of the cover, while the lower end is being driven into the side, said ends being suitably pointed and bent inward at an acute angle at d and e, substantially as set forth.

### No. 26,514. Self-adjusting lower wheel for Regulating the tension of Band-Saws. (*Roue inférieure automatique pour régler la tension des scies sans fin.*)

Charles Esplin, Minneapolis, Minn., U. S., 23rd April, 1887; 5 years.

*Claim.*—1st. The combination, in a band sawing-machine, with the band-saw and the upper wheel, of the lower wheel mounted in movable boxes and bearing upon the saw with a yielding pressure, whereby said wheel automatically regulates the tension of the saw, as set forth. 2nd. In a band sawing-machine, and in combination with the saw and supporting wheel, the lower wheel mounted in movable boxes and means for regulating the pressure of said wheel on the saw, as set forth. 3rd. The combination, in a band sawing-machine, with the lower wheel, its shaft and boxes of pivoted bars 9 supporting said boxes, a shaft 19 provided with crank arms 17, links 15 connected with said crank arms and with the free ends of said pivoted bars, transverse bar 21 secured to the shaft 19, and a sliding weight 23 on said bar, all substantially as described. 4th. The combination, in a band sawing-machine, with the saw and the upper wheel, of the lower wheel, its shaft mounted in yielding bearings, and adjusting means for horizontally and vertically moving the end of the shaft farthest from said lower wheel, as and for the purpose set forth. 5th. The combination in a band sawing-machine, with the supporting frame and the band-saw, of an upper supporting wheel mounted in fixed adjustable bearing, and a lower driving-wheel mounted in yielding bearings, for the purpose set forth. 6th. The combination, in a band sawing-machine, with the saw and the upper wheel, of the lower wheel, a shaft supporting said wheel upon one end, and adjustable at its opposite end both horizontally and vertically for the purpose of training the saw, substantially as described. 7th. In a band sawing-machine, and in combination with the saw and the upper wheel mounted in fixed bearings, an automatically adjustable lower wheel for regulating the tension of the saw, substantially as described.

### No. 26,515. Pump. (*Pompe.*)

John Woodward and Robert Anderson, Oil Springs, Ont., 23rd April, 1887; 5 years.

*Claim.*—1st. In a ball valve, the collar D held on the pipe B by screw-threads formed on the outer surface of said pipe, and on the inner surface of the collar D, substantially as shown and described. 2nd. In a ball valve, the combination of the ball A, pipe B and the cage C, with the collar D screwed on the pipe B, substantially as shown and described and for the purpose set forth.

### No. 26,516. Car-Coupling. (*Attelage de chars.*)

John Myers and Samuel L. Morrison, Springfield, Ohio, U. S. 23rd April, 1887; 5 years.

*Claim.*—1st. A car-coupling consisting of the draw-head A having the longitudinal opening B, and link-entering openings G therein, a

gravity-lever pivoted at or near its rear end in the opening B to the draw-head, in coupling-pin pivoted to the forward end of the gravity-lever in the rear of the coupling-pin, and a lug or equivalent to support the gravity-pawl when elevated, substantially as shown and described. 2nd. In a car-coupling, the combination, with the slotted draw-head A, having the lug H formed near its under face of the gravity-lever D, bifurcated at its extreme forward end, as described, and pivoted in the slot or opening B at its opposite end to the draw-head, the coupling pin pivoted between the ears b of the bifurcated lever and the gravity-pawl F, slotted longitudinally at its upper end to form ears c between which cars the gravity-lever extends and is pivoted, and constructed and arranged substantially as shown and described.

### No. 26,517. Lawn Mower. (*Faucheuse de pelouse.*)

The Hanika Iron Fence Company, (assignee of Christian Hanika and Timothy Rogers), Springfield, Ohio, U. S., 23rd April, 1887; 5 years.

*Claim.*—1st. In a lawn-mower, the ground-wheel G having the peripheral flange  $\sigma^2$  and the series of elongated teeth  $\sigma^3$  projecting from the inner side of the wheel in a line parallel to its axis, and sufficiently remote from the flange  $\sigma^2$  as to leave a space between said teeth and flange, substantially as and for the purpose described. 2nd. In a lawn-mower, the combination, with the side-plate A of the ground-wheel G pivotally secured thereto, and having the peripheral flange  $\sigma^2$  to overlap the edge of the side-plate, and having elongated teeth projecting from the inner side of the wheel in a line parallel to its axis, said teeth being remote from the inner face of the flange  $\sigma^2$  as to leave a space in the rear of the teeth, and terminating at a point remote from the inner face of the side-plate A as to leave a space for the exit or foreign matter, substantially as and for the purpose described. 3rd. In a lawn-mower, the combination, with the side-plate A having the central square opening h formed therein, and ground-wheel G having the journal bearing, opening  $\sigma^1$  of the removable connection consisting of the stud-bolt  $h^1$  extended through the side-plate and ground-wheel, the sleeve  $h^2$  engaging the stud-bolt, and the washer and nut to secure the parts together, substantially as described. 4th. In a lawn-mower, the side-plate A having the fixed outwardly projecting guard-bar, supporting-arm  $\alpha^1$  with the bearing  $\alpha^2$  formed at its forward end, and having the horizontal flanges  $f, f^1$  near its lower edge, in combination with the cutter-bar pivoted to said side-plate with its cutting edge adjustably secured between the flanges  $f, f^1$  by the set-screw  $\beta^3$ , extending through said flanges and bearing against the upper and lower faces of the cutter-bar, all substantially as and for the purpose described. 5th. The side-plate A having the journal box half e formed integral therewith, and having the opening e formed in the forward side below the guard-bar arm  $\alpha^1$ , as described, in combination with the journal-box cap  $c^1$ , having a flanged portion to fit into and fill the opening e, all substantially as set forth. 6th. In a lawn-mower, the combination of the side-plate A having the square central opening h, the stud-bolt  $h^1$  extended therethrough, the sleeve  $h^2$  loosely mounted upon said stud-bolt, the ground-wheel G having the peripheral flange  $\sigma^2$  to overlap the edge of the side-plate, and having the central journal-bearing  $\sigma^1$  to engage the sleeve  $h^2$ , and elongated teeth  $\sigma^3$  formed upon the inner side of the wheel considerably remote from and in a line parallel to the flange  $\sigma^2$  and a nut and washer secured to the end of the stud-bolt  $h^1$  to secure the parts in place, all substantially as described. 7th. In a lawn-mower, the combination, with the side-plate A having the square central opening e therein, as described, and the ground-wheel G having the central journal-bearing  $\sigma^1$  of the supporting-device for said ground-wheel, consisting of the stud-bolt  $h^1$  having a square upper end to fit the square opening in the side-plate, a circular central portion and a reduced screw-threaded lower end, as shown, the sleeve  $h^2$  interposed between the bolt  $h^1$  and the journal of the ground-wheel, and a nut and washer to secure the parts in place, substantially as and for the purpose described. 8th. In a lawn-mower, the combination, with the guard-bar B and handle bar E, of the handle F pivotally secured to the handle-bar, and indirectly and adjustably secured to the guard-bar by a handle or supporting-arm K pivoted to the guard-arm and adjustably secured to the handle F by a bolt and nut or equivalent, substantially as described. 9th. The combination, with the handle F pivotally secured to the handle-bar E at its lower end, of the bifurcated hanger K pivotally secured to the guard-bar, as described, and having the two radially slotted parallel arms  $k^1$  at its rear end engaging each side of the handle F, the bolt  $k^2$  extended through the radial slots  $h^2$  of the arms  $k^1$  and through handle and the thumb-nut  $k^4$  to clamp the arms  $k^1$  against the handle and hold it in adjusted position, substantially as described. 10th. In a lawn-mower, the combination, with a handle pivotally secured to the handle-bar, of the two bracing-arms  $k^3$ , pivotally secured at their upper ends to the handle (one at each side) and pivotally secured to the handle-bar at their lower ends, substantially as described. 11th. In a lawn-mower, the combination, with the handle F pivotally secured to the handle-bar, as described, of a handle connecting and supporting device consisting of the hanger K pivotally secured at its forward end to the guard-bar, and adjustably secured to the handle F at its rear end, and the bracing-arms  $k^3$ , pivotally secured to the handle F (one at each side) at their upper ends and having the eyes  $k^4$  at their lower ends to encircle and by which they are pivotally secured to the handle-bar, all substantially as and for the purpose set forth.

### No. 26,518. Time Signal. (*Signal horaire.*)

Albert P. O'Dell and Phillip M. Shannon, Bradford, Penn., U. S., 23rd April, 1887; 5 years.

*Claim.*—1st. In a time-signal, the combination of the spring placed between the tracks, a rod connected to its under side, the operating-lever, the valved piston-head, piston-rod, cylinder, and signal, substantially as shown. 2nd. In a time-signal, the combination of the spring placed between the tracks, the hooked rod connected to its under side, a spring placed upon the rod, the operating-lever, the valved piston-head, the piston-rod, the cylinder, and signal, substantially as described. 3rd. The combination of the spring B placed between the tracks, the rods C placed under the spring and provided

with the shoulder D on its lower end, the spring E placed around the rod, lever F, rods G, H, piston-rod, cylinder, piston, and time-signals, substantially as set forth.

### No. 26,519. Process of obtaining the Oxides, etc., of Metals from their Ores or from Crude Minerals.

(*Procédé pour extraire les oxydes, etc., des Métaux de leurs minerais ou des minerais crus.*)

Amos L. Keepert, Littlestown, Penn., U.S., 23rd April, 1887; 5 years.

*Claim.*—1st. The process of separating metals from their ores or from crude minerals, which consists in subjecting the same to the action of a reducing agent acting essentially upon those constituents of the ore that hold the metal or metals to be separated locked up to release the same, in contradistinction to the ordinary method of subjecting the ore to the action of a reducing agent acting directly upon the metal or metals to be separated without essentially affecting the other constituents of the ore, substantially as described for the purposes specified. 2nd. The process of separating metals from their ores or from crude minerals, which consists in subjecting the same to the action of a solvent, the nature of which is determined by the constituents of the ore that are soluble therein, and in which the metal or metals to be obtained are insoluble separating the solution of said soluble constituents from the insoluble, and separating the metal or metals from the latter by the ordinary process of chemistry, substantially as described. 3rd. In the separation of metals from their ores, a primary reducing agent or solvent holding in solution the soluble constituents of the ore to be treated or the most prevalent soluble constituents thereof, and in which the metal or metals to be obtained are insoluble, substantially as and for the purpose specified. 4th. The process of separating the metals of the platinum group from their ores, which consists in subjecting the ore to the action of a solvent in which the metal or metals to be obtained remain insoluble, and that will act as an oxidizing agent upon zirconium, if present in the ore, dissolving out all the soluble constituents, separating the constituents in solution from the metals, or the metals and oxide of zirconium, and other insoluble constituents, separating the oxide from the remaining metals and insolubles, and finally separating the metals from said insolubles by the ordinary methods of chemistry, substantially as described. 5th. The process of separating the metals of the platinum group from their ores, which consists in subjecting the ore to the action of a solvent holding in solution the soluble constituents or the most prevalent soluble constituents in the ore, and incapable of dissolving the metal or metals to be obtained, and acting as an oxidizing agent upon zirconium, if present in the ore, dissolving out all the soluble constituents, separating the constituents in solution from the metals, or the metals and oxide of zirconium, and other insoluble constituents, separating the oxide from the remaining metals and insolubles, and finally separating the metals from said insolubles by the ordinary methods of chemistry, substantially as described. 6th. The process of separating the metals of the platinum group from their ores, which consists in subjecting the same to the action of a solvent in which the metal or metals are insoluble, and that will act as an oxidizing agent upon zirconium, adding zircon to the ore or zirconia to the solvent if the ore treated is deficient in zirconium, dissolving out all the soluble constituents, separating the constituents in solution from the metals or the metals and oxide of zirconium and other insoluble constituents, separating the oxide from the remaining metals and insolubles, and finally separating the metals from said insolubles by the ordinary methods of chemistry, substantially as described.

### No. 26,520. Boiler Cleaner and Water Heater. (*Nettoyeur de Chaudière et réchauffeur d'eau.*)

Alfred H. Crookford, Harrison, N.J., U.S., 23rd April, 1887; 5 years.

*Claim.*—1st. In a water-heater, the combination of a water tank or receptacle, a cold water feed pipe leading down through the interior of said tank towards the bottom thereof, a discharge pipe leading down through the interior of said tank toward the bottom thereof, and adapted to be connected with a boiler to conduct the water therein to said tank, a pipe opening into the top of the interior of said tank and adapted to be connected with a boiler to conduct the water in said tank from the upper portion of the water column therein to said boiler, as and for the purposes set forth. 2nd. In a water-heater, the combination of a water tank or receptacle, a hot water discharge pipe leading down through the interior of said tank toward the bottom thereof, and adapted to be connected with a boiler to conduct the water therein to said tank, a pipe opening into the top of the interior of said tank and adapted to be connected with a boiler to conduct the water in said tank from the upper portion of the water column therein to said boiler, and an injector in one or both of said pipes to accelerate the circulation of the water there through to and from the tank and boiler, as and for the purposes set forth. 3rd. The combination, with a boiler, of a water tank or receptacle, a feed pipe leading from said boiler to said tank, and provided with an expanded or broadened end within the boiler, the end of said pipe which connects with or enters the tank extending down within the same, a discharge pipe leading from the top of said tank, an injector arranged in said discharge pipe, and connected by a suitable pipe with the steam space in said boiler, as and for the purposes set forth. 4th. The combination, with a boiler, of a water tank or receptacle, a cold water feed pipe leading to and connected with said tank, of feed pipe leading from said boiler to said tank, and provided with a broadened or expanded end within the boiler, the end of said feed pipe which connects with the tank extending within the same, a discharge pipe leading from the top or upper portion of the interior of said tank to the bottom of the interior of said boiler, and adapted to convey the water from said tank to said boiler, an injector arranged in said discharge pipe between the said tank and boiler, and connected by a suitable pipe with the steam space in said boiler, and a

sediment receptacle secured to or formed on the bottom of said water tank, substantially as and for the purposes set forth. 5th. In a water heater and boiler cleaner, the combination of a water tank having an inclined bottom, a silt receptacle opening into said inclined bottom of the tank, and provided with a man-hole and blow-off, a hot water discharge pipe leading down within said tank toward the bottom thereof, and said silt receptacle, and adapted to be connected with a boiler to conduct the water therein to the bottom of the interior of said tank, and a pipe opening into the top of the interior of said tank, and adapted to be connected with a boiler and to conduct the water in said tank from the upper portion of the water column therein to said boiler, as and for the purposes set forth.

### No. 26,521. Lock Stitch Sewing Machine.

(Machine à coudre à point de navette.)

Arthur F. Wileman, Ealing, Eng., 23rd April, 1887; 5 years.

Claim.—1st. In a lock stitch sewing machine, the combination of the hand-driven wheel D, the two equal pinions b and F, the rotating spindle B with the needle movement, and the rocking spindle C with the shuttle movement and with the under feed movement, substantially as described. 2nd. In a lock stitch sewing machine, the combination of the hand-driven wheel D, the two equal pinions b and F, the rotating spindle B with the needle movement, and the upper feed movement, and the rocking spindle C with the shuttle movement, substantially as described. 3rd. The combination of the pinion F, with crank pin f, slotted arm c, rocking spindle C and arms c<sub>3</sub> and S for working the shuttle s, substantially as described. 4th. In combination with the shuttle arm S, the pin c<sub>4</sub> on the arm c<sub>3</sub>, and the spring s<sub>1</sub> as means for giving access to the shuttle, substantially as described. 5th. The combination of the rocking arm c<sub>3</sub>, its pin c<sub>4</sub>, the lever N with its notched slot n<sub>1</sub>, n<sub>2</sub> jointed to the feed slide n and working on the adjustable fulcrum pin n<sup>3</sup> constituting the under feed apparatus, substantially as described. 6th. The combination of the rotating disc G, its crank pin p, the lever P with its cam slot, its fulcrum p<sup>1</sup> and presser foot p<sub>2</sub>, and the spring p<sub>3</sub>, constituting the upper feed apparatus, substantially as described.

### No. 26,522. Cultivator or Weeder.

(Scarificateur.)

Zephania Breed, Weare, N.H., U.S., 25th April, 1887; 5 years.

Claim.—The described weeder, having straight coiled or curved flexible fingers G, with their upper end inserted into head A, and provided with an adjustable check-bar D for increasing or diminishing the flexibility of said fingers below said check-bar, substantially as set forth.

### No. 26,523. Oven Drum for Stoves.

(Poêle Sourd de Fourneau de Cuisine.)

William J. Turkington, Aurora, Ont., 25th April, 1887; 5 years.

Claim.—The combination of the oven drum A, with damper H, stove pipe shelf F, with rods for drying, and double heater I, substantially as and for the purpose hereinbefore set forth.

### No. 26,524. Piece Forming Machine by which Lifts and Piece Lifts are Secured Together and formed into Rands or Lifts for Heels, etc. (Machine à Former et Poser les Couches Points des Talons, etc.)

William S. Childs, Montreal, Que., 25th April, 1887; 5 years.

Claim.—1st. In a piece-forming machine, the combination of the mould A, with flaring mouth and tightly-gripping section, a plunger and a friction block set in mould, all substantially as herein described and for the purposes set forth. 2nd. The combination of the mould A, plunger D operated by a treadle friction block H, H<sup>1</sup>, set in mould and knife O, all constructed and operating substantially as herein set forth. 3rd. The combination, with the mould A, of the spindle C, carrying plunger D, spring H for holding same up, treadle B and pin c working in slot g in sleeve G, all substantially as and for the purposes described. 4th. The combination, with the mould A, of the friction block formed of piece H, with rib h and piece H<sup>1</sup> forced apart by conical pin K working in threaded boss L, all substantially as and for the purposes set forth. 5th. The combination, with the mould A and friction block H H<sup>1</sup>, of slide N, with projections n, n, as and for the purposes set forth.

### No. 26,525. System of Water Distribution.

(Système de Distribution de l'Eau.)

George B. Bassett, Watertown, N.Y., U.S., 25th April, 1887; 5 years.

Claim.—1st. The method of increasing the pressure of water in a main by cutting off the supply from the reservoir, and increasing the pressure from the pumping mechanism, as and for the purpose shown and set forth. 2nd. In a system of water distribution, the combination of a reservoir, a pumping mechanism, a main connecting the reservoir with the pumping mechanism, and having service pipes and fire plugs in its line, and a check valve in the main near the reservoir opening away from it, and having means for instantly closing it from pump-house or other central station, as and for the purpose shown and set forth. 3rd. In a system of water distribution, the combination of a reservoir, a pumping mechanism, a main connecting the reservoir with the pumping mechanism, and having service pipes and fire plugs upon it, a check valve in the main near the reservoir opening away from it, and means for instantly closing or opening the said valve from a central point, cutting off the supply from the pumping mechanism to the reservoir, as and for the purpose shown and set forth. 4th. In a system of water distribution, the combination of a reservoir, a pumping mechanism, a main connecting the reservoir with the pumping mechanism, and having

service pipes and fire plugs upon it, a check valve in the main near the reservoir opening away from it, and means for instantly closing or opening the said valve from a central point, cutting off the supply from the pumping mechanism to the reservoir, and a relief or safety valve opening towards the reservoir, and adjustable to open at any desired pressure, as and for the purpose set forth.

### No. 26,526. Clutch Mechanism.

(Embrayage à Friction.)

John H. Thomas (assignee of Frank M. Waters), Springfield, Ohio, U.S., 25th April, 1887; 5 years.

Claim.—1st. In a clutch, the combination, with a pinion having offsets at one end thereof, with inclines between them, of a shaft having a seat, the rein and a key fitted to play in said seat, and having a fluke which extends from each side thereof, and which stands in the path of the offsets when the pinion is rotated in one direction, as described. 2nd. In a clutch, the combination, with a pinion having a recess in one end and offsets projecting into the recess, of a shaft having a seat therein, and a key fitted loosely to the seat and having a curved fluke extending from each side thereof into the recess, and between the offsets and the shaft, and adapted to engage the pinion in one direction and not in the other, as shown and described. 3rd. In a clutch, the combination, with a pinion having a recess in one end, a series of offsets projecting into it and having incline surfaces between them, of a shaft having a seat and a key tapered toward its inner edge and loosely fitted to the seat and provided with a curved fluke which extends from each side thereof into the recess, and between the shaft and the offsets, and adapted to engage the offsets when the pinion is rotated in one direction and not to engage them when rotated in the other direction, substantially as described. 4th. A key for a clutch constructed with a curved fluke, which extends from each side thereof, as shown. 5th. A key for a clutch, consisting of a bar reduced in thickness toward the inner edge thereof, and provided with a curved fluke, which extends from each side thereof, as shown and described. 6th. In a clutch, the combination, with a pinion having offsets at one end thereof, of a shaft and a key in engaging contact, and a fluke carried by the key and constructed to engage the offsets when the pinion revolves in one direction, and not to engage them when it revolves in the other direction, as described.

### No. 26,527. Safety Pin. (Epingle de Sûreté.)

William H. Cole, London (assignee of Henry W. Tonks, Birmingham), Eng., 25th April, 1887; 5 years.

Claim.—In the manufacture of safety pins, the method of protecting the points of such pins by means of an involuted coiled wire conical shield, substantially as hereinbefore set forth.

### No. 26,528. Clothes Line Fastener.

(Crochet de Ligne à Linge.)

John J. Hughes, Evans' Mills, James L. Hughes and Michael E. Hughes, Orleans Four Corners, N. Y., U. S., 25th April, 1887; 5 years.

Claim.—In a clothes-line pulley and fastening, a casing provided with a hook A and cross-bars c, C, in combination with a peripherally grooved pulley journaled between the side-pieces, and a catch D pivoted adjacent thereto, said catch being provided with a serrated end e, thumb-piece d and curved end f, substantially as described.

### No. 26,529. Double Spiral Bed-Spring Machinery. (Machine à Ressorts de Lit à Double Spirale.)

James H. Chryst, Fayetteville (assignee of Henry A. Blackmer, Clarksville), Ark., U.S., 25th April, 1887; 5 years.

Claim.—1st. The combination of the frame 1, having extended arms 2, perforated feet 3 and caps 11, with shaft 14, cog-wheel 13 rigidly secured on said shaft, cog-wheels 12 meshing with said wheel 13 and rigidly secured on shafts 9, spirally-grooved conical mandrels 7 rigidly secured on the forward ends of shafts 9, and having holes 19, guides 16 securely bolted on said frame, and having pins 21, support 17 hinged to the extended arms 2, and having pins 18 and holes 20, spring lever 22 and pin 23, all substantially as shown and described and for the purposes set forth. 2nd. In a machine for making double spiral springs, as above described, the combination of the extended arms 2, support 17 hinged on the forward ends of said arms, and having holes 20, pins 18 secured in said support and adapted to work in holes 19 in the forward ends of the conical mandrels 7, and points 21 on the forward ends of guides 16, all substantially as shown and described and for the purposes set forth. 3rd. In combination with the frame 1, supporting the shafts 9 and 14, bearing the cog-wheels, as above described, the conical mandrels 7 and guides 16, the support 17 having the pins 18 and holes 20 adapted to support the forward ends of the conical mandrels 7, having the holes 18 and guides 16, having pins 21, spring lever 22, secured on one end of the support 17, and pin 23 secured in the outer face and forward end of one of the extended arms 23 and arranged to hold support 17 in an upright position, all substantially as shown and described.

### No. 26,530. Automatic Car-Coupling.

(Attelage de Chars Automatique.)

John Coup, New York, N.Y., U.S., 25th April, 1887; 5 years.

Claim.—1st. A car-coupling draw-head, formed in two detachable sections, the ends of which are provided with intersecting members forming a segmental knuckle joint, admitting of vertical and lateral movement, and a cap or flange covering the joint to protect it, substantially as described. 2nd. A car-coupling draw-head, having a recess in one side, with curved front and rear walls, in combination with a hook having a lateral projection on one side, and a transverse pin provided with an operating eccentric cam, substantially as de-

scribed. 3rd. A car-coupling draw-head, having a hook with a lateral projection on its rear end, a transverse pin having an eccentric cam and supporting a swinging link, in combination with a pallet shaper cam, and suitable means for operating the several parts, substantially as described. 4th. A car-coupling draw-head, having a chamber therein, a link having a hook on its lower side, a transverse pin, a hook, a dog and a cam detachably secured to said pin, in combination with suitable operating means, substantially as described. 5th. In a car-coupling, a pallet shaped cam, having an eccentric flaring flange on its outer end, in combination with a hook and a transverse pin provided with an eccentric cam for throwing the hook, substantially as described. 6th. A car-coupling draw-head, provided with a transverse pin, having a disk on one end, and supporting a detachable hook and a cam, in combination with slotted studs swivelled in said disk, and in an operating lever and an intermediate link for connecting the swivelled stud, substantially as described.

### No. 26,531, Washing Machine. (*Laveuse.*)

Dewey K. Hickok, Morrisville, Vt., U.S., 26th April, 1887; 5 years

*Claim.*—1st. In a washing machine, the combination of a receptacle, a fixed guide frame, a plunger operating in the receptacle, and having a rod passing through the guide frame, a spring connected with the operating rod to normally hold the plunger in an elevated position, and a weight carried by the rod to assist the down stroke of the plunger, substantially as described for the purpose set forth. 2nd. In a washing machine, the combination, with the reciprocating plunger having an operating rod, of a retracting spring loosely connected with the rod to permit the latter and the plunger to rotate freely in horizontal planes, and the weight or weights carried by the upper end of the rod to assist the down stroke of the plunger, substantially as described for the purpose set forth. 3rd. In a washing machine, the combination of a reciprocating plunger having an operating rod, a spring connected to the rod for assisting in the elevation of the plunger and rod, and a weight carried by the operating rod for assisting the down stroke of the plunger, the spring being of greater power than the weight to normally hold the plunger in an elevated position, substantially as described for the purposes set forth. 4th. In a washing machine, the combination of a receptacle, a fixed guide frame, a plunger having an operating rod passing through the guide frame, a sleeve fixed to the operating rod, and a spring connected to the guide frame and loosely connected with the sleeve through an intermediate device, substantially as described for the purpose set forth. 5th. In washing machine, the combination of the receptacle, a fixed guide frame, a plunger operating in the receptacle and having a rod passing through the guide frame, a sleeve fitted on the rod and having a binding screw for adjustably clamping the sleeve to the rod, a spring connected to the guide frame, and a washer fitted on the rod and connected to the lower end of the spring to bear upon the lower end of the sleeve, substantially as described for the purpose set forth. 6th. In a washing machine, the combination of a receptacle, a fixed guide frame, a plunger operating in the receptacle and having a rod passing freely through the guide frame so as to be capable of rotary motion therein in addition to an end-wise movement, a sleeve rigidly affixed to the rod, a spring encircling the sleeve and rod and connected to the frame, and a washer bearing against the sleeve and connected to the spring, substantially as described. 7th. The combination of a receptacle having fixed cover sections *b*, *b*<sup>3</sup>, the flange formed by the extended ends *c* of the staves of the receptacle, and arranged concentric with the curved edge of the cover section *b*, and arranged at the outer edge thereof to receive a wringing machine, and a sectional cover hinged to the fixed sections *b* and *b*<sup>3</sup>, substantially as described for the purpose set forth. 8th. In a plunger for washing machines, the combination of a head having a closed air chamber, a series of cups or cells opening into the said chamber, and a single valve operating in the chamber, substantially as described for the purpose set forth. 9th. In a plunger for washing machines, the combination of a head having an air chamber, the guide pins fixed in the chamber, and valves working over and guided by the pins and enclosed within the chamber, and a series of cups or cells opening into the common air chamber, substantially as described for the purpose set forth. 10th. In a plunger for washing machines, the combination of a head having an air chamber, the removable cover rigidly affixed to the chamber, and the depending guide pins fixed to the cover, the valve guided by the pins and the series of cups or cells opening into a common air chamber, substantially as described. 11th. In a plunger for washing machines, the combination of a head having an operating rod affixed centrally thereto, the air chambers located in the head on opposite sides of the rod thereof, the series of cups or cells affixed to the head and opening into the chambers, the valves working in the said chambers and the fixed guide pins in the chambers for guiding the valves therein, substantially as described for the purpose set forth.

### No. 26,532. Thill Coupling.

(*Armon de Limonière.*)

William Watkins, Waterloo, Iowa, U.S., 26th April, 1887; 5 years.

*Claim.*—1st. In an anti-rattler thill-coupling, the combination, with piece A having a hooked end provided with an inclined slot, and with the lower portion of the outer periphery formed on a curve of the thill-iron, having an opening adapted to the hooked end of the piece A, and a bearing plate in the rear of the opening adapted to bear against the curved surface of the piece A and means for adjusting the bearing plate, substantially as described. 2nd. In an anti-rattler thill coupling, the combination, with the piece A having a hooked end provided with an inclined slot, and with the lower portion of the outer periphery formed on a curve of the thill iron, having an opening adapted to the hooked end of the piece A, and a bearing plate in the rear of the opening adapted to bear against the curved surface of the piece A and means for adjusting the plate, substantially as described. 3rd. In an anti-rattler thill-coupling, the combination, with the piece A having a hooked end provided with an inclined slot and with the lower portion of the outer periphery formed on a curved, and with a

notch in the upper portion thereof, of the thill-iron having an opening adapted to the hooked end of the piece A, a bearing plate in the rear of the opening adapted bear against the curved surface of the piece A, and means for adjusting the bearing plate so that it will engage with the said notch, substantially as described. 4th. In combination with the hooked end of the piece A, provided with the inclined slot, and having the curved portion *b* and the notch *a*, the thill-iron provided with the bolt adapted to bear in the inclined slot, the plate D bearing against the portion *b*, said plate being adjustable by means of the set-screw C whereby rattling is prevented, all substantially as described. 5th. In an anti-rattler thill-coupling, in combination, the hooked end of the piece A having the curved lower portion of the outer periphery and notched upper portion, the thill-iron carrying the set-screw, and the adjustable plate bearing against the portion *b*, whereby upon raising the thill-iron to such a height that the plate no longer bears upon the portion *b* it will bear in the notch *a*, and thus hold the thills in their upright position, substantially as described.

### No. 26,533. Automatic Railroad Signal.

(*Signal automatique de chemin de fer.*)

Edward D. Doherty, Philadelphia, Penn., U.S., 26th April, 1887; 5 years.

*Claim.*—1st. In a railroad signal, the combination, with a signal slide disk and devices located alongside of one of the rails of the rack, and adapted to be engaged by the wheels of a passing train, for automatically operating the slide or disk of an indicator, and device connecting the slide and indicator, whereby the position of the former is indicated on the latter, substantially as set forth. 2nd. In a railroad signal, the combination, with a signal slide or disk and devices for operating the same, of an indicator, a bell and devices connecting the slide and indicator for indicating on the latter the position of the former, and for sounding the bell as the danger signal is set, substantially as set forth. 3rd. In a railroad signal, the combination, with a slide, a lever located alongside of the track and adapted to be moved by the passage of a train over the same, and devices connecting the lever and slide of an indicator, and devices connecting the lever and indicator, substantially as set forth. 4th. The combination, with a slide or disk, a lever and a movable weight adapted to travel on said lever, of an indicator, and devices connecting the lever and indicator, as described. 5th. The combination, with a slide or disk, a lever and a roller adapted to move on said lever, of an indicator having an alarm bell thereon, and devices connecting the lever and indicator, substantially as set forth. 6th. The combination, with a standard, a lamp-case, a disk secured to a lever, and a bell secured to the lamp-case and adapted to be operated by the movement of said lever, of a pivoted lever, a weight adapted to move thereon, and a rod connecting the pivoted lever, and the lever carrying the disk, as described. 7th. The combination, with a slide or disk and a rod connected thereto, of a pivoted lever having a groove or channel therein, the lugs formed on said lever at the ends of said groove or channel, and a roller mounted on the lever and adapted to travel between the lugs, substantially as described. 8th. The combination, with a slide or disk, a pivoted lever, and a movable device mounted on said lever, of a semi-elliptical spring located in a position to be engaged by the wheel of a passing train, and a pin connected with said spring for operating the lever, as described.

### No. 26,534. Car-Coupling. (*Attelage de chars.*)

Charles E. Michaud, Yamaski, Que., 26th April, 1887; 5 years.

*Claim.*—1st. The combination of the draw-bar B, draw-head C, pin D, link E, bracket F, lever G, limb *g*, guide *g*<sup>1</sup>, shaft H, lever H<sup>1</sup>, link drop *h*, guide *h*<sup>1</sup>, catch *h*<sup>1</sup><sup>1</sup>, lever I, bracket I<sup>1</sup>, slide J, bearings C, C<sup>1</sup> and lever K, substantially as set forth. 2nd. The combination of the draw-bar B, head C, bracket F, lever G, *g*, pin D, link *h*, lever H<sup>1</sup>, drop *h*, guide *h*<sup>1</sup>, and catch *h*<sup>1</sup><sup>1</sup>, substantially as set forth. 3rd. The combination of the draw-bar B, draw-head C and catch *h*<sup>1</sup><sup>1</sup>, substantially as set forth. 4th. The combination of the draw-head C, bearing C<sup>1</sup>, bracket I<sup>1</sup>, lever I, slide J *g*<sup>1</sup>, and lever K, substantially as set forth. 5th. The combination of the bearings C<sup>1</sup>, slide J, head J<sup>1</sup>, slotted cross-bar J, lever K, cross-head K, and link E, substantially as set forth.

### No. 26,535. Coffee and Tea Pot.

(*Cafetière et théière.*)

John P. Gronemeyer, St. Louis, and John Polster, Warrenton, Mo., U.S., 26th April, 1887; 5 years.

*Claim.*—1st. A coffee and tea pot attachment, consisting of a vessel having a water chamber and a chamber for the material, a diaphragm between the chambers, a perforated cap to the chamber for the material and a pipe for the admittance of air to the water chamber, substantially as set forth. 2nd. A coffee and tea pot attachment, consisting of a vessel D formed with a bottom D<sup>1</sup> having a marginal flange *d*<sup>1</sup>, an opening *d*<sup>2</sup>, a neck D<sup>2</sup> and a flange *d*<sup>2</sup> surrounding the opening, the cap H having a perforated top H, the diaphragm E formed with perforations and having post E<sup>1</sup> extending to the top and the air-pipe J, substantially as set forth.

### No. 26,536 Adjustable Saw Tooth.

(*Dent de scie mobile.*)

John C. Dalton, Columbus, Ohio, U.S., 26th April, 1887; 5 years.

*Claim.*—The combination, with the saw-blade A having recesses formed of segments of circles having different centres, of the longitudinally adjustable tooth D and the longitudinally movable locking block B, said block being provided with apertures *a*, *a* for engagement therewith, of a wrench for moving it into and out of position, and the back of said block being formed on segments of circles having different centres, substantially as described.



### No. 26,537. Combined Heating and Cooking Device. (*Appareil de chauffage de cuisine.*)

Quimby S. Bachus, Philadelphia, Penn., U. S., 26th April, 1887; 5 years.

*Claim.*—1st. In a heating and cooking device, the combination of a removable lamp-stove, a compartment for the same provided with a reflecting fire-shield, a water-boiler situated in the rear of said fire-shield, and a pipe connecting with the water-boiler and coiled in advance of the fire-shield above the lamp wicks, substantially as shown and described. 2nd. In a heating and cooking device, the combination of a stove compartment having a reflecting fire-shield, a lamp-stove contained within the same, a water-boiler, a pipe connecting with the water-boiler and coiled in advance of the fire-shield above the lamp-wicks and a steam receiver, substantially as shown and described. 3rd. The combination, with a compartment open at one side, and having an open work front guard extending across the open side of the same, of a lamp-stove situated within the compartment, and a series of flat wick-tubes arranged in different lines overlapping each other, and extending entirely across the compartment, substantially as described. 4th. The combination of a removable lamp-stove, a compartment for the same, and an open-work front guard hinged in line with its upper edge to the compartment at about the height of the lamp-chimneys, substantially as and for the purpose set forth. 5th. The combination, with the stove-compartment, of a lamp-stove and a front guard connected with the said stove, so that they may be removable together from the compartment, substantially as described.

### No. 26,538. Steam Generator.

(*Générateur de Vapeur*)

Alfred H. Crookford, Harrison, N.J., U.S., 26th April, 1887; 5 years.

*Claim.*—1st. The combination, with a boiler, of a steam generator consisting of coiled pipes placed under the boiler, or below the crown sheet and over the fire, and connected with the front of the boiler at the top, and at the rear of the boiler by pipes (as *c, d*) of greater diameters than the said coiled pipes, as and for the purposes set forth. 2nd. The combination, with a boiler, of a steam generator consisting of coiled pipes placed under the boiler and over the fire, and connected with the front of the boiler at the top, and the rear of the boiler at the bottom by pipes of greater diameter than the said coiled pipes, and a sediment drum or receptacle having a removable head and a blow-off *i* in the same and sediment conductors *f*, as and for the purposes set forth. 3rd. The combination, with a steam generator, of a sediment or dirt receptacle, connected with said generator by one or more sediment conductors *f*, said conductors meeting said generator forming cross fittings *f*, and the head of the sediment drum being removable and having a blow off *i* in the same, substantially as set forth. 4th. The combination, with a boiler, of a steam generator consisting of coiled pipes arranged beneath said boiler and over the fire, and connected with the front of the boiler at the top, and rear of the boiler at the bottom, and inclined tubes *l* arranged beneath the boiler on opposite sides of the fire, and connected with the said coiled pipes at the front of the boiler and with the said boiler at the rear, as used for the purposes set forth. 5th. The combination, with a boiler, of a coil of pipes arranged beneath said boiler, and over the fire and connected with the front of the boiler at the top and the rear of the boiler at the bottom, a tubular water arch arranged and connected with the boiler, as set forth, tubes arranged in an inclined position on opposite sides of the fire and beneath the boiler, and connected with said water arch as set forth, and also with the rear of the boiler, for the purposes set forth. 6th. The combination, with a boiler, of a water arch or fire plate composed of pipes connected with said boiler, and constructed and arranged to receive a current of water there through into the boiler, substantially as and for the purposes set forth. 7th. The combination, with a boiler, of a coil of pipes arranged beneath said boiler and over the fire, and connected with the front of the boiler at the top and the rear of the boiler at the bottom, a sediment or mud drum connected with said coil at the rear of the boiler tubes *l*, arranged in an inclined position on opposite sides of the fire, and beneath the boiler, and connected with the coil of pipes at the front of the boiler and with the said boiler at the rear, and also with said sediment drum, substantially as and for the purposes set forth.

### No. 26,539. Car-Coupler. (*Attelage de Chars.*)

Alexander Heron, Delaware, Ont., 26th April, 1887; 5 years.

*Claim.*—1st. In a coupler for coupling the cars of a train, the pivotal link or pin *F* having an entering end *F*<sup>2</sup> formed with a knob or enlarged portion, substantially as shown and described and for purpose specified. 2nd. In a coupler for coupling cars, a link or pin *F* formed with a flaring end *F*<sup>4</sup>, slot *F*<sup>3</sup>, shoulder *F*<sup>5</sup>, and entering end *F*<sup>2</sup> formed with a knob or enlarged portion, substantially as shown and described and for the purpose specified. 3rd. In a coupler for coupling cars, a draw bar *C* formed with a rounded portion *C*<sup>1</sup>, substantially as shown and described and for the purpose specified. 4th. The link or pin *F*, formed with a flaring end *F*<sup>4</sup>, slot *F*<sup>3</sup>, shoulder *F*<sup>5</sup>, and entering end *F*<sup>2</sup> formed with a knob or enlarged portion, in combination with the draw bar *C*, substantially as shown and described and for the purpose specified. 5th. The combination of a pivotal link or pin *F* formed with a flaring end *F*<sup>4</sup>, shoulder *F*<sup>5</sup> and slot *F*<sup>3</sup>, and draw bar *C* formed with a rounded portion *C*<sup>1</sup>, in combination with a draw bar *C*, and pivotal link or pin *F* having an entering end *F*<sup>2</sup> formed with a knob or enlarged portion, substantially as shown and described and for the purpose specified.

### No. 26,540. Cowl or Ventilator for Chimney.

(*Capuchon ou Ventilateur pour Cheminées.*)

John R. Colls, Toronto, Ont., 26th April, 1887; 5 years.

*Claim.*—A chamber *B* surrounding and suspended above the top of

the pipe *A*, holes *a* made in the wall of the said chamber, in combination with the open bottomed chamber *D*, surrounding the chamber *B* and having an escape pipe or opening *E* formed in its top, substantially as and for the purpose specified.

### No. 26,541. Metallic Seal for Packages, Boxes, etc. (*Fermeture Scellée pour Paquets, Boîtes, etc.*)

Andrew J. Phelps, Syracuse, N.Y., U.S., 26th April, 1887; 5 years.

*Claim.*—1st. The combination of a soft metal seal having folding lips, a nail driven through the centre of the said seal, the tie or binder wound around the nail between the head thereof and underlying portion of the seal, and the lips of the seal folded over the head of the nail and compressed upon the same, substantially as set forth. 2nd. A seal composed of a soft or ductile metal tube, provided with incisions in its central portion, as specified. 3rd. The seal composed of a soft or ductile metal tube, provided at its central portion with a nail hole in one side, and with incisions in the opposite side, substantially as described and shown.

### No. 26,542. Snap Hook. (*Crochet à Ressort.*)

Nathaniel Kinsley and Albert Heusser, Taylor, Nev., U.S., 26th April, 1887; 5 years.

*Claim.*—In snap hook, the combination, with the stem *B* having the hole *N*, provided with the slot *L*<sub>1</sub>, of the pin *P* mounted in said hole, and formed with the tongue *P*<sub>1</sub>, the button *L* projecting from said pin through said slot, the spring *M* for outwardly pressing said pin, and the hook *A* pivoted at *A*<sub>1</sub> to the stem and formed with the lips *A*<sub>3</sub>, *A*<sub>4</sub>, and notch *A*<sub>2</sub> for engagement with said tongue *P*<sub>1</sub>, the outer portion of said hole *N* in the stem *B* being formed with the seats *B*<sub>4</sub> for receiving said lip *A*<sub>3</sub> and making a smooth point, as described.

### No. 26,543. Pump. (*Pompe.*)

William S. McLeod, Kingsville, Ont., 26th April, 1887; 5 years.

*Claim.*—1st. The combination of the cylinder heads, provided each with an opening on one side and a flanged plate, the cylinder fitting between the heads about the flanged plates, and the end pipes provided with laterally-extending heads connecting with the ends of the cylinder-heads, and means for binding the parts together, substantially as described. 2nd. The combination, with the cylinder heads, of the valve composed of the shell set within the head, and having a pallet provided with a projection on its top hinged between ears extending from the end of the shell, which ears form a stop, as shown, for the projection on the pallet to strike against, substantially as described. 3rd. The valve composed of the shell having an external flange, in combination with the pallet provided with a projection on its top, and hinged to ears at one end of the shell, substantially as described. 4th. The valve composed of the shell having the pallet hinged to ears at one end thereof, which ears form a stop, as shown, to the movement of the valve, substantially as described.

### No. 26,544. Churn. (*Baratte.*)

Sidney Smith, Cambridge, Mass., U.S., 26th April, 1887; 5 years.

*Claim.*—1st. A cylindrical churn having a pump, means for operating the same, and a suitable opening to conduct air from the pump into the churn, combined with a dash having a hollow cross bar adapted to coincide with said opening and conduct the air as described, the churn being provided with a suitable opening for the escape of the gases generated during the process of churning. 2nd. In combination, with a cylindrical churn, a rotating dasher having marginal frames *2* with sharp edges, and having an open center, and with cross-bars *3*, with sharp edges extending from the side bars *2* to sharp edged bars *4* parallel with the side bars, as set forth.

### No. 26,545. Steam Heater (Radiator.)

(*Calorifère à Vapeur*) (*Serpentiu.*)

Quimby S. Backus, Philadelphia, Penn., U.S., 26th April, 1887; 5 years.

*Claim.*—1st. The combination, with a fire-place compartment, of a steam radiator mounted thereon, a lengthened pipe coil in said compartment communicating therewith, and a series of burners placed in line or lines beneath said pipe coil and extending the entire length of the same, substantially as described. 2nd. The combination, with a fire plate compartment, of a steam radiator mounted thereon, a lengthened pipe-coil in said compartment communicating therewith and an oil-stove having lengthened wick-tubes placed end to end beneath said pipe-coil parallel with the pipes of said coil and extending the entire length of the same, substantially as described. 3rd. The combination, with a casing, open at the front, of a radiator, mounted thereon, a coil located within the casing and communicating with said radiator, and burners situated below the coil, substantially as described.

### No. 26,546. Railway Car Cover.

(*Couverture de Char de Chemin de fer.*)

Richard H. Wyman, Evanston, Ill., U.S., 26th April, 1887; 5 years.

*Claim.*—1st. The combination, with a railway freight car, of a flexible cover in two or more independent sections adapted to meet above the longitudinal central line of the car to cover said car, each section consisting of slats hinged together by means of links secured to said slats, and means, substantially as described, for raising and lowering said sections, for the purpose specified. 2nd. The combination, with a railroad freight car, of a flexible cover in two or more independent sections, each section consisting of slats hinged together, friction-wheels mounted upon the ends of the slats, guideways secured to said car at the end of said slats, and means, substantially as described, for raising and lowering said sections, for the purpose specified. 3rd. The combination, with a railway freight car, of a

flexible cover in two or more independent sections, each section consisting of slats hinged together, friction-wheels on the end of each slat, the curved guide H, and means, substantially as described, for raising and lowering said sections, as and for the purpose specified.

4th. A movable cover for railway freight cars in two or more independent sections, each section consisting of slats hinged together by means of links secured to said slats and extending outwardly therefrom and having each slat overlap the slat next below it, as described.

5th. The combination, with a railway freight car, of a flexible cover of two or more independent sections, each section consisting of slats extending lengthwise of the car, hinged links secured to said slats and extending outwardly from the surface of the slats, and sprocket wheels mounted on the sides of the car and adapted to engage with said hinged links, substantially as and for the purpose specified.

6th. The combination, with a railway freight car, of a flexible cover in two or more independent sections, each section consisting of slats hinged together and extending lengthwise of the car, friction-wheels on the ends of said slats, guideways secured to the car adapted to engage with said wheels, means substantially as described for raising and lowering said sections, and hooks secured to the upper slat of each section, as and for the purpose specified.

**No. 26,547. Machine for Setting Carriage Wheel Boxes.** (*Machine à poser les boîtes des roues de voitures.*)

Antoine E. Quintal, Montreal, Que., 27th April, 1887; 5 years.

*Réclame*.—Une machine à boiter les roues de voitures composée du bâti A B C D E F G J K L M N O, et les pieds B, B', C, C', supportant les diverses portions de la machine en question, de la table à rone V avec les supports Br X, la serre A<sup>6</sup>, le guide raies B<sub>3</sub> et le levier articulé Er, G<sub>1</sub>, H<sub>1</sub> de l'entoir T avec le tube R, les serres W, W' et les leviers U, d de la table à scier Q avec la soie à ruban J<sub>1</sub>, le volant V<sub>1</sub>, la roue évidée V<sub>2</sub>, le cadre mobile J<sub>5</sub> J<sub>6</sub> J<sub>7</sub> J<sub>8</sub> J<sub>9</sub> J<sub>10</sub> J<sub>11</sub>, le guide scie J<sub>22</sub> J<sub>25</sub> J<sub>26</sub> de la bise perforatrice L<sub>1</sub>, et l'écon à charnière Q<sub>1</sub>, et enfin du mécanisme moteur P<sub>1</sub>, J<sub>14</sub>, J<sub>15</sub>, J<sub>16</sub>, J<sub>17</sub>, J<sub>18</sub>, J<sub>20</sub>, J<sub>21</sub>, T<sub>1</sub>, D<sub>1</sub>, le tout tel que ci-dessus décrit et pour les fins sus-mentionnées.

**No. 26,548. Pottery Kiln.** (*Four de Poterie.*)

Edward M. Pike and Joseph B. Schopp, Chenoa, Ill., 27th April, 1887; 5 years.

*Claim*.—1st. The combination, in a kiln for burning earthenware, of the outer furnaces communicating with the interior of the upper part thereof, and the floor and lower flues, whereby a downward draft through the kiln is secured, and a uniform burning of the contained articles is effected, substantially as described.

2nd. The combination of a kiln for burning articles of earthenware, of the superstructure, the furnaces arranged around outside of the same, the perforated floor and lower flues, substantially as described.

3rd. The combination, with the kiln of the metallic door frame and the bands connected thereto and encircling the outside of the kiln, substantially as specified.

4th. The combination, with the superstructure of the furnace having a series of furnaces B connecting with the upper part thereof, and the intervening floor having flues T, the substructure being provided with an annular flue E, cross flues F and transverse flue G, the latter leading to the smoke-stack, substantially as described and for the purposes set forth.

5th. The combination, with the door of the furnace, of the iron frame L located therein, and the bands extending around the furnace, the ends of said bands at the door being bent and fastened over the outer edge of the frame, substantially as specified.

**No. 26,549. Burial Case or Casket Holder.** (*Boîte de Cercueil.*)

Eliza H. Metcalf, London Township, Ont., 27th April, 1887; 5 years.

*Claim*.—1st. The conical cover B, formed with an overhanging ledge A<sub>1</sub> and flange A<sub>2</sub>, in combination with a base or box A, all formed of crockeryware, stoneware, porcelain, earthenware, or other suitable material, substantially as shown and described and for the purpose specified.

2nd. The conical cover B, formed with an overhanging ledge A<sub>1</sub>, flange A<sub>2</sub> and handles H<sub>1</sub>, in combination with a base or box A having handles H, all formed of crockeryware, stoneware, porcelain, earthenware, or other suitable material, substantially as shown and described and for the purpose specified.

**No. 26,550. Boot and Shoe.** (*Chaussures.*)

George Valiant, Toronto, Ont., 27th April, 1887; 5 years.

*Claim*.—1st. In a boot or shoe, in combination with the tongue-piece and the quarter edges lacing-hooks on the tongue on opposite sides of its middle line and on the quarter edges, substantially as and for the purpose set forth.

2nd. In a boot or shoe, in combination with the vamp and the quarter cut in front, substantially as described, to leave considerable space between its edges across the instep, the tongue piece fastened to the vamp and extending up between the edges of the quarter, the series of lacing hooks along such edges, and the corresponding series of hooks at or near the sides of the tongue-piece, substantially as and for the purpose described.

3rd. In a boot or shoe, in combination with the vamp and the quarter having its opposite, forward, or inner edges cut, substantially as described, to leave a space across the instep between their lower portions when the shoe is laced or fastened, the tongue-piece attached to the shoe only at its lower end, and the corresponding fastening devices along the edges of the quarter and on each side of the tongue, substantially as and for the purpose described.

**No. 26,551. Dovetailing Machine.** (*Machine à Queue d'Aronde.*)

John B. Schmid, Baltimore, Md., U.S., 27th April, 1887; 5 years.

*Claim*.—1st. In a dovetailing machine, the combination of the

frame A, the standard B attached to the frame, the frame C pivoted to the standard and arranged to be placed at any desired angle on either side of a vertical plane, the rack D secured to the standard and provided with notches which engage with the lever attached to the frame C, and the lever  $\alpha$ , by which the frame is held at the desired angle, as set forth.

2nd. In a dovetailing machine, the combination of the frame C, pivoted and arranged to be placed and held at the desired angle on either side of a vertical plane, the reciprocating rod c arranged to hold a chisel, the cross-head d connected to the rod c, the rod  $\alpha$  pivoted to the cross-head, the shaft E and the eccentric  $\alpha$ , by which the rod c is reciprocated and placed at the desired angle on both sides of a vertical plane.

3rd. In a dovetailing machine, the combination of the frame A, the frame F having a vertical adjustment, the screw e<sup>1</sup> to adjust the frame, the table G having a horizontal movement, the rack g secured to the table, the pinion g<sup>1</sup> geared with the rack g, the shaft g<sup>11</sup> extending from the pinion above the frame A, and the handle f by which the table is moved sidewise, as set forth.

4th. In a dovetailing machine, the combination of the frame A, and the handle f by which the table is moved sidewise, the table G, the guide H having a diagonal movement, the pins i secured to the guide and arranged to enter the slots i in the plates l, the plates l arranged to be partly turned on their centres, the bar m connected to the plates l, by which the plates are moved in unison, and the latch n<sup>11</sup> arranged to hold the bar m in the desired position, the sector o arranged on the guide and the rack o<sup>11</sup> by which the guide is moved forward and the movement of the same directed diagonally, as set forth.

**No. 26,552. Motor to Impart Rotary Motion to Churn Dashes, etc.** (*Moteur pour Imprimer un Mouvement Rotatoire aux battes à Beurre, etc.*)

Joseph Ruesing (assignee of Fritz Foellmer), West Point, Neb., U.S., 28th April, 1887; 5 years.

*Claim*.—1st. A motor, comprising a rotatable feed shaft, a plunger adapted to be moved vertically and locking means for holding the plunger against vertical movement when desired, whereby the motor can be utilized to convey rotary motion or vertical pressure, as set forth.

2nd. A motor, comprising a threaded feed shaft, a cross-head fitted and adjustable vertically therein, the plunger rods connected to the cross-head and adapted to carry a follower, and a locking device or catch for holding the cross-head against movement on the feed shaft, as and for the purpose set forth.

3rd. A motor, comprising a suitable case or frame, the vertical and horizontal frames C, D, secured thereto, a driving-shaft, a vertical-threaded feed shaft journaled in the frame and geared to the driving shaft, a follower fitted on the feed shaft, a locking device pivoted to the vertical frames and adapted to be connected with the cross-head to prevent vertical play of the latter, and the plunger rods connected to the cross-head and having a connecting piece at their lower ends adapted to carry a follower, as and for the purpose described.

4th. The combination of a rotary shaft, a short shaft J adapted to carry a device to be actuated by the rotary shaft, and a sliding sleeve permanently fitted on the rotary shaft and having a slotted connection therewith, whereby the sleeve is capable of an endwise movement on the rotary shaft and is adapted to be coupled to the short shaft to rotate the same, as and for the purpose set forth.

5th. The combination of a rotary shaft, a coupling sleeve fitted permanently on the lower end thereof, and having a slot and notches, as shown, a pin passing through the slot of the sleeve to connect it to the rotary shaft, and a short shaft J having the studs or pins adapted to be fitted in the notches in the lower edges of the coupling sleeve, as and for the purpose described.

6th. A motor, comprising a feed shaft capable of rotary motion, a plunger adapted to be moved vertically, locking means for holding the plunger from movement when desired, a follower carried by the plunger, and a sliding coupling I permanently connected to the feed-shaft and having a slotted connection therewith, as and for the purpose set forth.

**No. 26,553. Combined Anti-Rattler and Bolt-Holder for Thill Couplings.** (*Armon de Limonière.*)

John M. Peregrine (co-inventor with Abijah L. Romanus), Jamestown, N.Y., U.S., 28th April, 1887; 5 years.

*Claim*.—1st. As an improved article of manufacture, the combined anti-rattler and bolt-holder A, consisting of a wedge-shaped spring having its front plate b, provided with bolt-holding arm a projecting from the upper edge of said plate, then bent downward, and its extremity bent forward to adapt it to enter a recess in the thill-bolt, and its rear plate c, provided with the guide-arms c<sup>2</sup> projecting forward and embracing the edges of the plate b, as set forth.

2nd. The combination, with the clip B, the thill-iron E and bolt D recessed at e, of the wedge-shaped spring A, provided with the arm a, projecting downwardly and forward and entering the recess of the said bolt, and the guide-arms c<sup>2</sup> projecting from the rear plate and embracing the edges of the front plate, substantially as herein shown and described.

**No. 26,554. Plough.** (*Charrue.*)

Peter M. Bawtinheimer, Ancoaster, Ont., 28th April, 1887; 5 years.

*Claim*.—1st. In a plough, the combination of the closed wheel B, with the landside A, constructed substantially as and for the purpose specified.

2nd. In a plough, the combination of the shield D, for the closed wheel B, with the landside A, substantially as and for the purpose specified.

3rd. In a plough, the combination of the scraper E and the closed wheel B, substantially as and for the purpose specified.

4th. In a plough, the combination of the closed wheel B, shield D, scraper E, with the landside A, substantially as and for the purpose specified.

**No 26,555. Seal for Packing Cases.** (*Fermature Scellée pour Boîtes d'Emballage.*)

Alexander D. Penfold, New York, N. Y., U. S., 28th April, 1887; 5 years.

*Claim.*—1st. A seal, of substantially the character described, made of metal and adapted to be driven in a packing case over the joints of the same, for the purpose specified. 2nd. A seal, adapted to be driven in a packing case and coated with a water color dye, for the purpose specified. 3rd. A metallic seal of the form shown, adapted to be driven in a packing case over the joints of the same, with outwardly and downwardly inclined sides and slitted end prongs, operating in the manner and for the purpose described. 4th. A metallic seal, of substantially the form shown and described, adapted to be driven in a packing case over the joints of the same, for the purpose described, with a number thereon indicating the shipping place.

**No. 26,556. Finger Tip for Counting Bank Notes.** (*Doigtier pour Compter les Billets de Banque.*)

Edward C. Grant, Ottawa, Ont., 28th April, 1887; 5 years.

*Claim.*—1st. A finger tip, used on the finger for turning up papers, and having a grasping or tenacious exterior surface, substantially as and for the purpose set forth. 2nd. A finger tip, provided with the furrows A, substantially as shown and described and for the purpose set forth. 3rd. A finger tip, provided with the vent holes B, substantially as shown and described and for the purpose set forth.

**No. 26,557. Umbrella Fastener.**

(*Ligature de Paraphine.*)

Hugo Rosenberg, Allegheny, Penn., U.S., 28th April, 1887; 5 years.

*Claim.*—1st. The combination, with an umbrella, of a flexible fastening-band attached to the umbrella-frame inside the cover and not to the cover itself, said band projecting below the cover when the umbrella is closed, and being reflex and encircling the umbrella, substantially as and for the purposes described. 2nd. As an umbrella fastener, the combination of a flexible cord or band attached to the umbrella frame on the inside of the cover, having a fastening device 5 at the end thereof, and a button arranged at an intermediate point, substantially as and for the purposes described. 3rd. The combination of the cord 2, looped to the umbrella frame on the inside of the cover, a button 3, a band 4 and a fastening device 5, substantially as and for the purposes described.

**No. 26,558. Broom.** (*Balai.*)

Augustus H. Hoskins, Niagara, Ont., 28th April, 1887; 5 years.

*Claim.*—As an improved article of manufacture, a broom B having one or more metal bands a, and a series of wires b stitched through the broom and clinched onto the bands a, substantially as shown and described.

**No. 26,559. Railway Passenger Car.**

(*Char à passager de chemin de fer.*)

Chester W. M. Smith, San Francisco, Cal., U. S., 29th April, 1887; 5 years.

*Claim.*—1st. The combination, in a car constructed wholly of iron, steel, or metal, and partially of iron or steel, and partially of wood, of the sills and beams or girders composed of angle plates bent so as to form double horizontal and rivetted lips or flanges, as described. 2nd. The combination, in a car, constructed wholly of iron, steel, or metal, or partially of iron and partially of wood, of the iron or steel sheet or flooring bolted between the horizontal lips or flanges of the sills, the edges of said sheet or floor extending to, or nearly to, the outer plates of the sills, in the manner described. 3rd. The combination, in a car constructed wholly of iron, steel, or metal, or partially of wood or partially of iron or steel, of the side walls or sheets E bolted or rivetted between the lips or flanges of the sills, and the lips or flanges of the beams or girders, in the manner set forth and specified. 4th. The combination, in a car constructed wholly of iron, steel, or metal, or partially of wood and partially of iron or steel, of the metallic roof G bolted or rivetted between the lips or flanges of the inverted beams or girders B, B', constructed and arranged substantially in the manner herein set forth and specified. 5th. In a railway car, the ends of the side sheets or walls bent around against the ends of the sills, and beams or girders to form the corners and ends of the car, in the manner described, when continuous or extended sheets are employed, or the separate end sheets or plates bent, so as to form the corners and front of the car body and lapped and rivetted to the said side sheets, as described. 6th. The combination in a car constructed wholly of iron, steel, or metal, or partially of wood, and partially of steel or iron, of the upright or vertical posts resting upon and bolted to the sills and beams or girders, or with the lower ends of said posts morticed into the sills, as specified, for the purpose set forth. 7th. The method herein described of forming sills, beams, or girders, for railway cars and other structures where sheets of metal are to be vertically and horizontally united by bolts or rivets consisting of two metal plates, one of which is bent at right angles, and the other plate bent to a right angle, and the edge of each member bent to a right angle and placed parallel to the outer plate, whereby the two series of vertical horizontal lips, laps or flange are formed for bolting or rivetting vertical and horizontal connecting sheets, as described. 8th. In a railway car composed wholly of sheet iron, or metal, or partially of wood, and partially of steel, iron, or metal, of the four tubes or conductors in the four corners of the car formed by the angle plates or beams, in the manner and for the purposes described. 9th. In a railway car, the conductor or flue formed in the dome of the car, substantially in the manner and for the purposes described.

**No. 26,560. Car and Car Truck.**

(*Char et châssis de char.*)

William Marky, Lancaster, N.Y., U.S., 29th April, 1887; 5 years.

*Claim.*—1st. The combination, with the bolsters e, e, brace-plates c, c, and sills b, b, of the tie-rods f<sub>1</sub>, f<sub>1</sub>, f<sub>1</sub> and f<sub>2</sub>, f<sub>2</sub> substantially as shown and for the purpose stated. 2nd. The brace-plates e, e secured between the sills b, b, in combination with the tie-rods f<sub>1</sub>, f<sub>1</sub> and f<sub>2</sub>, f<sub>2</sub>, for holding it in position, the brace-plates having apertures adapted for the reception rods d, d extending from the cross-heads, substantially as shown and described. 3rd. The combination, with the body bolster e having the socket plate e<sub>1</sub> with the slot e<sub>2</sub>, and socket e<sub>3</sub>, of the truck bolster h having the pin-plate k<sub>1</sub> with slot k<sub>2</sub> and pin k<sub>3</sub>, and the slotted attaching plate l, l and l<sub>2</sub> loosely arranged within the slot k<sub>2</sub>, the two bolsters being removably secured together, substantially as and for the purpose stated. 4th. The connection for car and truck consisting substantially as follows, viz: the body bolster e having the socket-plate e<sub>1</sub> with slot e<sub>2</sub> and socket e<sub>3</sub>, the truck bolster h having the pin-plate k<sub>1</sub> with slot k<sub>2</sub> and pin k<sub>3</sub>, and the slotted attaching plate l, l and l<sub>2</sub> loosely arranged within the slot k<sub>2</sub>, and the locking-plate m m<sub>2</sub> m<sub>2</sub> and locking pins n, n all combined and operating substantially as shown and described.

**No. 26,561. Hand Truck.** (*Camion à bras.*)

George Wilson, Toronto, Ont., 29th April, 1887; 5 years.

*Claim.*—1st. In a hand truck, the combination of the carrying bar C, with the axle H and the wheels K forming a part of a truck and the hook A, substantially as described and for the purpose specified. 2nd. In a hand truck, the combination of the carrying bar C, with the hook A, substantially as described and for the purpose specified.

**No. 26,562. Harrow.** (*Herse.*)

Frederick Nishwitz, Millington, N.J., U.S., 29th April, 1887; 15 years.

*Claim.*—1st. The combination of a support or carrying-beam, and an end for end reversible trailing knife-cutting harrow-tooth projecting rearwardly therefrom and having a continuous cutting edge. 2nd. The combination of a support or carrying-beam, and an end for end reversible trailing knife-cutting harrow-tooth, adapted to be attached to the support by either end. 3rd. The trailing knife-cutting harrow-tooth, formed with substantially like ends and adapted to have either end secured to a carrying-bar, substantially as set forth. 4th. The combination of a carrying-bar, curved or twisted harrow-teeth, substantially similarly shaped on opposite sides of their central transverse lines, and mechanism whereby the teeth may be secured by either end to the bar. 5th. The combination of a carrying-bar, unperforated trailing knife-cutting harrow-teeth formed with substantially like ends, and clamping mechanism, whereby the teeth may be secured to the carrying-bar by either end, substantially as set forth. 6th. A curved trailing reversible harrow-tooth formed of hollow rolled steel and similarly shaped on opposite sides of a transverse central line. 7th. The combination of a carrying-bar, end for end reversible trailing harrow-teeth, shaped so as to present a rocker-shape or curved lower edge from end to end in side elevation, and mechanism for attaching the teeth to the bar by either end. 8th. The combination of a front gang-bar, having harrowing or cultivating devices upon it, a rear gang-bar arranged upon a higher plane, end for end reversible curved or rocker-shaped harrow-teeth upon the rear gang-bar, and devices for securing said rocker-shaped teeth to the gang-bar by either end. 9th. The combination of a flat knife-cutting harrow-tooth, formed with a depression in its flat side for engagement with a clamping or holding device, a carrying-bar and devices for securing the tooth to the bar. 10th. The combination of a carrying-bar, trailing knife-cutting harrow-teeth formed with substantially like ends, and curved between their ends, and devices for connecting the teeth to the bar by either end. 11th. The combination of a carrying-bar, harrow-teeth formed with substantially like ends, and twisted between their ends and devices for securing the teeth to the bar by either end. 12th. The combination of a gang-bar, end for end reversible trailing harrow-teeth formed with a twist or curve to adapt them to cut under and turn the earth devices by which the teeth may be secured to the gang-bar by either end, and adjusting mechanism for swinging the rear ends of the teeth horizontally, substantially as and for the purpose set forth. 13th. The combination of a front gang-bar twisted, trailing end for end reversible harrow-teeth having flat ends for attachment to said bar, a rear gang-bar and sinuous S-shaped end for end reversible trailing teeth on the rear bar. 14th. The combination of a front gang-bar having end for end reversible trailing teeth thereon, which act on the soil in a uniform direction or manner on both sides of the central draft-line, a rear gang-bar and end for end reversible trailing-teeth on the rear gang-bar, which act on the soil in a uniform manner on both sides of the central draft-line. 15th. The combination of the front gang-bar, the casting H formed substantially as illustrated, the adjusting bar K, the upper casting L, formed substantially as illustrated, the harrow-tooth I, and the clamp-bolt. 16th. The combination of the rear gang-bar, the casting P, formed substantially as described, the harrow-tooth provided with a socket or depression near its end, the clamp casting Q, and the clamp-bolt. 17th. The combination of the gang-bar, the rearwardly projecting harrow-teeth, the castings or clamping devices by which said teeth are connected with the gang-bar, the sliding adjusting bar connected with said castings, and the adjusting bolt for effecting the adjustment of the sliding-bar. 18th. The combination of the gang-bar, the harrow-tooth formed with a notch upon its end, a casting or fastening device by means of which the tooth is connected with the gang-bar, having a lug or projection which enters the notch in the end of the harrow-tooth, and clamping devices for holding the parts together. 19th. The combination of the front gang-bar or frame, the draft-yoke or frame, the laterally shifting pole, and the shifting diagonal brace extending from the yoke to the pole, and adapted to be shifted to either side of the pole according to its position. 20th. The combination of the axle, the carrying wheels, a trailing-tooth harrow having its transverse gang-bar or bars which carry the trailing teeth arranged in front of the rock-

ing axle, a hinge or pivotal connection extending from the axle to the harrow, and mechanism for rocking the axle, for the purpose set forth. 21st. The combination of the rocking axle, the carrying wheels, mechanism for rocking the axle, a trailing-tooth harrow hinge or pivotal connections between the harrow and axle, a rack carried by the axle, and a pivoted detent mounted on the harrow, substantially as and for the purpose set forth. 22nd. The combination of the rocking axle, the wheels, a trailing-tooth harrow consisting of flexibly connected transverse gang-bars carrying trailing cutting teeth, pivotal rod-connections between the axle and transverse gang-bars of the harrow at or near the ends of the gang-bars, and mechanism for rocking the axle, for the purpose set forth. 23rd. The combination of the rocking-axle, the wheels, a trailing-tooth harrow consisting of flexibly connected transverse gang-bars carrying trailing cutting teeth, hinged or pivotal connections between the axle and harrow, and mechanism for rocking the axle, whereby the relation of the flexible harrow to the soil is varied.

**No. 26,563. Affixable Solid Flap for Plain Axles of Road Vehicles.** (*Echantignolle mobile pour essieux de voitures routières.*)

Ebenezer Partridge, Birmingham, Eng., 29th April, 1887; 5 years.

*Claim.*—In combination with a perforated double winged clip *a*, top plate *b*, projections *g*, *g*, stud *e* and pins *f*, *f*, as hereinbefore described and substantially as shown in the annexed drawings.

**No. 26,564. Smoke and Spark Arrester.** (*Arrête-fumée et arrête-étincelle.*)

Isaac Deyell, St Thomas, Ont., 29th April, 1887; 5 years.

*Claim.*—1st. In a smoke-stack, the combination of the flare *L* having the curve *H*, and the vertical cylindrical outlet *E*, substantially as and for the purpose hereinbefore set forth. 2nd. In a smoke-stack formed as above, the combination of the hopper *B*, the circular annular rim *M*, the oval-shaped extension *I* and the circular conducting pipes *c*, *c*, *c*, *c*, substantially as and for the purpose hereinbefore set forth. 3rd. In a smoke stack, in combination with the hopper *B*, the oval extension *I* and the conducting pipes *c*, *c*, the curved angular deflector *F*, substantially as and for the purpose

hereinbefore set forth. 4th. In a smoke stack, in combination with the hopper *B*, the oval extension *I* and the conducting pipes *c*, *c* and *c*, *c*, of the pipes *G*, *G* and the cocks *N*, *N*, substantially as and for the purpose hereinbefore set forth. 5th. In a smoke stack, in combination with flare *L* and the curve *H*, and the vertical cylindrical outlet *E*, a circular frame wire netting *K* made to revolve on the spindle *O* enclosed in a frame, substantially as and for the purpose hereinbefore set forth.

**No. 26,565. Bench Plane.** (*Rabet.*)

John P. Gage, Vineland, N.J., U.S., 29th April, 1887; 5 years.

*Claim.*—1st. In a bench plane, the combination, with the plane-stock, the tool-holder, slotted as described, and the adjusting screw *b* moving in a threaded opening in said tool-holder of the tool *C*, the clamping-plate *C* on the outer side of the tool, and the clamp *D* on the underside side thereof, the said clamp being provided with the block *d* passing through the slot *b* of the tool-holder, and having the recess *d* which engages the disk *b* of the screw *b*, and the screw holding the clamp to the tool, substantially as specified. 2nd. In a bench-plane, the combination, with the plane-stock and tool-holder, constructed as described, of the clamps *C* and *D*, the tool *C* arranged between the said clamps and having the transverse slots *c*, and the screw *c* for securing the clamps to the tool, substantially as specified.

**No. 26,566. Hot Water Circulating Boiler.** (*Chaudière de calorifère à eau.*)

Joseph D. Barceolow and Frederik Steben, Brookville, Ont., 30th April, 1887; 5 years.

*Claim.*—1st. A hot water circulating boiler having headers *A*, *G* connected by vertical tubes *F*, arranged in the line of a circle, the upper half or section of the tubes smaller than the lower section, and elbow branches *H* tending towards the centre of the circle, and entering the header *G* at about uniform distances apart, substantially as set forth. 2nd. The combination, with the casing *L*, of the annular header *A*, grate *C*, tubes *F*, branch pipes *H*, and flat circular header *G*, arranged as set forth, whereby the branch pipes are radially concentrated to receive the direct heat from the fire, as set forth. 3rd. The casing *L* having an exterior pipe *P* connecting the ash pit and smoke stack, as set forth.

**CERTIFICATES OF THE PAYMENT OF FEES FOR FURTHER TERMS HAVE BEEN ATTACHED TO  
THE FOLLOWING PATENTS.**

- |  |  |
|--|--|
| <p>859. J. H. BYRNE, 2nd 5 years of No. 14,529, from the 3rd day of April, 1887. Improvements on Frames for Supporting the Pump in Gasoline Gas Machines, 2nd April, 1887.</p> <p>860. J. E. TRENHOLM, 2nd 5 years of No. 14,658, from the 25th day of April, 1887. Improvements in Hay Presses, 2nd April, 1887.</p> <p>861. J. BENNETT, 2nd 5 years of No. 14,552, from the 5th day of April, 1887. Improvements on churns, 4th April, 1887.</p> <p>862. H. W. METCALF, 2nd and 3rd 5 years of No. 25,183, from the 22nd day of April, 1891. Improvements in Reed Organs, 7th April, 1887.</p> <p>863. J. W. F. SOLE, 2nd 5 years of No. 14,603, from the 17th day of April, 1887. Improvements on Furnaces, 15th April, 1887.</p> <p>864. M. V. KACER, 2nd 5 years of No. 14,614, from the 19th day of April, 1887. Improvements on Bottle Wrappers, 13th April, 1887.</p> <p>865. C. BOSS, 3rd 5 years of No. 7490, from the 1st day of May, 1887. Improvements in Preserving Chambers, 13th April, 1887.</p> <p>866. R. M. PATCHIN, 2nd 5 years of No. 14,590, from the 15th day of April, 1887. Improvements in Combined Burglar Alarm and Door Bolts, 15th April, 1887.</p> <p>867. C. W. DENNIS, 2nd 5 years of No. 14,622, from the 20th day of April, 1887. Improvements on Wash Boiler Fountains, 20th April, 1887.</p> | <p>868. H. MITCHELL, 2nd 5 years of No. 14,676, from the 27th day of April, 1887. Cloth Exhibitor, 21st April, 1887.</p> <p>869. A. DeLASKI, 2nd and 3rd 5 years of No. 26,048, from the 18th day of February, 1892. Improvements in Circular Looms, 21st April, 1887.</p> <p>870. J. HAY &amp; CO., (assignees), 2nd 5 years of No. 14,558, from the 8th day of April, 1892. Improvements in Machinery for Weaving Cane, 21st April, 1887.</p> <p>871. P. SMITH, 2nd and 3rd 5 years of No. 14,647, from the 23rd day of April, 1887. Improvements on Water Heaters and Circulators, 23rd April, 1887.</p> <p>872. E. E. SPENCER, 3rd 5 years of No. 7426, from the 1st, day of May, 1887. Improvements in Heaters 20th April, 1887.</p> <p>873. J. REECE, 2nd 5 years of No. 14,682, from the 27th day of April, 1887. Improvements on Button Hole Sewing Machines, 25th April, 1887.</p> <p>874. O. C. HANSEN, 2nd 5 years of No. 14,862, from the 29th day of May, 1887. Improvements in Fog Horns, 25th April, 1887.</p> <p>875. C. W. LEVALLEY, 2nd 5 years of No. 14,904, from the 3rd day of June, 1887. Improvements on Harvesting Machines, 25th April, 1887.</p> <p>876. F. H. AIRD, 2nd and 3rd 5 years of No. 7763, from the 7th day of August, 1887. Improvements in Refrigerators, 28th April, 1887.</p> <p>877. S. S. APPEGATE, 2nd 5 years of No. 14,761, from the 10th day of May, 1887. Improvements on Electric Alarm Apparatus, 26th April, 1887.</p> |
|--|--|

THE  
CANADIAN PATENT OFFICE RECORD.

ILLUSTRATIONS.

Vol. XV

MAY, 1887.

No. 5.

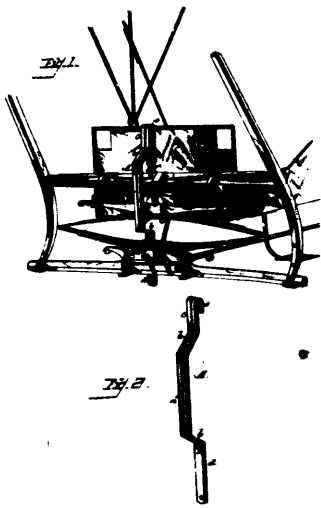

26344 Statter's Shaft Support for Vehicles.

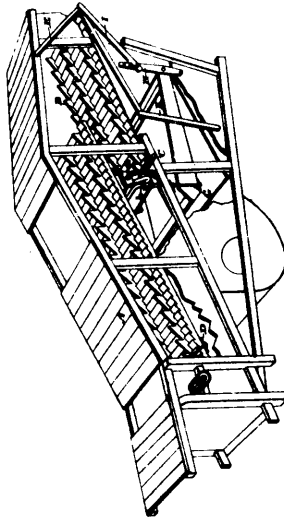

26346 Burkholder's Threshing Machine.

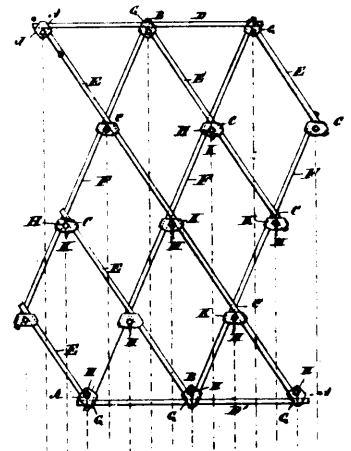

26347 Owen's Harrow.

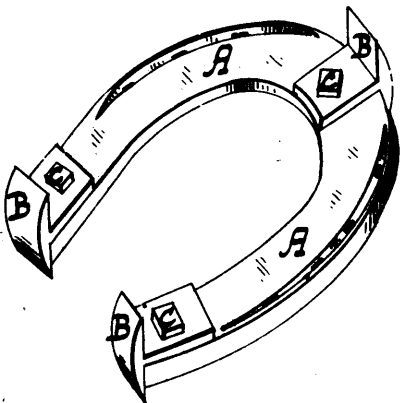

26348 Penhorwood's Horse-Shoe.

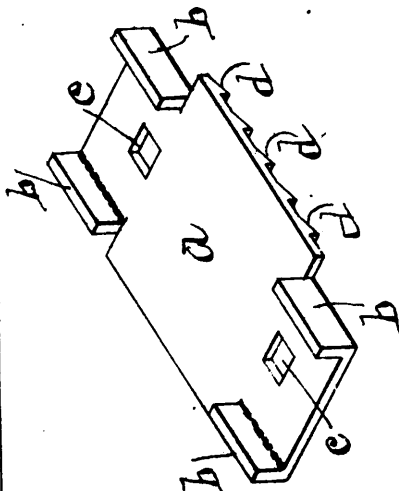

26349 Goldie's Railway Rail Chair.

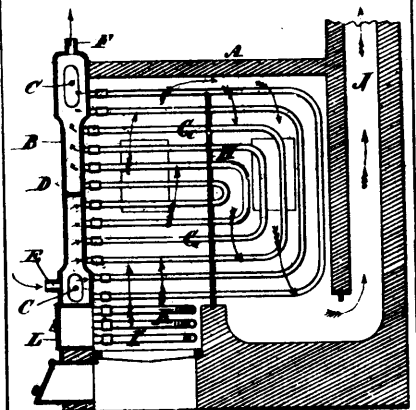

26350 Johnstone's Hot Water Boiler.

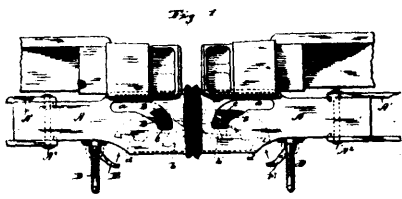

Fig. 2.

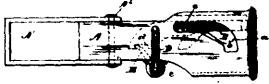
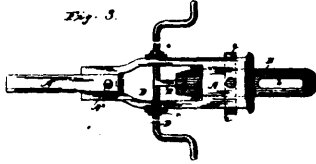

Fig. 3.



26351 Tunks' Car-Coupling.

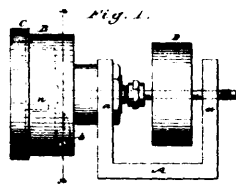

Fig. 2.

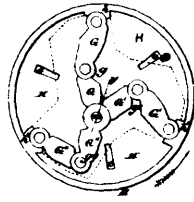
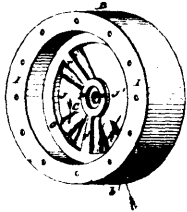
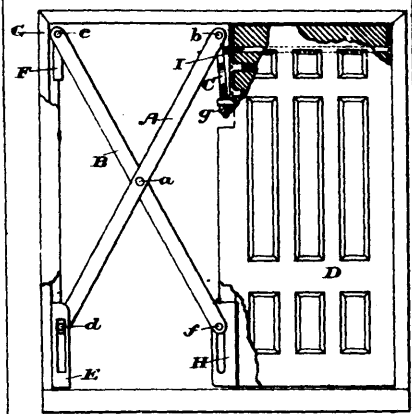

Fig. 3.



26352 Isbell's Engine for Steam, Water, etc.



26353 Clarke's Hanger for Sliding Doors.

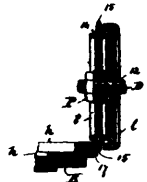
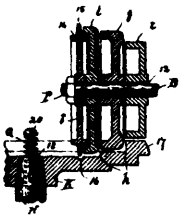
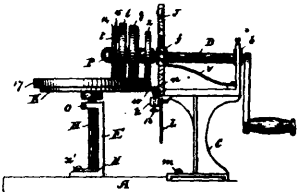

26354 Pattison's Press and Double Seaming Machine.

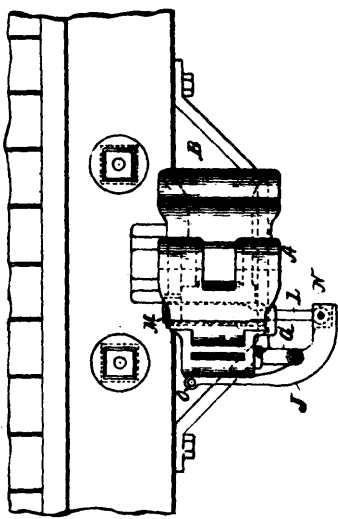

26355 Dowling's Car-Coupling.

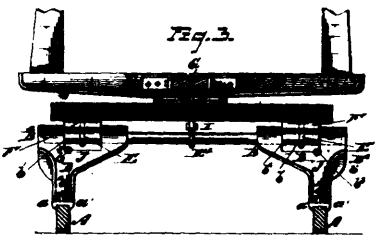
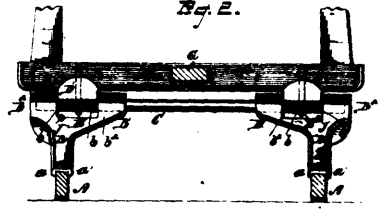

26356 Ovenshire's Sleigh.

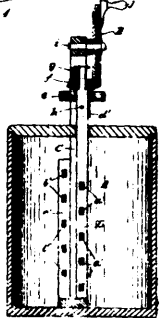
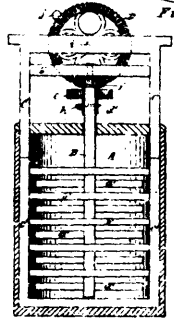
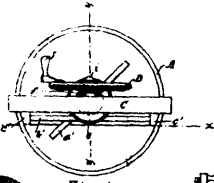

26357 McDonald's Churn.

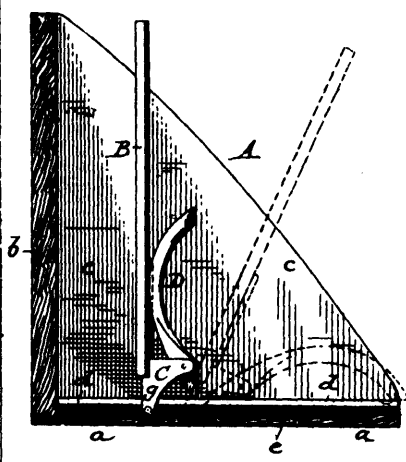

26358 Lang's Paper File.

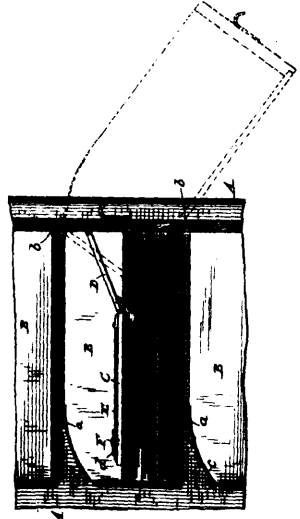

26359 Lang's File Case and Cabinet.

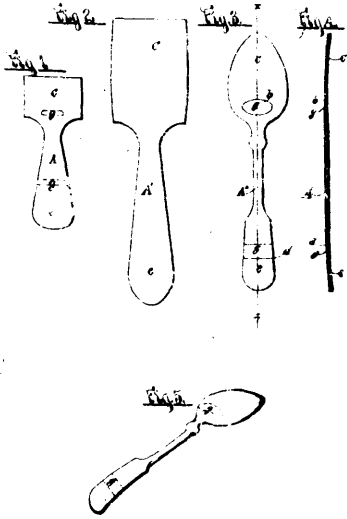

26360 Warner's Manufacture of Plated Ware.

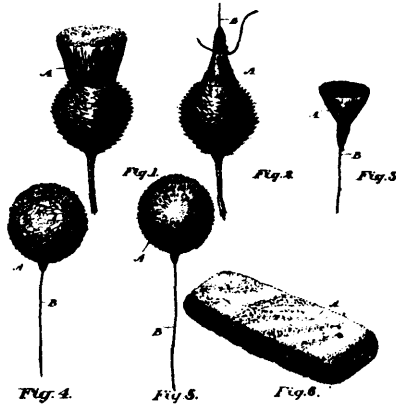

26361 Caston's Process of Manufacturing Thistle Down into Merchantable Material.

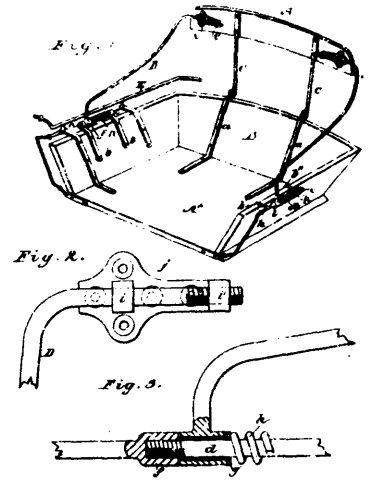

26362 Morgan's Carriage Seat.

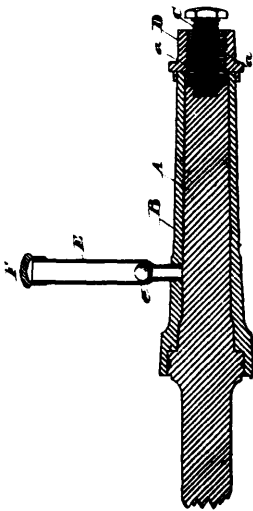

26363 Gibson's Axle.

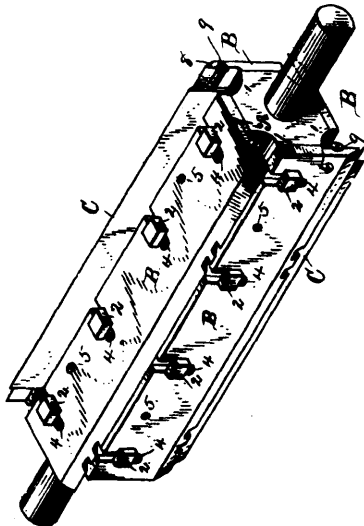

26364 Shimer's Cutter Head for Planing and Moulding Machines.

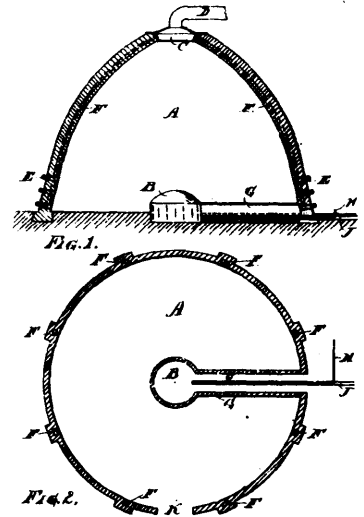

26365 Rathbun's Kiln for Making Charcoal.

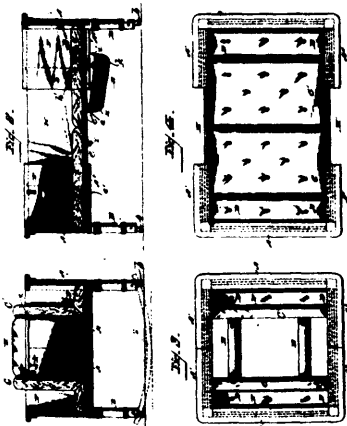

26366 Gleason's Baby Walker.

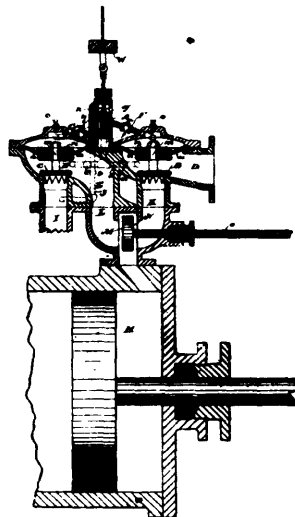

26367 Fenson's Hydraulic Valve.

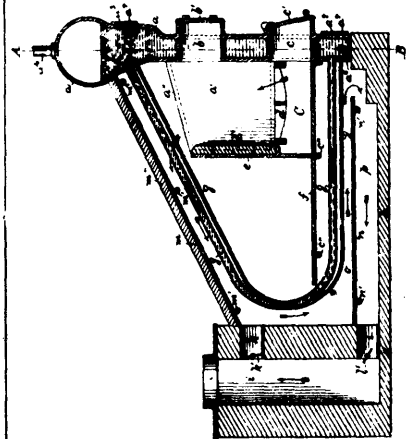

26368 Sawyer's Steam Boiler.



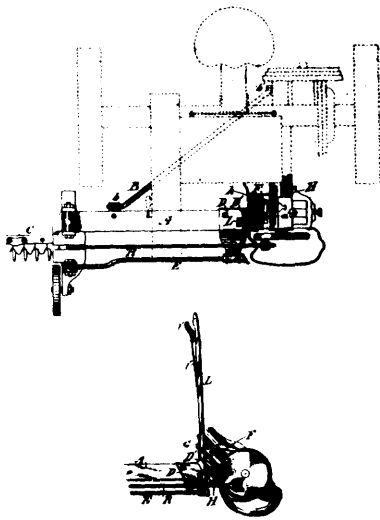

26370 Cossett's Cutter Bar Adjustments for Mowing Machines.

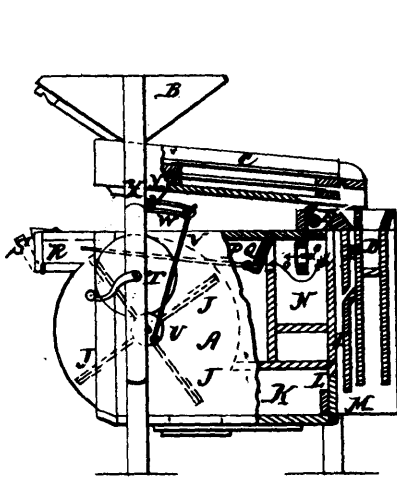

26371 Bond's Grain Separator and Cleaner.

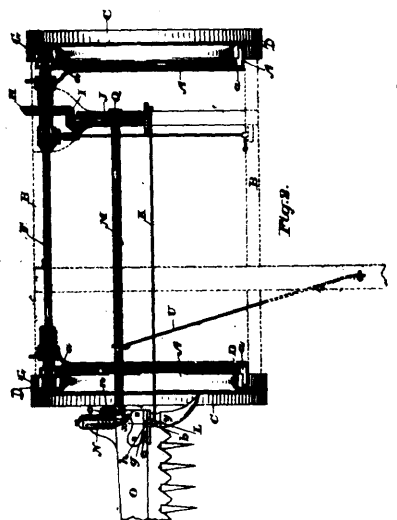

26372 Clokey's Mowing Machine.

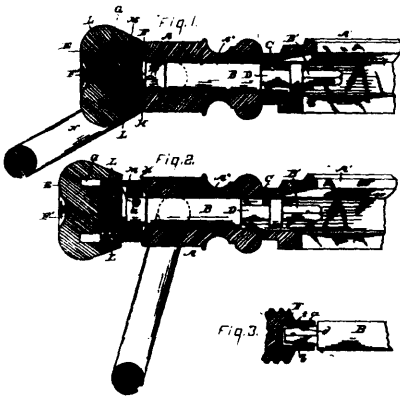

26373 Kistler's Watch Case Pendant.

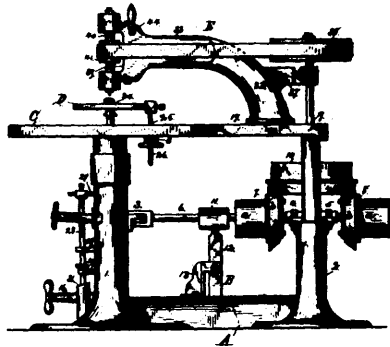

26374 Shimer's Variety Moulding Machine.

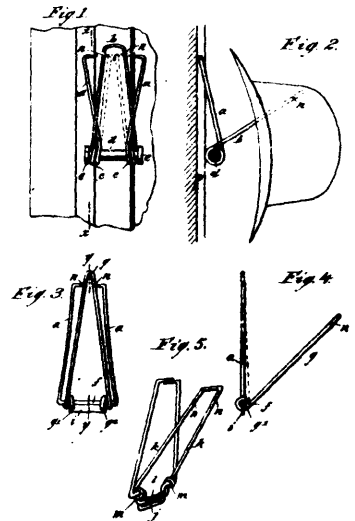

26375 Atwood's Hat Holder.



26376 Mount's Machine for Cutting Pipes.

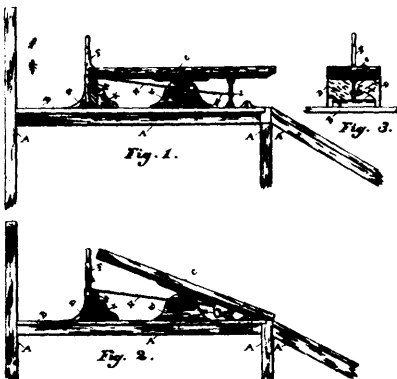

26377 Forge & Hillcoat's Toboggan and Boat Slide.

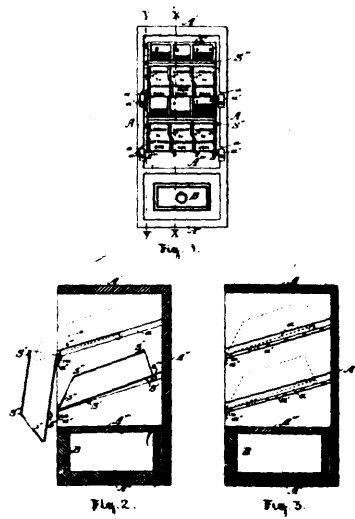

26378 Matchett's Ticket Case.

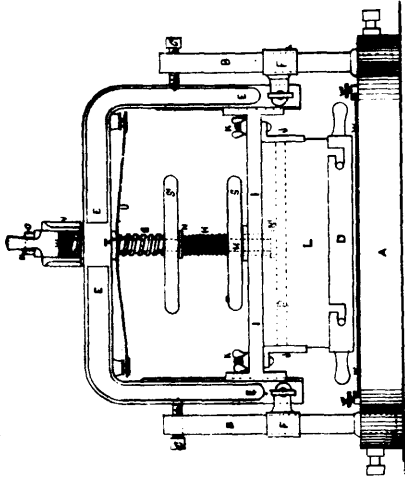

26379 Herissé's Machine for Decorating Biscuits and Cakes.

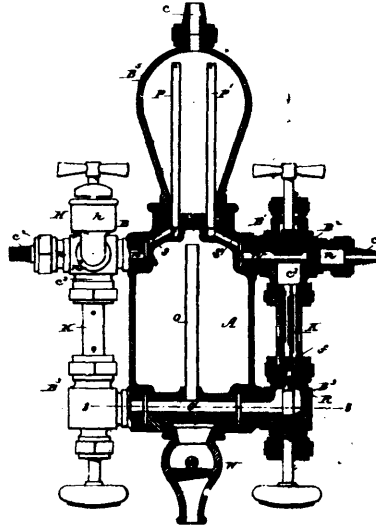

26380 Kaczander's Lubricator for Locomotives.

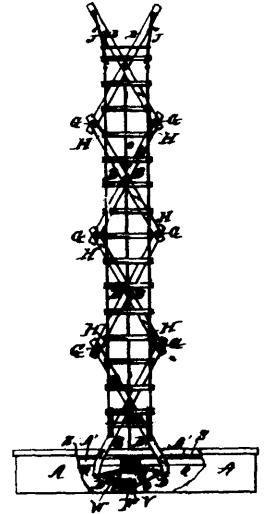

26382 Larkin's Fire Escape.

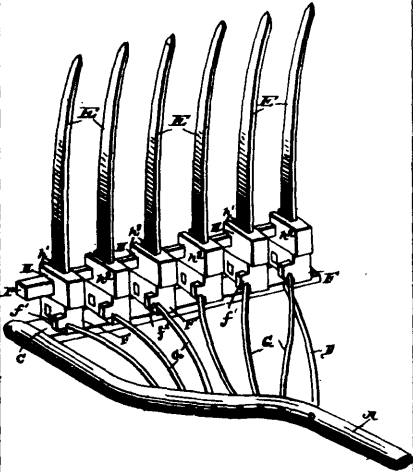

26383 Nally's Grain Cradle.

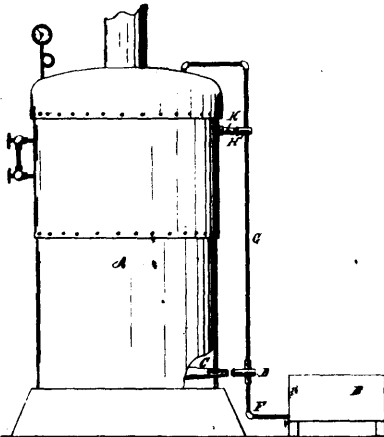

26384 Davison's Means for Controlling the Supply of Atomized Fuel for Steam Generators, etc.

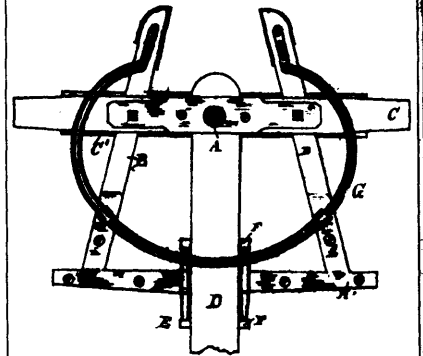

26385 Grant's Anti-Friction Roller for Waggon Beaches.

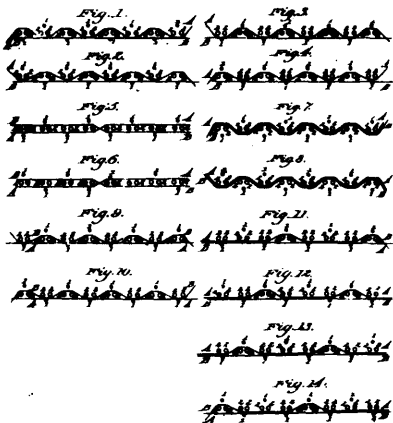

26386 Kerr's Woven Fabric.

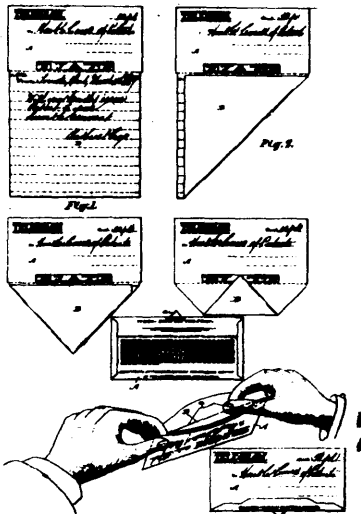

26387 Cox's Letter Blank and Envelope.

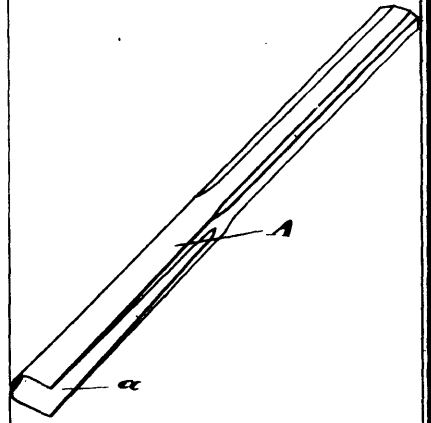

26388 Burrowes' Punch.

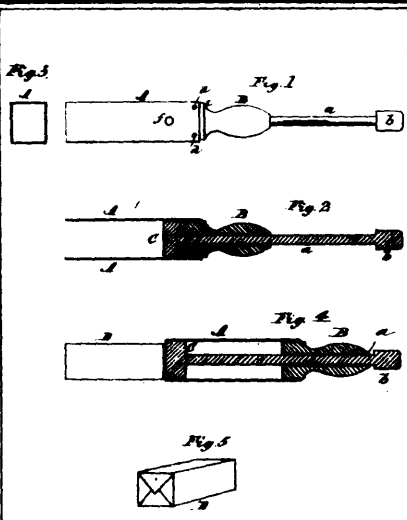

26389 Fearman's Machine for Making Lard Tablets.

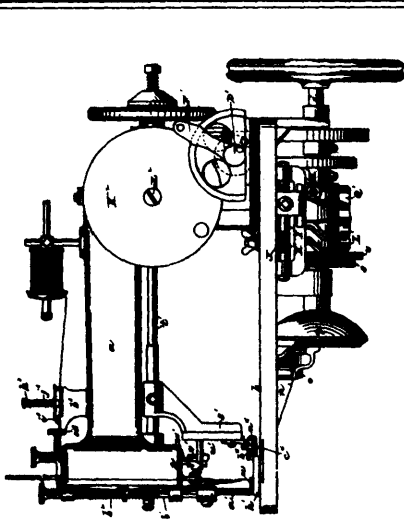

26390 Woodward's Sewing Machine.

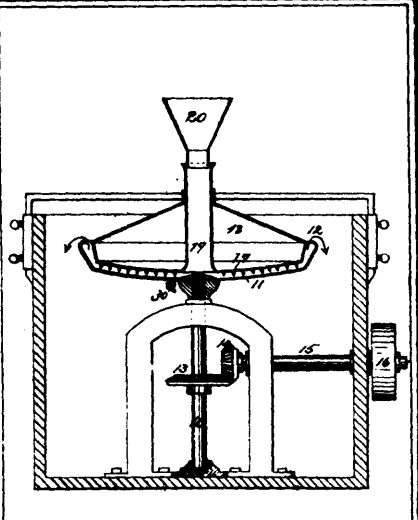

26391 White's Ore Amalgamator.

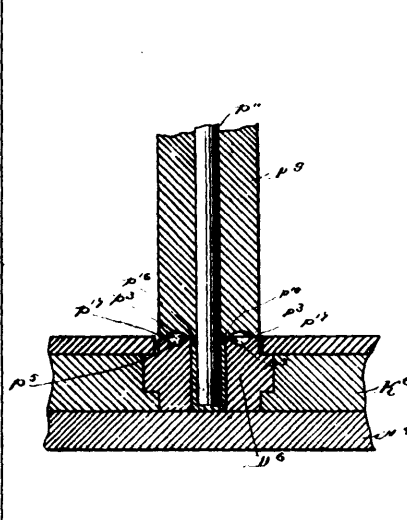

26392 White's Device for Trimming Cartridge Shells.

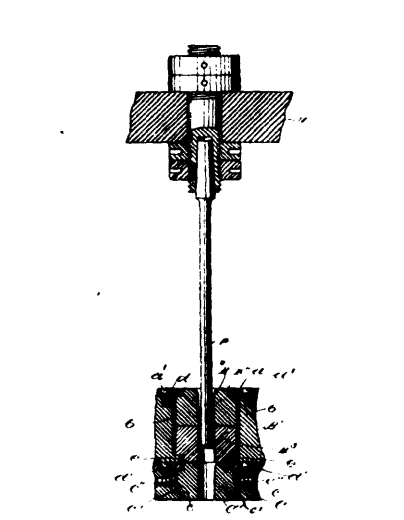

26393 White's dies for Drawing Cartridges, etc., from Metal.

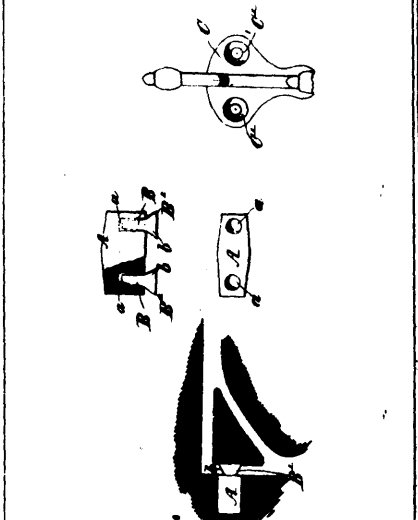

26394 Croteau's Chill for Small Castings.

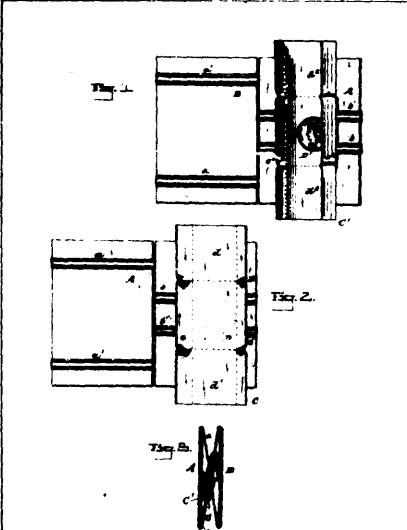

26395 Oellrich's Fussle.

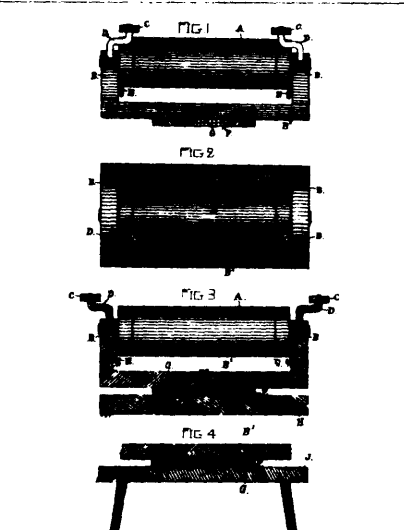

26396 Webb's Timber Roll.

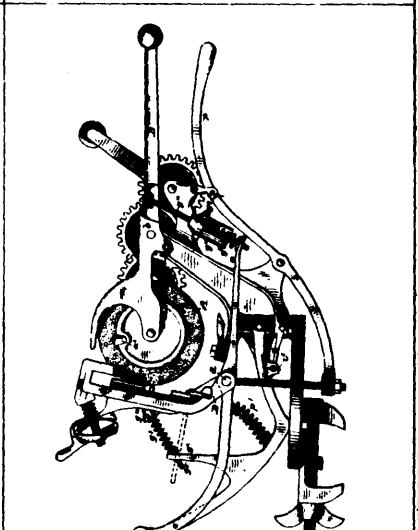

26397 Dutton's Machine for Grinding Mower Knives.



26398 Flemming's Strung Musical Instrument.

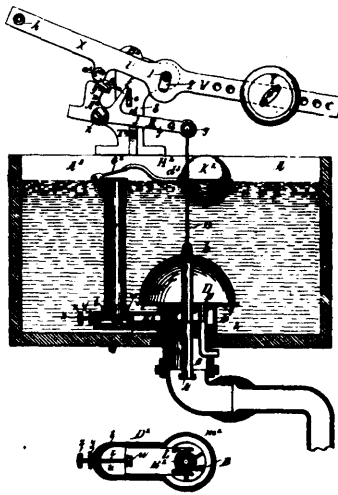

26399 Scott's Valve for Tanks.

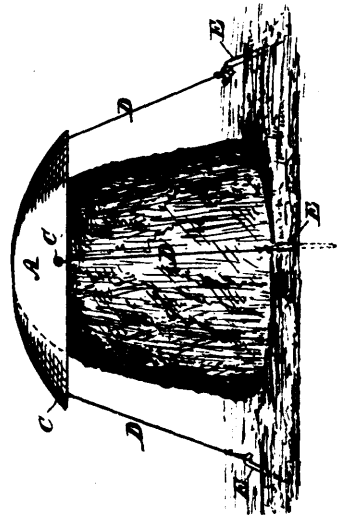

26400 Symmes' Hay and Grain Cock Weather Shield

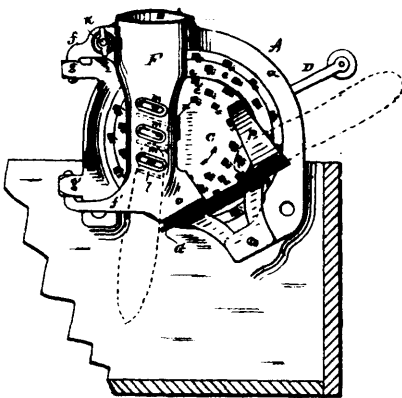

26401 Patch's Corn Shelter.



26402 Laforce's Carriage Train.

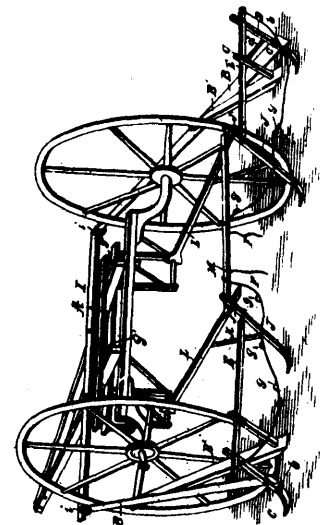

26403 Randaugh's Attachment for Sulky Ploughs.

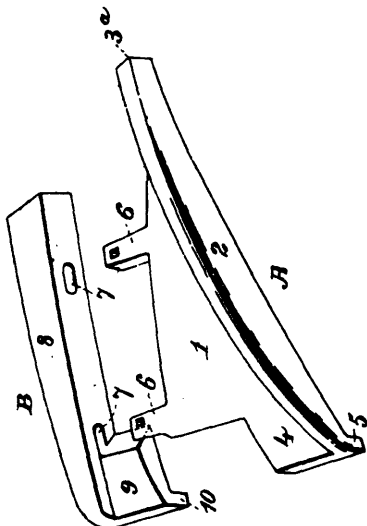

26404 Cook's Railway Portable Frog and Car Replacer.

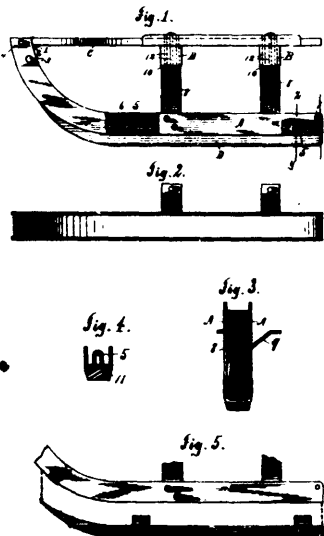

26405 Meek's Sled.

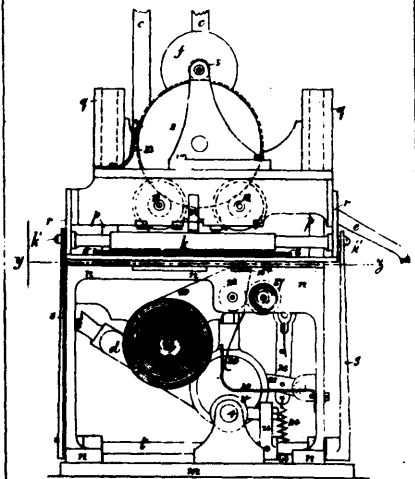

26406 Firth's Cash Counter, etc.

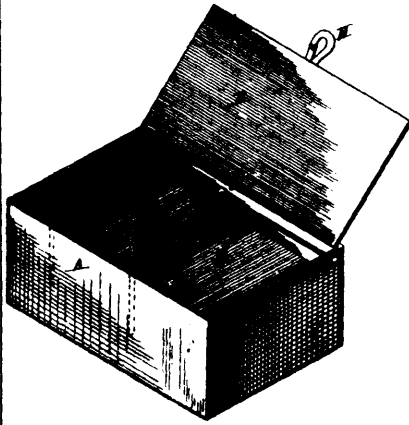

26407 Uhleh's Case for Physician's Prescription Papers, etc.

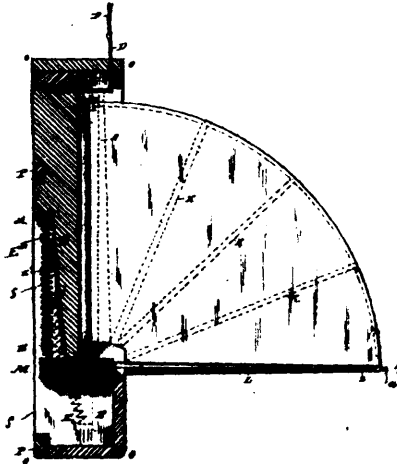

26408 Jones' Railway Danger Signal.

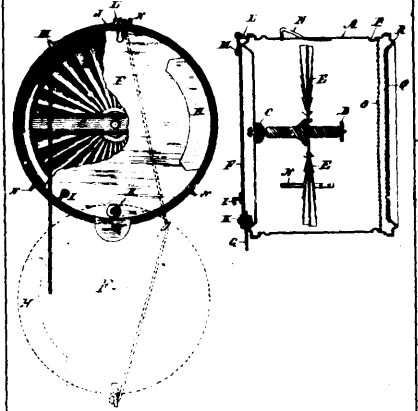

26409 Williams' Rotary Ventilator.

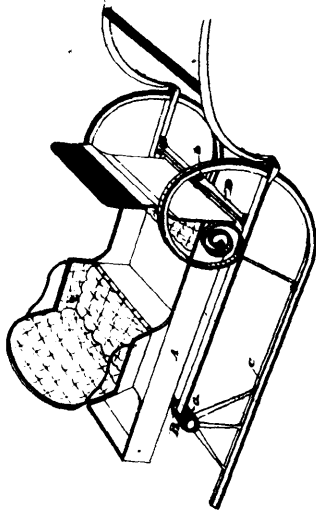

26410 Strickland's Sleigh.

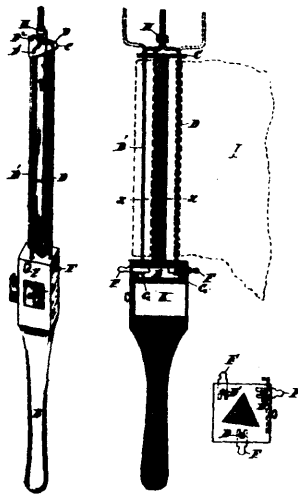

26411 Archey's Railway Flag Signal.

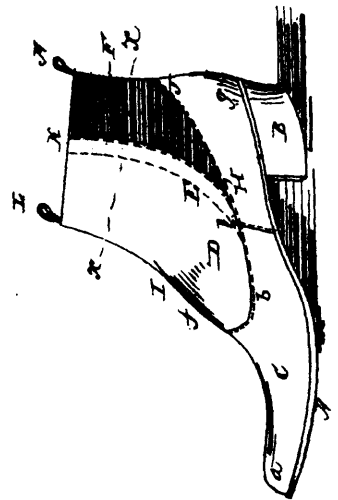

26412 Walker's Gaiter Boot and Shoe.

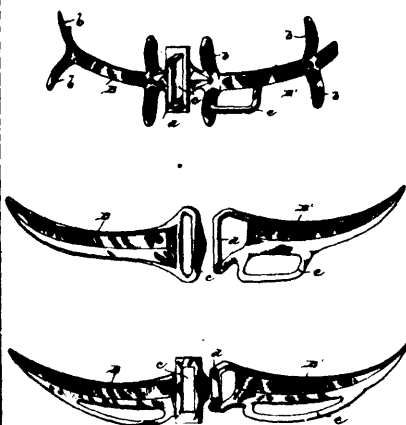

26413 Hayes' Horse Collar Fastening.

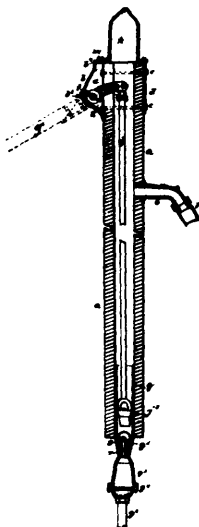

26414 Ayer's Pump.

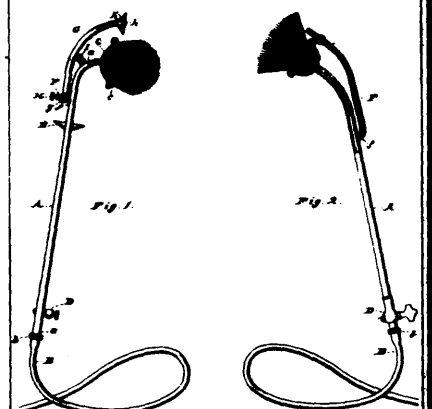

26415 Nichols' Cleaning Brush.

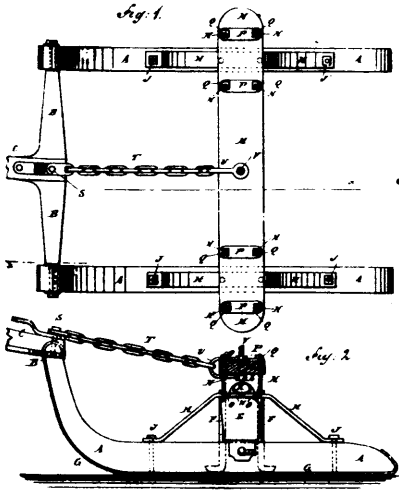

26416 Jeffrey & Liver's Bob Sleigh.

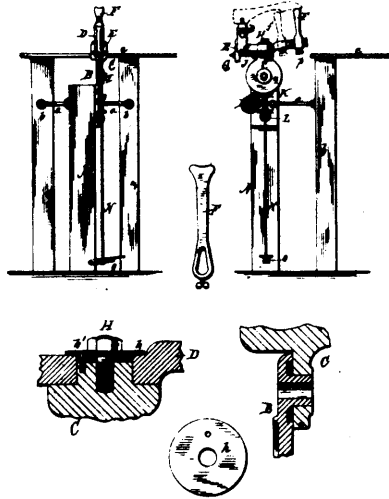

26417 Beaulieu's Lasting Jack.

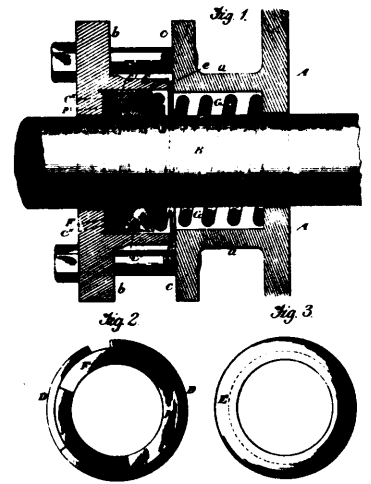

26419 Pohlman's Adjustable Packing for Piston Rods.

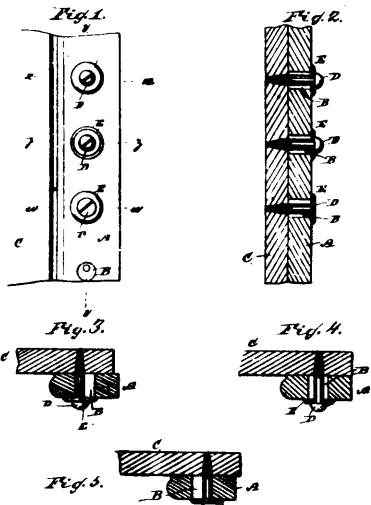

26420 Nelson's Bead Fastener for Window Frames.

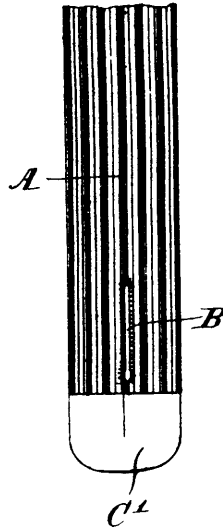

26421 Beaudry's Brace.

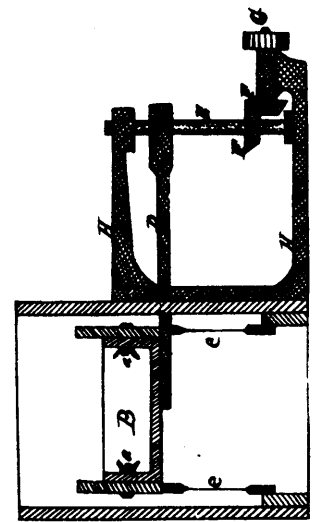

26422 Barnard's Feeder for Purifiers for Flour Mills.

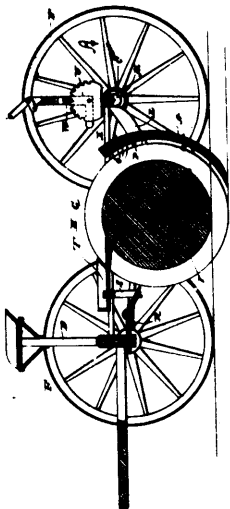

26423 Harper's Drain Plough.

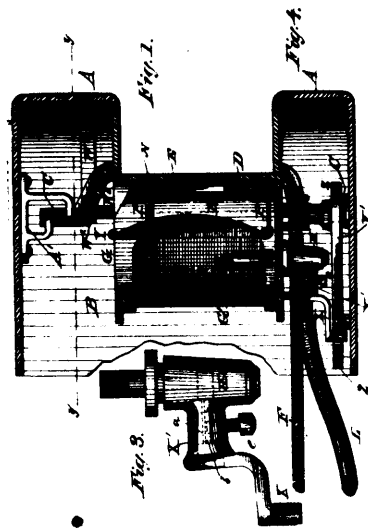

26424 Houten's Oven Light for Bakers' Ovens.

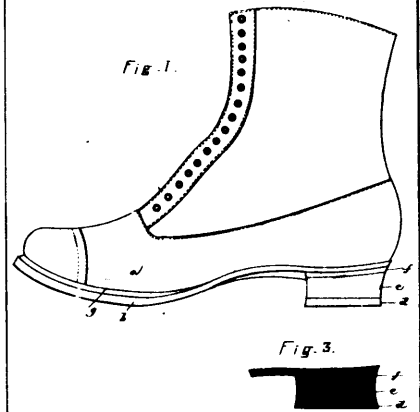

26425 Woodbury's Boot or Shoe.

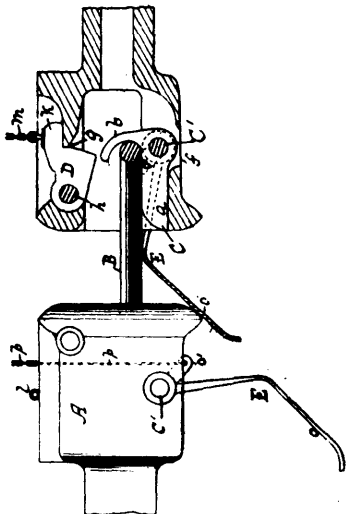

26426 Duros's Car-Coupling.

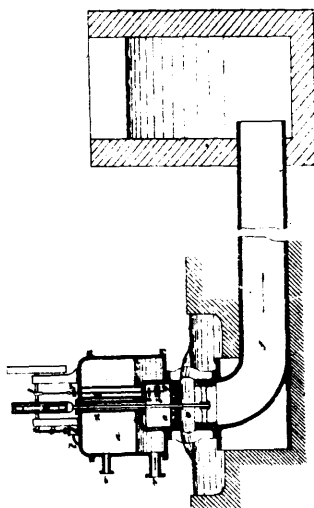

26427 Pearsall's Hydraulic Apparatus.

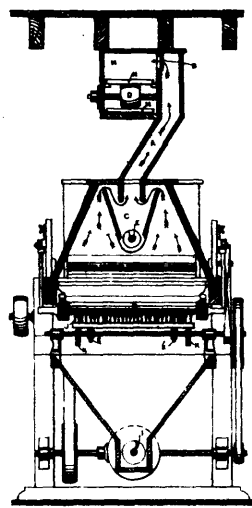

26428 Higginbottom & Stuart's Middlings Purifier

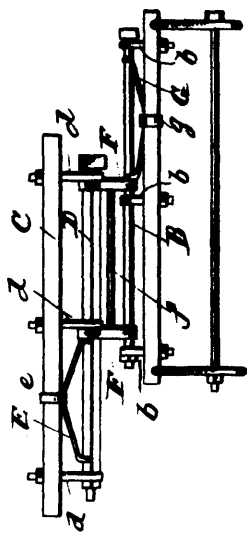

26429 Richardson's Shifting Thills for Sleighs and Cutters.

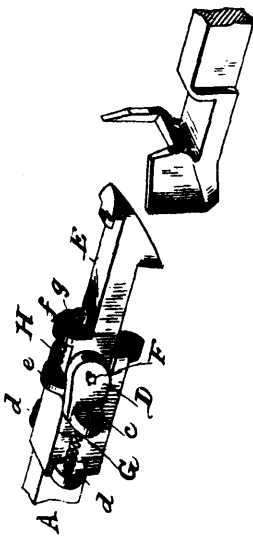

26430 Opheim's Car-Coupler.

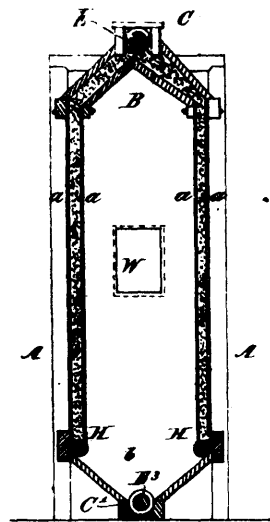

26431 Comerford's Dust Catcher.

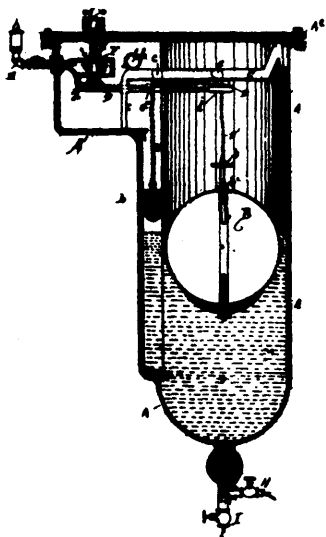

26432 Stevenson's Water Alarm for Boilers.

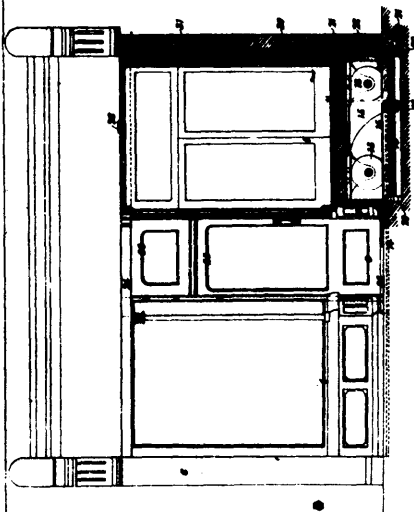

26433 Gooch's Shop Front.

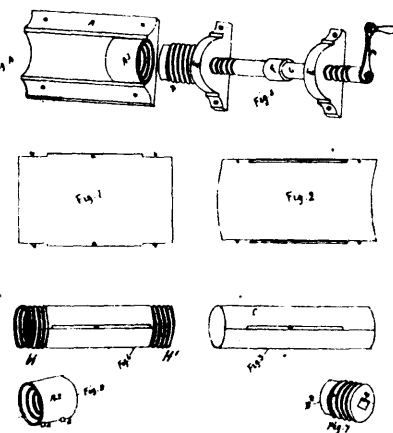

26434 Mummery's Stove Pipe.

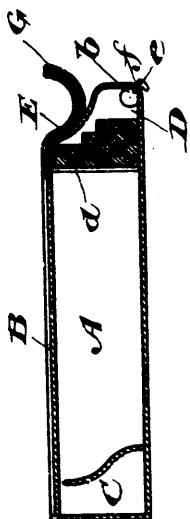

26435 Gardiner's Combined Tobacco Box, Match Box and Cigarette Former.

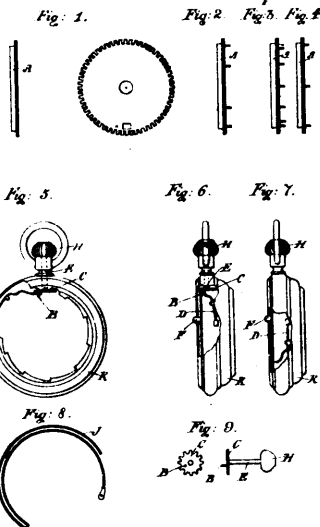

26436 Robinson's Keyless Watch.

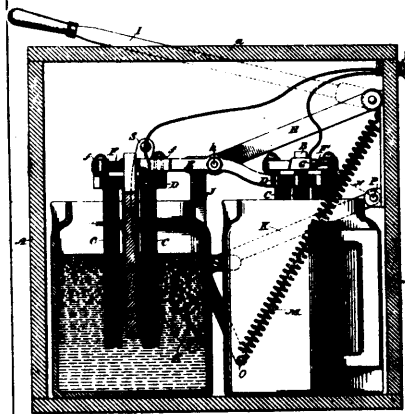

26437 Curtis, Crocker and Wheeler's Electric Battery

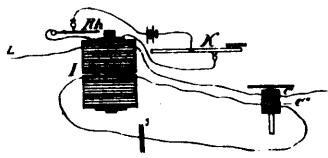

Fig. 5

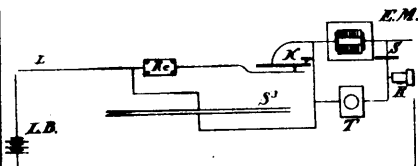
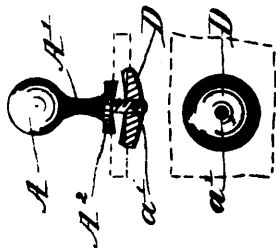
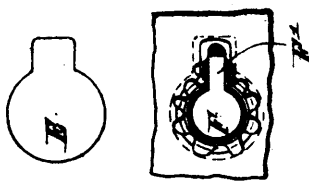
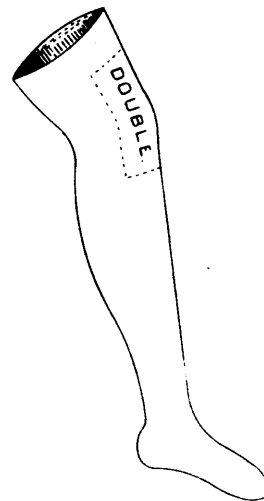

Fig. 8.

26438 Rosebrugh's Combined Telegraphic and Telephonic Circuit.



26439 Macdonald's Fastening for Gloves, Overshoes, etc.



26440 Place's Stocking.

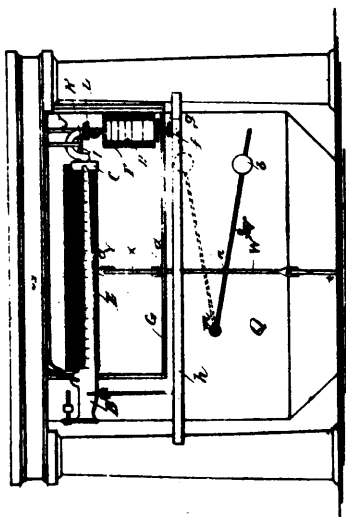

26441 Jamieson's Automatic Weight Register for Scales.

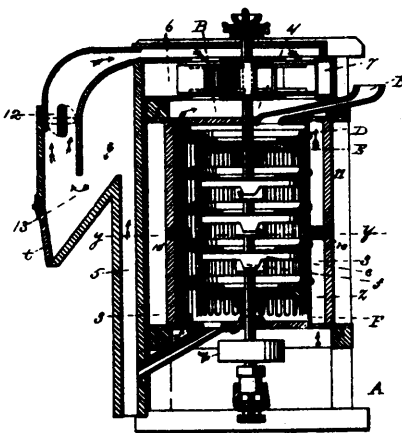

26442 Sergeant's Grain Cleaner.

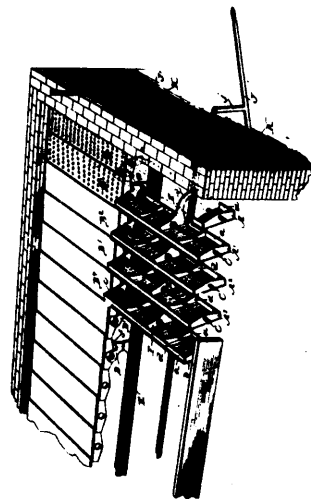

26443 Brada's Malt Kiln.



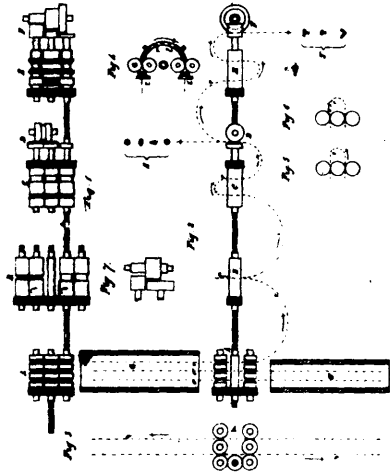

26444 Roy & Lambert's Rolling Mill.

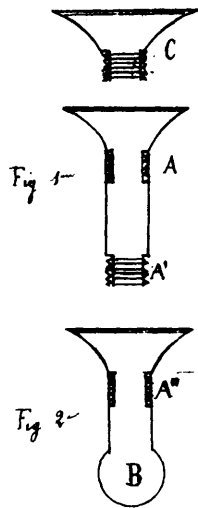

26445 Lanoue's Hygienic Tube for Bedding.

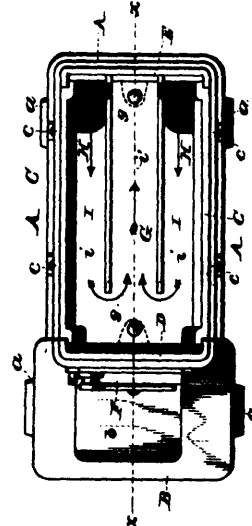

26446 Kibler's Stove.

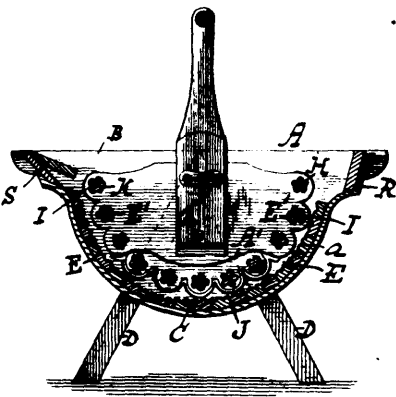

26447 Maxwell's Washing Machine.

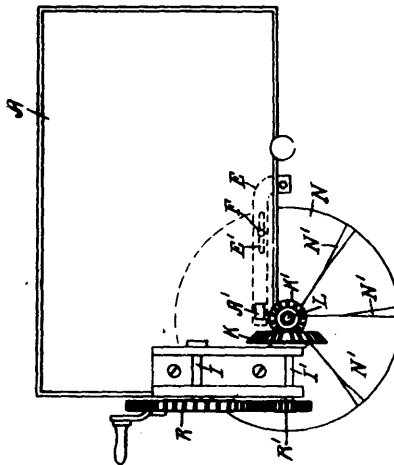

26448 Pedler's Grass Seed Sower.

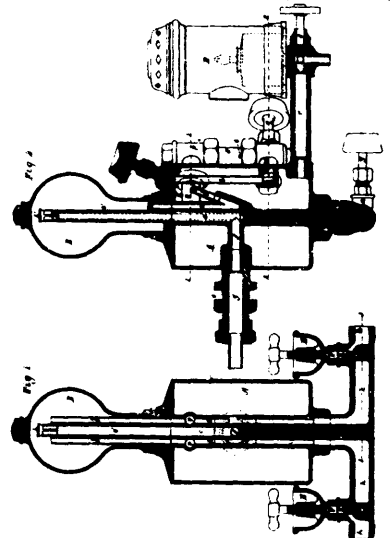

26449 Craig's Lubricator for Railway Steam Engines

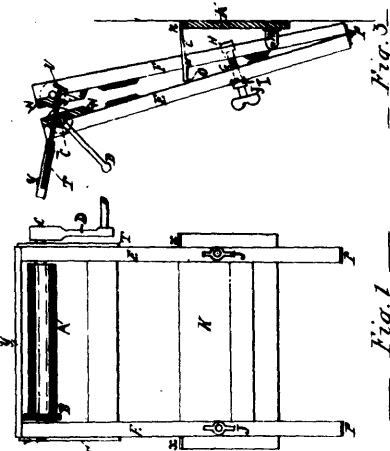

26450 Addison's Clothes Mangle.

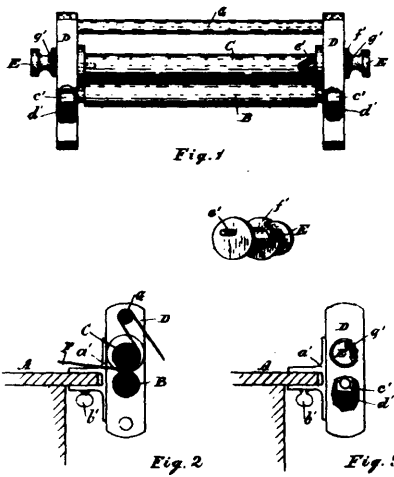

26451 Laurier's Dry Goods Blocking Machine.

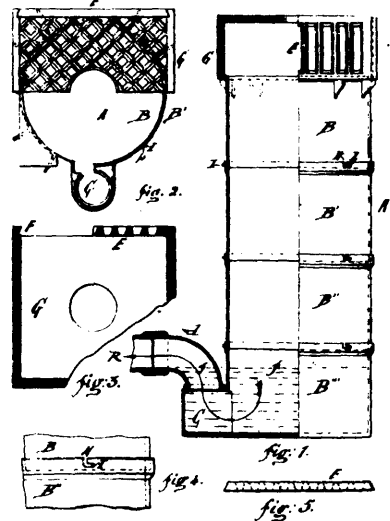

26452 Colas' Draining Well.

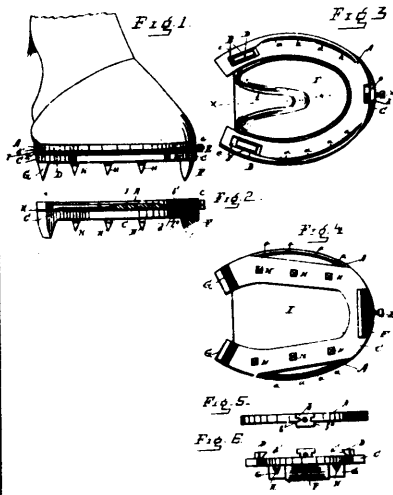

26453 Pryor's Horse Shoe.

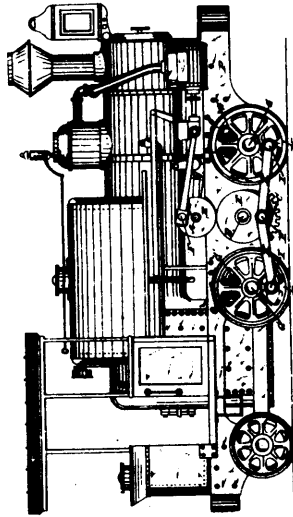

26454 Adams' Locomotive.

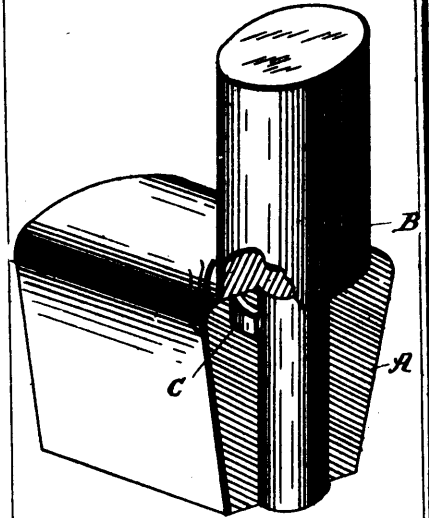

26455 Starr's Vehicle Wheel.

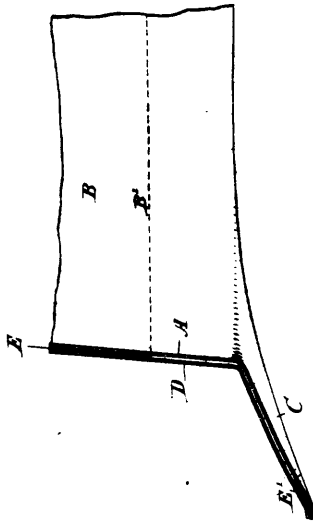

26456 Brahadl's Hat.

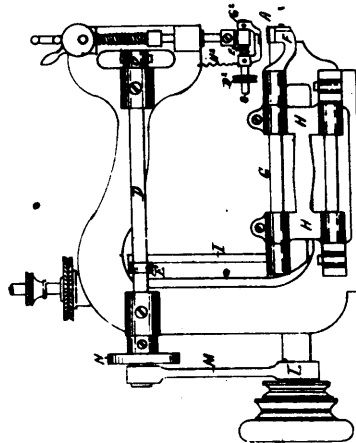

26459 Kay's Machine for Sewing Straw Braid for Hats.

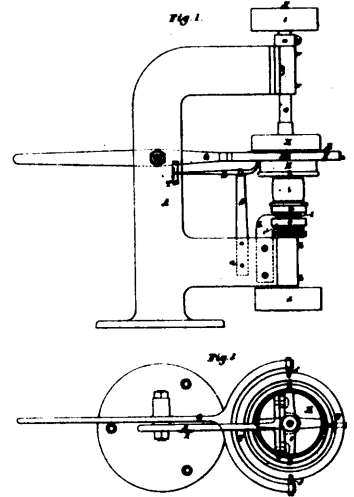

26460 Richardson's Machinery for Grinding Spherical Balls.

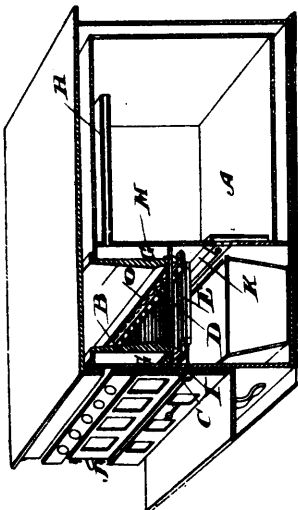

26461 Ransom's Stove.

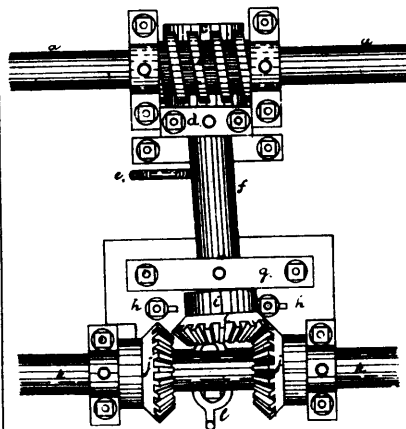

26462 Brown's Gearing for Traction Engines, etc.

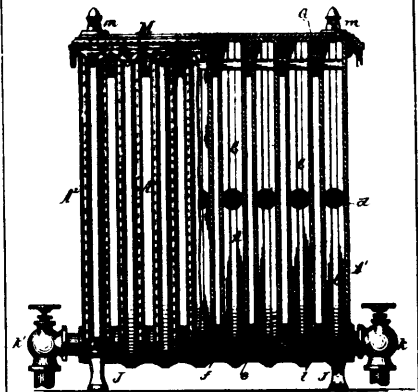

26463 Safford's Heat Radiator.

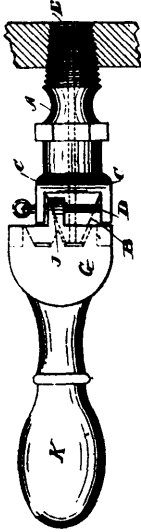

26464 Roberts' Water Gauge for Steam Boilers.

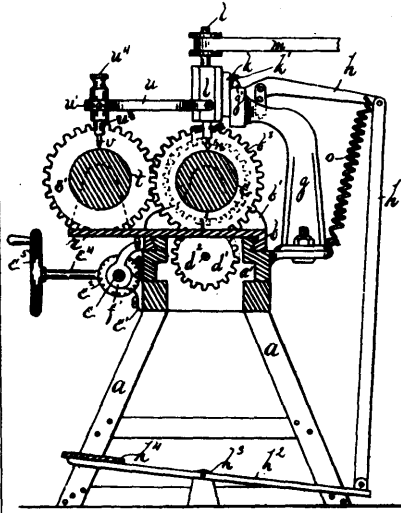

26465 Birge's Routing Machine for Wall Paper.

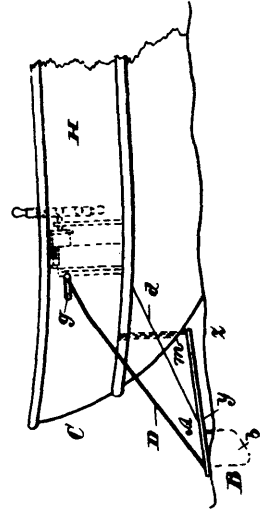

26466 Fleming's Rudder.

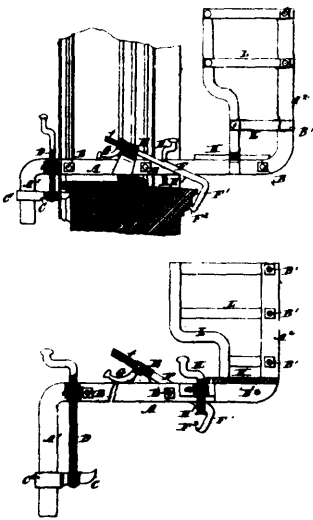

26467 Lapointe's Portable Scaffold.

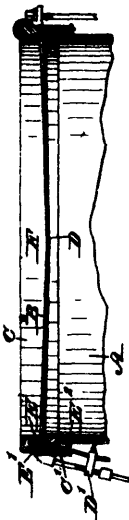

26468 Lehnert's Drum.

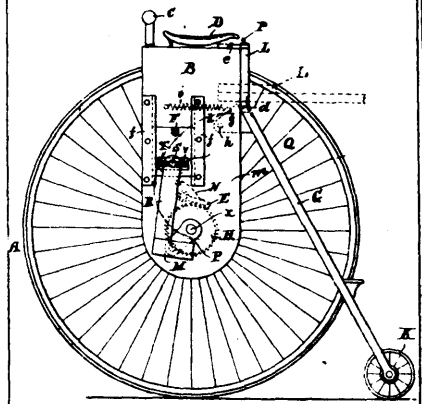

26469 Hernandez's Bicycle.

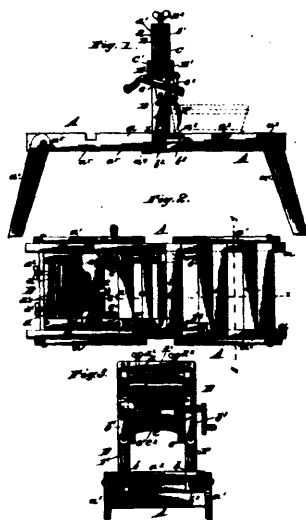

26470 Cline's Wringer Wash Bench.

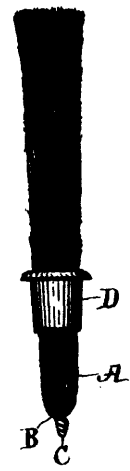

26471 Fellows' Tuft of Bristles for Brushes.

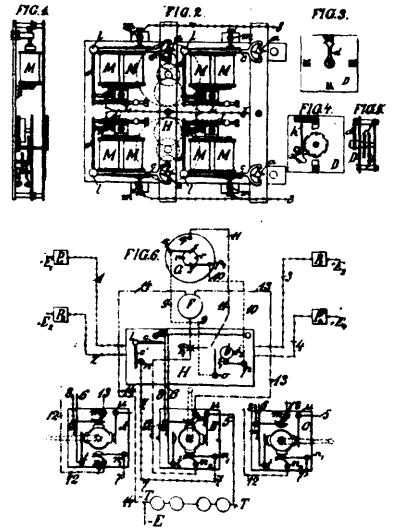

26472 Skrivan & Dvorak's Electric Watchmen Controlling Apparatus

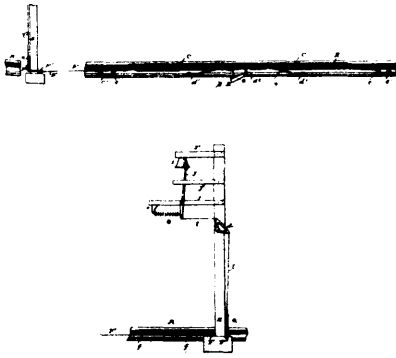

26473 Mott's Railway Signal.

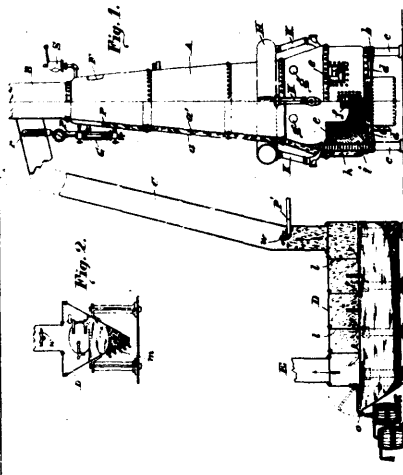

26474 Hartsfeld's Furnace for Precious Metals.

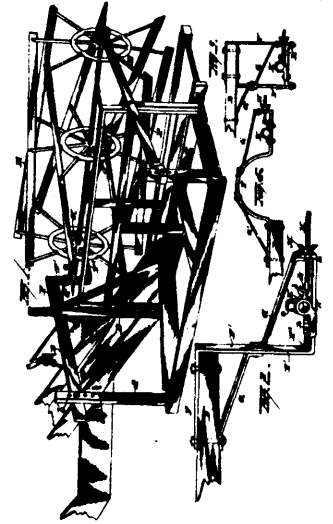

26475 Gemmill's Reel Supporting Arms for Harvesters.

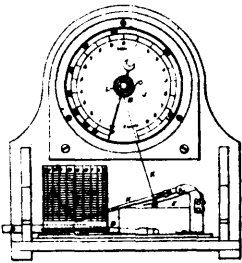

26476 Gordon & Lowdon's Speed and Pressure Air or Gas Gauge.

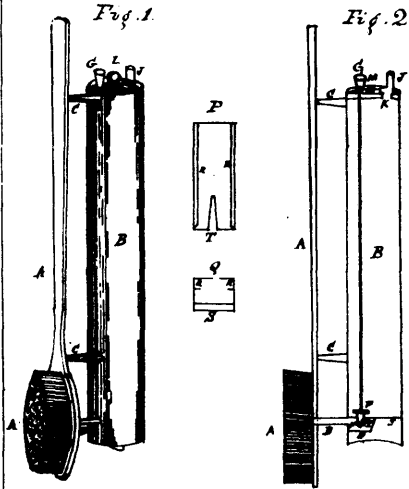

26477 Turkington's Flesh and Bath Brush.

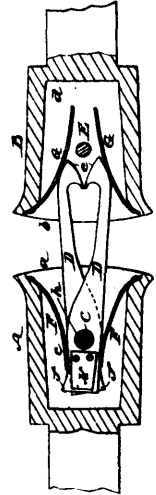

26478 Seabury's Car Coupler.

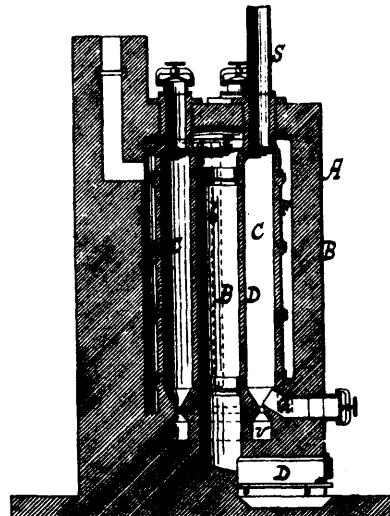
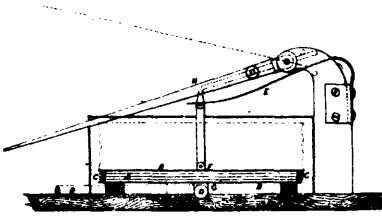

26480 Jerzmanowski's Gas Apparatus.

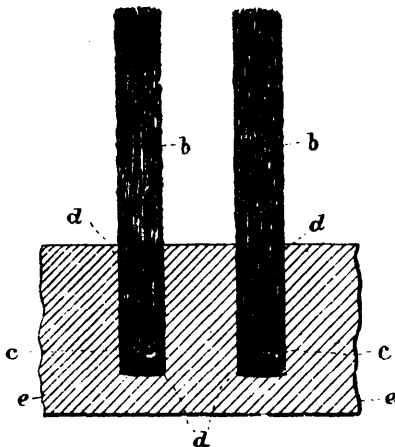

26479 Fellows' Art of Cementing Tufts in Brushes, etc.

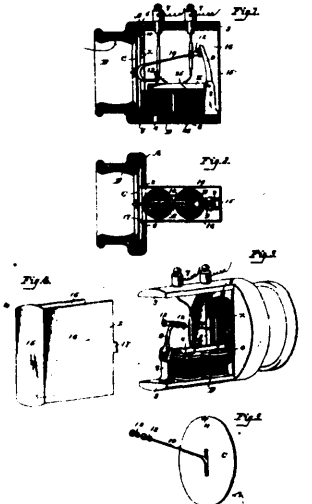

26481 House's Electro-Phonetic Telegraph Sounder.

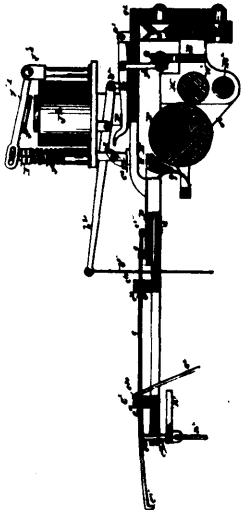

26482 Baldridge's Type-Writing and Matrix Marking Machine.

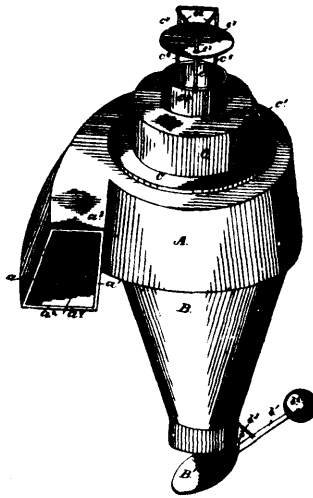

26483 Allington & Curtis' Dust Collector.

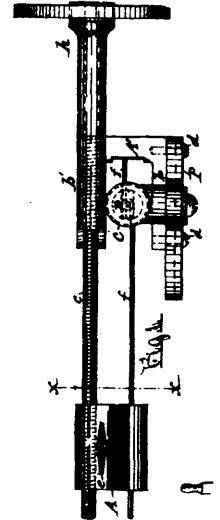

26484 Phelps' Apparatus for Sealing Boxes, etc.

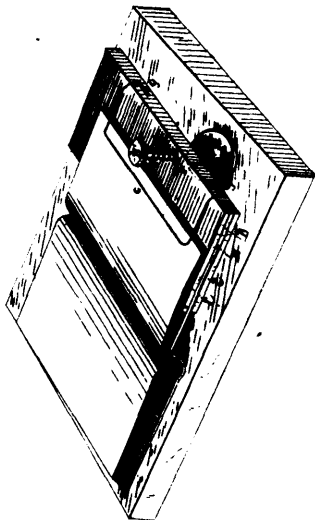

26485 Adair's Book Adjuster.

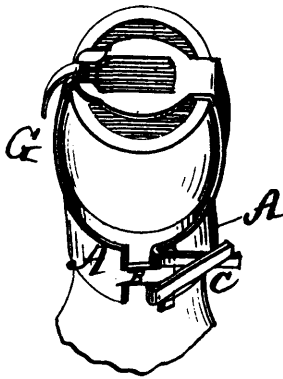

26487 Heining & Leidich's Bottle Cap.

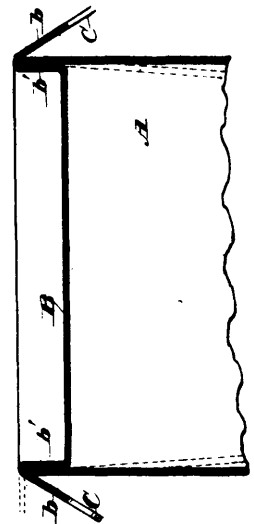

26488 Walsh's Sheet Metal Vessel.

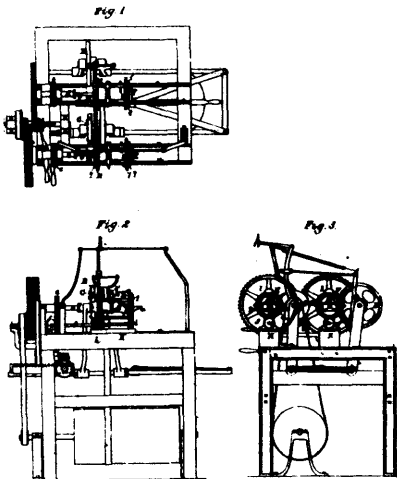

26489 DeLue's Lathes for Turning Lasts, etc.

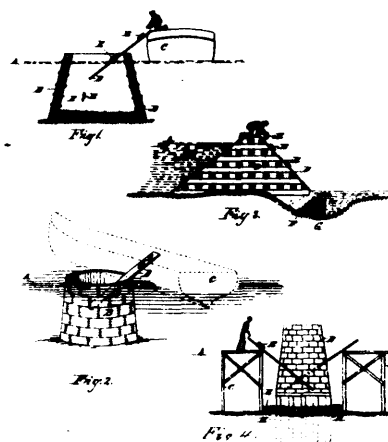

26490 Goodridge's Method of Laying Concrete Under Water.

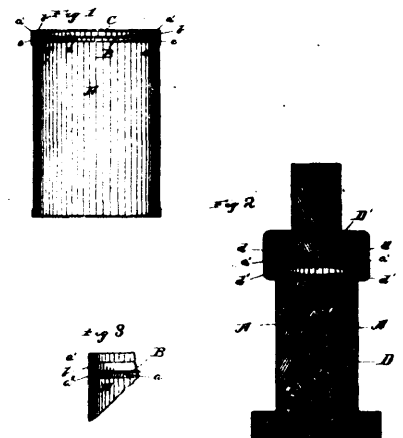

26491 Norton's Paint Can.

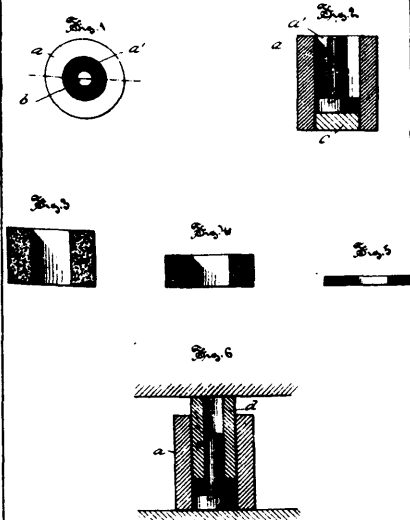

26492 Pratt's Asbestos Packing.

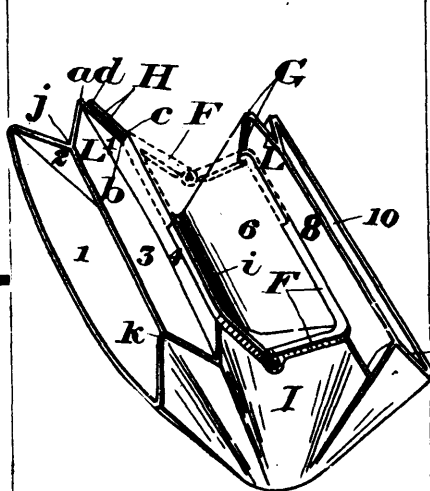

26494 Lieker's Purse.

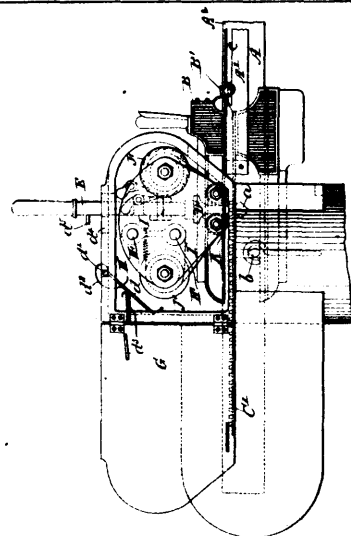

26495 Avery's Weighing Machine.

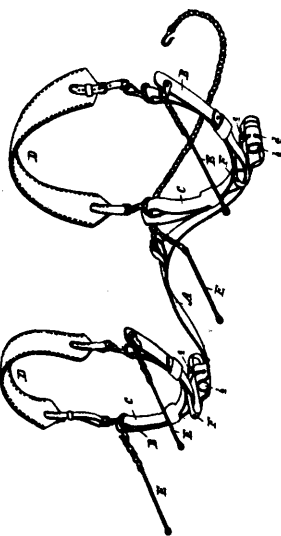

26496 Randall's Plough Harness.

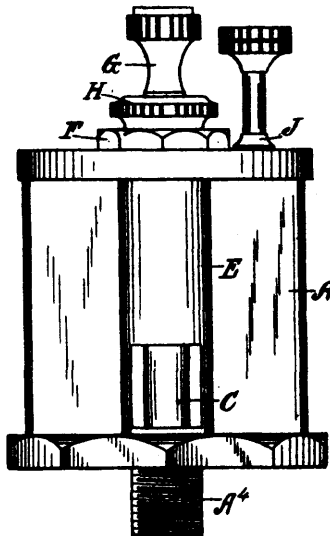

26497 Nopper's Automatic Lubricator.

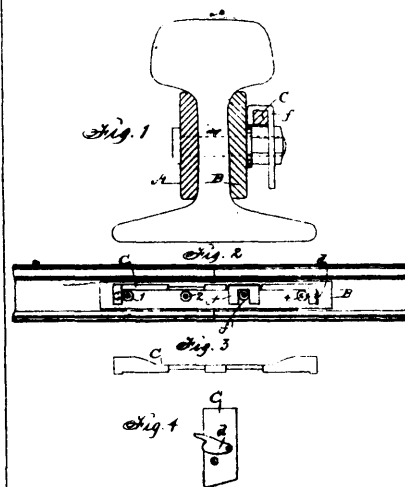

26498 Smith's Railway Nut Lock.

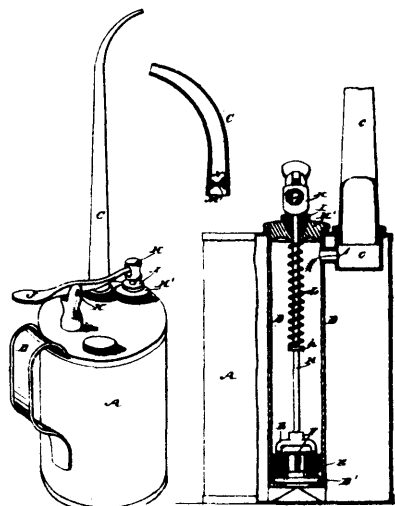

26499 Wilkinson & Cutler's Oiler.

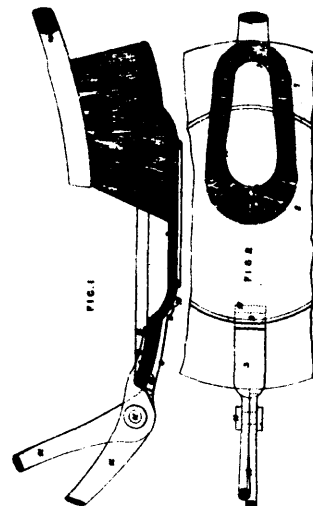

26500 Waite's Implement for Separating and Holding Plates and Like Articles while being Cleaned

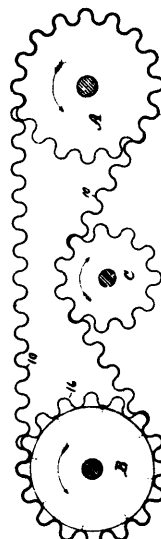

26501 Anderson & Adie's Construction of Driving Belts and Wheels Therefor.

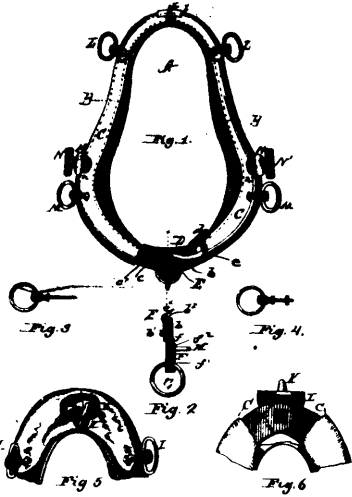

26502 Delande's Horse Collar.

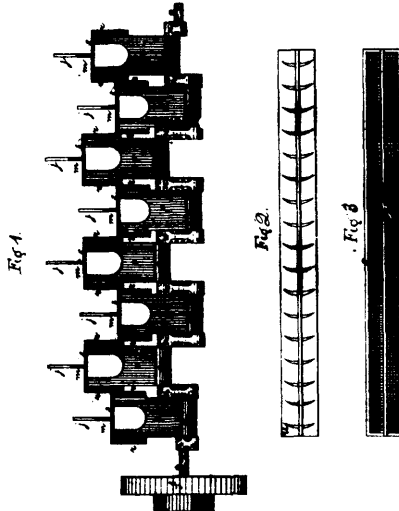

26503 Brown's Straw Rack for Thrashing Machines.

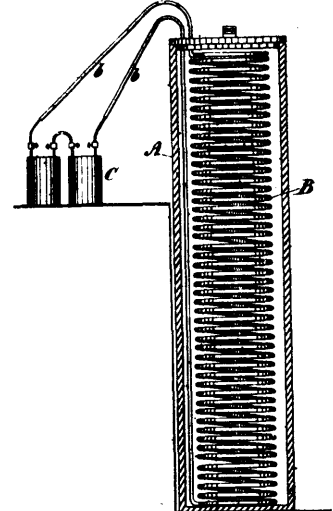

26504 Frazer's Apparatus for Treating Wine by Electricity.

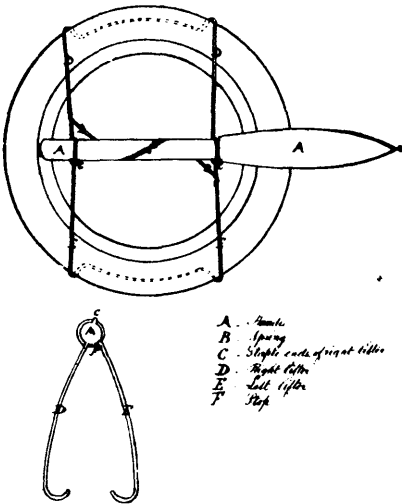

26505 Conyer's & McLeod's Pie and Dish Lifter.

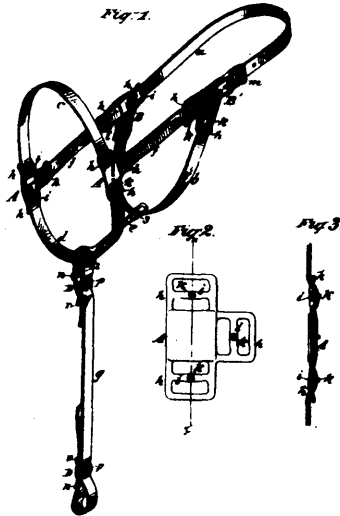

26506 Dowlin's Halter and Harness.

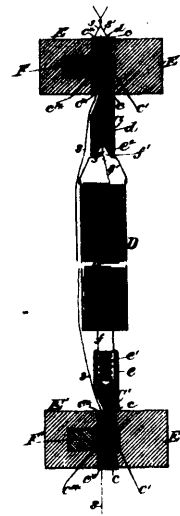

26507 Gilbert's Wire Netting Machine.

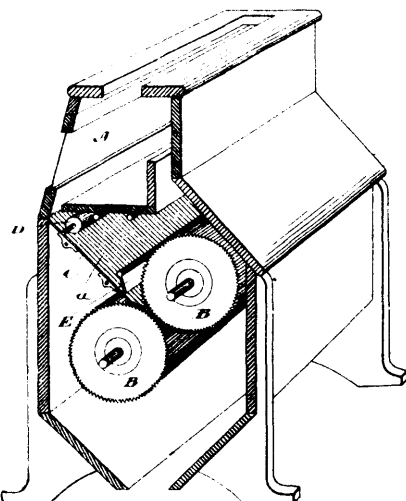

26508 Wilson & Thomson's Oat Meal Chopping Mill.

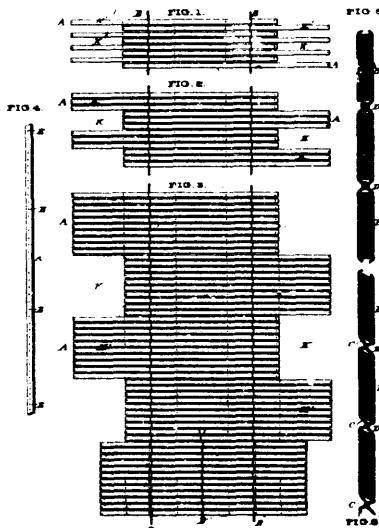

26509 Scott's Lathing.

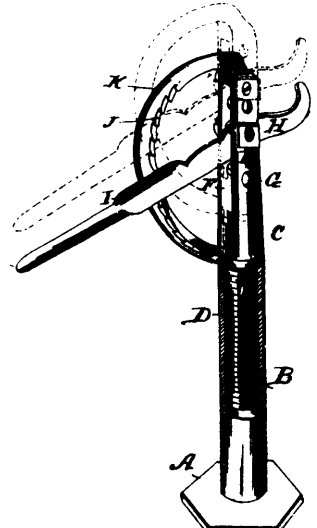

26511 Springer's Waggon Jack.

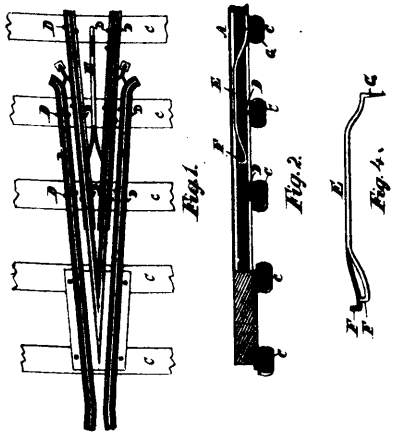

26512 Driscoll's Danger Guard for Railway Frogs.

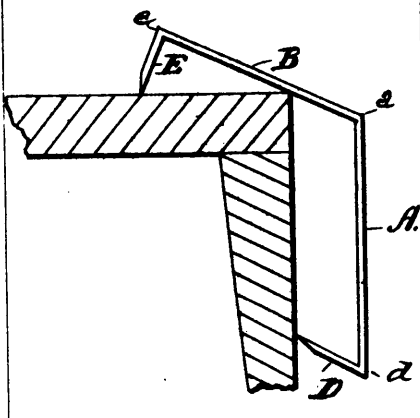

26513 Burt's Tub or Box Fastener.

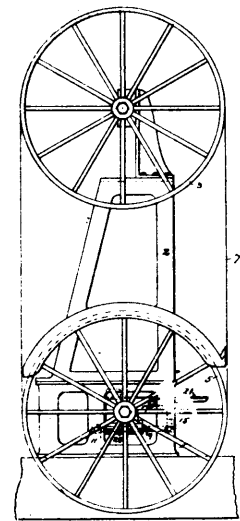

26514 Esplin's Wheel for Regulating the Tension of Band Saws.

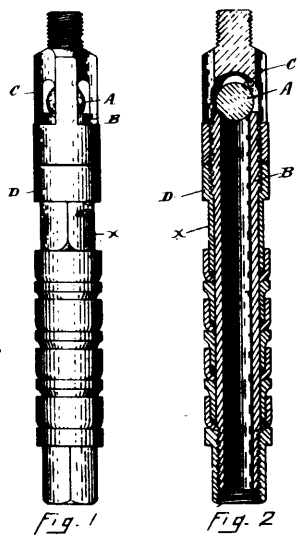

26515 Woodward & Anderson's Pump.

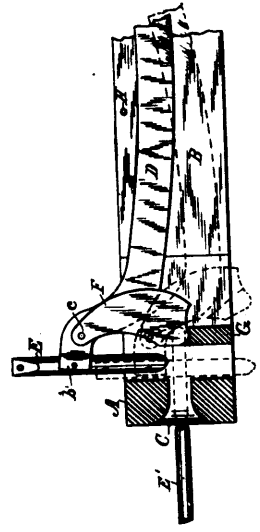

26516 Myers & Morrison's Car Coupling.

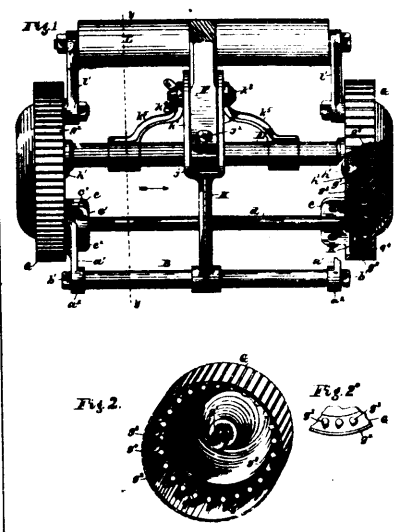

26517 Hanika & Rogers' Lawn Mower.

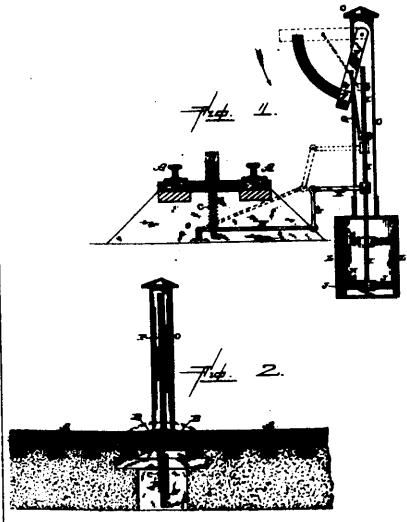

26518 Odell's Time Signal.

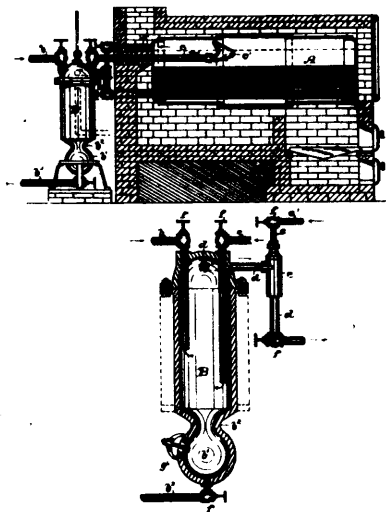

26520 Crockford's Boiler Cleaner and Water Heater.

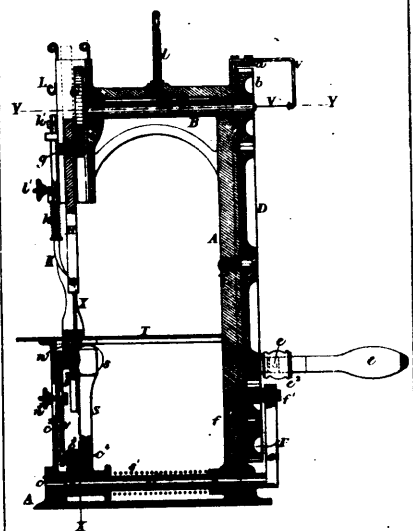

26521 Wileman's Sewing Machine.



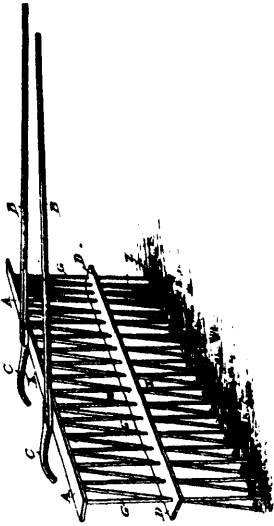

26522 Breed's Cultivator or Weeder.

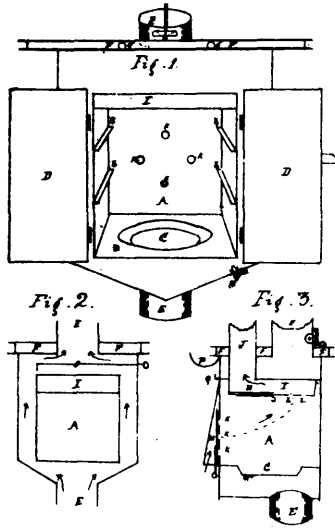

26523 Turkington's Oven Drum for Stoves.

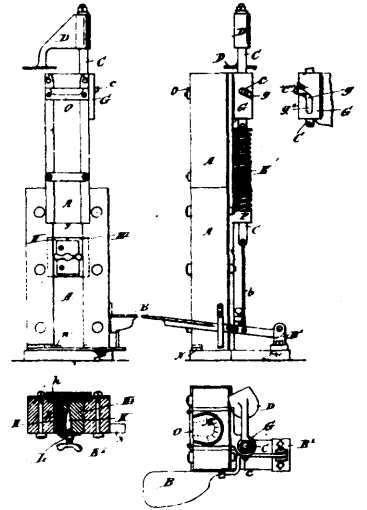

26524 Child's Piece Forming Machine for Making Heels, Slip Soles, etc.

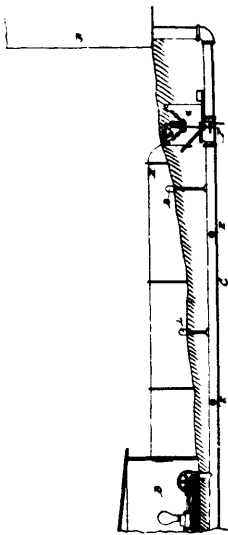

26525 Bassett's System of Water Distribution.

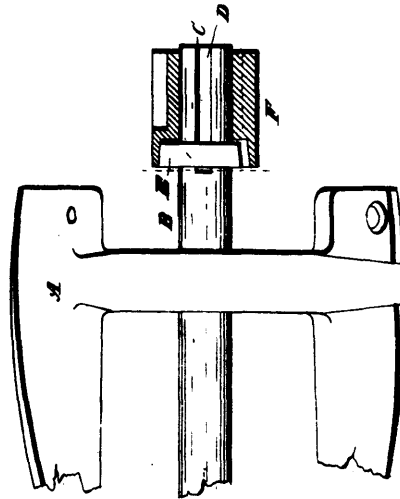

26526 Waters' Clutch Mechanism.

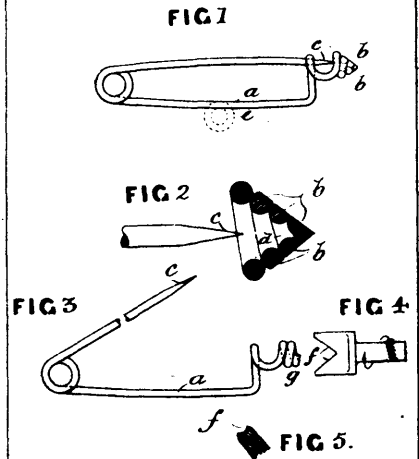

26527 Tonks' Safety Pin.

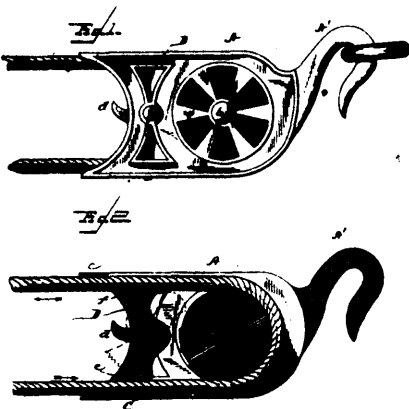

26528 Hughes' Clothes Line Fastener.

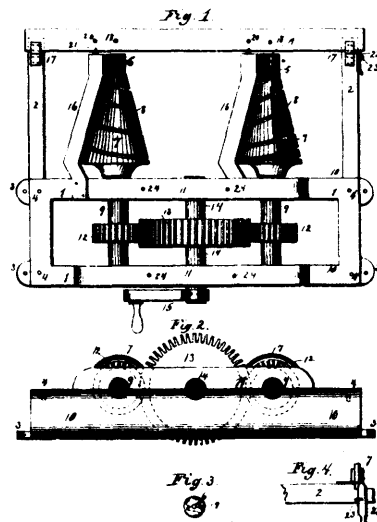

26529 Blackmer's Double Spiral Bed Spring Machine.

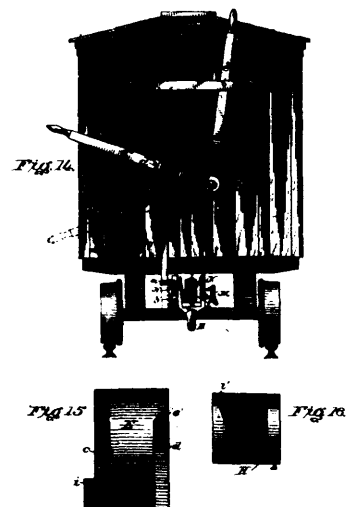

26530 Coup's Car-Coupling.

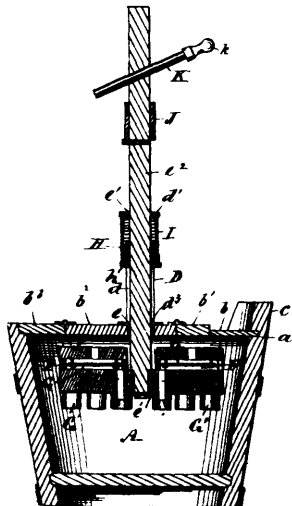

26531 Hickok's Washing Machine.

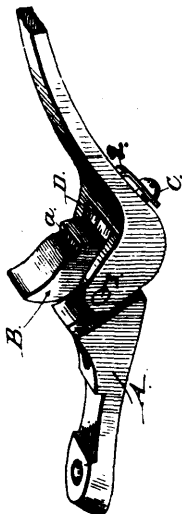

26532 Watkins' Thill Coupling.

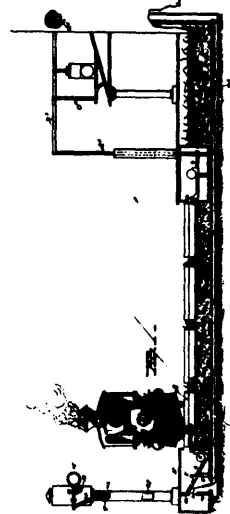

26533 Dougherty's Railway Signal.

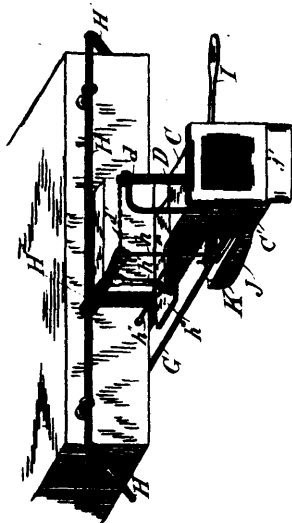

26534 Michaud's Car-Coupling.

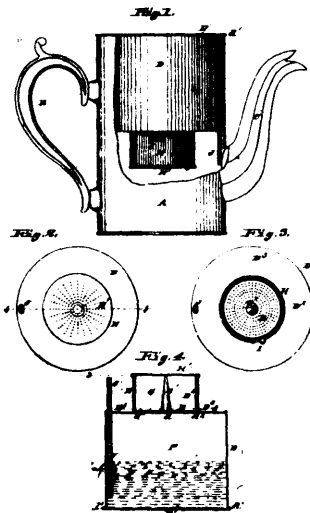

26535 Gronemeyer & Polster's Coffee and Tea Pot.

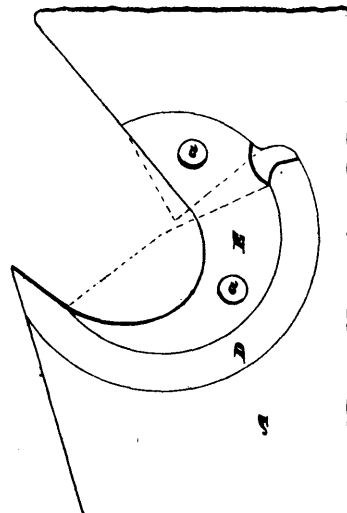

26536 Dalton's Adjustable Saw Teeth.

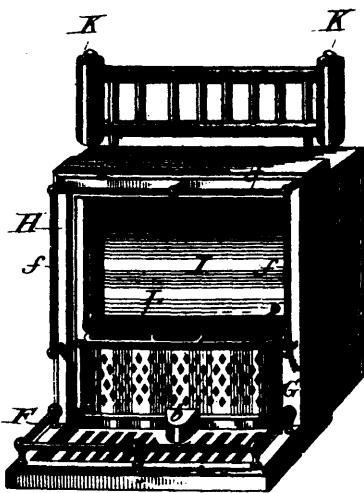

26537 Backus' Heating and Cooking Device.

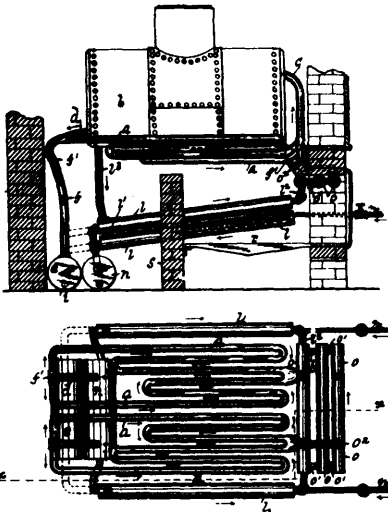

26538 Crockford's Steam Generator.

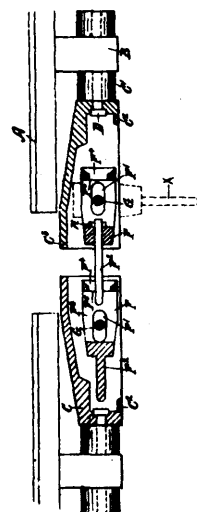

26539 Heron's Car-Coupling.

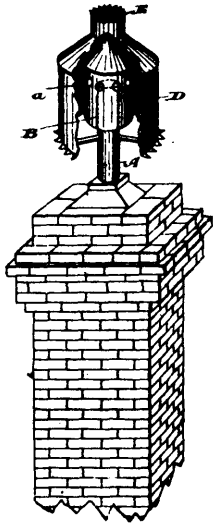

26540 Coll's Cowl for Chimneys.

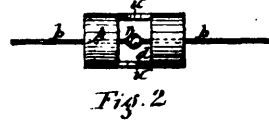
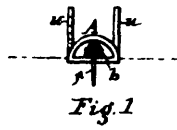

26541 Phelps' Metallic Seal for Packages, etc.

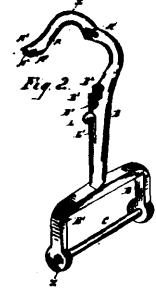
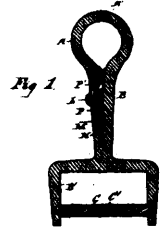

26542 Kinsley & Heusser's Hook.

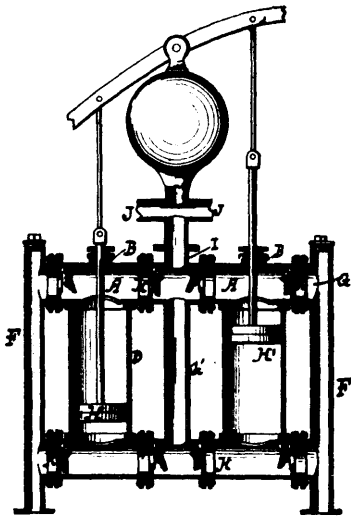

26543 McLeod's Pump.

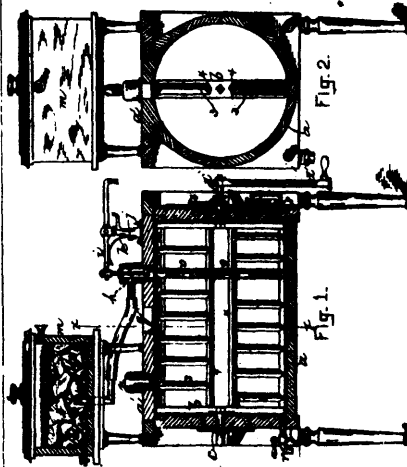

26544 Smith's Churn.

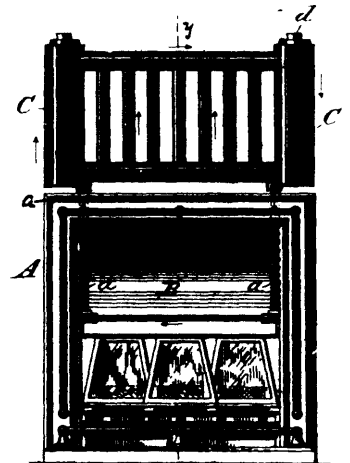

26545 Backus' Steam Heater.

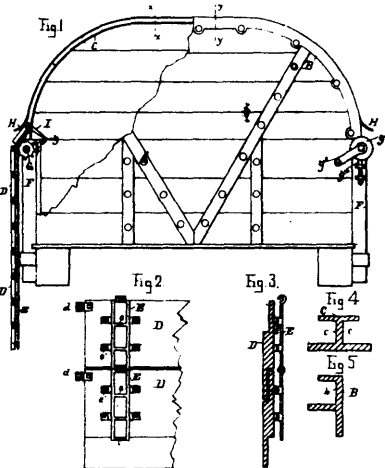

26546 Wyman's Railway Car Cover.

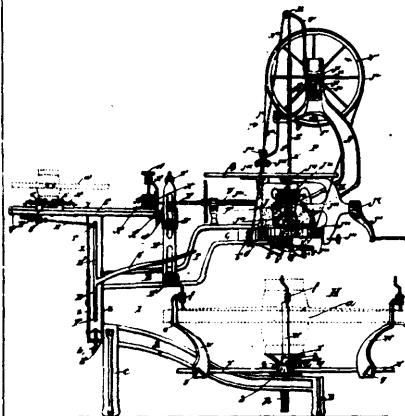

26547 Quintal's Machine for Placing Boxes on Carriage Wheels.

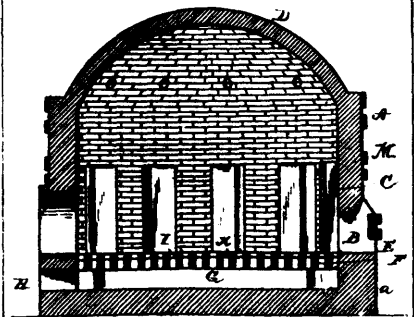

26548 Pike & Schoppe's Pottery Kiln.

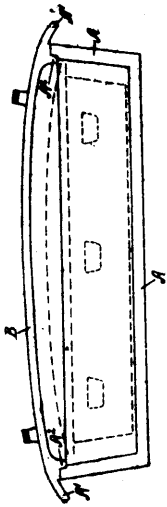

26549 Metcalf's Burial Case Holder.



26550 Valiant's Boot and Shoe.

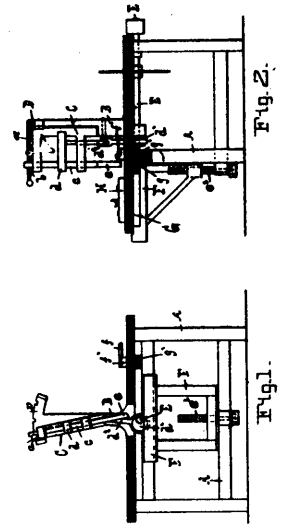

26551 Schmid's Dovetailing Machine.

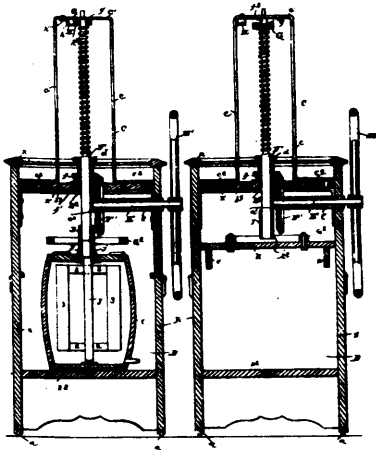

26552 Foellmer's Churn Motor.

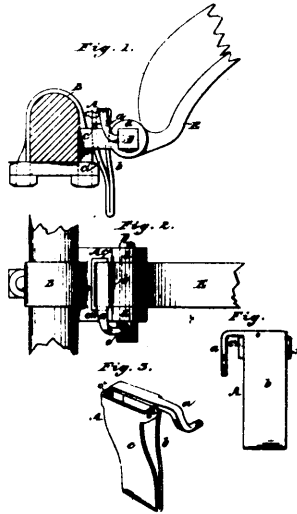

26553 Romans' Thill Coupling.

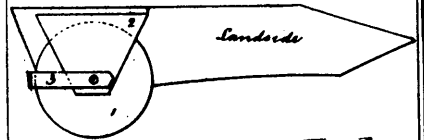

26554 Rawthelmer's Plough.

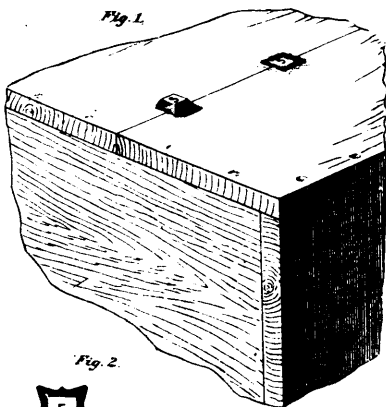

26555 Penfold's Seal for Packing Cases.

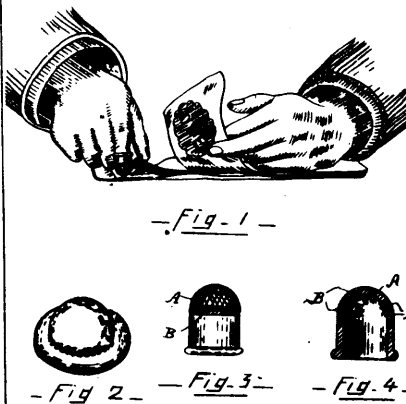

26556 Grant's Finger Tip for Counting Bank Notes, etc.

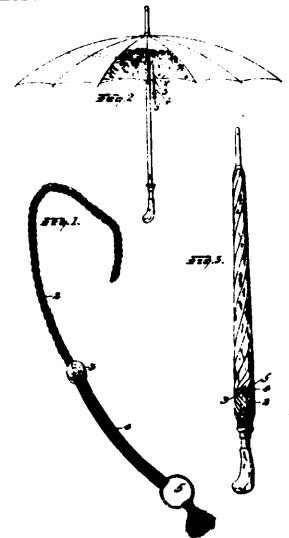

26557 Rosenberg's Umbrella Fastener.

5



26558 Hoskins' Broom.

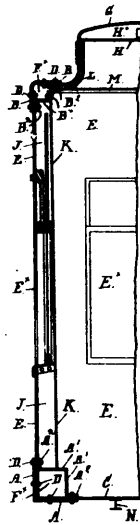

26559 Smith's Railway Passenger Car.

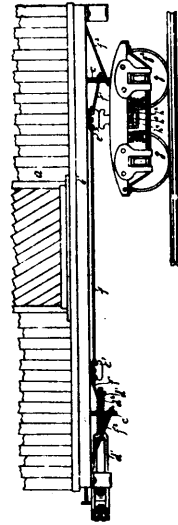

26560 Markey's Car and Car Truck.

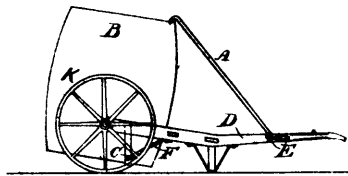

FIG. 1.

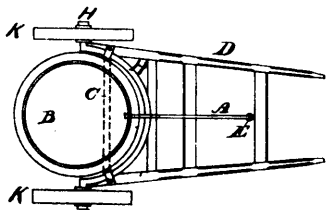
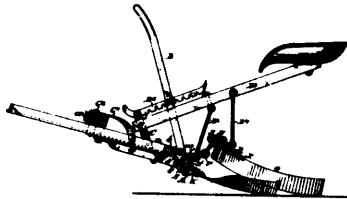
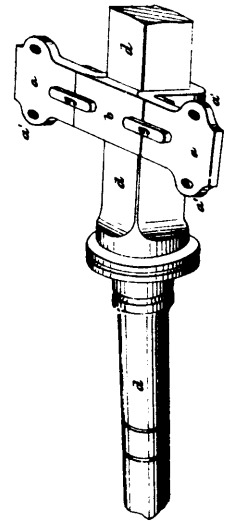

FIG. 2.

26561 Wilson's Hand Truck.



26562 Nishwitz's Harrow.



26563 Partridge's Affixable Solid Flap for Vehicle Axles.

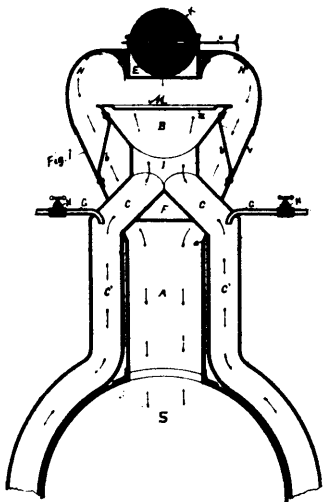

26564 Deyell's Smoke and Spark Arrester.

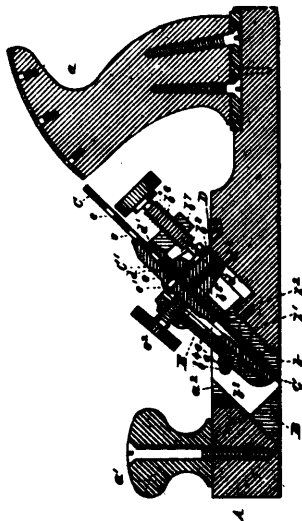

26565 Gage's Bench Plane.

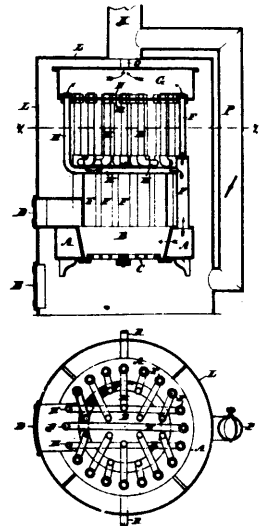

26566 Barcelow's Hot Water Circulating Boiler.