

**CIHM
Microfiche
Series
(Monographs)**

**ICMH
Collection de
microfiches
(monographies)**



Canadian Institute for Historical Microreproductions / Institut canadien de microreproductions historiques

© 1997

Technical and Bibliographic Notes / Notes techniques et bibliographiques

The Institute has attempted to obtain the best original copy available for filming. Features of this copy which may be bibliographically unique, which may alter any of the images in the reproduction, or which may significantly change the usual method of filming are checked below.

- Coloured covers / Couverture de couleur
- Covers damaged / Couverture endommagée
- Covers restored and/or laminated / Couverture restaurée et/ou pelliculée
- Cover title missing / Le titre de couverture manque
- Coloured maps / Cartes géographiques en couleur
- Coloured ink (i.e. other than blue or black) / Encre de couleur (i.e. autre que bleue ou noire)
- Coloured plates and/or illustrations / Planches et/ou illustrations en couleur
- Bound with other material / Relié avec d'autres documents
- Only edition available / Seule édition disponible
- Tight binding may cause shadows or distortion along interior margin / La reliure serrée peut causer de l'ombre ou de la distorsion le long de la marge intérieure.
- Blank leaves added during restorations may appear within the text. Whenever possible, these have been omitted from filming / Il se peut que certaines pages blanches ajoutées lors d'une restauration apparaissent dans le texte, mais, lorsque cela était possible, ces pages n'ont pas été filmées.
- Additional comments / Commentaires supplémentaires:

L'Institut a microfilmé le meilleur exemplaire qu'il lui a été possible de se procurer. Les détails de cet exemplaire qui sont peut-être uniques du point de vue bibliographique, qui peuvent modifier une image reproduite, ou qui peuvent exiger une modification dans la méthode normale de filmage sont indiqués ci-dessous.

- Coloured pages / Pages de couleur
- Pages damaged / Pages endommagées
- Pages restored and/or laminated / Pages restaurées et/ou pelliculées
- Pages discoloured, stained or foxed / Pages décolorées, tachetées ou piquées
- Pages detached / Pages détachées
- Showthrough / Transparence
- Quality of print varies / Qualité inégale de l'impression
- Includes supplementary material / Comprend du matériel supplémentaire
- Pages wholly or partially obscured by errata slips, tissues, etc., have been refilmed to ensure the best possible image / Les pages totalement ou partiellement obscurcies par un feuillet d'errata, une pelure, etc., ont été filmées à nouveau de façon à obtenir la meilleure image possible.
- Opposing pages with varying colouration or discolourations are filmed twice to ensure the best possible image / Les pages s'opposant ayant des colorations variables ou des décolorations sont filmées deux fois afin d'obtenir la meilleure image possible.

This item is filmed at the reduction ratio checked below /
Ce document est filmé au taux de réduction indiqué ci-dessous.

10x				14x				18x				22x			26x		30x												
				12x					16x					20x					24x					28x					32x

The copy filmed here has been reproduced thanks to the generosity of:

National Library of Canada

The images appearing here are the best quality possible considering the condition and legibility of the original copy and in keeping with the filming contract specifications.

Original copies in printed paper covers are filmed beginning with the front cover and ending on the last page with a printed or illustrated impression, or the back cover when appropriate. All other original copies are filmed beginning on the first page with a printed or illustrated impression, and ending on the last page with a printed or illustrated impression.

The last recorded frame on each microfiche shall contain the symbol \rightarrow (meaning "CONTINUED"), or the symbol ∇ (meaning "END"), whichever applies.

Maps, plates, charts, etc., may be filmed at different reduction ratios. Those too large to be entirely included in one exposure are filmed beginning in the upper left hand corner, left to right and top to bottom, as many frames as required. The following diagrams illustrate the method:

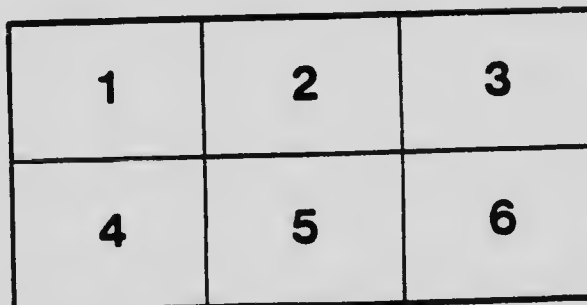
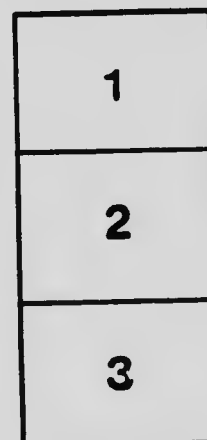

L'exemplaire filmé fut reproduit grâce à la générosité de:

Bibliothèque nationale du Canada

Les images suivantes ont été reproduites avec le plus grand soin, compte tenu de la condition et de la netteté de l'exemplaire filmé, et en conformité avec les conditions du contrat de filmage.

Les exemplaires originaux dont la couverture en papier est imprimée sont filmés en commençant par le premier plat et en terminant soit par la dernière page qui comporte une empreinte d'impression ou d'illustration, soit par le second plat, selon le cas. Tous les autres exemplaires originaux sont filmés en commençant par la première page qui comporte une empreinte d'impression ou d'illustration et en terminant par la dernière page qui comporte une telle empreinte.

Un des symboles suivants apparaîtra sur la dernière image de chaque microfiche, selon le cas: le symbole \rightarrow signifie "A SUIVRE", le symbole ∇ signifie "FIN".

Les cartes, planches, tableaux, etc., peuvent être filmés à des taux de réduction différents. Lorsque le document est trop grand pour être reproduit en un seul cliché, il est filmé à partir de l'angle supérieur gauche, de gauche à droite, et de haut en bas, en prenant le nombre d'images nécessaire. Les diagrammes suivants illustrent la méthode.

MICROCOPY RESOLUTION TEST CHART

(ANSI and ISO TEST CHART No. 2)

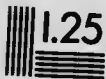
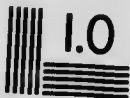

APPLIED IMAGE Inc

1653 East Main Street
Rochester, New York 14609 JSA
(716) 482 - 0300 - Phone
(716) 288 - 5989 - Fax

M87. 2

THE · COPYING · CAMERA
of THE SURVEYOR GENERAL'S OFFICE

By E. DEVILLE, LL. D.
SURVEYOR GENERAL *of*
DOMINION LANDS

OTTAWA
GOVERNMENT PRINTING BUREAU
1912

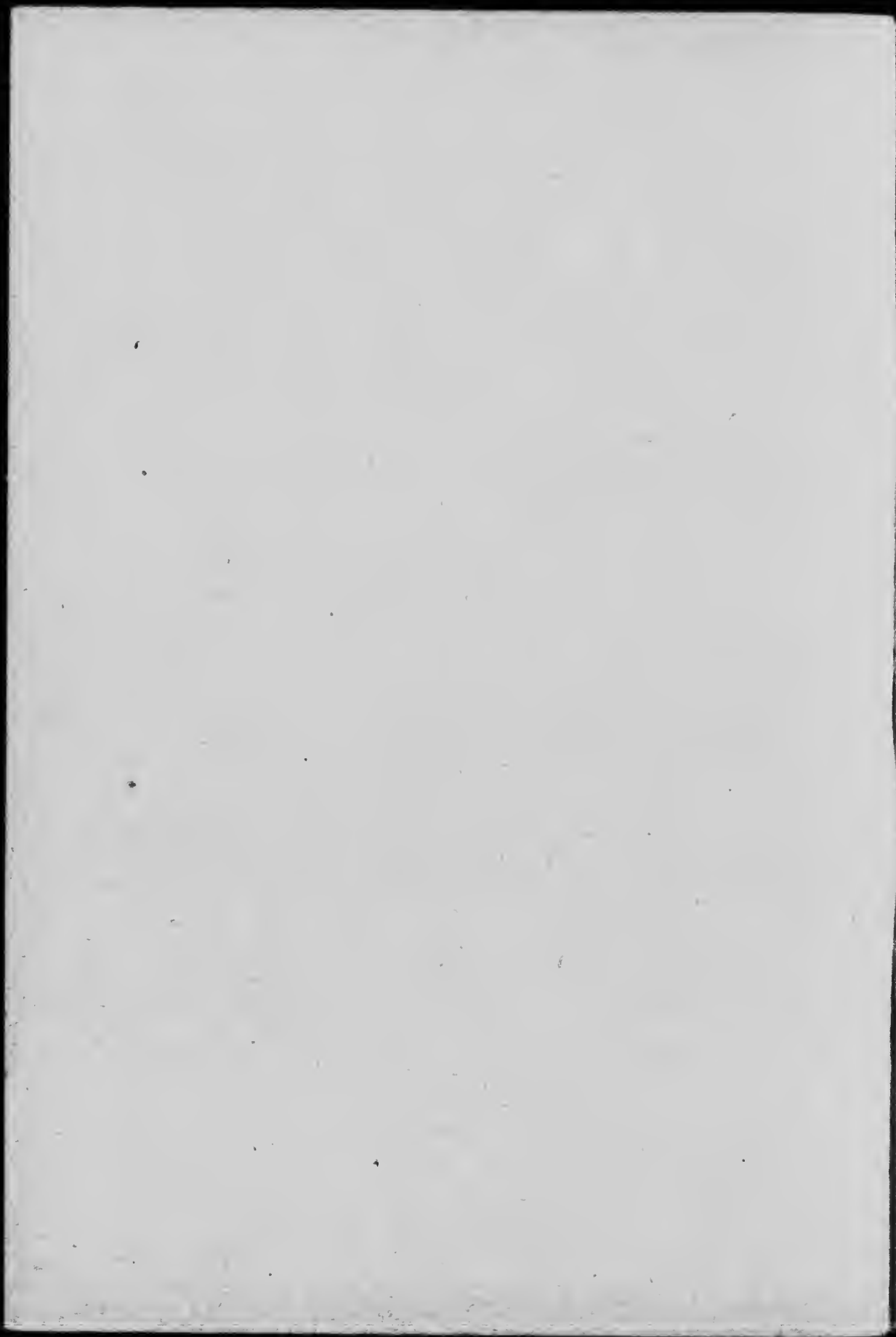

THE COPYING CAMERA

OF THE

SURVEYOR GENERAL'S OFFICE

BY

E. DEVILLE, LL.D.

Surveyor General of Dominion Lands

OTTAWA
GOVERNMENT PRINTING BUREAU
1912



CONTENTS

PART I—THE CAMERA.

	Page.
1.—General features of Copying Cameras.	5
2.—Camera of Surveyor General's Office.	6
3.—The Board.	7
4.—The Lens Carriage.	9
5.—The Plate Carriage.	9
6.—Reverse Camera.	11
7.—Setting the Camera.	12
8.—Focussing.	12
9.—Definitions.	13
10.—Geometry of the Copying Camera.	14
11.—Adjustments of the Camera.	16
12.—The Centre of the Board.	17
13.—The Centre of the Plate.	19
14.—Adjustment of the Board and Plateholder frame.	19
15.—Graduations.	22
16.—Readjusting the focus.	24
17.—Adjustment and graduation of the Reverse Camera.	25

PART II—THE ILLUMINATION OF THE BOARD.

18.—Lights and reflections.	31
19.—Light intensities with one lamp.	31
20.—Light intensities with two lamps.	32
21.—Light intensities with four lamps.	33
22.—Reflections and focal length of the lens for two lamps.	33
23.—Reflections and focal length of the lens for four lamps.	35

PART III.

Table of factors for computing the graduation of a Copying Camera, and of comparative exposure	39
--	----

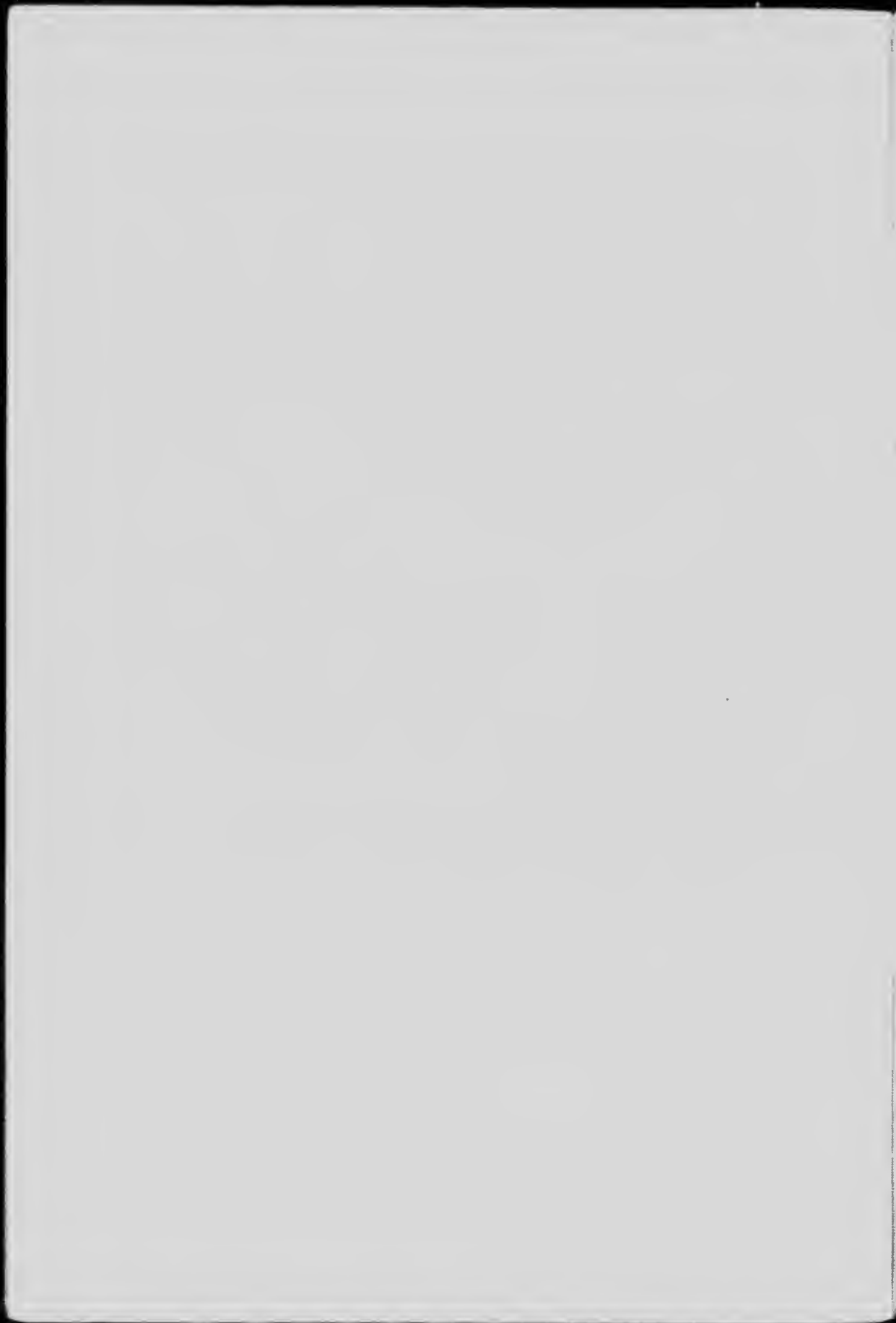

THE COPYING CAMERA

OF THE

SURVEYOR GENERAL'S OFFICE

PART I.—THE CAMERA.

1. General Features of Copying Cameras.

The evolution of the copying camera from the crude wooden box of the early days to the elaborate instrument now in general use is one of the many evidences of the progress of photography. Nowhere has photography proved more useful than in survey departments: apart from the printing of maps by the various processes of photo-lithography, photo-zincography and photo-engraving, the reductions, enlargements and other copies of maps and plans required by surveyors for field use or by draughtsmen for compiling other maps and plans, are now prepared by photography instead of being made by hand as formerly. The copying camera is accordingly an important adjunct of every survey office.

The land surveys of the Canadian Government now extend over some seven thousand townships, and the number is increasing every year. A plan of each township is printed for the administration and for the public. Every time further surveys are made in a township, and this happens frequently, a new plan has to be printed. The necessity of providing, without too great an increase in the photographic staff and equipment, for the publication of such a large number of township plans, and of the other maps and plans issued by the Survey Department, has developed a copying camera presenting some peculiar features, a description of which may prove of interest.

One of the first improvements in copying cameras was in the mode of suspension. It was found that the vibrations caused by the machinery always present in business buildings, or even by the street traffic, affected the sharpness of the negative; although the vibrations did not mar the appearance of a portrait, the quality of a line negative was seriously impaired. The vibrations were prevented at first by placing the camera and the board upon a cradle suspended by ropes from the ceiling. The board was fixed at one end and the camera moved to and fro upon rails on the cradle. The rope suspension is still in use, but is somewhat inconvenient; a better combination is to support the cradle by means of springs upon a stand, and this is the mode of suspension most frequently met with. So long as the camera is small, this suspension is convenient; the work of the process worker being, as a rule, of small size, this style fulfils his requirements. For the reproduction of maps, however, the conditions are different, because maps are frequently of large size. A large camera, with a board in proportion, and a spring cradle on a stand, would be

very unwieldy indeed, and most inconvenient in use. Such a combination is seldom found in survey departments, the trouble from vibrations being usually overcome by setting up the camera in a place far away from traffic and machinery. No such place was available here; the photographic office was on the top floor of a building in which lithographic presses were running, and some mode of spring suspension was imperative.

The solution adopted consists in suspending the cradle by springs from the ceiling, but instead of putting the camera and board on the cradle, they are placed underneath.

2. Camera of the Surveyor General's Office.

The board is fixed at one end of the cradle; the lens and plate are on two separate carriages sliding on two pairs of V rails. The rails for the plate carriage

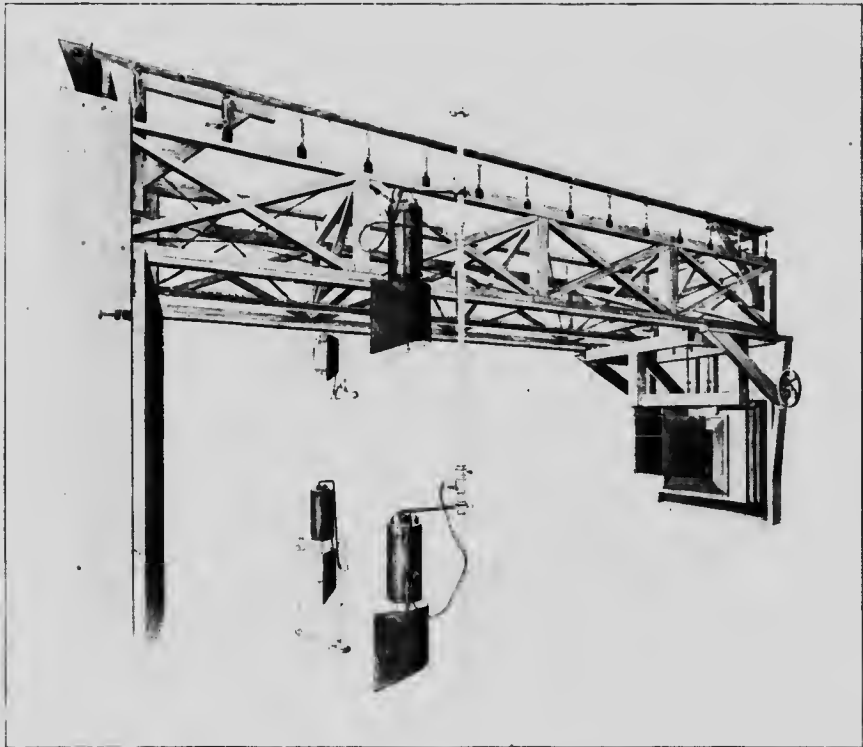

FIG. 1—Camera fitted with short bellows for great reduction.

are outside the cradle, those for the lens carriage are inside. The lens can be brought within ten inches of the plate (Fig. 1). Bellows suspended by chains from runners under the cradle can be inserted to give any camera extension needed

for enlarging (Fig. 2). Negatives for the offset lithographic press and for photographic printing are made with the camera so fitted. For half-tone and line engraving, and for printing from stones, the lens hood of the lens carriage is removed and a reverse camera substituted (Fig. 3).

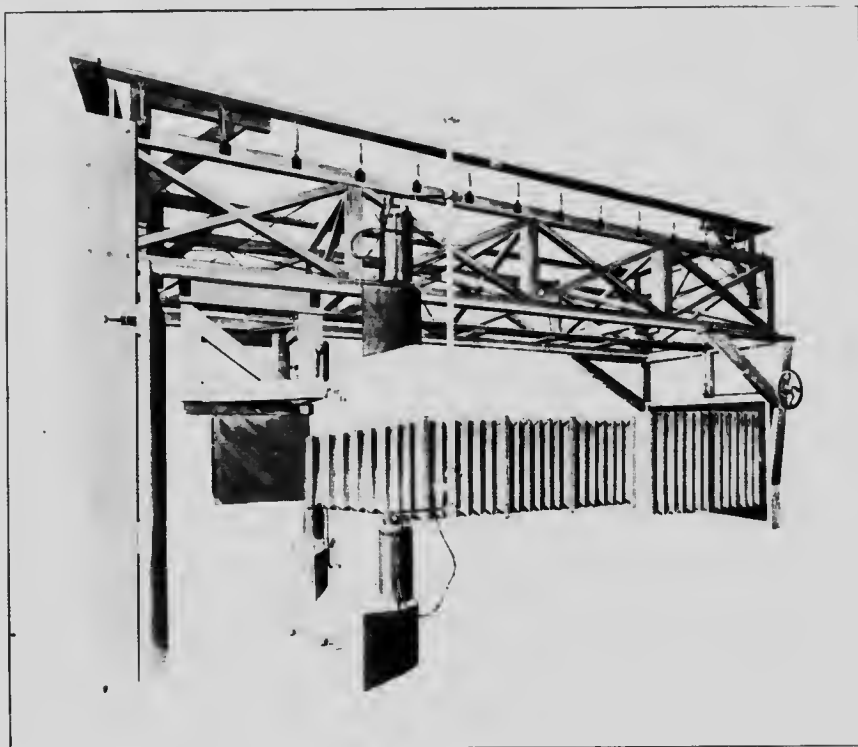

Fig. 2 Camera fitted with long bellows for enlarging.

The cradle is fourteen feet long and four feet wide. The first cradle of this pattern, although very strong, was subject to torsional vibrations; it was replaced by the present cradle, which is wider, deeper and strongly braced by iron rods with turnbuckles. Absolute rigidity of the cradle is essential.

The swing of the whole apparatus, if suspended freely, would be inconvenient. It is limited by wooden arms bolted to the ceiling at both ends and extending inside of the cradle. Pieces of soft rubber, half an inch thick, are inserted between the arms and the cradle, thus limiting the swing without transmitting vibrations.

3. The Board.

Two uprights fixed at one extremity of the cradle are terminated at their lower ends by iron brackets upon which the weight of the board rests; it is attached to the

uprights by four adjusting screws. The surface of the board is tested with a straight edge; if warped, it can be straightened by means of crossbars and bolts acting upon the cleats. About eighty per cent of the originals are of one particular size (township plans); these are placed on the board behind a glass plate held at the four corners by bolts and nuts. The original is adjusted to correct position, after which

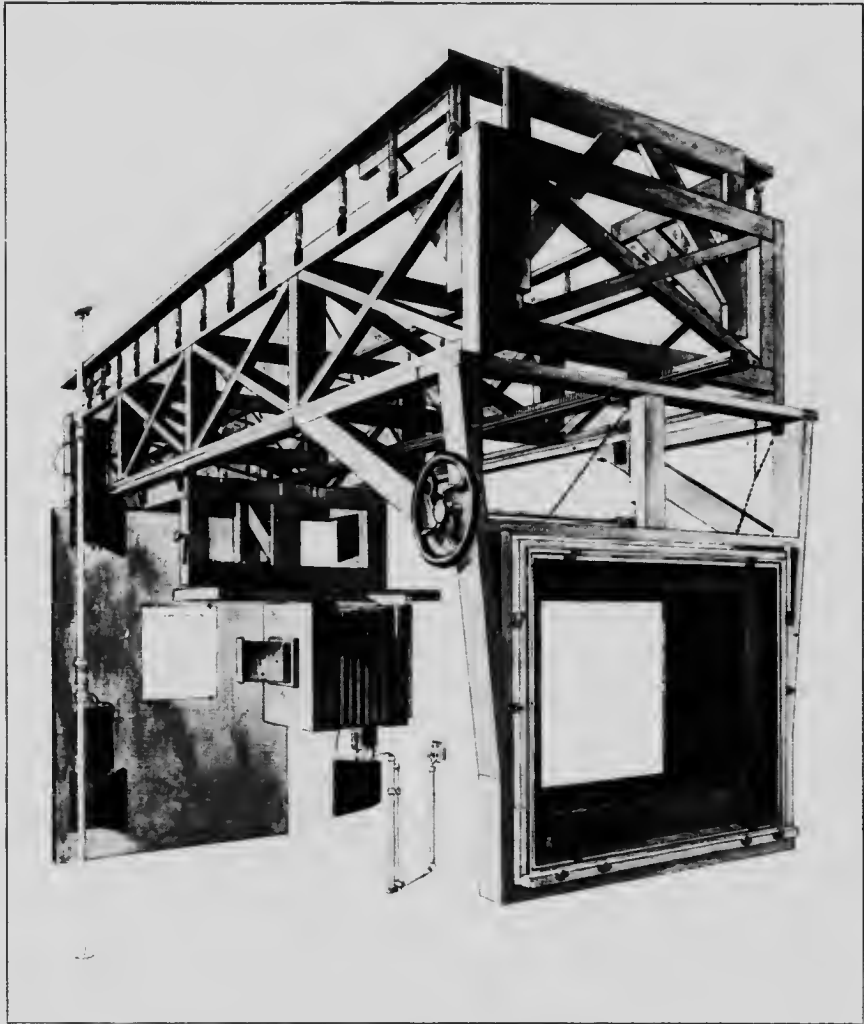

FIG. 3—Reverse Camera.

the nuts are tightened. The insertion of the glass plate shortens the optical distance from the lens by one-third the thickness of the plate; the board has to be moved that much farther away. Originals of other sizes are pinned to the board, the glass and bolts being removed.

Through the centre of the board two lines are drawn at right angles, approximately horizontal and vertical. Likewise the two middle lines, in the direction of the width and in the direction of the height, of the original to be reproduced, are indicated by short lines drawn on the border of the original. The latter is in correct position when its middle lines coincide with the lines of the board.

At the centre of the board is a hole through which a microscope or the telescope of an optical square can be inserted for adjusting the camera; it is closed by a plug when not in use.

4. The Lens Carriage.

The lens carriage slides on two pairs of steel shoes far enough apart to prevent wobbling; the motion is given by a rack and pinion through angle gear and a crank at the side of the carriage.

The lens board fits in a rebate at the bottom of a deep hood, the object of which is to keep stray light off the interior of the camera.

The bellows fit in another rebate at the back of the hood, where they are held by two turnbuckles. A lens of 33.7 inches focus is used for most of the work; for great reductions and for the reverse camera, a lens of shorter focus is employed.

The graduations for setting the carriages in position are on an enamelled hardwood rod, 1×3 inches, attached to the middle of the cradle, the pointers being fastened to the carriages. The lens carriage has two pointers, one for the direct camera and one for the reverse camera. Both pointers are adjustable, and can be clamped by screws when in correct position.

5. The Plate Carriage.

Sections of bellows of convenient size can be fitted up between the two carriages, providing camera extensions from 10 inches to 11 feet. They are fastened to each

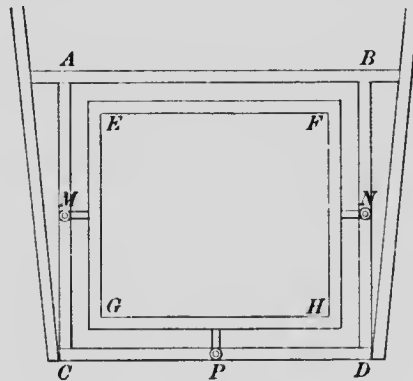

FIG. 4--Frame of Plate Carriage.

other by hooks and are supported by chains hanging from runners under the cradle. The plate carriage, like the other one, has two pairs of steel runners; they slide

upon the outside V rails, the motion being given through a rack and pinion and angle gear by a large hand wheel.

The plate carriage consists of a rectangular frame, $A B C D$ (Fig. 4), inside of which is another frame, $E F G H$, to which the plate-holder is attached. The inner frame is connected to the outer one by three trunnions, M , N and P . Each trunnion is on a steel plate which slides forwards and backwards in a steel groove by means of an adjusting screw. By turning the screw at P , the inner frame revolves around $M N$ as an axis. By turning the screws at M and N in opposite directions, the inner frame revolves around the vertical through P as an axis. For moving the inner frame bodily forwards or backwards, parallel to itself, the three screws are turned in the same direction.

The four plate-holders are $24'' \times 32''$, $20'' \times 24''$, $16'' \times 18''$ and $10'' \times 12''$, respectively; they can all be attached to the inner frame in accurate register. The larger one, which is somewhat heavy, is moved about on a truck, with rubber tire wheels

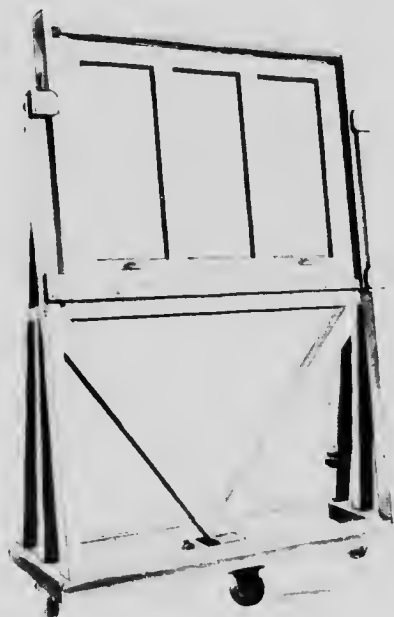

FIG. 5. Plate-holder Truck.

(Fig. 5), to which it is fastened by two turnbuttons and from which it is removed only for attaching to the camera. It remains on the truck in the dark room. When brought close to the plate carriage, a lift of a few inches brings it to its place on the camera.

The smaller holders are more easily handled; the operator always gives the preference to the smallest holder that will take in his plate.

Plates up to $20'' \times 24''$ are sensitized in a glass bath enclosed in a wooden case a little more than twice the height of the bath and inclined about ten degrees to

the vertical. The upper half of the case is closed by a sliding panel supported by a counterweight so adjusted that the panel stays either open or closed. Another counterweight heavier than the 20" x 24" plates, supports by means of a rope and pulley the dipper upon which the plate is placed for sensitizing. After coating the plate with collodion and putting it on the dipper, the panel is closed and the counterweight of the dipper is slowly lifted by hand from the lower shelf upon which it was resting, allowing the plate to descend into the bath, and is deposited upon an upper shelf when the plate is completely immersed. The plate is left four minutes in the bath and then the counterweight is taken from the upper shelf and slowly brought down to the lower shelf, withdrawing the plate from the solution and leaving the bottom of the plate upon the edge of the glass bath. The plate is allowed to drip for one or two minutes, the panel is opened and the plate transferred to the plate-holder. Up to the transfer of the plate to the plate-holder, the whole operation is performed in full daylight.

6. Reverse Camera.

The reverse camera, 18" x 20", is used with the smaller lens; the extension is 24 inches. The front is fixed, focussing being effected by moving the back by means of a double rack, pinion and crank. A graduated brass scale on the bed indicates the reduction.

The silvered glass reversing mirror fits snugly into the groove of a rectangular board connected to the mirror box by four adjusting screws, *A*, *B*, *C* and *D* (Fig. 6). By turning the screws *A* and *B* in opposite directions, the mirror revolves around a vertical axis through its centre. Likewise by turning the screws *C* and *D* in opposite

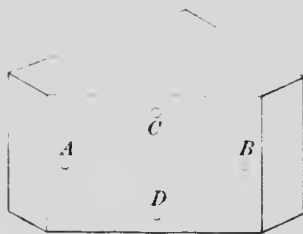

FIG. 6—Mirror Box.

directions, the mirror revolves around the horizontal line in its plane through its centre.

The equipment comprises two mirrors, one being in use while the other one is out for silvering. With proper care and provided it is slightly warmed before any attempt is made to polish it, the silvering is good for six months or more. Incidentally it may be mentioned that an optically plane mirror is an expensive article; many of those found in the trade are imperfect and spoil the definition of a good lens.

A feature of this style of copying camera is its adaptability to large sizes. A large plate holder, a few extra lengths of large bellows and a larger lens are all that

is needed. So far as the camera is concerned, the large plates are handled without any more trouble than the smaller ones. The size of the plate here has been limited to 24" x 32", merely because there is no occasion to use a larger plate.

7. Setting the Camera.

Two methods are available for setting a copying camera. By the first method the camera is adjusted at each operation so as to yield an image of a definite size and shape, which may or may not be an accurate reduction of the original. By the second method, the camera is adjusted once for all beforehand so as to yield in all cases an accurate reduction or enlargement of the original.

The first method is in general use and has some advantages. Let it be assumed, for instance, that a map has to be reduced to a rectangle 24" x 30". The operator rules on the ground glass a rectangle of that size, and endeavours in the usual manner to obtain an image filling approximately the rectangle so drawn. The next step is to bring one side of the image in coincidence with the corresponding side of the rectangle; this is done either by turning the board around an axis perpendicular to its face and by shifting it right or left and up or down, or by like motions of the camera. It is now found that the other sides of the rectangle do not fit, the shape of the image being an irregular quadrilateral; it has to be brought to correct shape by changing the inclination of the board to the axis of the camera. Every time an adjustment is made, it disturbs the preceding ones, which have all to be gone over again. To one without experience, the process is exceedingly tedious; like everything else, however, it is made easier by long practice, and some operators become in time very skilful. The main advantage of the method lies in the fact that, in some cases, it is possible to restore to correct proportions a drawing which has become distorted. Some kinds of paper, and especially tracing cloth, are affected by atmospheric conditions, and distortion occasionally becomes appreciable.

The advantage of the second method lies in its rapidity. The operator pins the original to the board, sets the two carriages by the scale to the reduction or enlargement marks on the job slip and exposes the plate. There is no focussing or twisting of the camera or board; in fact, no ground glass is used. This method was adopted by the office of the Surveyor General because the number of land survey plans to be reproduced is very great, and because the angles and lengths being marked in figures on the plans, sealing is unnecessary and a slight distortion would be immaterial. Moreover in an original properly cared for, distortion is seldom appreciable, and the most frequent case of distortion, that which is due to unequal expansion in the direction of and across the web of the paper, cannot be corrected by the adjustment of the camera.

8. Focussing.

Focussing is done with Carl Zeiss microscope (Fig. 7). This microscope, which has a power of 28 diameters, slides in an outer split sleeve terminated by a square base which can be applied against a glass plate. The coarse adjustment is effected by sliding the microscope in the outer sleeve till a distinct image is seen, and fastening it in that position by turning the milled screw ring at the top of the outer sleeve.

The fine adjustment is effected by screwing the body of the microscope in or out of an inner split sleeve, the second clamping ring (shown on the left of the 10 mm. division of the scale) having been released. The displacement of the microscope is read on the millimetre scale, the tenths of a millimetre being indicated by marks on the circumference of the inner sleeve and the hundredths easily estimated.

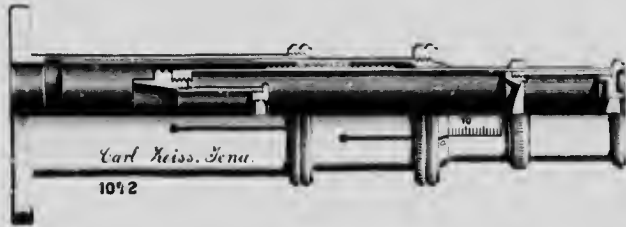

FIG. 7—Focussing Microscope.

For focussing the camera, a large piece of clear plate glass, perfectly plane, is selected, and a cross of two very fine lines is engraved in the centre with a diamond. The plate is inserted in the plate holder, engraved face towards the board, after removing the curtain and back of the holder. The base of the microscope is now applied against the back of the plate, it is set upon the engraved cross and the millimetre scale is read. The microscope is put against the plate again and is set this time upon the image of the original pinned to the board. The millimetre scale is read a second time. The difference of the two readings is the distance between the face of the glass plate and the plane of the image.

For instance, readings of 9.6 mm. on the engraved cross and 8.3 mm. on the image indicate that the image is 1.3 mm. in front of the plate, or in other words, that the plate carriage has to be moved 1.3 mm. forward in order to be in exact focus. Readings of 9.6 mm. on the engraved cross and 12.6 mm. on the image indicate that the image is 3 mm. behind the face of the glass and that the plate carriage must be moved 3 mm. backward.

9. Definitions.

The *axis of the camera* is a line through the optical centre of the lens parallel to the direction of motion, that is to say parallel to the rails. It must coincide with the optical axis of the lens; the flange of the latter must be so affixed to the camera that this condition is approximately fulfilled, otherwise the definition is impaired away from the centre of the plate.

The *centre of the board* is the point where the axis of the camera strikes the face of the board; it may be some distance from the geometrical centre.

The *centre of the plate* is the point where the axis of the camera strikes the face of the plate.

The image of the centre of the board always falls upon the same point of the plate (the centre of the plate). These two points are the only ones endowed with this reciprocal relation.

The *reduction* u , is the proportion of the lines of the original to the corresponding lines of the image.

The *enlargement*, also designated by u , is the proportion of the lines of the image to the corresponding lines of the original.

According to these definitions, a reduction of 3.00 means that the linear dimensions of the original are three times the dimensions of the image. An enlargement of 3.00 means that the linear dimensions of the image are three times the dimensions of the original. Reductions and enlargements are never less than unity.

10. Geometry of the Copying Camera.

Relations between conjugate foci.—Let A , Fig. 8, be the lens in position for reducing, u and v being the distances to the board and to the plate respectively. The relation is:—

$$u = \frac{u}{v}$$

The values of u and v are:—

$$u = (1 + u)f \quad (1)$$

$$v = \left(1 + \frac{1}{u}\right)f \quad (2)$$

f being the focal length of the lens.



FIG. 8.

Moving the lens to B for enlarging, the relations become:—

$$u = \frac{v'}{u'}$$

$$u' = \left(1 + \frac{1}{u}\right)f \quad (3)$$

$$v' = (1 + u)f \quad (4)$$

The various distances are accordingly as follows:—

	For reducing.	For enlarging.
Board to Lens	$(1 + u)f$	$\left(1 + \frac{1}{u}\right)f$
Lens to Plate	$\left(1 + \frac{1}{u}\right)f$	$(1 + u)f$
Board to Plate*	$\left(2 + u + \frac{1}{u}\right)f$	(5)

* 'Board to Lens' is in reality the distance to the first nodal point; 'Lens to Plate' is from the second nodal point. For 'Board to Plate', it would be necessary to add the distance between the nodal points, but this distance being eliminated in the application of these values made here, reference to the nodal points has, for the sake of simplicity, been omitted.

Differential motions.—If, the lens being at *A*, Fig. 9, for reducing the board is



FIG. 9.

slightly displaced from *C* to *C'*, the image which at first formed in *O* will now be in *O'*. The relation between the displacement of the board, *du*, and of the plate, *dv*, obtained by differentiating (1) and (2), is:—

$$du = -v' dv \tag{6}$$

For an enlargement the relation is inverted:—

$$dv' = -\frac{du'}{v} \tag{7}$$

Thus for a reduction of 3.00, the displacement of the plate is one-ninth of the displacement of the board, while for an enlargement of 3.00, the displacement of the plate is nine times the displacement of the board.

Changes of scale.—When a map on a scale of *a* miles to one inch is reduced *n*, the scale of the copy is *na* miles to one inch. To reduce a map on a scale of *a* miles to one inch to *b* miles to one inch, the reduction must be $\frac{b}{a}$. Likewise, when a map on a decimal scale $\frac{1}{a}$ is reduced *n*, the scale of the copy is $\frac{1}{na}$. To reduce a map on a decimal scale $\frac{1}{a}$ to the scale $\frac{1}{b}$, the reduction must be $\frac{b}{a}$.

An enlargement *n* of a map on a scale of *a* miles to one inch produces a copy on a scale of $\frac{a}{n}$ miles to one inch. To enlarge the map from the scale of *a* miles to one inch to the scale of *b* miles to one inch, the enlargement must be $\frac{a}{b}$.

Likewise, when a map on a decimal scale $\frac{1}{a}$ is enlarged *n*, the copy is on the scale $\frac{n}{a}$. To enlarge the map from the scale $\frac{1}{a}$ to the scale $\frac{1}{b}$, the enlargement must be $\frac{a}{b}$.

When a map on a scale of *a* miles to one inch is reduced *n'* and the copy is subsequently enlarged *n''*, the final scale is $\frac{n'a}{n''}$ miles to one inch. A map on a scale of *a* miles to one inch will be changed to a scale of *b* miles to one inch by reducing it *n'* and enlarging the copy *n''* provided:

$$\frac{n'}{n''} = \frac{b}{a}$$

When the copy desired is larger than the plate it is proposed to work with, the change of scale may be made in two different ways. A number of negatives sufficient to cover the whole map can be made on the desired scale; these are printed by contact and the prints are joined together to form the copy. The other way is to make a reduced negative of the whole map, to put the negative in the enlarging camera and to enlarge it to the requisite scale on a single piece of bromide paper. The first method gives a sharper result; the second method saves work and has the advantage of producing a copy on a single sheet of paper.

As an illustration, suppose a map $42'' \times 54''$ on a scale of 10 miles to one inch has to be reduced to 12 miles to one inch and the plate it is proposed to employ is $10'' \times 12''$. The reduction is:

$$n = \frac{12}{10} = 1.20$$

The reduced map will be $35'' \times 45''$. Setting the copying camera at a reduction of 1.20, it takes fifteen or sixteen negatives $10'' \times 12''$ to cover the map. The negatives are printed by contact and the fifteen or sixteen pieces are joined together to make the finished copy.

Sharpness of the lines may not be essential, or it may be desired to save work or to have the finished copy in one piece. Should this be the case, one negative of the whole map is made to be enlarged subsequently. The ratio of the short sides of the map and plate is $\frac{42}{10}$ or 4.20, the ratio of the long sides $\frac{54}{12}$ or 4.50; therefore the reduction n' must be at least 4.50 for covering the whole map with one negative. Make the negative with $n' = 5.00$ so as to leave a little margin on the plate. An enlargement n'' has now to be made from this negative. The relation quoted above between n' , n'' and the scales gives:

$$n'' = n' \times \frac{a}{b}$$

In this case:

$$n'' = 5.00 \times \frac{10}{12} = 4.167$$

Therefore the map has first to be reduced 5.00 and then enlarged 4.167.

11. Adjustments of the Camera.

A good anastigmat, if used at a moderate angle, gives an image practically free from distortion, provided the board and plate are parallel and the optical axis of the lens is perpendicular to both. The last condition is sufficiently well fulfilled in a camera carefully constructed but it will not be amiss to check it. The first condition must be accurately fulfilled, means of adjustment being provided for that purpose.

Before proceeding with the adjustment, it is necessary to check, and to correct if needed, some of the details of construction.

The rails must be perfectly straight and parallel. This is checked by stretching a thread from one end of each rail to the other end, first with the cradle lying flat

down and next with the cradle lying on its side. Parallelism is checked by measuring the spacing of the rails.

The board must be perfectly flat. This is checked with a steel straight edge applied on edge against the face of the board at different places and in different directions. The board is straightened by means of the screws at the back until perfectly straight in all directions.

The plates in all the plate holders must register alike. For checking this, the largest holder with the selected glass plate is attached to the camera and the bellows are removed. Two wooden rods with straight edges are clamped to the frame of the plate carriage in front of the plate holder, one of the rods being opposite the top of the plate, the other rod opposite the bottom. Each rod is adjusted so as to be parallel to the plate, the space between the plate and the edge of the rods being carefully measured. Another plate-holder with a selected glass plate is now substituted, and the space between the edge of the rods and the four corners of the plate measured. The plate-holder or its fittings must be adjusted until this space is exactly the same as for the large plate-holder. The other plate-holders are successively fitted in a cradle register by the same process.

12. The Centre of the Board.

The first adjustment of the camera is to find the centre of the board.

Shift the plate carriage to the end of the cradle as far as it will go, attach the plate-holder after inserting the engraved glass plate and removing the curtain and lock. Pin to the board, approximately in the centre, the millimetre scale shown in Fig. 10. The lens carriage is now shifted and brought by means of the focussing



FIG. 10. Millimetre scale.

microscope to focus the image of the millimetre scale upon the face of the plate. This image will fall upon the cross engraved on the plate if the points selected as centres of the board and plate are not too far out. The vertical line of the plate will lie across the horizontal arm of the scale, and the horizontal line of the plate will lie

across the vertical arm of the scale. The readings of the scale at the two crossings are noted.

The lens carriage is then shifted towards the board till the image is in focus again, and the readings of the scale are noted as before.

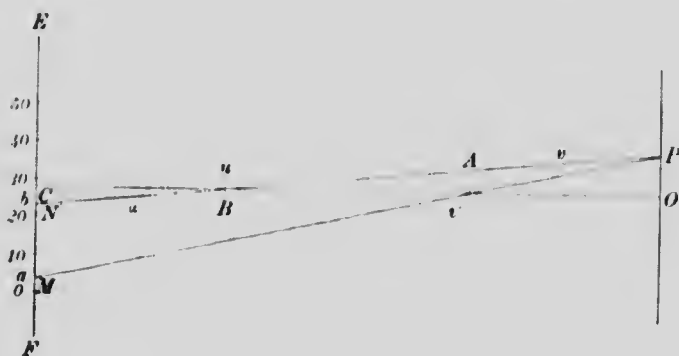

FIG. 11.

Let Fig. 11 represent a vertical section through the axis OC of the camera, EF being the board, OP the plate, A and B the first and second positions of the lens, P the horizontal line of the engraved cross, N and M the two divisions of the millimetre scale whose image falls upon P , and a and b the corresponding readings of the scale.

It will be noted that in this case $u = v'$ and $v = u'$; that is to say, the reduction and enlargement are equal:

$$u = \frac{u'}{v} = \frac{v'}{u'}$$

In reducing, PO is the image of MC ; hence:

$$PO = \frac{MC}{u}$$

In enlarging, PO is the image of NC ; hence,

$$PO = u \times NC$$

Combining the two equations:

$$u^2 \times NC = MC$$

and:

$$NC = \frac{MN}{u^2 - 1}$$

But:

$$MN = b - a$$

and:

$$NC = \frac{b - a}{u^2 - 1}$$

The reading of the scale where it is intersected by the horizontal line passing through the centre of the board is accordingly:

$$b + \frac{b-a}{u^2-1}$$

Through this division of the scale, a horizontal line is drawn on the board.

The same procedure is followed for the horizontal branch of the millimetre scale and a vertical drawn through the proper division of the scale. The intersection of the horizontal and vertical lines so drawn is the centre of the board.

Through the centre of the board two lines at right angles, approximately horizontal and vertical, are drawn right across the board. Their images must be as nearly as possible parallel to the sides of the plate.

The extension of the reverse camera being comparatively short, the limit of u for enlarging is small. With small values of u , the term $\frac{b-a}{u^2-1}$ in the expression for the reading of the scale becomes inaccurate. Instead of setting the reverse camera at equal reduction and enlargement, it is preferable to set it first at the greatest reduction, u , and then at the greatest enlargement, u' , the extension admitted. Keeping the same notation as before, it is easily found that the reading of the scale for the centre of the board is:

$$b + \frac{b-a}{uu'-1}$$

13. The Centre of the Plate.

The centre of the plate is the point upon which falls the image of the centre of the board. If the camera has been accurately constructed, this point is very close to the cross engraved on the plate. For convenience in registering lithographic transfers, it is necessary that the optical and geometrical centres of the plate should nearly coincide; the discrepancy, if any, must be removed by altering the plate-holder or its fittings. For the same reason, the images of the two lines drawn across the board must be parallel to the sides of the plate; care is taken to fulfil this condition in drawing the lines.

14. Adjustment of the Board and Plate-holder Frame.

The board and plate must both be accurately perpendicular to the axis of the camera.

The adjustment is effected by means of the optical square shown in Fig. 12. It consists of a telescope attached to two brass plates between which wooden arms are bolted. At the end of each arm is a small adjusting screw. The diaphragm of the telescope bears two threads at right angles, one of them being parallel to the wooden arms. Several pairs of wooden arms of different lengths are provided; the pair used for the board has the adjusting screws at the back instead of in front. The normal plane of the optical square is indicated by lines drawn on the two brass plates and by notches on the cell of the objective.

For adjusting the optical square, the plate carriage is moved to the extreme end of the cradle, the lens and front board are removed from the lens carriage and the millimetre scale shown in Fig. 10 is pinned to the centre of the board.

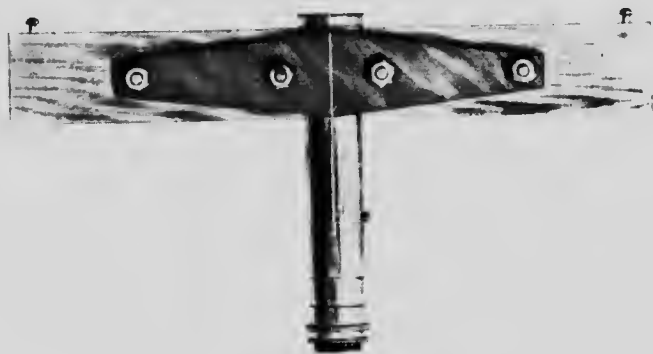

FIG. 12—Optical Square.

Let AB , Fig. 13, be the plate, DE the board, O the centre of the plate, C the centre of the board. Having focussed the telescope, apply the optical square against the plate, arms horizontal, screws G and H resting against the glass and the notch of the objective cell on the vertical line O of the central engraved cross. The line is too fine to be seen with the naked eye and must be indicated by a small piece of

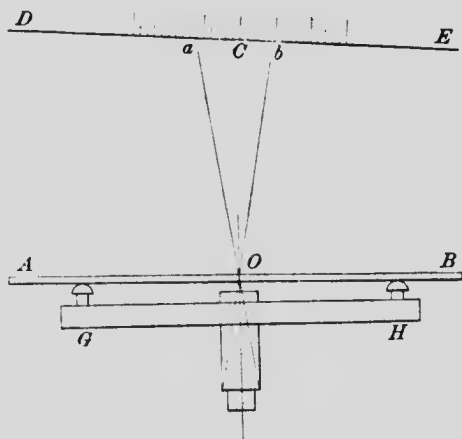

FIG. 13—Adjustment of the Optical Square.

paper pasted to the glass. Looking through the telescope, the vertical thread is seen to cross the horizontal arm of the scale and the reading, a , is noted. The optical square is now reversed end for end. If the same reading, a , of the scale is obtained, the optical square is in adjustment. If not, the second reading, b , is noted, and one

of the screws *G* or *H* at the end of the wooden arms is screwed or unscrewed until the reading on the scale becomes:

$$\frac{a+b}{2}$$

The adjustment of the plate-holder frame is now proceeded with. Applying the optical square against the plate *AB*, Fig. 14, arms horizontal, in the same position as before, the screws *S* and *T*, which command the slides of the trunnions, are turned in opposite directions till the vertical thread of the telescope is seen to pass through the centre *C* of the board.

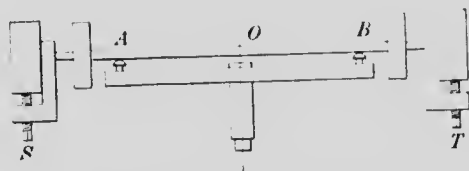
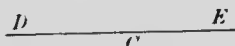

FIG. 14—Adjustment of the Plate-holder Frame.

The optical square is next fixed against the plate, wooden arms vertical, the notch of the objective cell being held on the horizontal line of the engraved cross.

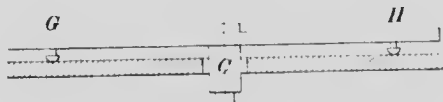
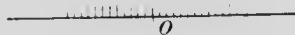

FIG. 15—Adjustment of the Board.

The bottom slide is screwed in or out until the horizontal thread of the telescope is seen to pass through the centre of the board.

The board is adjusted by the same method. The millimetre scale is stuck to the centre of the plate at *O*, Fig. 15, the plug in the centre of the board, *C*, is removed and the telescope of the optical square is inserted through the opening, arms horizontal, the line of the normal plane drawn on the instrument being brought in coincidence with the vertical line of the board. The optical square is adjusted in the manner already described by screwing in or out one of the screws, *G* or *H*. With the arms of the optical square horizontal, the board is revolved by turning in opposite directions its adjusting screws on the right and on the left until the vertical thread of the telescope is on the centre of the plate. With arms vertical, the board is revolved by turning in opposite directions its top and bottom adjusting screws, until the horizontal thread of the telescope is on the centre of the plate. Care must be taken to turn the screws evenly otherwise the face of the board would be bent.

15. Graduations.

There is a double graduation for each lens, one side being for setting the lens carriage, and the other side for the plate carriage.

The graduation is calculated as follows: Let *DE*, Fig. 16, be the board, *FG* the plate at the far end of the cradle, *CO* the axis of the camera, *A* and *B* the two positions of the lens for which the image is in focus on the plate, *OB* being equal to *AO*. The focal length found by subtracting (2) from (1) is:

$$f = \frac{AB}{n - \frac{1}{n}} \quad (8)$$

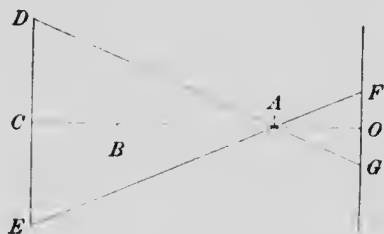

FIG. 16.

AB is the displacement of the lens carriage. It is measured on the rod attached under the cradle, the two positions being marked upon it. For focussing, the microscope is set on the plate at *O*, the tube is turned until the cross lines engraved on the plate are in focus and the reading of the microscope scale is noted. By repeating the operation several times the focus is accurately ascertained. Replacing the microscope on the plate, the tube is turned till the image of the board is perfectly sharp and distinct and the reading of the microscope scale is noted. This also is repeated several times. The difference of the two readings is approximately the distance the lens carriage has to be moved to bring the image of the board on the face of the plate. After moving the lens carriage, the focussing is repeated until an exact focus is obtained.

The reduction, n , is found by measuring DE and FG .

Through the centre of the plate, O , Fig. 17, draw a parallel MN to the long sides of the plate; at equal distances from the centre and near the edge, erect perpendiculars in M and N . The crosses at the two ends of this line must be drawn with a diamond on the plate. In drawing these lines as well as the cross at the centre, the diamond must be held at the proper angle and a very light pressure exerted, hardly more than the weight of the diamond, otherwise the lines will be ragged and accurate measurements impossible. Rubbing a pencil across the lines helps to make them visible.

Upon the board, two points, A and B , are marked on the horizontal line at equal distances from the centre, C , and such that their images will fall very nearly upon the points M and N of the plate. At these points erect perpendiculars to the hori-

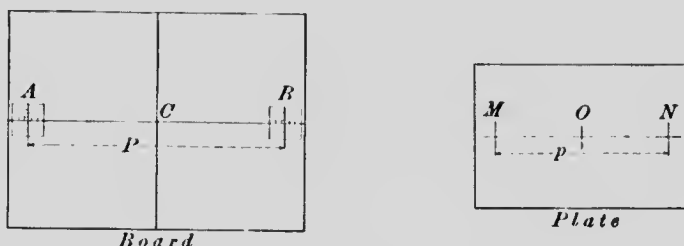

FIG. 17.

zontal line and upon the crosses so formed pin two of the millimetre scales shown in Fig. 10. Measure carefully the distances p between M and N , and P between A and B . Looking now at the plate the vertical line N will be seen to cross the horizontal arm of the scale A , and the vertical at M the horizontal scale B . Let a and b be the readings of the two scales; then the reduction is:

$$n = \frac{P + b - a}{p}$$

This value of n used in (8) gives the focal length.

It is somewhat difficult to focus accurately an enlarged image; it is, therefore, preferable to determine the position of the lens carriage at B , Fig. 16, by focussing from the board side. This is done by inserting the microscope through the centre hole of the board and resting the base against the face of the board. The reading of the microscope scale for the face of the board is ascertained by focussing a scratch on the back of a glass plate and adding the thickness of the base of the microscope.

The graduation for the plate carriage is obtained by calculating the distance board to plate for the various degrees of reduction or enlargement; this distance, given by (5), is:

$$\left(2 + n + \frac{1}{n}\right) f$$

For the lens carriage, the distance board to lens for a reduction is given by (1)

as:

$$(1 + n) f$$

For an enlargement, it is given by (3) as:

$$\left(1 + \frac{1}{n}\right) f$$

A table of the values of $2 + n + \frac{1}{n}$ and $1 + \frac{1}{n}$ is given in Part III; it is unnecessary to give a table of $1 + n$, as it would merely be one of consecutive numbers.

The numbers of these tables have to be multiplied by f ; this is quickly done with an arithmometer.

For drawing the graduation on the rod, the two reference marks at *A* and *B*, Fig. 16, are used as starting-points. The divisions are marked for every 0.01 of n ; they are located by dividing into equal parts the spaces between the values of the table. The figures for the lens carriage are made black and those for the plate carriage red.

Instead of the above graduations, a single scale of equal parts, a millimetre scale for instance, might be attached to the rod and the setting of the carriages done by means of the calculated tables. This would save drawing the graduation, the setting would be somewhat more accurate and it would have other advantages.

16. Readjusting the Focus.

The board, the plate holder frame, the graduation or the pointers may, for some reason or other, become displaced. Should this happen, the image of the board will no longer form on the face of the plate when the lens and plate carriage are set on corresponding divisions of the graduation. In order to ascertain how much the board and plate-holder frame have to be moved to bring them back to correct position, the camera is set for a reduction of n , the lens carriage being at *A*, Fig. 18, the plate at *O* and the board at *C*. Let *F* be the position of the image of the board; with



FIG. 18.

the focussing microscope measure the interval $OF = a$ between the plate and the image. Next move the lens carriage to *B* for an enlargement of n , and with the focussing microscope measure the interval $CE = b$ between the board and the image *E* of the plate. Let *D* and *G* be the correct positions of the board and plate respectively, y and x being the changes required to bring them to their correct places. In other words, if the board be moved from *C* to *D*, its image will move from *F* to *G*; and if the plate be moved from *O* to *G*, its image will move from *E* to *D*. But the relation between these displacements is given by (6). It is:

$$\begin{aligned} CD &= n^2 \times FG \\ OG &= n^2 \times DE \end{aligned}$$

or:

$$\begin{aligned} y &= n^2 (a - x) \\ x &= n^2 (b - y) \end{aligned}$$

The values of y and x derived from these equations are:

$$y = \frac{1}{1-n^2} \left(b - \frac{a}{n^2} \right)$$

$$x = \frac{1}{1-n^2} \left(a - \frac{b}{n^2} \right)$$

The tests are made for several values of n , the mean y and x being applied as corrections with the adjusting screws of the board and plate-holder frame. The correction can also be made by changing the position of the pointers, the lens carriage pointer being moved over an interval equal to y and the plate carriage pointer $x + y$.

It will be observed that the formula breaks down for $n = 1$, when the lens is midway between the plate and the board. The reason is because the lens, when near that position, can be moved forward or backward a small distance without changing the focus. It follows that the tests are best made with high values of n .

The factor

$$\frac{1}{1 - \frac{1}{n^2}}$$

is given below for different values of n up to 3.00. Above 3.00 the factor is unity.

n	$\frac{1}{1 - \frac{1}{n^2}}$	n	$\frac{1}{1 - \frac{1}{n^2}}$
1.20	1.93	1.80	1.10
1.30	1.54	1.90	1.08
1.40	1.35	2.00	1.07
1.50	1.25	2.25	1.04
1.60	1.18	2.50	1.03
1.70	1.14	3.00	1.01

Another method of readjusting a camera which has become disarranged is to focus it accurately and to measure the reduction as has already been explained. The pointers of the lens and plate carriages can then be moved to the divisions of the graduation representing the reduction found. This method is not as good as the other one.

17. Adjustment and Graduation of the Reverse Camera.

A new centre of the board has to be determined for the reverse camera; it may not be the same as for the direct camera. The determination is made in the manner already described for the direct camera.

The board being normal to the axis of the camera, requires no further adjustment. What remains to be done is to adjust the plate holder, or rather the mirror,

to set and clamp at the right place the reverse camera pointer of the lens carriage and to draw the graduation on the bed of the reverse camera.

The axis of the camera is reflected at right angles, or thereabouts, by the mirror; the condition that there shall be no distortion of the image requires that the plate be accurately perpendicular to the reflected axis. Evidently the adjustment could be made with the optical square by swinging the frame to which the plate-holder is attached, precisely as was done with the direct camera. It is preferable, however, instead of moving the plate-holder frame, to swing the mirror until the reflected axis is normal to the plate. Preference is given to the adjustment of the mirror because, being put in and taken out frequently, its position is liable to be disturbed, and because its readjustment, once its correct position has been determined, is very simple and quickly made.

The reflected axis must also be parallel, approximately at least, to the direction of motion of the plate, otherwise the centre of the plate will cease to be invariable and will change with the reduction or enlargement. Should the discrepancy be so large as to become troublesome, the fittings of the plate holder would have to be altered so as to make the plate normal to the direction of motion.

The first adjustment of the mirror can be made as follows:—

Draw a square on the plate, leaving a margin of an inch or two on the four sides; mark the four corners with a diamond, draw a corresponding square on the board so that its image shall coincide as nearly as possible with the square drawn on the plate. Unless the mirror is in adjustment, the image is not a square; the adjustment is effected by turning the mirror till the opposite sides of the image become equal.

Let $ABCD$, Fig. 19, be the square drawn on the plate and $EFGH$ the image. The distortion of the sides EG and FH can be measured by pinning continuous scales of equal parts to the board along EG and FH and counting the number of divisions intercepted on each scale between the lines AB and CD of the plate. The

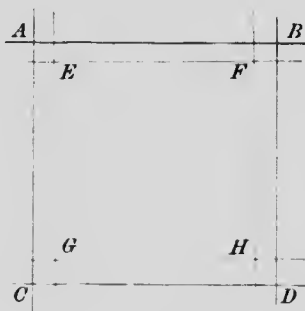

Fig. 19.

ends of the scales only being used, it is sufficient to measure on the board the length of the side of the square in millimetres and to pin at each of the four corners one of the millimetre scales shown in Fig. 19. The number of divisions that would be intercepted if the scales were continuous is readily figured out from the readings of the millimetre scales. The following is the rule for rotating the mirror:—

If the number of divisions intercepted is greater at the bottom of the plate than at the top, revolve the mirror around its horizontal axis so as to bring the top of the mirror nearer to the plate.

If the number of divisions intercepted is greater on the left of the plate than on the right, turn the mirror clockwise, looking from above, around its vertical axis.

The rule may be put in another form:—

Turn the mirror so as to decrease the distance between the side of the plate intercepting the smaller number of divisions and the corresponding side of the mirror.

After the mirror has once been adjusted, the centre of the plate, that is to say the image of the centre of the board, is marked on the framed glass plate. Whenever it is necessary to adjust the mirror again, for instance when it is changed, it is sufficient to turn it so as to bring into coincidence the image of the centre of the board and the mark for the centre of the plate, without resorting again to the process of adjustment described above.

The examination of the image near the corners of the plate is difficult, especially when the lens is working at a large angle, as it should be in order that the adjustment may be accurate. The difficulty may be overcome by making a negative and measuring the sides of the quadrilateral upon the negative.

Let Fig. 20 represent a horizontal section through the axis of the camera, DE being the board, AB the plate, G the image of the centre, C of the board, D and E

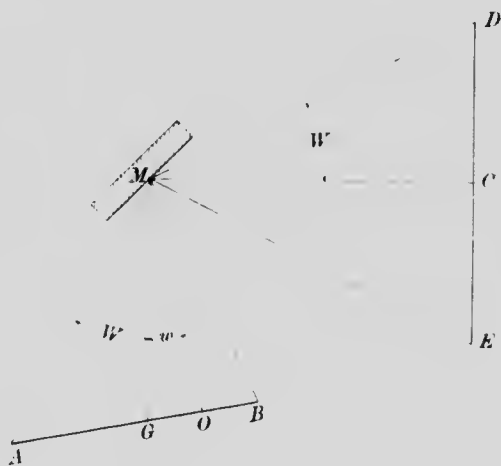

FIG. 20—Adjustment of the Mirror.

the sides of the square on the board, A and B the sides of the quadrilateral image, W the angle subtended at the lens by half of the square, L the length in millimetres of the left side of the quadrilateral at A , and B the length of the right side at B . As represented by the figure, L is greater than B ; to make them equal, the mirror must be turned, so as to bring the image of the centre from G to O , the line MO being

perpendicular to the plane of the plate. If a millimetre scale is pinned at C , the number of divisions d of the image corresponding to GO is:

$$d = n(L - R) \left[\frac{(n+1)f}{P} \right]^2$$

in which P is the side of the square on the board in millimetres.* The lengths L and R are measured on the negative. The image of the centre must be displaced towards the smaller side of the quadrilateral image.

Likewise, the image of the centre is moved towards the top or bottom according as the top or bottom side of the quadrilateral is smaller, the displacement being calculated by the same formula. In both cases the displacement is readily ascertained by means of the cross lines engraved near the centre of the plate.

Incidentally, it may be observed that the image of a square original whose opposite sides have become unequal through the stretching of the paper can be restored to correct proportions by the adjustment of the mirror calculated by the above formula, the lengths L and R being equal to the corresponding lengths of the original divided by n . The formula for rectangular originals could, if required, be easily calculated. Distortion can also be corrected by a like process in the direct camera. The need of such corrections has, however, not been felt here.

For graduating, the camera is set for a reduction such that the width of the board covers the full width of the plate; the reduction is measured by the process described for the direct camera. Having ascertained this reduction, the lens carriage pointer of the reverse camera is moved to the proper division of the graduation and firmly clamped in position. A mark is made on the bed of the reverse camera opposite the pointer, and the graduation is drawn from this mark by means of the table of the values of

$$\left(1 + \frac{1}{n} \right) f$$

which has already been calculated for the direct camera.

* Representing the angle GMO by w , the figure gives:

$$MA \times \cos(W + w) = MO$$

$$L = 2 MA \times \sin W$$

Multiplying by $\cos(W + w)$:

$$L \cos(W + w) = 2 MO \times \sin W$$

The angle w being small, its cosine can be taken as unity:

$$L \cos W = 2 MO \times \sin W + L \sin W \sin w$$

The right hand side of the figure gives in the same manner:

$$R \cos W = 2 MO \times \sin W - R \sin W \sin w$$

Subtracting the last equation from the preceding one, and reducing:

$$\sin w = \frac{n(L - R)}{2P \tan W}$$

$$GO = \sin w \times MO = n(L - R) \frac{(1 + \frac{1}{n})f}{2P \tan W}$$

But d , the number of divisions of the image of the millimetre scale corresponding to GO , is $GO \times n$, and:

$$\tan W = \frac{P}{2(1 + n)f}$$

Substituting these values:

$$d = n(L - R) \left[\frac{(1 + n)f}{P} \right]^2$$

It has been assumed at the start that the mirror was at the right place on the axis of the camera. This condition may not be accurately fulfilled.

Let Fig. 20a represent a section through the axis CP of the camera and the geometrical centre, O , of the glass plate marked by an engraved cross. The camera being set for an enlargement n' , the mirror M is turned so as to reflect the image of the optical centre of the board, C , upon the geometrical centre of the plate O . Moving the lens carriage to NQ for a reduction n , it will usually be found that the point of

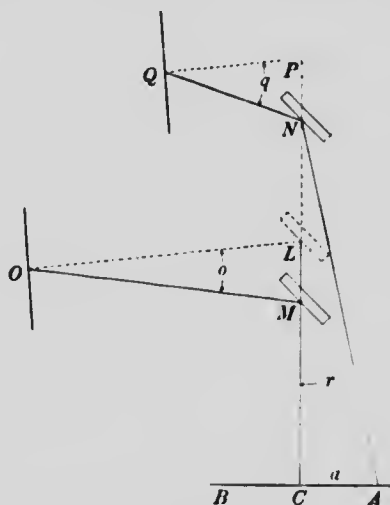

FIG. 20a — Position of Mirror on the Axis.

the board whose image is reflected upon the central cross of the plate is no longer the centre of the board C , but a point A , a millimetres away from the centre. In order that the image of the centre C may always coincide with the central cross of the plate, the mirror must be moved from M to L , OL being the line followed by the central cross O when the plate is racked backwards and forwards. The perpendicular distance, b , between the two positions M and L of the mirror is:—

$$b = \frac{a}{\sqrt{2}} \times \frac{1 + n'}{nn' - 1}$$

a is read on the millimetre scale glued to the plug in the centre of the board.*

* Let QP be the direction of translation of the plate parallel to OL , PN being equal to LM . Designate the angles LOM , PQN and $CN1$ by α , γ , and r respectively. The angles being small, their values are approximately:—

$$\alpha = \frac{LM}{OM}$$

$$\gamma = \frac{PN}{QN} = \frac{LM}{QN}$$

$$r = \gamma - \alpha = \frac{LM}{QN} - \frac{LM}{OM}$$

But:

$$a = r \cdot CN$$

and:

$$a = CN \cdot LM \left(\frac{1}{QN} - \frac{1}{OM} \right)$$

In the latest pattern of this copying camera, provision is made for this adjustment. Fig. 20*b* is a section of the mirror box. The mirror slides into the groove *AB*, being pressed forward at the bottom by the brass springs *A* and *B*, and at the top by a spring in the centre, so as to be held by three points only and so to be free from strains. Opposite the point where the optical axis strikes the mirror is a screw *C* screwing through a brass plate *HG* fastened to the mirror box. The rounded head of the screw bears against a brass plate *LK* fastened to the mirror slide. When it is

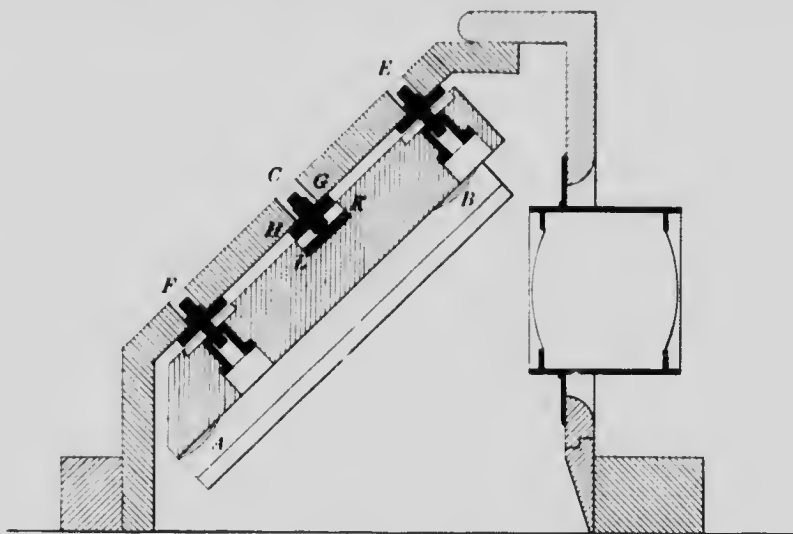

FIG. 20*b*. Mirror box.

desired to move the mirror slide forward, the screws *E* and *F* and the two other adjusting screws must first be loosened and then the screw *C* is turned to the right. If the slide has to be moved in the opposite direction, the screw *C* is turned to the left and the four adjusting screws are screwed in so as to bring the mirror slide and plate *LK* in contact with the top of the screw *C*. The number of turns and fraction of a turn necessary for the displacement *b* of the mirror is calculated from the known value of the screw thread.

The board has previously been made perpendicular to the axis when making the adjustments of the direct camera. For finding the centre of the board for the reverse camera, the lens carriage is brought as close to the board as it will go and a set square applied against the board and opposite sides of the lens tube. The point so ascertained is quite accurate enough for practical purposes.

The values of *CN*, *QN* and *OM*, derived from (1), (2) and (4), are:

$$\begin{aligned} CN &= (1 - m)f \\ QN &= \left(1 + \frac{1}{a}\right)f \\ OM &= (1 + n)f \end{aligned}$$

Substituting these values in the preceding equation and reducing:

$$LM = a \frac{1 - n^2}{nn^2 - 1}$$

The mirror being inclined at 45° to the axis the perpendicular distance *b* between the two positions *M* and *L* is equal to *LM* divided by the square root of two, or:

$$b = \frac{a}{\sqrt{2}} \times \frac{1 - n^2}{nn^2 - 1}$$

PART II.—THE ILLUMINATION OF THE BOARD.

18. Lights and Reflexions.

Electric light is so much more convenient than daylight for copying that there can be no hesitation in selecting between the two. Two kinds of light are available, viz., the mercury tube and the arc lamp. The latter is in use here.

In disposing the lights, care must be taken to secure even illumination and to avoid reflexions. Photographs on glossy paper, varnished paintings, etc., are apt to cause trouble unless the lights are outside the range of reflexion. It is different with drawings: an original on glossy tracing linen may give a perfect negative, while one on dull paper photographed under identical conditions may produce a negative in which the lines are more or less fogged. The explanation is that the reflexions which cause the trouble are from the surface of the ink lines, while those from the blank spaces are comparatively harmless. Ordinary Indian ink dries shiny. Several photo-drawing inks are in the market, but they are not in favour with draughtsmen.

The light from an alternating current lamp is fairly uniform in all directions within a wide angle; this is not the case with direct current lamps, and the remarks which follow do not apply to them. The intensity of an arc lamp fluctuates considerably; any conclusion that may be arrived at respecting the strength of the illumination produced must be taken as a rough approximation only. Fortunately moderate variations from the normal exposure do not affect the quality of the negative.

19. Light Intensities with One Lamp.

The brightness of a surface, *BC*, Fig. 21, at various distances from a source of

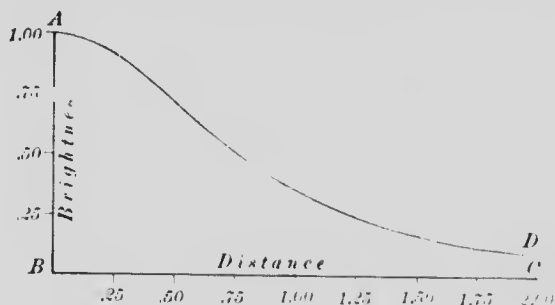

FIG. 21 - Illumination of a surface by a luminous point.

light, *A*, is represented by the curve *AD*. The curve shows that the brightness is tolerably uniform just opposite the light but falls off rapidly as the distance increases. It follows that unless the original to be copied is small, a single arc lamp has to be far away in order to give even illumination. Moreover, it has to be placed to one side for avoiding reflexions, and this is apt to show the grain of the paper.

20. Light Intensities with Two Lamps.

With two lamps, conditions are improved. Fig. 22 shows the brightness at several points of a square illuminated by two lamps opposite *A* and *B* at a distance from the square equal to half of its diagonal, the brightness of one lamp at that distance being taken as unit. The brightness is greatest just opposite the lamps and somewhat less in the centre, but it falls off rapidly away from the middle line, being only six-tenths of the greatest brightness at the top and bottom of the square. The best illumination is secured by placing the longest dimension of the original to be copied in the direction of the line of the lamps.

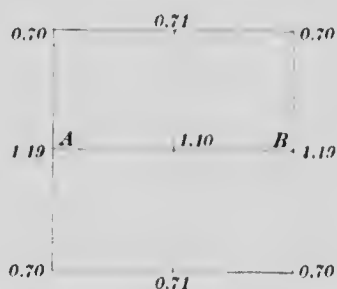

FIG. 22 -Brightness of a square illuminated by two lamps

By increasing the distance of the lamps one-fifth, making it equal to $AB \times .85$, the uniformity of the illumination, shown in Fig. 23, is somewhat better; it is uniform along the middle line, and nearly seven-tenths of its greatest value at the top and bottom of the square. This illumination is sufficient to yield a good nega-

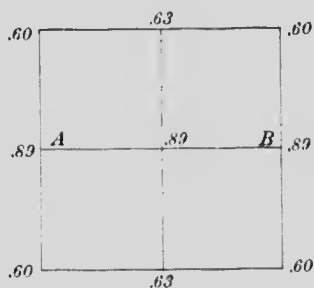

FIG. 23 -Brightness of a square illuminated by two lamps.

tive of a line drawing. Still the operator might as well have all chances in his favour, and a better result is obtained with four lamps.

21. Light Intensities with Four Lamps.

The most even illumination in this case is secured by placing the lamps at equal distances from the board and from the axis of the camera.

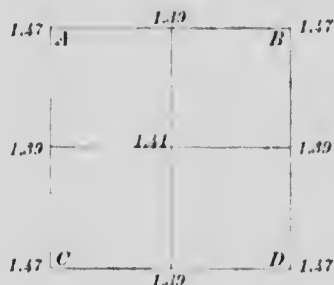

FIG. 24. Brightness of a square illuminated by four lamps.

Fig. 24 shows the brightness of a square illuminated by four lamps opposite the corners A, B, C, D , the distance from the board being equal to $\frac{1}{2} AB \sqrt{2}$. By placing the lamps a little closer to the board, the brightness is greater at the margin than in the centre, and this is as it should be for producing even illumination on the plate.

22. Reflexions and Focal Length of the Lens for Two Lamps.

The trouble from reflexions is not peculiar to artificial light; it arises in daylight from a bright background behind the camera or from light reflected by a polished camera front or by the lens mount. No good reason exists why the front of

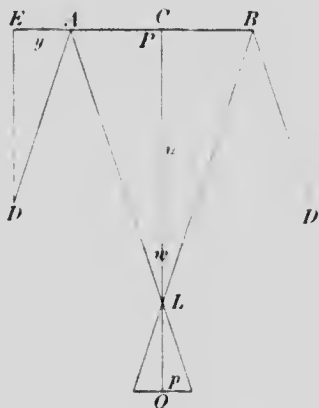

FIG. 25.

the camera should be polished; it is preferable to have it dull and dark. A lens protected by a deep hood, as it should always be, cannot reflect stray light. The space behind the camera should preferably be dark.

Are lamps must be placed far enough from the axis of the camera to be beyond the range of reflexion, their distance depending upon the dimensions of the original to be copied and the focal length of the lens. Considering first the case of two lamps, let AB , Fig. 25, represent the original pinned to the board, OC the axis of the camera, L the lens, y the distance from the lens to the board, O the plate, P and p the widths of the original and plate. From A and B draw the lines AD and BD' , making the same angle with the board as AL and BL . Reflexions are avoided if the lamps are kept outside of the lines AD and BD' . Let them be put in D and D' . From D let fall a perpendicular DE to the plane of the board, and denote AE by u . It has been shown that in order to produce tolerably uniform illumination, the distance DE from the lamps to the board must be about $.85 \times 2 EC$, or:

$$DE = .85 (2y + P)$$

Similar triangles give:

$$\frac{DE}{y} = \frac{u}{\frac{1}{2}P}$$

Combining the two equations:

$$\frac{2y + P}{P} = \frac{u}{\frac{1}{2}P} = .85 \quad (9)$$

$2y + P$ is the separation DD' of the two lamps. The numerical value of the ratio $\frac{2y + P}{P}$ for the various values of $\frac{u}{P}$ and the angle $2W$ subtended at the lens by the width of the original, are given below:

$\frac{u}{P}$	$\frac{2y + P}{P}$	$2W$
1	6.67	53°
2	1.71	28
2.55	1.50	22
3	1.40	19
4	1.27	14
5	1.20	11

These figures illustrate how important it is to work with a lens of long focus. For:

$$\frac{u}{P} = 1$$

that is to say when the distance from the lens to the board is equal to the width of the original, the separation of the lamps must be 6.67 times the width of the original and their distance from the board 5.67 times the width. This would be impracticable for originals of large dimensions. For convenience in working, the lamps should not be farther apart than one and a half times the width of the largest originals. The table shows that this requirement is fulfilled when the distance from the lens to the board is 2.55 times the width of the original the angle subtended at the lens being 22°.

The limitation of the separation of the lamps to one and a half times the width of the original determines the minimum focal length of the lens. Noting that:

$$\frac{P}{u} = \frac{u}{(u+1)f}$$

and

$$y = \frac{1}{2}P$$

Equation (9) gives:

$$f = 2.55p \frac{u}{u+1}$$

This shows that the greater the reduction, the longer the focal length must be. For a reduction not exceeding 1.25:

$$f = 1.45p$$

This is very nearly the diagonal of a square plate. The rule sometimes given in text books that the focal length must be equal to the diagonal of the plate is therefore correct so long as the reduction is small. For a reduction of 3.00 the focal length would have to be

$$f = 1.9p$$

which is 1.31 times the diagonal.

The conclusion that the focal length required increases with the reduction must be qualified. It rests upon the assumption that the whole plate is covered by the image, but when the reduction reaches a certain limit, the image with originals of ordinary dimensions becomes too small to cover the plate and the rule ceases to apply.

Another conclusion from (9) is that the wider the original, the farther apart the lamps have to be. For a rectangular original, the best position for avoiding reflexions is accordingly across the line of the lamps, the longest dimension being vertical if the lamps are to the right and left of the camera. But it has been shown that the most uniform illumination is secured when the longest dimension is parallel to the line of the lamps; this is another argument against the use of only two lamps for large work.

23. Reflexions and Focal Length of the Lens for Four Lamps.

With a four lamps outfit, D and D' , Fig. 25, may be taken to represent the projections of the lamps. It was found that for uniform illumination:

$$DE = \frac{1}{2}P_1 \cdot 2$$

This and a consideration of the similar triangles in the figure give:

$$\frac{2y+P}{P} = \frac{\frac{u}{P}}{\frac{u}{P} + 1}$$

The numerical values of the ratio, $\frac{2y+P}{P}$, of the distance between two adjoining lamps to the width of the original, and of the angle $2W$ subtended at the lens, is given below for various values of $\frac{u}{P}$

$\frac{n}{P}$	$\frac{2g+P}{P}$	2 W
1	3.12	53 ^v
2	1.55	28
2 12	1.50	27
3	1.31	19
4	1.22	14
5	1.16	11

A comparison with the table for two lamps shows at once the superiority of the four lamps equipment. The lamps need not be put so far apart, and they are closer to the board, thus giving stronger illumination. For instance, when the distance from the lens to the board is twice the width of the original ($\frac{n}{P} = 2$), the separation of the two lamps of a pair (side of the square) is only 1.55 times the width of the original, while it is 1.74 times the width with two lamps. The four lamps are at a distance $1.1 P$ from the board against $1.5 P$ for two lamps. Another advantage is that it is sufficient to place the four lamps beyond the range of reflexion for the shortest dimension of the original, while the two lamps must be beyond the range for the greatest dimension.

Limiting again the separation of the two lamps of a pair to one and a half times the width of the original, the focal length required is deduced as before:

$$f = 2.12p \frac{n}{n+1} \quad (10)$$

The largest plate of the camera of the Surveyor General's office is $24'' \times 32''$. The lens was selected and the lamps disposed for a reduction of 2.00. The original which, reduced twice, fills the plate must be $48'' \times 64''$; no larger originals are handled in the office. The lamps are placed above and below the range of reflexion, that is to say the height of the plate, $24''$ is taken for p in (10). The formula gives:

$$f = 337.9$$

The focal length of the lens actually used is 337 inches (8564 mm.); it is employed for enlargements and for reductions up to 2.45 when the plate carriage is at the extreme end of the cradle.

For the reduction of 2.00, the original being 48 inches high, the normal disposition of the lamps would be a square of 72 inches side (one and a half times 48 inches), and their distance from the board seven-tenths of 72 inches or 50 inches. They have, however, been placed a little closer to the board and form a smaller square so as to give more light to the margin of the board than to the centre. According to the explanation given, there can be no reflexion up to a reduction of 2.00, nor can there be any between 2.00 and 2.45, because the image no longer fills the plate.

Very little work requires a reduction of more than 2.45. For such work a lens of $18'' \cdot 6$ focus (472.9 mm.) is provided; its range extends from 2.45 to 6.65, in connection with small plates, the image being always small with such large reductions. This small lens is also used on the reverse camera, which is for work of comparatively small size. Its range there is from an enlargement of 1.20 to a reduction of 5.80.

PART III



TABLE



**PART III.—TABLE OF FACTORS FOR COMPUTING THE GRADUATION OF
A COPYING CAMERA AND OF COMPARATIVE EXPOSURES.**

Reduction or Enlargement	Lens Carriage	Plate Carriage	COMPARATIVE EXPOSURES.		Reduction or Enlargement	Lens Carriage	Plate Carriage	COMPARATIVE EXPOSURES.	
			Enlarging (0+n) ²	Reducing (1+ $\frac{1}{n}$) ²				Enlarging (0+n) ²	Reducing (1+ $\frac{1}{n}$) ²
1.00	2.00000	1.00000	1 0	4 0	3.25	1.30769	5.55769	18 1	1 7
.05	1.95238	.00238	2	3 8	.30	.30303	.60303	5	
.10	.90909	.00909	4	6	.35	.29850	.61850	18 9	
.15	.86956	.01956	6	4	.40	.29411	.62411	19 1	
.20	.83333	.03333	8	3	.45	.28987	.63985	8	1 6
.25	.80000	.05000	5 0	2	.50	.28571	.65571	20 2	
.30	.76923	.06923	3	1	.55	.28169	.67169	7	
.35	.74074	.09074	5	0	.60	.27777	.68777	21 2	
.40	.71428	.11428	7	2 9	.65	.27397	.70397	6	
.45	.68965	.13965	6 0	.8	.70	.27027	.72027	22 1	
.50	.66666	.16666	2	7	.75	.26666	.73666	6	
.55	.64516	.19516	5	6	.80	.26315	.76315	23 0	
.60	.62500	.22500	7	6	.85	.25974	.79974	5	
.65	.60606	.25606	7 0	5	.90	.25641	.83641	24 0	
.70	.58823	.28823	2	1	.95	.25316	.87316	5	
.75	.57142	.32142	5	1	1.00	.25000	.91000	25 0	
.80	.55555	.35555	8	1	.05	.24691	.94691	5	1 5
.85	.54054	.39054	8 1	.3	.10	.24390	.98390	26 0	
.90	.52631	.42631	1	.3	.15	.24096	.99096	5	
.95	.51282	.46282	7	2	.20	.23809	.99809	27 0	
2.00	.50000	.50000	9 0	.2	.25	.23529	.98529	6	
.05	.48780	.53780	.3	2	.30	.23255	.97255	28 1	
.10	.47619	.57619	6	.2	.35	.22988	.95988	6	
.15	.46511	.61511	9	.1	.40	.22727	.94727	2 2	
.20	.45454	.65454	10 2	.1	.45	.22471	.93471	7	
.25	.44444	.69444	.6	.1	.50	.22222	.92222	30 2	
.30	.43478	.73478	9	.0	.55	.21978	.90978	8	
.35	.42553	.77553	11 2	0	.60	.21739	.89739	31 4	
.40	.41666	.81666	.6	.0	.65	.21505	.88505	9	
.45	.40816	.85816	9	0	.70	.21276	.87276	32 5	
.50	.40000	.90000	12 2	.0	.75	.21052	.86052	33 1	
.55	.39215	.94215	.6	1 9	.80	.20833	.84833	6	1 4
.60	.38461	.98461	9	9	.85	.20618	.83618	34 2	
.65	.37735	5.02735	13 3	.9	.90	.20408	.82408	8	
.70	.37037	.07037	7	.9	.95	.20202	.81202	35 4	
.75	.36363	.11363	14 1	.8	5.60	.20000	.80000	36 0	
.80	.35714	.15714	.4	.8	.05	.19801	.78801	6	
.85	.35087	.20087	8	.8	.10	.19607	.77607	37 2	
.90	.34482	.24482	15 2	.8	.15	.19417	.76417	8	
.95	.33898	.28898	6	.8	.20	.19230	.75230	38 1	
3.00	.33333	.33333	16 0	.8	.25	.19047	.74047	39 1	
.05	.32786	.37786	.4	.7	.30	.18867	.72867	7	
.10	.32258	.42258	.8	.7	.35	.18691	.71691	10 3	
.45	.31746	.46746	17 2	.7	.40	.18518	.70518	41 0	
.20	.31250	.51250	.6	.7	.45	.18348	.69348	6	

FACTORS FOR COMPUTING GRADUATION OF COPYING CAMERA AND COMPARATIVE EXPOSURES.

Reduction or Enlargement	Lens Carriage $1 + \frac{1}{n}$	Plate Carriage $2 + n + \frac{1}{n}$	COMPARATIVE EXPOSURES.		Reduction or Enlargement	Lens Carriage $1 + \frac{1}{n}$	Plate Carriage $2 + n + \frac{1}{n}$	COMPARATIVE EXPOSURES.	
			Enlarging $(1+n)^2$	Reducing $(1+\frac{1}{n})^2$				Enlarging $(1+n)^2$	Reducing $(1+\frac{1}{n})^2$
5.50	1.18181	7.68481	42.2	1.1	7.75	1.12903	9.87903	76.	1.2
.55	.18018	.73018	.9		.80	.12820	.92820	77.	
.60	.17857	.77857	43.6		.85	.12738	.97738	78.	
.65	.17699	.82699	44.2		.90	.12658	10.02658	79.	
.70	.17543	.87543	.9		.95	.12578	.07578	80.	
.75	.17391	.92391	45.6		8.00	.12500	.12500	81	
.80	.17241	.97241	46.2		.05	.12422	.17422	81.	
.85	.17094	8.02094	.9		.10	.12345	.22345	82	
.90	.16949	.06949	47.6	1.3	.15	.12269	.27269	83.	
.95	.16806	.11806	48.3		.20	.12195	.32195	84.	
6.00	.16666	.16666	19.0		.25	.12121	.37121	85.	
.05	.16528	.21528	.7		.30	.12048	.42048	86.	
.10	.16393	.26393	50.4		.35	.11976	.46976	87.	
.15	.16260	.31260	51.1		.40	.11904	.51904	88.	
.20	.16129	.36129	.8		.45	.11834	.56834	89.	
.25	.16000	.41000	52.6		.50	.11764	.61764	90.	
.30	.15873	.45873	53.3		.55	.11695	.66695	91.	
.35	.15748	.50748	54.0		.60	.11627	.71627	92.	
.40	.15625	.55625	.8		.65	.11560	.76560	93.	
.45	.15503	.60503	55.5		.70	.11491	.81491	94.	
.50	.15384	.65384	56.2		.75	.11428	.86428	95.	
.55	.15267	.70267	57.0		.80	.11363	.91363	96.	
.60	.15151	.75151	.8		.85	.11299	.96299	97.	
.65	.15037	.80037	58.5		.90	.11235	11.01235	98.	
.70	.14925	.84925	59.3		.95	.11173	.06173	99.	
.75	.14814	.89814	60.1		9.00	.11111	.11111	100.	
.80	.14705	.94705	.8		.05	.11049	.16049	101.	
.85	.14598	.99598	61.6		.10	.10989	.20989	102.	
.90	.14492	9.04492	62.4		.15	.10928	.25928	103.	
.95	.14388	.09388	63.2		.20	.10869	.30869	104.	
7.00	.14285	.14285	64.0		.25	.10810	.35810	105.	
.05	.14184	.19184	.8		.30	.10752	.40752	106.	
.10	.14084	.24084	65.6		.35	.10695	.45695	107.	
.15	.13986	.28986	66.4		.40	.10638	.50638	108.	
.20	.13888	.33888	67.2		.45	.10582	.55582	109.	
.25	.13793	.38973	68.1		.50	.10526	.60526	110.	
.30	.13698	.43698	.9		.55	.10471	.65471	111.	
.35	.13605	.48605	69.7		.60	.10416	.70416	112.	
.40	.13513	.53513	70.6		.65	.10362	.75362	113.	
.45	.13422	.58422	71.4		.70	.10309	.80309	114.	
.50	.13333	.63333	72.2		.75	.10256	.85256	115.	
.55	.13245	.68245	73.1		.80	.10204	.90204	117.	
.60	.13157	.73157	74.0		.85	.10152	.95152	118.	
.65	.13071	.78071	.8		.90	.10101	12.00101	119.	
.70	.12987	.82987	75.7	1.2	.95	.10050	.05050	120.	

