

Technical and Bibliographic Notes / Notes techniques et bibliographiques

The Institute has attempted to obtain the best original copy available for filming. Features of this copy which may be bibliographically unique, which may alter any of the images in the reproduction, or which may significantly change the usual method of filming, are checked below.

L'Institut a microfilmé le meilleur exemplaire qu'il lui a été possible de se procurer. Les détails de cet exemplaire qui sont peut-être uniques du point de vue bibliographique, qui peuvent modifier une image reproduite, ou qui peuvent exiger une modification dans la méthode normale de filmage sont indiqués ci-dessous.

Coloured covers/
Couverture de couleur

Coloured pages/
Pages de couleur

Covers damaged/
Couverture endommagée

Pages damaged/
Pages endommagées

Covers restored and/or laminated/
Couverture restaurée et/ou pelliculée

Pages restored and/or laminated/
Pages restaurées et/ou pelliculées

Cover title missing/
Le titre de couverture manque

Pages discoloured, stained or foxed/
Pages décolorées, tachetées ou piquées

Coloured maps/
Cartes géographiques en couleur

Pages detached/
Pages détachées

Coloured ink (i.e. other than blue or black)/
Encre de couleur (i.e. autre que bleue ou noire)

Showthrough/
Transparence

Coloured plates and/or illustrations/
Planches et/ou illustrations en couleur

Quality of print varies/
Qualité inégale de l'impression

Bound with other material/
Relié avec d'autres documents

Continuous pagination/
Pagination continue

Tight binding may cause shadows or distortion along interior margin/
La reliure serrée peut causer de l'ombre ou de la distorsion le long de la marge intérieure

Includes index(es)/
Comprend un (des) index

Title on header taken from:/
Le titre de l'en-tête provient:

Blank leaves added during restoration may appear within the text. Whenever possible, these have been omitted from filming/
Il se peut que certaines pages blanches ajoutées lors d'une restauration apparaissent dans le texte, mais, lorsque cela était possible, ces pages n'ont pas été filmées.

Title page of issue/
Page de titre de la livraison

Caption of issue/
Titre de départ de la livraison

Masthead/
Générique (périodiques) de la livraison

Additional comments:/
Commentaires supplémentaires:

This item is filmed at the reduction ratio checked below/
Ce document est filmé au taux de réduction indiqué ci-dessous.

10X	14X	18X	22X	26X	30X
<input type="checkbox"/>	<input type="checkbox"/>	<input type="checkbox"/>	<input type="checkbox"/>	<input checked="" type="checkbox"/>	<input type="checkbox"/>
12X	16X	20X	24X	28X	32X

The Canadian Patent Office

RECORD



Vol. III.—No. 5.

MAY, 1875.

Price in Canada \$2.00 per An
United States - \$2.50

CONTENTS.

INVENTIONS PATENTED,	53
INDEX OF INVENTIONS,	LIX
INDEX OF PATENTEES,	LIX
ILLUSTRATIONS,	59

INVENTIONS PATENTED.

No. 4444. LEANDER B. POAN, Yarmouth, Ont., 1st March, 1875, for 5 years: "Stove-Pipe Shelf." (Tablette de tuyaux de poele.)

Claim.—1st. The manner of fastening and supporting the shelf to and by the stove pipe by the widening of the stationary portion of the clamp, as shown, 2nd. The manner of moving the shelf to and from the stove pipe by means of the bevelled rails E E' and the bearers, as shown.

No. 4445. JOHN THOMPSON, Crestline, Ohio, U. S., 1st March, 1875, for 10 years: "Face-Tester for Millstones. (Vérificateur des meules de moulins.)

Claim.—A face-tester for millstones, composed of the circular metal plate A, having a perfectly smooth face C, covering the entire surface of the stone, as set forth.

No. 4446. WILLIAM TRABUE, Louisville, Ky., U. S., 1st March, 1875, for 5 years: "Needle Machine." (Machine à aiguilles.)

Claim.—1st. The combination with the rotating dies D, D, of the revolving cutters H, H, hung in movable bearings, as described; 2nd. The sliding blocks L, L, provided with revolving cutters I, I, in combination with the rotatory dies D, D, having cam surfaces a, b, whereby the cutters are automatically brought toward or forced from the blank, as set forth; 3rd. In combination with the cam-faced dies and sliding blocks, the screw bolts L, springs m, and block K, or head J, as set forth; 4th. The frame A, bifurcated and otherwise constructed, as described, to form bearings for the die and cutter shafts, as set forth.

No. 4447. ENOCH S. YENTZER, Ottawa, Ill., U. S., 1st March, 1875, for 5 years: "Pantaloons Stays." (Gousset de cambrure de pantalons.)

Claim.—The pantaloons leg stays D, and E.

No. 4448. THOMAS PRIOR, Carrollton, Mo., U. S., 1st March, 1875, for 5 years: "Improvements in Churns." (Perfectionnements aux barattes.)

Claim.—1st. The construction and arrangement of the platform A, with its sockets a, and pins a', and the churn B and its legs E, as described; 2nd. The construction and arrangement of the axle C and c, as set forth; 3rd. The water chamber b, when constructed and arranged as described.

No. 4449. DANIEL F. MOSMAN, Chelsea, Mass., U. S., 1st March, 1875, for 5 years: "Method of generating and utilizing Steam." (Mode de produire et utiliser la vapeur.)

Claim.—1st. The method of heating feed water, for steam boilers, by discharging the exhaust steam from the engine or other device

into a heating chamber or structure, which is closed to the atmosphere and contains the feed water in transit to the boiler, and exhaust steam being introduced or discharged preferably directly in contact with or through this water, and the whole being as stated; 2nd. In combination with the closed vessel receiving exhaust steam as stated, flues or passages whose exterior surfaces are heated from the feed water or the heat of the exhaust steam, or both, and whose interior areas constitute air flues through which air is supplied to the boiler furnace, and which air becomes heated in passing through such flues or spaces, as stated; 3rd. The combination of the engine A, boiler B, heating structure H, and pump Q. 4th. The construction of the structure or heater II, as formed with a closed water space or chamber L, into which exhaust steam is directly admitted and with or without the flue or passage K, K, &c., and W, and the conduit H, communicating with the boiler B, as stated; 5th. The combination of the steam engine A, generator B, and closed heating apparatus or structure II, with the pump Q, or its equivalent, the whole cooperating to produce results, as stated; 6th. The cistern d, in combination with the heater II, as stated.

No. 4450. EDWIN DAVIDS, and CHARLES K. JONES, Bronte, Ont., 3rd. March, 1875, for 5 years: "Fumigating and Fire-lighting Coal Oil Can." (Bidon à pétrole fumigateur et pour allumer le feu.)

Claim.—A coal oil can for fumigating trees or igniting fires having a close fitting cap C, a socket D, and a stem F, for attachment of an absorbent material to be fired, as set forth.

No. 4451. WILLIAM J. MANCHESTER, jr., Stittsville, Ont., 3rd March, 1875, for 5 years: "Folding Sash Window." (Croisée pliante.)

Claim.—1st. The folding sashes B, C, either of wood, iron, &c., in parts, in combination with the window A. 2nd. The folding double window C, in parts, in combination with the window frame F; 3rd. The butt hinges N, having a socket L, hinged flanges O, and hinged flaps P, Q, screwed on one side of the rail U, or L, and fastened by buttons R, on the other side of said rail U, or L; 4th. The sash fastener A, having a button a, slides c, and sliding pieces d, the socket L, having one flange O, in combination with a butt hinge, B; 5th. The butt hinge P, having the middle lug, in combination with the upright bar K, and cross bar; 6th. The barrelled bolt E, and its bolt g, in combination with the butt hinge D, having a socket L, and flange O; 7th. The middle bar K, dowelled in the butt hinge socket N, in combination with the sashes B, C, and double window C; 8th. The slit M, of the rails, styles, uprights, and cross bars of the inside sashes, and double sash, so as to set the panes of glass therein in combination with the sashes B, C, the double windows C, and a shop window G, having one or more panes of glass, as set forth; 9th. The cloths k, the cleat h, having the slots d, and button m, the style n, having a slot l, the pins n, and the deep groove p, the grooves p, of the shop window frame I, with the shop window G, as set forth.

No. 4452. CHARLES A. SHAW, Boston, Mass., U. S., (Assignee of H. Halvorson), 3rd March, 1875, for 5 years: "Improvements on Lamp Wicks." (Perfectionnements aux mèches de lampes.)

Claim.—A fibrous lamp wick oxidized, as specified.

No. 4453. JOHN G. TAYLOR, and JAMES H. SMITH, Port Huron, Mich., U. S., 3rd March, 1875, for 5 years: "Extension Fire Ladder." (Echelle de sauvetage à rallonge.)

Claim.—The construction and arrangement of the frame A, ladder sections B, C, D, cross bars a, c, d, f, pulleys b, h, fair leader e, sheave e, shaft J, drum K, rope L, and braces I, with their ratchet bars, as set forth.

No. 4454. HUGH NEILSON, Toronto, Ont., 3rd March, 1875, for 5 years: "Gravity Battery." (Batterie électrique.)

Claim.—1st. The glass tube F, in combination with the upper copper plate C, having a hole D, and trimmings E, as set forth; 2nd. The combination of a glass cup A, with the reservoir P, to be filled with sulphate of copper solution or emptied of it, as required, by means of the glass tube F, set on the trimming E, on the upper copper plate C, as set forth.

No. 4455. HENRI E. CASGRAIN et GEORGES DROLET, Québec, Que., 3 Mars, 1875, pour 5 ans: "Machine à gaz d'éclairage." (Illuminating Gas Machine.)

Résumé.—1o. La combinaison des réservoirs A et C, avec les réservoirs B et D, fonctionnant tel que décrit; 2o. Le réservoir I, et sa disposition au-dessus de l'appareil contenant spécialement le gazoline et l'empêchant de refluer dans les tubes à air; 3o. Le diaphragme P, agissant sur le gazoline tel que décrit; 4o. La soupape de refus on nonchouche O, tel que décrit; 5o. La soupape G, admettant l'air dans le réservoir C, le tout fonctionnant ensemble tel que décrit.

Claim.—1st. The combination of the reservoirs A and C, with the reservoirs B and D, working as described; 2nd. The reservoir I, and its situation above the apparatus containing the gasoline, and the prevention of the back flow into the air tubes; 3rd. The diaphragm P, acting on the gasoline as described; 4th. The india rubber stop valve as described; 5th. The valve G, admitting air into the reservoir C, the whole working together as described.

No. 4456. ANDREW ALLAN, Montreal, Que., (Assignee of C. C. Jordeson) 3rd March, 1875: (Extension of Patent No. 267, for 5 years:) "Revolving Screw Windlass." (Vindas à vis de renversement.)

Claim.—1st. The arrangement and combination of the vertical screw H, working in the circular angular groove G, either attached to windlasses or for raising by continuous motion; 2nd. The capstan J, revolving on the spindle or pivot of and independent of the perpendicular or vertical screw H.

No. 4457. HENRY BOLTON, Elizabethtown, Ont., 4th March, 1875, (Extension of Patent No. 1570) for 5 years: "Improvements on Churns." (Perfectionnements aux barattes.)

Claim.—The arrangement of the friction-bar F, spring H, friction-roller C, and driving-wheel B, in combination with the inclined platform A, turning on journals J, J.

No. 4458. ADOLPHUS TRUMBLE and JEAN BARON, Ottawa, Ont., 4th March, 1875, for 5 years: "Washing Machine." (Machine à laver.)

Claim.—The conical slats H, and interspaces I, of the semi-circular bottom C, and the conical slats O, and interspaces K, of the inside semi-circular box J, said interspaces I, and K, being set diagonally to each other, in combination with a washing machine A.

No. 4459. ROBERT P. SPICE, Westminster, Eng., 5th March, 1875, for 5 years: "Gas Apparatus." (Appareil à gaz.)

Claim.—1st. The construction of vertical and taper retorts open at the bottom, as described; 2nd. The construction of the mouth piece with its hopper and appliances for charging the retorts, as described; 3rd. The troughs for cooling the bottoms of the retorts, as described; 4th. The construction and application of the steam superheaters, as described; 5th. The construction and arrangement of the condensers, as described; 6th. The general arrangement in the setting of the retorts and apparatus; 7th. Introducing into the retort the heavy spirit or oil of petroleum with steam, as described; 8th. Passing hot gas into the saturator, as described.

No. 4460. FRANKLIN P. LAUBACH, Catasauqua, Pa., U. S., 5th March, 1875, for 5 years: "Water Cooler." (Réfrigérant à eau.)

Claim.—1st. The combination with a water cooler of the outlet or drain pipe a, communicating with the inner pan A, and passing thence through the centre of the outer pan B.

No. 4461. JOHN S. ROYCE, Cuylerville, N. Y., U. S., 5th March, 1875, for 5 years: "Improvements on Harvesters." (Perfectionnements aux moissonneuses.)

Claim.—1st. The combination of the fixed divider plate K₁, the laterally adjustable divider L, pivoted thereon, and the supplementary laterally movable grain guard L₁, pivoted to the divider; 2nd. The clutch t, on the tumbling shaft t₁, in combination with a spring hook t₂, also on the shaft to hold one member of the clutch out of gear when desired; 3rd. The combination of the rake arm, the rake head so pivoted as to be capable of swinging around said arm, the locking spring latch Y, on the rake head and a swinging tripping lever Y₁ on the cam, whereby each rake head, after sweeping the out grain upon the platform, is automatically released and allowed to turn up out of the way until a gavel of sufficient size has accumulated on the platform; 4th. The combination of the rocking trunnion f, the rocking bar H, secured thereto, and the bifurcated bracket g, on the finger-beam, capable of moving vertically on said rod, these members being constructed and operating in combination to admit of the rising and falling as well as of the rocking of the finger-beam; 5th. The combination of the rocking trunnion f, the rocking bar, the bifurcated bracket movable endwise thereon and the spring g₁, interposed between the trunnion and bracket to diminish the pressure of the cutting apparatus upon the ground and render it easier to lift; 6th. The combination of the rocking trunnion f, rocking lever, its spring handle rocking on a pivot transverse to the rocking trunnion, and the detent whereby the lever may be released and rocked, as set forth; 7th. The combination of the driving wheel, the frame plate, the seat standard mounted thereon, the rocking lever mounted on said standard, the bifurcated bracket movable endwise thereon, the lifting lever pivoted on the seat standard and the lifting chain, all these members being constructed and operating in combination; 8th. The combination of the disc shaped driving wheel, the frame plate enclosed thereon, the crank shaft mounted in a pipe box pivoted to vibrate laterally on said plate, and the cam lever or shipping lever pivoted on said plate, and acting upon a lug on the crank shaft pipe box to throw the cutters into or out of gear, as set forth; 9th. The combination of the tongue, the frame plate, the rocking trunnion f, the rocking lever, the finger beam, and the diagonal draw bar pivoted to the tongue and to a post or standard on the finger beam but above it, these members being constructed and operating in combination.

No. 4462. DAVID MOODIE, Bell's Corners, Ont., 6th March, 1875, for 5 years: "Potato-digger." (Extracteur à patates.)

Claim.—The revolving shaft I, having a series of hoes H, operating within a frame A, and over a cutting knife or point G, secured to the said frame, as set forth.

No. 4463. WARREN HARRIS, Danville, Vt. U. S., 6th March, 1875, for 5 years: "Reflecting Stereoscopic Camera." (Chambre à réflexion stéréoscopique.)

Claim.—The combination of two reflectors with the two object glasses of a stereoscopic camera, as described.

No. 4464. HENRY C. BUTLER, Minceapolis, Ma., U. S., 6th March, 1875, for 10 years: "Gang Saw Hanger." (Châssis à scie multiples.)

Claim.—1st. In combination with the rods M, the rods F, and connecting bars O, O, O, as set forth; 2nd. In combination with the rods M, and F, F, and the connecting bars O, O, O, O, the bevel slotted pieces K, K, and the saw frame H, I, H, as set forth.

No. 4465. PARLEY J. AYRES, Lindsay, Ont., 6th March, 1875, for 5 years: "Stump Machine." (Arrache-souche.)

Claim.—1st. The construction of the frame A, with timber trussom A, carrying two girders K, K, to carry winch B, as set forth; 2nd. The combination of the triple geared winch B, with the reeling pulley D, thereto attached with the frame A, as set forth.

No. 4466. EDMUND C. TOZEL and RICHARD D. SOUTHWOOD, New Castle, N. B., 6th March, 1875, for 5 years: "Freezing Apparatus." (Appareil de congélation.)

Claim.—1st. The perforated pipes M, in combination with the pipes H, and G, as set forth; 2nd. The air tubes N, in combination with the waste pipe J, and cylinder I, as set forth; 3rd. The racks P, constructed of perforated posts a, and adjustable horizontal bars b, as set forth; 4th. The boxes Q, constructed with perforated sides and having open partitions c, for the circulation of air, as set forth.

No. 4467. WILLIAM R. WAGNER, Syracuse, N. Y., U. S., 6th March, 1875, for 5 years: "Improvements in Churns." (Perfectionnements aux barattes.)

Claim.—1st. A barrel churn A, the inside of uniform and the outside of graduated diameter, as set forth; 2nd. The cover C, having peripheral chamber b, to set within and project over the rim of the churn A, as set forth; 3rd. The dasher head D, having upper and lower stops a, a', as set forth.

No. 4468. KENNARD KNOTT, London, Ont., 6th March, 1875, for 5 years: "Method of Slaughtering, Preparing and Packing Meat for Exportation." (Méthode d'abattage et de préparation et d'empaquetage de la viande pour l'exportation.)

Claim.—1st. The combination of the drop door F, half doors D, F, actuated by handles r, s, and controlled by eccentrics e, e', and the movable floor G, controlled by spring a, as described; 2nd. The car I, tramway D, friction rollers G, G', and shaft G, as set forth; 3rd. The car I, chain and lever L, shaft J, winch J', and shaft K, as set forth; 4th. The wheel hooks L, tramways L', circular saw M, and balance frame M', with shaft J, as set forth; 5th. The box N, lifting gear N', car O, and tramway O', as set forth; 6th. The collecting car P, operated by crank and driving wheel P', and furnished with corresponding trams P', as set forth; 7th. The freezing boxes Q, with tramways Q', openings Q, and Q', as set forth; 8th. The shaft drum R, casing R', endless chains S, shelves S', wheels S'', and pulley R', as set forth; 9th. Collector T, constructed and arranged to operate in combination with the elevator; 10th. The carrier T', when constructed as described, with endless chains T, revolving shafts or drums T, in combination with and operated by a tooth wheel T', engaging with chains S, of elevator as set forth; 11th. The winch Y, chain Y', and pulley V', in combination with the carrier T', as set forth; 12th. The iron uprights W, bearers W', shelves W'', iron rods W', wheel frames and pulleys W, and hooks W', as described; 13th. The process of converting the hold of a vessel into an ice packing box by means of ice arranged along the top and sides X, and ventilating by apertures X', and excluding the outside temperature by means of a packing of saw dust or bark Y, as described; 14th. The box Y, constructed with chambers or vats Y', circulating channels Y', rocker Z, screw caps Z', tap Z'', and hose pipe Y'', as set forth; 15th. The combination of the box Y, and hose pipe Y'', with a packing of ice round the sides and top of vessel arranged as set forth.

No. 4469. CALIB T. CLEVELAND, Oldtown, Me., U. S., 6th March, 1875, for 5 years: "Joint for Furniture, &c." (Joint de meuble, &c.)

Claim.—The device for uniting the corners of furniture, &c., to wit, the angle-iron a, provided with the groove b, and angle or wedge-iron d, having a corresponding flange c, fitting said groove, their sides when united forming sockets to receive the side pieces of the article, as set forth.

No. 4470. LOUIS CÔTE, St. Hyacinthe, Que., 10th March, 1875, (Extension of Patent No. 526), for 5 years: "Machine for Trimming and Finishing Boot and Shoe Soles." (Machine à parer et polir les semelles de chaussures.)

Claim.—1st. The novel combination of the cross bar C, pivot C', rack C'', pivot d, eye d', handle d'', pivot e, curved link f, eye f', spindle end of knife g, knife g', handle g'', guide h, slotted hole h', screw h'', spring i, heel plate k, screw k', die l, holder l', projection m, n; 2nd. The novel combination of the knife a', handle a'', pivot d, eye d', pivot e, curved link f, eye f', spindle end of knife g, handle g', guide h, and spring e; 3rd. The novel combination of the general heel plate holder k, pivot d, heel plate l', and screw k'; 4th. The novel combination of the sole trimming knife in its die l, holder l', and projections m, n.

No. 4471. LOUIS CÔTÉ, St. Hyacinthe, Que., 10th March, 1875, (Extension of Patent No. 526), for 5 years: "Machine for Trimming and Finishing Boot and Shoe Soles." (Machine à parer et polir les semelles de chaussures.)

No. 4472. THOMAS S. ELLIOTT, Guelph, Ont., 10th March, 1875, for 5 years: "Washing Machine." (Machine à laver.)

Claim.—1st. The combination of the corner pieces B B B, the ribs a, a', a'', &c., and the pins C, C', C'', as set forth; 2nd. The combination with the corners B, B', B'', the ribs a, a', a'', &c., and the pins C, C', C'', of the wheels E, F, and the pin K, as described.

No. 4473. ROBERT H. HUDGIN, Whitby, Ont., 10th March, 1875, for 5 years: "Improvements on Gates." (Perfectionnement des barrières.)

Claim.—1st. The combination of the arms B, B', and the head-block C; 2nd. The combination of the head-block, together with the iron pintle, as set forth.

No. 4474. RUFUS N. MERIAM, Worcester, Mass., U. S., 10th March, 1875, for 5 years: "Expansive Gear for Feed Rolls of Wood Planers and other Machines." (Engrenage à détente pour les rouleaux d'alimentation des machines à raboter le bois et autres.)

Claim.—1st. The coupling-bar N, and slotted support M, in combination with the fixed stud K, and vibrating stud L, their gear wheels a, b, the gear of the rolls A, B, as described; 2nd. The double wheel I, mounted on a fixed stud and the gear wheel J, on a vibrating stud, in combination with the gear wheels G, H, rolls A, B, coupling bar N, and slotted support M, as described.

No. 4475. JOHN H. STONE, Hamilton, Ont., 10th March, 1875, for 5 years: "Improvements in Bottoms of Milk Cans." (Perfectionnements dans les fonds des bidons à lait.)

Claim.—1st. The hoop or band B, in combination with the bottom A, as specified; 2nd. The ring or band C, of wire rod or heavy iron, in combination with the band B, and bottom A, as specified.

No. 4476. JOSEPH B. McCUNE and RICHARD M. WANZER, Hamilton, Ont., 10th March, 1875, for 5 years: "Ramming and Moulding Machine for Metal Castings." (Machine à damer et mouler la fonte métallique.)

Claim.—1st. The combination of a ramming and moulding machine for metal castings wherein the flask is lifted upwards against the rammer for pressing the sand and the pattern drawn downwards out of the sand in the flask, as specified; 2nd. The upright rod L and swinging bracket O, and collars a, a', in combination with the sliding frame C, C', as specified; 3rd. The arrangement and construction of the movable top-plate E, as specified; 4th. The arrangement of the latches P, P', for securing the plate E, to the uprights D, D, as specified; 5th. The arrangement and combination of the grooved standards B, B', sliding frame C, C', with the rods R, R', projecting points b, b', rocker bar Q, operated by lever S, as specified.

No. 4477. JOHN S. ROOD, Waterbury, Ct., U. S., (Assignee of G. W. Eddy), 10th March, 1875, for 5 years: "Sewing Machine Castor." (Roulette de machine à coudre.)

Claim.—The operating lever i, rock shaft h, connecting rods a, a', four castors g, g', g'', g'', arms f, f', pivoted to the front table legs through the medium of the clamps and the arms h, h', pivoted to the rear table legs through the rock shaft, as described.

No. 4478. ENOS WRIGHT and JOHN J. KREIBEL, Denmark, Iowa, U. S., 10th March, 1875, for 15 years: "Carriage Spring." (Resort de voiture.)

Claim.—1st. The combination of the spring bars C, and C', with the bearer B, as described; 2nd. The cap A, provided with the lugs c, c', in combination with the bearer B, spring bars C, and C', and holding irons H, H', as set forth; 3rd. The attachment block X, provided with the plate F, in combination with the cap A, as set forth.

No. 4479. JOHN HODGSON, Toronto, Ont., 10th March, 1875, for 5 years: "Apparatus for Consuming Smoke from Steam Boilers and other Furnaces." (Appareil fumivore pour les fourneaux de chaudières à vapeur et autres.)

Claim.—1st. The introduction of steam from the steam boiler A, or from the exhaust pipe of the engine into the back part of the fire chamber D; 2nd. The combination of the boiler A, with the steam pipe C, valve B, and perforated end C'. 3rd. The door F, with tube E, in combination with the perforated pipe C, and air-space K. 4th. The branch pipes c, c', with apertures for the purpose of introducing steam into the back of the fire chamber D, as specified.

No. 4480. RICHARD G. BLAMEY and JOHN KULOW, Petersburg, Ont., 10th March, 1875, for 5 years: "A Churn." (Une baratte.)

Claim.—The perforated plate or wire-sieve E, E, as described.

No. 4481. WALTER O'HARA and CHARLES M. O'HARA, Fall River, Mass., U. S., 10th March, 1875, for 5 years: "Non-conducting Covering for Boilers, &c." (Enduit anti-calorique pour les chaudières à vapeur, &c.)

Claim. 1st The non-conducting cellular composition formed by the combination of ashes and silicate of soda, 2nd. The combination of said composition with jute, bagging and cotton cloth.

No. 4482. MARTIN DEAL, Bucyrus, Ohio, U. S., 10th March, 1875, for 5 years: "Scouring-case for Combined Smutter and Separator." (Boite de nettoyage pour les émotteurs et les séparateurs combinés.)

Claim.—1st. The continuous cylindrical scouring-case E, constructed with the horizontal perforations lapping over one another in combination with half round top cover G, as set forth, 2nd. The mode of attaching the scouring-case to the frame A, by the studs F, so as to leave a continuous intervening draught space, as set forth.

No. 4483. EMMANUEL ANDREWS, Williamsport, Pa., U. S., 10th March, 1875, for 5 years: "Improvement on Hand and other Short Saws." (Perfectionnement des scies à manches et autres scies courtes.)

Claim.—In combination with a saw handle, the saw blade extended centrally through the same and conforming to the outlines thereof, as described.

No. 4484. ALEXANDER A. MURPHY and CHARLES C. HEARLE, Montreal, Que., 10th March, 1875, for 5 years: "Improvements in Fire Extinguishers." (Perfectionnements aux extincteurs d'incendie.)

Claim.—The application of the principle together with the arrangement of the compartments or reservoirs A, B, and connected by a pipe D, E, provided with a valve, as set forth.

No. 4485. JOSEPH H. DORION, Yamachiche, Que., 10 Mars, 1875, pour 5 ans: "Charpente brisée." (Imbricated frame-work.)

Résumé.—L'emploi et la disposition particulière des planches A, et C, dans la charpente, soit des pans, des cloisons, du comble ou des planchers d'une maison ou autre construction, et leur consolidation par les planchettes O, le tout tel que décrit.

Claim.—The employment and peculiar arrangement of the planks A, and C, in the frame work, either of the sides, partitions, roof or flooring of a house or other building and their consolidation by the boards O, as described.

No. 4486. JAMES L. WILSON, Woodstock, Ont., 10th March, 1875, for 5 years: "Improvements in Watches." (Perfectionnements dans les montres.)

Claim.—1st. The slot A, in the common pinion B, to be used in notches which are set on the face of the watch; 2nd. The slot D, in the centre pin E, to be used in watches which are set at the back of the watch, as set forth.

No. 4487. PIERRE MAYRAND, Père, Gentilly, Qué., 12 Mars, 1875, pour 5 ans: "Moulin flottant et machine à fendre le bois de corde." (Floating Mill and Machine for Splitting Cord Wood.)

Résumé.—1o Un moulin ou moulin flottant A, ayant les roues dentées D, D', portant chacune une hache E, E', sur leur circonférence, et mises en mouvement par les poulies H, H', dont les essieux portent les roues d'air G, G', et les pignons L, L', pour fendre des billes et des bûches en bois de corde; 2o. La combinaison avec les grandes roues dentées D, D', portant les haches E, E', sur leur circonférence, des pignons I, I', et des pompes K, K', qui font marcher les chaînes sans in M, M', ayant des pistons O, O'. 3o. La combinaison avec les chevâlets B, B', et C, C', portant les grandes roues dentées D, D', des gardes H, H', pour empêcher les quartiers de bois de passer sous la roue D; 4o. La combinaison

avec la poulie P, et les roues dentées Q, R, des élévateurs T, T', et des tabliers S, S'. 5o. La combinaison avec la poulie B, et les roues dentées Q, et V, des glissoirs Y, Z, et les chaînes d'enrayure W, X, &c. La combinaison avec la poulie C, et les roues dentées D', et E', de la chaîne d'enrayure de renvoi F', et de chute A', posée sur la plateforme B'. La combinaison des grandes roues dentées D, D', chacune portant une hache E, E', sur leur circonférence, des gardes H, H', et des roues d'air G, G', les poulies H, H', les pignons d'engrenage L, L', I, I', et J, J', les pompes K, K', la poulie P, les roues dentées Q, R, et Q', V, les élévateurs T, T', les tabliers S, S', et les barres, et mailles J, Z, les glissoirs Y, Z, et les chaînes d'enrayure W, X, la glissoir U, et la chaîne d'enrayure de renvoi F', avec la plateforme B', et la chute A', tel que décrit.

Claim.—1st. A mill or floating mill A, having toothed wheels D, D', each carrying an axe E, E', upon its circumference, and set in motion by the pulleys H, H', whose axles support the fly wheels G, G', and the pinions L, L' for splitting cord wood; 2nd. The combination with the large toothed wheels D, D', carrying the axes E, E', upon their circumference, of the pinions I, I', and J, J', and the blocks K, K', driving the endless chains M, M', having bolts O, O'; 3rd. The combination with the racks B, B', and C, C', bearing the large toothed wheels D, D', of the guard H, H', to prevent the split wood from passing under the wheel L. 4th. The combination with the pulley P, and the toothed wheels Q, R, of the elevators T, T', and the apron S, S'; 5th. The combination with the pulley B, and the toothed wheels Q, R, and V, of the slides Y, Z, and the lock chains W, X; 6th. The combination with the pulley C, and the toothed wheels D, D', and E', of the return lock chain F', and of chute A', placed on the platform B'; 7th. The combination of the large toothed wheels D, D', each bearing an axe E, E', upon its circumference, guards H, H', fly wheels G, G', pulleys H, H', gear pinions L, L', I, I', and J, J', blocks K, K', pulley P, toothed wheels Q, R, and Q', V, elevators T, T', aprons S, S', with bars i, i, and links j, j, slides Y, Z, the slide G', and return lock chain F', with the platform B', and the chute A', as described.

No. 4488. GEORGE R. EDWARDS, Galena, Ill., U. S., and SAMUEL ROWE, Yorkville, Ont., 12th March, 1875, for 5 years: "Improvements on Whittle Trees." (Perfectionnements aux palonniers.)

Claim.—1st. The combination of lever plate E, springs H, H', rods D, and bolts C, to hold the bolts B, yielding in the end apertures of the guard a, as set forth; 2nd. The combination with spring hold rods D, D, and draw-rod C, of a cylinder plate lever E, having the rods D, D, and G, pivoted thereto operating by the lever J, as set forth.

No. 4489. JEAN G. HAVA, New-Orleans, La., U. S., 12th March, 1875, for 10 years: "Treatment of Cod Liver Oil." (Traitement de l'huile de foie de morue.)

Claim.—The treatment of cod liver oil with a solution of gelatinous tribasic phosphato of lime.

No. 4490. JOSEPH S. GARNER, Galena, Ill., U. S., 12th March, 1875, for 5 years: "Wash Board." (Planche à savonner.)

Claim.—The corrugated rollers C, in combination with the wash board, sections B, and frame A, as set forth.

No. 4491. JAMES A. LAKIN, Westfield, Mass., U. S., 12th March, 1875, for 5 years: "Improvements on Overdraw Checks for Horses." (Perfectionnements aux fausses rênes.)

Claim.—The combination of the piece a, bar A, straps b, b, and loop c.

No. 4492 HUGO B RATHBUN, and EDWARD W. RATHBUN, Mill Point, Ont., (Assignees of James W. Herington), 12th March, 1875, (Extension of Patent No. 315), for 5 years: "Improvements in machines for Cutting the Headings of Barrels." (Perfectionnements aux machines à tailler les fonds de barils.)

Claim.—1st. The employment and use of a carriage T, for conveying the material to the saws C, C'; 2nd. The operation of the carriage T, from the shaft L, by the combination and arrangement of the flexible band V, loose-pulley R, and chuck S, and the manner of engagement and disengagement of the two latter by the operation of the carriage T, upon the angle arm a, and X, and lever P, as described, and the use of a weight W, and cord and pulley to withdraw the carriage from the saws; 3rd. The arrangement and combination of mitre wheels K, K', and J, and lever b, with the shaft B, for operating the carriage T, and endless chain C, by a forward and reverse motion of the shaft L, and 4th. The endless chain c, and operating it from the shaft L, by the drum p and pulley r, as set forth.

No. 4493. CYRENIUS C. ROE, Hamilton, Ont., 15th March, 1875, for 5 years: "Machine Belt Buckle or Fastener." (Boucle en agrafe de courroie de machines.)

Claim.—The arrangement of the buckle *d*, for fastening machine Belts, as specified.

No. 4494. CHARLES J. CORBIN, East Oxford, Ont., 15th March, 1875, (Extension of Patent, No. 287) for 5 years: "Improvement on the "Corbin's Horse Rake." (Perfectionnement du Râteau à cheval dit "de Corbin.")

Claim.—The entire construction of the iron-frame consisting of side pieces A, B, C. and D, E, F, hinge G, connecting side-pieces, spring H, to throw side-piece D, E, F, over tooth of rake, the tenon at the top of side piece D, E, F, working in a groove at the upper end of the side piece A, B, C. the lower end of the side piece D, E, F, working through the aperture at the end of the side piece A, B, C.

No. 4495. MANASSEH PETTENGILL, Minneapolis, Ma., U. S., 15th March, 1875, for 5 years: "Automatic Car-Coupler." (Attelage automatique de wagons.)

Claim.—The head *b*, having the vertical concavity in its face, and the series of horizontal semi-circular grooves *d*, with bevelled intermediate ribs, as described.

No. 4496. ELIJAH L. HOWARD, Boston, Mass., U. S., 15th March, 1875, for 5 years: "Hem-Stitching Attachment to Sewing Machines. (Ajustage des lames à ourlets des machines à coudre.)

Claim.—1st. An attachment for sewing machines to create a hem stitch, consisting of a bar or horn pivoted to the presser foot or other portion of the machine, and vibrating or oscillating with respect to the needle or path of movement of the latter in such manner as to compel the formation about such bar or horn of a succession of loose stitches; 2nd. The bar *a*, as containing as part thereof the loop portion or eye *c*, or an equivalent construction, and horn *b*, under such an arrangement as shown, that each and every loop of thread formed over the horn is free to pass unobstructed from the point or free end of the latter as the fabric is fed along; 3rd. The oscillating or vibratory bar, bearing as an attachment or part thereof a horn, or former about which the thread forms in loose bights when pivoted to the presser-foot; 4th. The mechanism for actuating the shifting-bar *b*, consisting of the pitman *f*, and cam *g*, the pitman being impelled against the cam by a spring or otherwise, and the cam rotated by suitable means.

No. 4497. CHARLES F. RITCHEL, Cory, Pa., U. S., 15th March, 1875, for 5 years: "Brush Block Boring Machine." (Machine à percer les bois des brosses)

Claim.—1st. The series of link-motions or universal joints *C*, secured by a ball at one of their ends to the crank-shanks *n*, passing through the first perforated plate *N*, and by a ball also at their other end to the bit-shanks *p*, passing through the second perforated plate *P*, in combination with the bit-shanks *p*, and their holding devices, and the bits *Q*, to bore with one movement all the holes straight and flare, 2nd. A series of link-motions or universal joints *C*, in combination, with sets of cranks *M*, passing the driving-plate *I*, which plate *I*, is set in motion by the eccentrics *H*, *H*, the pulleys *F*, *F*, and their belts, and in combination with the drum *C*, having a crank *E*, or a belt by which said drum *C*, is made to revolve, this mechanism being secured to the sliding carriage *B*, and bed *A*, this arrangement being to give the requisite motion and direction to the bits *Q*.

No. 4498. LOUIS CÔTÉ, St. Hyacinthe, Que., 15th March, 1875, for 15 years: "Machine for Bending and Forming Stiffeners for Boots and Shoes." (Machine à courber et former les contre forts de chaussures.)

Claim.—The matrix wheel *B*, provided with an elastic periphery *b*, in combination with the mandrel *C*.

No. 4499 JOHN S. ANDERSON, Flintville, Wis., U. S., 15th March, 1875, for 5 years: "Boiler Washing Machine." (Chaudiere de buanderie.)

Claim.—A combined boiler and washing machine, consisting of the vessel *a*, which is divided into two compartments by a curved partition: in combination with the double crank *d*, and handle *c*, the partition and ends of the boiler being formed into a semi-circle.

No. 4500. RÉMI PARADIS, St. Hyacinthe, Qué., 15 Mars, 1875, pour 5 ans: "Machine à bardeau." (Shingle Machine.)

Résumé.—1o. La plateforme ou chariot circulaire *B*, qui charriote les billots de bois à bardeauter, pour les faire passer sous la sole circulaire *y* compris toutes ses armatures: griffes fixes *F*, et griffes mobiles *G*, leurs bras de leviers d'action *H*, ainsi que leurs ressorts *J*, et en outre celui de le construire avec un plus ou moins grand nombre de cases à billots en augmentant ou en diminuant le nombre des bras-casiers *C*, 2o. La tête *I*, des bras de leviers *H*, porte griffes mobiles d'un galet qui aurait l'avantage de diminuer la perte de force causée par la friction de la dite tête *I*, contre la surface du guide semi-circulaire *W*, qui force les griffes à pénétrer dans les billots (comprisonnes dans leurs casiers respectifs) au moment où ils sont transportés sous les dents de la sole. 3o La glissière ou guide semi-circulaire *W*; 4o. Le commando du chariot par pignon *P*, et par les intermédiaires. 5o. Le système d'action de la haseule à bardeaux *S*, par doigt *L*, et triangle *T*, accouplé au tourniquet *Y*.

Claim.—1st. The circular platform or carrier *B*, which carries the logs to be cut into shingles, so that they may pass under the circular saw, including therein all its gearing: fixed claws *F*, and movable claws *G*, their action lever arms *H*, as well as their springs *J*, besides *C*, the constructing it with a greater or lesser number of log holders, by increasing or diminishing the number of boiler arms *C*. 2nd. The head *I*, of the lever arms *H*, movable claw holder with running sheaf, having the advantage of diminishing the loss of power caused by the friction of the said head *I*, against the surface of the semi circular guide *W*, forcing the claws to penetrate the logs (confined in their respective holders) at the moment of their being carried under the teeth of the saw. 3rd. The slide or semi circular guide *W*. 4th. The control of the log carrier by the pignon *P*, and by the gearing. 5th. The method of tipping the shingle *S*, by the finger *L*, and triangle *T*, coupled to the pulley sheaf *Y*.

No. 4501. THOMAS RICHARDSON, and MALCOLM MCINNIS, Fergus, Ont., 15th March, 1875, for 5 years: "Improvements on Ploughs." (Perfectionnements aux charrues.)

Claim.—1st. The shape and manner of strengthening and securing the frame *A*, *A'*, *A''*; 2nd. The shape of the neck of the plough *B*, and the manner of fastening the same to the frame, 3rd. The combination of levers *C*, *C'*, *C''*, and the semi circular toothed rack *F*, and spring catch *E*, engaging therewith whereby the wheels are adjusted.

No. 4502. JOSEPH K. FEICK, Berlin, Ont., 16th March, 1875, for 5 years: "Felt Boot Tree." (Forme de tige de botte en feutre.)

Claim.—1st. A tree for the fabrication of felt boots, the front composed of two or more sections *A*, *B*, and the rear of two or more sections *C*, *D*, and two or more intermediate keys *E*, *F*, *G*; 2nd. The foot piece of the tree composed of two parts *H*, *I*, subdivided horizontally from the toe rearward on the curved cut *G*.

No. 4503. GREENLEAF HOULTON, St. Andrews, and HENRY OSBURN, St. Stephen, N. B., 16th March, 1875, for 5 years: "Car Axle Box." (Boite d'essieu de wagon.)

Claim.—1st. The metal drawer *B*, having longitudinal partitions *F*, and upper side walls adjusted to fit into, and be secured within the axle box *A*; 2nd. In combination with the drawer *B*, the spring *D*, pad-holder *E*, and pad *C*. 3rd. In combination with the slide *K*, the leaf spring *L*, placed upon the outside of said slide *K*, and curved outward centrally to serve as a handle. 4th. In combination with the drawer *B*, the upper loose journal-bearing *I*, having lips *a*.

No. 4504. WALTER R. CLOSE, Bangor, Me., U. S., 16th March, 1875, for 15 years: "Improvements in Friction Catch Wheels. (Perfectionnements aux roues à estoquiaux de friction.)

Claim.—1st. The wheel *E*, fixed permanently on the shaft *B*, formed with the central or principal part *a*, in which part are formed recesses *n*, *m*, with planes running to the periphery of *a*, and when used in connection with the hoop *g*, forming wedge shaped pockets, in which the friction rolls *b*, *b'*, act by their own weight to wedge between the planes of the recesses and the inner circumference of the hoop *g*, whenever the wheel *D*, revolves in a forward direction towards the shallowest part of the recesses thereby compelling *a*, to revolve in the same direction, but when the revolution of *D*, is reversed the rolls *b*, *b'*, return into the deepest parts of the recesses, and allow the hoop *g*, to revolve freely around *a*; 2nd. The wheel *E*, fixed permanently on the shaft *B*, formed with the central or principal part *a*, flange *b*, and recesses, or pockets *m*, *m'*, *m''*, carrying the friction rolls *b*, *b'*, *b''*, and acting in connection with the peripherally flanged wheel *D*, set collar *c*, and connecting rod *d*, to impart motion to the lumber-carriage of a saw mill or to any other machinery; 3rd. The "Compound Friction Catch Wheel" composed of the wheel *E*, having a projecting central part *a*, in which are the recesses *m*, *m'* formed

with plauer running from the deepest parts of the recesses to the periphery of *a*, the friction rolls *b, b*, playing in the recesses *m, m*, and the peripherally flanged wheel *D*, so formed that the flange *g* shall form a hoop extending over and around *a*, and the rolls *b, b*, the whole operating so that when *D* revolves in one direction the rolls *b, b* will wedge between the planes of the recesses *m, m*, and the inner surface of the hoop *g*, causing the wheel *E* to be revolved in the same direction, but when *D* is reversed and revolved in an opposite direction, the rolls retire and allow *D* to be revolved without carrying *E*, in the same direction, all as described.

No. 4505. JOSHUA COLLINS, Montreal, Que., 16th March, 1875, for 5 years: "Bag Tie and Fastener." (Courroie agrafe de Sac)

Claim.—A Bag tie or fastener consisting of a piece of metal so cut, stamped or cast, of wire so bent as to form shoulders or loops *b, b*, and *A, A*, at the end of arms *D, D*, between which a notch is placed to hold the cord *F*, securely, as specified.

No. 4506. JOHN C. PEACOCK, London, Eng, 16th March, 1875, for 5 years: "Non Conducting Material Applicable where Exclusion of Heat is required." (Conduit anti-calorique.)

Claim.—The combination of cork soot with apparatus for the retention or exclusion of heat either alone or mixed with lime, Portland cement or ashes, or substances having a hardening or setting power as described.

No. 4507. JAMES F. WILLIAMS, Niagara, Ont., 17th March, 1875, (Extension of Patent No. 289), for 5 years: "Buckle for Fastening Straps and Bands." (Boucle pour joindre les courroies et les bandes.)

Claim.—The uniting of two complete and distinct levers, fig. 1, one of the first order of lever *A*, and one of their second order of lever *B*, hinged together at their fulcrums *A, A*, and pressing upon each other at the points *B, B*, where the lever is usually applied to

the object to be moved so as to form the buckle or fastener fig. 1, for the purpose of fastening by pressure and friction bands, straps, &c., by passing the object *C*, to be held between the levers above mentioned through at the point *B, B*, of pressure.

No. 4508. LUTHER J. HOUSE, and ALBERT C. HOUSE, Stanstead, Que., 18th March, 1875, for 5 years: "Stump Extractor and Stone Puller." (Appareil pour arracher les souches et enlever les pierres.)

Claim.—1st. The combination of the pivoted working lever *C*, as provided with guide stay straps *E*, with the adjustable standard *B*, and platform *a*; 2nd. A lever *C*, provided with straps *D* and two rows of lever sockets, formed by pins *l, l*, for the purposes set forth; 3rd. A lever *C*, provided with guide straps *E*, and strap *D*, for the support of bearings *l, l*, of the adjustable hand spike *F*, in combination with a supporting and pivoted standard *B*; 4th. The Standard *B*, having a vertical adjustment by means of the rack and pinion, as set forth, in combination with the posts *l, l*.

No. 4509. CHRISTOPHER C. JONES, Fredericton, N. B., 18th March, 1875, for 15 years: "Improvements in Pumps." (Perfectionnements dans les pompes.)

Claim.—1st. The combination of the wooden top *A*, with the metal cylinder *m*, and the metal tube *n*; 2nd. The combination of the wooden top *A*, with the metal cylinder *m*; 3rd. The combination of the wooden top *A*, with the metal tube *n*; 4th. The use in applying this combination of the plate, table or flange *c*, surmounted by the rim, crown or hoop *d, d*, by means whereof the wooden part is prevented from splitting and leaking,

No. 4510. STEPHEN E. FOSTER, Minneapolis, Ma., U. S., 18th March, 1875, for 5 years: "Spring for Vehicles." (Ressorts de voitures.)

Claim.—In combination with the rubber springs *d*, the hook *f*, and clasp *c*, as described.

INDEX OF INVENTIONS.

Bag tie and fastener, J. Collins 4505
 Barrels, machines for cutting the headings of, (extension),
 H. B. and E. W. Rathbun 4492
 Battery, gravity (electric), H. Neilson 4454
 Belt buckle or fastener for machines, C. C. Roe 4493
 Bolters, non conducting covering for, W. and C. M. O'Hara
 Boot and shoe soles, machine for trimming and finishing,
 (extension), T. Côté 4470 4471
 Boots and shoes, machine for bending and forming stiff
 eners for, L. Côté 1498
 Brush block boring machine, C. F. Ritcheb 4497
 Buckle for fastening straps and bands, J. F. Williams 4507
 Camera, reflecting stereoscopic, W. Harris 4463
 Car axle box, G. Houlton and H. Osburn 4503
 Car coupler, automatic, M. Pettengill 4485
 Carriage spring, E. Wright and J. J. Krehbiel 4478
 Castings, metal, ramming and moulding machine for, J.
 B. McCune and R. M. Wanzer 4476
 Churn, R. G. Blamey and J. Kulow 4480
 " (extension), H. Bolton 4457
 " T. Prior 4448
 " W. R. Wagner 4467
 Coal oil can, fumigating and fire lighting, E. Davids and
 C. K. Jones 4450
 Cod liver oil, treatment of, J. G. Hava 4489
 Cord wood, floating mill and machine for splitting, P.
 Mayrand, père 4487
 Felt boot tree, J. K. Felck 1502
 Fire extinguisher, A. A. Murphy and C. C. Hearle 4481
 Frame work, imbricated, J. H. Dorion 4485
 Freezing apparatus, E. C. Tozer and R. D. Southwood 4466
 Furniture, &c., joint for, C. T. Cleaveland 4469
 Gas apparatus, R. P. Spice 4469
 Gas, illuminating, machine, H. E. Casgrain and G. Drolet
 Gate, R. H. Hudgin 4455 4473
 Harvester, J. S. Royce 4461
 Horses, overdraw checks for, J. A. Lakin 4491
 Horse rake (extension) C. J. Corbin 4494
 Ladder, extension fire, J. G. Taylor and J. H. Smith 4453
 Lamp wicks, C. A. Shaw 4452
 Meat, method of slaughtering, preparing and packing for
 exportation, K. Knott 4468
 Milk cans, bottom of, J. H. Stone 4475
 Mill stones, face tester for, J. Thompson 4445
 Needle machine, W. Trabue 4416
 Non-conducting material, J. C. Peacock 4506
 Pantaloon stays, E. S. Yentzer 4417
 Planers of wood, &c., expansive gear for feed rolls of, R.
 N. Merlam 4474
 Plough, T. Richardson and M. McInnes 4501
 Potato digger, D. Moodie 4462
 Pump, C. C. Jones 4509
 Sash, folding, window, W. J. Manchester, Jr 4451
 Saw, gang, hanger, H. C. Butler 4464
 Saws, hand and other short, E. Andrews 4483
 Separator and smutter combined, scouring case for, M. Deal
 Sewing machine castor, J. S. Rood 4477
 " " hem stitching attachment to, E. I. Howard
 Shingle machine, R. Paradis 4500
 Smoke consumer, J. Hodgson 4479
 Smutter and separator combined, scouring case for, M. Deal
 Springs for vehicles, S. E. Foster 4510
 Steam, method of generating and utilizing, D. F. Mosman
 Stone and stump extractor, L. J. and A. C. House 4508
 Stove pipe shelf, L. B. Doan 4444
 Stump machine, P. J. Ayres 1465
 Stump and stone extractor, L. J. and A. C. House 4507
 Wash board, J. S. Garner 4490
 Washing machine, A. Trumble and J. Baron 4458
 " " T. S. E"out 4472
 " " boiler, J. S. Anderson 4499
 Watch, J. L. Wilson 4486
 Water cooler, F. P. Laubach 4460
 Wheels, friction catch, W. R. Close 4504
 Whiffletrees, G. R. Edwards, and S. Rowe 4488
 Windlasses, revolving screw, (extension), A. Allan 4456
 Window, folding sash, W. J. Manchester, Jr 4451

INDEX OF PATENTEEES.

Allan, Andrew, (assignee), revolving screw windlasses 4456
 Anderson, John S., boiler washing machine 4499
 Andrews, Emmanuel, hand and other short saws 4483
 Ayres, Parley J., stump machine 4465
 Baron, Jean and A. Trumble, washing machine 4458

Blamey, Richard G., and J. Kulow, churn 4480
 Bolton, Henry, churn 4457
 Butler, Henry C., gang saw hanger 4404
 Casgrain, Henri E., & G. Drolet, illuminating gas machine
 Cleaveland, Caleb T., joint for furniture, &c 4469
 Close, Walter R., friction catch wheels 4501
 Collins, Joshua, bag tie and fastener 4505
 Corbin, Charles J., horse rake 4494
 Côté, Louis, machine for trimming and finishing boot and
 shoe soles 4470 4471
 " " machine for bending and forming stiffeners for
 boots and shoes 4498
 David, Edwin, and C. K. Jones, fumigating and fire light-
 ing coal oil can 4150
 Deal, Martin, scouring case for combined smutter and sepa-
 rator 4482
 Doan, I. Vander B., stove pipe shelf 4411
 Dorion, Joseph H., imbricated frame work 4485
 Drolet, George and H. E. Casgrain, illuminating gas ma-
 chine 4455
 Edwards, George R. and S. Rowe, whiffletrees 4488
 Elliott, Thomas S., washing machine 4472
 Felck, Joseph K., felt boot tree 4502
 Foster, Stephen E., springs for vehicles 4510
 Garner, Joseph S., wash board 4490
 Harris, Warren, reflecting stereoscope camera 4463
 Hava, Jean B., treatment of cod liver oil 4489
 Hearle, Charles C. and A. A. Murphy, fire extinguisher 4484
 Hodgson, John, smoke consumer 4479
 Houlton, Greenleaf and C. Osburn, car axle box 4503
 House, Luther J. and Albert C., stump and stone extractor
 Howard, Elijah L., hem stitching attachment to sewing
 machine 4496 4473
 Hudgin, Robert H., gate 4473
 Jones, Charles K. and E. Davids, fumigating and fire light-
 ing coal oil can 4450 4509
 Jones, Christopher C., pump 4509
 Knott, Kennard, method of slaughtering, preparing and
 packing meat for exportation 4468
 Krehbiel, John J. and E. Wright, carriage spring 4478
 Kuow, John and R. G. Blamey, churn 4480
 Lakin, James A., overdraw checks for horses 4491
 Laubach, Franklin P., water cooler 4460
 McCune, Joseph B. and R. M. Wanzer, ramming and
 moulding machine for metal castings 4476
 McInnes, Malcolm and T. Richardson, plough 4501
 Manchester, William J., folding sash window 4451
 Mayrand, Pierre, père, floating mill and machine for split-
 ting cord wood 4487
 Merlam, Rufus N., expansive gear for feed rolls of wood
 planers, &c 4472 4462
 Moodie, David, potato digger 4462
 Mosman, Daniel F., method of generating and utilizing
 steam 4419
 Murphy, Alexander A. and C. C. Hearle, fire extinguisher 4485
 Neilson, Hugh, gravity battery 4454
 O'Hara, Walter and Charles M., non-conducting material
 for bolters 4481
 Osburn, Henry and G. Houlton, car axle box 4503
 Paradis, Remi, shingle machine 4500
 Peacock, John C., non-conducting material 4506
 Pettengill, Manassch, automatic car coupler 4495
 Prior, Thomas, churn 4418
 Rathbun, Hugo B. and Edward W., machines for cutting
 the heading of barrels 4492
 Richardson, Thomas and M. McInnes, plough 4501
 Ritcheb, Charles F., brush block boring machine 4497
 Roe, Cyrenius C., machine belt buckle or fastener 4493
 Rood, John S., sewing machine castor 4477
 Rowe, Samuel and G. R. Edwards, whiffletree 4488
 Royce, John S., harvester 4461
 Shaw, Charles A., (assignee), lamp wick 4462
 Smith, James H. and J. G. Taylor, extension fire ladder 4453
 Southwood, Richard D. and E. C. Tozer, freezing apparatus
 Spice, Robert P., gas apparatus 1459
 Stone, John H., bottoms of milk cans 4475
 Taylor, John G. and J. H. Smith, extension fire ladder 4453
 Thompson, John, face tester for mill stones 4445
 Tozer, Edmund C. and R. D. Southwood, freezing apparatus
 Trabue, William, needle machine 4446
 Trumble, Adolphus and J. Baron, washing machine 4458
 Wagner, William K., churn 4467
 Wanzer, Richard M. and J. B. McCune, ramming and
 moulding machine for metal castings 4476
 Williams, James F., buckle for fastening straps and bands
 Wilson, James L., watch 4480
 Wright, Enos and J. J. Krehbiel, carriage spring 4478
 Yentzer, Enoch S., pantaloon stays 4447

THE CANADIAN PATENT OFFICE RECORD.

ILLUSTRATIONS.

Vol. III.

MAY, 1875.

No. 5.

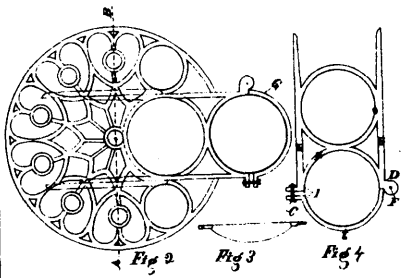

4444 Doan's Stove-pipe Shelf.

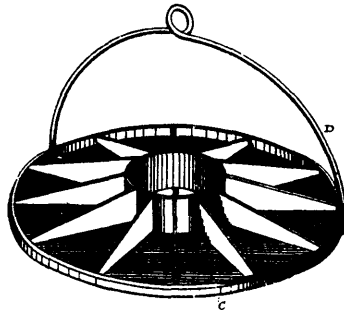

4445 Thompson's Face-tester for Mill-stones.

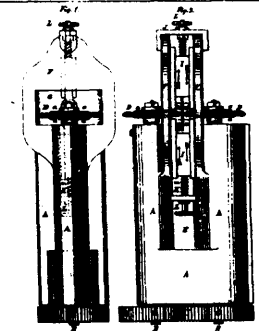

4446 Trabue's Needle Machine.

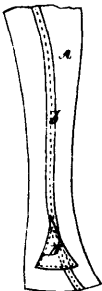

4447 Yentzer's Pantaloen Stays.

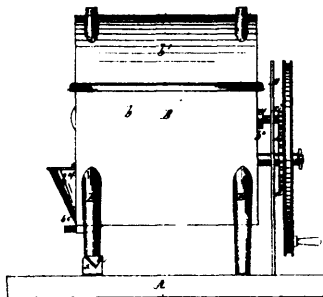

4448 Prior's Improvements in Churns.

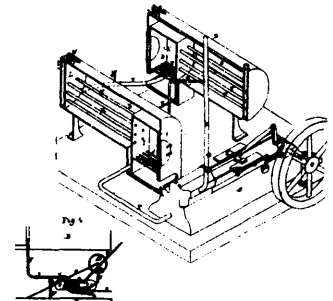

4449 Mosman's Method of Generating and Utilizing Steam.



4450 Davids & Jones' Fumigating and Fire-lighting Coal Oil Can.

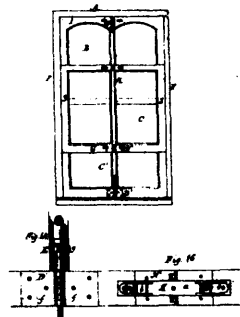

4451 Manchester's Folding Sash Window.

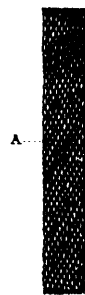

4452 Halvorson's Improvements on Lamp Wicks.

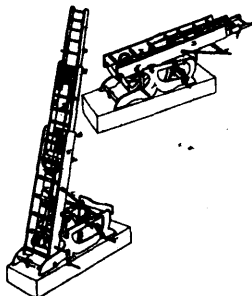

4453 Taylor & Smith's Extension Fire Ladder.

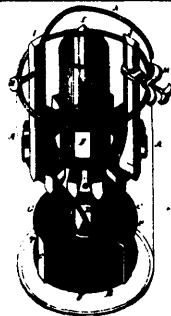

4454 Neilson's Gravity Battery.

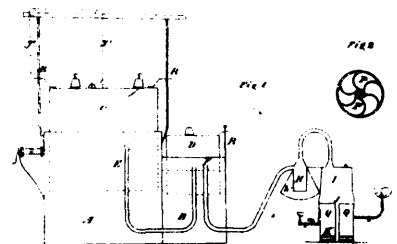

4455 Casgrain & Drolet's Illuminating Gas Machine.

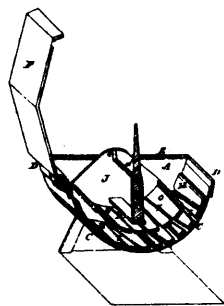

4458 Trumble & Baron's Washing Machine.

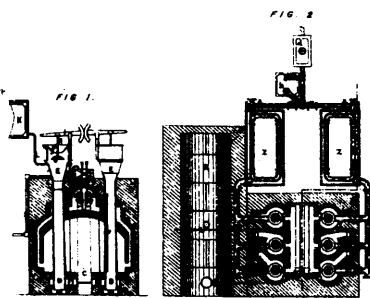

4459 Spice's Gas Apparatus.

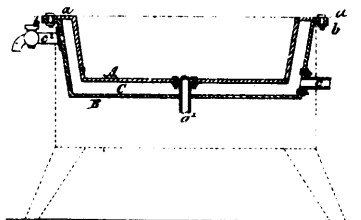

4460 Laubach's Water Cooler.

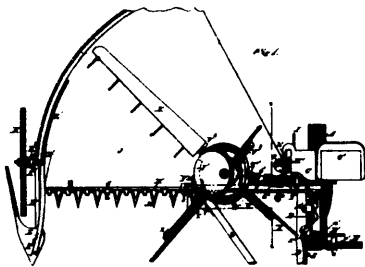

4461 Royce's Improvements on Harvesters.

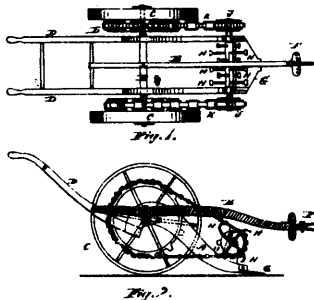

4462 Moodie's Potato-digger.

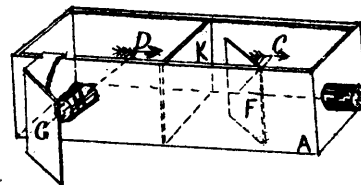

4463 Harris' Reflecting Stereoscopic Camera.

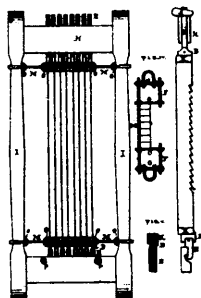

4464 Butler's Gang Saw Hanger.

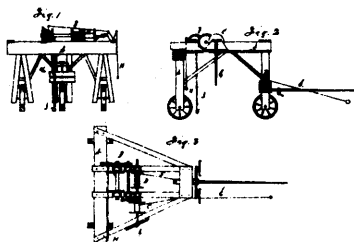

4465 Ayres' Stump Machine.

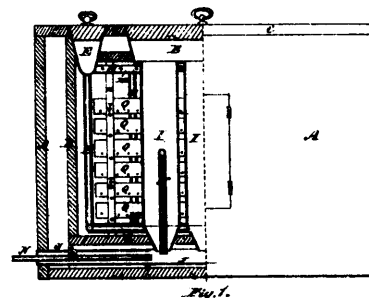

4466 Tozel & Southwood's Freezing Apparatus.

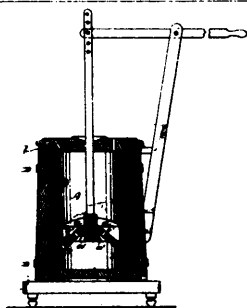

4467 Wagner's Improvements in Churns.

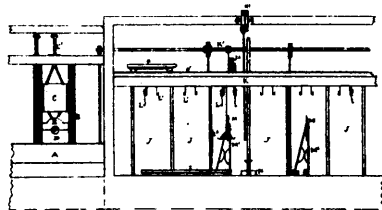

4468 Knott's Method of Slaughtering, Preparing and Packing Meat for Exportation.

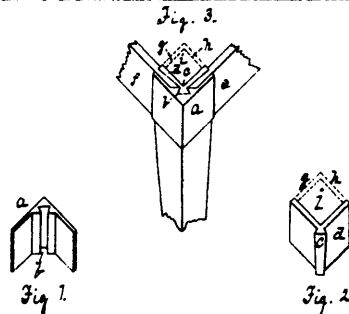

4469 Cleaveland's Joint for Furniture.

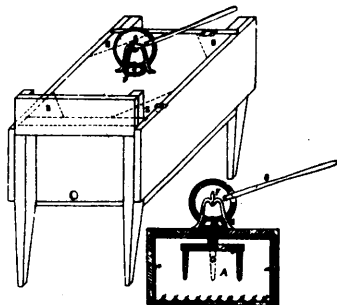

4472 Elliott's Washing Machine.

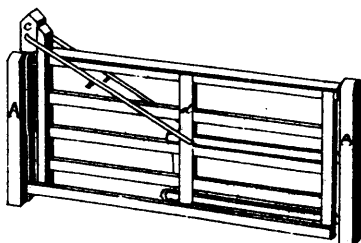

4473 Hudgin's Improvements on Gates.

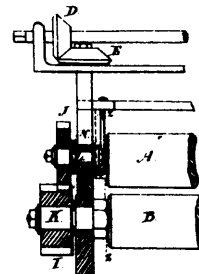

4474 Meriam's Expansive Gear for Feed Rolls of Wood Planers and other Machines.

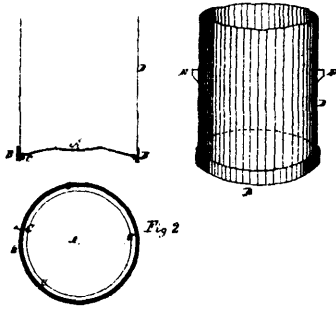

4475 Stone's Improvements in Bottoms of Milk Cans.

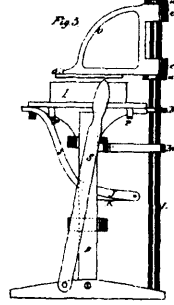

4476 McCune & Wanzer's Ramming and Moulding Machine for Metal Castings.

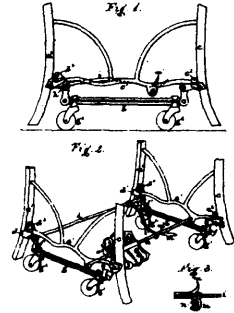

4477 Eddy's Sewing Machine Castor.

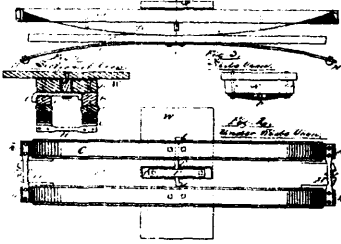

4478 Wright & Krehbiel's Carriage Spring.

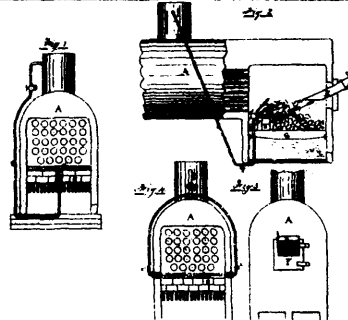

4479 Hodgson's Apparatus for Consuming Smoke for Steam Boilers and other Furnaces.

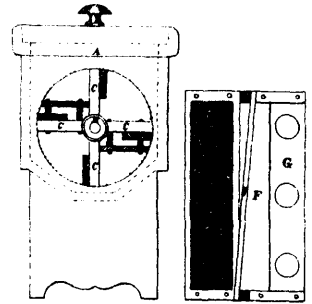

4480 Blamey & Kulow's Churn.

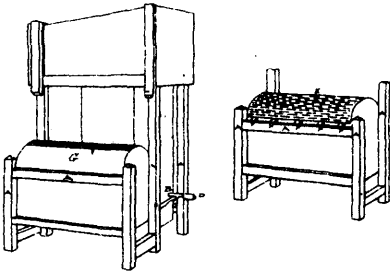

4482 Deal's Scouring-case for Combined Smutter and Separator.

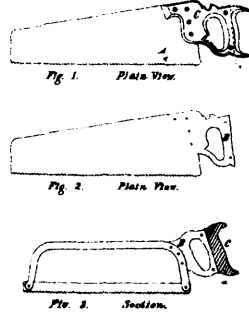

4483 Andrews' Improvements on Hand and other Short Saws.

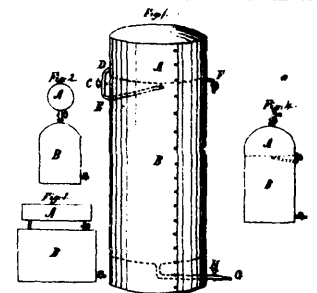

4484 Murphy & Hearle's Improvements in Fire Extinguishers.

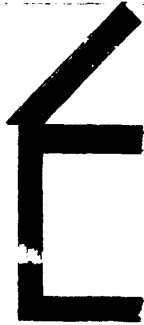

4485 Dorion's Imbricated Frame-work.

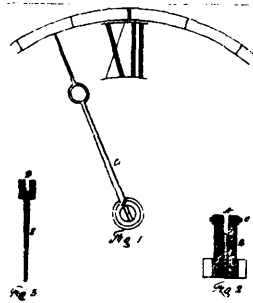

4486 Wilson's Improvements in Watches.

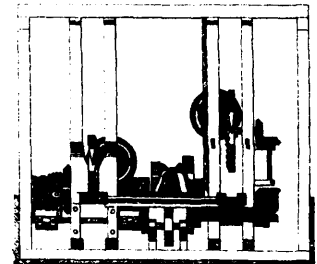

4487 Mayrand's Floating Mill and Machine for Splitting Cord Wood.

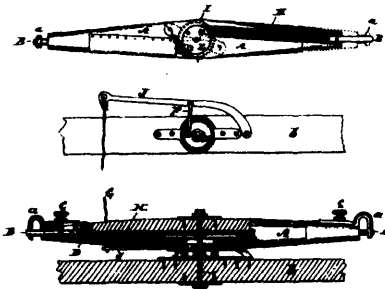

4488 Edwards & Rowe's Improvements on Whiffle Trees.



4490 Garner's Wash Board.

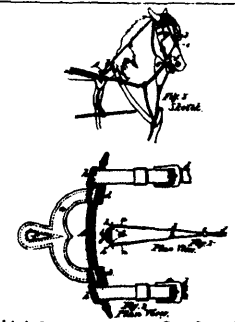

4491 Lakin's Improvements on Overdraw Checks for Horses.

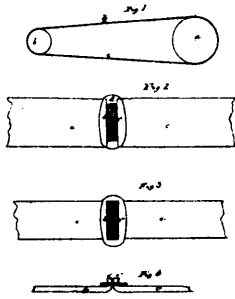

4493 Roe's Machine Belt Buckle or Fastener.

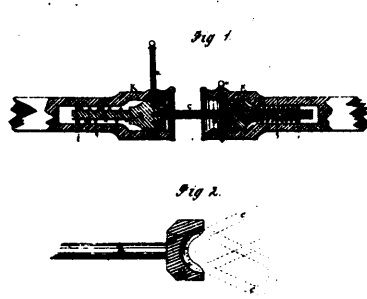

4495 Pettengill's Automatic Car-coupler

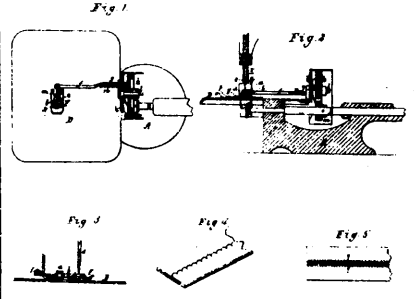

4496 Howard's Hem-stitching Attachment to Sewing Machines.

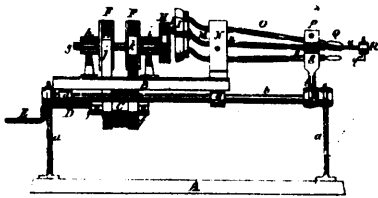

4497 Ritchel's Brush Block Boring Machine.

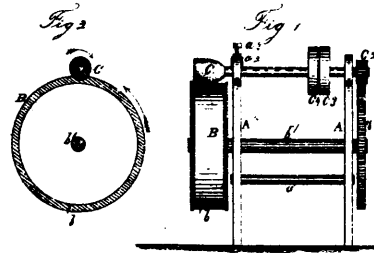

4498 Coté's Machine for Bending and Forming Stiffeners for Boots and Shoes.

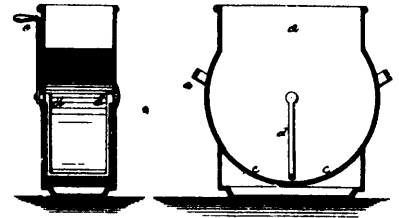

4499 Anderson's Boiler Washing Machine.

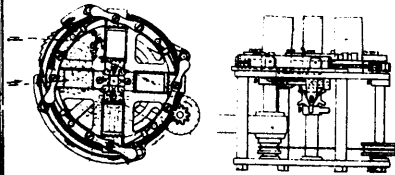

4500 Paradis' Shingle Machine.

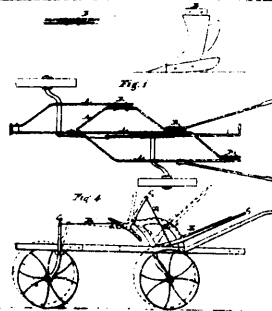

4501 Richardson & McInnes' Improvements on Ploughs.

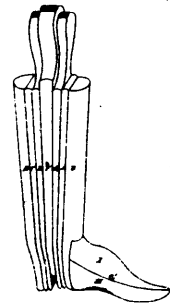

4502 Feick's Felt Boot Tree.

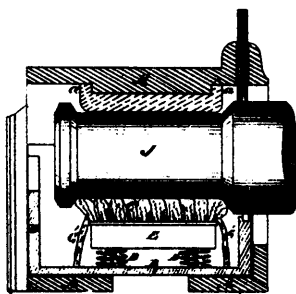

4503 Houlton & Osburn's Car Axle Box.

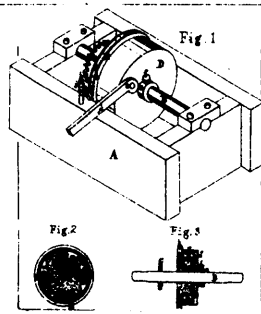

4504 Close's Improvements in Friction Catch Wheels.

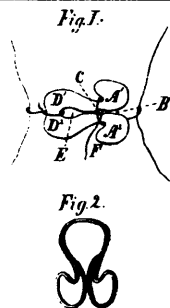

4505 Collins' Bag Tie and Fastener.

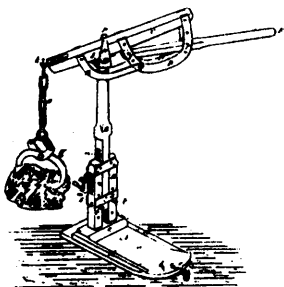

4508 House's Stump Extractor and Stone Puller.



4509 Jones' Improvements in Pumps.

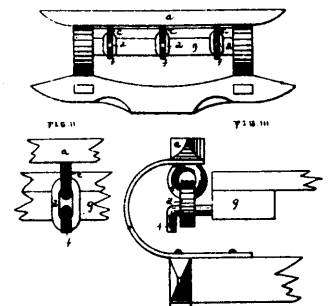

4510 Foster's Spring for Vehicles.