

THE CANADIAN THRESHERMAN & FARMER

CANADA'S FARM- MACHINERY MAGAZINE

WINNIPEG

CANADA

JANUARY, 1914



A Hard Job Made Easy

AND A LOT OF TIME SAVED

The new Deere is equipped with the John Deere Quick-Detachable Share—the handiest feature ever put on a plow.

Note in illustration the position of bolt—in plain view, easy to get at. Unscrewing this one nut is all there is to taking off the John Deere Quick-Detachable Share.

And they are quick-attachable too. They can be put on as easily as they can be taken off.

The John Deere Quick Detachable Share is an exclusive John Deere feature.

Only One Nut to Remove to take off Share

—and you don't have to lie down in the dirt, under the plow, to do that.

The exasperating, tedious task of unscrewing several nuts when in a cramped position is entirely done away with.

Bolt that holds share to moldboard is in plain view—it is handy to get at.

How it's Done

All that is necessary to remove share is to unscrew this one nut from eyebolt and give share a kick with foot.

And, remember, the share is just as easily put on—simply slip share in place and tighten up nut.

Either operation can be done in a few seconds.

These shares save three-fourths of the time usually required in taking off and putting on ordinary shares.

This is mighty important, because any time saved during the plowing season is money saved to the farmer.



Only One Nut to Remove

Here are some reasons why John Deere Quick-Detachable Shares are superior to the ordinary shares:

- 1st—They save 80 per cent of time in changing shares.
- 2nd—No tipping of plow or lying in the dirt.
- 3rd—Simplest and strongest share ever made.
- 4th—No lost, bent or broken bolts or nuts.
- 5th—Only one nut to remove instead of four or five.
- 6th—Locks rigidly—equalized strain on all parts.

Why They are Stronger

An eyebolt attached to the share passes through a bracket and holds share in place—better than when bolted to the frog in the old style manner.

The frog extends well under the share, giving it a very solid support.

One extra heavy malleable brace furnishes a firm bearing for wing of share.

Lug on landside of share passes into a slot in the frog, holding it firmly. It answers the same purpose as two bolts in the landside.

Each share fits the frog and bottom perfectly. It is held tightly in place by the lug and well-distributed pressure exerted when nut on the eyebolt is drawn up.

With bolted shares this must be done as far as possible with a drift punch, which causes sudden shocks from the hammer blows and unequal strain on the share.

The re-sharpened John Deere Quick-Detachable Share that has been sprung can be brought to place with less effort than can the bolted share.

There are many other reasons for the superiority of these shares brought out by actual field experience—your John Deere dealer will be pleased to tell you about it.

Ask to see the Q-D Share. Your John Deere Dealer will show you

Here are some more Superior Points of the New Deere

The plows that can be depended upon to do good work—years of field use prove it.

Do uniform good work in any soil—the final test of a plow's real merit. They have made good wherever used and they are used all over the country.

STRENGTH, durability, light draft and ease of operation give plow satisfaction. You get all these qualities when you buy a New Deere.

MADE OF THE RIGHT MATERIAL

Not a cheap piece of material goes into the New Deere. This is one reason the New Deere Sulky and Gang give from three to five years more service than ordinary makes.

LIGHT DRAFT AND STEADY RUNNING

The New Deere is easy-running because of the special material and shape of the bottoms, the keen thin "Wedge" and the proper distribution of weight on the wheels. The device for locking the plows in the ground is so constructed

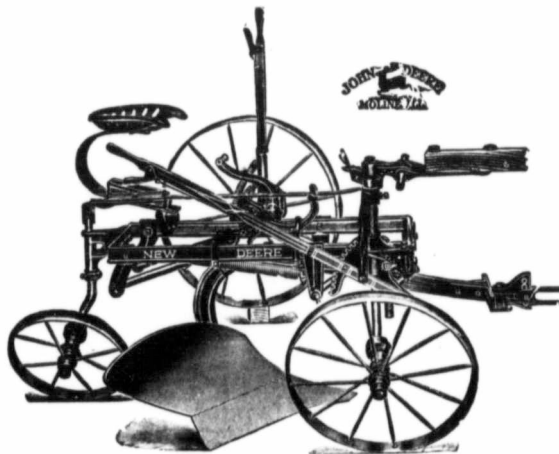

Light Running New Deere Sulky

Made to last—not a cheap piece of material in them.

Easy to handle—a boy can lift bottoms when team is standing.

Consistent good workers—they work right all the time.

that the harder the ground, and consequently the greater the draft, the more securely are the plows held to their work.

After the first furrow is opened, an entire land can be plowed without adjusting a lever, except perhaps to land the front furrow wheel when following crooked furrows.

In point of construction, material, ease of management, light draft, etc., the New Deere Gang and the New Deere Sulky are alike.

The principle difference between the two is that the Gang is adapted for two bottoms and has both hand and foot lift. The hand lift makes it easy for a small boy to lift both bottoms when team is standing.

Remember, when You Get a New Deere You Get Satisfaction.

JOHN DEERE PLOW CO., LIMITED

Winnipeg Regina Saskatoon Calgary Lethbridge Edmonton

Ask your John Deere dealer to show you the New Deere equipped with "Q-D" Shares.

Write us for further information about the New Deere, mentioning the C. T. & F.

ROLLE together of th make Spread are n that h the c Deere than i in the though feature cussed book.

FEW PA chains in fact, parts li done av the ma tion, n the dri until th large at the ma

ONLY H load. I is only hips. manure where i can a/w spreader



John Deere Spreader

With the Beater on the Axle

No Clutches

No Adjustments

No Chains

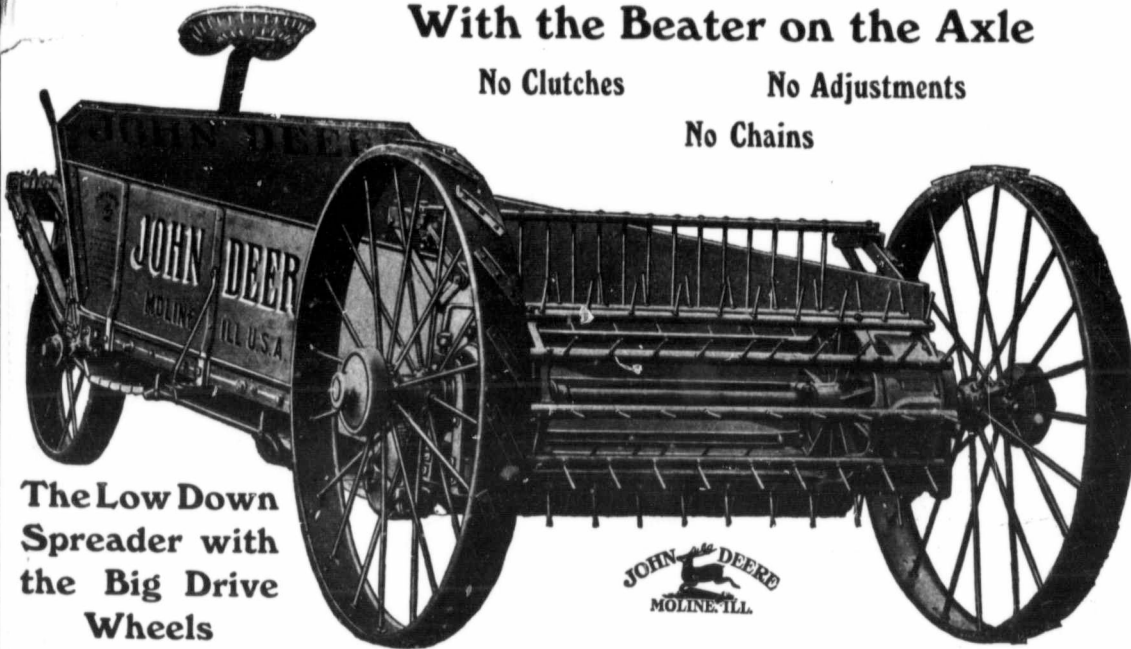

The Low Down Spreader with the Big Drive Wheels

ROLLER BEARINGS, together with the simplicity of the machine itself, make the John Deere Spreader light draft. There are many more reasons that have helped to make the demand for John Deere Spreaders greater than all those interested in the spreader business thought possible. These features are fully discussed in our spreader book. You can get it free.

FEW PARTS. Clutches, chains and adjustments—in fact, some two hundred parts in all—are entirely done away with. To throw the machine into operation, move the lever at the driver's right, back until the finger engages a large stop at the rear of the machine.

ONLY HIP-HIGH, easy to load. The top of the box is only as high as your hips. Each forkful of manure is placed just where it is needed. You can always see into the spreader.

Repeated trials extending over a number of years have demonstrated the fact that a Manure Spreader used on forty acres of land will more than pay the cost of the machine in one season by increasing the crop, to say nothing of the great saving in labor.

WHAT YOU WANT

Here's your chance to get exactly what you want in a manure spreader. One that is easy to load, light for your horses, free from constant repairing, and one that will last as long as you think it ought to.

WHAT YOU GET

With a John Deere Spreader you get a low-down spreader in which the advantage of big drive wheels is not sacrificed for the low-down feature. You get a spreader that is easy for your horses because it has these big drive wheels, together with roller bearings, few parts, the center of the load, comparatively near the horses and evenly distributed over all four wheels.

There are no clutches to get out of order, no chains to give trouble, no adjustments necessary.

Built with a steel frame, securely braced, like modern railway bridges—strong and durable.

WHY YOU GET THESE THINGS

Mounting the beater on the axle makes all these things possible in the John Deere Spreader.

It does away with some two hundred trouble-giving parts. It makes the spreader low-down. It permits the use of big drive wheels. It does away with clutches, chains and adjustments. It puts all the strain and stress of spreading on the rear axle, where it belongs, not on the sides and frame of the spreader. It does a lot of other good things, too. They are fully illustrated and described in our new spreader book.

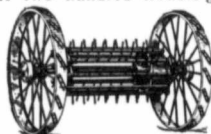

The Beater on the Axle

THIS VALUABLE BOOK FREE

Our new book, "Farm Manures and Fertilizers," was written to give our customers plain facts about how to raise more crops on the same land; what kind of fertilizer to use, when and how to apply it; and how to get the best results. With this book we will send you an illustrated folder telling all about the John Deere Spreader.

POSITIVE APRON DRIVE.

By the use of a very simple locking device on the inside of the ratchet feed, the apron is positively locked against racking when spreading up-hill or over exceedingly rough ground. The result is that when spreading with the John Deere Spreader, the manure is always spread evenly. A ratchet feed that is entirely new to manure spreaders is put on the John Deere. It is driven from one end of the beater by a large eccentric that gives the two ratchet arms forward and backward movement.

BEATER and all its driving parts are mounted on the rear axle. Power to drive it is taken from the rear axle through simple gears like those that have been used on horse-powers for many years. This construction is patented. You cannot get it on any other spreader.

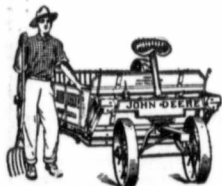

On'y as high as your hips

John Deere Plow Co., Ltd.

Winnipeg Regina Saskatoon Calgary
Lethbridge Edmonton

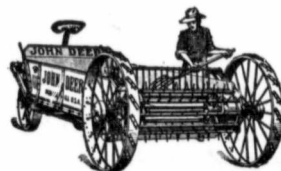

Low Down, Easy to Load

You saw this advertisement in this magazine. Don't forget to say so when writing.

The Simplest Tractor of All!

Illustration shows
the Hart-Parr "One
Man" outfit—The
27 B.H.P. Tractor
and 4-Furrow self
and hand lift plow.

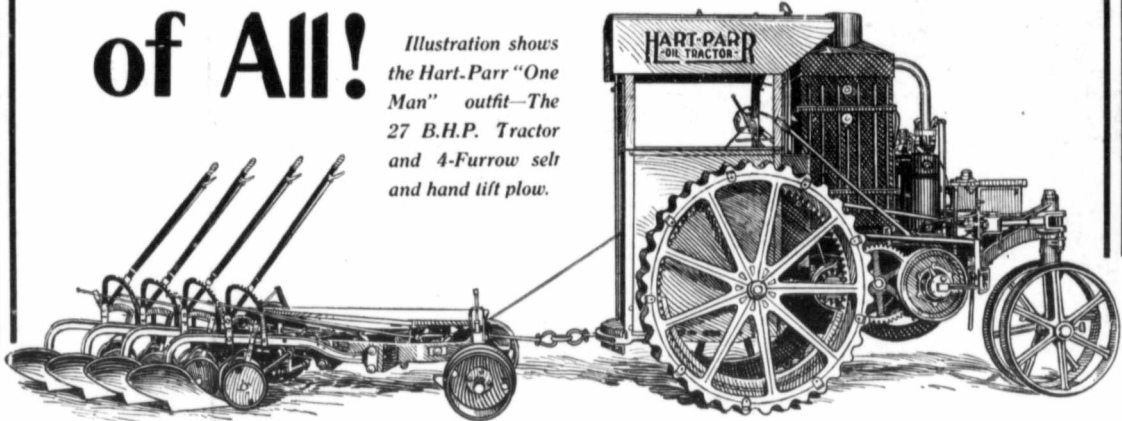

Simplicity, plus reliability, are the two main things to look for in a Tractor

By actual comparison, the Hart-Parr 27 B.H.P. Oil Tractor has 500 to 1200 fewer manufactured parts than any other make. It contains only 300. All others contain 800 to 1500 each. Fewer parts means less chance for trouble, less complication in design, greater simplicity.

A Four-Piece "Backbone"

The main frame is a single casting, to which is fastened a front wheel frame of steel and two steel side frames. No channels in this foundation, no eyebeams or angles with a multitude of pieces—just four, strong, substantial castings. Long experience has proven this to be the ideal construction for this size tractor. The engine crank case, transmission cases and tractor frame are combined into one unit, designed to withstand the heavy strains of rough, uneven fields and roads. The "vitals" of this tractor cannot get out of place or go wrong.

Solid Steel Drivers

The drive wheels are solid castings—not built up nor pieced—and are cast with our famous wave form lugs. Casting these drivers of tough steel eliminates hundreds of small parts and insures great strength, yet light weight. One under test withstood a crushing blow of 216,000 pounds. For work in very soft soil, the drivers can easily be fitted with Hart-Parr "Hold Fast" extension lugs—the lugs which have a bull dog grip, but don't pack the soil.

Sure-Feed Simple Carburetor

The carburetor is of the float feed type, simple in design and has comparatively few parts. On no load, light load or heavy load, it handles CHEAPEST KEROSENE economically and successfully. It's a sure-feed carburetor in every kind of weather—hot or cold. Our method of cooling the motor with oil, further ensures perfect operation.

Every Part is Simple

Every part of the Hart-Parr "27" is just as simple and efficient as the parts we have just described. It is built throughout with big margins of safety and strength. No skimping anywhere. Nothing omitted which will ensure the farmer a "better than usual" tractor, at a very reasonable price. We could build this tractor cheaper and make a bigger profit, by substituting cheaper materials, construction and workmanship. But we don't aim to see how cheap we can build it, but how simple, substantial and reliable we can make it. And this policy, we find, "makes good" for us, because the tractor "makes good" for the farmer and gives the longest possible service in actual field work.

HART-PARR

-OIL TRACTORS-

Use it on 160 Acres

The Hart-Parr "27" is a big profit earner on as little as 160 acres. In combination with the Hart-Parr 4-Furrow Self and Hand Lift Plow, it is an ideal One Man Outfit, easily handled in field and belt work, at a surprisingly low cost for operation, up-keep and repairs.

Write for Literature

The original features of this tractor are strikingly pictured in some special circulars we have just issued. Write for them; also general catalog and literature on power farming costs.

Hart-Parr Company

30 Main St., Portage la Prairie, Man.
57 West 23rd St., Saskatoon, Sask.

1616 8th Ave., Regina, Sask.

THE CHAPIN CO., 325 8th Ave. West,
Calgary, Alta.



The Premier Company

The Premier Goods

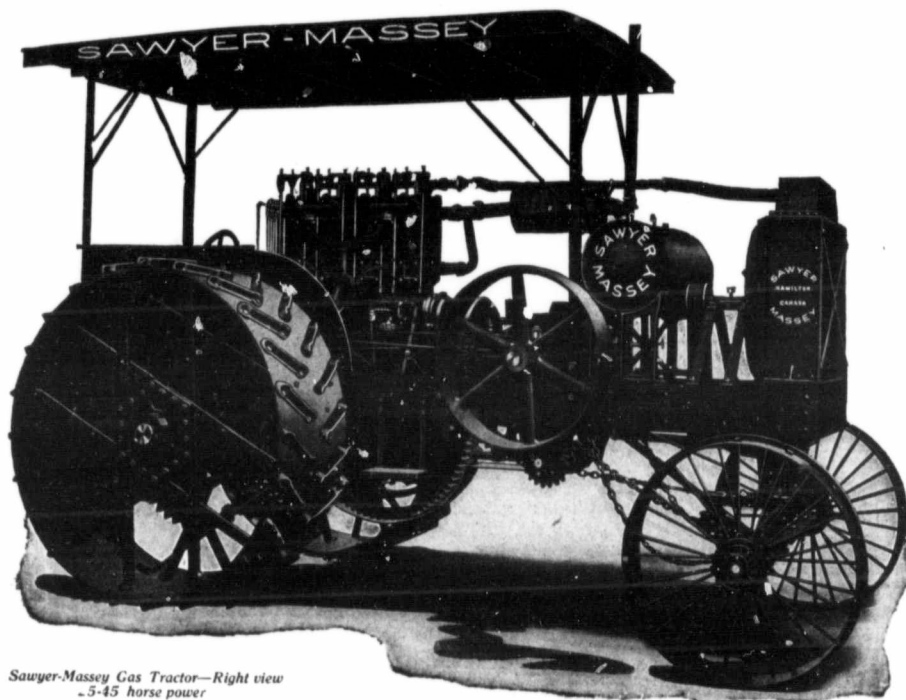

*Sawyer-Massey Gas Tractor—Right view
—5-45 horse power*

Let the Premier Tractors Do Your Plowing

Gas Tractors have won popularity with farmers throughout Canada largely as a result of the efficiency and positive economy of the Sawyer-Massey Gas Tractor. There will be many more used this year than ever before.

Tests in the field and in contests have proven the Sawyer-Massey Gold Medal Gas Tractor a powerful, reliable, efficient and economical tractor. It plows straighter, smoother furrows, does more work, requires less fuel and very little water, shows slightest vibration and lowest cost of up-keep. Rated at 25-45 horse-power, it easily develops over 50 horse-power, which indicates it is honest in construction and will not disappoint the user should excess power be required.

Those who desire Steam Tractors for any purpose will be interested in our new catalogue. This describes the entire Premier line, including the Gas Tractor illustrated here, grain threshers, road-making machinery and various types and sizes of Sawyer-Massey Steam Tractors. There is one Sawyer-Massey Tractor best suited for your particular need. Our catalogue will help you make your choice. Write for it today.

SAWYER-MASSEY COMPANY, Limited

Builders of Steam and Gas Tractors, Threshers and Road-making Machinery.

Head Offices and Factories HAMILTON, CANADA

Branches and Warehouses: Winnipeg, Manitoba; Regina, Saskatchewan; Calgary, Alberta;
Buenos Aires, Argentina.

SAWYER-MASSEY



Vol. XIX.

WINNIPEG, CANADA, JANUARY, 1914.

No. 1.

IN seeking to do justice to the past year's record of Western Canada's winnings in international contests, the press of all sections finds itself confronted with a task that baffles its best efforts. With all sorts of descriptive genius, prophetic instinct and boundless imagination to draw upon, it must after all, in this case, feel very much what Dr. Johnson called "oppressed with a stifling consciousness of its own limitations."

A fitting climax to the year's accumulation of splendid achievement and hard won honors has been reached by Mr. J. D. McGregor of Brandon in winning for the second year in succession the grand championship of the world for fat steers in what was probably the greatest live stock show that has ever been held on either hemisphere.

This, the fourteenth "International" blanketed all records, certainly in point of numbers, and in the judgment of specialists, both of European and American celebrity, it was at least second to no exhibit within living memory in downright quality — which makes the victory of "The McGregor" all the more wonderful and impressive.

No man is yet able to grasp the full significance of the incident to Western Canada. Men are slow to assimilate the real import of these great happenings. Scotch men, particularly, are accounted somewhat sluggish in their efforts

OUR WORLD-WIDE WINNINGS

to "see the point" whether it is in the nature of a joke or some new experience that calls for the exercise of rapid foresight and calculation over a field with which they are not quite familiar.

McGregor is nothing if it is not a perfervidly Scotch name, and it is just possible that Mr. J. D. of that historic clan (known to his

in that vast assembly must have felt a something that could never be expressed in language. What the thoughts of its owner were in that proud moment is not yet a

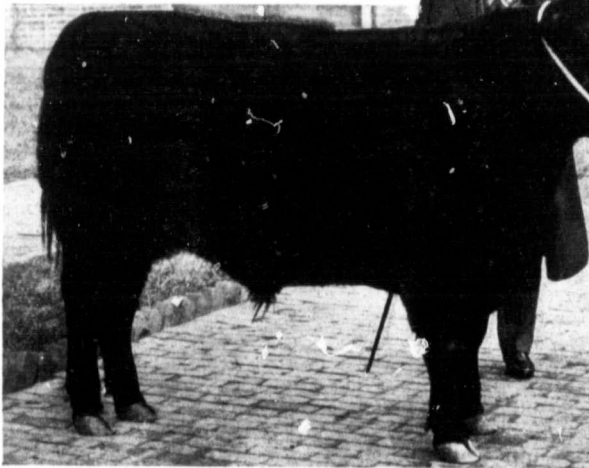

GLENCARNOCK VICTOR II
Sweepstakes grand champion steer International, Chicago, 1913. Harry Bowman who fed the steer is holding him and Robert Lorimer, of Ivanston, Ill., a recognized authority on bullocks, is inspecting him.

friends as "Jim") is least of all aware of what he has really done, and what a stir this steer of his will make in the fortunes of succeeding generations—it may even in our own generation.

When the winning "Angus Doddie" was led into the lime light in the presence of the cloud of witnesses that filled the great arena, the heart of every Canadian

matter of general knowledge, but to a select circle he has modestly imparted the information that he felt more proud of the conduct and bearing of the lad, Harry Bowman, who stood by its head than he did of anything else connected with the incident in which he did or did not take a responsible part.

The steer was reared and fed by

Harry, a boy of scarcely seventeen years. His father is Mr. McGregor's partner on the farm near Brandon on which the animal was bred. He came West from Ontario some five years ago at Mr. McGregor's invitation, and while at no time has he regretted the step he took, he has now reason to believe it was perhaps the most fortunate move he ever made.

His boy is of the type who is not likely to suffer from the phenomenal success which has waited upon him so early in his career. Judging from the unassuming character of his sire and his own admirable deportment as he responded to the hundreds of inquiries that were addressed to him in that show, the quality of common sense is in the blood and an in-born modesty belongs to him which is likely to last him all his days.

What an incentive to young Canada! We hear a lot and we write a good deal about the attractions of agriculture, and "how to keep the boys on the farm," but here is the whole solution of the thing in a nutshell. This boy's father is an enthusiast in his own line. He at least takes a real delight in stock raising, and because of this feeling, he has instinctively imparted the same intelligent interest to his boy whom he has made his chum and that is the only way to handle a boy.

If any father seeks to train "the young idea" by driving it at the point of the stable fork instead of leading it by kindly suggestion and the guide rope of mutual interest, he had better give it up at once. That stable of things has never won out. It is an impos-



Three best steers, grades or cross-breeds at International, Chicago, 1913. Calif. yearling and two-year-old Aberdeen-Angus, all bred and owned by J. D. McGregor, Brandon.

sible policy because it is out of line with every prescription of natural law, and the end of it is what we meet with practically every day—lads and lasses who simply hate the farm and are glad to get away from it under any pretext.

Last year the Americans opened their eyes very widely when it came out that the grand championship had been won by "some man from Western Canada" with a black Aberdeen Angus steer. It gave "Canada" another boost and our cousins over the line in their genuine sportsmanlike spirit honestly congratulated "Canada." But when the same man with another of the same type lifted the money in this year's contest, the matter took on a still deeper significance and it was McGregor of "Brandon" that passed from mouth to mouth while that great discourse of the world's best stockmen held together.

So McGregor with his Aberdeen Angus cattle has branded the name of Brandon as deeply into the grey matter of the farming world everywhere as "Clydesdale" or "Hereford," "Ayreshire" or "Jersey" have become everlasting synonyms for certain types of animals that possess distinguishing qualities and that mark them off from all else in live stock and about which there can never be any peradventure.

Emerson has said that "Every institution is but the lengthened shadow of some great man. At all events, the initiation of that which is of real account in the progress of civilization is invariably the fruit of one strong soul that towers indefeasibly above its fellows, and it is to the honor and glory of the average man that he is capable of following that initiative."

J. D. McGregor is the last man

on earth to draw the suspicion upon himself that he is aware of his achievements in that unsavory manner we know of by "self-consciousness." He has done something great in spite of himself, and those who have an intimate knowledge of the man know also

that the greatest tribute his fellows can pay him will not be found in the spreading eloquence of a complimentary banquet, but in a unanimous disposition to follow up what he has initiated in common sense, intensive farming.

There are certain aspects of this great world's triumph that were not in evidence at Chicago except to a few intimates, but which were very forcibly enunciated and illustrated at the complimentary

Banquet

tendered to Mr. McGregor in Brandon by his fellow citizens there.

For once at least it was demonstrated that a prophet is not always without honor even in his own country. This banquet was nothing if it was not a spontaneous and irrepressible outburst of the kindly feelings of the men among whom the guest of honor had spent the best years of his life. The largest banquet hall of the city was crammed by enthusiastic citizens presided over by their Mayor (Fleming) with the guest of honor on his right, the pair being flanked by the Lieutenant Governors of Manitoba and Saskatchewan respectively.

The gathering was thoroughly representative of the very best of Western Canada's stockmen, of the great transport companies, packing houses and grain interests, etc., and the speakers without exception were of an unusually high order: that is to say that there were no windy perorations got up for the occasion and which meant little or nothing. Every man who spoke had a practical intimacy with what he was talking about, and every word went home. It was an intellectual feast—a banquet of good things in the form of

information on all points in which men have raised stock or grown grain with conspicuous and uniform success.

Much of what was said is already common property, but there were one or two points in the address of the guest of honor that struck a note which every farmer who is at the game in all seriousness will set himself to work out in his own kingdom if they have not already been operating in his particular programme.

One of these referred to the place which our common and easily grown barley holds as a food stuff. The all but universal impression has been that corn is the king of all feeds for hogs and cattle, but Mr. McGregor pointed out that this grand champion steer (Glencarnock Victor II) had never had a single meal of corn, neither did his championship herd of one two-year-old, yearling and calf.

While not depreciating the value of corn as a food, he made a strong bid for the more general use of barley in this connection and for its better cultivation in Western Canada. His comparison between the two was significant. The average crop of corn grown on ideal land was something like 33 bushels to the acre. In Western Canada the average yield of barley is about 35 bushels, but barley is commonly regarded a "scratch" crop that may be sown in "any old place." But if grown on the best land, the average need not be short of 50 bushels or more, and weight for weight, barley is very little if at all behind corn in feed value.

Still further point is given to Mr. McGregor's claim for the barley-feed in the fact that the grand champion sheep of 1913—Mr. J. D. Campbell's Grade Shropshire Wether—was not a

\$10.00 per head on the ewes which had been fed from the same staple home grown diet.

"We have proved that there is as much profit in one ewe as there is in an acre of wheat. Sheep will eat nearly any weed grown, and after the crop is off they will fatten on the stubble. There is no animal kept on the farm that is more profitable than sheep."

Commenting on the advantage Western Canada possessed for the production of high grade pork, Mr. McGregor passed on to speak of his remarkably satisfactory experience in growing alfalfa. Last year on the occasion which some of his friends now said seemed to look like becoming an annual affair, he prophesied some very strong things with regard to the future of this wonderful gume in Western Canada. "After another year's experience in growing this valuable forage plant, I feel that all I said on that occasion has been abundantly verified and that every business farmer in Western Canada should interest himself in the cultivation of alfalfa on his own farm and in his own district. It means more cattle and better cattle, sheep and hogs, and more fertility returned to the land. It will return the humus we have stolen from the land with the result that we will see better crops of wheat and all kinds of grain; it means, in fact, the salvation of the country.

Saskatchewan's Honors

Saskatchewan was fittingly represented at the banquet by its Lieutenant Governor Brown and Deputy Minister of Agriculture, Frank Mantle. Mr. McGregor paid a graceful compliment to the splendid horse exhibit made at Chicago by the sister province and congratulated it on the fact that to him these Clydesdale beauties were one of the most noteworthy

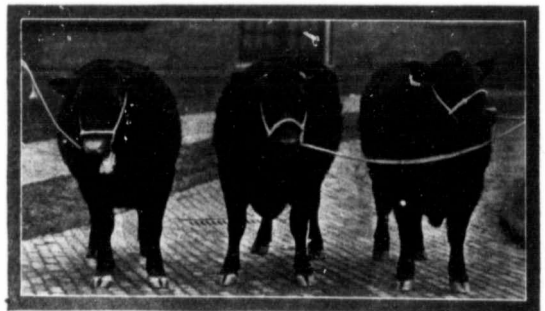

Three best steers get of one sire, International, Chicago, 1913. Bred and owned by J. D. McGregor. The sire was "Golden Gleam."

corn fed animal, and the carlot of lambs that captured the highest honors had been fed on small grain and alfalfa. Further, on the Rugby farm conducted by his partner Mr. Bowman, Mr. McGregor informed his audience that they had secured a profit of

and interesting features of that wonderful exposition of quality horses.

Out of the very large number of entries that were sent in regardless of cost, it was a most gratifying fact that the Saskatchewan boys were nearly ai-

ways in the money with their home-bred stock, while pitted against celebrated imported animals which had been purchased at a figure running into many thousands of dollars.

From the attitude of the transportation companies to this incident in their offer of free conveyance of the grand champion to any point of Canada for exhibition purposes, it can be fairly assumed that when there is some solid evidence that men are raising quality stock, stock that is really worth carrying to the most distant market, the railways will not prove a stumbling block either in rates, delay or suitable accommodation in transit. They cannot help themselves. The country is behind this business of agriculture and whatever laws or by-laws exist to its prejudice and to the sole advantage of the carrying companies must give way to the will of the people.

But candidly, so far an alarming percentage of the beef and dairy cattle that is to be seen in process of shipment has been of a character to freeze the warmest blood of a constitutionally tropical enthusiast. Breeding and feeding have been a matter of the purest accident. Anything within sight from Stink-weed to Sow-thistle and Burdock, has been considered good enough for "the beasts," but to the man who knows a well bred and a well fed animal when he sees it, much of the "live stock industry" one sees on the farms and in the stock yards is of an indescribable type. It reminds one of Sam Sadler's pup.

(Sam was never an expert in any matter of selection, and of all that concerned the dog world he was "highly and hopelessly ignorant." Some friend desiring to get rid of a mongrel without actually shooting it, took advantage of Sam's ignorance and foisted on him this squirming mixture of legs and tail that never had the promise of a tyke. Sam took it in good faith and in

the belief that he had acquired a dog. Asking a friend who dropped in one day what he thought of it, the candid one replied: "Well Sam, to tell you the gawd's truth, it's just the very sort of a dog that I would have expected you to take an interest in!")

This exactly illustrates the attitude of many "mixed-farmers" with regard to the live stock end of their business.

The pleasantries of this memorable occasion were sustained by every speaker — the various "clans" represented at the gathering furnishing a convenient rallying point for much of the shafts of wit that were flung off with an utter disregard to any "tenderness" that might afflict the object

of those predatory times had been conceived and executed; that while his (The Cameron) clan had usually been satisfied with a few humble sheep, it was only the fattest herds of cattle that Rob and his following thought it worth while to transport across the border and drive into the security of their mountain eyrie.

The old records, however, have made a verbal distinction here which possibly Mr. McGregor did not know of, otherwise he might have been glad to take advantage of it. In the old "Black Books" of the several counties which describe the penalties that were meted out to those fellows who had the ill luck to be caught red-handed, the text invariably

may take comfort from the fact that probably every man or woman he speaks to in these better regulated times has at least to carry the memory of some such bar-sinister bequeathed to the family by the left-handed operations of some scion of the house. There is a legend to the effect that a worthy daughter of the Frazer Clan (who was being assiduously courted by a not less worthy Cameron) felt it her duty to tell her "Joe" before it had gone too far that one of her uncles so far forgot himself that he was ultimately hanged for sheep stealing. "Let not that distress you, my lass," said the honest fellow, "if I hadn't ane uncle who was hanged for sheep stealing—I had five who ocht to have been!"

The climax of the evening's fun was the introduction to the banquet of the youngest calf of the celebrated herd. It was most tastefully decorated with the "family honors" captured at Chicago and elsewhere and wheeled in by the herdsman and his assistant on a diminutive truck. The incident was a surprise to most of the guests and needless to say evoked tremendous enthusiasm.

This was possibly the "Woe McGregor" that will be fed and nursed into condition for the great show of 1914, and it may be the "Grand Champion" for the third time in succession. Who can tell? Mr. McGregor is certainly not going to make a soft bed of his laurels. He contemplates going on after still finer achievements. He and his "men behind the gun," to whom he never fails to give the fullest credit, will go on to still greater conquests, and if they should go down in 1914 at Chicago or in any contest, they will go down fighting still.

There is a hoary old saw which not only Mr. McGregor but the humblest seeker after success should never lose sight of in any effort made:

"Tis not in mortals to command success; we will do more — deserve it."



Four distinct types of paying guests who with fair treatment are never in arrears. Cattle, sheep, hogs and poultry on the farm of John Corr.

aimed at. This recklessness was more than justified, for every man knew his mark. The very atmosphere was charged with perfect understanding and complete accord that night. It did, however, look at one time as if there was going to be a general resurrection of those deadly differences that separated the McGregors from the Cameron Clan, and the Frazers from both in the old marauding days; when Rob Roy and his horde of caterans held by

"The good old rule, the simple plan,
That they should take who have the power,
And they should keep who can."

His Honor D. C. Cameron cheerfully reminded his neighbor that around the name of the McGregor the greatest deprivations

reads "cattle lifting" and "sheep stealing."

Mr. A. C. Frazer did his best to whitewash the record of his own ancestors of the '45, and as he proceeded, it became a study in human expression to look around the tables. It is at any time a perilous business to examine too minutely the out-croppings of one's family tree, but there was scarcely a physiognomy among those two or three hundred gourmands that just about this time did not begin to take on the gloomy foreboding of guilt; not only of a "guilty" ancestry but the still more humiliating fact that they had been found out.

But these kindly apologists of a long-buried line of forefathers



A corner of J. D. McGregor's alfalfa hay crop, near Brandon.

THE CANADIAN THRESHERMAN AND FARMER

CANADA'S LEADING AGRICULTURAL MAGAZINE

E. H. HEATH,
PRESIDENT
E. W. HAMILTON,
MANAGING DIRECTOR
F. C. BRAY, TREASURER



E. H. HEATH COMPANY, Limited,
WINNIPEG, CANADA



J. D. DUTHIE, EDITOR

C. B. FULLER,
FIELD REP.

(MEMBERS WESTERN CANADA PRESS ASSOCIATION)

AUTHORIZED BY THE POSTMASTER GENERAL, OTTAWA, CANADA, FOR TRANSMISSION AS SECOND CLASS MATTER

J A N.

CUT OUT THE THORN

1914

OUR GUARANTEE

No advertisement is allowed in our columns until we are satisfied that the advertiser is absolutely reliable and that any subscriber can safely do business with him. If any subscriber is defrauded, E. H. Heath Co., Ltd., will make good the loss resulting therefrom, if the event takes place within 30 days of date advertisement appeared, and complaint be made to us in writing with proofs, not later than ten days after its occurring, and provided, also, the subscriber in writing to the advertiser, stated that his advertisement was seen in "THE CANADIAN THRESHERMAN AND FARMER." Be careful when writing an advertiser to say that you saw the advertisement in "THE CANADIAN THRESHERMAN AND FARMER."

"THE PURPOSE OF ALL LIFE is to secure the greatest results and the best results within the sphere of that life."

Whatever the end may be or however frequent and deplorable are the lapses that figure as an almost daily occurrence, in most lives, there is not a single self-respecting soul who would not let it be known sometime if not all the time that it is his or her earnest desire and purpose to make a brilliant success. No one ever nurses failure. The worst man would have it believed of him that he is a good man and the most weak-kneed that he is capable of doing anything that any two-legged creature can endure or accomplish.

A NEW DOOR OF HOPE OPENS for everybody as we write on the threshold of 1914. With all the sanguine expectancy of young explorers we enter it. We have done the same thing consciously or unconsciously for over a half a century and as the years increase, we confess

that the quality of eagerness is not blunted; rather that it is mellowed and sobered somewhat to that degree of temperature that registers a moderate expectation as distinguished from the extravagance of the years of adolescence. Our belief in ourselves to do the right thing is stronger, if anything, than it ever was—notwithstanding a whole graveyard-full of shortcomings—and it is in this spirit that we lift the latch and pen these observations.

ADVICE IS CHEAP in these days, and as the world wags on, its value continues to drop in the exchange of human experience. The best "advice" we ever got was the silent example of those men and women we became most familiar with, whose careers seemed to be one calm and continued course of well-doing. They lived a day at a time. They never "preached". When they said they would do a thing, we grew accustomed to the feeling that in so far as those people were concerned, the thing was already done. We required no security for their promises and if they died before the due date, we could reckon on picking up the threads without having to spend one moment in disentangling the skein.

THEY NEVER SEEMED TO WORRY. They never did worry and we never found them frothing and fuming in a fit of temper because the train they intended to catch had just pulled out and left them high-and-dry till the same hour next day. No reverse or abuse administered by a fellow creature ever for one moment upset them or changed their attitude of habitual kindness or good will. Why? Because they knew from every past experience that it was with them as with Bernard of Clairvaux: "Nothing can work me damage but myself, the evil that I sustain I carry about with me, and I am never a real sufferer except by my own fault."

WE ARE ALL TEACHERS—for the most part silent ones, and the more successful the more silent. No man likes to be told what he ought to do and very few fellows have done great things or travelled along in the quiet path of continued well-doing who were bullied or preached at. The real teacher has a wonderful way with him. He does not parade his possessions and yet he is the most successful "advertiser" on earth. He does not talk in liquid syllables but he presents his goods in such an attractive, not to say captivating form, that without a word of noise or pictorial embellishment he gets there. The demand for his wares is insatiable and will never know what it is to slacken off while the world lasts.

WE ALL KNOW TEACHERS OF THIS SORT and they are the only preceptors we seek to be influenced by. There is really nothing heroic about it, and yet in the deepest level of our natures we acclaim these men and women the only heroes worth the name. They belong not to the "blow-hards," they are the last people on earth to offer "advice," but the very first to render real assistance when they are given the slightest encouragement to help a fellow traveller. They do not live in "cold storage apartments." To us they seem to have reached as near to the goal of human perfection as there is "any use for."

THE BUGBEARS OF THE AGES have been the elements of fear, anger, worry; but the teaching of our day has replaced that old hell-fire, predestination hopelessness by the process of simply eliminating or "denying" these false but fearfully damning nightmares. This teaching is embodied in the personality and lives of the men and women we have been speaking of and their hopeful, healthy band, thank God, is growing in numbers every day. Said one of them recently in writing to Professor James, of Harvard: "From the instant I realized that these cancer spots of worry and anger were removable, they left me. With the discovery of their weakness, they were exercised. From that time life has had an entirely different aspect."

THIS DENYING PROCESS, moreover, is more than a negative quantity. The act of simple elimination while cutting off the most prolific source of failure, has left the men free to do something he could never else have done. This correspondent goes on to say: "It took me some months to feel absolutely secure in my new position; but as the usual occasions for worry and anger have presented themselves over and over again, and I have been unable to feel them in the slightest degree, I no longer dread or guard against them and I am amazed at my increased energy and vigor of mind, at my strength to meet situations of all kinds, and at my disposition to love and appreciate every thing."

SUBSCRIPTION RATES

Postage prepaid, Canada and Great Britain,
\$1.00 Per Year.

Postage prepaid, United States and Foreign Countries,
\$2.00 Per Year.

Failing to receive paper, you should notify the office at once, when mistakes, if any, will be corrected immediately.

All Subscriptions must be paid for in advance and are positively discontinued at date of expiration unless renewed.

Advertising copy in order to secure good position should be in our hands not later than the 15th of the month preceding date of issue.

Advertising rates furnished on application

A Money-Making Satisfying Outfit

The Kind that Makes Good Everywhere—It's a Famous Up-to-the-Minute AULTMAN-TAYLOR

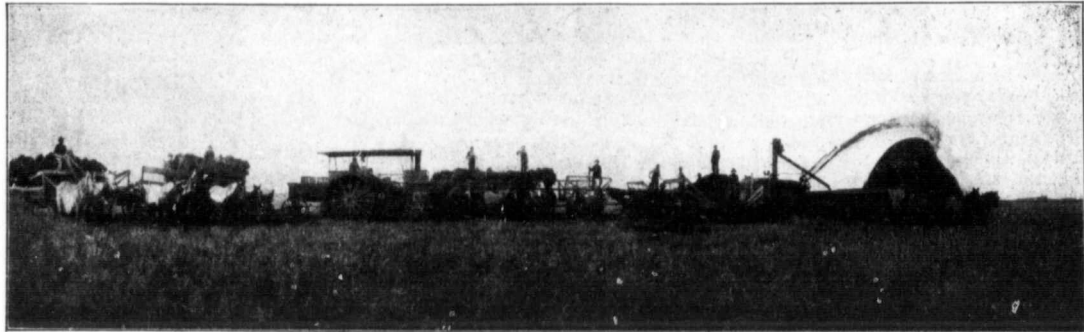

Just What You Want For 1914

OUR 1914 CATALOG tells you all about the many superior features of construction of AULTMAN-TAYLOR Machinery. It's a book brimful of pointers. It contains just the information you're looking for. Do you want one of these big, new catalogs? If so, use the coupon or drop us a post card.

Get our Catalog—Read it carefully, then let us figure with you on your requirements. If you need an engine, we can furnish you either gas or steam, both of which are leaders in their class. The Aultman-Taylor 30-60 Gas Tractor holds Three World's Records and is without an equal—a tractor that does just what we recommend it to do. If you prefer a steam tractor engine, the Aultman-Taylor Independently Mounted Engine with its Famous Boiler is just what you should have.

How about that new Separator? Sure you have heard about the "New Century." Have you seen it work? It's a dandy. It certainly will pay you to see this wonderful separator before you buy. Its Open Webb Conveyor and Rotary Straw Rack form the greatest combination of separating devices ever used in the construction of a separator—the only perfect system of separation known. Investigate and learn the difference. It has pleased thousands of wide-awake, progressive Canadian Threshermen. It will please you.

We are also builders of the "Matchless" Clover and Alfalfa Huller. The Speediest and cleanest huller in the market. Ask any man who owns one. He can tell you.

By all means get our catalog before you buy. We can save you money.

INTERNATIONAL HARVESTER COMPANY OF CANADA, Ltd., Canadian Sales Agents for the Famous "New Century" Separator.

AULTMAN-TAYLOR MACHINERY CO., Mansfield, O.	
Please mail me 1914 Catalog as checked :	
Steam Engine	<input type="checkbox"/>
Separator	<input type="checkbox"/>
Huller	<input type="checkbox"/>
Gas Tractor	<input type="checkbox"/>
What machinery do you need for 1914 ?	
.....	
Name.....	
Town.....	Prov.....

The Aultman & Taylor Machinery Co.

Lock Box No. 64. MANSFIELD, OHIO

BRANCHES: Minneapolis, Minn., U.S.A.; Calgary, Alta.; Regina, Sask., Canada

TRACTION PLOWING

AS TOLD BY THE MEN WHO DO IT

Plowing Harder Than Threshing

My engine is a 25 h.p. International. I have never used it for anything but plowing and threshing. The gang I use is a P & O. This I think is a very good plow, only I find it very bad to clog up under certain conditions when the soil is dry and loose, or when the soil is a little gummy, but this could easily be overcome by putting a larger wheel for the lift.

As I have not used any other make, I cannot tell which make of engine is best, but from what I have seen I think the International Harvester is about as good as any. I think plowing much harder on an engine than threshing for the reason that dust and sand are continually gathering and collecting on the bearings.

As to my idea on the cost of using the gas engine on the farm, this I think all depends on how your engine is run. If your engine is running in perfect time, and in good order and gasoline not over 25c per gallon, I feel certain that they can be run to an advantage, but as to depending upon the engine to do all the farm work, I am afraid the man that does it will make a great mistake. I am speaking about this locality. There may be other places more suitable.

I never kept an exact account, but will give what I think a fair estimation of the cost when plowing. I travel two miles per hour easily, and draw six 14-inch plows. As far as I know, it requires about 30 gallons to plow 20 acres, if your engine is running right and if it is not you might have to double that quantity. Gasoline in this locality costs 26c per gallon.

I like the gasoline engine the best for plowing summer fallow, as a general rule. The horse is a little weary after a long hard seeding, and it is much nicer to see the horse spending a holiday in the pasture than to be spending a couple or three weeks plowing summer fallow, with the temperature at 90 in the shade. As to using the engine for seeding or harrowing, I think it is a failure, at least in this locality, as there is too much sand and dust, and I think it would cost more to keep an engine running through this sandy soil, than it would cost to work it by teams.

As to threshing, I think the gas engine is equal to steam, providing threshing can be all done in warm weather. I am enclosing you a photograph of my outfit at work.

I find the Canadian Thresherman and Farmer a very interesting monthly visitor.

Yours truly,
N. S. Irwin,
Beaver, Man.



Horses Not In It

For the past two seasons we have been operating an engine on our farm with what we consider good success. Our land is very heavy clay, mixed with what is called gumbo. To work it suc-

We estimate the cost of plowing at \$2.00 for breaking and \$1.25 per acre for stubble plowing, and for seeding, we estimate the cost at 35c per acre.

One great advantage traction farming has over horses, is, that it enables the farmer with a small number of men to do a greater amount of work in the season when it should be done. For instance, last spring, we had 55 acres to break and 240 acres of stubble to plow, and 320 acres to seed. Of course we had part of our seeding done before the time of which I speak. Three of us did that work in three weeks, and it would have been utterly impossible with the usual number of horses found on a farm. Our big-

it in the spring and it dies we will prime it again, and it will go, but if a horse dies, we debit loss account. I might also say that our repair bill for the past two years has not exceeded one hundred dollars including batteries.

Respectfully yours,
McElmon Bros.,
Kronan, Sask



Hauling a Success

Your communication to hand requesting my experience in traction cultivation.

From my standpoint this method of tillage is an established success, and in many ways superior to the horses.

My engine is a Rumely OilPull 15-30, a very popular tractor in this district, and I find that it does a full day's work, and does it well. Fuel consumption is very economical; not above 36 gallons per ten hour day being used, and a daily consumption of about 16 gallons of water, which I consider very good for the amount of work done.

We have only two men at work on the outfit, engineer and plowman, and when a man is needed to haul supplies, one man can quite capably handle the work. In connection with the engine, we have a wagon-tank with a capacity of about 500 gallons of fuel oil and 100 gallons of water, thus making the supply of these quite simple. A number of Rumely owners here, last summer, imported 8,000 gallons of engine distillate which gives equal satisfaction to the kerosene, but is much cheaper, being laid down for about 15c per gallon.

My estimated cost for plowing is about 85c per acre, and for the combined operations of discing, floating and harrowing, about 55c per acre. Have done no seeding with the tractor so am unable to estimate the cost.

I do not consider a tractor detrimental to plowed land, at least mine was not. But what would be the result if a heavier machine were used, I am not in a position to say, but do not think any material detriment would be done if extension wheels are used, although we never used them on our tractor.

The tractor is quite capable of handling six 14-inch plows in



"A halt to have a picture took."

cessfully we found that we had to have a large number of costly horses, any one of which was liable to die at any time, so instead we purchased a few horses and a 22-45 h.p. Hart-Parr OilPull engine.

We pull six 14-inch breakers for plowing sod, and fourteen disc plows, each cutting nine inches for plowing stubble, sometimes dragging harrows.

In a ten hour day we use about fifty gallons of kerosene. It required two men steady and an extra man and team about one day a week to haul fuel and water, as we use nearly as much water as oil for fuel.

For seeding with five drills, it requires three men and a team, and we haul five drills.

gest day's plowing was 40 acres in nineteen hours.

We have never done any discing, as all the discing we do can be done by our outfit in about two weeks.

We often hear people say that an engine is injurious to the land, but so far we have not found it so. The most of our land was broken with a heavy steam outfit, and since has been worked by the engine we now have, and produces good crops. Our oats seeded the latter part of May, yielding as high as eighty bushels per acre on spring plowing, and 250 acres averaging seventy bushels, and wheat on summer fallow averaging forty bushels.

Our engine at present is not eating anything, and if we start



IT WILL SOON BE SPRING

WE CAN'T plow in January, but we *can* plan. A little figuring now will help you do your work easier, better and cheaper next season.

Count up the cost per acre to plow with horses. Then figure the saving of plowing with an OilPull or GasPull and you can come to only one conclusion: that you need one of our outfits if your farm is of average size or larger.

Find out about the Rumely Engine Gang and the Sanders Traction Disc and you will convince yourself that one of these plows will be best to complete your spring plowing outfit.

A GasPull or OilPull outfit increases your profits in other ways. With it, you can plow just as deep as you wish and you can prepare the seed bed better. It enables you to work fast so more ground may be planted, if you wish, and your seed put in at just the right time. These things mean better crops.

When you have finished your own planting, you can very likely help someone else and be well paid for your work.

An OilPull or a GasPull cannot be surpassed for threshing power. Either one will do most any kind of belt or tractive work in an economical and thoroughly satisfactory way.

We show some interesting catalogs in another advertisement in this magazine. Ask our nearest branch for the ones you want. Make your plans now. Figure out the matter this winter when there is plenty of time and be ready when spring opens. Let the Rumely man help with your plans. He will be glad to help figure the cost of doing your work with a GasPull or OilPull outfit.

While planning for next season, do not overlook our machines that will help with the work you have to do now. Olds Gasoline Engines and Falk Kerosene Engines with the machines they operate help with the jobs around the barn-yard, shop and kitchen all the year around.

Be Sure to Ask for Catalogs

Rumely Products Company

Incorporated

Power-Farming Machinery

Chicago, Illinois, U.S.A.

Canadian Branches:

Calgary, Alta.; Estevan, Sask.; Regina, Sask.; Saskatoon, Sask.; Winnipeg, Man.; Toronto, Ont.

858

stubble, and five in breaking, but we usually hauled a set of harrows after the plows in stubble, thus making a nice smooth job with the one operation. In plowing stubble, we attached about 15 feet of wire to each plow beam, allowing them to drag in the furrow, this being a great success in burying the stubble, a bug-bear which many farmers have, but which is vanquished in this simple manner.

The second operation we combined discing, floating and harrowing, a procedure which was found very successful in tilling the broken land. We used two sets of double-cut discs, followed by a plank float and finally by two sets of harrows, thus completely pulverizing the soil ready for the drill.

We estimated that we turned over about \$3,200 worth of work at a cost of about \$1,300, thus achieving a net saving of some 60 per cent. All these figures are of course approximate, but I think they give ample cause for my assertion that traction cultivation is a success.

We did some grain hauling with the tractor and were able to draw 500 bushels per trip using four tanks, but we did not do enough to enable us to estimate the cost but think that the procedure is quite practical and indeed one of our prominent farmers hauled all of his grain in this manner, with a Rumely 15-30 engine and drawing 500 bushels to the trip.

This is the gist of the matter as I found it but of course differs with circumstances. However, taking into consideration all factors, a farm tractor is a great boon to all progressive farmers, who desire to get their work done in the shortest possible time, and with the smallest possible expense.

Yours truly,
C. H. Rowe,
Strassburg, Sask.



Runs His Own Engine

Your letter to hand and contents noted. In answer would say, I have only had one summer's experience with my gas tractor so cannot give you any great amount of knowledge along that line. However I will be glad to give my opinion on farming with a gas tractor.

My engine is a 15-30 Fairbanks-Morse oil tractor. I burn on an average of 35 gallons of kerosene per twelve hour day, plowing about 12 acres. My reason for using kerosene is that the engine develops more power with it than it does with gasoline as fuel. I use about two barrels of water per day for cooling and mixing with the kerosene for fuel.

I run my own engine, and hire a man to run the plows and sharpen the shares. As my outfit is only a small one, I do not keep a team with it all the time. I have six horses on my farm, and when I need a tank of oil or water I take a team off the farm. I use one tank of oil for fuel in a week, and one tank of water, so I think it would not pay to keep a team with the outfit, as I can get all the outside work I can do close to home, then there is always some work on the farm that cannot be done with an engine, which makes it necessary to have an outfit of horses.

For plowing, the cost depends on the nature of the soil. In very heavy soil I pulled four plows, and estimated the cost at \$1.80 per acre, but in lighter soil where I could pull five plows, I estimated the cost at \$1.60 per acre. Of course I have to haul fuel oil

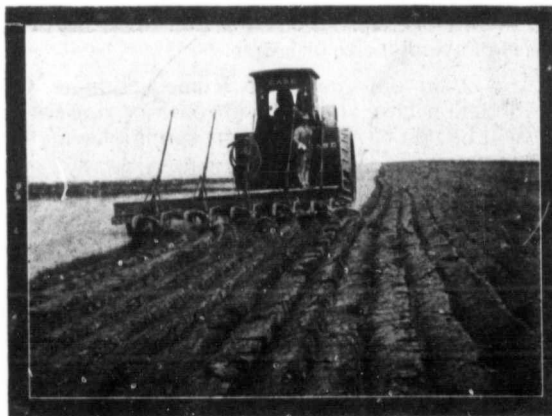

Miles of splendid work.

thirty miles, which adds more cost to the work done with the engine.

When seeding, I hauled three seeders, sowing about 50 acres per day. Of course it being my first experience in tractor work of that kind, I did not understand making a proper hitch so was handicapped in that line. Later I tried two seeders and harrows to cover the amount sown, which worked quite satisfactorily. I think I have a hitch figured out now for this spring's sowing, which will work to a better advantage; if so, I will write you about it after I give it a trial. I think the cost of seeding would be about 35c an acre. I have not done any discing with the engine, only behind the plows. I tried pulling five plows and a disc hitched to the plows, which I think is the proper way to work up new breaking as the disc cuts and packs the fresh plowed land better than it does after the soil becomes dry. Of course this might not apply to all kinds of soil.

I think that an engine does not affect new land that has been broken only three or four years, but only land that has been broken, say ten or twelve years or longer; a tractor if used to work up a summer fallow, may have a tendency to pack the soil too firm to insure a proper seed bed, that is when used throughout the entire season.

Now, I have not been able to write a very extensive letter on tractor farming, but hope that what I have written may help your paper. I will close by saying that I think tractor work is cheaper than horse power, considering the price of horses and scarcity of men to drive them, as two men and a gas tractor can do as much work as five men and 20 or 24 horses.

Yours truly,
W. J. Hughson,
Bryceton, Sask.

Advice for Scrub Land

Dear Sirs: In reply to your letter, would say we have just had one year's experience with a traction outfit. We have a Rumely 25 x 45 OilPull engine, a 33 x 50 Geiser sieveless separator. The largest gang we have had yet was six stook teams and three pitchers, but I think we could keep eight teams and four pitchers pretty busy. We use one barrel of kerosene in a day of ten hours threshing. Our engine is oil cooled, and we use water in the mixture, about a barrel per day.

We have a P & O 8-furrow 14-inch plow, and we pull them all in stubble; we pull six in breaking, we have pulled the eight, but I think six is enough, as we do not like to overload the engine. We have never done any seeding, discing or harrowing. I do not think a tractor detrimental to plowed land; I think it is a benefit in this part, as our land is very heavy and the packing done by the tractor tends to ripen the grain earlier. We broke

some scrub land with our tractor and a John Deere 24-inch Jumbo scrub plow. We plowed right through poplar stumps fourteen inches across the stump. I would advise anyone who has scrub land to break to get a tractor and a scrub plow. We have broken scrub land with horses, but the most of the stumps and roots are left pretty solid unless they are grubbed out, but the traction leaves nothing.

Yours truly,
Christy McNeil,
Foxwarren, Man.



A Small Repairs Bill

Dear Sirs: I own and operate a Hart-Parr engine, 60 b.h.p., and have been well pleased with the results. Last season I plowed 300 acres of stubble and 900 acres of prairie from April 10th to July 1st. I used six 14-inch plows and a packer attached behind the plows. I had two men working, besides myself, and by changing off worked the outfit about fourteen hours per day. Two men were with it all the time, one on the engine and the other on the plows. I averaged twenty acres per day and used from 65 to 70 gallons of coal oil and about 30 gallons of water per day with the coal oil. As the engine is oil cooled this was all the water required.

Kerosene costs us about 18c. per gallon and gasoline 30c., so there is quite a saving by using kerosene and it is more powerful. I consider the cost of plowing was about \$1.00, without my own labor.

I used a team half a day once a week to haul a tank of kerosene. They were working on the farm the balance of the time. The water I drew with a single horse.

My repair bill for the season was less than \$10 for engine and plows.

I have not done any seeding or cutting with my engine yet, but have seen a good bit of it done in this part of the country, and believe that either operation can be done with the engine very satisfactorily and more economically than with horses where the area is sufficiently large. An ordinary engine does not pack the ground enough to interfere with the growing of the grain.

Yours truly,
Charles W. Gibbings,
Rosetown, Sask.



Mrs. A.—I told Willie on his way home from school to get me a bar of soap.

Mrs. B.—Oh, he'll forget it; my boy never remembers.

Mrs. A.—No danger; I said he might buy five cents worth of candy at the same time.

Better, Faster, Easier Plowing



PLOWING is not as simple as it looks to the untried man who watches at the edge of the field. Your experience has taught you that to turn your soil right is an exacting task. You can easily recall difficulties you have had in the furrow.

You are looking for the best plow for your land. Western Canadian soil conditions require certain types and designs of plows. You are aware of that. So have the Oliver Plow Works been aware of that. To western plowing problems they have given special attention. You will find abundant evidence, among users, that

Oliver Plows—Horse Drawn, or Drawn by I H C Tractors—Mogul or Titan

will give you general good service and least difficulty.

No plow has had more friends on the farms of West Canada, for instance, than the Oliver No. 1 Gang. It was built to do the most plowing in the shortest time. It keeps the horses off the plowed ground. Its wonderful lightness of draft—due largely to an Oliver feature, the centre draft principle—the convenience in operation, and other strong points, have made it a favorite plow.

Practically the same design, except for the single bottom, has led to the success of the No. 1 Sulky. And the Oliver tractor gang plows have grown up in Canadian estimation along with Canadian development.

That Oliver-built plows are right and lasting in principle, design and construction, and have given unusual satisfaction, you can realize from the tremendous growth of the Oliver output. Send a card now for a catalogue and full information to the nearest branch house. It is a simple matter and may lead to added profit and satisfaction.

International Harvester Company of Canada Ltd.

WESTERN BRANCH HOUSES

At Brandon, Man.; Calgary, Alta.; Edmonton, Alta.; Estevan, Sask.; Lethbridge, Alta.; North Battleford, Sask.; Regina, Sask.; Saskatoon, Sask.; Winnipeg, Man.; Yorkton, Sask.

XX

The Improvement of Cereal Crops

By SEAGER WHEELER, Rosthern, Sask.
(From Dry Farming Bulletin)

XX

I will now give my personal experience of hand selection covering the last six years. I took up this work at the request of the secretary of the Canadian Seed Growers' association. At this time I had no knowledge of the work, but it appealed to me as I was always particular as to the quality of the seed I used, cleaning it heavily in the fanning mill. I have not regretted the step taken as I have noted a decided improvement each season. At the time I took up this work I was growing a variety of wheat named Preston, a high bred cross between red Fife and Ladoga. At this time this variety was not fixed true to type. Some of the heads had a white chaff, others a reddish chaff, the grains being both yellow and red in color. There was no means of knowing what a head contained as far as the color of the grain was concerned. It was a grand mix-up. Reddish chaff contained yellow grain and red grain white chaff. The first year I made selections for the color of the chaff, selecting the white. After that was fixed true by selections I had to go after the color of the grain. This was done by selecting a double quantity of heads and by rubbing each head out singly by hand. The red grain was saved for the following year seed plot, and the yellow grain discarded. My Preston is now true to color of chaff and grain. This brings me back to what I stated before, that the beginners should commence with as pure a variety as possible and save some years' work.

Good Yields in a Bad Season

Regarding the quality of selected seed: In the year 1909 I had a field of new breaking prepared and made ready for the seeder the year following. I chose one corner of this field for my 1/4 acre seed plot in the spring of 1910. The spring opened up early. Seeding commenced the last of March. After sowing my plot, the rest of the field was sown to the same variety of wheat, but the seed was not selected, but was cleaned up thoroughly by the fanning mill. The grain at the start made a very promising growth, but no rain fell until July 3, three months after seeding. During April and May we had frost on five different occasions which cut the grain down to the ground each time they

came, succeeded by a hot spell during June. Each time the grain was frozen down it came up strong again. In this vicinity, whole fields were completely killed out, not a plant remaining. Many acres which were sown were plowed up at harvest time. My seed plot gave a return of 40 bushels per acre, while two smaller plots alongside sown to two other varieties of wheat (selected seed) gave a similar return of 40 bushels per acre. The rest of the field gave a yield of 28 bushels per acre, while many fields in the vicinity gave yields of six to ten bushels per acre. This was an exceptionally unfavorable season for this district.

Won the World's Prize

In the year 1911 I obtained small lots of selected Marquis wheat from the cerealist of the Ottawa experimental farm, the Rosthern experimental farm, and another source. The two first lots were carefully graded up and separation made of the small and large grains, and were sown side by side but separately. During the growing season there was a marked distinction between the plots sown to the large and the small grains, in respect to the height of the straw and size of heads. The selected seed obtained from Ottawa gave a yield of 80 2-3 bushels per acre and that from the experimental farm at Rosthern a yield of 70 5-8 bushels per acre, while the other lot of small grain gave a return of 45 bushels per acre. All were sown under equal conditions.

Part of these wheats were sent to New York in November, 1911, and won the Shaughnessy prize of \$1,000 in gold. Marquis wheat, which won the prize, is a high-bred wheat, the progeny of a cross made between red Fife and Calcutta red. The cross was made about 20 years ago by Dr. William Saunders, then director of the Dominion experimental farm, Ottawa, but no attempt was made to fix this strain until Dr. Charles Saunders, cerealist of the farm, made selection resulting in Marquis wheat. Today it is the most promising variety grown in western Canada.

In the same year, 1911, my seed plot of Preston wheat gave a return of 53 bushels per acre. The multiplying plot of Preston wheat, the product of the previous season's seed plot, gave a yield of 48 bushels per acre.



TRACTOR IGNITION

Demands Strong, Reliable, Damage-Proof Batteries. Columbia Multiple Batteries are all this and more. They are the most economical source of current

on the market. Get one from your dealer. If he does not handle them, write us and we will tell you where to get them.

We will send you a 32-page book on Ignition, free. It gives you valuable points about finding and remedying trouble in gasoline engines and shows you how to keep your motor running properly. Address mail to

Tractor Department
Canadian National Carbon Co., Ltd.
99 PATON ROAD, TORONTO, ONT.

You saw this advertisement in this magazine. Don't forget to say so when writing.

IGNITION and LIGHTS

We furnish the magneto for ignition and lights for your automobile, motorcycle, gasoline tractor, motor boat or stationary gasoline engine. Either direct current or alternating current types of magnets furnished for every purpose.

Write us today for our catalog and prices.



Henricks Novelty Co.
1504 St. Paul St.
INDIANAPOLIS - IND.

You saw this advertisement in this magazine. Don't forget to say so when writing.

The Trulite

Gold Blast Lantern

The Latest and Best Thing in Lantern Manufacture

Glass will not break, crack, or become smoked.

They give 12 candlepower bright white light.

They burn 24 hours with one filling.

Bowl shaped glass is easily cleaned.

Sold by all Dealers

Manufactured by
Ontario Lantern & Lamp Company, Limited
Hamilton • • • Canada

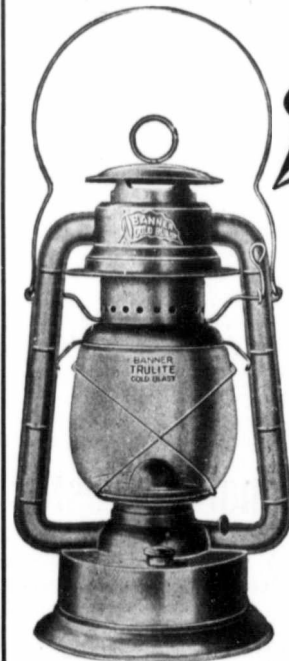

You saw this advertisement in this magazine. Don't forget to say so when writing.

Having taken up the work of selection of barley in 1910, my seed plot of Canadian Thorpe barley, a two-rowed sort, gave me a yield of 54 bushels per acre. O. A. C. barley, a six-rowed sort, gave 58 bushels per acre. This variety is the progeny of a single selected plant made by Professor Zavitz of the Ontario Agricultural college, hence its name O. A. C. The Canadian Thorpe barley took first prize at the Provincial seed fair, also the challenge cup. The O. A. C. barley took first prize at the Provincial seed fair, also medal for the best malting barley in the west. The Preston wheat took first prize at the Provincial seed fair, also, in 1911.

Good Seed Makes Winning Grain

Preston wheat grown in 1912 on the same land that in 1911 gave a yield of 48 bushels per acre, gave a return the following year, 1912, of 30 bushels per acre. I am convinced that I could not have won the \$1,000 prize at New York if I had not been a member of the Canadian Seed Growers' association, and had experience in the selection of seed grain and cleaned the same up thoroughly by the fanning mill.

First prize grain does not come from the threshing machine direct without having been thoroughly prepared, and to grow good quality seed we must sow seed of a good quality for purity. Uniformity counts for a good deal in the eyes of the judge, and you cannot have uniformity unless the grain is pure and sound and graded in the fanning mill. A great number of persons have the impression that all the big prize grains are hand picked. While in some cases this may be a fact, I would say there is no need for this. Grow good seed from good seed, then make the fanning mill do the hand picking by a proper use of sieve, etc. Few prizes will be awarded to grain that has a mixture of other varieties on account of the variation in size, shape and color. By selection this may be avoided.

Regarding the sowing of plump, large, sound grains of a uniform size, I have noted each season an improvement in the beautiful, strong growth of the plant of wheat, oats or barley; the strong, rank leaves of unusual width and the rich dark color; the uniformity of color and stand; the habit of growth, the plants spreading from row to row, and the stooling qualities; all these indicate the strength of the plant. While I am not able to give data in a tabulated form as to result obtained by selection of seed, as this is the work for experimental stations, I can say that the results obtained in my case are extremely gratifying, and they have more than repaid me for the ex-

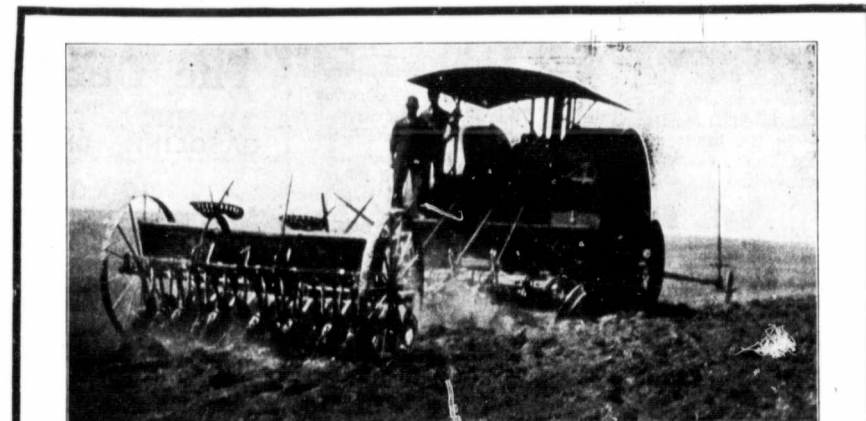

ALWAYS A GOOD TRACTOR
THE BIG FOUR "30"

This Trade-mark, the sign of the *Big Four*, will always be found on a *Big Four* Tractor. Whenever you see this sign of the *Big Four* you will know that it represents a good tractor that year after year has proved its "goodness". It represents a smooth running, practical and enduring tractor. But besides all this, it represents a name that has been built up by always making good.



Macoun, Sask., Dec. 7, 1913.

Dear Sirs:—I think the Big Four "30" is the best plowing engine I know of. I did all my work with my engine. I didn't have a horse in the field all summer. We plowed and harrowed 55 acres and pulled home in two days. Was home a little after sundown. In harvest, we cut 60 acres in 4 hours. We pulled four binders. In seeding, we pulled two double discs, two 11-foot drills, and a 24 inch harrow. We put in 1200 acres of crop altogether. Sixty acres was the best we put in in a day. In threshing, the engine did splendid work.

Yours truly,

ARCHIE A. COULTER.

Govan, Sask., Nov. 27, 1913.

Dear Sirs:—I purchased one of your Big Four "30" engines in the fall of 1911, and have used it for threshing now three seasons and plowed two seasons. The engine has given entire satisfaction and has done everything you claimed for it. We pulled eight 14-inch plows in breaking and 10 in stubble with ease. I recommend the Big Four to any one planning to purchase a tractor.

Yours truly,

D. S. MOLLISON.

MAIL THIS COUPON TODAY

EMERSON-BRANTINGHAM IMPLEMENT CO., (Inc.)
Regina, Sask.

Please send me copy of your latest *Big Four* "30" Catalog.

Name _____ Address _____

You saw this advertisement in this magazine. Don't forget to say so when writing.

tra care and attention given in the selection of my seed.

Results in 1912.

I stated before that my yield of Preston wheat in 1910 was 40 bushels per acre; in 1911, 53 bushels per acre; in 1912, 44 bushels per acre. The season of 1912 was unfavorable to the production of good grain, as continued rains throughout July during the period when fertilization takes place, lowered the yield considerably.

The following are the results of my seed plot of one-fourth acre in 1912: Marquis wheat, 60 bushels per acre; Preston wheat, 44 bushels per acre; O. A. C. barley, six-rowed, 58 bushels per acre; Canadian Thorpe barley,

46 bushels per acre (a quantity was left on the ground on account of being badly lodged); Victory oats, 120 bushels per acre. A single selected head of Preston wheat gave two and one-half pounds of seed in one season.

In 1911 the Rosthern experimental farm sowed a small plot of my Preston wheat in comparison with several other varieties. This wheat stood third in the list of yields, giving a return of 76 bushels per acre, while another similar plot of ordinary Preston wheat obtained elsewhere stood very low in the list with about half of the above yield.

In 1911 I sowed five pounds of selected Marquis wheat and harvested four bushels, 30 lbs. when

cleaned of chaff, etc. After being put through the fanning mill to separate all the smaller grain this was sown last season 1912 and gave a return of 80 bushels—enough to seed 60 acres.

Large Returns From Good Seed

One need not be shy of paying a little extra for good seed, as the returns are large. The following statistics will give the production of small grain for the United States and Canada in the year 1912 in bushels:

U. S. Wheat	690,000,000
U. S. Oats	1,290,000,000
U. S. Barley	209,000,000
Canada Wheat	206,029,000
Canada Oats	376,943,000
Canada Barley	46,500,000

Suppose that every farmer who

helped to produce this quantity of grain, grew selected seed (and it is possible by selection to raise the yield at least five bushels per acre, and in some cases more), what a sum in dollars and cents would be in the hands of the farmer!

If the boys and girls on the farms of Canada who operated the seed plots mentioned in my March article and raised the yield of wheat 10 bushels in three years, and of oats 20 bushels, why should not the farmers of the United States and Canada also do the same?

I have referred to my own case in the increased yield and quality in six years, but I have made no mention of the rest of the work accomplished. I would add that I have, by making single selections of individual plants, obtained entirely new types or strains. Also a red wheat from a white wheat, and a spring wheat out of a winter wheat. I have changed a long grain to a short grain. I have under test about 100 new wheats, on a small scale. I have a variety that ripens one week earlier by the selection of early strains. I have barley that is very stiff in the straw where the same variety lays down when grown on the same land. All these and more are secured by hand selection. These are only a few of the possibilities that lie in the hand of every farmer. All these different types and forms are growing in their fields and may be had by going after them.

Good Rules For Better Crops

In all this work the fanning mill plays an important part, and to be successful we must grade up our seed carefully. Whether selected or not, in conclusion I would mention a few details that should be observed while operating the seed plot:

Secure good pure seed from a reliable source.

See that the seeder is perfectly free from other grain and weed seed.

Treat the seed for smut.

Have the seed bed in as prime condition as possible.

Deposit the seed at a uniform depth.

Make the plot long and narrow.

When the grain is headed out watch for and pull out any foreign variety or plants that are false to the type.

Allow the grain to mature.

Do not select heads when in a damp condition.

Select heads that are uniform to the type, as compact as possible, and well filled from the base to tip.

Place the heads in sacks half full and hang in a dry, airy place until ready to thresh.

Thresh the heads in the sacks.

Methods for Curing Meats

"There is no best way of curing meat. It is largely a matter of taste and judgment. Here is the approved dry cure: For 1,000 pounds of meat use the following compound: Forty pounds of common salt, 10 pounds New Orleans sugar, 4 pounds black pepper, 1½ pound saltpetre, ½ pound cayenne pepper. Weigh the meat and use such part of the compound as that weight is a part of 1,000. Allow the meat to cool thoroughly, and after the ingredients have been properly mixed use half of the amount for rubbing into the meat. Place the meat in a dry, cool place, but never in a cellar. Allow it to remain for two weeks and then rub on the remainder of the cure and let it lie for about six weeks, when it is ready to smoke. Smoking should be done slowly and should occupy from four to six weeks, with very little heat. Slow smoking gives a very delicate flavor. After smoking is finished, wrap each piece in paper, put in an unwashed flour sack and hang in a dry place.

"The brine cure requires exactly the same materials as the dry cure with the exception of the pepper. When the meat is properly cooled it is rubbed with salt and allowed to drain over night. It is then packed in a clean barrel, with the heavier pieces, like hams and shoulders, at the bottom. For every 100 pounds of meat use 8 pounds of salt, 2 pounds brown sugar and 2 ounces saltpetre. Dissolve these in four gallons of water and cover the meat with the solution. The thin sides of meat should remain in this solution from four to six weeks and the ham six to eight weeks. After the meat has been thoroughly cured and dried it may be smoked as in the case of the dry cure."

The above is submitted by President H. J. Waters, Kansas Agricultural College, who believes in every farmer being his own butcher.



"John," said the farmer's wife, "before we start for home, I think I'd ought to have that tooth pulled out. It's ached the whole day." "I know, Mary," replied John dubiously, "but by the time we get that jug filled an' the plug of terbacker, we hain't got much money to spend in luxuries."



Mary had a little lamb,
She fed it kerosene;
One day it got too near the fire.
Since then it's not benzine.

The Dominion Engine

FOR
GASOLINE DISTILLATE KEROSENE

High Grade—High Power

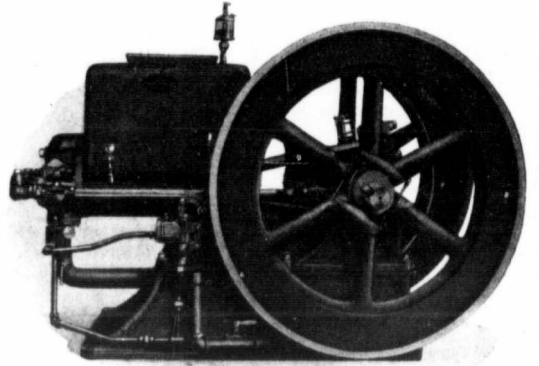

Manufactured by
The North American Machinery Co.

Higgins Avenue, (Near Louise Bridge)

WINNIPEG

You saw this advertisement in this magazine. Don't forget to say so when writing.

LAST AND BEST

IN AN
**All-Purpose
Gasoline
Engine**

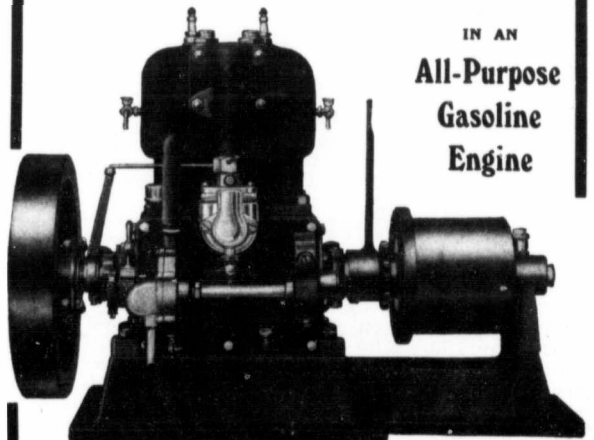

6-8 H.P. 4 Cycle 2 Cylinder

Weight only 325 lbs. Cylinder 4 x 4 inches. Power 4 to 8 H.P. Speed 600 to 900 R.P.M. Fly Wheel 14 x 4 inches.

The remarkable light weight of this engine is obtainable only in this advanced type of construction. With its light weight it is the most compact and convenient engine to handle on the market. Its size adapts it perfectly to every kind of work on the farm. Length of base 29½ inches; height of base, 29½ inches; width, 8 inches and 12 inches; height of base, 4½ inches; to crank shaft, 8½ inches; total height, 24 inches; shaft, 1½ inches.

Also built in special electric light type with double fly wheels. Regularly mounted on wooden skids; includes ignition system, etc., ready for operation. Magneto to order. Get our full specifications.

WRITE FOR DEALERS PROPOSITION AND FULL PARTICULARS
Cushman Motor Works of Canada, Ltd.

202 Chambers of Commerce. Winnipeg

You saw this advertisement in this magazine. Don't forget to say so when writing.

The FARMER'S FRIEND AND HIS WIFE'S FRIENDS

LOWEST IN PRICE BECAUSE MADE IN LARGE QUANTITIES AT LOW MANUFACTURING COST

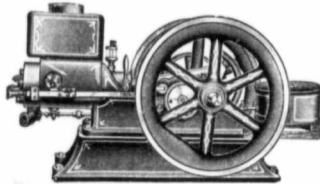

GUARANTEED FIVE YEARS

The DEXTER

The Dexter Double Levers make this machine run One Third Easier than ordinary washers.

Price: Cash with Order, **\$12.40**



FREE. Extra quick detachable belt pulley given with every Dexter.

Stronger Leverage is obtained by having the fulcrum bearing placed at bottom of the lowest hoop instead of middle hoop as in the case of single-lever washers. This gives a most powerful lever proportion as the part above bearing is more than six times as long as the part below.

High Speed is got by large gear wheel running into a small one (under the tub), mounted on the ball-bearing shaft that carries the heavy fly wheel. This gives great momentum and a large part of your work is done automatically. The Dexter Washer gets the dirt and there is no tiresome stooping or bending of the operator.

THE WATERLOO BOY GASOLINE ENGINE

Will run all day without attention, furnish exactly the power you need, maintain a uniform speed and save you money every hour it works.

Use either Kerosene or Gasoline for fuel. Best economist of time and money you can place on the farm.

PRICES FOR CASH WITH ORDER

1 1/2 H.P. Air Cooled Engine	\$ 38.40
1 1/2 H.P. Hopper Cooled Engine	39.20
2 1/2 H.P. Hopper Cooled Engine	56.80
4 H.P. Hopper Cooled Engine	104.00
6 H.P. Hopper Cooled Engine	148.00
8 H.P. Hopper Cooled Engine	209.60
12 H.P. Hopper Cooled Engine	314.50

These engines will all develop from a half to a horse power more than they are rated above.

CHEAPEST POWER FOR EVERY JOB.

The DEXTER Power Washer

Safe Strong Convenient

Price: Cash with Order, **\$22.50**



Built to lift the burden of wash-day drudgery from the shoulders of the busy housewife—and it does it.

Makes Washing So Easy. Just put in hot water, soap and the clothes—start the engine and go about your other household work. When the first batch is washed (taking only about 5 minutes) run it through the power wringer into rinse tub. Then refill machine with soiled clothes and, while they are washing, run the first batch out of the rinse tub back through the power wringer and hang on the line. Repeat this operation a few times and your washing is done.

There is no waiting. Dexter will wash and wring at the same time, or it will perform the operation separately.

The DEXTER Electric Washer

Price: Cash with Order, **\$55.00**

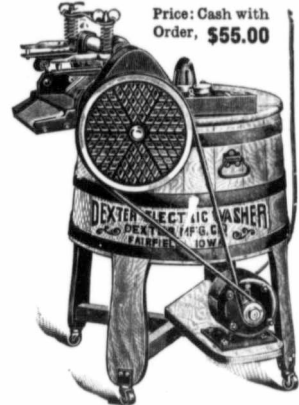

Its absolute safety, ease of operation and substantial construction make a strong appeal to every prospective purchaser.

Admiration is expressed by everyone at the neatness, safety and convenience of this machine. When in operation, one becomes enthusiastic at its marvelously smooth and perfect work, making wash-day delightful. Put in the "dope" switch on the electricity and it is practically all over but looking at it. Absolutely safe, as all moving parts are entirely covered by smooth metal cases. No danger of injury to the fingers—no chance of tearing or soiling the clothes as the Dexter cleans by agitation rather than by friction.

Write for complete literature.

Burridge Cooper Co.

Limited
WINNIPEG and REGINA

You saw this advertisement in this magazine. Don't forget to say so when writing.

A Musical Home

Is your home attractive to you, or do you simply live there because it is just a plain home? Home is only what you make it. If it is dull it's because you may be worried. If it's sunny, it's because you are sunny. If it's dull, there is an offer for you that will bring sunshine into every corner of it. If it's sunny now, you may make it a hundred times more attractive. The new Edison Phonograph makes a palace out of the humblest home—just as it makes the grandest home a place of the strongest attraction.

If you are tired, this wonderful instrument rests you. If you are seeking pleasure, its melodies will give you a world of delight. If true refinement is desired, the Edison gives you the benefit of the highest culture—real culture—that comes with the healthy music. If you are seeking perfect happiness, you will know what it means when you listen to an instrument that drives away all your cares and all your worries and gives you that wonderful pleasure that comes from a perfect voice, the perfect song, the perfect musical instrument.

Laughter and Song

Laughter and song move the world. They make the home. They are the perfect jewels that crown the domestic circle. The Edison Phonograph laughs, it sings, it talks. Its voice thrills you with its beautiful music; moves you with its wonderful singing or sets you off into a roar of laughter with its comical utterances. Where the Edison is, there is no care, there are no blues.

Music appeals to all. The Edison Phonograph is music itself. A child feels its refining influence and enjoys its delight. The young folks take keen pleasure in its waltz, two-step or reel. The old folks get the full joy that comes from songs they love or new things they admire. A happy home—that is what the Edison Phonograph gives. And a happy home is beyond price.

What do you do on a cold winter evening, when the storm blows without? Everything in the house is tight and snug. The fire-place casts a grateful warmth, the lights throw their yellow glow over the faces now smiling

with joy. Reading tires and the conversation lags. What shall we do?

The Edison Phonograph is brought out and, lo! there bursts forth through the house the thrilling strains of a Sousa march. What is your mood? Serious or light? The Phonograph answers. It is a companion who never tires; a friend that never fails.

Suppose you want to fill your home with fun. You have only to pick out from the thousands of records what your taste suggests from a long list of rollicking songs, comical recitations and lively minstrel performances. Every shade of taste is represented, so that you can suit yourself perfectly. If your friends want to dance, you can have a marvelous selection of waltzes, two-steps, reels and jigs. If you want a Sunday service, you can pick the finest sacred music ever written—your favorite hymns. If you want singing, you can get the best of songs by the best of singers. If you would rather have instrument music, the list of

band and orchestra pieces are immense.

Phonograph a Necessity

People who have the Phonograph now say that they could not possibly do without it. It is becoming what you call a necessity, and not an expensive necessity at that. It is not a fad—it never tires. You play the things you like over and over again. If you are tired of them, you have a whole world of new things to choose from.

You can have the Edison Phonograph sent to your home now and it costs you nothing. You know what a happy home will mean to you. If your home is already happy, send for this Phonograph anyway, and make it still happier. Why not have your home the happiest home?



"Oh, dear," sighed her husband's wife, "I can't find a pin anywhere! I wonder where all the pins go to, anyway?"

"That's a difficult question to answer," replied his wife's husband, "because they are always pointed in one direction and headed in another."

A CASE Tip

Consider first the problem of **your** soil. The Case-Racine Automatic-Lift Tractor Gang Plow (formerly called Case-Sattley) produces excellent results in **any** soil—in stony, hilly land, in gumbo, in soil netted with roots of underbrush. Ability to do this is what makes plowing with the Case-Racine Plows a profitable business.

Without taking into consideration the merits of **any** particular type, figure out just what **you** expect of a power plow: Great strength, a construction that eliminates breakdowns; easy adjustment and manipulation, evenness of draft, regular lay of furrow slice, straightness of furrow, evenness of cut—**deep** plowing, hence crop insurance.

The **one** plow that possesses these essentials in a greater degree than any other plow—as proved by the competitive trials at Winnipeg and the Wheatland-Illinois Contest—the plow that not only won the Gold Medal but all the Sweepstakes honors awarded by hard-headed plowmen, was the

Case-Racine Automatic-Lift Tractor Gang Plow



The catalog, just out, describes it in detail, as also the Case-Racine Jr.,—both equipped with our famous Automatic-Lift. Write for the Catalog today.

J. I. CASE THRESHING MACHINE CO.

(INCORPORATED) 741-791 STATE ST. RACINE, WIS., U. S. A.

CANADIAN BRANCHES—TORONTO, WINNIPEG, SASKATOON, REGINA & CALGARY

On Spring Plowing

Motive Power is of equal importance with the plow itself. Case Steam, Gas or Oil Tractors—just which one the fuel supply of your section determines—are head and shoulders "above" the others. Why? Our Catalog tells you. They all have contributed to the prize-winning performances of our plows.

All Case Tractors have the CASE "Clear View Ahead." All possess tremendous reserve power. They will pull more bottoms, and rolling and drilling can be done at the same time. Figure the saving there. The Case Engine, with its reputation for unequaled efficiency, is the seat of this Case superiority, and this is reinforced by the unsurpassed soundness and strength of Case construction.

Whatever the fuel, Case consumes it most economically. It stands up best under the hardest kind of service. When your plowing is done it is ready for other work, earning a continual return on your investment, without repairs, without expensive breakdowns.

Case Steam Traction Engines Case Gas and Oil Tractors



Case Tractors are fully described in our new 1914 Catalog. We welcome your sending for it because it will prove, point for point, Case superiority.

J. I. CASE THRESHING MACHINE CO.
(INCORPORATED) 741-791 STATE ST. RACINE, WIS., U. S. A.

CANADIAN BRANCHES, TORONTO, WINNIPEG, SASKATOON, REGINA & CALGARY

A MAN'S TALK TO MEN By Rev. Dr. J. L. GORDON

Keeping a Secret

THERE is nothing which classes a man so high in the estimation of his friends as the ability to tell less than he knows.



The Hell which is Here

MOST folks believe in the hell which is hereafter, but few have much to say about the hell which is here.



Travelling Abroad

TRAVELLING abroad is great for those who love new scenes and new views. What can be more inspiring than to gaze upon the historical monuments of the past: Great battlefields, ancient cathedrals, and venerable edifices.

"I ought to go with you to Rome, but my difficulty is to appreciate my own little back garden, our copper beech, our weeping ash, our little nailed-up rose tree, and twisting nailed-up creepers. My difficulty is to get all out of that. I think when I have finished

with the back garden I will go as far as Rome!" In another letter he adds these wonderfully fine words: "I have just been down to the end of Church Street to get a blow before settling down for the night, and as I looked at the wild, wintry clouds I had a new feeling of immortality."

Pegging Away

THERE are days when the postman brings us nothing. There are weeks when nothing develops. There are months when not a foot of progress is discernible in any particular direction.

Stand by Your Friends

STAND by your friends. Stand by them when they are right. Stand by them when they are wrong. That's when they need you most.

"Yes," the convict answered bitterly, "but the time a man needs friends to stand by him is when he does wrong."



How Old Are You?

IT is small use worrying about your age. Youth comes but once, and then slips by forever. The wise thing to do is to prepare for the inevitable. Do the thing which will bring a smile to your face about the time the wrinkles are supposed to gather there. Let the silver threads in your hair

and your endowment policy in The Rising Sun Assurance Association, mature about the same time. See to it that when that time arrives in life when physical vitality with most men is low, that your bank account is not in the same depleted condition.



Asking a Blessing

IT is a good deal easier to "ask a blessing" at the meal hour than it is to "act" the blessing in between meals. We have heard men complain about business, grumble about the weather, whine about their own physical condition, enlarge upon the faults of our present civilization, expatiate about the unsatisfactory character of help, and have a sigh concerning the general drift of things the world over and then, sitting down before a noon-hour supply of ham and eggs, thank a "bountiful Jehovah," for all his blessings and benedictions.

It is said that once when Dr. Johnson was about to say grace, his wife stopped him by saying, "Don't go through the mockery of thanking God for what in a few minutes you will declare is not fit to be eaten." I am afraid many of our thanksgivings and prayers are often as superficial as Dr. Johnson's grace.



Infidels are Scarce

INFIDELS are scarce, these days. Most men know enough to know that there is a God and few men of intelligence doubt that Christianity is a regenerating force in the affairs of men. But, ever and anon, you meet a man who cannot look upon religion, politics, society and business through the conventional spectacles of the average man.

"The Great Minneapolis Line"

MINNEAPOLIS

The Line of Satisfaction

SUPERIORITY

MINNEAPOLIS

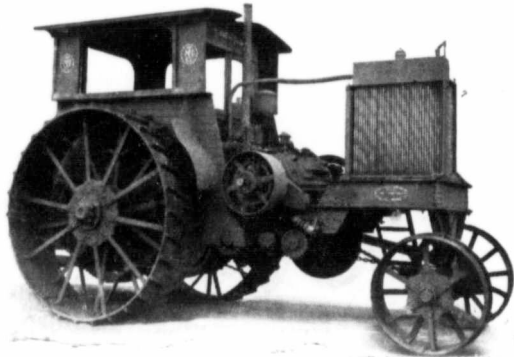

MINNEAPOLIS FORTY

Minneapolis Superiority means Satisfaction. Satisfaction means all the operator can reasonably expect or with conscience demand of a Gas Engine, including full rated horse power, simplicity of operation, economy in fuel consumption, strength and durability.

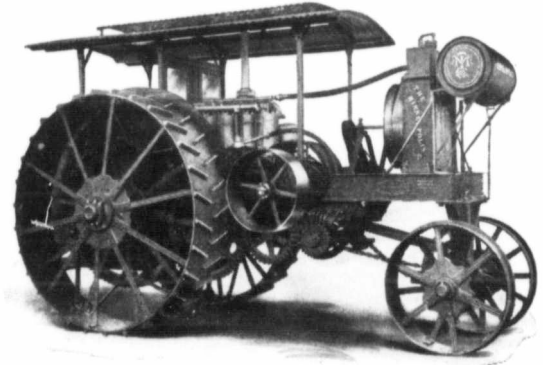

MINNEAPOLIS TWENTY-FIVE

The Minneapolis Twenty-five is one of the first four cylinder farm motors on the market and has a record second to none. Hundreds of satisfied operators sing its praises because it gives satisfaction in the fullest sense.

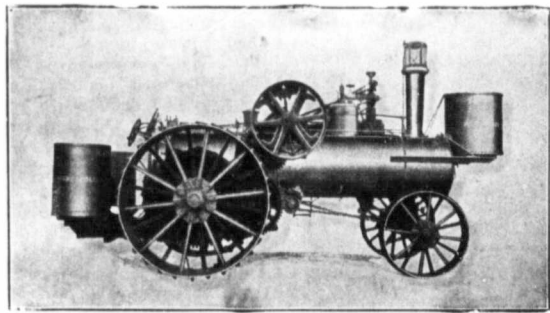

MINNEAPOLIS STEAM ENGINE



MINNEAPOLIS STANDARD SEPARATOR

The old reliable Minneapolis line of Steam Engines and Separators Need no introduction. They lead the world, because they satisfy.

Write us for our beautifully illustrated book of Threshing and Plowing scenes Free.

The Minneapolis Threshing Machine Co.

Hopkins (West Minneapolis) Minnesota

REGINA WINNIPEG CALGARY EDMONTON

You saw this advertisement in this magazine. Don't forget to say so when writing.

14
322
322
322
322
Rising about at time y with out is Watch es and long to ears or 'ime as ternal. n good en the non on days dom," accord- : might ; but I wisest

essing" ct" the e heard rumble ir own : faults e about lp, and drift of g down d eggs, all his

on was him by cery of minutes " I am s and John-

Most t there ligence erating er and k upon usiness of the eculiar, ily im- y they theist," n Hall y room v com- Weiss- glacier, nquiry, yndall, y and y room ouse." tea to le took t, com- rn and ive me assure t these

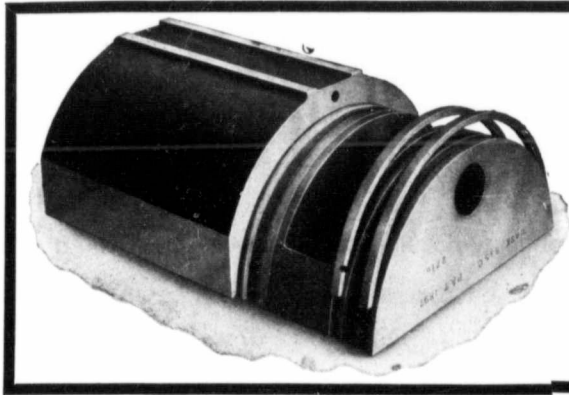

GOULD BALANCE VALVES

The SUCCESSFUL THRESHERMAN of to-day must practice EFFICIENCY—an increase in power of his engine—a saving in the consumption of fuel, water and lubricating oil—the elimination of wear and tear on valve gear, all appeal to him because they are big factors in his profit and loss account.

To these threshermen we have sold thousands of Gould Balance Valves in the last nine years. They are enthusiastic. They know it is a paying investment, because they have tried it. In the "Evidence," on page 40, one thresherman says: "I would not sell my Gould Balance Valve for \$500 if I could not get another."

Send for the Evidence and a copy of our 1914 catalog. A post card with your name and address will bring both books postpaid. Address:

Gould Balance Valve Company,

MANUFACTURERS OF

Gould Balance Valves

Iowa Ensilage Cutters

Gardner Grain Conveyors

KELLOGG, IOWA.

You saw this advertisement in this magazine. Don't forget to say so when writing.

THE International Live Stock Show at Chicago, from 1913 onward, will mean more than it has ever done before to the farmers of the Canadian West. When in 1912 J. D. MacGregor, of Brandon, carried off the grand sweep stakes for fat steers (the most coveted prize of the show) and took with his pure bred herd more prizes than any other herd at the show, everyone in the West rejoiced, but they did so with a sort of feeling that it had just been a kind of lucky happening, without much chance of its being repeated.

Beyond a statement, at the banquet tendered to him in Brandon in 1912, that the calf that was brought into the room would be champion in 1913, Mr. MacGregor said very little of his plans, and though some of his intimate friends knew that the steer was being steadily got ready for Chicago, the public knew little or nothing about it until the steer started for the show. Mr. MacGregor, however, knew what he was about and in his own mind was confident that he had a steer that could beat all comers and his estimate proved correct. Straight through, class after class, from start to finish, the steer was supreme. Hildebrand, the official photographer at the show, the man who ranks next to Reid in the Old Country for the beauty and accuracy of his photographs of live stock, told the writer personally that he had photographed nearly all of the grand champions, and that Glencarnock Victor II was the first that he had not had to retouch his negative. He had, to use the phrase adopted by Goodwin of the Builders Gazette, "no holes in him." Not the greatest professional beauty can have it said of her that she has been photographed and the negative required no retouching. James E. Poole, one of the editors and owners of the Live Stock World, known as "the Dean" of the Union Stock Yards in all

Western Canada at the International

By R. Corn Hlad

matters pertaining to markets and the quality of live stock, and who knows every man in the game from Illinois to Texas and back, said before the judging was done "That is sure some steer from Western Canada." I have been

something more than winning the grand championship with a single steer. He won first for the herd of grade and cross bred steers, which was made up of a calf, a yearling and a two year old. He also won first in a group

advertisement for Manitoba and the possibilities of live stock development. It must always be borne in mind that steers from the West go down to compete not only with steers that are corn fed, but steers that experience little or no hardship and as a rule are highly bred. Moreover, our American cousins are experienced, careful and enthusiastic feeders, and to beat them at the game which they have carried on successfully for so many years, is no light matter.

Not to be Estimated

The value of these wins to the Province of Manitoba in the matter of advertising her possibilities, simply cannot be estimated. The fact that the State Agricultural College of Iowa at Ames asked Mr. MacGregor for the loan of this steer to make a tour of the State, is in itself most significant. Ames College fitted two previous grand champions. They competed both in 1912 and 1913 and were defeated by the black steers from Manitoba. They fitted to win both times and thought they had picked steers of good type to feed. Now they realize that there are some things they have to learn from the Canadian West, and they are determined to learn them. The fact that cattle now go free into the United States adds to the value of these winnings. The man who looks on the Manitoba steer and realizes that he has been largely fed on barley, which, with little more than half the cultivation given to corn, can be made to produce 50 bushels to the acre, is likely to make enquiry as to the lands in such a province, and to be attracted to that province with a view to stock farming.

The Hon. George Brown, Lieutenant-Governor of Saskatchewan, speaking at the banquet tendered to Seager Wheeler, on the occasion of his winning the World's Championship for wheat at New York, said that he be-

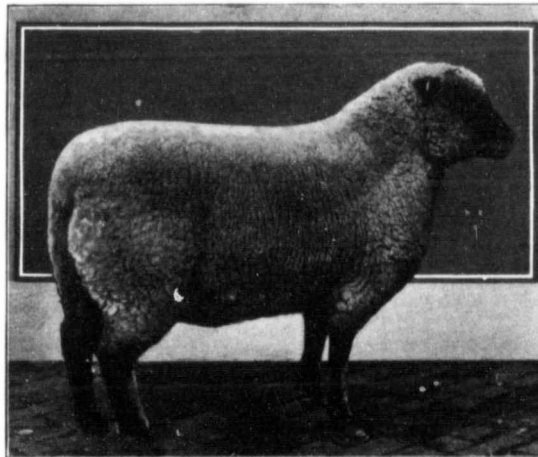

WON BY CANADA.

Grand champion wether of the 1913 International, at Chicago. Shropshire grade wether, bred and owned by J. and D. Campbell, Woodville, Ont.

here ever since there has been a show, and I have never had so many men come into my office and tell me what steer was going to be grand champion. Later, just as the show was closing, Mr. Poole said, "I have not heard a single man question the placing of the Grand Championship ribbons for steers. Glencarnock Victor II is the undisputed and unquestioned grand champion." This is praise indeed, but Mr. MacGregor succeeded in doing

of three, the get of one sire. While Glencarnock Victor I was an evidence of what could be done in the way of feeding with coarse grains, turnips and hay, he was not conclusive. One steer does not make the feeding record of a country any more than one swallow makes a summer, but two grand championships, backed up by the herd prizes, is an advertisement not only for the wisdom of Mr. MacGregor in choosing the right type, but it is an amazing

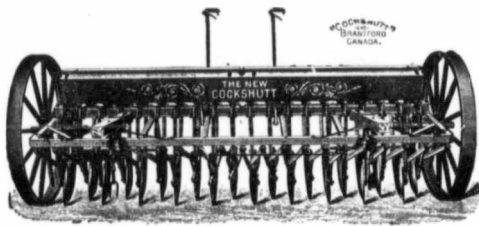

There's a Difference in Drills and the Best Time to Learn about that Difference is Before You Buy

Their difference is important to you because the drill you use will materially affect the amount of crop you harvest. The Cockshutt Drill is the best you could use. It means bigger and better crops. Read these superior features of the Cockshutt Drill:

The Construction

The frame is made of heavy angle steel, securely braced and Hot Rivetted, there are no bolts to work loose and cause trouble. A heavy steel I beam extends from wheel to wheel and is securely fastened to each axle. This beam supports the seed box and absolutely prevents sagging, with the result that there is no binding which would interfere with the regular operation of the feed cups, and the drills always cut an even depth; the seed is planted uniformly, and an even stand of grain is secured.

An examination will convince you that this is the most satisfactory frame ever put on a drill.

There are many other reasons why the Cockshutt is the most satisfactory drill for you to use. Ask us to send you full information, or make it a point to call on the Cockshutt Agent in your district and examine one.

The Discs

The discs are so placed that there is a gradual widening of space between the discs towards the rear, which prevents clogging; consequently they will turn and cut even in wet soil. Stones and trash cannot clog there and stop the revolutions of the discs. Dust-proof, self-oiling bearings are used; when these chambers are once filled with oil the drill can be run an entire season without re-oiling. The furrows opened by these discs have wide bottoms, permitting the seed to scatter out so that large roots may grow and draw plant food from a large amount of soil. The discs are set staggered to ensure their passing over loose sod, or clods, which ordinarily would interfere with their work. Carefully fitted scrapers on both sides keep the discs always clean.

The Feed

The feed is chain driven. This is far more satisfactory than the gear drive because the chain is placed well under the seed box where dirt and dust from the wheels cannot be thrown on it, causing extra wear. The chain drive is the most simple, durable and reliable. The indicators are distinctly marked and are always under the eye of the operator. Set a Cockshutt Drill to sow a certain number of bushels to the acre and you can be sure that is just the amount you are sowing.

FREE We will be glad to mail you on request our complete catalogue giving more information about Cockshutt Farm Machinery. This catalogue is fully illustrated and contains information you should have before you buy any new implements. Write for it today.

COCKSHUTT PLOW CO., LIMITED

Branches: Winnipeg Regina Calgary Saskatoon

Distributing Points: Red Deer, Lethbridge, Edmonton, Brandon, Portage la Prairie

You saw this advertisement in this magazine. Don't forget to say so when writing.

believed this win by Mr. Wheeler had added five dollars an acre to the value of every acre of land in Northern Saskatchewan. It is not too much to say that Mr. MacGregor winning the Grand Championship for fat steers at the International Show at Chicago, has really added an equal amount to the value of every acre of land in the Province of Manitoba. Manitoba has been sadly neglected by those who ought to have done most to bring her advantages before intending settlers. There is an abundance of splendid land uncultivated, the whole province is within easy reach of the biggest market west of the great lakes, and in future it will not be that everyone coming from the United States hurries through Manitoba to Saskatchewan and Alberta, but they will stop in Manitoba to at least look into the possibilities, and having done that fairly and honestly, in nine cases out of ten, the intending settler will buy his land in Manitoba.

One man, who farms somewhat extensively in Nebraska, was asking questions about Manitoba after the win had been declared, and when he found that even with very inferior cultivation and planting it on dirty land, the average yield of barley for Manitoba for the past 20 years had

been 35 bushels to the acre, and that this land could be bought at the present time from \$25.00 to \$45.00 an acre, said, "Why have we heard nothing about this land

poses. It is the long haul that takes the bloom off finished steers, and from what I can learn you can get your steers in from any point in Manitoba to the Winni-

It is more than probable that Mr. MacGregor's wins have turned the tide of immigration, or at least a portion of it, towards Manitoba. The three provinces can all produce the feed and the same healthy and hearty type of steer, but when it comes to marketing, Manitoba still has the supreme advantage in being within such easy distance of Winnipeg. As the three provinces develop, the markets at Edmonton, Calgary, Regina and Moose Jaw, will more nearly approximate that of Winnipeg, but in the meantime at least Manitoba has the advantage, and J. D. McGregor more than any other man, has brought that to the attention of the intending American emigrant.

Saskatchewan Horses

The Department of Agriculture of the Province of Saskatchewan is to be warmly congratulated in their enterprise in assisting the various breeders to assemble and

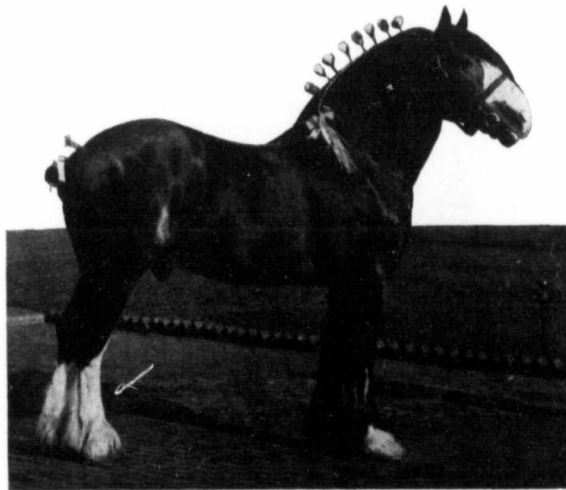

Fyvie Baron, Grand Champion Clydesdale at International, Chicago, 1913. Owned by Conyngnam Bros., Wilkesbarre, Pa.

before? We have had agents all through our state singing the praises of Saskatchewan and Alberta, but from the stock feeders standpoint there can be no comparison in the value of the three provinces for feeding pur-

poses. I have three sons whom I was thinking of sending to Alberta, but since I have looked over these steers and find what they have been fed on, I am going to insist on my sons seeing Manitoba first."

QUALITY SEEDS

Farmers who are particular about the quality of the seeds they sow will be interested in our advertisement on page 63 of this paper.

The Mooney Seed Co. Ltd.
"Seedsmen to men who care."

Mention this magazine when writing advertisers.

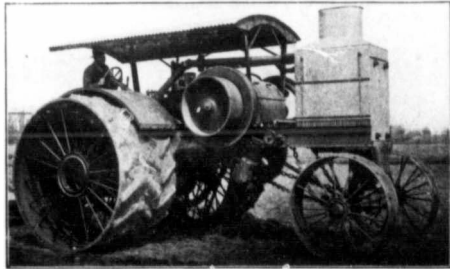

**As an Aid to Farm Prosperity
THE
FAIRBANKS TRUCK SCALE**

Why take the other man's word? No man is infallible. Mistakes are bound to occur. Check up for yourself! By the use of a Fairbanks Scale you can know to a pound how much you deliver or receive. Modern business—and present conditions, more especially—compel attention to the small leaks; a Fairbanks Scale will pay for itself by eliminating them.

FAIRBANKS PITLESS SCALES

Comprise the same efficiency on a larger scale. We have a plan by which several farmers can combine to buy one of these on a joint ownership. Write for details.

Ask us for Booklets on the lines in which you are interested.

The Canadian Fairbanks-Morse Co. Limited

WINNIPEG REGINA SASKATOON CALGARY
Montreal St. John Ottawa Toronto Vancouver Victoria

THE farmer who reads needs little argument to convince him of the Tractor's place on the farm. His main object now is to decide what Tractor will best meet his needs.

**The Fairbanks-Morse
OIL TRACTOR**

enjoys a unique preference amongst all who have made closest study of the subject.

In the first place, it uses for motive power the **cheapest grades of fuel oil** instead of expensive gasoline. This feature alone saves the owners of a Fairbanks-Morse Oil Tractor hundreds of dollars during the life of the machine.

OTHER POINTS ARE:

- SIMPLICITY.**—Practically every owner of a Fairbanks-Morse Oil Tractor operates it himself.
- ACCESSIBILITY.**—Pistons, valves, etc., are easily removable without disturbing other parts.
- STARTS ON COMPRESSION.**—No pulling on fly-wheels; one man starts any Fairbanks-Morse Oil Tractor promptly and with ease.
- RELIABILITY.**—Fairbanks-Morse Oil Tractors will operate under any weather conditions.
- FAIRBANKS-MORSE OIL TRACTORS ARE BUILT TO LAST!**—Extra heavy brand shafts, connecting rods and engine moving-parts ensure long life to the engine with light repair bills.

Write to-day for our Booklets, and compare Fairbanks-Morse specifications with those covering any other tractor on the market.

We Manufacture

- Fairbanks-Morse Oil Tractors, 15-30, 20-40 and 30-60 H.P.
- Oil Engines, Portable and Stationary, 1 to 500 H.P., for all purposes.
- Marine Engines, 2 to 4 Cycle, 3/4 to 100 H.P.
- Binder Engines, adapted to all makes of Binders.
- Hand and Power Pumps for every purpose.
- Truck and Pitless Scales, specially designed for farm use.
- Electric Lighting Plants, suitable for country residences.



You saw this advertisement in this magazine. Don't forget to say so when writing.

send to Chicago an exhibit of 20 Clydesdale horses, the major portion of which had been bred in Saskatchewan. The horses were "in the money" in every class in which they were entered, and they created a very great deal of interest and made a strong impression. Three first prizes, six seconds, three thirds, and so on down the line is a mighty good record. Clydesdale horses are not so popular in the United States as are the Percherons, but within the past few years, several millionaire Americans of Scotch descent, have taken up the matter of Clydesdale horses, put in extensive breeding studs, and are doing all in their power to popularise the breed. Among these men are the Conyngham Brothers, Wilkesbarn, Pennsylvania, and the Fairholme Farm, Newmarket, N.J. These men are in a position, not only to pay any price they feel inclined to for horses, but they are in a position to pay very fancy salaries to expert breeders and feeders. To come in competition from the States from such stables as these, and get away with the money is something of which Saskatchewan may well be extremely proud.

Among the aged stallions in a class of 35, Prince Robert, a Saskatchewan bred horse, was beaten for first place by Fyvie Baron, a Baron's Pride horse, was imported from Scotland, and for



J. R. Campbell, Sutherland, Scotland, foreign Judge at the 1913 International.

which they are rumored to have paid \$6,000. The champion mare, Harvoustoun Baroness, was also imported. No championships were carried off by American bred horses. One of the things that was

not only much admired, but also very much commented upon, was the speed and style with which the Western Canadian horses travel. Not one of those sent down was a bad mover, and comment around the ring side was very strongly in favor of the Canadian horses on this particular count. They were also very superior in the matter of legs and feet. This exhibit and the success of it, will also stimulate those who are in the horse breeding business to come to Saskatchewan to do it. The fine climate and the fact that the horses spend so large a portion of the year in the open, gives them healthy, sound and well developed frames, from which may be built up the very highest type of draught horse. In speaking of the very gratifying success of Saskatchewan in exhibiting horses, it may not be out of place to say a word of warning to the Western breeder not to sacrifice everything to feet and legs, but to get a little more body on his horse. This is the only objection which can be raised successfully against Clydesdale horse breeding in Canada.

Sheep

Not only did Western Canada give so good an account of herself at Chicago, but Eastern Canada in horses and sheep, more particularly the latter, kept up her reputation. John Campbell carried off the sweep stakes grand championship for fat wethers, with possibly as fine a type of sheep as has ever come into the Chicago show rings. Ontario had many other winnings in sheep, and the Graham Bros., of Claremont were also successful exhibitors of Clydesdales.

Altogether Canada was very much in evidence at the International, and made so good a showing that they will no doubt bring excellent results in the line of an increased flow of immigration.



Mother—Tommie, did you set the old hen?

Tommie—Yes, mum.
Mother—How many eggs, Tommie, did you put under her?

Tommie—Sixty, mum.
Mother—Why, Tommie, what did you do that for?

Tommie—Oh, jist to see the old critter spread herself.



1914 A Bigger Year

THE figure in the date line has increased; three has changed to four. Plan a greater year for yourself. Let our machines increase your crops, your profits, and your satisfaction.

We are better able to serve our customers now than we were last year. Our machines have been improved, and we are better able to take care of them than we have ever before been. We believe you should select your machines from our three big lines. Do not buy on our say so, but you

owe it to yourself to find out all about our machines before you place your order.

You should have one of our catalogs when you take up the question of spring plowing outfits, threshing outfits, or of other machines for next season. The Advance line catalog, the Rumely line catalog and the Gaar-Scott line catalogs which we show at the top of this page, give complete descriptions, specifications and equipment of the machines in our three principal lines.

Along the side of the page we

Indiana School of Tractoreering

Traveling Courses

Held in co-operation with Rumely Products Company, Inc., at the following points:

- Calgary, Alta. Feb. 23 to March 7
- Estevan, Sask. Feb. 23 to March 7
- Regina, Sask. Feb. 26 to March 7
- Saskatoon, Sask. Feb. 9 to Feb. 21
- Winnipeg, Man. Jan. 12 to Jan. 24

Arrange to take the course at our nearest branch and get maximum results from your tractor.

show other interesting booklets. The OilPull catalog and the GasPull catalog give more detailed information concerning our tractors than that given in our line catalogs. The All Around Power Plant and Power-Farming are not catalogs. The All Around Power Plant is a farm engine text book. Power-Farming gives valuable tractor information.

POWER-FARMING MACHINERY

We Can Furnish the Sizes for Your Work

- | | |
|---------------------|----------------|
| Kerosene Tractors | Silage Cutters |
| Gasoline Tractors | Grain Graders |
| Steam Tractors | Pump Jacks |
| Gasoline Engines | Feed Mills |
| Kerosene Engines | Grain Mills |
| Steam Engines | Grain Dumps |
| Engine Gang Plows | Saw Mills |
| Traction Disc Plows | Saw Rigs |
| Grain Separators | Power Pumps |
| Oil Tanks | Power Hoists |
| Water Tanks | |

Our testimonial folders explain what our machines have done for folks farming under the same conditions as those under which you farm. We have a folder for each section. We can very likely send you one that contains letters from farmers near you.

Ask our nearest branch for catalogs. A post card will bring the ones you want. Talk to owners of our machines who live near you. If

you have work that is costing too much or that is taking too long, ask the Rumely man to explain how our machines will help.

We wish you a happy New Year, and if good machines and good service will do it, Rumely machines and Rumely service will make the New Year happy and prosperous for you all the year round.

Rumely Products Company

Incorporated

Power-Farming Machinery

Chicago

Canadian Branches:

Illinois, U.S.A.

Winnipeg, Man.; Regina, Sask.; Brandon, Man.; Edmonton, Alta.; Saskatoon, Sask.; Calgary, Alta.; Estevan, Sask.; Toronto, Ont.

PRACTICAL TALKS TO THRESHERMEN Talk No. LXXVI.

Conducted By PROFESSOR P. S. ROSE

Note.—The term "gas engine" in these lessons will be used indiscriminately in speaking about all internal combustion engines.

THE transmission system of a tractor comprises all those parts by means of which power is transmitted from the engine to the drive wheels. It includes the clutch, counter shaft, change speed gears, differential gear, driving pinions and drive

and style are used on tractors, but the simplest in construction and one quite generally used is the internal expansion clutch similar to those commonly used on steam tractors. In this style of clutch there is a heavy fly wheel whose internal face is turned smooth and

rim of the fly wheel by means of suitable toggle levers, thus locking the two members together by frictional contact.

Two forms of this clutch appear in figures 169 and 170. In the former, the shoe arms are counterbalanced with weights on the ends of the shoe arms opposite the shoes, for the purpose of overcoming the centrifugal force of the shoes and making it easy to release the clutch. The block on the right of the wheel is a brake to stop the belt wheel quickly in case of accident to any of the machinery that it drives. Figure 170 is a clutch of somewhat similar form used on a tractor in which the engine shaft is set parallel with the frame. The fly wheel is bolted to the engine shaft at A, while the expanding part of the clutch is rigidly attached to the transmission shaft.

also the rim of the fly wheel is turned on the inside to fit a solid cone keyed to the transmission shaft, while the fly wheel itself is keyed to the engine shaft. The fly wheel rim must be made extra strong to withstand the stress imposed upon it because it is made smaller in diameter than the wheels of the other kind of clutch. Both transmission shaft and engine shaft are in line with each other and are connected by means of the frictional contact between the two members of the clutch. The cone part of the clutch is generally faced with leather or asbestos in order to increase friction. The elements of a clutch of this kind appear in figure 172.

The multiple disc clutch, which is used so extensively on automobiles, also finds considerable favor with tractor designers. In this style of clutch the frictional

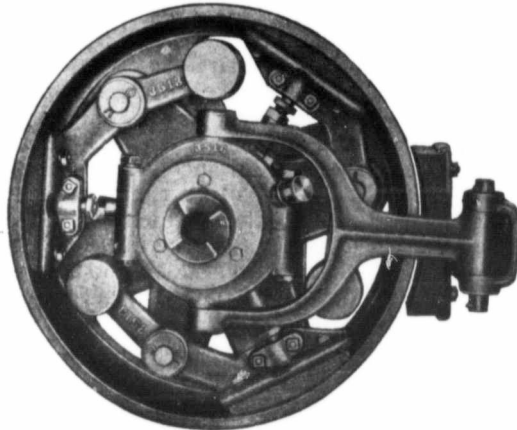

Fig. 169. Clutch used on Avery tractor.

gears, together with all necessary levers by which any of the parts are operated.

The first of these to be considered is the clutch. It would be difficult, awkward and dangerous to have to start a gas engine geared directly to the driving gears and so some means must be provided whereby the engine may be started free and then afterwards connected with the transmission mechanism. This is accomplished with the clutch, which enables the operator to apply the load gradually thus relieving the motor and gearing of all shock.

The clutch is built in two sections, each of which may contain a number of parts. One section is attached to the engine shaft, the other to the transmission shaft. When the clutch is thrown in, the two parts of the clutch engage through frictional contact which provides for enough slippage to start the machine in motion gradually. If an attempt were made to start a heavy tractor with its load by suddenly applying the power, there would be grave danger of stripping some of the gears, breaking a shaft or of stopping the engine. There is even more necessity for using a clutch on a tractor than on an automobile and in either machine it is indispensable.

Clutches of almost every kind

either made cone shaped or cylindrical. This wheel is attached to the engine shaft, while on the transmission shaft there is mounted a pinion to the hub of which there is attached a number of arms carrying wooden shoes on their outer ends which are made to press firmly against the inner

Figure 171 shows another form of internal expanding clutch with driving pinion attached. In this case the fly wheel is keyed to the engine shaft and runs when the engine runs. The clutch arms and pinion are free on the shaft and revolve only when the clutch is locked to the fly wheel. This is identical with steam tractor construction.

The friction cone clutch used on a few tractors is a modification of the internal expanding clutch already described. In this case

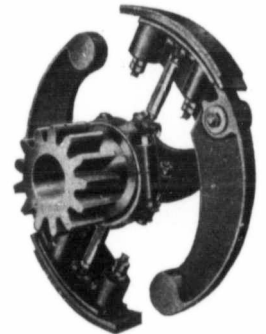

Fig. 171. Style of clutch used on Nichols & Shepard tractor.

surface is larger than in any of the other clutches described and is distributed over the surfaces of a number of thin discs of steel.

The effectiveness of the disc clutch can easily be demonstrated by pressing a disc of pasteboard between the two discs or a dollar between a couple of half dollars and trying to move the middle coin. It will be observed that only a slight pressure is necessary to clamp the inner one quite firmly. If the discs are perfectly smooth and true they hold even better than the rough coins. This, then, is the principle upon which the disc clutch works.

The two members of the multiple disc clutch consist of a number of thin plates, half of which are attached to a flange bolted to the engine shaft, the others fastened to the transmission shaft. A strong helical spring presses the two sets of discs together when the clutch is engaged,

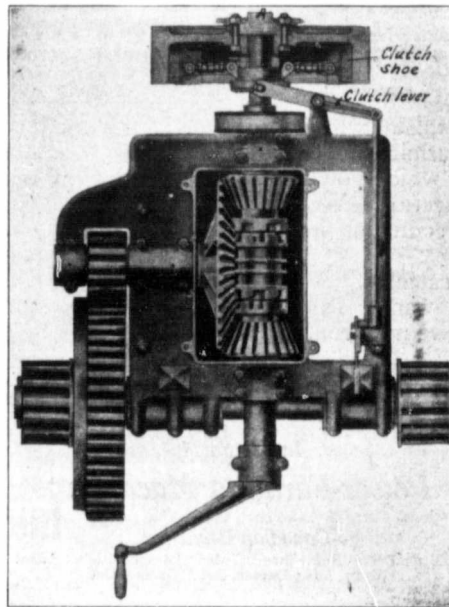

Fig. 170. Clutch and transmission of Twin City "40" tractor.

Continued on page 54

PLAY A SAFE GAME

Your interests demand it.
The interests of your customers demand it.
You cannot afford to take too many chances.
You don't have to.

In buying an Engine, a Thresher or a Tractor, buy the best you can.

Don't try to save a few dollars and get yourself in wrong.

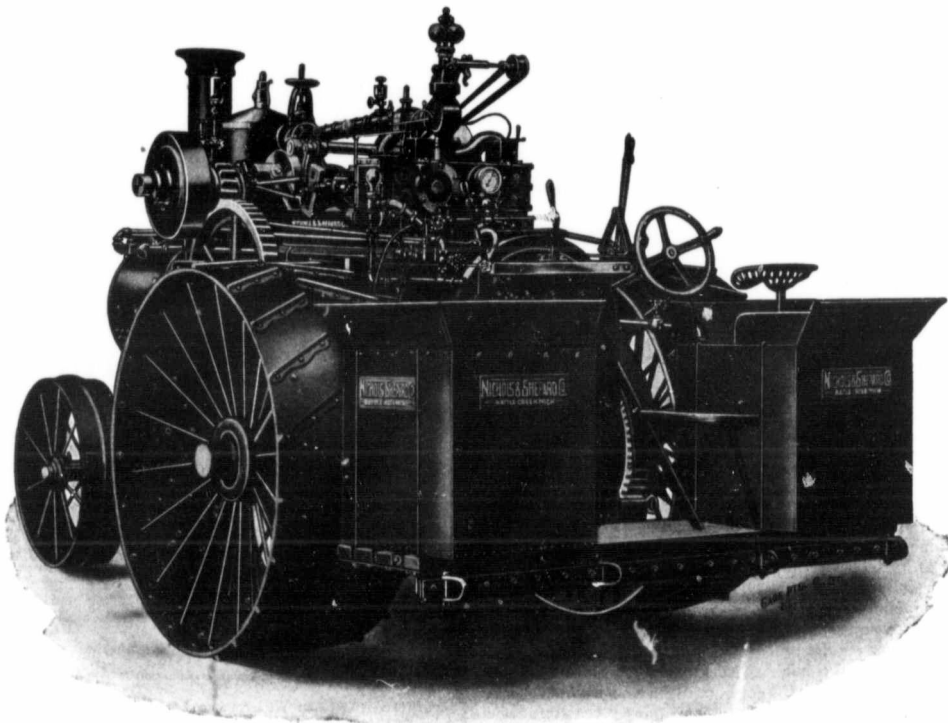

Nichols-Shepard Big Double Cylinder Plow Engine

The old reliable Red River Special Line has always consisted of honest goods, honestly made.

A company that has been in continuous business since 1848 is behind it.

Sixty-five years of effort to produce what the thresherman wants and needs.

All the thought and effort of those years concentrated upon Traction Engines and Threshers.

No other line bothered with.

A large force of specialists trained to produce that which is best adapted to the threshing business.

Get right by buying your machinery from a good, strong, reliable company that is putting its whole effort upon threshing machinery.

You make more money with such machinery.

You have less break-downs and less trouble.

You give the farmer, your customer, more satisfaction.

You save his thresh bill with the Red River Special Line.

He knows it and wants you to equip yourself with that line.

It leads and you are safe in buying it.

Mr. Reinhold Spangenberg of Elgin, North Dakota, says under date of June 26th, 1913:

"The 30 Horse Double Steam Engine we bought of you in 1911 worked fine in plowing. We plowed 20 acres in twelve hours, and the 10 plows were nothing for it. We are well pleased with our engine."

Send for catalogues and printed matter fully setting forth its great advantages.

NICHOLS & SHEPARD COMPANY BATTLE CREEK, MICHIGAN

In continuous business since 1848

Builders of the Red River Special Threshers, Steam and Oil-Gas Tractors, Wind Stackers, Self Feeders and all attachments

Canadian Branches: WINNIPEG, MAN. REGINA, SASK.

You saw this advertisement in this magazine. Don't forget to say so when writing.

The Thresherman's Question Drawer

ANSWERS TO CORRESPONDENTS

Q. F.G. I am running a 20 horse power steam traction engine belted to a feed mill. The engine runs at 225 revolutions per minute and steam pressure varies from one hundred and twenty to one hundred and forty pounds. The engine has plenty of power and I run it with the reverse lever hooked up in the first notch from the center. I am thinking of buying a gasoline engine to run the feed mill and would like to know how large an engine I should buy. Also advise me which would be the cheaper to operate, the steam engine with coal at five dollars per ton or the gas engine with gasoline at sixteen and one-half cents per gallon and kerosene at eight cents. It requires two men to operate the mill and I thought if I got a gas engine one man could do the work. Would you advise making the change?

A. With the reverse lever hooked up in the first notch from center the engine will probably develop about 20 horse power at the brake when fully loaded or possibly a little more. It is evident that 20 horse power is as large as you would ever require to run the mill and we should think a 15 horse power gasoline engine would probably do the work acceptably. You do not state the size of the mill and so we can only make a rough guess. We know that most of the feed mills are advertised to run with from 12 to 15 horse power. Estimating that you use a maximum of 15 horse power it would require about sixteen or eighteen gallons of gasoline in ten hours or if you purchase a kerosene engine, about twenty gallons of kerosene the way most of the kerosene engines run. Knowing the amount of coal you use and the prices of kerosene and gasoline you can easily figure whether the gasoline engine would be a saving or not. We should think it would show not only a saving in the fuel of about two dollars a day but a saving in the wages of one man. There are a number of engines at the present time that will successfully burn kerosene. Nearly all of them have to be started on gasoline and after they come up to speed and get warm the gasoline is burned off and the kerosene is used until within a few minutes of stopping. You should be careful if you purchase a kerosene en-

gine that it is properly fitted up for using both kinds of fuel and also that it has a water spray.



Q. M.S.K. What is the total pressure to the square inch in a boiler when the steam gauge registers one hundred pounds plus the atmospheric pressure, which amounts to 14.7 pounds at sea level? M.S. says that this is wrong and that the pressure in the boiler is exactly what the steam gauge shows and no more. M.C., on the other hand, contends that the 14.7 pounds pressure was in the boiler to begin with—before steam was raised, and that it remains after steam rises and adds that much to the steam pressure.

2. What does my book mean when it asks the question: "What pressure does an ordinary steam gauge register? and it answers, "pressure above the atmospheric pressure of 14.7 pounds per square inch." Will a condenser save anything when used in connection with an engine?

A. 1. The absolute pressure per square inch in a boiler when the steam gauge registers one hundred pounds is one hundred pounds plus the pressure of the atmosphere which is 14.7 pounds when the barometer stands at 30 inches.

2. Atmospheric pressure is practically everywhere and is exerted both on the outside and on the inside of a boiler. The effective pressure in such a boiler where used with an ordinary non-condensing engine is just what the steam gauge shows. If a condenser is attached it reduces back pressure by allowing the engine to exhaust into a partial vacuum instead of against atmospheric pressure. The removal of back pressure amounts to the same thing as adding forward pressure and so the power of the engine is increased because the average forward pressure is increased.

Your book is correct. The steam gauge registers steam pressure only and takes no account of the pressure of the atmosphere. A steam gauge on a cold boiler registers zero, while at the same time there is about 14.7 pounds air pressure in the boiler.

We Sell More "DREADNOUGHT"

Sewn-Canvas Thresher Belts Than any other Concern in Western Canada



Manufactured in England from the Highest Grade Cotton Duck to specifications called for by the Western Canadian market. Perfect satisfaction guaranteed. We are the sole importers and carry a large stock. All our belts are seasoned with non-freezing oil and therefore will not harden in cold weather.

Write at once for our samples. If your dealer does not handle our belt ask him to get it.

Dealers Wanted Everywhere. General Supply of Canada Ltd. 85 Water St. Winnipeg. Ottawa, Toronto.

You saw this advertisement in this magazine. Don't forget to say so when writing.

They Win Their Way Because They Pay

The Baker Balance Valve

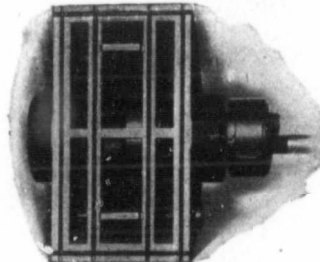

is a wonderful improvement on any style of slide engine. Saves Fuel, Oil, and Water, and increases power of engine greatly.

Statement of J. W. Partridge—"I had ten of the Baker Valves on my territory last season and did not have a single complaint. In fact, every man was more than pleased with them. Engines used less

water and steamed much easier. A child could reverse engine under full head of steam."

AGENTS WANTED: We have a good proposition to offer you.

The Gray Adjustable Exhaust Nozzle

is a great improvement on anybody's engine. Can regulate exhaust to give proper draft without causing back pressure on engine. Can be adjusted to any load. AGENTS WANTED.

YOU WILL NEED A MORRIS IMPROVED BEADING TOOL



before you start to work. You can't afford to be without one. AGENTS WANTED.

SOLD BY THE Baker Valve Co. 100 JAMES STREET WINNIPEG MAN.

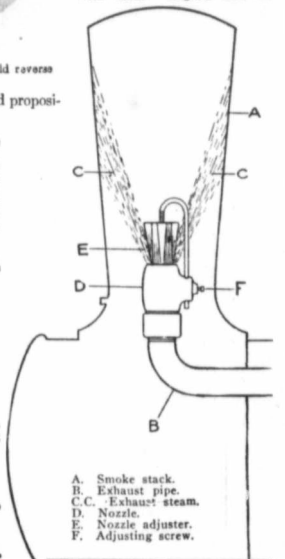

A. Smoke stack.
B. Exhaust pipe.
C. C. Exhaust steam.
D. Nozzle.
E. Nozzle adjuster.
F. Adjusting screw.

You saw this advertisement in this magazine. Don't forget to say so when writing.

Q. A.G. Would like to have you tell me what dead center is meant by crank end dead center. Is it when the crank pin is on the center farthest from the cylinder? Please tell me where I

could get some information about setting a piston slide valve.

A. The crank end dead center in which the crank is the farthest from the cylinder. A piston slide valve is set just exactly like the

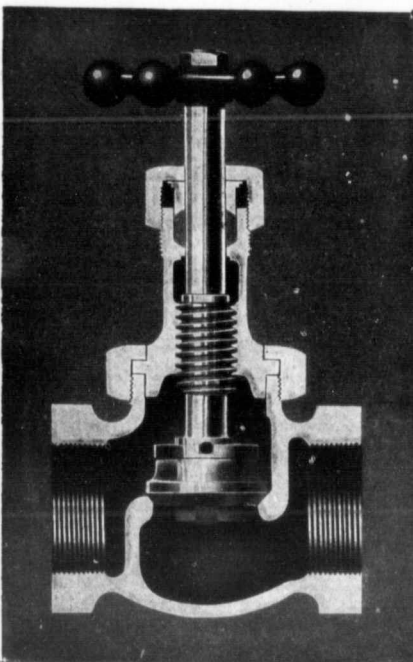

"Without an Equal"



Regrinding Brass Valves

Guaranteed for 200 lbs. steam pressure and approved by and registered in the provinces of Ontario, Alberta and Saskatchewan for the above pressures.

*"The Valves That Give
The Service"*

And Specially Designed for Western Conditions. Specify them if you want
VALVE SATISFACTON

STOCKED BY ALL LEADING JOBBERS AND DEALERS

MANUFACTURED BY

Penberthy Injector Co., Limited, Windsor, Ontario

You saw this advertisement in this magazine. Don't forget to say so when writing.

plain slide valve, in fact, it is a plain slide valve rolled up in cylindrical form. Lap, lead and all those things are just the same as in the flat valve.



Q. J.S. 1. How would you set a valve on a link reverse engine, that is, the kind of reverse used on the Gaar-Scott engine? Can you give an illustration of same?

A. The following directions, which we have copied from Traction Engine Troubles, explain how to set the valve on the Gaar-Scott engine:

1. Adjust the length of the reversing rod so that when the reversing lever is in the middle notch, the lower end of the bell crank lever stands vertically below the pivot.

2. Put the engine on the crank end center and rotate both eccentrics until one stands with its throw vertical above the shaft, and the other is exactly opposite. Fasten them with the set screws lightly.

3. Connect both eccentric rods with the rods parallel, making their length as nearly equal as possible, so that the link stands vertical with the block in the middle.

4. Turn the engine over slowly and notice if the valve stem strikes the end of the steam chest. If it does, shorten both eccentric rods.

5. Put the engine on the other dead centre, throw the reverse lever over to one end of the quadrant, and place the valve as nearly central over the ports as possible and fasten it in position.

6. Turn the eccentric, in line with the valve stem, completely around, and note if the valve uncovers one port as much as it does the others; if not, move the valve on its stem until it does.

7. Reverse the engine and turn the other eccentric completely around the shaft. If the valve does not, uncover both ports equally, change the length of the eccentric rod now in line with the valve stem until it does.

8. Now rotate the eccentric in line with the valve slightly past center until it gives the valve one thirty-second of an inch lead. Fasten the eccentric in place. Reverse the engine and do the same with the other eccentric.

9. Put the engine on the opposite dead center and note if the lead is the same; if not, correct half of the error by changing the position of the eccentric and the other half by changing the length

of the eccentric rod. Reverse the engine and do the same if necessary. Check results by putting the engine on the other dead center.



Q. E.E.T. 1. Would like to hear from some of the brother threshermen who have had experience with adjustable sieves, if they consider them as good as the round-hole sieve.

2. What is the gain in power, also the saving of fuel and water in compounding a simple engine? The working pressure is 160 pounds, size of cylinder 9 x 11, speed 220 revolutions.

A. 1. The consensus of opinion of all the threshermen we have talked with is that the adjustable sieve is entirely satisfactory and fully as good as the round hole sieve for nearly all conditions. This also squares with the writer's experience in handling separators.

2. This question is an exceedingly difficult one to answer for the reason that there are a large number of variable factors which enter into the problem. The question of correct proportion of the moving parts, the proper proportion of ports and clearance spaces, and the means for

preventing excessive radiation together with the nicety of workmanship all effect the problem. It is generally conceded that there is no gain in power in compounding, that is, if you have a 10 x 12 cylinder simple engine and then change that over, adding a small cylinder to it, you would obtain no increase in power. There should be a slight gain in economy, but just how much it is, is impossible to say.

Mention this magazine when writing advertisers

Engineering books and engine designers state that for small powered engines the gain is much less proportionately than it is in large engines. Furthermore, the conditions under which the engine runs as to exposure to the wind and currents of air together with the arrangement of the piping and the boiler seriously affect the problem. We may state that in our opinion you would obtain no increase in power through compounding an engine of the size mentioned, but there might be a slight gain in economy. Under favorable conditions, amounting to as much as twenty or twenty-five per cent for traction engines working under outdoor conditions, it is doubtful if the compound engine is an advantage over the simple.

Q. C.B. 1. How do you find the striking points of an engine, or, in other words, equalize the clearance of the piston?

2. How do you set the valve on an engine having an automatic cut-off governor; that is, what position must the governor be placed in?

3. What points do you caliper from to obtain the center line of the cylinder in lining up an engine?

4. Explain the action of the Corliss valve gear and how the governor changes the point of cut-off.

5. How do you change the speed of an engine with an automatic governor in the fly wheel?

A. 1. An easy way to equalize the clearance of the piston is, first place the engine on dead center, then scratch a line across the cross heads and guides; now remove the brasses from the crank pin end of the connecting rod and shove the piston to the end of its stroke or until it strikes. Now measure the distance between the mark on the cross head and on the guides. This distance will be the clearance for one end. Slip the brasses back in again and shove the piston to the other end of its stroke and repeat the operation. You will then have the clearance at the other end of the cylinder. If these two distances are not equal, make the correction by screwing the piston rod either in or out of the cross head a distance equal to half of the error.

2. In setting the valve of an automatic governor engine the governor is not adjusted at all, but is allowed to stand in its normal position while the valve is being set.

3. In locating the center line of the engine caliper from the inside of the cylinder at the head end and from the inside of the

stuffing rod box at the other.

4. The usual type of Corliss governor is what is known as a double pendulum governor, that is, there are two balls at the ends of long arms pivoted at the top to a spindle, which moves a collar on a vertical shaft. These balls constitute a revolving pendulum, and as they rotate the balls move outward and upward, moving the collar on the shaft and changing a cam, which causes the hook which pulls the valve open to be disengaged from the valve and thus allowing the valve to snap shut. If the speed increases, the balls fly out early in the stroke and unhook the valve, and if the speed is somewhat slower the valve remains open until near the end of the stroke.

5. The speed of the engine fitted with a fly wheel governor is changed by changing the tension of the governor spring in the fly wheel and by shifting the weights along the weight arm.

Q. K.M. Please explain how to figure the safe working pressure of a steam boiler having either single riveted or double riveted seams.

A. There is positively no way of figuring the safe working pressure of an old boiler. All we can do in such cases is to make an estimate, or, in other words, guess at how strong it is. If our judgment is correct, well and good, if not, there may be a disastrous boiler explosion. In examining an old boiler, the examiner's judgment should be founded on the general appearance of the boiler, its known care, the amount of work it has done and the kind of water that has been used.

All these things have a vital bearing. For example, alkali or acid water corrodes the plate quite badly and in a few years weakens it materially. Rules for figuring safe working pressure are strictly applicable only to new boilers and even then do not take into account any defects that may exist either in the material or in the workmanship, except as these are provided for in what is called the factor of safety. This factor usually amounts to five, that is, one-fifth of the calculated bursting pressure is taken as the safe working pressure.

RULE. Multiply together the thickness of the boiler plate, expressed in inches, by the ultimate tensile strength of the boiler plate, and this product, by the efficiency of the joint in per cent and divided by five hundred times the radius. The quotient is the safe working pressure for the cylindrical portion of a new boiler. Where the rule says "efficiency is per cent" used 56



"The Best Belt I Ever Bought"

Here's a letter that Mr. A. P. Goff, Labelle, Kansas, sent us some time ago: "I have one of your 7" drive belts that I have used six years and it is all you claim for it. I have been a thresherman for twenty-six years, and it is the best belt I ever bought. Of course I take good care of my belting. I run a wind stacker with a Gandy Belt and it does its work well. I am much pleased with it." The

GANDY Thresher Belt

to merit letters like the above must be a pretty good proposition, don't you think? Twenty thousand American threshermen have found it so at least and that is the best reason why you, as a thresherman, should investigate this belt.

The GANDY is the pioneer stitched cotton duck belt. It stands up in all kinds of weather and service. It is the red belt with one green edge, trade marked and branded for your protection against the inferior imitations. Send for a free sample today.

The Gandy Belting Company

733 W. Pratt Street, Baltimore, Md.

NEW YORK OFFICE—88-90 READE STREET

You saw this advertisement in this magazine. Don't forget to say so when writing.



THE BEST
Anti-Friction
BABBITT
On the Market is

The Frost King

The "Frost King" is the product of our long years of experience, and is without doubt the most reliable Anti-Friction Babbitt made to-day. It is specially designed for Threshing Engines, Separators and Machinery of all kinds. If your dealer does not stock it—write for sample 30-pound box.

Hoyt Metal Co.

Eastern Ave. and Lewis St.
TORONTO

FACTORIES—London, Eng.; Toronto, New York, and St. Louis

You saw this advertisement in this magazine. Don't forget to say so when writing.



Steam or Gas Tractors

Equipped with

PICKERING
THE GOVERNOR WITHOUT JOINTS

give greatest efficiency

FITTED TO EVERY BUILD OF
ENGINE

Patent Ball Ranger Speed Changer Supplied on all Genuine Pickering Governors. Will increase speed 50% or more.

The Pickering Governor Co.

PORTLAND

CONN., U.S.A.



You saw this advertisement in this magazine. Don't forget to say so when writing.

A BELT WITHOUT A RIVAL

The test of time and continuous service in all weathers, under the most trying conditions, is the only test that will count in the life of a Thresher Belt. Nothing in power service used on the farm is of greater importance than the belt used. So much depends on its regular transmission of power that only THE VERY BEST that can be had is worth a moment's thought. The belts that have stood all tests—the belts that never buck, break, or slip the pulley are the



Lion Brand

Rubber Belts

AND THE

Maple Leaf

Endless Thresher Belts



Remember that practically all thresher companies doing business in Canada supply our belts as a part of their regular equipment. This is done in a great many cases in the face of a lower price from our competitors. The conclusion is obvious. The thresher companies fully realize that the belts that connect their engines and threshers in actual field work must be of the highest quality. They have tried our brands and found them not wanting.

Gutta Percha and Rubber Limited, WINNIPEG CALGARY

NOT IN ANY TRUST OR COMBINE

You saw this advertisement in this magazine. Don't forget to say so when writing.

for a single riveted point and 70 for a double riveted. Otherwise the rule applies to either kind of riveting.

EXAMPLE. Suppose we have a boiler thirty inches in diameter, one-quarter inch plate having a tensile strength of 60,000 pounds, what is its safe working pressure with riveting?

SOLUTION:

$$\frac{\frac{1}{4} \times 60,000 \times 56}{15 \times 500} = 112$$

With double riveting 56 would be replaced and the results would be 140 pounds for the working pressure. This answer applies only to the cylindrical part. If the boiler has a fire box it is advisable to figure this and take the smaller of the two results obtained for the safe working pressure of the whole structure. The rule for figuring flat surfaces is as follows:

RULE. Multiply the square of the thickness of the plate in sixteenths of any inch by 112, divide this product by the square of the distance from center to center of the stays. The results will be the allowable working pressure for plates seven-sixteenths of an inch thick and under. For heavier plates use 120 in place of 112.

EXAMPLE. In the above

boiler the walls of the fire box are three-eighths of an inch thick and the stay bolts are spaced five inches apart each way.

SOLUTION:

$$\frac{6 \times 6 \times 112}{5 \times 5} = 161 \text{ pounds}$$

The shell of the boiler will bear only 140 pounds, and this being the smaller number we will say that it represents the allowable working pressure.



Q. C.E.N. Will you please explain in your question department why it is that, in a boiler under steam during some parts of the day, the water evaporates so much more rapidly than at others, doing the same work and using the same amount of fuel? I have tried this very thoroughly, and can find no satisfactory solution. Some engineers tell me that it is because we have to fire harder on account of the low pressure of the atmosphere, but if such was the case how is it that one uses the same amount of fuel per hour and using two and seven-eighths barrels per hour and pressing the same amount of hay (two and one-half tons) both hours? would be pleased to see your explanation?

A. Before theorizing on the subject, we should first want to prove that the basis of your question is correct. You will pardon us if we suggest that possibly you may be mistaken in regard to the large difference which you imagine you find. The writer has run a large number of boiler tests in different parts of the country, using all grades of coal, and has made these tests very carefully, weighing the water and weighing the coal and measuring the amount of work done, and only slight variations appear from hour to hour and these can be accounted for by the condition of the fire, method of firing, or temperature of the feed water. In the case of a traction engine working out of doors, a considerable change in the weather or in the velocity of the wind would influence the amount of steam used a considerable amount, because of the heat wasted through radiation. Also, in traction engines, if the water is high in the boiler there may be considerable loss through priming, the water going out at the smoke stack. With the wind velocity practically the same and the temperature of the outside air practically the same, we feel perfectly safe in saying that there will be very little difference in the fuel and water consumption

for a given amount of work from hour to hour. There is one thing to take into account in the handling of the traction engine, and that is the position of the reverse lever. It is easier to use a great deal more steam with the reverse lever down in the corner and at the same time do no more work. This is something you must also take into consideration.



Exciting Fishing

A man was telling some friends about a proposed fishing trip to a lake in Colorado which he had in contemplation.

"Are there any trout out there?" asked one friend.

"Thousands of 'em," replied Mr. Wharry.

"Will they bite easily?" asked another friend.

"Will they?" said Mr. Wharry. "Why they're absolutely vicious. A man has to hide behind a tree to bait a hook."



An alien wanted to be naturalized and was required to fill out a blank. The first three lines of the blank had the following questions: "Name? Born? Business?"

He answered:

"Name—Michael Levinsky."

"Born—Yes."

"Business—Rotten."

Belt
ht"
some
years
ent-
care
e its
ion't
so at
l in-
s up
reen
erior
ly
d is
It is
f all
ors
enuine
ERING
DE MARK
REGISTERED

Avery Threshing Outfits are the Big Money Makers

Charlie Ferrier, of Dover, Minn., was in our office the other day. He wrote us a letter in 1907, which read as follows:—

"I am still running the two full rigs I bought of you in 1895 and 1896. They have given the best of satisfaction both to me and my customers. I thresh in the same locality every year and they run like new and thresh like the devil and I wouldn't run them a minute if they didn't."

He says he is still running the same old rigs and they are still threshing in the same old way. He tells us they have made him over \$20,000 clear profits.

A few days ago we received a letter from another Avery customer, Estenson Bros., of Sarles, N.D. Here's what they say:—

"In 1903 at Ada, Minn., I bought an Avery 22 H.P. return flue engine and a 36-60 Avery separator. This same rig was used three years at Ada, four years at Sarles, North Dakota, and has been used the last four years at Sedley, Saskatchewan, Canada.

We have kept fairly careful account of what we have done with this outfit and also of what the repairs have cost us. On the separator we have spent \$225.00 for repairs. The repairs on the engine amount to about \$175.00. The number of bushels of all kinds of grain threshed in these eleven seasons in round numbers is as follows:—1903, 82,000; 1904, 67,000; 1905, 36,000; 1906, 70,000; 1907, 80,000; 1908, 76,000; 1909, 60,000; 1910, 55,000; 1911, 45,000; 1912, 83,000; 1913, 77,000, making an average of about 66,000 bushels per year. The average for all kinds of grain per bushel will run about eight cents. Figuring our work on this basis we made about \$5,280.00 per year, and allowing 65 per cent for expenses we had left \$1,848.00 per year for eleven years, which amounts to \$20,328.00. The original cost of our rig was \$3,250.00, thus leaving a net balance of \$17,078.00."

There's good money threshing with the right kind of a rig, handled in the right kind of way, as these two cases clearly prove.

Why You Can Make More Money Threshing With Avery Outfits

The 27 Field Tests threshing on canvas made with Avery "Yellow-Fellow" Separators proved beyond question that they were the Best Grain Savers built. No other make of Separator has ever made such a proven record of grain saving as was made by Avery Separators in these canvas tests—an average saving of 99.9-10 of the grain.

That's the first big reason why an owner of an Avery can get the jobs and make more money because saving the grain is the thing farmers are most concerned about.

You can also do more kinds of threshing with an Avery—it will thresh any kind of grain and seeds, besides hulling clover or alfalfa, shredding corn, threshing peas, rice, etc., and is the only separator that has established a reputation for doing all of these things successfully.

By being able to hull clover, shred corn, thresh peas and do other work, you can make a lot of extra money, and when you own an Avery Separator you can do it all with one

machine without any extra investment for a huller or shredder.

With an Avery Separator you can make a lot of money because you can please the farmers and get the jobs, you can thresh fast and you can do all kinds of work. And with an Avery, what you make is almost all profit, for you don't have big repair bills to eat up what you make. We guarantee Avery Separators against breakage stronger than any other machine. Avery Teeth are guaranteed for life against breakage.

To pull your Avery Separator you can suit your choice with an Avery Return Flue Single Cylinder Steam Engine, a Straight Flue Single Cylinder Steam Engine, an Avery Double Undermounted Steam Engine or an Avery Gas or Oil Tractor.

Every one of these has proven itself in tests to be unusually economical in the consumption of fuel and each one is backed up by stronger guarantees than you can get with any other engine.

Avery Threshing Outfits are the Real Big Money Makers. Get ALL the Facts about them. Write us, telling the kind and size outfit you are interested in, and you will receive full information with copies of our new complete 1914 catalogs. Use the coupon or write us a letter or a postal. Address:



Avery Single Cylinder Return Flue Steam Engine and "Yellow-Fellow" Separator.

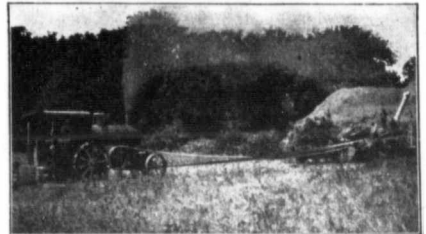

Avery Double Undermounted Steam Engine and "Yellow-Fellow" Separator.



Avery 12-25 H.P. Avery Gas or Oil Tractor and "Yellow-Kid" Separator.

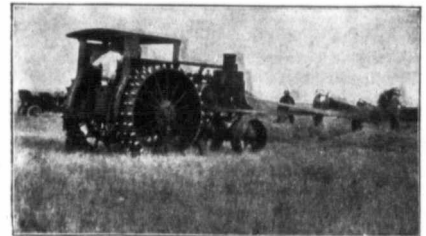

Avery 40-80 H.P. Tractor Threshing.

EVERY COMPANY, 675 Iowa St., Peoria, Illinois

Canadian Avery Co. Ltd., Winnipeg, Regina, Calgary, Western Canadian Distributors



Get an Avery Bull-Dog Watch Fob

It's a Dandy. Representation of the Famous Avery Bull Dog Trade-mark.

Send us the lists of names mentioned below, together with 10 cents in stamps or silver, and we will mail same at once.

These are the lists of names to send:

1. List of Threshermen in your neighborhood.
 2. List of Plow Outfit Owners in your neighborhood.
 3. List of those talking of buying an Engine, Separator or Plow this year (if you know of any).
- Names, initials and addresses must be correctly given.

Avery Company, 675 Iowa St., Peoria, Ill.

Gentlemen—Please mail new 1914 catalogs as checked here:

- Steam Engine Separator
 Tractor and Plow Truck

What machinery are you thinking of buying in 1914?.....

.....

Name.....

Town.....Prov.....

Do Plowing, Grading and Other Work This Year and Make More Money

A. J. Plumbeck, of Egbert, Wyoming, bought an Avery 20/35 Tractor, 5 bottom Plow and Separator, and on Nov. 10 he wrote us:—

"I made the price of the outfit the first season and had money left. I plowed 840 acres of land and threshed 43,000 bushels of grain and had no breakdowns whatever. I gave an order for a 40/80 tractor to-day to your Mr. Meetz."

Emil Fredrickson, of Flaxton, N.D., writes:—

"Just a few lines to tell you how well pleased I am with my 20/35 Avery Tractor and Plow I bought last spring and some of the things I have done with it. I plowed and packed 550 acres this spring. I cut 700 acres of grain with the Tractor and now I am threshing with my 32/54 Avery Separator."

Bjorgo & Berg, of Maxbass, N.D., says:—

"Two years ago we purchased an Avery Tractor. In the two years we have plowed 1,700 acres, harvested 1,400 acres, pulled a road grader 300 miles and hauled 1,500 bushels of grain to market."

W. A. Dodge, of Collins, Mont., writes us that from June 1st to July 8th:—

"I have taken in \$1,431.00 for the plowing I have done."

C. E. Knapp, of Chinook, Mont., says about his 40/80 Avery Tractor and Plow:—

"Upon the showing I have made with this rig, I have been offered over 700 acres of breaking for spring. I finished a land of 10 acres in five hours and ten minutes and the owner gave me a check for \$50.00."

Why You Can Make More Money Plowing With Avery Tractors and Plows

In the first place you can make more money because you can run the entire plow outfit alone. You don't need any plowman to help you. You save his wages and board. An Avery "Self-Lift" Plow makes it possible for you to run the entire outfit alone.

In the second place, you can save fuel with an Avery Tractor. Avery Tractors have established themselves in contests to be the greatest combination gasoline and kerosene burning Tractors built. You can burn either fuel you wish.

In the third place, with an Avery "Light-Weight" Tractor you don't waste fuel or power moving around useless dead weight like you do with the heavy-weight tractors. It takes about two gallons of gasoline to move around an extra ton a day. If you have to roll around two or three tons you lose enough power to pull an extra plow. Avery Tractors are the Lightest Weight Tractor built considering their draw bar efficiency. Every Tractor is built light-weight from the 8/16 H.P. up to the 40/80 H.P. size. Because

they don't waste power moving around useless dead weight you can do more work in a day which means more money and you save fuel which means less expense.

Because of the wonderful simplicity of Avery Tractors you can keep running steady right along. Avery Tractors are the simplest Tractors built. No fan, no fuel pump, no water pump, only one clutch, no counter-weights on the crank shaft, no intermediate gear for traveling ahead. You can keep going right along no matter what kind of work you are doing, by giving the Tractor the right kind of care.

The way to make the most money is to keep your machinery running as nearly all the time as possible. With an Avery Tractor you can not only do threshing, but can also do plowing, road grading, house moving, hedge pulling, hauling, shelling, shredding, clover hulling, ensilage cutting and other kinds of work and have practically an all-year-around big money-making business all the time.

Write for new 1914 Catalog of Avery "Light-Weight" Tractors and "Self-Lift" Plows, and find out all about the work they will do. Avery Tractors are built in five sizes, 8-16, 12-25, 20-35, 25-50 and 40-80 H.P., and Avery "Self-Lift" Plows in all sizes from 3 to 10 bottom. You can get a size Avery Tractor and Plow to just fit your needs. Call on us at our Home Office or any of our Branch Houses, Jobbers or Agents, and write direct for new catalog.



Avery 8-16 H.P. "Light-Weight" Tractor and 3-bottom Avery "Self-Lift" Plow.

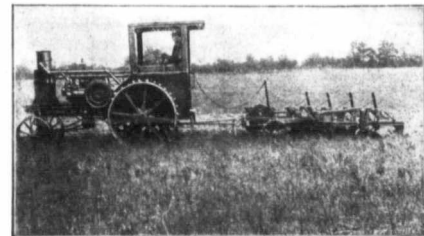

Avery 12-25 H.P. "Light-Weight" Tractor and 4-bottom Avery "Self-Lift" Plow.

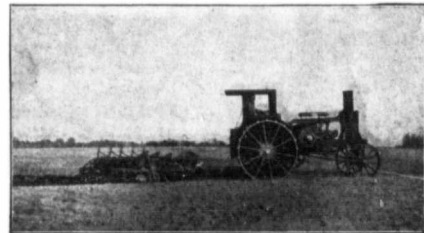

Avery 20-35 H.P. "Light-Weight" Tractor and 5-bottom Avery "Self-Lift" Plow. We also build a 25-50 H.P. size "Light-Weight" Tractor which pulls 6 to 7 plows.



Avery 40-80 H.P. "Light-Weight" Tractor and 8-bottom Avery "Self-Lift" Plow doing breaking.



Feeding Farm Horses for Best Results

By W. H. Underwood.

I am of the opinion that a large number of farm horses are fed more than there is any need of when they are idle or doing very light work, and probably do not receive sufficient feed when they are doing heavy work. The ration for a horse weighing 1,000 pounds when doing light work should consist of about 1½ pounds of protein, 9½ pounds of carbohydrates, ½ pound of fat and about 20 pounds of dry matter. As the work of the horse is increased the whole ration, of course, should be increased in proportion to the amount of work done. This ration is too light for a horse weighing 1,200 or 1,500 pounds, and should be increased accordingly.

For a horse weighing 1,000 pounds, 15 pounds of timothy hay would furnish .42 pound of protein, 3 pounds of corn .23 pound, 3 pounds of oats .28 pound, and 3 pounds of wheat bran .37 pound of protein, which will furnish a sufficient ration for a farm horse doing little or no work. This, of course, means an entire day's ration. The horse should have no more than this during the whole 24 hours.

When the animal is put to good ordinary work, then the weight of the corn and oats may be doubled or made 6 pounds each and about 4 pounds of bran given. If the animal was put to exceedingly heavy work, all that he could stand to do, of course the grain ration could be yet increased with profit. As a matter of fact, when a horse is doing all the work he can do every day, he ought simply to be given all he can eat up clean of the hay and grain, and supplied in the proportion indicated in the ration. I put wheat bran as the other concentrate in the ration because I do not believe there is any better by-product fed to the horse than wheat bran. It has splendid effect upon the digestion and is an appetizing, healthful food.

A great many horses are allowed to eat too much hay when they stand idle in the barn, too much for their own good. Most

of those that have their breathing affected have this undesirable condition brought on by the pernicious practice of allowing them to eat hay throughout the day.

I am an advocate of feeding corn in the ear to horses, because I believe it is good for their teeth to have to eat the corn from the cob. I am confident that just as good digestion is secured unless the animal has poor teeth or is old, from eating corn in the ear as from shelled corn or cornmeal. Furthermore, my horses seem to eat the corn on the cob better than they do shelled corn or cornmeal. Some horse owners grind their corn, cob and all, but as corncob meal is practically worthless as a food for horses, I believe that more harm is done in feeding it than good accomplished.

The regulation of feeding hours is a matter of prime importance in feeding horses, and should be adhered to as nearly as possible. Too long abstinence between feeds or too much food supplied at a time, followed by voracious eating, which is usually the case in matters of this kind, is apt to bring on colic and indigestion.

A plentiful supply of good, pure water is equally as important as the feed, and arrangements should be such as to allow the animals to partake of water whenever they desire to do so, except immediately after eating. It is reasonable that horses should not drink directly after having consumed their ration, as the water is likely to carry out of the stomach a portion of undigested feed, which is wasted.

In addition to the feed and water, salt is necessary; but the animals should not be given a large quantity at irregular intervals. An excess of salt at one time produces congestion of the stomach and induces excessive thirst. It is a good plan to keep rock salt in reach of the animals at all times, for thus they can satisfy their appetite by an occasional lick. Those who do not follow this practice should introduce it gradually by giving the animals a little salt with their regular ration for a week.

The way horses are worked and



THE MILKER

AND THE

"MAGNET"



complete the most successful "combine" ever introduced into Canadian farming. Let her be Shorthorn or Jersey, Holstein or Ayrshire, the well-bred Milker will give the milk in abundance and the

MAGNET CREAM SEPARATOR

will positively skim the last particle of profit-making cream that can be taken from quality milk. The "Magnet" is no less a part of Canadian history than these celebrated dairy breeds and is to dairy farming what the Self-binder is to grain growing. The "Magnet" is Made in Canada by Canadian men who have spent a lifetime in the practice of dairy-farming and the construction of dairy machinery. Among a score of exclusive features, its rock-firm steadiness on any foundation and its Square Gear are the admiration of every expert. There is no wobbling or gyrating as in the case of the old "worm" gear utensils. It means

GREAT SERVICE and BIG PROFITS

Our Slogan is "TO SATISFY"—and we will do it at all costs. We will prove every point we claim for the superiority of the "Magnet" on your farm—at our expense

Our 1914 Calendar is now ready for distribution.

The Petrie Mfg. Co. Ltd.

Head Office and Factory: HAMILTON, ONT.

Winnipeg, Calgary, Regina, Vancouver, Montreal, St. John, N.B., Edmonton, Alta.

Dr. Thomas' Eclectric Oil
Relieves all Pain in Man or Beast
25 Cent Bottles at all Dealers

You saw this advertisement in this magazine. Don't forget to say so when writing.

WILD OAT SEPARATOR

We positively guarantee our Separator to remove EVERY KERNEL of Wild or Tame Oats from your SEED WHEAT and NO WHEAT LOST with the oats.

Perfect Separation of OATS from BARLEY or RYE for Seed.

Made in Three Sizes:
6-Shoe Power Separator
3-Shoe Hand Separator
1-Shoe Elevator Wheat Tester

WM. H. EMERSON & SONS
DETROIT, MICH. AND WINDSOR, ONT.

Write for Circular fully explaining this wonderful Separator

You saw this advertisement in this magazine. Don't forget to say so when writing.

handled makes a great difference in the amounts of feed required and the flesh they will carry. A horse that is ill treated and excited all the time will not keep fat. Gentle treatment and sympathy and friendly relations between the man and his team will save feed and secure greater and more satisfactory labor from the animals.

Some farmers do not think it worth while to groom their work horses in order to make them look sleek and shiny, and would rather leave them in their natural state. It is well to bear in mind that in the domestic horse more is demanded than in the wild animal, and he consequently requires more fostering to supply the wear of this extra demand. And grooming does not mean merely to cultivate a "sleeky" appearance, although I do not mean to depreciate the virtue of those who take pride in keeping their horses in fine coat and condition. It means a stimulating of the respiratory system, and consequently increased vigor and health of the animal.

Secretions are continually forming in the glands of the skin, which are given off in the form of perspiration, and this secretive action increases more rapidly the better the animal is fed or the harder he is worked, so that by perspiring freely nature comes to the assistance in preventing the pores of the skin from becoming choked. But the fatty fluid which comes from the glands in the form of sweat is apt to consolidate again at the roots of the hair and form a covering of dandruff, which clogs the action discharged through the pores of the skin. When a horse is doing no work grooming is not so necessary, and yet it pays to keep him well groomed, but the working animal must be kept in better vigor; and, besides, the labor and more nitrogenous food usually given induce more excessive perspiration.

When the horses come into the stable either wet or perspiring, they should be well rubbed down at once with a handful of straw or hay, and be given a good feed. After they have become dry a thorough grooming will well repay the labor. After the use of the curry comb and brush a good rub down with a heavy woolen cloth will help considerably in improving their appearance.

Considerable attention is demanded in harnessing a team. There are two ways in which this may be done. One is to do it in the very cheapest and easiest way that will enable us to get work out of the animals, and the other is to harness them not only to get work but also to protect the horses and make a good appear-

Be Sure to Get Your "Alpha" Engine Catalogue

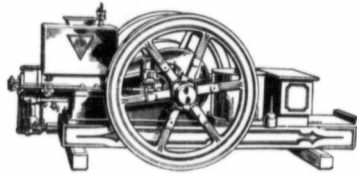

It gives "real" information about a "real" gas engine that will give you "real" service and satisfaction.

Write at once to the nearest De Laval branch below for this catalogue. It contains a lot of "real" information that will interest you and then when you have read the catalogue, if you want to look the "Alpha" over and see for yourself its splendid construction and how perfectly it works we can no doubt arrange for you to do so.

ENGINE buyers expect good service. They have work to do and want an engine that is always in condition to do it.

ALPHA Engines never disappoint. They are so sure to start and keep running that they have knocked out all the mystery of why an engine does not work.

ALPHA Engines are strictly modern in every detail of design and manufacture. Good engineering and a wide-awake management has kept them ahead of the rest in developments that make for real service.

THE ALPHA Engine was first to successfully use the hopper cooled cylinder; first to adopt the built-in slow speed magneto and perfect a method of using it for starting and running to the exclusion of batteries. First also to perfect a carburetor commercially practical for use of kerosene and low grade fuels.

THESE are only three of the many features in this modern engine which bring real service such as engine buyers can find in no other machine.

THESE and its many other features are fully described in the ALPHA Catalogue. Write for it to-day.

De Laval Dairy Supply Co., Ltd. MONTREAL WINNIPEG PETERBORO VANCOUVER
LARGEST MANUFACTURERS OF DAIRY SUPPLIES IN CANADA AND MANUFACTURERS AND EXCLUSIVE DISTRIBUTORS OF DE LAVAL CREAM SEPARATORS AND IDEAL GREEN FEED SILOS. LOCAL AGENTS EVERYWHERE.

You saw this advertisement in this magazine. Don't forget to say so when writing.

ance. No one who has had intelligent experience will minimize the importance of a well-fitting collar that holds its shape and protects the shoulders. Then of almost equal importance are the hames. They should fit snugly in the collar. Leather tugs are far superior to chains in that they do not so irritate the sides of the animal and rub off hair and even skin and flesh. The harness should set off a team instead of detracting from its appearance. Bright buckles and well oiled harness inspire the driver and feel better to the team.

Horses that are given good quarters and proper care, proper exercise and not overworked, a good ration and pure water, keep in good condition and are ready and willing to perform their portion of the labor on the farm. The owner gives great attention to their management, for he is well aware of the fact that it means considerable to him as well as to the animals.

Wake Up Canada!

(The following timely bulletin has just been issued by the Saskatchewan Department of Agriculture. We strongly urge upon our readers to give this matter their most serious thought.—Ed.)

The United States has removed the tariff on all meat producing animals; why? Because pro-

duction of meat within her boundaries cannot keep pace with consumption. This is an invitation to Canada and Canadians to step in and fill the breach. Can Canada do it? How is the Dominion situated as regards meat products? Investigation shows that Canada not only cannot supply her own people, but imports meat products from the United States, Australia and the Argentine to the value of several million dollars annually.

Is live stock in Canada increasing? Let us look at the cattle section of the live stock industry in the three western provinces. For the year ending July 1st, 1913, there was a decrease of 770,000 beef cattle in Manitoba, Saskatchewan and Alberta. In the United States in thirteen years there has been a decrease of 15,000,000 beef cattle. What does that look like? It looks like money for the mixed farmer; a steady market and sure profits for some time to come. Wake up! you Westerners and keep that calf, heifer or cow from the block. Get a strangle hold on your breeding females and hang on. Every one that goes to the butcher now is a dead loss to the people and the province.

Over 10,000 calves slaughtered in Canada every month. A dead loss and poor business. Wake up!

PEERLESS PERFECTION

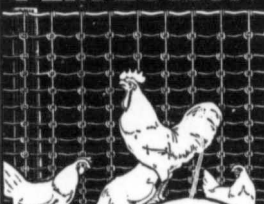

The Fence That's Locked Together

It's close enough to keep small fowl in and strong enough to keep large animals out. Securely locked together at each intersection of the wires. It's many times heavier and stronger than poultry netting, and being well galvanized, will last many years longer. Top and bottom wires are extra heavy. No top and bottom boards required. PEERLESS Poultry Fence is built so strong and heavy, that but half the ordinary number of posts are required. It gives you real fence service.

Here's How Strong It Is

Read this Letter
Dear Sir: I am writing a testimonial as to the strength of PEERLESS Junior Chicken Fence. Mine is four feet high. It turned two horses each weighing 1400 pounds. They ran full tilt into the fencing about 2 rods from each other at the same time. The result was that they both turned a somersault over the fence, alighting on their heads and necks, scratching their eyes some, but the fence remained intact.
Yours truly,
Surrey Custer, B. C. Joe Boothroyd

Think of it—a poultry fence strong enough to withstand the combined weight of two big horses. And that without a top or bottom board either. If you are interested in such fencing, write us. Ask for our literature. We also manufacture farm fence and ornamental gates.

Agents nearly everywhere. Live agents wanted in unassigned territory.
The Banwell-Hoxie Wire Fence Co., Ltd.
Winnipeg, Man. Hamilton, Ont.

The peacock is a fine bird, but the stork delivers the goods.

Development Through
Dry Farming

By W. M. Jardine, Dean of Agriculture, Kansas Agricultural College.

I have met many men in the last few years who had no idea what the International Dry-Farming Congress is trying to do, and no adequate conception of what dry-farming means in the development of the west. This shows that, no matter how much you print, no matter how popularly it is written, there are many persons who never will see it.

Yet the subject is important. It is discussed everywhere. Every locality has its story to tell and each one's view is given as the only safe and sane basis upon which to found a permanent agriculture for dry lands. Practically every section has its own local problems. This accounts for so many varying opinions. For example, dry-farming in the Estancia valley of New Mexico must be conducted on a very different basis from the most approved methods used in the Judith Basin of Montana, because the growing season and the crops are different, due to the differences in altitude and climatic conditions, all of which must be taken into consideration in determining the best methods for profitable crop production.

Upon traveling through the various districts where dry-farming is being conducted, one is impressed with the tremendous influence it is exerting upon the development of the west. This is most noticeable, perhaps, to those who are familiar with the growth of the arid region during the past five years, or since the inception of dry land farming as it is now understood.

The New Crop Area

Districts where only a short time ago the unirrigated land, even in the very door yards, was utilized only for grazing purposes, and in some instances not even for this, are being now rapidly converted into productive fields of grain and other crops. Railroads are being extended into new areas, commercial enterprises are everywhere starting up, villages, and even cities, are coming into existence yearly as a direct result of the increased business due to this movement.

Millions of bushels of wheat and other cereals are being produced where less than five years ago none was grown, so that the west is now an exporter of grains instead of an importer, as was only recently the case. Each succeeding crop is much larger than the previous one and, judging from present indications, the

country lying between the one hundredth meridian on the east and the Columbia River basin on the west, is destined to become one of the greatest wheat producing sections of the United States. This vast region, moreover, will be famous not only for its crops of wheat, but the improved methods of farming will make possible the growing of forage crops on the dry lands, and thus the already important industry of live stock raising will be greatly enhanced.

Many people have recently settled within this area. In one year more than 50,000 original homestead entries were made in Colorado, Wyoming, Montana and New Mexico, to say nothing of the thousands who settled on dry lands by purchasing their holdings from various companies and individual land owners. These figures, of course, do not indicate the number of people who remain as permanent home builders, since a large percentage of them fail during the first eighteen months—that period which is most trying to the dry-farmer and especially trying to those who are unfit to take up an occupation so exacting.

Those who fail come from all sections of the United States, as well as from foreign countries; and, for the most part, are entirely ignorant of dry-farming methods. Many of them are lacking in agricultural knowledge of any kind, coming as they usually do from all walks of life, and failures attributed to the country are too frequently a direct result of unfamiliarity with farm life.

The Cause of Many Failures

Probably a more serious drawback than this, however, is the general lack of funds among the new settlers to maintain their families and develop their property until a crop can be taken from the land. Poverty, to begin with, is unfortunately too common, and under such circumstances development is slow and difficult. The farmer is often forced to abandon his own place to go in search of employment at the very time his presence is most needed on his own farm. The man who is able to remain and develop his holdings from the very beginning is the one who usually succeeds. When the first eighteen months are passed and a crop is harvested, even if it be a poor one, there is little danger of failure.

INTERNATIONAL STOCK FOOD



keeps horses, cows, sheep and pigs in such prime condition, because it is composed of the same herbs, roots, seeds and barks that these animals eat freely when running wild. We grind these ten medicinal substances to a fine powder, mix them thoroughly and give them to you, at their best in International Stock Food. This is why a table-spoonful of International Stock Food with the regular grain feed tones up the system of horses, gives them new life, and a glossy coat of hair. It is the best thing you can give a horse for indigestion, liver trouble, coughs, influenza, hide bound or blood trouble. International Stock Food is equally good for horses, cattle, sheep and hogs. It keeps the system in a healthy condition and promotes rapid growth. For sale by dealers everywhere. 111 INTERNATIONAL STOCK FOOD CO. LIMITED, TORONTO, Ont., Can.

You saw this advertisement in this magazine. Don't forget to say so when writing.



THIS LOCK

Mr. Farmer, is the one used in our "Great West" Fencing. You might possibly get some cheaper Fence than ours, but you will look in vain for any better. Our Fences are made in the West, designed especially for the Western Farmer and we guarantee every Rod as to strength and durability. It is the "Standard Fence" of our "Great West."

Write for our Illustrated Catalogue.

THE GREAT WEST WIRE FENCE CO., LTD.

76-82 Lombard Street, WINNIPEG, Man. Calgary Office:—Care of Reynolds & Jackson, Box 2063. Edmonton Office:—Care of Race, Hunt & Giddy, Cor. Fifth and Columbia Avenue.

You saw this advertisement in this magazine. Don't forget to say so when writing.



'Engine Gang' Plows

We want to send you a copy of our Traction Engine Plowing Catalog, in which we show all of our famous line of engine plows, including the Mogul, Senior, Junior, and Disc Engine Plows. P & O Engine Plows are built for every kind and condition of soil, and to withstand the hardest kind of work. Our New

Engine Grub Breaker

will interest you if you have work which requires a plow of this kind. It is absolutely the strongest single bottom plow ever built. And our Diamond Three-Furrow Riding Plow for use with horses, embodying the famous High Lift, Light Draft, and automatic control features of our well-known Diamond Gang (Two-furrow). These also are shown and described. Don't fail to get one of these catalogs. A postal request will bring it. Address:

Parlin & Orendorff Co., Canton, Ill., U.S.A. International Harvester Company of Canada, Ltd.

SOLE AGENTS FOR CANADA



- Winnipeg
- Brandon
- Regina
- Saskatoon
- Yorkton
- North Battleford
- Estevan
- Calgary
- Edmonton
- Lethbridge

You saw this advertisement in this magazine. Don't forget to say so when writing.

Fortunately, failures due to the above mentioned causes are yearly becoming less frequent. Isolated districts are being more thickly populated, business is increasing and there is a growing demand for labor. The man with small means can now usually secure employment within close range of his farm at odd times and without seriously interfering with operations upon his own place. Thus he can provide for his family while he is bringing his farm under cultivation. The future homesteader, therefore, will not be a pioneer in the same sense as those who preceded him. He will have the advantage of the experience of others, who have already succeeded in putting dry-farming beyond the experimental stage. In fact he will be able to come in daily contact with successful dry-farming operations.

Many Agencies Are Helping

Conditions are being still further improved by the support of men interested in the legitimate development of the west. These men are assisting in every way possible to place before the public reliable information regarding existing conditions in the various localities. State experiment stations, farmers' institutes, and the United States department of agriculture, with the aid of such organizations as the International Dry-Farming Congress, are wielding powerful influences in the right direction. Such assistance could be made still more effective, however, if a more systematic and organized effort were made to collect, publish and disseminate accurate and reliable data regarding the most improved methods of dry-farming for each specific locality. Information such as can be obtained from the very best farmers now located in this belt—the farmers who have made good, together with the data obtained from government and state experiment stations and experts, could be made thoroughly worth while and of great assistance now to the new settler.

Future Lies in Live Stock

Notwithstanding the phenomenal growth that has been made in the west through the influence of dry-farming, and in spite of the fact that hundreds of farmers are obtaining a strong foothold upon the land, we must not forget that the dry-farming industry is new and that no satisfactory farm management schemes have yet been devised. If we ever expect this industry to develop into the thriving and permanent one that the country seems to warrant, we must encourage more diversified farming. Every dry-farmer of the future should be a stock man as well as a wheat grower. These two industries go well together and

each helps to bolster up the other. In fact, the only possible way by which we can expect to place dry-land farming on a permanent basis will be to adopt a system that will allow the raising of live stock.

By live stock raising we do not mean that every farmer is to transform his place into a cattle ranch or to keep such animals as those now found on the open range. We mean that a few good dairy cows, a number of hogs, some poultry, and a team or two of good mares should be kept on even the smallest of the dry farms. With our present knowledge of dry-farming and of the great variety of crops that can be grown there need not be a year when sufficient grain and forage could not be produced from 25 acres to feed the stock during the winter months, and 50 acres of land under proper management should supply the needed pasturage. From the live stock the farmer should realize sufficient income to provide for his family and to defray the running expenses of the farm, and the remainder of his land could be utilized in the production of such crops as would be found to

CANADA Portland CEMENT

SOME men ask for so many bags of "cement"—

Others, more careful, say they want "Portland Cement"—

But the man who does the best work insists upon getting "Canada" Portland Cement—

And he looks to see that every bag bears this label



Write the Canada Cement Information Bureau, Montreal, for a free copy of "What the Farmer Can Do With Concrete."

There is a Canada Cement dealer in your neighborhood. If you do not know him, write for his name.

You saw this advertisement in this magazine. Don't forget to say so when writing.

MACHINERY AT LESS THAN WHOLESALE PRICES.

As I have bought the remaining Machinery of the late Harmer Implement Co., of Winnipeg, Man. I am offering it at the following prices:

1 Superior Stand Grinder (Jewel), 8-inch Plate	20	2 Caboose Steel Trucks with wide bunks	40
1 Superior Stand Grinder (Jewel), 6-inch Plate	18	5 Grain Picklers (Western Radiator)	5
1 Saw and Frame	20	47 Harrow Carts (Sclipses), 24 and 26- and 36-inch wheels	7
1 Swift Grinder, 6-inch Plate	18	3 Air Cooled Engines, 1 1/2 H.P., Big Chief	20
1 Stand Grinder, Swift, 5-inch Plate	5	1 Hopper Cooled Engine, 1 1/2 H.P., Big Chief	25
1 Bag Holder (Reimer)	5	1 Hopper Cooled Engine, 6 H. P., Big Chief	140
1 Potato Digger (Irie Iron)	12	1 Hopper Cooled Engine, 12 1/2 H.P., Big Chief, equipped with a friction clutch pulley (less friction clutch, \$30 off)	325
1 Corn Cultivator (J. L. Case)	22	1 Hopper Cooled Engine, 1 1/2 H.P., (Gray)	25
1 Bone Crusher (Stover)	6	1 Hopper Cooled Engine, 2 1/2 H.P., (Aermotor)	50
1 Garden Seeder and Tools (Eureka)	8	2 Sets Trucks, 1 1/2 H.P. Engines	6
1 Garden Cultivator with full set of Tools	6	4 Sets Trucks, 2 1/2 and 4 H.P. Engines	7
1 Garden Disc	4	The Big Chief Engines are made by the same firm as the Waterloo Boy and Eaton's Engines. Repairs and all parts are interchangeable.	
1 Garden Spray, hand	6	All the above Machinery is new, having never been used and is in good condition. These prices are F.O.B. Winnipeg, CASII WITH ORDER.	
1 Speed Changer (use with Engine to regulate speed when running cream separa or churn, etc.)	7	THOS. H. CUDDY 594 Agnes Street, Winnipeg.	
23 Rotary Harrows	8	You saw this advertisement in this magazine. Don't forget to say so when writing.	
2 Disc Plow Sharpeners	4		
3 Baggers, 8 ft., suitable for any crusher	15		

be most profitable. Men who are now farming in accordance with such a plan are the ones who succeed all over the west.



You Can't Fool Pat

Mike went to the telephone, when the following conversation took place:
 "Is this Miller & Jones?"
 "Yes."

"Will you send up six-bags of oats, and hurry up with 'em."
 "All right, who are they for?"
 "Arrah, now, don't get gay—for the horses, to be sure," and Mike rang off.

If you save money you're a grouch; if you spend it you're a loafer; if you get it you're a grafter; if you don't get it you're a bum. So what's the use!

POULTRY. Telling the Laying Hens.

By MICHAEL K. BOYER

TO make a success, it is imperative that we know our hens. We must test their abilities. We cannot afford to keep drones.

Therefore, we must adopt some method by which we can determine the good from the bad. Noticing a hen repeatedly upon the nest is not a guarantee that she is about to lay. In using trap nests I have almost daily captured hens on the nest, but no eggs, and their annual records were very low.

Every time a hen cackles when coming out of the laying room is no criterion that she has laid. I believe it was Collingswood who once said, "A cackling hen is either a layer or a liar"—and in using trap nests I have found quite a number of these cacklers to be "liars."

So, prior to the adoption of trap nests, the selection of layers has been more or less guess work. It was said by some writers that "spare and leggy birds are the best layers." This opinion, no doubt, was based upon the fact that the Mediterranean class is built after that fashion.

This view was corroborated by the late Francis A. Mortimer when he said that he found that hens with short legs, chunky bodies, short necks and small heads are, as a rule, indifferent layers. This would seem so from the standpoint that such hens are more of the meat order, but trap nests have told us that during the past few years our chukiest Wyandottes were in the front row of layers.

Felch said the pullets that commence laying earliest in life are the ones to lay the largest number of eggs through life. There is some logic in that, but we cannot always tell our earliest layers if we have no system of trapping them.

Some years ago there was quite a discussion of the so-called "egg-type." Nearly all these opinions were based on the style of the Leghorn, but some writers differed. For example, one writer said that good layers have a "long, slim body, are broad across the shoulders, are triangular, deep in front, not compact and have legs of good length." Another differed by saying: "Carefully avoid the leggy, high-built, reared-up hen of the game-cock style. It is the short-legged, heavy-set, motherly-looking hen that shells out the eggs." Many references could be given on this

type question, but nearly all differ in some particular, but the opposites, quoted above, are fair samples of representations made in the early days.

There is but one sure way of finding out which are our workers: We must catch the hens in the act. Each hen is known by the number on the band or ring that is placed on her leg. Catching the hen in the trap nest, her number is ascertained, and this marked on the egg. Each evening, after the eggs are gathered, these numbers are properly credited on a record blank provided for that purpose. At the end of the year we know for a certainty how many eggs the hen has laid. Not only that, but we also know the size of her egg—whether normal or not—and the color, whether white, brown or tinted.

I do not, however, employ trap nests solely for the purpose of finding out which are my best year-round layers. What I care most to know is which are my best cold-weather layers. I want to know which are the profitable workers during the late fall, winter and early spring—times when eggs bring the best prices. It is not a question with me how many eggs a hen lays in a year, but how much money her product brings. If it is possible to concentrate the bulk of her crop in six months of the year, when prices are high, and induce her to "take it easy" during the warm months, devoting the most of that time to broodiness and molting, I will have stronger and harder stock, and, consequently, more profit.

In conclusion, let me state, there is but one guaranteed way of determining our profitable layers, and that is by the aid of trap nests, and no poultryman can afford to do without them. It will mean a profit in the crop, and a saving of feed, room and labor.

Poultry Pointers

While it is best at all times to have good, sharp grit constantly before the fowls, it is especially important that grit be supplied when feeding whole oats so that the hulls of the oats, which are very tough and unyielding, will be properly ground. With plenty of sharp grit there is no danger attending oat feeding, although the safest rule is to first soak the

Ontario Wind Engine & Pump Company's LINES ARE SUPREME



We have made our goods good, our users made them famous. We manufacture what our customers say, to be the best Kerosene and Gasoline Engines, Wind Mills, Feed Grinders, Saws, Pumps, Scales, Tanks, Water Basins, Stanchions, Well Drills and Pressure Tanks, and we believe they know.

Is Your House Properly Equipped with Water?

Have you a Toronto Pneumatic Tank? Get all the advantages of a city home where you live. Put the water on the top floor in your bathtub, and sprinkle your lawn and garden. Enjoy the comforts of running water and baths, and protect your home against fire. Relieve your wife and family of drudgery, and add to the beauties of country life the advantage of plenty of water by turning a tap.

Get our Pressure Tank and Power Catalog. It is what you want. It's yours for the asking. Write today.



Ontario Wind Engine & Pump Co., Ltd.
HEAD OFFICE—TORONTO
Branch Houses: Montreal, WINNIPEG, Calgary

You saw this advertisement in this magazine. Don't forget to say so when writing.



Buy It Because It's a Better Car

Model T.
Touring Car
f.o.b. Ford,
Ontario \$650

Get catalog and particulars from Ford Motor Car Company of Canada, Limited, Winnipeg.

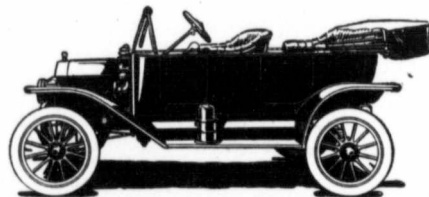

You saw this advertisement in this magazine. Don't forget to say so when writing.

SHIP YOUR FURS AND HIDES

TO McMILLAN FUR & WOOL CO.
WINNIPEG, MANITOBA

Write for Circular

oats for an hour in water so that they may become more softened.

Green bones are bones fresh from the butcher, with the adhering gristle, meat, etc.

The sooner farmers recognize the fact that poultry culture should be followed along the same lines as dairying—giving food and care to secure results—the sooner will they begin to reap their share of profits and become competitors with practical poultry raisers.

Green bones contain the natural juices as well as the adhering substances, making it superior to the bones that have lain on the ground for a while and lost all the natural juices or animal matter. Green bones are also more soluble and capable of having the mineral matter digested.

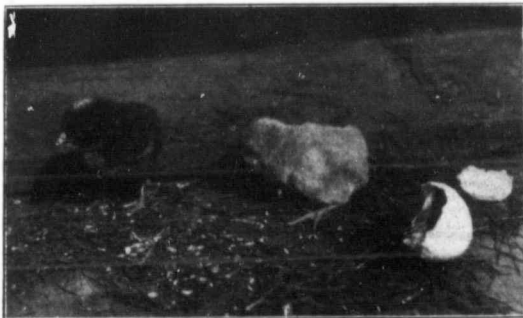

"Where are we anyway?"

In parts of England, turkeys are fattened chiefly on Indian corn, scalded Indian meal and boiled potatoes, with home grown corn for a change.

"Utility" does not mean "mongrelism" any more than "throughbred" means "Standard-bred."

The old way of carrying fowls by their legs, or by the wings, is not practised by the present-day poultrymen. It is a cruel practice. Holding the fowl firmly by the legs and allowing the body to rest on the arm is a much better method.

Fowls are obliged to throw off much of the waste of the body through the lungs. They do not sweat in the same sense that do other animals, but instead breathe several times faster than sweating animals when heated. To keep in good health a hen requires nearly seven times the amount of fresh air in proportion to its size that does a horse.

There is almost as much difference between different families or strains of each breed, as between the different breeds. Therefore, receive with some allowance the praise or condemnation of any breed.

In Paris markets the eggs are dated, and one pays according to the freshness, so that it is possible to be certain of newly-laid eggs; or, if it is necessary to be economical, yesterday's eggs, or the day's before, are offered at a reduction.

There are still some people who imagine they can tell the sex of eggs before they are hatched, or as soon as they are laid. Some tell us that long eggs always hatch females, while others say that such eggs invariably hatch males. When it is considered that each hen shapes her eggs according to the condition of her ovaries, and uniformly lays eggs

of similar shape, the absurdity of the shape theory becomes apparent.

A fat young Guinea is a gamey and savory table fowl, though the flesh is dark.

It takes about two weeks to fatten a duck for market.

When the Indian Runner duck has reached a marketable age, she has nearly completed her growth, and has little left to do but complete her plumage and begin to lay.

A little granulated charcoal mixed in the soft food will generally check bowel trouble in chicks.

Too much use of cayenne pepper has caused considerable trouble among poultry, and so has overfeeding. The former brings on liver ailments, and the latter leads on to indigestion, fever, gangrene of the intestines, and other fatal disorganizations of the muscular tissues of the liver.

THE "HERCULES" PUMP GOVERNOR
is the new name for **THE ADVANCE PUMP GOVERNOR**
WHICH WE NOW CONTROL IN WESTERN CANADA

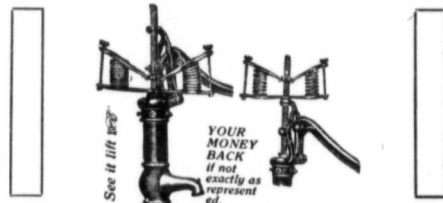

See it lift up!

YOUR MONEY BACK if not exactly as represented

Can. Pat. 144464. Dec. 3rd. 1912

Write for our Pump Governor Pamphlet which gives all information, and also a plan to MAKE A LITTLE MONEY without soliciting, collecting or obligating on your part.

The Western Steel and Iron Co. Ltd., Winnipeg, Canada

You saw this advertisement in this magazine. Don't forget to say so when writing.



Game Heads

Preserved against all decay or injury from climate or insects and mounted with strict fidelity to

NATURE

Send me a trial order of your hunting trophies; game heads or the entire animal, no matter what its size. Birds of every kind.

Money refunded if I fail to give perfect satisfaction.

One patron (a keen naturalist of world wide experience) says: "I have never seen more artistic or more realistic setting."

FRANK TOSE
PHONE MAIN 5185

SUCCESSOR TO
JOHN AMBROSE

173 Fort St.
WINNIPEG
Send for Price List

You saw this advertisement in this magazine. Don't forget to say so when writing.

SPARK ARRESTER

One that gets all the sparks without clogging or interfering with the draft. Fits any engine. Screens adapted to any fuel.

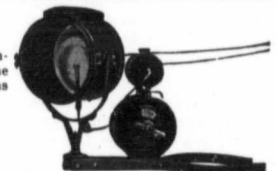

ACETYLENE GAS HEADLIGHT

Turns night into day. Bracket to fit any make of engine. Throws light 400 feet. Operating expense about 1c. per hour.

FLUE CUTTER

You need this tool to get ready for your Spring Plowing. Is adjustable in length and size. Cuts the flue without burring the end. Try it.

Estate of E. M. POPE, Watertown, S. Dakota, U. S. A.
Send for Catalogue and Price List to

THE MATTAG COMPANY, LIMITED, Winnipeg, Man

You saw this advertisement in this magazine. Don't forget to say so when writing.

Eating Oranges in a Canadian Orchard



would attract everybody. Down at Fontana, California, only two hours' ride from Los Angeles city, happy, care-free men, women and children are enjoying the balmy ocean breezes among the green-leaved trees with their wealth of oranges, grape-fruit and olives. The Fontana Company have spent One Million Dollars preparing this land for you. Five, ten or twenty acres can be bought on payments so light that you get most of them out of the products. Price \$300.00 per acre, nine years to pay. Mr. Wright's five acre orange grove gave him a net profit of \$330.00 per acre, season 1912. Wouldn't you like a home with an income like that attached? Our Mr. Stephens has spent many days at Fontana among these groves and can tell you much about them. Ask him for FREE descriptive folders, booklets, etc. Write him to-day.

New Canada Investment Company, 910 Lindsay Bldg., Winnipeg, Canada

You saw this advertisement in this magazine. Don't forget to say so when writing.

INVESTIGATE BEFORE YOU BUY

Don't take our word for it alone but get into touch with hundreds of users and hear from them what they think of the--

Stewart Sheaf Loader



Let them tell you how they

- Have Saved Grain
- Have Saved Men and Teams
- Have Handled their Crop in the Shortest Possible Time
- Have Saved the Price of the Machine in One Season

NOW is the time to investigate the merits of this machine that stands in the same place as the self-binder in the farmer's implement equipment. Find out what it will do for you, but don't wait until the 1914 crop is ready to cut. Look into it now while you can do it at leisure and write us for all details.

The Stewart Sheaf Loader Co., Ltd.

804 Trust and Loan Building, Winnipeg, Manitoba

Patmore's Promise of a Fine Garden

There is no spring literature half so captivating as the seedsman's catalogue. When we see it with its wealth of embellishment—its fine reproductions of last season's horticultural wonders, we feel that we are again within speaking distance of that most hopeful and cheering portion of all that the four seasons hold out to us. It is now time to sketch out the new plan for the garden patch, to find and secure the best our judgments can direct us to in clean seed that will not disappoint when germination is expected in our field crops.

The Patmore Nursery Company of Brandon and Saskatoon have surpassed even their own brilliant record with their new catalogue for 1914. That it is a complete encyclopedia for garden and field, of trees and shrubs, etc., goes without saying, but in its plenitude of variety will be found some very striking new ideas, all designed for the beautification and profit of the farm and city home. The illustrations are not fanciful drawings, but are taken from actual photographs of real products of their own seed specialities.

Many of these, particularly of the more popular and easily grown flowers and vegetables are

of an exceptionally striking character. A perusal of the work is a real pleasure under any circumstances, and to any one with the slightest interest in horticulture and forestry, it cannot fail to afford peculiar delight and real assistance.

Manitoba Engines Pass Every Test!

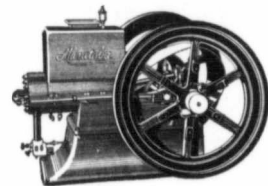

When you are thinking of buying an engine, don't forget that the cost of operating is far more important than price. Consider the cost of running, how much for repairs, how much time and attention needed, and **ABOVE ALL**, "Will it run just as well in midwinter?"

A **MANITOBA** engine will run as cheaply as any ever built, will cost far less for repairs than an inferior machine, requires very little attention, and **ABOVE ALL**, will run just as well in zero weather as in July. The **MANITOBA** is the right kind of engine. It runs smoothly, quietly, has the power, gives no trouble, is economical and makes good generally. Our engine catalogue is yours for the asking and it is worth having because it tells the facts. Write for a copy today.

WE MANUFACTURE Gasoline Engines, 1½ to 25 H. P.; Grain Grinders, 6 to 12 inch; Wood and Iron Pumps; Wood Saws, all sizes; Pumping and Power Windmills, 8 to 14 feet

"MADE IN THE WEST FOR WESTERN NEEDS"

MANITOBA ENGINES, LIMITED
Brandon, Man. Saskatoon, Sask. Calgary, Alta.

You saw this advertisement in this magazine. Don't forget to say so when writing.

The Patmore Nursery people are the oldest horticultural folks in Western Canada, and have certainly found the way to success in their own line under Western conditions. They have also discovered by long and costly experience what will not

do, and are in the very best position to give advice and to guarantee what they offer as far as Nature will permit them to guarantee anything in seed or seedling which has ever been tested on the prairies.



NO. 1 HARD

Winnipeg, Jan. 3, 1914.

Speeding the departing year 1913 with its superstitution of the "13" and its wars, financial distress and social unrest, Western Canada can still be thankful for a good crop well saved. The period of scarcity of capital and exhausted credits seems about past and with general soil preparation for our next crop and a fine start made by American winter wheat, the outlook is most promising for a return of greater prosperity and easier credits in 1914.

The remarkably mild season to date, saving the Canadian West easily \$10,000,000 in coal expense alone, has resulted in slower trade conditions in textile and some other lines. The grain has been moved very rapidly, and now receipts are running only about one-half those of a year ago and away below the average of the last four years.

It is generally conceded that the percentage of grain left in farmers' hands on both sides of the line is remarkably small, and such grain will dribble along through March, April and June. Winnipeg inspections to December 31, 1913, are relatively very large:

	1913	1912
	Bushels	Bushels
Wheat	115,749,800	82,753,875
Oats	43,490,850	24,714,300
Barley	11,788,200	8,429,400
Flax	9,374,200	8,781,150

The Argentine crop is proving somewhat disappointing in threshing returns. The International Institute of Agriculture, with all the world's figures, finds that the northern hemisphere raised a smaller crop of cereals than in 1912, while the Argentine and Australia, the two chief wheat countries of the southern hemisphere, have larger crops. The wheat in India has suffered greatly from drought.

Foreign crop prospects generally are favorable, but the percentage of Russia's 1913 crop, yet to market, is only a surmise though that country continues a good steady shipper. Australia has a good crop of high grade wheat. The United States winter wheat crop has recently received a good snow covering, and while crop promises well, it is known to be poorly rooted and will be easily injured by hard spring freezing.

Canadian terminal elevator stocks are not unduly large and some all-rail business has been done right along since the close of navigation. Holiday dullness has prevailed lately, but with harder winter weather at hand and light interior stocks, a gradual hardening of the prices of wheat seems due and very likely to come. The period of accumulation is over and a good revival of demand seems imminent.

Great Britain has been a steady buyer and likely will continue so. Millers report a fair trade, with an increased enquiry as wheat receipts dwindle. It is to be noted that the crop in both the United States and Canada is relatively much more out of the farmers' hands than ever before in the history of the West. Thus the carry-over in both the countries will be small even after the two largest crops ever harvested in each country have been garnered, as the result of a larger consumptive demand. Taking everything into consideration, the holders of wheat should find their property enhance greatly in value before spring, especially if "Free wheat" becomes a reality, giving Western Canada a wider market for her product. Canadian millers will, in that event, become very active buyers of the remainder of our high-grade wheat.

Coarse Grains

The oat market has held quite steady with a little lower tendency as corn declined abroad. But this grain is quite on an export basis and should not work much lower. The consumption of corn and oats has been much under the average everywhere on account of the extreme mild weather. There will shortly be a market to Ontario and Quebec for high grade clean oats for seed purposes.

No action in barley but only a draggy market with poor absorption of offers. Nor is the outlook any more promising. All coarse grains can be more profitably fed on the farm this year. This especially applies to mixed grain, which sells at very heavy discounts and does not bring near its intrinsic value.

Flax

The situation in flax is satisfactory. Pending the readjust-

Now For Better Prices

Grain receipts are running remarkably light. World situation points to higher prices. Farmers, get the most out of your grain by shipping. If we can give you special billing instructions when loading, we can get you excellent premiums now on all grains. Try our service.

BLACKBURN & MILLS (A. M. Blackburn) (D. K. Mills)
531 Grain Exchange **Winnipeg, Man.**

Licensed Reference: The Royal Bank of Canada Bonded
 Telephones—Main 46 and Main 3570

You saw this advertisement in this magazine. Don't forget to say so when writing.

FARMERS! SHIP YOUR GRAIN

TO THE

CANADIAN ELEVATOR CO. LTD.
GRAIN COMMISSION MERCHANTS, WINNIPEG

It is as much our business to give satisfaction as to secure grain shipments. We watch the grading of each car and allow liberal advances on all bills of lading.

You saw this advertisement in this magazine. Don't forget to say so when writing.

SIMPLICITY - VALUE - SERVICE

in all that is needed in power on the farm is to be found at less cost than in any other engine of equal horse power in the

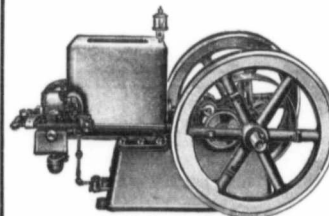

Fuller & Johnson
Type "N"
Kerosene Engine

2, 4, 6, 8 and 10 h.p. Stationary and Portable.

This wonderful, compact, easily operated engine is the very last word in internal combustion, power machinery. Made of the best material only, and its structural parts so proportioned and distributed as to give unusual strength and rigidity.

SOLD ON A GUARANTEE TO WORK
SUCCESSFULLY ON KEROSENE OR
:: :: YOUR MONEY REFUNDED. :: ::

WRITE FOR COMPLETE LITERATURE TO

HENRY RUSTAD, 108 CARLTON BLDG. WINNIPEG, MAN.

You saw this advertisement in this magazine. Don't forget to say so when writing.

Have You Used
'SILKSTONE'
 The Beautiful Flat Wall Paint,
'IT WASHES'

Mention this magazine when writing advertisers.

TRAVELING SALESMEN
Earn \$1000 to \$5000 a Year
 You can learn to be a salesman in eight weeks by mail and our good agents will give you our training. No money or experience necessary. Write today for list of our agents and literature. Write today for list of our agents who are now earning \$100 to \$500 a month. Address nearest office, Department
National Salesmen Training Association
 Chicago New York Kansas City San Francisco

BIBLE HELPS
 Earnest Bible Students may harmonize the Scriptures by reading our Booklet "About Hell." Based on the latest authorities. The last word on this important subject, with other valuable information. Price ten cents. (To the poor free).
INTERNATIONAL BIBLE STUDENTS ASSOCIATION
 29 Alloway Avenue, Winnipeg

Mention this magazine when writing advertisers.

ces

situation grain by hen load-

ackburn) Mills)

Man.

Bonded

writing.

SHIP UR AIR

LTD.

n ships-ces on

writing.

ICE

ine

rd in only, usual

DG.

EN

A Year ready by mail, list of goods of any size, a month, no postage on fractions

sonize booklet author-ization.

ENTS

vertisers.

ment of business conditions in the United States now that the currency bill has passed, the flax market has been marking time. But with an improved financial outlook and with fairly light stocks of oil, there should be a gradually improving demand for flax. The linseed exported from the United States to Great Britain for 1913 almost doubled that sent over in 1912.



New Threshermen's Organization

What promises to be a powerful organization, with far-reaching effects, was launched on Saturday last, when the threshermen of the Saskatoon district met in the King Edward Hotel and organized the "Canadian Threshermen's Association," with headquarters in Saskatoon.

The meeting was fairly well attended, representatives being present from Dundurn, Zealandia, Delisle, Biggar and other points, along with a liberal number of local threshermen. After a short discussion, it was unanimously decided to organize the threshermen of Saskatchewan, with headquarters at Saskatoon, and with local associations at every town and village throughout the province.

The objects of the association are: To create a better understanding among threshermen; to assist each other by the exchange of ideas and the imparting of practical information; to advocate and obtain legislation governing machinery sales, collections and collection of threshing accounts; to initiate and amend other laws affecting the threshermen, and by organization to control and place the threshing industry on the sound business basis that its immense capital investment demands.

The association was properly organized, with sound and practical constitution and by-laws; officers were appointed, and an experienced organizer engaged. No effort will be spared to complete the organization of the threshermen of the province in the shortest possible time.

Judging from the determination displayed at this meeting, the old saw, we have heard so often, that "farmers cannot stick," is about due for a rude shake, for (as plainly expressed at the meeting) it is but equivalent to asserting that "farmers and threshermen have neither brains, intelligence, ability nor loyalty, but that the above virtues are controlled exclusively by dish-washers, retailers, capitalists, etc., who have their unions, etc., etc." Saskatchewan threshermen are not ready to admit this, and are determined to prove otherwise, and when their organization is com-

DOMINION Nobby Tread



"Dominion Tires are Good Tires"

The World's Best Tire is now "Made in Canada" in this New Million Dollar DOMINION Tire Factory

THE demand across the Line for the "Nobby Tread" Tire keeps four great American factories busy. Its superiority has been clearly demonstrated both there and here in Canada.

We have secured the Canadian rights to all the patented designs and exclusive processes which have made U.S. "Nobby Treads" the world's best. We have erected the big factory you see below, and equipped it with duplicates of all the special machines used in the four great factories of the U.S. Tire Company.

The product of this Factory, the DOMINION "Nobby Tread", is certainly the best tire that has ever been made on Canadian soil, and has no superior in any other country. There is nothing experimental about it—every feature,

every manufacturing process has been thoroughly tried out and proven satisfactory.

It has the same absolutely Non-skid "Nobby Tread" which was worked out in co-operation by the Morgan & Wright, Hartford, G. & J. and Continental Tire people. It has the same uniform bull-dog strength in every part of the carcass, because we build it on the same machines, by the same exclusive processes.

So keen is the demand for DOMINION "Nobby Treads" that we have had to cut down some of the largest orders so as to be able to supply some, at least, to every dealer in Canada. To avoid delay, get your order in with your dealer at once.

DOMINION TIRE CO., LIMITED
BERLIN, ONTARIO.

Sole Selling Agents:
Canadian Consolidated Rubber Co., Limited
MONTREAL 25 Branches throughout Canada.



You saw this advertisement in this magazine. Don't forget to say so when writing.

plete they will be a power to be reckoned with.

And certainly the time has come to strike out from the shoulder, for conditions surrounding the threshing industry in Western Canada could not well be worse, and threshermen themselves are the only ones that can remedy those conditions.

A further meeting to complete plans for organization and general details will be held in the King Edward Hotel, Saskatoon, at 2 p.m. on Saturday, Jan. 17th.

Director of Traction Engineering Schools

The above illustration is that of Mr. A. C. Campbell, who will have charge of the Indiana School of Traction Engineering at Winnipeg, Regina, Saskatoon and Calgary.

These schools have been carried on now for a number of years and have proven to be very popular

and at the same time fill a long felt want among the traction engine owning public.



Mr. Campbell is a man of wide experience, and under his supervision we are certain that those who attend the Indiana Schools of Traction Engineering in 1914 will get full value for their money.

Traveller (hastily).—"Porter, have I time to kiss my wife good-by?"

"How long have you been married?"

It is only in war that the unexpected admittedly happens. In love and other domestic calamities there is always a relative who knew it all the time.

Fistula and Pohl Evil

Any person, however inexperienced, can readily cure either disease with

Fleming's
Fistula and Pohl Evil Cure
—even bad old cases that skilled doctors have abandoned. Easy and simple, no cutting; just a little attention every fifth day—and your money refunded if it fails. Cures most cases within thirty days, leaving the horse sound and smooth. All particulars given in

Fleming's Vest-Pocket
Veterinary Adviser
Write us for a free copy. Ninety-six pages, costing more than a hundred other veterinary books, bound, in cloth and illustrated.

FLEMING BROS., Chemists,
41 Church Street, Toronto, Ont.

Mention this magazine when writing advertisers

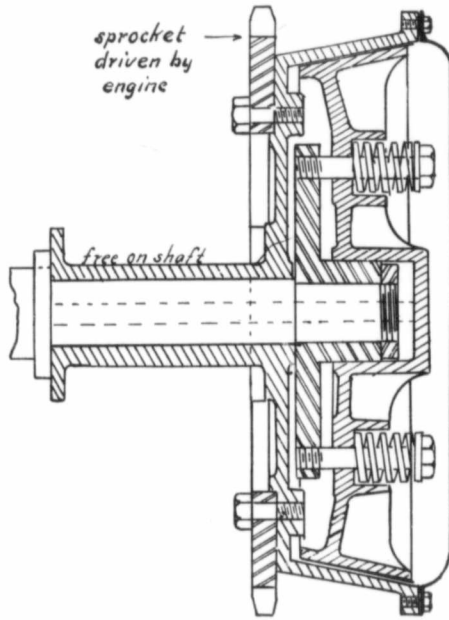

Fig. 172. Form of cone clutch used on Leader tractor.

and when the clutch is released this spring is compressed, thus relieving the pressure on the discs.

The flange bolted to the engine shaft carries a number of studs, on which the first set of discs are loosely threaded by suitable holes drilled near the rim of the large discs. The other set of discs, which are smaller, are supported by a similar flange with studs, which flange is fitted to the square end of the transmission shaft. The large discs are cut out in the center, thus allowing room for the studs which support the smaller set of discs. The inner or smaller discs are small enough to

rest inside of the studs that hold the large discs, thus only the outer rims of the small discs and the inner surfaces of the large discs are in contact. A stout spring slides the flange on the transmission shaft forward, thus engaging the clutch. A clutch of this type generally runs in oil to prevent the cutting and roughening of the discs. When pressure is put on by the spring, the oil is gradually squeezed out from between the discs, but until the oil is all squeezed out more or less slipping will occur. With this style of clutch, therefore, the load is not suddenly applied because a certain amount of slippage is provided for.

Course in Gas Engineering

Conducted by PROF. W. J. GILMORE

LUBRICATION

IF ONE were to ask a great many gas engine salesmen what in their opinion was the one thing most characteristic of gas engines which had caused them to become so rapidly adopted as a source of power, the probable answer would be, "The fact that gas and gasoline engines require so little attention." This is apt to be a stumbling-block for the person who buys an engine without having had previous experience or knowledge of such engines. It is being continually impressed on his mind, both by the salesman and the catalogues he receives, that the gas engine requires "no at-

tention whatever." A few of the salesmen who are not less zealous than the others to secure the order, but who are looking forward to the future, may state in an indefinite way that, while gas engines need some attention, the time involved does not really amount to much. The result is that the inexperienced purchaser often is sorely disappointed. He has been under the impression that all that was necessary was to start the engine, after filling the oil-cups, and then let it alone until he wishes to shut it down.

And yet not all this misunderstanding is the fault of the salesman or the manufacturer. In the first place, one should remember

Your 1914 Resolution:

"I will save cigar money and increase my smoking satisfaction by buying my cigars direct of the Reo Cigar Company."

This month of January commences the third year that the REO and the KING GARCIA have been offered exclusively direct by mail to the discriminating smokers of Western Canada. We tripled our business in 1913.

Why this Success?

- Because we supply our customers with very superior goods at a much lower price than they can obtain elsewhere.
- Because we sell direct to the customer, saving them all the middleman's expense and profit.
- Because we thus enable our customers to save a tidy sum each year by reducing their cigar expense.
- Because every man likes to have a box of cigars handy in his own home for occasional guests and personal comfort.
- Because we furnish an absolute written guarantee with every cigar we ship.
- Because the goods behind the guarantee are so uniformly good, so closely inspected, that in two years, we have never had one box returned.
- Because, if you happen to be one of our old customers, you know the above reasons are correct, and that we thank you for your past patronage, and will continue to merit it.

THE REO

A combination of clear Havana and domestic filler. Better than and 3 for 25c. cigars on sale in the stores. Sold under our absolute guarantee by mail to cost you only 4) cents each.

THE KING GARCIA

Known throughout Canada as "the quality smoke." Clear, first-grade Havana Tobacco, Spanish hand made. Full five-inch size. The regular 2 for 25c. grade sold to you under our guarantee at 6c.

Box of 50 King Garcia Cigars.....	\$3.00
Box of 10 " " " " " " " " " "65
Box of 50 Reo Cigars.....	2.25

REO CIGAR COMPANY, Dept. K
437 Main St., Winnipeg, Man.

Find enclosed money order for..... \$..... for which ship to my address one box of..... cigars, light, medium, or dark, subject to the following guarantee:

Name.....
Address.....

WE hereby agree that should the cigars accompanying this guarantee not be to your satisfaction, to refund you the sum of \$..... provided that you give the goods fair and impartial trial, using not to exceed six cigars, and have returned the balance to us in 1.00 order, postage or express charges prepaid, within thirty days of date of shipment.

REO CIGAR COMPANY.....
..... Nanager
N.P.—This form of guarantee will be signed and accompany goods.

You saw this advertisement in this magazine. Don't forget to say so when writing.

that there is no machine which will run indefinitely without needing some attention, and the better and more intelligently the attention is given it, the better the results are likely to be. And if the simplest form of machines require attention occasionally, how can we expect a gas engine (which, of necessity, must be complicated in comparison to a great many kinds of machines) to run without attention? And yet it is undoubtedly true that many engines do run without being cared for at all. The result, however, is that they do not last more than a year or two at best, and then they must be replaced.

If there is one thing that is necessary for the successful operation of a gas engine it is oil. While many gas engine operators seem to recognize this, they

FIRST CLASS TRACTION ENGINEER
wants position for season (plowing and threshing), with some reliable party or contractor. 15 years' experience. Sober, steady. References. Will do repairing and go any place.
L. H. RATHBUN
Rockford, Michigan

SEEDS

DROP A POST CARD for
MCKENZIE'S
1914
SEED CATALOG

A.E. MCKENZIE Co. Ltd.
BRANDON, MAN.
CALGARY, ALTA.

Western Canada's Greatest Seed-House
1914 Catalogue Now Ready



In Time of Peace Prepare for War

A splendid principle! Applied to your business it means: **Plan now for your next spring and summer rush.**

You cannot plan wisely without our Catalog of **POWER FARMING EQUIPMENT** because it shows the most complete and up-to-date line of **Disc and Seeder Hitches, Binder Hitches, Engine Wagons, Soil Packers, Belt Guides, etc.,** ever placed upon the market.

If you **FARM WITH POWER**, our machinery will absolutely save you more time, labor and money than any other part of your outfit of equal cost. It will pay for itself in a single season. You actually lose money without it.

Our Disc and Seeder Hitch will haul any number of Discs, or Discs and Seeders, or both, required. Keep them always in place, without piling up and never break down. It is light and adds no load to your engine. Furthermore the price is reasonable. **To own one is cheaper than not.** Let us tell you all about it, and the **Famous Caswell Belt Guide.** Ask for our catalog. It was printed for you. Write us today, now, while you think of it. A postal card will do. Address:

Caswell Mfg. Co. - - Cherokee, Iowa



fail to bear in mind that oil of a proper quality is needed, and that it is needed in certain places and not needed in others. The operator is apt to become careless and let oil get all over the engine and catch and hold dirt and this gives the engine a very unpleasant appearance, if nothing else. But there are a number of engines which have parts where oil is not intended to go and if it gets there trouble results. Further, oil will get in around working parts and after getting gummed up with dirt, will stick the parts and cause them to operate slowly and stiffly, so that they get out of time. It is a good plan to put some gasoline in a squirt can and squirt some of it on to such parts every week or so. This cleans off the gummy oil and dirt, and after letting the engine run a while with the gasoline, oil can be put on such parts as need it.

The engineer should not fail to wipe his engine off at least once a day. As one writer says, he had better wipe up the engine after shutting down in the evening, for he may not have time to do it in the morning. Then, too, in this way the oil is not allowed to remain on the paint, etc., over night. The writer knows of at least one engine which is cleaned up both at noon and at night, as soon as it is shut down. Although the engine has been in use over a year and a half, the paint is bright and fresh as ever. This may not appear to be of any particular advantage, but if the owner tried to sell his engine second hand, its appearance would be worth much more than what it has cost him to keep it clean.

The lubrication of the cylinder, however, is one point which many gas engine users seem to attend to with the utmost care, and yet with dire results. Many operators realize that the oiling at this point is a matter of great importance, and they therefore proceed to get the best steam engine cylinder oil at the very highest price. Now, while their intentions are good, their deeds are not. Steam engine cylinder oil is intended to lubricate the

cylinder under conditions which are very different from those under which oil in the gas engine cylinder must operate. In the steam engine there is more or less moisture, and the temperature is fairly high. But in a gas engine, especially after it has been running for several hours, the heat is exceedingly dry and intense, much more so than in a steam engine. The gas engine cylinder oil must, therefore, be able to withstand a very high temperature, and lubricate under very dry conditions. A good grade of gas engine cylinder oil which has a high flashing-point can be secured for less money than the best steam engine cylinder oil, and answers the purpose better. Any gas engine manufacturer can furnish such an oil on direct inquiries where to secure it.

But a supply of the proper kind of oil is not all that is necessary. It must be properly applied or fed to the cylinder. It is usual for engines to be supplied with lubricators which hold enough oil for a run of about ten or twelve hours, and in such cases the feed can be set so that one cupful will last about that length of time. Too little oil, of course, causes the piston and cylinder to become dry, and if the lack of oil is continued they will begin to cut and heat. If this condition still continues, the piston may expand so as to stick in the cylinder. I have known of several instances where an engineer forgot to open his lubricator on starting the engine and did not notice it until the engine stopped from the piston sticking in the cylinder. This, of course, cuts the cylinder up badly, and soon necessitates reboring of the cylinder and fitting a new piston.

On the other hand, it is more usual to meet cases where too much cylinder oil is supplied, rather than too little. In their endeavor to avoid the one, many engineers fall into the other habit. The result is not so disastrous to the engine itself as it is to the successful operation of it. If too much oil is fed, the surplus over that which is required for lubrication is forced

back into the combustion-space. Here it is partly burned up by the intense heat and flame, and part of it is blown out with the exhaust gases. That which remains becomes gummy and deposits in numerous parts of the cylinder. It falls on the igniter points and prevents a proper spark. It collects around the piston rings and sticks them fast in their grooves, so that they fail to spring out and hold the compression. The oil which is thrown out with the exhaust clogs up the auxiliary exhaust ports, if there are any. I have known these ports to be clogged so completely that a casual examination of the inside of the cylinder failed to show where they were, and it was only by taking a hammer chisel that they could be found

and cleaned out. The burned oil which passes out through the exhaust-valve sticks on the valve stem and seat and causes the valve to work slowly and perhaps not seat entirely. This means frequent regrinding and cleaning of the valve. Then, too, the exhaust-pipe becomes partially clogged up with the grease. The muffler plates also become clogged up with the dirt which is thrown out, and so completely does this occur that it almost prevents the escape of the gases. All these things cause a heavy back pressure in the cylinder and decrease the power developed. In some cases the back pressure of burned gases is so great that the gases contaminate incoming charges so that they fail to ignite.

"FLOUR CITY" TRACTORS



1914 Should be the Biggest Year for the Flour City

The year that has just closed has witnessed the appearance of some new tractors and the disappearance of others, but after all has been "said and done" the "FLOUR CITY" stands out pre-eminently as the one Successful tractor that continues to hold the most advanced position in design, construction, simplicity and efficiency.

Such features as the bevel gear transmission, the over-head valves, the large diameter drivers, the proper distribution of weight, and the one lever control are special "FLOUR CITY" features and have made possible our claim of power development, durability and economy, all of which has been verified by six years of continuous service.

The "FLOUR CITY" is not a so-called assembled tractor, but is built in its entirety in our shops. It has received the highest honors in all contests and demonstrations in which it took part. Naught can be said against it and much can be said in its favor.

It is a tractor worthy of your consideration, built in three sizes—20, 30 and 40 H.P. Send for descriptive catalog.

828 44th Ave., No.

KINNARD-HAINES CO.
MINNEAPOLIS, MINN.

the REO direct by 7e tripled

written guar-

ratione are so ted, that in 1 one box

of our old reasons are of your past writ it.



NEER g and ry or Sober, ailing



How Interest Rates may
be Reduced

By J. H. Worst, Pres. N.D. Agricultural College

HERE is no question that if farmers were to engage more largely in dairying and raising livestock, and were to farm their land more scientifically, the rates of interest they are required to pay the banks would be materially lowered. Why, do you ask? Because certainty of receiving prompt payment when principal and interest are due, to a very large extent, determines the rate of interest.

It is a well-known fact, judging from the manner in which much of our farming is done, that there is but little assurance of profitable crops, should the season prove unfavorable—and such seasons will come—hence the banker makes a rate that takes into account the probabilities of poor crops when seasons are bad—and then some. Why not? You would do the same.

As a matter of fact, there is not much charity in matters of a purely business character. Even should some new banking system be devised, a banking system calculated to benefit the farmer by furnishing him with cheap money, yet money must be safe before it will become cheap. Good farming offers reasonable assurance of profitable crops. If all farmers were good farmers, the crops would be more likely to prove profitable than where many of them are careless, or rather where they undertake to farm so many acres that failure or a very low yield per acre is likely to be the result. In other words, if all the land under cultivation were well tilled and otherwise properly managed, the assurance of profitable crops almost every year would cause interest rates to gravitate toward a lower level.

On the other hand, if farmers generally were to engage quite generously in raising livestock—a department of agriculture not readily menaced by such calamities as hot winds, hail storms, early or late frosts, etc., the assurance of a fair annual profit for the farmer would tend to lower the rates of interest. It is true that livestock must have feed and that the elements just enumerated exert a baneful influence on corn for feed or silage, or on meadows and pastures; nevertheless, the actual losses are never so great nor do the elements injure them in the same degree. Moreover, at the very worst the live stock can

be disposed of at prices that will still enable the farmer to pay his debts and get started again. It beats a total clean out by hail, frost, or hot wind, where the entire dependence was put in wheat, by a mile.

Cheap money, therefore, depends more upon the assurance of profitable crops than upon the abundance of money. The surest crop for a farmer is livestock, and the surest and most profitable division of livestock is dairying. If practically every farmer patronized a creamery, had an eye for good dairy stock, and gratified his eye's desire, and otherwise managed his dairy herd on business lines, the rate of interest would not be worth bothering about, and largely because we would have changed our system of farm management from one of considerable uncertainty to one of almost absolute certainty.

Another great advantage would accrue to the farmer from the fact that his ability to pay cash, or at least to pay promptly, would enable him to purchase his supplies much cheaper than where the merchant, like the banker, must take a chance at ever getting his pay.

Many of the ills we complain of can be cured thus by our own foresight and sagacity. The wide-awake farmer will eliminate the element of chance as far as practicable by substituting reasonably certain things for things uncertain. For a steady and almost sure income, dairying doubtless stands first, among farm enterprises. It requires good judgment and steady work, but without intelligent labor little can be accomplished in any pursuit.

Other kinds of livestock also are remunerative and afford a fairly certain income. As a matter of fact livestock of any kind is more certain to produce regular profits than the cultivation of grain. Naturally the two should go together. It would enable the husbandman to distribute his work throughout the year, with fair assurance of profitable income together with by-products that would replenish the soil with fertility taken from it by the cereal crop. It would also enable a farmer to convert many things that otherwise would be wasted, into ready cash.

By all means establish a system of farm management that will

SEEDS

Steele, Briggs

No matter what you need in Seeds, this name stands for the highest quality.

Purity, Quality and Variety

absolutely unrivalled for Western Canada.

11 Booklets—"How to Grow the Best"—152 Pages

copyrighted; FREE TO CUSTOMERS. Covering all leading varieties; the fine points about Preparing the Seed Bed, Manuring, Starting the Seed, Forcing, Ripening, Storing, etc., are all made clear.

\$\$\$\$ In Prizes for Competition

Write to-day for 136-page Catalogue, which is free to all on request.

Steele, Briggs Seed Co., Limited

WINNIPEG

Canada's Greatest Seed House

You saw this advertisement in this magazine. Don't forget to say so when writing.

come as near as possible to affording a sure annual income, even if it does require more thought and labor. When a man is so situated, he should be able to borrow money from the banks at as low interest rates as business men do.

"Boys on the Farm"

"The practice of the well-to-do farmer who moves to town to 'educate his children' is an old story and is fraught with many a hidden tragedy, to say nothing of the impoverishment of the land and the social order left behind," writes W. A. McKeever, of the Kansas Agricultural College, in his book, "Boys on the Farm." There is much good reading in this book and every farmer will enjoy it whether or not he is in sympathy with the expressed view. He says: "Why cannot the intelligent farmer remain on the home place and join a movement having for its purpose that of making the neighborhood a more desirable place of human habitation?"

"One of the duller places in the world is the country town which has been filled up with retired farmers. These are usually men who came into the place for the purpose of getting all the possible advantages at the lowest possible cost. In the typical case, the new city dweller of this class secures a very good residence, and that often, if possible, just outside the city limits in order to avoid local taxes. He takes little or no interest in the town's municipal affairs and votes against nearly all improvements. He keeps his own cow,

horse, chickens and garden, and brings extra supplies in from the farm. Gradually he takes on a few city ways. That is, he uses less home produce and dbuys more at the stores. But for want of stimulating employment he gradually grows stouter and mentally more stupid—and indication that he is dying at the top and that he is soon to be cut down. Really the retired farmer is a nuisance to a town and the town is a bore to him.

"But what of the children whom he brought in to 'educate'? They learn rapidly, soon take on city manners. The natural restraints from evil conduct, which the farm home furnished, is now wanting. The blare and bluster of the town both excite and delight them, while the parents have positively no rules or standards by which to govern and direct their young in the new situation. All the boys and girls need to do in order to gain a parental consent to go out at night is to declare that 'everybody is going' or that they are 'expected' to be there, and the thing is settled. Thus the young ruralists newly come to town go dancing and prancing off into a veritable world of sweet dreams and delights—spoiled forever for any service that they might have rendered in building up the country community—and finally destined to become mere cogs in the ever grinding wheels of the same city.

PATENTS
LLOYD BLACKMORE & CO. LTD.
Hope Bldg., 63 Sparks St., Ottawa, Ont.
Write for Free Book of Information.

Minneapolis Steel & Machinery Co. of Canada, Limited

We approach the coming tractor season with the most complete line of perfected oil tractors ever offered the Canadian Farmer in the FOUR sizes of

Twin City Tractors

Which is the Tractor that Fits your Farm?

Twin City "60"

Cylinders 7½ in. x 9 in.
The most powerful Tractor in the World.

Twin City "40"

Four Cylinders, 7½ in. x 9 in.
The Original Twin City Tractor. The machine that has carried the Name of Twin City Tractors all over this Country, South America and Europe.

Twin City "25"

Four Cylinders, 6 in. x 8 in.
A remarkably powerful machine that equals many of the so-called thirties in draw bar pull.

Twin City "15"

Four Cylinders, 4½ in. x 7 in.
The last word in small tractor design.

All Twin City Tractors use Kerosene, Gasoline or Distillate

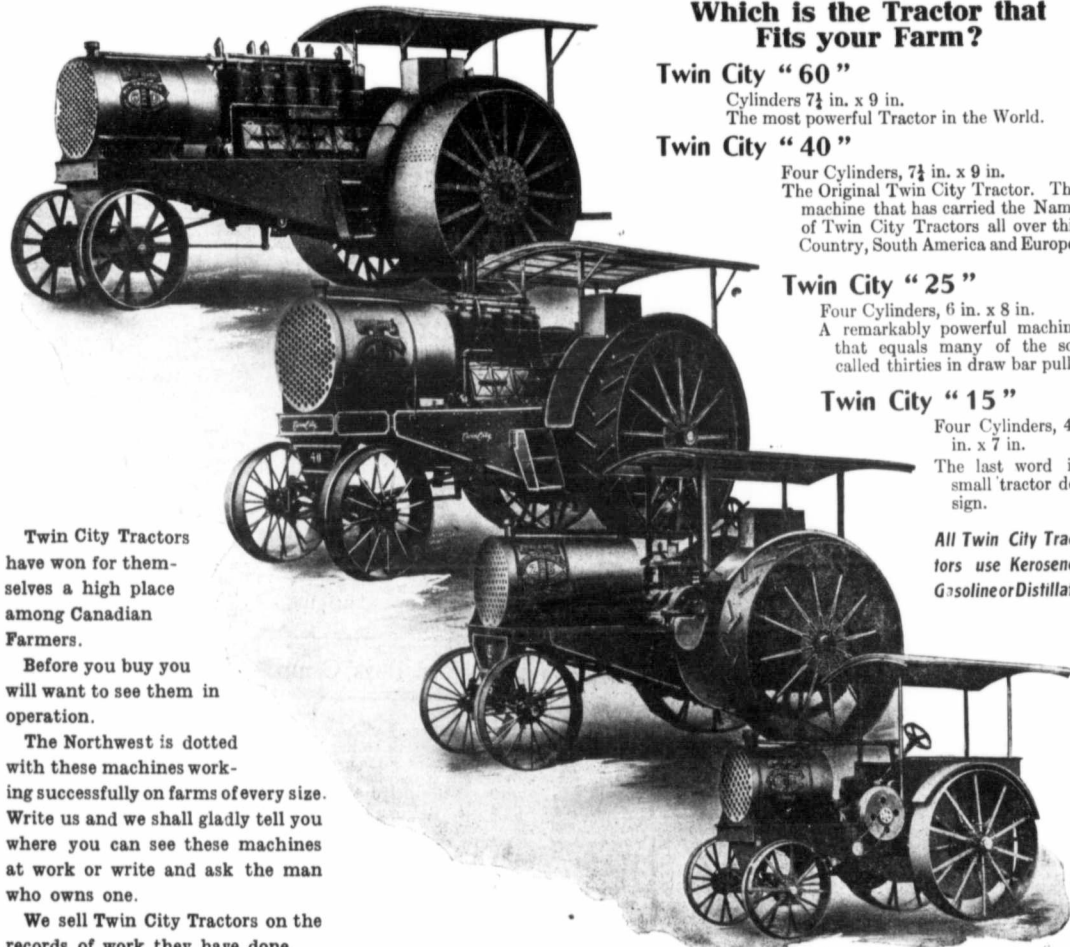

Twin City Tractors have won for themselves a high place among Canadian Farmers.

Before you buy you will want to see them in operation.

The Northwest is dotted with these machines working successfully on farms of every size. Write us and we shall gladly tell you where you can see these machines at work or write and ask the man who owns one.

We sell Twin City Tractors on the records of work they have done.

Get A Tractor That Fits Your Farm

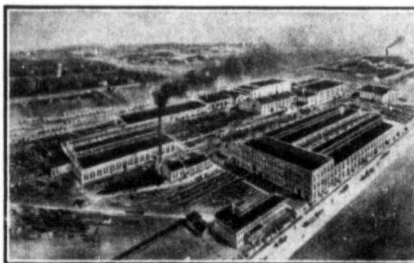

Plant covering 20 acres—Home of Twin City Tractors

Use this Coupon to ask for Free Catalog of the Twin City Oil Tractors
Please mail me your New Catalog of the full line of Twin City Oil Tractors

Name

Post Office

Minneapolis Steel & Machinery Co. of Canada, Ltd.
L. L. BROCKETT, Manager
WINNIPEG, MAN.

I would like to correspond with any of the members of my own age.
Hoping my letter will not lose its life in the fight with the W.P.B. I will close, wishing the club every success.

I remain,
William Stacey.

Ravine Bank, Sask.,

Dear Boys' Camp:
This is my third letter to your camp. I was very glad to see my last letter in print, and hope to see this one in print.

I will tell you a story that I saw in a book one day. A Jewish boy went into a delicatessen store the other evening and said to the proprietor: "How much are three pounds of sausages at 60c. a pound, five pounds of butter at 30c. a pound, five pounds of corned beef at 40c. a pound?" "How much is it," the proprietor said; "that will be five dollars; do you want to take them with you?" And the boy told him: "No, dat's my arithmetic lesson for to-morrow."

I will close with a riddle: Can the sardine box, no but the tomato can.
Yours truly,
R. D. Underwood.

What I saw and Learned at the Exhibition

(Portion of First Prize Essay awarded to boys who were the Guests of the Winnipeg Exhibition Association, 1913—Won by Robert Coulter, (age 16) Swan River, Man.)

I left Swan River for Winnipeg on Monday, July 7th, at about 5 o'clock in the morning and arrived at my destination at about 5.30 in the evening. I got on a street car at the depot and it was not very long before I arrived at the King Edward School. This school is a fine building situated (close to the Exhibition Grounds) on Selkirk Avenue.

The Fair started on Tuesday morning, July 8th, and that day we listened to a lecture by Prof. Chase. He said that in the motor competition, the engine which did the greatest amount of work, with the least fuel in an hour won the prize. He also said that energy and power like other things must have a unit of measure. This unit is horse power. Horse power is the work required to raise 33,000 lbs. one foot per minute. He told us how the amount of work done by the engine was found out and after that was found out it would be an easy matter to weigh the fuel used.

Moving Picture Machine FREE

To the girl or boy selling 50 sets of our...
Toronto News Co. Dept. 581

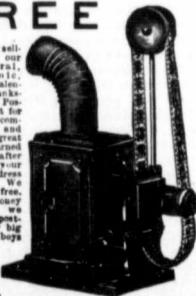

Mention this magazine when writing advertisers

On Wednesday morning, I looked over the machinery exhibit outside of the buildings. This included motor truck, plowing outfits, scales, threshing outfits, etc. The J. I. Case Co. had a splendid exhibit of threshing machinery. It was a J. I. Case engine which won first prize in the Motor Competition. Threshers were also shown by the Red River Special, Waterloo, Huber, Avery, Great Minneapolis Line, Sawyer-Massey and Geo. White & Sons companies.

The J. I. Case Co., showed the high climbing abilities of their engines, by having one climb a hill inclined at an angle of about 40 degrees. The Hackney Auto Plow was shown. It has the plow attached under the machine. The hind wheel of the auto goes over the furrow and packs the sod down, so that it will not fall back after the plows have gone by. The Canadian Fairbanks-Morse Co., showed an exhibit of their scales.

At the New Agricultural College

At 9 o'clock we had a lecture by Prof. Rutherford, who for a number of years was chief veterinarian for Canada. He said that there was not a better trade than farming scientifically. People in commercial life have to study hard in school for a long time before they can obtain their position, and then 90 per cent of them fail afterwards, while not near as large a percentage of farmers fail although hardly any of them get their knowledge from school. He said that all the cities and railways, and in fact everything in commercial life depends on the farmer for its support. He also stated that the farmer was the most independent person in the world.

After this Prof. Jones gave a lecture. He gave us the following verse of poetry:

"The farmer trade is one of work.
He's a partner with the sun and earth,
He's partner with the sky and rain,
And no one loses for his gain.
Men may rise and men may fall,
But the farmer needs must feed them all."

He gave a short talk on Clyde horses, pointing out their most important characteristics. The skin between the hock and fetlock should be like the paper on the wall; that is, there should not be any meat between the skin and bone. The ankle should be sloping. If the ankles were straight, the horse would get a very heavy jar when the horse stepped out on it.

Prof. Jones also said a few words on Percheron horses. This horse comes from France. In early times it used to be used as a stage horse. The Percheron is about the same size as the Clyde and black or grey in color. The stallions of this breed are always worked in France. It is noted for

its good disposition. The Percheron should not have much hair on the legs. The feet are large. The ankles are sloop and they should be rounded at the tail head.

Prof. Jones then called for a horse, so we could see what a real good horse looked like. "Rosene" a splendid Percheron mare owned by the Upper Bros., was selected. This mare took first prize at the Chicago International Fair, against 84 entries. Also second prize at the World's Fair. She was champion at the Iowa State Fair, Minnesota State Fair, North Dakota State Fair and the Calgary Fair held this year. She is one of the three best Percheron horses on the American Continent. To judge a horse you should always start at the head. First look at the eyes to see whether the horse is blind, then notice the ears; they should be erect; the nostrils should be open not too large nor yet too small.

The horse should be trotted about five hundred yards for a test of its wind. You can tell at the time she is finished trotting whether her wind is good or not, by noticing the way she breathed. Next open the mouth to see if her teeth meet. A horse has difficulty in cropping grass, if its top and bottom teeth do not meet. Some times there are little lumps at the back of the horses mouth. These are very sore and often prevent her from eating. A person can find out if a horse is effected in this way by holding her tongue between her teeth with one hand, while you feel the inside of her mouth with the other. The horse should not be thick at the jaws.

The neck should be stylish and the head should be held up. The shoulders should be sloping. Sloping shoulders mean sloping ankles. The breasts should be wide and well filled, and the legs should be set well under the body. There should not be any fat at the top of the front leg. This is all muscle in a good horse. The wall of the hoof should be about three-quarters of an inch from the sole. The size of the foot is always judged from the size of the sole. A horse with a good constitution has a deep chest.

A draft horse should have a good middle, because if it is expected to work much, it must eat lots of feed. A balky, prancing horse generally has a light middle and these do not live as long as the others. A horse with a good middle will also stand sickness better than a horse with a light one. The muscle used against the collar is found right along the front of the back. Horses with poor kidneys are generally light in muscle over the loins.

When holding a horse to be judged, it should not be held so



French Doll FREE

to the little girl selling 50 sets of our Birthday, Floral, Snow, Gnome, Christmas, Valentine, Easter, Thanksgiving in season, Postal Cards, (6 in set for 10c) the doll has sleeping eyes, long flowing curls, jointed limbs, very daintily dressed. Send your name and address to-day plainly written, we will send cards free. Returns us money when sold and we will mail doll post paid (cost big catalogue of free premiums for boys and girls. Toronto News Co. Dept. 580

Mention this magazine when writing advertisers.

that the hind legs jut out behind the animal. His legs should be directly underneath him. Brood mares have a small hollow at the back of the ribs. This concluded Prof. Jones lecture.

We then listened to a lecture by Prof. Curtis. He said that the well fed nations were the greatest powers of the earth, and it was just the same in regard to cattle. The farmer who is a good feeder always has the best stock.

The city people are always more or less uncertain where to obtain their food, and as the British are called the beef eaters of the world, there should never be any trouble to market all the cattle one could raise. A farmer should know a good animal and also know how to raise it, before he should start to make a business of raising cattle. Beef cattle should always be fat, while dairy cattle should be rough and angular. The udders of dairy cattle should not carry too much flesh, but they should be a good size. The teats should be close together.

To be continued next month

Send your Raw FURS to John Hallam

Sixty Thousand trappers now send us their Raw Furs. Why not you? We pay highest prices and express charges, charge no commission and send money same day goods are received. Millions of dollars are paid trappers each year. Deal with a reliable house. We are the largest in our line in Canada.

FREE HALLAM'S TRAPPERS GUIDE

A book of 96 pages, fully illustrated. Game Laws revised to date—tells you how, when and where to trap, bait and traps to use, and many other valuable facts concerning the Raw Fur Industry, also our "Up-to-the-minute" for quotations, sent ABSOLUTELY FREE for the asking. Write today—address JOHN HALLAM, Limited, Mail Dept. 362, 111 Front St. East, TORONTO

Mention this magazine when writing advertisers.



Womans' Department

Conducted by PEARL RICHMOND HAMILTON

A HOUSEHOLD FORUM FOR THE DISCUSSION OF EVERYTHING THAT PERTAINS TO THE HOME



MY MOTHER'S GARDEN

Her heart was like her garden,
Old-fashioned, quaint and sweet,
A wealth of buds and blossoms
Hid in a still retreat.
Sweet violets of sympathy
Were always opening there,
And lilies white and pure enclosed,
Each one a whispered prayer.

Forget-me-nots there lingered
To late perfection brought,
And there bloomed purple pansies
In many a tender thought,
There hope's first snowdrops took deep
root
And flowered because they must,
There love's own roses reached toward
heaven
On trellises of trust.

And in that quiet garden,
The garden of her heart,
Song-birds built nests, and caroled
Their songs of cheer apart.
And from it still floats back to us,
O'ercoming sin and strife,
Sweet as the breath of roses blown,
The fragrance of her life.
—Alice E. Allen.

Home Economics

Kindly send all communications and reports to 983 Grosvenor Avenue, Winnipeg.

Miss E. M. Baldwin wrote the article entitled "Women in the Business World" published in the November number of our magazine.

Mrs. Price, a member of the H.E.S. provincial board, sent me a paper entitled "The Winter's Supply of Vegetables." Unfortunately the paper did not reach me. This is a subject that is of great interest to our home makers. Mrs. Price, in a letter to me, states this fact: "You remember in February, at the convention, farmers and their wives were recommended to grow their own vegetables and not have to buy, as elicited by several illustrations. It has struck me forcibly since our meeting that, perhaps, much of the trouble lies, not so much in the lack of production as lack of knowledge of the necessary conditions of preservation, without which any amount of production will be worse than useless."

Mrs. Price has made a good point and I hope our members will send us their experience in caring for vegetables. I remember that on the old farm of my girlhood, vegetables such as cabbage, turnips and carrots were placed in a cave dug in the ground for them, and we had these vegetables all winter.

Mrs. Dayton, provincial president of the H.E.S., has sent a review of her visit to the different societies. I am sure our members will be very much interested in it.

The Manitou society had a most unique and splendid scheme for raising money. Mrs. Brown, the former president of the Manitou society, called on me while in the city. During our conversation she very modestly mentioned it and I insisted on a report of it for this department.

The paper entitled "Our Woods" should be read by every boy and girl in Western Canada, as well as by our older readers. It is very instructive.

In a recent street parade a beautiful horse pranced ahead of a staggering drunken man. The question was: "Which is the beast?"

THOUSANDS OF LIVES

Women are abandoning the use of birds and plumage for the decoration of hats, according to Col. Joseph H. Acklen, chief warden of the United States, to enforce the recently enacted migratory bird protection law.

This tendency will be welcomed with joy by all wise and humane women. There are plenty of beautiful things to use for trimmings, without encouraging the cruelty and waste involved in the destruction of bird life.

Men are apt to criticize women severely for the wearing of plumage. To be sure, it is men who kill the birds, but they are sacrificed for women's pleasure—or, rather, to enable men to make money by giving women pleasure—and without the demand, there would be no supply. Hence women cannot escape their share of responsibility. But when some men cite this slaughter of birds as a proof of women's unfitness to vote, they use an absurd argument, and one inviting a terrible retort. Women are responsible for the lives of thousands of birds, killed for their pleasure? Yes, it is too true. And who is responsible for the lives of the 60,000 women that die in the United States every year in consequence of the white slave traffic? For whose pleasure are they killed?

—A.S.B.

VRIDEN

The annual meeting of the Virden Home Economics Society was held on the last Saturday in November, about 70 members being present.

The reports from the work the society is interested in being read, showed a very successful year. The reading and rest room report (which, with the assistance of the W.C.Y.N., the society is working for) was most encouraging. During the year 1,500 women, either before or after a long drive, had a cup of tea, and about double that number used the rooms to warm themselves, tidy up or rest while waiting for husbands; much appreciation is expressed by the country members for this convenience.

In connection with the reading room, we have also a magazine exchange.

Great encouragement is given to the committee in charge, by grants from the various councils.

Socials and entertainments, which help to bring the people of the town and country together, are also held for the support of this work. The expense of running the rooms during the year was over \$700.

This society is also interested in the beautifying of our cemetery, and each year we pay the caretaker, collecting the money from the plot owners. The amount paid out this year was \$235.

We also collected \$1.25 for Ninette Sanitarium.

Splendid papers, good addresses and attendances were maintained throughout the year. The membership for this year is 103.

Dear Mrs. Hamilton: I thought a short description of my visit to the following societies might be of interest and, perhaps, do something toward encouraging the workers of others.

This visit was one of great pleasure to me, and I am more than ever convinced of the splendid type of women who are giving of themselves to this work.

The first society visited was Hamiota, the home of our provincial vice-president, who, with some of the most intelligent women I have met, are doing good work. This is the only society of the province that I have heard of successfully conducting a travel club, holding an extra meeting a month to do so. They are also greatly interested in all that pertains to child welfare, labor saving devices for the home, and many of the members have done pioneer work in assisting in the building of a beautiful new cottage hospital, the matron of which told me that out of twenty-seven cases recently treated, nineteen of them were maternity, thus helping to solve the problem of the proper care of the mothers during a most critical time. This hospital is most comfortable and tastefully fitted up, the different men's societies of the place helping. Our own provincial vice-president has furnished a ward in memory of an only daughter, who died in infancy.

My next point was Minnedosa, where Mrs. Thomas Cooper (nee Margaret Bennett), a splendid example of the educated Englishwoman, making good in this country, is president. Before Haverigal College was started she, with an older sister, organized and conducted a young ladies school in Winnipeg, at which many of our cities' younger mothers were educated, and whose lives must have been greatly benefited by coming under the influence of such a woman. This society has converted what was once a shed into a most comfortable rest room, where they hold their meetings

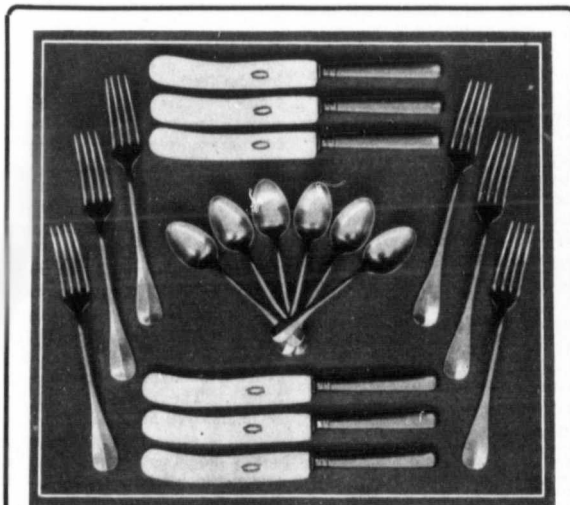

A SPECIAL OFFER

6 KNIVES
6 FORKS
6 SPOONS

FREE

The above illustration is an exact photograph of our offer. The forks are of the regular dinner size, and the spoons are generous teaspoons, and both are made of a solid metal superior to white metal and cannot wear in spots and always keeps bright and shiny. The knives are also dinner size and have genuine steel blades and a convenient sized handle.

OUR OFFER. Send us in your renewal subscription and two new subscriptions, together with your remittance for three dollars for same and we will send you a complete 18-piece set as illustrated above FREE AND PREPAID to your own post office. They won't last long. Send in your subscriptions right away and secure a set.

Cutlery Dept. E. H. Heath Co., Ltd., Winnipeg

Our success has been of our and Octob prepa

and are greatly interested in the larger scope of the work.

From Minnedosa I proceeded to Birtle, where the society is planning, if possible, the opening of rooms in the nature of a club for young men, recognizing the necessity for recreation under the best influences, and judging by the women of Birtle, I feel sure that any object they undertake will be successfully carried through.

I was most hospitably entertained at the home of the late William Patterson, whose young widow, a member of the society, is managing a 1,300-acre farm, carrying on mixed farming and rotation of crops. This farm is most beautifully situated and equipped; a farm home of the highest type, whose spaciousness and good taste would do credit to a queen.

From here I travelled to Neepawa, and though on account of the annual meeting the previous week I was unable to have a meeting, yet I met the directors, who are most earnest, broad minded women, working for the greater benefit of the home and community, and are planning, if possible, to open a market twice a week where the women who have to sell may get in direct touch with those who have to buy; in this way both may be benefited, and I am sure that many other societies will follow their lead, as during the summer months much garden stuff goes to waste that our town sisters would be glad to have. It would be also an incentive to the producing of better butter and fresh eggs, and many a country sister could add to her pin money in this way.

From Neepawa to Swan River, about 180 miles, to the youngest society of the province, that, as yet, is feeling its way, but judging by the ability of the officers, I feel sure they will do much for the advancement of the homes and of their pretty town and country. The president of this society has had domestic science training herself, and I am sure will be a great help to the society. The members of this society are also working hard to support their hospital.

From Swan River west to Benito, about twenty-five miles, and although this is in one of the newest parts of the country and one of our newest societies I found it most interested and energetic. The day I arrived the ladies held a bazaar, the decoration of which would have done credit to many a city, the apple-blossom booth being particularly attractive. The proceeds netted the handsome sum of \$75, which is to be spent in the beautifying of their cemetery. Think, dear friends, of what it means to have the lonely neglected God's acres converted into beauty spots. This society has also installed street lamps in the town.

Many nationalities are represented in this community, and more than any other society that I know of, it is helping to solve the problem of making of them good Canadians.

In the evening there was a Christmas tree entertainment, the hall being packed with men, women and children, among the latter being many Doukhobor children taking part in the drills and program, and I am told they often act as interpreters. One very pleasing feature of the entertainment was a dramatic performance given by the members of the society, which was a decided success, no one thinking they were too old to help. A splendid spirit exists, the dainty little bride of the aforementioned apple blossom booth and the young women entering heartily into the work with the older members. One mother of a large family said to me: "You have no idea what this society has meant to me; before its advent I rarely went from home, now I am meeting and making friends of my neighbors."

Yours very truly,
Rebecca Dayton.

EMERSON

Our society is nearing the end of a successful year's work. Besides the extensive list of prizes offered at our summer fair, nearly seventy dollars have been expended on the cemetery. Most of our meetings have been well attended and our prospects are encouraging. In October we had a paper on "Environment," prepared by our vice-president and read

Buy this oven-tested flour

Your oven will certainly produce more bread and better bread as a result of our oven test.

From each shipment of wheat delivered at our mills we take a ten-pound sample. It is ground into flour. We bake bread from this flour. If this bread is high in quality and large in quantity we use the shipment of wheat from which it came. Otherwise, we sell it.

PURITY

The baking quality of flour sold under this name is therefore an exact certainty. Buy and benefit!

"More Bread and Better Bread" and "Better Pastry Too"

527

You saw this advertisement in this magazine. Don't forget to say so when writing.

by Mrs. McDougal, and an address by Rev. Geo. Reynolds on "Character Building." This was an instructive and enjoyable meeting.

At our November gathering an interesting and humorous sketch was read by Mrs. Ballantyne of "How our Grandfathers Lived; or Early Pioneer Life." We were all glad we lived in our own times instead of those early days.

The best of our fall gatherings was on Hallowe'en, when we had the pleasure of having Mrs. McClung with us. She gave an evening of readings, and there was vocal and instrumental music by popular local talent. Those present appreciated highly our Manitoban authoress' rendition of selections from her writings, and many were the compliments regarding Mrs. McClung's ability as a writer and entertainer.

We are hoping for a good time during the winter. Our largest meetings have always been when our country members have most leisure.

(May we have the paper entitled "How our Grandfathers Lived" for this department?)

OAK LAKE

The Home Economic Society had a very interesting meeting in November. Each meeting we are pleased to greet new faces—our society is steadily growing.

The curfew bell has been established in our town. The town council showed itself very willing to co-operate in this movement.

The principal item on the programme was a paper given by Mrs. Nelson Bannister entitled "Kindness to Animals." There was also a display of fancy work—suggestions for Xmas gifts. This feature was a new idea and much appreciated. The ladies catered for a banquet given by the Grain Growers here, and materially increased their bank account.

The Oak Lake Society extends the greetings of season to the other societies of Manitoba, and wishes them all success.

Mrs. W. Cochrane,
Corr. Sec.

(May we have the paper entitled "Kindness to Animals" for Our Boys' and Girls' Department?—P.R.H.)

MANITOU

The Talent Fund—How to Make Money At the present time when money is "tight," this heading should prove particularly attractive. Men who have accumulated wealth, generally concede that the "start" was the hardest to get. Owing to the lack of initiative and incentive, in other words "getting started," the great majority remain in the ranks of mediocrity, talents lying buried. This article is written in the hope that it may prove an incentive to the members of other Home Economic Societies in the way of raising funds.

The Manitou Home Economic Society ladies agreed that a rest room in town, for the free use of the people of the district, was much needed and its patronage since its opening is ample proof of the appreciation of the women, children and men thus benefited. The regulations prohibit smoking. Some member of the society visits the rest room every day, and with the co-operation of every person interested, no difficulty has been experienced in maintaining the best of order.

Two rooms in a central location were rented, one fitted up with linoleum floor covering, a couch, rocking chairs, reading table and literature, an extension table and dishes, a coal range, tea kettle, tea pot and tea and sugar for the free use of the patrons. Every morning a fire is built by the caretaker, the kettle put on and the rooms opened, and they remain open until ten thirty at night. The other room is fitted up as a lavatory. The cost of maintaining the rest room during the winter is about thirty dollars per month.

It is to the methods adopted to raise the funds required that special attention is directed. On the 1st of July, when about 3,000 people had gathered in town to celebrate Dominion Day, the members of the society served dinner and supper, they donating the food and undertaking the work. This proved very successful, \$100 being made. With this amount on hand the rest room was furnished and opened. On the opening day, a Saturday, tea was served in the rest room, and the sum of \$20 collected. The question of maintaining it was next in order, and one of the most energetic members of

the society suggested a "Talent Fund." Each member was to take twenty-five cents of her own money as a talent, invest it and at the end of a year turn it in to the society funds with the profits accrued. Quite a number acted on the suggestion, and at the end of the year at a regular meeting of the society the money was brought in and the methods adopted described, much to the interest and amusement of those present.

Some clubbed together, gave an ice cream social, others gave a New England dinner, while another group made aprons and sold them at the rest room on a Saturday afternoon. In each case the sum of \$15 was realized, which was turned over again and again in various ways. One lady invested her "Talent" in sweet pea seed, and with the blossoms captured a prize at the local exhibition; another bought an oiled duster and rented it to her husband for use in his office for twenty-five cents a month; while another baked a loaf of bread, which took first prize in the H.E. department at the Winnipeg Exhibition. Many other ingenious methods of increasing the "Talent" were rendered, the encouraging sum of \$88 was found to have been made, and the faithful stewards were enthusiastically complimented on their ingenuity and industry.

Both men and women, outside of the society, have lent the most generous aid to the members in their efforts.

The society motto is "Excellior."
(Contributed.)

SWAN LAKE

Special Meeting of the H.E.S.

On Tuesday, November 11th, the H.E.S. of Swan Lake enjoyed a visit from Miss Ross, demonstrator and lecturer from the Agricultural College, Winnipeg. Nearly all the members turned out, and there were a good many visitors to appreciate a thoroughly instructive and pleasant afternoon.

While preparing for the demonstration on "Fruits," Miss Ross gave what was, to the major portion of her audience, the most interesting part of the programme, a chat on Home Nursing, in which she gave much valuable advice, as well as outlining the course which will be sent

the Virden held on the r, about 70
the society owed a very ng and rest e assistance is working During the ore or after t, and about e rooms to rest while h apprecia-ly members
ding room, hange.
ven to the is from the
its, which the town o held for he expense ; the year
ted in the and each lecting the s. The \$235.
r Ninette
es and at- throughout this year
hought a o the fol- interest ward en-
pleasure ever non- f women to this
Hamiota, resident, itelligent od work. province dily con- an extra hey are hat per- ving de- of the t in as- eautiful tron of y-seven of them o solve of the l time. dly and : men's or own ished a ughter,
where t Ben- ucated i this ririgal older young which others must oming onah. s once resting

PATMORE NURSERY CO.

OUR RELIABLE SEEDS, TREES, SHRUBS AND PLANTS

can be found growing in every district in Western Canada, and we gratefully acknowledge the many nice letters we are constantly receiving from our customers. We know our Seeds and Products are the best for this Western climate and our customers are proving this. We can buy seeds to sell at half the price we do; but we don't handle that sort; we want the best only. So do you.

Garden Seeds, Grasses and Fodders

Our grass seed stocks are the purest and the most reliable to be obtained— noted for their quality and high germination. A full description of many new and useful grasses is to be found in our 1914 Catalogue and no farmer in Western Canada can afford to miss this. Ours is the oldest horticultural establishment in Western Canada.

Special Nursery Offer For Spring 1914

For \$10.00 We Will Send

50 Currant and Gooseberry bearing bushes of best varieties.
100 Raspberry Plants, best varieties.
12 Plum and Fruit Trees, young and thrifty, 2 to 3 feet high, and 12 Rhubarb Roots.

Why Not Have A Good Fruit Garden?

We have to offer this spring 200,000 Maples, 6 to 10 feet, 200,000 Poplars and Willows, 3 to 4 feet high.

WRITE TO-DAY FOR OUR 1914 CATALOGUE

It is compiled jointly with Messrs. SUTTON & SONS (for whom we are Special Agents for Canada) and is a safe and profitable guide to Horticulture in the Canadian West, as we list and describe only such varieties as we have found reliable in our 31 years of practical, steadily-acquired knowledge of Western Horticulture.

SASKATOON, SASK.
THE PATMORE NURSERY COMPANY
BRANDON, MAN.

RELIABLE SEEDS-TESTED FOR WESTERN CONDITIONS

You saw this advertisement in this magazine. Don't forget to say so when writing.

out from the college later. At the beginning of her talk on nursing, Miss Ross emphasized the importance of the small things which add to a patient's comfort and advised the humoring of a sick person as much as possible, maintaining firmness in all things essential. Five pillows at least are necessary when propping a patient up in bed, two of which should be small, to tuck in between the shoulders and the base of the spine.

One of the surest ways to soothe a restless patient is to bathe the face and hands in lukewarm water, brush the hair and gently rub the tired limbs and muscles. Bed sores are always a fearful possibility to every nurse who is undertaking a long case; perfect cleanliness, keeping the sheet taut and unwrinkled and the bed free from crumbs and easing the pressure on any part by means of an air cushion or a circular pad made of batten and covered, will do much to prevent them; one precaution which should always be taken at the beginning of any illness likely to be tedious, is to rub the elbows, shoulders and base of the spine at least once every twenty-four hours with a little alcohol or methylated spirits in the palm of the hand, dusting a little boracic powder or Fullers Earth on afterwards; this tends to harden the skin and, except in very unusual cases, will entirely prevent the forming of bed sores.

General directions were given as to the care to be taken in the administration of medicines; hot, but not too hot, water bottles for chilly patients; the cautious use of alcohol; the necessity of preparing the patient entirely for sleep and getting the house perfectly quiet before administering a sleeping draught, and many other useful items which will doubtless be elaborated during the course, but which were so clearly explained by Miss Ross that there is little danger of those who listened, forgetting her helpful lecture.

The second part of the afternoon was given to a chat on Food Values, canning vegetables, bottling fruit and the practical illustration of three tasty ways of cooking apples, which recipes were afterwards given to the audience. One remark made by Miss Ross, when speaking of food values, seemed to us the epitome of sense, when one thinks of the present high cost of living: "The most expensive foods are not the most nutritious," an axiom with which we may comfort our digestions when we sit down to a lowly meal of "herbs and lentils." The afternoon was closed by a hearty

vote of thanks to Miss Ross, who had earned the gratitude of her audience by the clear, concise way in which she gave her demonstration and made her explanations.

ANNUAL MEETING OF THE H.E.S.

The annual meeting of the Swan Lake H.E.S. was held on Saturday, December 6th, with a very fair representative turnout. After the programme for the afternoon was opened and it was found that only one member, Mrs. Penniston, had responded to the request for Christmas gifts, the other business was taken.

First, however, the president, Mrs. Gordon, gave a comprehensive resume of the year's happenings in the society. She pointed out that the year had dealt kindly, in that none of the members had been called away by death. Mrs. Gordon also spoke of the success which had followed the appointing of four ladies to take charge of the programme each month, instead of setting special subjects to be taken up. Some of the papers had been so interesting that they were considered worthy of a wider audience than could gather in Swan Lake, and a copy of Miss Edith Gamble's paper on the happiness and interests to be found in a country life will be published shortly in the Canadian Thresherman and Farmer, while the paper read earlier in the season by Miss Beech on the trees, flowers, etc., of the Manitoban woods has also been asked for. As far as the actual work of the society was concerned, the president had but little to report, as it had been found impossible to quite finish the work undertaken in the cemetery; but the quiet, unostentatious work of making the H.E. a pleasant meeting place for town and country to gather in social intercourse had been eminently successful, as was proved by a membership of fifty-four, thirteen in excess of last year.

The election of officers was then proceeded with and expectation was made certainly when Mrs. G. B. Gordon was re-elected president for the fourth time in succession, which is tantamount to saying that Mrs. Gordon has been the honored president of the society since its inception. The hearty applause which greeted the announcement testified once again, not only to the popularity which Mrs. Gordon has always enjoyed, but to the satisfaction every member felt at her re-election to a position which she fills so worthily and with so much tact and diplomacy.

The secretary, Mrs. W. H. Hartwell, was also re-elected, which will also be her fourth year in this position, for there again it was felt that it is rarely wise to try and "improve the best." Mrs. B. Langridge is the corresponding secretary, and the following ladies are on the board of directors: First vice-president, Mrs. A. E. Downey; second vice-president, Mrs. Gardner; and Mesdames A. E. Penniston, R. Blair, H. Dodd, S. P. Hodgson, W. W. Shirley, J. Herbert and A. J. Moore. Mrs. Gardner was again chosen chairwoman of the meeting and filled the position admirably. Mrs. H. Dodd kindly acted as secretary during the absence of Mrs. Hartwell. The four ladies in charge of the January programme are the president, the two vice-presidents, and the secretary.

(This paper was read before the Swan Lake Society.)

OUR WOODS

Having always lived and taught school in the country, and having had from one-half to two miles to walk to my different schools, I have had ample opportunity to study our native woods. It has been the greatest pleasure to walk along planning in my mind picturesque homes, made so, entirely, with what I could find in our woods. Our trees and shrubs are beautiful now in their natural state, how much better they would become under cultivation?

Manitoba is in great need of hedges to prevent the terrible sweep across the fields in the early spring and after the autumn plowing. The soil seems to be heavy enough to withstand the wind on most farms around us, but I have seen sandy soil pile along the roadside in great banks often five feet deep. Hedges and more trees would prevent this blowing to a great extent on such farms, and on others they would beautify if nothing else. What pretty hedges our wild rose and hawthorne would make, with the hazel nut here and there. What a simple thing it would be to make one. They grow so entangled that it would not be necessary for so many fences and they would replace the cruel barb wire. These shrubs are not pretty during the summer months only, but the whole year. The rose blooms some where about the second week in June, and it has an endless variety of shades, from a pure white and faintly tinted pink to a deep red. The red berries of both the hawthorne and rose are showy until Christmas and after. I have noticed flocks of birds

feeding on these berries, preparing for flight, long after they have disappeared from near our homes. We are so many months without our feathered friends, I think we should have around our homes every inducement to keep them near us as long as weather permits. It seems as though these shrubs are becoming quite uncommon as the country is turned into large fields and they are broken out of the highways to prevent the high drifts in winter. In the wild state I have seen the rose tree five feet high, and under cultivation about seven feet. Like every thing in the garden and orchard it needs to be trained and the dead wood cut away, but I think it would greatly take from its beauty to clip it.

Among the prettiest of shrubs for standing out singly is the high bush cranberry, with its long drooping branches. During the winter months the light-colored wood is most effective against the darker trees. And the clusters of red berries remain hanging the greater part of the winter months. Have you ever noticed in the early spring the pretty leaf buds of the cranberry? The bud is a dark red and gradually the pale yellow leaves come bursting through. The blossom is uncommonly pretty and the large bunches of berries are a grand sight. Whenever I am gathering cranberries I always stand back to admire them before I begin my work of destruction. I will not give my opinion of green cranberry jelly as I have taken the liberty to bring some with me to speak for itself to those who have never tried it. Cranberry catsup also is not to be despised. Low land is the natural home of the cranberry, but it grows very well on uplands too. I believe it was at Fort William I noticed the cranberry shrubs growing along the side-walks. They were about seven or eight feet high, and although it was late in October they still had great clusters of berries.

Again, we have some very fine fruit trees, such as the red and black cherries, the wild plum and the wild apple. I have seen the pin cherry tree in a garden and it was a splendid specimen about twenty feet high. The cherries were nearly four times the original size. You all know what a rich flavor there is to the pin cherry jelly. The choke cherry is most prolific every year, but they are not nearly so nice for jamming purposes, although they make delicious wine. The shiny blackness also adds beauty to the forest. I have with me a sample of the wild plum preserved. So many people think our wild plants are useless,

when really I think there is no comparison between the flavor of our plums and that of the bought fruit. There are two kinds that I know of and there may be more—the small long shaped plum, which is rather nice to eat raw, but bitter when cooked, and the large cooking plum. When mother first came to Manitoba a lady told her the right way to cook the native plums, that they might lose the bitter taste, was to boil them about ten minutes in soda water and then strain them and proceed to preserve them the usual way. We boil about four quarts in enough water to cover them with a teaspoon of soda. The native apple I know very little about. It is not unlike the one in both size and flavor. The tree seems to be very scarce. I saw one once and thought what a pity it was not transplanted.

Every one knows of the beauty of our maple, oak, ash, elm and evergreens; but have you ever noticed what a much finer tree our Balm of Gilead, or as it is locally called, the black poplar, is in comparison with the common poplar? It has a larger and finer leaf with a silvery shade on the under side. The tree itself grows much higher and seems to be a sturdier tree in every way. In northern Manitoba they have forests of Balm of Gilead, and our trees always look stunted and shabby beside them. I love to inhale the morning air when the Balm of Gilead is in bud. The scent is so strong that you can detect it for a long distance. Mother used to have a jar of Gilead salve always in readiness for our numerous burns and scalds, and she has found nothing more healing. She made it by boiling together two cups of buds with nearly a pound of butter and then strained it into a jar. This salve will keep for years without losing its strength.

After all this hurry and rush, when the land is broken and the farms have their permanent landlords, I believe, that men will turn their attention to beautifying their country homes, and that after a time we shall have ideal homes in Manitoba. I trust they will have the native woods doing their share in the pleasant task of delighting the eye.

Bessie Beech.

KEEPING YOUNG PEOPLE INTERESTED IN COUNTRY LIFE

By Edith Gamble

(This paper was also read before the Swan Lake Society.)

Keeping young people interested in country life seems to be quite a problem. It needs careful consideration and planning to keep them happy and contented on the farm.

Most families in the country have much work to do. It becomes so monotonous if there is not a change once in awhile. It is a hard life when a young girl works from early morning until late at night without a rest or a little recreation. If they could only have the evening to themselves, it may be spent, either in visiting, reading, music or games. With her work somewhat reduced she would have more time to plan and give to the family and to her friends, and also for study and interchange of thought.

Parents should give their sons and daughters a chance to go to school. It is only but fair to give them a good education. Help them in their studies and appear interested in their work. Even if the parents do not make quite so much money at the time, they will see in after years that the education has been of more benefit than a large bank account. When they see their children's happiness and success, they are surely rewarded for the inconvenience with which they had to contend in giving this opportunity.

Give the young people spending money. Let the girls on an allowance, or so much to dress on. This will train them to buy sensible material and to see the difference of dress goods that are on the market.

If there is a society or league in connection with the church, the young people may derive much pleasure and benefit by attending such.

Let the boy have a share in the stock. For instance, give him a pig. When it grows up and is sold, let him have the proceeds. Do not let it be "Johnny's

pig and father's pork," for it will discourage him and he will soon lose all interest in farm life.

The daughter may be given an acre in the garden, or a few fowl. Let her have the benefits. See how interested she grows. At the first sign of her seeds sprouting, or the first fruits, she will run in with great excitement, telling about her success.

Parents should make the home and its surroundings as beautiful as possible. Paint the house and barns; keep the garden trim, decorated with flowers, shrubs and trees. If this is done, surely the young people would have no desire to leave their beautiful country home for a small, cramped dwelling in the city.

Encourage the young people. Tell them how much temptation and sin there is in the city, and of the health, sunshine, fresh air and clean sport of rural life. An occasional trip to the city will help to break the monotony and quietness of country life, and it will give the man idea of what city life is. If the son is sent to the Agricultural College or the daughter to the Household Science Department for the winter months, they come home eager and willing to put into practice the scientific methods they have been taught.

Every civilized person has a longing for the beautiful, whether that beautiful be expressed as a kind act, a sunset, a couplet in verse, a song, a picture, a charming face, a harmoniously planned room, or a lovely bit of handiwork. The city affords much in that which is beautiful, so we will try to lead the young people to see these things in the nature's work of rural life.

MIAMI

Dear Mrs. Hamilton:

The September meeting of Miami Home Economics was held in vestry of the church. Several articles on "The Selection of Meats from the Market" were read, and a very interesting discussion took place.

Mrs. McNevin read an interesting paper entitled "Too Neat a House."

In October, our subject was "The Value of Cheese in the Diet." A paper was received from the college on the subject and was appreciated by all. Several ladies gave recipes for using cheese, which proved helpful.

In November, Miss Playfair, from Hartney, was present with us, and addressed a mixed audience on the subject of "Farm Life for the Boy and Girl." I cannot commence to give you any details of her address, but only those of us who have listened to her know the value of her speeches.

Our December meeting took the form of our annual meeting. Ten new directors were appointed as follows: Mrs. Kerr, Mrs. McNevin, Mrs. Reeve, Miss Seip, Miss Collins, Mrs. M. Anderson, Mrs. Blanchard, Mrs. Good, Mrs. Sutherland, Mrs. Rumbal.

At the close of the meeting the directors met and elected their officers: President, Mrs. McNevin; first vice-president, Miss Seip; second vice-president, Mrs. Reeve; secretary-treasurer, Mrs. T. H. Rumbal.

I will enclose the paper entitled, "Sleighing as a Fine Art," with January's report.

Yours sincerely,
Mrs. T. H. Rumbal.

DELORAINÉ

Delorainé,

Dec. 15th, 1913.

Dear Mrs. Hamilton: The December meeting of the Delorainé Home Economics Society was held in the basement of the Presbyterian Church, December 6th. The only business was the election of officers, which resulted as follows: President Mrs. (Dr.) Thornton; vice-president, Mrs. R. J. Price; secretary-treasurer, Mrs. R. H. Dymond; directors, Mrs. Rankin, Mrs. R. Franklin, Mrs. Widenheimer, Mrs. Pierce, Mrs. P. Perry, Mrs. Thomas, Mrs. Sawyer, Mrs. J. Steadman; auditors, Mrs. W. E. Cowan, Mrs. W. Thomas. The meeting closed with the National Anthem.

Yours,
R.H.C.

For Wedding Anniversary or Birthday Gifts

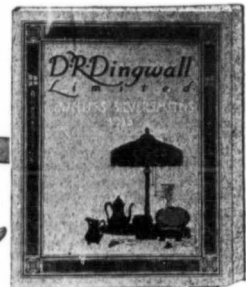

You will find it a most pleasing occupation to choose them from the 1914 Dingwall Catalogue of Jewellery, Silverware and Cut Glass.

Articles of beauty and value suitable for any of these occasions are clearly shown in it on page after page of fine illustrations, with brief descriptions of their style and price.

Whether it be a small Bon-Bon or Salted Almond Dish, a pretty Scarf Pin or Brooch, or an elaborate Tea and Coffee Service of Sterling Silver you will find them in this really attractive and interesting book.

So if you have a copy, make use of it; if not, send your name and address to us with a request to forward one, and we will see that one is sent forward by return mail, postpaid and free of charge.

D. R. Dingwall Limited
Jewellers, Winnipeg
C.T.

You saw this advertisement in this magazine. Don't forget to say so when writing.

QUALITY SEEDS

Make more money by sowing more productive seed. Buy "Quality Seeds", the only kind we sell. Our line of seeds is more complete than ever before, and we can supply choice seed of the varieties best suited to Western Canada. Write for prices and samples of any of the following:

- Wheat Marquis, Red Fife.
- Oats Gold Rain, Banner, Abundance.
- Barley Eclipse (Registered) O.A.C. No. 21.
- Flax Premost, Common.
- Grasses and Clovers.... Western Rye, Brome, Timothy, Kentucky Blue, Canadian Blue, "Regina" Brand Lawn Grass Seed, Alsike, White Clover.
- Alfalfa Montana and Turkestan.
- Corn, Potatoes, Rape, etc., etc.

Write today specifying requirements.

The Mooney Seed Co. Ltd.,

"Seedsmen to men who care."
Regina, Sask.

You saw this advertisement in this magazine. Don't forget to say so when writing.

Mothers' Corner

Lullabies

In a little booklet I find this quotation before lullabies of different nations:

"The one priceless jewel in the world is the child; the one priceless crown, the crown of motherhood. In the cradle the mother's influence begins. The lullabies she croons, the stories she tells, the pictures she draws, aid the dawning consciousness—the uncut jewel of the mind—to reflect all that is fair, and so form correct habits for life. While the gem has the power to draw to itself the loveliest ray of light, the text of Nature's sermon in stone is, "We must become fixed at maturity. The brightest ray of the jewel cannot hide the flaw that by some false habit of crystal growth, formed years before, was to lessen its value forever."

German Cradle-Song

Sleep, baby sleep!
Thy father guards the sheep,
Thy mother shakes the dream-land tree,
And from it fall sweet dreams for thee;
Sleep, baby sleep!
Sleep, baby sleep!

Japanese Cradle-Song

Hush! Hush! my lotus blossom,
Go to sleep, go.
Neu Neko okorori
Neu Neko yo.

Sleep, sleep, my lotus blossom,
Go to sleep, go.
Neu Neko okorori
Neu Neko yo.

Birdies their wings are folding,
Fold thy sleeves so.
Neu Neko okorori
Neu Neko yo.

Moonbeams are softly stealing,
Stars come and go.
Neu Neko okorori
Neu Neko yo.

Fireflies around thy pillow,
Flit to and fro.
Neu Neko okorori
Neu Neko yo.

American Cradle-Song

Rock-a-bye, baby, on the tree-top,
When the wind blows the cradle will rock,
When the bough breaks, the cradle will fall,
And down come baby, cradle and all.

West Indian Lullaby

Where the coral reef is deep,
Where the flying fishes leap,
And the crystal waters creep,
Lull-a-by.
My little Black Pearl,
My little Black Pearl,
My little Black Pearl,
Sleep! Lullaby.

Still is the plumed palm,
And the spices breathe a balm,
And safe in mother's arms,
Lull-a-by.

Rest little Black Pearl,
My little Black Pearl,
My little Black Pearl,
Sleep! Lullaby.

Hush! Thy father's sail I see,
Where the white-caps fleck the sea,
He is sailing home to thee,
Lull-a-by.

To his little Black Pearl,
His little Black Pearl,
His little Black Pearl,
Sleep! Lullaby.

Deep, 'neath the foaming brine,
He dives for jewels fine,
But the dearest gem is mine,
Lull-a-by:

It is mine, it is mine,
My little Black Pearl,
My little Black Pearl,
My little Black Pearl,
Sleep! Lullaby.

Russian Cradle-Song

Lull a-by, my pretty baby,
Close thine eyes so bright;
While the moon pours o'er thy cradle
All her sil'ry light;
While the moon pours o'er thy cradle
All her sil'ry light.

I will tell thee tales of fairies,
Lull thee with a song;
While the moon, heaven's lonely wand'r'er
Creeps the sky along;
While the moon, heaven's lonely wand'r'er
Creeps the sky along.

Italian Cradle-Song

Sleep, my baby, sleep my darling;
While I hush thee with my song;
Sleep until the new sun rises,
Sleep in peace the whole night long.
Slumber without care or sorrow,
My torment—and ah! my bliss;
Slumber, till the Lord's own angel,
Wake thee with his gentlest kiss.
Slumber, slumber, slumber!

Indian Cradle-Song

Nic-nac no-shion nady,
Mush-ni-na-qua,
Mush-ni-na-qua,
O-ic-tion, o-ic-tion!

Nic-nac-no-shion na-dy,
Nic-nac-no-shion no-dy,
Mush-ni-na-qua,
Mush-ni-na-qua,
O-ic-tion, o-ic-tion!

Will some one send the Canadian Cradle-Song to this corner, please?

P.R.H.

The book entitled "Helps for Expectant Mothers," will be sent free to any wife who requests it. The following letter to this corner is most encouraging:

"Dear Mother's Corner:
"I have long since meant to write to you and tell you that we have another little girl. You will, perhaps, remember I wrote last winter asking for a booklet and advice. We were then twenty-five miles from a doctor, but am glad to say the railway is built past our homestead now, and we are only a mile and a half from town, and there is a doctor in the town now. I think that the Mother's Corner was just fine this month, and must congratulate you also. I agree with you that child life is certainly the greatest blessing. I have two little girls, one three and the baby. There certainly is a crying need for doctors and nurses on this prairie. I do think it is very terrible to think of those poor women who are in the asylum just because they had no doctor. It is a great risk. I must close now, with best wishes to the Mother's Corner, also the Canadian Thresherman and Farmer.
"I am, yours very truly,
"A Prairie Mother."

Let us have more letters for publication in this corner. I have many private letters to this corner which I am pleased to receive, but I want more to publish. Mothers of families could help young mothers so much if they would give their experiences in caring for children. I will not publish the names of the writers.
P.R.H.

THE NEW BABY

S. Josephine Baker, M.D., has a most helpful article entitled "Fair Play for the New Baby," in Pictorial Review. She says:

"Fair play for the new baby means a fighting chance to live, and for health and strength. There is nothing more fragile, more helpless or more precious, than a new baby, and the baby must necessarily be wholly dependent upon the intelligence to whose care it has been committed. The first year is the most hazardous year and the most important year, and a wise mother will bend all her energies to giving the baby a fair start.

"First, a mother's highest duty is to nurse her baby. Another important point is the matter of handling." Do not make a plaything of baby. Why I have actually seen a woman put a six weeks baby in a sitting position and trot it in a shaky jiggle on her knee till its little cheeks would shake. A grown person could not endure this. This has laid the foundation of many nervous wrecks.



Mason & Risch Pianos

"FROM FACTORY TO HOME"
17 WESTERN BRANCH STORES

A Mason & Risch Piano does not only fulfill the function of a high-grade instrument, but is an object of artistic adornment as well. It is just the kind of a Piano you would expect one of the oldest and foremost factories in the world to build.

WRITE US FOR BOOKLET TO-DAY.

MASON & RISCH LIMITED

WINNIPEG, MAN.

You saw this advertisement in this magazine. Don't forget to say so when writing.

These stand for everything in music

Columbia Records



and for the best in records and talking machines

For Sale by
WINNIPEG PIANO CO.
295 Portage Avenue Manitoba Hall

The back bone is a delicate thing and the important nerves of the body centre in the back bone.

"Do not handle a baby all the time during its waking hours. The dancing, jumping, jolting and trotting many babies are subjected to are simply laying the ground work of a disturbed nervous system that will mean ill-health, nervous

irritability and poor physical development in after life. A baby's nervous system suffers most from this practice. St. Vitus' dance can often be traced to this. Forcing a baby to smile is another bad practice. Stimulated activity is the most cruel form of treatment to them. Being forced to laugh, to smile and to play, wrecks havoc in the nervous system.

Allow the baby to be handled quietly. It is most injurious to talk to it much and to attract its attention.

"In a family of kittens the one that is fondled most grows very little and often dies, while the others grow strong. The little pup that is handled much does not grow like those that are not handled much. The same is true of babies. Thousands of babies suffer a lifetime of penalty and shattered nerves because of over-stimulation and trotting on the knee during babyhood. The mother who has learned this lesson will receive more joy from holding the quiet little body in her arms and seeing sleep come slowly over it, as normal sleep should, than she ever will after she has tired herself and really injured the baby by rocking it to habits of trotting, rocking or walking the floor.

"The growth of the baby is very rapid during the first year, and in order that the growth shall be undisturbed, the baby needs quiet and rest.

"Babies need fresh air in winter as well as summer, and do not cover the face with a silk handkerchief or a veil. Veils are injurious to the eyes, and silk is liable to smother them. A baby should not be subjected to a strong light. Half of the babies in cities have weak eyes through the fault of nurses. Eight nurses out of ten will hold a young baby under a strong light.

"Keep the baby's feet and stomach very warm to prevent colic—but keep the head cool. Silk or cotton should be worn next to the head and not wool.

"If babies are not disturbed while sleeping they will rest better. Do not turn them in their sleep. A mother can change the position when the baby takes its next nap.

"Keep baby very quiet. It is a crime to make a plaything of him."

Last month a mother who has taken care of her little four year old and supported her since birth was forced to give the little one to a cruel father who planned to take her to the Old Country. Can you imagine yourself in the place of that broken-hearted mother? Yet the judge decided in the father's favor.

The same month a negro was fined fifty dollars for ruining a girl—it was so decided by the judge. A fair girl's virtue was worth only fifty dollars. Would that we had women judges at times.

Recipes

Prune Pie

Stew prunes as for sauce. Stone them. Line a deep pie tin with puff paste and fill with the prunes, sprinkling over the top one-half cup of sugar. Cover with a frosting made from the whites of two eggs beaten with sugar

Date Pie

Wash the dates in warm water, allowing them to lie in it for two or three minutes. Stone and put in a pie tin on which the lower crust has been spread. Add a little cold water, sprinkle with flour, dot with butter, put on an upper crust and bake. Or instead of a crust, frosting may be used as in prune pie.

Banana Pie

Slice the bananas thinly and put over them the grated peel and juice of one lemon. Let them absorb the acid for an hour or two before using. Sweeten to taste and bake with two crusts.

Rice Pie

Add three cups of cream to one of steamed rice. Sweeten to taste and flavor with cinnamon. Beat the whites of two eggs to a froth, then beat all together and put in a deep pie plate with under crust only. Bake about thirty minutes.

The Finest Lemon Pie

(Enough for two pies.) Form a crisp crust, line pie tins, prick the crust with a fork and bake it a light brown before pouring in the following filling: Stir in two cups of boiling water four tablespoons of cornstarch dissolved in cold water; allow this to boil, and in the

meantime beat together the yolks of four eggs (reserve the whites for frosting) two cups of granulated sugar, the grated rind of one, and the juice of two lemons, and stir into the cornstarch while it is boiling; then draw this off the stove and allow it to stand on the back of the stove for a few minutes. Pour this mixture into the previously lined tins. Beat the whites of the eggs to a stiff froth and into this stir one tablespoonful of powdered sugar, spread over the pie and place in a quick oven, allowing to remain till the frosting turns to a rich golden brown.

Cocoanut Pie

One pint scalded milk, one-half cupful sugar, yolks of two eggs, and a dessert-spoonful of cornstarch, dissolved in

milk. Beat all together, cook in boiling milk, and add one cupful cocoanut which has been soaked in milk overnight. Bake with lower crust and meringue if liked.

Fruit Pot Pie

Take an enamel dish about four or five inches deep, line the bottom with pie crust, put in a layer of apples cut up fine, sprinkle with raisins, sugar and cinnamon (or nutmeg, if that flavor is preferred), dot with bits of butter, put on another layer of pie crust, more apples, etc., until the dish is full, having a crust on top, slit in two or three places. Bake about two hours, turn over on to a dish, sprinkle with more sugar and cinnamon, and eat while warm, with or without sauce. This is delicious.

Philadelphia Butter Pie

Cover a pie plate with crust as for custard pie, a piece of butter the size of an egg, two-third cup sugar, one cup sweet cream—or rich milk will do with little more butter added, one tablespoon flour. Stir butter, flour and sugar together, then stir in the cream, pour in the plate and bake till brown.

Mock Mince Pie

To one cup cracker crumbs or stale bread, add one cup molasses, one cup sugar, one-half cup vinegar, one and one-half cups water, one teaspoon mixed spice and butter size of an egg, also raisins, if you have them. Mix and let come to a boil, when the "meat" is ready for use. It is a real good substitute for mince meat. Will fill three pies.

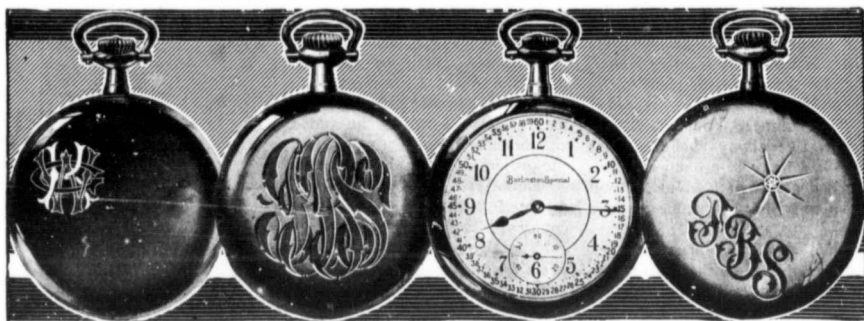

Superb Burlington Special Watch for Ladies



The Perfect Timekeeper Exquisite New Style Gold Strata Cases

Just Out! Superb New Ideas In Watch Cases!

The latest products of the craft. Exquisitely beautiful. Your own initials handsomely engraved on the superb gold strata case. Your choice of Inlay Enamel Monograms, Block and Ribbon Monograms, Diamond Set, Lodge, French Art, Dragon Designs. Open face or hunting cases, ladies' or gentlemen's 12 and 16 sizes. A watch to suit every taste. And—DIRECT—at the rock-bottom price. The masterpiece of watch manufacture—19 jewels—adjusted to the second—adjusted to positions—adjusted to temperature—adjusted to isochronism.

These Exquisite New Designs

In watch cases are winning favor everywhere. And wherever the great Burlington Special has been introduced it is noted for its wonderful time keeping qualities. Ask any railroad man what he thinks of the Burlington Special. Ask a bus driver, engineers and men in all walks of life whose duties require them to put a watch to the hardest tests prefer the Burlington because they know they can depend upon it.

In the U. S. Navy

Every fighting vessel has the Burlington Watch aboard. The S. S. Connecticut alone has over 200 Burlingtons aboard; the Battleship Georgia has 159 Burlingtons; the new dreadnought Wyoming already over one hundred watches. Many other battleships, such as the New Hampshire, North Carolina, Minnesota, have over 100 Burlingtons aboard.

Think of the constant vibration, the extreme heat in the boiler rooms, the salt air and the change of climate from the Arctic to the Tropical: if a watch will stand up and give accurate service aboard a man-of-war it will stand up everywhere.

New Ideas In Watch Cases

1. Inlay Enamel Monograms. Your choice of any initials in any colors. The latest design. The newest product of the designers' art.
2. Ribbon Monogram. You may have your initials handsomely engraved on the gold strata case by hand. A justly popular design.
3. Montgomery Dials. Every minute numbered. Especially popular with railroad men.
4. Diamond Set Initial Cases. The glitter of a diamond on the back of gold cases quadruples the beautiful effect of the gold. These gems are not chips, but 1/4 carat, pure white, genuine full cut and faceted diamonds.
5. The Burlington Special Dial is very popular in ladies' size watches.
6. Inlay Enamel Monogram. For the woman who wants the latest of watch cases and one that is distinctively individual. Scores of other exquisite designs for ladies' and gentlemen's watches.

Special

A Remarkable Special Offer

For reasons explained in our letter to you (special trade reasons) you can now get direct the Superb Burlington Watch at the rock-bottom price—the same price that even the wholesale jeweler must pay—and in order to encourage everybody to secure this watch at once, purchasers may pay this rock-bottom price direct from us either for cash or \$2.50 a month on this great special offer! We send the watch on approval, prepaid.

Sent—No Money Down—Prepaid. Remember, the highest grade watch direct (for special reasons, now) at the same price that even the wholesale jeweler must pay! You risk absolutely nothing—you pay nothing—not one cent—unless you want this exceptional offer after seeing and thoroughly inspecting the watch.

Send the Coupon for Our New Book on Watches

Learn the inside facts about watch prices, and the many superior points of the Burlington over double-priced products. Also illustrations of all the newest up-to-date ideas in exquisite watches, and our letter to you sending the rock-bottom price—direct. Just send the coupon, or a letter or a postal.

Burlington Watch Company

Dept. 7701 289 Carlton Street Winnipeg, Man.

Watch Book Coupon Burlington Watch Co. Dept 7701

289 Carlton St., Winnipeg, Manitoba. Please send me (without obligations, prepaid), your free book on watches showing all the latest designs, with full explanation of your cash, or \$2.50 a month offer on the Burlington Watch.

Name _____ Address _____

A NOVELTY IN MYSTERY STORIES
THE SECRET OF LONESOME COVE
By
SAMUEL HOPKINS ADAMS
 AUTHOR OF **AVERAGE JONES ETC**
Copyright, 1912, The Bobbs-Merrill Company.

Continued from page 104 December
 "If you are going back to the hotel, may I take you along? I am Alexander Blair."

"Thank you. I'll be glad of a lift. My name is Chester Kent."

"Not the Professor Kent of the Ramsay case?"

"The same. You know, Mr. Blair, I've always believed that you had more of a hand in Ramsay's death than I. Now, if you wish to withdraw your offer of a lift—"

"Not at all. A man who has been so abused by the newspapers as I, can stand a little plain speaking. For all that, on my word, Professor Kent, I had no hand in sending Ramsay on that dirty business of his."

The scientist considered him thoughtfully. "Well, I believe you," said he shortly, and got into the machine.

"This meeting is a fortunate chance for me," said Blair presently.

"Chance?" murmured Kent interrogatively.

The car swerved sharply, but immediately resumed the middle of the road.

"Certainly, chance," said the motorist. "What else should it be?"

"Of course," agreed Kent. "As you say."

"I said fortunate," continued the other, "because you are, I believe, the very man I want. There is an affair that has been troubling me a good deal. I haven't been able to look into it personally, because of the serious illness of my son, who is at my place on Sundayman's Creek. But it is in your line, being entomological, and perhaps criminal."

"What is it?" asked Kent.

"An inexplicable destruction of our stored woolens by the clothes moth. You may perhaps know that I am president of the Kinsella Mills. We've been having a great deal of trouble this spring, and our superintendent believes that some enemy is introducing the pest into our warehouses. Will you take the case?"

"When?"
 "Start to-night for Connecticut."

Chester Ken's long fingers went to the lobe on his ear. "Give me until three o'clock this after-

noon to consider. Can I reach you by telephone?"

"Yes, at Hedgerow House, my place."

"That is how far from here?"

"Fourteen miles; but you need not come there. I could return to the hotel to conclude arrangements. And I think," he added significantly, "that you would find the project a profitable one."

"Doubtless. Are you well acquainted with this part of the country, Mr. Blair?"

"Yes, I've been coming here for years."

"Is there an army post near by?"

"Not within a hundred miles."

"Nor any officers on special detail about?"

"None, so far as I know."

Kent produced from his pocket the silver star with the shred of cloth hanging to it. "This may or may not be an important clue to a curious death that occurred here three days ago."

"Yes, I've heard something of it," said the other indifferently. "I took it to be mostly gossip."

"Before the death there was a struggle. This star was found at the scene of the struggle."

"It looks like the star from the collar of an officer. I should say positively that it was from an army or navy uniform."

"Positiveness is the greatest temptation and snare that I have to fight against," remarked Chester Kent. "Otherwise I should say positively that no officer, going to a dubious rendezvous, would wear a uniform which would be certain to make him conspicuous. Are you yourself an expert in woolen fabrics, Mr. Blair?"

"I have been."

"Could you tell from that tiny fragment whether or not the whole cloth is all wool?"

Without replying, Blair gave the steering handle a quick sweep, and the car drew up before a drug store. He took the star and was gone a few minutes.

"Not all wool," he announced on his return.

"Exit the army or navy officer," remarked Kent.

"Why so?"

"Because regulations require all-wool garments—and get them. What is the fabric?"

ASK FOR
FIVE ROSES
FLOUR
The World's Best

You saw this advertisement in this magazine. Don't forget to say so when writing.

FOR A BRIGHT AND CHEERFUL KITCHEN

BLACK KNIGHT STOVE POLISH

A PASTE NO WASTE No DUST No RUST

You saw this advertisement in this magazine. Don't forget to say so when writing.

ANNUAL SALE
PURE-BRED CATTLE

Under Auspices of
 Cattle Breeders' Association of Manitoba
 and Department of Agriculture, Ottawa

Brandon, Man. :: March 4, 1914

*Special rates for contributors to this sale
 Best opportunity this year of selecting your herd bull
 at his value*

ENTRIES CLOSE January 24th, 1914

JAS. DUTHIE, Pres. A. W. BELL, Secy.
 Hartney 226 Chambers of Commerce
 Winnipeg

You saw this advertisement in this magazine. Don't forget to say so when writing.

WINNIPEG - - -
719 MINTYRE BLOCK
JOHN A. HERRON

fully all that I submit. Address: made is that you shall read care- your money. The only stipulation sale venture, then I want none of sound, conservative and highly profit- do not market you that it is safe. the proper thing to do. All I ask is a hearing. If the facts I present intelligent judgment tells you it is expect you to buy unless your own object is to sell stock, but I will not or not. Primarily, of course, my all about it, whether you buy stock obligation to me—I want you to know information. You will be under no deal of very useful and beneficial in- use to which you put your money. you will at least have secured a great that you can make more money by investing a few dollars in Western, by a preponderance of evidence, and if I do not succeed in convincing

WHITE TO ME

Manitoba Agricultural College

Home Nursing

A SHORT COURSE

For women who desire to learn more about caring for the sick. Lectures and demonstrations by skilled Physicians and Professors of College Staff.

Two Weeks—Commencing Feb. 3rd, 1914

Write for descriptive circular—
W. J. BLACK, President

KNITTING MACHINES



Home Knitting is quick and easy with any one of our 6 Family Knitting Machines. Socks and Stockings, Underwear, Caps, Gloves, Mittens, etc.—Plain or Ribbed—can be knitted ten times as fast as by hand, and for far less than they cost ready-made.

A child can work our machine. Besides your own family work, you can make good money knitting for others.

6 Illustrated Catalogues—No 658—FREE

Agents wanted in every locality for typewriters and home-money-maker knitting machines. Address—

CREELMAN BROS.
Box 8 Georgetown, Ontario

Mention this magazine when writing advertisers.

CHALLENGE COLLARS

Acknowledged to be the finest creation of Water-proof Collars ever made. Ask to see, and buy no other. All stores or direct for 25c.

THE ARLINGTON CO. of Canada, Ltd.
80 PRINCE AVENUE TORONTO

All "ARLINGTON COLLARS" are good, but our **CHALLENGE BRAND** is the best. Mention this magazine when writing advertisers

"A fairly good mixture, from the very elemental chemical test I made. Something in the nature of a worsted batiste, I should judge, from what I could make out under the inferior magnifying glass that they loaned me."

"Thank you, Mr. Blair. You've eliminated one troublesome hypothesis for me. I'll telephone you before three o'clock. Good day."

From the woolen manufacturer, Chester Kent went direct to the Martindale Center library, where he interviewed the librarian.

"Do you get the Agriculture Department publications?"

"Yes."

"Have you a pamphlet issued by the Bureau of Entomology, Helmund on The Swarm Phenomenon in Lepidoptera?"

"Yes, sir. It was inquired for only yesterday by Mr. Blair."

"Ah, yes. He's quite interested in the subject, I believe."

"It must be quite recent, then," said the librarian. "We haven't seen him here for a long time until two days ago, when he came and put in a morning, reading on insects."

"So, Mr. Alexander Blair," said Kent, addressing the last fence post on the outskirts of the town, after a thoughtful walk, "that was a fatal break on your part, that mention of Helmund. Amateurs who have wholly dropped a subject since years back don't usually know publications issued only within three months. That casual meeting with me was well carried out, and you called it chance. A very palpable manufactured chance! But why am I worth so much trouble to know? And why does Alexander Blair leave a desperately ill son to arrange an errand for me at this particular time? And is Hedgerow House, fourteen miles distant and possessing just such an electric car as a woman would use in driving round the country, perhaps the place whence came Sedgwick's sweet lady of mystery? Finally, what connection has all this with the body lying in Annalaka burying-ground?"

Eliciting no reply from the fence post, Kent returned to the Eyrie, called up Hedgerow House, and declined Blair's proposition.

Early that evening Francis Sedgwick came to the hotel. The clerk, at first negligent, pricked up his ears and exhibited unmistakable signs of human interest when he heard the name; for the suspicion attaching to the artist had spread swiftly. Moreover, the caller was in a state of hardly repressed excitement.

"Mr. Kent? I'm afraid you can't see him, sir. He isn't in his room."

No. 1
Blue Ribbon Coffee and Baking Powder

Has your morning cup of coffee a full rich flavor and delicate aroma? If not ask for **BLUE RIBBON** coffee when giving your next order and notice the difference. You will be agreeably surprised.

BLUE RIBBON Tea, Coffee, Baking Powder, Spices and extracts all one grade—**THE BEST.**

CROWN BRAND

CORN SYRUP

The Children's Choice
PURE AND WHOLESOME

CROWN BRAND fits the kiddies for their strenuous winter sports.

Get it at your Grocer's.

THE CANADA STARCH CO. LIMITED

MANUFACTURERS OF THE

EDWARDSBURG BRANDS

Works: Cardinal and Brantford, Ont.

Offices: MONTREAL, TORONTO, CALGARY, VANCOUVER

Write for Recipe Book

You saw this advertisement in this magazine. Don't forget to say so when writing.

REGISTERED TRADE MARK

JOSEPH RODGERS & SONS, Limited
SHEFFIELD, ENG.

Avoid imitations of our **CUTLERY** by seeing that This **EXACT MARK** is on Each Blade.

SOLE AGENTS FOR CANADA
JAMES HUTTON & CO., MONTREAL

SYNOPSIS OF CANADIAN NORTH-WEST LAND REGULATIONS.

Any person who is the sole head of a family or any male over 18 years old, may homestead a quarter-section of available Dominion land in Manitoba, Saskatchewan or Alberta. The applicant must appear in person at the Dominion Lands Agency or Sub-Agency for the district. Entry by proxy may be made at any agency, on certain conditions, by father, mother, son, daughter, brother or sister of intending homesteader.

Duties—Six month a residence upon and cultivation of the land in each of three years. A homesteader may live within nine miles of his homestead on a farm of at least 80 acres solely owned and occupied by him or by his father, mother, son, daughter, brother or sister.

In certain districts a homesteader in good standing may pre-empt a quarter-section alongside his homestead. Price \$2.00 per acre. **Duties**—Must reside six months in each of six years from date of homestead entry (including the time required to earn homestead patent) and cultivate fifty acres extra.

A homesteader who has exhausted his homestead right and cannot obtain a pre-emption may enter for a purchased homestead in certain districts. Price \$2.00 per acre. **Duties**—Must reside six months in each of three years, cultivate fifty acres and erect a house worth \$300.00.

W. W. GORY,

Deputy of the Minister of the Interior

N.B.—Unauthorized publication of this advertisement will not be paid for.

Mention this magazine when writing advertisers

1877-1913

Thirty-six years' experience in brewing

Drewry's Redwood Lager

tells the story of its popularity

TRY IT

Mention this magazine when writing advertisers.

CHEW MAPLE SUGAR TOBACCO

MILD, SWEET, MELLOW AND JUICY

Manufactured by

ROCK CITY TOBACCO CO.

Quebec

Winnipeg

Mention this magazine when writing advertisers.

"Isn't he about the hotel?"

The clerk hesitated. "I ought not to tell you, sir, for it's Mr. Kent's strict orders not to be disturbed; but he's in his special room. Is it anything very important? Any new evidence, or something of that sort?"

"That is what I want Mr. Kent to decide."

"In that case I might take the responsibility. But I think I had better take you to him myself."

After the elevator had carried them to the top of its run, they mounted a flight of stairs, and walked to a far corner of the building.

"Nobody's been in here since he took it," explained the clerk as they walked. "Turned all the furniture out. Special lock on the door. Some kind of scientific experiments, I suppose. He's very quiet about it."

Having reached the door, he discreetly tapped. No answer came. Somewhat less timidity characterized his next effort. A growl of surpassing savagery from within was his reward.

"You see, Mr. Sedgwick," said the clerk. Raising his voice he called, "Mr. Kent, I've brought—"

"Get away and go to the devil!" cried a voice from inside in fury. "What do you mean by—"

"It's I, Kent, Sedgwick. I've got to see you."

There was a silence of some seconds.

"What do you want?" asked Kent at length.

"You told me to come at once if anything turned up."

"So I did," sighed Kent. "Well, chase that infernal bell-boy to the stairs, and I'll let you in."

With a wry face the clerk retired. Kent opened the door, and his friend squeezed through into a bare room. The walls were hung and the floor carpeted with white sheets. There was no furniture of any kind, unless a narrow mattress in one corner could be so reckoned. Beside the mattress lay a small pad and a pencil. Only on the visitor's subconscious self did these peculiarities impress themselves, such was his absorption in his own interests.

"It's happened!" he announced.

"Has it?" said Kent. "Lean up against the wall and make yourself at home. Man, you're shaking!"

"You'd shake, too," retorted the artist, his voice trembling.

"No; anger doesn't affect me that way. Wait! Now, don't tell me yet. If I'm to have a report, it must be from a sane man, not from one in a blind fury. Take time and cool down. What do you think of my room?"

"It looks like the abode of white silence. Have you turned Trappist monk?"

BUYERS OF Gasoline Engines BEWARE!

Certain unscrupulous dealers are selling imitations of Stover Engines and rating a 2½ h.p. engine as a 3 h.p.; a 4 h.p. engine as a 4½ h.p.; a 6 h.p. engine as a 7 h.p.; an 8 h.p. engine as a 10 h.p., etc.

DO NOT BE DECEIVED. Buy the ORIGINAL STOVER, manufactured and guaranteed by the Stover Engine Works, of Freeport, Ill., the largest exclusive gasoline engine factory in United States.

The STOVER represents the highest quality Engine and will develop at least 25% more than rated power. The STOVER is in fact the lowest price good engine made to-day.

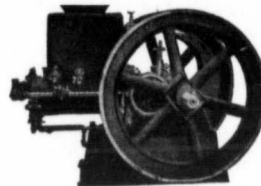

Prices of STOVER Engines:

1 h.p.	- \$ 36.25	Prices
2½ h.p.	- 85.00	all
4 h.p.	- 130.00	l.h.s.
6 h.p.	- 195.00	Brandon,
8 h.p.	- 295.00	Man.

Write for Catalogue

Canadian Stover Gasoline Engine Co., Ltd.

EIGHTH and PACIFIC AVENUE, BRANDON

You saw this advertisement in this magazine. Don't forget to say so when writing.

Service - Safety - Satisfaction

For Every Power User If He Gets A

GILSON "GOES-LIKE-SIXTY" ENGINE

More Value, More Power, More Service, More Satisfaction.



Does SERVICE, SAFETY and SATISFACTION mean anything to you? Does money saved in repairs and expense bills, time, equipment, etc., mean anything to you? Get Gilson Facts and find out how the Gilson 60-Speed and 100 per cent Service Engines do the greatest variety of work—give the maximum satisfaction—are trouble proof and fool proof. Their scientific design makes them absolutely safe—they are approved by the National Board of Fire Underwriters; no insurance troubles.

NEW FEATURES AND LATEST IMPROVEMENTS

The new Gilson 100 per cent SERVICE ENGINES, 4 H.P. and upwards, are equipped with our new friction clutch pulley with five interchangeable rims, each of a different diameter. Change to the proper speed for every job in a few minutes. A NEW and EXCLUSIVE GILSON FEATURE. These engines are also equipped with a magneto, without batteries or coil, with spark retarder,—no cranking necessary. A child can start them.

We also make 60-SPEED Engines in 1¼ and 3 H.P. sizes. These are mounted on truck, with line shaft and five interchangeable pulleys, and pump-jack. Drop us a card today, and we will send you full descriptive literature. We are making special prices to the first purchaser of one of these engines in every locality. Write NOW.

AGENTS WANTED.

GILSON MFG. CO., LTD. 2218 York St., Guelph, Ont.

You saw this advertisement in this magazine. Don't forget to say so when writing.

The Business World

offers you a good place at a good salary as a graduate of one of our schools. Why not prepare for and enjoy these results as so many do every term? Catalogue free. Enter any time. Write W. H. SHAW, President, Shaw's Business and Shorthand Schools. Head Offices: Yonge and Gerrard Streets, Toronto.

You saw this advertisement in this magazine. Don't forget to say so when writing.



Canadian Hog Motor Co. Ltd.
 172 Portage Ave. Winnipeg, Man.
 Mention this magazine when writing advertisers.

AGENTS WANTED
 in Every Town and District
 Shipments made from Galt, Ont. and Winnipeg, Man.
 Address to Head Office



Strite Governor Pulley Co. Ltd.
 310 S. 3rd St., WINEAPOLIS
 Mention this magazine when writing advertisers

Desires Increase Your Sales!
 Take a Look at the Strite Governor Pulley
 It's the original and the only thing for driving cream separators with gasoline engines. One trial, always find they are more to use than all others combined. Cost less than 10¢. Also ask about our friction clutch pulleys.

MEN WANTED

to learn to operate and repair gasoline tractors and automobiles. Prepare now for the coming season. More engines and automobiles than ever in use. Our graduates are receiving \$5 to \$8 per day. Write for free catalogue.
OMAR SCHOOL OF TRADES AND ARTS,
 483 Main Street, WINNIPEG, MAN.

Books \$1.00 Each

- Physical Life of Woman - - - Napheys
- Home Cook Book - - - Ladies of Toronto
- Transmission of Life - - - Napheys
- Advice to Wife and Mother - - Chevasse
- Chase's Recipes - - - Dr. A. W. Chase
- Family Physician - - - Leading Doctors
- Gleason's Horse Book - - - Gleason

AGENTS WANTED

The Hunter-Rose Co. Ltd.

15 Sheppard St., Toronto, Ont.
 Mention this magazine when writing advertisers.



THE Double Track Route TO Detroit, London, Hamilton, Toronto, Montreal and New York via Niagara Falls
 Smooth road-bed, polite employees, excellent dining-car service, and latest standard equipment
AGENTS, COOK'S TOURS AND ALL STEAMSHIP LINES
 Rates, reservations and all particulars at Ticket Office
 Phone Main 7008 260 Portage
WINNIPEG
 Mention this magazine when writing advertisers.

Erickson Leg
 Does not chafe, prevent or give pain, or cause blisters for Castles.
 Arms, Braces, Wheel Chairs, SOLD ON EASY TERMS.
 E. B. Erickson Artificial Limb Co., Largest Limb Factory in World
 11 Wash. Av., Minneapolis, Minn.

"Not such a bad guess. This is the retreat of my mind. I think against the blank walls."
 "What's the game?" asked Sedgwick, interested in spite of himself.
 "It dates back to our college days. Do you remember that queer freshman, Berwind?"
 "The mind-reader? Yes. The poor chap went insane afterward."

"Yes. It was a weak mind, but a singularly receptive one. You know we used to force numbers or playing-cards upon his consciousness by merely thinking of them."
 "I recollect. His method was to stand gazing at a blank wall. He said the object we were thinking of would rise before him visually against the blankness. Did you ever figure out how he managed to do it?"

Not exactly. But his notion of keeping the mind blank for impressions has its points. If you throw off the clutch of the brain, as it were, and let it work along its own lines, it sometimes arranges and formulates ideas that you wouldn't get from it under control."

"Sort of self-hypnosis?"
 "In a sense. For years I've kept a bare white room in my Washington house to do my hard thinking in. When your affair promised to become difficult for me, I rigged up this spot. And I'm trying to see things against the walls."

"Any particular kinds of things?"
 Kent produced the silver star from his pocket, and told of its discovery. "The stars in their courses may have fought against Siser," he remarked; "but they aren't going out of their way to fight—to fight—to—to—" Kent's jaw was sagging down. His lean fingers pulled savagely at the lobe of his long-suffering ear. "The stars in their courses—in their courses— That's it!" he half whispered. "Sedgwick; what was it your visitor said to you about Jupiter?"

"She didn't mention Jupiter."
 "No, of course not. Not by name. But what was it she said about the planet that she pointed out, over the sea?"

"Oh; was that Jupiter? How did you know?"
 "Looked last night, of course," said Kent impatiently. "There's no other planet conspicuous over the sea at that hour, from where you stood. That's not important; at least, not now. What did she say?"

"Oh, some rot about daring to follow her star and find happiness, and that perhaps it might lead me to glory or something."
 A kind of snort came from Kent. "Where have my brains been!" he cried. He thrust the



A Moose Head, Horns with Spread of 72 inches.

Western Canada's Leading Taxidermist
 The Oldest and Best
 Expert Mounting of Game Heads and Birds
 Highest Prices for all kinds of Raw Furs, Hides and Game Heads - Will buy Wolf, Lynx and Bear Skulls.
Taxidermist Supplies
 Write for New Fur List
E. W. Darbey, 231 Main St., Winnipeg
 Official Taxidermist to Manitoba Government.

Patent Rights for Sale OF Willey's Adjustable Spark Arrester
 A snap for small manufacturing concerns and machine shops

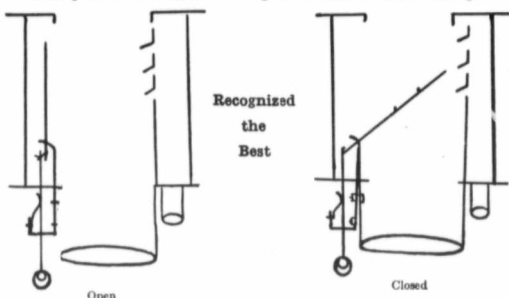

I will sell the rights to manufacture this device in provinces or counties on easy terms. It is easy and cheap to manufacture, and has a big demand. Write for particulars early so as to get choice of districts or the entire patent rights.
C. W. WILLEY, Manufacturer Box 2, BIRNIE, MAN.

CAEW "BAT" PLUG TOBACCO
 THE ROCK CITY TOBACCO CO. LIMITED - QUEBEC.

A New Year's Message FROM THE GREAT-WEST LIFE

The Directors of The Great-West Life announce to all Policyholders, present and future, and to all existing beneficiaries—

That henceforward all Settlements under instalment Policies will, in addition to the interest rate of 3½ per cent guaranteed, share in the surplus interest-earnings of the Company.

Thus among certain beneficiaries this year

One expecting.....	\$1,000 will receive	\$1,044.45
Another expecting	50 " "	53.05
" "	250 " "	275.80
" "	50 " "	53.15
" "	50 " "	53.35
" "	250 " "	293.70
" "	1,000 " "	1,162.45
" "	250 " "	299.70
" "	250 " "	305.40
" "	250 " "	307.15

(In determining the Surplus, the number of instalments still to be paid is taken into consideration.)

Those who wisely turn to Life Insurance for the eventual care of dependents or of their own declining years may in this way secure the added benefit of safe and profitable administration of their funds by a Company enjoying exceptional interest-earning facilities. For further information address

The Great-West Life Assurance Company
 Head Office Winnipeg, Man.
 Applications for 1913 over \$27,000.00. | Ask for a Great-West Calendar

Well Drilling Machines

Over 70 sizes and styles for drilling either deep or shallow wells in any kind of soil or rock. Mounted on wheels or on gins or horse powers. Strong, simple, durable. Any mechanic can operate them. Send for catalog.

WILLIAMS BROS.
TRACA, N. E.

Mention this magazine when writing advertisers

Imperial Bank OF CANADA

Established 1878

Capital Authorized \$10,000,000
Capital Paid Up 4,958,000
Reserve and Undivided Profits 8,100,000
Total Assets 23,000,000

BRANCHES IN WESTERN CANADA

Province of Manitoba
Brandon Portage la Prairie Winnipeg

Province of Saskatchewan
Regina Broadview North Battleford
Rosthern Fort Qu'Appelle Prince Albert
Saskatoon Moose Jaw Regina
Wilkie Hague Wynyard

Province of Alberta
Athabasca Landing Edmonton Strathcona
Banff Lethbridge Wetaskiwin
Calgary Red Deer Redhill
Rocky Mountain Hts. Medicine Hat Millet

SAVINGS DEPARTMENTS AT ALL BRANCHES

Interest allowed at Current Rates
Drafts and Letters of Credit issued available in all parts of the world.

Winnipeg Branch
N. G. LESLIE, Manager.

Mention this magazine when writing advertisers.

The Pump That Pumps

MYERS PUMPS

Double-acting Lift, Tank and Spray

SPRAY PUMPS

Stare Ladders, Etc.

MYERS HAY TOOLS

of all kinds. Write for descriptive circular and prices. Exclusive agents given to right party who will buy in quantity.

MYERS STAYON FLEXIBLE DOOR HANGERS

with steel roller bearings, easy to push and to pull, cannot be thrown off the track—comes in many styles. Write for descriptive circular and prices. Exclusive agents given to right party who will buy in quantity.

MYERS & CO., Ltd.

Mention this magazine when writing advertisers

THE ORIGINAL PECH Boring Machine

THE OLD RELIABLE

Best to operate Bores Faster Most Durable

Improved Up-to-date Drilling Machines

DESCRIPTIVE CATALOGUE FREE

Cherokee Mfg. Co., Dept. A, Cherokee, Iowa.

Mention this magazine when writing advertisers.

WELL DRILLING

GUS PECH FOUNDRY AND MANUFACTURING COMPANY

Manufacturers of the Celebrated

MONITOR WELL AUGERS AND DRILLS

Write for prices and illustrated Catalogue.

LE MAR, IOWA U.S.A.

Branch House: REGINA, SASK.

Mention this magazine when writing advertisers.

bit of embroidery back into his pocket. Then, with an abrupt change of tone:

"Well, is your temper in hand?"

"For the present."

"Tell me about it, then."

"You remember the—the picture of the face?" said Sedgwick with an effort.

"Nobody would easily forget it."

"I've been doing another portrait from the sketches. It was on opaque glass, an experimental medium that I've worked on some. Late this afternoon I went out, leaving the glass sheet, backed against a light board, on my easel. The door was locked with a heavy spring. There's no possible access by the window. Yet somebody came in and smashed my picture to fragments. If I can find that man, Kent, I'll kill him!"

Kent glanced at the artist's long strong hands. They were clenched on his knees. The fingers were bloodless.

"I believe you would," said the scientist with conviction. "You mustn't, you know. No luxuries, at present."

"Don't joke with me about this, Kent."

"Very good. But just consider, please, that I'm having enough trouble clearing you of a supposed murder of your doing, to want a real one, however provoked, on my hands."

"Keep the man out of my way, then."

"That depends. Anything else in your place damaged?"

"Not that I noticed. But I didn't pay much attention to anything else. I came here direct to find you."

"That's right. Well, I'm with you, for the Nook."

Locking his curious room after him, Kent led the way to the hotel lobby, where he stopped only long enough to send some telegrams. The sun was still a few minutes short of its setting when he and his companion emerged from the hotel. Kent at once broke into a trot.

CHAPTER X
The Invasion

Such ruin as had been wrought in Sedgwick's studio was strictly localized. The easel lay on the floor, with its rear leg crumpled. Around it were scattered the fragments of the glass upon which the painter had set his labor of love. A high old-fashioned chair faced the wreckage. On its peak was hung a travelling cap. Lopping across the back sprawled a Norfolk jacket belonging to Sedgwick. Chester Kent lifted the coat, and after a swift survey let it drop.

UNION BANK OF CANADA

Established 1868

Head Office Winnipeg

Paid-up Capital \$5,000,000
Reserve and Undivided Profits 3,400,000
Total Assets, over 80,000,000

Hon. President - - WM. PRICE

PRESIDENT - JOHN GALT

VICE-PRESIDENTS
R. T. RILEY G. H. THOMPSON

DIRECTORS
W. R. ALLAN E. E. A. DU VER
Hon. S. BARKER, P.C. NET, K.C.
M. P. S. HAAS
M. BULL F. W. HEYBACH
Lieut.-Col. J. CARSON F. E. KENNISTON
B. CROFTON Wm. SHAW
E. L. DREWRY

G. H. BALFOUR, General Manager.
H. R. SHAW, Assistant General Manager.
F. W. S. CRISPO, Superintendent of Branches and Chief Inspector.

London, England, Branch No. 51 Threadneedle Street, E.C.

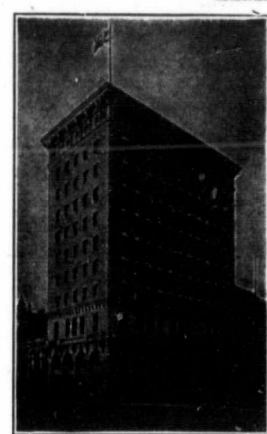

Head Office, Winnipeg.

SPECIAL ATTENTION GIVEN TO FARMERS' BUSINESS

Grain Drafts Negotiated. Interest Allowed on Deposits

Branches and Agencies West of Great Lakes.

Manitoba—Baldur, Hirtle, Bois-e-vain, Brandon, Carberry, Carman, Carroll, Clearwater, Crystal City, Cypress River, Daumbia, Deloraine, Glenora, Hamiota, Hartney, Holland Killarney, Manitou, Melita, Minnedosa, Minto, Morden, Neepawa, Neudale, Nipaw, Rapid City, Roblin, Russell, Shoal Lake, Souris, Strathairn, Virton, Waskada, Wawanesa, Willowood, Winnipeg.

Saskatchewan—Abbeey, Adanac, Almak, Arcola, Assiniboia, Bountey, Buchanan, Cabri, Canora, Carlyle, Craik, Cupar, Cut Knife, East End, Esterhazy, Eyebrow, Fillymore, Gravelbourg, Gull Lake, Herbert, Humboldt, Indian Head, Janzen, Leboucq, Kerrobert, Kenderley, Landis, Lang, Lanigan, Leoville, Lemberg, Lumsden, Lussell, Macleod, Maple Creek, Maryfield, Meyronne, Milestone, Moose Jaw, Moosomin, Netherhill, Neudorf, Ozeona, Outlook, Oxbow, Pense, Perdue, Plenty, Qu'Appelle, Regina, Rosedale, Roseston, Saskatchewan, Scott, Simpson, Sisseton, Southey, Strathburg, Swift Current, Tessier, Theodore, Togo, Toxana, Vanguard, Viceroy, Wapella, Wawota, Watrous, Webb, Weyburn, Wilkie, Witherbert, Wolseley, Yorkton, Zealandia.

Alberta—Airdrie, Aik, Barons, Bashaw, Bassano, Bellevue, Blackie, Blairmore, Bowden, Bow Island, Brooks, Calgary, Carbon, Cardston, Carleton Place, Carstairs, Carletonhill, Cochrane, Consort, Cowley, Didsbury, Edmonton, Fort Saskatchewan, Grande Prairie, Gray Lake, High River, Hillcrest, Innisfail, Irvine, Lacombe, Landon, Lethbridge, Macleod, Medicine Hat, Okotoks, Pasburg, Pincher Creek, Seven Persons, Strathmore, Swain, Three Hills, Wainwright.

British Columbia—Enderby, Glacier, Hazelton, Nanaimo, New Hazelton, Prince Rupert, Smithers, Telkwa, Vancouver, Vernon, Victoria.

Winnipeg Branch, D. M. NEVEE, Manager. F. E. WILSON, Asst.-Manager.

F. J. BOULTON, Manager Portage Ave. Branch, corner Garry (adjoining Post Office)

Tanning—A Fine Art

If you have a hide or skin to be tanned for a coat, robe, gauntlets or rug, let us have it and we will make it as soft as a glove. It will be perfectly tanned and preserved against every element that can effect a partially cured skin. We use no acid in our tanning process—only the purest and best bark and mineral extracts. We have been tanning for sixteen years in Western Canada and uniformly with the very best results.

Let us prove our capabilities by a trial order and we know you will be glad to come again and to recommend us to all your neighbors. Send for our Raw Fur and Hide Report. We pay the highest prices.

Brandon Tannery

SUCCESSORS TO CARRUTHERS & CO.

Brandon Manitoba

Manitoba Winter Fair and Fat Stock Show

MANITOBA POULTRY SHOW AND SEED GRAIN FAIR

BRANDON, Manitoba, MARCH 2nd to 6th, 1914

CANADA'S GREATEST WINTER FAIR

Horses, Beef Cattle, Sheep and Swine, Poultry and Seed Grain

LIBERAL PRIZES AND COMPETENT JUDGES

Entries Close February 21st. Prize List on Application

SINGLE FARE RATES ON ALL RAILWAYS

J. D. MCGREGOR President
W. H. ENGLISH Vice-President
W. I. SMALE Secy. and Manager

ADADA

l'nnipeg
 .. \$5,000,000
 offts 1,400,000
 .. 80,000,000
 WM. PRICE
 N GALT
 ITS
 THOMPSON

A. D'VER-
 ET, K.C.
 AN
 HUBBACH
 KENASTON
 RHAW

1 Manager,
 1st Manager,
 1st of Fran-
 .. 51 Thread-
 0 branches in
 lence to the
 facilities for
 verification of
 irrepudiable
 throughout
 e Continent
 onia,
 nars of the
 dly remitted

1 Deposits

Clear water
 re, Hilled
 ale, Niara
 Wawanesa

nan, Calori,
 re, Gravel-
 Kerrol-
 die, Maple
 ef, Orama,
 Saskatoon,
 lone, Toso,
 n, Wilkie,

s, Bowden,
 larcobim,
 de Prairie,
 elbridge,
 trathmore,

o Rupert,
 fans gar,
 1 Office)

rt

lets or
 e. It
 nning
 We
 ormly

ou will
 hours
 prices

ba

how

try

tion

Warranted to Give Satisfaction.

Gombault's Caustic Balsam



Has Imitators But No Competitors.
 A Safe, Speedy and Positive Cure for
 Curb, Spint, Swoony, Capoes Hook,
 Strained Tendons, Founder, Wind
 Puffs, and all lameness from Sprain,
 Ringbones and other bony tumors.
 Cures all skin diseases or Parasites,
 Thrush, Diphtheria. Removes all
 Bunches from Horses or Cattle.

As a Human Remedy for Rheumatism,
 Sprains, Sore Throat, etc., it is invaluable.
 Every bottle of Caustic Balsam sold is
 warranted to give satis action. Price \$1.50
 per bottle. Sold by druggists, or sent by ex-
 press charges paid, with full directions for
 its use in English for descriptive circulars,
 testimonials, etc. Address
 The Lawrence-Williams Co. Toronto, Ont.

Mention this magazine when writing advertisers.

PATENTS TRADE MARKS AND DESIGNS
 Write for booklet, circulars, terms, etc.

FETHERSTONHAUGH & CO.
 FRED. B. FETHERSTONHAUGH, K. C. M. E.
 GERALD S. ROXBURGH, K. A. S.C.

Portage Avenue, WINNIPEG,
 209-10 Bank of Nova Scotia

Mention this magazine when writing advertisers.



\$1500 to \$5000 Per Year

have been made by hundreds of people operating the "American" Drilling Machines. 40 years' experience, 50 regular styles and sizes and the output of the world's largest manufacturers of this kind of machine. y make "AMERICAN" MACHINES STANDARD

Made in types for every kind of earth and rock drilling or mineral prospecting, equipped with any power, or operated with your traction engine. Our new 100 Horse Catalog Free.

THE AMERICAN WELL WORKS

General Office and Works:
 AURORA ILL., U.S.A.
 Chicago Office: First Nat. Bldg. Ill.

Mention this magazine when writing advertisers.

ERZINGER'S No. 2 CUT PLUG
 Leads them all. It's the Best Dollar Tobacco sold anywhere.

JOHN ERZINGER
 McIntyre Bldg. - 293 Portage Ave.
 Phone 69 Phone 2677

Mention this magazine when writing advertisers.

"Did you leave that there?" he asked.

"I hung it across the back of the chair," answered Sedgwick.

"North window closed?"

"Yes, as you see it now."

"And west one open?"

"Nothing has been changed, I tell you, except this." Sedgwick's hand, outstretched toward the destroyed portrait, condensed itself involuntarily into a knotty fist.

"The lock of the door hasn't been tampered with," said Kent. "As for this open window," he leaned out, looking around, "any man gaining access here must have used a ladder, which is unlikely in broad daylight."

"How about a pass-key for the door?"

"There's a simpler solution near at hand, I fancy. You didn't chance to notice that things have happened to the coat, as well as to the easel."

"Then the invader went through the coat and, not finding what he was looking for, smashed my picture," cried Sedgwick.

"Through the coat, certainly," agreed Kent, with his quiet smile. "Now hang it across the chair back just as it was, please."

Sedgwick took the Norfolk jacket from him. "Why, there's a hole through it!" he exclaimed.

"Exactly: the path of the invader."

"A bullet!"

"Right again. Instead of murdering, as you pine to do, you've been murdered. That the picture was destroyed is merely a bit of ill fortune. That you weren't inside the coat when the bullet went through it and cut the prop from your easel, is a bit of the other kind. Hang up the coat please."

Sedgwick obeyed.

"There," said Kent viewing the result from the window. "At a distance of, say, a quarter of a mile, that arrangement of coat and cap would look uncommonly like a man sitting in a chair before his work. At least, I should think so. And yonder thicket on the hillside," he added, looking out of the window again, "is just about that distance, and seems to be the only spot in sight giving a straight range. Suppose we run up there."

Sound as was his condition, Sedgwick was panting when he brought up at the spot, some yards behind his long-limbed leader. As the scientist had surmised, the arrangement of coat and cap in the studio presented, at that distance, an excellent simulacrum of the rear view of a man lounging in a chair. Bidding the artist stay outside the copse, Kent entered on hands and knees and made extended exploration. After a few moments the sound

Big Ben



Hitch Your Sleeping Schedule to Big Ben

Big Ben will wake you early enough for profitable before-breakfast action. His gentle get-up call starts the day with a flying start on thousands of farms.

For your accommodation he rings TWO WAYS. He'll get you up by degrees or in a hurry. Set him either way you wish—to give one long five-minute ring, or ten short rings at one-half-minute intervals, until you're wide awake.

He stands 7 inches tall; is triple-nickel plated over a tested implement steel coat, the handsomest and truest throughout in the clock world. He has big, bold numerals and hands that show the time plainly at a glance, large keys that anyone can wind easily, and such a pleasant tone that you are glad to get up when he calls.

He makes early rising easy. He's the cheerful "good morning" ring calls millions of the wises to action. Thousands of successful farms are run on a Big Ben schedule. He starts you off right in the morning and keeps you right all day. From "sun up" to "lights out" he regulates your day. He'll work for 30 hours at a stretch and overtime, if necessary. The only pay he asks is one drop of oil a year.

He is sturdy and strong—built to last a lifetime. Yet under his dust-proof steel coat is the most delicate work. That's why his one-of-a-kind accuracy has won him fame.

Big Ben's wonderful sales are due to his having "made good." His biggest hit has been with folks with the "make good" habit. He stands for success—that's why you'll like him for a friend.

When 1 million families find Big Ben a good clock to buy and 20,000 dealers prove he's a good clock to sell, it's evidence that he is worth \$3.00 of your money. Suppose you trade \$1.00 for him today.

A community of clockmakers stands back of him. Their imprint, *Made in La Salle, Illinois, by Wadsworth*, is the best alarm-clock insurance you can buy.

Big Ben Alarm Clocks

ARE ILLUSTRATED IN THE CATALOGUE OF

D. R. DINGWALL, Limited
 JEWELLERS, WINNIPEG

WRITE FOR A COPY OF THIS BOOK

If you saw this advertisement in this magazine, don't forget to say so when writing.

Family Group Photos a Specialty

—AT—

STEELE & CO., LTD.

MAIN ST. AND BANNATYNE AVE. WINNIPEG

If you saw this advertisement in this magazine, don't forget to say so when writing.

NEW COAL OIL LIGHT BEATS ELECTRIC OR GASOLINE

10 Days FREE—Send No Money

We don't ask you to pay us a cent until you have used this wonderful modern light in your own home for ten days, then you may return it at our expense if not perfectly satisfied. We want you to prove for yourself that it gives five to fifteen times as much light as the ordinary oil lamp; beats electric, gasoline or acetylene. Lights and is put out just like the old oil lamp;

BURNS 10 HOURS ON 1 GALLON OIL

Gives powerful white light, burns common coal oil (kerosene), no odor, smoke or noise, simple, clean, won't explode, unquenchable.

\$1000.00 Reward

will be given to the person who shows us an oil lamp equal to this Aladdin in every way (details of offer given in our circular). Would you dare make such a challenge to the world if there was the slightest doubt as to the merits of the Aladdin? We want one person in each locality to whom we can refer customers. Write quick for our 10 Day Absolutely Free Trial Proposition, Agents' Wholesale Prices, and learn how to get ONE FREE.

MANTLE LAMP CO., 278 Adelaide Bldg., Montreal & Winnipeg

AGENTS WANTED

To demonstrate in territory where oil lamps are in use. Experience unnecessary. Many agents average five sales a day and make \$200.00 per month. One farmer cleared \$1000.00 in 4 weeks. You can make money quickly and save time. Write quick for territory and sample.

RAW FURS
 We Pay Highest Values
 Write for Price List
 and Shipping Tags
Pierce Fur Co., Ltd.
King and Alexander WINDSOR, Canada

FREE
\$10,000
IN CASH PRIZES
Given Away
FIRST PRIZE \$3000 IN GOLD

This is just a plain business proposition to advertise Mountview, Hamilton's new high class residential district, and is open to every person in Canada. There is no catch or fake about it, and everybody stands an equal chance of securing one of the magnificent prizes. Write today and start on the road to fortune.

ENCLOSE STAMP AND FULL PARTICULARS WILL BE MAILED YOU
COOKE & GOULDING
 Federal Life Building
 HAMILTON - ONT.

WANTED
More Workers

AT ONCE, families, sons and daughters to color pictures in the home, for the trade, by a **NEW COLORING PROCESS**. We furnish everything, you do the work. We send plain outline pictures which you color and return to us. No experience required. Work is easy and fascinating. Good wages. Work all year round, for whole or spare time. No canvassing our travelers sell the goods. Write today for instructions and contract (free) and start work at once.

Highest Award Toronto Exposition, 1912
Commercial Art Studio
 216 College St. TORONTO, Canada.

SEEDS

SURE GROWERS
GOVERNMENT TESTED
Write for Catalogue
Wm. RENNIE Co., Limited
 394 Portage Avenue, WINNIPEG.

J. M. Reid
REAL ESTATE & INVESTMENT BROKER
 649 Somerset Block, Winnipeg
Specializing in Warehouse and Trackage Property
 If thinking of locating in Winnipeg, write for list of choice properties.

In Answering Advertisements in this Magazine be sure and mention where you saw the advt. Remember we guarantee the reliability of all our advertisers.

Mention this magazine when writing advertisers

of low lugubrious whistling was heard from the trees, and presently the musician emerged leading himself by the lobe of his ear.

"Evidently you've found something," commented Sedgwick, who had begun to comprehend his friend's peculiar methods of expression.

"Nothing."

"Then why are you so pleased with yourself?"

"That is why."

"Because you've found nothing?"

"Exactly."

"It seems an easy system," observed the artist sarcastically.

"So it is, to a reasoning being. I'm satisfied that some one fired a shot from here. The marksman—a good one—saw you, as he supposed, jerk to the shot as if with a bullet through you, and went away satisfied."

"Leaving no trace behind him," added Sedgwick.

"No trace that is tangible. Therein lies the evidence."

"Of course you don't expect me to follow that."

"Why not? Look at the ground in the thicket."

"What is there to be seen there, since you've said there are no marks?"

"The soil is very soft."

"Yes; there's a spring just back of us."

"Yet there's not a footprint discernible on it."

"I've got that part of the lesson by heart, I think."

"Use your brain on it, then. Some one designing to make you his target, has been in this thicket; been and gone, and left the place trackless. That some one was a keen soft-footed woodsman. Putting it in words of one syllable, I should say he probably had the racial instinct of the hunt. Does that flush any idea from the deep and devious coverts of your brain?"

"Racial instinct? Gansett Jim!" said Sedgwick.

"Exactly. If I had found tracks all over the place, I should have known it wasn't he. Finding nothing, I was naturally pleased."

"That's more than I am," retorted the other. "I suppose he's likely to resume his gunnery at any time."

"Unless we can discourage him—as I expect we can."

"By having him arrested?"

"Difficulties might be put in our way. Sheriff Len Schlager and the half-breed are in some sort of loose partnership in this affair, as you know. Gansett Jim honestly thinks that you had a hand in the Lonesome Cove murder, as he believes it to be. It isn't possible that the sheriff has subtly egged him on to kill you in revenge."

To be continued.

New Model 27 Marlin REPEATING RIFLE

.25 Rim Fire—for all game smaller than deer. Uses cartridges of surprising accuracy up to 200 yards, powerful and reliable but cheap because rim-fire.

Rifle with round barrel \$13.15

7 Shots

The Marlin Firearms Co. New Haven, Conn.

Its exclusive features: the quick, smooth working "pump" action; the wear-resisting Special Smokeless Steel barrel; the modern solid-top and side ejector for rapid, accurate firing, increased safety and convenience. It has take-down construction and Peery Bolt front night, these cost extra on other rifles of these calibers.

Our 128 page catalog describes the full Marlin line. Sent for three stamps postage. Write for it.

Made in U.S.A. and .32-20 calibres also; octagonal barrel only; \$15. Use both regular and high velocity cartridges. Powerful enough for deer, safe to use in settled districts, excellent for target work, foxes, geese, woodchucks, etc.

You saw this advertisement in this magazine. Don't forget to say so when writing.

Mackenzie, Brown, Thom & McMorran
Mackenzie, Brown, MacDonald & Bastedo
 Barristers, Solicitors, &c.
Regina, Saskatchewan, Canada

Norman MacKenzie, K.C. Hon. George W. Brown Douglas J. Thom
 T. Sydney McMorran Hector V. MacDonald Frank L. Bastedo

General Solicitors in Canada for the National Thresher Manufacturers' Association of America
 General Solicitors in Canada for the American Collectors' Association
 General Solicitors in Saskatchewan for Fifteen Canadian and American Thresher and Implement Companies.

You saw this advertisement in this magazine. Don't forget to say so when writing.

The Occidental Fire Insurance Co.
 Head Office: WAWANESA, MAN.

A. NAISMITH, President R. M. MATHESON, Vice-President
 A. F. KEMPTON, Sec. and Mgr. C. D. KERR, Treasurer

Subscribed Capital \$500,000.00
 Security to Policy-holders 640,817.29

Full Deposit with Dominion Government
Agents wanted in unrepresented districts

You saw this advertisement in this magazine. Don't forget to say so when writing.

Alex. Naismith, Pres. S.H. Henderson, Vice-Pres. C. D. Kerr, Treasurer

The WAWANESA MUTUAL INSURANCE COMPANY
 HEAD OFFICE: WAWANESA, MAN.
 A. F. KEMPTON, Secretary-Manager

Amount of Insurance in force Dec. 31st, 1912 \$34,606,660.00
 Assets over Liabilities \$887,557.67

THE NUMBER OF FARMERS INSURED, 31st Dec. 1912, 23,261

The Largest Farmers Mutual Fire Insurance Company in Canada. Agents wanted in unrepresented districts

You saw this advertisement in this magazine. Don't forget to say so when writing.

National Trust Company, Ltd.
 TORONTO, WINNIPEG, EDMONTON, MONTREAL, REGINA, SASKATOON
 Capital and Reserve, \$2,900,000.00

The strain and worry of managing Estates will all be borne for you by this Company.

A PRIVATE Executor may die or become incapable of acting before the completion of the Trust. A Trust Company is PERMANENT and will survive the longest Trusts.

This Company's financial strength and expert staff ensure responsible and capable administration.

We act as Trustee, Executor, Administrator, Guardian, Liquidator, Assignee Financial Agent

SAFE DEPOSIT VAULTS SAVINGS DEPARTMENT

D. H. COOPER, Manager, Winnipeg Branch, 323-325 Main Street.
C. Y. STANTIER, Secretary.

You saw this advertisement in this magazine. Don't forget to say so when writing.

HUNTERS, TRADERS AND TRAPPERS, ATTENTION!

We are going to give prices for furs this season that will startle you, and make you think that you will make a fortune before the season is over.

If you aim to make money on your furs DO NOT SELL before you have secured our price list, which will be sent you on request.

We have an exceptional demand for the different species of furs, and therefore can outpay all other dealers.

M. ROSENBAUM & CO.
 207 2nd Street DES MOINES, IOWA



N
 OOI
 W
 W
 W
 FA
 FA
 HO
 LE
 OK
 We
 1-32
 1-A
 1-Min
 all
 1-32
 1-30
 2-Ave
 1-30
 1-J
 all
 1-42
 for
 if
 are
 want
 EAU
 Mentio



Conducted for the benefit of Dealers, Threshermen and Farmers who have anything to sell or exchange. Five cents a word for each insertion.

BUYERS, ATTENTION!

THE GEORGE WHITE & SONS COMPANY LIMITED, BRANDON, MAN.

Engines, Tractors, Separators, and other machinery for sale with prices listed.

FOR SALE.

List of machinery for sale including Horse Case Simple Portable Engine and other items.

LEARN TELEGRAPHY and railroad work. Result is good wages. Take our inexpensive Home Study Course and get ready. Sample lesson free.

WANTED—Improved farms and wild lands. Best situation for quick results. Full particulars and magazine free.

FOR SALE—A Cuddy steering device for a 20 H.P. International Gasoline Engine.

A SIX CYLINDER ENGINE—If you have a new six cylinder Gas Engine get an engineer that knows his business.

FOR SALE—25 H.P. Gas Tractor in excellent condition.

FOR SALE—30 H.P. Rumley Steam Plowing Engine, entirely rebuilt and repainted by the Rumley Company.

COMPLETE THRESHING OUTFIT—25 H.P. Case engine, 40-62 separator, nearly new, also tank, cook car, trucks, tender, eight bottom gang, packer, everything to go to work.

IMMORTALITY CERTAIN—Swedenborg's great work on "Heaven and Hell" and "Life After Death" 400 pages.

POSITION WANTED—As Engineer on gas, steam, plowing, and threshing outfits.

ALFALFA, GRASS, CLOVER AND ROOT SEED—Garton's catalog contains some surprising information about these seeds.

HAVE YOU HEARD ABOUT SEGER OATS—The new breed introduced from Sweden? It certainly does wonders.

GARTON'S ABUNDANCE OATS—Won world's championship Tulsa, Okla. They weighed 71 pounds per measured bushel.

FOR SALE—Cocksboot Engine Gang, 10 furrows, 14-inch stubble and breaking bottoms.

GOLD RAIN OATS—The wonderful new breed direct from Prof. Nilsson's Swedish plant breeding establishment last season yielded over 100 bushels per acre.

FOR SALE—Bargain. Established machinery repair business, containing all necessary machinery tools and equipment.

MARQUIS WHEAT—Grown on our own 2,482 acre seed farm from our own selected stock seed.

Cunard Line logo with 'THE OLD RELIABLE' and 'ESTABLISHED 1840'. Text: 'For Your Voyage, Assures COMFORT, and ENJOYMENT. You will act wisely when travelling, or sending for relatives or friends, to insist on a passage via THE CUNARD CANADIAN SERVICE'.

The equipment is magnificent. The Splendid Steamers of latest model, and highest efficiency, carrying one class (I.I.) Cabin and Third Class only, are most admirably appointed.

The Cunard Co. also maintains services between: New York, Queenstown, Fishguard, Liverpool. Boston, Queenstown, Fishguard, Liverpool. New York, Mediterranean, Adriatic.

THE CUNARD STEAMSHIP COMPANY, LTD 304 MAIN STREET WINNIPEG, MAN.



There Is No String To This Pipe

It is absolutely FREE to subscribers who take advantage of this offer. The Weekly Free Press and Prairie Farmer, Winnipeg The Canadian Thresherman and Farmer Both including Pipe for \$1.25 the nominal sum of

The lowest price at which these two papers will be offered this year is \$1.25. It makes no difference whether you take the pipe or not, the price is the same.

Weekly Free Press and Prairie Farmer 1913 Winnipeg, Man.

Find enclosed \$1.25, for which send the "Weekly Free Press and Prairie Farmer" one year, and the "Canadian Thresherman and Farmer," one year, together with pipe to the following address:

Form with fields for Name, Town, and Province, P.O. Box.

Made in 25-20 and 32-20 calibres also; occasional regular and cartridge for deer, safe for ducks, etc.

Willow Street - Haven, Conn.

J. Thom Baste

President

IPANY

nted in un-

you by

Agent

ON!

WA

Mention this magazine when writing advertisers.

Mention this magazine when writing advertisers.

Never Idle—Always Earning

An engine of any make is a poor investment if it is allowed to stand idle a large part of the year. An engine of any make will make **some** money if it can be **kept busy all the time**, but how many engines can be safely trusted to run continuously without eating their heads off in fuel and repairs? The

HUBER GAS TRACTOR

can be depended upon to run night and day if necessary from the 1st of January to the 31st of December for many years with the one understanding that it enjoys its Sunday rest. With reasonable care its repairs will be a negligible quantity, and its earning capacity is practically unlimited.

In
Road Grading or Any Kind of Haulage
there is no more dependable power than a HUBER TRACTOR. With a train of dump wagons the crushed stone or gravel can be hauled on the job faster and better and cheaper than in any other way. If there is grading or plowing to be done, you have a steady, strong power to pull the grader or rooter plow; also for hauling away the dirt in wagons.

In the GOOD ROADS MOVEMENT, no finer, more effective or economic service can be employed

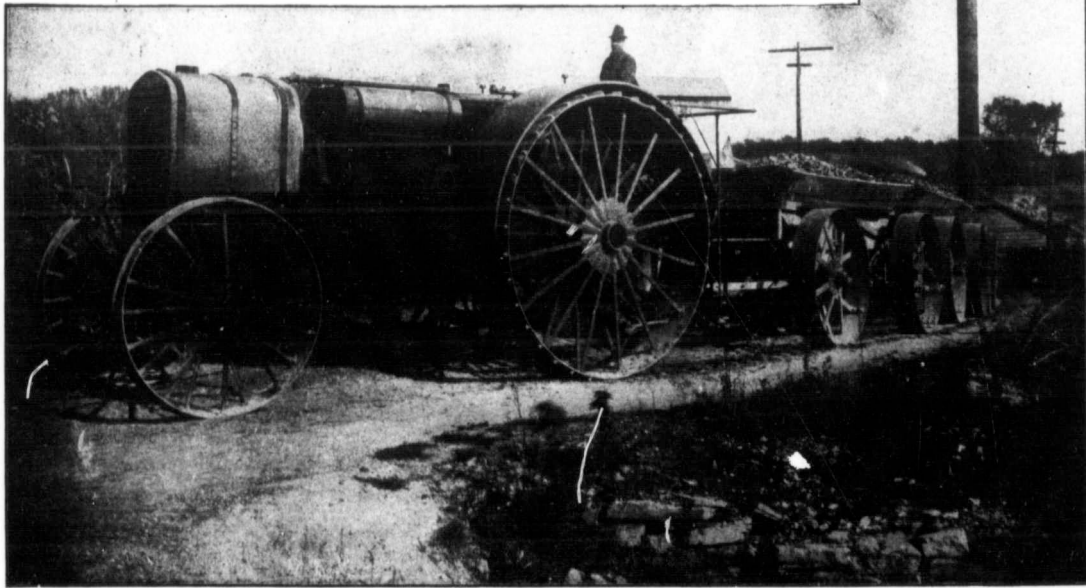

THE HUBER GAS TRACTOR, MADE IN TWO SIZES—18-30 AND 30-60 (TWO AND FOUR CYLINDER RESPECTIVELY)

All our tractors are fitted with a band pulley, making an ideal power for every kind of stationary work. As a threshing engine it is unequalled.

The Huber Gas Tractor "Thirty-Six" is four cylinder, with drive wheels eight feet high and strong gearing built for the hardest work. It uses gasoline or kerosene with great efficiency and economy.

THE HUBER MANUFACTURING COMPANY

Canadian Office: Arlington and Logan, WINNIPEG, MANITOBA
Home Office and Factory: MARION, OHIO, U.S.A.

RY
Use it.
MACHINES.
..... 15
..... 30
..... 35
..... 36
..... 30
..... 10
..... 30
..... 55
..... 17

SHINERY, SELF STACKERS AND MENTS.
..... 50
..... 50
..... 30
..... 30
..... 3
..... 14
Any Thresher
..... 62
..... 30
..... 50
..... 9
..... 35-58
..... 21
..... 35
..... 58-57
..... 29
..... 39
(Ask any
..... 40
..... 43
..... 42
..... 35
(Ask any
..... 35
..... 38
..... 51
..... 58
..... 59
..... 56
..... 63
..... 35

APPLIES.
(Ask Any
..... 8
..... 11
..... 17
..... 17
..... 28
Co.
..... 24
d in West-
Thresher
..... 35
..... 17
..... 35
ny Thresh-
..... 35
use Goods
in Jobbers
..... 64

IONS.
..... 18
vy Team
..... 18
..... 18
..... 55
..... 28
..... 30
..... 30
..... 10-54
ruok... 18
..... 30
..... 17
..... 27
..... 65
..... 10
..... 60
..... 28
..... 30
..... 58-50
..... 17
..... 36
..... 17
..... 17
..... 30
pha... 30
..... 30
..... 36
..... 58
..... 18
..... 30
..... 36

SHINERY.
..... 7
..... 7
..... 8
..... 48
PUMPS
..... 8
..... 48
..... 37-7
..... 44
Mills
..... 24
..... 35
..... 34
..... 33
..... 33
..... 43

THESE MESSAGES ARE FOR
YOU

LABOR SAVERS
MONEY MAKERS
TIME SAVERS
PROFIT PRODUCERS

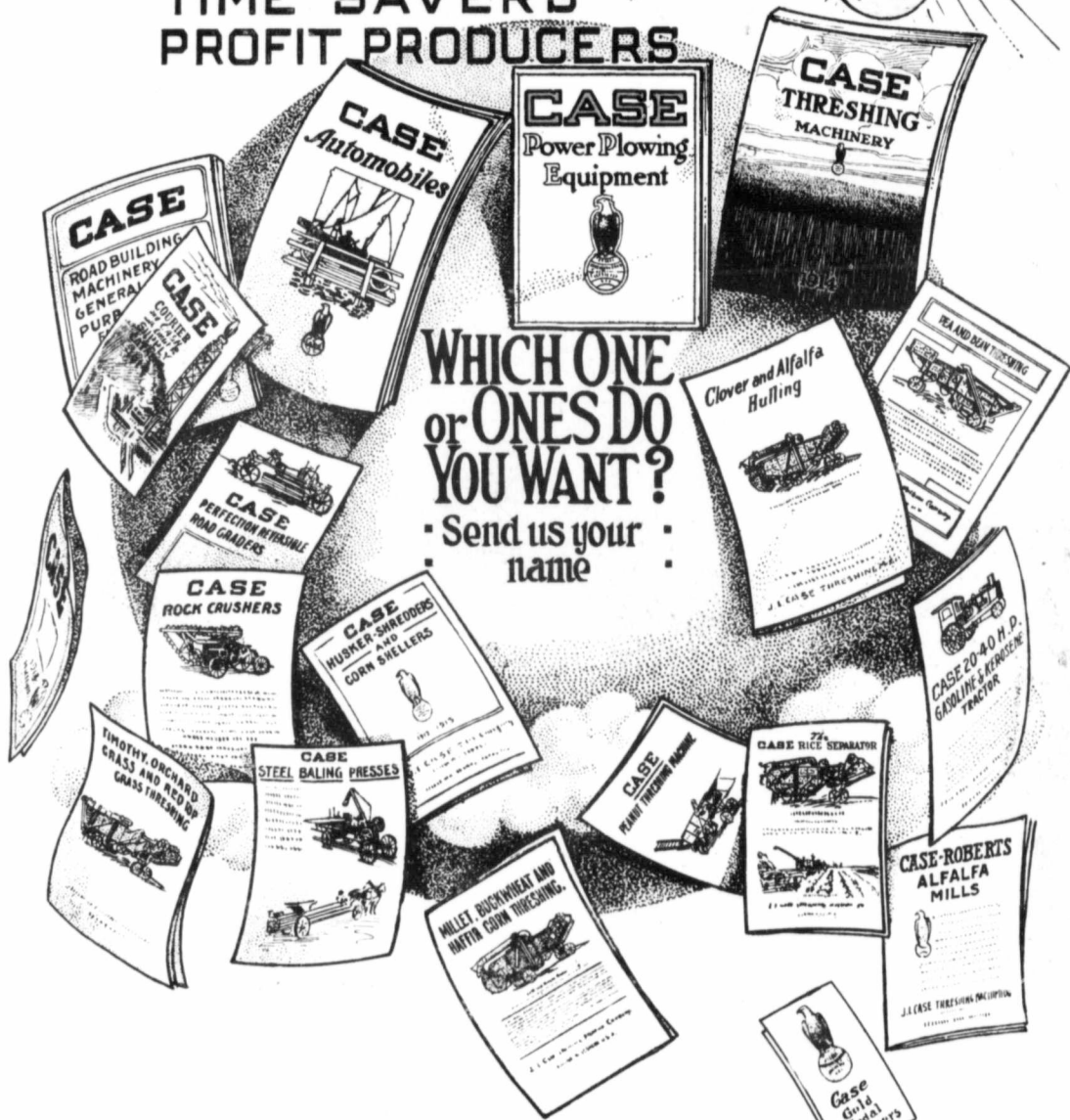

1914 **CASE** CATALOGS

J. I. Case Threshing Machine Company, (Inc)

741-791 State Street

Racine, Wisconsin, U.S. A.

CANADIAN BRANCHES. TORONTO, WINNIPEG, SASKATOON, REGINA & CALGARY